

UNCLASSIFIED

AD NUMBER
AD005154
NEW LIMITATION CHANGE
TO Approved for public release, distribution unlimited
FROM Distribution authorized to U.S. Gov't. agencies and their contractors; Administrative/Operational Use; MAR 1953. Other requests shall be referred to National Aeronautics and Space Administration, Washington, DC.
AUTHORITY
NASA TR Server website

THIS PAGE IS UNCLASSIFIED

Reproduced by

Armed Services Technical Information Agency
DOCUMENT SERVICE CENTER

KNOTT BUILDING, DAYTON, 2, OHIO

AD -

5154

UNCLASSIFIED

NACA TN 2922

ND No. 5154
ASTIA FILE COPY

NATIONAL ADVISORY COMMITTEE FOR AERONAUTICS

TECHNICAL NOTE 2922

THE DESIGN OF VARIABLE MACH NUMBER ASYMMETRIC SUPERSONIC NOZZLES BY TWO PROCEDURES EMPLOYING INCLINED AND CURVED SONIC LINES

By Clarence A. Syvertson and Raymond C. Savin

Ames Aeronautical Laboratory
Moffett Field, Calif.



Washington

March 1953

TECHNICAL NOTE 2922

THE DESIGN OF VARIABLE MACH NUMBER ASYMMETRIC SUPERSONIC
NOZZLES BY TWO PROCEDURES EMPLOYING INCLINED
AND CURVED SONIC LINES

By Clarence A. Syvertson and Raymond C. Savin

SUMMARY

Two theoretical procedures are developed for designing asymmetric supersonic nozzles for which the calculated exit flow is nearly uniform over a range of Mach numbers. One procedure is applicable at Mach numbers less than approximately 3. This approach yields, without iteration, a nozzle for which the calculated exit flow is uniform at two Mach numbers and, with proper design, is nearly uniform at Mach numbers between, slightly above, and slightly below these two. The use of an inclined and curved sonic line is an essential feature of this approach. The second procedure requires iteration and is used for designs at Mach numbers exceeding 3. Although it is not a necessary feature, an inclined and curved sonic line is also used in this procedure. In both approaches the flow field downstream of the sonic line is determined using the method of characteristics.

INTRODUCTION

The asymmetric, sliding-block-type nozzle was first shown by Allen (reference 1) to be an effective means for producing reasonably uniform supersonic flow over a range of Mach numbers. Allen indicated that the principal advantage of this type of nozzle was its structural and mechanical simplicity; however, he noted that the asymmetric nozzles which were investigated had shown undesirable horizontal and vertical static-pressure gradients at some operating speeds. An investigation was therefore undertaken to develop systematic procedures for designing asymmetric nozzles which would produce exit flows of the desired uniformity for wind-tunnel testing over a given range of Mach numbers. The purpose of the present paper is to describe the two most suitable design procedures developed to date at the Ames Laboratory. Many features of these procedures have resulted primarily from experience gained in the design of 18 nozzles, 8 by the first procedure to be presented, and 10 by the second procedure.

SYMBOLS

a	local speed of sound
h	height
M	Mach number, ratio of local velocity to local speed of sound
p	static pressure
q	dynamic pressure
R	radius of curvature of streamline
u	dimensionless perturbation velocity component parallel to x axis $\left(\frac{\bar{u}}{a^*} - 1\right)$
v	dimensionless perturbation velocity component parallel to y axis $\left(\frac{\bar{v}}{a^*}\right)$
\bar{u}	velocity component parallel to x axis
\bar{v}	velocity component parallel to y axis
W	dimensionless resultant velocity $\left(\frac{\sqrt{\bar{u}^2 + \bar{v}^2}}{a^*}\right)$
x,y	rectangular coordinates
α_M	Mach angle $\left(\text{arc sin } \frac{1}{M}\right)$
γ	ratio of specific heats (1.400 for air)
$\frac{\Delta p}{q}$	stream static-pressure coefficient $\left(\frac{p-p_0}{q_0}\right)$
θ	angle between direction of flow and some reference axis

Subscripts

L lower wall

M	conditions at a specified Mach number
N	measured normal to a surface
o	initial or reference conditions
s	conditions along a streamline
U	upper wall

Superscripts

*	conditions where the Mach number is unity
---	---

ANALYSIS

Two Basic Features of the Variable Mach Number Asymmetric Nozzle

Before discussing specific procedures for designing two-dimensional asymmetric nozzles, it is useful to consider from a qualitative point of view the reasons why such nozzles are capable of producing uniform exit flows at more than one Mach number. It is generally accepted that if a supersonic nozzle is to produce uniform exit flow at more than one Mach number, the shape of the nozzle passage must be different for each exit Mach number. For this reason, most variable Mach number wind tunnels have employed either a series of interchangeable nozzle walls (blocks), each of fixed geometry, or flexible nozzle walls. With both of these solutions the contours of the nozzle walls are changed to give the changes in passage shape required for variation of the exit Mach number.

In contrast to these solutions, Allen's proposal is that the contoured nozzle walls be rigid and that they be moved relative to each other so as to form asymmetric passages of various shapes for producing flows at different exit Mach numbers. An asymmetric nozzle of this type is shown in figure 1. The solid lines show the passage shape for a high Mach number exit flow; the dashed line shows the lower rigid wall moved to a new position to produce a passage shape for a low Mach number exit flow. The lower wall is moved in a direction parallel to the walls of the test section and the ratio of minimum section area to test section area is thus changed while the test section area is maintained constant. This first feature of the sliding-block asymmetric nozzle makes it a practical device for varying the exit Mach number.

It is also clear from figure 1 that certain portions of the walls are included in the supersonic flow region at the high Mach number setting that were included in the less critical subsonic flow region at the low Mach number setting. They may, therefore, be shaped to make the remaining downstream portions of the walls (designed to produce uniform exit flow at the lower Mach number) consistent with uniform exit flow at the higher Mach number. This second feature of the asymmetric nozzle makes it possible to produce uniform exit flows at more than one exit Mach number. As is discussed later, it is this feature which allows the development of an explicit procedure for designing asymmetric nozzles operating at Mach numbers less than approximately 3.

Determination of Flow Characteristics in Asymmetric Nozzles

The problem of determining the characteristics of the flow between the walls of an asymmetric nozzle can be divided into three parts. Figure 2, a schematic diagram of the construction of the flow field in a typical nozzle, will be used to illustrate the different parts of the problem. Part 1 is the determination of the flow conditions in the region of the minimum section where supersonic flow first occurs. Line AB in figure 2 represents the location of the points where the initial flow conditions are calculated. Proceeding downstream, part 2 is the determination of the flow characteristics from these initial points to the region just upstream of the nozzle exit (area ABDC in fig. 2). Part 3 is the construction of the flow field which must exist in the region just upstream of the nozzle exit in order to have uniform exit flow. The region of the nozzle affected by this part of the problem is represented by the area CDE.

It will be seen later in the analysis that the procedure developed herein for Mach numbers less than 3 requires the nozzle walls to be curved in the region of the minimum section. This curvature of the walls will cause the sonic line to be inclined with respect to the flow direction and generally curved. Part 1 of the problem of determining the flow characteristics in an asymmetric nozzle is the determination of the flow in the region of the inclined and curved sonic line. The solution of this problem is discussed in appendix A.

Throughout this study the method of characteristics will be employed to construct the region of the supersonic flow field associated with part 2 of the problem of determining the flow in asymmetric nozzles. The characteristic solution of two-dimensional supersonic flows was originally developed by Prandtl and Busemann (reference 2). This solution may be accomplished by numerical or graphical processes, or a combination of these two. Of the alternative approaches, the

graphical method was chosen as most suitable for the nozzle-design problems considered here. The reasons for this choice are (1) the net size can be easily varied during the construction of the flow field; and (2) the designer is enabled to visualize graphically the velocity diagram of the flow field.

Sauer (references 3 and 4) has developed a graphical method for axially symmetric flow fields in which the characteristic lines in the hodograph plane are constructed in a step-by-step process. An adaptation of this method to two-dimensional supersonic flows is employed in this paper. The hodograph on which the nozzle flow fields are diagrammed is constructed using the polar coordinates W and θ and, for convenience, the hodograph is marked with lines of constant α_M and θ . (A W -scale of 0.02 to the inch is used.) For an irrotational, two-dimensional flow field, the characteristic lines in the hodograph plane all have the same shape. This property permits the use of a characteristic template which greatly increases the speed of the calculations (i.e., the construction of the Mach net). The shape of the template can easily be determined since the relationship between Mach angle and flow direction along the characteristic lines is the same as for the expansion about a corner of a uniform, two-dimensional, supersonic stream. This relationship, given by the familiar Prandtl-Meyer equation (see, e.g., reference 5),

$$\theta - \theta^* = \sqrt{\frac{\gamma+1}{\gamma-1}} \arctan \left[\sqrt{\frac{\gamma-1}{\gamma+1}} \tan (90^\circ - \alpha_M) \right] - (90^\circ - \alpha_M)$$

is plotted on the hodograph and the template is made from the curve. All the characteristic nets to be discussed are constructed using the hodograph and template just described.

The requirement for uniform exit flow in a nozzle is satisfied if the entire flow field downstream of the nozzle exit can be represented by a single point in the hodograph diagram. This point is unique since it represents the design flow parameters θ and α_M for the test section. The effect of this requirement on part 3 of the problem of determining the flow characteristics in a nozzle is that area CDE in figure 2 will be represented in the hodograph diagram by a single second-family characteristic line.¹ This characteristic line passes through the unique point mentioned above. The flow in region CDE will be of the Prandtl-Meyer type. A discussion of this type of flow is presented in appendix B.

¹A second-family characteristic line is a Mach line negatively inclined with respect to the flow direction.

Design Procedure for Mach Numbers Less Than Approximately 3

The following procedure for designing variable Mach number asymmetric nozzles is the more direct of the two to be presented. This procedure consists of three major steps. These steps are as follows: First, the contours of the downstream portions of the walls are determined to produce uniform exit flow at the lower design Mach number; second, the flow field that must exist between these wall portions for uniform exit flow at the higher design Mach number setting is determined; and third, the portions of the walls upstream of those considered in step one are shaped so as to produce the flow field determined in step two. These three steps ensure that the nozzle will produce theoretically uniform exit flow at the two design Mach numbers. It is required, however, that the exit flow be nearly uniform over a range of Mach numbers from slightly below the lower to slightly above the higher design Mach number. Experience gained in this investigation has indicated that specifying continuous pressure gradients in the nozzle at the design Mach numbers and continuous variation of the second derivatives of the nozzle wall contours tends to minimize the calculated flow irregularities over the Mach number range. These specifications, therefore, are embodied in both design procedures. The uniformity of the flow at other than the two design Mach numbers should, of course, be investigated.

It has also been found for the proposed design procedures that in order to minimize the flow irregularities at off-design Mach numbers it is desirable to have the position of the minimum section move continuously upstream along both walls as the exit Mach number is increased. The continuous movement will be accomplished if the wall contours satisfy certain conditions in the region where the minimum section moves. These conditions are: First, the wall contours should have single curvature (no inflection points); second, they should have finite radii of curvature; and third, the local radius of curvature of the lower wall should always be sufficiently less than the local radius of curvature of the upper wall to ensure that in a given position the nozzle has only one minimum section.

The upper and lower design Mach numbers and the test-section height are first selected for any design undertaken. It follows from the discussion of the uniformity of the exit flow at off-design Mach numbers that the two design Mach numbers may be selected somewhat within the extremes of the desired range of operation of the nozzle. A typical low Mach number construction, representing the first step for such a design, is shown in figure 3. For the first part of this construction the flow parameters θ and α_M at a series of initial points just downstream of the sonic line are determined from the transonic equations given in appendix A. These initial points are shown

along line A-B. Use of the equations in appendix A requires that the radii of curvature of both walls in the region of the minimum section be known. The radius of curvature of the lower wall is made large compared to the minimum section height (of the order of 10 minimum section heights) to permit an accurate application of these equations. The upper-wall radius of curvature at the minimum section is selected in accordance with the discussion of appendix B to give Prandtl-Meyer type flow in the region just upstream of the nozzle exit. (See equation (B2).) To satisfy the conditions of appendix A, both radii are kept constant a short distance (of the order of one-half the minimum section height) upstream and downstream of the minimum section. The upper and lower walls are extended upstream to points J and L, respectively, to fulfill this requirement.

For the second part of this construction the characteristic net is constructed downstream of the initial points putting in one second-family Mach line at a time. Line C-D in figure 3 is a typical second-family Mach line. The radius of curvature of the upper wall is held constant until the flow along that wall becomes of the Prandtl-Meyer type.² This occurs at point E of figure 3(a). The curvature of the lower wall is held constant until the design Mach number is approached on that surface.³ The curvature is then gradually decreased, becoming zero where the design Mach number is attained (point G in figure 3(a)).⁴ When the characteristic net is complete, the shape of the downstream portions of both walls is determined. The first major step in the design procedure is now complete.

²The flow along the upper wall becomes of the Prandtl-Meyer type when the line representing that wall in the hodograph diagram, line ACE in figure 3(b), becomes tangent to a second-family characteristic line such as line E-H. Experience has indicated that this tangency will occur if the upper-wall radius of curvature is selected by use of equation (B2) and if the other suggestions are followed.

³The curvature of the lower wall is maintained constant over most of the length of this construction since this results in the shortest nozzle without increasing the curvature. Increasing curvature in the streamwise direction has been found difficult to handle in later constructions.

⁴It is difficult to establish a definite rule for the length of the portion of the lower wall along which the curvature is decreased to zero. A length of one-half to one test-section heights has been found satisfactory.

The flow field that must exist between these portions of the walls for uniform exit flow at the higher Mach number setting will now be determined. Maintaining the test-section height constant, the upper- and lower-wall portions are rotated to make $\theta = 0$ in the test section. Then holding the upper wall stationary, the lower wall is translated horizontally until it is in the higher design Mach number setting. A satisfactory criterion for this position is that the downstream ends of the contoured portions, points G and H in figure 4(a), be aligned along the same first-family Mach line inclined at the Mach angle corresponding to the higher design Mach number. Specifying uniform flow downstream of this Mach line, the characteristic net can be constructed between the portions of the walls in the reverse of the flow direction. Such a construction is shown in figure 4. The construction is continued to the upstream end of the upper-wall portion, point J. In general, the termination of the construction on the lower wall, point K of figure 4(a), will lie downstream of the end of the predetermined portion, point L; if not, the lower wall can be extended at constant curvature. This characteristic net construction determines the flow conditions that must exist between the two wall portions if the exit flow is to be uniform at the higher design Mach number.

The next problem is to determine the shape of the portions of both walls between the new minimum section and the line J-K of figure 4. This shape must be such as to produce the same variation of Mach angle and stream angle along the Mach line J-K as was obtained by the characteristic net construction outlined in the preceding paragraph. The radius of curvature of the lower wall at the minimum section is selected in the same manner as for the lower design Mach number. The height of the minimum section may be calculated by use of the one-dimensional area-ratio relationship since the curvature of the sonic line does not significantly influence the mass flow. The radius of curvature of the upper wall is selected with the aid of equation (B2) to give approximately the same variation from Prandtl-Meyer type flow as occurs at the Mach line J-K.⁵ This selection need only be an

⁵The difference from Prandtl-Meyer type flow at point K in figure 4 is defined here as the difference between $d\theta/d\alpha_M$ along line KG evaluated at point K and $d\theta/d\alpha_M$ along the second-family characteristic line passing through point K. If, for example, $|d\theta/d\alpha_M|$ along line KG is 10 percent less than along the characteristic line, the curvature of the upper wall should be about 10 percent less than that calculated for Prandtl-Meyer type flow. The curvature for Prandtl-Meyer type flow may be calculated by use of equation (B2). In that equation R_L is the radius of curvature of the lower wall at point K and h_N is the normal distance between the two walls which may be estimated graphically in figure 4(a).

estimate. It should be pointed out that there is no way of knowing in advance the location of the new minimum section with respect to the test section. For this reason a different coordinate system is used for the new construction.

Following the procedure of the lower Mach number design, the initial points are selected along line A'-B' of figure 5. The characteristic net will be constructed downstream of the initial points until the Mach number on the lower wall coincides with the Mach number at point K in figure 4(a). At this point on the lower wall two other conditions should also be satisfied. These conditions are: (1) the rate of change of Mach angle with flow angle along the lower wall should be the same as at point K, and (2) the radius of curvature of the lower wall at this point and upstream of the point a distance equal to the distance K-L of figure 4(a) should be the same as at point K. These conditions may be satisfied by using the following procedure. The net is first constructed as far as point P in figure 5, while simultaneously the radius of curvature of the lower wall is gradually increased. This part of the construction determines line B'-P in the hodograph (fig. 5(b)). The point where the Mach number coincides with point K will be designated as point M. A line representing the lower wall in the hodograph diagram is faired from point P to point M in a manner to be tangent to the line B'-P and to give the same $d\theta/d\alpha_M$ along this line at point M as the previous construction (fig. 4) had along the line K-G at the point K. This curve represents a lower wall which will satisfy condition (1) and determines the value of θ at point M. With the value of θ and the radius of curvature at point M the shape of the portion of the lower wall from point P to point M may be chosen to satisfy condition (2). Several points are chosen along line P-M and are combined with the Mach line Q-P to determine the net in the region QNMP in figure 5(a). The shape of the upper wall in this region is the streamline through point Q.

The two constructions in the physical plane (figs. 4(a) and 5(a)) are then joined at points K and M and properly oriented by equating θ at the two points. This orientation brings the two constructions to the same coordinate system. The combined constructions in the physical plane are shown in figure 6. The characteristic net is constructed between the two portions in the region NKJ and the upper wall contour is determined by plotting a streamline connecting the two portions of the upper wall. This completes the design of the contoured walls which will produce theoretically uniform exit flow at both design Mach numbers.

The flow in the nozzle should be investigated at several other Mach numbers in the design range to determine if any significant variations of Mach number or flow inclination occur in the test section. This has

not occurred in any of the eight designs attempted. Should any significant variations occur, however, appropriate corrective measures of the type discussed in the next section can be taken.

In theory there is no apparent reason why this design procedure should be restricted to two Mach numbers or why it should be limited to Mach numbers less than 3. Practical difficulties do limit its applicability, however. For example, if the higher design Mach number exceeds approximately 3, it becomes very difficult to find contours for the lower Mach number portions of the walls to which any additional portions may be added to give uniform exit flow at this higher Mach number. The difficulty develops when the characteristic net is constructed in the reverse of the flow direction. Expansion wavelets, which diverge in the streamwise direction, converge in this construction. Above $M = 3$ the rate of convergence is such that, in approximately 10 constructions attempted, several waves were found to coalesce. When this coalescence occurs, no solution at the higher design Mach number is possible using the present method. A similar difficulty (note discussion in appendix B) develops when the procedure is repeated for a third Mach number below 3. These difficulties could possibly be overcome by considerably increasing the length of the nozzle. This solution is impractical, however, for many applications (e.g., large wind tunnels).

Design Procedure for Mach Numbers Greater Than Approximately 3

The procedure for designing variable Mach number asymmetric nozzles to operate at Mach numbers greater than 3 employs an averaging process and yields nozzles for which the analysis indicates approximately uniform exit flow. The contour is designed first for the highest Mach number by a procedure similar to that used for the design of the lower Mach number portion of the walls discussed in the preceding section. Figure 7 represents the physical plane of a construction of this type. A difference between this design procedure and the one referred to above is that the flow along the upper wall does not become of the Prandtl-Meyer type before point C. At this point it must, to satisfy the requirements for uniform exit flow. In general, it has been found desirable to turn the flow between points A and E through an angle no greater than the Prandtl-Meyer expansion angle for the lowest design Mach number. The reason for this limitation is discussed in the next paragraph.

The contours for the highest Mach number are translated to the lowest design Mach number setting and the characteristic net is reconstructed. Adjustments are made to the shape of the portion of the upper wall between point C and point E of figure 7 to provide uniform exit flow at this lowest Mach number. The process is repeated at two

intermediate Mach numbers. For the portion C-E, four contours result. These results are plotted in the form of slope curves (i.e., θ as a function of x) and an arithmetic mean of the extremes taken. Experience gained in constructing 10 nozzles by this method has shown that limiting the angle through which the flow is turned in the manner suggested in the previous paragraph will minimize the difference between the four contours for the portion of the wall between point C and point E.

The mean contour is then substituted for the portion C-E in each of the four constructions. The characteristic nets are changed in this region and extended into the test section. From these constructions, plots are made of the stream angle and Mach number distributions in the test section. Should any unacceptable variations result, they are traced back through that particular construction and appropriate adjustments made to the walls. The effect of these adjustments on the other three constructions must then be considered. Through a series of such adjustments, nearly uniform flow (stream-angle variations of less than $\pm 0.25^\circ$) can generally be obtained at all four Mach numbers.

Computation of Ordinates and Boundary-Layer Correction

A first determination of the basic wall contours has now been made; however, as was discussed previously, these contours must be examined to ensure that the second derivative curves are fair. The slope curves of the contours (i.e., θ as a function of x) are converted to first derivative curves (i.e., dy/dx as a function of x) which are differentiated graphically to obtain the values of the second derivatives. Curves are faired through these values and revised first derivatives and slopes are obtained from graphical integration of these curves. Experience has indicated that the original and revised slopes should agree to within $\pm 0.03^\circ$ at all stations. The process of fairing and integrating should be repeated, if necessary, until this criterion is satisfied. The revised ordinates are obtained in the usual manner from the revised first derivative curves.

The results of Tucker (reference 6) may be used to compute the boundary-layer correction for both low and high Mach number nozzles. To be consistent with the determination of the uncorrected nozzle contours, care should be taken to ensure that the boundary-layer correction is also fair to the second derivative.

DISCUSSION

Many variations of the procedures given for the design of variable Mach number, asymmetric, supersonic nozzles are possible. The

suggestions given result primarily from experience. In regard to the fairness of the nozzle walls, something more should be said. As the second derivative of the nozzle contour is directly related to the pressure gradient, continuous variation of the second derivative along the nozzle wall tends to ensure continuous variation of the pressure gradient. Theoretically, a discontinuity in the second derivative is permissible, provided the Mach line (or its reflection) passing through this discontinuity also passes through another discontinuity of opposite nature and equal magnitude. With asymmetric nozzles of the type under consideration, this requirement would not necessarily be satisfied at all settings; hence, continuity of the second derivative of both walls is specified. It follows, of course, that the curvature of both walls goes to zero continuously at the nozzle exit.

The usefulness of the design procedure for Mach numbers less than approximately 3 lies in its direct, noniterative approach and in the fact that theoretically uniform exit flow in a nozzle can be obtained at two Mach numbers. If the flow is uniform at two Mach numbers, it seems reasonable to expect the flow to be nearly uniform at intermediate Mach numbers and Mach numbers slightly above the higher and slightly below the lower design Mach number. Theoretical analyses of the flow at several off-design Mach numbers have substantiated this expectation in all eight designs completed.

No experimental results for large-scale nozzles are available with which the theoretical predictions of the methods presented in this paper may be compared. Some data are available which were obtained in a 2- by 2-inch nozzle designed by the procedure for Mach numbers less than 3. This nozzle was designed to have uniform exit flow at Mach numbers of 1.5 and 2.6. The coordinates for the walls of this nozzle are presented in table I. These coordinates do not include a correction for boundary layer; however, the coordinates of the nozzle fabricated did have a boundary-layer correction.⁶ Static- and pitot-pressure surveys were made in the test section and the results of these surveys, converted to stream static-pressure coefficient, are shown in figure 8. These results indicate that variations in stream static-pressure coefficient are small, never exceeding approximately ± 0.006 over the Mach number range. These variations are of the same order as the errors involved in the measurements. The results of the surveys indicate no large, undesirable gradients as were observed at some Mach numbers by Allen (reference 1) in the tests which led to the present investigation.

⁶The coordinates of the walls of this nozzle are not given with correction for boundary layer since these coordinates would apply only for the Reynolds number at which these tests were conducted.

CONCLUSIONS

Two theoretical procedures are developed for designing asymmetric supersonic nozzles for which the calculated exit flow is nearly uniform over a range of Mach numbers. One procedure is applicable at Mach numbers less than approximately 3 and yields, without iteration, a nozzle producing theoretically uniform exit flow at two Mach numbers and nearly uniform exit flow over a range of Mach numbers. An essential feature of this procedure is the use of an inclined and curved sonic line. The other procedure requires iteration and is used for nozzles designed to operate at Mach numbers greater than approximately 3. Although it is not an essential feature, an inclined and curved sonic line is also employed in this procedure.

A 2- by 2-inch nozzle was designed by the procedure for Mach numbers less than 3 to operate over the Mach number range from 1.5 to 2.6. The results of static- and pitot-pressure surveys in the test section of this nozzle indicate a maximum variation of ± 0.006 in the stream static-pressure coefficient over the design Mach number range.

Ames Aeronautical Laboratory
National Advisory Committee for Aeronautics
Moffett Field, Calif., Jan. 19, 1951

APPENDIX A

DETERMINATION OF THE FLOW FIELD NEAR THE SONIC LINE

Sauer (reference 7), among others, has developed equations defining the sonic line in flow through the minimum section of a symmetrical nozzle. Sauer also developed similar equations defining transonic flow about profiles. The equations for the transonic flow about a profile may be applied to flow through the minimum section of an asymmetric nozzle.

The origin of the coordinate system is placed at the point where sonic velocity occurs on the upper contour, and the x axis is made tangent to this contour. (See fig. 9.) By the use of Sauer's development but adding a term in the fourth power of y in the velocity potential, the following equations result:

$$u = \alpha x - \beta y + y^2 \left[\frac{\gamma+1}{2} \alpha^2 + \beta^2 \right] + \dots \quad (A1)$$

$$v = -\beta x + xy \left[2\beta^2 + (\gamma+1) \alpha^2 \right] - \left[\alpha\beta \frac{\gamma+1}{2} + 4\beta x \left(\frac{\gamma+1}{2} \alpha^2 + \beta^2 \right) \right] y^2 + y^3 \frac{(\gamma+1)^2}{6} \alpha^3 + \dots \quad (A2)$$

where

$$\beta = \frac{1}{R_U} \quad (A3)$$

$$\alpha^2 = \frac{1}{\gamma+1} \left[\frac{1}{y_s} \left(\frac{1}{R_U} - \frac{1}{R_L} \right) - \frac{1}{R_U^2} \right] \quad (A4)$$

Equations (A1), (A3), and (A4) are the same as Sauer's results. Equation (A2) includes one additional term.

In order to fix the sonic line with respect to the minimum section, it is necessary to know x_{M_U} or x_{M_L} . (Note fig. 9.) It may be deduced from the geometry of the problem that

$$\frac{x_{M_U} - x_{M_L}}{y_s} = \left(\frac{v}{1+u} \right)_{\substack{x=x_{M_U} \\ y=0}} \quad (A5)$$

and

$$\frac{x_{M_U}}{R_U} - \frac{x_{M_L}}{R_L} = \left(\frac{-v}{1+u} \right)_{\substack{x=0 \\ y=y_s}} \quad (A6)$$

Setting

$$K = \left(\frac{-v}{1+u} \right)_{\substack{x=0 \\ y=y_s}}$$

making the necessary substitutions in equations (A5) and (A6), and solving for x_{M_U} and x_{M_L} yields

$$x_{M_U} = \frac{1}{2\alpha(R_U - R_L)} \left[\sqrt{(R_U + y_s - R_L + \alpha K R_L R_U)^2 - 4\alpha K R_L R_U (R_U - R_L)} - (R_U + y_s - R_L + \alpha K R_L R_U) \right] \quad (A7)$$

and

$$x_{M_L} = R_L \left(\frac{x_{M_U}}{R_U} - K \right) \quad (A8)$$

Equations (A1) through (A8) define the shape of the sonic line, provided the local flow velocity is not too different from sonic velocity in the region near the sonic line and provided the radii of curvature of the lower and upper walls are essentially constant in this region. The stream angle and Mach angle at any point near the minimum section can be calculated by standard methods from the known values of u and v . The correction to mass flow due to the curvature and inclination of the sonic line was investigated and found to be negligible for nozzles having moderately curved and inclined sonic lines.

If the nozzle is symmetrical, then the upper wall is the plane of symmetry and it follows that

$$\beta = 0$$

The previously developed equations for flow in the region of the sonic line now reduce to

$$\begin{aligned} u &= \alpha x + \frac{\gamma+1}{2} \alpha^2 y^2 \\ v &= (\gamma+1)\alpha^2 xy + \frac{(\gamma+1)^2}{6} \alpha^3 y^3 \\ \alpha^2 &= -\frac{1}{\gamma+1} \frac{1}{y_s R_L} \end{aligned}$$

and

$$x_M = -\frac{\gamma+1}{6} \alpha y_s^2$$

These equations are identical to those developed by Sauer for a symmetric nozzle. It should be noted that in this analysis y_s is, of course, always negative.

APPENDIX B

PRANDTL-MEYER FLOW

In the region just upstream of the exit from an asymmetric supersonic nozzle, a special type of flow occurs. This region (ABC in fig. 10) is bounded by the curved upper tunnel wall and the Mach line passing through the downstream end of this wall. Since the walls are straight downstream of the line A-B, any variations in Mach number and flow angle along this line will be present in the test region. For uniform exit flow the flow conditions along this line, or any other first-family Mach line in this general region, must be constant. The relationship between Mach number and flow angle along the upper wall from point C to point A must therefore be the same as for Prandtl-Meyer expansion of a uniform, two-dimensional, supersonic stream about a corner. The solution to this flow problem is well known (see, e.g., references 8 and 9) and will not be presented here, but rather the application of the solution to the problem of supersonic nozzle design will be discussed.

Consider now a nozzle made up of elements of two Prandtl-Meyer streamlines as shown in figure 11. It is clear from the figure that

$$h_N = h_{M_U} - h_{M_L} \quad (B1)$$

Assume that the ratio between the normal height from the streamline to the effective corner h_M and the radius of curvature of the streamline R is a function of the local Mach number only. This will be proven subsequently. Replacing h_{M_U} and h_{M_L} with the product of this ratio and the proper radius of curvature, equation (B1) becomes

$$h_N = \frac{h_M}{R} (R_U - R_L) \quad (B2)$$

The function P is defined as

$$P \equiv \frac{h_N}{R_U - R_L} - \frac{h_M}{R} \quad (B3)$$

By combining equations (B2) and (B3) it can be seen that the equation

$$P = 0 \quad (B4)$$

applies only when the flow is of the Prandtl-Meyer type between the two streamlines. With this type of flow the change in flow angle between any two Mach lines of the first family, such as those shown

in figure 11, is the same along either streamline.

Consider now when

$$P > 0 \quad (B5)$$

If all the quantities in P are treated as fixed with the exception of R_L (note equation (B3)) the inequality means that R_L is greater than for the case of Prandtl-Meyer flow. The change in flow angle along the lower streamline between two Mach lines will be less. Some additional turning of the stream will be required by reflected wavelets from the upstream portion of the nozzle. In this case the wavelets would be expansions.

Consider the inequality

$$P < 0 \quad (B6)$$

By use of the same reasoning as in the previous paragraph, it can be shown that reflected compression wavelets are required.

For a given asymmetric nozzle the ratio $h_M/(R_U-R_L)$ will be fixed by the geometry of the nozzle (as determined, for example, at the first design Mach number) while h_M/R will vary with the Mach number in the region of the nozzle exit. Hence, knowing the variation in h_M/R it will be possible to determine qualitatively the variation in P and thus the type and concentration of wavelets that must be reflected in the nozzle at various Mach numbers.

It now remains to determine the manner in which h_M/R varies with Mach number. The equation of a Prandtl-Meyer streamline in polar coordinates as given by Sauer (reference 4) is

$$r = h_0 \left[\cos \left(\sqrt{\frac{\gamma-1}{\gamma+1}} \omega \right) \right]^{-\frac{\gamma+1}{\gamma-1}} \quad (B7)$$

The coordinate system is shown in figure 12. The radius of curvature of this streamline can be found as a function of h_0 and ω . The angle ω is related to the local Mach number by the following equation, also taken from reference 4:

$$M^2 = \frac{(\gamma+1) - 2 \cos^2 \left(\sqrt{\frac{\gamma-1}{\gamma+1}} \omega \right)}{(\gamma-1) \cos^2 \left(\sqrt{\frac{\gamma-1}{\gamma+1}} \omega \right)} \quad (B8)$$

Equation (B8) can be combined with the expression for the radius of curvature in terms of h_0 and ω to give

$$R = \frac{h_0 (\gamma+1) M^3}{2 (M^2-1)} \left[\frac{1 + \frac{\gamma-1}{2} M^2}{\frac{\gamma+1}{2}} \right] \frac{\gamma+1}{2(\gamma-1)} \quad (\text{B9})$$

From one-dimensional area-ratio considerations (reference 5)

$$\frac{h_0}{h_M} = M \left[\frac{\frac{\gamma+1}{2}}{1 + \frac{\gamma-1}{2} M^2} \right] \frac{\gamma+1}{2(\gamma-1)} \quad (\text{B10})$$

Combination of equations (B9) and (B10) yields

$$\frac{h_M}{R} = \frac{2}{(\gamma+1)} \frac{(M^2-1)}{M^4} \quad (\text{B11})$$

The ratio h_M/R is plotted as a function of Mach number in figure 13.

Consider now a typical example of how the parameter P can be employed to guide asymmetric nozzle design. Assume a nozzle is designed with no reflected wavelets at a Mach number of 1.2; in this case, then, P equals 0. The nozzle is required, however, to operate up to a Mach number of 2.0. It is clear from figure 13, the equation for P , and the previous discussion that, up to a Mach number of 1.8, P is less than 0 and hence reflected compression wavelets are required near the exit. Above a Mach number of 1.8, P is greater than 0 and hence reflected expansion wavelets are required to give uniform flow at the exit. This change in the type of reflected wavelets required is difficult to obtain with walls of reasonable shape. Reflected compression wavelets result from an upper wall of relatively large curvature and reflected expansion wavelets result from an upper wall of relatively small curvature. Therefore, the design of a nozzle operating over a range of Mach numbers spanning the peak in the h_M/R curve is difficult. One nozzle was designed to give uniform exit flow at $M = 1.2, 1.6,$ and 2.0 ; however, the second derivative of one portion of the upper wall varied rapidly over a short distance. This portion produced a shock wave at $M = 1.8$.

REFERENCES

1. Allen, H. Julian: The Asymmetric Adjustable Supersonic Nozzle for Wind-Tunnel Application. NACA TN 2922, 1953.
2. Prandtl, L., and Busemann, A.: Nahrungsverfahren zur zeichnerische Ermittlung von ebenen Strömungen mit Überschallgeschwindigkeit. Stodola Festschrift, Zurich, 1929.
3. Sauer, R.: Method of Characteristics for Three-Dimensional Axially Symmetrical Supersonic Flows. NACA TM 1133, 1947.
4. Sauer, R.: Introduction to Theoretical Gas Dynamics (Translation by Freeman K. Hill and Ralph A. Alpher), (Ann Arbor), J. W. Edwards, 1947, pp. 84-87.
5. Staff of the Ames 1- by 3-Foot Supersonic Wind-Tunnel Section: Notes and Tables for Use in the Analysis of Supersonic Flow. NACA TN 1428, 1947.
6. Tucker, Maurice: Approximate Turbulent Boundary-Layer Development in Plane Compressible Flow Along Thermally Insulated Surfaces with Application to Supersonic-Tunnel Contour Correction. NACA TN 2045, 1950.
7. Sauer, R.: General Characteristics of the Flow Through Nozzles at Near Critical Speeds. NACA TM 1147, 1947.
8. Prandtl, L.: Neue Untersuchungen über die strömende Bewegung der Gase und Dampfe. Phys. Zeitschrift, Bd. 8, no. 1, 1907, pp. 23-30.
9. Meyer, Th.: The Two Dimensional Phenomena of Motion in a Gas Flowing at Supersonic Velocity. Cornell Research Foundation, Buffalo, N. Y., Aug. 1945. (Translation from Mitteilungen über Forschungsarbeiten auf dem Gebiete des Ingenieurwesens, Heft 62, 1908, pp. 31-67.)

TABLE I.— COORDINATES OF NOZZLE WALLS DESIGNED FOR MACH NUMBERS OF 1.5 AND 2.6.*

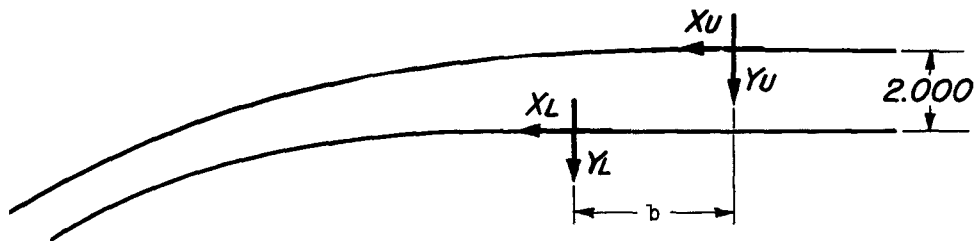

X_U	Y_U	X_U	Y_U	X_L	Y_L	X_L	Y_L
0.000	0.0000	9.200	0.6860	0.000	0.0000	6.600	0.3629
.200	.0000	9.400	.7265	.200	.0000	6.800	.3976
.400	.0001	9.600	.7683	.400	.0001	7.000	.4345
.600	.0002	9.800	.8115	.600	.0003	7.200	.4737
.800	.0006	10.000	.8559	.800	.0007	7.400	.5153
1.000	.0011	10.200	.9016	1.000	.0013	7.600	.5592
1.200	.0020	10.400	.9486	1.200	.0022	7.800	.6056
1.400	.0032	10.600	.9969	1.400	.0035	8.000	.6544
1.600	.0047	10.800	1.0465	1.600	.0052	8.200	.7056
1.800	.0067	11.000	1.0975	1.800	.0074	8.400	.7593
2.000	.0091	11.200	1.1497	2.000	.0102	8.600	.8155
2.200	.0120	11.400	1.2033	2.200	.0134	8.800	.8743
2.400	.0154	11.600	1.2582	2.400	.0173	9.000	.9356
2.600	.0193	11.800	1.3146	2.600	.0219	9.200	.9995
2.800	.0238	12.000	1.3723	2.800	.0271	9.400	1.0660
3.000	.0290	12.200	1.4316	3.000	.0332	9.600	1.1352
3.200	.0348	12.400	1.4928	3.200	.0401	9.800	1.2071
3.400	.0412	12.600	1.5562	3.400	.0479	10.000	1.2818
3.600	.0484	12.800	1.6221	3.600	.0568	10.200	1.3592
3.800	.0563	13.000	1.6906	3.800	.0668	10.400	1.4395
4.000	.0651	13.200	1.7618	4.000	.0780	10.600	1.5226
4.200	.0747	13.400	1.8357	4.200	.0905	10.800	1.6087
4.400	.0853	13.600	1.9123	4.400	.1044	11.000	1.6977
4.600	.0968	13.800	1.9914	4.600	.1197	11.200	1.7896
4.800	.1094	14.000	2.0730	4.800	.1365	11.400	1.8845
5.000	.1231	14.200	2.1568	5.000	.1548	11.600	1.9826
5.200	.1379	14.400	2.2423	5.200	.1748	11.800	2.0837
5.400	.1538	14.600	2.3295	5.400	.1963	12.000	2.1880
5.600	.1708	14.800	2.4183	5.600	.2196	12.200	2.2955
5.800	.1890	15.000	2.5087	5.800	.2445	12.400	2.4062
6.000	.2084	15.200	2.6006	6.000	.2713	12.600	2.5201
6.200	.2289	15.400	2.6940	6.200	.2999	12.800	2.6374
6.400	.2507	15.600	2.7891	6.400	.3304	13.000	2.7581
6.600	.2737	15.800	2.8859				
6.800	.2979	16.000	2.9642				
7.000	.3233	16.200	3.0843				
7.200	.3499	16.400	3.1860				
7.400	.3778	16.600	3.2894				
7.600	.4070	16.800	3.3945				
7.800	.4345	17.000	3.5014				
8.000	.4692	17.200	3.6100				
8.200	.5022	17.400	3.7204				
8.400	.5364	17.600	3.8325				
8.600	.5719	17.800	3.9465				
8.800	.6087	18.000	4.0622				
9.000	.6467	18.200	4.1798				

For $M = 1.5$, $b = 2.236$
 $M = 2.6$, $b = 4.800$

*Coordinates do not include correction for boundary layer.



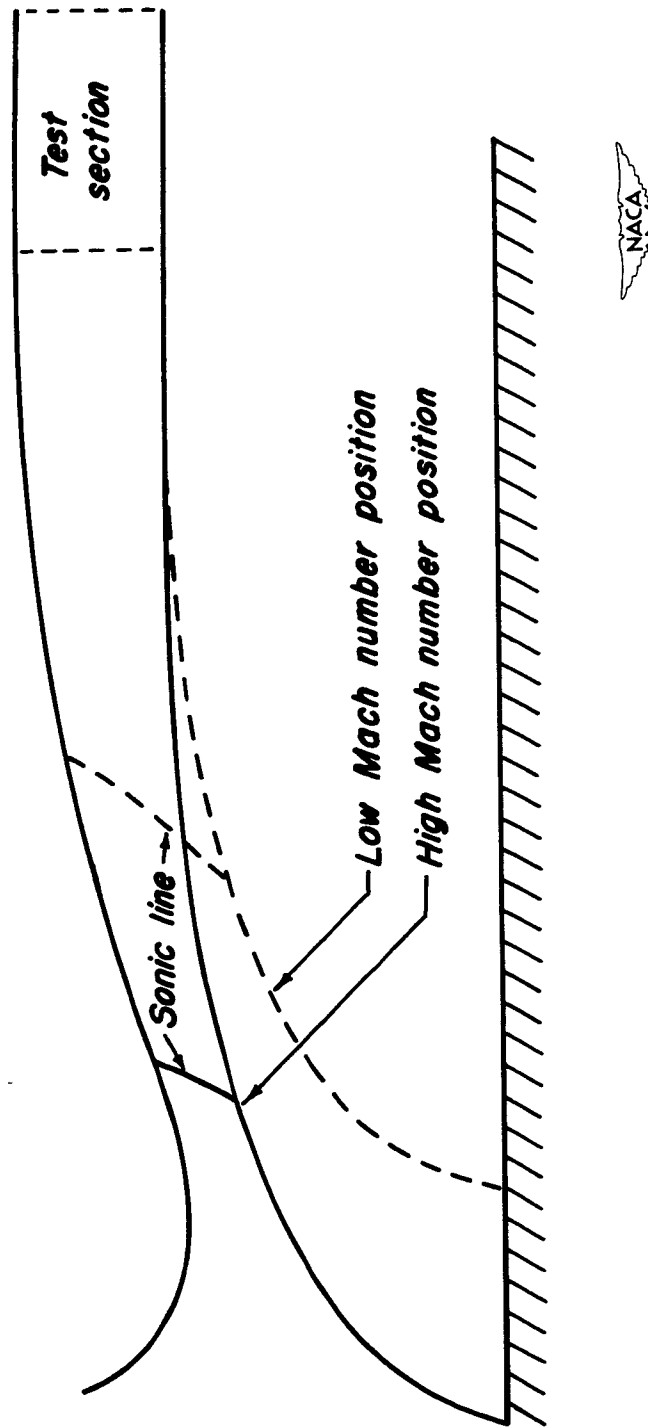

Figure 1. - Variable Mach number asymmetric supersonic nozzle.

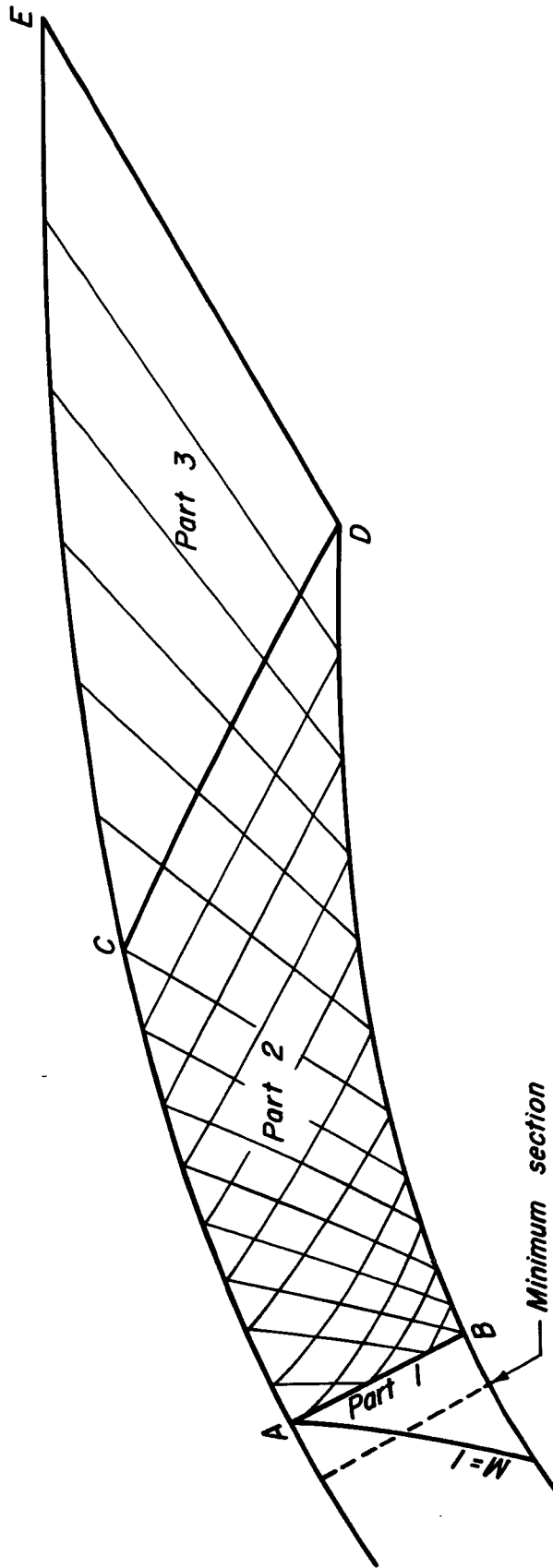
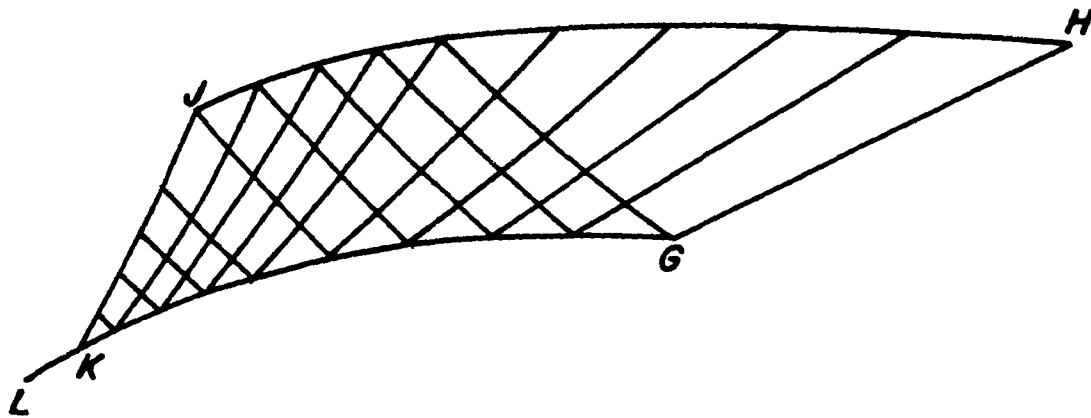
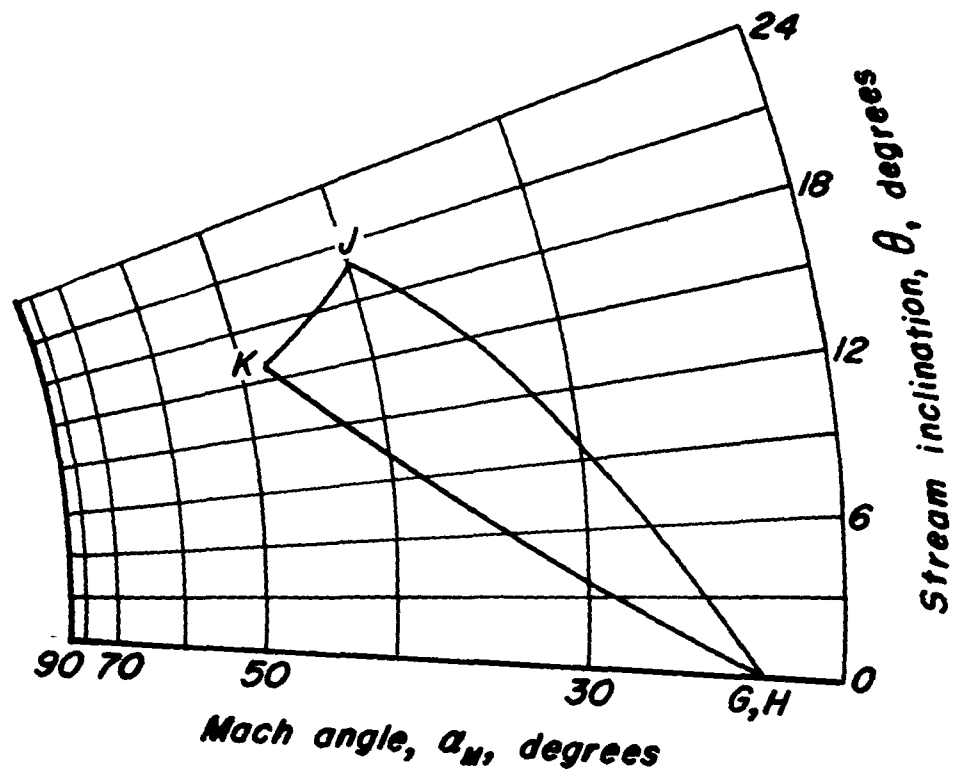

Figure 2.— Schematic diagram of the construction of the flow field in a typical asymmetric nozzle.



(a) Physical plane.



(b) Hodograph plane.



Figure 4.— Typical construction of characteristic net in reverse of flow direction at higher design Mach number.

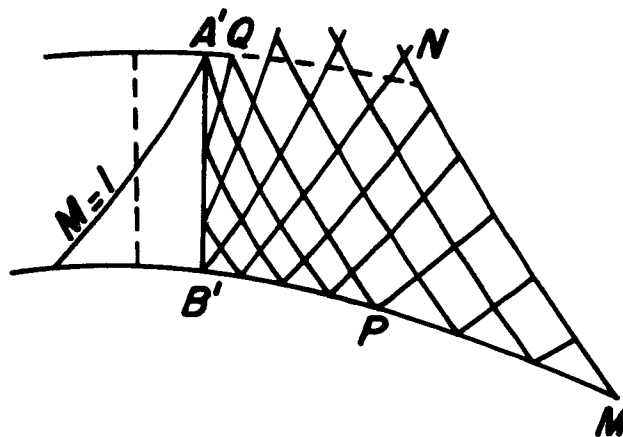

(a) Physical plane.

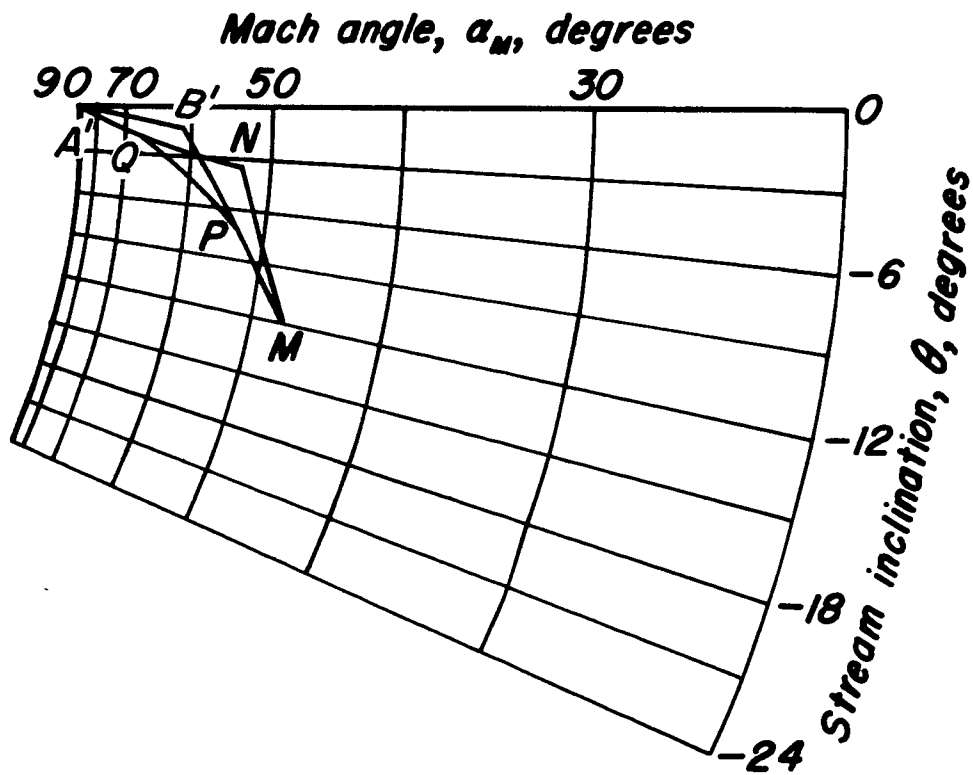

(b) Hodograph plane.



Figure 5.- Typical construction downstream of minimum section at higher design Mach number.

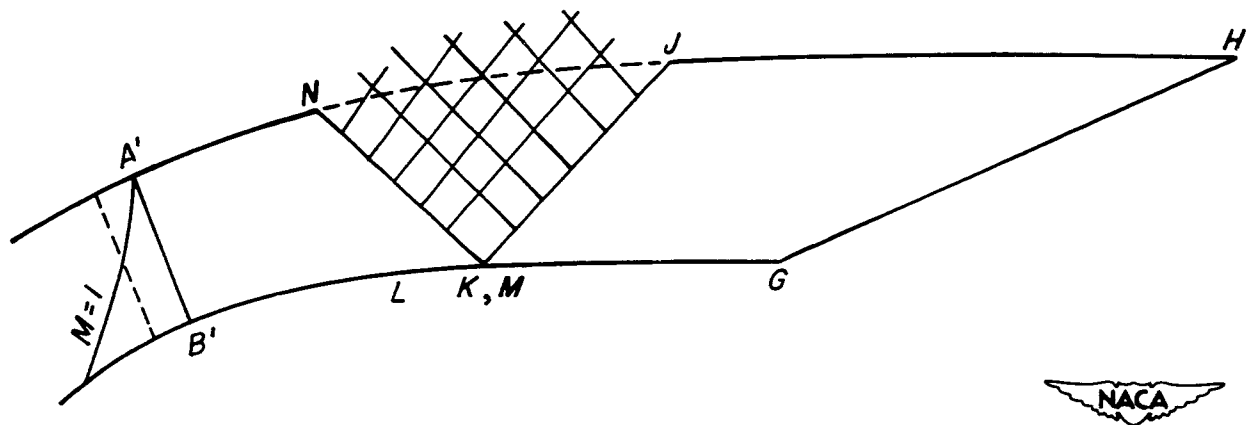

Figure 6.— Combined constructions at higher design Mach number showing completed characteristic net and streamline uniting the two portions of the upper wall.

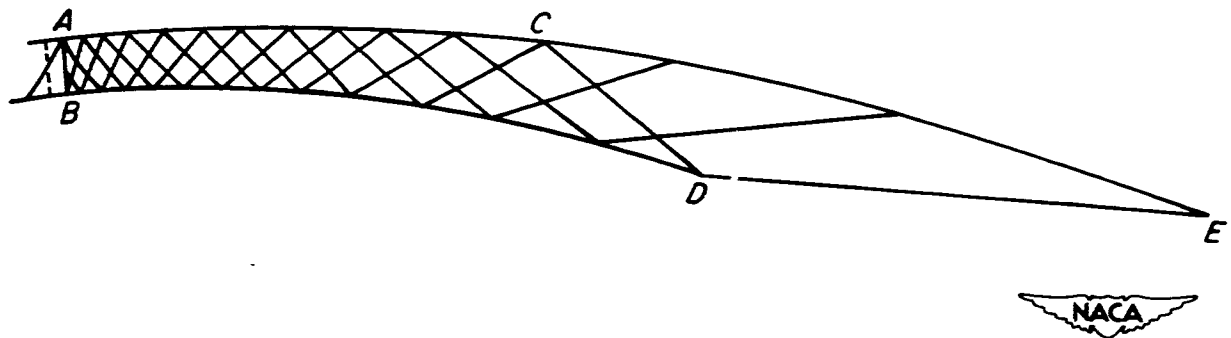
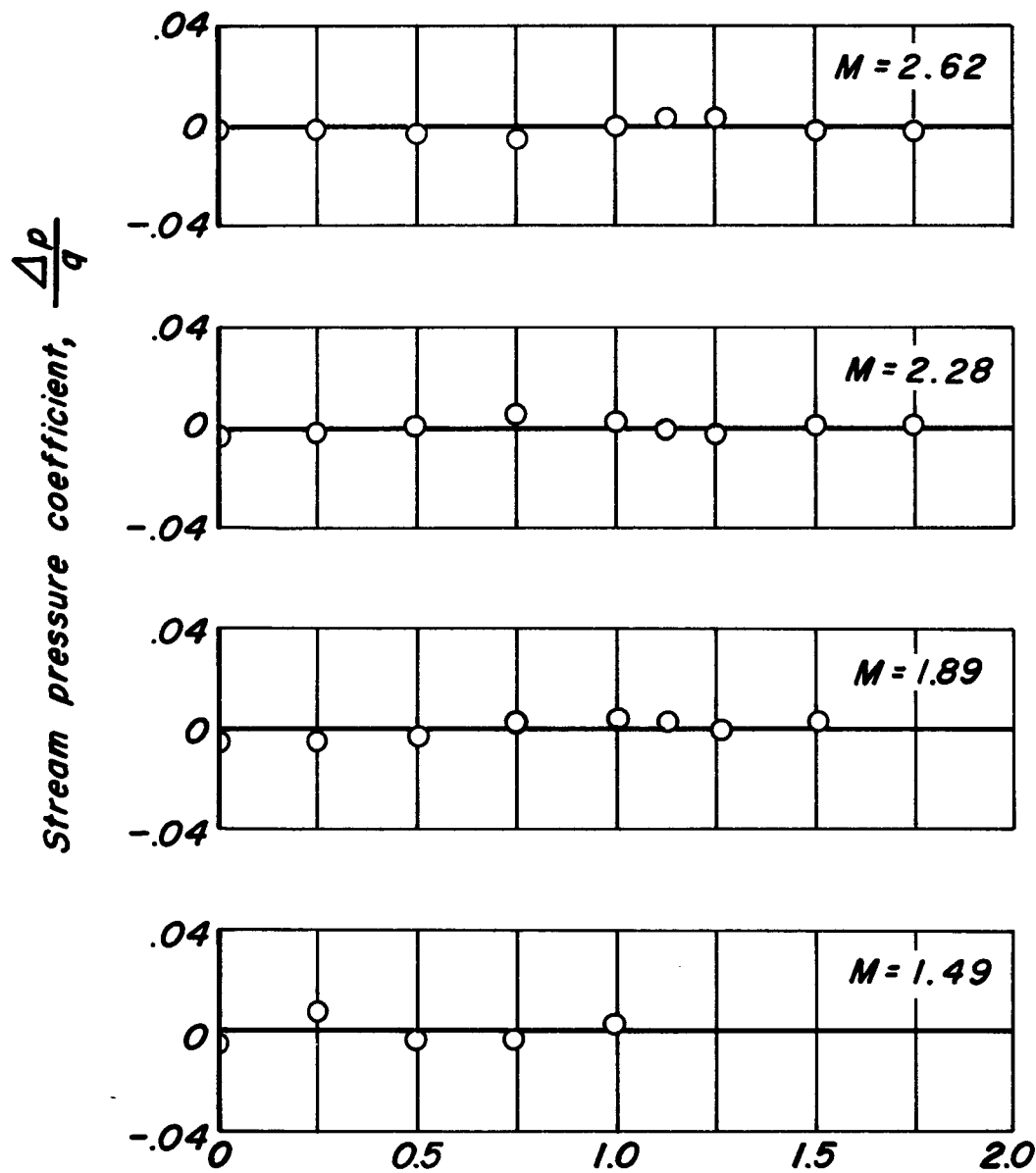

Figure 7.— Construction for high Mach number design procedure.



Horizontal distance from leading edge of test section, test section heights

(a) Along the center line.



Figure 8.— The variation of the stream static pressure coefficient axially in the 2- by 2- inch test section.

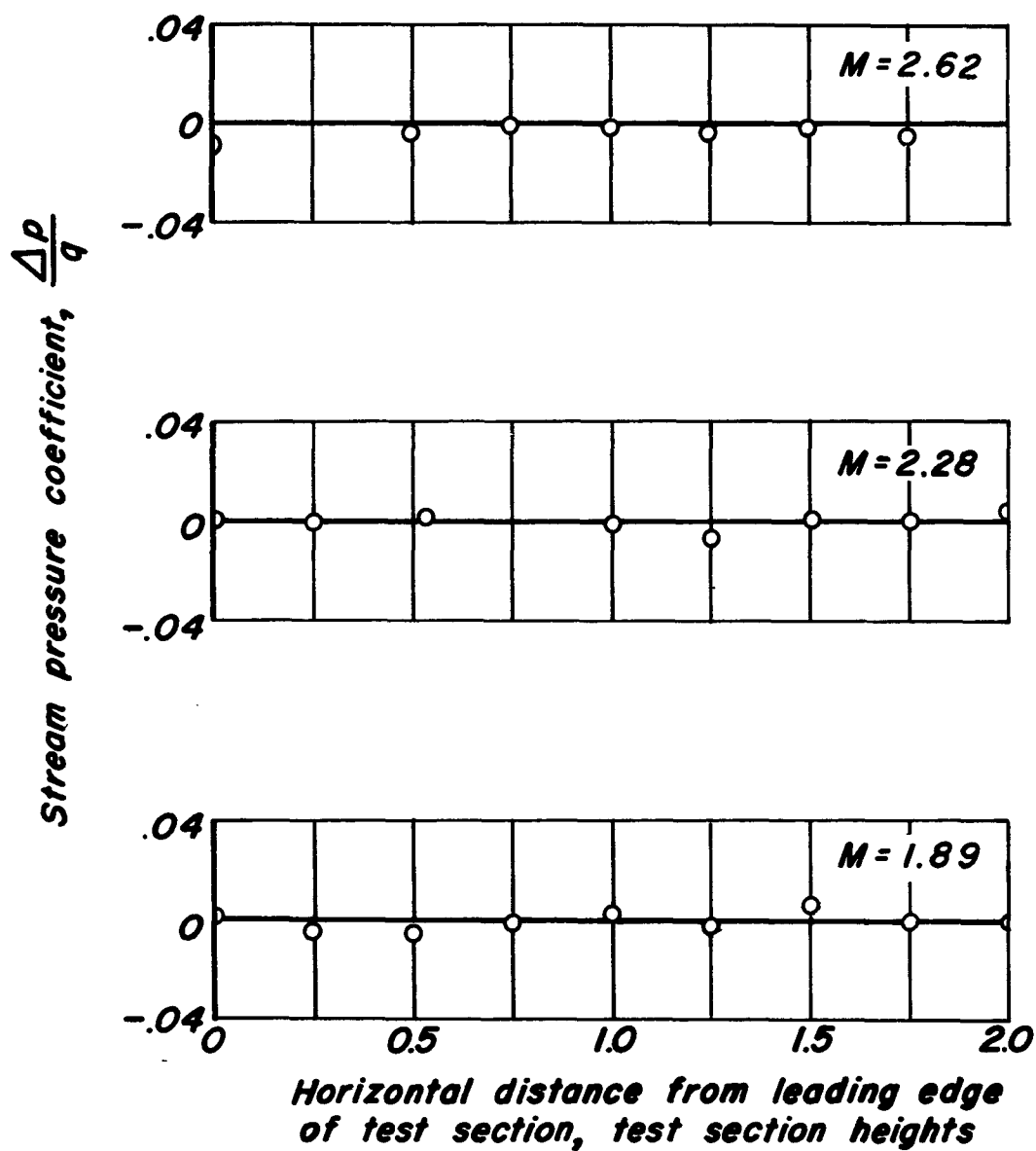

(b) 0.75 inches above the center line.



Figure 8.— Continued.

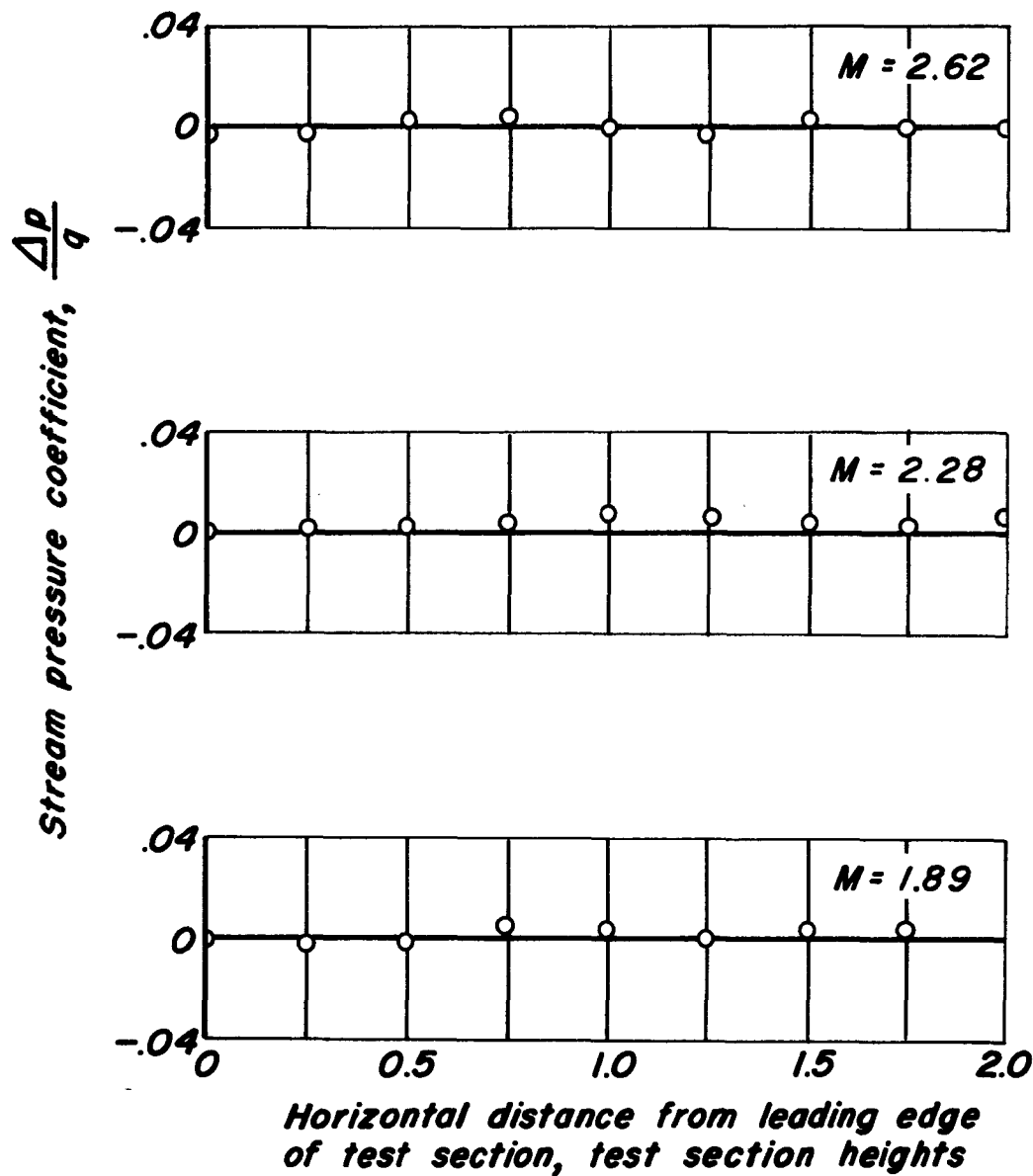

(c) 0.25 inches below the center line.



Figure 8.— Concluded.

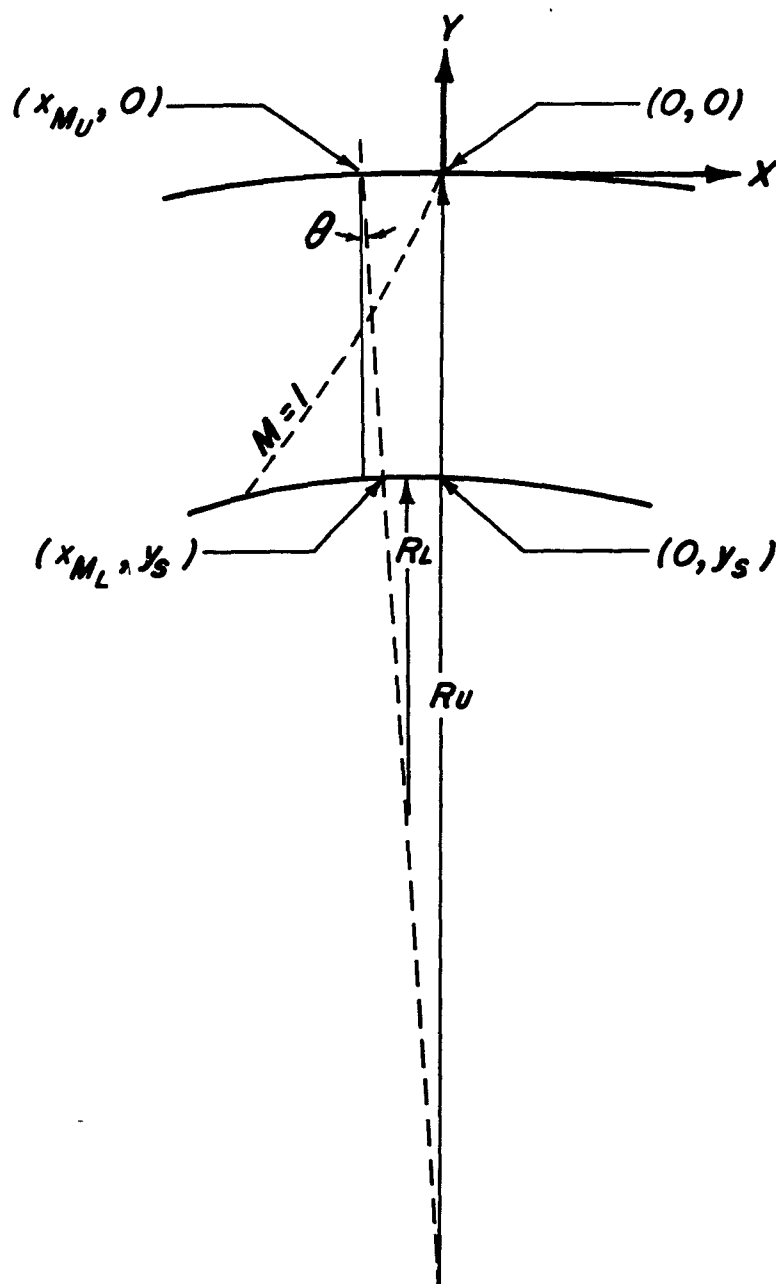

Figure 9.— Geometry of the minimum section of an asymmetric nozzle.

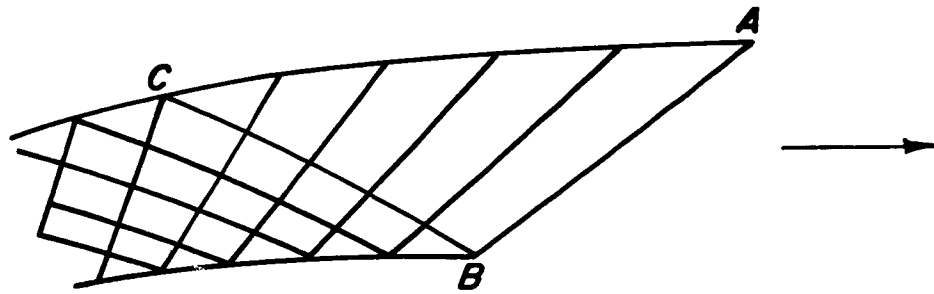

Figure 10.— *Downstream end of flow field in an asymmetric nozzle with uniform exit flow.*

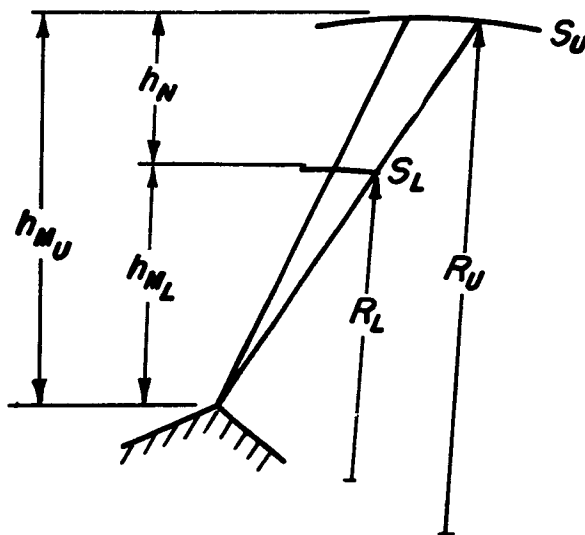

Figure 11.— *Section of asymmetric nozzle made up of elements of two Prandtl-Meyer streamlines.*

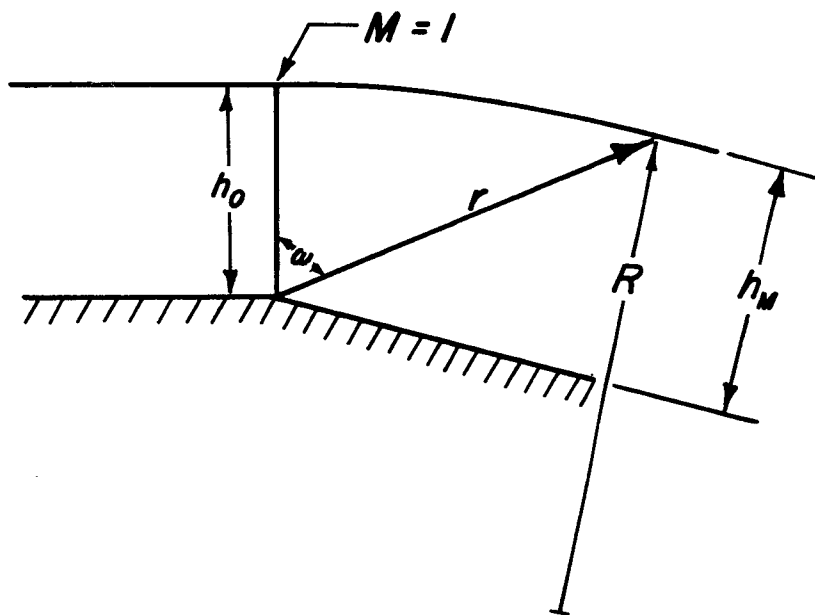

Figure 12.— Schematic diagram of Prandtl-Meyer flow about a corner.

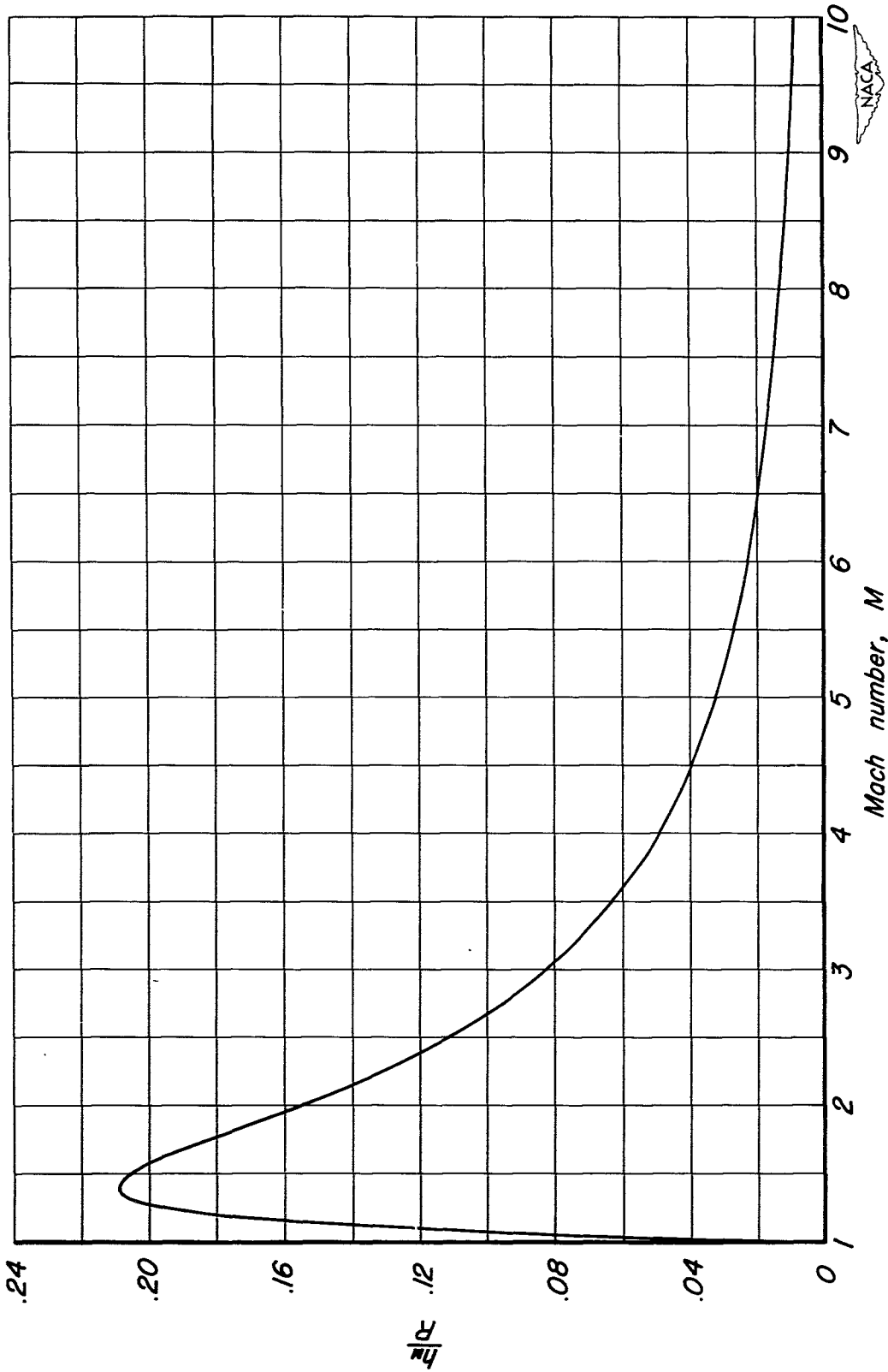

Figure 13.— Ratio of normal height, h_w , to radius of curvature, R , for a Prandtl-Meyer streamline as a function of Mach number.

NACA TN 2922
National Advisory Committee for Aeronautics.
THE DESIGN OF VARIABLE MACH NUMBER
ASYMMETRIC SUPERSONIC NOZZLES BY TWO
PROCEDURES EMPLOYING INCLINED AND
CURVED SONIC LINES. Clarence A. Syvertson and
Raymond C. Savin. March 1953. 35p. diags.,
tab. (NACA TN 2922)

Two procedures are developed for designing asymmetric supersonic nozzles for which the calculated exit flow is essentially uniform over a range of Mach numbers. One procedure is applicable at Mach numbers below approximately 3; the other procedure is used for designs at Mach numbers exceeding 3.

Copies obtainable from NACA, Washington



1. Nozzles (1.4.2.2)
 2. Wind Tunnels (9.1.1)
 3. Flow, Compressible (1.1.2)
- I. Syvertson, Clarence A.
 - II. Savin, Raymond C.
 - III. NACA TN 2922

NACA TN 2922
National Advisory Committee for Aeronautics.
THE DESIGN OF VARIABLE MACH NUMBER
ASYMMETRIC SUPERSONIC NOZZLES BY TWO
PROCEDURES EMPLOYING INCLINED AND
CURVED SONIC LINES. Clarence A. Syvertson and
Raymond C. Savin. March 1953. 35p. diags.,
tab. (NACA TN 2922)

Two procedures are developed for designing asymmetric supersonic nozzles for which the calculated exit flow is essentially uniform over a range of Mach numbers. One procedure is applicable at Mach numbers below approximately 3; the other procedure is used for designs at Mach numbers exceeding 3.

Copies obtainable from NACA, Washington



1. Nozzles (1.4.2.2)
 2. Wind Tunnels (9.1.1)
 3. Flow, Compressible (1.1.2)
- I. Syvertson, Clarence A.
 - II. Savin, Raymond C.
 - III. NACA TN 2922

NACA TN 2922
National Advisory Committee for Aeronautics.
THE DESIGN OF VARIABLE MACH NUMBER
ASYMMETRIC SUPERSONIC NOZZLES BY TWO
PROCEDURES EMPLOYING INCLINED AND
CURVED SONIC LINES. Clarence A. Syvertson and
Raymond C. Savin. March 1953. 35p. diags.,
tab. (NACA TN 2922)

Two procedures are developed for designing asymmetric supersonic nozzles for which the calculated exit flow is essentially uniform over a range of Mach numbers. One procedure is applicable at Mach numbers below approximately 3; the other procedure is used for designs at Mach numbers exceeding 3.

Copies obtainable from NACA, Washington



1. Nozzles (1.4.2.2)
 2. Wind Tunnels (9.1.1)
 3. Flow, Compressible (1.1.2)
- I. Syvertson, Clarence A.
 - II. Savin, Raymond C.
 - III. NACA TN 2922

NACA TN 2922
National Advisory Committee for Aeronautics.
THE DESIGN OF VARIABLE MACH NUMBER
ASYMMETRIC SUPERSONIC NOZZLES BY TWO
PROCEDURES EMPLOYING INCLINED AND
CURVED SONIC LINES. Clarence A. Syvertson and
Raymond C. Savin. March 1953. 35p. diags.,
tab. (NACA TN 2922)

Two procedures are developed for designing asymmetric supersonic nozzles for which the calculated exit flow is essentially uniform over a range of Mach numbers. One procedure is applicable at Mach numbers below approximately 3; the other procedure is used for designs at Mach numbers exceeding 3.

Copies obtainable from NACA, Washington



1. Nozzles (1.4.2.2)
 2. Wind Tunnels (9.1.1)
 3. Flow, Compressible (1.1.2)
- I. Syvertson, Clarence A.
 - II. Savin, Raymond C.
 - III. NACA TN 2922