

UNCLASSIFIED

AD NUMBER

AD030222

CLASSIFICATION CHANGES

TO: unclassified

FROM: confidential

LIMITATION CHANGES

TO:
Approved for public release, distribution unlimited

FROM:
Distribution authorized to U.S. Gov't. agencies and their contractors; Administrative/Operational Use; 11 MAY 1954. Other requests shall be referred to National Aeronautics and Space Administration, Washington, DC.

AUTHORITY

NASA TR Server website; NASA TR Server website

THIS PAGE IS UNCLASSIFIED

Armed Services Technical Information Agency

Because of our limited supply, you are requested to return this copy **WHEN IT HAS SERVED YOUR PURPOSE** so that it may be made available to other requesters. Your cooperation will be appreciated.

AD

30222

NOTICE: WHEN GOVERNMENT OR OTHER DRAWINGS, SPECIFICATIONS OR OTHER DATA ARE USED FOR ANY PURPOSE OTHER THAN IN CONNECTION WITH A DEFINITELY RELATED GOVERNMENT PROCUREMENT OPERATION, THE U. S. GOVERNMENT THEREBY INCURS NO RESPONSIBILITY, NOR ANY OBLIGATION WHATSOEVER; AND THE FACT THAT THE GOVERNMENT MAY HAVE FORMULATED, FURNISHED, OR IN ANY WAY SUPPLIED THE SAID DRAWINGS, SPECIFICATIONS, OR OTHER DATA IS NOT TO BE REGARDED BY IMPLICATION OR OTHERWISE AS IN ANY MANNER LICENSING THE HOLDER OR ANY OTHER PERSON OR CORPORATION, OR CONVEYING ANY RIGHTS OR PERMISSION TO MANUFACTURE, USE OR SELL ANY PATENTED INVENTION THAT MAY IN ANY WAY BE RELATED THERETO.

Reproduced by
DOCUMENT SERVICE CENTER
KNOTT BUILDING, DAYTON, 2, OHIO

CONFIDENTIAL

**NOTICE: THIS DOCUMENT CONTAINS INFORMATION AFFECTING THE
NATIONAL DEFENSE OF THE UNITED STATES WITHIN THE MEANING
OF THE ESPIONAGE LAWS, TITLE 18, U.S.C., SECTIONS 793 and 794.
THE TRANSMISSION OR THE REVELATION OF ITS CONTENTS IN
ANY MANNER TO AN UNAUTHORIZED PERSON IS PROHIBITED BY LAW.**

CONFIDENTIAL

69
Copy
RM E54B16

NACA RM E54B16

302222

ASTIA FILE COPY



RESEARCH MEMORANDUM

LOW-VELOCITY TURNING AS A MEANS OF MINIMIZING BOUNDARY-
LAYER ACCUMULATIONS RESULTING FROM SECONDARY FLOWS
WITHIN TURBINE STATORS

By Warner L. Stewart and Robert Y. Wong

Lewis Flight Propulsion Laboratory
Cleveland, Ohio

CLASSIFIED DOCUMENT

This material contains information affecting the National Defense of the United States within the meaning of the espionage laws, Title 18, U.S.C., Secs. 793 and 794, the transmission or revelation of which in any manner to an unauthorized person is prohibited by law.

NATIONAL ADVISORY COMMITTEE
FOR AERONAUTICS

WASHINGTON

May 11, 1954

CONFIDENTIAL

54AA-31358

NATIONAL ADVISORY COMMITTEE FOR AERONAUTICS

RESEARCH MEMORANDUM

LOW-VELOCITY TURNING AS A MEANS OF MINIMIZING BOUNDARY-LAYER

ACCUMULATIONS RESULTING FROM SECONDARY FLOWS

WITHIN TURBINE STATORS

By Warner L. Stewart and Robert Y. Wong

SUMMARY

A series of three single-passage nozzles, designed to turn the flow at different velocity levels but to identical outlet conditions, were investigated to determine whether secondary-flow accumulations of boundary-layer fluids within nozzles could be minimized by use of low-velocity turning. The results of the investigation indicated that this type of turning with subsequent acceleration is highly effective in minimizing secondary-flow accumulations at the corner where the suction surface joins the end walls.

As applied to turbine stators, gains in turbine performance may be expected, provided that the long blade surfaces required do not cause excessive wake losses and that three-dimensional effects on the boundary layer of the long blade do not appreciably increase the secondary-flow accumulations. It is to be noted that the effect of reduced secondary-flow accumulation on turbine performance to date has not been evaluated.

INTRODUCTION

Turbine performance has been found to be affected to varying degrees by secondary flows which may be divided, in general, into two categories: namely, effects on turbine-stator performance and effects on turbine-rotor performance.

Various investigations of secondary flows within turbine stators (ref. 1, for example) have shown that secondary flows cause the accumulation of boundary-layer fluids into cores of low-momentum fluids at the corner where the blade suction surface joins the walls. The mechanism by which these cores form also is described and is shown by flow-visualization methods (ref. 2). The actual stator losses arising from these secondary flows, however, have been shown to be quite small, and hence, the loss itself can represent only a small fraction of the overall turbine losses. In the case of the turbine rotors, however, these

secondary-flow accumulations of boundary-layer fluids within the stator and passing through the rotor have been found to adversely affect rotor performance to a large extent (refs. 3 and 4) by causing large regions of low blade elemental efficiency at the turbine outlet. Thus, it appears that if the turbine stator could be designed such that these accumulations of boundary-layer fluids resulting from secondary flows could be minimized, considerable improvement in turbine efficiency might be realized.

A turbine stator has the function of imparting a specified angular momentum to the fluid by turning the flow a specified angle and increasing the velocity level such that the desired angular momentum is obtained. Conventional turbine stators impart the desired angular momentum to the flow by simultaneously turning and accelerating the flow. The secondary-flow accumulations of boundary-layer fluids within these stators have little chance to dissipate since there is very little distance between the end of the turn and the stator outlet. Also, since the velocity level is high, the total-pressure losses within these accumulations are high, as will be discussed in the subsequent section Basic Considerations.

Turning the flow the required angle at a low velocity level with subsequent acceleration to the desired outlet velocity may be one way of minimizing the accumulation of the boundary-layer fluid within a stator. This type stator would have an advantage over the conventional-type stator in that (1) the total-pressure loss in the secondary-flow accumulations formed in the turn would be low since the velocity level is low, and (2) the subsequent acceleration after the turn would tend to dissipate the accumulations that have occurred in the turn.

The potential improvement in turbine efficiency by minimizing the secondary-flow accumulations of boundary fluids within the stator has motivated an investigation at the NACA Lewis laboratory to determine whether low-velocity turning and subsequent acceleration would be an effective means of accomplishing this. Three single-passage nozzles were investigated, each designed to turn the flow 60° and have an outlet Mach number of 1.0. The first nozzle, considered representative of current turbine stators, is designed to turn and accelerate the flow at a high velocity level and at a constant passage height. The second nozzle is the same as the first with the exception of an additional section at the inlet to accelerate the flow from a relatively low velocity to that specified at the beginning of the turn by means of a variable passage height. The third nozzle, designated the low-velocity-turning nozzle, is designed to turn the flow the desired angle at a low-velocity level and at constant passage height with subsequent acceleration of the flow to the desired outlet velocity by varying the passage height. This report presents a description of the three nozzles together with the results of the experimental investigation. These experimental results are

3218

presented in the form of contour plots of total-pressure ratio across the nozzles at the nozzle outlet at design operating conditions.

DESIGN OF NOZZLES

Basic Considerations

In the flow of real fluids, the maximum total-pressure loss within the boundary layer occurs at the wall where the velocity is zero. Thus, the maximum attainable total-pressure loss of the boundary-layer fluid is equal to the initial total pressure of the fluid minus the static pressure within the boundary layer. This static pressure within the boundary layer is approximately equal to that of the adjacent free-stream fluid. Thus, for a given initial total pressure, low total-pressure loss within the boundary layer corresponds to high free-stream static pressure, which in turn corresponds to low free-stream velocities.

A turbine stator utilizing the aforementioned considerations would turn the flow the desired angle at a low-velocity level and then accelerate the flow to the desired outlet velocity. This type stator would have two advantages over conventional stator designs:

(1) The boundary-layer accumulations resulting from secondary flow within the turn would have a relatively small total-pressure loss, since the velocity level is low.

(2) The subsequent acceleration downstream of the turn would also accelerate the boundary-layer accumulation and would tend to dissipate it over the flow area.

Description of Nozzles

The three nozzles investigated were designed to turn the flow 60° and to have an outlet Mach number of 1.0. Orthographic and isometric views of the three nozzles are shown in figure 1, and the differences in the three nozzles are shown in the following table summarizing the design conditions. Shown also are the static- to total-pressure ratios P/P' corresponding to the Mach number, the significance of which will be discussed in the section Discussion of Nozzles.

Nozzle	Turn- ing angle, deg	Inlet		Entering turn		Leaving turn		Outlet		Nozzle- outlet throat area, sq in.
		Mach num- ber	$\frac{P}{P'}$	Mach num- ber	$\frac{P}{P'}$	Mach num- ber	$\frac{P}{P'}$	Mach num- ber	$\frac{P}{P'}$	
1	60	0.3	0.9395	0.3	0.9395	1.0	0.5283	1.0	0.5283	3
2	60	.1	.9930	.3	.9395	1.0	.5283	1.0	.5283	3
3	60	.1	.9930	.1	.9930	.2	.9725	1.0	.5283	3

Nozzle 1. - Isometric and orthographic views of nozzle 1 are shown in figure 1(a). This nozzle was designed to closely approximate the velocity levels found in a conventional turbine stator. As can be seen from the preceding table, the flow enters the nozzle at a Mach number of 0.3 and simultaneously turns and accelerates to the outlet Mach number of 1.0.

Nozzle 2. - Nozzle 2, shown in figure 1(b), is similar to nozzle 1 with the exception of a long acceleration passage upstream of the turn. As can be seen from the preceding table, nozzles 1 and 2 are designed to turn the flow under identical velocity levels except that the flow enters nozzle 2 at a Mach number of 0.1 and accelerates in the converging passage to 0.3 before entering the turn.

Nozzle 3. - Isometric and orthographic views of nozzle 3 (the low-velocity-turning nozzle) are shown in figure 1(c). A comparison of figures 1(b) and (c) shows that nozzle 3 has an accelerating passage similar to that of nozzle 2. This accelerating passage, however, is downstream of the two-dimensional turn and is symmetrical about the center line as shown. It can be seen from the figure and the preceding table that the nozzle was designed to turn the flow 60° and simultaneously accelerate from an inlet Mach number of 0.1 to 0.2. From the turn the flow is then further accelerated without further turning to the outlet Mach number of 1.0 as it passes through the converging passage.

Discussion of Nozzles

Shown in the table is the static- to total-pressure ratio corresponding to the design Mach numbers at the various stations through the nozzle passages. In view of the discussion in Basic Considerations, it can be seen that the maximum attainable total-pressure loss in any secondary-flow accumulation resulting from flow through nozzles 1 and 2 is 47.2 percent, since 47.2 percent of the total pressure at the outlet is converted into dynamic pressure. However, most of the turn is executed at

velocities much lower than the outlet velocity; hence, the maximum total-pressure loss in the secondary-flow accumulation will be between 6 and 47.2 percent. For nozzle 3, however, the maximum total-pressure loss in any secondary-flow accumulations at the exit of the turn is 3 percent, and the subsequent acceleration may be expected to dissipate the accumulation of these losses to some extent.

APPARATUS

A photograph of the apparatus used in this investigation is shown in figure 2. The wooden nozzle shown was mounted on the end of an 8 foot long vertical pipe which was 12 inches in diameter. Dry combustion air was brought to the top end of this pipe from the laboratory combustion-air system through butterfly controls and suitable ducting. A wood fairing with a large radius (fig. 1) was used at the inlet to each nozzle to assure uniform inlet conditions.

INSTRUMENTATION

Instrumentation was provided to measure inlet total pressure and outlet total pressure across the entire nozzle outlet. Inlet total pressure was measured with a static-pressure tap approximately 3 pipe diameters upstream of the nozzle inlet. A wall static-pressure tap was used because the inlet pipe diameter was large enough that the difference between the static and total pressure was within the accuracy of reading on a manometer. Outlet total-pressure surveys were made with a standard miniature total-pressure claw mounted in a probe actuator that could move the probe angularly about the probe's axis and traverse the probe both along and perpendicular to its axis. Total-pressure variations were obtained as a differential between outlet total pressure and outlet static pressure (barometric pressure) and transmitted through a pressure transducer to an automatic curve tracer to be recorded against probe travel. This recording system had an accuracy of ± 2 percent of full scale which was ± 0.4 pound per square inch for this investigation. Typical recorder traces of total-pressure variations are shown in figure 3 for nozzles 1, 2, and 3.

Although the recording system is a 2-percent instrument, it was found that the repeatability of a given pressure trace was considerably better. Since this investigation was concerned mainly with comparative results, this system was considered adequate.

PROCEDURE

The experimental investigation was conducted by setting the inlet total pressure so that a critical pressure ratio existed across each

nozzle. This pressure was maintained constant while surveys of outlet total pressure were made in a plane 1/8 inch from the nozzle outlet for half of the jet area (fig. 2), since the nozzles were symmetrical about a plane perpendicular to the suction and pressure surfaces of the nozzles midway between the end walls. The surveys were taken such that the total-pressure variations across the jet were completely defined.

RESULTS OF INVESTIGATION

As discussed previously, three single-passage nozzles were investigated to determine the effectiveness of low-velocity turning as a means of minimizing the accumulation of boundary-layer fluids at the nozzle outlet. The nozzles were designed to give identical outlet flow conditions, with the flow within the passage and at the inlet of the nozzles being varied. Nozzle 1 was designed to turn the flow at velocity levels comparable to those of conventional turbine stators. Nozzle 2 was designed to turn the flow at velocity levels identical to those of nozzle 1 with a passage of varying height upstream of the turn to accelerate the flow from a relatively low velocity to that specified at the inlet of the turn. Nozzle 3, the low-velocity-turning nozzle, was designed to turn the flow two-dimensionally at relatively low velocities and then accelerate the flow to the specified outlet conditions by varying the passage height.

The results of this investigation are presented in figure 4 in terms of indicated total-pressure ratio $P'_{\text{outlet}}/P'_{\text{inlet}}$ across the nozzle for one-half of the jet. Also indicated on figure 4 is the projected nozzle outlet into the survey plane 1/8 inch from the nozzle outlet. A comparison of figures 4(a) to (c) shows that there is an accumulation of boundary-layer fluids at the corners between the suction surface and the passage end wall for all three nozzles. It is further noted, however, that the accumulation of boundary-layer material is smallest for nozzle 3 and is distinguished from the boundary layer only by a slight hump in the pressure-ratio contours. It is seen that the maximum total-pressure loss in the accumulation is about 4 percent of the inlet total pressure, whereas the maximum total-pressure loss in the accumulation of nozzles 1 and 2 is of the order of 20 percent. This result is also shown by the traces of total-pressure variation shown in figure 3, which were taken along the dotted lines in figure 4, and appears to verify the theoretical considerations presented in DESIGN OF NOZZLES. Therefore, it is concluded that nozzle 3 was effective in minimizing the boundary-layer accumulations at the outlet of this nozzle.

A further inspection of figure 4 indicates that the boundary layer on the suction surface of nozzles 2 and 3 is comparatively thick and that the measured jet size is greater than the nozzle opening. It is

possible that this thickening could have been caused by the combined effects of the long surface and some adverse pressure gradient on the suction surface of the turn. It is also believed that mixing of entrained air with the jet could have had considerable effect on the apparent boundary-layer thickness since the survey plane is downstream of the nozzle outlet. It is further believed that the exterior geometry of the nozzle adjacent to the outlet can also have an effect on the mixing region, since it will affect the path by which the entrained air must follow into the mixing region. From figure 1 it can be seen that the exterior geometry of the nozzle adjacent to the nozzle outlet is similar in all three nozzles except for that adjacent to the suction surface. It is noted that the angle which the exterior wall adjacent to the suction surface makes with the suction surface varies over a considerable range, and thus its effect on the mixing and hence on the apparent boundary-layer thickness may also be considerable. Since the effect of the exterior geometry on the mixing is unknown, the significance of the thickened boundary layer, if any, is obscured. The enlargement of the jet in the survey plane noted previously may be attributed to mixing and to the spread of the mixing region.

APPLICATION OF LOW-VELOCITY TURNING TO TURBINE STATORS

As discussed in the INTRODUCTION, various studies have indicated that gains in turbine efficiency may be realized if the accumulations of boundary-layer fluids resulting from secondary flow in the stator could be minimized. In this investigation, low-velocity turning of the fluid with subsequent acceleration was found to be effective in reducing the accumulations of boundary-layer fluids at the outlet. Since the mass-averaged total-pressure loss in turbine stators has been shown to be quite small, it is probable that the differences in the mass-averaged total-pressure loss at the outlet of the nozzles investigated herein will also be small. However, as previously pointed out, it is the accumulation of the boundary-layer fluids resulting from secondary flows rather than the loss in total pressure itself that appears to induce appreciable losses within the turbine rotor. Hence, even if there is no appreciable reduction in mass-averaged stator total-pressure loss, gains in turbine efficiency may still result from use of stators which use low-velocity turning and subsequent acceleration, provided that the relatively long blade surfaces do not form such large boundary layers that blade-wake losses become appreciably large and that three-dimensional effects on these boundary layers do not appreciably increase the secondary-flow accumulations. It is to be noted that the actual effect of reduced stator secondary-flow accumulation on turbine rotor efficiency, although indicated by rotor-exit surveys, to date has not been evaluated.

CONCLUSION

From the results of this investigation, it is concluded that a nozzle utilizing low-velocity turning with subsequent acceleration is highly effective in minimizing secondary-flow accumulations of boundary-layer fluids at the corner where the suction surface joins the end wall.

Lewis Flight Propulsion Laboratory
National Advisory Committee for Aeronautics
Cleveland, Ohio, February 17, 1954

3218

REFERENCES

1. Kofskey, Milton G., Allen, Hubert W., and Herzig, Howard Z.: Comparison of Secondary Flows and Boundary-Layer Accumulations in Several Turbine Nozzles. NACA TN 2989, 1953.
2. Hansen, Arthur G., Herzig, Howard Z., and Costello, George R.: A Visualization Study of Secondary Flows in Cascades. NACA TN 2947, 1953.
3. Whitney, Warren J., Buckner, Howard A., Jr., and Monroe, Daniel E.: Effect of Nozzle Secondary Flows on Turbine Performance as Indicated by Exit Surveys of a Rotor. NACA RM E54B03, 1954.
4. Stewart, Warner L., Wong, Robert Y., and Evans, David G.: Design and Experimental Investigation of Transonic Turbine with Slight Negative Reaction Across Rotor Hub. NACA RM E53L29a, 1954.

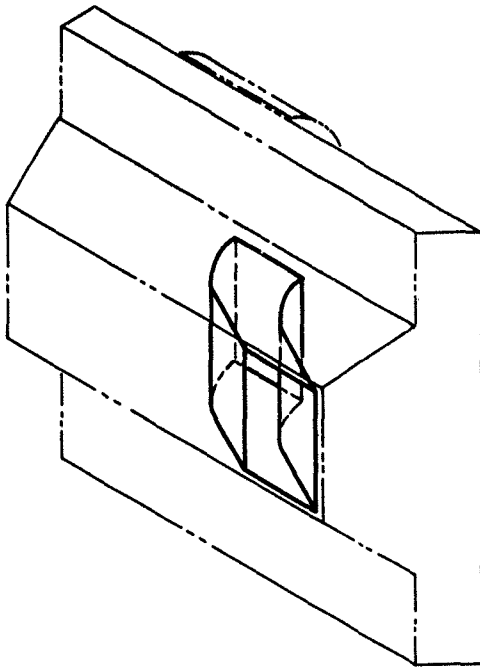

Isometric view

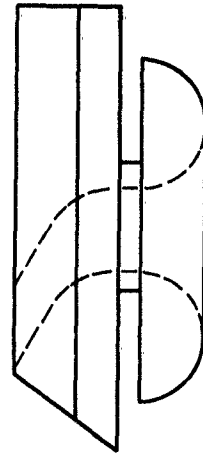

Top view

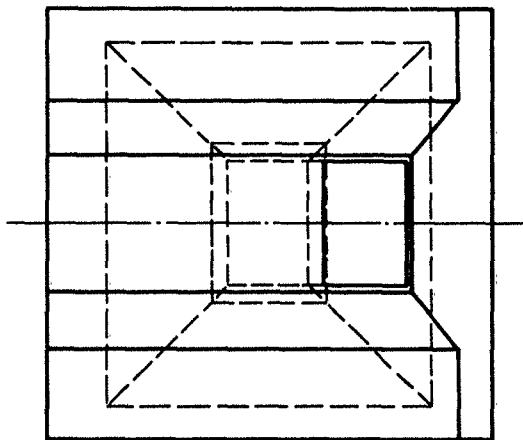

Front view

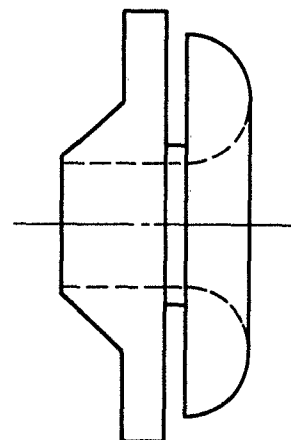

Side view

CD-3542

(a) Nozzle 1.

Figure 1. - Isometric and orthographic views of nozzles.

RT2C

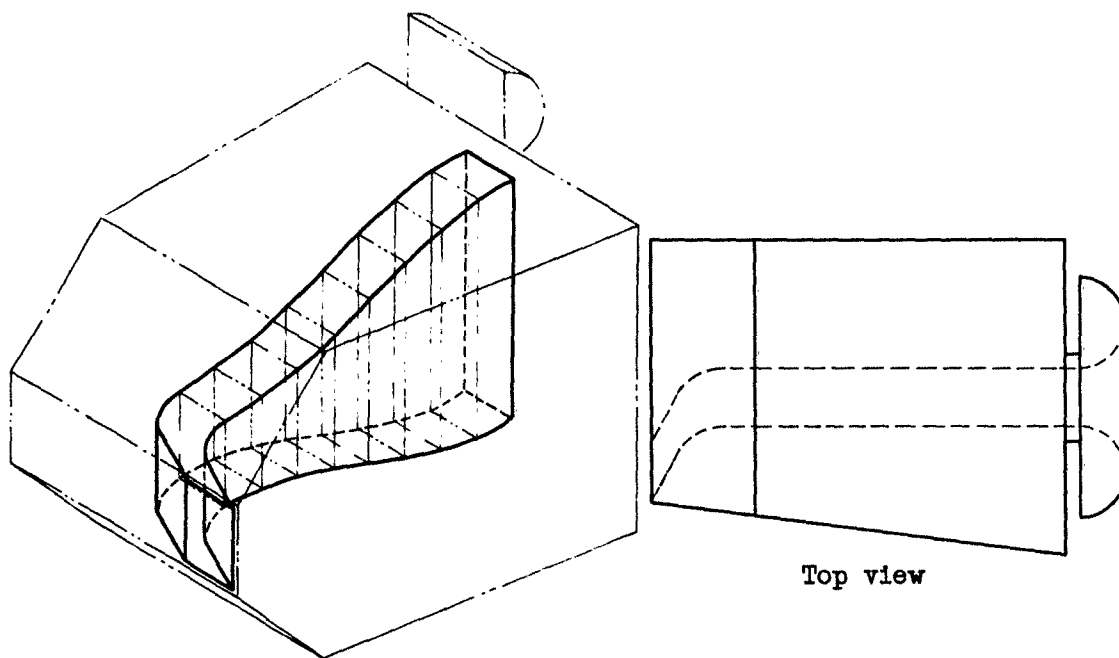

Isometric view

Top view

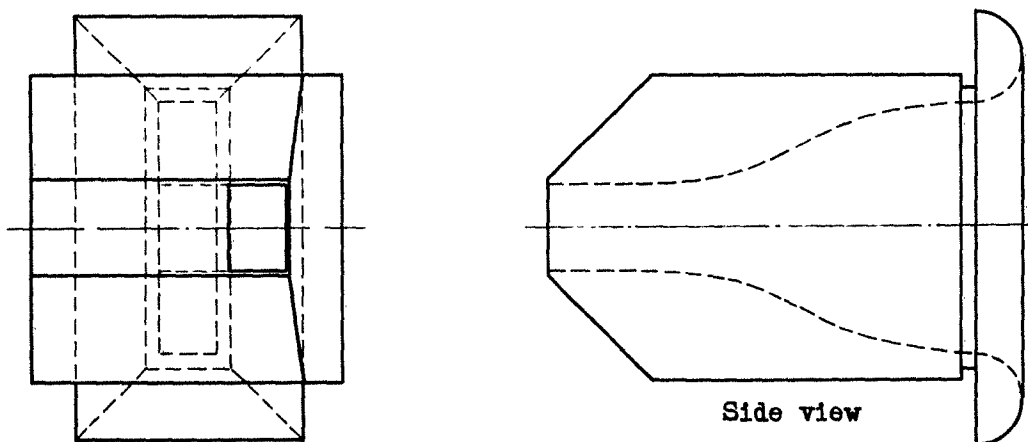

Front view

Side view

(b) Nozzle 2.

CD-3406

Figure 1. - Continued. Isometric and orthographic views of nozzles.

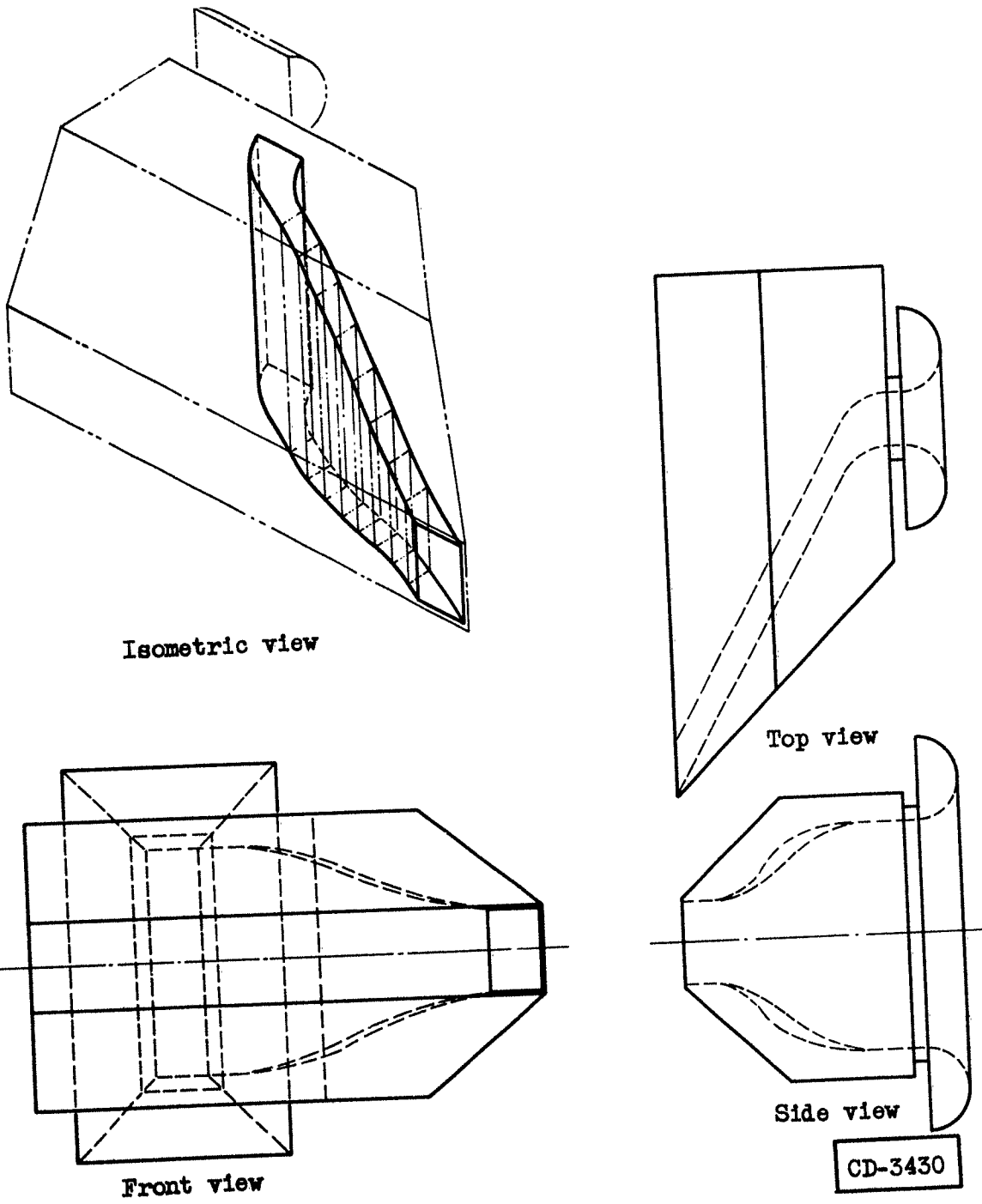

(c) Nozzle 3 (low-velocity-turning nozzle).

Figure 1. - Concluded. Isometric and orthographic views of nozzles.

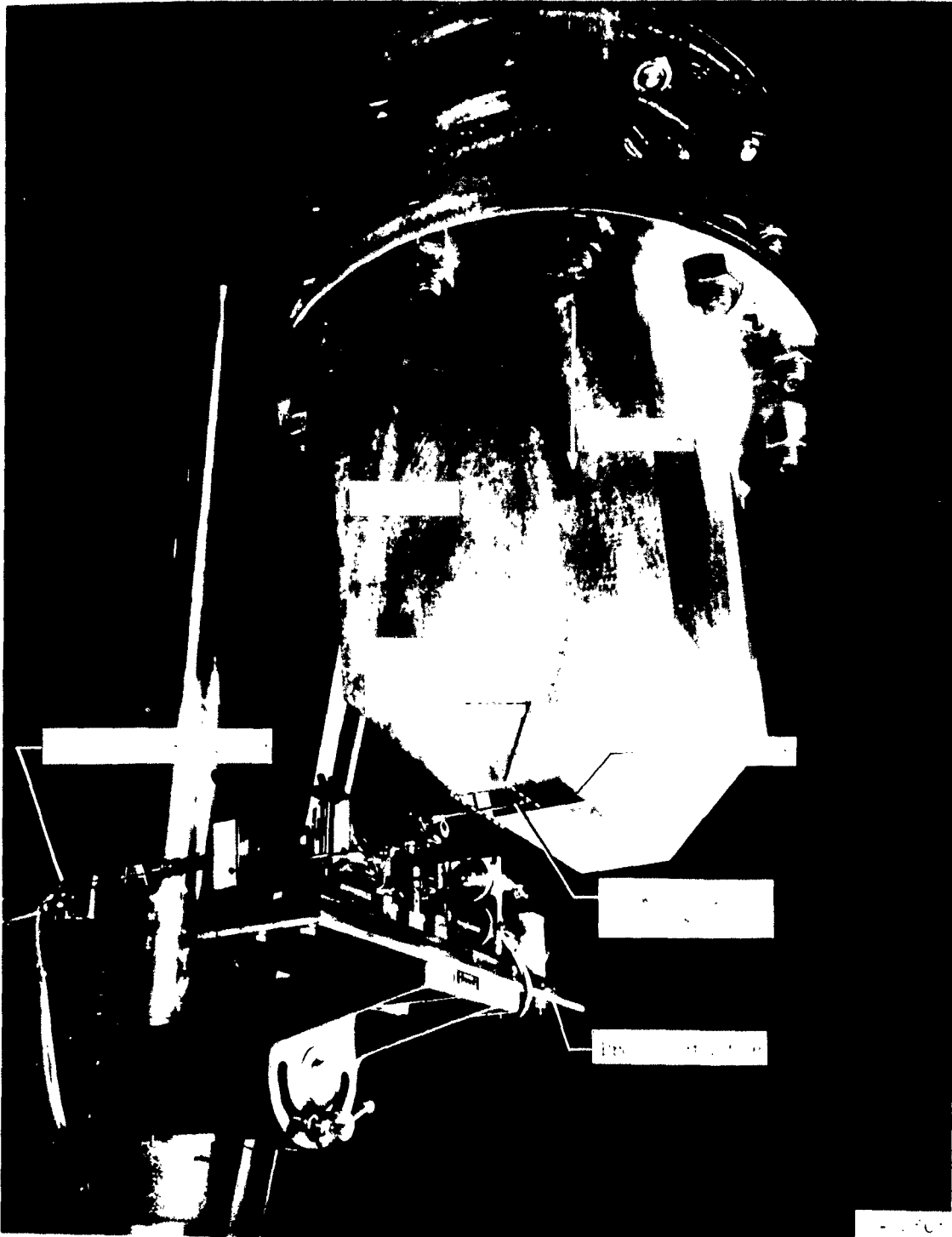
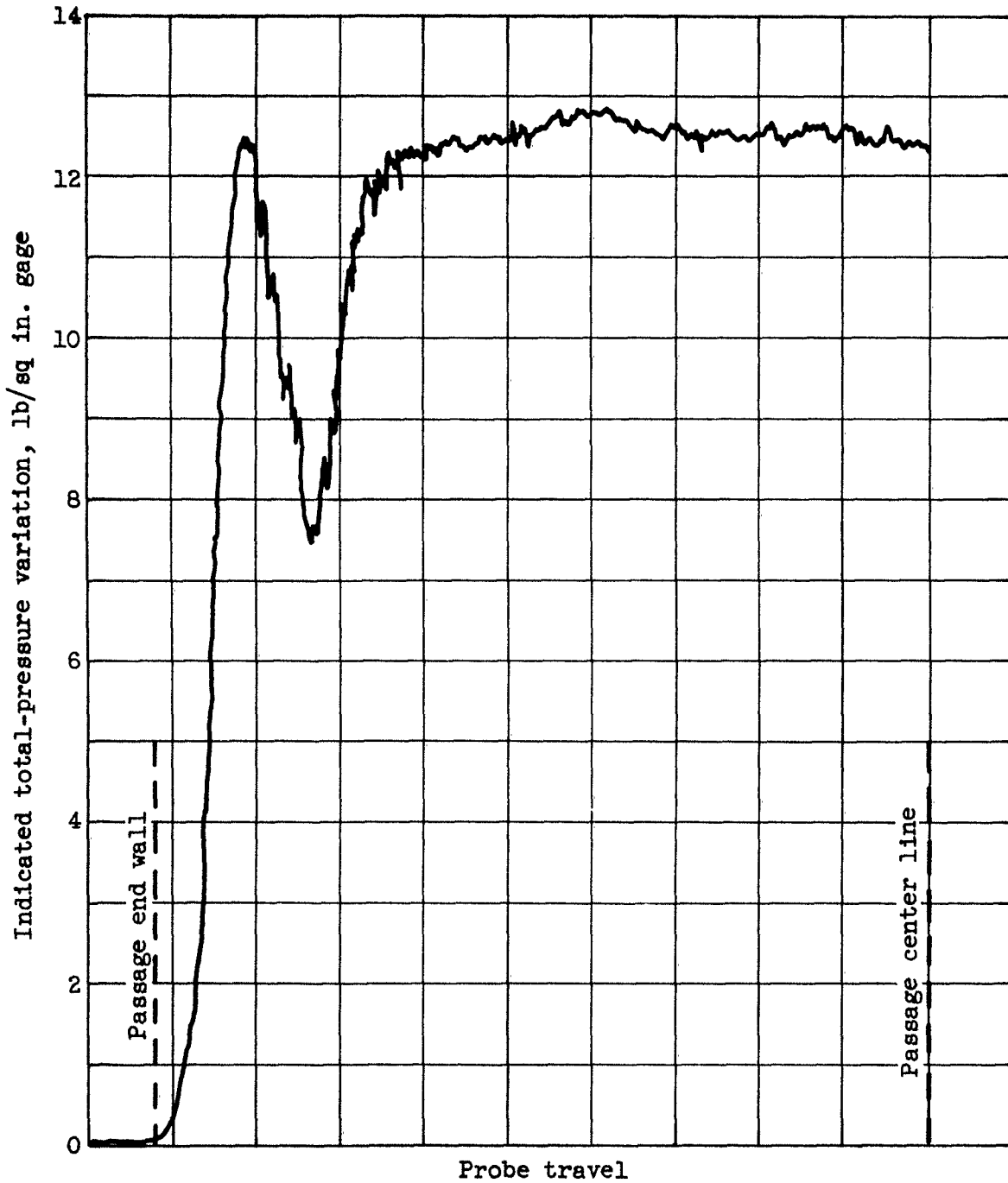

Figure 2. - Experimental setup.



(a) Nozzle 1.

Figure 3. - Typical automatic recorder trace.

3218

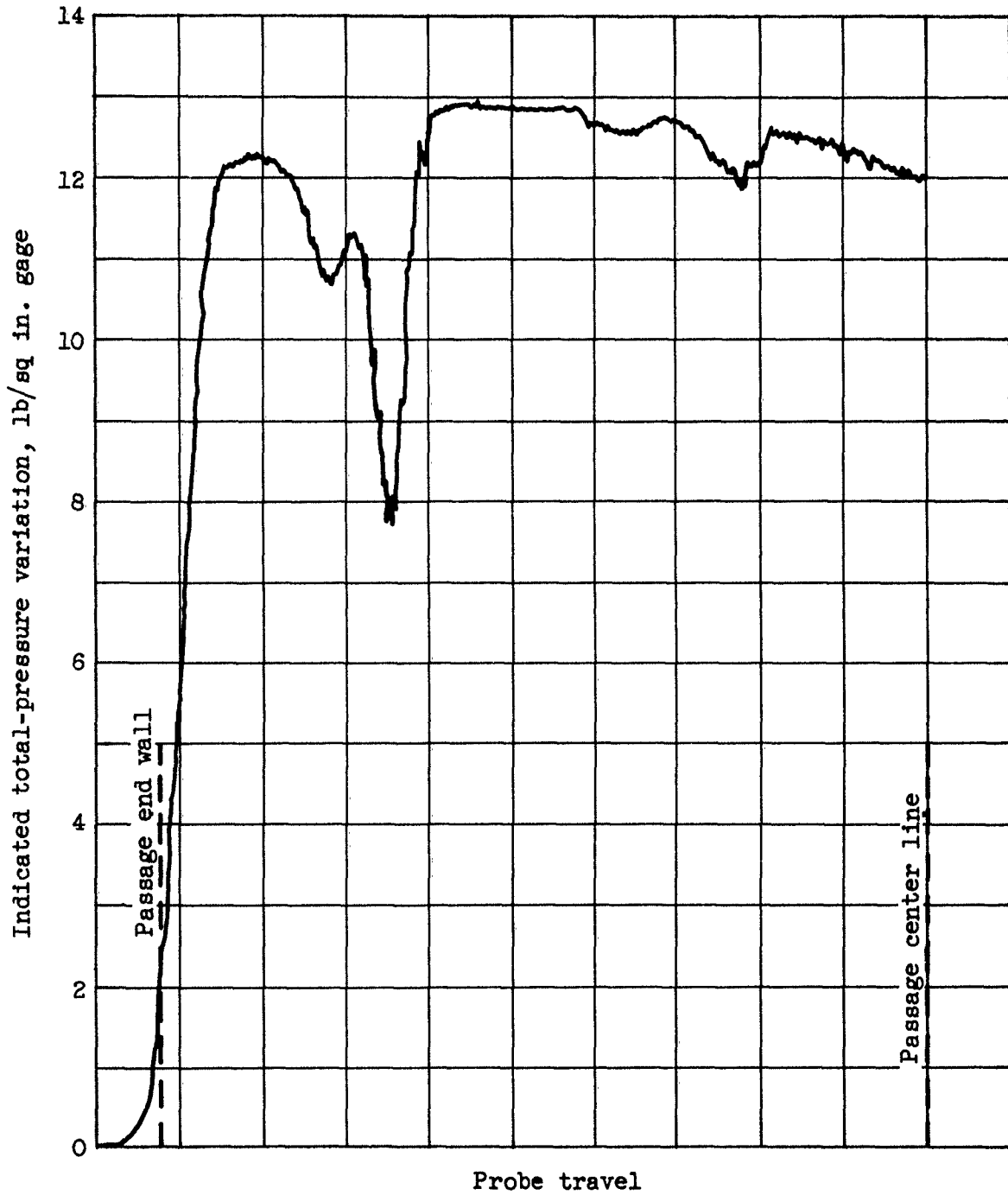

(b) Nozzle 2.

Figure 3. - Continued. Typical automatic recorder trace.

3218

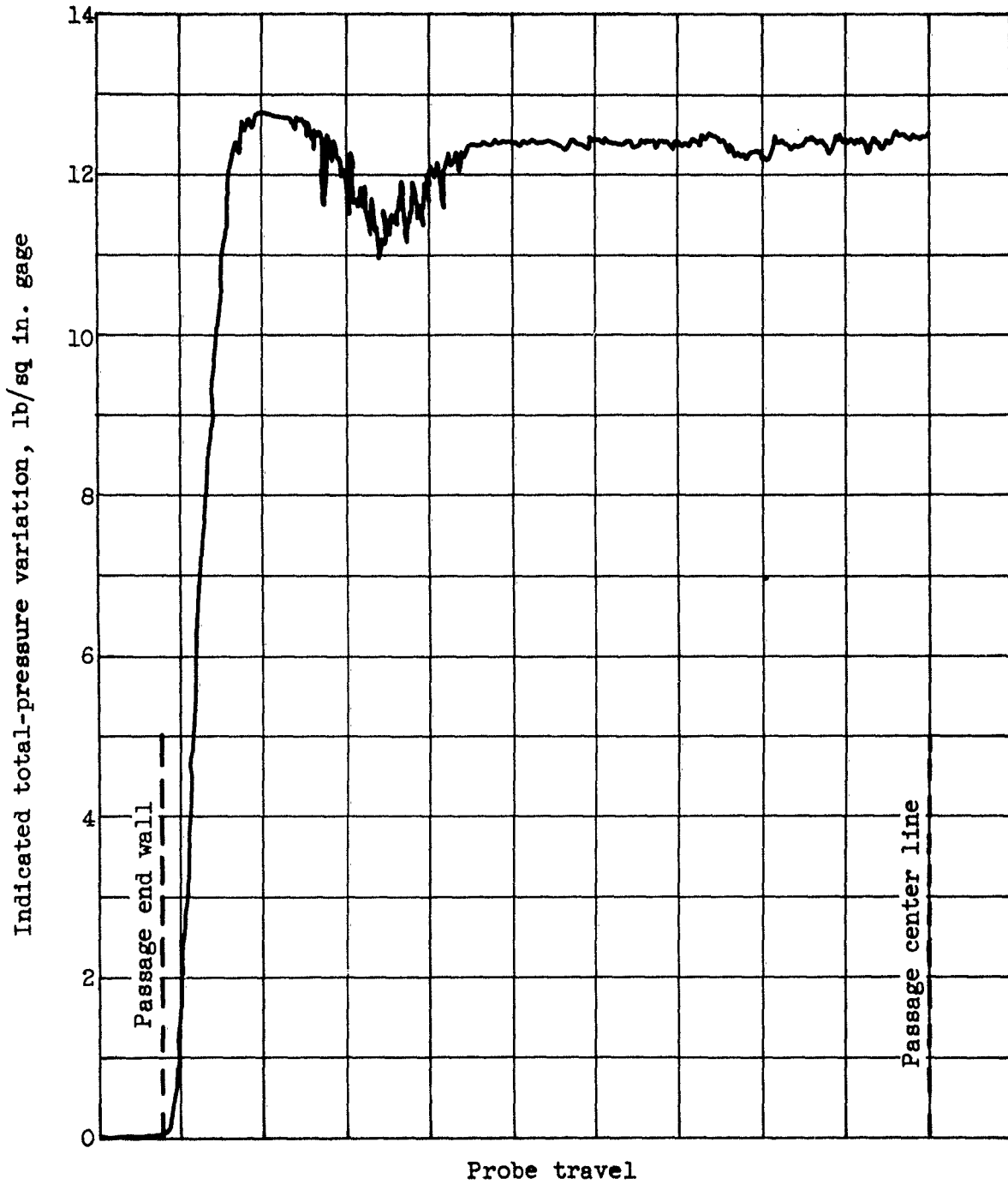

(c) Nozzle 3.

Figure 3. - Concluded. Typical automatic recorder trace.

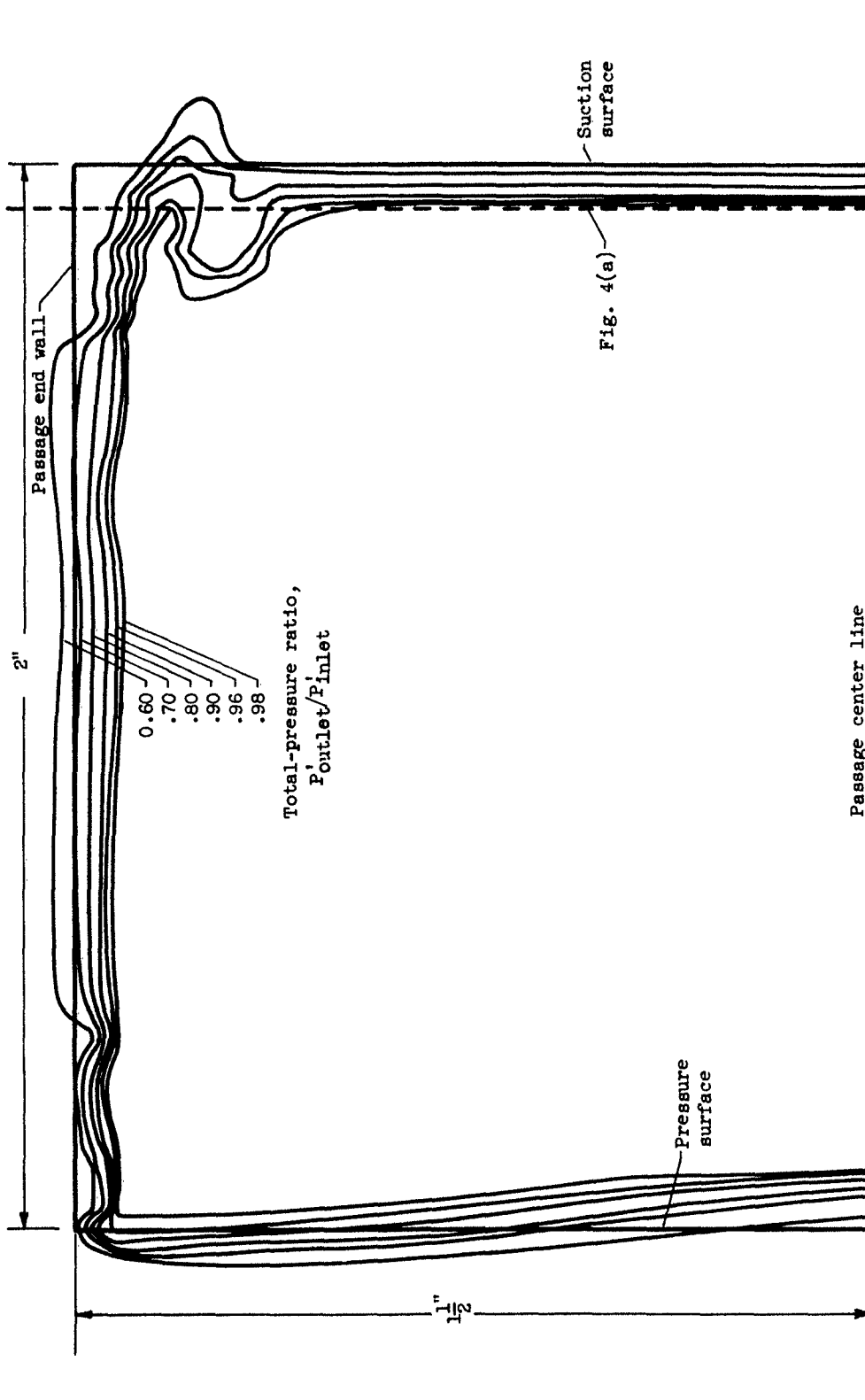

(a) Nozzle 1.

Figure 4. - Contours of total-pressure ratio.

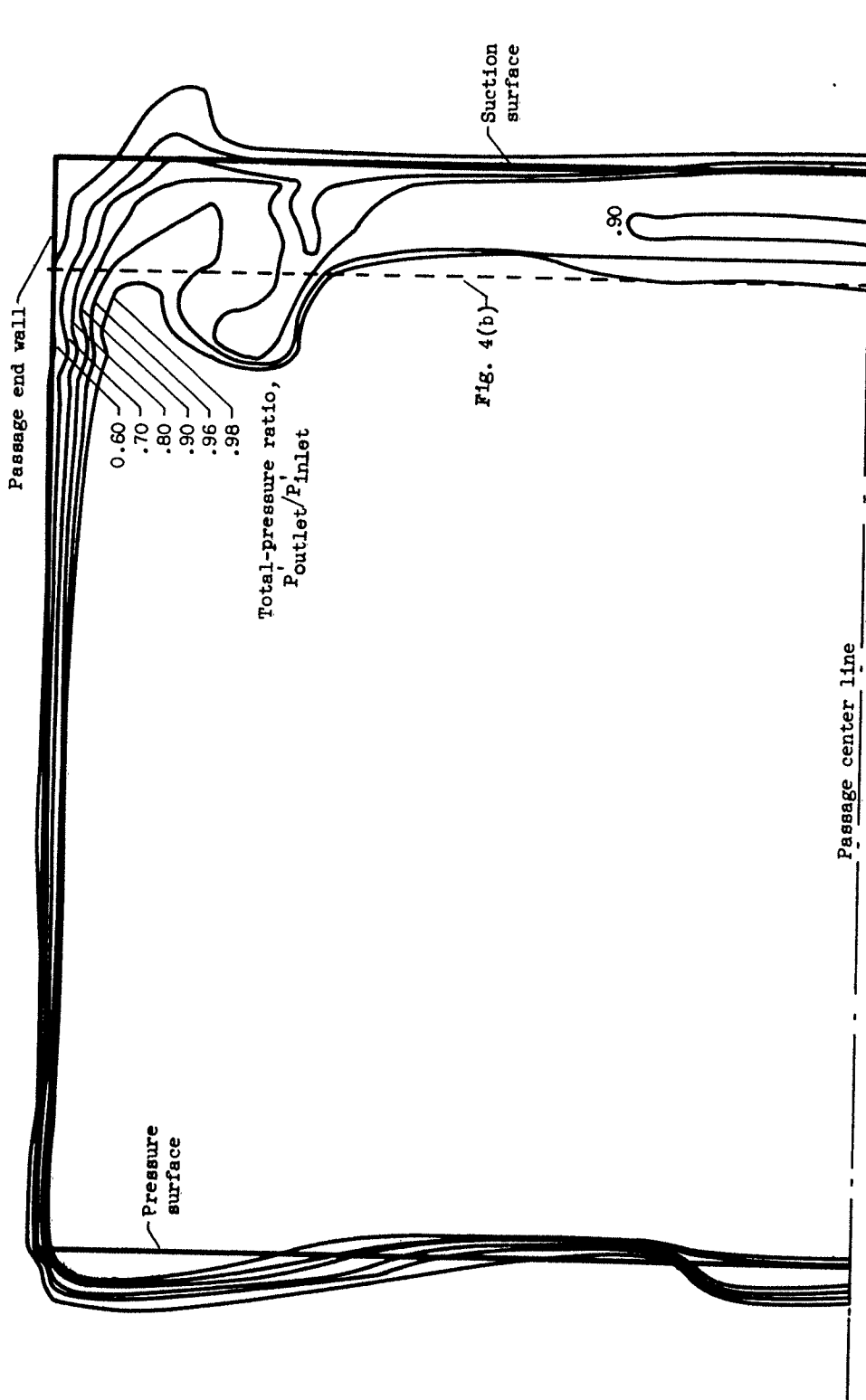

Figure 4. - Continued. Contours of total-pressure ratio.

NACA RM E54B16

National Advisory Committee for Aeronautics.
LOW-VELOCITY TURNING AS A MEANS OF
MINIMIZING BOUNDARY-LAYER ACCUMULATIONS
RESULTING FROM SECONDARY FLOWS WITHIN
TURBINE STATORS. Warner L. Stewart and Robert
Y. Wong. May 1954. 18p. diagra., photo. (NACA
RM E54B16) CONFIDENTIAL

A series of three single-passage nozzles, designed to turn the flow at different velocity levels but to identify outlet conditions, were investigated to determine whether secondary-flow accumulations of boundary-layer fluids within nozzles could be minimized by use of low-velocity turning. The results of the investigation indicated that this type of turning with subsequent acceleration is highly effective in minimizing secondary flow accumulations at the corner where the section surface joins the end walls. As applied to turbine stators, gains in turbine performance may be expected, provided that the long blade surfaces re-

Copies obtainable from NACA, Washington

(over)

CONFIDENTIAL

1. Flow, Subsonic (1. 1. 2. 1)
 2. Flow, Supersonic (1. 1. 2. 3)
 3. Flow, Turbulent (1. 1. 3. 2)
 4. Cascades, Theory (1. 4. 5. 1)
 5. Boundary-Layer Characteristics - Internal Aerodynamics (1. 4. 7. 1)
 6. Turbines - Axial-Flow (3. 7. 1. 1)
- I. Stewart, Warner L.
II. Wong, Robert Y.
III. NACA RM E54B16

NACA

CONFIDENTIAL

NACA RM E54B16

National Advisory Committee for Aeronautics.
LOW-VELOCITY TURNING AS A MEANS OF
MINIMIZING BOUNDARY-LAYER ACCUMULATIONS
RESULTING FROM SECONDARY FLOWS WITHIN
TURBINE STATORS. Warner L. Stewart and Robert
Y. Wong. May 1954. 18p. diagra., photo. (NACA
RM E54B16) CONFIDENTIAL

A series of three single-passage nozzles, designed to turn the flow at different velocity levels but to identify outlet conditions, were investigated to determine whether secondary-flow accumulations of boundary-layer fluids within nozzles could be minimized by use of low-velocity turning. The results of the investigation indicated that this type of turning with subsequent acceleration is highly effective in minimizing secondary flow accumulations at the corner where the section surface joins the end walls. As applied to turbine stators, gains in turbine performance may be expected, provided that the long blade surfaces re-

Copies obtainable from NACA, Washington

(over)

CONFIDENTIAL

1. Flow, Subsonic (1. 1. 2. 1)
 2. Flow, Supersonic (1. 1. 2. 3)
 3. Flow, Turbulent (1. 1. 3. 2)
 4. Cascades, Theory (1. 4. 5. 1)
 5. Boundary-Layer Characteristics - Internal Aerodynamics (1. 4. 7. 1)
 6. Turbines - Axial-Flow (3. 7. 1. 1)
- I. Stewart, Warner L.
II. Wong, Robert Y.
III. NACA RM E54B16

NACA

CONFIDENTIAL

CONFIDENTIAL

NACA RM E54B16

quired do not cause excessive wake losses and that three-dimensional effects on the boundary layer of the long blade do not appreciably increase the secondary flow accumulations. It is to be noted that the effect of reduced secondary-flow accumulation on turbine performance to date has not been evaluated.



Copies obtainable from NACA, Washington

CONFIDENTIAL

NACA RM E54B16

quired do not cause excessive wake losses and that three-dimensional effects on the boundary layer of the long blade do not appreciably increase the secondary flow accumulations. It is to be noted that the effect of reduced secondary-flow accumulation on turbine performance to date has not been evaluated.



Copies obtainable from NACA, Washington

NACA RM E54B16
 National Advisory Committee for Aeronautics.
LOW-VELOCITY TURNING AS A MEANS OF MINIMIZING BOUNDARY-LAYER ACCUMULATIONS RESULTING FROM SECONDARY FLOWS WITHIN TURBINE STATORS. Warner L. Stewart and Robert Y. Wong. May 1954. 18p. diags., photo. (NACA RM E54B16) **CONFIDENTIAL**

A series of three single-passage nozzles, designed to turn the flow at different velocity levels but to identify outlet conditions, were investigated to determine whether secondary-flow accumulations of boundary-layer fluids within nozzles could be minimized by use of low-velocity turning. The results of the investigation indicated that this type of turning with subsequent acceleration is highly effective in minimizing secondary flow accumulations at the corner where the section surface joins the end walls. As applied to turbine stators, gains in turbine performance may be expected, provided that the long blade surfaces re-

Copies obtainable from NACA, Washington (over)

- CONFIDENTIAL**
1. Flow, Subsonic (1. 1. 2. 1)
 2. Flow, Supersonic (1. 1. 2. 3)
 3. Flow, Turbulent (1. 1. 3. 2)
 4. Cascades, Theory (1. 4. 5. 1)
 5. Boundary-Layer Characteristics - Internal Aerodynamics (1. 4. 7. 1)
 6. Turbines - Axial-Flow (3. 7. 1. 1)
- I. Stewart, Warner L.
 II. Wong, Robert Y.
 III. NACA RM E54B16
- 
CONFIDENTIAL

NACA RM E54B16
 National Advisory Committee for Aeronautics.
LOW-VELOCITY TURNING AS A MEANS OF MINIMIZING BOUNDARY-LAYER ACCUMULATIONS RESULTING FROM SECONDARY FLOWS WITHIN TURBINE STATORS. Warner L. Stewart and Robert Y. Wong. May 1954. 18p. diags., photo. (NACA RM E54B16) **CONFIDENTIAL**

A series of three single-passage nozzles, designed to turn the flow at different velocity levels but to identify outlet conditions, were investigated to determine whether secondary-flow accumulations of boundary-layer fluids within nozzles could be minimized by use of low-velocity turning. The results of the investigation indicated that this type of turning with subsequent acceleration is highly effective in minimizing secondary flow accumulations at the corner where the section surface joins the end walls. As applied to turbine stators, gains in turbine performance may be expected, provided that the long blade surfaces re-

Copies obtainable from NACA, Washington (over)

NACA RM E54B16
 National Advisory Committee for Aeronautics.
LOW-VELOCITY TURNING AS A MEANS OF MINIMIZING BOUNDARY-LAYER ACCUMULATIONS RESULTING FROM SECONDARY FLOWS WITHIN TURBINE STATORS. Warner L. Stewart and Robert Y. Wong. May 1954. 18p. diags., photo. (NACA RM E54B16) **CONFIDENTIAL**

A series of three single-passage nozzles, designed to turn the flow at different velocity levels but to identify outlet conditions, were investigated to determine whether secondary-flow accumulations of boundary-layer fluids within nozzles could be minimized by use of low-velocity turning. The results of the investigation indicated that this type of turning with subsequent acceleration is highly effective in minimizing secondary flow accumulations at the corner where the section surface joins the end walls. As applied to turbine stators, gains in turbine performance may be expected, provided that the long blade surfaces re-

Copies obtainable from NACA, Washington (over)

- CONFIDENTIAL**
1. Flow, Subsonic (1. 1. 2. 1)
 2. Flow, Supersonic (1. 1. 2. 3)
 3. Flow, Turbulent (1. 1. 3. 2)
 4. Cascades, Theory (1. 4. 5. 1)
 5. Boundary-Layer Characteristics - Internal Aerodynamics (1. 4. 7. 1)
 6. Turbines - Axial-Flow (3. 7. 1. 1)
- I. Stewart, Warner L.
 II. Wong, Robert Y.
 III. NACA RM E54B16
- 
CONFIDENTIAL

NACA RM E54B16
 National Advisory Committee for Aeronautics.
LOW-VELOCITY TURNING AS A MEANS OF MINIMIZING BOUNDARY-LAYER ACCUMULATIONS RESULTING FROM SECONDARY FLOWS WITHIN TURBINE STATORS. Warner L. Stewart and Robert Y. Wong. May 1954. 18p. diags., photo. (NACA RM E54B16) **CONFIDENTIAL**

A series of three single-passage nozzles, designed to turn the flow at different velocity levels but to identify outlet conditions, were investigated to determine whether secondary-flow accumulations of boundary-layer fluids within nozzles could be minimized by use of low-velocity turning. The results of the investigation indicated that this type of turning with subsequent acceleration is highly effective in minimizing secondary flow accumulations at the corner where the section surface joins the end walls. As applied to turbine stators, gains in turbine performance may be expected, provided that the long blade surfaces re-

Copies obtainable from NACA, Washington (over)

- CONFIDENTIAL**
1. Flow, Subsonic (1. 1. 2. 1)
 2. Flow, Supersonic (1. 1. 2. 3)
 3. Flow, Turbulent (1. 1. 3. 2)
 4. Cascades, Theory (1. 4. 5. 1)
 5. Boundary-Layer Characteristics - Internal Aerodynamics (1. 4. 7. 1)
 6. Turbines - Axial-Flow (3. 7. 1. 1)
- I. Stewart, Warner L.
 II. Wong, Robert Y.
 III. NACA RM E54B16
- 
CONFIDENTIAL

- CONFIDENTIAL**
1. Flow, Subsonic (1. 1. 2. 1)
 2. Flow, Supersonic (1. 1. 2. 3)
 3. Flow, Turbulent (1. 1. 3. 2)
 4. Cascades, Theory (1. 4. 5. 1)
 5. Boundary-Layer Characteristics - Internal Aerodynamics (1. 4. 7. 1)
 6. Turbines - Axial-Flow (3. 7. 1. 1)
- I. Stewart, Warner L.
 II. Wong, Robert Y.
 III. NACA RM E54B16
- 
CONFIDENTIAL

NACA RM E54B16

quired do not cause excessive wake losses and that three-dimensional effects on the boundary layer of the long blade do not appreciably increase the secondary flow accumulations. It is to be noted that the effect of reduced secondary-flow accumulation on turbine performance to date has not been evaluated.

CONFIDENTIAL

Copies obtainable from NACA, Washington



CONFIDENTIAL

NACA RM E54B16

quired do not cause excessive wake losses and that three-dimensional effects on the boundary layer of the long blade do not appreciably increase the secondary flow accumulations. It is to be noted that the effect of reduced secondary-flow accumulation on turbine performance to date has not been evaluated.

CONFIDENTIAL

Copies obtainable from NACA, Washington



CONFIDENTIAL

NACA RM E54B16

quired do not cause excessive wake losses and that three-dimensional effects on the boundary layer of the long blade do not appreciably increase the secondary flow accumulations. It is to be noted that the effect of reduced secondary-flow accumulation on turbine performance to date has not been evaluated.

CONFIDENTIAL

Copies obtainable from NACA, Washington



CONFIDENTIAL

NACA RM E54B16

quired do not cause excessive wake losses and that three-dimensional effects on the boundary layer of the long blade do not appreciably increase the secondary flow accumulations. It is to be noted that the effect of reduced secondary-flow accumulation on turbine performance to date has not been evaluated.

CONFIDENTIAL

Copies obtainable from NACA, Washington



CONFIDENTIAL

NACA RM E54B16
National Advisory Committee for Aeronautics.
**LOW-VELOCITY TURNING AS A MEANS OF
MINIMIZING BOUNDARY-LAYER ACCUMULATIONS
RESULTING FROM SECONDARY FLOWS WITHIN
TURBINE STATORS.** Warner L. Stewart and Robert
Y. Wong. May 1954. 18p. diags., photo. (NACA
RM E54B16) **CONFIDENTIAL**

A series of three single-passage nozzles, designed to turn the flow at different velocity levels but to identify outlet conditions, were investigated to determine whether secondary-flow accumulations of boundary-layer fluids within nozzles could be minimized by use of low-velocity turning. The results of the investigation indicated that this type of turning with subsequent acceleration is highly effective in minimizing secondary flow accumulations at the corner where the section surface joins the end walls. As applied to turbine stators, gains in turbine performance may be expected, provided that the long blade surfaces re-

Copies obtainable from NACA, Washington (over)

CONFIDENTIAL

1. Flow, Subsonic (1. 1. 2. 1)
 2. Flow, Supersonic (1. 1. 2. 3)
 3. Flow, Turbulent (1. 1. 3. 2)
 4. Cascades, Theory (1. 4. 5. 1)
 5. Boundary-Layer Characteristics - Internal Aerodynamics (1. 4. 7. 1)
 6. Turbines - Axial-Flow (3. 7. 1. 1)
- I. Stewart, Warner L.
II. Wong, Robert Y.
III. NACA RM E54B16

CONFIDENTIAL

NACA RM E54B16
National Advisory Committee for Aeronautics.
**LOW-VELOCITY TURNING AS A MEANS OF
MINIMIZING BOUNDARY-LAYER ACCUMULATIONS
RESULTING FROM SECONDARY FLOWS WITHIN
TURBINE STATORS.** Warner L. Stewart and Robert
Y. Wong. May 1954. 18p. diags., photo. (NACA
RM E54B16) **CONFIDENTIAL**

A series of three single-passage nozzles, designed to turn the flow at different velocity levels but to identify outlet conditions, were investigated to determine whether secondary-flow accumulations of boundary-layer fluids within nozzles could be minimized by use of low-velocity turning. The results of the investigation indicated that this type of turning with subsequent acceleration is highly effective in minimizing secondary flow accumulations at the corner where the section surface joins the end walls. As applied to turbine stators, gains in turbine performance may be expected, provided that the long blade surfaces re-

Copies obtainable from NACA, Washington (over)

NACA RM E54B16
National Advisory Committee for Aeronautics.
**LOW-VELOCITY TURNING AS A MEANS OF
MINIMIZING BOUNDARY-LAYER ACCUMULATIONS
RESULTING FROM SECONDARY FLOWS WITHIN
TURBINE STATORS.** Warner L. Stewart and Robert
Y. Wong. May 1954. 18p. diags., photo. (NACA
RM E54B16) **CONFIDENTIAL**

A series of three single-passage nozzles, designed to turn the flow at different velocity levels but to identify outlet conditions, were investigated to determine whether secondary-flow accumulations of boundary-layer fluids within nozzles could be minimized by use of low-velocity turning. The results of the investigation indicated that this type of turning with subsequent acceleration is highly effective in minimizing secondary flow accumulations at the corner where the section surface joins the end walls. As applied to turbine stators, gains in turbine performance may be expected, provided that the long blade surfaces re-

Copies obtainable from NACA, Washington (over)

CONFIDENTIAL

1. Flow, Subsonic (1. 1. 2. 1)
 2. Flow, Supersonic (1. 1. 2. 3)
 3. Flow, Turbulent (1. 1. 3. 2)
 4. Cascades, Theory (1. 4. 5. 1)
 5. Boundary-Layer Characteristics - Internal Aerodynamics (1. 4. 7. 1)
 6. Turbines - Axial-Flow (3. 7. 1. 1)
- I. Stewart, Warner L.
II. Wong, Robert Y.
III. NACA RM E54B16

CONFIDENTIAL

NACA RM E54B16
National Advisory Committee for Aeronautics.
**LOW-VELOCITY TURNING AS A MEANS OF
MINIMIZING BOUNDARY-LAYER ACCUMULATIONS
RESULTING FROM SECONDARY FLOWS WITHIN
TURBINE STATORS.** Warner L. Stewart and Robert
Y. Wong. May 1954. 18p. diags., photo. (NACA
RM E54B16) **CONFIDENTIAL**

A series of three single-passage nozzles, designed to turn the flow at different velocity levels but to identify outlet conditions, were investigated to determine whether secondary-flow accumulations of boundary-layer fluids within nozzles could be minimized by use of low-velocity turning. The results of the investigation indicated that this type of turning with subsequent acceleration is highly effective in minimizing secondary flow accumulations at the corner where the section surface joins the end walls. As applied to turbine stators, gains in turbine performance may be expected, provided that the long blade surfaces re-

Copies obtainable from NACA, Washington (over)

CONFIDENTIAL

1. Flow, Subsonic (1. 1. 2. 1)
 2. Flow, Supersonic (1. 1. 2. 3)
 3. Flow, Turbulent (1. 1. 3. 2)
 4. Cascades, Theory (1. 4. 5. 1)
 5. Boundary-Layer Characteristics - Internal Aerodynamics (1. 4. 7. 1)
 6. Turbines - Axial-Flow (3. 7. 1. 1)
- I. Stewart, Warner L.
II. Wong, Robert Y.
III. NACA RM E54B16

CONFIDENTIAL

CONFIDENTIAL

1. Flow, Subsonic (1. 1. 2. 1)
 2. Flow, Supersonic (1. 1. 2. 3)
 3. Flow, Turbulent (1. 1. 3. 2)
 4. Cascades, Theory (1. 4. 5. 1)
 5. Boundary-Layer Characteristics - Internal Aerodynamics (1. 4. 7. 1)
 6. Turbines - Axial-Flow (3. 7. 1. 1)
- I. Stewart, Warner L.
II. Wong, Robert Y.
III. NACA RM E54B16

CONFIDENTIAL

CONFIDENTIAL

NACA RM E54B16

quired do not cause excessive wake losses and that three-dimensional effects on the boundary layer of the long blade do not appreciably increase the secondary flow accumulations. It is to be noted that the effect of reduced secondary-flow accumulation on turbine performance to date has not been evaluated.



CONFIDENTIAL

CONFIDENTIAL

Copies obtainable from NACA, Washington

NACA RM E54B16

quired do not cause excessive wake losses and that three-dimensional effects on the boundary layer of the long blade do not appreciably increase the secondary flow accumulations. It is to be noted that the effect of reduced secondary-flow accumulation on turbine performance to date has not been evaluated.



CONFIDENTIAL

Copies obtainable from NACA, Washington

CONFIDENTIAL

NACA RM E54B16

quired do not cause excessive wake losses and that three-dimensional effects on the boundary layer of the long blade do not appreciably increase the secondary flow accumulations. It is to be noted that the effect of reduced secondary-flow accumulation on turbine performance to date has not been evaluated.



CONFIDENTIAL

CONFIDENTIAL

Copies obtainable from NACA, Washington

NACA RM E54B16

quired do not cause excessive wake losses and that three-dimensional effects on the boundary layer of the long blade do not appreciably increase the secondary flow accumulations. It is to be noted that the effect of reduced secondary-flow accumulation on turbine performance to date has not been evaluated.



CONFIDENTIAL

Copies obtainable from NACA, Washington