

UNCLASSIFIED

AD NUMBER: AD0072176

LIMITATION CHANGES

TO:

Approved for public release; distribution is unlimited.

FROM:

Distribution authorized to U.S. Gov't. agencies and their contractors; Administrative/Operational Use; 17 Sep 1947. Other requests shall be referred to the Office of Naval Research, Washington, DC 20360.

AUTHORITY

ONR ltr dtd 9 Nov 1977

72176

Armored Services Technical Information Agency

Reproduced by

DOCUMENT SERVICE CENTER

KNOTT BUILDING, DAYTON, 2, OHIO

NOTICE: WHEN GOVERNMENT OR OTHER DRAWINGS, SPECIFICATIONS OR OTHER DATA ARE USED FOR ANY PURPOSE OTHER THAN IN CONNECTION WITH A DEFINITELY RELATED GOVERNMENT PROCUREMENT OPERATION, THE U. S. GOVERNMENT THEREBY INCURS NO RESPONSIBILITY NOR ANY OBLIGATION WHATSOEVER; AND THE FACT THAT THE GOVERNMENT HAS FORMULATED, FURNISHED, OR IN ANY WAY SUPPLIED THE SAID DRAWINGS, SPECIFICATIONS, OR OTHER DATA IS NOT TO BE REGARDED BY ANY PERSON OR CORPORATION, OR CONVEYING ANY RIGHTS OR PERMISSION TO MANUFACTURE, OR TO SELL OR PATENTED INVENTION THAT MAY IN ANY WAY BE RELATED THERETO.

UNCLASSIFIED

BEST

AVAILABLE

COPY

D-15

PRODUCT
WINDMILL

Contract N5ori69



REF ID: R-124

ITIC 100 1000

Project Whirlwind
Servomechanisms Laboratory
Massachusetts Institute of Technology
Cambridge, Massachusetts

SUBJECT: MAGNETIC RECORDING - ITS USE FOR STORAGE OF INFORMATION IN
ELECTRONIC COMPUTERS

Written by: E. S. Rich

Date: September 17, 1947

FOREWORD

The following report contains a survey of the field of magnetic recording, a summary of the work done in this field in the Center of Analysis at M.I.T. from September 1946 to June 1947, and recommendations for further experimental work. The purpose of the work was to investigate magnetic recording as a means for storing information for electronic computing machines.

TABLE OF CONTENTS

	Page Number
FOREWORD	1
SUMMARY	
Work done to date	2
Recommendations for further experimental work	3
DISCUSSION	
The nature of a magnetic recording	4
Types of magnetic recordings	4
Types of head construction	4
Comparison of types of recordings and types of heads	4
Methods of recording	4
Signal reproduction	5
Erasing	6
Frequency response of a magnetic recording system	6
Requirements in a recording system	7
Experimental magnetic recording system	9
Results of tests on Experimental System	11
	12
RECOMMENDATIONS FOR FURTHER EXPERIMENTAL WORK	15
REFERENCES	18
APPENDIX	
B-H curve tracer	19
Table of symbols and definitions	19
Description of magnetic materials	23
List of drawings	24
	26

SUMMARYWork Done to Date

Up to the present time, the investigation of magnetic recording systems for storage purposes has covered only some preliminary stages of construction of test equipment, design of recording, playback, and erasing heads, and comparison of different types of recording media. This preliminary work was undertaken to determine the best recording medium and the best system design for testing various storage methods. Since a maximum number of words per unit length of the medium is desirable for efficient storage, the upper frequency limit of a recording for a given linear speed of the medium was taken as a measure of the system performance.

The recording equipment used was designed and constructed in the laboratory. It consisted of pulleys arranged on a panel to hold a short loop of a recording medium and draw it at a uniform speed over the erasing, recording, and playback heads. Suitable amplifiers connected to these heads allowed the recording and reproduction of continuous sinusoidal signals. Six different recording media were tested, three of these being paper or cellulose acetate tapes coated with a powdered magnetic material and the others being solid metal tapes. A tape speed of 8"/sec was used in all tests.

All of the heads were of ring-type core construction, since such cores permit recording of higher frequencies than is possible with other types. They were oriented so as to produce longitudinal magnetization in the tapes. Demagnetization by means of a 50-KC field accomplished the erasing process, and a high-frequency bias in the recording head provided a minimum of amplitude distortion in the recorded signal. These methods were chosen instead of erasing by saturating the medium and using a d-c bias to provide a linear characteristic because of the higher signal-to-noise ratio obtainable.

In articles in the literature it has been shown that a high residual flux density in the recording medium gives high output at low frequencies, while a high coercive force contributes to a high output at high frequencies. The ideal response of the system for a constant recording-signal current is an output voltage proportional to frequency. However, at high frequencies the output voltage decreases rapidly because of self-demagnetization in the medium, demagnetization caused by leakage flux around the working gap of the recording head, decreased flux penetration in the medium as a result of skin effect, and a decrease in flux linkages through the playback head because of its finite air-gap width. Self-demagnetization is a function of the slope of the demagnetizing portion of the B-H curve; therefore the ratio of residual flux density, B_r , to coercive force, H_c , has been described as a figure of merit for the high-frequency response of a given medium. For a low B_r to H_c ratio, self-demagnetization is less and the output at high frequencies is greater.

Demagnetization caused by leakage flux at the recording head is minimized by using a core material with the highest permeability possible at the flux densities involved and recording with the minimum flux density consistent with output requirements.

Hysteresis loops and frequency response curves were plotted for the six magnetic tapes previously mentioned. The best high-frequency response was obtained from one of the powder-coated tapes which had a coercive force of about 350 oersteds and the lowest B_r to H_c ratio, which was about 2.2. The difference

in response between solid metal tapes and coated ones, however, was not wholly indicated by this ratio. For example, a solid tape having an H_c of 215 oersteds and B_R to H_c ratio of 28 gave approximately the same high frequency response as a coated tape having an H_c of 130 oersteds and a B_R to H_c ratio of 5.4. In general a high coercive force is desirable in a magnetic recording medium, but this value is limited to about 400 oersteds because of the difficulty of producing sufficient MMF in the heads for erasing and recording.

Operating with optimum values of signal and bias currents for good high-frequency response, it was found that the best powder-coated tape was one obtained from Minnesota Mining and Manufacturing Company and the best solid metal tapes were Vicalloy and the Brush Development Company's plated tape, the latter two giving approximately equal results. The Vicalloy tape is a homogeneous metal, whereas the Brush plated tape has a thin magnetic plating on a brass strip. Assuming a minimum signal-to-noise ratio of 25 db as defining the upper frequency limit of recording, it was observed that the MM powder-coated tape allowed a maximum of about 1200 cycles per inch of tape, while the Vicalloy and the Brush plated tape each allowed about 800 cycles per inch.

Recommendations for Further Experimental Work.

The best method for utilizing a magnetic recording medium for storage of information must be determined by further research. Since the speed at which the medium is driven governs the rate at which information can be recorded and removed, this speed should be as high as possible. The limit in this respect would be set by the mechanical considerations of strength of the medium, wear on the heads and on the medium, and maintenance of uniform contact between the heads and the medium. Based on reports of work at other institutions, a speed of 50 to 100 feet per second should be practicable.

Pulse signals instead of modulated sinusoidal signals should be investigated. It is reasonable to assume that a discrete pulse can be recorded on the same length of tape or wire that would be required for the minimum number of cycles of a sinusoidal signal that would excite the circuits of the reading equipment. On the basis of the response figures stated above, about 200 pulses per inch might be recorded. In addition, the use of pulse signals would greatly simplify the design of the recording and reproducing circuits.

Means for improving head design should be studied. A determination of the leakage field around the recording head would be particularly helpful in selecting the core material and method of core construction. For high-speed operation a ring-type erasing head could not be used, so an alternate type would have to be designed and tested. The windings on the recording and playback heads also would have to be designed for the high frequencies or short pulses used.

Multichannel recording on a flat tape is feasible, and possible applications of this method of recording to computer problems should be determined. By using heads with thin cores, the desired narrow recording paths may be obtained. In a commercial disk recorder manufactured by the Brush Development Company a spiral path is used, giving the equivalent of 40 channels per inch.

Means for locating a particular piece of recorded information are essential in computer applications. This probably will have to be done by recorded marking and synchronizing signals which govern the driving mechanism. The way in which this control may be obtained is a problem in electrical and mechanical design which might be solved by the application of servomechanism principles or by a suitable arrangement of clutches. Multichannel recording offers certain advantages over single-channel recording in the solution of these problems: with multichannel recording more information can be stored on a given length of the medium, so that less movement of the medium is required to locate and reproduce the information.

DISCUSSION

The Nature of a Magnetic Recording

A recording on a magnetic medium such as a wire or tape consists of variations in the intensity of magnetization along the medium. These variations in intensity of magnetization are usually produced by drawing the recording medium at a uniform speed past the pole pieces of a recording head and varying the magnetomotive force of this recording head in the desired manner. To reproduce the recording, the medium is drawn past the pole pieces of a playback head, and the change of flux linkages induces a voltage in this head corresponding to the signal impressed on the medium. A recording may be erased or removed from the medium simply by passing it either through a strong unidirectional magnetic field which saturates all portions of the medium or by passing it through a strong alternating field to demagnetize it. A comparison of these methods of erasing will be made in a following section.

Types of Magnetic Recordings

Magnetic recordings may be classified into three types depending on how the magnetizing field is applied to the medium: (1) longitudinal, (2) perpendicular, and (3) transverse, in which the magnetizing MMF gradient is respectively along the length of the medium, along the thickness dimension, or along the width dimension as shown in Fig. 1. For a round wire, perpendicular and transverse recordings are, of course, identical.

Types of Head Construction

In order to evaluate these types of recordings, some knowledge of recording and playback head construction is necessary. A few general types of core construction are shown in Fig. 2. It is seen that these may have open or closed magnetic circuits and may have pole tips on one or both sides of the medium. The designs of Figs. 2(a) and 2(b) are applicable to transverse as well as perpendicular recording merely by changing the orientation of the pole pieces so that they contact the edges of the medium rather than top and bottom. The designs of Figs. 2(a) and 2(b) may also be used for longitudinal recording by shifting one pole piece slightly along the longitudinal axis of the tape as in Fig. 2(b). The ring type core of Fig. 2(c) is used primarily for longitudinal magnetization.

Comparison of Types of Recordings and Types of Heads

Longitudinal magnetization is used almost exclusively in present-day magnetic recording equipment. The chief reason for this is that the ring-type

core with a very small air gap allows a signal of shorter wavelength to be recorded and reproduced than is possible with other types of core construction. An air-gap length of 0.0005" is easily obtained with ring-type cores. For perpendicular or transverse recording, core construction of the types of Figs. 2(a) and 2(b) is necessary and the shortest wavelength that can be recorded is, to a first approximation at least, limited by the thickness of the pole pieces. To be mechanically rigid these pole pieces must be of the order of a few thousandths of an inch thick, so the shortest recorded wavelength is several times that obtainable with the ring-type core. This comparison is evident from Figs. 3(a) and 3(c). The fact that solid metal recording materials are more easily magnetized in the direction of rolling or drawing and that the ring-type head allows easy removal of the tape or wire and does not require adjustment are further reasons for the use of longitudinal type recording. From a practical point of view, a perpendicular or transverse recording in the case of a wire recording material is ruled out by the tendency for the wire to twist as it is drawn past the heads.

Methods of Recording.

The residual flux which constitutes the recording on a magnetic material is related to the MMF of the recording head by the familiar B-H curves of that material, so this relation can be considered linear only over a restricted range. In recording systems where amplitude distortion of the reproduced signal must be kept to a minimum, it is necessary to use a "biasing" MMF in the recording process to ensure that the desired linear transfer characteristic is obtained. Prior to about 1942, the recording method in use employed a constant unidirectional biasing MMF in the recording head and a recording medium that had been saturated in the erasing process by a unidirectional magnetic field. The erasing process leaves all portions of the medium with a flux density B_p as shown in Fig. 4. The biasing MMF is of the proper magnitude and direction to reduce the flux density in the portion of the medium at the pole pieces of the recording head to the value indicated by point P of the hysteresis loop of Fig. 4. If a signal MMF, $H(t)$, is superimposed on the biasing MMF, H_p , the amount by which the flux density of a given element of the medium is reduced is determined by the total MMF in the recording head at the time that element is at the pole pieces of the head. If the minimum MMF is H_1 and the maximum is H_2 , the flux density of successive elements will be lowered to values corresponding to points between M and N on the B-H curve of Fig. 4. When the tape elements leave the recording head the applied MMF drops to zero and the residual flux density rises along minor hysteresis loops to corresponding values between M' and N'. By proper choice of biasing MMF and signal amplitude, then, an approximately linear relation between signal and recorded flux may be obtained.

About 1942 a recording method employing a high-frequency or superaudio bias was adopted. This method permits recording on a demagnetized medium, so that the noise level of the output is much less than for a saturated medium, while the maximum signal amplitudes are approximately equal in the two cases. This improvement in signal-to-noise ratio has resulted in almost universal adoption of the high-frequency bias where minimum non-linear distortion is desired. A signal-to-noise ratio of 50 db with only a few percent distortion is practicable with this method of recording. Bias frequencies used in commercial sound recording equipment are in the range from 20 KC to 60 KC.

A complete theory of recording on a magnetic medium by the high-frequency bias method has not been published. Such a theory would involve consideration of magnetic skin effect, the finite width of pole pieces or recording air gaps, demagnetization in the medium, and leakage flux about the recording head. However, a qualitative explanation of the recording process neglecting these effects is easily made. Assume a bias frequency of 30 KC, a signal frequency of 1000 cps, a tape speed of 10"/sec, and a recording air-gap width of 0.001". For this case any element of the recording medium is in the recording gap for 100 μ sec or 3 cycles of the bias MMF. The total MMF applied to an element of the recording medium is the instantaneous sum of the signal and bias MMF's as shown in Fig. 5(a). The bias MMF amplitude is approximately that required to just pass the lower knee of the magnetization curve. An element of the medium in passing the gap of the recording head, then, is subjected to an MMF which forces the flux density in the medium through a series of minor hysteresis loops as shown in Fig. 5 (c), (d), and (e). These figures are for elements of the medium that enter the gap at times t_1 , t_2 , and t_3 , respectively (see Fig. 5 (b)). Upon leaving the gap these elements have residual flux densities of B_1 , B_2 , and B_3 as shown in the figures. The effect of this high frequency bias is to remove the curved portion of the magnetization curve at the origin and give a linear relation between signal MMF and residual flux density. It should be pointed out again that the preceding explanation is incomplete since an accurate plot of residual flux density against signal MMF would show a component of the bias frequency present. In practice this is not observed primarily because of the effect of demagnetization in the medium. This effect, which will be discussed later in connection with magnetic properties of recording media, causes elements of the medium having a length that is small compared with thickness to be brought to essentially the same residual flux density, so that the bias-frequency component is lost.

Signal Reproduction

The reproduction of a signal that has been recorded on a magnetic medium is essentially the same for all types and methods of recording. The types of core construction shown in Fig. 2 apply to playback as well as recording heads. For a given system the orientation of the pole pieces or the air gap should correspond to those of the recording head so that a maximum number of flux linkages through the playback head winding will be produced by the residual flux from the recording medium. It has been found that the ring-type core is superior to other types for playback heads for the same reasons as for recording heads.

Erasing

As has been previously mentioned, a recorded signal may be erased either by saturation or by demagnetization of the recording medium. Saturation is easily accomplished either with a permanent magnet or with an electromagnet of a type similar to one of those of Fig. 2. For this purpose, of course, neither narrow pole pieces nor a short air gap is necessary. An obvious method for demagnetizing a recording medium is to pass it through the center of a coil in which alternating current is flowing. This method is not generally used

however, because shielding of the recording and playback heads from the high leakage field becomes a problem. Present practice is to use a closed core as shown in Fig. 2(c) having an air gap of 0.010" to 0.020" in contact with the recording medium. A high-frequency MIF of sufficient magnitude to raise the flux density of the medium to saturation is applied to the medium while it is passing this air gap. As the tape leaves the gap, the flux density is effectively reduced to zero by the demagnetizing effect mentioned in connection with the recording process.

Frequency Response of a Magnetic Recording System.

It is very difficult, if not impossible, to compute theoretically the frequency response characteristic of a given magnetic recording system, if it could be assumed that a constant current in the recording-head winding produced a constant magnetizing MIF and hence a constant residual flux density for all frequencies, then the voltage generated in a ring-type playback head under ideal conditions would be

$$e = K_1 \frac{d}{dt} (\phi \sin \omega t)$$

$$= K_2 f \phi \cos \omega t$$

This corresponds to a straight line rising 6 db per octave when output voltage in db is plotted against the log of frequency as shown by the broken line in Fig. 6. The actual response from a typical recording system for a constant recording current falls below the ideal response both at low frequencies and at high frequencies as shown by the solid curve of Fig. 6. The drop at the low-frequency end occurs when the wavelength of the recorded signal is comparable to the physical dimensions of the playback head. By reference to Figs. 7(a) and (b), it is seen that when the recording medium is in a position to produce the maximum flux through the playback head, only a fraction of the total flux links the windings for long wavelengths while substantially all of the flux links the windings for short wavelengths. This results in a decreased output voltage for very low frequencies.

The drop in output at the high-frequency end is due to several factors, the major ones being demagnetization in the recording medium, leakage field about the recording head, and the scanning effect caused by the finite width of the air gap in the playback head. Magnetic skin effect in the recording medium and eddy currents in the core of the playback head may also contribute under certain conditions.

It is well known that as the ratio of the length of a bar magnet to its thickness decreases, the field at one end of the magnet due to the pole at the other end decreases. This "self-demagnetization" reduces the total field strength. At high frequencies, then, when the half-wavelength of a recorded signal approaches the thickness of the medium a similar condition exists where

the section of the medium a half-wavelength long is considered as an individual magnet. For a magnetic tape 0.001" thick running at a speed of 10 inches per second, the frequency having a half-wavelength equal to the tape thickness is 5000 cycles per second.

A continuous recording of a sinusoidal signal may be considered as a series of magnets each a half-wavelength long with like poles placed next to each other. For this case the field at any point is a resultant of the field of all magnets in the vicinity. As the length of these magnets decreases, the influence of neighboring magnets becomes more pronounced and reduces the effective field of an individual magnet. The magnitudes of these demagnetizing factors are difficult to calculate since they depend not only on physical dimensions but also on the distribution of the magnetization and the magnetic properties of the recording medium. However, it can be shown that materials of high coercive force and low residual magnetism suffer less demagnetization than materials of low coercive force and high residual magnetism.

The flux that enters the recording medium from a ring-type recording head is that which fringes the air gap. In the ideal case this flux enters the medium only in the area that is between the gap faces as in Fig. 8(a). Actually the leakage flux around the recording gap spreads beyond the gap faces and enters the tape on either side of the gap as shown in Fig. 8(b). It is evident that if the direction of the recording MMF is reversed before a magnetized element of the medium leaves the region of this leakage field, the element will suffer some demagnetization. This situation, of course, exists when short-wavelength or high-frequency signals are being recorded. The use of a core material having a high-saturation flux density and recording with as low an MMF as possible helps to minimize demagnetization by this leakage field.

The decrease in output as frequency is increased that is caused by the finite width of the air gap in the playback head is readily computed to be the function

$$\frac{\sin \pi \frac{S}{\lambda}}{\pi \frac{S}{\lambda}}$$

where S is the gap width and λ is the wavelength of the recorded signal. The loss due to this effect, however, is a small part of the total loss. For example, a signal of 10 KC recorded at a speed of 10"/sec has a wavelength of 0.001", and assuming $S = 0.0005$ " the value of the above function is $\frac{2}{\pi}$, or about 4 db. The total loss under these conditions is normally several times this value.

The effect of eddy current set up in the magnetic medium during the recording process and in the core of the playback head during playback have not

been evaluated. If the operating speed is such that very high frequencies are recorded, it is reasonable to assume that some loss in output at high frequencies occurs as a result of these eddy currents. The cores of playback heads are usually laminated to minimize eddy current losses in the reproducing process. Of course skin effect at the bias frequency limits the penetration of flux into the recording medium, but this causes a decrease in output level for all signal frequencies and would not affect the shape of the response curve.

Requirements in a Magnetic Recording System.

The design of a complete magnetic recording system involves consideration of many factors. Certain properties in the recording medium, the head and the drive mechanism are basic requirements, while the materials used, the actual form of the equipment, and its operating speed are determined by the particular application for which the system is intended. From the information contained in the preceding discussion it is possible to enumerate some of these requirements.

High coercive force and low residual magnetism are essential properties in a recording medium where maximum high-frequency response or good resolution of pulsed signals is desired. However, in practice coercive force is limited to 350 to 400 oersteds by the difficulty of obtaining sufficiently high magnetizing fields in the recording head without excessive leakage flux. The value of residual magnetism also must be sufficient so that a usable output level is obtained from the playback head. Reducing the thickness of a tape or the diameter of a wire decreases the demagnetization of a recorded signal. The limit to reduction in size in this respect is set by considerations of mechanical strength and output level. High resistivity is another desirable property in the recording medium. Higher resistivity reduces the magnetic skin effect and allows greater penetration of flux in the recording process. The choice of solid metal or powdered materials and of tape, wire, or disc form depends on the particular application of the system. Solid metal materials are mechanically strong and experience little wear with use. Powdered materials coated on a suitable backing give better high-frequency response, but have a low output and wear out after a few thousand playings. Wire occupies less space than flat tape when wound onto a reel so is advantageous when a long recording time is desired.

It is evident that for the core of the recording head a high-permeability material should be used. In particular it should have the highest saturation flux density possible along with a negligible residual magnetism. It must also be of laminated construction to reduce eddy current effects particularly at the bias frequency. To facilitate winding of the coils on ring-type heads, the cores are usually made in two parts, and the faces on these two parts are ground to give a good fit on assembly. No spacer is used in the recording gap if maximum high-frequency response is desired. The type of winding used depends somewhat on the design of the amplifiers supplying the bias and recording signals. Both high-impedance and low-impedance windings are found on commercial recording equipment, the former type being coupled directly to the plate of the output amplifier and the latter coupled through a suitable

transformer. Where high bias and signal frequencies are employed, transformers generally cannot be used. Furthermore, care must be taken to keep distributed capacity in the coil to a minimum to avoid resonance effects within the operating range. Separate windings for the bias and recording signals may be utilized, and have the advantage of more simple amplifier design when economy of tubes is not important.

The core of the playback head should satisfy the general requirements of low loss and negligible residual magnetism as in the case of the recording head. However, its important characteristic is initial permeability, which should be as high as possible. Although best results would be expected from a magnetic circuit having a single air gap, it is more practical to divide the core as has been described for the recording head. Symmetry in the core and in the windings placed on the two halves gives the further advantage of less pickup from extraneous magnetic fields. In any case magnetic shielding of the playback head is essential, especially with low-output-level recording media such as the powdered materials. A high-impedance winding to connect directly to the grid of the playback amplifier is usually satisfactory, although a low-impedance winding and step-up transformer may be desirable if the head is very small or if the core has been formed in one piece.

The requirements for the core material of the erasing head are identical with those of the recording head. Its features of construction are also the same except that a gap of 0.010" to 0.020" is necessary. Its winding should be designed to obtain a maximum power transfer from the erasing amplifier.

For faithful reproduction, the recording medium should pass the recording and the playback heads at as nearly a constant speed as possible, since fluctuation in speed will cause variations in both the amplitude and the frequency of the reproduced signal. For this reason some type of friction drive is used instead of gears or belts. Usually a mechanical filter arrangement such as a rubber-tired idler engaging both the motor shaft and the rim of a flywheel on the drive shaft is incorporated in the speed reducer design.

The choice of the form of the recording medium determines other requirements in mechanical construction of a recording system. For long recordings on tape, suitable reels and a rewinding mechanism are necessary. This also applies to long recordings on wire, but in this case level-winding devices to prevent bunching of the wire on the reels must be provided. For recordings of a few seconds or less a continuous loop of tape or wire may be formed and passed over a series of pulleys; a disc of magnetic material might also be used.

Since slight variations in the contact between the recording medium and the recording and playback heads will cause considerable variation in amplitude of the reproduced signal, the medium must be guided so that these do not occur. Equally important for good high-frequency response is proper alignment of the recording and playback gaps. Both gaps should make the same angle with the direction of tape motion. Since for high frequencies the wavelength on the tape approaches the order of magnitude of the gap width, a small difference in these angles will cause a substantial loss in output. The difficulty of maintaining this adjustment in commercial equipment prevents the use of wide cores to increase the signal level from the playback head.

Experimental Magnetic Recording System

The general features of the recording system designed for experimental purposes in the Center of Analysis Laboratory are shown in Figs. 9 and 10. The base and front are of 1/4" aluminum and of standard panel width for mounting in a rack. The pulleys shown will accommodate loops of tape from 54" to 60" long and up to 1/4" wide. A brass idler pulley maintains tension in the tape. The mounting plates for the heads may be tilted in any direction by thumbscrew adjustment. They also may be raised and lowered and rotated about an axis perpendicular to the tape. This flexibility in the head mounting allows different sizes and types of heads to be adapted to the machine. The drive shaft is mounted on ball bearings with the drive pulley on the front and a brass flywheel behind the panel. The drive pulley is turned by friction between the flywheel rim and a rubber-tired wheel on the motor shaft. The motor is a 1/125 HP d-c motor with split field windings. To obtain an adjustable speed over a wide range by field control, the field windings are connected in parallel to a 220-volt line through suitable rheostats and the armature is supplied from a 110-volt line. There are two rubber wheels on the motor shaft so that two ranges of speed can be obtained by shifting the motor to engage one or the other wheel with the flywheel. By this arrangement the speed may be adjusted from about 3.5"/sec to 6"/sec and from 11"/sec to 5"/sec. The speed controls and an on-off switch, as well as input and output plugs, appear on the front panel.

A schematic diagram of the complete recording system is shown in Fig. 11. The amplifier circuits and head construction were changed from time to time, and space does not permit a description of all the designs tested. Those that were used to obtain the curves included in this report, however, will be described.

The erasing head has a split ring-type core of 0.003" x 1/4" Hipersil laminations stacked to a thickness of 1/8", the laminations being perpendicular to the radial direction of the core. This core was obtained from a Raytheon UX-7360 pulse transformer. The head has a single winding of 25 turns of No. 25 wire and a working air gap about 10 mils. wide. At 50 KC this head has an inductance of 3.2 mh and a Q of about 5.

The recording head is also of split ring-type construction but is made of 0.005" 4-79 Mo-Sernalloy laminations. In this head the laminations are parallel to the radial direction and are stacked to a depth of 1/8", making the face of the head 1/8" wide as compared with 1/4" for the erasing head. The laminations are shaped so that the width of a lamination tapers to 1/16" at the working gap as shown in Fig. 12. Two windings are placed on each half of the core. The signal winding consists of 26 turns on each half or a total of 52 turns, and the bias winding 150 turns on each half or a total of 300 turns. Number 29 wire is used for all windings. Since the faces of the cores were ground to a close fit, it is estimated that the working gap of this head is less than 0.0005". The bias winding has an inductance of 6.3 mh and a Q of about 2 at 50 KC. The signal winding has an inductance of 410 mh at 1 KC.

The playback head is a Brush Development Company type BK-919 head. It has a core $1/8$ " wide of laminations approximately 0.015" thick and is mounted in a molded bakelite holder encased in a magnetic shield. The core is a split ring type with a winding on each half. The two halves with their windings are symmetrical to reduce pickup from extraneous fields. Data on the number of turns of the windings is not available, but the measured inductance is 300 mh at 1 KC.

As can be seen on the diagram of Fig. 11, four separate amplifiers are used in the complete recording system: for erasing, bias, recording, and playback respectively. Circuit diagrams for these are shown in Figs. 13, 14, 15, and 16.

The erasing amplifier, Fig. 13, and bias amplifier, Fig. 14, are similar; they consist of an inverter stage driving a push-pull power amplifier stage. The plate loads of these power stages consist of the windings of the respective heads tuned for parallel resonance at 50 KC and coupled to the plates of the tubes through suitable condensers. The small resistance in series with the bias winding provides a means of measuring bias current. Maximum values of 50 ma erasing current and 35 ma bias current were required for the heads used.

The recording amplifier, Fig. 15, also consists of an inverter and push-pull power amplifier but is coupled to the signal winding of the recording head through a transformer. It was designed to provide a constant current of 20 ma max. through the winding for constant input voltage over a frequency range of 100 to 18,000 cps. The desired constant current characteristic is obtained by providing a negative feedback voltage proportional to output current.

The playback amplifier, Fig. 16, is a two-stage R-C coupled amplifier having an essentially flat frequency response from 100 to 18,000 cps. To prevent the appearance of any 50 KC voltage from the erase or bias fields in the amplifier output, a low-pass filter with cutoff at 20 KC was added. With this filter the amplifier response at 50 KC is 50 db below that at 18 KC. Its gain at 1000 cps is 26.3 times or 28.4 db.

Results of Tests on Experimental System.

With the recording equipment described above tests were conducted with six different recording media to evaluate the performance of the equipment and determine what factors required further investigation to improve high-frequency response or resolution of discrete signals representing coded information. Up to the present time the data obtained is insufficient to allow conclusive statements to be made regarding some features of the system and recording media. Certain results however are significant.

The recording media used in the tests were all of tape form and included both powdered materials and solid metals, one of the latter being in the form of a plating on a brass tape. These tapes were the following:

	<u>DESCRIPTION</u>	<u>TYPE</u>	<u>SOURCE</u>
1.	Vicalloy	Solid metal	Bell Labs.
2.	Steel	Solid metal	Cut from a sheet found in laboratory
3.	Brush plated	Solid metal plated on brass	Brush Development Co.
4.	MMH	Powder coated on cellulose acetate film	Minn. Min'g & Mfg. Co.
5.	Brush paper	Powder coated on paper	Brush Development Co.
6.	Kyflux	Powder coated on paper	Indiana Steel Products Co.

Drawings showing cross-sectional dimensions of these tapes and the magnetic materials in them are presented in Fig. 17.

Hysteresis loops for each of the materials in tape form for a 60 cps magnetizing force were obtained by means of the B-H curve tracing equipment described in the Appendix. From these curves the following values of coercive force and residual flux density were determined.

<u>DESCRIPTION</u>	<u>COERCIVE FORCE (H_c)</u> <u>(OERSTEDS)</u>	<u>RESIDUAL FLUX DENSITY (B_r)</u> <u>(GAUSS)</u>
1. Vicalloy	235	5000
2. Steel	85	6700
3. Brush plated	215	6000
4. MMH	345	750
5. Brush paper	130	700
6. Kyflux	(130)*	(1400)*

* For peak MMF of 1300 oersteds. The magnetic material in the Kyflux tape has an exceptionally high coercive force and the available magnetizing equipment would not produce sufficient MMF to saturate it. For this reason the figures given above for Kyflux are not the true values of H_c and B_r but are somewhat lower.

In Figure 18 are shown the complete hysteresis loops for these tapes all drawn to the same scale. These curves and the tabulated values of H_c and B_R obtained from them are included primarily to show the order of magnitude of the quantities being considered. Because of limitations in the test equipment, sources of error exist which have not been measured precisely. From correlation with known values, however, it is estimated that the errors do not exceed 10 percent.

All of the tests performed on the recording equipment were at a tape speed of 3"/sec, which of itself imposed an upper frequency limit of about 10,000 cps on the recording. This was done to reduce tape wear, reduce amplifier design problems, and allow use of a lower bias frequency. Neglecting second order effects, the shape of the frequency response curve is a function of tape wavelength rather than actual frequency. Therefore, tests taken at a low speed were considered to be indicative of system performance at higher speeds.

A frequency of 50 KC was used both for bias and erasing. It was observed that for ratios of bias frequency to signal frequency of less than 5, modulation effects occurred, causing distortion of the output signal.

As might be expected, the maximum level of the recording signal for distortionless recording varies with different recording media, with bias amplitude, and with recording frequency. In the tests to be described the recording signal level was kept sufficiently low to avoid serious distortion from any of these causes.

Comparative response curves for the six recording media with approximately their normal values of bias current are shown in Fig. 19. The general shape of each curve corresponds to the typical response of Fig. 6. The output levels at low frequencies to a first approximation are the comparative signal levels that can be expected from the different media. It can be seen that there is a direct relationship between these levels and the respective values of B_R previously tabulated. The curve for Brush plated tape does not show this directly since it is a narrow tape having a width roughly 1/10 that of the recording path on the other tapes. However, since the signal-to-noise level is approximately the same for all media, this difference in output level at low frequencies can be compensated for by proper amplifiers. Therefore, it is the frequency or more accurately the wavelength at which maximum response occurs and the slope of the response curve for high frequencies that indicate the merit of the recording system.

As has been pointed out previously, demagnetization in the tape and leakage flux at the recording head are principal factors causing the decrease in response at short wavelengths. Since the demagnetization factor depends on the B_R ratio, as would be expected there is a correlation between the frequencies

at which maximum response occurs in Fig. 19 and the shape of the B-H curves of Fig. 18. The steel tape has the highest $\frac{B_R}{H_C}$ ratio and lowest maximum-response frequency, while the MM tape has the lowest $\frac{B_R}{H_C}$ ratio and highest maximum-response frequency.

The magnitude of the drop in high-frequency response caused by leakage flux at the recording head is not evident from the response curves of Fig. 19. However, the effect of this factor is illustrated in Fig. 20 and 21, which are response curves for two recording media for different values of bias current. For the higher values of bias current, or recording MM, the maximum-response frequency is lowered and the response curve falls more rapidly with increasing signal frequency.

Some information on the variation in frequency response with changes in bias frequency was also obtained. The tests which were made show only a comparison between bias frequencies of 50 KC and 140 KC where the magnitudes of the respective bias currents were adjusted to give equal outputs for low signal frequencies. Figure 22 shows the results for the Brush plated tape and the MM tape which are typical of the results from all of the tapes. A slightly higher output was obtained for short wavelength signals with the higher bias frequency than with the lower bias frequency. The reason for this is not known; whether it is a function of the skin effect in the tape, the leakage flux distribution in the recording head, or the mechanism of the recording process as discussed on pages 7 and 8 must be determined by further experimentation.

Recommendations for Further Experimental Work.

The test results that have been discussed in the preceding paragraphs point out a lack of information about several factors in the recording process and suggest some changes in equipment design for studying storage methods. The most obvious fault is excessive leakage flux about the working gap of the recording head. A core material such as permendur which has a very high saturation flux density should be tried, and the tips of the core might be shaped so that they contact the tape only at the gap. This would give a somewhat longer path for the unwanted leakage flux. The effect of grinding and polishing after heat treatment on the permeability of the core tips is not known, so a means for accurate determination of flux distribution around the recording gap would be very beneficial in the design and construction of recording heads.

Since the speed at which information may be recorded on and read from a magnetic storage medium depends on the speed at which the medium is moving, tests should be conducted to determine the practical limit on operating speeds and the results of recording at such speeds. It is estimated that these speeds might be of the order of magnitude of 100 ft/sec. Such high speeds would require a redesign of the erasing head as well as the recording and playback heads. At these speeds an erasing frequency that exceeds the highest that could be recorded would not have sufficient penetration for complete erasing. For this reason, erasing or demagnetization of the medium would have to be accomplished by a low-frequency decaying field such as would be obtained by passing the wire or tape through the center of an air-cored coil. For high speed operation, of course, the recording and playback heads must be designed for the high frequencies or short pulses which would be used.

Circuits for supplying and reading the coded information to be stored should be built for use with the recording system. Although little information is available on techniques of recording pulse signals, it is reasonable to assume that the length of a recorded pulse on the medium would not exceed that required for recording the minimum number of cycles of a sinusoidal signal that would excite a tuned circuit in the reading equipment for the latter type of signal. This is assuming that sinusoidal signals of two different frequencies would be used to represent the two binary digits and that the reading equipment would contain filter circuits for separating the two frequencies. In the field of carrier telegraphy it has been found that at least 5 cycles of a sinusoidal signal are required for such selection. The use of pulse signals, therefore, should not result in a loss of recording capacity, while it allows the recording and reading circuits to be of much simpler design. The use of a high-frequency bias signal in pulse recording would be unnecessary since a linear characteristic is not required; however, the results of recording with different bias frequencies, as shown in Fig. 22 indicate that the effect on pulse amplitude of using a bias signal should be investigated.

On a flat recording medium such as a tape or disk it is possible to obtain more than one recording track. In electronic computer applications the additional tracks might be utilized for synchronizing signals or for recording additional information which is not required to be read independently of that on the parallel tracks. An estimate of the width and spacing of such tracks may be obtained from data on the Brush Development Company disk-type recorder. Using a powder-coated paper disk, it produces a sound track 0.014" wide and spacing between tracks of 0.011", or the equivalent of 40 tracks per inch. Heads with thin cores are used for obtaining these narrow tracks.

The problem of marking the location of specific information recorded on a magnetic medium and of positioning the medium for removal of that information require separate study. Multi-channel recording on a flat medium has certain advantages over single-channel recording in these respects. Some of these advantages are: (1) a separate channel might be used for synchronizing and marking signals; (2) information might be grouped on sections of the tape thus reducing the time required to position the tape for playback; (3) recording might be done in opposite directions on adjacent channels to avoid loss of time in rewinding or (4) successive signals might be recorded on separate channels to allow recording at a higher pulse repetition rate; for example, with four channels, pulses 1, 5, 9, 13 etc., would be recorded on one channel, pulses 2, 6, 10, 14, etc., would be recorded on another channel, pulses 3, 7, 11, 15 etc. would be recorded on a third, and pulses 4, 8, 12, 16 etc., would be recorded on the fourth channel. The solid metal tapes providing several channels also are stronger than wire media so would be desirable where rapid positioning of the medium places considerable stress upon it.

The problem of positioning the recording medium is one of mechanical design as well as electrical control. The solution may lie in a suitable application of servomechanism principles or in the construction of a satisfactory system of clutches to engage the tape or wire system with a rotating drive shaft as desired.

Written by E. S. Rich
Approved by J. H. Forester

References:

- Selby, M. C., "Investigation of Magnetic Tape Recorders." Electronics, Vol. 17, No. 5, (May 1944) pp. 133-135
- Holmes, L. C., and Clark, D. L., "Supersonic Bias for Magnetic Recording." Electronics, Vol. 18, No. 7, (July 1945) pp. 126-136
- Woolbridge, D. E., "Signal and Noise Levels in Magnetic Tape Recording." AIEE Trans. Vol. 65, No. 6 (June 1940) pp. 343-352
- Camras, M., "Theoretical Response from a Magnetic Wire Record." IRE Proc., Vol. 34, No. 6, (August 1946) pp. 597-602
- Begun, S. J., "Recent Developments in Field of Magnetic Recording." SMPE Journ., Vol. 48, No. 1, (January 1947) pp. 1-12
- Camras, M., "Magnetic Sound for Motion Pictures." SMPE Journ., Vol. 48, No. 1 (January 1947) pp. 14-24.
- Howell, H. A., "Magnetic Sound Recording on Coated Paper Tape." SMPE Journ., Vol. 48, No. 1 (January 1947) pp. 36-45.
- Tinkham, R. J., and Boyers, J. S., "A Magnetic Sound Recorder of Advanced Design." SMPE Journ., Vol. 48, No. 1 (January 1947) pp. 39-33
- OSRD Report No. 5325, June 30, 1946

APPENDIXB-H Curve tracing

To provide a means for comparing hysteresis loops of various magnetic recording tapes, equipment for tracing B-H curves on a cathode-ray oscilloscope was developed. It consists of a magnetizing solenoid wound on a cylindrical tube which will allow insertion of a pickup coil down the center of the tube, and suitable circuits to give the desired horizontal and vertical deflections on the cathode ray oscilloscope (CRO). A diagram of the magnetizing coil is shown in Fig. 23. The pickup coil is wound on a slotted form so that a length of the tape to be tested can easily be threaded through it. When in position for making tests, then, the pickup coil is moved to the center of the magnetizing coil and the tape passes through both coils.

The theory of the operation of the equipment is as follows. A 60-cycle sinusoidal magnetizing force is generated in the magnetizing coil by passing 60-cycle current through its winding. Since the magnetizing force is proportional to the current flowing, the voltage drop across a resistance in series with the coil is proportional to H and can be used to give the horizontal deflection on the CRO. Furthermore the voltage induced in the pickup coil is proportional to the rate of change of flux through it, so the integral of this voltage is proportional to the flux through the pickup coil. If this flux were entirely within the tape, then this integrated voltage would also be proportional to the desired value of flux density, B , and could be used to give the vertical deflection on the CRO. The pickup coil used, however, necessarily had a cross-sectional area several times that of a tape, so that the actual flux in the tape is only a fraction of the total flux through the coil. For this reason a second pickup coil similar to the first but without a slot was placed beside the slotted coil in the magnetizing field. By connecting the two pickup coils in a suitable balancing circuit, a resultant voltage proportional to the flux through the tape alone is obtained. The integral of this voltage, then, is proportional to the flux density in the tape.

Since the cross-sectional area of the magnetic material in the tape is not the same for all tapes, the circuit must be balanced for each measurement. To accomplish this a calibrating coil was also mounted with the pick-up coils. This calibrating coil was constructed to produce a voltage equal to that generated in the slotted pickup coil if it had a cross-section of $1/4" \times 0.002"$, or the dimensions of an average tape. Calibration thus consists of adjusting the output of the pickup coils to be the proper fraction of the voltage from the calibrating coil, this fraction being determined by the ratio of the tape area to the average area of 0.0005 sq. in. The construction of the complete pickup coil assembly is shown in Fig. 24.

Circuit diagrams of the amplifiers used with the B-H curve tracing equipment are shown in Figures 25 and 26. The H-amplifier (Fig. 25) consists of a single stage with a phase-shift control. It has a gain of 9. The B-amplifier (Fig. 26) contains a two-stage preamplifier, an R-C integrating

circuit, and a three-stage final amplifier. When measurements are being taken on solid metal tapes having a high flux density, the preamplifier is not required and may be switched out. The measured values of gain at 60 cps are 40 for the preamplifier, 1/165 for the integrator, and 3680 for the final amplifier, or an overall gain of 892.0. The requirements of high gain and zero phase shift over a band of frequencies necessitated careful design of the amplifiers. Compensating circuits and negative feedback were used to obtain the required phase characteristic. It was found necessary to use a d-c filament voltage because even small amounts of pickup from a 60-cycle filament current caused objectionable distortion in the curves traced on the CRO.

The procedure for making a hysteresis-loop measurement and determining the scale factors is as follows: A schematic diagram of the equipment is shown in Fig. 27. The pickup coil assembly without the tape sample is positioned at the center of the magnetizing coil and the switches are adjusted so that the output of the calibrating coil appears as the vertical deflection on the CRO. This deflection is adjusted to a convenient value by means of the gain control on the CRO. The calibrate switch is then thrown to its "test" position and the balance control adjusted until the vertical deflection is the proper fraction of that observed for the "calibrate" position this fraction being determined from the cross-sectional area of the magnetic material in the tape in the manner previously described. The phase control is now adjusted so that the trace on the CRO is a single straight line. Next the tape to be tested is inserted into the pickup coil. It should be long enough so that it extends a few inches beyond either end of the magnetizing coil. Suitable adjustment of the gain controls gives the desired B-H curve for the tape.

The horizontal scale factor for the B-H curve obtained is determined in the following manner: The output of the calibrating coil is measured with a voltmeter for the same magnetizing current as used in the test. This voltage, e_c , is

$$e_c = N_c A_c \frac{dB}{dt} \times 10^{-8} = N_c A_c \omega B_{cm} \cos \omega t \times 10^{-8} \quad (1)$$

where N_c is the number of turns on the calibrating coil, A_c is the cross-sectional area of this coil, and B_{cm} is the maximum value of flux density in it. Solving for B_{cm} and substituting constant values gives

$$B_{cm} = 3.9 \times 10^4 E_c \quad (2)$$

where E_c is the r.m.s. value of e_c .

The magnetizing force, H , is numerically equal to B , so if d_H is the peak-to-peak horizontal deflection, the desired scale factor for the abscissa,

S_H is

$$S_H = \frac{3.9 \times 10^4}{d_H/2} E_C = 7.8 \times 10^4 \frac{E_C}{d_H} \text{ oersteds per unit distance} \quad (3)$$

To determine the vertical scale factor, the peak-to-peak horizontal and vertical deflections of the B-H curve are observed. The horizontal deflection should be the same as that for which E_C was measured. Then the magnetizing force is removed and a 60 cps voltage from an oscillator or a potentiometer placed across the wiper line is applied to the amplifier input. The magnitude of the voltage required to produce a vertical deflection equal to the horizontal deflection observed for the B-H curve is measured with a voltmeter. Let the r.m.s. value of this voltage be V .

It is evident that if this value of V is equal to E_C then the vertical scale factor, S_V , for a tape of average cross-sectional area is the same as the horizontal scale factor or

$$S_V = 7.8 \times 10^4 \frac{E_C}{d_H} \text{ gaussses per unit distance} \quad (4)$$

For V not equal to E_C , S_V is changed in the ratio of $\frac{V}{E_C}$ so

$$S_V = 7.8 \times 10^4 \frac{E_C}{d_H} \times \frac{V}{E_C} = 7.8 \times 10^4 \frac{V}{d_H} \text{ gaussses per unit distance} \quad (5)$$

However, since E_C , and hence V , depends on the total effective flux through the pickup coils and not on the flux density alone, the factor relating the cross-sectional area of the tape, A_T , to the average area, A_A , which was used in the balancing step must be included in the expression for S_V . Therefore the complete expression for the vertical scale factor is

$$S_V = 7.8 \times 10^4 \frac{A_A}{A_T} \frac{V}{d_H} \text{ gaussses per unit distance}$$

In the operation of this equipment certain limitations were noted which might be removed by a change in design. The most objectionable defect is the tendency for the CRO trace to drift up and down on the face of the tube. When tapes requiring a low vertical gain setting are being tested, this drifting is slow and of small magnitude, but with high vertical gain settings it is rapid and of considerable amplitude. This jumping is caused by fluctuations in the supply voltage which produce spurious signals at the plate of the first tube. These signals are passed on to succeeding stages by the high-time-constant coupling networks. A regulated a-c supply and extremely stable d-c supply would be required to eliminate this drifting.

The presence of harmonics in the 60-cycle magnetizing current also is objectionable. These harmonics change the shape of the B-H curve and result in an incorrect B-H curve measurement.

For tests on tapes with small cross-sectional areas, an additional calibrating coil corresponding to a smaller area than the one described would provide more accurate balance adjustments.

The use of a higher-frequency magnetizing current would be very desirable in many respects. In particular it would permit simpler amplifier design, require less amplification, and reduce the tendency for the pattern on the oscilloscope screen to drift. The 400-cycle power available in the laboratory was ruled out, however, because of its high harmonic content.

TABLE OF SYMBOLS AND DEFINITIONS

<u>SYMBOL OR TERM</u>	<u>DEFINITION</u>
NMF	Magnetomotive force.
oersted	Unit of magnetic field intensity or magnetizing force.
gauss	Unit of magnetic flux density.
H	Magnetic field intensity.
B	Magnetic flux density.
H_c - coercive force	The magnitude of the magnetizing force at which the flux density is zero when a magnetic material is being symmetrically cyclically magnetized.
B_R - residual flux density	The value of flux density for the condition of zero magnetizing force when the material is being symmetrically cyclically magnetized.
B-H curves	A plot of the flux density in a magnetic material as a function of magnetizing force.
μ - permeability	Ratio of flux density to magnetizing force.
μ_i - initial permeability	Ratio of flux density to magnetizing force for very small values of magnetizing force.
μ_{max} - maximum permeability	Maximum value of $\frac{B}{H}$ that occurs as the flux density in a magnetic material is increased from zero to saturation.
Saturation	Condition that exists when flux density has been increased to the point where the permeability is equal to unity.
Saturation flux density	Flux density at which the permeability drops to unity.
Flux linkages	Product of total flux passing through a coil times the number of turns in the coil.

DESCRIPTION OF MAGNETIC MATERIALS

<u>Material</u>	<u>Composition</u>	<u>Properties</u>	<u>Source</u>
Mo-Permalloy	Fe, 16.4% Ni, 79.0% Mo, 4.0% Mn, 0.6%	μ_i , 22,000 μ_m , 72,000 B_R , 5,000 gaussess H_C , 0.05 oersteds ρ , 55 μ ohm/cm Saturation flux density, 8500 gaussess Hysteresis loss at saturation 200 ergs/cc	Allgheny Ludlum Steel Corp. Brackenridge, Pa. Mr. William S. Spring Electrical Sales Eng.
Vanadium Permalloy	Fe, 49.0% Co, 49.0% V, 2.0%	i , 800 m , 4500 B_R , 14,000 gaussess H_C , 2.0 oersteds ρ , 26 μ ohm/cm Saturation flux density, 24,000 gaussess Hysteresis loss at saturation, 6000 ergs/cc	(Same as for Mo-Permalloy)
Hipersil*	Fe, 96-97% Si, 3-4%	B_R , 17,400 gaussess H_C , 2 oersteds (approx) ρ , 58 μ ohm/cm Saturation flux density, 20,000 gaussess Hysteresis loss at saturation, 5000 ergs/cc	(None of this material was purchased)
Vicalloy	Va, 6-10% Co, 36-62% Fe, 30-52%	H_C , 200-400 oersteds B_R , 5000-9600 gaussess	Western Elec. Co. 195 Broadway, N.Y.C. Mr. O. Carpenter Coordinator of College Relations
Brush plated Tape	Co, 80% Ni, 20% plating	H_C , 200 oersteds B_R , 6000-10,000 gaussess	Brush Development Co. 3405 Perkins Avenue Cleveland, Ohio.
Brush Paper Tape	Powdered magnetite coating, particles diameters less than 1 micron	H_C , 100-200 oersteds B_R , 400-700 gaussess	(Same as for Brush Plated tape)

Material	Composition	Properties	Source.
Hyflux Tape	Metallic powder coating, composition unknown, particle diameters less than 1 micron.	H_c . 300-550 oersteds H_R . 500-1500 gaussses	Mr. John P. Manley The Indiana Steel Products Co. 58 Park Sq. Bldg. Boston. Mass.
MMI Tape	Powder coating, composition unknown.	H_c . 350 oersteds H_R . 750 gaussses	Mr. McKnight Minnesota Mining & Mfg. Co. 51 Sleeper Street Boston. Mass.

- Manufacturing process produces orientation of crystals so that there is a preferred direction of magnetization in the material. Therefore the material must be used so that the flux path is in this preferred direction.

List of Drawings

Figure number

Drawing number

1	A-30951
2	A-30952
3	A-30953
4	A-30954
5	B-30955
6	A-38293-G
7	A-30956
8	A-30957
9	A-30996
10	A-30997
11	A-30958
12	A-30959
13	A-30960
14	A-30961
15	A-30962
16	A-30963
17	A-30964
18	A-38294-G
19	A-38295-G
20	A-38296-G
21	A-38297-G
22	A-38298-G
23	A-30965
24	A-30966
25	A-30967
26	B-30968
27	A-30969

USED IN CONNECTION WITH R-124

A.30951

MASSACHUSETTS INSTITUTE OF TECHNOLOGY	
DATE	NO.
6345	
1954	

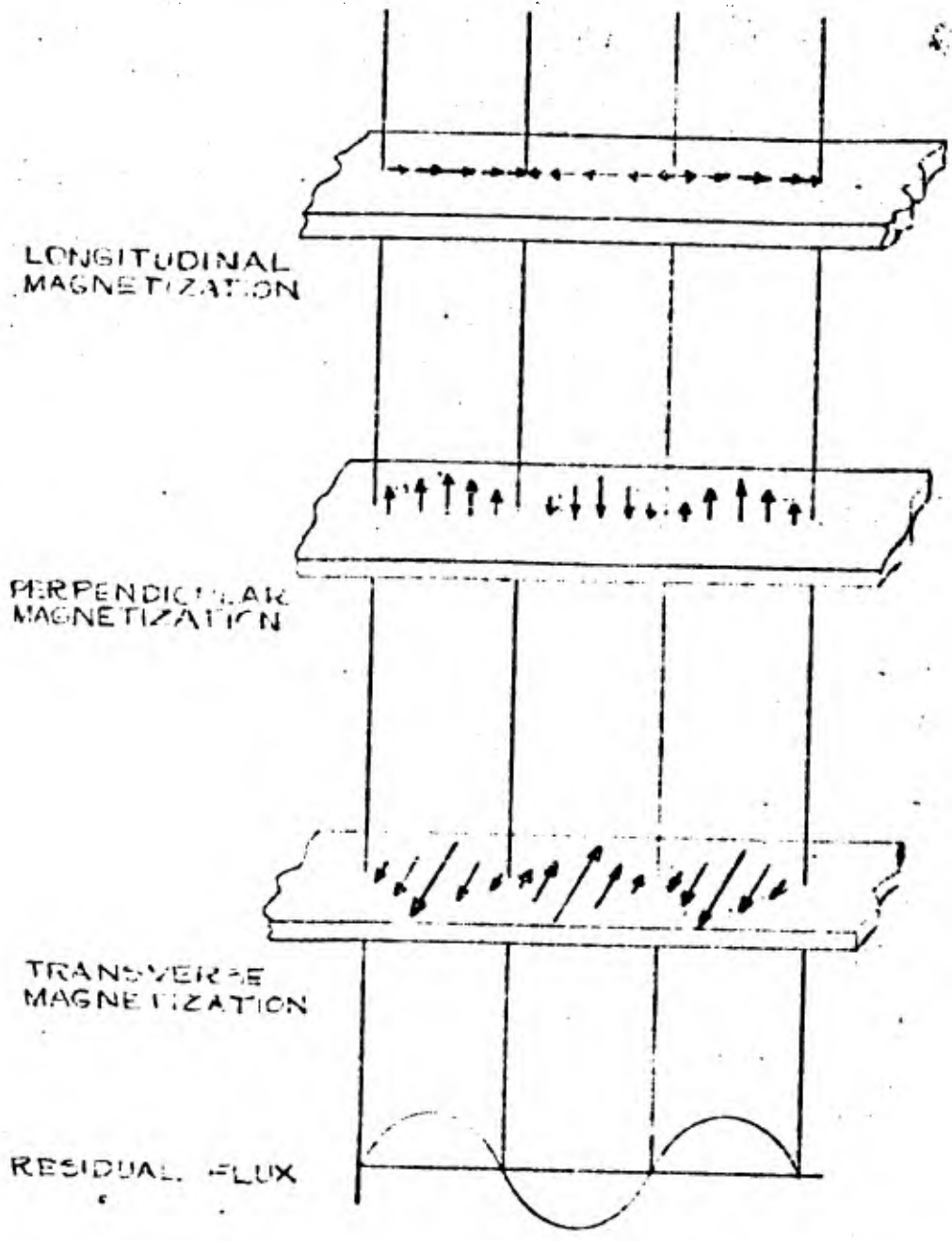
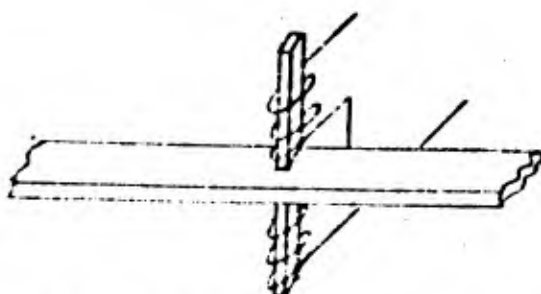
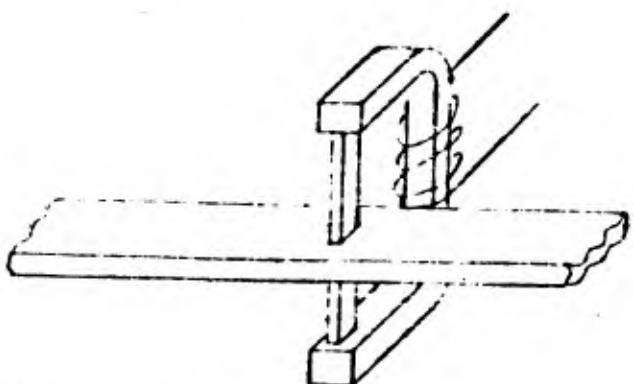

FIG. 1. TYPES OF MAGNETIC RECORDINGS. ARROWS INDICATE DIRECTION AND MAGNITUDE OF FLUX IN SECTIONS OF THE RECORDING MEDIUM.

USED IN 6345 REPORT NO. R-124



(a) POLE PIECES WITH OPEN MAGNETIC CIRCUIT



(b) POLE PIECES WITH CLOSED MAGNETIC CIRCUIT

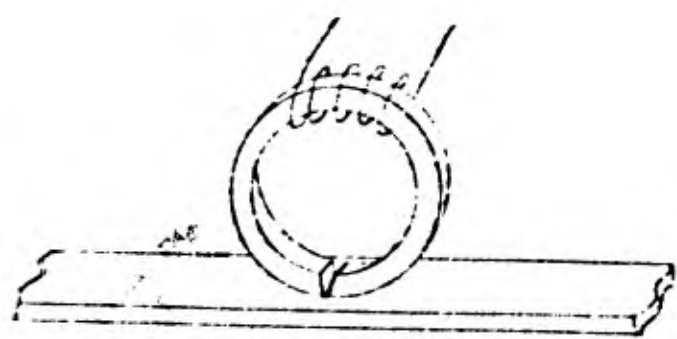

(c) RING TYPE CORE

FIG. 1 TYPES OF CORE CONSTRUCTION FOR HEADS USED IN A MAGNETIC RECORDING SYSTEM.

4-3095

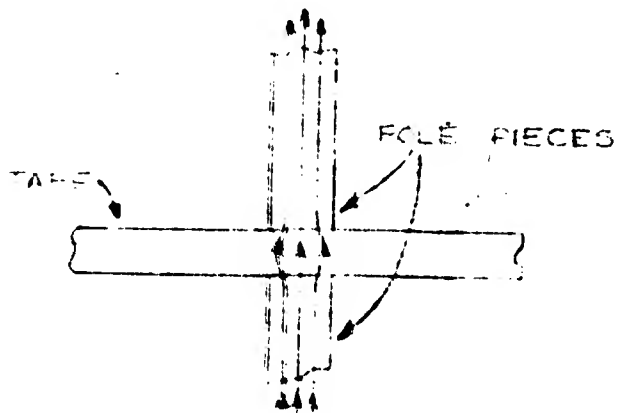

(A) PERPENDICULAR OR TRANSVERSE MAGNETIZATION USING CORE CONSTRUCTION OF FIG. 2(A) OR 2(B).

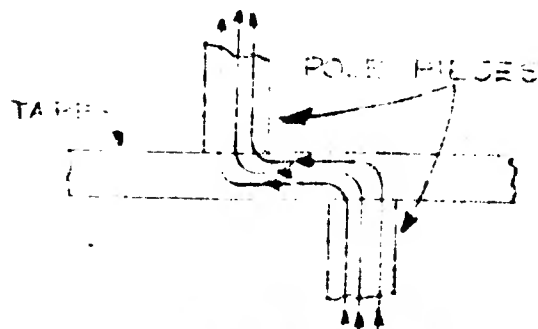

(B) LONGITUDINAL MAGNETIZATION USING CORE CONSTRUCTION OF FIG. 2(A) OR 2(B).

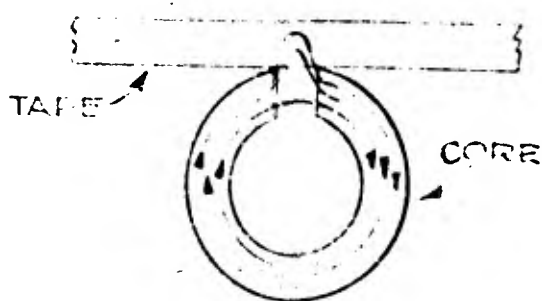

(C) LONGITUDINAL MAGNETIZATION USING CORE CONSTRUCTION OF FIG. 2(C).

FIG. 3. REFERENCE TO FIG. 1 AND FIG. 2 FOR VARIOUS TYPES OF MAGNETIC RECORDING HEADS.

USED IN 6345 REPORT NO. R-124

A-30953

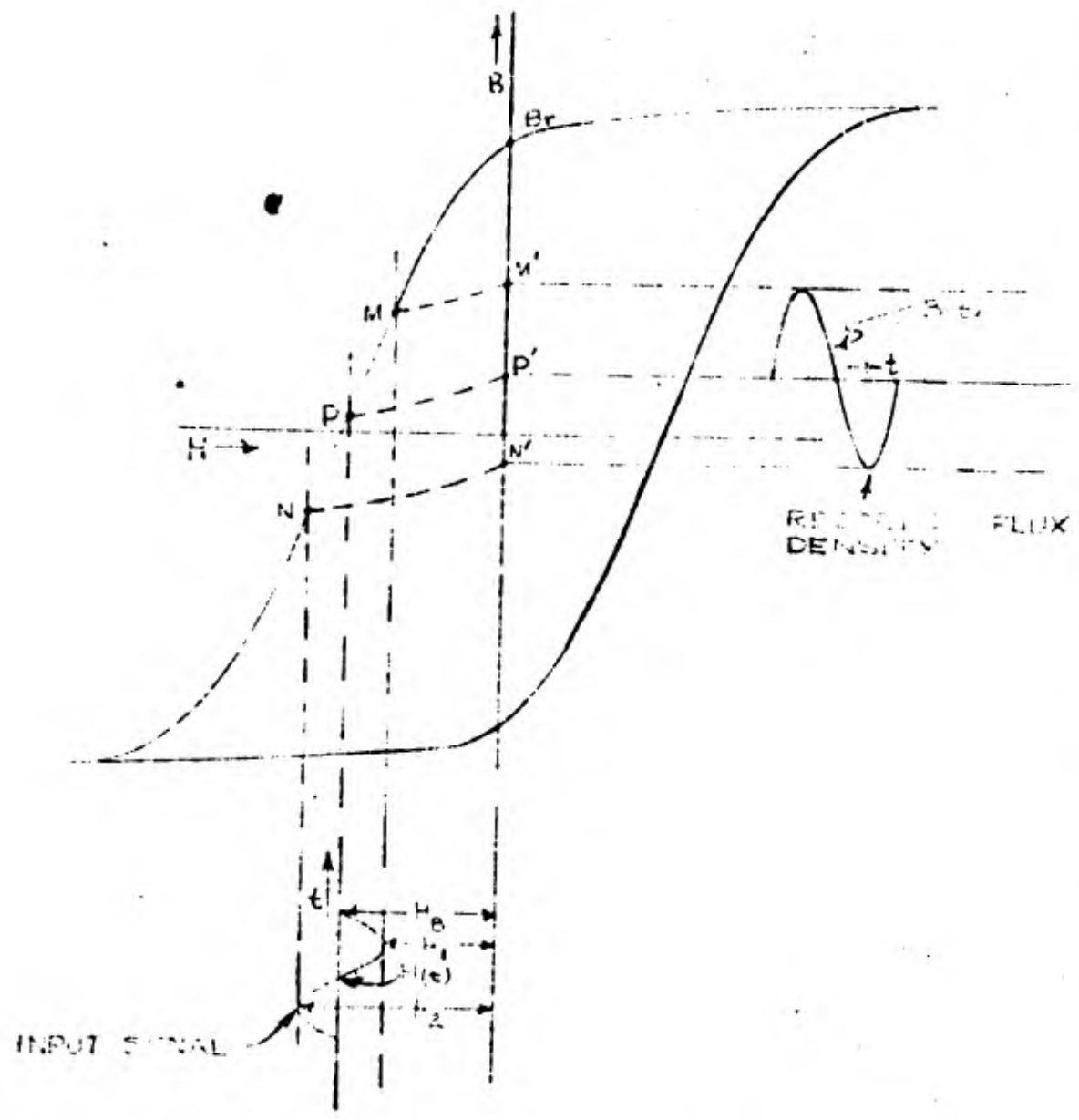
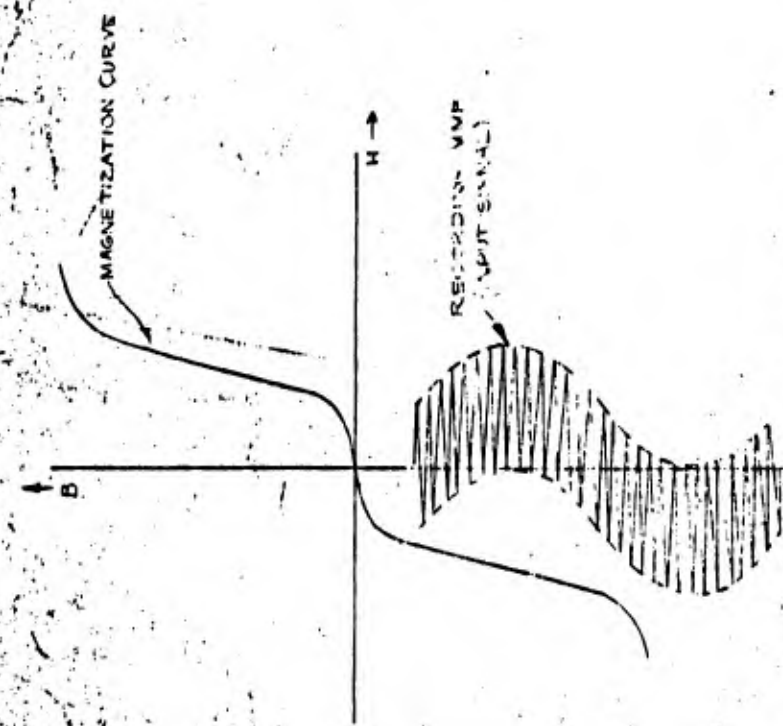
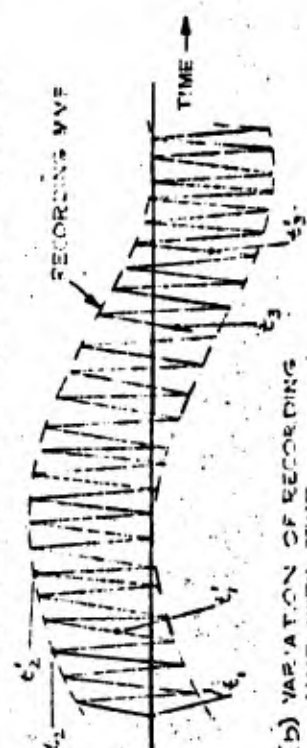

FIG. 4. RELATIONSHIP BETWEEN INPUT SIGNAL AND RECORDED FLUX DENSITY FOR THE BIAS METHOD OF RECORDING.



(a) RELATIONSHIP OF RECORDING V.M.F. TO MAGNETIZATION CURVE OF RECORDING MEDIUM



(b) VARIATION OF RECORDING V.M.F. WITH TIME

FIG. 5. RELATIONSHIP BETWEEN INPUT SIGNAL AND RECORDED FLUX DENSITY FOR THE A-C BIAS METHOD OF RECORDING.

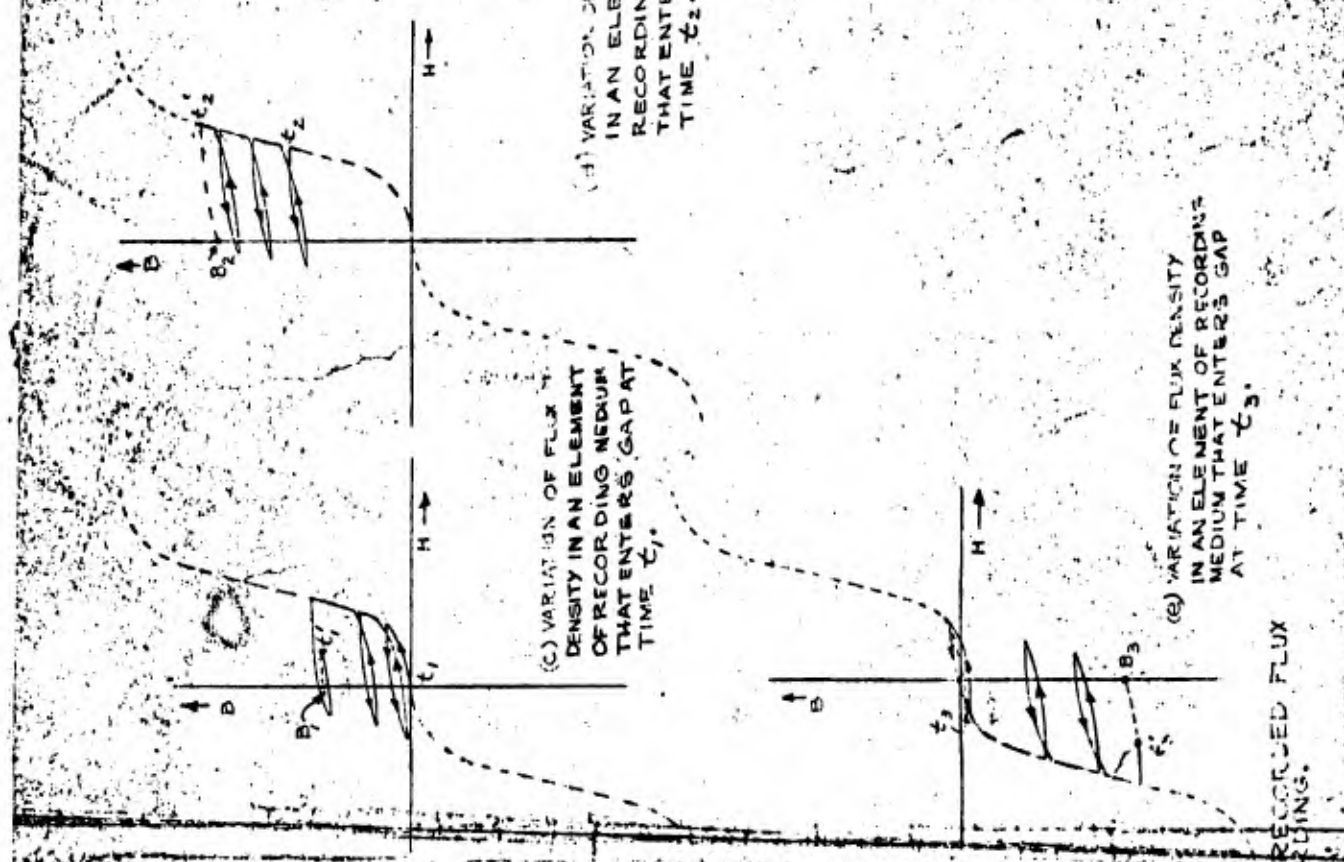

(c) VARIATION OF FLUX DENSITY IN AN ELEMENT OF RECORDING MEDIUM THAT ENTERS GAP AT TIME t_1 .

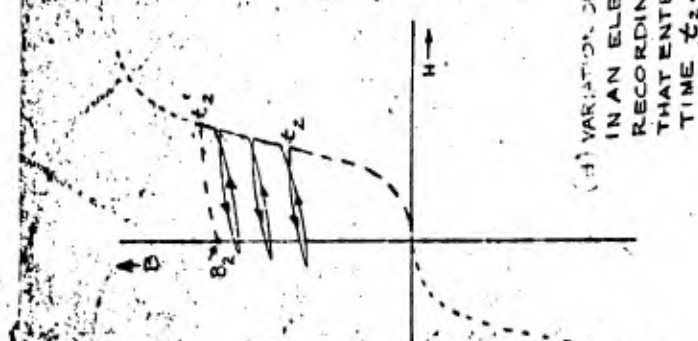

(d) VARIATION OF FLUX DENSITY IN AN ELEMENT OF RECORDING MEDIUM THAT ENTERS GAP AT TIME t_2 .

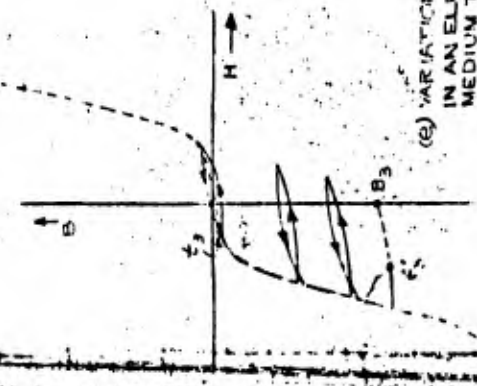

(e) VARIATION OF FLUX DENSITY IN AN ELEMENT OF RECORDING MEDIUM THAT ENTERS GAP AT TIME t_3 .

A-55203G

U.S. INCO REPORT NO R-124

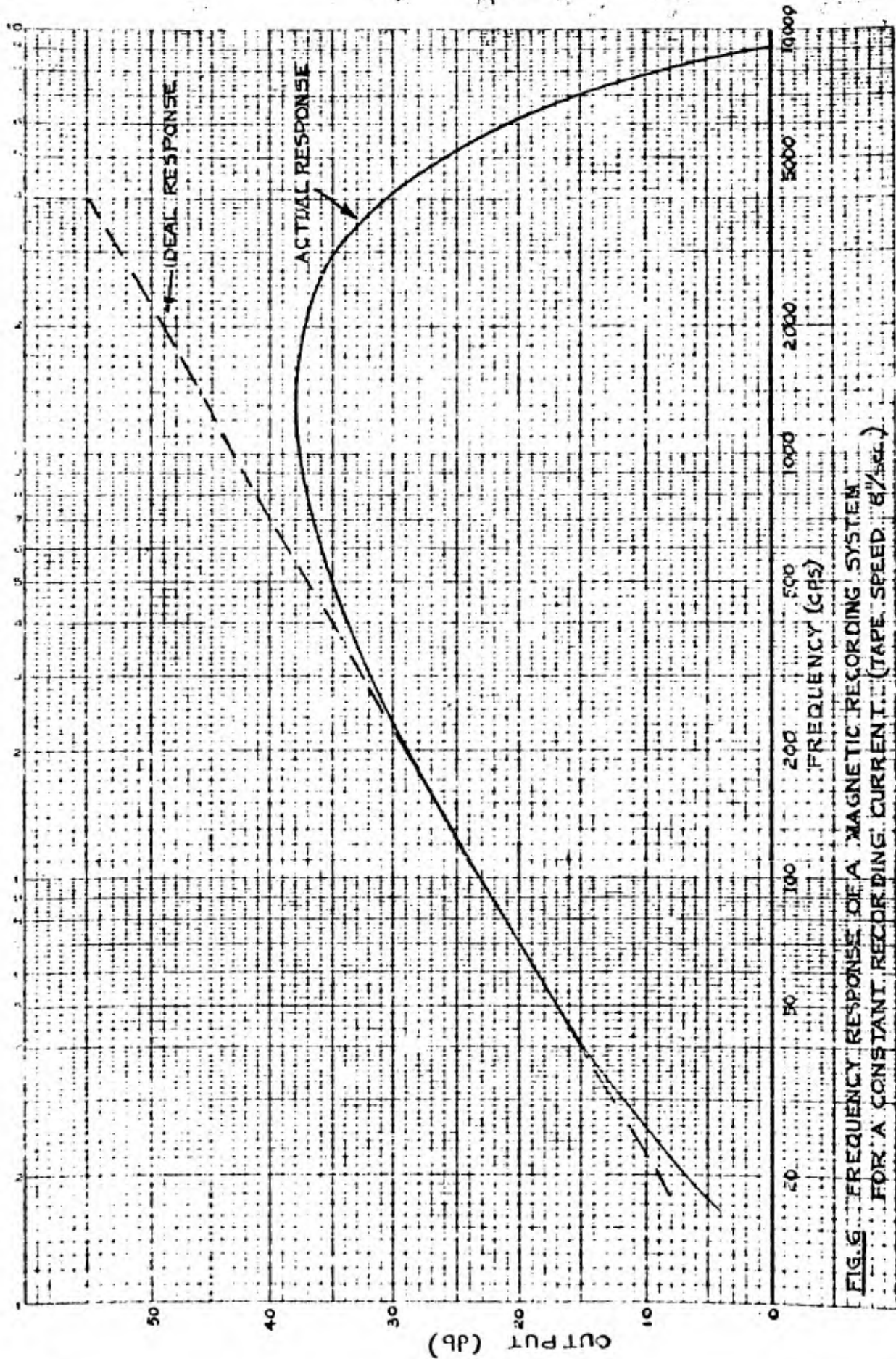
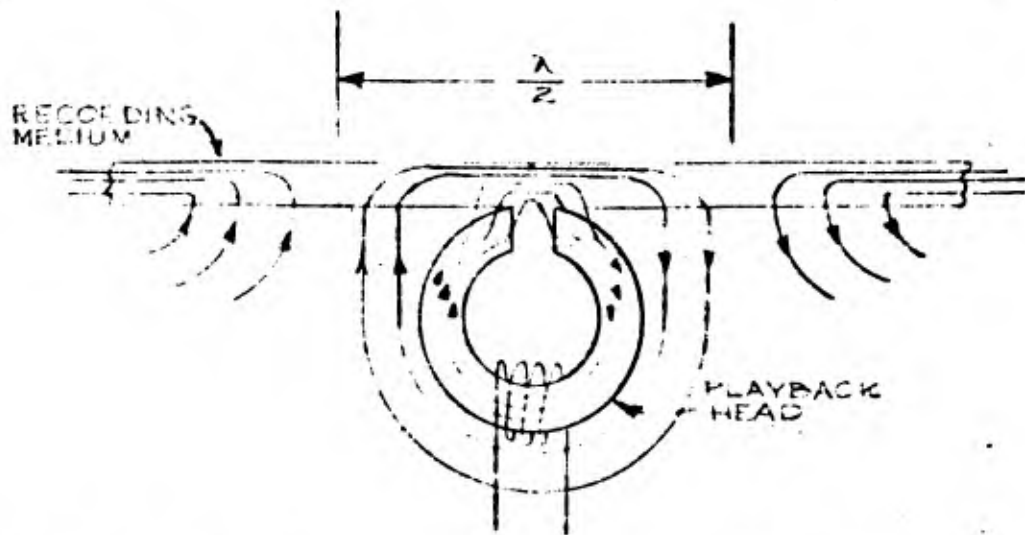
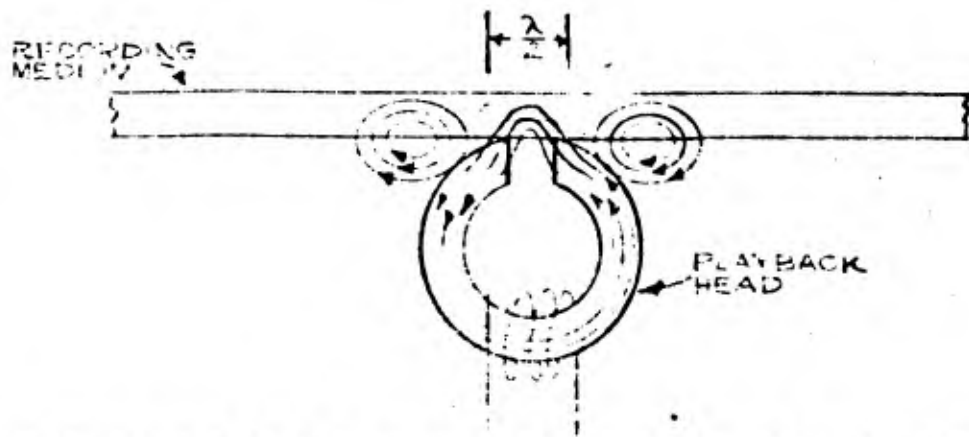

FIG. 6. FREQUENCY RESPONSE OF A MAGNETIC RECORDING SYSTEM FOR A CONSTANT RECORDING CURRENT... (TAPE SPEED, 6 1/2 IN./SEC.)



(a) FLUX LINKAGES IN PLAYBACK HEAD FOR LONG WAVELENGTHS OF RECORDED SIGNAL.



(b) FLUX LINKAGES IN PLAYBACK HEAD FOR SHORT WAVELENGTHS OF RECORDED SIGNAL.

FIG. 7 FLUX DISTRIBUTION AROUND THE GAP OF A RING-TYPE PLAYBACK HEAD.

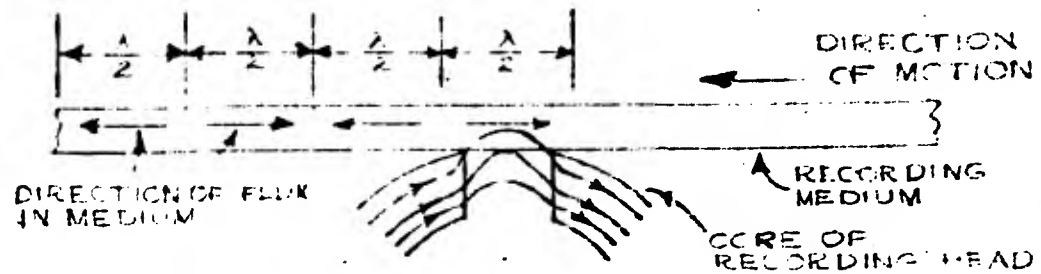

(a) FLUX CONFINED TO REGION BETWEEN GAP FACES.

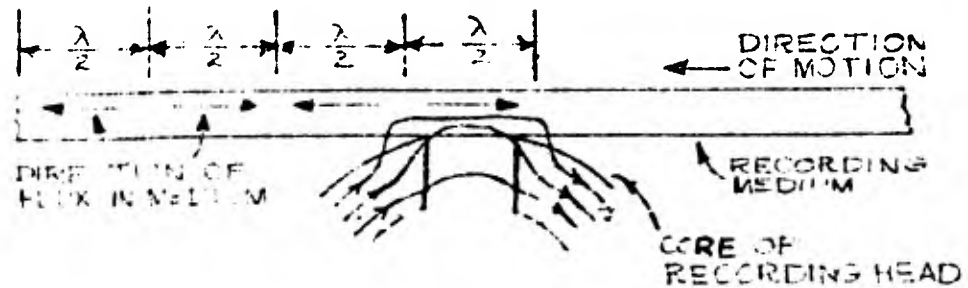

(b) LEAKAGE FLUX SPREADING BEYOND REGION BETWEEN GAP FACES.

FIG. 8. FLUX DISTRIBUTION AT GAP OF RING-TYPE RECORDING HEAD.

7

... ..

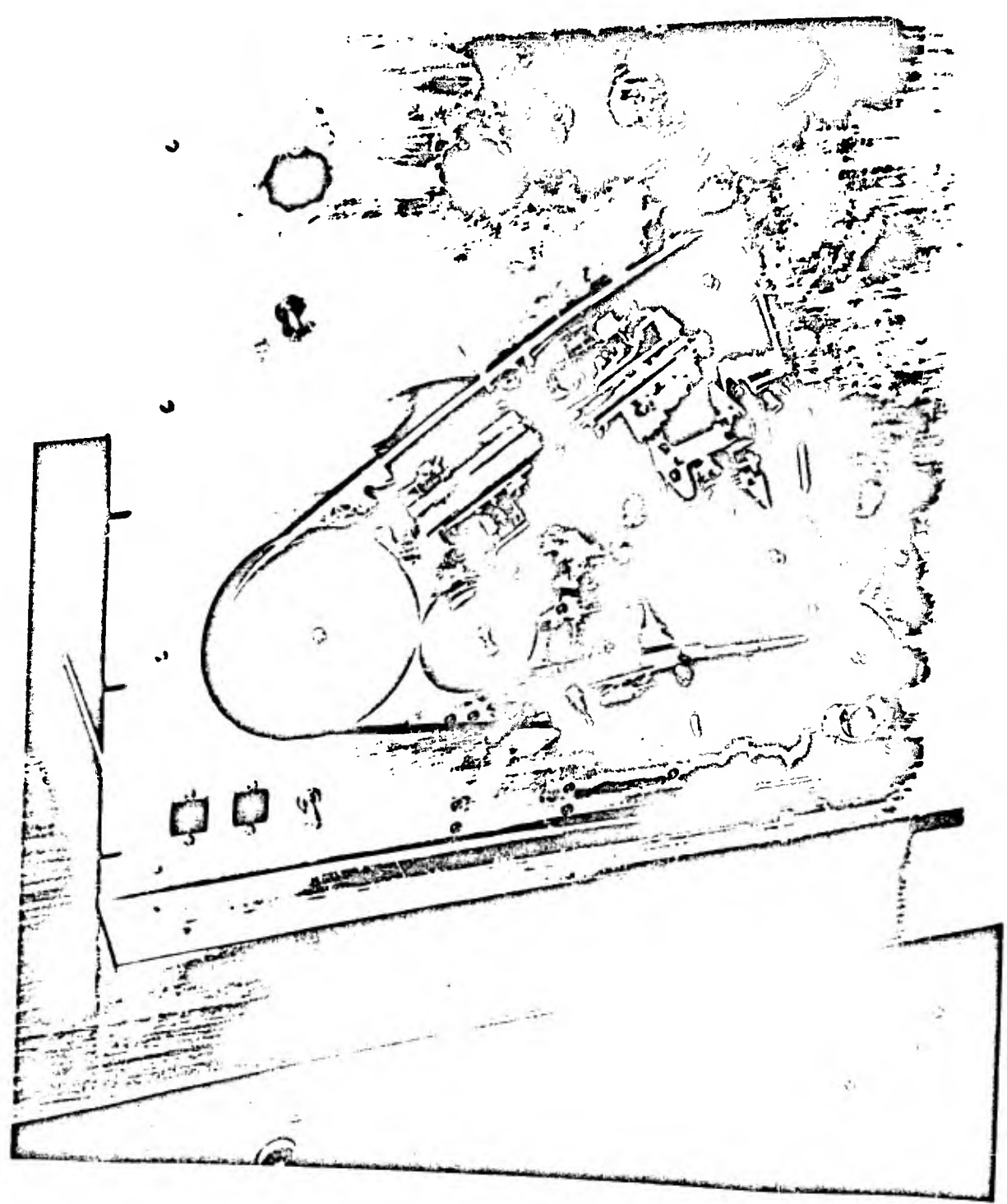

A-30996

FIG. 10. REAR VIEW OF EXPERIMENTAL MAGNETIC
RECORDING APPARATUS.

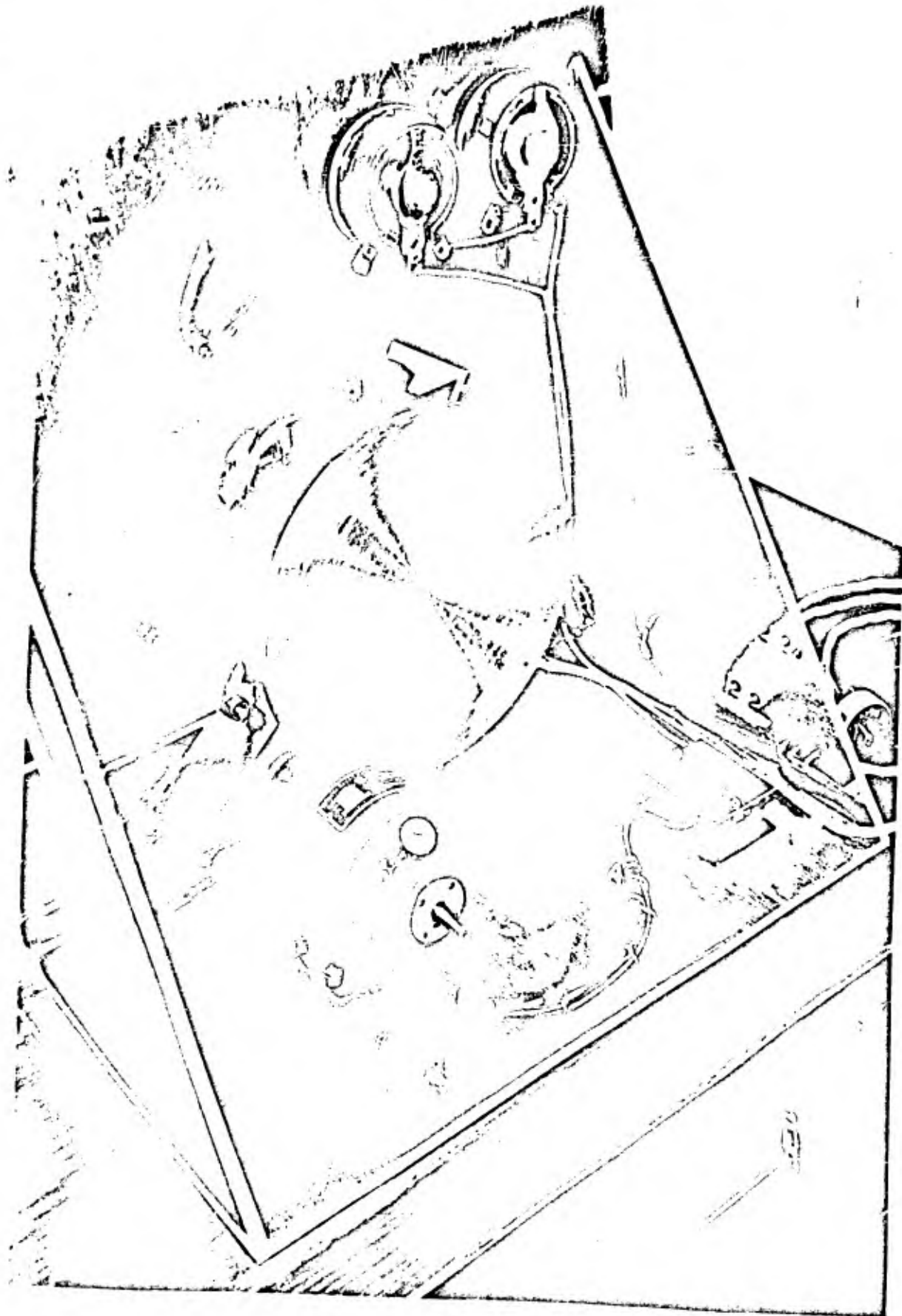

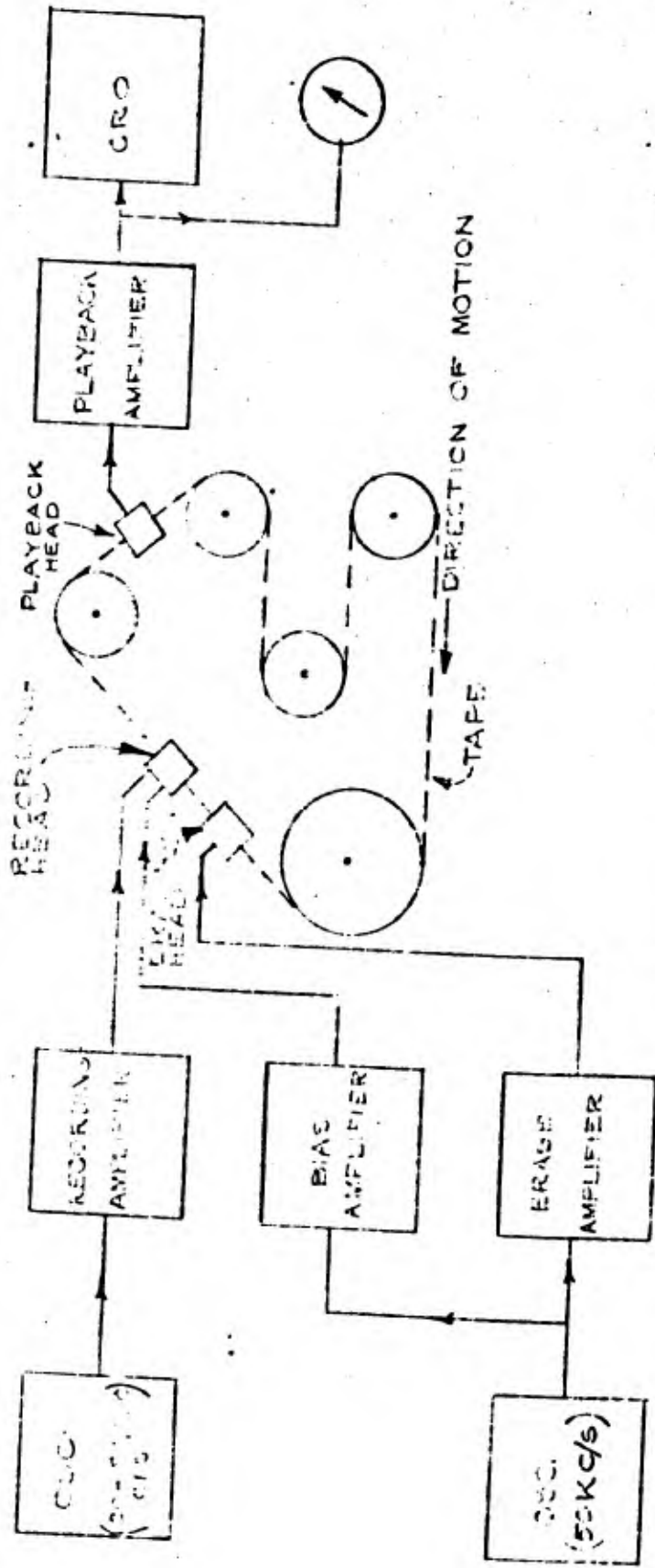

FIG. 11. SCHEMATIC DIAGRAM OF COMPLETE EXPERIMENTAL MAGNETIC RECORDING SYSTEM.

USED IN 6345 REPORT NO. R-124

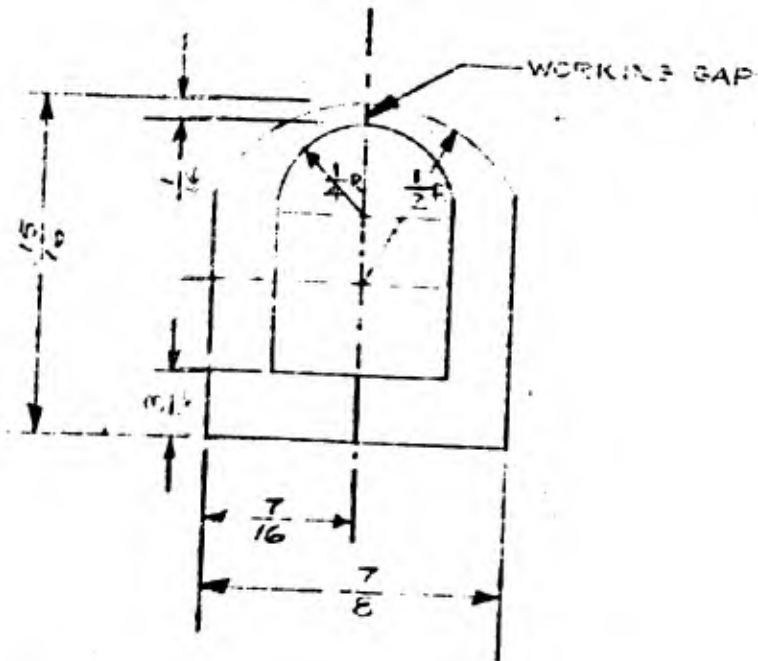

FIG. 12. SHAPE OF LAMINATIONS IN CORE OF RECORDING HEAD.

A-309

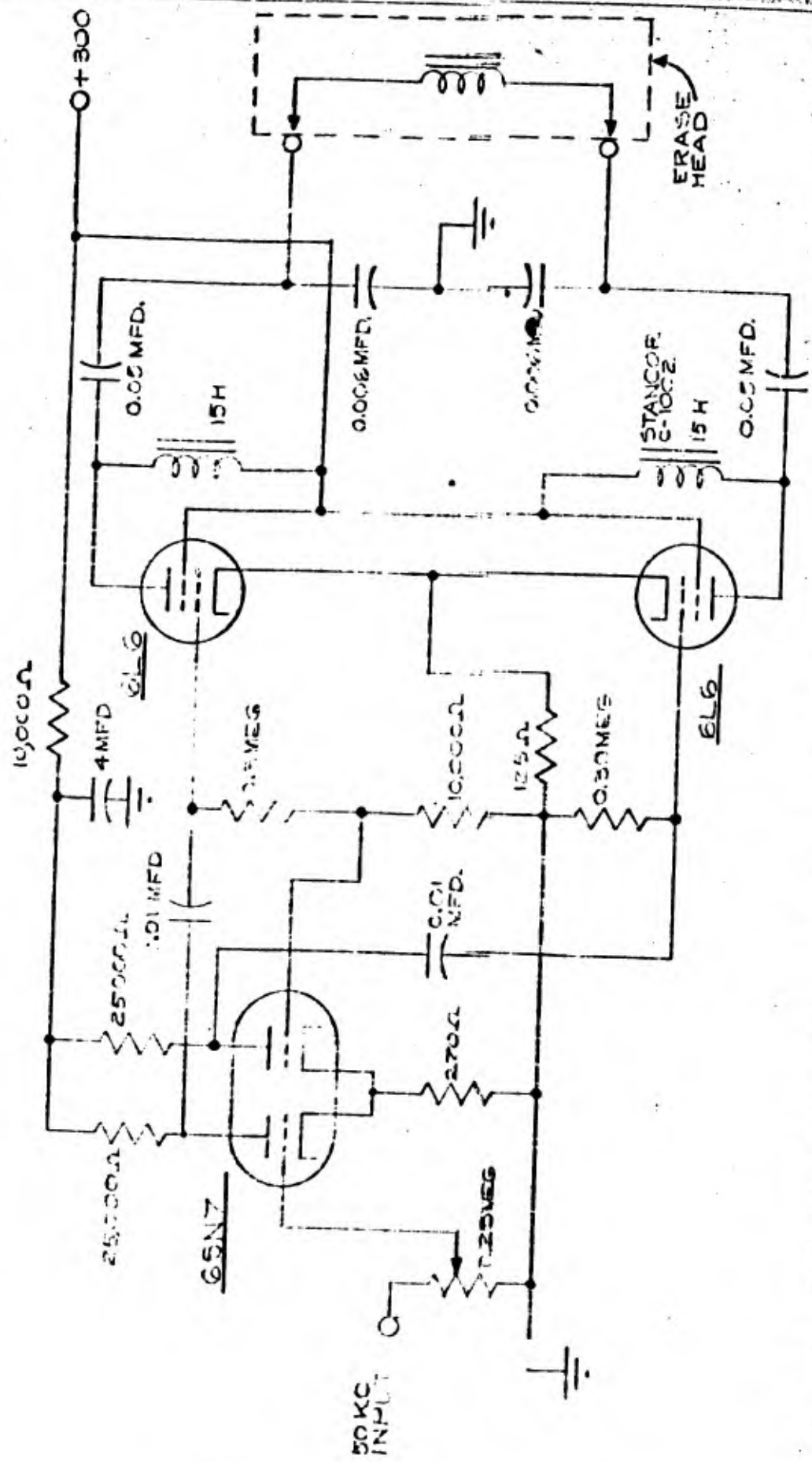

FIG. 13. CIRCUIT DIAGRAM OF ERASING AMPLIFIER.

A-3090

USED IN 6345 REPORT NO. R-124

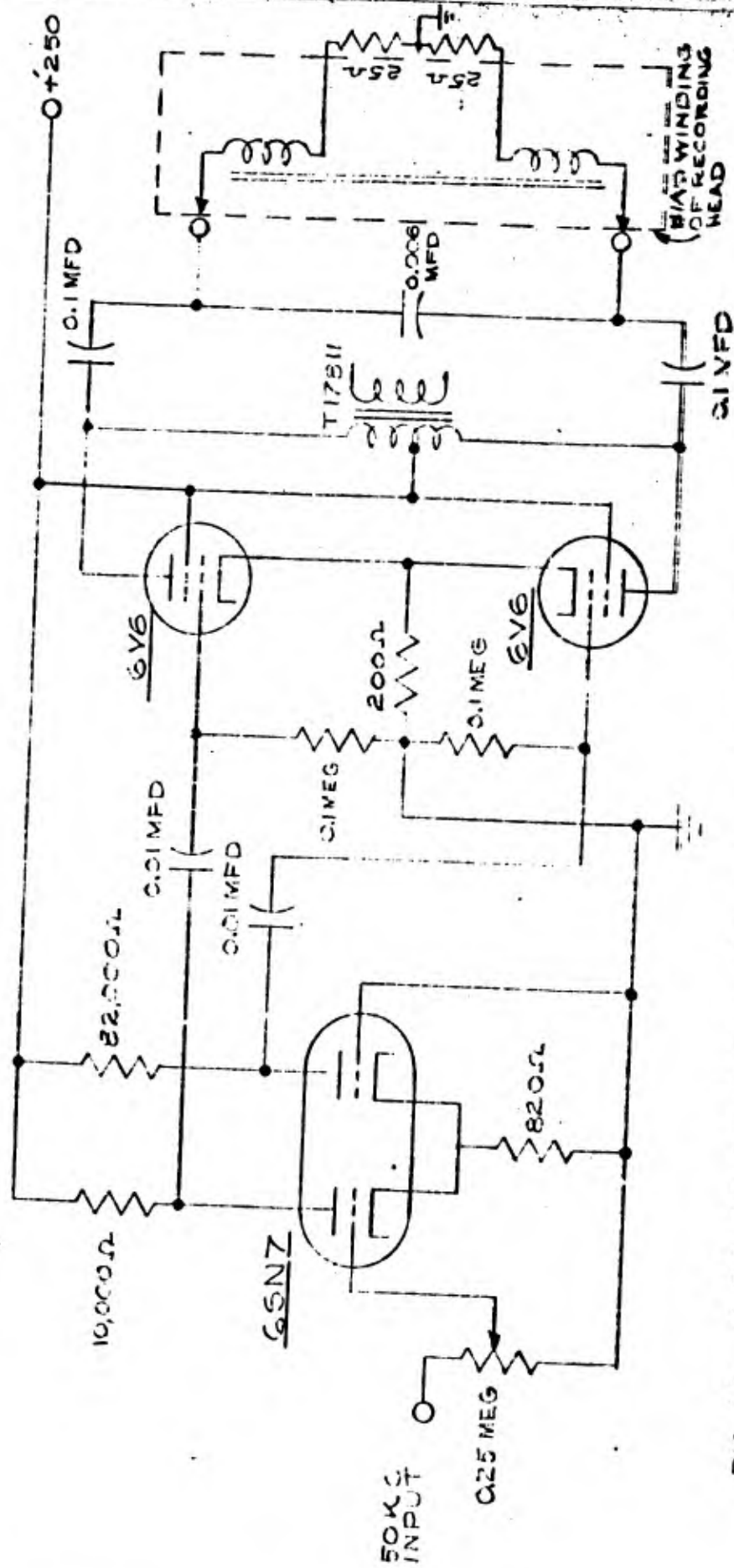

FIG. 14. CIRCUIT DIAGRAM OF BIAS AMPLIFIER.

A-30963

USED IN 6345 REPORT NO. R-124

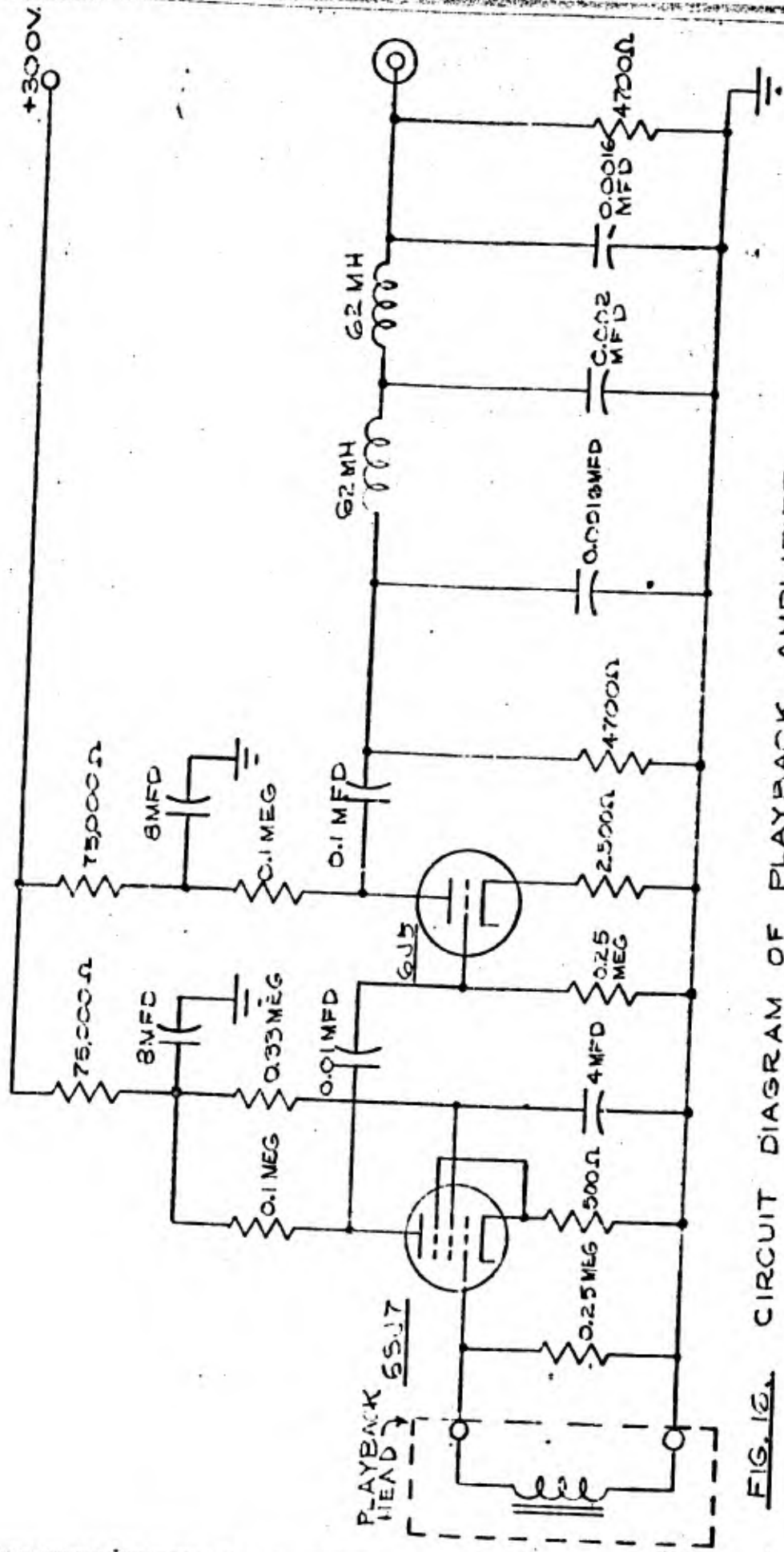

FIG. 16. CIRCUIT DIAGRAM OF PLAYBACK AMPLIFIER.

USED IN G345 REPORT NO. R-124

A-309601

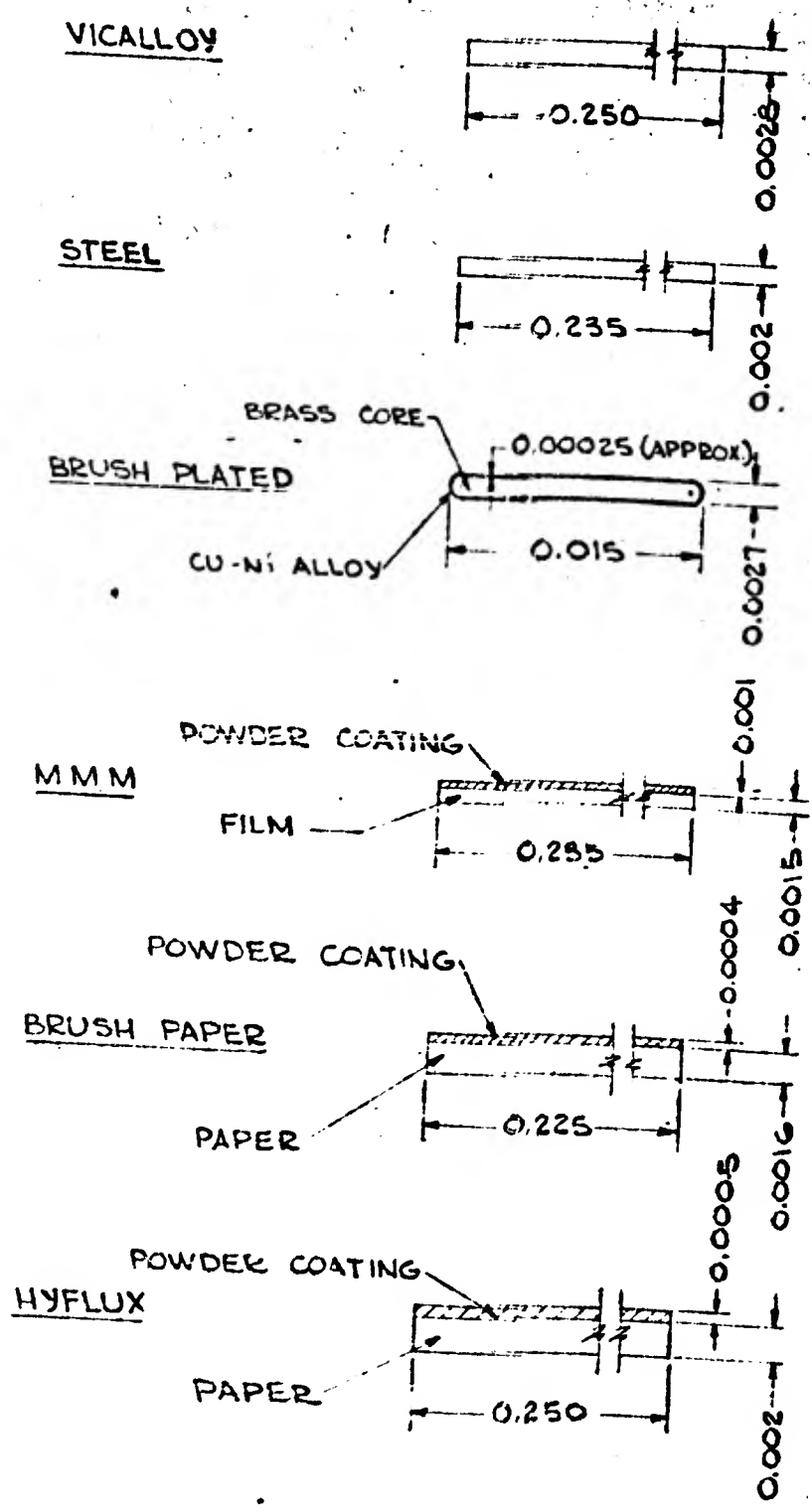

FIG. 17 CROSS-SECTIONS OF TAPES FOR MAGNETIC RECORDING

NO. 16710 DISTEREN GRAPH BOARD
16.5x10 PER. 504

CUBICAL DIVISION CO.
NEW YORK, N. Y.

A-59294G

USED IN 6349 REPORT NU. R-124

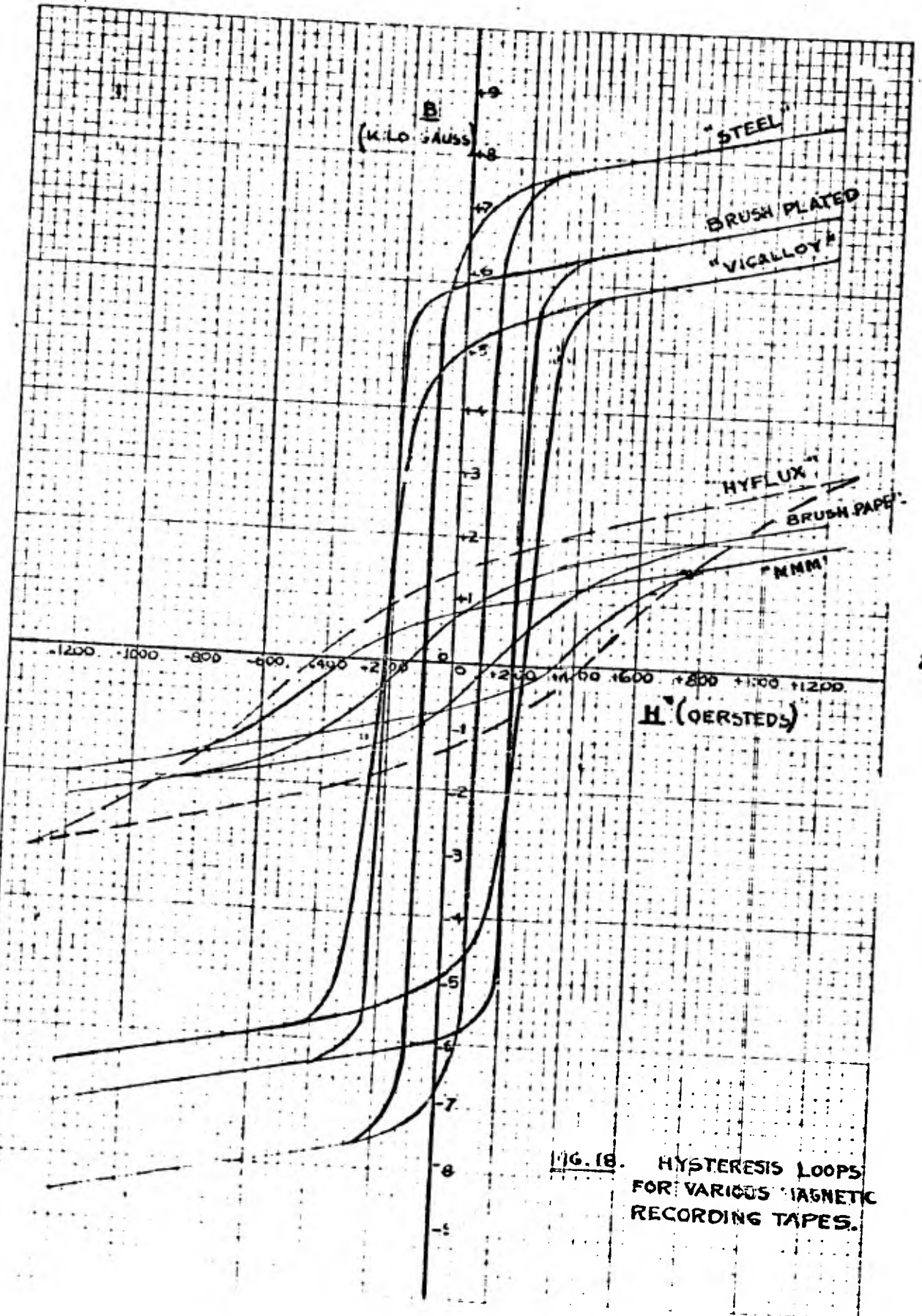

FIG. 18. HYSTERESIS LOOPS FOR VARIOUS MAGNETIC RECORDING TAPES.

A-38295G

USED IN 6345 REPORT NO. R-124

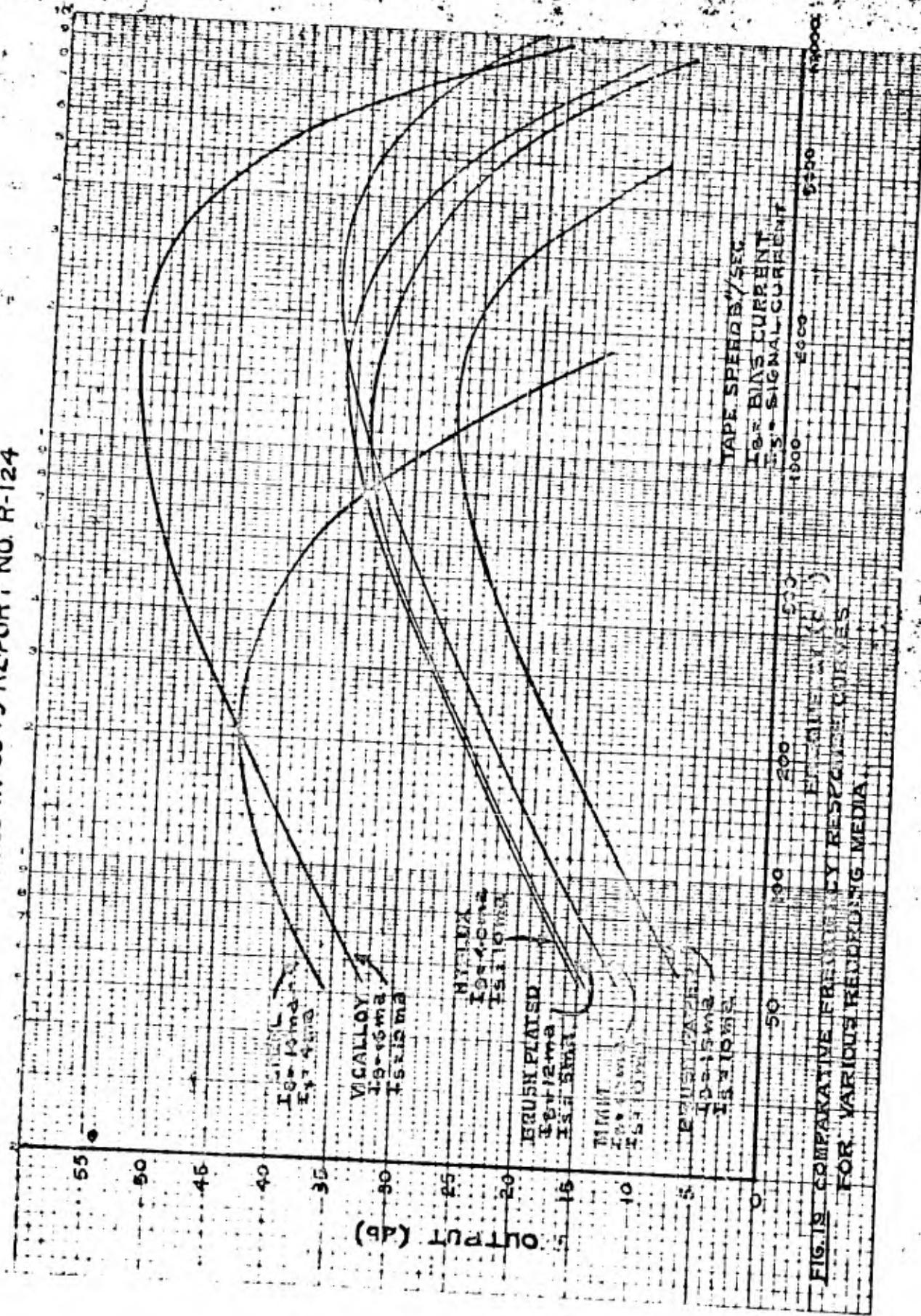

FIG. 19 COMPARATIVE FREQUENCY RESPONSE CURVES FOR VARIOUS RECORDING MEDIA

NO 340 L310 DIETZEN GRANT PAIR
SEMILOGARITHMIC 3 CYCLES X 10 DIVISIONS

ENGINEERING

A-382966

USED IN 6345 REPORT NO. R-124

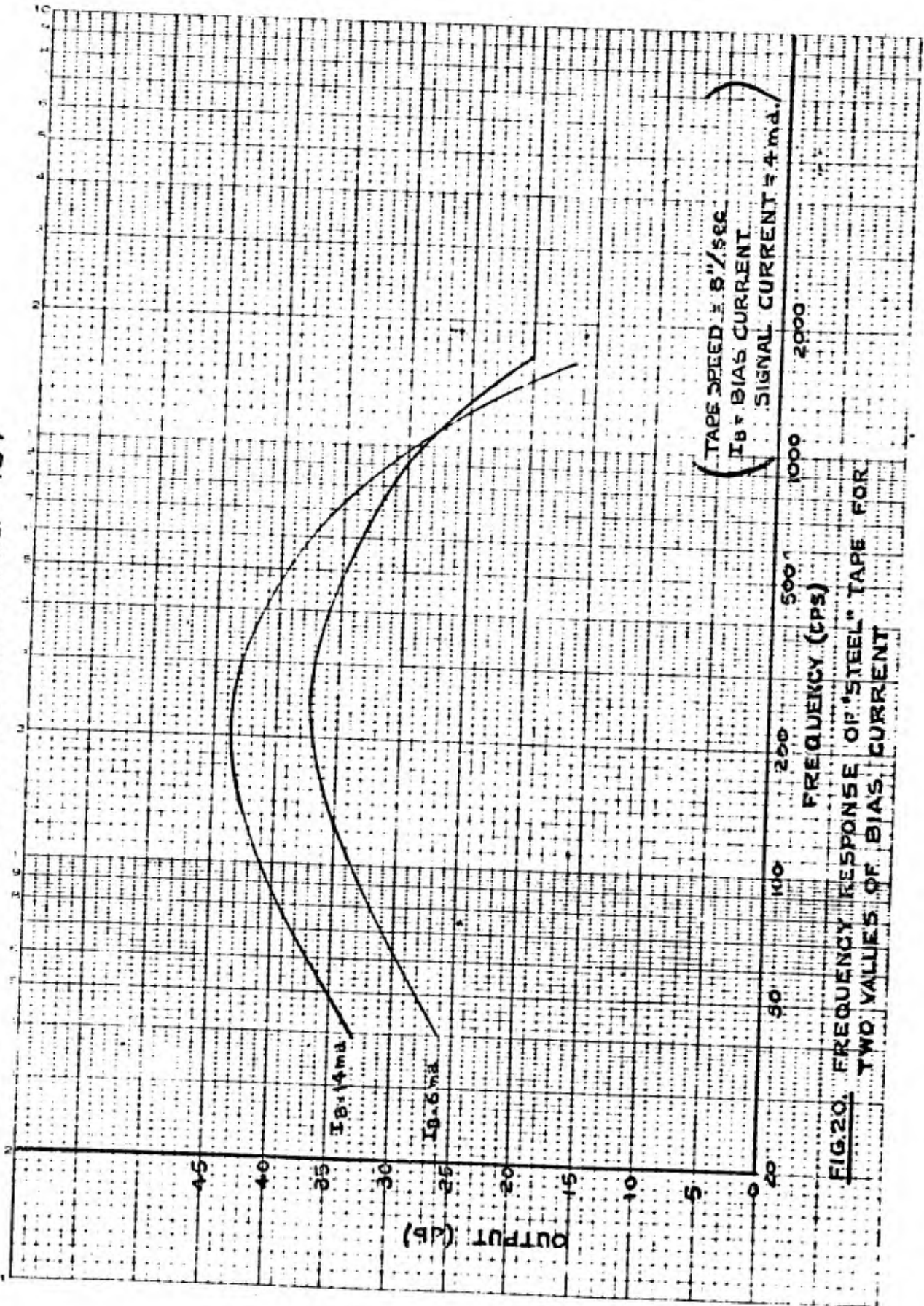

FIG. 20. FREQUENCY RESPONSE OF "STEEL" TAPE FOR TWO VALUES OF BIAS CURRENT

A-38297G

USED IN 6345 REPORT NO. R-124

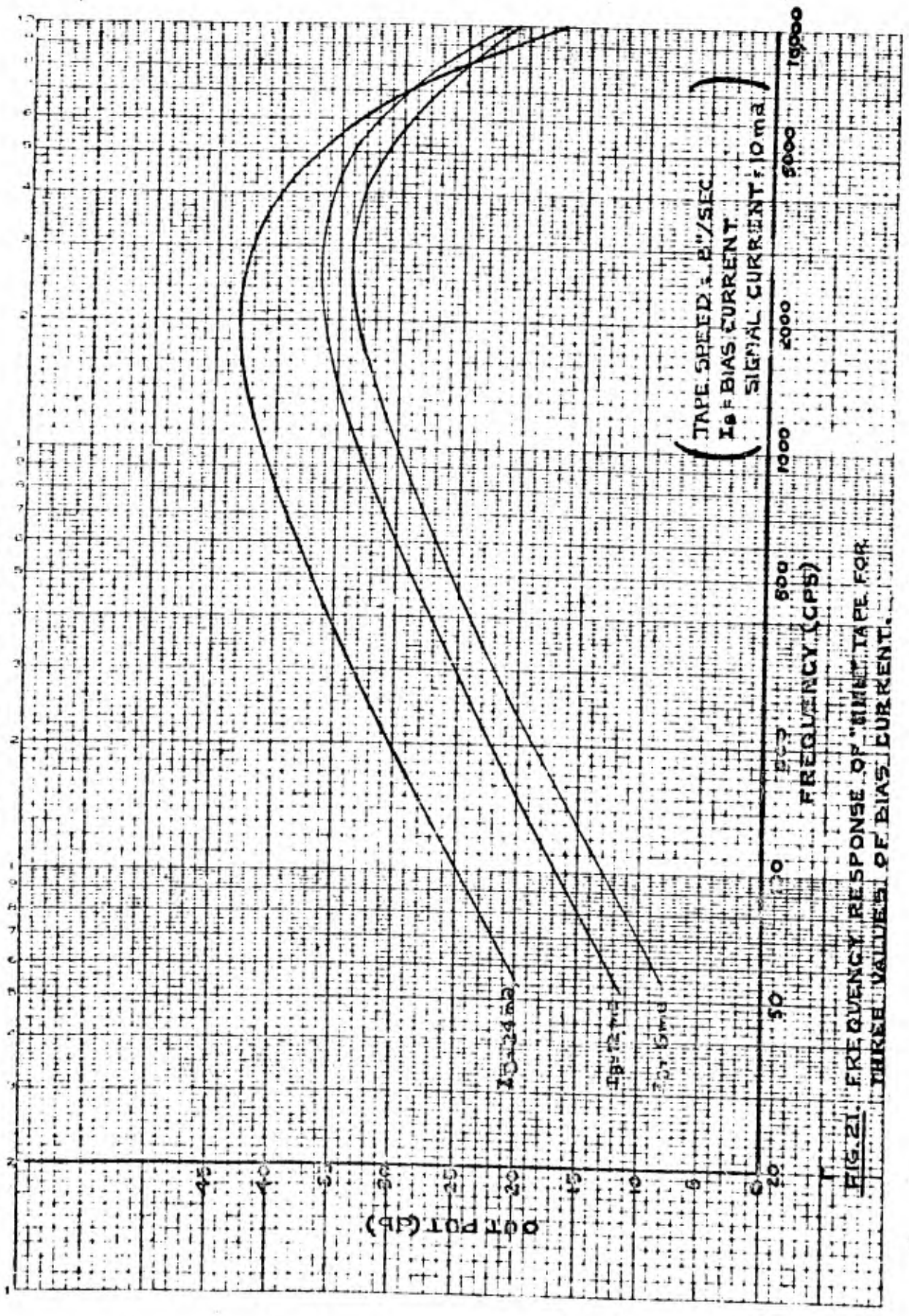

FIG. 21. FREQUENCY RESPONSE OF "MINI" TAPE FOR THREE VALUES OF BIAS CURRENT.

A-39298G

USED IN 6345 REPORT NO. R-124

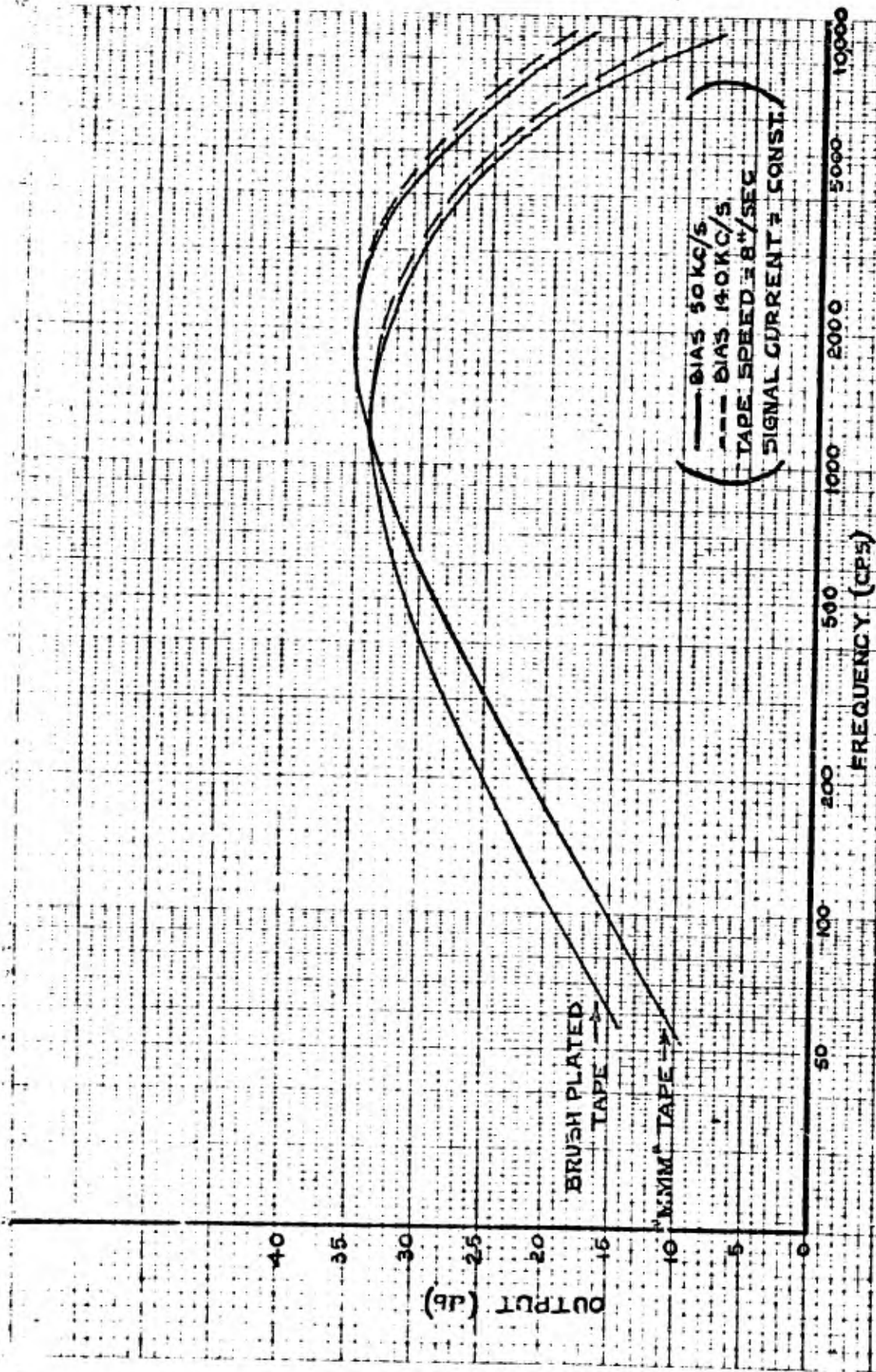

FIG. 22. VARIATION OF FREQUENCY RESPONSE OF RECORDING MEDIA WITH CHANGE IN BIAS FREQUENCY.

USED IN 6345 REPORT NO. R-124

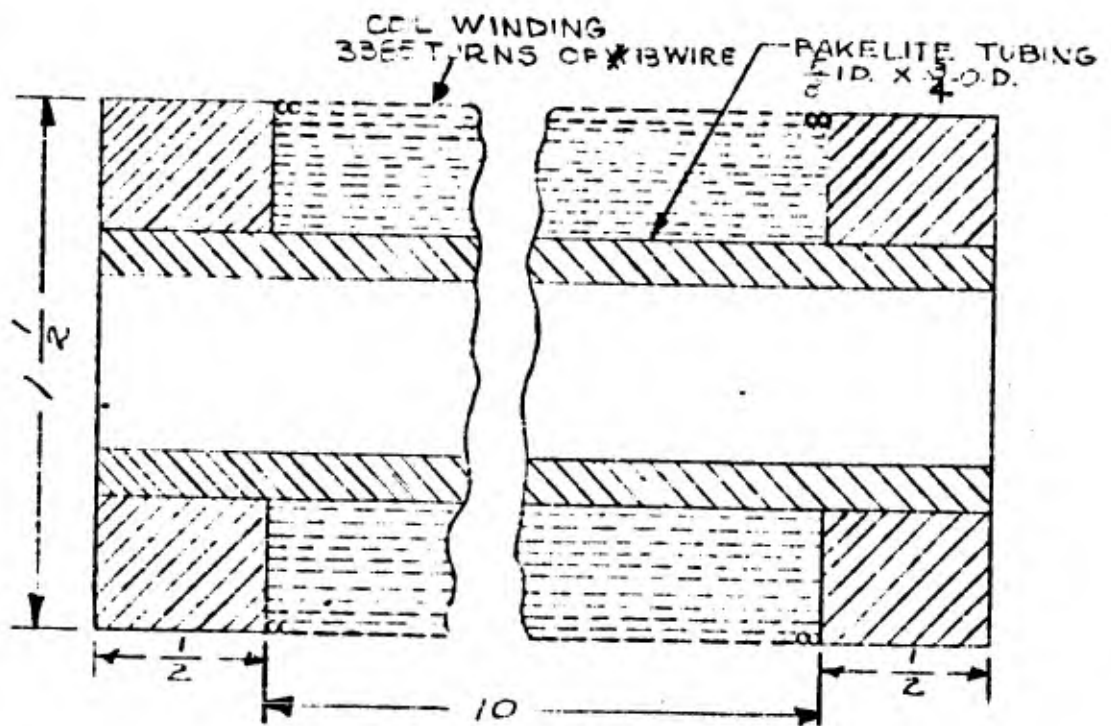

FIG. 23 MAGNETIZING COIL FOR B-H CURVE TRACER.

A-30055

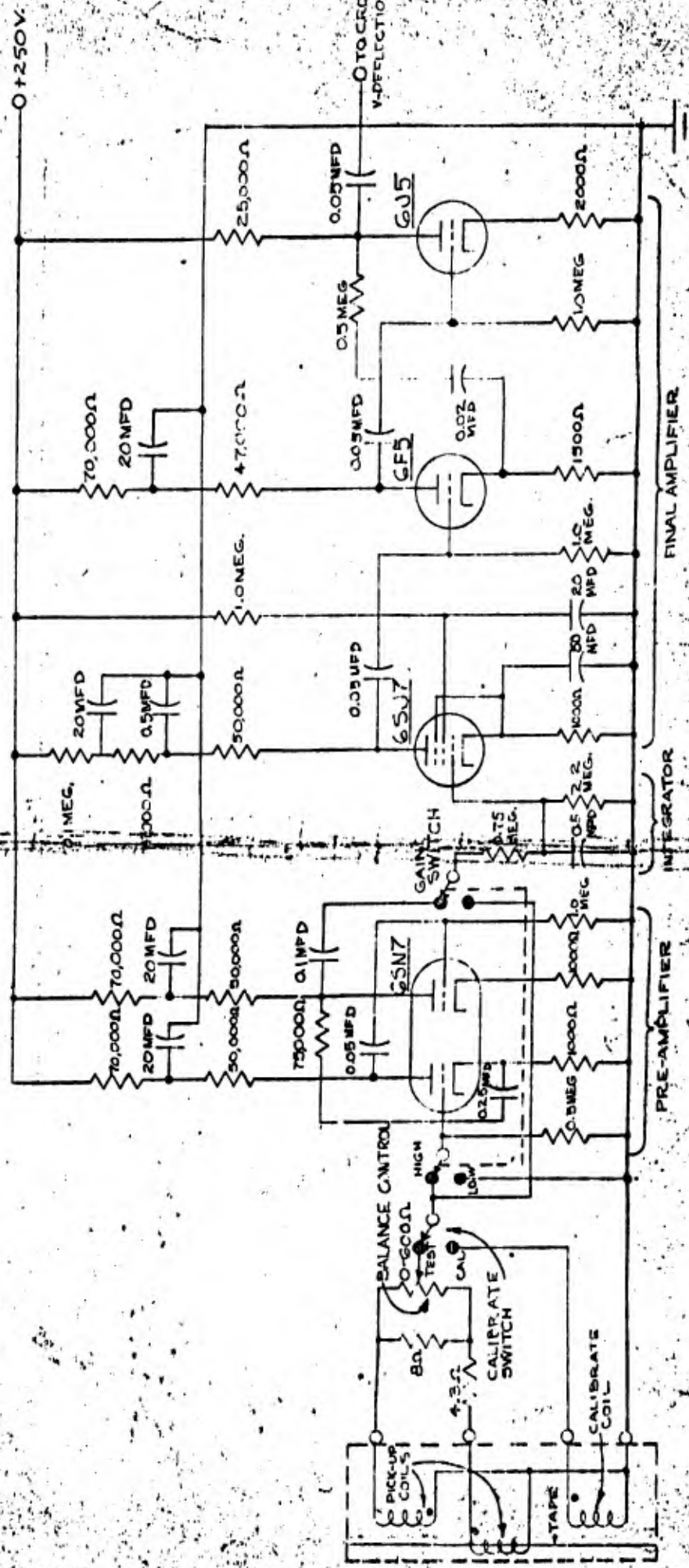

FIG. 26. B-AMPLIFIER FOR B-H CURVE TRACER

30968

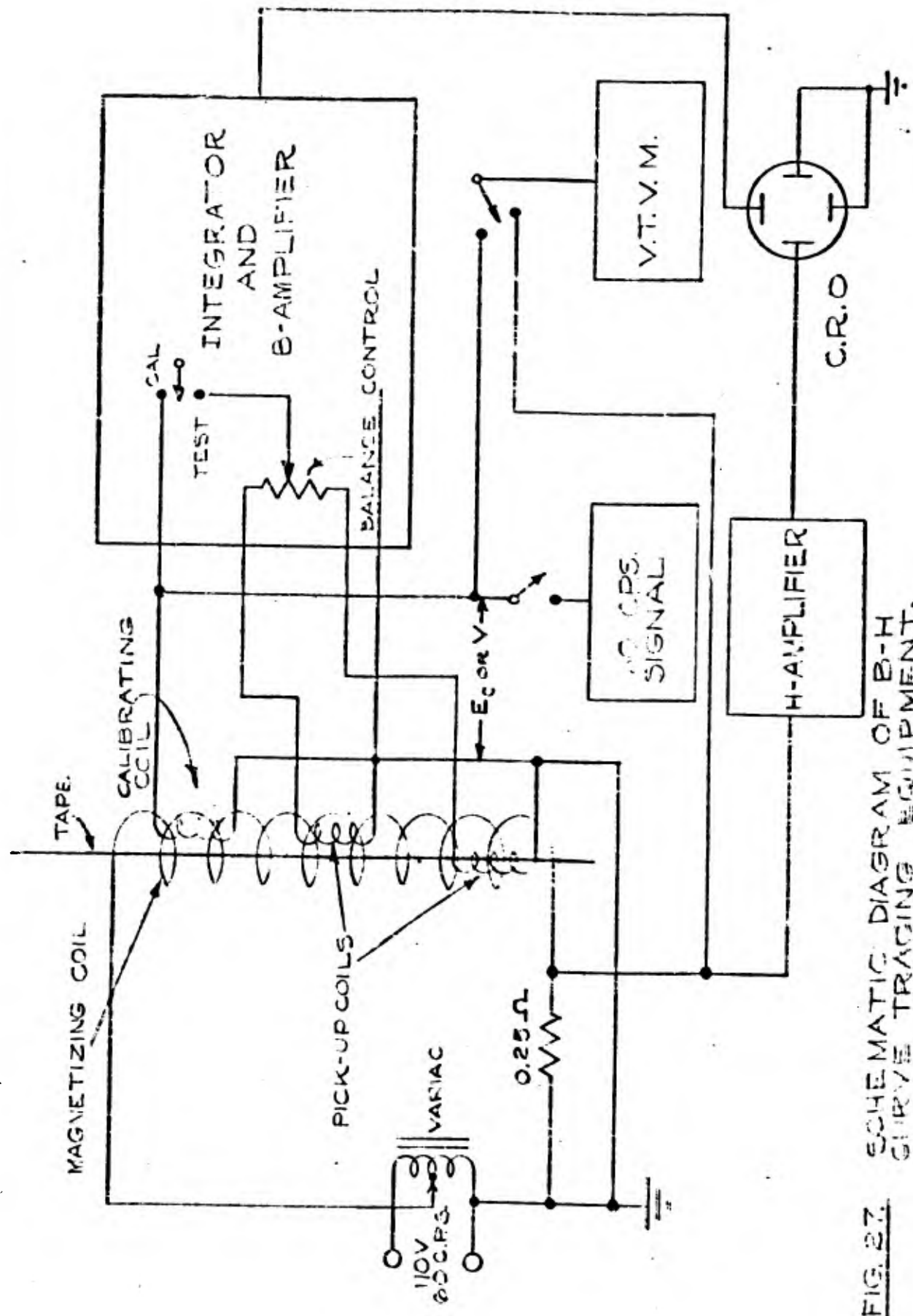

FIG. 27. SCHEMATIC DIAGRAM OF B-H CURVE TRACING EQUIPMENT.

AD 72176

Armed Services Technical Information Agency

Reproduced by
DOCUMENT SERVICE CENTER
KNOTT BUILDING, DAYTON, 2, OHIO

NOTICE: WHEN GOVERNMENT OR OTHER DRAWINGS, SPECIFICATIONS OR OTHER DATA ARE USED FOR ANY PURPOSE OTHER THAN IN CONNECTION WITH A DEFINITELY RELATED GOVERNMENT PROCUREMENT OPERATION, THE U. S. GOVERNMENT THEREBY INCURS NO RESPONSIBILITY, NOR ANY OBLIGATION WHATSOEVER; AND THE FACT THAT THE GOVERNMENT MAY HAVE FORMULATED, FURNISHED, OR IN ANY WAY SUPPLIED THE SAID DRAWINGS, SPECIFICATIONS, OR OTHER DATA IS NOT TO BE REGARDED BY IMPLICATION OR OTHERWISE AS IN ANY MANNER LICENSING THE HOLDER OR ANY OTHER PERSON OR CORPORATION, OR CONVEYING ANY RIGHTS OR PERMISSION TO MANUFACTURE USE OR SELL ANY PATENTED INVENTION THAT MAY IN ANY WAY BE RELATED THERE TO.

UNCLASSIFIED