

UNCLASSIFIED

AD NUMBER

AD072906

CLASSIFICATION CHANGES

TO: UNCLASSIFIED

FROM: CONFIDENTIAL

LIMITATION CHANGES

TO:
Approved for public release; distribution is unlimited. Document partially illegible.

FROM:
Distribution authorized to U.S. Gov't. agencies and their contractors;
Administrative/Operational Use; 07 OCT 1955.
Other requests shall be referred to National Aeronautics and Space Administration, Code AO, 300 "E" Street, SW, Washington, DC 20546-0001.

AUTHORITY

1 Mar 1960, per ASTIA TAB nol U-60-1-5, per document marking; per nasa ltr, 21 jun 1960

THIS PAGE IS UNCLASSIFIED

THIS REPORT HAS BEEN DELIMITED
AND CLEARED FOR PUBLIC RELEASE
UNDER DOD DIRECTIVE 5200.20 AND
NO RESTRICTIONS ARE IMPOSED UPON
ITS USE AND DISCLOSURE.

DISTRIBUTION STATEMENT A

APPROVED FOR PUBLIC RELEASE;
DISTRIBUTION UNLIMITED.

AD- 066636
SECURITY REMARKING REQUIREMENTS
DOD 5200.1-R, DEC 78
REVIEW ON 28 JAN 75

UNCLASSIFIED

AD

72 906

Reproduced

Armed Services Technical Information Agency

ARLINGTON HALL STATION; ARLINGTON 12 VIRGINIA

NOTICE: WHEN GOVERNMENT OR OTHER DRAWINGS, SPECIFICATIONS OR OTHER DATA ARE USED FOR ANY PURPOSE OTHER THAN IN CONNECTION WITH A DEFINITELY RELATED GOVERNMENT PROCUREMENT OPERATION, THE U. S. GOVERNMENT THEREBY INCURS NO RESPONSIBILITY, NOR ANY OBLIGATION WHATSOEVER; AND THE FACT THAT THE GOVERNMENT MAY HAVE FORMULATED, FURNISHED, OR IN ANY WAY SUPPLIED THE SAID DRAWINGS, SPECIFICATIONS, OR OTHER DATA IS NOT TO BE REGARDED BY IMPLICATION OR OTHERWISE AS IN ANY MANNER LICENSING THE HOLDER

CONFIDENTIAL
CLASSIFICATION CHANGED FROM _____
TO UNCLASSIFIED AUTHORITY LISTED IN

ASTIA TAB NO. _____ U 60-1-5 _____ DATE _____ 1 Mar. 60.

AD 72906

Armed Services Technical Information Agency

Reproduced by
DOCUMENT SERVICE CENTER
KNOTT BUILDING, DAYTON, 2, OHIO

This document is the property of the United States Government. It is furnished for the duration of the contract and shall be returned when no longer required, or upon recall by ASTIA to the following address:
Armed Services Technical Information Agency, Document Service Center,
Knott Building, Dayton 2, Ohio.

NOTICE: WHEN GOVERNMENT OR OTHER DRAWINGS, SPECIFICATIONS OR OTHER DATA ARE USED FOR ANY PURPOSE OTHER THAN IN CONNECTION WITH A DEFINITELY RELATED GOVERNMENT PROCUREMENT OPERATION, THE U. S. GOVERNMENT THEREBY INCURS NO RESPONSIBILITY, NOR ANY OBLIGATION WHATSOEVER; AND THE FACT THAT THE GOVERNMENT MAY HAVE FORMULATED, FURNISHED, OR IN ANY WAY SUPPLIED THE SAID DRAWINGS, SPECIFICATIONS, OR OTHER DATA IS NOT TO BE REGARDED BY IMPLICATION OR OTHERWISE AS IN ANY MANNER LICENSING THE HOLDER OR ANY OTHER PERSON OR CORPORATION, OR CONVEYING ANY RIGHTS OR PERMISSION TO MANUFACTURE, USE OR SELL ANY PATENTED INVENTION THAT MAY IN ANY WAY BE RELATED THERETO.

CONFIDENTIAL

DISCLAIMER NOTICE

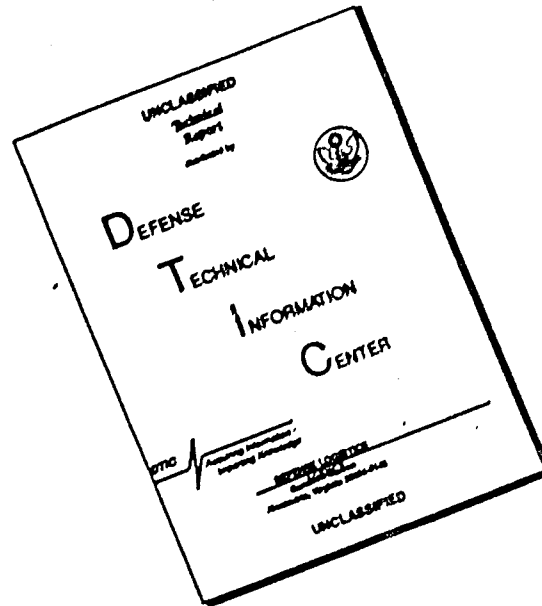

THIS DOCUMENT IS BEST QUALITY AVAILABLE. THE COPY FURNISHED TO DTIC CONTAINED A SIGNIFICANT NUMBER OF PAGES WHICH DO NOT REPRODUCE LEGIBLY.

CONFIDENTIAL

74906
NACA REPORT 149

76

NACA

RESEARCH MEMORANDUM

A COMPARISON OF THE HYDRODYNAMIC FORCES
ON 1/25-, 1/10-, AND 8/10-SIZE MODELS
OF A CONVAIR XF2Y-1 HYDRO-SKI

By Ellis E. McBride

Langley Aeronautical Laboratory
Langley Field, Va.

**NATIONAL ADVISORY COMMITTEE
FOR AERONAUTICS**

WASHINGTON

October 7, 1954

CONFIDENTIAL

K

NACA RM L55G29a

CONFIDENTIAL

NATIONAL ADVISORY COMMITTEE FOR AERONAUTICS

RESEARCH MEMORANDUM

A COMPARISON OF THE HYDRODYNAMIC FORCES

ON 1/25-, 1/10-, AND 8/10-SIZE MODELS

OF A CONVAIR XF2Y-1 HYDRO-SKI

By Ellis E. McBride

SUMMARY

Force tests were conducted in Langley tank no. 2 to investigate scale effects on the original Convair XF2Y-1 hydro-ski configuration. Two sizes of models, 1/10 and 8/10, were tested in order to cover a large range of speed and Reynolds number. Lift data from a 1/25-size model tested in a free-water jet are included in the comparisons. Tests were made at trims of 6° and 9° , and at constant speeds of 20 to 200 feet per second, which covered a Reynolds number range of 5×10^5 to 1×10^7 .

The results of the investigation show that reasonable agreement of the force coefficients with all three sizes of models was obtained. The beaching wheel and its fairing generally increased the lift and drag of the ski and reduced the lift-drag ratio about one-third when compared to the bare ski. No major force breaks or cavitation were observed. Ventilation around the wheel and fairing was observed throughout the tests. The possibility of some scale effect because of this ventilation was indicated.

INTRODUCTION

The original hydro-skis used on the Convair XF2Y-1 airplane had both longitudinal and transverse curvature with an inserted wheel and its fairing near the trailing edge. This complicated shape and the high landing speed introduced the possibility of cavitating or ventilating flows not ordinarily encountered with seaplane hulls. It was of interest therefore to investigate the scale effects of this type of hydro-ski. This interest and the need to provide force data through the maximum speed and Reynolds number range available led to the present investigation in which the lift and drag were measured on 1/10- and 8/10-size models of the hydro-ski in Langley tank no. 2.

CONFIDENTIAL

55AA 49741

The configurations tested were models of only the rear one-third of the full-size ski. The lift data from a 1/25-size model of the same hydro-ski as obtained in a free-water jet (ref. 1) are included for comparison.

SYMBOLS

C_D	hydrodynamic drag coefficient, $\frac{D}{\frac{\rho}{2} SV^2}$
C_F	skin-friction drag coefficient, $C_D - C_L \tan \tau$
C_L	hydrodynamic lift coefficient, $\frac{L}{\frac{\rho}{2} SV^2}$
D	corrected hydrodynamic drag, lb
N_{Fr}	Froude number, $\frac{V}{\sqrt{gl}}$
g	acceleration of gravity, 32.2 ft/sec ²
L	corrected hydrodynamic lift, lb
l	wetted length of planing surface, ft
R	Reynolds number, $\frac{Vl}{\nu}$
S	wetted area of planing surface, sq ft
V	corrected horizontal speed, fps
ν	kinematic viscosity, ft ² /sec
ρ	density of tank water, $\rho/2 = 0.984$ slug/cu ft
τ	trim of ski, the angle between the flat part of ski bottom and the free-water surface

APPARATUS AND PROCEDURE

Description of Models

A photograph of the 1/10- and 8/10-size models of the Convair XF2Y-1 hydro-ski is shown in figure 1. Figure 2 is a drawing of the 1/10-size model showing the installation of the beaching wheel and its fairing. Tests were made with the wheel and fairing installed and in the bare-ski configuration which is with the wheel and fairing removed and the wheel slot plugged. The planing condition of interest was when the water line intersected the ski at about the leading edge of the fairing. Therefore the configurations tested were models of only the rear one-third of the full-size ski. The skis were run with a 6° yaw so that the direction of motion was parallel to the wheel as it is on the full-size airplane. The wheel was mounted on bushings and was free to rotate. The 1/10- and 8/10-size models including the wheels were constructed of mahogany and painted white. The bottoms of the two models were marked with grids to facilitate the reading of wetted areas. The 1/25-size model is described in reference 1.

Test Methods and Equipment

The 1/10-size model was tested on the main towing carriage in Langley tank no. 2 using the small model towing gear. Aerodynamic tares were eliminated by a wind screen in front of the model. The lift and drag forces were measured by electrical strain-gage beams and the deflections were read visually on galvanometers.

The 8/10-size model was the largest size that could be accommodated by the existing equipment in Langley tank no. 2. The model was attached by means of a rigid strut to a two-component electrical strain-gage balance capable of measuring lift up to 3,500 pounds and drag up to 1,500 pounds. The balance fed into a two-channel strip-chart recorder which provided a record of the values measured. In the tests of both the 1/10- and 8/10-size models, the trim and wetted length were preset to the desired values before each run.

Tests were made at constant speeds from 20 to 80 feet per second, the maximum speed of the carriage. The desired constant speed could be preset to an accuracy of about 1 foot per second. The true speed was determined from an oscillograph trace of time and distance to an accuracy of about ± 0.10 foot per second. The data were corrected to the desired speed. This correction was small and in no case amounted to more than about 2 percent of the measured force. The configuration with the wheel and fairing installed was tested at trims of 6° and 9° . The bare-ski configuration was tested at 9° trim.

CONFIDENTIAL

The preset trim of the model could not be maintained because of the deflections of the balance and balance support frame. The trim change varied with applied moment and was calibrated before the tests were run. For the small model, the change in trim varied from 0° to 0.25° , and for the large model from 0° to 1° .

In addition to the correction for speed, the data have been corrected to the desired trim.

Underwater photographs used in measuring the wetted length of the model were made by a 70-millimeter camera mounted in a waterproof box on the bottom of the tank. Photographs were also made by a similar camera mounted on a boom attached to one side of the towing carriage.

The accuracy of the balances and recording devices was considered to be as follows:

Lift of 8/10-size model, lb	± 4.0
Drag of 8/10-size model, lb	± 2.0
Lift of 1/10-size model, lb	± 0.080
Drag of 1/10-size model, lb	± 0.020
Trim, deg	± 0.10
Speed, fps	± 0.10
Wetted area of 8/10-size model, sq ft	± 0.04
Wetted area of 1/10-size model, sq ft	± 0.003

RESULTS AND DISCUSSION

The lift and drag forces corrected to the desired speed and trim are plotted in figures 3 to 8 against the wetted area measured from the underwater photographs.

From these plots, data for a length-beam ratio of 1.783 which corresponds to a wetted area of 0.0600 and 3.84 square feet for the 1/10- and 8/10-size models, respectively, were reduced to coefficient form. This length-beam ratio and the corresponding wetted areas were selected as being representative of the planing condition of interest when the water line intersects just behind the leading edge of the fairing. Figure 9 gives these coefficients for the 1/10- and 8/10-size models and flat-plate data for a length-beam ratio of 1.783 from reference 2. These data show reasonable agreement between the two models. No large force breaks occurred, but for the ski with the wheel and fairing installed, some variation from a constant lift coefficient with speed is shown. No cavitation was observed throughout the speed range tested, but a ventilation of the flow around the fairing and through the forward part of the wheel slot was apparent throughout the speed range for both

the 1/10- and 8/10-size models. Figure 9(a) shows that the models with the wheel and fairing at 6° trim had higher lift and drag coefficients than the flat plate. Figures 9(b) and 9(c) show that generally the models at 9° trim had slightly lower lift coefficients than the flat plate. With the bare-ski configuration (fig. 9(c)) the drag was about the same as that of the flat plate. Figure 10 shows a comparison of the lift-drag ratios of the 1/10- and 8/10-size models with that of a flat plate. No appreciable variation of L/D with speed or model size was obtained. It can be seen that the wheel and fairing reduced the lift-drag ratio of the bare ski about one-third.

Data for the 1/25-size model of the ski with wheel and fairing configuration were previously unpublished but were obtained along with the bare-ski data of reference 1. The drag data for the 1/25-size model were unavailable, but the lift coefficient is plotted against Reynolds number along with the lift and drag coefficients of the 1/10- and 8/10, size models in figure 11. These data show that the lift coefficient was unaffected by Reynolds number. The 1/25- and 1/10-size model data agree well even though the tests were run in different type facilities. The skin-friction coefficients of the bare ski at 9° trim (fig. 11(c)) indicate that the 8/10-size model was in the fully turbulent region throughout the entire speed range. The boundary layer of the 1/10-size model was transitional becoming fully turbulent at the higher speeds.

The lift coefficients of the three models are plotted against Froude number in figure 12. Good agreement with all three sizes of models was obtained at all conditions except in the Froude number range of between 6 and 10 with the wheel and fairing installed at 9° trim (fig. 12(b)) where a substantial difference is shown between the 1/10 and 8/10 scale data. This may indicate some scale effect on the lift coefficient because of ventilation around the wheel and fairing. For the wheel and fairing configuration the agreement is actually somewhat better when the data are compared at the same speed (figs. 9(a) and 9(b)).

The ventilation is shown in the two typical underwater photographs of figure 13. It appears to have originated at two distinct points - at the intersection of the fairing and the ski, and through the slot around the wheel. There was no appreciable difference in the effects of the ventilation on the flow pattern at high or low speeds. It is thought that this ventilation prevented the occurrence of cavitation at the higher speeds.

Figure 14 shows some sequence photographs of the 8/10-size model taken at the lower speeds. Wheel rotation could be observed and was present at all speeds. The direction of rotation was always as if the wheel were rolling on the water. The vertical plume of spray can be seen rising from the slot to the rear of the wheel. At the higher speeds this spray became a high-speed jet which limited the speeds at which it

could be photographed. Figure 15 is a photograph taken after the carriage had passed by, showing the large amount of spray generated by the 8/10-size model.

CONCLUSIONS

Comparison of the data from three sizes of models of a Convair XF2Y-1 hydro-ski led to the following conclusions:

1. Reasonable agreement of the force coefficients for the three sizes of models was obtained.
2. The beaching wheel and its fairing generally increased the lift and drag of the ski and reduced the lift-drag ratio about one-third when compared with that of the bare ski.
3. No major force breaks or cavitation were observed. Ventilation around the wheel and fairing was observed throughout the speed range with the 1/10- and 8/10-size models. The possibility of some scale effect because of this ventilation was indicated.

Langley Aeronautical Laboratory,
National Advisory Committee for Aeronautics,
Langley Field, Va., July 19, 1955.

REFERENCES

1. McGehee, John R., Weinflash, Bernard, and Pelz, Charles A.: The Hydrodynamic Planing Lift of Four Surfaces As Measured in a 200-FPS Free Jet. NACA RM L54F01, 1954.
2. Weinstein, Irving, and Kapryan, Walter J.: The High-Speed Planing Characteristics of a Rectangular Flat Plate Over a Wide Range of Trim and Wetted Length. NACA TN 2981, 1953.

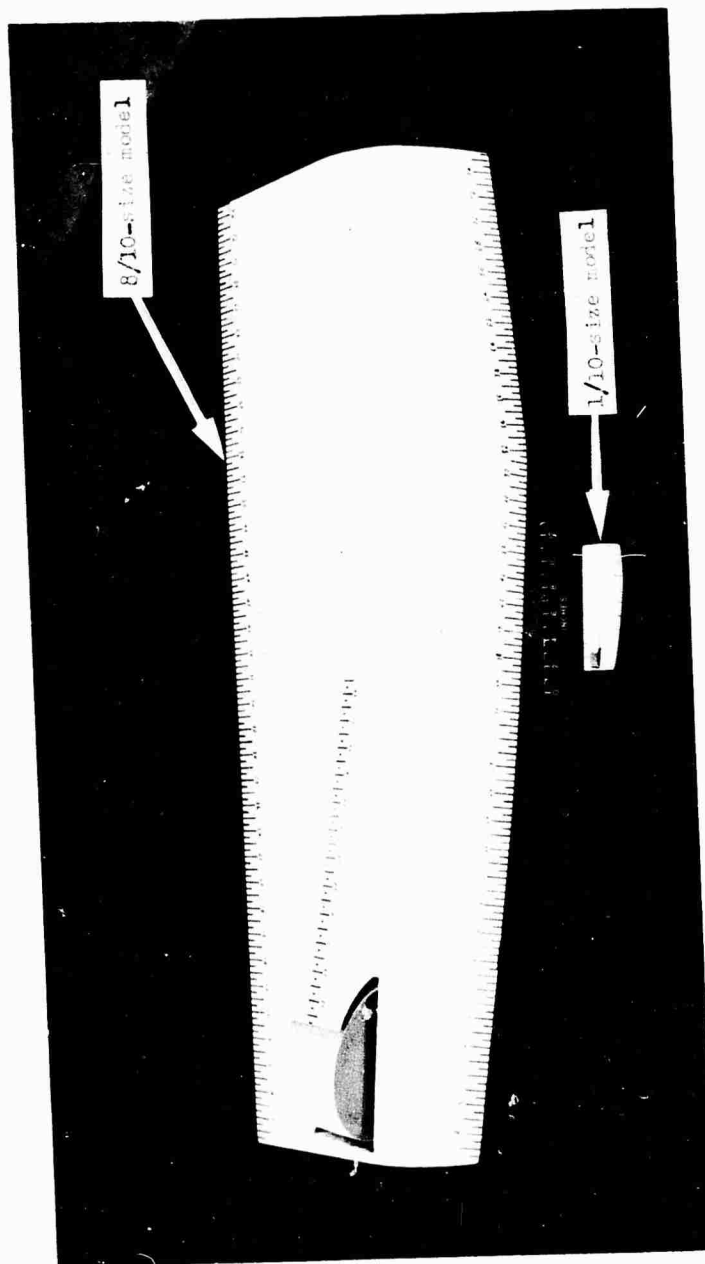

L-89160.1

Figure 1.- Photograph of the 1/10- and 8/10-size models of the Convair
XF2Y-1 hydro-ski.

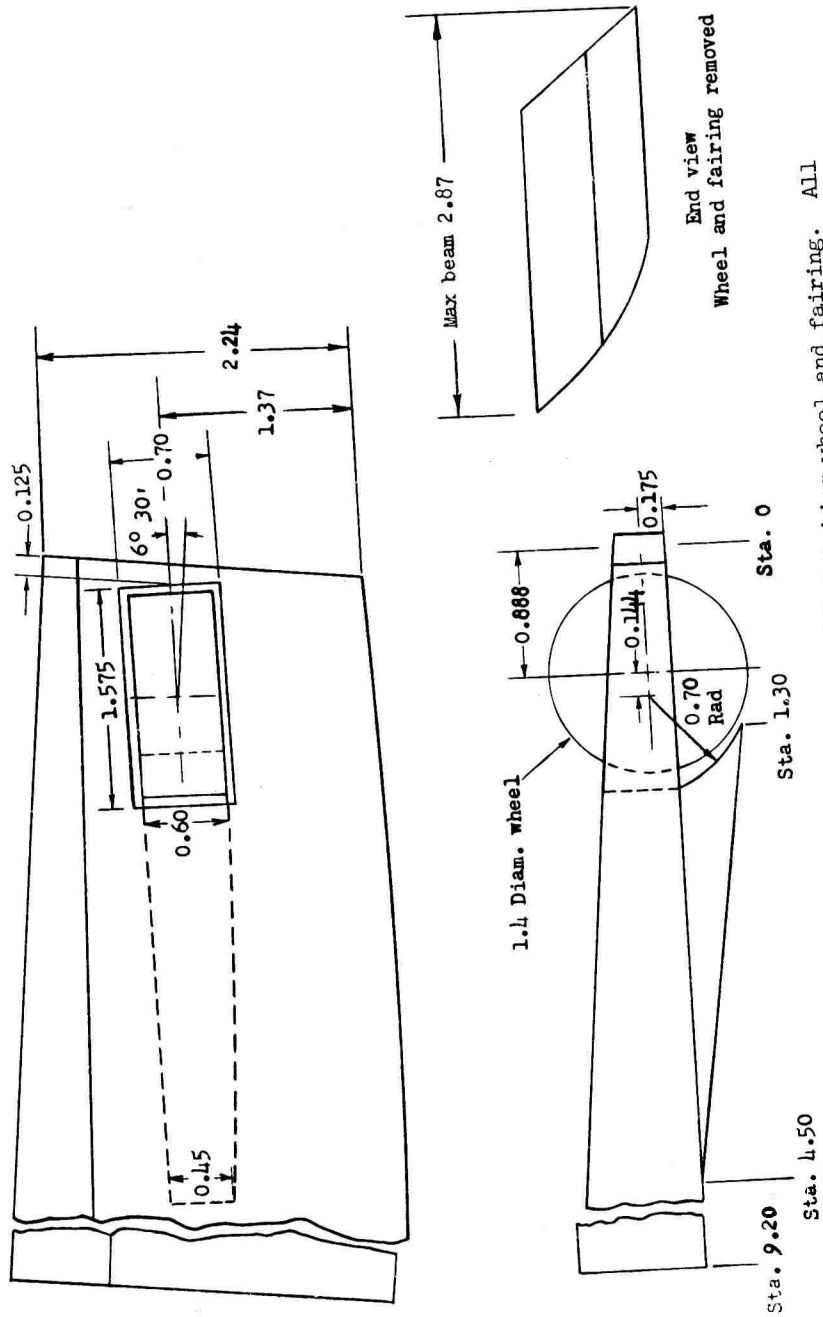
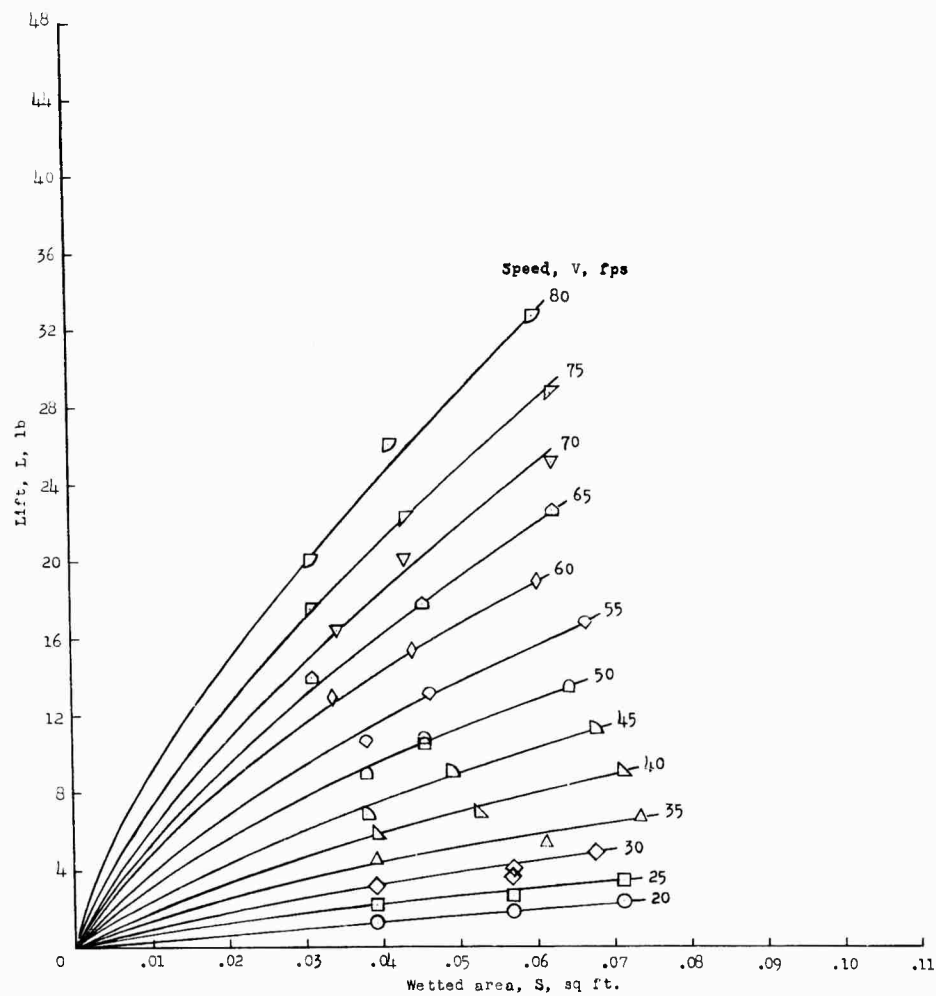
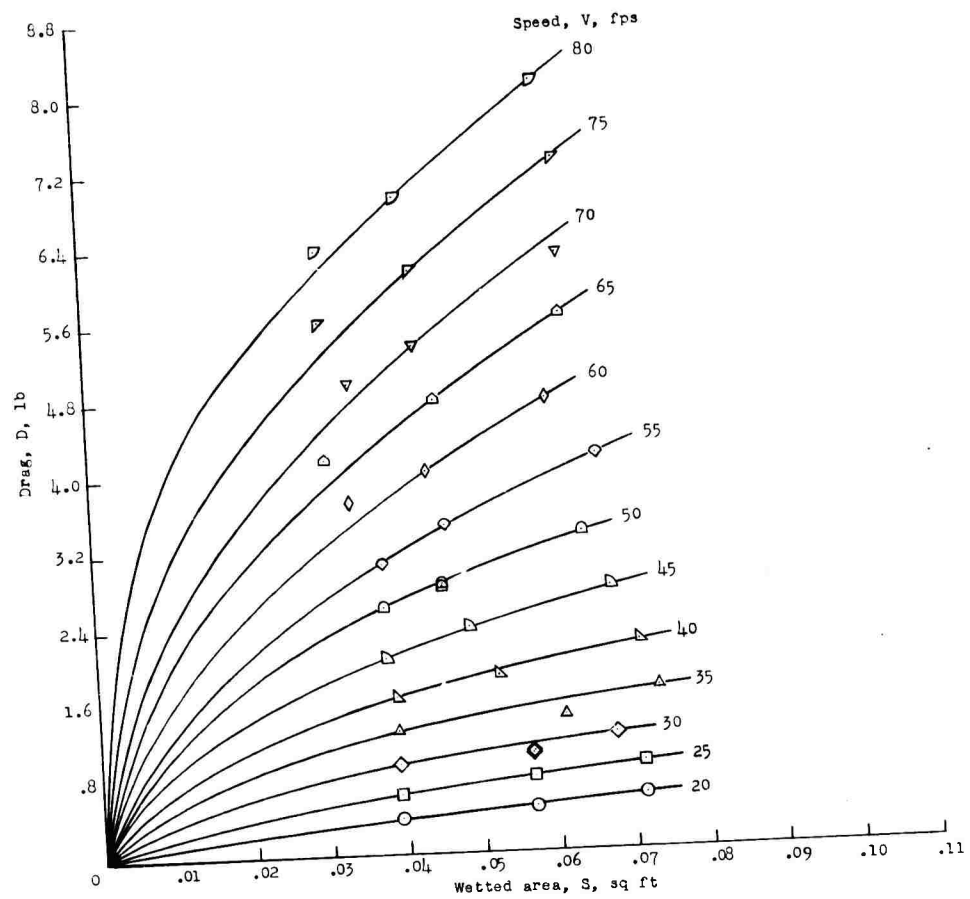

Figure 2.- The 1/10-size hydro-ski with beaching wheel and fairing. All dimensions are in inches.



(a) Lift.

Figure 3.- Planing data for 1/10-size model with wheel and fairing installed. Trim, 6°.



(b) Drag.

Figure 3.- Concluded.

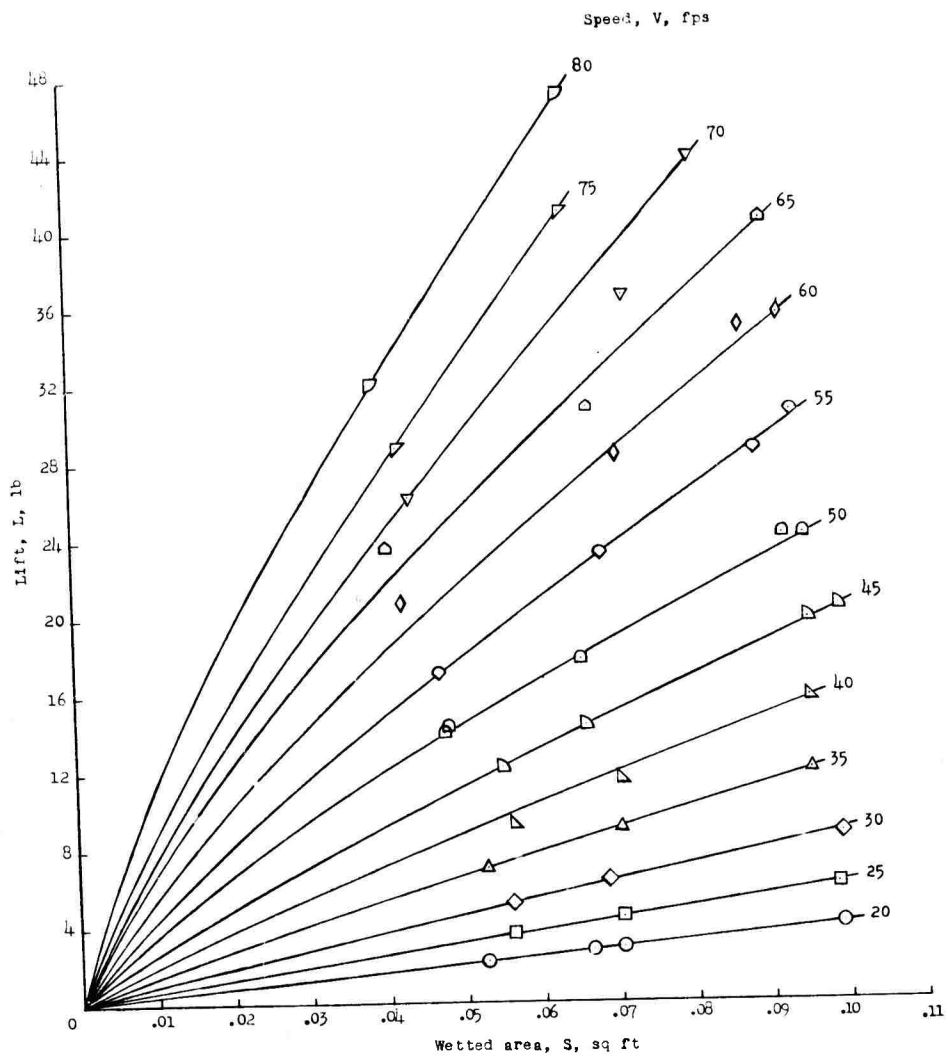

(a) Lift.

Figure 4.- Planing data for 1/10-size model with wheel and fairing installed. Trim, 9°.

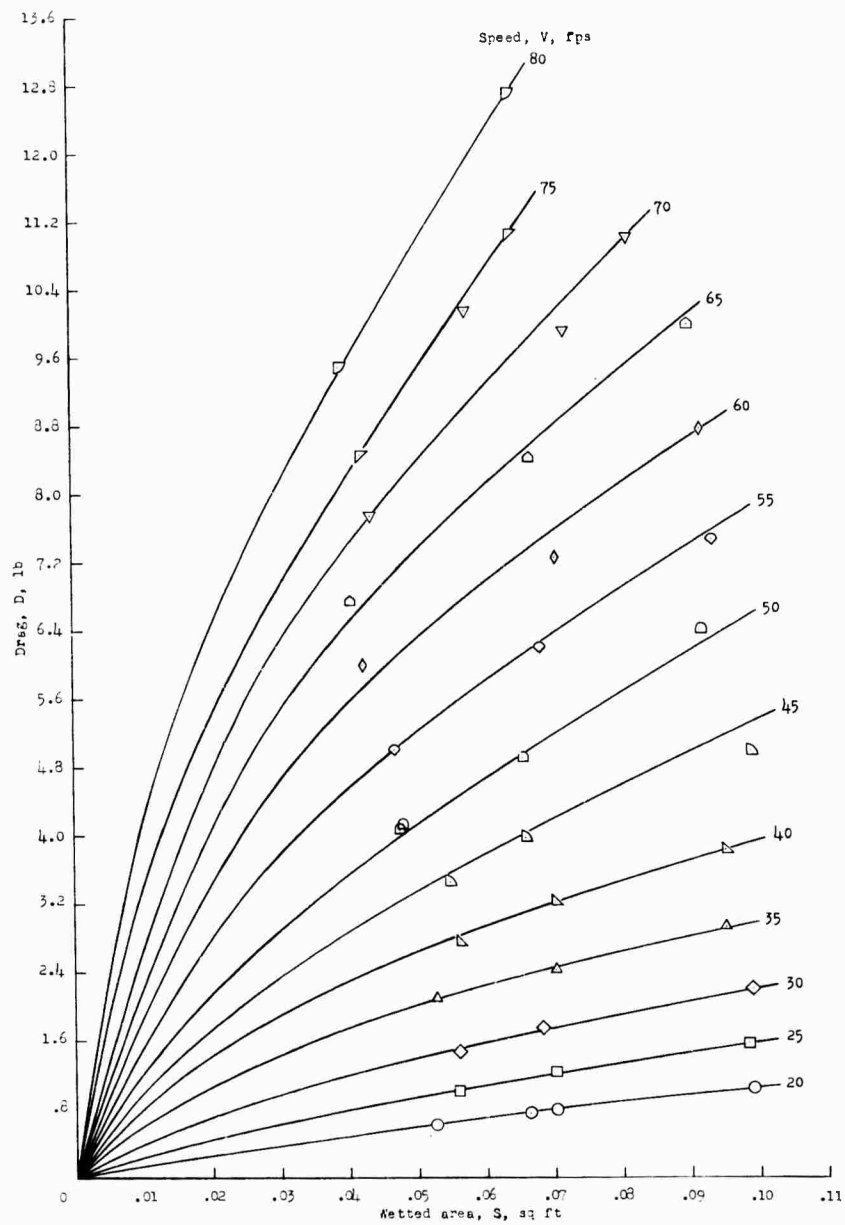

(b) Drag.

Figure 4.- Concluded.

CONFIDENTIAL

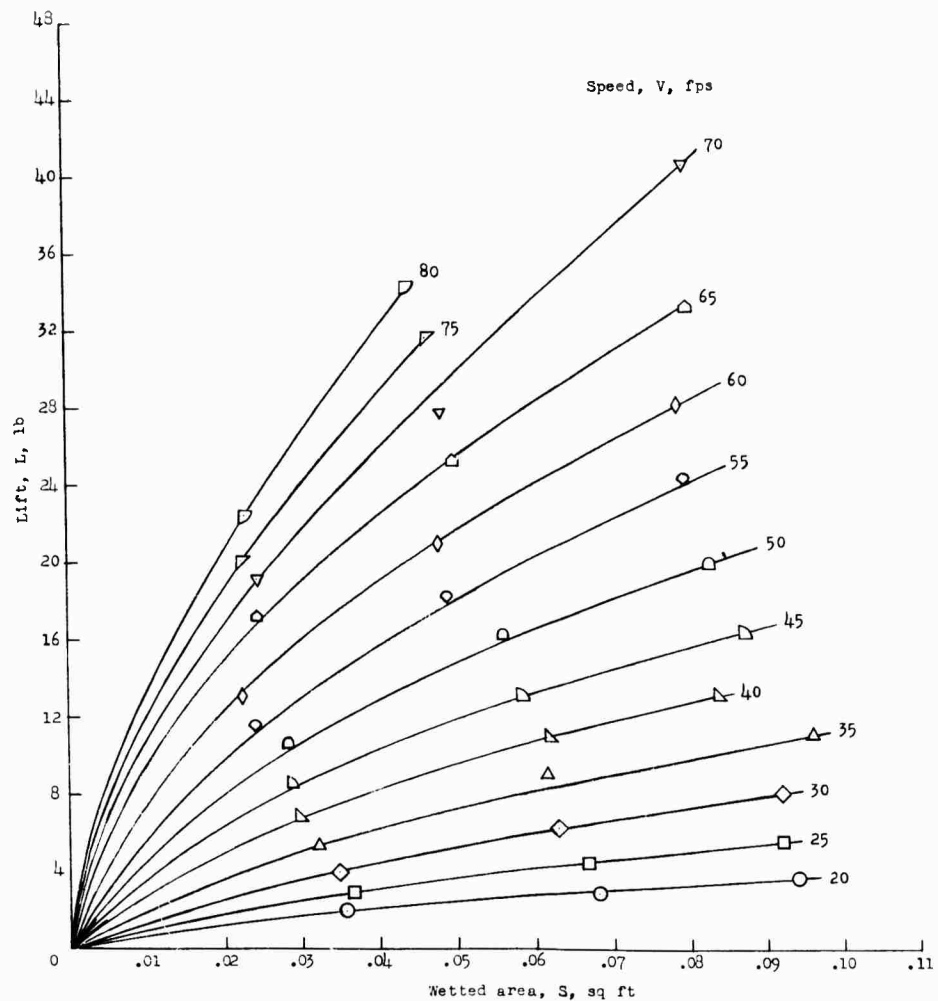

(a) Lift.

Figure 5.- Planing data for 1/10-size model with bare-ski configuration.
Trim, 9°.

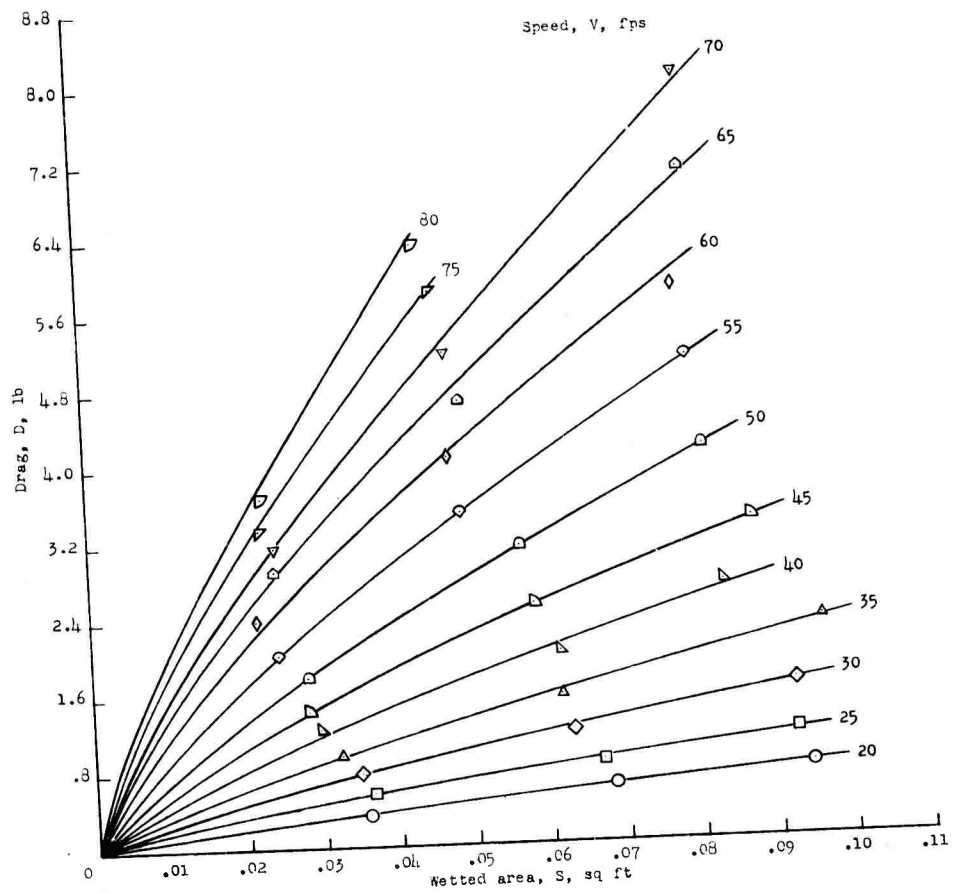

(b) Drag.

Figure 5.- Concluded.

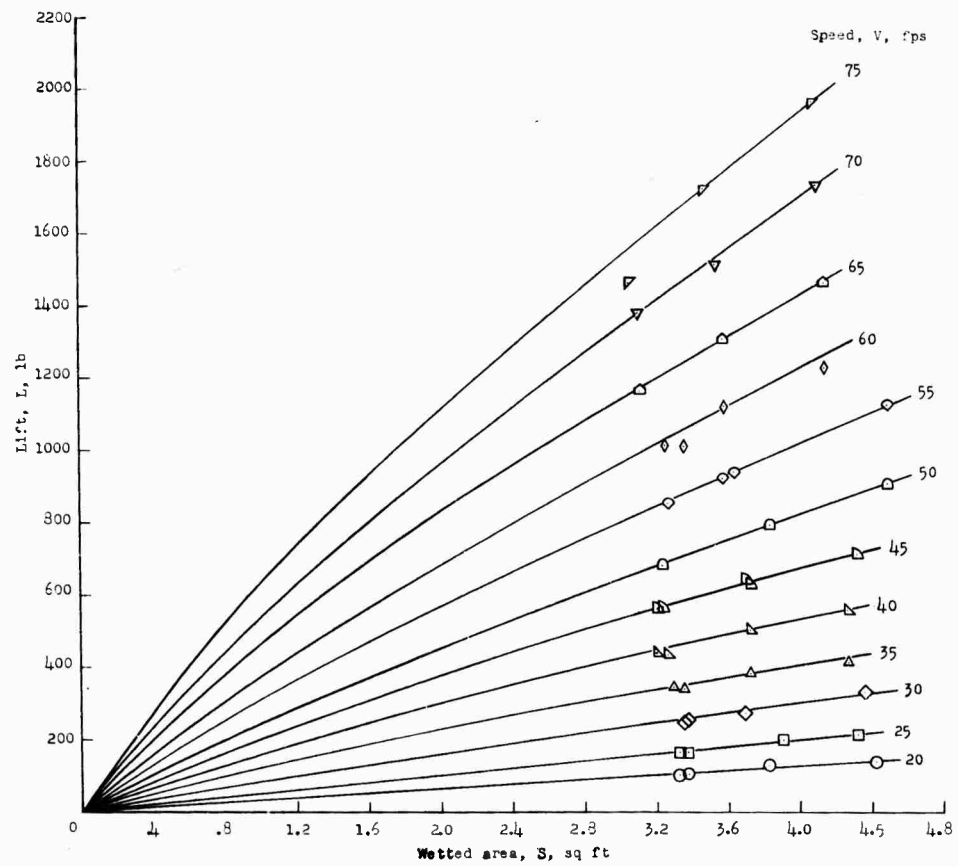

(a) Lift.

Figure 6.- Planing data for 8/10-size model with wheel and fairing installed. Trim, 6°.

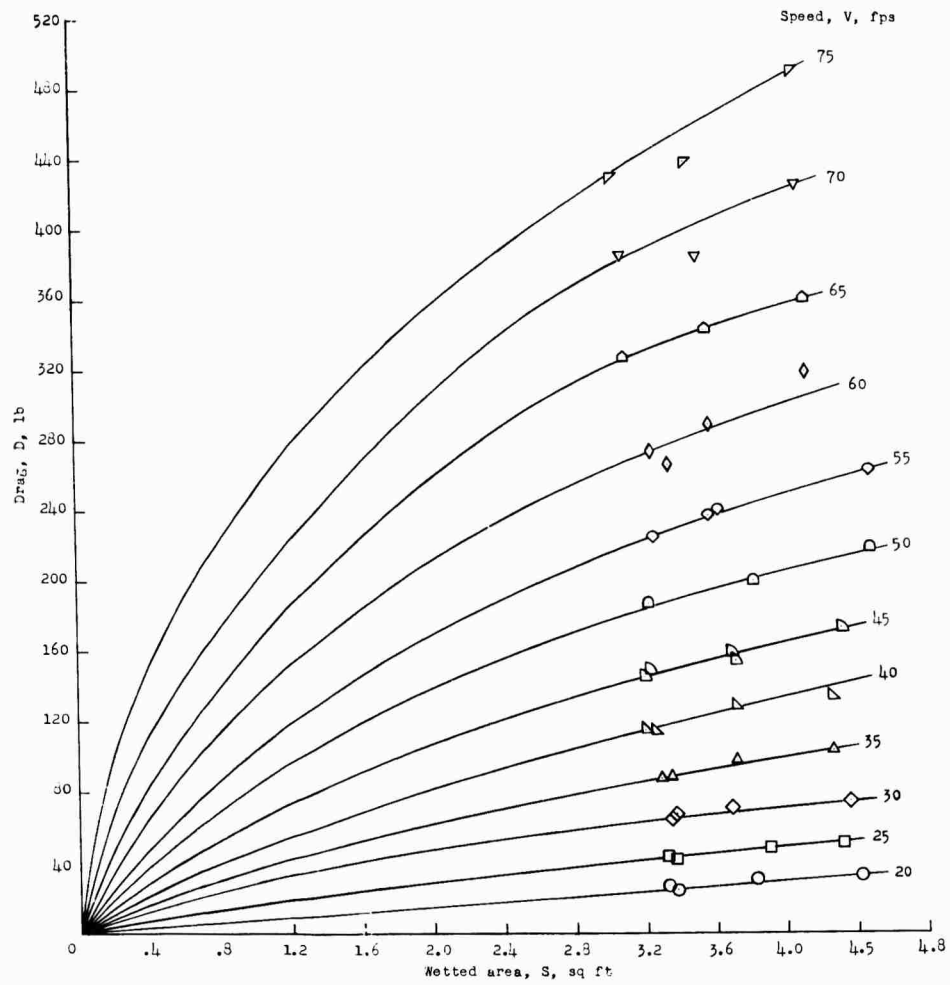

(b) Drag.

Figure 6.- Concluded.

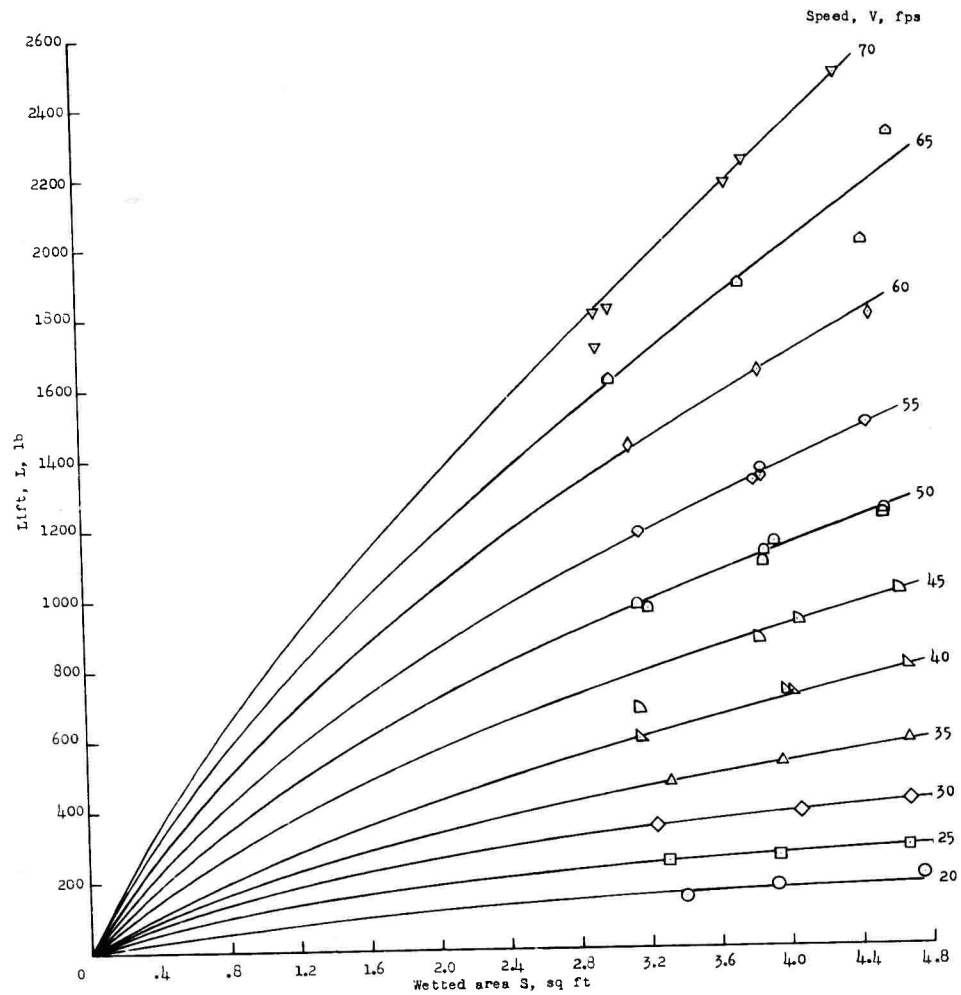

(a) Lift.

Figure 7.- Planing data for 8/10-size model with wheel and fairing installed.
Trim, 9°.

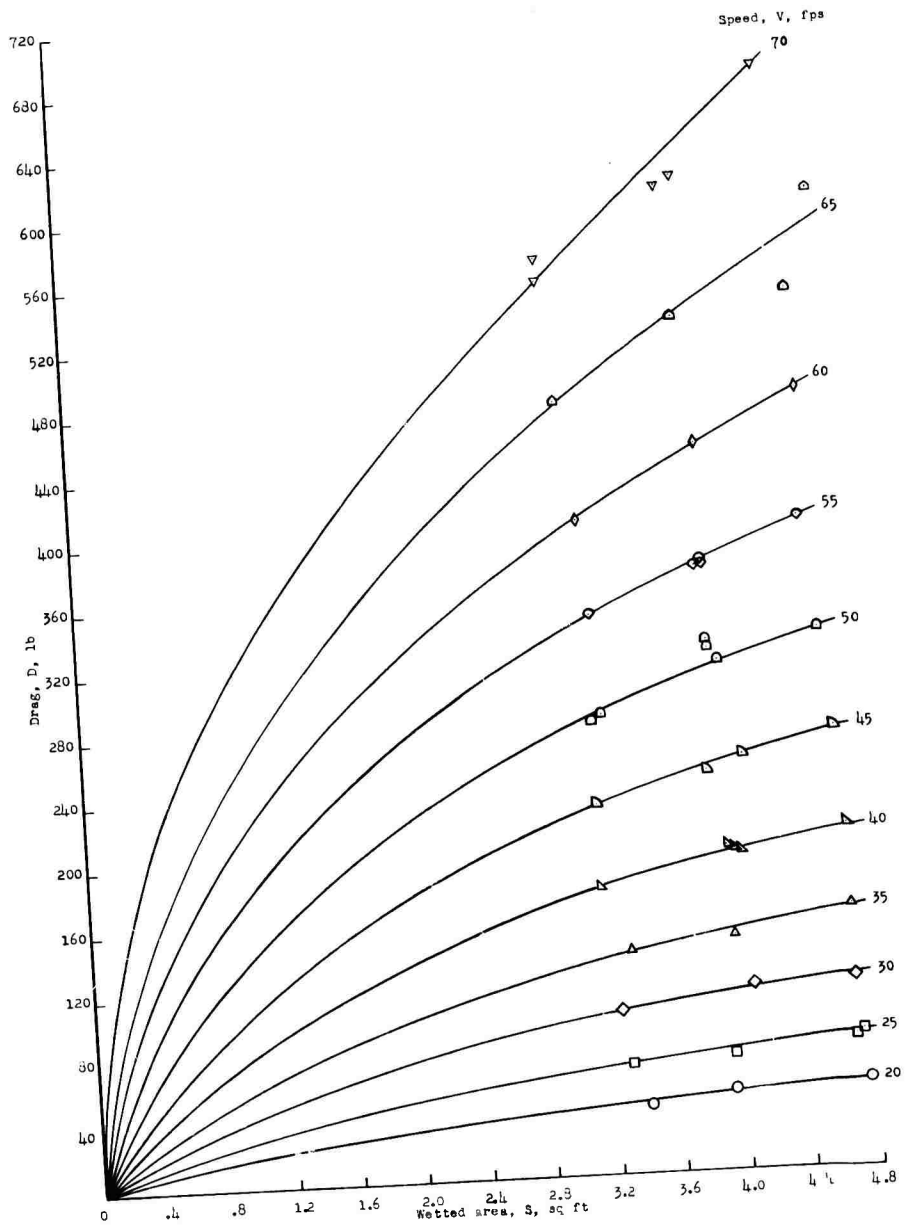

(b) Drag.

Figure 7.- Concluded.

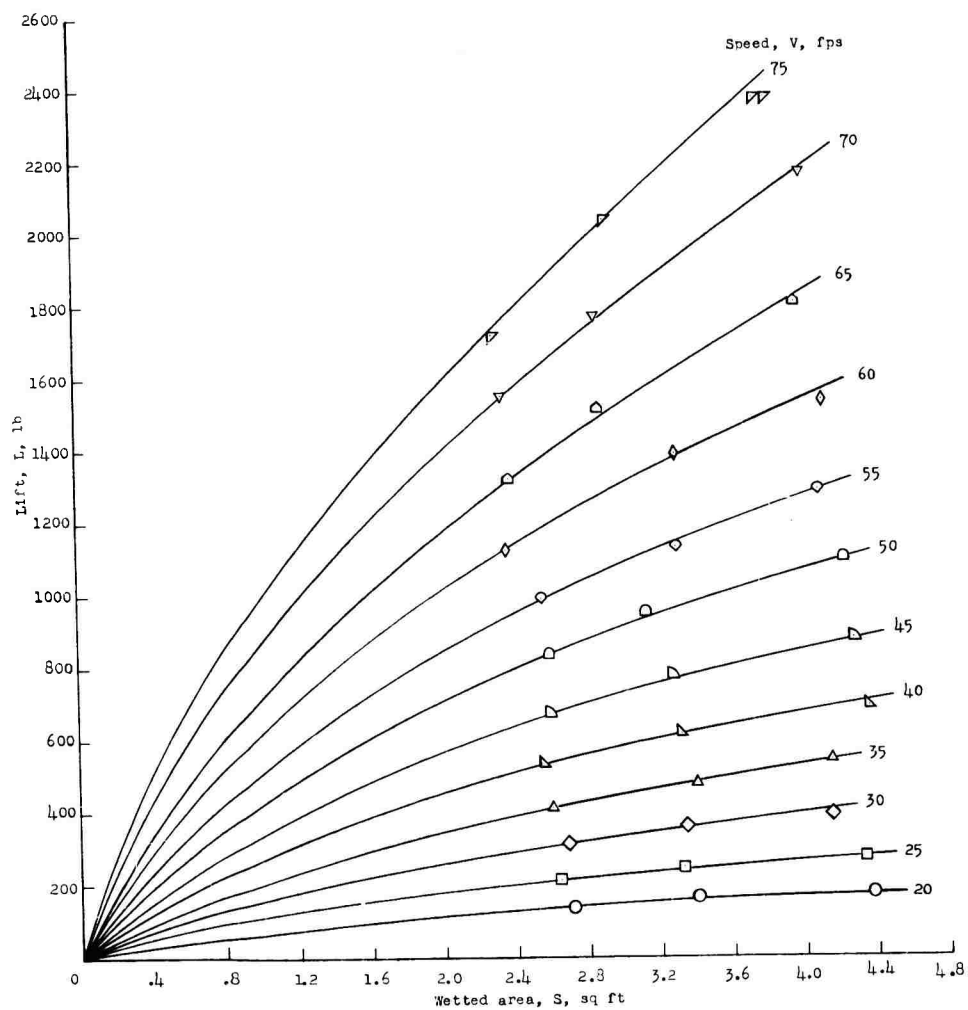

(a) Lift.

Figure 8.- Planing data for 8/10-size model with bare-ski configuration.
Trim, 9°.

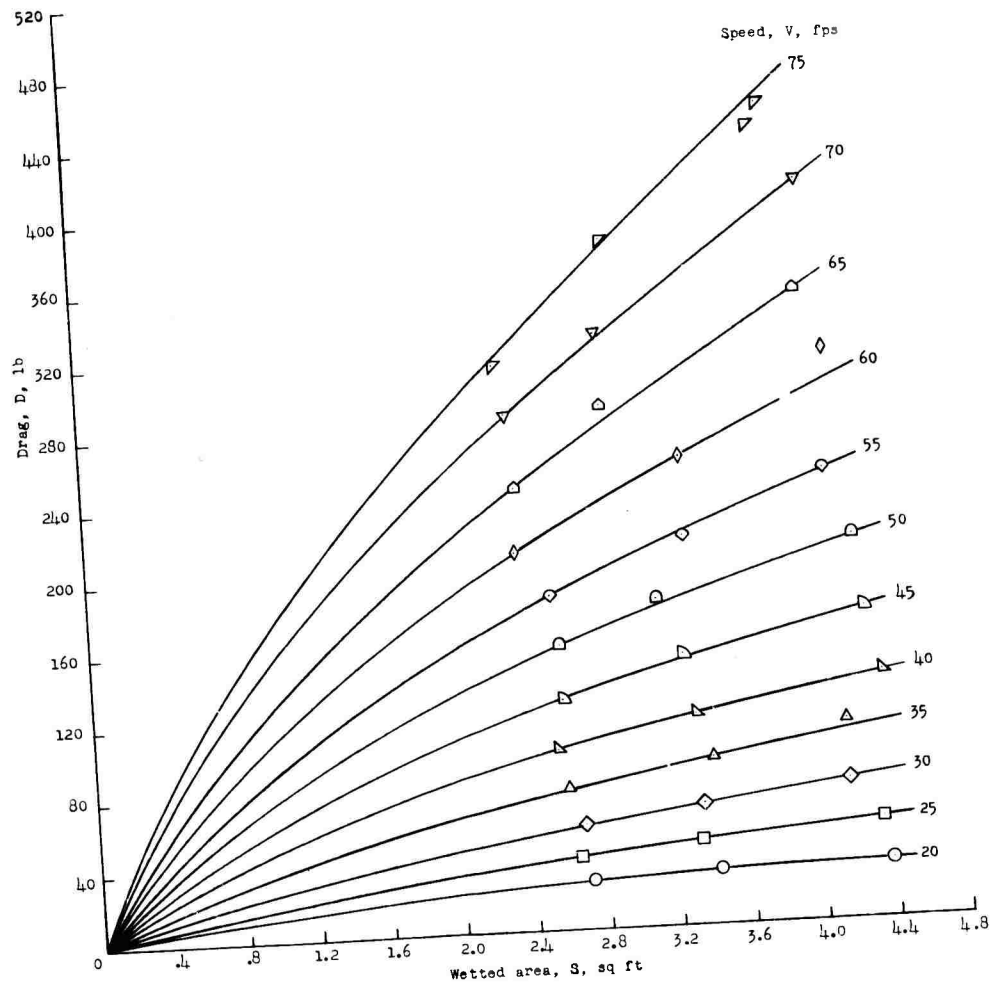

(b) Drag.

Figure 8.- Concluded.

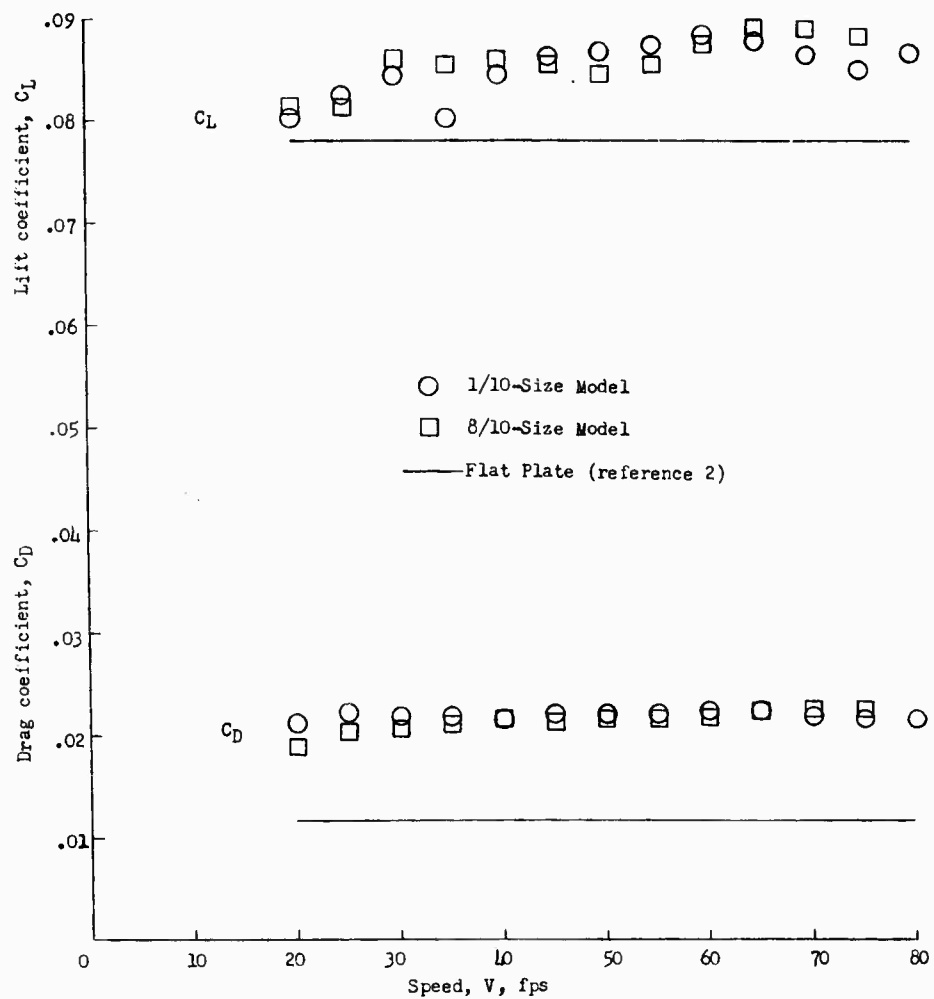

(a) Ski with wheel and fairing at 6° trim.

Figure 9.- Lift and drag coefficients of the 1/10- and 8/10-size models and equivalent flat-plate data.

(b) Ski with wheel and fairing at 9° trim.

Figure 9.- Continued.



(c) Bare ski at 9° trim.

Figure 9.- Concluded.

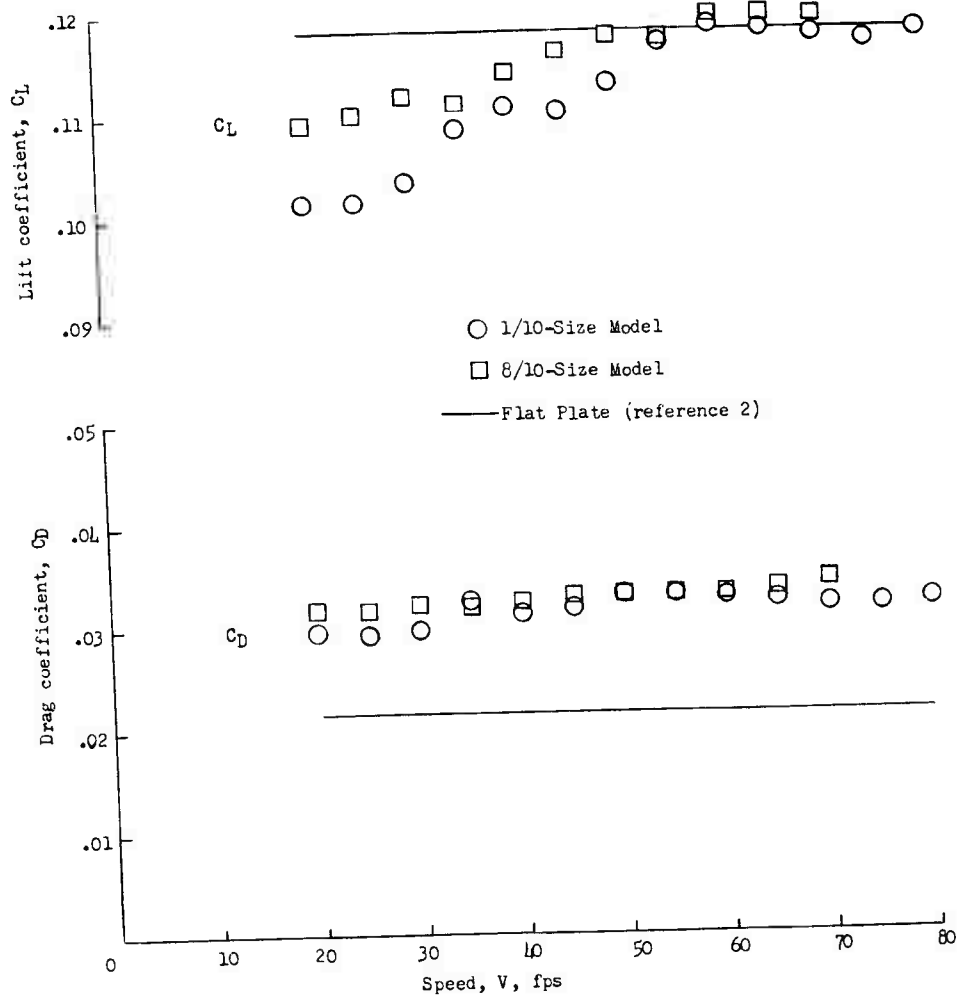
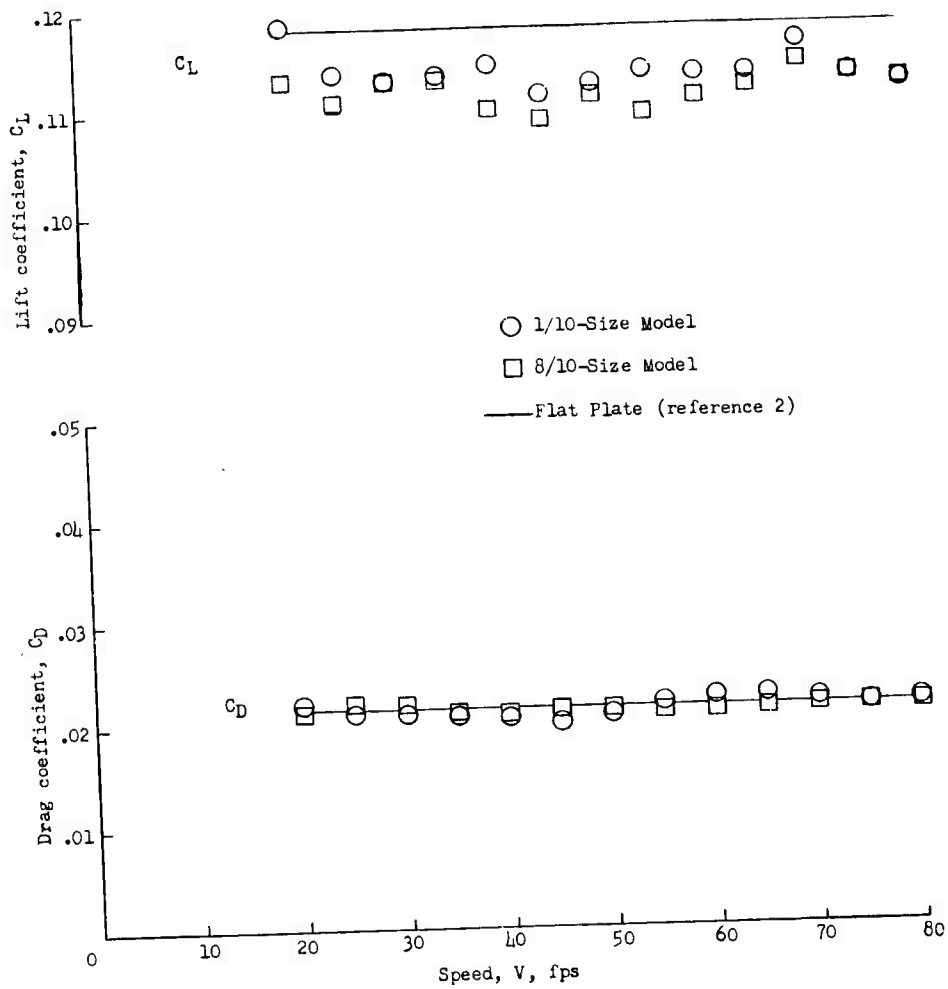
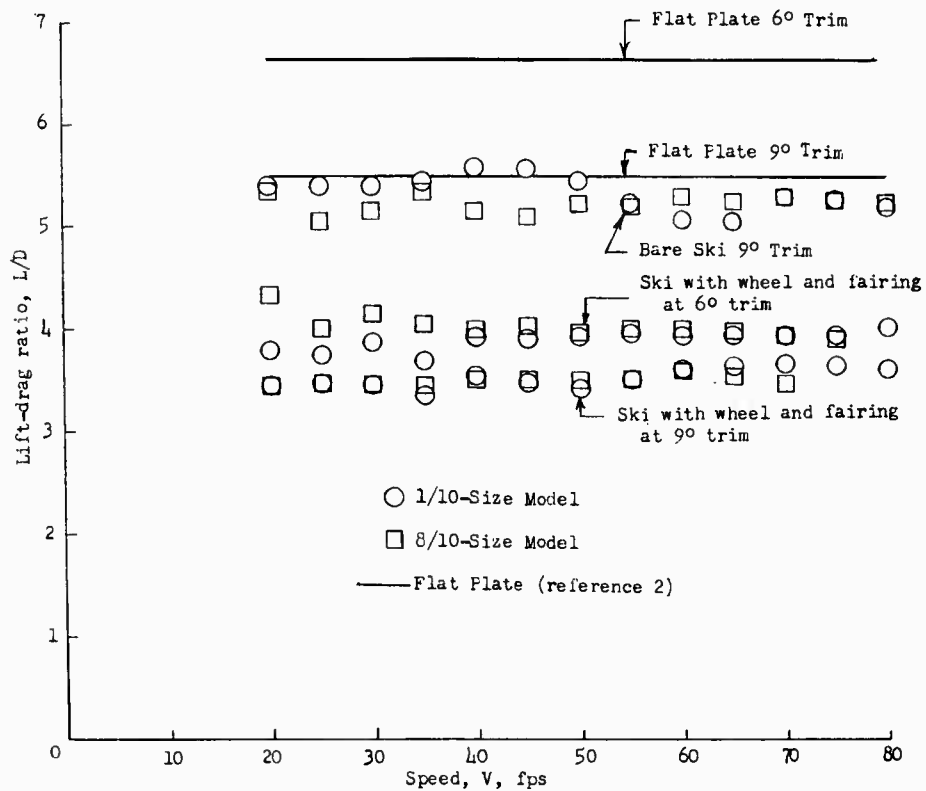
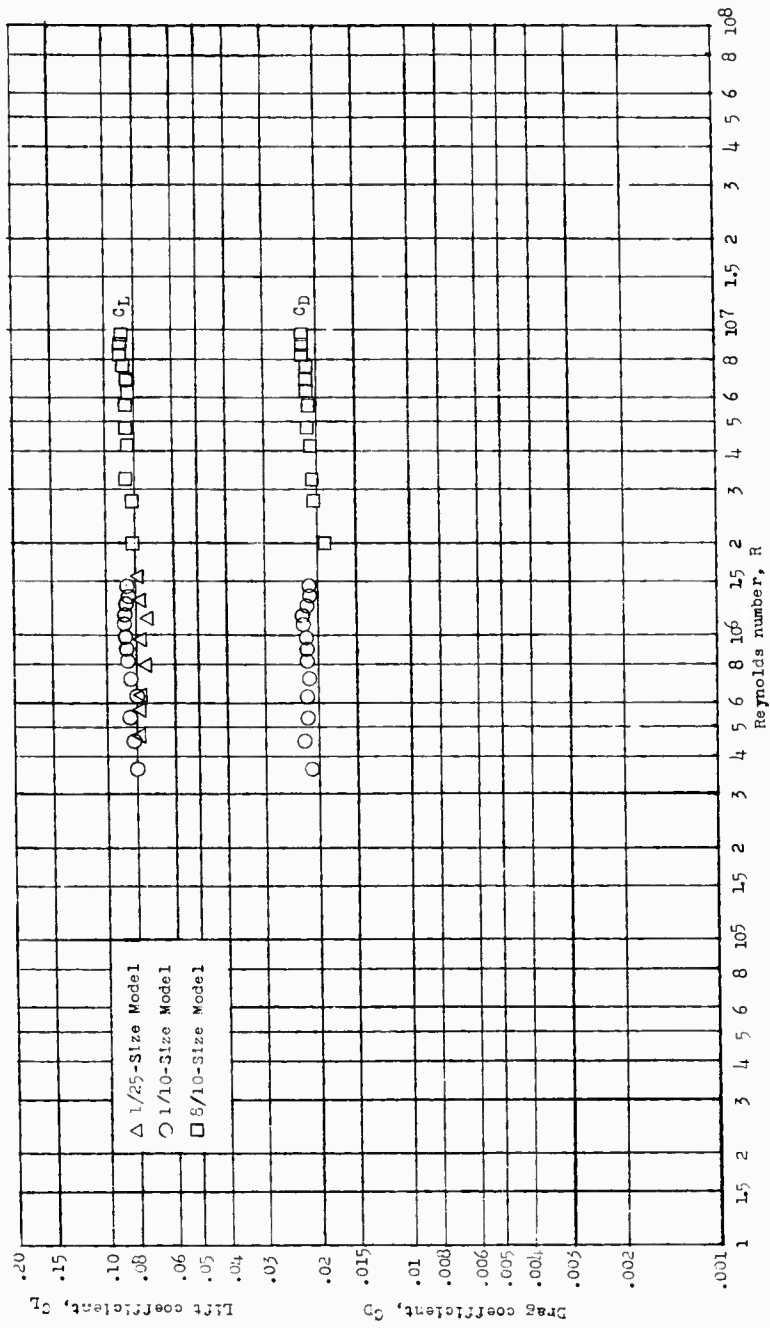

Figure 10.- Variation of lift-drag ratio with speed.



(a) Ski with wheel and fairing at 6° trim.

Figure 11.- Variation of the force coefficients with Reynolds number.

(b) Ski with wheel and fairing at 9° trim.

Figure 11.- Continued.



(c) Bare ski at 9° trim.

Figure 11.- Concluded.

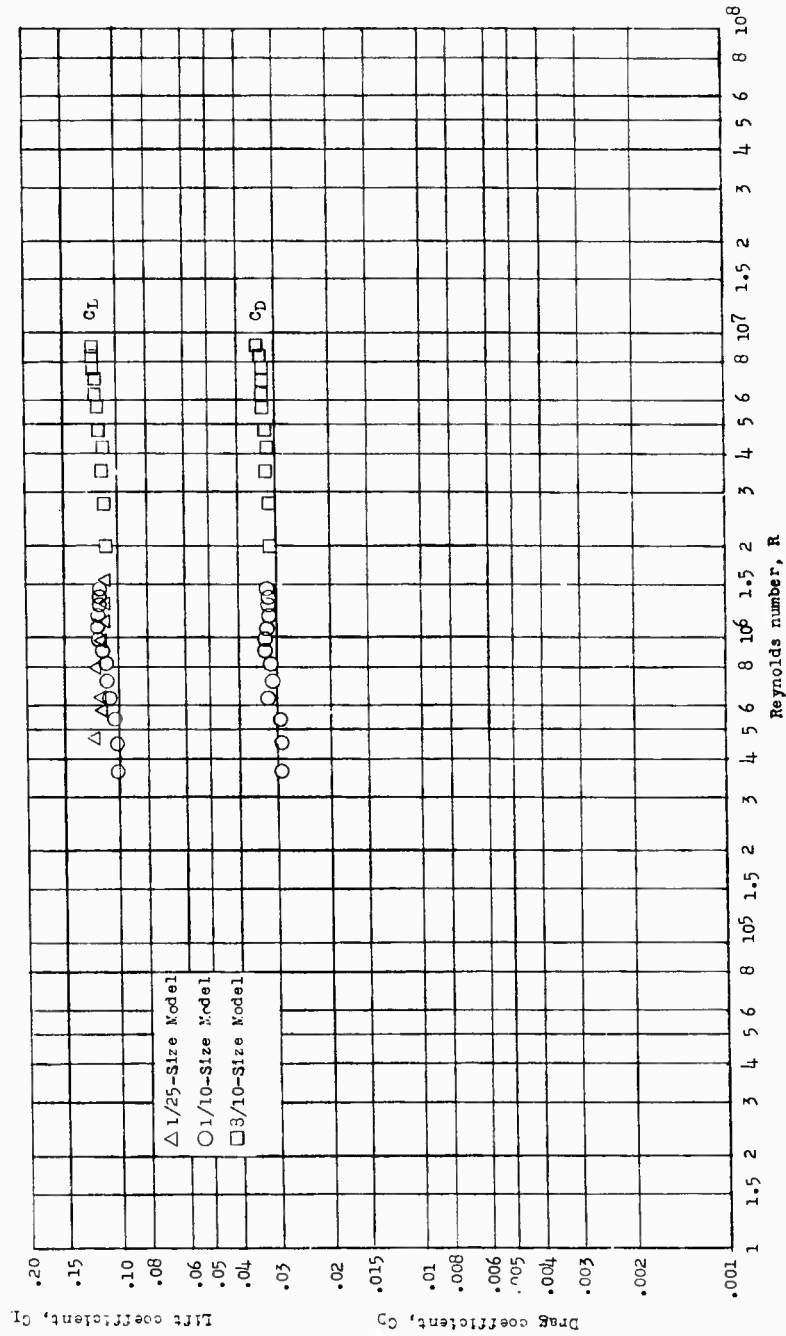
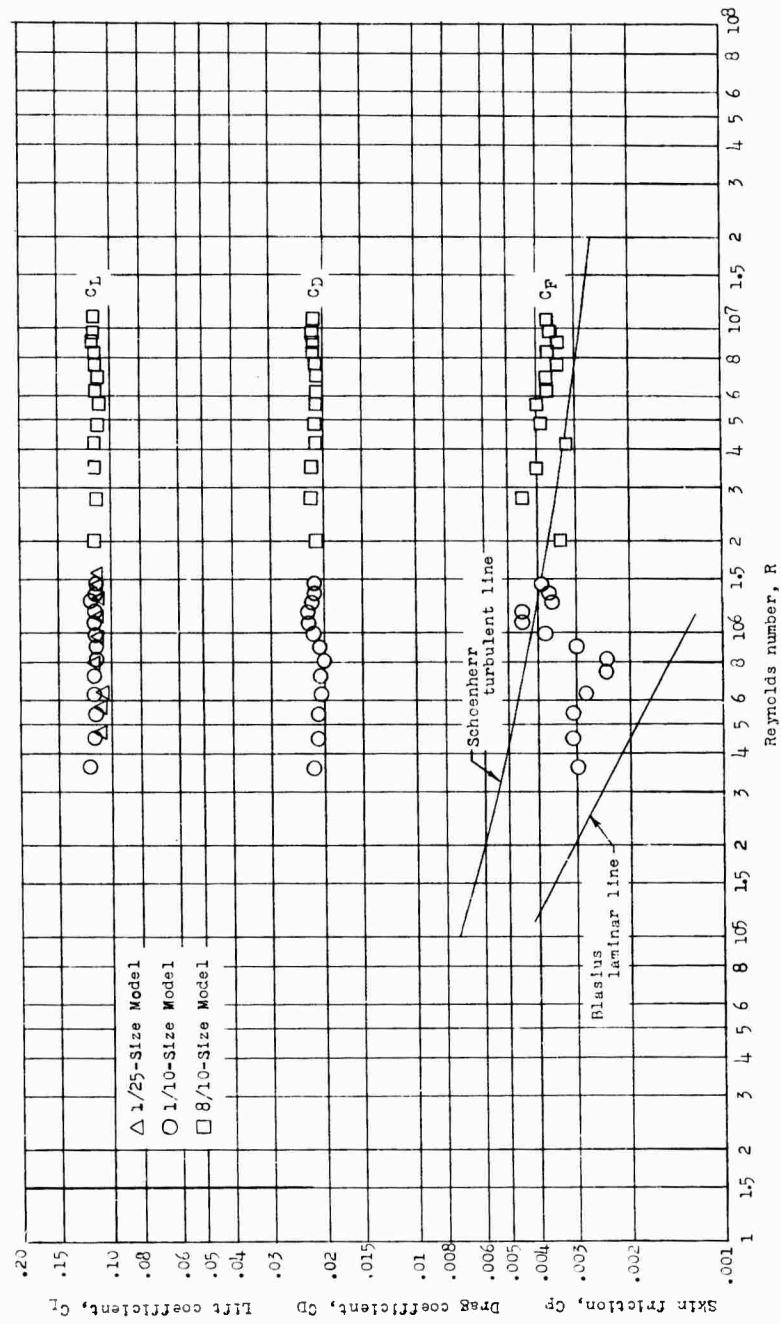
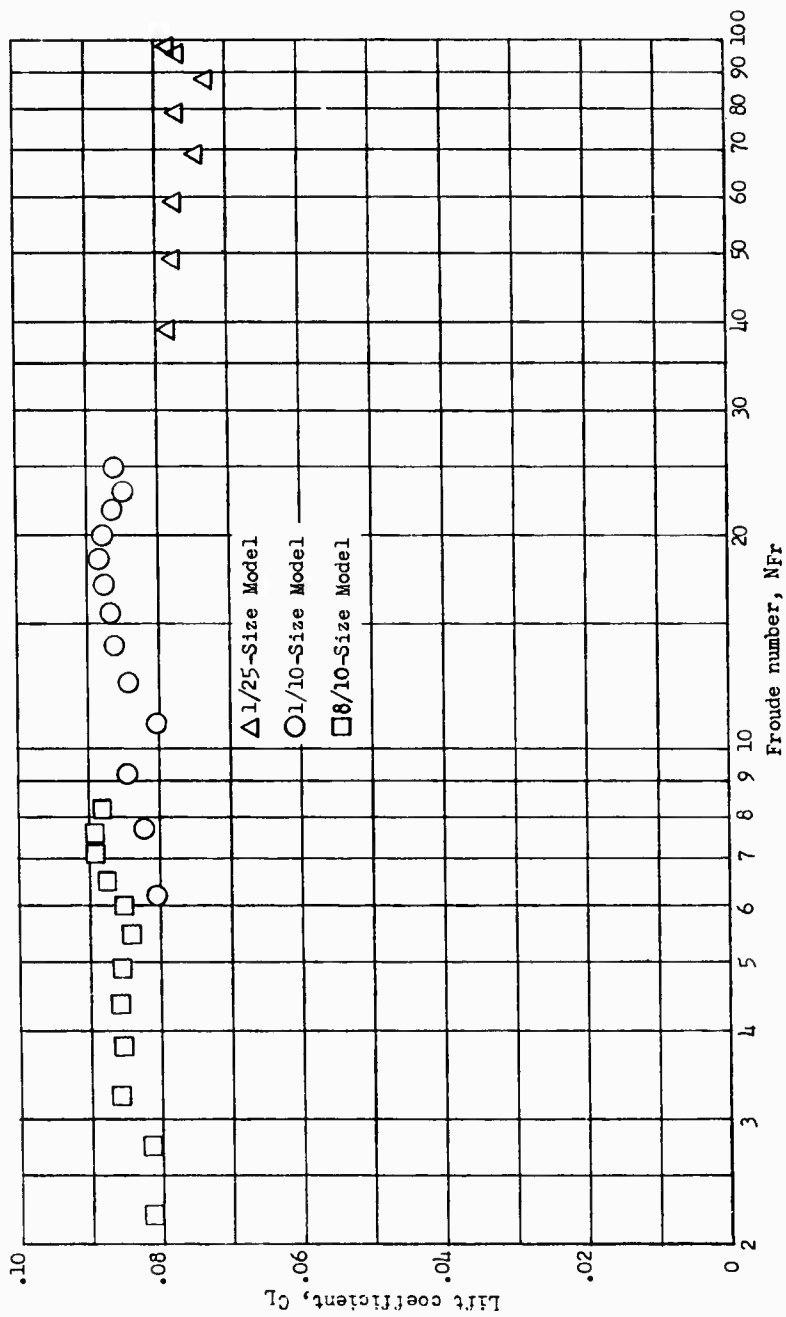

(a) Ski with wheel and fairing at 6° trim.
 Figure 12.- Variation of lift coefficient with Froude number for the three models.

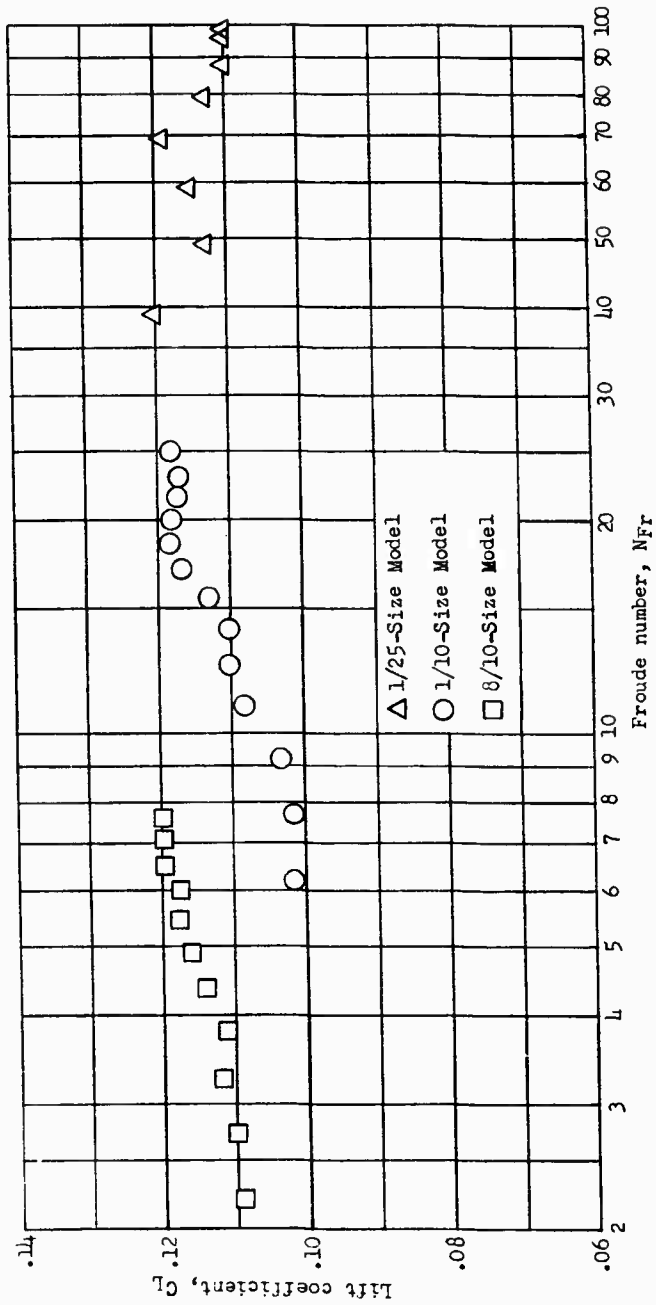

(b) Ski with wheel and fairing at 9° trim.

Figure 12.- Continued.

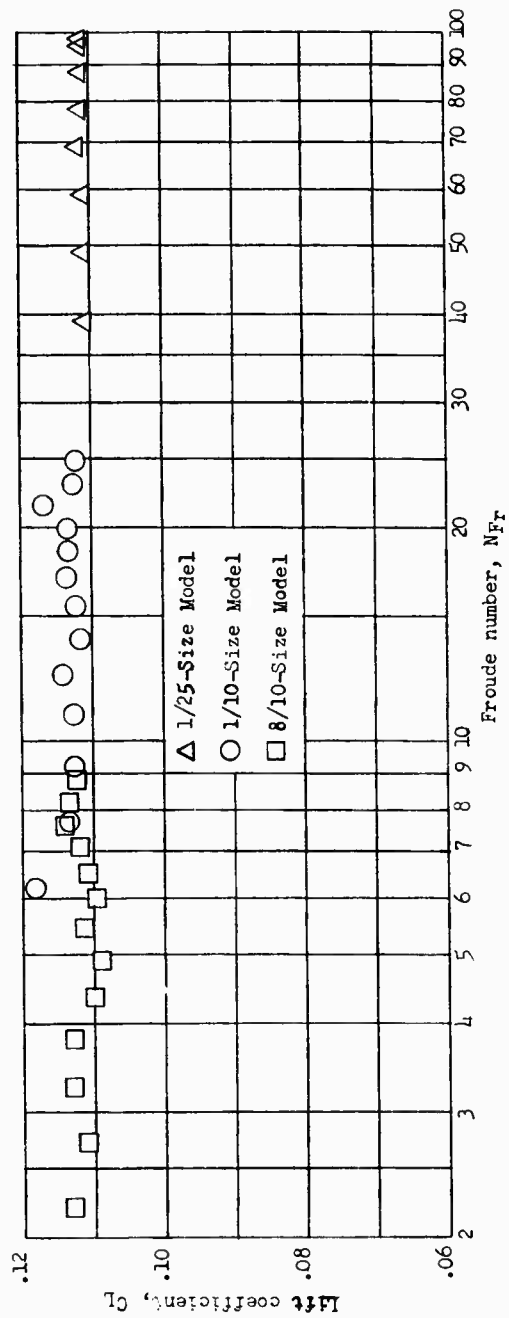

(c) Bare ski at 9° trim.

Figure 12.- Concluded.

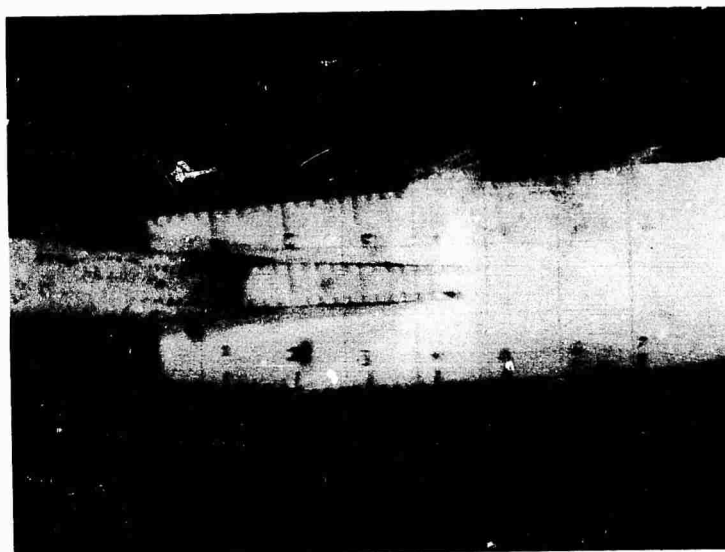

1/10-size model

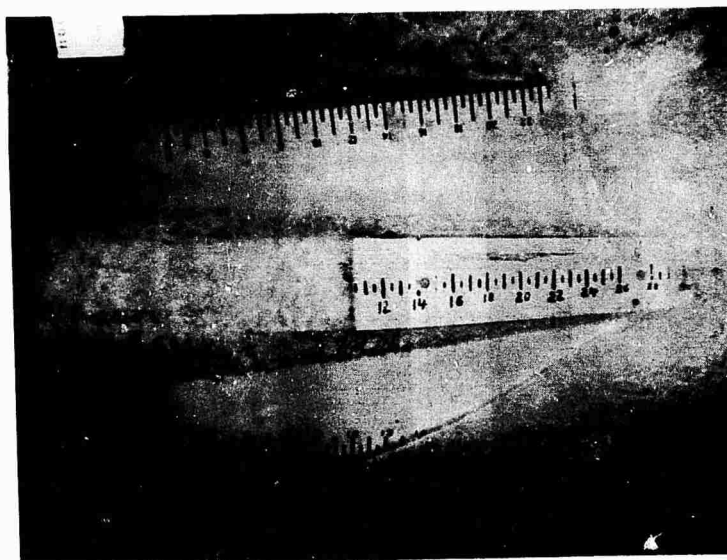

8/10-size model

Figure 13.- Typical underwater-flow photographs of the 1/10- and 8/10-size models.

L-89382

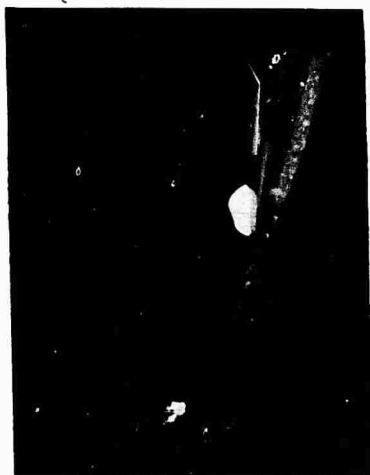

V = 10 fps



V = 20 fps



V = 0 fps



V = 15 fps

Figure 14.- Photographs of the 8/10-size model spray. L-89383



V = 30 fps



V = 40 fps



V = 25 fps



V = 35 fps

L-89384

Figure 14.- Concluded.



L-89381

Figure 15.- Test run of 8/10-size model.