

UNCLASSIFIED

AD NUMBER

AD109766

CLASSIFICATION CHANGES

TO: UNCLASSIFIED

FROM: CONFIDENTIAL

LIMITATION CHANGES

TO:  
Approved for public release; distribution is unlimited.

FROM:  
Distribution authorized to U.S. Gov't. agencies and their contractors;  
Administrative/Operational Use; 20 DEC 1950.  
Other requests shall be referred to Office of Naval Research, Arlington, VA 22203.

AUTHORITY

ONR ltr 26 Oct 1977 ; ONR ltr 26 Oct 1977

~~CONFIDENTIAL~~

**A  
D 109766**

**Armed Services Technical Information Agency**

Reproduced by

**DOCUMENT SERVICE CENTER**

**KNOTT BUILDING, DAYTON, 2, OHIO**

This document is the property of the United States Government. It is furnished for the duration of the contract and shall be returned when no longer required, or upon recall by ASTIA to the following address: Armed Services Technical Information Agency, Document Service Center, Knott Building, Dayton 2, Ohio.

**NOTICE: WHEN GOVERNMENT OR OTHER DRAWINGS, SPECIFICATIONS OR OTHER DATA ARE USED FOR ANY PURPOSE OTHER THAN IN CONNECTION WITH A DEFINITELY RELATED GOVERNMENT PROCUREMENT OPERATION, THE U. S. GOVERNMENT THEREBY INCURS NO RESPONSIBILITY, NOR ANY OBLIGATION WHATSOEVER; AND THE FACT THAT THE GOVERNMENT MAY HAVE FORMULATED, FURNISHED, OR IN ANY WAY SUPPLIED THE SAID DRAWINGS, SPECIFICATIONS, OR OTHER DATA IS NOT TO BE REGARDED BY IMPLICATION OR OTHERWISE AS IN ANY MANNER LICENSING THE HOLDER OR ANY OTHER PERSON OR CORPORATION, OR CONVEYING ANY RIGHTS OR PERMISSION TO MANUFACTURE, USE OR SELL ANY PATENTED INVENTION THAT MAY IN ANY WAY BE RELATED THERETO.**

~~CONFIDENTIAL~~

# DISCLAIMER NOTICE

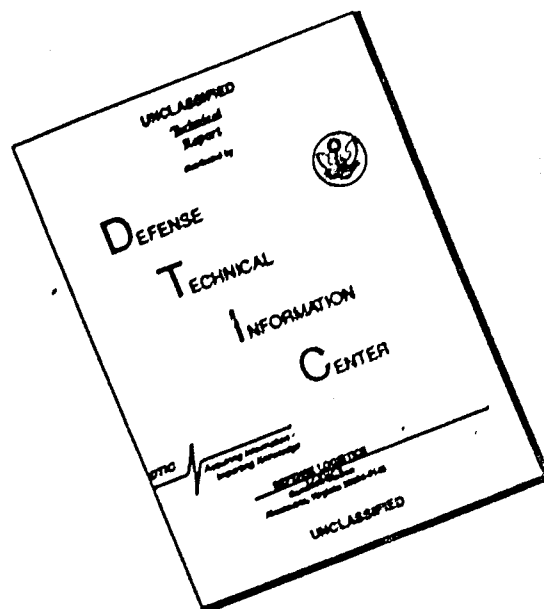

THIS DOCUMENT IS BEST QUALITY AVAILABLE. THE COPY FURNISHED TO DTIC CONTAINED A SIGNIFICANT NUMBER OF PAGES WHICH DO NOT REPRODUCE LEGIBLY.

CONFIDENTIAL

M

109766

229  
**NELL AIRCRAFT CORPORATION**

**BERT-ST. LOUIS MUNICIPAL AIRPORT**

DETAILED FINAL REPORT OF RESEARCH ON  
HIGH-SPEED ROTARY-FLAP WING AIRCRAFT

VOLUME IV

SAMPLE AIRCRAFT PERFORMANCE DATA

OFFICE OF NAVAL RESEARCH, MEMPHIS BRANCH  
PROJECT NR 250-001 CONTRACT N0001-49-001

Report 1904-A

Serial 16

20 December 1950

CONFIDENTIAL

56 HH 545 84

Enclosure (5) to  
MRC Letter 2136-701-1756

**CONFIDENTIAL**

REPORT..... 1904-A

DATE 20 December 1950

REVISED.....

**MCDONNELL** *Aircraft Corporation*  
ST. LOUIS 3, MISSOURI

DETAILED FINAL REPORT OF RESEARCH ON  
HIGH SPEED ROTARY-FIXED WING AIRCRAFT

VOLUME IV

SAMPLE AIRCRAFT PERFORMANCE DATA

SUBMITTED UNDER Contract N9onr-84901 to the Office of Naval Research,  
Amphibious Branch, Project NR 250-001

PREPARED BY *R.C. Snyder*  
R.C. Snyder

*H.N. Heck*  
A.N. Heck

APPROVED BY *K. H. Hohenemser*  
K. H. Hohenemser

APPROVED BY

APPROVED BY

*C. H. Hurkamp*  
C. H. Hurkamp

**CONFIDENTIAL**

20 December 1950

**CONFIDENTIAL**

Report 1904  
Model 78

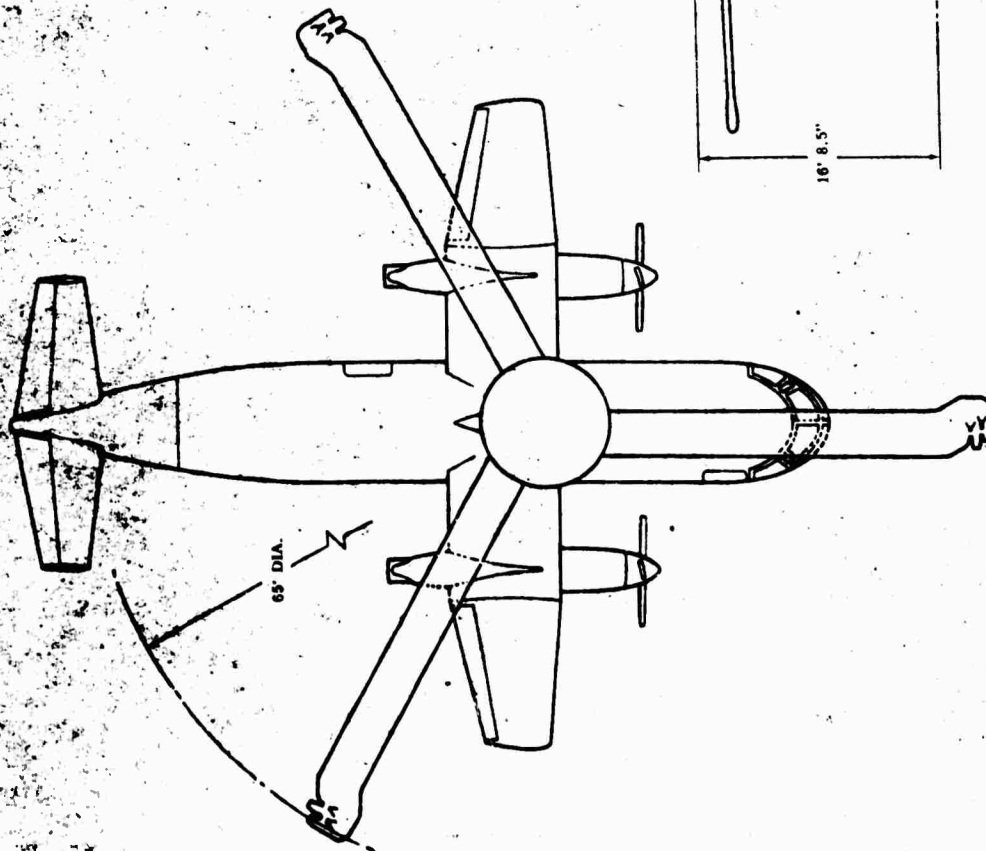
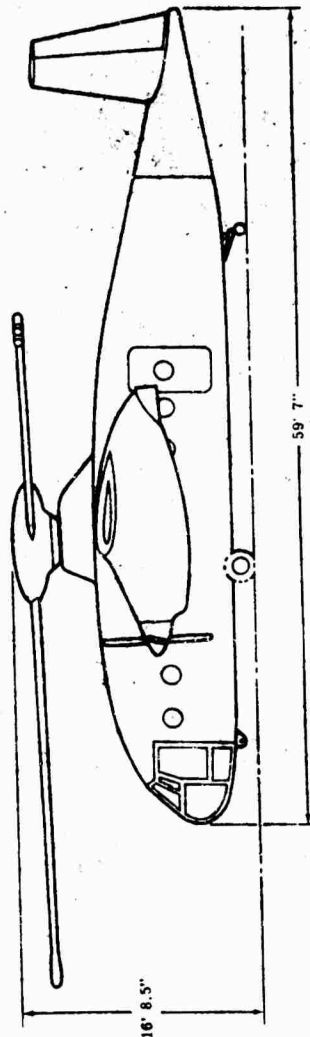
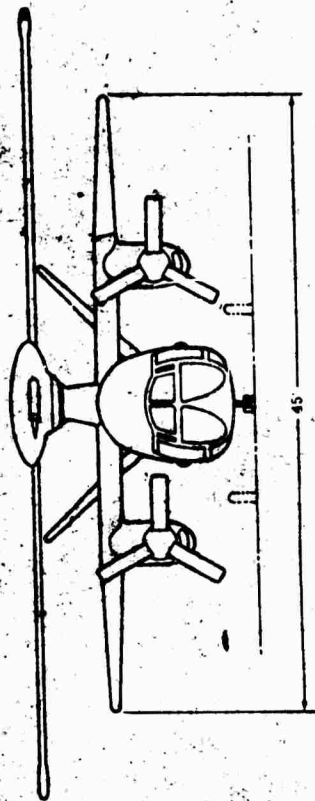

GENERAL ARRANGEMENT - MODEL 78

**CONFIDENTIAL**

20 December 1950

**CONFIDENTIAL**

Report 1904  
Model 78

# Basic Assault Mission

NORMAL GROSS WEIGHT

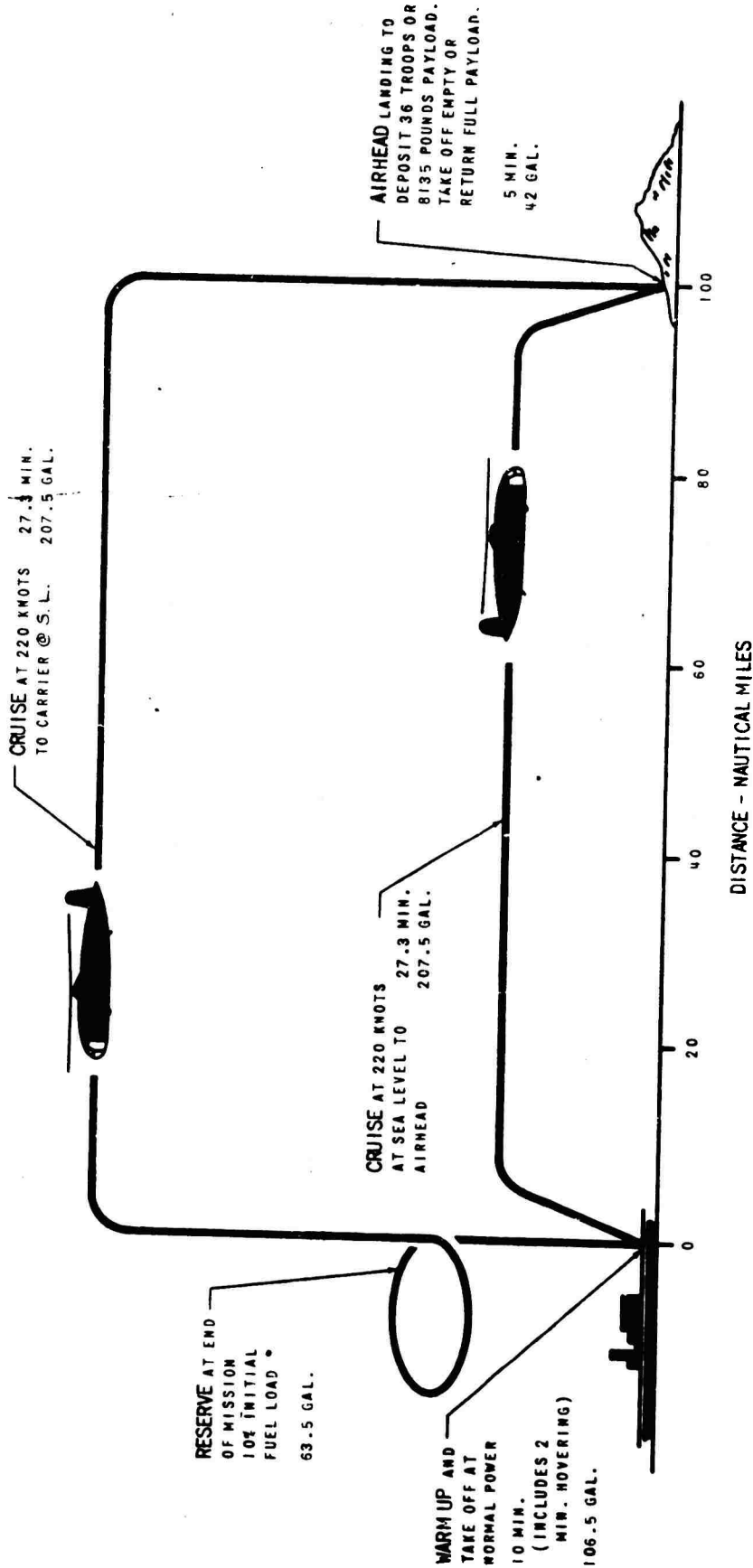

TOTAL FUEL	627 GAL.
TOTAL MISSION TIME	70 MIN.
RADIUS OF ACTION	100 NAUTICAL MILES

**CONFIDENTIAL**

# McDONNELL Aircraft Corporation

ST. LOUIS 3, MISSOURI

CONFIDENTIAL

## INDEX

	<u>PAGE</u>
1. Summary . . . . .	3
. . . Introduction . . . . .	4
. . . Summary of Performance Summary . . . . .	7
2. Discussion . . . . .	12
. . . The listed data . . . . .	14
. . . 1. Rotation and spin rate . . . . .	14
. . . 2.1. Pitch moment . . . . .	16
. . . 2.2. Roll moment . . . . .	17
3. Aerodynamic Data . . . . .	19
. . . 3.1. Laminar flow . . . . .	19
. . . 3.2. Fixed air surface areas . . . . .	21
. . . 3.3. Propeller characteristics . . . . .	21
. . . 3.4. Lift and drag . . . . .	23
. . . 3.5. Landing-lift lift . . . . .	24
. . . 3.5.1. Forward . . . . .	24
. . . 3.5.2. Vertical lift . . . . .	25
. . . 3.5.3. Forward lift . . . . .	26
. . . 3.5.4. Vertical lift . . . . .	26
. . . 3.6. Turbo-prop engine . . . . .	27
. . . 3.6.1. Characteristics . . . . .	27
. . . 3.6.2. Forward lift . . . . .	30
. . . 3.6.3. Vertical lift . . . . .	30

DATE 20 December 1950

REVISED \_\_\_\_\_

REVISED \_\_\_\_\_

**MCDONNELL** *Aircraft Corporation*  
ST. LOUIS 3, MISSOURI  
CONFIDENTIAL

PAGE 2

REPORT 1904

MODEL 79

	<u>Page</u>
6.7 Autorotation Characteristics . . . . .	36
7. Power Available . . . . .	37
8. Performance . . . . .	38
8.1 Sample Calculations . . . . .	38
8.2 Performance Curves . . . . .	40
9. References . . . . .	62

DATE 20 December 1950

REVISED \_\_\_\_\_

REVISED \_\_\_\_\_

**MCDONNELL** *Aircraft Corporation*  
ST. LOUIS 3, MISSOURI  
**CONFIDENTIAL**

PAGE 3REPORT 1904MODEL 78

### 1. SUMMARY

The preliminary estimated performance data characteristics are presented for a rotorcraft of advanced design that fulfills or exceeds the specified requirements for an assault helicopter. This helicopter, designated the Model 78, is propelled by a rotor for take-off, hovering, and slow translational flight, and by propellers for cruise and high-speed flight. For rotor-propelled flight, a pressure-jet rotor system and conventional helicopter controls are utilized. For high-speed flight, the major portion of the aircraft weight is supported by a small fixed-wing surface with the lightly loaded rotor in low-pitch autorotation. Two gas turbine-driven propellers and conventional airplane controls provide propulsion and control.

The vertical and high-speed flight characteristics and high payload of Model 78 are readily adapted to an assault mission. At the maximum level flight speed of 240 knots and an 8135-pound payload (36 troops), thirty-three troops per hour per aircraft can be transported to an airhead, as compared to the 9.7 troops per hour per aircraft just meeting the assault specifications. Therefore, on the first wave, the Model 78 is capable of performing the work of 1.8 aircraft which just meet the assault specification, or on a shuttle basis, is the equivalent of 3.4 such aircraft.

All performance estimates are based upon proven methods of analysis developed by the NACA, or upon wind tunnel model test data obtained in a twenty-month research program under contract to the Office of Naval Research. Much of these test data have shown substantial agreement with data from previous test programs of the NACA and with McDonnell theoretical analyses.

**CONFIDENTIAL**

DATE 20 December 1950

REVISED \_\_\_\_\_

REVISED \_\_\_\_\_

**MCDONNELL** *Aircraft Corporation*  
 ST. LOUIS 3, MISSOURI  
**CONFIDENTIAL**

PAGE 4

REPORT 1904

MODEL 73

2. INTRODUCTION

The McDonnell Aircraft Corporation presents herewith the preliminary aerodynamic performance estimates for a rotorcraft of advanced design. This aircraft, designated the Model 73, has the cruise speed of an airplane, the lifting capacity of a jet rotor and the ability to land either troops or cargo at any selected point. The design principle is based upon the finding that lifting rotors, when not required to deliver the entire lifting or propulsive force of the aircraft, may advance at far higher speeds than heretofore considered possible. This principle has been confirmed as a result of twenty months of research conducted under contract to the Office of Naval Research. Rotor lift, drag, blade motions, blade stresses, wing interference, aircraft stability, and many other details have been analyzed and tested through a wide range of variables.

The Model 73 incorporates a single lifting rotor with pressure-jet drive, a relatively small fixed wing to unload the rotor at high speeds, a conventional empennage for aircraft stability, a twin-engine installation driving variable-pitch propellers and two axial flow compressors for rotor propulsion, and side-by-side seating for pilot and copilot. The twin-engine design using available gas turbines and compressors (Allison 35 and Westinghouse 13-XB respectively) offers reliability and greatly improved performance over that of conventional helicopters. Since the rotor autorotates in forward flight and rotor power is required only for short periods of hovering and acceleration, it is possible to use a jet drive without appreciable penalty from its relatively high fuel consumption. Of the jet rotor drives available, the pressure-jet rotor is the most suitable because of its lower fuel consumption, easier starting and high power, its high

DATE 20 December 1950

**McDONNELL** *Aircraft Corporation*

PAGE 5

REVISED \_\_\_\_\_

ST. LOUIS 3, MISSOURI

REPORT 1904

REVISED \_\_\_\_\_

**CONFIDENTIAL**

MODEL 78

lifting capacity and its ability to fulfill the maneuvering requirements at high forward speeds.

For hovering and slow forward flight, the aircraft is flown by rotor propulsion utilizing the pressure-jet power derived from turbine-driven compressors and conventional single rotor control (i.e., vertical control by collective pitch variation and transverse control by cyclic pitch variation.) For high-speed flight, in which the major portion of the weight is supported by a fixed wing and in which the lightly loaded rotor is autorotating, propulsion is obtained from two gas turbine-driven propellers and control is by conventional airplane aileron-elevator-rudder systems. The transition from rotor-driven to propeller-driven flight is performed at nearly constant altitude by shifting from pressure-jet power to propeller power with the intermediate power being supplied by the residual rotor kinetic energy and a change in velocity kinetic energy.

Although Model 78 is designed to presently considered practical values of blade tip speed and maximum advance ratio in order to guarantee its immediate usefulness in military operation, rotor model tests conducted up to an advance ratio of 2.5 have shown that, even for a Mach number of the advancing blade less than .85, flight speeds over 350 knots may be attained in the future. The most surprising result of these model tests, confirmed by theoretical studies, was the increase of aerodynamic efficiency with increasing advance ratio. A lift to drag ratio of the autorotating model rotor (excluding hub) of 11.5 was measured at an advance ratio of 2.0. This indicates full-scale lift to drag ratios of the same order of magnitude as those for a fixed wing. A number of problems pertaining to rotor control, blade motions and blade stresses have to be studied prior to the

**CONFIDENTIAL**

DATE 20 December 1950

REVISED \_\_\_\_\_

REVISED \_\_\_\_\_

**MCDONNELL** *Aircraft Corporation*  
ST. LOUIS 3, MISSOURI  
**CONFIDENTIAL**

PAGE 5REPORT 1904MODEL 78

utilization of tip speeds and advance ratios very much in excess of those used in the normal operation of Model 78.

The preliminary performance estimates for the Model 78 are based upon wind tunnel model test data, obtained in a research program sponsored by the Office of Naval Research, and in the conventional helicopter or rotor propulsion advance ratio range, upon proven methods of analysis.

**CONFIDENTIAL**

3. SUMMARY PERFORMANCE TABLES

3.1 Summary Performance Table and Figures

Take-off weight . . . . .	30,000 pounds
Fuel . . . . .	3750 pounds
Payload . . . . .	8135 pounds
Engine power (normal rating)* . . . . .	3870/14000 hp/rpm
Disc loading (1/3) . . . . .	9.94 lbs./sq.ft.
Power loading . . . . .	7.75 lbs./hp
Maximum speed - sea level . . . . .	240 knots
Rate of climb - sea level	
Rotor propulsion . . . . .	3120 ft./min.
Propeller propulsion . . . . .	1850 ft./min.
Time to 5000 feet	
Rotor propulsion . . . . .	1.79 min.
Propeller propulsion . . . . .	2.90 min.
Time to 10,000 feet	
Rotor propulsion . . . . .	4.18 min.
Propeller propulsion . . . . .	6.51 min.
Vertical rate of climb - sea level . . . . .	3040 ft./min.
Absolute hovering ceiling . . . . .	10,000 feet
(stall limitation)	
Combat radius/Average velocity . . . . .	100 n.m./220 knots
Maximum endurance/Average velocity . . . . .	1.28 hrs./200 knots
Ferry range (1880 gal. fuel) . . . . .	776 nautical miles

\* Power available, considering losses

FIGURE - 1

# Level Flight Performance

## HORSEPOWER REQUIRED VS VELOCITY

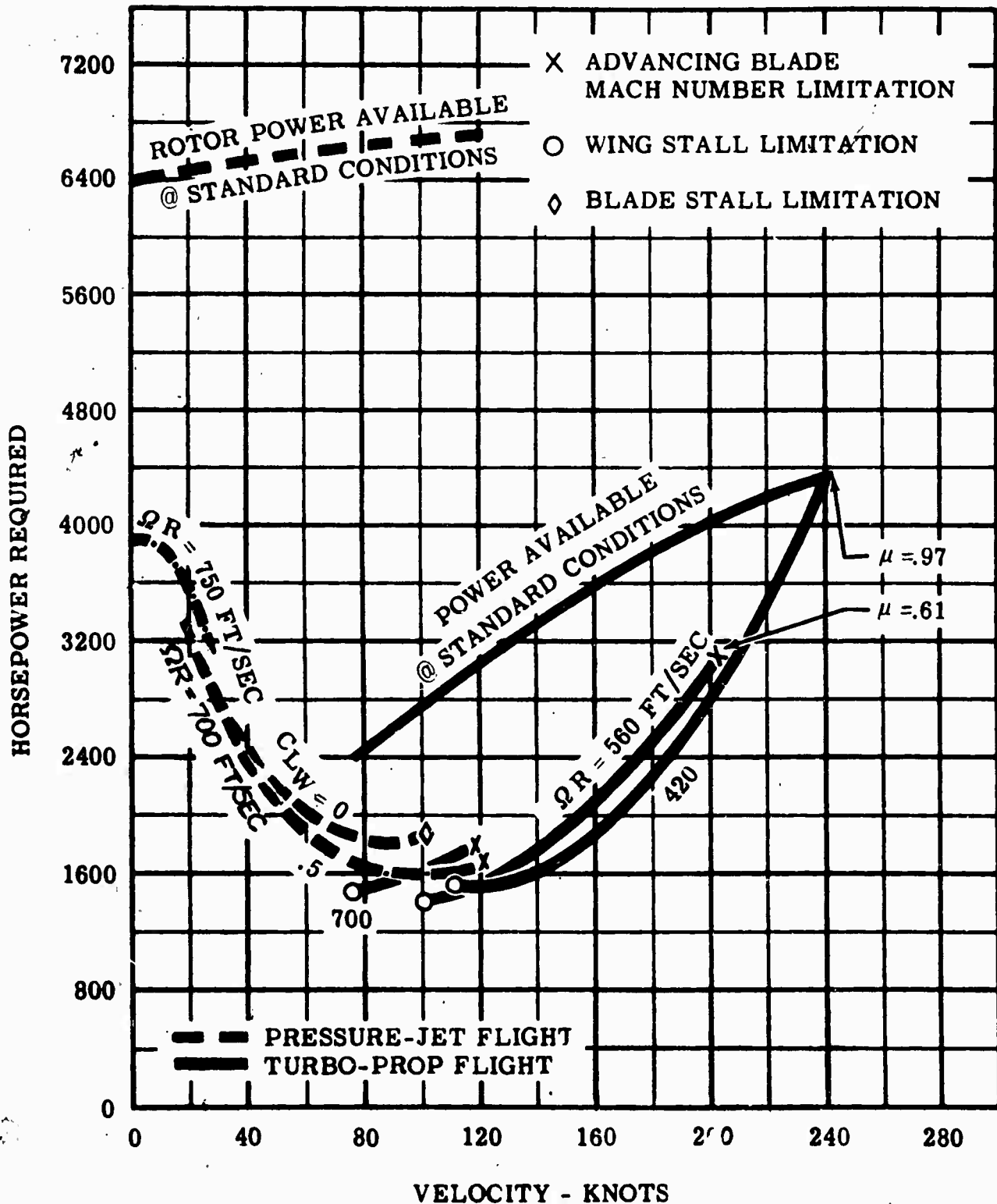

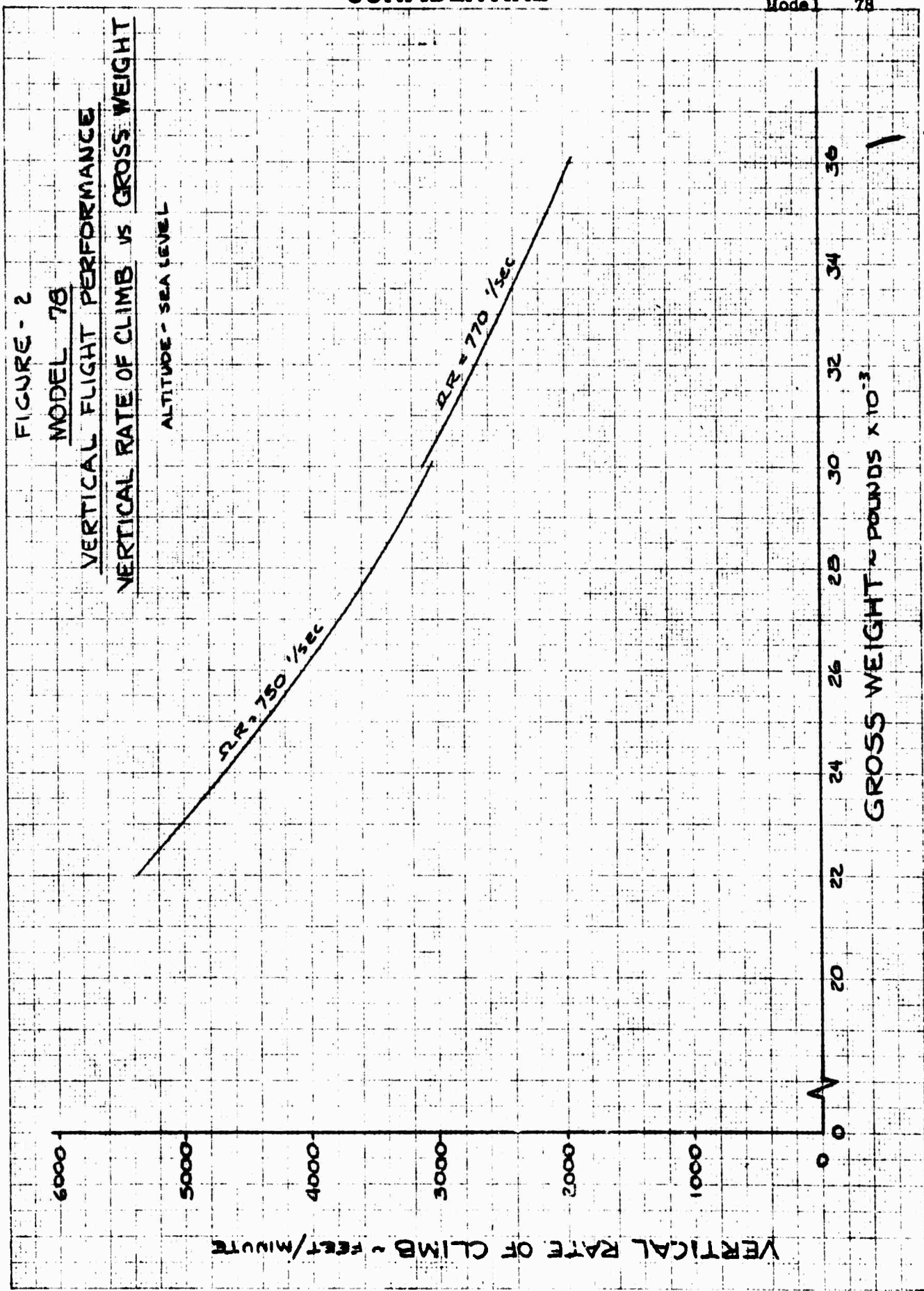

MEUFFEL & ESSER CO.

No. 3111 - Milling, 5 mm. 1/2" diam. and in lines bray.

FIGURE - 3  
MODEL 78  
PAYLOAD vs COMBAT RADIUS

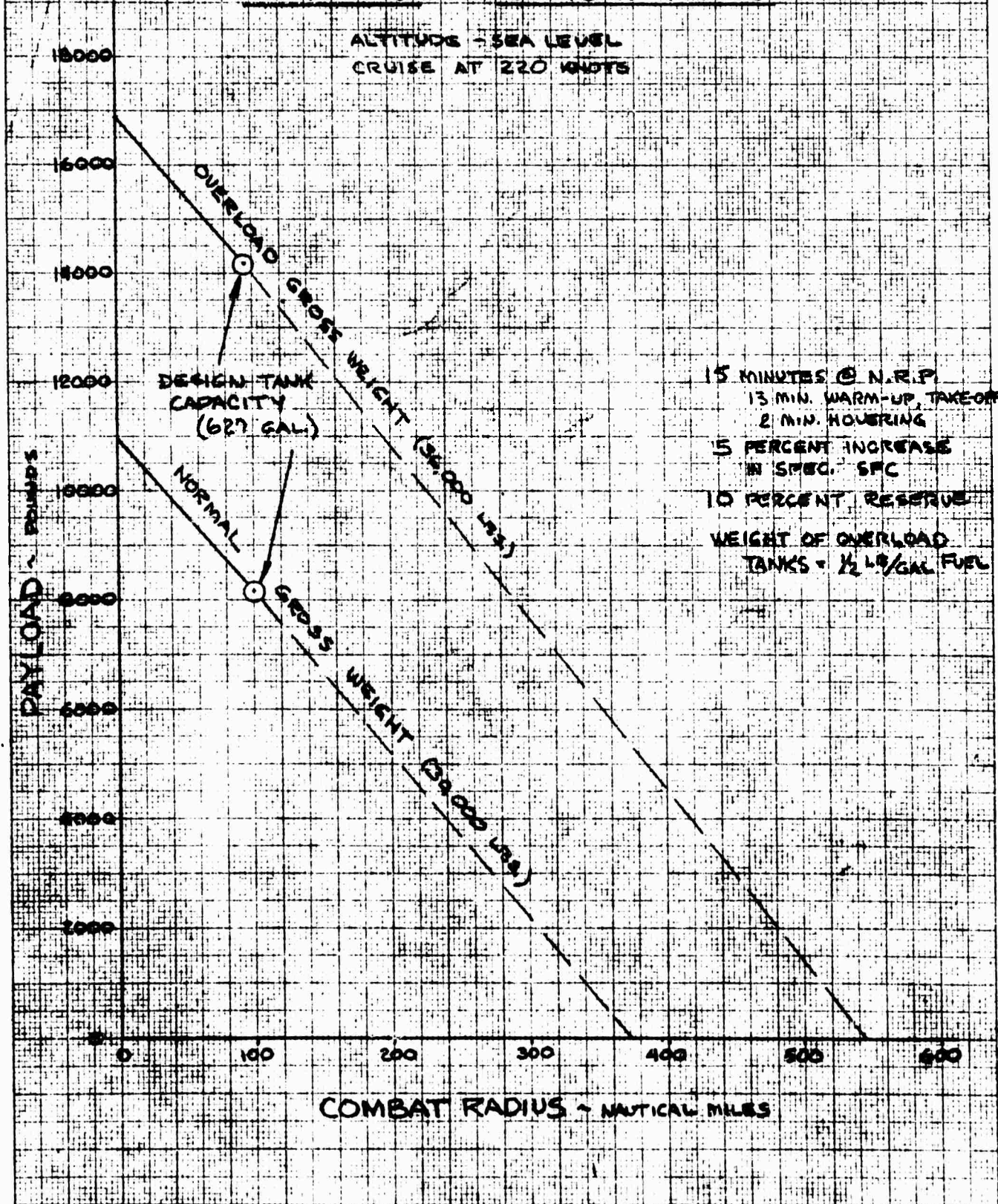

KEUFEL & ESSER CO.

No. 359-14. Millimeters 5 mm lines (printed), cm lines (heavy).  
U.S. N. S. S. S.

20 December 1950

**CONFIDENTIAL**

Page 11  
Report 1904  
Model 78

FIGURE - 4  
MODEL 78

LEVEL FLIGHT PERFORMANCE  
AVERAGE SPEED vs COMBAT RADIUS

NORMAL GROSS WEIGHT  
ALTITUDE - SEA LEVEL

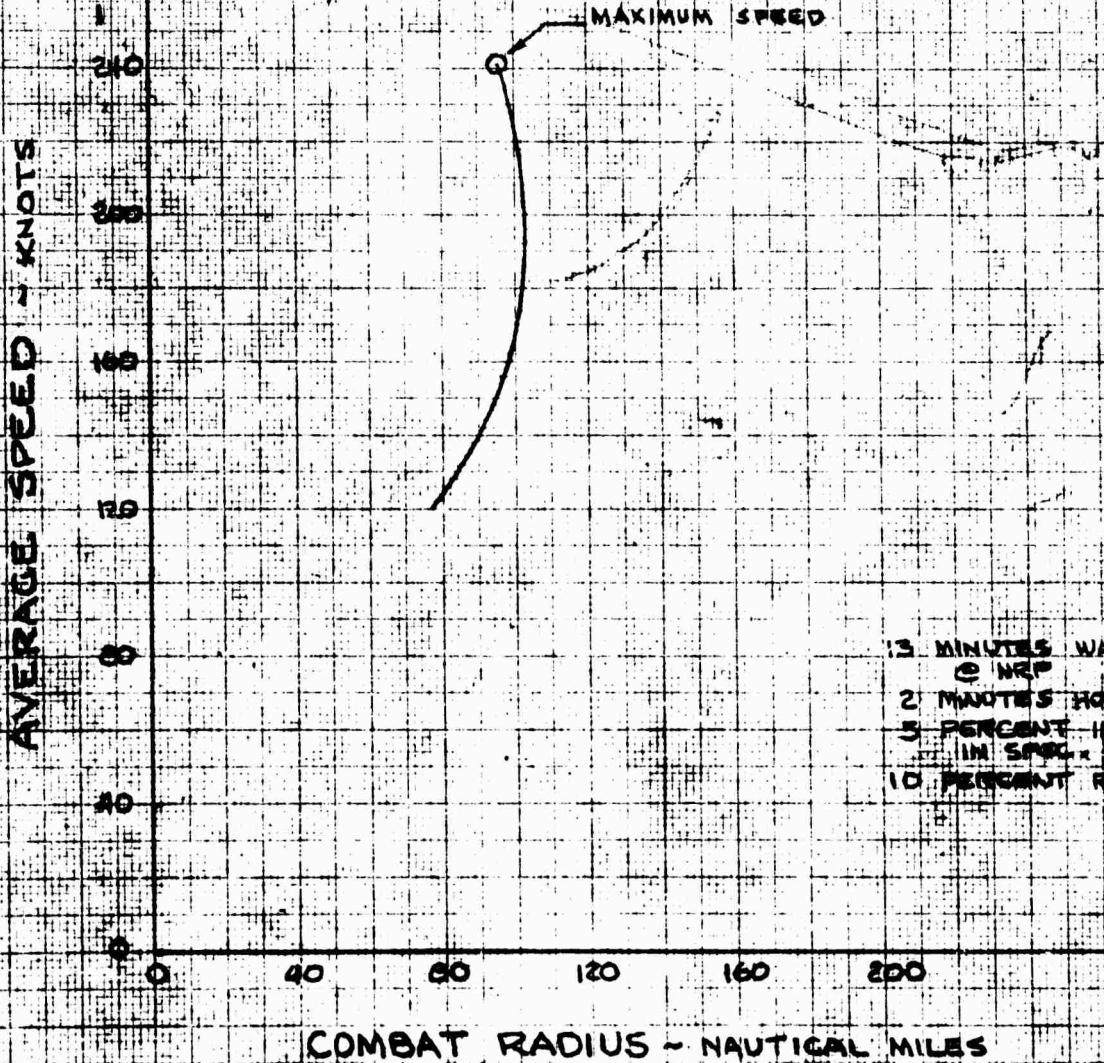

KEUFFEL & ESSER CO.

No. 359-14. Millimeters, 5 mm lines accented, cm lines heavy.  
MADE IN U.S.A.

**CONFIDENTIAL**

DATE 20 February 1950

REVISED \_\_\_\_\_

REVISED \_\_\_\_\_

**MCDONNELL** *Aircraft Corporation*  
 ST. LOUIS 3, MISSOURI  
 CONFIDENTIAL

PAGE 12

REPORT 1904

MODEL 75

4. DISCUSSION

The principle of a combined rotary-fixed wing aircraft was realized to practice in the early days of the autogyro, and an extensive flight test program has been conducted with such aircraft by the NACA (references 8.11 and 8.12). This program included conditions up to an advance ratio of the lifting rotor of .7 and up to a load on the fixed wing of 35% of the total aircraft weight. The aircraft tested by the NACA was controlled by conventional aileron, elevator, and rudder controls with no means provided to change the relative attitude of wing and lifting rotor or the blade pitch angle in flight. The main conclusions from these tests were that a wide variation of rotor speed as a function of airspeed may be obtained by suitable adjustments of the relative wing and rotor attitude (which were made on the ground during the test program) and that the interference of the wing on the lifting rotor is negligible in the tested range.

As compared to this early version of rotary-fixed wing aircraft, model 75 incorporates the following additional features: a rotor attitude control, longitudinally and laterally; a collective blade pitch control; and jet rotor drive for vertical take-off and forward acceleration up to 118 knots. In rotor propelled, or pressure-jet flight, which is possible between zero and 118 knots, the aircraft is controlled by the longitudinal and lateral rotor attitude control with the fixed surface controls relatively ineffective. In propeller propulsion, or turbo-prop flight, which is possible between 30 and the limit air speed of 300 knots, the aircraft is controlled by the fixed surface controls. The rotor lateral attitude control is still connected to the control sticks, though relatively ineffective, while the rotor longitudinal attitude control is disconnected from

DATE 2 December 1950

REVISED \_\_\_\_\_

REVISED \_\_\_\_\_

**MCDONNELL** *Aircraft Corporation*  
ST. LOUIS 3, MISSOURI  
CONFIDENTIAL

PAGE 13REPORT 1904MODEL 75

the control stick and an automatic rotor attitude control is incorporated to achieve rotor speed stability.

The design features of the rotor are selected to insure immediate usefulness in military operations. Available power plants, compressors, and practical limits on rotor advance ratio, rotor diameter, etc., are used to guarantee such operation. Although the gas turbine has, when operating at the lower altitudes, part throttle, and on heavy summer days, a higher fuel consumption than a reciprocating engine, the saving in weight and in aerodynamic drag by far offsets these disadvantages for the relatively short range that is required for an assault aircraft. Gas turbine development to be expected during the prototype design stage of this aircraft should further enhance their selection.

CONFIDENTIAL

DATE 20 December 1950

REVISED \_\_\_\_\_

REVISED \_\_\_\_\_

**MCDONNELL** *Aircraft Corporation*

ST. LOUIS 3, MISSOURI

CONFIDENTIAL

PAGE 14

REPORT 1904

MODEL 78

5. TABULATED DATA

5.1 Notation and Symbols -

- $\alpha$  = Lift curve slope
- $R$  = Aspect ratio
- $A$  = Area, square feet
- $b_H$  = Number of blades
- $b$  = Span, feet
- $c$  = Mean chord, feet
- $C_T$  = Rotor thrust coefficient  $\frac{T}{\rho \pi R^2 (\Omega R)^2}$
- $C_T \sigma$  = Aerodynamic blade loading
- $C_{L_R}$  = Rotor lift coefficient  $\frac{L_R}{\rho/2 \pi R^2 V^2}$
- $C_{L_W}$  = Fixed wing lift coefficient  $\frac{L_W}{\rho/2 A_W V^2}$
- $C_Q$  = Rotor torque coefficient  $\frac{Q}{\rho \pi R^2 (\Omega R)^2 R}$
- $L/D$  = Equivalent drag-lift ratio
- $f$  = Parasite drag area, square feet
- $F$  = Pressure-jet thrust, pounds
- $K_v$  = Ratio  $\frac{\text{Excess power}}{\text{Effective vertical climb power}}$
- $L$  = Total lift force, pounds
- $L_R$  = Rotor lift force, pounds
- $L_W$  = Fixed wing lift force, pounds
- $L/D$  = Lift-drag ratio

DATE 20 December 1950

REVISED \_\_\_\_\_

REVISED \_\_\_\_\_

**MCDONNELL** *Aircraft Corporation*  
 ST. LOUIS 3, MISSOURI  
 CONFIDENTIAL

PAGE 15REPORT 1904MODEL 78

- Q = Rotor torque, foot-pounds
- q = Dynamic pressure, pounds/square foot
- R = Rotor radius, feet
- R/C = Maximum rate of climb, feet/minute
- T = Rotor thrust, pounds
- T/F = Covering merit factor
- $v_i$  = Rotor induced velocity, feet/second
- V = Flight path velocity, feet/second
- $V_v$  = Vertical rate of climb, feet/second
- $\mu$  = Advance ratio,  $\frac{V}{\Omega R}$
- $\Omega$  = Rotor angular velocity, radians/second
- $\rho$  = Air density, slugs/cubic feet
- $\sigma$  = Rotor solidity,  $\frac{b^2 C_D}{R}$
- $\theta$  = Rotor blade angle, degrees
- $\alpha_{(Tip)(270)}$  = Retreating blade tip angle of attack, degrees

Subscripts

- i = Induced
- J = Tip jet
- o = Profile
- P = Parasite
- R = Rotor
- W = Fixed-wing

DATE 20 December 1950

REVISED \_\_\_\_\_

REVISED \_\_\_\_\_

**MCDONNELL** *Aircraft Corporation*

ST. LOUIS 3, MISSOURI

**CONFIDENTIAL**

PAGE 16

REPORT 1904

MODEL 78

5.2 Dimensional Data -

5.2.1 Fixed Wing

Span, inches . . . . .	540
Chord, inches: root . . . . .	97.75
tip . . . . .	57
MAC . . . . .	90
Projected area, sq.ft. . . . .	332
Airfoil section - root . . . . .	23018
tip . . . . .	23012
Incidence, degrees . . . . .	3
Effective aspect ratio . . . . .	6.1
Aileron area, sq.ft. . . . .	21.50
Split-flap area, sq.ft. . . . .	18.00

5.2.2 Rotors

Number of rotors . . . . .	1
Number of blades per rotor . . . . .	3
Rotor diameter, feet . . . . .	65
Rotor disc area, sq.ft. . . . .	3320
Disc loading, lbs./ft. <sup>2</sup> . . . . .	9.04
Rotor solidity . . . . .	.09
Blade chord, inches . . . . .	37
Blade twist, degrees . . . . .	0
Blade airfoil section . . . . .	NACA 23015
Rotor tip speed, ft./sec. -	
Hovering . . . . .	750
Helicopter forward flight . . . . .	750, 700
Propeller forward flight . . . . .	700, 500, 420

DATE 20 December 1950

REVISED \_\_\_\_\_

REVISED \_\_\_\_\_

**MCDONNELL** *Aircraft Corporation*

ST. LOUIS 3, MISSOURI

CONFIDENTIAL

PAGE 17

REPORT 1904

MODEL 78

5.2.3 Wing (V-type)

Airfoil section - root . . . . .	NACA 0015
tip . . . . .	ACA 0009
Effective aspect ratio . . . . .	4.65
Dihedral, degrees . . . . .	45
Wing incidence, degrees . . . . .	0
Mean aerodynamic chord, inches . . . . .	37.25
Total area, sq.ft. . . . .	142.0
Control surface area, sq.ft. . . . .	44.0

5.2.4 Propellers

Number of propellers . . . . .	2
Number of blades per propeller . . . . .	3
Manufacturer . . . . .	Aero Products
Model designation . . . . .	A 63ZF
Propeller diameter, feet . . . . .	10
Activity factor . . . . .	450
Propeller gear ratio . . . . .	7.95:1
Propeller speed, rpm . . . . .	1750

5.3 Weight Data

5.3.1 Gross weight, pounds . . . . .	30,000
Weight empty . . . . .	10,054
Useful load . . . . .	18,046
Payload . . . . .	8,135

DATE 20 December 1950

REVISED \_\_\_\_\_

REVISED \_\_\_\_\_

**MCDONNELL** *Aircraft Corporation*

ST. LOUIS 3, MISSOURI

CONFIDENTIAL

PAGE 10

REPORT 1904

MODEL 70

5.4.2	Maximum T.O. weight, pounds . . . . .	36,000
	Weight empty . . . . .	18,954
	Useful load . . . . .	18,046
	Payload . . . . .	14,135

5.4 Power Plant Data \*

5.4.1 Engine Data

Number of engines . . . . .	2
Manufacturer . . . . .	Allison Division, General Motors
Model designation . . . . .	Allison Model 501 power section
Engine ratings -	
Specification normal rating . . . . .	2235/14000
Performance normal rating ** . . . . .	1935/14000

5.4.2 Compressor Data

Manufacturer . . . . .	Westinghouse
Model designation . . . . .	19XB

5.4.3 Pressure-Jet Data

Manufacturer . . . . .	McDonnell Aircraft Corporation
------------------------	-----------------------------------

\* For more complete Power Plant data, see reference 9.7.

\*\* Includes losses for inlets, ducts, etc., see reference 9.9.

DATE 20 December 1950**MCDONNELL** *Aircraft Corporation*PAGE 19

REVISED \_\_\_\_\_

ST. LOUIS 3, MISSOURI

REPORT 1904

REVISED \_\_\_\_\_

CONFIDENTIAL

MODEL 78

## C. AERODYNAMIC DATA

6.1 Parasite drag estimate - For estimating parasite drag power losses, a breakdown of the component parasite drag areas is made. The following tables of component parasite drag areas were prepared to cover the requirements of the performance estimate. The component drag coefficients were obtained from reference 9.5. Note that the wing is not considered in Table I, since the drag effect of the wing in forward flight is included in the L/D of the wing. Also, the hub effect is treated as a separate component in the rotor-powered flight performance, and for turbo-prop flight, the hub drag is contained in the L/D for the rotor.

TABLE I

<u>Component</u>	<u>Area</u>	<u>C<sub>D</sub></u>	<u>f(sq.ft.)</u>
Fuselage	68.5	.11	7.54
Pylon	26.5	.016	.42
Nacelles	29.5	.10	2.95
Empennage	120.0	.012	1.44
Landing gear (retracted)	-	-	.35
Interference (10% assumed)	-	-	<u>1.30</u>
		Total	<u>14.00 *</u>
Hub (based on disc area, C <sub>D</sub> from model test data)		.0013	<u>4.32</u>
		Total	<u>18.32 **</u>

\* Turbo-prop flight (wing drag, induced and profile, included in L/D wing; hub drag included in L/D of rotor).

\*\* Powered rotor flight (wing drag, induced and profile, included in L/D wing).

CONFIDENTIAL

TABLE II

Parasite Drag Estimate (vertical flight) \*

<u>Component</u>	<u>Area</u>	<u>C<sub>D</sub></u>	<u>f(sq.ft.)</u>
Fuselage	415	.35	145
Wing	218	1.00	218
Nacelles	100	.35	35
Propellers	66	1.00	66
Tail	82	1.00	82
			<u>546 sq.ft.</u>

Hovering Download Area Estimate \*\*

Fuselage	245	.35	30
Wing	148	1.00	148
Nacelles	100	.35	35
			<u>203 sq.ft.</u>

\* In vertical rate of climb calculations, the total platform area is used to obtain the parasite drag load. For calculations of rates of climb at forward speeds, it is necessary to obtain the effect of parasite drag on the rotor in a vertical direction. Therefore, the induced area of the wing is subtracted from the total platform area and considered separately. The parasite drag area resulting is 546 sq.ft. minus 332 sq.ft. which equals 214 sq.ft.

\*\* To get the hovering power required considering the effect of rotor downwash, an estimate is made of the area in the path of the downwash velocity.

DATE 20 December 1950

**MCDONNELL** *Aircraft Corporation*  
 ST. LOUIS 3, MISSOURI  
 CONFIDENTIAL

PAGE 21

REVISED \_\_\_\_\_

REPORT 1904

REVISED \_\_\_\_\_

MODEL 78

4.2 Fixed wing characteristics - The Model 78 fixed wing of A# 28012 to 28018 airfoil section has a 0.1 aspect ratio. The airfoil section characteristics for infinite aspect ratio obtained from reference 1.5 are corrected to the infinite aspect ratio of 0.1 by equations:

$$\alpha_{R} = \alpha_{\infty} + \frac{1.24 C_{LW}}{AR}$$

$$C_{D_{FR}} = C_{D_{\infty}} + \frac{C_{LW}^2}{\pi AR}$$

A further correction on the lift-drag ratio is made to account for wing taper in accordance with reference 1.7. Figure 14 presents the corrected airfoil characteristics used in the aerodynamic performance estimates. The variation of lift coefficient with forward velocity in level flight is shown in figure 10.

### 4.3 Propeller characteristics -

4.3.1 Discussion - The preliminary turbo-prop installation consists of two, three-bladed full-featured Aero Products propellers driven by two Allison Model 501 gas turbines through Allison T1-38 gear boxes. During helicopter operation, the propeller pitch is set at that which results in minimum power absorption by the propellers. For a preliminary estimate, this propeller setting is assumed to absorb 5% of the available engine shaft horsepower throughout the helicopter flight range. (See reference 1.5.) The preliminary propeller data are presented in section 4.3.4.

4.3.2 Propeller efficiencies - The preliminary propeller efficiency curve, figure 1, is estimated from the data presented and reference 1.5. The method is as follows:

DATE 20 December 1950**MCDONNELL** *Aircraft Corporation*PAGE 22

REVISED \_\_\_\_\_

ST. LOUIS 3, MISSOURI

REPORT 1904

REVISED \_\_\_\_\_

CONFIDENTIAL

MODEL 78

Step 1 - Assume velocity, altitude 220 knots, sea level

Step 2 - Determine engine power, propeller speed 2290 HP, 1760 rpm

Step 3 - Compute J

$$J = \frac{88 V_{mph}}{1.45} = \frac{88 \times 220 \times 1.15}{1760 \times 10} = 1.27$$

Step 4 - Compute  $C_p$ 

$C_p = .210$

$$C_p = \frac{.5(\text{HP}/1000)}{e/\rho_0 (V/1000)^3 (D/10)^5}$$

$$C_p = \frac{.5 \times 2.29}{(1.75)^3 (1)^5} = .210$$

Step 5 - Determine X and  $C_{P_X}$ 

X = .60

Activity factor = 450

$C_{P_X} = .350$

$$C_{P_X} = \frac{C_p}{X} = \frac{.210}{.60} = .350$$

Step 6 - Compute  $J/(C_p)^{1/3}$ 

$$J/(C_p)^{1/3} = \frac{1.27}{(.210)^{1/3}} = \frac{1.27}{.595} = 2.10$$

Step 7 - From chart (reference 9.3, page 180) read  $\eta = .85$ 

Figure 19, propeller efficiency against velocity, is obtained by assuming various velocities and repeating the steps required to obtain propeller efficiency. These propeller efficiencies are used in transforming the shaft horsepower and net jet thrust to horsepower available for level flight performance calculations.

DATE 20 December 1950

REVISED \_\_\_\_\_

REVISED \_\_\_\_\_

**MCDONNELL** *Aircraft Corporation*  
ST. LOUIS 3, MISSOURI  
**CONFIDENTIAL**

PAGE 23

REPORT 1904

MODEL 78

#### 6.4 Flight limitations

6.4.1 Blade stall - Retreating blade stall is considered a limiting flight velocity criteria because of loss of control and objectionable vibration. ACA flight tests, reference 9.8, indicate that a retreating blade tip angle of attack of 12 degrees is the beginning of blade stall. Operation at tip angles greater than this causes increased profile power loss and objectionable vibration with loss of control occurring about 4 degrees above the initial stall angle.

Blade stall is primarily dependent upon the advance ratio and the aerodynamic blade loading ( $C_T/\sigma$ ) which is a measure of the mean blade angle of attack. Figure 17 presents the relationship of initial stall  $C_T/\sigma$  with rotor shaft power parameter ( $P/L$ ) for constant advance ratios,  $\mu^*$ . A discussion of this graph and its source is presented in section 6.5.4. For the Model 78, because of the aerodynamic blade loading and because of the effect of the fixed wing in forward flight, blade stall is avoided in the helicopter level flight condition, except for operation at or near  $C_{L_w}$  of fixed wing equal to zero. Other limits are more critical for the higher fixed-wing lift coefficients. In propeller flight, the increased drag losses, because of blade stall, are accounted for in the model test lift-drag ratio of the rotor; and since control is attained by a conventional aileron-elevator system, blade stall is not a limiting criteria.

6.4.2 Advancing blade velocity - An advancing blade velocity limitation is considered necessary to avoid increased power loss caused by Mach number drag divergence and objectionable vibration, fatigue, and control characteristics caused by blade lift loss and center of pressure movement. A limit of forward velocity plus rotational tip speed ( $V + \Omega R$ ) of 900 feet per second is assumed,

**CONFIDENTIAL**

DATE 20 December 1950

REVISED \_\_\_\_\_

REVISED \_\_\_\_\_

**MCDONNELL** *Aircraft Corporation*  
 ST. LOUIS 3, MISSOURI  
**CONFIDENTIAL**

PAGE 24

REPORT 1904

MODEL 73

which gives rise to a .80 Mach number at sea level. Reference 9.10 shows that rearward shifts of center of pressure are avoided if the Mach number is limited to this value. However, operation at higher advancing blade Mach numbers than .80 is probably practical because of the intermediate nature of the problem. Further wind tunnel research and full-scale flight test programs should provide additional information on this limitation.

6.4.3 Wing stall - The minimum propeller-driven flight speed is assumed to be dictated by the maximum wing lift coefficient. Actually, this is not a physical limit, since at these minimum speeds, the rotor is supporting a sufficient portion of the weight to maintain control. However, for analytical purposes, the maximum wing lift coefficient is used as a minimum velocity limit.

6.5 Pressure-jet flight condition

6.5.1 hovering - The hovering aerodynamic efficiency of a jet rotor is best represented by the ratio of rotor thrust to jet thrust which may be written non-dimensionally as -

$$\frac{T}{F} = \frac{T}{Q} = \frac{C_T \rho \pi R^2 (\Omega R) 2R}{C_Q \rho \pi R^2 (\Omega R) 2R} = \frac{C_T}{C_Q}$$

The hovering jet rotor torque requirements are the profile and the induced torques,

$$C_Q = C_{Q_0} + C_{Q_1}$$

For an ideally twisted rotor, the profile torque coefficient in terms of the NACA three-term drag polar which is representative of smooth, well-contoured

DATE 20 December 1950

PROJECT \_\_\_\_\_

REVISION \_\_\_\_\_

**MCDONNELL** *Aircraft Corporation*

ST. LOUIS 3, MISSOURI

CONFIDENTIAL

PAGE 25

REPORT 1904

MODEL 78

blades is by reference 9.13,

$$C_{Q_0} = \frac{\sigma}{c} \delta_0 + \frac{2}{3} \delta_1 \frac{C_T}{\rho b^2} + \frac{4}{3} \frac{c}{\sigma} \left[ \frac{C_T}{\rho b^2} \right]^2$$

and the induced torque coefficient is,

$$C_{Q_i} = \frac{.104(C_T)^{3/2}}{B}$$

For the Model 78, it is assumed that the profile drag, thus torque, is independent of blade twist and that the induced drag is increased ten percent to account for the variations from uniform inflow encountered with rectangular untwisted blades. The tip loss factor assumed is that presented by Sissingh in reference 9.13,

$$B = 1 - \frac{\sqrt{3C_T}}{b_F}$$

Since the jet thrust presented in reference 9.9 is gross internal thrust excluding jet external drag, the hovering rotor thrust - jet thrust ratio is modified to account for the drag torque of the jet units. An equivalent parasite area of .11 square feet per blade is assumed and the T/F ratio corrected accordingly,

$$\Delta C_Q = \frac{b_F f_J \rho (\Omega R)^2 R}{\rho \pi R^2 (\Omega R)^2 R} = \frac{b_F f_J}{2(\pi \cdot 2)}$$

$$T/F = C_T / (C_{Q_0} + C_{Q_i} + \Delta C_Q)$$

- Figure 15 presents the variation of the rotor thrust-jet thrust ratio with aerodynamic blade loading ( $C_T/\sigma$ ). This figure is the basis of all hovering and vertical climb performance estimates.

DATE 20 December 1950

REVISED \_\_\_\_\_

REVISED \_\_\_\_\_

**MCDONNELL** *Aircraft Corporation*  
 ST. LOUIS 3, MISSOURI  
 CONFIDENTIAL

PAGE 26REPORT 1904MODEL 78

6.5.2 Vertical climb - In a vertical climb, the rotor handles a greater mass of air (due to climb velocity) than in hovering and, therefore, needs to accelerate the air mass loss to produce the same thrust. As a result, the induced power losses in a climb are less than those in hovering. Results of NACA tests (reference 9.12) were used to obtain the variation of the ratio of the excess horsepower to the effective climb horsepower with climb velocity (figure 16). The vertical rate of climb was calculated using this figure and the calculated excess horsepower.

$$V_v = \frac{HP_c \times 33,000}{W}$$

The effective climb horsepower,  $HP_c$ , was determined with due consideration given the increased rotor lift required to overcome fuselage - fixed wing parasite drag in vertical climb. (See sample calculation).

6.5.3 Forward flight - Helicopter steady state forward flight performance is calculated by NACA methods of analysis (reference 9.8). Individual power losses are expressed as the energy dissipated per second by an equivalent drag force moving at the translational velocity of the aircraft. The sources of power loss are the rotor profile and induced drags, the jet unit external drag, the wing profile and induced drag, and the fuselage parasite drag.

An equivalent drag balance divided by lift is the basis of all steady state flight performance calculations. This drag balance is modified to account for a portion of the total lift being carried by the fixed wing with the resulting drag-lift equation reading:

$$I/L = L_R/L \left[ (D/L_R)_o + (D/L_R)_1 + (D/L_R)_J \right] + L_w/L \left[ I/L_w \right]_w + \left[ L/L \right]_P$$

CONFIDENTIAL

DATE 20 December 1950

REVISED \_\_\_\_\_

REVISED \_\_\_\_\_

**MCDONNELL** *Aircraft Corporation*  
ST. LOUIS 3, MISSOURI  
CONFIDENTIAL

PAGE 27REPORT 1904MODEL 78

In the helicopter flight condition, the jet external drag does not affect rotor characteristics such as blade angle and flapping coefficients, but does affect the power required, since gross internal thrust is used as jet thrust available. For these reasons, both  $(D/L)_{TOT}$  including and excluding  $(D/L)_J$  are calculated. (See sample calculation.) The power required is then calculated from the  $(D/L)_{TOT}$  including the jet drag-lift ratio by:

$$HP(REQ) = \left[ \frac{D}{L} \right]_{TOTAL} \times \frac{L \times V}{550}$$

The drag-lift ratios used in the total drag-lift balance are developed individually:

Rotor profile drag-lift ratio  $(D/L)_O$  - The rotor profile drag-lift ratios for the various flight conditions are determined from the NACA charts of reference 9.8. These charts are developed for assumptions of zero twist and a profile drag polar ( $C_D = .0087 - .0216\alpha + .40\alpha^2$ ) which is representative of smooth, accurately-contoured blades.

Rotor induced drag-lift ratio  $(D/L)_i$  - The rotor induced drag-lift ratio is calculated by treating the rotor as a lifting wing of  $4/\pi$  aspect ratio. Thus:

$$(D/L)_i = \frac{C_{Di}}{C_{LR}} = \frac{C_{LR}^2}{\pi AR C_{LR}} = \frac{C_{LR}}{4}$$

Fuselage parasite drag-lift ratio  $(D/L)_p$  - The fuselage drag-lift ratio is calculated from the estimated equivalent parasite area. (See table I).

Thus:

$$(D/L)_p = \frac{f \cdot 1/2 \rho V^2}{W} = \frac{f q}{W}$$

CONFIDENTIAL

DATE 20 December 1950

REVISED \_\_\_\_\_

REVISED \_\_\_\_\_

**MCDONNELL** *Aircraft Corporation*  
 ST. LOUIS 3, MISSOURI  
**CONFIDENTIAL**

PAGE 28

REPORT 1904

MODEL 78

Jet external drag-lift ratio  $(D/L)_J$  - The jet external drag-lift ratio is determined from an estimated cold drag coefficient of .145 which is based upon experience gained under the Air Materiel Command H-20 jet rotor contract. The maximum cross-sectional area of each pressure jet unit is 108 square inches. Therefore, the equivalent parasite area per unit is .11 square feet. Having established the equivalent parasite area, the jet drag-lift ratio may be determined by:

$$(D/L_R)_J \times LRV = 1/2\pi \int_0^{2\pi} b_{RFJ} \rho/2 (\Omega R + V \sin\psi)^3 d\psi$$

which integrates to:

$$(D/L_R)_J = \frac{b_{RFJ}}{C_{LR} \pi R^2} \left[ 1/\mu^3 + 3/2\mu \right]$$

For quick estimation of the jet drag-lift ratio, non-dimensional plots of  $(D/L_R)_J$  against the reciprocal of the rotor lift coefficient for a ratio of  $b_{RFJ}/\pi R^2$  equal to unity are presented as figures 20 and 20a. The value read from these charts must be multiplied by the actual ratio of cold jet equivalent parasite area to rotor disc area which is .00610 for Model 78.

For rotor-powered flight, the jet unit drag has no effect on the rotor characteristics, such as blade angle, angle of attack and  $a_1$  flapping, but as already stated, does affect the power required. Therefore, the  $(D/L_R)_J$  ratio is subtracted from the total D/L ratio for the determination of rotor characteristics other than power required.

Wing drag-lift ratio  $(D/L)_W$  - The wing drag-lift ratio is obtained from a plot of the wing airfoil characteristics (figure 18) for the flight condition assumed, i.e., at the given wing lift coefficient. The variation of wing lift

coefficient with level forward flight velocity is presented as Figure 10.

8.1.4 Maximum rate of climb - In determining the maximum rate of climb in rotor-powered flight, it is necessary to calculate the rate of climb for several forward velocities because of the limiting criteria. Two curves are obtained, one, considering power limitation, and a second curve, considering blade stall as a limiting factor. The intersection of these two curves determines the maximum rate of climb. (See Figure 10). In considering blade stall as a limit, it is convenient to obtain a plot of  $C_T/\sigma$  at initial stall for corresponding values of  $P/L$  and  $\mu$ . Figure 17 is such a plot and is obtained by converting the  $C_L/\sigma$  values at initial blade stall from the NACA charts of reference 1.3 to  $C_T/\sigma$  for various  $\mu$  and  $P/L$  values. This plot is used in conjunction with the assumed stall limit rotor load for checking the maximum rate of climb as shown in sample calculation 8.1.5.

The method used in constructing the rate of climb curves is the typical ACA analysis for rotor-powered flight.

$$P/L = (P/L)_o + (P/L)_i + (P/L)_J + (P/L)_L + (P/L)_w + (P/L)_c$$

A trial and error method is required to determine the actual operating conditions and power losses during climb. (See sample calculations 8.1.5.1 and 8.1.5.2.)

8.2 Turbo-prop flight condition

8.2.1 Basis of analysis - In the turbo-propeller flight condition, the total weight of the aircraft is supported by a fixed-wing lifting surface combined

DATE 20 December 1950

REVISED \_\_\_\_\_

REVISED \_\_\_\_\_

**MCDONNELL** *Aircraft Corporation*  
ST. LOUIS 3, MISSOURI  
CONFIDENTIAL

PAGE 30REPORT 1904MODEL 78

with an autorotating rotor. Wind tunnel model test programs contracted to the Office of Naval Research show that lightly loaded autorotating rotors may advance at far higher advance ratios than heretofore considered practical. Through these programs, rotor lift, drag, blade motion, blade stresses, fixed-wing interference, aircraft stability, and many other details have been analyzed and tested through a wide range of variables. The results of these model test programs and studies form the basis for the Model 78 aerodynamic performance estimates in the turbo-prop flight condition. Applicable test data are presented in figures 5, 6, 7, and 8; for further data, see NACA Engineering Letters, reference 9.18.

Figure 5, "Rotor Lift Coefficient Against Advance Ratio", presents a comparison of McDonnell wind tunnel tests at the high advance ratios and other pertinent test data from previous NACA programs. Figure 6 gives a mean curve used in the performance estimates.

Figure 7, "Rotor Lift-Drag Ratio Against Advance Ratio", shows comparative results of NACA tests with a ten-foot rotor model (reference 9.17) and with a full-scale Pittcairn rotor (reference 9.16) and McDonnell tests with an eight-foot rotor model, together with the results of McDonnell theory. Accounting for Reynolds number effect, all the different test results and theoretical results are in satisfactory agreement. Figure 8 gives the rotor lift-drag curve used in the Model 78 preliminary performance estimates.

6.6.2 Forward flight - Level flight power required for forward velocities is obtained in a manner similar to that described in the section on rotor-powered forward flight (section 6.5.5). A modified drag-lift equation is used for turbo-prop flight. The power loss due to drag of the rotor is based on autorotational

DATE 20 December 1950

REVISED \_\_\_\_\_

REVISED \_\_\_\_\_

**MCDONNELL** *Aircraft Corporation*  
 ST. LOUIS 3, MISSOURI  
**CONFIDENTIAL**

PAGE 31

REPORT 1904

MODEL 78

wind tunnel data which does not separate the profile and induced losses in the rotor (see figure 8). In these tests, which compare favorably with other wind tunnel and theoretical data, the rotor and its hub are considered as one unit. Therefore, it is only necessary to add the tip jet drag contribution to the rotor for a drag power loss due to the autorotating rotor.

It should also be noted that the parasite drag area used for the parasite drag loss differs in the rotor-powered and turbo-prop power required calculations. This difference is due to the fact that the hub drag is included with that measured for the rotor in the autorotational test data. In the rotor-powered flight, the hub drag is taken as a component of the parasite drag area for the whole ship and included with the parasite drag power loss.

The resulting drag-lift equation is as follows:

$$D/L = L_R/L \left[ (D/L_R)_H + (D/L_R)_J \right] + L_W/L \left[ D/L_W \right]_W + \left[ D/L \right]_P$$

The power required is then calculated from the  $D/L_{TOTAL}$  using the following equation:

$$HP(REQ) = (D/L)_{TOTAL} \times \frac{L \times V}{550}$$

(See sample calculation 9.1.4).

The percent load carried by the rotor throughout the flight velocity range is presented as figure 11. The dash lines represent the percent load carried by the rotor in helicopter flight, while the solid lines are for turbo-prop flight at various autorotating rotor tip speeds.

20 December 1950

CONFIDENTIAL

Page 32  
Report 1904  
Model 78

FIGURE - 5  
LIFT COEFFICIENT  $C_L$  OF ROTOR IN AUTOROTATION  
ACCORDING TO WIND TUNNEL TESTS

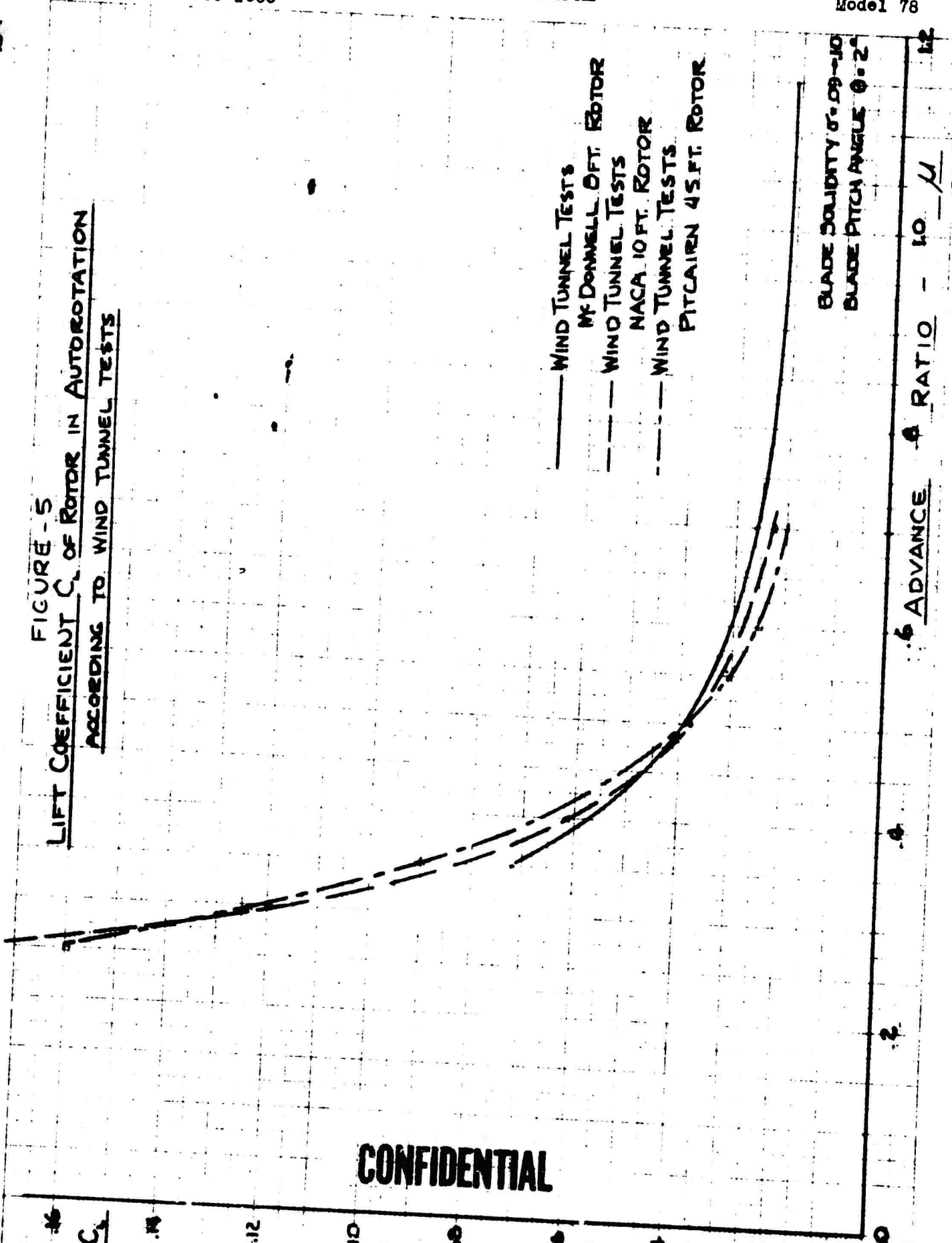

CONFIDENTIAL

**CONFIDENTIAL**

**FIGURE - 6**  
**LIFT COEFFICIENT  $C_L$  OF ROTOR IN AUTOROTATION**  
**ASSUMED FOR PERFORMANCE ESTIMATES**

BLADE SOLIDITY  $\sigma = 0.09$   
BLADE PITCH ANGLE  $\theta = 2^\circ$

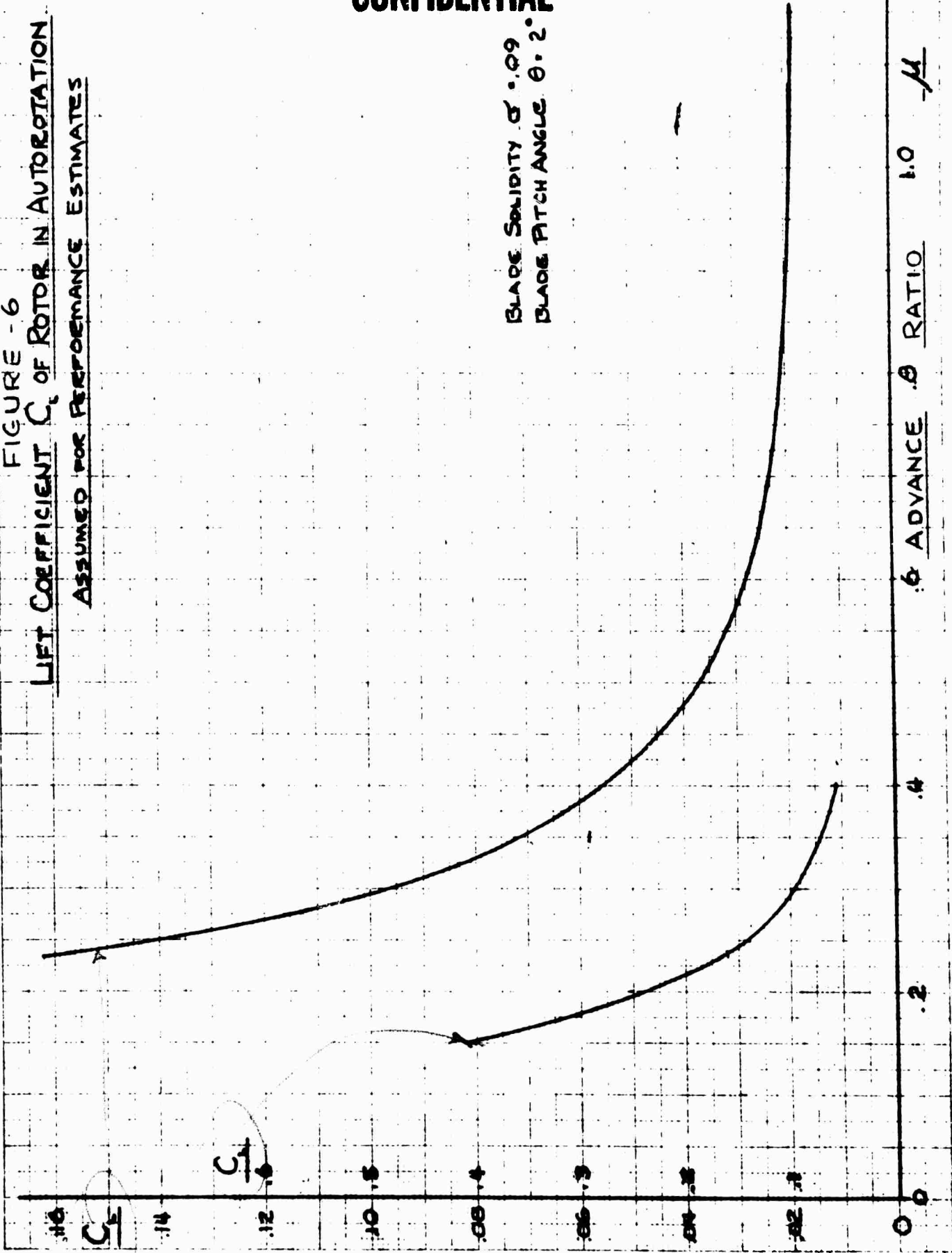

**CONFIDENTIAL**

20 December 1950

CONFIDENTIAL

Page 34  
Report 12904

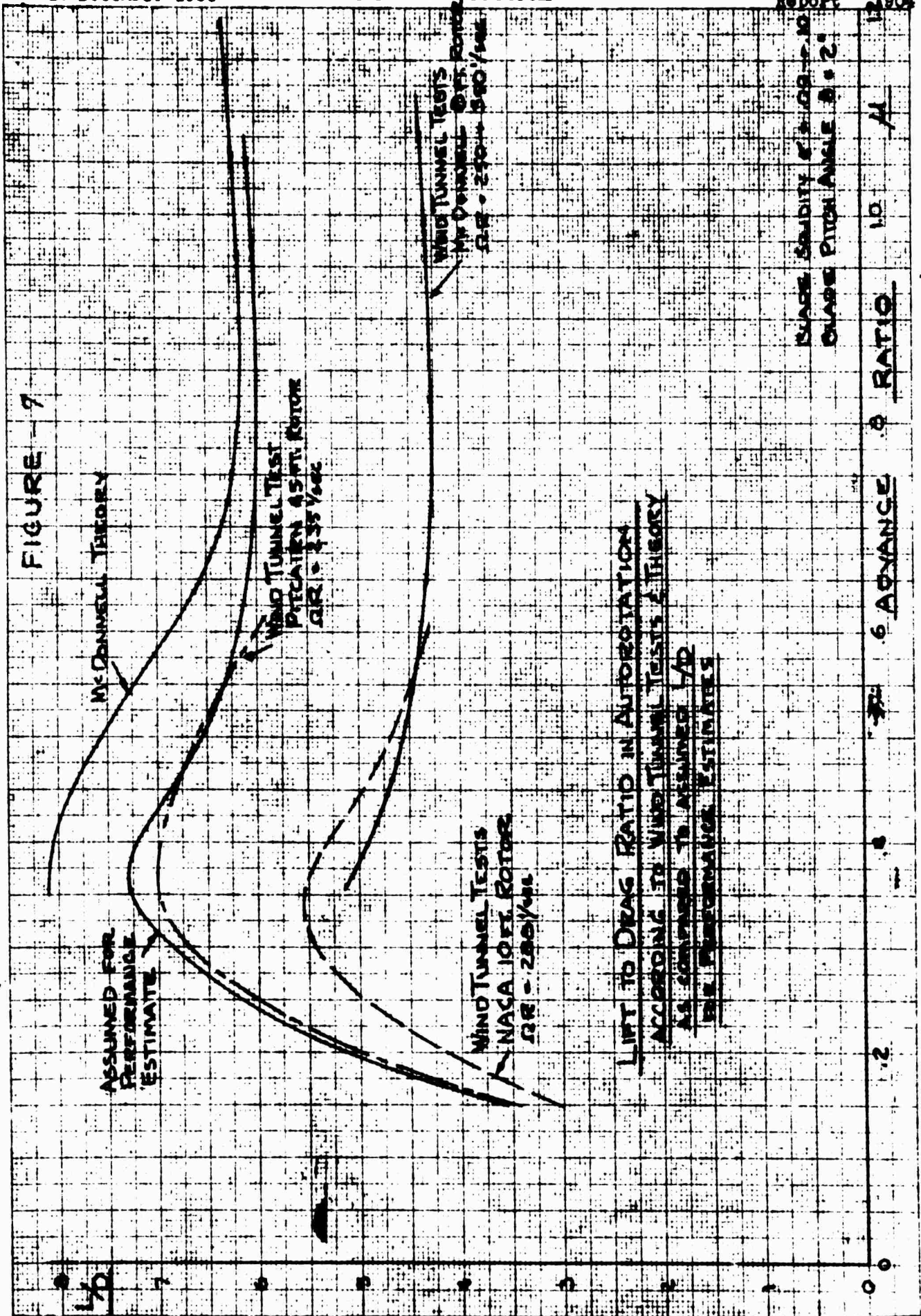

CONFIDENTIAL

CONFIDENTIAL

FIGURE - 6  
LIFT TO DRAG RATIO OF ROTOR IN AUTOROTATION  
AS ASSUMED FOR PERFORMANCE ESTIMATE

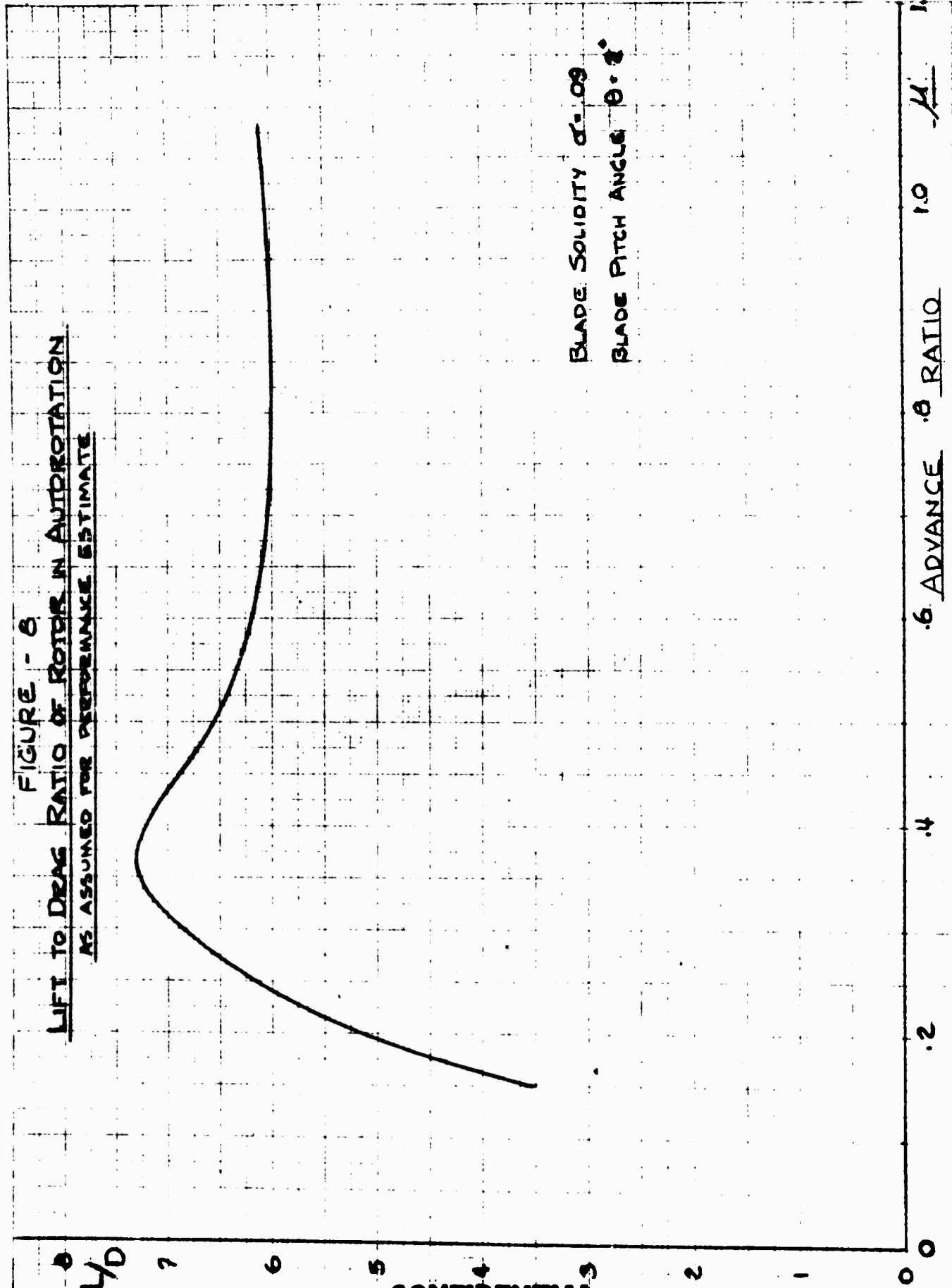

CONFIDENTIAL

REDFEEL - ESSER CO.

REDFEEL - ESSER CO.

DATE 20 December 1950

REVISED \_\_\_\_\_

REVISED \_\_\_\_\_

**McDONNELL** *Aircraft Corporation*  
 ST. LOUIS 3, MISSOURI  
 CONFIDENTIAL

PAGE 39

REPORT 1004

MODEL 72

6.6.3 Maximum rate of climb - From the "unpowered required" curve, Figure 1, the point of maximum excess horsepower is taken as the point for the maximum rate of climb. The excess horsepower available is calculated available for climb and applied in the following manner:

$$\text{Max. } \dot{h} = 1.1 \text{ (HP}_{\text{excess}} / 31,000) = \text{ft./in.}$$

6.7 Autoretation characteristics - The auto-retain ability of the wing gives this configuration an advantage over the conventional configuration in autorotation. The benefit of the wing is also tested in a descent to the landing operation. The total lift and drag, the rate of descent are calculated from the following:

$$L = C_L \cdot \frac{\rho}{2} \cdot V^2 \cdot S$$

The  $C_L$  values for this equation are the level climb or required climb values for turbo-prop operation. In a normal descent, the motor is autorotative. Taking the design lift ratios and rates for total power-off flight at their respective forward flight velocities, the rates of descent are calculated using the above equation.

DATE 20 December 1950

**MCDONNELL** *Aircraft Corporation*

PAGE 57

REVISED

ST. LOUIS 3, MISSOURI

REPORT 1-04

REVISED

CONFIDENTIAL

MODEL

V. 1.0.3 AVAILABLE

1.1 Discussion - A detailed explanation of the ...  
and ... to obtain ...  
... ..

It will be noted that the ...  
... ..  
... ..  
order to obtain stall-free operation and ...  
the preliminary performance estimates, it is ...  
in tip speed would effect an appreciable ...  
trust or the ... ..  
... ..  
... ..  
... ..

1. WIND TUNNEL

2.1 Sample calculation

2.1.1 of rise per cent. line of mean effect

- Altitude = sea level
- Gross weight = 30,000 pounds
- Rise area = 3320 sq. ft.
- Motor tip speed = 710 ft./second
- Motor solidity = .03
- Motor rise load =  $\frac{30,000 + \text{downwash load on passage}}{3320}$

Assuming downwash load to be 1120 pounds, compute the rise velocity, *see below*

$$v_1 = \sqrt{\frac{.5 \cdot T}{\rho \cdot A}} = \sqrt{\frac{30,000 + 1120}{\rho \cdot (3320)}} = 44.5 \text{ ft./second}$$

Allow for rise of 33 ft. in flow contraction,

$$(44.5) 1.33 = 60.5 \text{ ft./second}$$

of rise downwash area,  $f = 250 \text{ sq. ft.}$  (See page 10.)

Downwash load:

$$L = \frac{1}{2} \rho v_1^2 f = \rho/2 (60.5)^2 250 = 1120 \text{ pounds}$$

$$C_T = \frac{T}{\rho A (\Omega)^2} = \frac{30,000 + 1120}{\rho (3320) (710)^2} = .00734$$

$$C_T / \sigma = \frac{.00734}{.03} = .0732$$

DATE: 20 December 1950

REVISED: \_\_\_\_\_

REVISED: \_\_\_\_\_

**McDONNELL** *Aircraft Corporation*  
 ST. LOUIS 3, MISSOURI  
**CONFIDENTIAL**

PAGE \_\_\_\_\_

REPORT: 1804

MODEL: 73

From figure 1, hovering,  $W/F = 11.0$

$$\text{required jet thrust} = \frac{31180}{11.0} = 2835 \text{ pounds}$$

$$\text{required hovering rotor power} = \frac{2835 \times 700}{550} = 3675 \text{ HP}$$

c.1.2 hovering power required (considering induced drag) on a level rotor  
day - sea level

$$e = .002242$$

$$C_D = \frac{31180}{32.2 \times (.002242) (700)^2} = .00748$$

$$C_{D/f} = \frac{.00748}{.09} = .083$$

$$W/F = 10.34 \text{ (Figure 1b)}$$

$$\frac{31180}{10.34} = 2975 \text{ pounds jet thrust}$$

$$\text{required rotor HP} = \frac{2975 \times 700}{550} = 3820 \text{ HP}$$

From figure 30, reference 1.1, the tip jet thrust available on a level rotor day is 4420 pounds at  $\Omega = 700$  ft./sec. Assuming an equal available thrust at  $\Omega = 700$  ft./sec., the horsepower available becomes

$$4420 \times \frac{700}{550} = 5620$$

$$\frac{3820 \times 100}{7000} = 54.6$$

is to meet the requirement of the reference. The actual test  
power should be available on the motor.

2.1.3 Vertical rate of climb

- Gross weight = 30,000 lbs
- Motor diameter = 60 in
- Motor tip speed = 7,000 rpm
- Motor efficiency = .80
- Parasite area (planform) = 40 sq ft (see para 2.0)
- Overhead load = 110 lbs

From vertical power requirements:

$$P(HP) = 3750$$

$$M_{(AVL)} = 1830$$

$$P(HP) = P(AVL) - P(HP)$$

$$P(HP) = 3750 - 3750 = 0$$

$$\text{Approx } P(HP) = \frac{30,000 \times 30,000}{30,000} = 30,000 \text{ HP}$$

To allow for losses in the drive mechanism, assume vertical rate of climb

3000/ft.

$$(M_{(AVL)} = 1.1 \text{ from para 1})$$

**McDONNELL** *Aircraft Corporation*  
ST. LOUIS 3, MISSOURI  
CONFIDENTIAL

For this derivation...

$$- e^{1/2} - e^{1/2} = 12 \dots$$

For this derivation...

$$\frac{1/2}{1/2 + 11} = \dots$$

at length:

$$1. - 2 \times 10^4 = \dots$$

$$1/2 = \frac{(10^4 - 4 \times 10^4) \dots}{50,000} = \dots$$

DATE 20 December 1950

REVISED \_\_\_\_\_

REVISED \_\_\_\_\_

**MCDONNELL** *Aircraft Corporation*  
 ST. LOUIS 3, MISSOURI  
**CONFIDENTIAL**

PAGE 42

REPORT 1904

MODEL 78

**8.1.4 Pressure-jet level flight power required**  
 Altitude = Sea level

Gross weight = 30,000 lbs. Total parasite area = 18.32 ft.<sup>2</sup>  
 Rotor disc area = 3320 ft.<sup>2</sup> Fixed wing area = 332 ft.<sup>2</sup>  
 Rotor tip speed = 700 ft./sec. Wing lift coefficient = .5  
 Rotor solidity = .09 L/D for wing = 20.9

$\mu$	ASSUMED	.10	.15	.20	.25	.30	.35
V	FT./SEC.	70	105	140	175	210	245
V <sub>KN</sub>	KNOTS	41.5	62.5	83	103.6	124.5	145.2
q	$\frac{1}{2} \rho V^2$	5.82	13.12	23.3	36.4	52.4	71.4
L <sub>w</sub>	$C_{Lw} \times A_w \times q$	965	2180	3865	5040	6700	11850
L <sub>R</sub>	L - L <sub>w</sub>	29035	27320	24135	23960	21300	18150
C <sub>L<sub>R</sub></sub>	$L_R / 3320 q$	1.50	.839	.548	.1983	.1224	.0787
1/C <sub>L<sub>R</sub></sub>		.67	1.57	2.68	5.05	8.18	13.05
C <sub>L<sub>R</sub></sub> / $\mu$		1.68	7.10	3.37	2.21	1.36	.85
$\left[ \frac{D}{L} \right]_{D_{90}}$	NACA CHARTS	.1750	.1170	.0930	.0840	.0845	.0910
$\left[ \frac{D}{L} \right]_{D_{90}i}$	$C_{L_R} / 4$	.3750	.1800	.0846	.0496	.0306	.0192
$\left[ \frac{D}{L} \right]_{D_{90}v}$	FIGURE 20 & 20 a	.0680	.0475	.0380	.0350	.0340	.0360
$\left[ \frac{D}{L} \right]_{D_{90}R}$	$\frac{L_R}{L} \left[ \left( \frac{D}{L} \right)_0 + \left( \frac{D}{L} \right)_i + \left( \frac{D}{L} \right)_v \right]$	.5980	.3010	.1872	.1345	.1066	.0865
$\left[ \frac{D}{L} \right]_P$	$18.32 q / L$	.0036	.0020	.0142	.0222	.0320	.0435
$\left[ \frac{D}{L} \right]_w$	$\frac{L_w}{L} \left[ \left( \frac{D}{L} \right)_w \right]$	.0015	.0035	.0062	.0097	.0139	.0190
$\left[ \frac{D}{L} \right]_{TOT}$	$\left[ \frac{D}{L} \right]_R + \left[ \frac{D}{L} \right]_P + \left[ \frac{D}{L} \right]_w$	.6031	.3125	.2076	.1664	.1525	.1510
F <sub>s</sub>	$\left[ \frac{D}{L} \right]_{TOT} \times \frac{L \times V}{700}$	1808	1410	1245	1249	1373	1535
HP <sub>(REQ.)</sub>	$F_s \times \frac{700}{550}$	2300	1795	1585	1580	1748	2020
$\frac{D}{L_R}$	*	.5552	.2894	.2010	.1735	.1797	.2137
$\theta$	NACA CHARTS	9.0°	8.0°	7.0°	7.45°	7.55°	8.6°

\*  $\frac{D}{L_R}$  calculated as the sum of the induced, profile, wing, and fuselage drag-lift ratios based on rotor lift in order to determine  $\left[ \frac{D}{L} \right]_R$  and blade angle  $\theta$  (See section 8.5.3).

DATE 20 December 1950

**MCDONNELL** *Aircraft Corporation*  
 ST. LOUIS 3, MISSOURI  
**CONFIDENTIAL**

PAGE 15

REVISED \_\_\_\_\_

REPORT 1007

REVISED \_\_\_\_\_

MODEL 70

8.1.5 Turbo-prop level flight power required  
 Sea level  $\rho = .002378$

Gross weight = 58,000 lbs. Parasite drag area = 14.00 ft.<sup>2</sup>  
 Fixed-wing area = 300 ft.<sup>2</sup> Cruise speed = 700 ft./sec.  
 Motor disc area = 300 ft.<sup>2</sup> Motor solidity = .08

$\mu$	Assumed	.15	.20	.25	.30	.35
$CL_R$	Figure 6	.1	.24	.142	.026	.017
$1/CL_R$		2.44	4.17	7.04	10.42	14.38
V	ft./sec.	108	110	170	210	240
$V_{KN}$	knts	61.2	65	100.0	124.0	141.2
q	$\frac{1}{2}\rho V^2$	18.1	23.28	37.4	60.1	71.8
$L_P$	$CL_R(3320)q$	17840	19550	17100	16700	17850
$L_W$	$L - L_P$	12150	11400	12850	13300	14100
$CL_W$	$L_W/3320q$	2.795	1.404	1.004	.760	.698
$(L/D_W)_W$	Figure 13	10.0	10.0	14.0	17.55	20.7
$(L/D_R)_R$	Figure 8		6.15	6.15	6.95	7.7
$(D/L_R)_R$	*		.1200	.0983	.0810	.0776
$(D/L_R)_J$	**		.0845	.0232	.0242	.0218
$D/L_P$	$14q/L$		.0101	.0170	.0244	.0333
$(D/L_W)_W$	$L_W/L [1/(L/D)_W]$		.0657	.0506	.0253	.0216
$1/L_{tot}$	$D/L_P + D/L_R + D/L_W$		.1987	.1391	.1452	.1548
HP (req)	$1/L_{tot} \times (L \times V) / 550$		1519	1515	1780	2015

\*  $(D/L_R)_R = L_R/L [1/(L/D)_R]$

\*\*  $(D/L_R)_J = L_R/L [ \text{Value from Figure 20, } 200 \text{ ft. } \rho = .002378 ]$

DATE 20 October 1950

REVISED \_\_\_\_\_

REVISED \_\_\_\_\_

**MCDONNELL** *Aircraft Corporation*

ST. LOUIS 3, MISSOURI

CONFIDENTIAL

PAGE 44

REPORT 1004

MODEL 73

9.1.0 Pressure distribution on the tail

Gross weight = 30,000 lbs.

Lift area = 3000 sq. ft.

Motor efficiency = .80

9.1.1 Assume the plane is still as the lift is 30,000 lbs.

Assume  $\mu = .18$ , hence velocity = 130 ft./sec at  $\Omega = 700$  ft./sec.

Assume  $\omega = 1200$  ft./min.

Then  $\alpha = 18^\circ$

$$\tan \alpha = \frac{31}{106}$$

$$\alpha = 11.3^\circ$$

$$\text{Angle of attack} = -11.3 + 1.0 = -10.3^\circ$$

From Figure 1,  $C_{L_{\alpha}} = -.02$        $L/\bar{q} = 14.6$

$$\text{Lift slope } L = C_{L_{\alpha}} \times \rho/\bar{q} \times V^2 \times A$$

$$= -.02 \times .002377 \times 3 \times 31.2 \times 1170$$

$$= -3.36 \text{ lbs.}$$

Parasitic drag load =  $D \times q$

$$= 214 \times \rho/\bar{q} (V)^2 = 112 \text{ lbs.}$$

$$\text{Total load on r. bar} = 30,000 + 2340 + 112 = 32,452 \text{ lbs.}$$

DATE 20 Dec 1950

**MCDONNELL** *Aircraft Corporation*

PAGE 4b

REVISED \_\_\_\_\_

ST. LOUIS 3, MISSOURI

REPORT 1504

REVISED \_\_\_\_\_

**CONFIDENTIAL**

MODEL 75

Assuming 32,462 lbs. to be stall limit rotor load at 105 ft./sec., calculate power required for this cruise condition:

$$C_T/\sigma = \frac{32,462}{\sigma \times \rho \times 3320(700)^2} = .0955$$

Figure 17 shows for initial stall  $C_T/\sigma$  of .0955 at  $\mu = .15$ , that  $P/L$  for rotor = .54

For  $P/L = .54$ , calculate the following using ACA charts:

$$C_L/\sigma = \frac{32,462}{\sigma \times \rho / 2 \times 3320(105)^2} = 9.81 ; C_L = .749$$

From ACA charts and by the methods of section 6.3.3

$$(D/L)_J = .1180$$

$$(D/L)_I = .1870$$

$$(D/L)_D = .0400$$

$$(D/L)_P = .0074$$

$$L_w/L(D/L)_w = \frac{.0037}{.3581} = (\eta)_{TOTAL}$$

$$(D/L)_C = .0400 - .3581 = .1839$$

$$HP_{CLIMB} = .1839 \times \frac{32462 \times 105}{550} = 1140$$

$$V/S = 1140 \times \frac{33000}{30000} = \underline{1250 \text{ ft./min.}}$$

which checks the assumed value of 1200 ft./min.

DATE 20 December 1950

REVISED \_\_\_\_\_

REVISED \_\_\_\_\_

**MCDONNELL** *Aircraft Corporation*  
 ST. LOUIS 3, MISSOURI  
**CONFIDENTIAL**

PAGE 40

REPORT 1304

MODEL 72

3.1.2 Considering power available as the limiting factor:

Assume  $\mu = .10$ , once velocity = 185 ft./sec. at  $\Omega = 7.0$  ft./sec.

blade max  $V/c = 3000$  ft./min.

Climb angle:

$$\tan \angle = \frac{60.6}{105}$$

$$\text{Angle} = 30^\circ$$

$$\text{Inc angle of attack} = -30 + 3 = -27^\circ$$

From figure 18,  $C_{L\alpha} = -1.68$   $L/c = 9.7$

$$\text{Inc download} = -1.68 \times \frac{\rho}{2} \times 332 \times 11,700$$

$$= -9750 \text{ lbs.}$$

Parasite drag load =  $A \times q$

$$= 214 \times \frac{\rho}{2} (10.6)^2 = 936 \text{ lbs.}$$

$$\text{Total rotor load} = 30,000 + 9750 + 936 = 40686 \text{ lbs.}$$

$$\text{Rotor P/L} = \frac{HP \times 550}{L \times V} = \frac{3600 \times 550}{40686 \times 105} = .348$$

$$\text{Rotor } C_{T/\sigma} = \frac{40,686}{\sigma \times \frac{\rho}{2} \times 3320 (105)^2} = 10.46$$

DATE 20 December 1950**MCDONNELL** *Aircraft Corporation*PAGE 47

REVISED \_\_\_\_\_

ST. LOUIS 3, MISSOURI

REPORT 1904

REVISED \_\_\_\_\_

CONFIDENTIAL

MODEL 78

From NACA charts at  $V/L = .50$ , which is permissible, since  $(D/L)_0$  varies but little with  $D/L$  change in the low advance ratio range. (See reference 8.8).

$$(D/L)_0 = .1205$$

$$(D/L)_i = .2355$$

$$(D/L)_J = .0320$$

$$(D/L)_P = .0059$$

$$\frac{L_w/L}{(D/L)_w} = \frac{.0275}{.4214} = (D/L)_{TOTAL}$$

$$(L/L)_0 = .8480 - .4214 = .4266$$

$$HP_{LIMB} = .4266 \times \frac{40686 \times 105}{550} = 3320$$

$$R/C = 3320 \times \frac{33000}{30000} = \underline{\underline{3650 \text{ ft./min.}}}$$

which checks the assumed value of 3640 ft./min.

#### 8.1.7 Propeller propulsion maximum rate of climb

Excess horsepower at 140 knots = 1680

(Reference figure 9.)

$$\text{Therefore, } R/C = \frac{1680 \times 33000}{30000} = \underline{\underline{1850 \text{ ft./min.}}}$$

CONFIDENTIAL

DATE 20 December 1950

REVISED \_\_\_\_\_

REVISED \_\_\_\_\_

**MCDONNELL** *Aircraft Corporation*

ST. LOUIS 3, MISSOURI

CONFIDENTIAL

PAGE 46

REPORT 1904

MODEL 78

8.1.3 Normal Fuel Load Calculation

The calculated total fuel load requirements of the model 78 consist of the following:

- a. 15 minutes at normal rated power
  - (1) 2 minutes hovering;
  - (2) 13 minutes at 100-knot cruising;
- b. 100-mile combat radius at cruise speed of 220 knots
- c. 10% reserve
- d. 5% increase in all fuel for service variation

overhaul fuel required = 6770 lbs./ hr. (Conservative estimate from reference 9.9)

Turbo-prop fuel required = 2876 lbs./hr. (reference 9.9)  
(normal rated power)

Turbo-prop fuel required = 2010 lbs./hr. (reference 9.9)  
(at cruise horsepower)

15 minutes warm-up

$$6770 \times 1.05 \times \frac{2}{60} = 237 \text{ lbs.}$$

$$2876 \times 1.05 \times \frac{13}{60} = 654 \text{ lbs.}$$

100-mile cruise radius at 220 knots

$$2010 \times 1.05 \times \frac{200}{220} = 2480 \text{ lbs.}$$

10% reserve = 376 lbs.

TOTAL = 3757 lbs.

20 December 1950

**CONFIDENTIAL**

Page 49  
Report 1904  
Model 78

**FIGURE - 9**  
**MODEL 78**  
**LEVEL FLIGHT PERFORMANCE**  
**POWER REQUIRED vs VELOCITY**

ALTITUDE - SEA LEVEL  
NORMAL GROSS WEIGHT

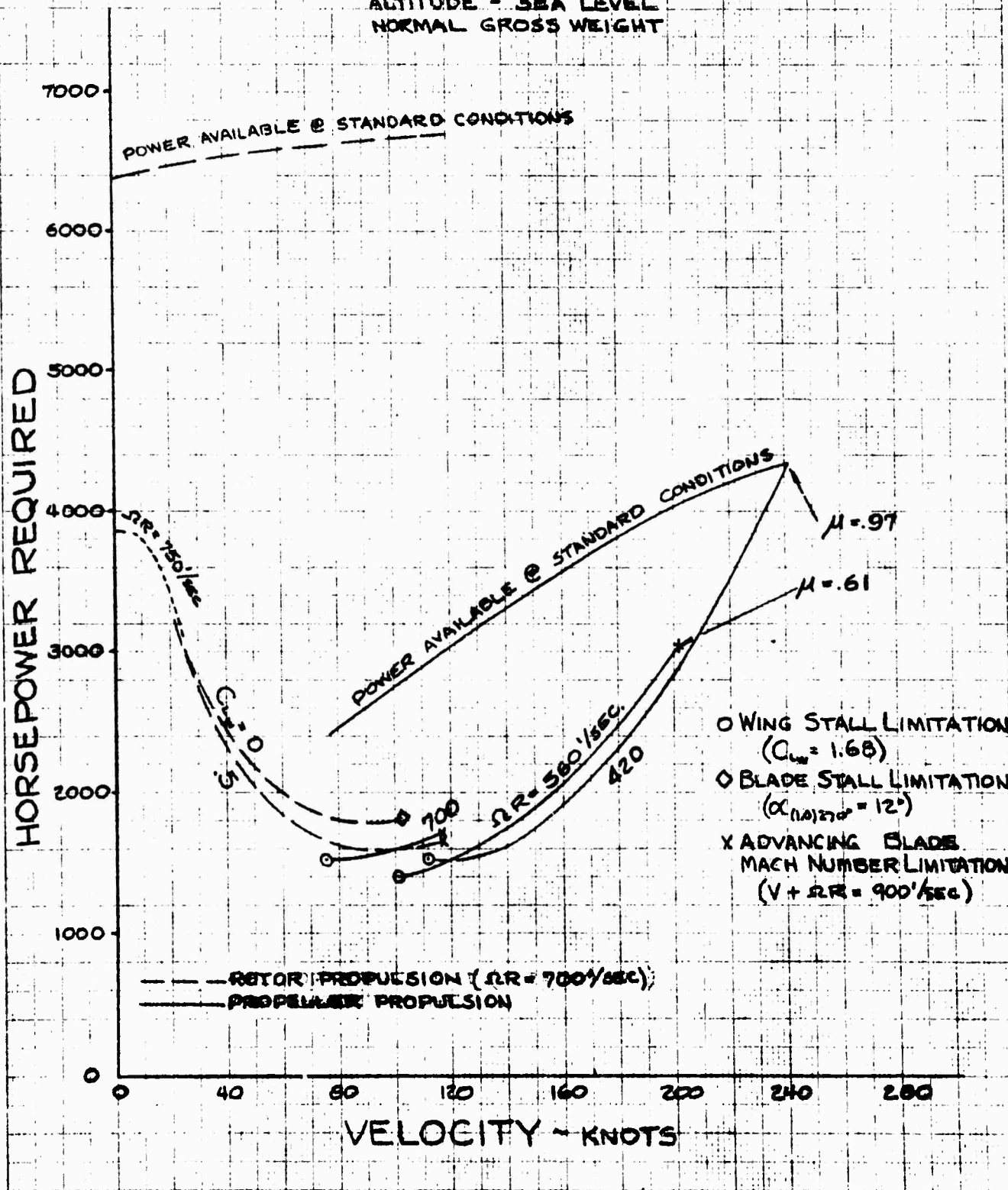

**CONFIDENTIAL**

PERUET & ECKER CO.

16, 24, 31, 37, 43, 49, 55, 61, 67, 73, 79, 85, 91, 97, 103, 109, 115, 121, 127, 133, 139, 145, 151, 157, 163, 169, 175, 181, 187, 193, 199, 205, 211, 217, 223, 229, 235, 241, 247, 253, 259, 265, 271, 277, 283, 289, 295, 301, 307, 313, 319, 325, 331, 337, 343, 349, 355, 361, 367, 373, 379, 385, 391, 397, 403, 409, 415, 421, 427, 433, 439, 445, 451, 457, 463, 469, 475, 481, 487, 493, 499, 505, 511, 517, 523, 529, 535, 541, 547, 553, 559, 565, 571, 577, 583, 589, 595, 601, 607, 613, 619, 625, 631, 637, 643, 649, 655, 661, 667, 673, 679, 685, 691, 697, 703, 709, 715, 721, 727, 733, 739, 745, 751, 757, 763, 769, 775, 781, 787, 793, 799, 805, 811, 817, 823, 829, 835, 841, 847, 853, 859, 865, 871, 877, 883, 889, 895, 901, 907, 913, 919, 925, 931, 937, 943, 949, 955, 961, 967, 973, 979, 985, 991, 997, 1003, 1009, 1015, 1021, 1027, 1033, 1039, 1045, 1051, 1057, 1063, 1069, 1075, 1081, 1087, 1093, 1099, 1105, 1111, 1117, 1123, 1129, 1135, 1141, 1147, 1153, 1159, 1165, 1171, 1177, 1183, 1189, 1195, 1201, 1207, 1213, 1219, 1225, 1231, 1237, 1243, 1249, 1255, 1261, 1267, 1273, 1279, 1285, 1291, 1297, 1303, 1309, 1315, 1321, 1327, 1333, 1339, 1345, 1351, 1357, 1363, 1369, 1375, 1381, 1387, 1393, 1399, 1405, 1411, 1417, 1423, 1429, 1435, 1441, 1447, 1453, 1459, 1465, 1471, 1477, 1483, 1489, 1495, 1501, 1507, 1513, 1519, 1525, 1531, 1537, 1543, 1549, 1555, 1561, 1567, 1573, 1579, 1585, 1591, 1597, 1603, 1609, 1615, 1621, 1627, 1633, 1639, 1645, 1651, 1657, 1663, 1669, 1675, 1681, 1687, 1693, 1699, 1705, 1711, 1717, 1723, 1729, 1735, 1741, 1747, 1753, 1759, 1765, 1771, 1777, 1783, 1789, 1795, 1801, 1807, 1813, 1819, 1825, 1831, 1837, 1843, 1849, 1855, 1861, 1867, 1873, 1879, 1885, 1891, 1897, 1903, 1909, 1915, 1921, 1927, 1933, 1939, 1945, 1951, 1957, 1963, 1969, 1975, 1981, 1987, 1993, 1999, 2005, 2011, 2017, 2023, 2029, 2035, 2041, 2047, 2053, 2059, 2065, 2071, 2077, 2083, 2089, 2095, 2101, 2107, 2113, 2119, 2125, 2131, 2137, 2143, 2149, 2155, 2161, 2167, 2173, 2179, 2185, 2191, 2197, 2203, 2209, 2215, 2221, 2227, 2233, 2239, 2245, 2251, 2257, 2263, 2269, 2275, 2281, 2287, 2293, 2299, 2305, 2311, 2317, 2323, 2329, 2335, 2341, 2347, 2353, 2359, 2365, 2371, 2377, 2383, 2389, 2395, 2401, 2407, 2413, 2419, 2425, 2431, 2437, 2443, 2449, 2455, 2461, 2467, 2473, 2479, 2485, 2491, 2497, 2503, 2509, 2515, 2521, 2527, 2533, 2539, 2545, 2551, 2557, 2563, 2569, 2575, 2581, 2587, 2593, 2599, 2605, 2611, 2617, 2623, 2629, 2635, 2641, 2647, 2653, 2659, 2665, 2671, 2677, 2683, 2689, 2695, 2701, 2707, 2713, 2719, 2725, 2731, 2737, 2743, 2749, 2755, 2761, 2767, 2773, 2779, 2785, 2791, 2797, 2803, 2809, 2815, 2821, 2827, 2833, 2839, 2845, 2851, 2857, 2863, 2869, 2875, 2881, 2887, 2893, 2899, 2905, 2911, 2917, 2923, 2929, 2935, 2941, 2947, 2953, 2959, 2965, 2971, 2977, 2983, 2989, 2995, 3001, 3007, 3013, 3019, 3025, 3031, 3037, 3043, 3049, 3055, 3061, 3067, 3073, 3079, 3085, 3091, 3097, 3103, 3109, 3115, 3121, 3127, 3133, 3139, 3145, 3151, 3157, 3163, 3169, 3175, 3181, 3187, 3193, 3199, 3205, 3211, 3217, 3223, 3229, 3235, 3241, 3247, 3253, 3259, 3265, 3271, 3277, 3283, 3289, 3295, 3301, 3307, 3313, 3319, 3325, 3331, 3337, 3343, 3349, 3355, 3361, 3367, 3373, 3379, 3385, 3391, 3397, 3403, 3409, 3415, 3421, 3427, 3433, 3439, 3445, 3451, 3457, 3463, 3469, 3475, 3481, 3487, 3493, 3499, 3505, 3511, 3517, 3523, 3529, 3535, 3541, 3547, 3553, 3559, 3565, 3571, 3577, 3583, 3589, 3595, 3601, 3607, 3613, 3619, 3625, 3631, 3637, 3643, 3649, 3655, 3661, 3667, 3673, 3679, 3685, 3691, 3697, 3703, 3709, 3715, 3721, 3727, 3733, 3739, 3745, 3751, 3757, 3763, 3769, 3775, 3781, 3787, 3793, 3799, 3805, 3811, 3817, 3823, 3829, 3835, 3841, 3847, 3853, 3859, 3865, 3871, 3877, 3883, 3889, 3895, 3901, 3907, 3913, 3919, 3925, 3931, 3937, 3943, 3949, 3955, 3961, 3967, 3973, 3979, 3985, 3991, 3997, 4003, 4009, 4015, 4021, 4027, 4033, 4039, 4045, 4051, 4057, 4063, 4069, 4075, 4081, 4087, 4093, 4099, 4105, 4111, 4117, 4123, 4129, 4135, 4141, 4147, 4153, 4159, 4165, 4171, 4177, 4183, 4189, 4195, 4201, 4207, 4213, 4219, 4225, 4231, 4237, 4243, 4249, 4255, 4261, 4267, 4273, 4279, 4285, 4291, 4297, 4303, 4309, 4315, 4321, 4327, 4333, 4339, 4345, 4351, 4357, 4363, 4369, 4375, 4381, 4387, 4393, 4399, 4405, 4411, 4417, 4423, 4429, 4435, 4441, 4447, 4453, 4459, 4465, 4471, 4477, 4483, 4489, 4495, 4501, 4507, 4513, 4519, 4525, 4531, 4537, 4543, 4549, 4555, 4561, 4567, 4573, 4579, 4585, 4591, 4597, 4603, 4609, 4615, 4621, 4627, 4633, 4639, 4645, 4651, 4657, 4663, 4669, 4675, 4681, 4687, 4693, 4699, 4705, 4711, 4717, 4723, 4729, 4735, 4741, 4747, 4753, 4759, 4765, 4771, 4777, 4783, 4789, 4795, 4801, 4807, 4813, 4819, 4825, 4831, 4837, 4843, 4849, 4855, 4861, 4867, 4873, 4879, 4885, 4891, 4897, 4903, 4909, 4915, 4921, 4927, 4933, 4939, 4945, 4951, 4957, 4963, 4969, 4975, 4981, 4987, 4993, 4999, 5005, 5011, 5017, 5023, 5029, 5035, 5041, 5047, 5053, 5059, 5065, 5071, 5077, 5083, 5089, 5095, 5101, 5107, 5113, 5119, 5125, 5131, 5137, 5143, 5149, 5155, 5161, 5167, 5173, 5179, 5185, 5191, 5197, 5203, 5209, 5215, 5221, 5227, 5233, 5239, 5245, 5251, 5257, 5263, 5269, 5275, 5281, 5287, 5293, 5299, 5305, 5311, 5317, 5323, 5329, 5335, 5341, 5347, 5353, 5359, 5365, 5371, 5377, 5383, 5389, 5395, 5401, 5407, 5413, 5419, 5425, 5431, 5437, 5443, 5449, 5455, 5461, 5467, 5473, 5479, 5485, 5491, 5497, 5503, 5509, 5515, 5521, 5527, 5533, 5539, 5545, 5551, 5557, 5563, 5569, 5575, 5581, 5587, 5593, 5599, 5605, 5611, 5617, 5623, 5629, 5635, 5641, 5647, 5653, 5659, 5665, 5671, 5677, 5683, 5689, 5695, 5701, 5707, 5713, 5719, 5725, 5731, 5737, 5743, 5749, 5755, 5761, 5767, 5773, 5779, 5785, 5791, 5797, 5803, 5809, 5815, 5821, 5827, 5833, 5839, 5845, 5851, 5857, 5863, 5869, 5875, 5881, 5887, 5893, 5899, 5905, 5911, 5917, 5923, 5929, 5935, 5941, 5947, 5953, 5959, 5965, 5971, 5977, 5983, 5989, 5995, 6001, 6007, 6013, 6019, 6025, 6031, 6037, 6043, 6049, 6055, 6061, 6067, 6073, 6079, 6085, 6091, 6097, 6103, 6109, 6115, 6121, 6127, 6133, 6139, 6145, 6151, 6157, 6163, 6169, 6175, 6181, 6187, 6193, 6199, 6205, 6211, 6217, 6223, 6229, 6235, 6241, 6247, 6253, 6259, 6265, 6271, 6277, 6283, 6289, 6295, 6301, 6307, 6313, 6319, 6325, 6331, 6337, 6343, 6349, 6355, 6361, 6367, 6373, 6379, 6385, 6391, 6397, 6403, 6409, 6415, 6421, 6427, 6433, 6439, 6445, 6451, 6457, 6463, 6469, 6475, 6481, 6487, 6493, 6499, 6505, 6511, 6517, 6523, 6529, 6535, 6541, 6547, 6553, 6559, 6565, 6571, 6577, 6583, 6589, 6595, 6601, 6607, 6613, 6619, 6625, 6631, 6637, 6643, 6649, 6655, 6661, 6667, 6673, 6679, 6685, 6691, 6697, 6703, 6709, 6715, 6721, 6727, 6733, 6739, 6745, 6751, 6757, 6763, 6769, 6775, 6781, 6787, 6793, 6799, 6805, 6811, 6817, 6823, 6829, 6835, 6841, 6847, 6853, 6859, 6865, 6871, 6877, 6883, 6889, 6895, 6901, 6907, 6913, 6919, 6925, 6931, 6937, 6943, 6949, 6955, 6961, 6967, 6973, 6979, 6985, 6991, 6997, 7003, 7009, 7015, 7021, 7027, 7033, 7039, 7045, 7051, 7057, 7063, 7069, 7075, 7081, 7087, 7093, 7099, 7105, 7111, 7117, 7123, 7129, 7135, 7141, 7147, 7153, 7159, 7165, 7171, 7177, 7183, 7189, 7195, 7201, 7207, 7213, 7219, 7225, 7231, 7237, 7243, 7249, 7255, 7261, 7267, 7273, 7279, 7285, 7291, 7297, 7303, 7309, 7315, 7321, 7327, 7333, 7339, 7345, 7351, 7357, 7363, 7369, 7375, 7381, 7387, 7393, 7399, 7405, 7411, 7417, 7423, 7429, 7435, 7441, 7447, 7453, 7459, 7465, 7471, 7477, 7483, 7489, 7495, 7501, 7507, 7513, 7519, 7525, 7531, 7537, 7543, 7549, 7555, 7561, 7567, 7573, 7579, 7585, 7591, 7597, 7603, 7609, 7615, 7621, 7627, 7633, 7639, 7645, 7651, 7657, 7663, 7669, 7675, 7681, 7687, 7693, 7699, 7705, 7711, 7717, 7723, 7729, 7735, 7741, 7747, 7753, 7759, 7765, 7771, 7777, 7783, 7789, 7795, 7801, 7807, 7813, 7819, 7825, 7831, 7837, 7843, 7849, 7855, 7861, 7867, 7873, 7879, 7885, 7891, 7897, 7903, 7909, 7915, 7921, 7927, 7933, 7939, 7945, 7951, 7957, 7963, 7969, 7975, 7981, 7987, 7993, 7999, 8005, 8011, 8017, 8023, 8029, 8035, 8041, 8047, 8053, 8059, 8065, 8071, 8077, 8083, 8089, 8095, 8101, 8107, 8113, 8119, 8125, 8131, 8137, 8143, 8149, 8155, 8161, 8167, 8173, 8179, 8185, 8191, 8197, 8203, 8209, 8215, 8221, 8227, 8233, 8239, 8245, 8251, 8257, 8263, 8269, 8275, 8281, 8287, 8293, 8299, 8305, 8311, 8317, 8323, 8329, 8335, 8341, 8347, 8353, 8359, 8365, 8371, 8377, 8383, 8389, 8395, 8401, 8407, 8413, 8419, 8425, 8431, 8437, 8443, 8449, 8455, 8461, 8467, 8473, 8479, 8485, 8491, 8497, 8503, 8509, 8515, 8521, 8527, 8533, 8539, 8545, 8551, 8557, 8563, 8569, 8575, 8581, 8587, 8593, 8599, 8605, 8611, 8617, 8623, 8629, 8635, 8641, 8647, 8653, 8659, 8665, 8671, 8677, 8683, 8689, 8695, 8701, 8707, 8713, 8719, 8725, 8731, 8737, 8743, 8749, 8755, 8761, 8767, 8773, 8779, 8785, 8791, 8797, 8803, 8809, 8815, 8821, 8827, 8833, 8839, 8845, 8851, 8857, 8863, 8869, 8875, 8881, 8887, 8893, 8899, 8905, 8911, 8917, 8923, 8929, 8935, 8941, 8947, 8953, 8959, 8965, 8971, 8977, 8983, 8989, 8995, 9001, 9007, 9013, 9019, 9025, 9031, 9037, 9043, 9049, 9055, 9061, 9067, 9073, 9079, 9085, 9091, 9097, 9103, 9109, 9115, 9121, 9127, 9133, 9139, 9145, 9151, 9157, 9163, 9169, 9175, 9181, 9187, 9193, 9199, 9205, 9211, 9217, 9223, 9229, 9235, 9241, 9247, 9253, 9259, 9265, 9271, 9277, 9283, 9289, 9295, 9301, 9307, 9313, 9319, 9325, 9331, 9337, 9343, 9349, 9355, 9361, 9367, 9373, 9379, 9385, 9391, 9397, 9403, 9409, 9415, 9421, 9427, 9433, 9439, 9445, 9451, 9457, 9463, 9469, 9475, 9481, 9487, 9493, 9499, 9505, 9511, 9517, 9523, 9529, 9535, 9541, 9547, 9553, 9559, 9565, 9571, 9577, 9583, 9589, 9595, 9601, 9607, 9613, 9619, 9625, 9631, 9637, 9643, 9649, 9655, 9661, 9667, 9673, 9679, 9685, 9691, 9697, 9703, 9709, 9715, 9721, 9727, 9733, 9739, 9745, 9751, 9757, 9763, 9769, 9775, 9781, 9787, 9793, 9799, 9805, 9811, 9817, 9823, 9829, 9835, 9841, 9847, 9853, 9859, 9865, 9871, 9877, 9883, 9889, 9895, 9901, 9907, 9913, 9919, 9925, 9931, 9937, 9943, 9949, 9955, 9961, 9967, 9973, 9979, 9985, 9991, 9997, 10003, 10009, 10015, 10021, 10027, 10033, 10039, 10045, 10051, 10057, 10063, 10069, 10075, 10081, 10087, 10093, 10099, 10105, 10111, 10117, 10123, 10129, 10135, 10141, 10147, 10153, 10159, 10165, 10171, 10177, 10183, 10189, 10195, 10201, 10207, 10213, 10219, 10225, 10231, 10237, 10243, 10249, 10255, 10261, 10267, 10273, 10279, 10285, 10291, 10297, 10303, 10309, 10315, 10321, 10327, 10333, 10339, 10345, 10351, 10357, 10363, 10369, 10375, 10381, 10387, 10393, 10399, 10405, 10411, 10417, 10423, 10429, 10435, 10441, 10447, 10453, 10459, 10465, 10471, 10477, 10483, 10489, 10495, 10501, 10507, 10513, 10519, 10525, 10531, 10537, 10543, 10549, 10555, 10561, 10567, 10573, 10579, 10585, 10591, 10597, 10603, 10609, 10615, 10621, 10627, 10633, 10639, 10645, 10651, 10657, 10663, 10669, 10675, 10681, 10687, 10693, 10699, 10705, 10711, 10717, 10723, 10729, 10735, 10741, 10747, 10753, 10759, 10765, 10771, 10777, 10783, 10789, 10795, 10801, 10807, 10813, 10819, 10825, 10831, 10837, 10843, 10849, 10855, 10861, 10867, 10873, 10879, 10885, 10891, 10897, 10903, 10909, 10915, 10921, 10927, 10933, 10939, 10945, 10951, 10957, 10963, 10969, 10975, 10981, 10987, 10993, 10999, 11005, 11011, 11017, 11023, 11029, 11035, 11041, 11047, 11053, 11059, 11065, 11071, 11077, 11083, 11089, 11095, 11101, 11107, 11113, 11119, 11125, 11131, 11137, 11143, 11149, 11155, 11161, 11167, 11173, 11179, 11185, 11191, 11197, 11203, 11209, 11215, 11221, 11227, 11233, 11239, 11245, 11251, 11257, 11263, 11269, 11275, 11281, 11287, 11293, 11299, 11305, 11311, 11317, 11323, 11329, 11335, 11341, 11347, 11353, 11359, 11365, 11371, 11377, 11383, 11389, 11395, 11401, 11407, 11413, 11419, 11425, 11431, 11437, 11443, 11449, 11455, 11461, 11467, 11473, 11479, 11485, 11491, 11497, 11503, 11509, 11515, 11521, 11527, 11533, 11539, 11545, 11551, 11557,

CONFIDENTIAL

Page 50  
Report 1904  
Model 78

20 December 1950

FIGURE 4-10  
MODEL 78

LEVEL FLIGHT PERFORMANCE  
WING LIFT COEFFICIENT VS VELOCITY

ALTITUDE - SEA LEVEL

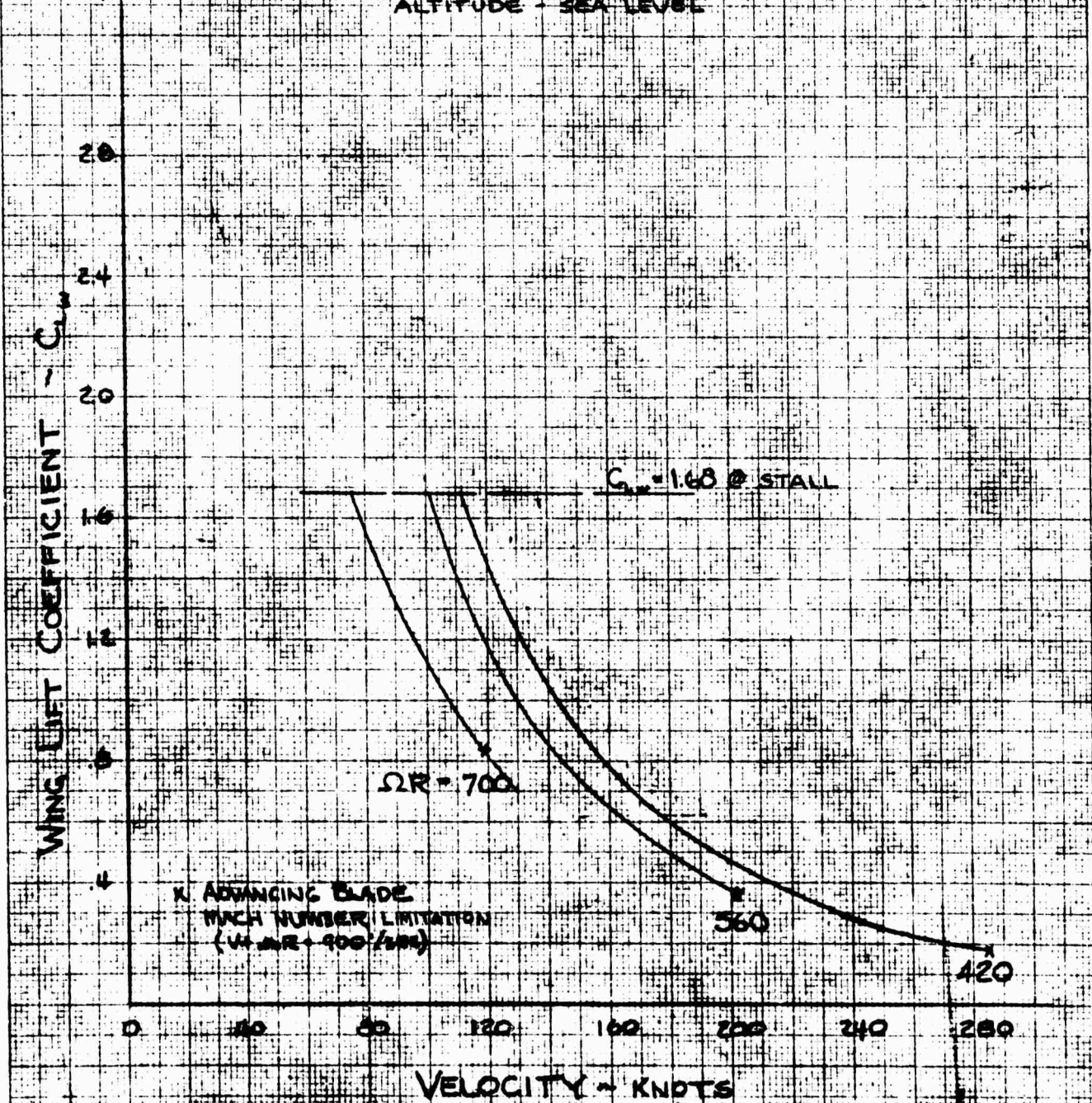

KEUFFEL & ESSER CO.

No. 359-14. Millimeters, 5 mm lines accented, cm lines heavy.  
MADE IN U. S. A.

CONFIDENTIAL

20 December 1950

**CONFIDENTIAL**

Page 51  
Report 1904  
Model 78

**FIGURE 10**  
**MODEL 78**  
**LEVEL FLIGHT PERFORMANCE**  
**ROTOR LOAD vs VELOCITY**

GROSS WT = 30,000 LBS.  
ALTITUDE = SEA LEVEL

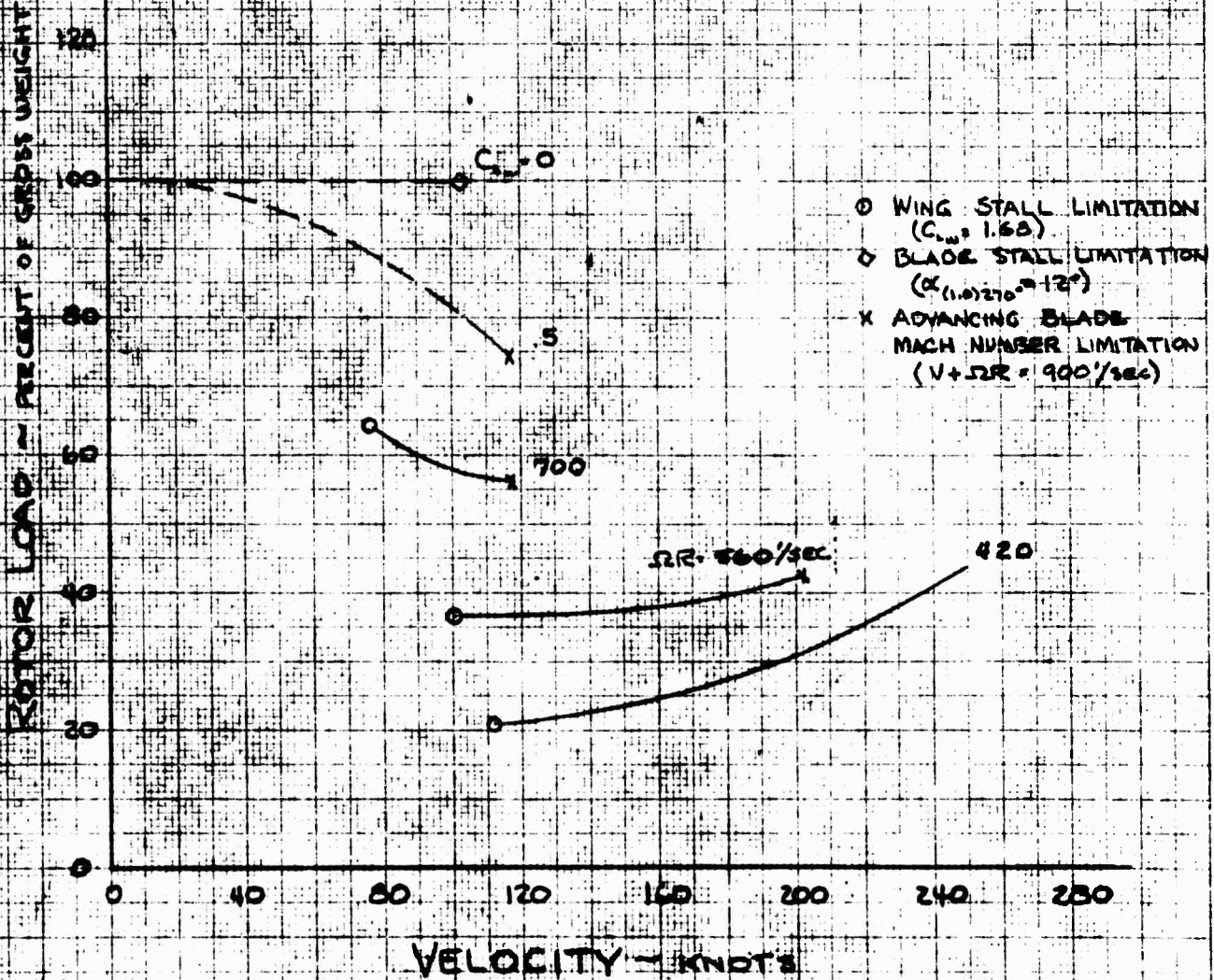

KEUFFEL & ESSER CO.

No. 359-14. Millimeters, 5 mm lines accented, cm lines heavy.  
MADE IN U.S.A.

**CONFIDENTIAL**

20 December 1950

**CONFIDENTIAL**

Page 52  
Report 1904  
Model 78

FIGURE - 12  
MODEL 78  
LEVEL FLIGHT PERFORMANCE  
MAXIMUM VELOCITY vs ROTOR TIP SPEED

NORMAL GROSS WEIGHT  
ALTITUDE - SEA LEVEL

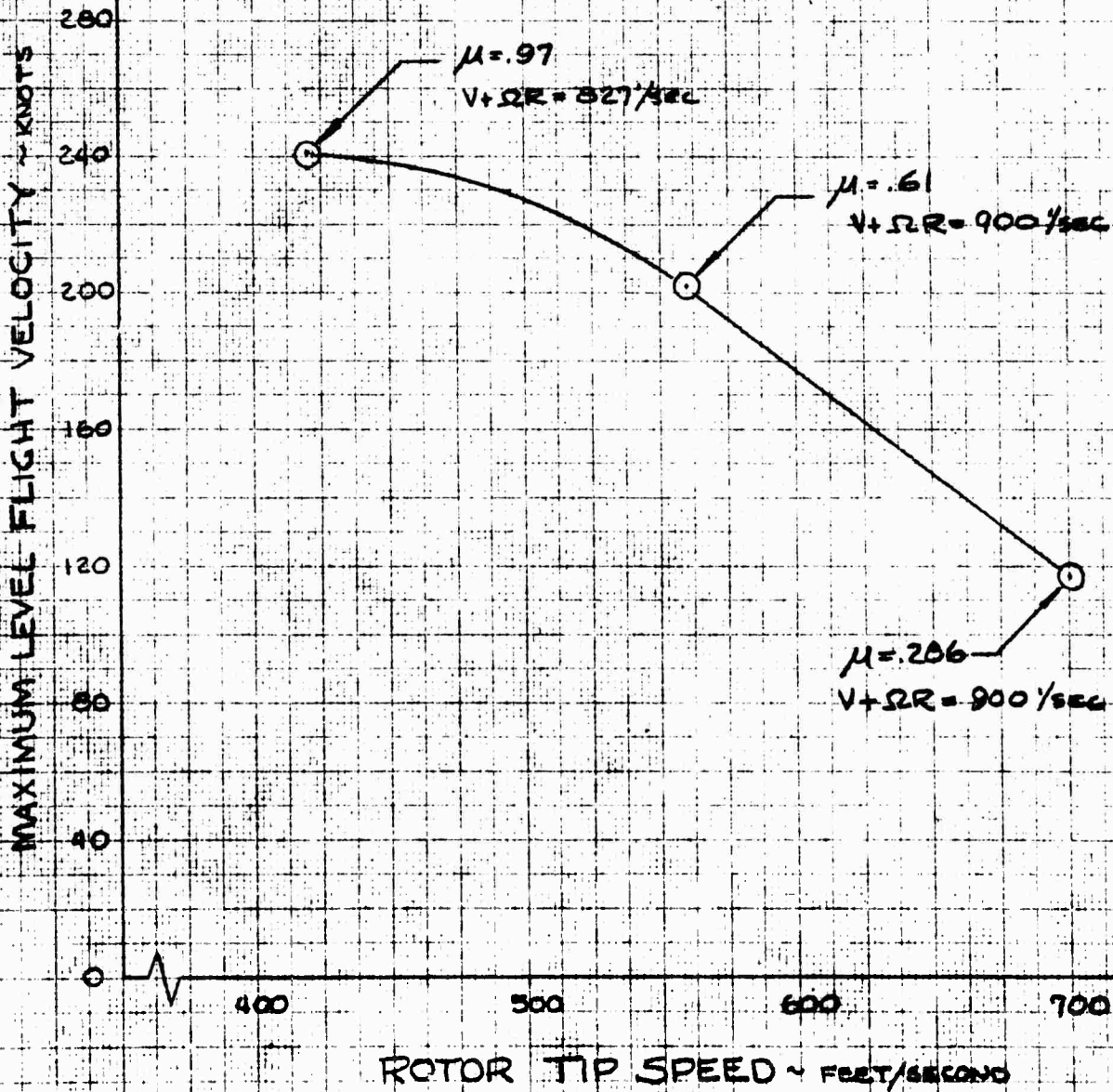

**CONFIDENTIAL**

KEUFFEL & ESSER CO.

No. 353-14. Millimeter & inch lines indicated, on linear heavy.

20 December 1950

**CONFIDENTIAL**

Page 55  
Report 1904  
Model 78

FIGURE -13

MODEL 78

MAXIMUM RATE OF CLIMB vs VELOCITY

NORMAL GROSS WEIGHT  
ALTITUDE - SEA LEVEL

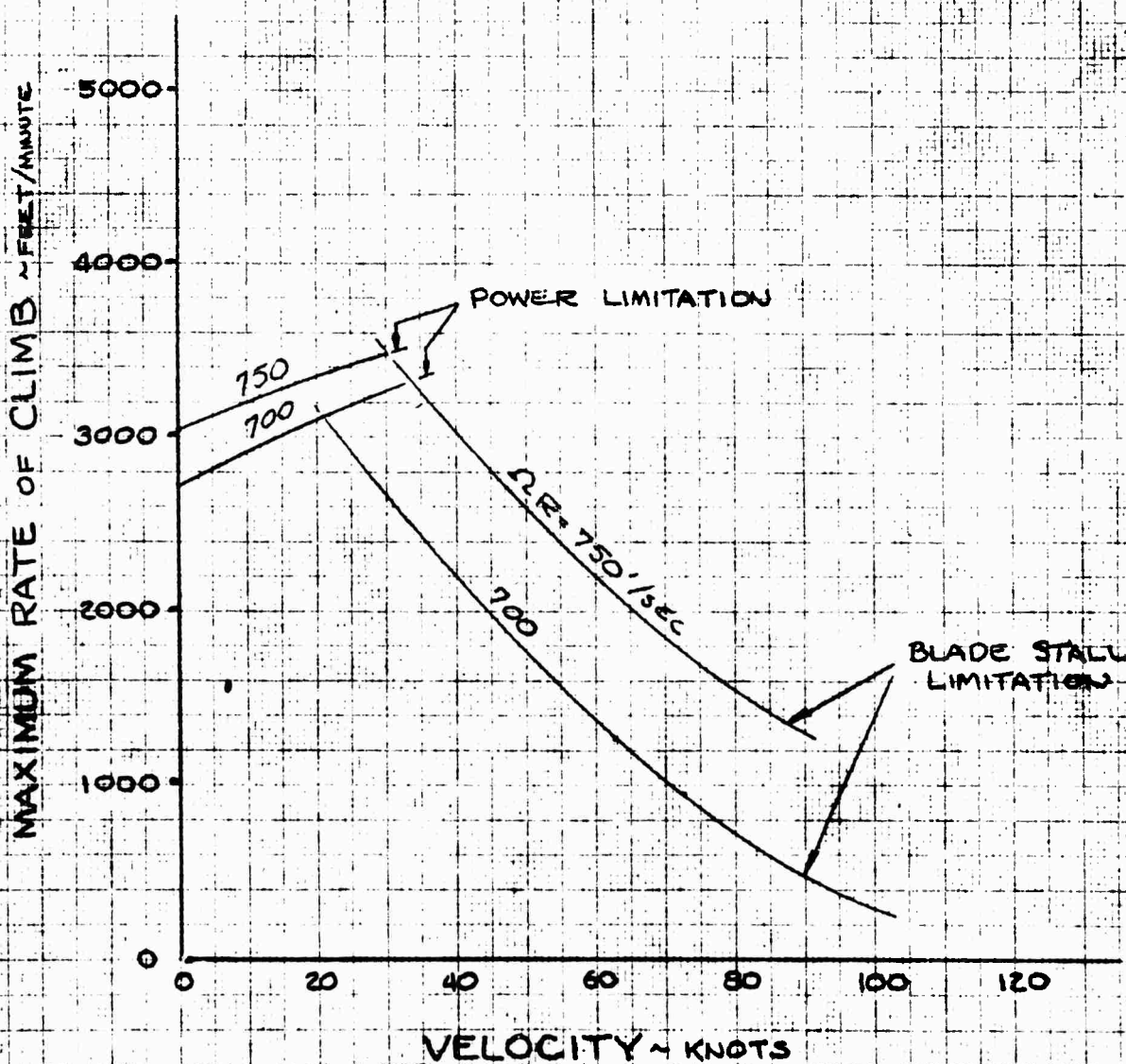

REUFFEL & ESSER CO.

No. 359-14 Millimeters, 2 mm lines accepted, cm lines heavy.

**CONFIDENTIAL**

20 December 1950

**CONFIDENTIAL**

Page 54  
Report 1904  
Model 78

**FIGURE - 18**  
**MODEL 78**  
**AUTOROTATIVE FLIGHT**  
**MINIMUM RATE OF DESCENT VS VELOCITY**

NORMAL GROSS WEIGHT  
AT SEA LEVEL

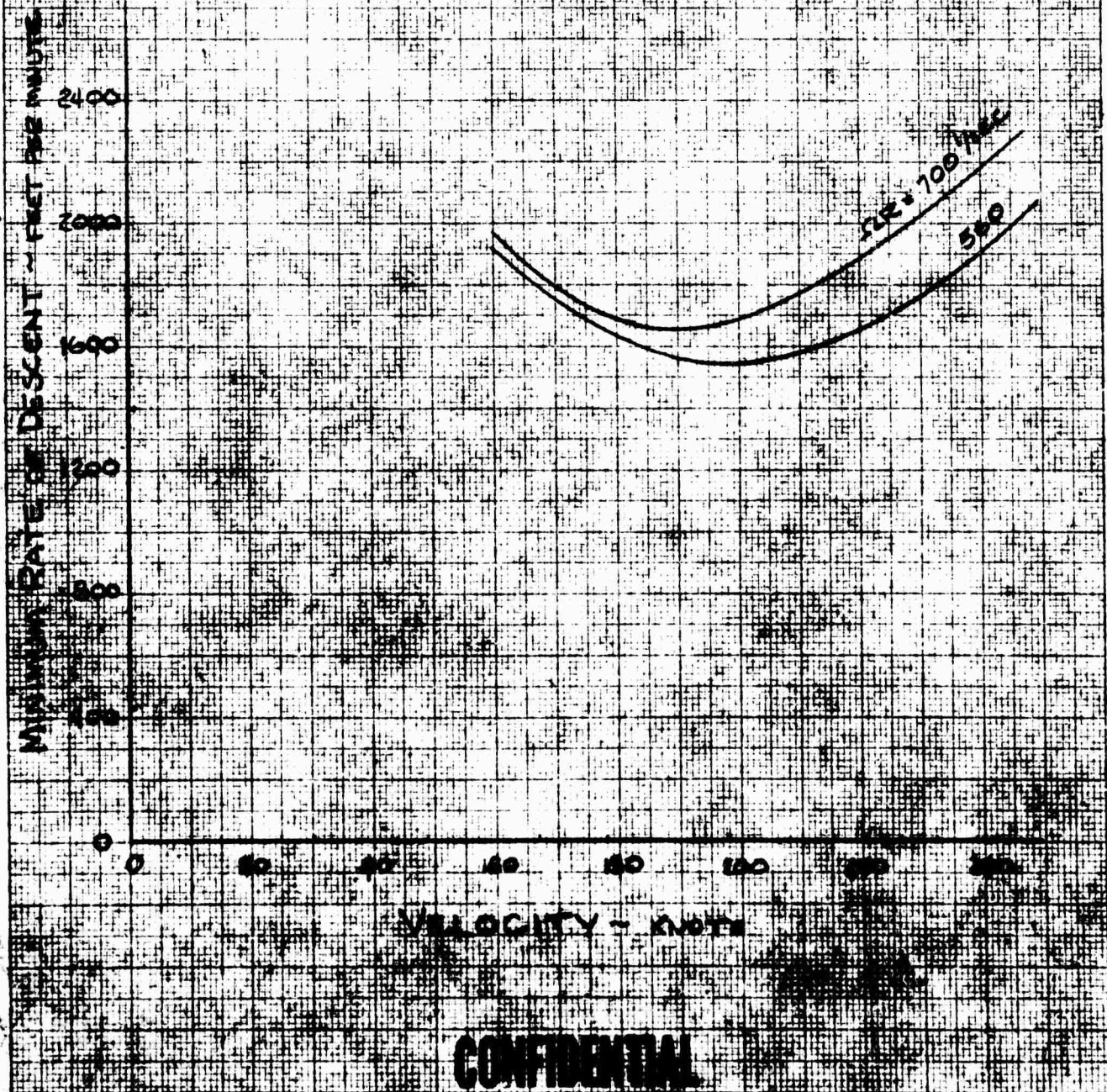

**CONFIDENTIAL**

KEUFFEL & ESSER CO.

No. 359-14. Milligrams, 5 mm lines accented, on linen heavy.  
MADE IN U.S.A.

20 December 1950

**CONFIDENTIAL**

Page 55  
Report 1904  
Model 78

FIGURE 18  
MODEL 78

HOVERING V/F CHART

HOVERING & VERTICAL FLIGHT PERFORMANCE

50 FT PER JET UNIT  
 $\sigma = .09$

ROTOR THRUST - JET THRUST RATIO  $\frac{T}{T_0}$  (EQUALS  $\frac{C_L}{C_{L0}}$ ) -  $\frac{\text{LBS.}}{\text{LB.}}$

20  
10  
16  
12  
10  
8  
6  
4  
2  
0

0 .02 .04 .06 .08 .10 .12 .14

ROTOR THRUST COEFFICIENT - SOLIDITY RATIO

9/10

**CONFIDENTIAL**

KEUFFEL & ESSER CO.

No. 359-14. Millimeters, 5 mm lines accented, cm lines heavy.  
MADE IN U.S.A.

**CONFIDENTIAL**

**FIGURE - 16**

**MODEL 78**

**RATIO OF EXCESS POWER TO EFFECTIVE CLIMB POWER  
VS  
VERTICAL RATE OF CLIMB**

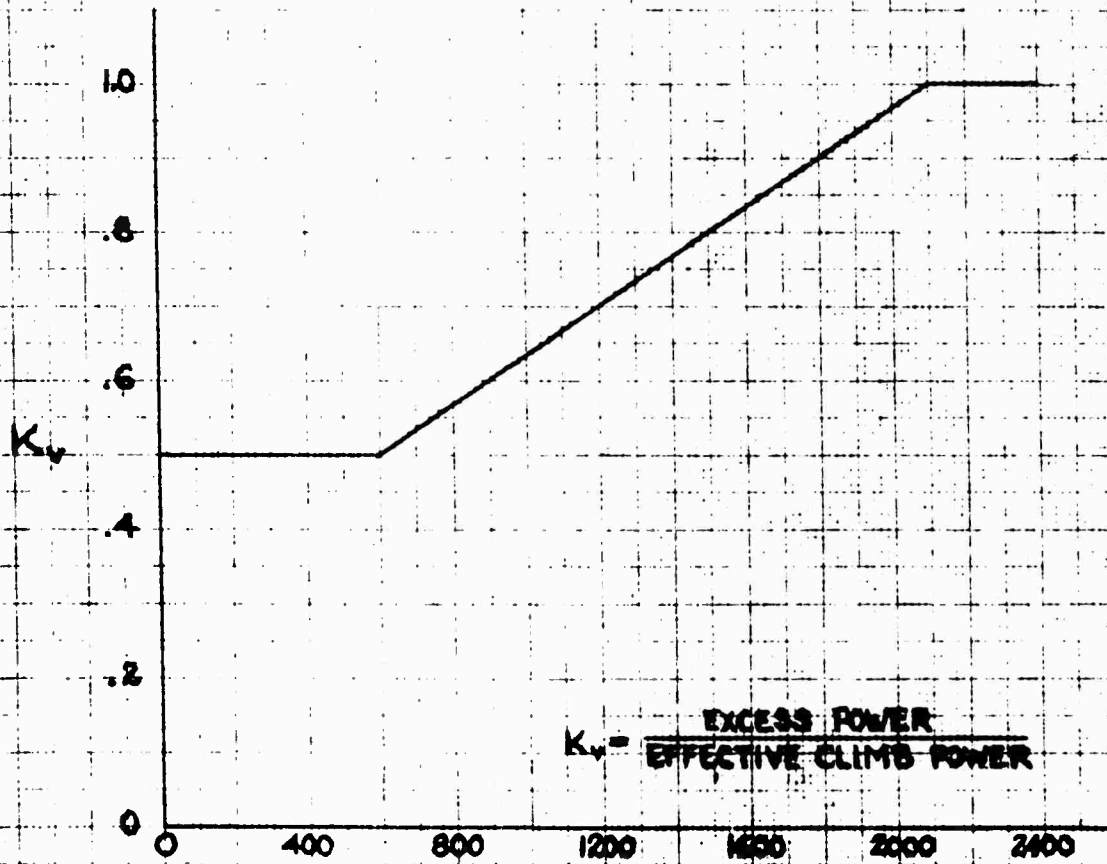

$$K_v = \frac{\text{EXCESS POWER}}{\text{EFFECTIVE CLIMB POWER}}$$

**VERTICAL RATE OF CLIMB - FEET PER MINUTE**

**BASED ON NACA FLIGHT TEST RESULTS  
REPORTED IN REFERENCE**

**CONFIDENTIAL**

KEUFFEL & ESSER CO.

No. 359-14. Millimeters, 5 mm. lines accented, cm. lines heavy.

20 December 1950

**CONFIDENTIAL**

Page 57  
Report 1904  
Model 78

FIGURE - 12

MODEL 78

$C_{T/G}$  AT STALL vs  $P/L$  OF ROTOR

REFERENCE - 9.8

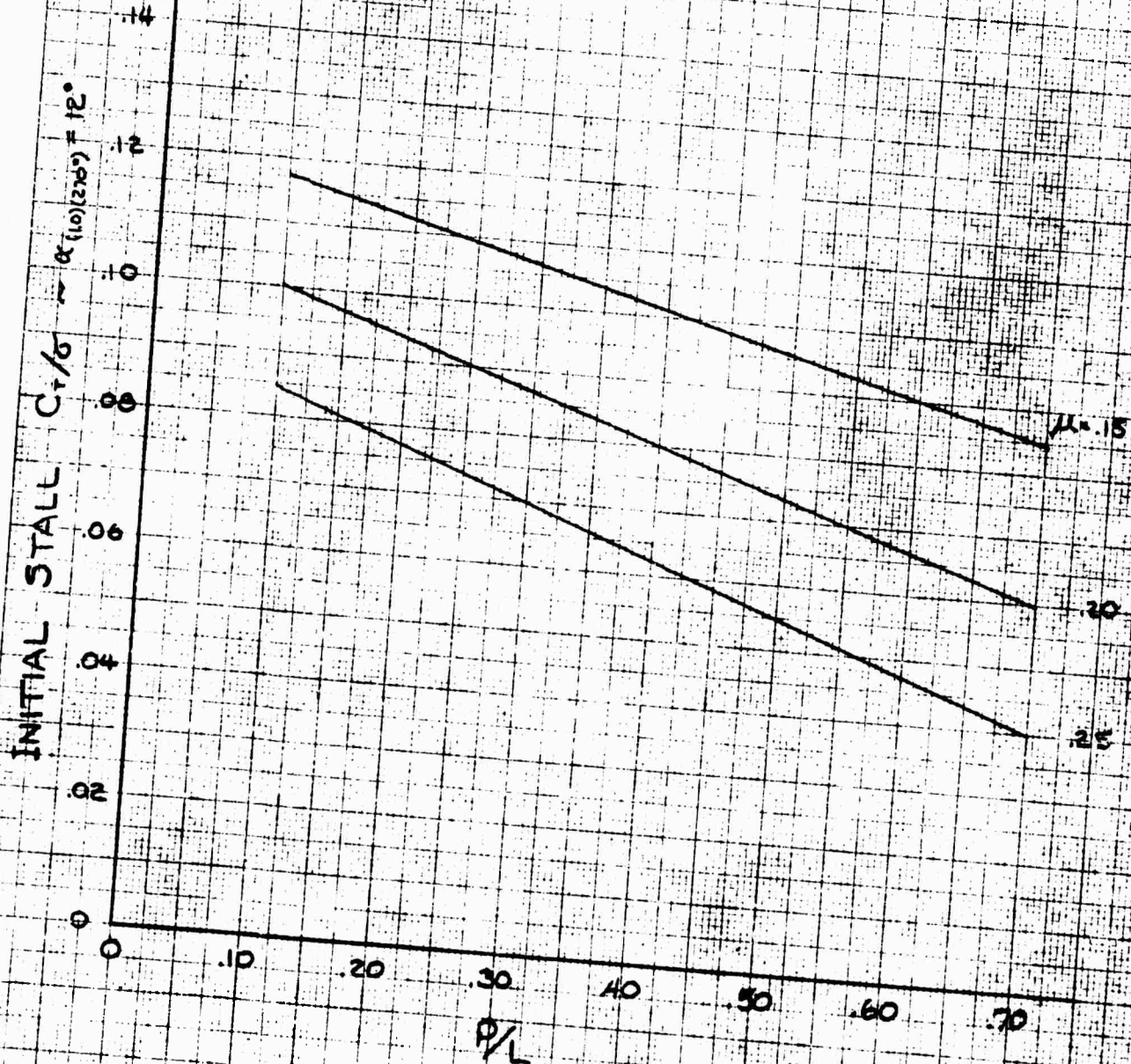

NEUFEL & ESSER CO.

No. 359-14. Millimeter, 5 mm. 100% in paper heavy.

**CONFIDENTIAL**

20 December 1950

**CONFIDENTIAL**

Page 58  
Report 1904  
Model 78

**FIGURE 10**  
**MODEL 78**  
**WING AIRFOIL CHARACTERISTICS**

SECTION NACA 2301B  
NACA 23012  
ASPECT RATIO 6.1

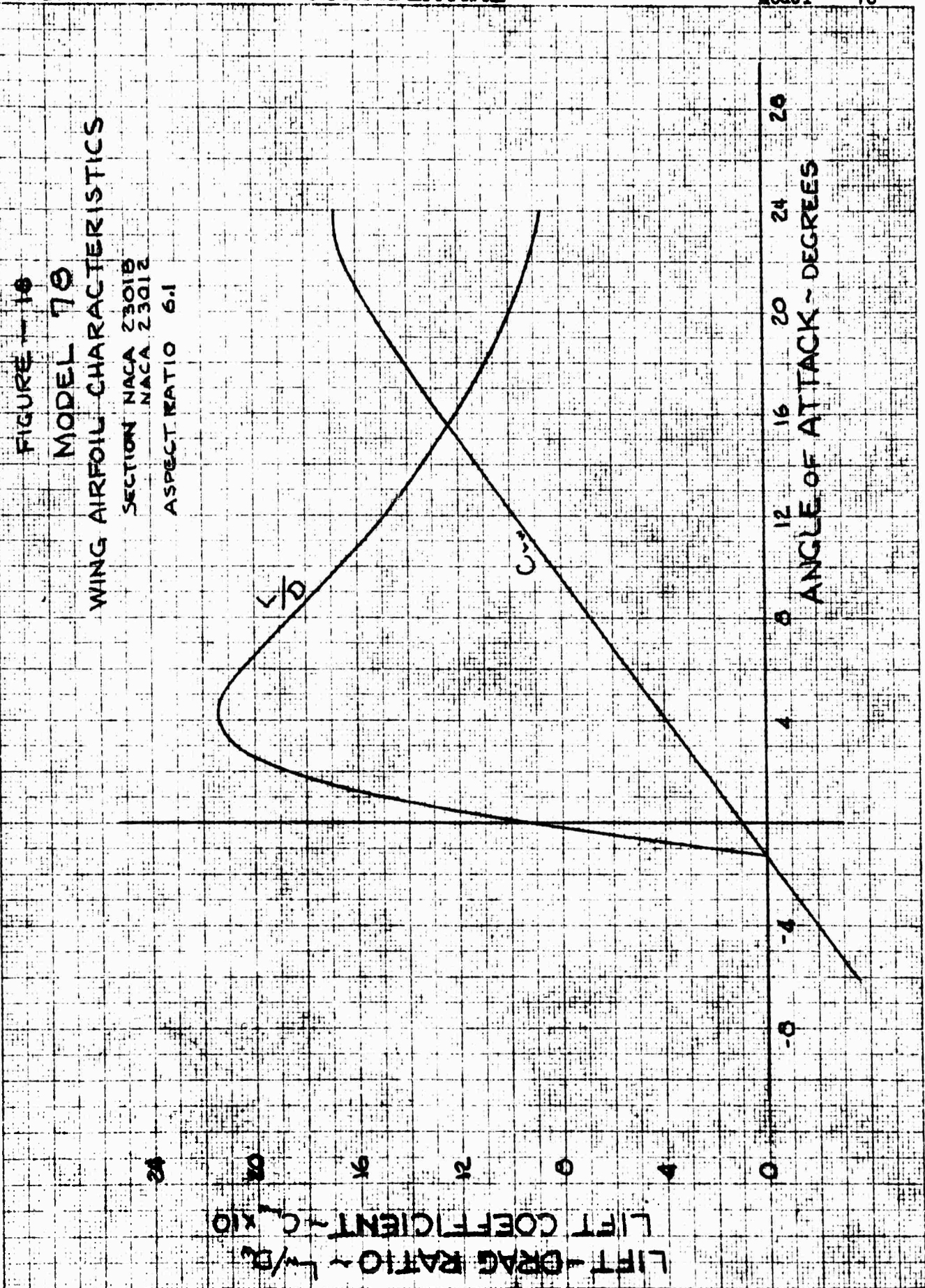

**CONFIDENTIAL**

20 December 1950

**CONFIDENTIAL**

Page 59  
Report 1904  
Model 78

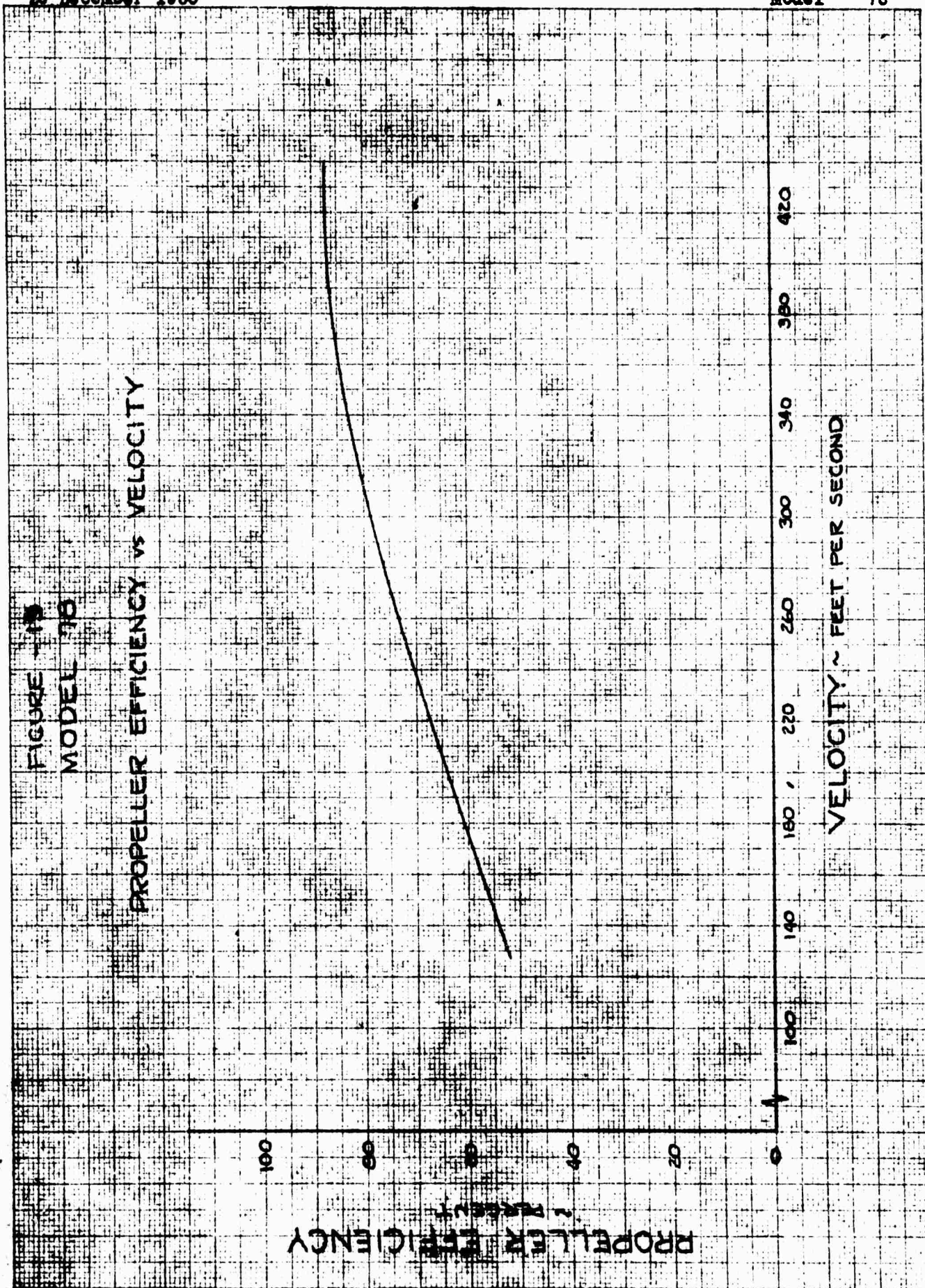

**CONFIDENTIAL**

20 December 1950

CONFIDENTIAL

Page 60  
Report 1904  
Model 78

FIGURE - 8D  
JET DRAG-LIFT RATIO VS RECIPROCAL OF ROTOR LIFT COEFFICIENT

$\frac{D_{jet}}{\pi R^2} = 1$   
FOR MODEL 78  
MULTIPLY ORIGINATE  
BY .00010

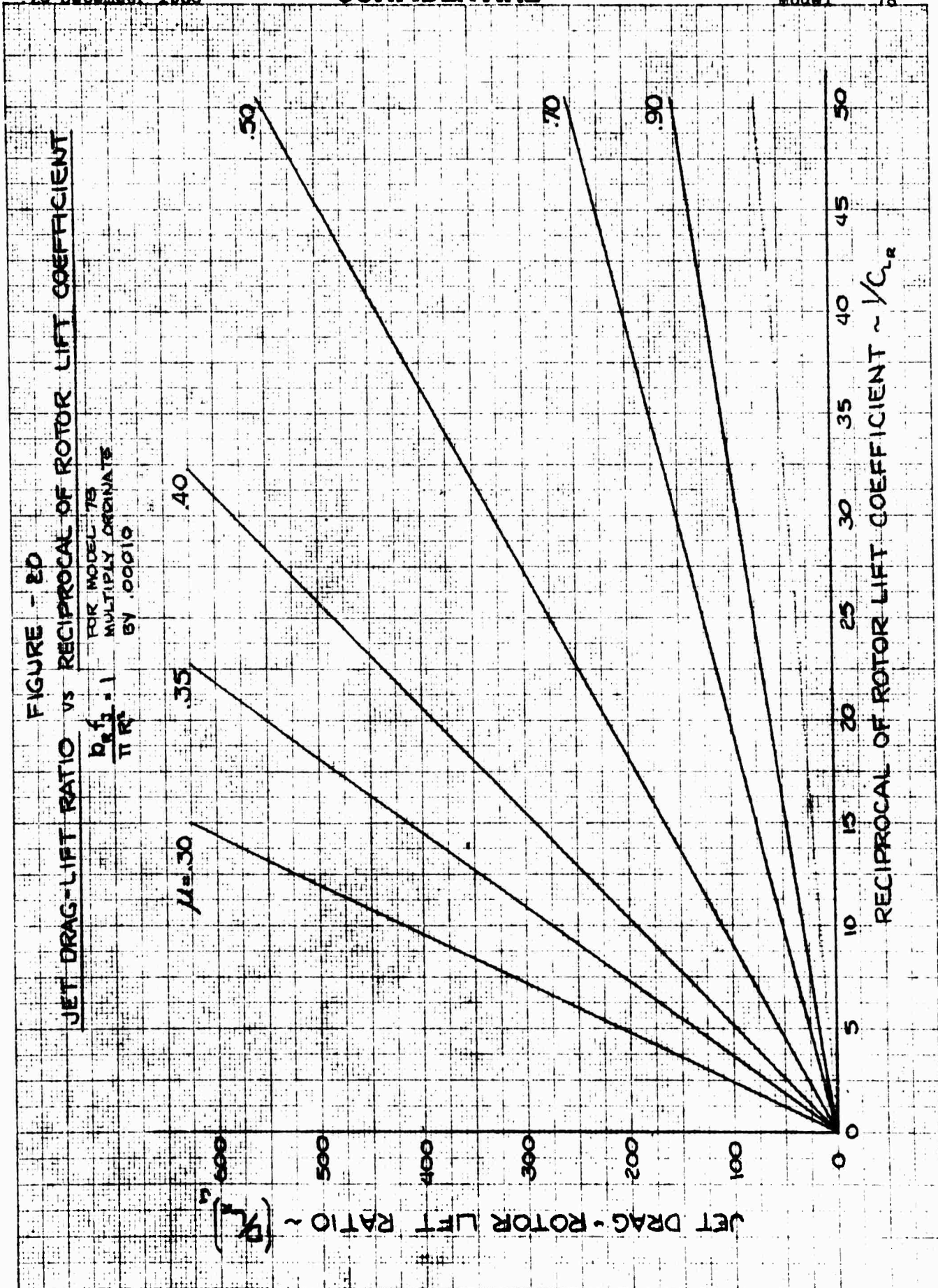

CONFIDENTIAL

20 December 1950

**CONFIDENTIAL**

Page 61  
Report 1904  
Model 78

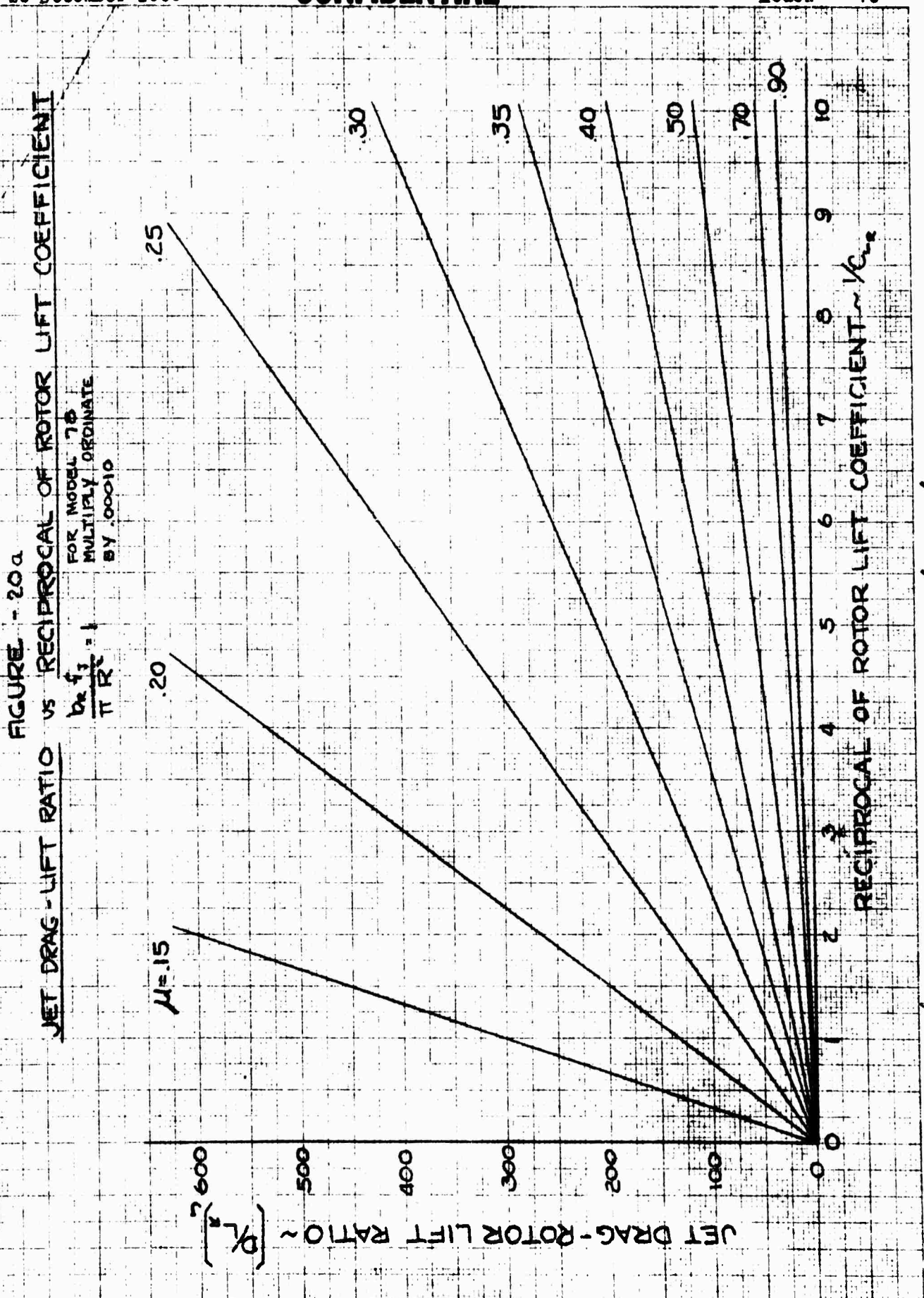

**CONFIDENTIAL**

*same as pg 60 but scale is changed.*

DATE 20 December 1950

REVISED \_\_\_\_\_

REVISED \_\_\_\_\_

**MCDONNELL** *Aircraft Corporation*  
ST. LOUIS 3, MISSOURI  
**CONFIDENTIAL**

PAGE 62

REPORT 1904

MODEL 78

#### 9. REFERENCES

9.1 BuAer confidential letter serial 09231, dated 5 September 1950.

9.2 "BuAer Specification for the Aerodynamic, Structural, and Power-Plant Requirements for Helicopters", NAVAER SE-189, effective 1 August 1950.

9.3 "Charts, Standard Aircraft Characteristics and Performance, Piloted Aircraft", MIL-C-5011, dated 20 January 1950.

9.4 Diehl, Walter S.: "Engineering Aerodynamics", Ronald Press Company, 1936.

9.5 Perkins, Cortland L. and Hage, Robert E.: "Airplane Performance, Stability, and Control", John Wiley and Sons, Inc., 1949.

9.6 Abbott, Ira A. and Greenberg, Harry: "Tests in the Variable-Density Wind Tunnel of the NACA 23012 Airfoil with Plain and Split Flaps", NACA T.R. 661, 1939.

9.7 Anderson, Raymond J.: "The Experimental and Calculated Characteristics of Twenty-two Tapered Wings", NACA T.R. 627, 1938.

9.8 Bailey, J. I., Jr. and Gustafson, J. B.: "Charts for Estimation of the Characteristics of a Helicopter Rotor in Forward Flight. I - Profile Drag-Lift Ratio for Untwisted Rectangular Blades", NACA ACE L4407, 1944.

9.9 Brown, K. L.: "Model 78 Power Plant and Duct Analysis", MAC Engineering Report 1905, 1950.

**CONFIDENTIAL**

DATE 20 December 1950

**MCDONNELL** *Aircraft Corporation*  
 ST. LOUIS 3, MISSOURI  
 CONFIDENTIAL

PAGE 05

REVISED \_\_\_\_\_

REPORT 1904

REVISED \_\_\_\_\_

MODEL 78

9.10 Grabe, W. J., Fitzbert, L. L., Isaac, R. S.: "A Systematic Investigation of Pressure Distributions at High Speeds over Five Representative ACA Low-Drag and Conventional Airfoil Sections", NACA T.R. 832, 1946.

9.11 Gustafson, J. B., and Myers, W. C., Jr.: "Stalling of Helicopter Blades", NACA T.R. 1083, 1946.

9.12 Gustafson, J. B. and Benson, Alfred: "Flight Tests of the Sikorsky HHS-1 (Army YH-4B) Helicopter. II - Hovering and Vertical Flight Performance with the Original and an Alternate Set of Main Rotor Blades, Including a Comparison with Hovering Performance Theory", NACA TR LSD09a, 1945.

9.13 Sissingh, G.: "Contribution to the Aerodynamics of Rotating Wing Aircraft", NACA TR 890.

9.14 Wheatley, J. B.: "Wind Pressure Distribution and Rotor Blade Motion of an Autogiro as Determined in Flight", NACA T.R. 476, 1933.

9.15 Wheatley, J. B.: "The Influence of Wind Velocity on the Wing Load and Rotor Speed of a PCA-2 Autogiro as Determined in Flight", NACA T.R. 523, 1935.

9.16 Wheatley, J. B. and Wood, L. J.: "Full Scale Wind Tunnel Tests of a PCA-2 Autogiro Rotor", NACA T.R. 515.

9.17 Wheatley, J. B. and Violetti, G.: "Wind Tunnel Tests of 10-Foot Diameter Autogiro Rotors", NACA T.R. 552.

DATE 29 December 1950

REVISED \_\_\_\_\_

REVISED \_\_\_\_\_

**MCDONNELL** *Aircraft Corporation*  
 ST. LOUIS 3, MISSOURI  
**CONFIDENTIAL**

PAGE 64

REPORT 1804

MODEL 70

9.18 McDonnell Aircraft Corporation Engineering letters submitted to the Office of Naval Research:

- 9.18.1 2136-701-1380, dated 5 July 1949
- 9.18.2 2136-701-1390, dated 26 August 1949
- 9.18.3 2136-701-1406, dated 14 November 1949
- 9.18.4 2136-701-1441, dated 13 January 1950
- 9.18.5 2136-701-1498, dated 21 March 1950
- 9.18.6 2136-701-1544, dated 15 May 1950
- 9.18.7 2136-701-1605, dated 14 July 1950
- 9.18.8 2136-701-1626, dated 18 August 1950
- 9.18.9 2136-701-1644, dated 15 September 1950
- 9.18.10 2136-701-1667, dated 26 October 1950
- 9.18.11 2136-701-1675, dated 7 November 1950