

UNCLASSIFIED

AD

15 1 668

FOR
MICRO-CARD
CONTROL ONLY

Reproduced by

Armed Services Technical Information Agency

ARLINGTON HALL STATION; ARLINGTON 12 VIRGINIA

UNCLASSIFIED

AD No. 151668

ASTIA FILE COPY

AD
151668

THE DEPENDENCE OF THE MAGNUS FORCE AND MOMENT ON THE NOSE
SHAPE OF CYLINDRICAL BODIES OF FINENESS RATIO 5 AT
A MACH NUMBER OF 1.75

FC

15 APRIL 1957



6

FILE COPY
Return to
ASTIA
ARLINGTON HALL STATION
ARLINGTON 12, VIRGINIA
Attn: TISS

U. S. NAVAL ORDNANCE LABORATORY
WHITE OAK, MARYLAND

**Best
Available
Copy**

UNCLASSIFIED
NAVORD Report 4425 ✓

Aeroballistic Research Report 361 ✓

THE DEPENDENCE OF THE MAGNUS FORCE AND MOMENT ON
THE NOSE SHAPE OF CYLINDRICAL BODIES OF FINENESS
RATIO 5 AT A MACH NUMBER OF 1.75

Prepared by:

Wallace Luchuk

ABSTRACT: This report presents the results of wind-tunnel measurements of the Magnus force and moments on cylindrical bodies of fineness ratio 5 at a free stream Mach number of 1.75 and a Reynolds number of 5.5 million (based on model length). Six configurations were tested, five of which had variations in nose shape and one configuration had artificial roughness added to the very tip of the nose. Data for one configuration was taken by two different techniques as a check. The angle of attack range was from +16 degrees to -22 degrees and the rotational speeds attained were as high as 660 revolutions per second.

U. S. NAVAL ORDNANCE LABORATORY
WHITE OAK, MARYLAND

1
UNCLASSIFIED

15 April 1957

This report presents the results of Mignol-force measurements conducted in the NOL 40 x 40 Aeroballistic Tunnel No. 1 using cylindrical bodies of fineness (length to diameter) ratio 5. There were six configurations in all, of which five configurations differed only in the nose shape. The nose length for all the models was two body diameters. Three of the five different nose shapes had a systematic variation in the ogival radius. The test was performed at a free stream Mach number of 1.75 and a Reynolds number of 5.5 million (based on the model length). One configuration was tested employing two different wind-tunnel techniques in order to afford a check on the data. The angle of attack range was from +16 degrees to -22 degrees and rotational spin rates as high as 660 revolutions per second were attained. A complete discussion of the instrumentation and wind-tunnel test techniques is presented.

This test was performed through the direction of the Bureau of Ordnance (BoO) under the task number 803-767/73003/01-040.

W. W. WILBOURNE
Captain, USN
Commander

H. H. KURZWEG
By direction

TABLE OF CONTENTS

	Page
Introduction	1
List of Symbols	1
Historical Sketch of the Magnus Phenomenon	3
Introduction to the Problems of Wind Tunnel Magnus Measurement	6
Objectives of the Test	10
Description of the NOL 40 x 40 cm Aeroballistics Tunnel No. 1	11
Test Instrumentation	11
Models	14
Wind Tunnel Test Techniques	15
Coefficients	16
Data Reduction and Accuracy	17
Results	20
Discussion	21
Conclusions	25
References	27
Appendix	29
Tabulated Data	30
Explanation of Data Listing	31

ILLUSTRATIONS

Figure 1	Rotational Speed Versus Wind Tunnel Mach Number for Various Size Models (Advance Ratio = 1 in 20)
Figure 2	Cutaway Drawing of the NOL Wind Tunnel Building
Figure 3	Assembly Drawing of the Model-Air Turbine Unit
Figure 4	Exploded Model-Air Turbine Unit
Figure 5	Diagrammatic Sketch of the Strain Gage Readout System
Figure 6	Strain Gage Readout System and the Frequency Console
Figure 7	Wind Tunnel Test Set-up
Figure 8	Diagrammatic Sketch of the Frequency Console
Figure 9	Schematic Diagram of Servo-Speed Control
Figure 10	Servo-Speed Control
Figure 11	Model Dimensions
Figure 12	Assembled Model with the Tangent Ogive Nose
Figure 13	Cone Nose
Figure 14	Secant Ogive Nose
Figure 15	Tangent Ogive Nose
Figure 16	Haack-Sears Nose
Figure 17	Typical Projectile Nose
Figure 18	Cone Nose with No. 100 Grit
Figure 19	Sample Traces of the Constant Angle of Attack, Variable Spin Type of Blow

ILLUSTRATIONS (Cont'd)

- Figure 20 Sample Traces of the Constant Spin, Variable Angle of Attack Type of Blow
- Figure 21 Force and Moment Coordinate System
- Figure 22 Side Force Coefficient, C_Y , versus Rotational Speed, p , Cone Nose
- Figure 23 Yawing Moment Coefficient, C_ψ , versus Rotational Speed, p , Cone Nose
- Figure 24 Side Force Coefficient, C_Y , versus Rotational Speed, p , (rev./sec.) - Secant Ogive Nose
- Figure 25 Yawing Moment Coefficient, C_ψ , versus Rotational Speed, p - Secant Ogive Nose
- Figure 26 Side Force Coefficient, C_Y , versus Rotational Speed, p - Tangent Ogive Nose
- Figure 27 Yawing Moment Coefficient, C_ψ , versus Rotational Speed, p - Tangent Ogive Nose
- Figure 28 Side Force Coefficient, C_Y , versus Rotational Speed, p - Haack-Sears Nose
- Figure 29 Yawing Moment Coefficient, C_ψ , versus Rotational Speed, p - Haack-Sears Nose
- Figure 30 Side Force Coefficient, C_Y , versus Rotational Speed, p - Typical Projectile Nose
- Figure 31 Yawing Moment Coefficient, C_ψ , versus Rotational Speed, p - Typical Projectile Nose
- Figure 32 Side Force Coefficient, C_Y , versus Rotational Speed, p - Cone Nose with No. 100 Grit
- Figure 33 Yawing Moment Coefficient, C_ψ , versus Rotational Speed, p - Cone Nose with No. 100 Grit
- Figure 34 C_Y , C_ψ , and Center of Magnus versus α_I for the Typical Projectile Nose ($p = 125$ rev./sec.)
- Figure 35 C_Y , C_ψ , and Center of Magnus versus α_I for the Typical Projectile Nose ($p = 126$ rev./sec.)
- Figure 36 C_Y , C_ψ , and Center of Magnus versus α_I for the Typical Projectile Nose ($p = 126$ rev./sec.)
- Figure 37 C_Y , C_ψ , and Center of Magnus versus α_I for the Typical Projectile Nose ($p = 204$ rev./sec.)
- Figure 38 C_Y , C_ψ , and Center of Magnus versus α_I for the Typical Projectile Nose ($p = 203$ rev./sec.)
- Figure 39 C_Y , C_ψ , and Center of Magnus versus α_I for the Typical Projectile Nose ($p = 255$ rev./sec.)
- Figure 40 C_Y , C_ψ , and Center of Magnus versus α_I for the Typical Projectile Nose ($p = 309$ rev./sec.)
- Figure 41 C_Y , C_ψ , and Center of Magnus versus α_I for the Typical Projectile Nose ($p = 312$ rev./sec.)
- Figure 42 C_Y , C_ψ , and Center of Magnus versus α_I for the Typical Projectile Nose ($p = 370$ rev./sec.)

ILLUSTRATIONS (Cont'd)

- Figure 43 C_Y , C_ψ , and Center of Magnus versus α_I for the Typical Projectile Nose ($p = 432$ rev./sec.)
- Figure 44 C_Y , C_ψ , and Center of Magnus versus α_I for the Typical Projectile Nose ($p = 508$ rev./sec.)
- Figure 45 C_Y , C_ψ , and Center of Magnus versus α_I for the Typical Projectile Nose ($p = 169$ rev./sec.)
- Figure 46 C_Y , C_ψ , and Center of Magnus versus α_I for the Typical Projectile Nose ($p = 86$ rev./sec.)
- Figure 47 C_Y , C_ψ , and Center of Magnus versus α_I for the Typical Projectile Nose ($p = 92$ rev./sec.)
- Figure 48 C_Y , C_ψ , and Center of Magnus versus α_I for the Typical Projectile Nose ($p = 94$ rev./sec.)
- Figure 49 C_Y , C_ψ , and Center of Magnus versus α_I for the Typical Projectile Nose ($p = 90$ rev./sec.)
- Figure 50 C_Y , C_ψ , and Center of Magnus versus α_I for the Typical Projectile Nose ($p = 122$ rev./sec.)
- Figure 51 C_Y , C_ψ , and Center of Magnus versus α_I for the Typical Projectile Nose ($p = 211$ rev./sec.)
- Figure 52 C_Y , C_ψ , and Center of Magnus versus α_I for the Typical Projectile Nose ($p = 263$ rev./sec.)
- Figure 53 C_Y , C_ψ , and Center of Magnus versus α_I for the Typical Projectile Nose ($p = 309$ rev./sec.)
- Figure 54 C_Y , C_ψ , and Center of Magnus versus α_I for the Typical Projectile Nose ($p = 373$ rev./sec.)
- Figure 55 C_Y , C_ψ , and Center of Magnus versus α_I for the Typical Projectile Nose ($p = 468$ rev./sec.)
- Figure 56 The Effect of Nose Shape on the Side Force Coefficient, C_Y ($p = 153$ rev./sec.)
- Figure 57 The Effect of Nose Shape on the Yawing Moment Coefficient, C_ψ ($p = 153$ rev./sec.)
- Figure 58 The Effect of Nose Shape on the Center of Magnus ($p = 153$ rev./sec.)
- Figure 59 The Effect of Nose Shape on the Side Force Coefficient, C_Y ($p = 305$ rev./sec.)
- Figure 60 The Effect of Nose Shape on the Yawing Moment Coefficient, C_ψ ($p = 305$ rev./sec.)
- Figure 61 The Effect of Nose Shape on the Center of Magnus ($p = 305$ rev./sec.)
- Figure 62 The Effect of Nose Shape on the Side Force Coefficient, C_Y ($p = 458$ rev./sec.)
- Figure 63 The Effect of Nose Shape on the Yawing Moment Coefficient, C_ψ ($p = 458$ rev./sec.)
- Figure 64 The Effect of Nose Shape on the Center of Magnus ($p = 458$ rev./sec.)

ILLUSTRATIONS (Cont'd)

- Figure 65 The Effect of Ogival Radius on the Initial Magnus Characteristics of Bodies of Fineness Ratio 5 at $p = 305$ rev./sec.
- Figure 66 The Effect of Spin on the Initial Magnus Characteristics of the Typical Projectile Nose
- Figure 67 Comparison of the Side Force Coefficients Obtained by Two Test Techniques
- Figure 68 Comparison of the Yawing Moment Coefficients Obtained by Two Test Techniques

THE DEPENDENCE OF THE MAGNUS FORCE AND MOMENT ON
THE NOSE SHAPE OF CYLINDRICAL BODIES OF FINENESS
RATIO 5 AT A MACH NUMBER OF 1.75

INTRODUCTION

1. In the continuing task of providing accurate prediction of missile stability, ballisticians have concentrated, in recent years, on obtaining more reliable measurements of the aerodynamic stability derivatives. Two of these derivatives are the Magnus force and the Magnus moment derivatives. These derivatives are due to forces and moments which appear when the body is spinning and at an angle of attack with the relative wind. These forces and moments are, in general, considerably smaller than the static aerodynamic forces and moments, and are far more difficult to measure. Formerly, these derivatives were obtained only from the free-flight ballistics ranges, but with the development of new and specialized instrumentation, the wind-tunnel facility at the Naval Ordnance Laboratory has successfully completed a series of Magnus measurements. This report presents the results of one part of the overall program of Magnus measurement in the wind tunnels.

List of Symbols

a	free-stream speed of sound ft./sec. ($=\sqrt{\delta} \cdot I$)
a_c	speed of sound at stagnation conditions ft./sec. ($=\sqrt{\gamma RT_0}$)
A	coefficient reference area ft. ² ($=\pi D^2/4$)
A_y	data reduction constant (see Appendix)
A	data reduction constant (see Appendix)
B_y	data reduction constant (see Appendix)
B	data reduction constant (see Appendix)
C_y	side force coefficient, non-dimensional ($= Y/qA$)
$C_{y\gamma}$	yawing moment coefficient, non-dimensional ($= Y'/qAD$)
$C_{Yp\alpha}$	Magnus force coefficient, non-dimensional ($d/d\alpha$) ($C_{y2V/pD}$)
$C_{Yp\alpha}$	Magnus moment coefficient, non-dimensional ($d/d\alpha$) ($C_{y2V/pD}$)
D	body diameter (0.25 ft.)
K_3	forward yaw strain gage constant (in.lbs./chart division)

NAVORD Report 4425

List of Symbols (Cont'd)

K_4	aft yaw strain-gage constant (inch lbs./chart division)
l	nose length (0.5 ft.)
l_3	forward yaw gage chart reading under load (chart divisions)
l_{3_0}	forward yaw gage chart reading under no load (chart divisions)
l_4	aft yaw gage chart reading under load (chart divisions)
l_{4_0}	aft yaw gage chart reading under no load (chart divisions)
L	overall body length (1.25 ft.)
M	free stream Mach number ($M = 1.75$)
ω	rotational velocity radians/sec.
p	free stream static pressure lbs./ft ²
P_0	free stream rest or stagnation pressure lbs./ft ²
q	free stream dynamic pressure lbs./ft ² ($\frac{\rho V^2}{2}$)
r	body radius (0.125 ft.)
R	gas constant (1716 ft ² /sec ² °R)
Re	free-stream Reynolds number based on model length computed by Sutherland formula, non-dimensional (5.5 million)
T	free stream static temperature, degrees Rankine
T_0	free stream total temperature, degrees Rankine
V	free stream air velocity, ft./sec.
x	axial distance from the model nose, ft.
x_3	axial distance from the model nose of the forward yaw gage electrical center, ft.
x_4	axial distance from the model nose of the aft yaw gage electrical center, ft.
x	axial distance from the model nose of the Center of Gravity, (3.80 ft.)

NAVORD Report 4425

List of Symbols (Cont'd)

Y	lateral coordinate, ft.
Y	side force, lbs.
α	angle of attack, degrees or radians
α_1	indicated angle of attack, degrees
δ	ratio of specific heats, non-dimensional (1.4)
E	probable error notation
Ψ	yawing moment, inch lbs.

Ballistic Magnus Coefficient Symbols

F	Magnus force, lbs.
i	90 degree rotation vector
K_F	Ballistic Magnus Force Coefficient, non-dimensional
K_T	Ballistic Magnus Moment Coefficient, non-dimensional
T	Magnus moment, ft. lbs.
α	pitch angle, degrees or radians
β	yaw angle, degrees or radians
β	complex yaw angle degrees or radians, ($= \alpha + i \beta$)
ρ	free stream air density, lb.sec ² /ft ⁴

Historical Sketch of the Magnus Phenomenon

2. Throughout this report the terms, "Magnus force and Magnus moment", or, "Magnus characteristics", are extensively used, and as a concession to brevity they may sometimes be referred to simply as "Magnus."
3. In the search for material on the history of Magnus the author was unable, in some instances, to study "first sources" for their substance. When this occurred, it was necessary to rely on the reports and comments of those authors who were fortunate enough to have access to them.
4. The "Magnus" effect is that aerodynamic phenomenon that describes the fact that a two dimensional or three dimensional body rotating in a cross-flow experiences a lift force at right angles to the flow. The effects of

this phenomenon have been observed for many years with the earliest reports occurring in the seventeenth century. G. T. Walker (reference a) states that the first observations of the effects of Magnus were made in 1671 when it was noted that the path of a "cut" tennis ball or a "sliced" golf ball described a curve. Sir Isaac Newton was aware of this fact (reference b). The effect was later observed by artilleryists in the deflected trajectories of cannon balls. B. Robins (references c and d) also contended that the curved flight of cannon balls was due to rotation. In the early nineteenth century artilleryists began to experiment to explain these erratic trajectories by eccentrically weighting the cannon balls, and by inserting the cannon balls into the cannon with the center of gravity of the ball in some preferred position, the resulting trajectory was curved in that direction. The great French mathematician, Poisson, demonstrated in 1839 that the deflections could not be explained by the increased air friction on one side of the rotating ball as was popularly supposed at that time (reference e). Around 1850, about the time that the spiral bore gun was being introduced, the Berlin physicist, Professor G. Magnus was presented with the problem. He then proceeded with a series of experiments that conclusively proved the existence of a "Magnus" force and also made some original observations of the flow around bodies (reference f). Professor Magnus did not actually measure a Magnus force, but simply showed that one did exist and, in the light of his other observations, was able to show that this force could be explained by the fluid flow equation of Daniel Bernoulli. In 1877 Lord Rayleigh, (reference g) utilizing improvements in potential flow theory by Helmholtz, Sir William Thompson and others, was able to formulate a mathematical flow picture of a rotating cylinder in a uniform stream and to compute a Magnus force. This classical two-dimensional calculation, the superposition of a uniform parallel potential flow and a circulation flow, may still be found in theoretical hydrodynamic textbooks of the present day (references h, i, and j). Rayleigh, however, cautioned that while his potential flow construction yielded a substantially correct flow representation, a treatment of the real flow case must take into consideration the effect of the viscous flow at the surface of the cylinder as the connective link between the circulation of the body and the free stream. He insisted that the real case must obey Sir William Thompson's proposition that "circulation in a real fluid is impossible without viscosity."

5. The first quantitative measurements of a Magnus force were made by Lafay (references k and l) in wind-tunnel tests early in the twentieth century. Lafay measured the Magnus force on a rotating cylinder in a crossflow, but due to the short length of his cylinder, he was unable to attain the large forces predicted by Rayleigh. Shortly after World War I a group of British ballisticians introduced the effects of Magnus into a new treatment of the dynamical behavior of rotating projectiles (references m and n). These men, aware of the existence of Magnus, had no knowledge of the magnitude of the Magnus force on a three-dimensional body and therefore they could arrive at no conclusions regarding the importance of Magnus on the free-flight behavior of projectiles. Nevertheless, they included Magnus in their work for the sake of completeness.

In 1923 Ackeret (reference o) made the first significant Magnus measurements in the wind tunnels at Göttingen, Germany. Using a new high-speed electric motor to rotate a cylinder in the windstream, Ackeret originally measured forces not much greater than those measured by Lafay. The small increase in force was due to the fact that Ackeret used a cylinder with a higher length to diameter ratio than that used by Lafay. Ackeret also noticed in his early experiments that there was a strong "end" effect which prevented his cylinder from developing the maximum Magnus force on all but the innermost portion of the cylinder. When, at L. Prandtl's suggestions, Ackeret terminated his cylinder with large end discs, he was able to attain Magnus forces approaching those predicted by the theory. Ackeret's measurements also showed that although the Magnus (or lift) forces attainable with a rotating cylinder were large, the drag of the cylinder was correspondingly large. The resulting lift to drag ratio of the rotating cylinder was substantially lower than those that could be obtained with the better airfoils of the day, so it appeared that use of a rotating cylinder as a means of aerodynamic sustentation was not very practical. However, at that time Anton Flettner, a German shipping magnate, was financing experiments at Göttingen to ascertain the feasibility of replacing the sails on his shipping vessels with more efficient airfoils, and upon hearing of the large forces developed by the rotating cylinder, conceived the idea of using the cylinders to replace the sails (reference p). This idea was highly publicized and discussed in papers by the foremost aerodynamicists at Göttingen; namely, Betz, Prandtl, and Ackeret (references q, r, and s), and aroused interest and criticism both on the Continent and in the United States (references t and u). Flettner proceeded to convert two of his ships into "rotorships" to prove the practicality of his idea. The tests of the ships indicated that the rotors did produce large forces, but the project was abandoned probably due to the fact that the rotorships were still required to tack in much the same manner as sailing ships. Consequently, even if the linear speed was high, the point-to-point speed was substantially reduced by the tacking. The rotorship, it appears, was not an aerodynamic failure but a transportational failure; however, there were papers as late as 1929 denouncing it as a misconception of aerodynamic theory (reference v). Shortly after Ackeret's measurements there was another similar test conducted in the United States by E. G. Reid which essentially checked Ackeret's results (reference w).

6. In 1924 a series of tests was conducted in Holland that attempted to unite the large lift of a rotating cylinder with the low drag of a conventional airfoil (references x, y, and z). These tests consisted of force measurements in a wind tunnel using a wing with a rotating cylinder fitted into the leading edge. These tests were not conclusive, the configuration being a poor airfoil shape when the cylinder was not rotated and an ineffective rotor when the cylinder was rotated. The boundary layer surveys that were taken in these tests did reveal that energy could be imparted to the boundary layer, and separation retarded, by rotating the cylinder. About this time Prandtl and Tietjens (reference a.1) were obtaining excellent pictures of the flow about rotating and non-rotating cylinders which photographically revealed the differences between real fluid flow and ideal fluid flow.

7. In 1944 new criteria for the dynamic stability of spinning projectiles were advanced by Kelley and McShane which placed greater emphasis on the aerodynamic characteristics of the projectile (reference a.2). About this time the free-flight ballistic ranges were constructed at Aberdeen Proving Ground, Maryland which produced time-position-attitude histories of gun-launched projectiles with unprecedented accuracy. These new precise measurements made it possible to determine the Magnus characteristics of projectiles from their freeflight behavior (reference a.3). Most of this work dealt with security-classified projects and cannot be mentioned here. A few years later the first wind-tunnel Magnus force measurements on three dimensional bodies were undertaken at low subsonic speeds, but even up to the present time there have been only a few such tests.

8. The new quantitative measurements of the Magnus force and moments probably stimulated the development of the first theory of Magnus for a three dimensional body. Martin (reference a.4), in 1953, devised a "distorted body" theory in which the distortion of the boundary layer (due to angle of attack and body rotation) produced a new "effective" body shape which is not symmetrical in the yaw plane. On the basis of the new shape, a side force can then be computed by linearised potential flow. Kelley corrected and added to Martin's work (reference a.5). This present theory, the only one in existence, is severely limited in its proper application in that it should only be used for a long body with a laminar boundary layer at small angles of attack in subsonic incompressible flow.

9. For more than two years the Naval Ordnance Laboratory has been performing wind-tunnel Magnus measurement tests at both subsonic and supersonic speeds.

Introduction to the Problems of Wind Tunnel Magnus Measurement

10. This introduction is intended to present a background to the problems that occurred with the undertaking of Magnus measurement in the NOL wind tunnels, and to present some of the possible solutions that appeared. It should serve to indicate how the development of the test technique and the test instrumentation took place with each bit of experience gained up to the present time.

11. Recent aeroballistic studies, which have more accurately evaluated the importance of the Magnus effect on the dynamic stability of spinning missiles, have emphasized the necessity of obtaining reliable Magnus-force measurements. Since about 1944 ballistic ranges were the only facilities working on this problem until around 1951 when the first wind-tunnel Magnus measurement activity began. It was quite natural to introduce this problem into the wind tunnel, because of the fine control of the flight variables possible. Also, the reliability of a set of data would be established if the measurements could be reproduced by another facility employing a widely different experimental procedure.

12. Since the free flight ballistics ranges had been actively engaged in the problem of measuring supersonic Magnus forces and moments for some

time before the wind tunnel undertook the problem, it was therefore logical to examine their test results for some indication of the magnitude of the Magnus force. Some of their results indicated that the ballistic Magnus force coefficient, K_F , could be as small as 1/25th to 1/40th the ballistic normal force coefficient, K_N (see list of symbols and reference a.6) for these definitions). These ballistic coefficients are actually coefficient slopes in the usual aerodynamic sense and are similar to the ordinary aerodynamic stability derivatives. These ratios indicated that for many flight conditions there may often be greater than one order of magnitude difference in the actual forces. It should also be mentioned at this point that these ballistic range results were obtained for projectiles with high rotational velocities, having been fired from standard guns (guns with spiral bores that made one complete rotation as the projectile advanced between 20 to 40 body diameters down the gun barrel) or from a high-twist gun (a gun with a spiral bore that made one rotation in ten to twenty diameters of projectile advance). It was also apparent that if the wind-tunnel instrumentation could not produce the high rotational speeds necessary to duplicate the advance ratios produced by the range firings, then the Magnus forces in the wind tunnel would be even smaller (for the same size projectile) than those developed in the range.

13. Thus, the initial requirements of the wind-tunnel instrumentation were established. These requirements were:

1. an electrical strain-gage balance sufficiently strong in the pitch plane to withstand the strong normal forces, yet sufficiently weak in the yaw plane to be sensitive to the small Magnus forces.

2. a rotational motive source small enough to put inside a wind-tunnel model with sufficient power to rotate the model to the high spin rates necessary to duplicate the advance ratios of gun-launched projectiles. An idea of these spin rates may be obtained from Figure 1 which shows the spin rates required in the wind tunnel to duplicate the advance ratio of a 1 in 20 gun, for various size models, and for Mach numbers up to five.

14. In addition to these two major problems of instrumentation there was the problem of how to best perform the tests. The most straightforward way was to take data with all the test variables constant; namely, the Mach number, the angle of attack, and the rotational velocity. Since there were only fixed supersonic Mach numbers available for testing, the other two variables were of more concern. They could both be held constant and data taken, or one of them could be allowed to vary while data was recorded continuously. For the first exploratory tests the former method was used. This method proved much too slow and unrewarding and indicated the necessity of adopting one of the latter methods.

15. The statement of the two major instrumentational problems given above is overly simplified. Some of the other attendant problems were as follows. The strain gage balance could not be the usual type of balance but would require major modifications since it had to carry some sort of power to the spin motor, and since the motor had to be housed within the model, the balance sections were required to be located externally, behind the model.

This type of balance required a windshield to protect it from free stream air loads. The spin motor was required to have bearings that could endure both the high rotational speeds and the high radial loadings of the normal forces for sufficient lengths of time, without failure, to allow the data to be taken without frequent interruptions. The motor had to be such that it produced no "interference" or false reading of the electrical strain-gage balance. Since the models were of substantial length, the problem of dynamical or three-dimensional balance was critical, especially at the higher speeds. Good motor speed control and regulation was also desirable but it appeared unlikely that such would be the characteristics of motors of this size operating at such high speeds. Thus, more substantially, was the nature of the problem.

16. The very first attempts to perform Magnus measurements on spinning models were done at low subsonic speeds using commercially-available electric motors. The electric motors were mounted between the sting and the model in the simplest mechanical arrangement possible, the rotor being fastened to the sting and case attached to the model shell. The case and the model shell were then the rotating parts of the system. Subsequent tests were also attempted at supersonic speeds with electric motors but in both instances the data was bad. Several types of electrical motors were tried during this period but were found to be unsatisfactory due to the following reasons either singly or in combination:

1. the maximum spin rates attainable were insufficient to duplicate the advance ratios of gun-launched projectiles,
2. the heavy rotating parts of these motors had dynamical unbalances which excited strong vibrations in the entire model-balance-sting system rendering the force measurement system ineffective, and
3. speed regulation and control was poor.

17. The unsatisfactory performance of the available electric motors made it necessary to turn to some other kind of rotational power and the next most logical motor was an air turbine motor. Air turbine motors were known to have attained high rotational speeds in such applications as grinder motors, and could be built in very small sizes. The first type of turbine designed and constructed for Magnus models was the one described in reference (a.7). This type of air turbine was designed to exhaust the turbine air into the tunnel free-stream air at the rear of the sting, because at this time it was not known if there would be any aerodynamic interference on the model if this "external" air was dumped into the airstream near the model. Thus, the turbine supply air had to be introduced to the turbine through the sting and the exhaust air from the turbine also had to be carried out through the sting. This meant that the turbine had to be completely enclosed and airtight, and the sting had to have two air passages. This air turbine was built for a small finned model and was tried in the wind tunnel. This test was not successful due to the low torque of the motor being unable to overcome the torque of the canted fins in the airstream, and the smallness of the model provided no appreciable Magnus force.

18. A much simpler type of turbine which vented the exhaust air out of the base of the model was then devised to be used in the following manner. The turbine was allowed to power the model up to some high rotational speed before the intermittent wind tunnel blowing was started (see Description of Wind Tunnel section). The air to the turbine was then cut off and as the model's rotational speed began to diminish, the wind-tunnel blow was started. Data was continuously recorded as the model's rotational speed decayed. This technique was employed because it was still not known what the effect of releasing the exhaust air (from the turbine) out of the model's base, was on the external aerodynamics of the model. When the existence of such an effect was investigated by taking data both while the model was coasting down from some initially high spin (with no exhaust air being emitted from the model base) and while the model was being powered up to some high speed (with air coming out of the base), it was learned that there was no measureable difference in the data. This "coasting" technique was also slow and unproductive because the model rotational speed decayed very slowly necessitating several wind tunnel blows to cover the entire speed range. The "power up" technique, it was also learned, had several important advantages which could not be ignored. These advantages stemmed from the fact that the turbine's power was greatly increased during the wind-tunnel blow because the back pressure to the turbine was the wind-tunnel ambient pressure, only a few millimeters of mercury as compared to atmospheric pressure in the tunnel before the blow. Advantages of this type of procedure were that the entire speed range could be covered in a single blow, and that the maximum spin rate of the turbine was substantially increased.

19. The early exploratory tests indicated certain facts which still define some of the instrumentational requirements up to the present time. It was learned, for instance, that the requirement of perfect three-dimensional balance cannot be overstressed as the quality of the test data seems to be directly related to the degree of freedom from vibration and unbalance. Another fact that was learned was that large models, which produced larger and more easily measurable forces, required lower spin rates to duplicate the advance ratios of gun-launched projectiles, and permitted the construction of balances which were more sensitive to the yaw forces while still retaining the strength in pitch to resist the normal forces.

20. One piece of instrumentation that changed very little as more experience was gained was the strain-gage balance. From the calibrations of the balances, it was learned that they possessed a high degree of sensitivity to small steady state forces, and the wind-tunnel tests also showed that they were sensitive to the small fluctuations in the forces on the model due to air-stream fluctuations. The only essential improvement that was made on the strain-gage balances was to design them with low natural frequencies. This was done to minimize the possibility of high frequency resonances which might seriously damage the bearings or rotating parts.

21. The major changes that occurred in the strain-gage readout instrumentation was the incorporation of the X₁, X₂, Y recorder into the system to obtain continuous traces of the Magnus force variation with either spin or angle of attack, and the change over from an AC to a DC strain-gage system.

Originally a 400 cycle AC voltage was used to power the strain gages, but during the period when electric motors were being tried as the source of rotational power, it was discovered that the electrical power fed to the motor would cause erratic readings of the strain gages, especially around 400 cycles per second. This was serious enough to warrant the change to a DC power source for the strain gages.

22. The instrumentation in use at the present time is fully discussed later in the section on instrumentation, and the techniques employed are more fully described in the section on test technique.

Objectives of the Test

23. The basic objective of the tests was to obtain experimental data on the effect of the nose shape on the Magnus characteristics of cylindrical bodies of fineness ratio five. It was desirable to know of such an effect, because it might aid in the design of projectiles with higher overall dynamic stability. Since the Magnus moment always contributes a destabilizing effect to the dynamical behavior of spinning projectiles (bodies alone), it would be advantageous to be able to design projectiles to have no Magnus moment. Elimination of the Magnus moment would be even more desirable if it could be accomplished by some small configurational change, such as a small change in ogival radius.

24. Another objective of these tests was to try to determine, if possible, what the functional variation of the Magnus characteristics with spin and angle of attack was. The last objective of these tests was to take data on the same configuration by two different wind-tunnel techniques, to check the data.

25. The utilization of the constant spin-variable angle of attack technique was attempted for additional reasons. This procedure would more closely duplicate the actual motion of a projectile, and would provide continuous force traces through zero degrees angle of attack, where the force vanishes.

26. The outcome of the attempt to utilize the constant spin-variable angle-of-attack technique was completely dependent on the degree of success of the servo-speed control's operation, since another objective of the tests was to determine the operational characteristics of the unit in controlling the model's rotational speed.

27. The five caliber long bodies were chosen because it might be expected that the effect of nose shape would be more pronounced on a short body than on a long body.

Description of NOL 40 x 40 cm Aeroballistics Tunnel No. 1

28. These tests were performed in the NOL 40 x 40 cm Aeroballistics Tunnel No. 1, an open jet, intermittent, blow-down tunnel. It should more correctly be called a "suck down" or "indraft" tunnel since it utilizes the pressure difference between the atmosphere and the "vacuum" of a storage sphere. The storage sphere is continuously evacuated by a set of three Demag sliding vane pumps which are automatically switched between parallel and series-parallel operation to minimize the pump down time. The tunnel can be operated over a range of fixed supersonic Mach numbers from 1.22 to 5.0 by inserting sets of nozzle blocks. The test section is an open jet in that the nozzle blocks and their side walls are enclosed in a small plenum chamber and the actual testing region is a space of uniform flow described by a wedge upstream of the nozzle exit and a pyramid down-stream of the nozzle exit. Downstream of the test section is an adjustable diffuser, designed to be set (in opening) to achieve the optimum pressure recovery in order to attain the longest blowing time. Located immediately behind the adjustable diffuser is a "fast acting" Polte valve which controls the starting and stopping of the tunnel. Blow times as long as 40 seconds at $M = 3.24$ can be obtained. A silica gel air dryer dries the air before it reaches the test section and is regenerated by auxiliary equipment when the tunnel is now blowing. A "cutaway" view of the supersonic wind-tunnel building can be seen in Figure 2 and a more complete description of the wind-tunnel facility can be found in reference (a.8).

Test Instrumentation

29. The test instrumentation, not including the models, can be broken down into five individual units, namely, the air "coaster" turbine motor, the external electric strain gage balance, the strain gage readout system, the frequency console, and the servo-speed control.

30. The air "coaster" turbine derives its name from the fact that it was designed to be used to "power" up the model to some high rotational speed before the wind-tunnel blow commenced and then allowed to "coast" down to zero rotational speed during the blow. In this way any effect of the air-flow, required to power the turbine, on the strain gage balance would be avoided. This type of operation would also permit the exhaustion of the turbine air out of the base of the model. However, when it was learned that the decay in rotational speed during "coast down" was small, thus requiring several blows to cover the entire speed range, and that there was no noticeable effect of the turbine air on the strain gage balance, the "power up" of the model during the wind-tunnel blow was found to be more satisfactory (for several reasons discussed in the section on Introduction to the Problems of Wind-Tunnel Magnus Measurements). The construction of the air turbine can be seen in Figures 3 and 4. The turbine nozzle box is fixed on the stationary hollow sting while the turbine wheel is attached to the model shell. The air to power the turbine comes through the hollow sting to the nozzle box, passes through the nozzles, by the turbine blades, and finally, out the base of the model.

31. The turbine's rotational speed is indicated by the frequency of the sine wave generated by a small wire coil, mounted on the stationary turbine shaft, under the influence of a ring magnet attached to, and rotating with, the model shell.

32. The electric strain-gage balance used in these tests is similar to most pitch or yaw strain-gage balances with the single exception that it had to be hollow to allow for the passage of air supplied to the turbine. Its design was critical in that it must have sufficient strength to withstand heavy loads in the pitch plane and yet be sufficiently weak in the yaw plane to be sensitive to the small Magnus forces developed by the model. As was mentioned previously (in the Discussion of the Problems of Wind-Tunnel Magnus Measurement), at low rotational speeds the ratio of the normal force to the yaw (or Magnus) force can become exceedingly large, especially at high angles of attack. The construction of the balance was more intricate than a simple pitch or yaw balance in that a change over from a circular cross-section to a flat cross-section at the gage sections necessitated the fabrication of the balance in several pieces, since the cross-sectional variation of the hollow passageway could not be machined out of a single solid piece of metal. The separately machined pieces were welded together and then the external surfaces of the assembled balance were finished off on a milling machine. The strain gages were then mounted in the usual bridge circuit and the addition of the power and signal lead completed the balance construction. The balance behaved as the usual pitch or yaw balance in that each of the two gage sections were sensitive to bending moments about an electrical center located somewhere in the gage section. The location of the electrical centers and the sensitivities of the two gage sections were accurately determined in calibration. The slight tendency of the gages to respond to forces other than that for which they were intended, was nullified by electrical shunting (reference a.9).

33. The strain-gage readout system, broken down into its component parts consisted of: a wet cell battery to supply the power to the strain gages; a nulling and calibrating unit which was used to determine the electrical characteristics of the strain-gage balance (and could be used as a nulling type of strain indicator); a Leeds and Northrup D.C. amplifier-micro-voltmeter which was used both to read out the unbalance voltage of one of the bridges (indicative of the bending moment about the gage), and to amplify this unbalance voltage to a sufficient level for presentation to the recorder; a Leeds and Northrup X_1 , X_2 , Y recorder to permanently record the variation of the bending moments about the two strain-gage sections as functions of either the model rotational speed or the model angle of attack. A diagrammatic sketch of the strain gage readout system may be seen in Figure 5, and photographs of the system are presented in Figures 6 and 7.

34. The frequency console was an assemblage of electronic units to convert the variable frequency generated by the tachometer pickup coil in the model into a direct current voltage proportional to that frequency. The console consisted of the following units: a General Radio Audio Oscillator; a Gates Amplifier; a General Radio Frequency Meter, a Waterman 3 inch Oscilloscope, and a Berkeley EPUT meter. The basic function of the console required the operation of only the Gates Amplifier to amplify the variable frequency signal

from the tachometer pickup coil, and the General Radio Frequency Meter to convert the variable frequency voltage into a D.C. voltage proportional to that frequency. This D.C. voltage was used as the input to the Y function on the recorder. The Berkeley EPUT Meter was used to monitor the tach signal frequency by counting the number of cycles per second (thus the designation Events Per Unit Time meter) and presented, in digital form on the front panel of the unit, the number it had sampled in that time interval. The Waterman Oscilloscope was used to visually monitor the quality of the signal from the tachometer pickup coil. Any malfunction of the pickup coil could easily be detected on both the oscilloscope and the EPUT meter. The function of the General Radio Audio Oscillator in the system was to provide accurate, fixed frequencies to define rotational speed limits on the Y function of the recorder. The Y function on the recorder was linear with frequency (presented to the console) and thus required only two defining limits, a zero frequency and a "maximum" frequency. The frequency readout system had one shortcoming. The system could not respond to frequencies below 18 cycles per second. This was due both to a limitation of the General Radio frequency meter and to the low output voltage of the pickup coil at low frequencies. A diagrammatic sketch of the frequency console is presented in Figure 8 and the unit may be seen in Figures 6 and 7.

35. The Servo-Speed Control was a unit designed and built at the NOL, for the expressed purpose of controlling the rotational speed of any of the several sizes of air turbines in use for Magnus testing. It is an experimental model to determine how effectively a high-speed air turbine can be controlled and regulated with a relatively simple apparatus such as this. Part of the actual wind-tunnel testing was devoted to determining the characteristics and the degree of control provided by this unit. The control was constructed using a relatively simple circuit conceived by Dr. W. A. Menzel at the NOL using as the major components, a Brown servo-amplifier, a Brown servo-motor, and a standard 1/2 inch pipe valve. The control circuit may be seen in Figure 9 and a photograph of the complete control unit may be seen in Figure 10. The primary function of the Servo-Speed Control was to hold the rotational speed constant at some fixed value while the aerodynamic loading on the model varied such as occurs when the model's angle of attack is changed. The secondary function was to be able to set the model's rotational speed at arbitrary fixed values. From the use of the control during the wind-tunnel tests it was learned that the model's rotational speed could easily be held constant to $\pm 2\%$ at speeds between 80 cycles per second and 500 while the model's angle of attack was varied between ± 10 degrees. A fine degree of control was attained after some experience in adjusting the supply pressure and the Servo-Speed Control settings to satisfy the needs of the turbine. The setting of the rotational speed to some nominal value by the speed control was not so successful as was the speed regulation in that when the wind tunnel blow was started, the model would always speed up to some higher value than was set before the blow. This can be readily explained when one considers that when the wind tunnel is blowing, the ambient pressure surrounding the model is only a few millimeters of mercury. Thus, the back pressure to the turbine is extremely low, the power of the unit is considerably multiplied and the

turbine speeds up. Nevertheless, the regulating effect of the control would take hold at the new higher speed and precisely regulate the rotational speed. With a little experience, this speed-up could be reckoned with and compensated for beforehand to achieve a speed setting close to the desired one.

Models

36. All of the models tested in this investigation had a length-to-diameter ratio of five, the noses being two body diameters in length and the cylindrical after-bodies three body diameters in length. The only configurational variation was in the nose shapes. Of the six noses tested three formed a systematic variation in ogival radius. These three noses were: a cone nose of infinite ogival radius, a secant ogive nose with an ogival radius of 8.5 body diameters, and a tangent ogive nose with an ogival radius of 4.25 body diameters. Each of the remaining three noses had no relationship to any other in the group but was tested because it was an "interesting" shape. One of the remaining three noses was the Haack-Sears nose, a nose whose profile was determined by the equation $\frac{y}{r} = \left[1 - \left(1 - \frac{x}{r}\right)^2\right]^{3/4}$ and possessed the theoretically minimal wave drag for a given length and volume (reference a.10). Another nose shape was the "typical projectile" nose, which was basically a cone with a blunted tip - in this case, a spherical tip - and a rounded shoulder. The blunted nose was desirable from the standpoint of fuse installation and operation and the rounded shoulder was characteristic of many varieties of service ammunition. The last nose tested was the cone nose with artificial roughness applied to a small region near the tip. Number 100 emery grit was chosen as the artificial roughness in an attempt to produce a completely turbulent boundary layer over the entire model. The size of this grit was chosen on the basis of yet unpublished data obtained from tests on boundary layer transition conducted at the Jet Propulsion Laboratory, Pasadena, California. The variety of nose shapes tested were expected to yield results which would be representative of most practical supersonic nose shapes. All of the noses are good supersonic shapes in that none have high drag.

37. The models were machined out of magnesium, the lightest common metal, to the dimensions given in Figure 11. Photographs of the model parts are presented in Figures 12 to 18. The models were fabricated with the tolerances on the concentricity of the rotating circular surfaces as small as was possible using ordinary machine shop equipment. The precision of manufacture and the lightness of the models reduced the level of any dynamic unbalance to an insignificant level.

38. The model size, three inches in diameter and fifteen inches long, was determined by test section considerations. The models were the largest that could be tested in the test section of the Mach 1.75 nozzle at angles of attack as high as 22 degrees. The moment reference center was taken to be 3.04 body diameters back from the nose.

Wind Tunnel Test Techniques

39. Magnus forces and moments are dependent on several aerodynamic variables which influence the viscous flow about the model (i.e. the structure of the boundary layer and the vortices shed on the lee side of the body). Some of these variables are, the Mach number, the Reynolds number, the rotational velocity, the angle of attack, the surface roughness, the pressure and temperature gradients, and in the case of the wind tunnel, any nozzle disturbances and air turbulence. Experimental Magnus data as functions of these variables are necessary for the understanding of the Magnus mechanism and to establish a satisfactory Magnus theory, which at the present time does not exist. Within a larger program of the Aeroballistic Research Department of the Naval Ordnance Laboratory, the effect of nose shape (which primarily affects the pressure gradient) on the Magnus forces and moments of a 5-caliber long body was examined. This investigation was attempted to provide some insight as to how to improve the free-flight characteristics of some missiles under development. If a large orderly variation in the Magnus characteristics could be determined, then this variation might be exploited to yield body shapes with no adverse Magnus effects.

40. The test of the six models was performed at a Mach number of 1.75 only in order to limit the quantity of data obtained. At this Mach number, the dynamic pressure in the wind tunnel is sufficiently high to produce appreciable Magnus forces and because of the exceptional flow quality of the nozzle used to produce this Mach number.

41. The major portion of this test was carried out with the constant angle of attack and variable spin method. This technique is not troubled by the appearance of gyroscopic forces (since the model is held fixed in space), nor is the control or regulation of the rotational speed of any concern so long as the frequency recording system has a sufficiently fast response. The test procedure employing this technique is as follows: the angle of attack is set to some nominal value before the wind-tunnel blow; the wind tunnel blow is started and once flow is established, high pressure air is admitted to the air turbine; the model accelerates from zero rotational speed up to some high rotational speed; during the blow, continuous traces of the variation of the bending moments about the two yaw gages are permanently recorded as functions of the rotational speed; finally when the high rotational speed is reached, the wind-tunnel blow is stopped.

42. The constant rotational speed, variable angle of attack technique was employed for one configuration. As was stated previously, this part of the test was of an exploratory nature in that it was not known how effective the Servo-Speed Control would operate. The procedure employed for this type of test was as follows: the model's angle of attack was set at some extreme value and the model was spun up to some nominal value of rotational speed; the tunnel blow was started causing the model's rotational speed to increase; after a few seconds the Servo-Speed Control took hold and kept the rotational speed constant; once it was noticed that the rotational speed had

stabilized, the angle of attack was varied, while the angle of attack was varied, the variation of the bending moments about the two yaw gages was permanently recorded as functions of angle of attack; when the other extreme value of angle of attack was reached, the wind-tunnel blow was stopped. This technique produces gyroscopic forces, which have to be eliminated in the data reduction.

Coefficients

43. The Magnus force and moment coefficients, as originally defined by ballistic investigations, are:

$$\left. \begin{aligned} K_F &= F/\rho V D^3 \dot{\theta}_p \\ K_T &= -T/\rho V D^4 \dot{\theta}_p \end{aligned} \right\} \text{ see (reference a.6)}$$

The terms in the above equations are defined in the List of Symbols. The angle, θ , is the angle between the axis of symmetry (length axis) of the projectile and the free-stream velocity vector and corresponds to the aerodynamic angle of attack. The inclusion of the rotational vector, i , is to denote that the Magnus force, F , occurs at right angles to the plane in which θ is contained. It is assumed that these coefficients are linear functions of both spin and angle of attack when the time-position-attitude measurements of the ballistic ranges are evaluated. The present investigation shows that this assumption is erroneous.

44. The yaw or side force coefficient and the yawing moment coefficient as used for static wind tunnel measurements are respectively

$$C_Y = Y/qA$$

$$C_\Psi = \Psi/qAD$$

Throughout this report, these coefficients will be used to define the forces and moments produced by the Magnus effect. It should be noted that the difference between these coefficients and the ballistic Magnus coefficients is that these coefficients are not non-dimensionalized for spin or angle of attack.

45. Another non-dimensional quantity which describes the helical angle of a point on the surface of the body as it flies through the air (same as the lead of a screw thread) is the advance ratio. It is:

$$\text{Advance Ratio} = (pD/2V).$$

If the wind-tunnel yaw force and yawing moment coefficients are linear with both spin and angle of attack, then these coefficients may be non-dimensionalized for advance ratio (spin) and angle of attack into wind-tunnel Magnus coefficients which may be readily compared with the ballistic coefficients. These are:

$$C_{Y_{P\alpha}} = \frac{C_Y}{\alpha} \left(\frac{2V}{pD} \right) = \frac{16}{\pi} K_F$$

$$C_{Y_{T\alpha}} = \frac{C_Y}{\alpha} \left(\frac{2V}{pD} \right) = -\frac{16}{\pi} K_T$$

46. If the wind-tunnel measurements reveal that the Magnus is non-linear with both rotational velocity and angle of attack, then another procedure must be followed to obtain coefficients which may be compared with the ballistic coefficients. To obtain wind-tunnel Magnus coefficients in this case, the advance ratio of the projectile must be known. The rotational velocity required to duplicate this advance ratio in the wind tunnel must be determined. At this spin rate, the wind-tunnel Magnus coefficients may then be computed:

$$C_{Y_{P\alpha}} = \left(\frac{d}{d\alpha} \right)_{\alpha = 0} \left(\frac{C_Y}{p} \right) \left(\frac{2V}{D} \right)$$

$$C_{Y_{T\alpha}} = \left(\frac{d}{d\alpha} \right)_{\alpha = 0} \left(\frac{C_Y}{p} \right) \left(\frac{2V}{D} \right)$$

The Magnus coefficients obtained by this method are probably closest to "true" Magnus coefficients, because they are most representative of the instantaneous forces acting on a projectile. These coefficients consider the spin as a constant (which is true for short distances along the projectile's trajectory), and are determined for zero degrees angle of attack (defining the initial Magnus force behavior).

Data Reduction and Accuracy

47. The raw data obtained for the constant angle of attack-variable spin type of blow were in the form of recorder traces of the yaw gage readings (indicative of the bending moments about the yaw gages) versus the rotational speed. Sample traces of this type may be seen in Figure 19. From these traces the side force coefficient, C_Y , and the yawing moment coefficient, C_Y , may be computed (by the equations presented in Appendix I and reference a.9) as functions of the rotational speed. In this data reduction, the fewest number of data points were taken that would adequately define the data. In some cases, where the traces were clearly linear, only two points from each trace were read. These two points were, the zero rotational speed point and the maximum rotational speed point. The zero rotational speed point was considered as the point of "zero" Magnus and any reading of the strain gages at this point was due to some small static yaw angle. Thus, for a linear trace only the values of the Magnus coefficients at the maximum

spin were computed. For the majority of traces, many points along the traces had to be read because the traces were clearly non-linear. One source of error in reading the traces was due to the fact that the traces did not start from exactly zero rotational speed, but commenced at approximately twenty revolutions per second. This was due to the inability of the frequency console to respond to low frequencies and the tachometer generator to produce a sufficient signal voltage at these low frequencies. All of the traces had to be faired to zero rotational speed in order to determine the "zero" Magnus point. This fault in the instrumentation introduced a reader error in the data which is probably most evident in flaws in the array of the basic data plots.

48. The raw data obtained for the constant rotational speed-variable angle of attack type of blow were of the form of traces of the strain-gage readings versus the angle of attack. Sample traces of this kind may be seen in Figure 20. On this type of trace, the angle of attack was linear between the two extremities of the trace. The extremities of the trace were a maximum positive angle of attack and a maximum negative angle of attack. To reduce the data, a "zero" Magnus point had to be determined and this was taken to be the interpolated zero degrees angle of attack point. Any reading of the strain gages at zero degrees angle of attack was attributed again to a static yaw angle and also to a small precessional force. Tare readings had to be subtracted from the readings of the traces and these were the variations of the no-spin strain gage readings with angle of attack, which were small.

49. The readings obtained from both types of traces were punched into IBM cards and reduced to coefficient form by IBM 650 computing machines used by the Applied Mathematics Division of NOL.

50. There were no corrections applied to the data. A correction to the indicated angle of attack due to the deflection of the balance under the pitch plane loads is normally warranted, but requires the measurement of the pitch plane loads. However, previous experience with this balance showed this correction to be negligible. The aerodynamic trim has also been left in the data since the subtraction of the trim angles would not alter the form of the data but would only shift them to the origin. This was not done because of the considerable work involved.

51. In the case of the constant spin, and variable angle of attack method a precessional moment is present and must be accounted for in the data reduction. The magnitude of this precessional moment depends on the moment of inertia of the rotating parts, the rate of change in the angle of attack, and the rotational velocity. The rotational velocity for the run utilizing this technique varied between about 80 revolutions per second to about 510 revolutions per second, but the rate of change of the angle of attack was only about one degree per second. However, if the rate of change in angle of attack was a constant, then the precessional force must be a constant, and it would be properly deducted from the total force reading (leaving only the Magnus force reading) by the data reduction procedure described

above. Also if the direction of the angle of attack variation were reversed then the direction of precessional force would be reversed. The effect of rotational speed on this precessional force did show up in the data in a small change in "zero Magnus" point; the largest "zero Magnus" point corresponding to the highest rotational speed. That the precessional moments have been eliminated from the data is substantiated by the good comparison of the data taken in this fashion with the data taken by the constant angle of attack, variable spin technique, a technique for which no precessional moment is present.

52. A probable error analysis for these tests was attempted, but the results were approximately one order of magnitude smaller than the error determined from what repeat points were taken. This was probably due to the fact that all of the variables which affect the data could not be accounted for in the probable error analysis. Some of these variables are: tunnel air fluctuations, vibrations of the model-sting system, the aerodynamic trim (which is still present in the data), and reader error in the fairing and reading of the recorder traces. These factors, while small in themselves are probably significant contributors to the total error when one considers the smallness of the Magnus forces. To indicate a level of measurement accuracy the following RMS values of the residuals (based on repeat points) are presented, for a spin rate of 600 rev./sec.

	$\alpha = 4^\circ$	$\alpha = 8^\circ$	$\alpha = 18^\circ$
E_{C_Y}	± 0.024	± 0.011	± 0.006
E_{C_ψ}	± 0.021	± 0.016	± 0.010

If these errors are referred to the measured coefficients then the percentage errors are

	$\alpha = 4^\circ$	$\alpha = 8^\circ$	$\alpha = 18^\circ$
C_Y	± 19.2	± 2.45	± 0.75
C_ψ	± 38.9	± 5.37	± 1.52

53. The system of coordinate axes defining the signs of the forces and moments are presented in Figure 21.

Results

54. The primary results of these tests are presented in the form of data tables and graphical plots of the side force coefficients and the yawing moment coefficients versus rotational speed or angle of attack. This presentation is made in the same general order in which the data were taken. In other words, if the raw data were obtained by the constant angle of attack, varying spin technique, then the computed coefficients are presented as functions of the spin, with the constant angles of attack as a parameter. The tabulated data are presented at the end of the report with an explanatory sheet. The primary data plots for the six configurations, as obtained using the constant angle of attack, variable spin technique are presented in Figures 22 to 33 in the following configurational order: the cone nose; the secant ogive nose; the tangent ogive nose; the Haack-Sears nose; the typical projectile nose; and lastly the cone nose with No. 100 grit. These graphical plots are alternately, the side force coefficients and the yawing moment coefficients (plotted against the rotational speed) for the respective configurations. It was possible to present all of the measured coefficients (of one kind) for each configuration on a single graph. Thus, the presentation of this data required only two plots for each configuration. The data obtained for the single run using the typical projectile nose, and employing the constant rotational speed-variable angle of attack technique, could not be as conveniently presented without completely obscuring the data around zero degrees angle of attack, and required Figures 34 to 55 to clearly present these results. In each of these figures are presented the side force coefficient, the yawing moment coefficient, and the center of Magnus plotted against the angle of attack for constant values of the spin.

55. The presentation of some of the important effects revealed by the data necessitated a number of crossplots and comparison plots. The effect of nose shape (for three spin rates - 153, 305 and 458 revolutions per second) is revealed in Figures 56 to 64. In Figures 56, 59, and 62, the side force coefficients for all of the nose shapes are plotted against angle of attack for each of the three speeds respectively. The yawing moment coefficients are presented in Figures 57, 60, and 63, in the same form. Figures 58, 61, and 64 present the centers of Magnus versus absolute value of the angle of attack, for all of the configurations. For these plots the data has had the aerodynamic trim angle of attack removed in order to accurately determine center of Magnus values at small angles of attack. If the trim were not removed, the center of Magnus determinations at small angles of attack would be meaningless. The good agreement of the centers of Magnus between plus and minus angles of attack point up the symmetry of the data. From each of the three sets of three figures an effect of the ogival radius may be obtained, at each constant rotational speed, if we consider the three noses that have the systematic variation in ogival radius. Figure 65 presents the effect of ogival radius on the Magnus characteristics of bodies of fineness ratio 5. In this figure are presented the Magnus force coefficient, $C_{Y_{\text{M}}}$, the Magnus moment coefficient, $C_{M_{\text{M}}}$, and the center of Magnus

as functions of the ogival radius at a spin rate of 305 revolutions per second. Figure 66 presents the effect of spin on the initial Magnus characteristics of the typical projectile nose as determined by "slopes" at

zero degrees angle of attack from the many traces obtained by the constant spin, variable angle test technique.

56. A comparison of the results obtained for identical test conditions on the same configuration by employing the two different test techniques is presented in Figures 67 and 68. These figures contain the crossplots of C_Y and C_Ψ for the typical projectile nose versus angle of attack (as presented in Figures 59 and 60, $p = 305$ rev./se.), and the same coefficients as obtained by the constant spin variable angle of attack technique (namely the data as presented in Figures 40, 41, and 53, at approximately the same spin rate).

Discussion

57. The examination of the graphical plots of the coefficients, C_Y and C_Ψ , is not sufficient by itself to reveal the effects of nose shape variation. As a matter of fact, there is so much data in these figures (Figures 22 to 33) that differences between the various noses are actually obscured. The comparison crossplots, Figures 56 to 64, give a better picture of the nose effect. The plotted points in these figures are values which have been interpolated in the tabulated results. From Figures 56, 59, and 62 (note change in scale of Figure 62), the crossplots of the side force coefficients, the following general effects, for each spin rate, may be seen:

1. the force coefficients follow approximately a cubical relationship with small and moderate angles of attack, then generally reaching either a peak or a plateau at some high angle of attack;
2. there is a progressive increase in the Magnus force as the ogival radius decreases (proceeding from cone nose to tangent ogive nose);
3. the Haack-Sears nose appears to have the highest maximum Magnus forces of all the noses tested;
4. the typical projectile nose seems to have about the same forces as the secant ogive nose;
5. there appears to be little if any difference between the forces developed on the cone nose and on the cone nose with No. 100 grit;
6. there is an almost linear relationship of coefficient with rotational speed.

From Figures 57, 60, and 63, the crossplots of the yawing moment coefficients, it may also be seen that:

1. the various noses produce appreciable differences in the Magnus moment behavior at small angles of attack - these differences include reversals in sign;

2. there are small differences in the maximum values of the moment coefficient at high angles of attack, although there appears to be a slight increase in moment coefficient with diminution of the ogival radius;

3. the tangent ogive nose and the Haack-Sears nose appear to have similarly shaped moment coefficient curves at small angles of attack;

4. the typical projectile nose has about the same Magnus moment characteristics as the secant ogive nose at both high and low angles of attack;

5. the application of the No. 100 grit to the cone nose appears to have changed the Magnus moment coefficients appreciably at small angles of attack, but not at all at the high angles of attack;

6. all of the Magnus moment coefficients appear to have reached a peak or plateau at the high angles of attack;

7. the maximum moment coefficient values exhibit an almost linear dependence on spin rate, however there appears to be almost no dependence of the moment coefficient at small angles of attack once a spin rate of about 305 revolutions per second has been exceeded.

From Figures 58, 61, and 64, the crossplots of the centers of Magnus, it may be seen that:

1. the centers of Magnus for all the configurations (including the cone nose with grit) at high angles of attack are almost the same;

2. at small angles of attack, there appears to be very strong effect of nose bluntness on the centers of Magnus with the blunter configurations having the more rearward centers of Magnus;

3. the application of the grit to the cone nose moves the center of Magnus from ahead of the nose rearward to approximately one caliber ahead of the base, at small angles of attack. (Since schlieren photographs of the boundary layer were not obtained it is not conclusively established what changes in boundary layer were produced by the application of the grit. The two changes that the grit could produce are: the shifting of the transition point from somewhere aft on the body to the very tip of the nose, and the simple thickening of an already turbulent boundary layer. The large change in center of Magnus due to the application of the grit may be evidence that the former effect is probably occurring along with strong variations of the distribution of the Magnus forces along the body.)

4. there appears to be no effect of spin on the centers of Magnus at large angles of attack and only the centers of Magnus of the cone nose and the secant ogive nose appear to be markedly affected by the spin rate at small angles of attack.

58. The effect of ogival radius on the initial Magnus characteristics of bodies of fineness ratio 5 may be seen in Figure 65, in which the Magnus force coefficient, $C_{Y_{pz}}$, the Magnus moment coefficient, $C_{Y_{pz}}$, and the centers of Magnus at zero degrees angle of attack (determined from the slopes of the crossplots of Figures 59 and 60) are plotted against ogival radius. With decreasing ogival radius the Magnus force coefficient increases, the Magnus moment coefficient decreases and even becomes negative, and the center of Magnus moves rearward from ahead of the nose to behind the center of gravity. This figure was presented to emphasize the substantial differences in the Magnus coefficient, produced by the different nose shapes, at low angles of attack.

59. Examination of the data obtained for the constant spin, variable angle of attack test technique (Figures 34 to 55) reveals effects at very small angles of attack that are not ordinarily discernible by the constant angle of attack, variable spin test technique. During the actual testing, the original angle of attack range was between plus and minus ten degrees, but the unusual variations in the recorder traces that occurred at very small angles of attack (between plus and minus one degree) indicated very pronounced movements of the center of Magnus, and prompted the exploration of these unusual effects at a greater sensitivity and on a reduced scale (between plus and minus five degrees). The inspection of these data shows that at very small angles of attack:

1. the Magnus force coefficient can be very non-linear;
2. the Magnus moment coefficients exhibit "reversals" and even "double reversals;"
3. the centers of Magnus are extremely unsteady, being very sensitive to changes both in spin rate and angle of attack. The argument that these very small angle effects may be due to "vagaries" of the instrumentation can be refuted by the good repeatability of the data (from repeat traces at two sensitivities), by the symmetry of the data, and by the agreement of the data taken by two different techniques (to be discussed later). The author had some reason to suspect that mechanical vibration of the model-turbine-sting system might be producing these unusual small angle of attack effects, however, a detailed investigation proved this suspicion to be groundless. Since the typical projectile nose was the only configuration tested in this fashion (because of model difficulties), it is not known whether the many variations in the very small angle of attack data are peculiar only to this configuration or whether this behavior is representative of many, or all, configurations. One of the most interesting features of these data (Figures 34 to 55) is the behavior of the center of Magnus at zero degrees angle of attack as the spin changes. It can be seen by successively examining the figures that there is a profound movement in the center of Magnus as the spin is increased, moving from behind the center of gravity at low spin rates (90 rev./sec.) to far ahead of the nose at medium spin rates (300 rev./sec.), then back to a position just ahead of the nose at high spin rates (500 rev./sec.). The center of Magnus determinations at zero degrees angle of attack were made by using the slopes of the traces at zero degrees

angle of attack, because at zero degrees angle of attack the side forces and moments themselves become zero. The effect of spin rate on the initial Magnus characteristics of the typical projectile nose configuration is evident in Figure 66. It can be seen that as the spin is increased the Magnus force coefficient goes to zero; the Magnus moment coefficient changes sign, peaks, then begins to decrease; and the center of Magnus moves off the body to some point a great distance ahead of the body, then moves rearward again. The fact that the moment coefficient reaches a maximum and remains finite in value, while the force coefficient goes to zero, can only be explained by the presence of a couple. This would mean that there must be two effectively independent systems of aerodynamic activity at work on the body producing this effect.

60. The comparison of the data obtained by the two different test techniques (Figures 67 and 68) indicates that the two sets of data are in good agreement. It should be pointed out that the aerodynamic trim is still present in the data, and the comparison might be improved if the trim were removed. The author feels that each test technique has certain advantages depending on what is desired most from the test. For very small angles of attack, the constant spin-variable angle of attack technique is much more revealing than the other technique. It also yields Magnus coefficients at zero degrees angle of attack. The constant angle of attack-variable spin technique requires less instrumentation and uses a simpler data reduction procedure.

61. From the consideration of the results of these tests certain general conclusions may be inferred. One conclusion, that verifies present opinion, is that at small angles of attack the nature of the boundary layer is the most important factor in the behavior of the Magnus. It also appears that any disturbance introduced to alter the behavior of the boundary layer, such as spin, nose shape variations or surface roughness, may produce very great changes in the force distribution over the body (and the corresponding variation in the moment and center of Magnus). It might be expected that the effect of nose shape on Magnus would be more pronounced on a short body than on a long body, because of the longer run of boundary layer on the longer body, but there is no evidence to prove or disprove this.

62. Another conclusion that may be drawn from these tests is that the force distribution on the body at very small angles of attack is the result of two systems of aerodynamic activity. A possible picture of this activity might be that at low angles of attack, the viscous flow on the sides of the body might be combined into two effectively discrete vortex systems similar to those that occur at high angles of attack. These two vortices would be, of course, very close to the body, possibly completely within the attached boundary layer. If the strengths of the two vortices were nearly the same, the net force would be close to zero, but if the circulation distribution of these vortices along the body were different, a finite moment might be the result.

63. A third conclusion that can be made is that body disturbances, such as mentioned above, have little influence on the distribution of the forces on the body at high angles of attack. The constancy of the centers of Magnus at high angles of attack between all of the configurations, may indicate that the shed vortices on the lee side of the body have about the same paths and circulation distributions for all of the configurations, but the differences in the maximum forces indicate that the different shapes are able to impart different amounts of (total) circulation, by their rotation, to the shed vortices.

64. A possible explanation for the peaking of the Magnus force might be that the shed vortices are moving away from the body as the angle of attack is increased, and, when the body reaches a certain "critical" angle the vortices are so far away from the rotating body that the body cannot effectively communicate circulation to them. After this "critical" angle of attack is passed the force tends to diminish.

65. As was stated earlier (in the Historical Sketch) there exist only two papers that attempt to predict theoretically the Magnus characteristics of three dimensional bodies. Unfortunately, most of the conditions of this theory, namely, a long body with a laminar boundary layer in a subsonic incompressible flow at small angles of attack, are violated by the conditions of these tests. Thus, no valid comparison with this theory could be expected. Nevertheless, the Martin-Kelley theoretical Magnus coefficients are included in Figure 65 for academic reasons.

CONCLUSIONS

66. From the consideration of the results of these tests, the following specific conclusions are evident for a body of fineness ratio 5 at a Mach number of 1.75 and a Reynolds number of 5.5 million.

1. The shape of the nose has a profound effect on:
 - a. the magnitude of the Magnus force at high angles of attack
 - b. the behavior of the Magnus moment at small angles of attack
 - c. the location of the center of Magnus at low angles of attack.
2. The shape of the nose has a lesser effect on:
 - a. the magnitude of the Magnus force at small angles of attack
 - b. the magnitude of the Magnus moment at high angles of attack.
3. The shape of the nose has a very small effect on the center of Magnus at high angles of attack.

4. The rotational velocity has a profound effect on the initial ($\alpha = 0$ degrees) Magnus characteristics of the typical projectile nose configuration. Whether this strong spin dependency is representative of many or all configurations remains to be demonstrated.

5. The application of artificial roughness to the tip of the nose caused very substantial changes in the Magnus moment and the center of Magnus at small angles of attack.

6. No present theory can adequately predict the Magnus characteristics of short bodies at supersonic speeds.

7. The constant rotational speed-variable angle of attack test technique has demonstrated that:

a. the data obtained by this technique agrees well with the data obtained by the previous technique of holding the angle of attack constant and taking data while the rotational speed was varied

b. this technique determines the small angle of attack Magnus characteristics more satisfactorily than the previous technique

c. this technique affords an opportunity of determining the initial Magnus characteristics, namely those at zero degrees angle of attack

8. The Servo-Speed Control Unit, designed and built for the purpose of effectively controlling the rotational speed of the air turbine was a success.

References

- (a) Walker, G. T. Spiel und Sport. Encyclopadie der Mathematischen Wissenschaften, IV 9, p 136 ff, 1900.
- (b) Newton, Isaac. Philosophical Transactions. 6, 1672.
- (c) Robins, B. Mathematical Tracts of Gunnery. p 200 ff, London: 1761.
- (d) Robins, B. New Principles of Gunnery. London: 1842.
- (e) Poisson, S. D. Recherches sur le mouvement des projectiles. Paris: 1839.
- (f) Magnus, Gustav. Ueber die Abweichung der Geschosse. Abhandlungen der Berliner Akademie, 1852, or Poggendorfer Annalen, Vol. 88, p 1, 1853.
- (g) Strutt, J. W. (Lord Rayleigh). On the Irregular Flight of a Tennis Ball. Messenger of Mathematics. 7, 14, 1877, also Scientific Papers, Vol. I, p 344, Cambridge: 1899.
- (h) Glauert, H. Aerofoil and Aircsrew Theory. Cambridge: At the University Press. New York: The Macmillan Company, 1926.
- (i) Goldstein, Sidney (editor). Modern Developments in Fluid Dynamics. Vol. 1 and 2, Oxford at the Clarendon Press: 1938.
- (j) Rauscher, Manfred. Introduction to Aeronautical Dynamics. p 244-252, New York: John Wiley & Sons Inc., London: Chapman & Hall Ltd. 1953.
- (k) Lafay, M. Sur l'inversion du phenomenon de Magnus. Conte Rendu 151, 867, 1910.
- (l) Lafay, M. Contribution experimentale a l'aerodynamique du cylinder. Revue Mechanique 30, p 431 ff. 1912.
- (m) Fowler, R. H., E. G. Gallop, C. N. H. Lock and H. W. Richmond. The Aerodynamics of a Spinning Shell. Philosophical Transactions of the Royal Society. London: 1920.
- (n) Fowler, R. H. and C. N. H. Lock. The Aerodynamics of a Spinning Shell. Part II. Philosophical Transactions of the Royal Society. London: 1921.
- (o) Ackeret, J. Neuere Untersuchungen der Aerodynamischen Versuchsanstalt in Göttingen. Zeitschrift fur Flugtechnik und Motorluftschiffahrt. Feb. 14, 1925. translated in NACA Technical Memorandum No. 323. July 1925.
- (p) Flettner, Anton. Anwendung der Erkenntnisse der Aerodynamik zum Windvortrieb von Schiffen. Zeitschrift fur Flugtechnik und Motorluftschiffahrt, pp 52-63. Feb. 14, 1925.
- (q) Prandtl, Ludwig. Magnuseffekt und Windkraftschiff. (a lecture delivered before Physikalische Gesellschaft, Göttingen. November 17, 1924). Die Naturwissenschaften, Vol. XIII, pp 93-108, June 2, 1925. translated in NACA Technical Memorandum No. 367, June 1926.
- (r) Ackeret, J. Das Rotorschiff und seine physikalischen Grundlagen. Göttingen: Vanderhoeck and Ruprecht. 1925.
- (s) Betz, A. Der Magnus Effekt, die Grundlage der Flettnerwalze. Zeitschrift des Vereins Deutscher Ingenieure, January 3, 1925. translated in NACA Technical Memorandum No. 310, April 1925.

- (t) Bairstow, L. The Rotorship and Aeronautics. Nature, No. 2891, Vol. 115, pp 462-464, March 28, 1925.
- (u) Rizzo, F. The Flettner Rotor Ship in the Light of the Kutta-Joukowski Theory and of Experimental Results. NACA Technical Note No. 228. October 1925.
- (v) Ahlborn, F. Der Magnus Effekt in Theorie und Wirklichkeit. Zeitschrift fur Flugtechnik und Motor Luftschiffahrt, pp 642-653, December 28, 1929. translated in NACA Technical Memorandum No. 567.
- (w) Reid, Elliot G. Tests of Rotating Cylinders. NACA Technical Note No. 209, December 1924.
- (x) Wolff, E. B. Voorloopig Onderzoek naar den invloed van een draaiende rol aangebracht in een vleugteugprofiel. Report A 96 of the Rijkstudiedienst voor de Luchtvaart, Amsterdam. reprinted in De Ingenieur, No. 49, December 6, 1924. translated in NACA Technical Memorandum No. 309, March 1925.
- (y) Wolff, E. B. and C. Koning. Beschouwingen naar aanleiding van de grenslaagmetingen aan het model met draaiende rol. Report A 130 of the Rijkstudiedienst voor de Luchtvaart, Amsterdam. reprinted in De Ingenieur, December 25, 1926. translated in NACA Technical Memorandum No. 424, August 1927.
- (z) Wolff, E. B. and C. Koning. Tests for Determining the Effect of a Rotating Cylinder Fitted into the Leading Edge of an Airplane Wing. NACA Technical Memorandum No. 354, March 1926.

- (a.1) Prandtl, Ludwig and Oskar Tietjens. Kinematographische Strömungsbilder. Die Naturwissenschaften, Vol. 13, pp 1050-1053. translated in NACA Technical Memorandum No. 364, May 1926.
- (a.2) Kelley, J. L. and E. J. McShane. On the Motion of a Projectile with Small or Slowly Changing Yaw. Ballistic Research Laboratory Report No. 446, January 1944.
- (a.3) Turetsky, R. A. Reduction of Spark Data. Ballistic Research Laboratory Report No. 684, 1948.
- (a.4) Martin, John C. On Magnus Effects Caused by the Boundary Layer Displacement Thickness on Bodies of Revolution at Small Angles of Attack. Ballistic Research Laboratory Report No. 870, June 1953.
- (a.5) Kelly, Howard R. An Analytical Method for Predicting the Magnus Forces and Moments on Spinning Projectiles. U. S. Naval Ordnance Test Station Technical Memorandum No. 1634, 12 August 1954.
- (a.6) McShane, E. J., J. L. Kelley and F. V. Reno. Exterior Ballistics. The University of Denver Press, 1953.
- (a.7) Cornett, Raymond. Design of a Miniature High Speed Air Turbine for Spinning Wind Tunnel Models. Masterate Thesis, Department of Mechanical Engineering, University of Maryland, 1955.
- (a.8) Lightfoot, James R. The Naval Ordnance Laboratory Aeroballistics Research Facility. NAVORD Report 1079, 15 August 1950.
- (a.9) Shantz, Irving, Bernard D. Gilbert and Charles E. White. NOL Wind Tunnel Internal Strain-Gage Balance Systems. NAVORD Report 2972, 21 September 1953.
- (a.10) Sears, W. R. On Projectiles of Minimum Wave Drag, Quarterly of Applied Mathematics, Vol. IV No. 4, pp 361-366, January 1947.

Appendix

Data Reduction Equations

$$C_Y = -A_Y (\ell_3 - \ell_{30}) + B_Y (\ell_4 - \ell_{40})$$

$$C = A (\ell_3 - \ell_{30}) + B (\ell_4 - \ell_{40})$$

$$A_Y = K_3/q A (X_3 - X_4)$$

$$B_Y = K_4/q A (X_3 - X_4)$$

$$A = K_3(X - X_4)/qAD(X_3 - X_4)$$

$$B = K_4(X_3 - X)/qAD(X_3 - X_4)$$

$$q = (\gamma/2) (P/P_0) P_0 M^2$$

$$A = (\pi D^2/4)$$

$$\text{Center of Magnus} = (1 - X_\psi/D + C_\psi/C_Y) (D/L)$$

At zero degrees angle of attack:

$$\text{Center of Magnus} = [1 - X_\psi/D + (dC_\psi/d\alpha)/dC_Y/d\alpha] (D/L)$$

The Magnus Coefficients are:

$$C_{Y_{p\alpha}} = (d/d\alpha) (C_Y/p) (2V/D)$$

$$C_{\psi_p} = (d/d\alpha) (C_\psi/p) (2V/D)$$

$$V = M (\rho/\rho_0) \alpha_0$$

$$\alpha_0 = \sqrt{\gamma R T_0}$$

TABULATED DATA

<u>Run No.</u>	<u>Configuration</u>	<u>Type of Run</u>
1	Secant Ogive Nose	constant α , variable rpm
2	Cone Nose	constant α , variable rpm
3	Tangent Ogive Nose	constant α , variable rpm
4	Haack-Sears Nose	constant α , variable rpm
5	Typical Projectile Nose	constant α , variable rpm
7	Typical Projectile Nose	constant rpm, variable α
8	Cone Nose with No. 100 Grit	constant α , variable rpm

Explanation of Data Listing

<u>Program Identification</u>	<u>Group No.</u>	<u>Run/Blow</u>	<u>Spin Rate</u> (rps)	<u>C_y</u>	<u>C_z</u>	<u>Magnus</u> <u>C.P.</u> (% length from base)
241	01	1/01				
<u>Point No.</u>	<u>Indicated Angle</u> <u>of Attack</u>					
02	2.00	26.5	26.5	.0090	.0004	.4009
03	2.00	63.2	63.2	.0168	.0063	.4670
04	2.00	10.0	10.0	.0206	.0161	.5483
05	2.00	136.8	136.8	.0212	.0294	.6694

NAVORD REPORT 4425

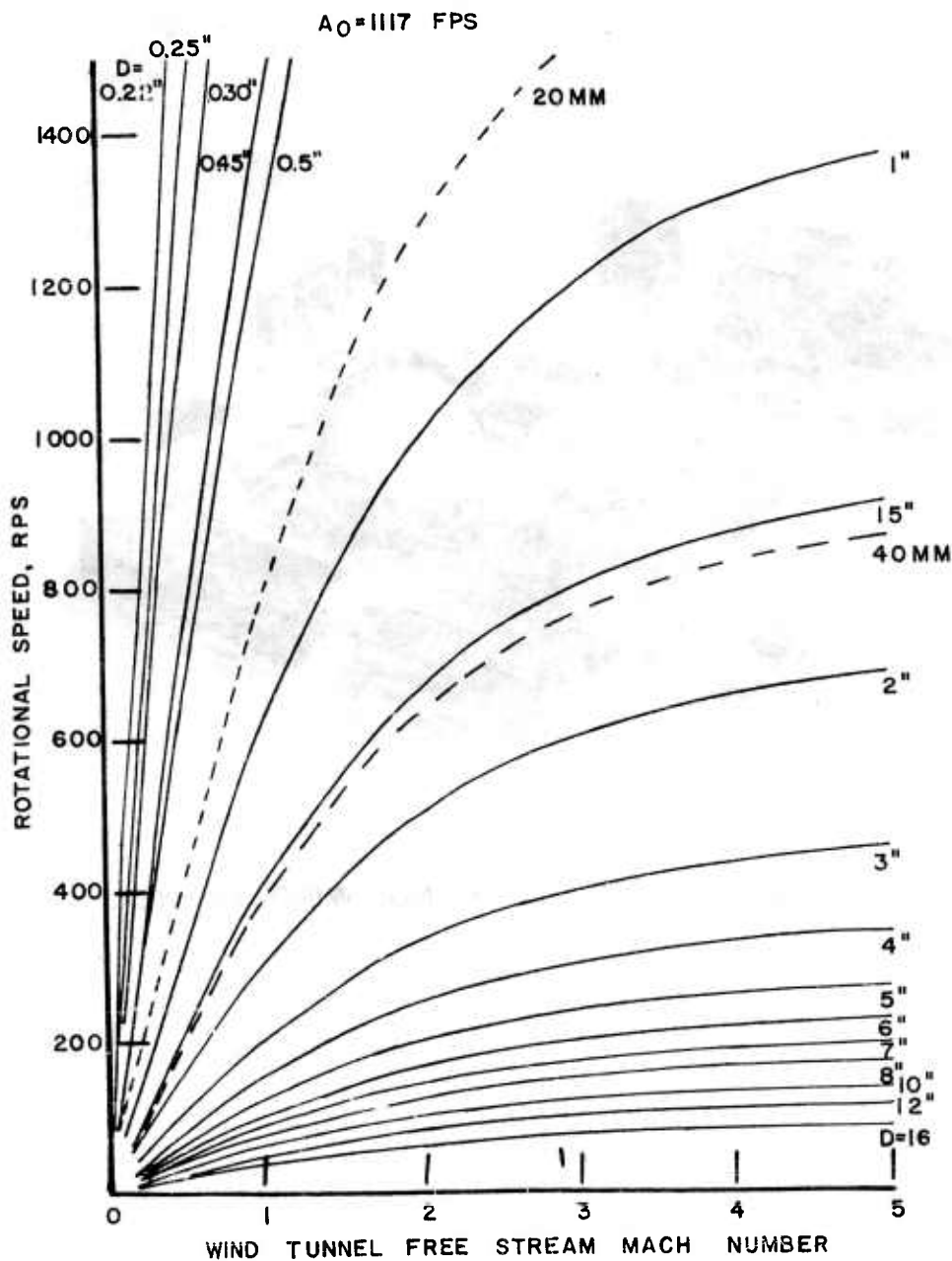

FIG.1 ROTATIONAL SPEED VS WIND TUNNEL MACH NUMBER FOR VARIOUS SIZE MODELS (ADVANCE RATIO = 1 IN 20)

NAVORD REPORT 4425

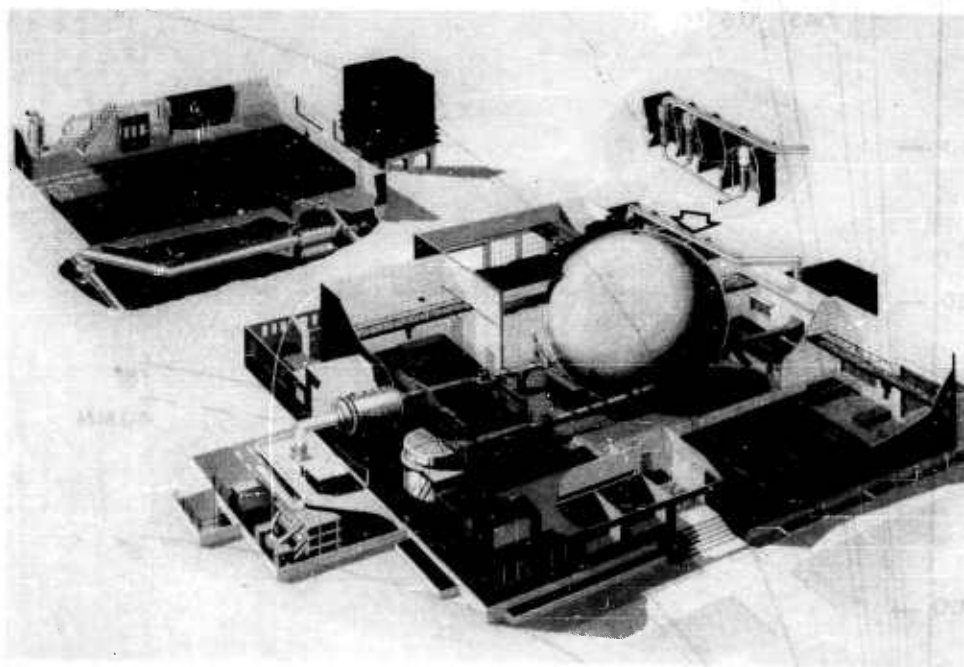

FIG. 2 CUTAWAY DRAWING OF THE NOL WIND TUNNEL BUILDING

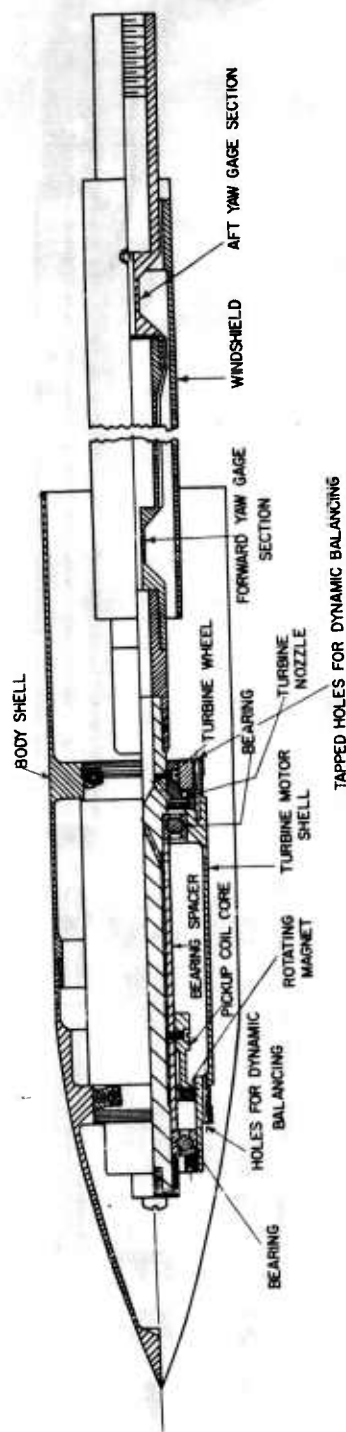

FIG. 3 ASSEMBLY DRAWING OF THE MODEL-AIR TURBINE UNIT

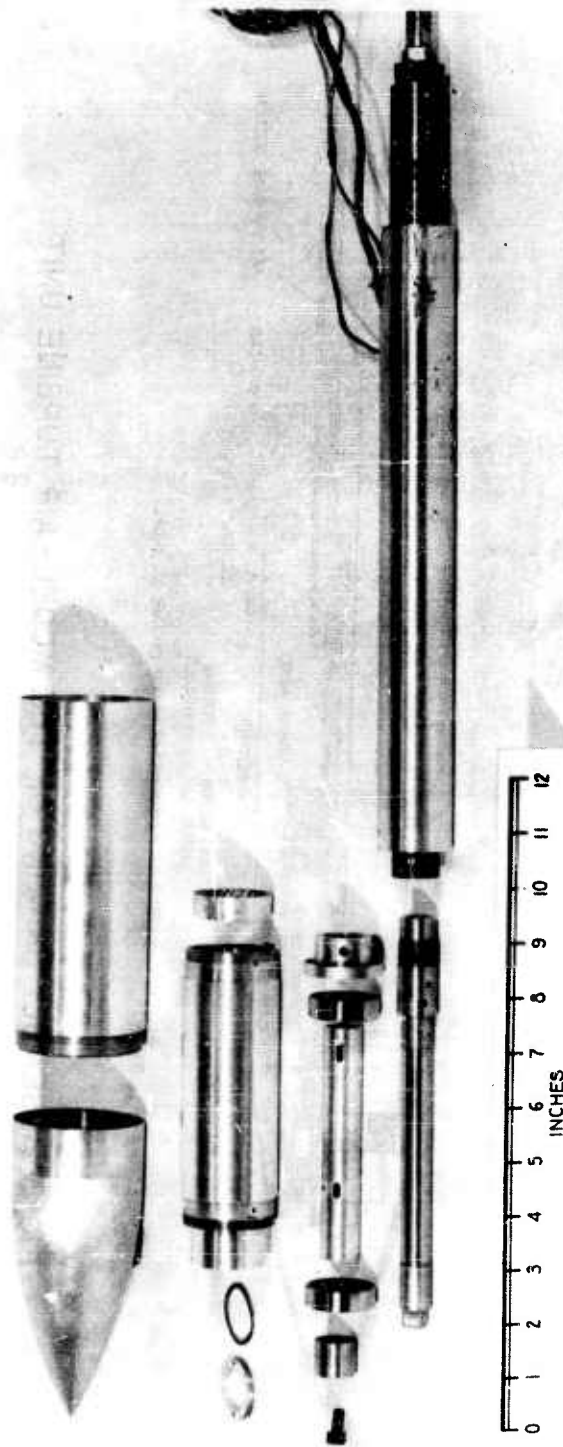

FIG. 4 EXPLODED MODEL-AIR TURBINE UNIT

NAVORD REPORT 4425

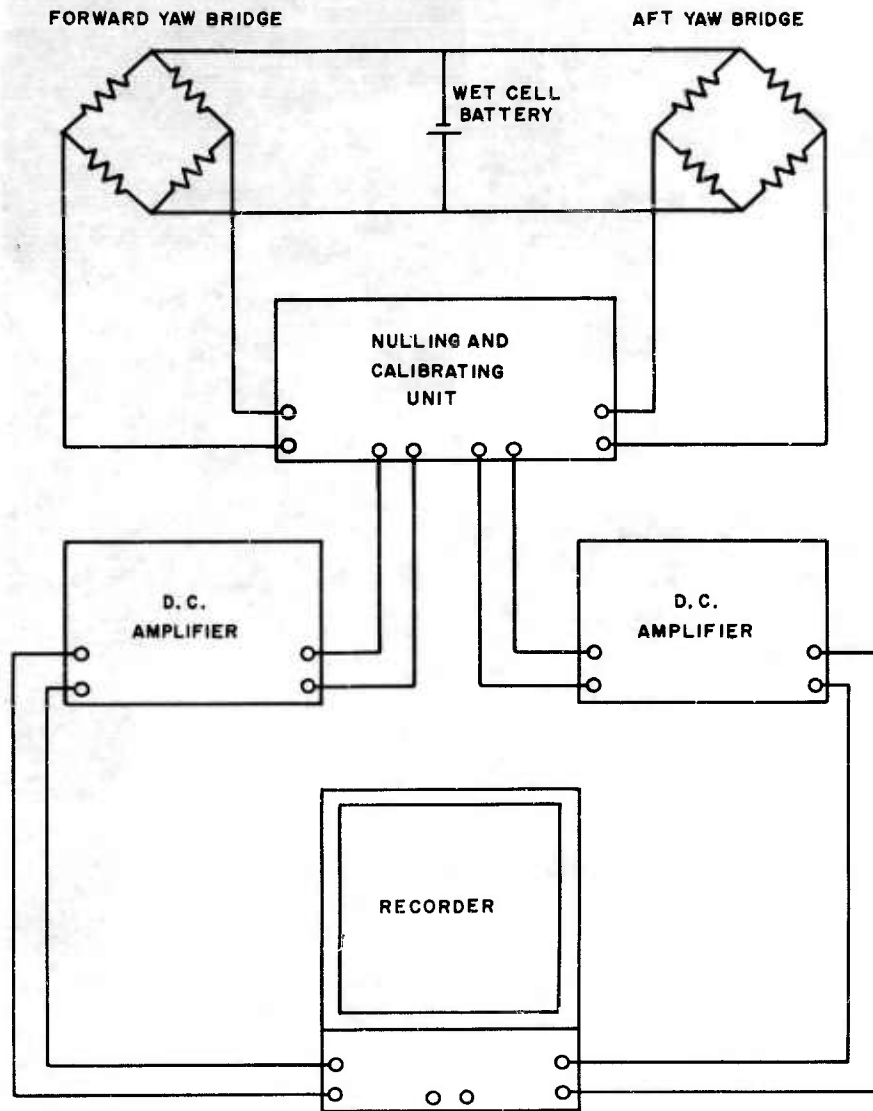

FIG. 5 DIAGRAMATIC SKETCH OF THE STRAIN GAGE READOUT SYSTEM

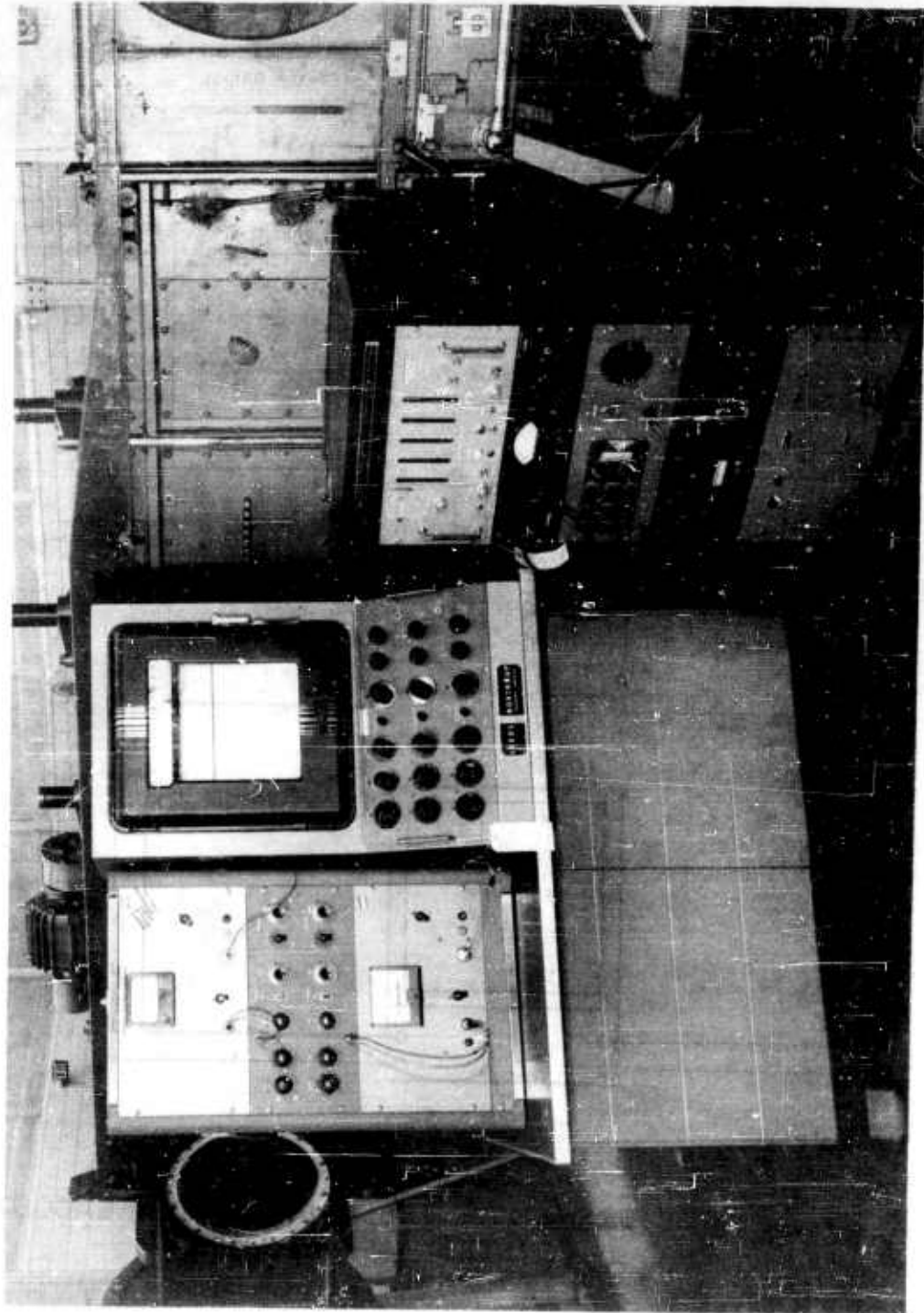

FIG. 6 STRAIN GAGE READOUT SYSTEM AND FREQUENCY CONSOLE

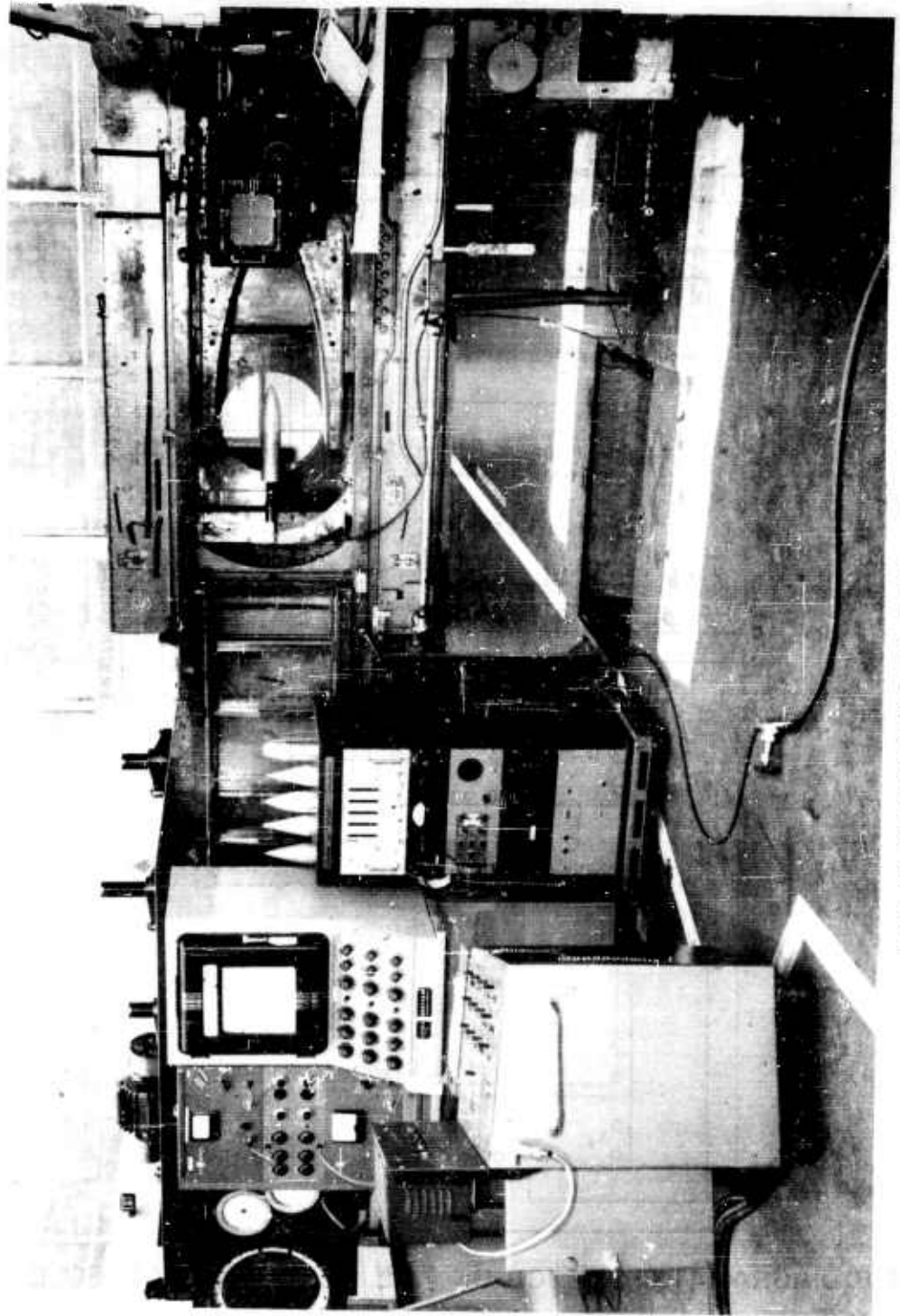

FIG. 7 WIND TUNNEL SET-UP

NAVORD REPORT 4425

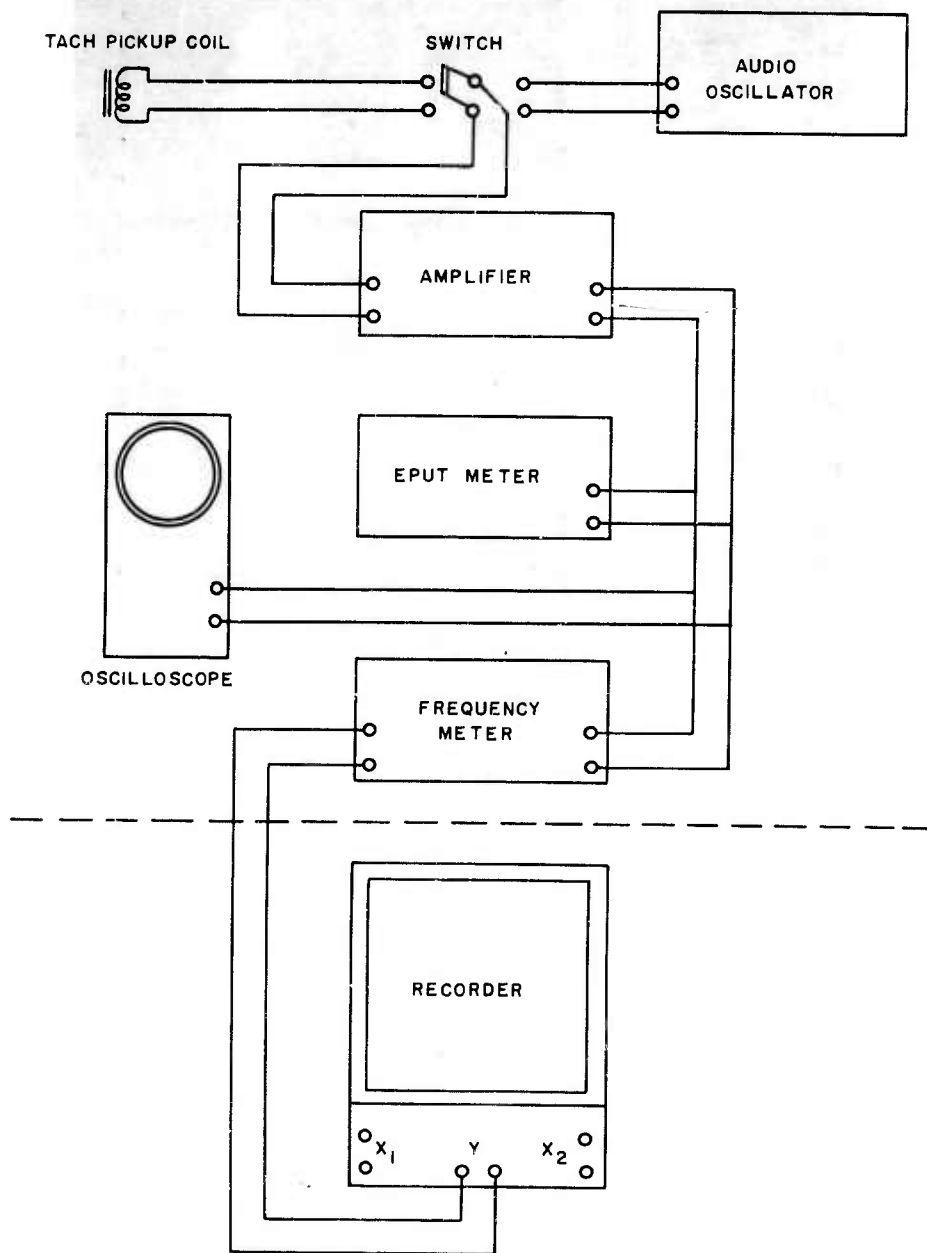

FIG. 8 DIAGRAMATIC SKETCH OF THE FREQUENCY CONSOLE

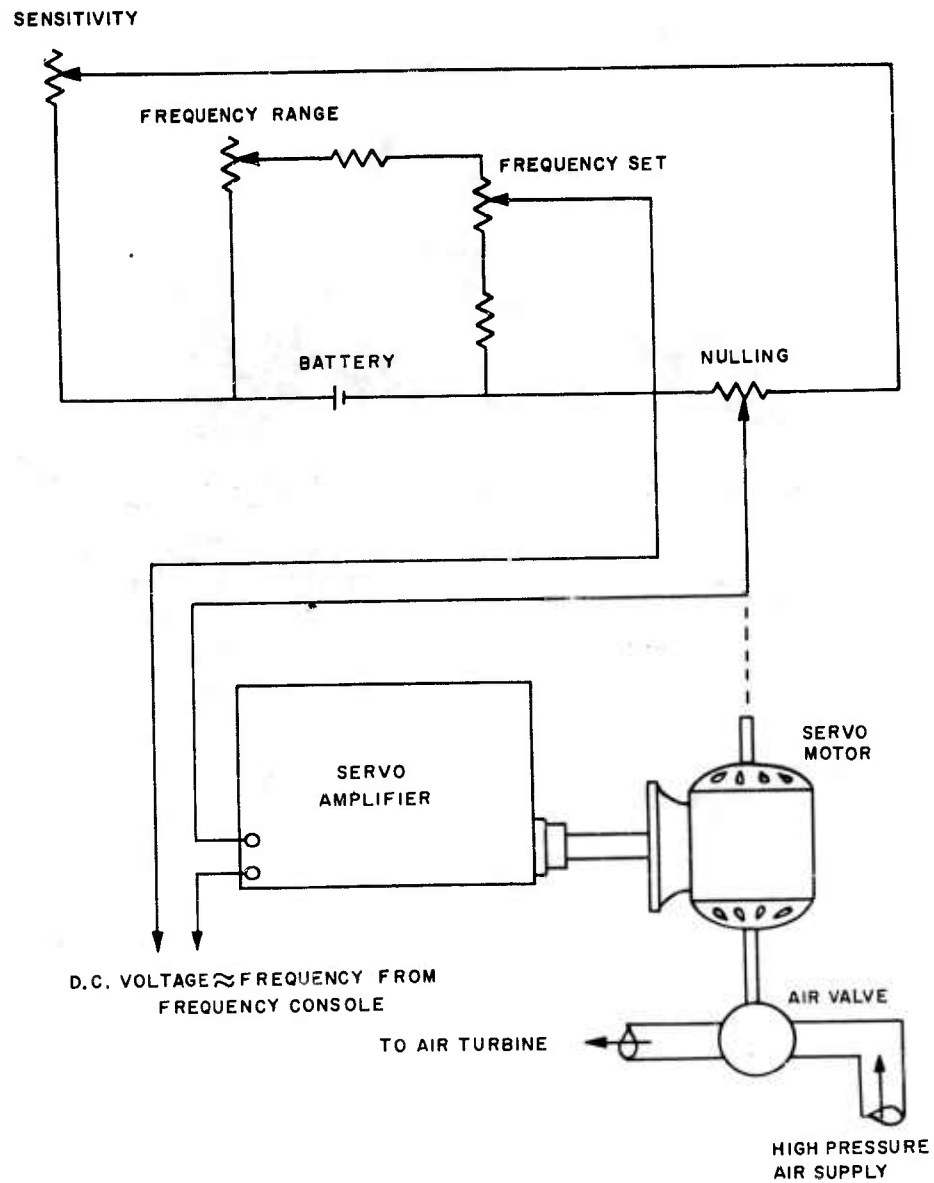

FIG. 9 SCHEMATIC DIAGRAM OF THE SERVO-SPEED CONTROL

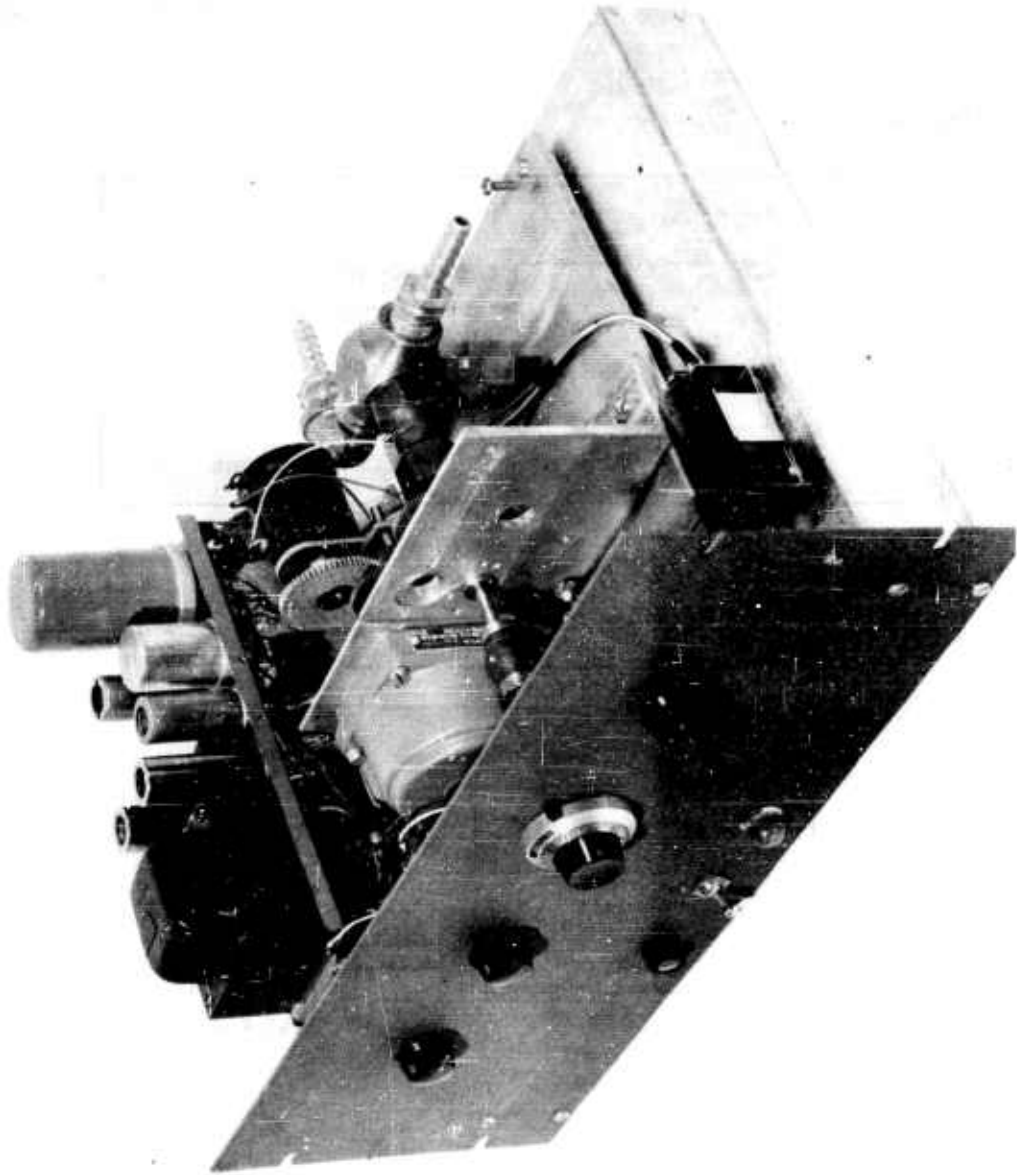

FIG. 10 SERVO-SPEED CONTROL

0

0

0

0

8

NAVORD REPORT 4425

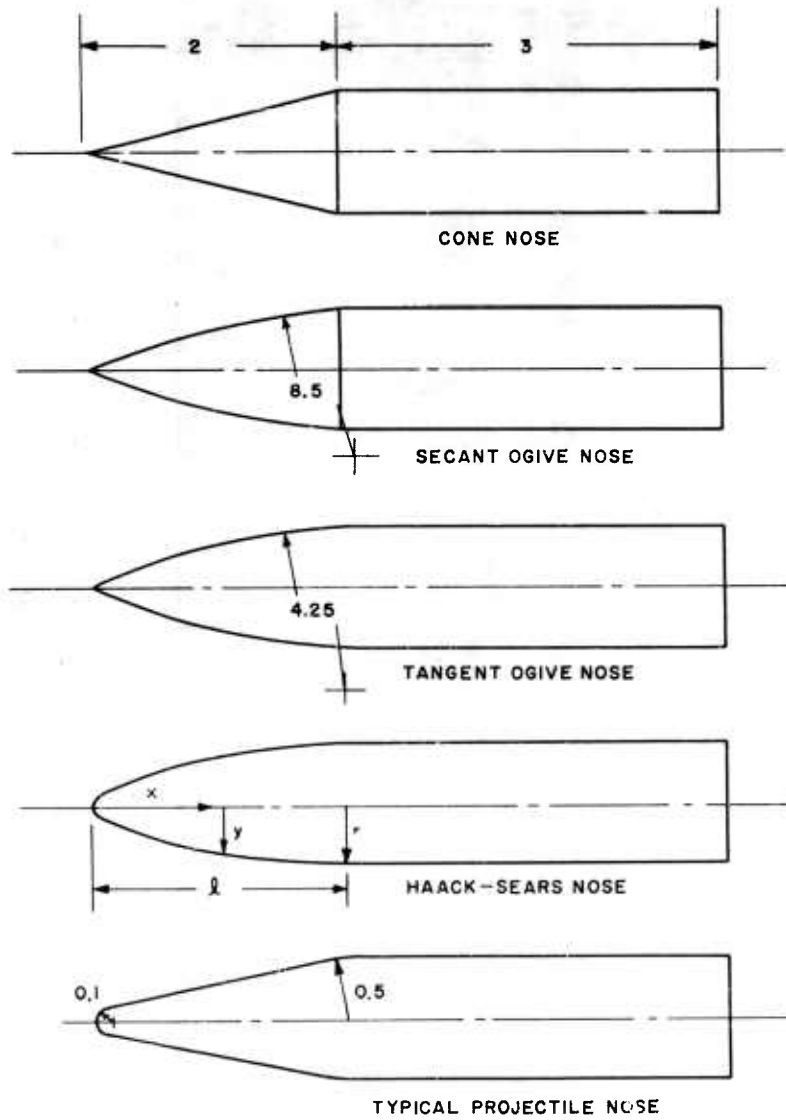

ALL DIMENSIONS GIVEN IN BODY DIAMETERS (D = 3.0 INCHES)

FIG. II MODEL DIMENSIONS

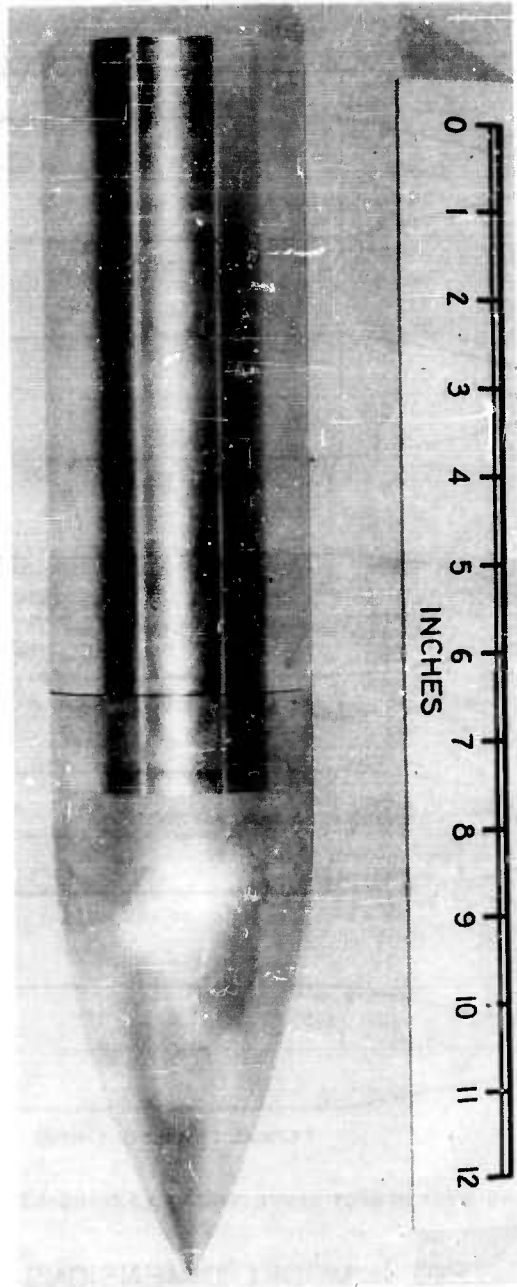

FIG. 12 ASSEMBLED MODEL WITH THE TANGENT
OGIVE NOSE

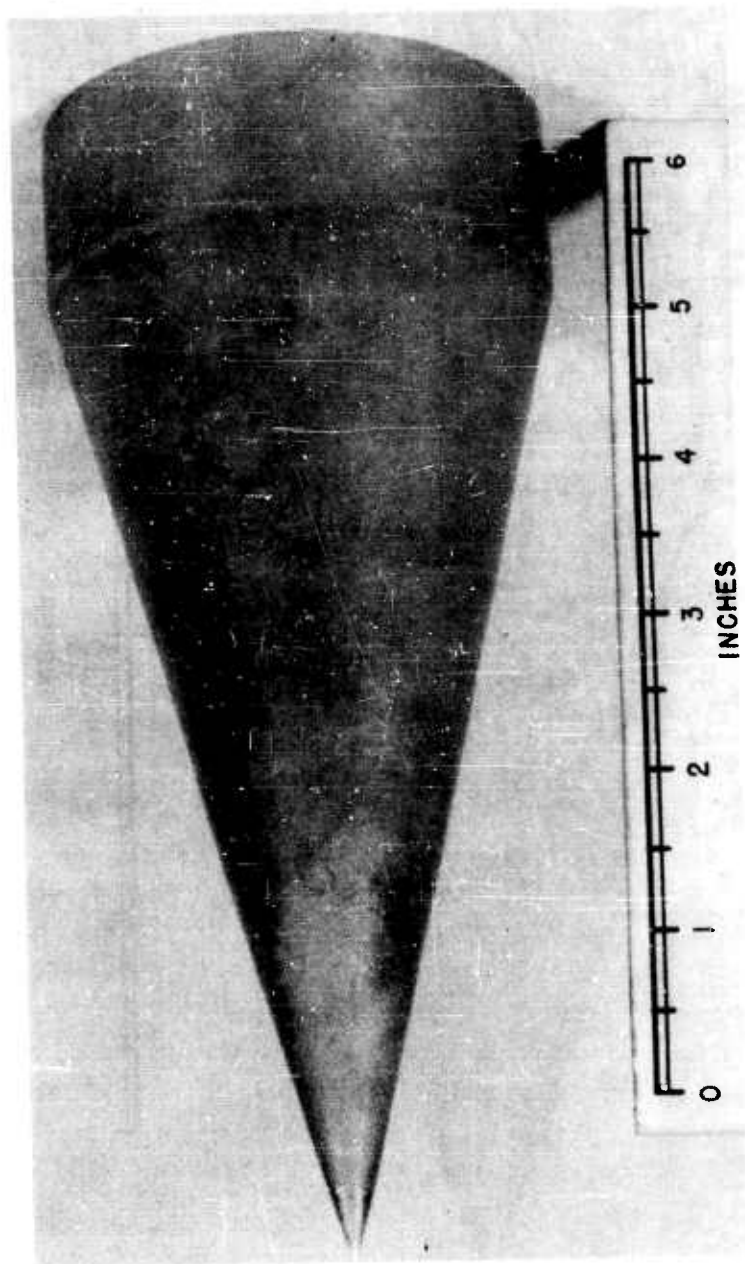

FIG. 13 CONE NOSE

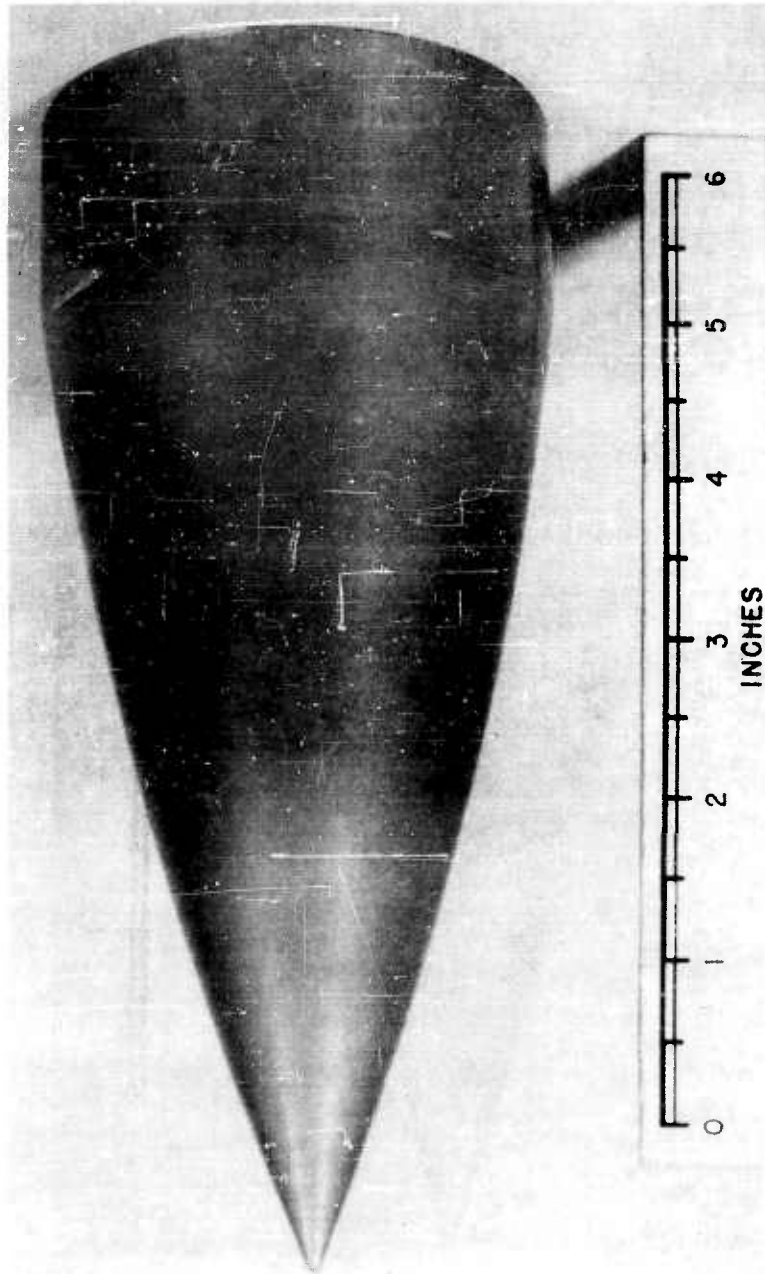

FIG. 14 SECANT OGIVE NOSE

0

0

0

0

B

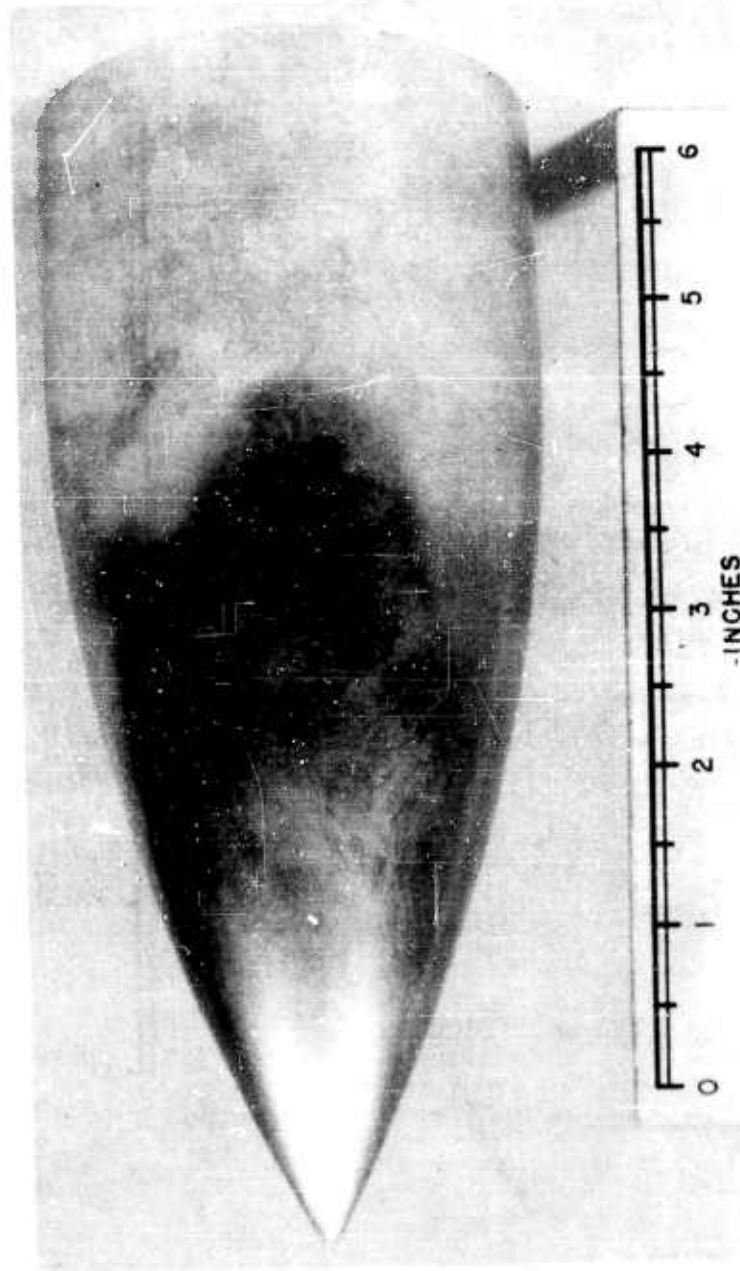

FIG. 15 TANGENT OGIVE NOSE

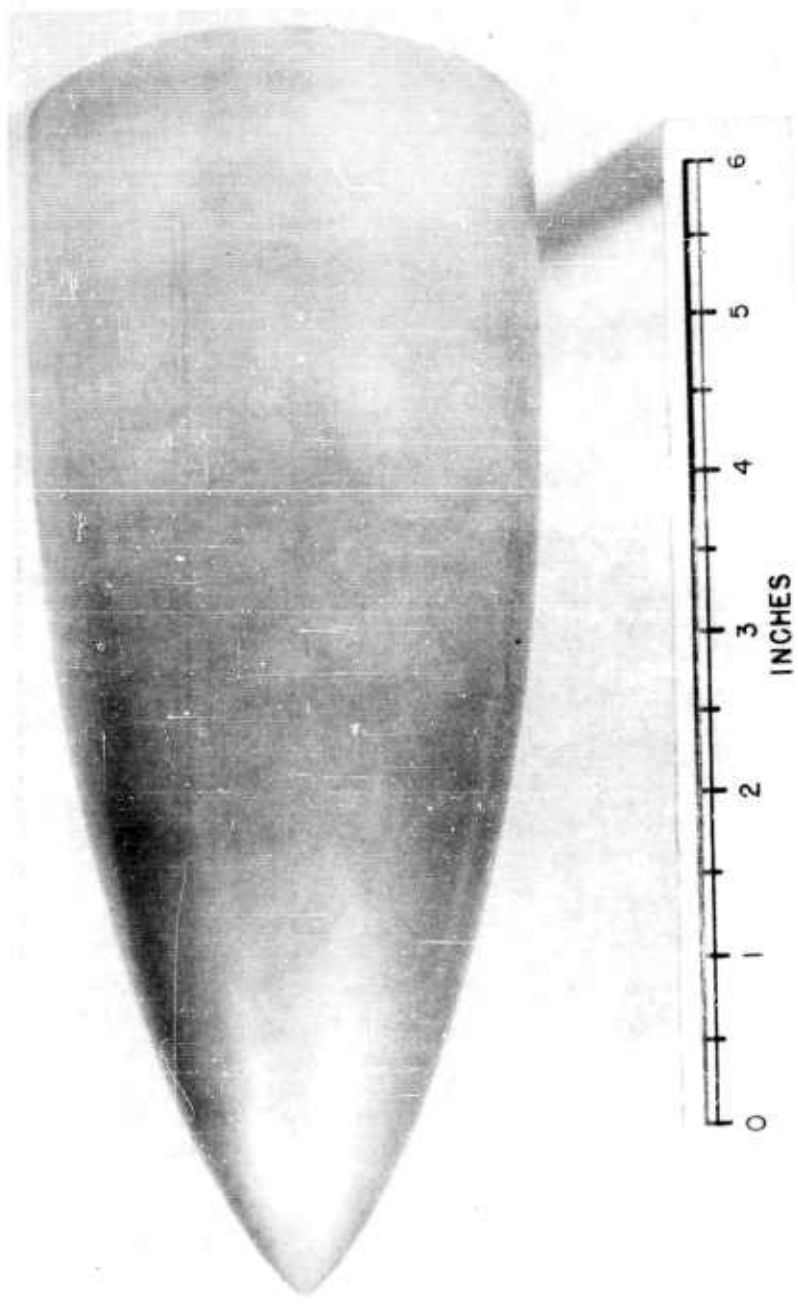

FIG. 16 HAACK-SEARS NOSE

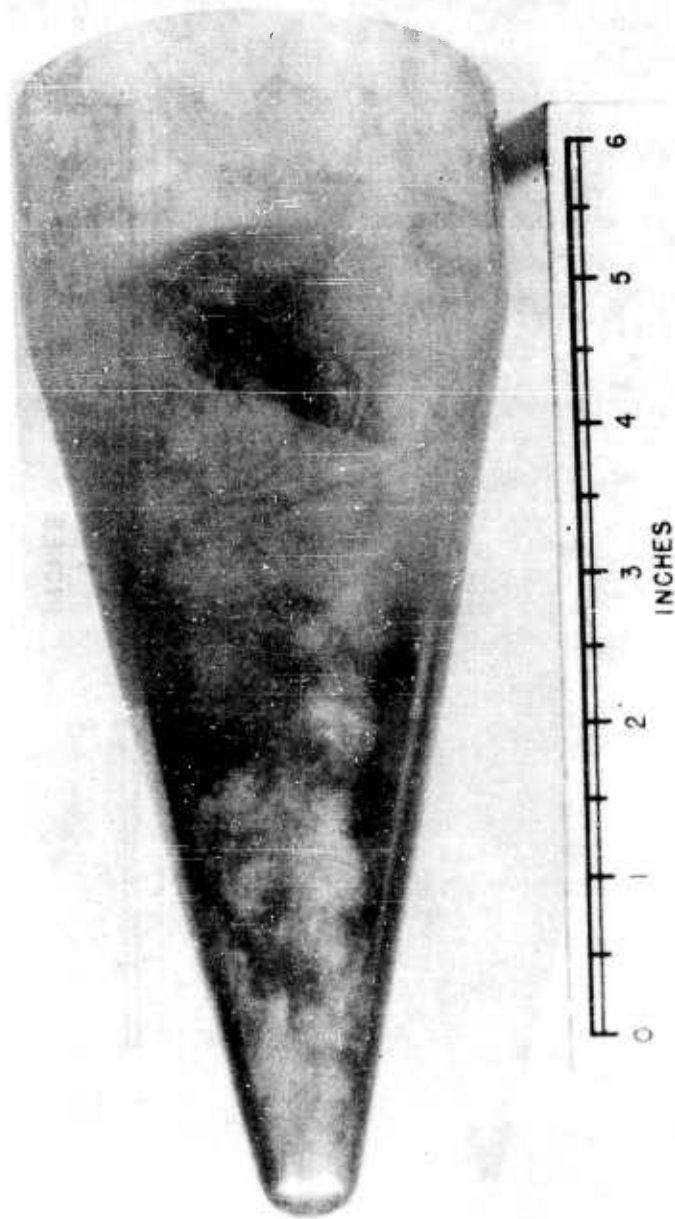

FIG. 17 TYPICAL PROJECTILE NOSE

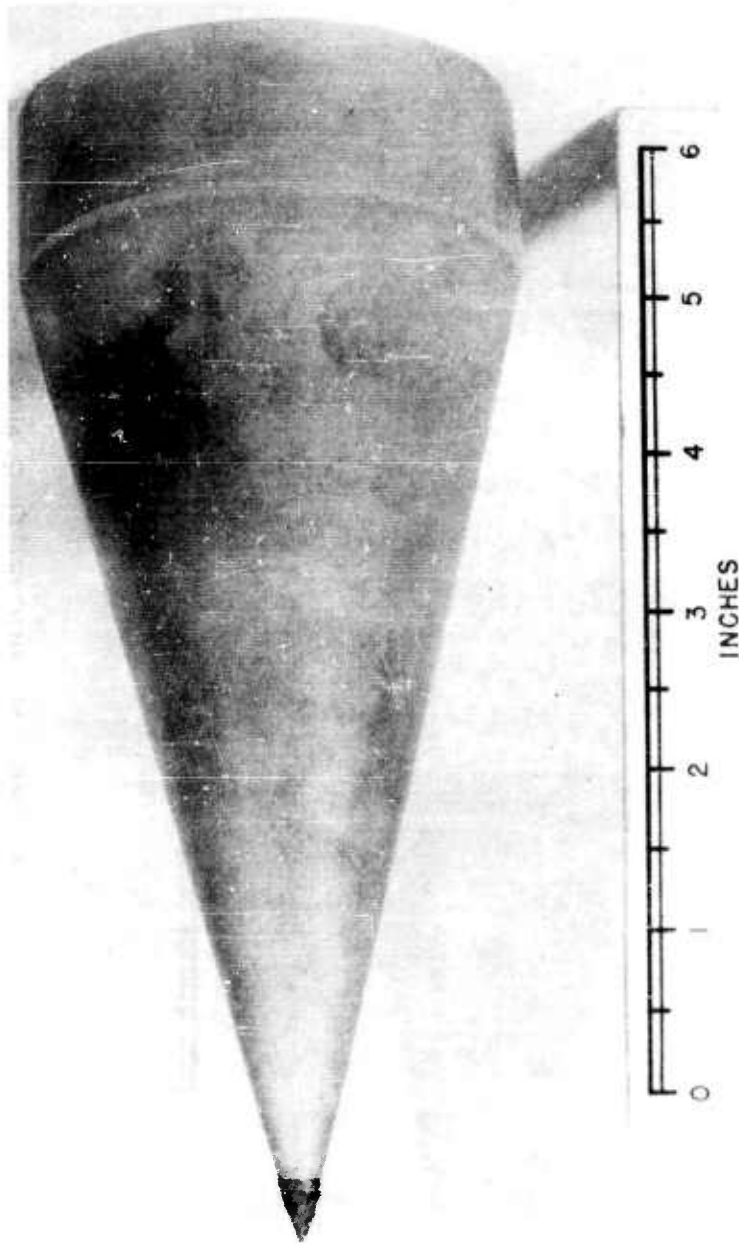

FIG. 18 CONE NOSE WITH NUMBER 100 GRIT

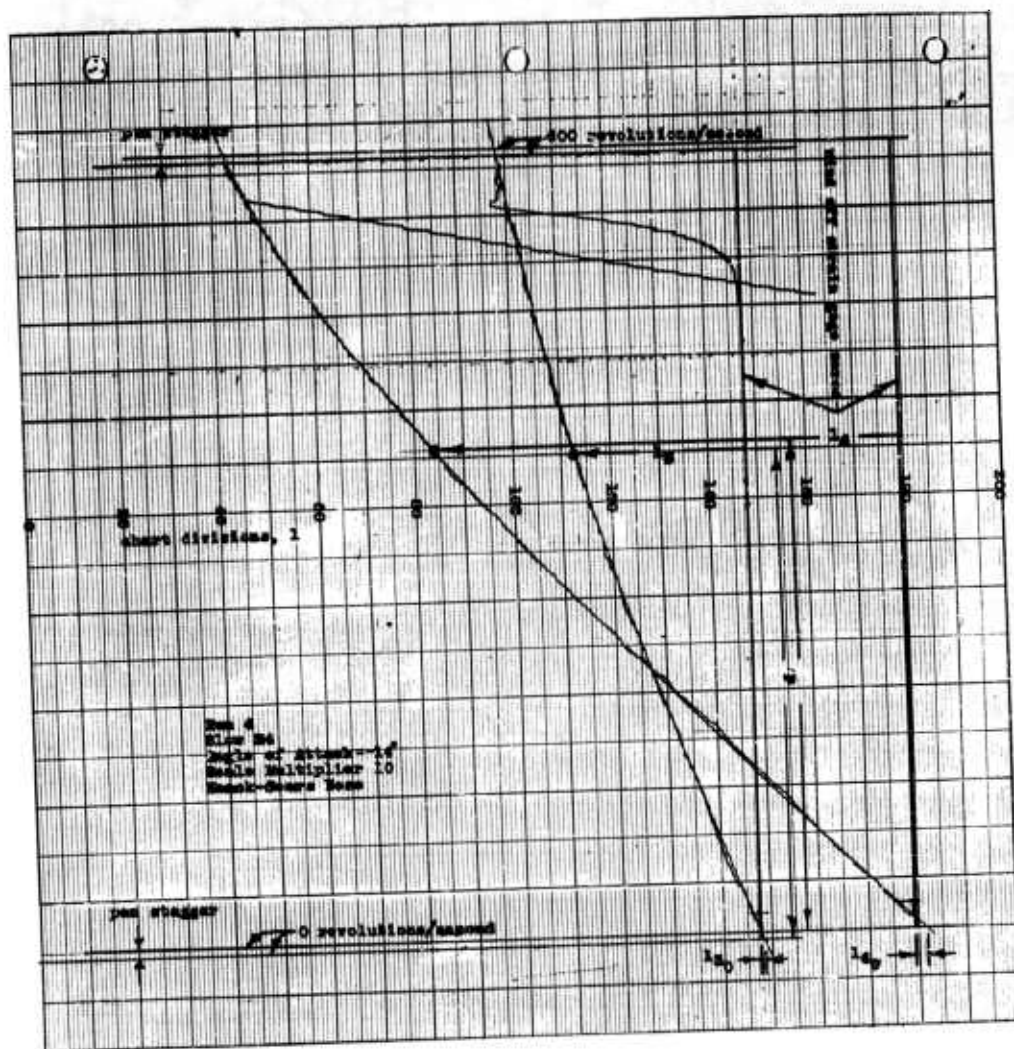

FIG. 19 SAMPLE TRACES OF THE CONSTANT ANGLE OF ATTACK,
VARIABLE SPIN TYPE OF BLOW

NAVORD REPORT 4425

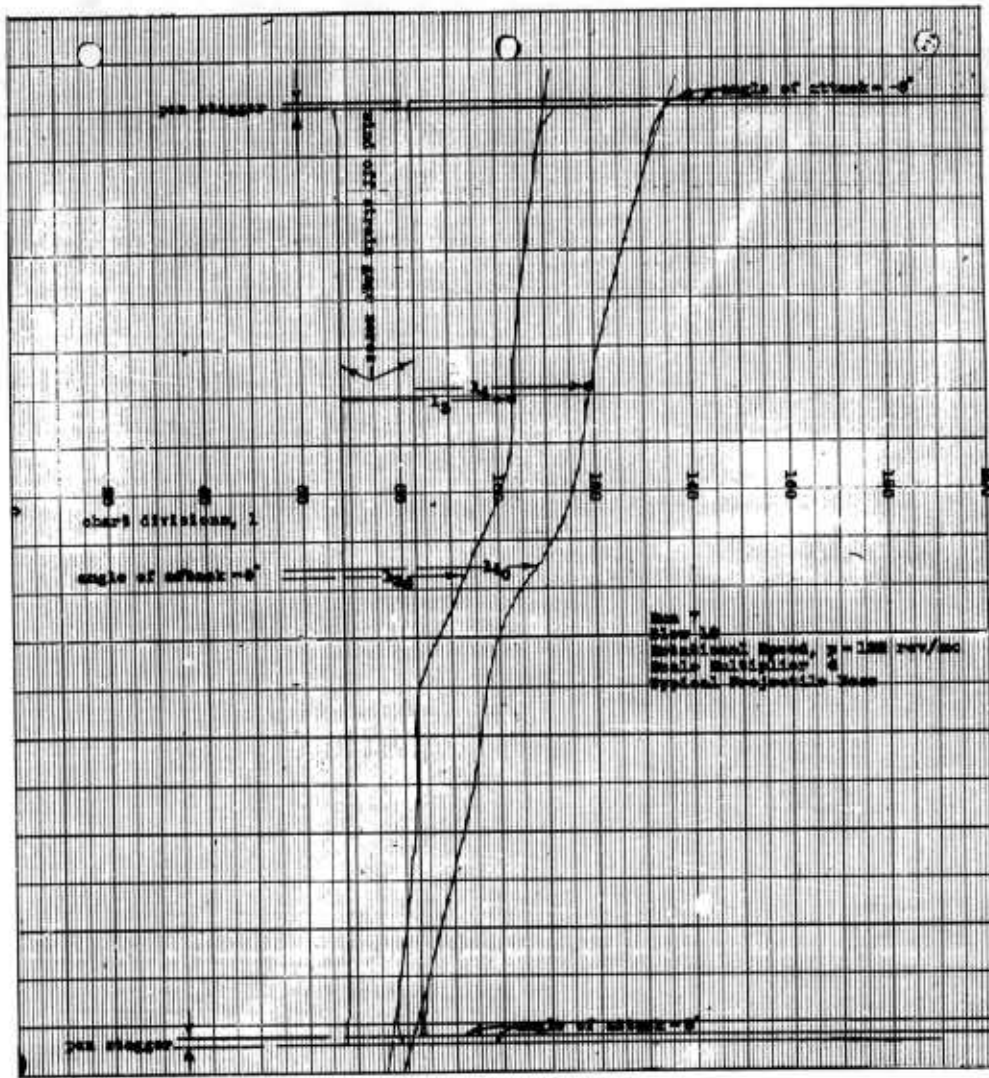
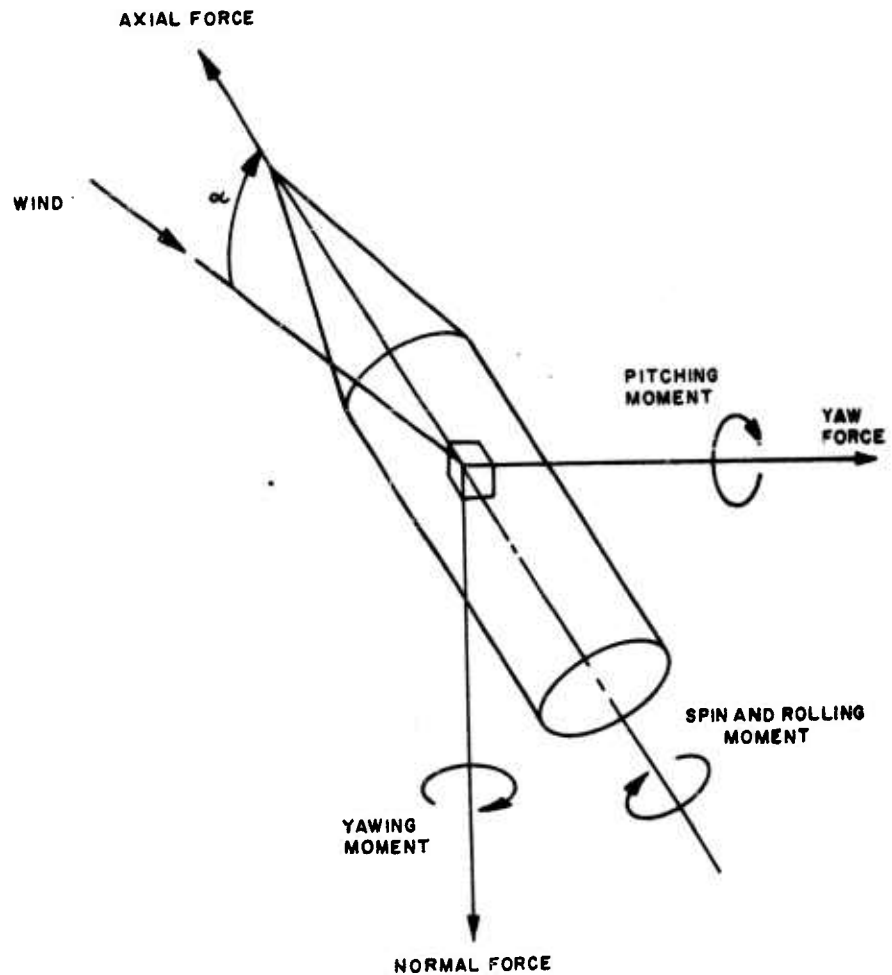

FIG. 20 SAMPLE TRACES OF THE CONSTANT SPIN, VARIABLE ANGLE OF ATTACK TYPE OF BLOW



ARROWS INDICATE POSITIVE DIRECTION

FIG. 21 FORCE AND MOMENT COORDINATE SYSTEM

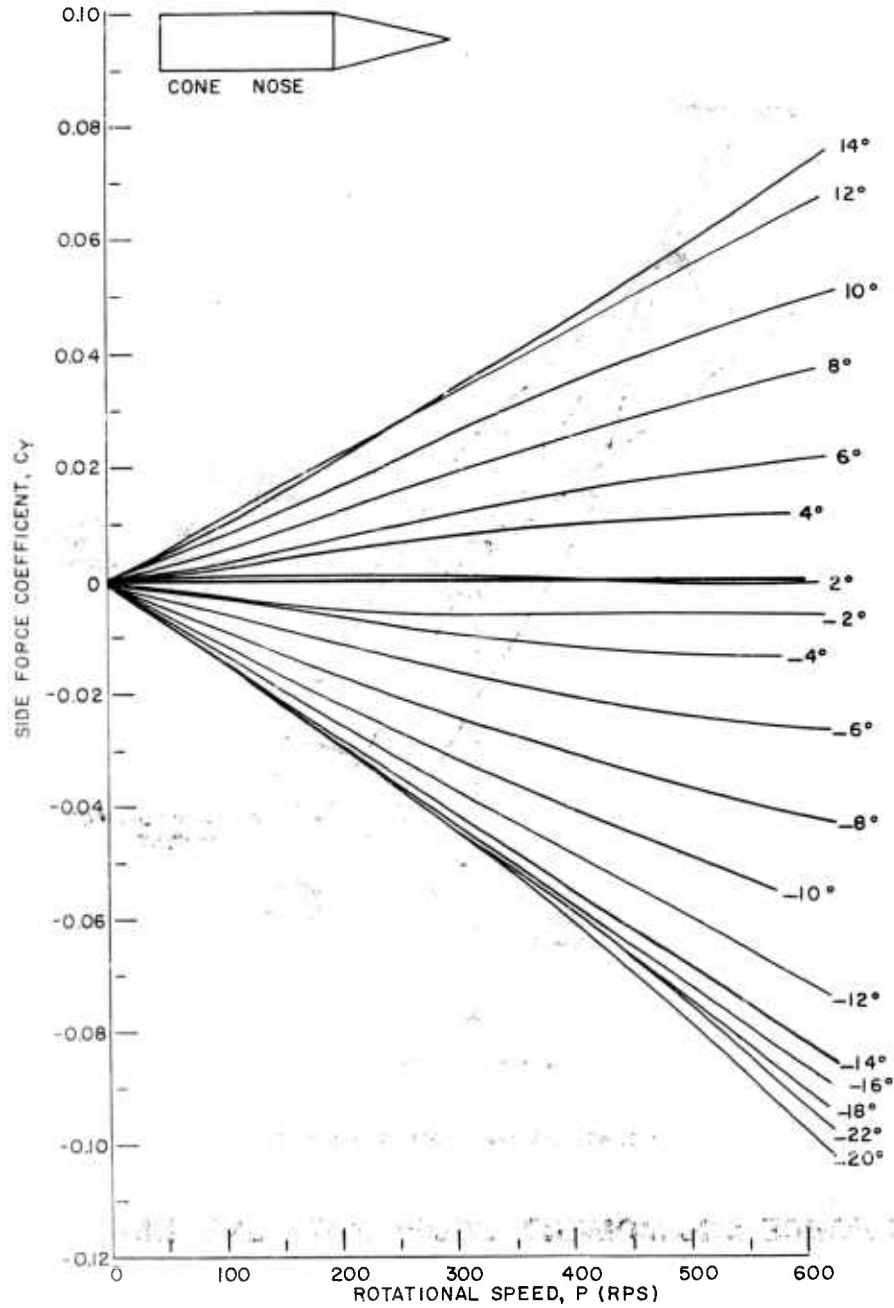

FIG. 22 SIDE FORCE COEFFICIENT, C_y , VS ROTATIONAL SPEED, P , CONE NOSE

NAVORD REPORT 4425

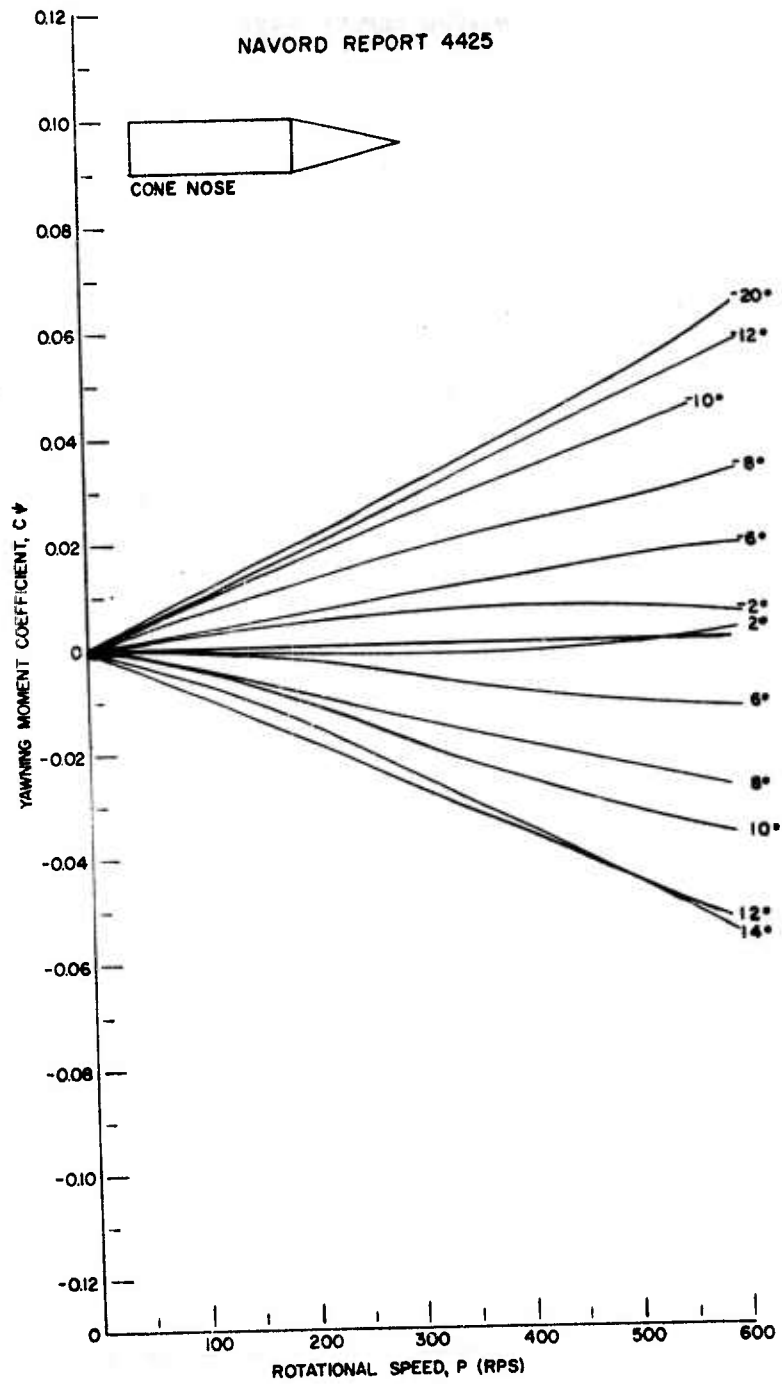

FIG. 23 YAWING MOMENT COEFFICIENT, C_ψ , VS
ROTATIONAL SPEED, P, CONE NOSE

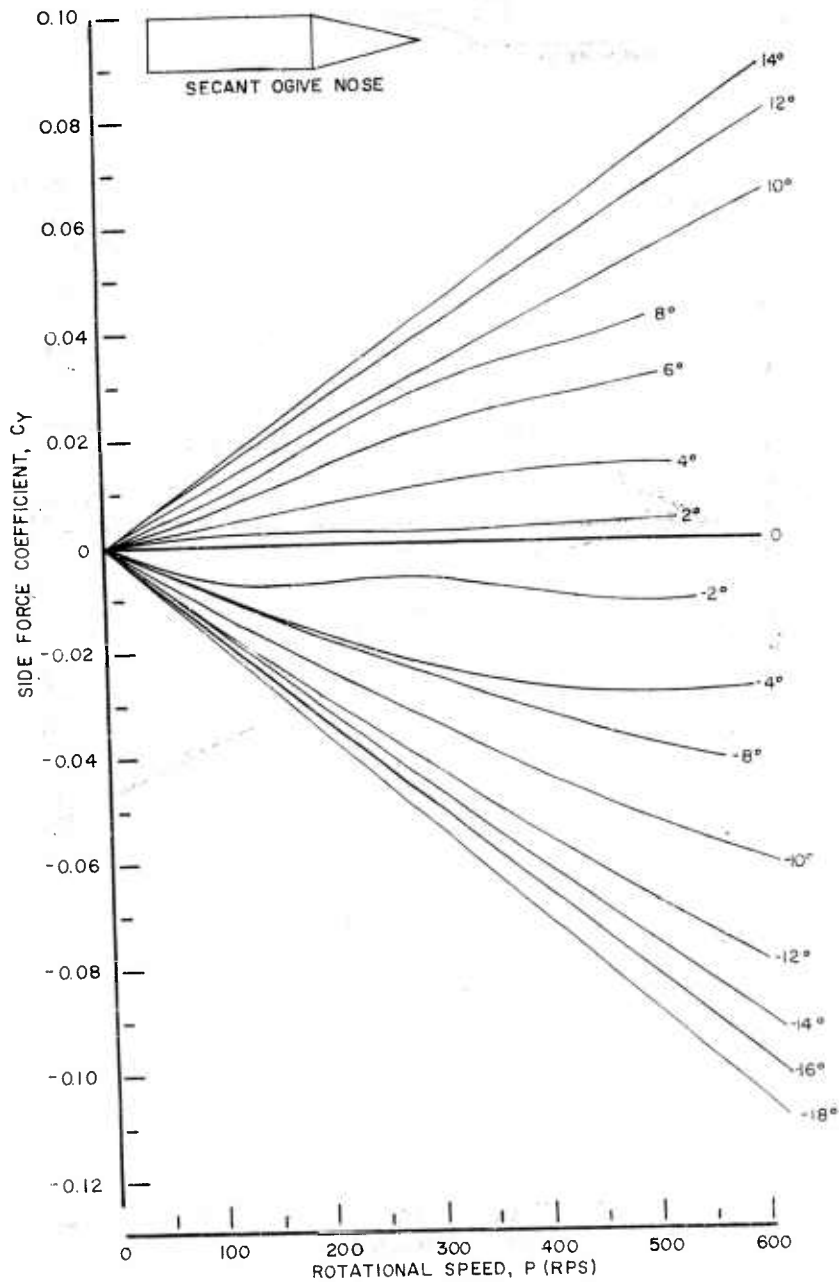

FIG. 24 SIDE FORCE COEFFICIENT, C_Y, VS ROTATIONAL SPEED, P, (RPS)-SECANT OGIVE NOSE

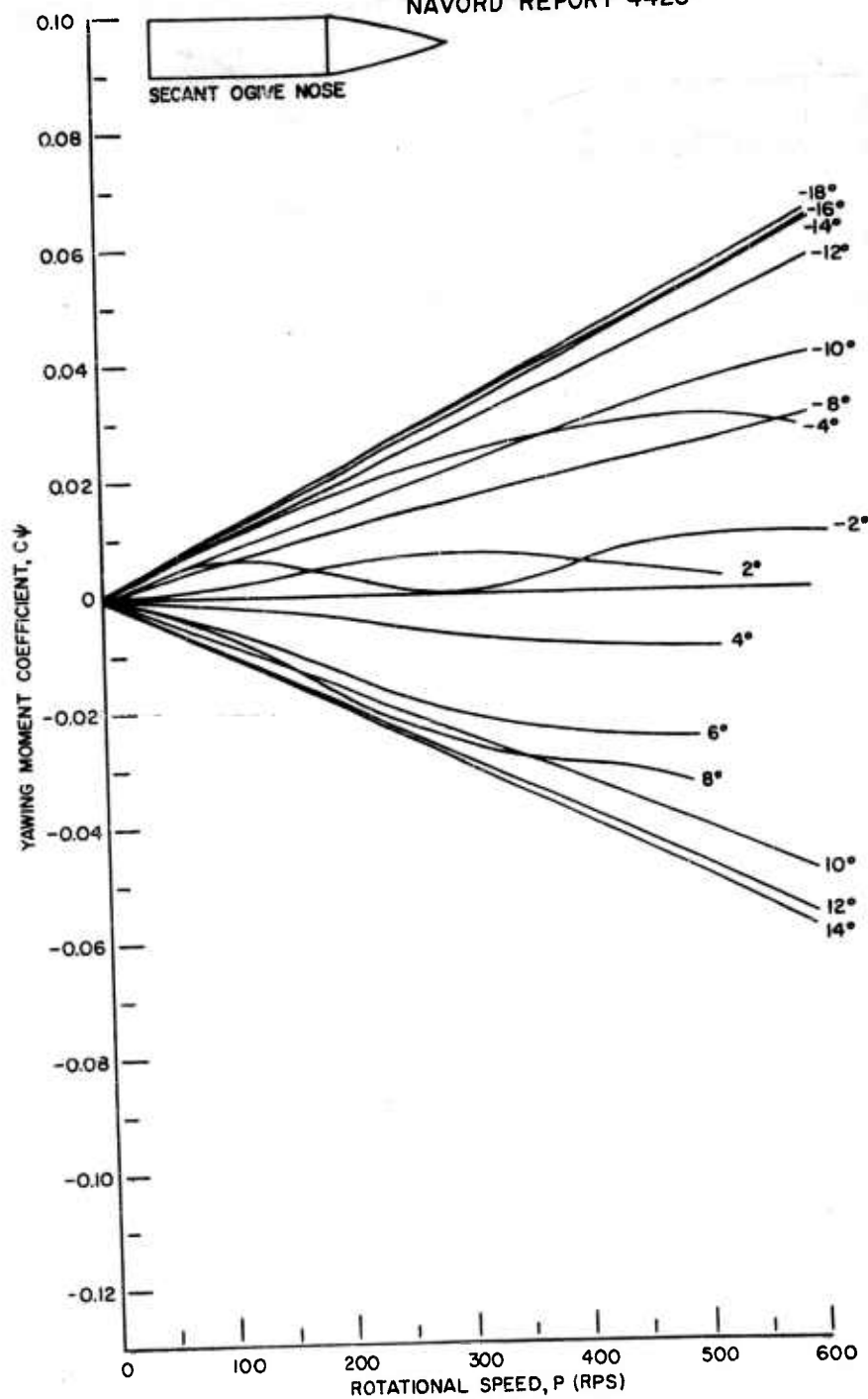

FIG. 25 YAWING MOMENT COEFFICIENT, C ψ , VS ROTATIONAL SPEED, P,-SECANT OGIVE NOSE

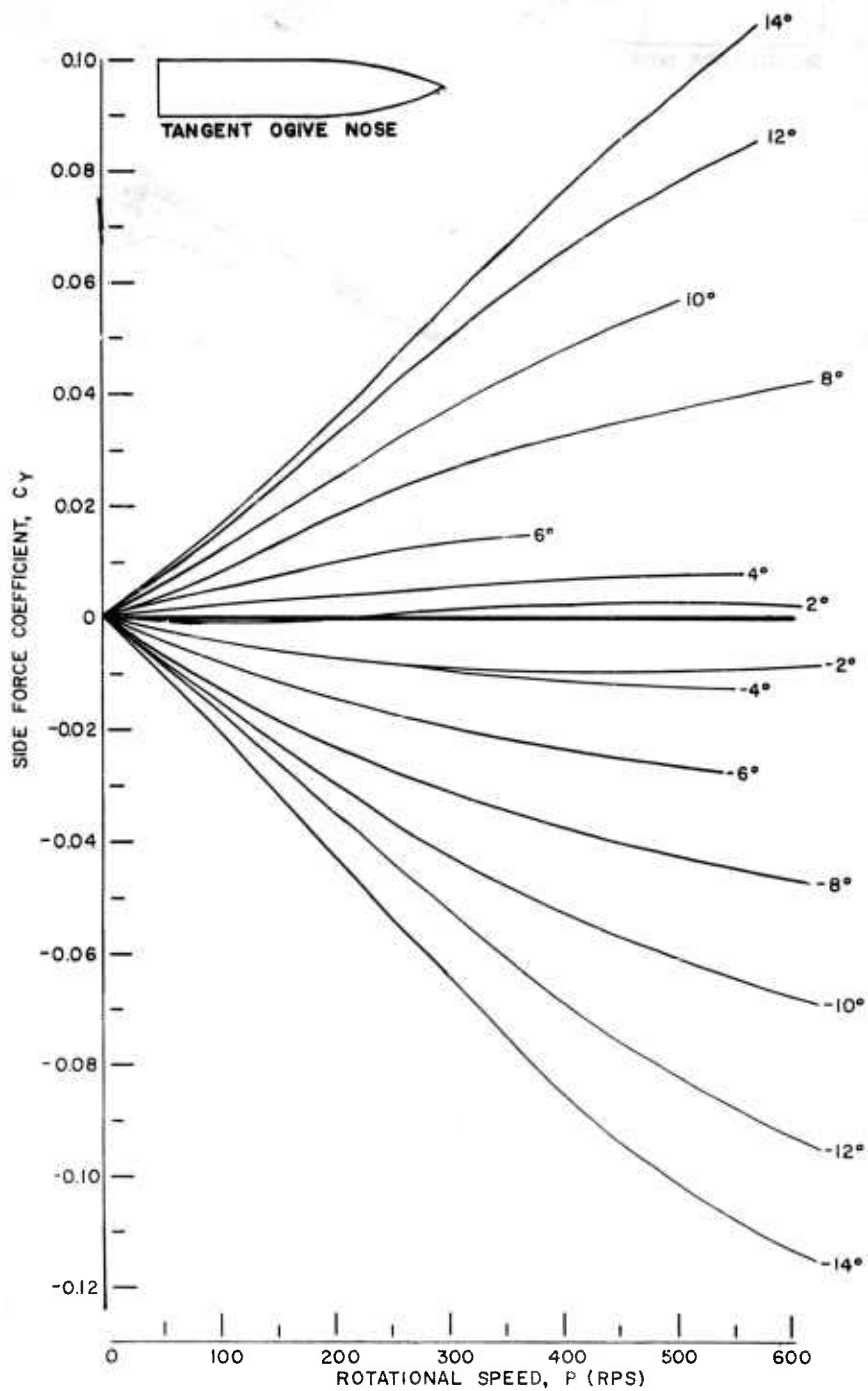

FIG. 26 SIDE FORCE COEFFICIENT, C_Y, VS ROTATIONAL SPEED, P-TANGENT OGIVE NOSE

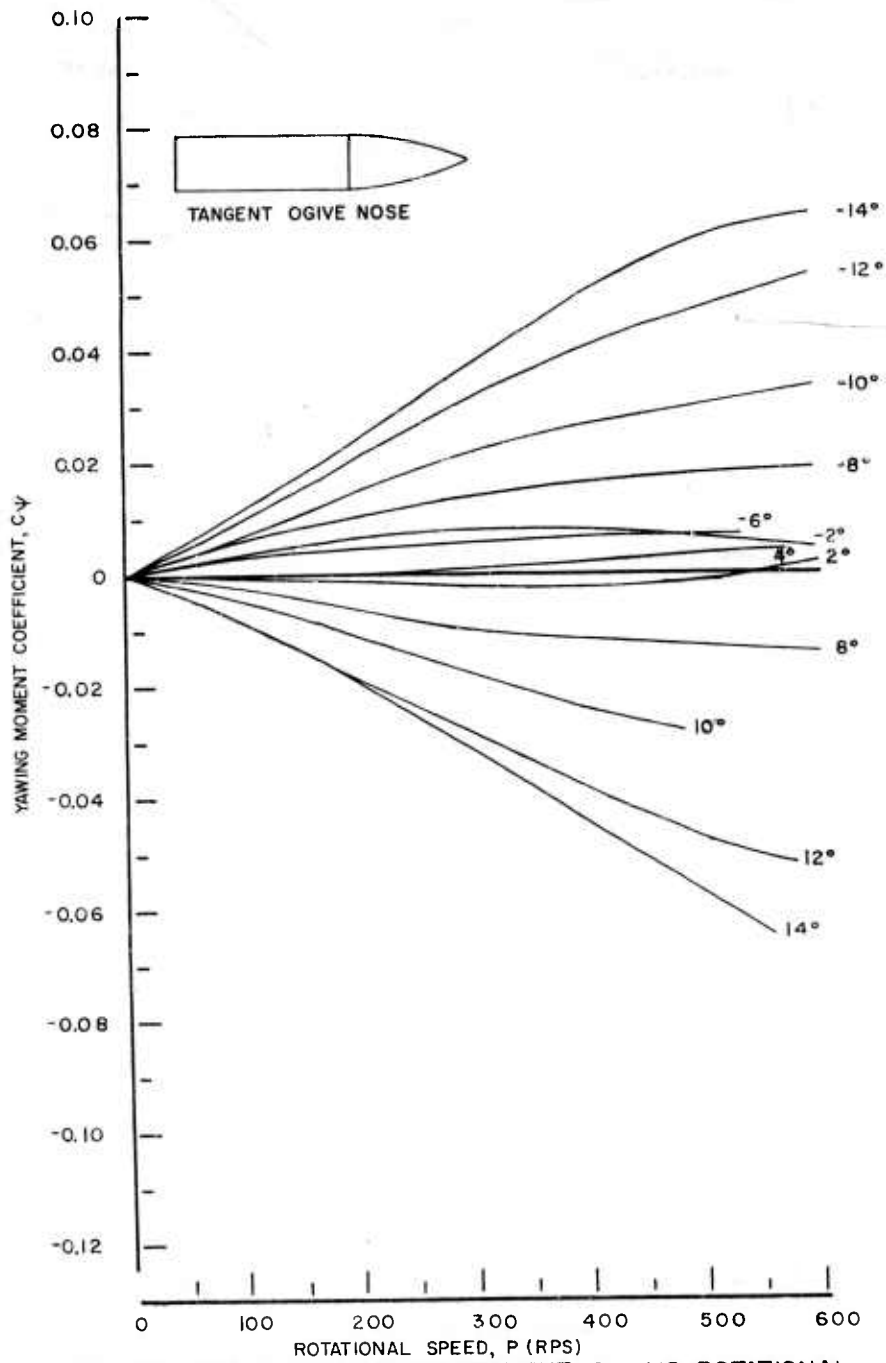

FIG. 27 YAWING MOMENT COEFFICIENT, C_ψ , VS ROTATIONAL SPEED, P, - TANGENT OGIVE NOSE

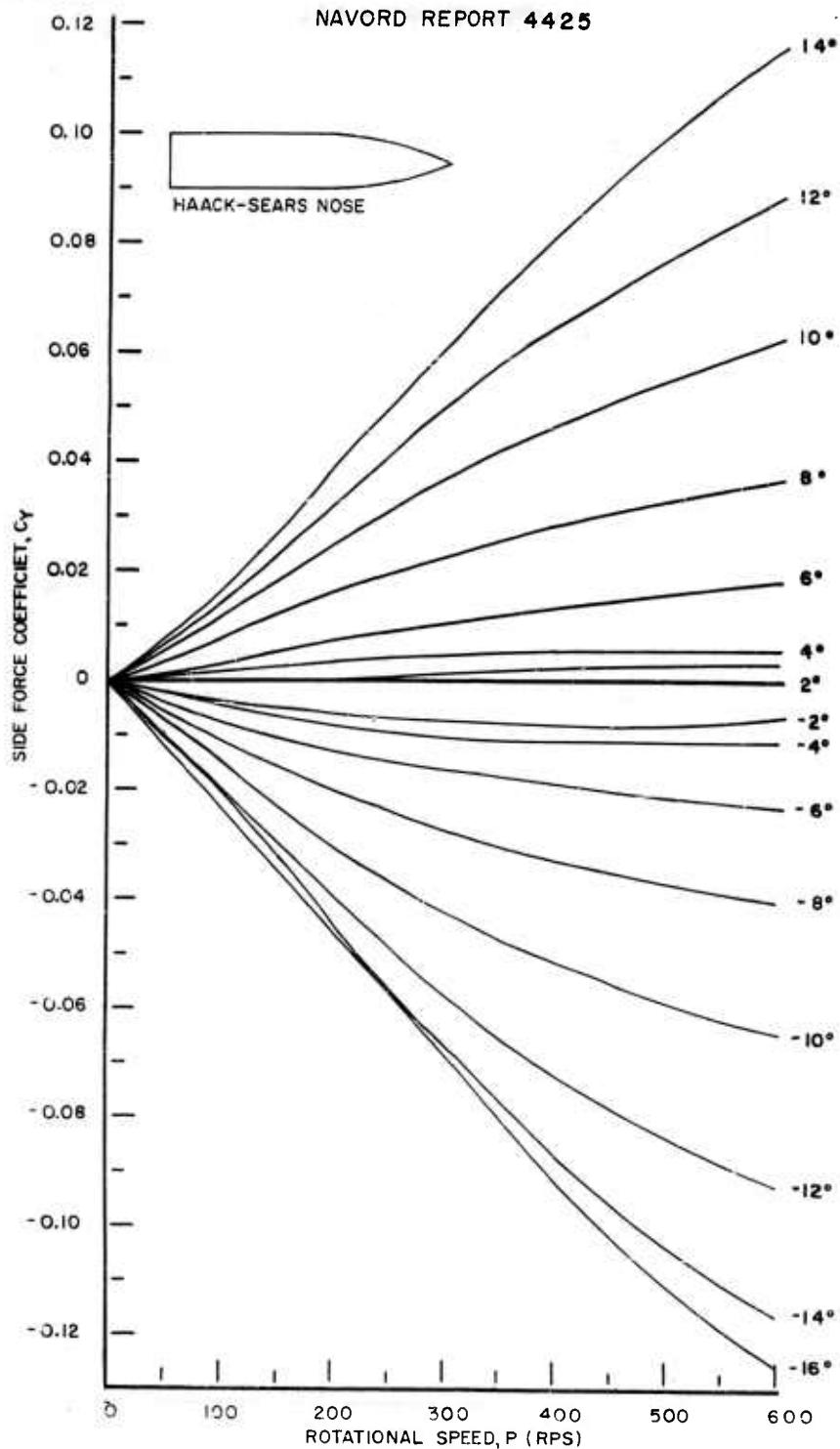

FIG. 28 SIDE FORCE COEFFICIENT, C_y VS ROTATIONAL SPEED, P , - HAACK-SEARS NOSE

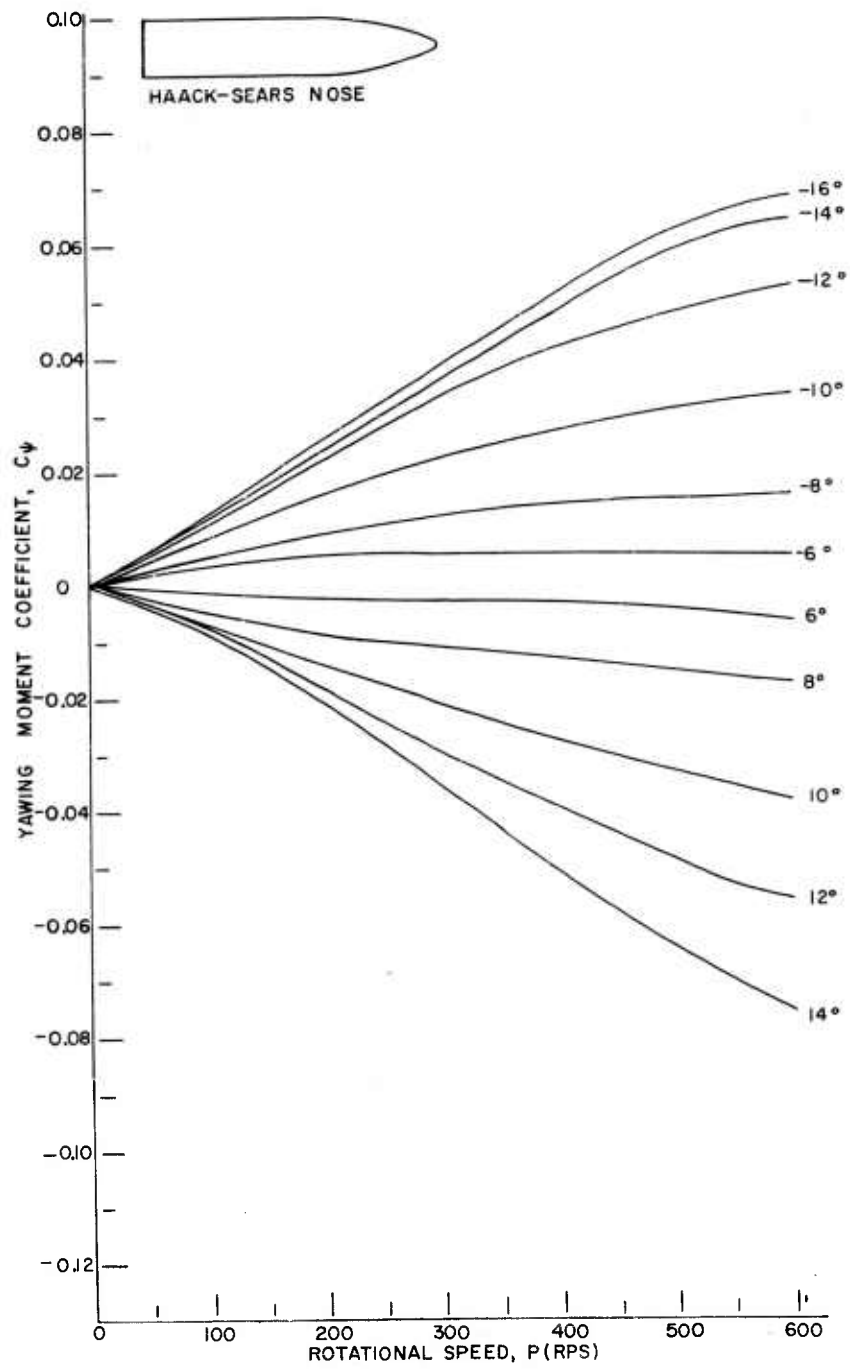

FIG. 29 YAWING MOMENT COEFFICIENT, C_ψ VS ROTATIONAL SPEED, P; HAACK-SEARS NOSE

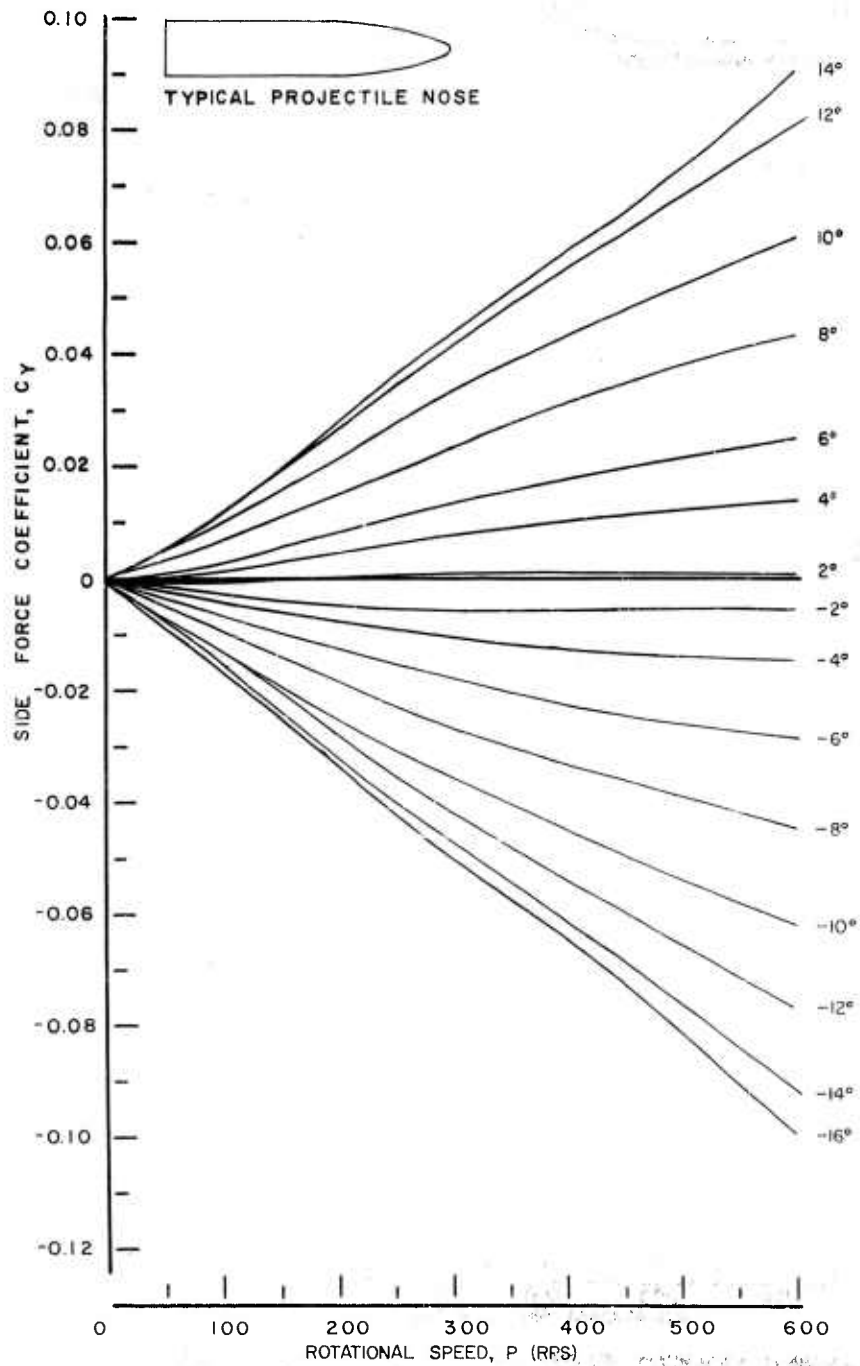

FIG. 30 SIDE FORCE COEFFICIENT, C_Y, VS ROTATIONAL SPEED, P, TYPICAL PROJECTILE NOSE

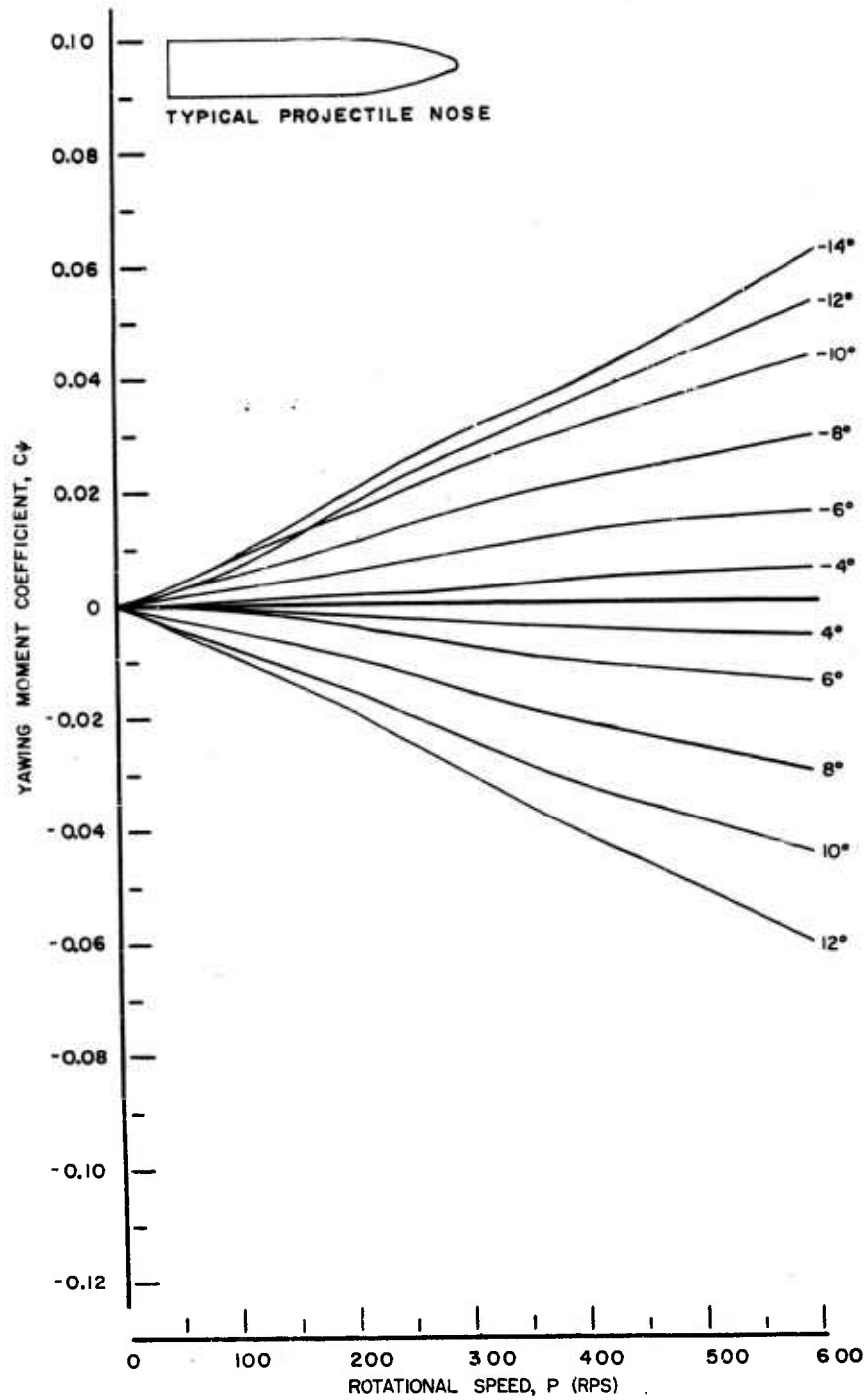

FIG. 31 YAWING MOMENT COEFFICIENT, C_ψ , VS ROTATIONAL SPEED, P, TYPICAL PROJECTILE NOSE

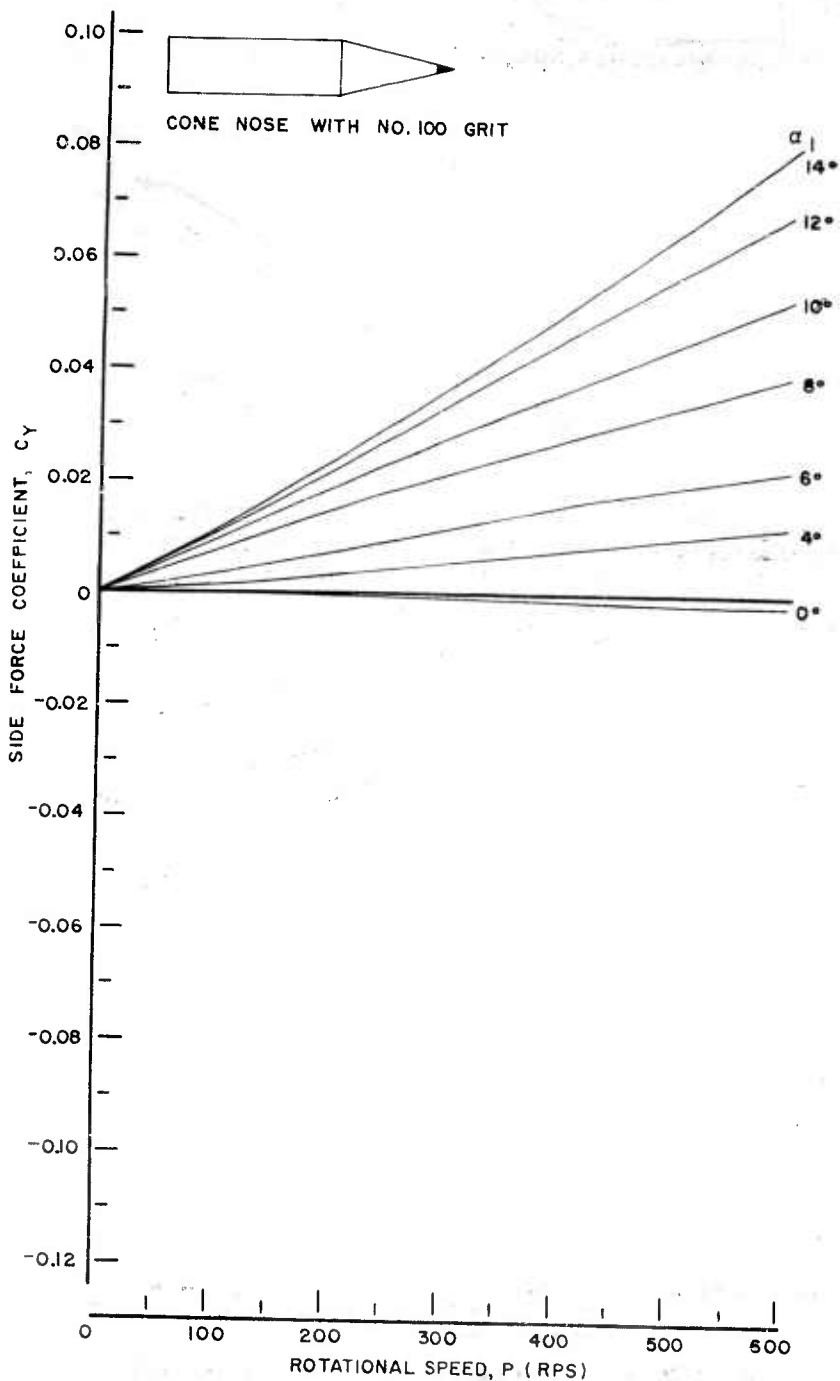

FIG. 32 SIDE FORCE COEFFICIENT, C_Y , VS ROTATIONAL SPEED, P , - CONE NOSE WITH NO. 100 GRIT

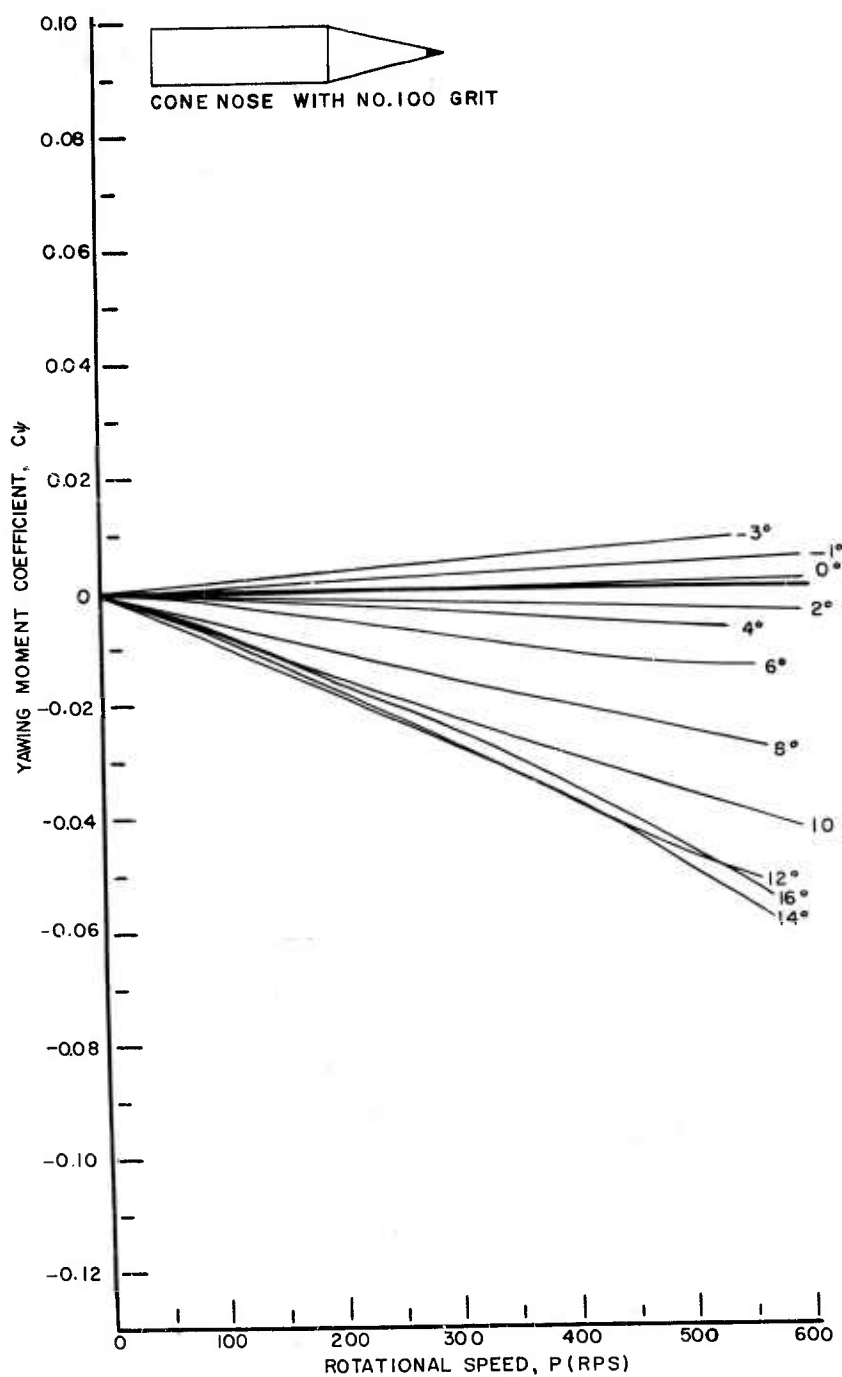

FIG. 33 YAWING MOMENT COEFFICIENT, C_ψ , VS ROTATIONAL SPEED, P, -CONE NOSE WITH NO. 100 GRIT

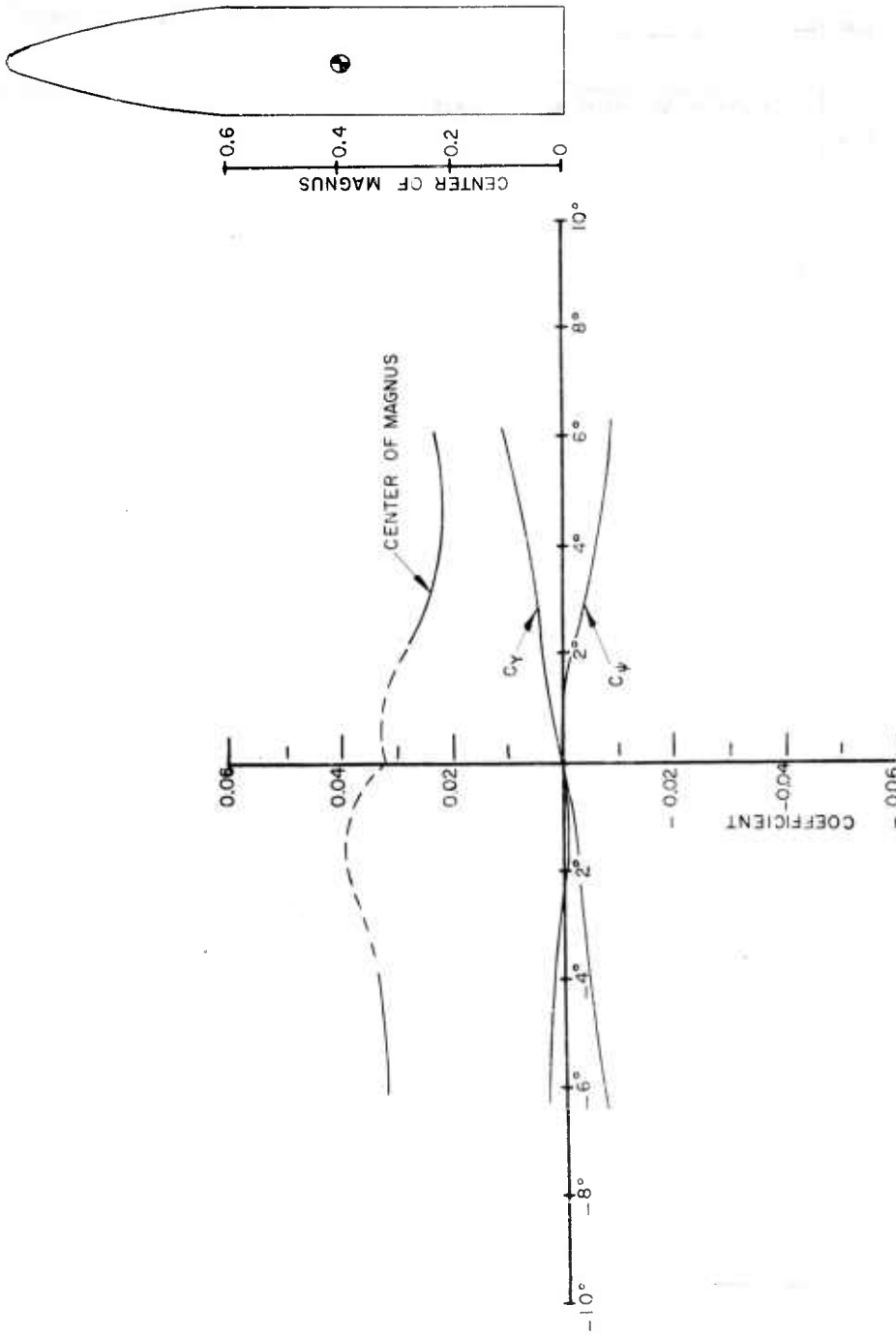

FIG 34 C_Y , C_ψ AND CENTER OF MAGNUS VS α_1 FOR THE TYPICAL PROJECTILE NOSE (P=125 RPS)

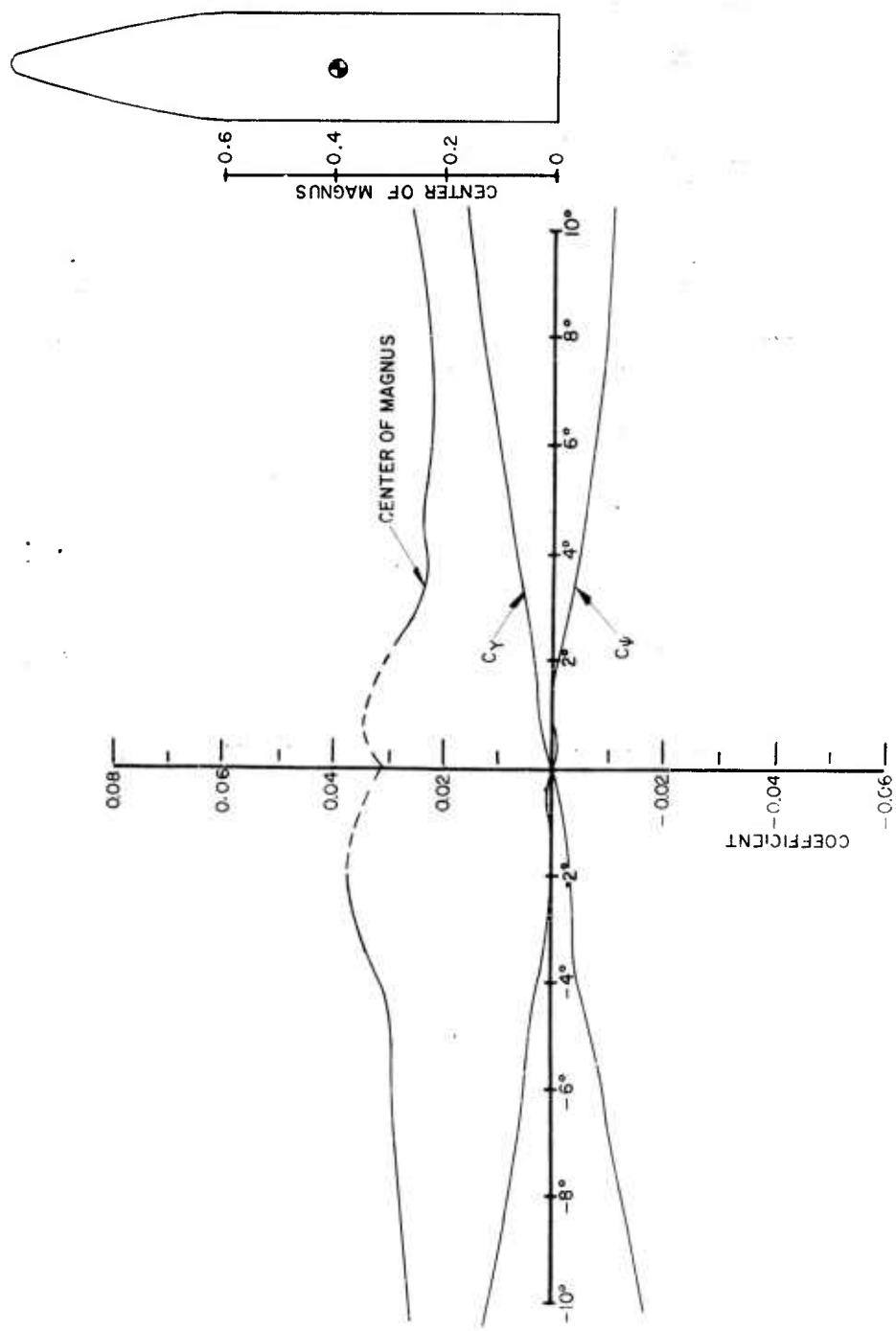

FIG. 35 C_Y , C_ψ , AND CENTER OF MAGNUS VS α_1 FOR THE TYPICAL PROJECTILE NOSE (P=126 RPS)

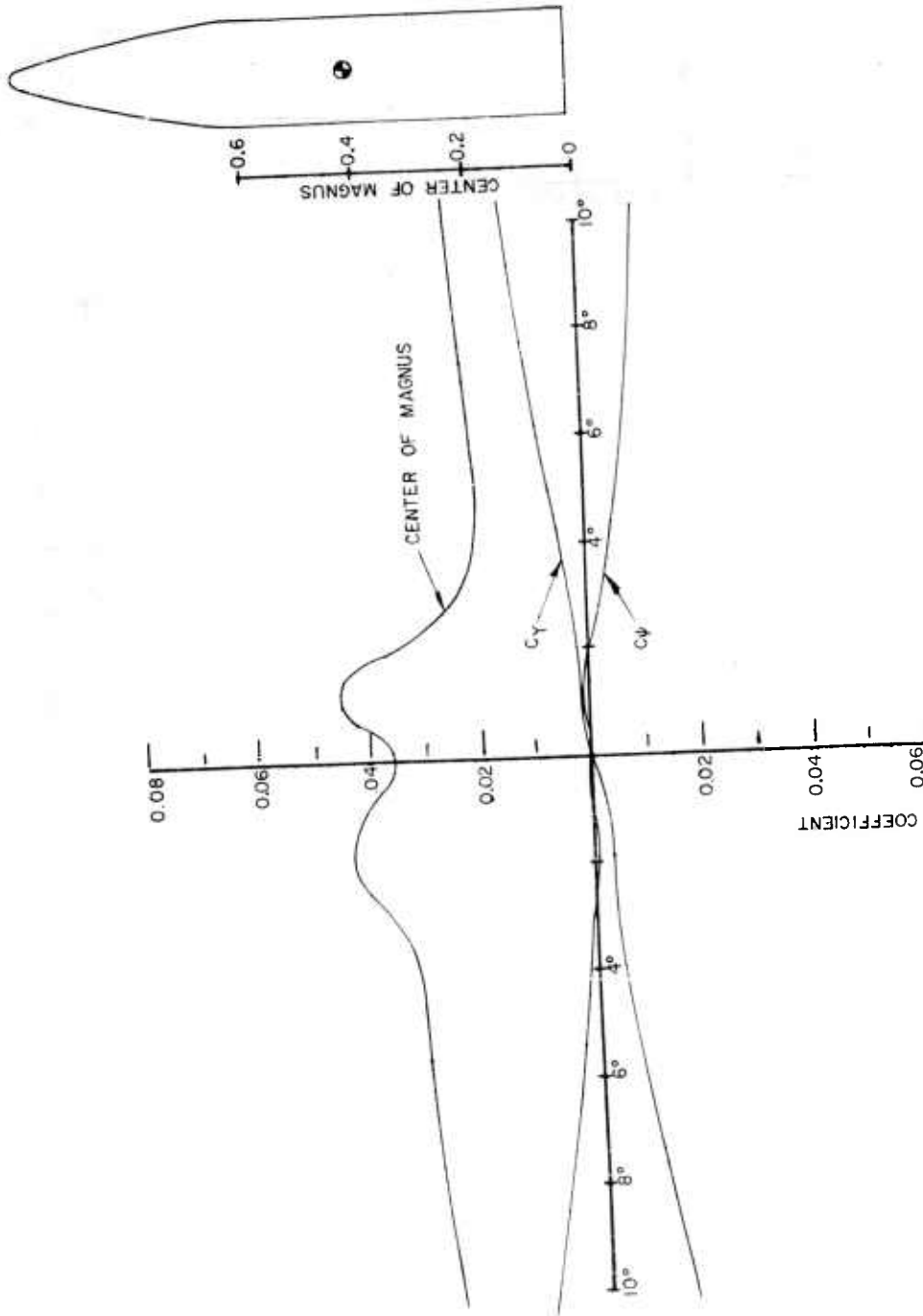

FIG. 36 C_Y , C_ψ , AND CENTER OF MAGNUS VS α_1 FOR THE TYPICAL PROJECTILE NOSE (P=126 RPS)

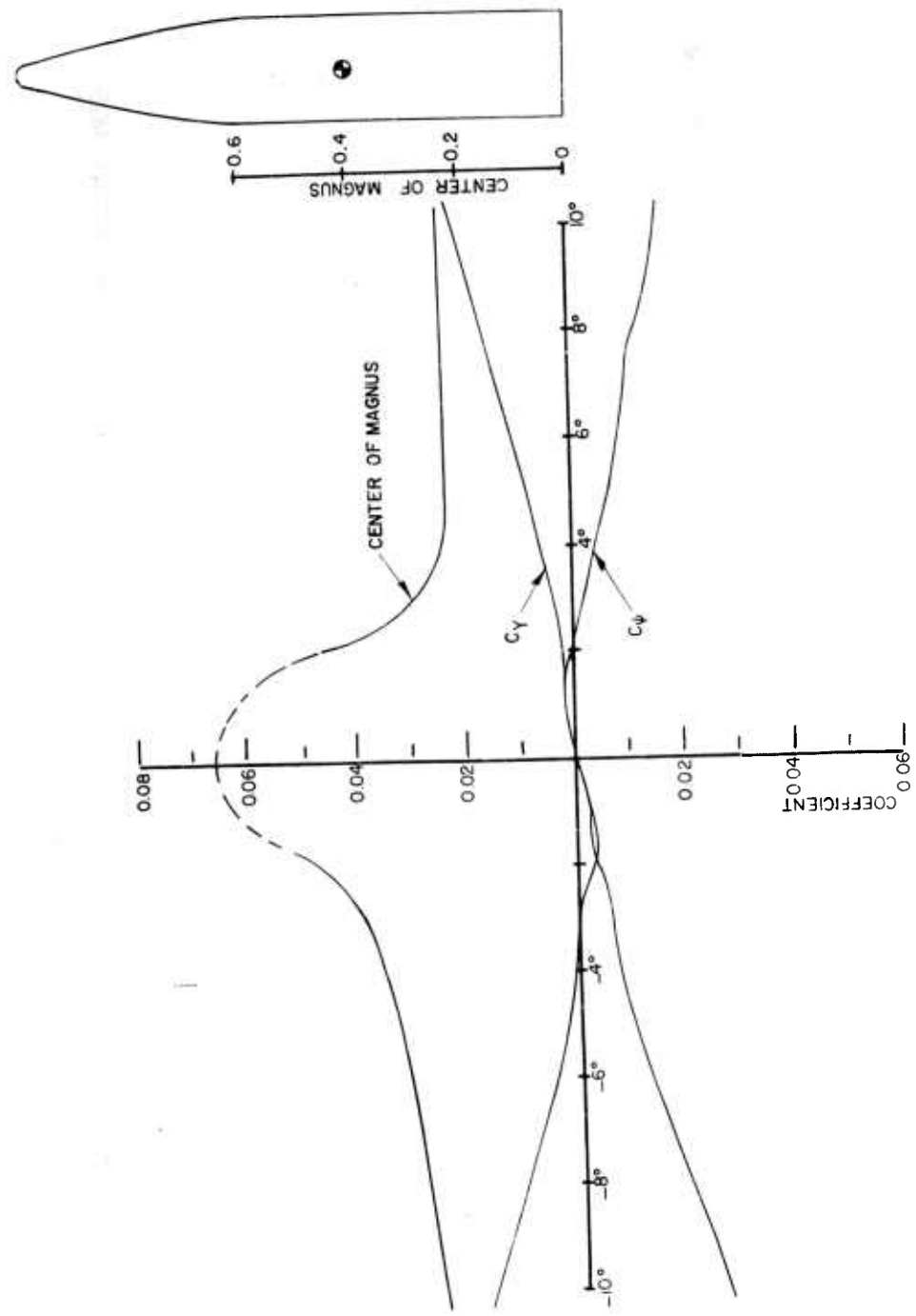

FIG. 37 C_Y , C_ψ AND CENTER OF MAGNUS VS α_1 FOR THE TYPICAL PROJECTILE NOSE (P-204 RPS)

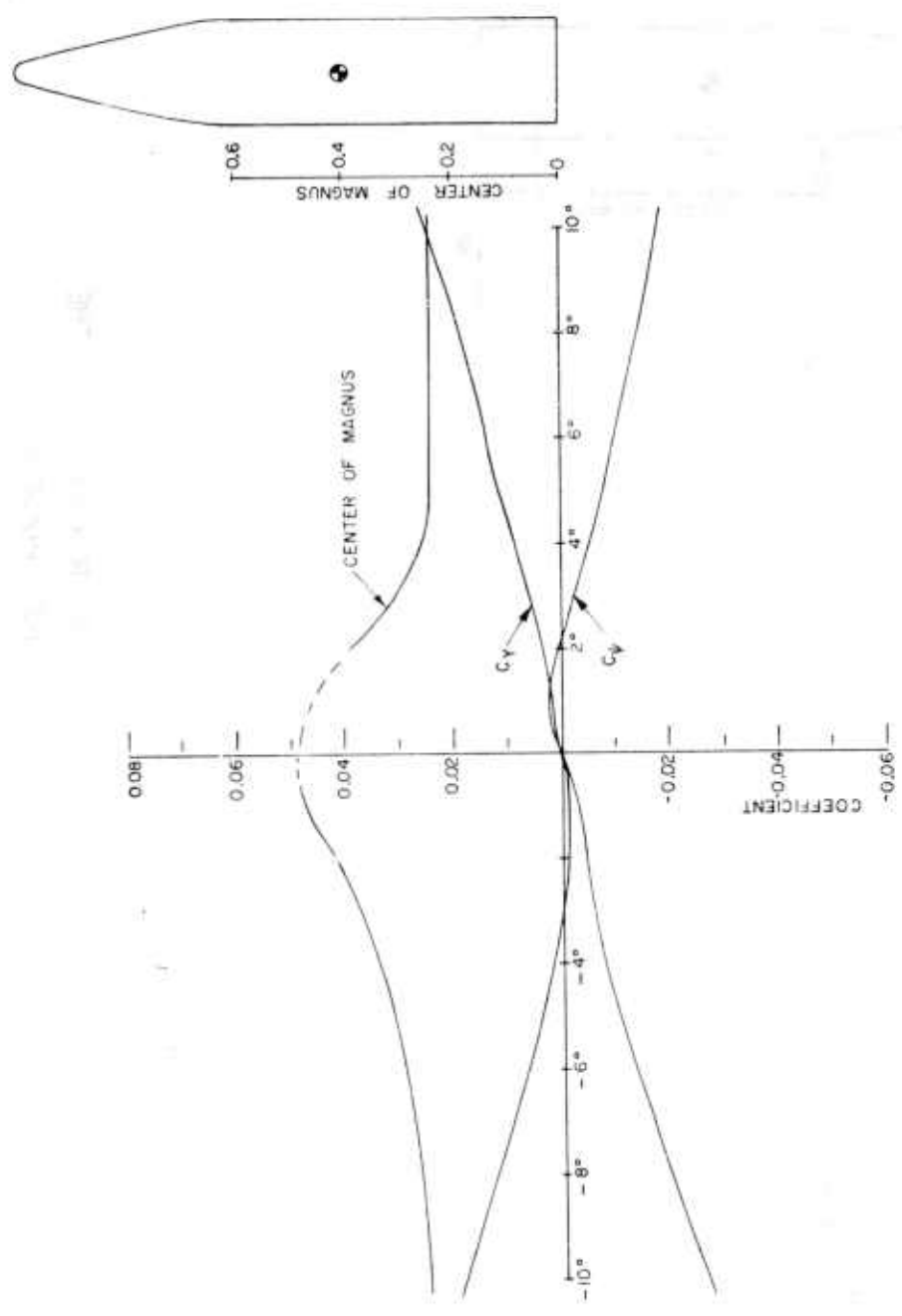

FIG. 38 C_Y , C_ψ , AND CENTER OF MAGNUS VS α_1 FOR THE TYPICAL PROJECTILE NOSE
(P=203 RPS)

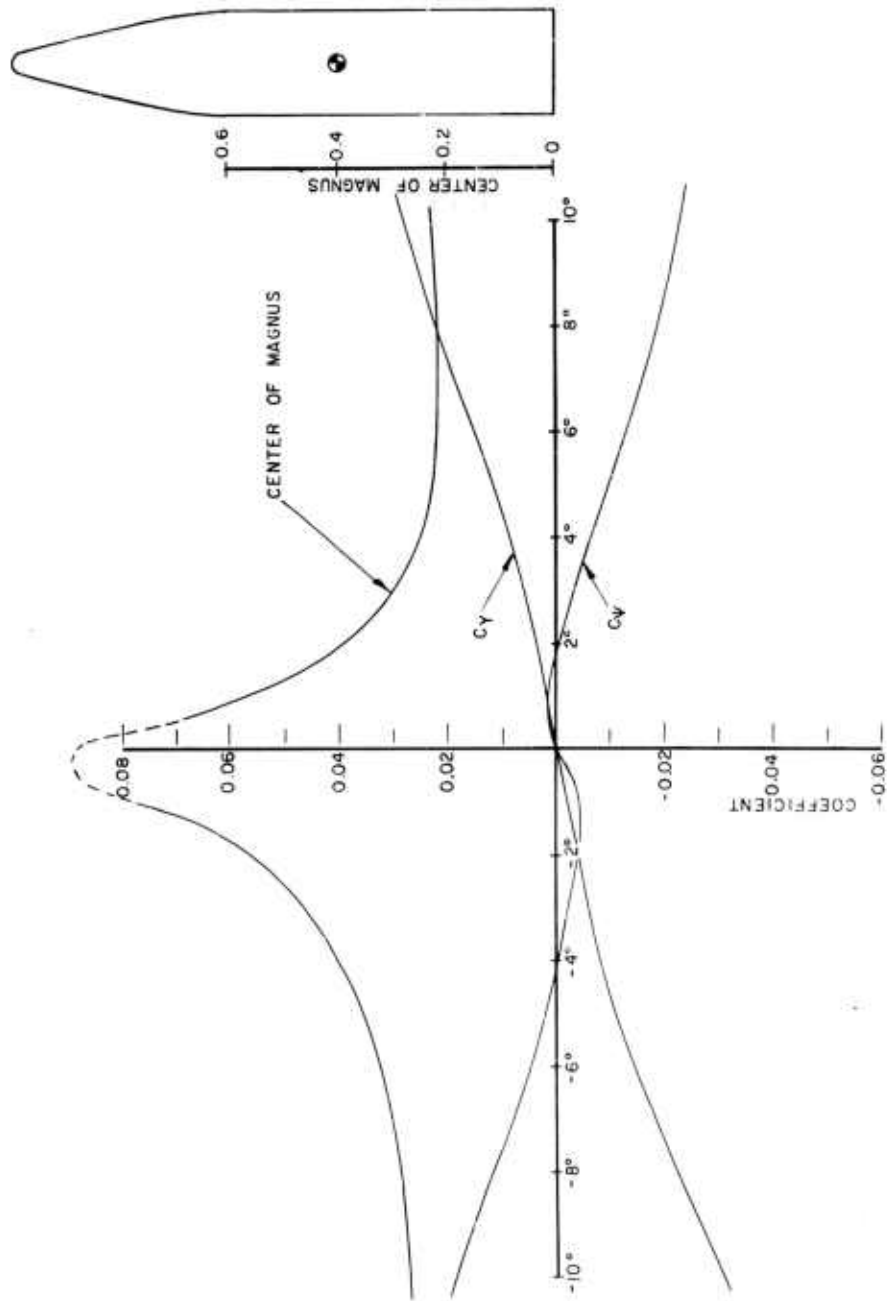

FIG. 39 C_y , C_ψ AND CENTER OF MAGNUS VS α_1 FOR THE TYPICAL PROJECTILE NOSE
(P = 255 RPS)

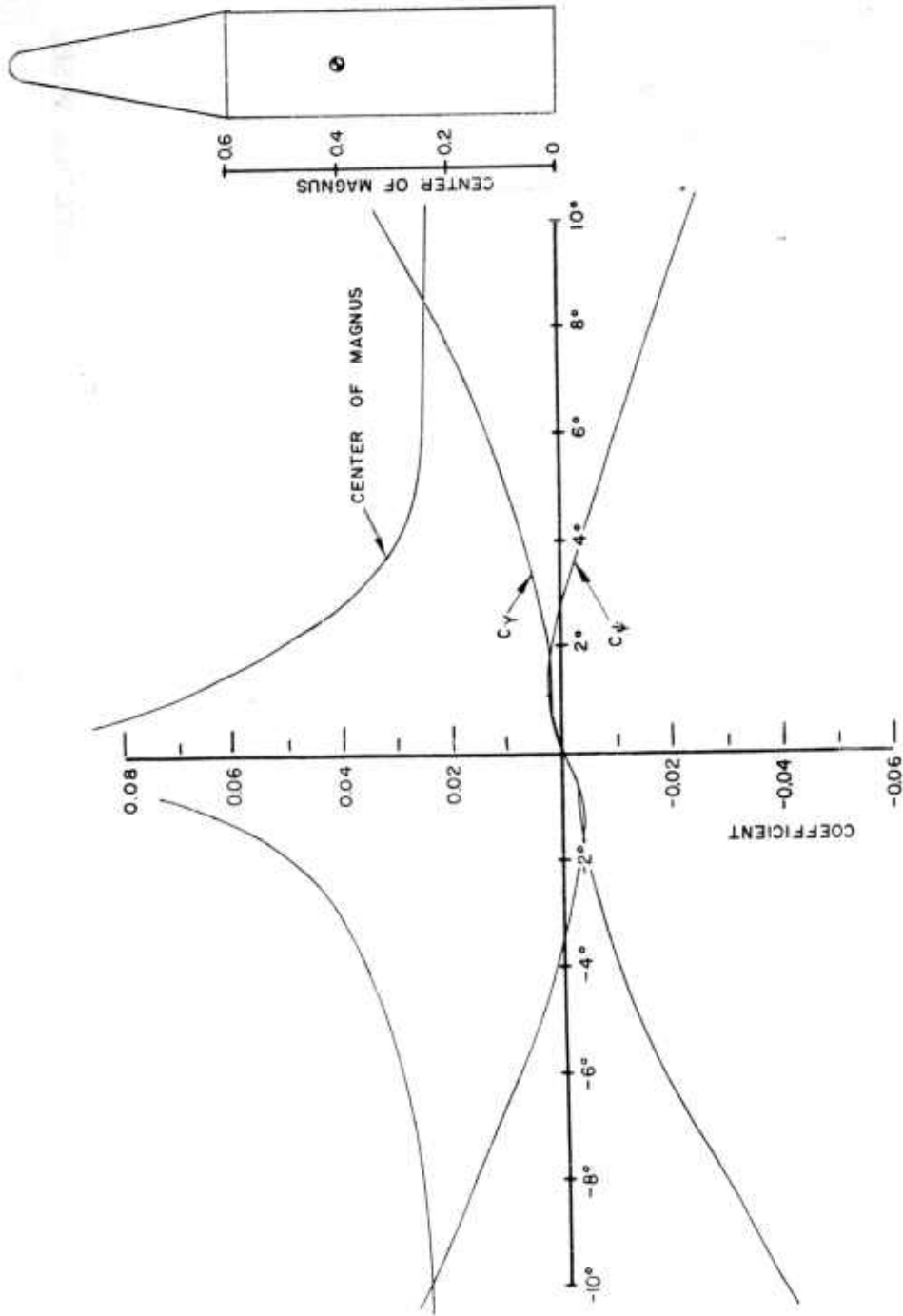

FIG. 40 C_γ , C_ψ AND CENTER OF MAGNUS VS α_1 FOR THE TYPICAL PROJECTILE NOSE (P-309 RPS)

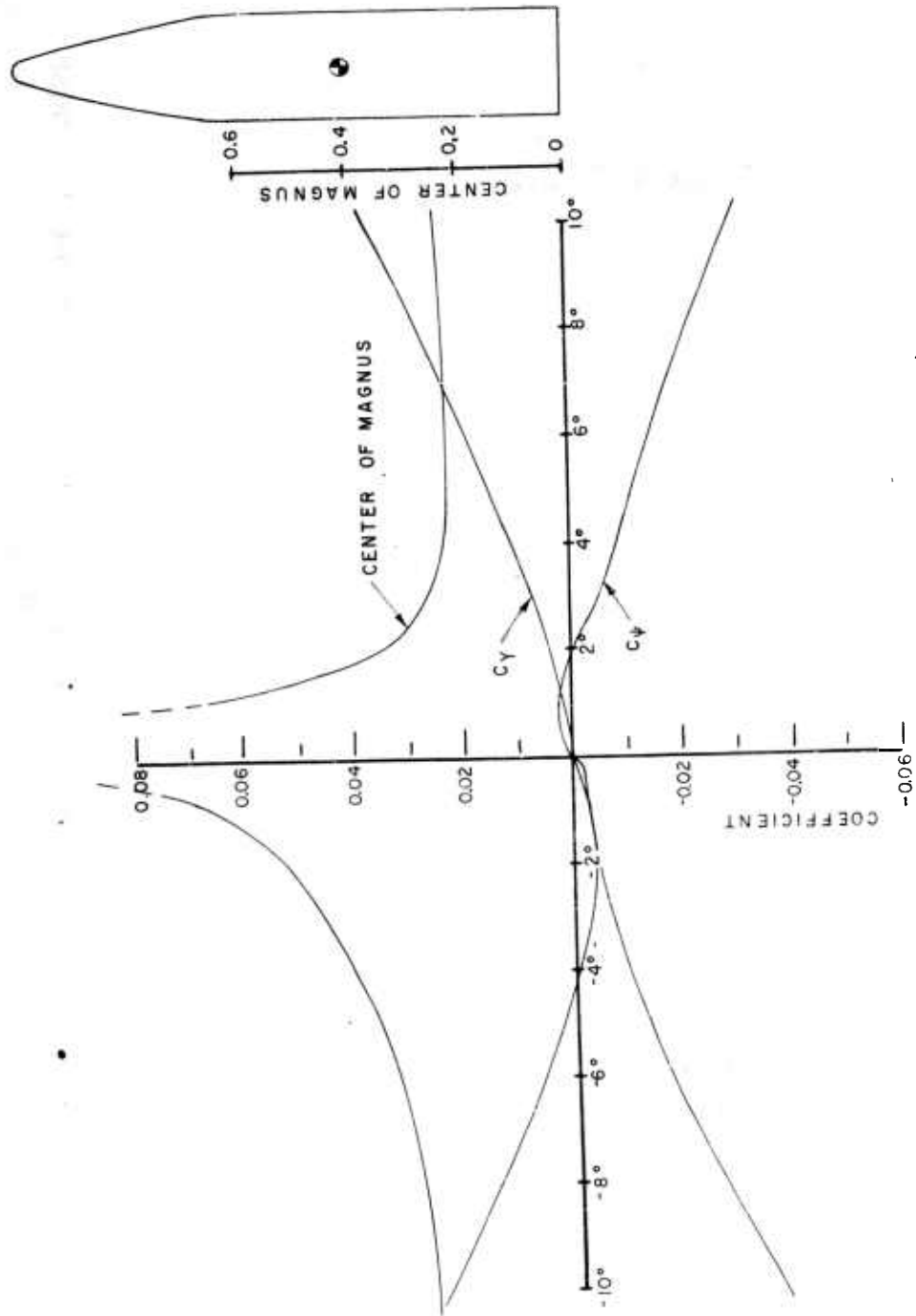

FIG. 41 C_Y , C_ψ , AND CENTER OF MAGNUS VS α_1 FOR THE TYPICAL PROJECTILE NOSE
($P = 312$ RPS)

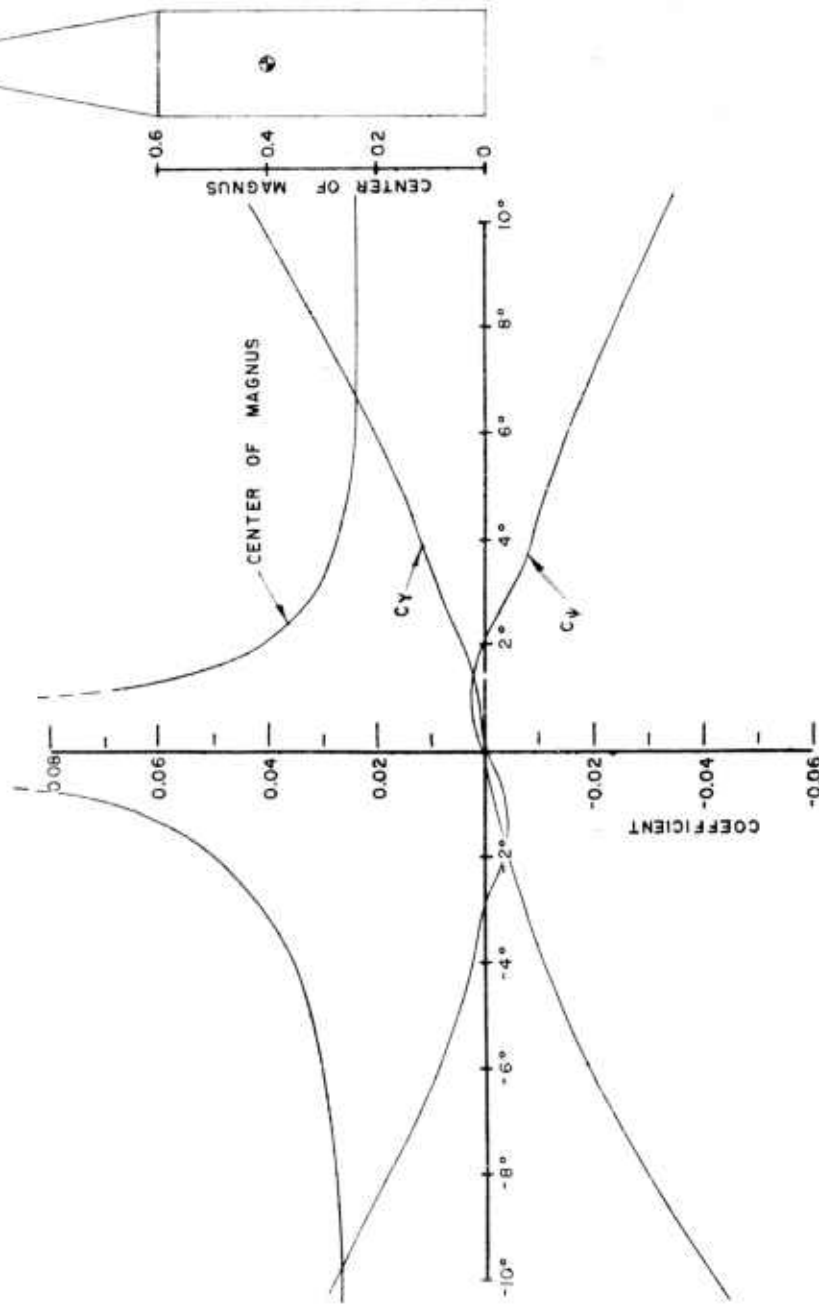

FIG. 42 C_Y, C_ψ , AND CENTER OF MAGNUS VS α_1 FOR THE TYPICAL PROJECTILE NOSE
(P=370 RPS)

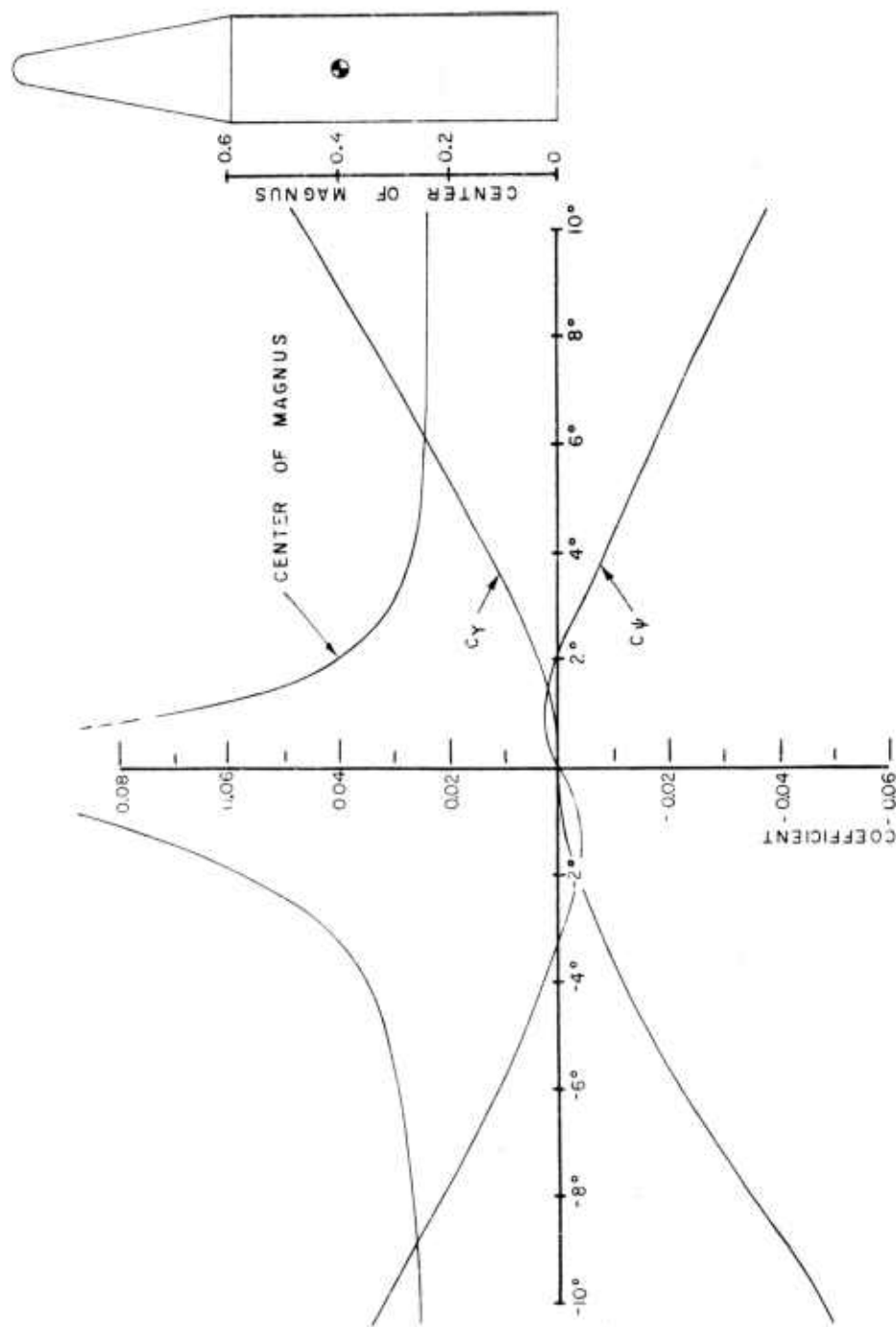

FIG. 43 C_Y , C_{Ψ} AND CENTER OF MAGNUS VS α_1 FOR THE TYPICAL PROJECTILE NOSE (P-432 RPS)

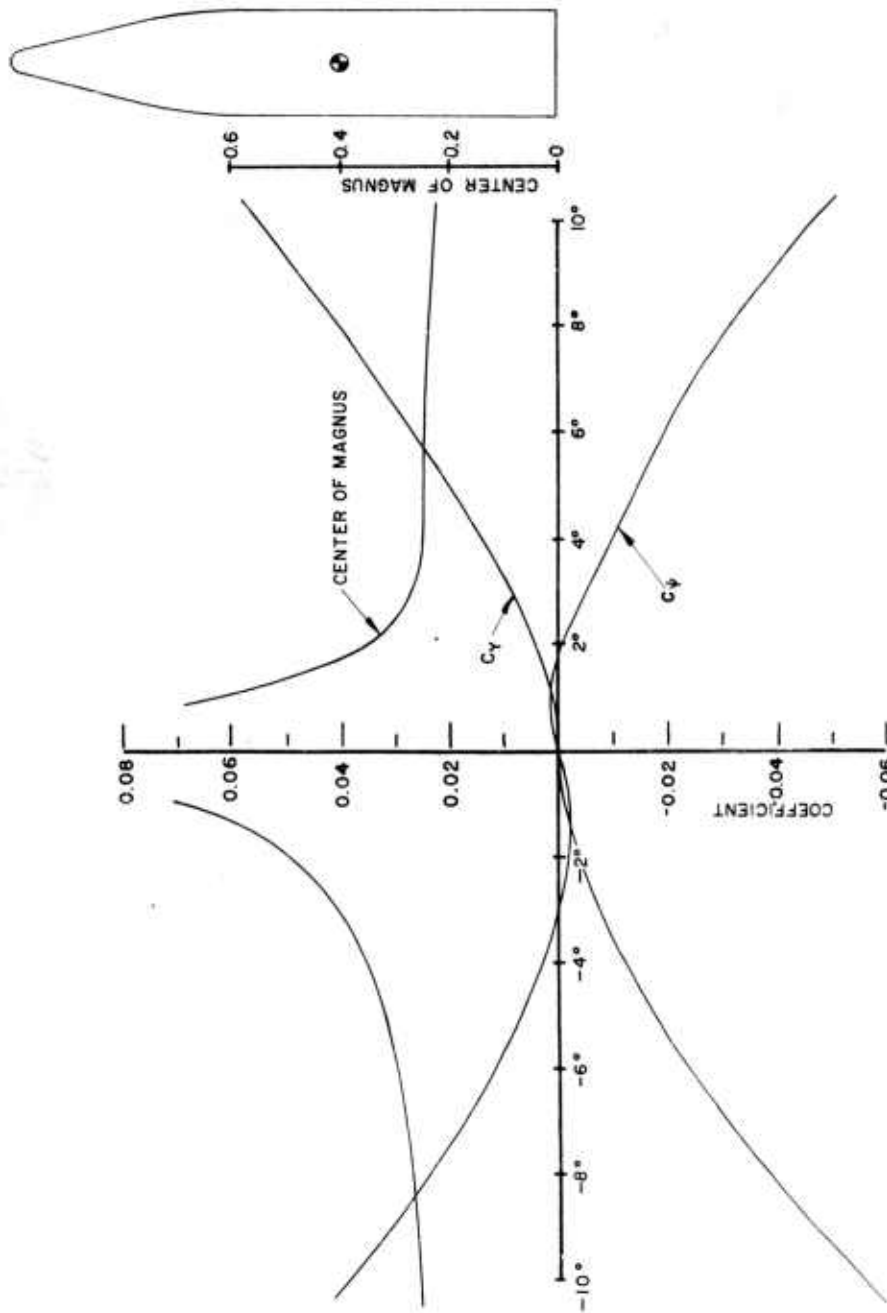

FIG. 44 C_{γ} , C_{ψ} , AND CENTER OF MAGNUS VS α_1 FOR THE TYPICAL PROJECTILE NOSE
(P=508 RPS)

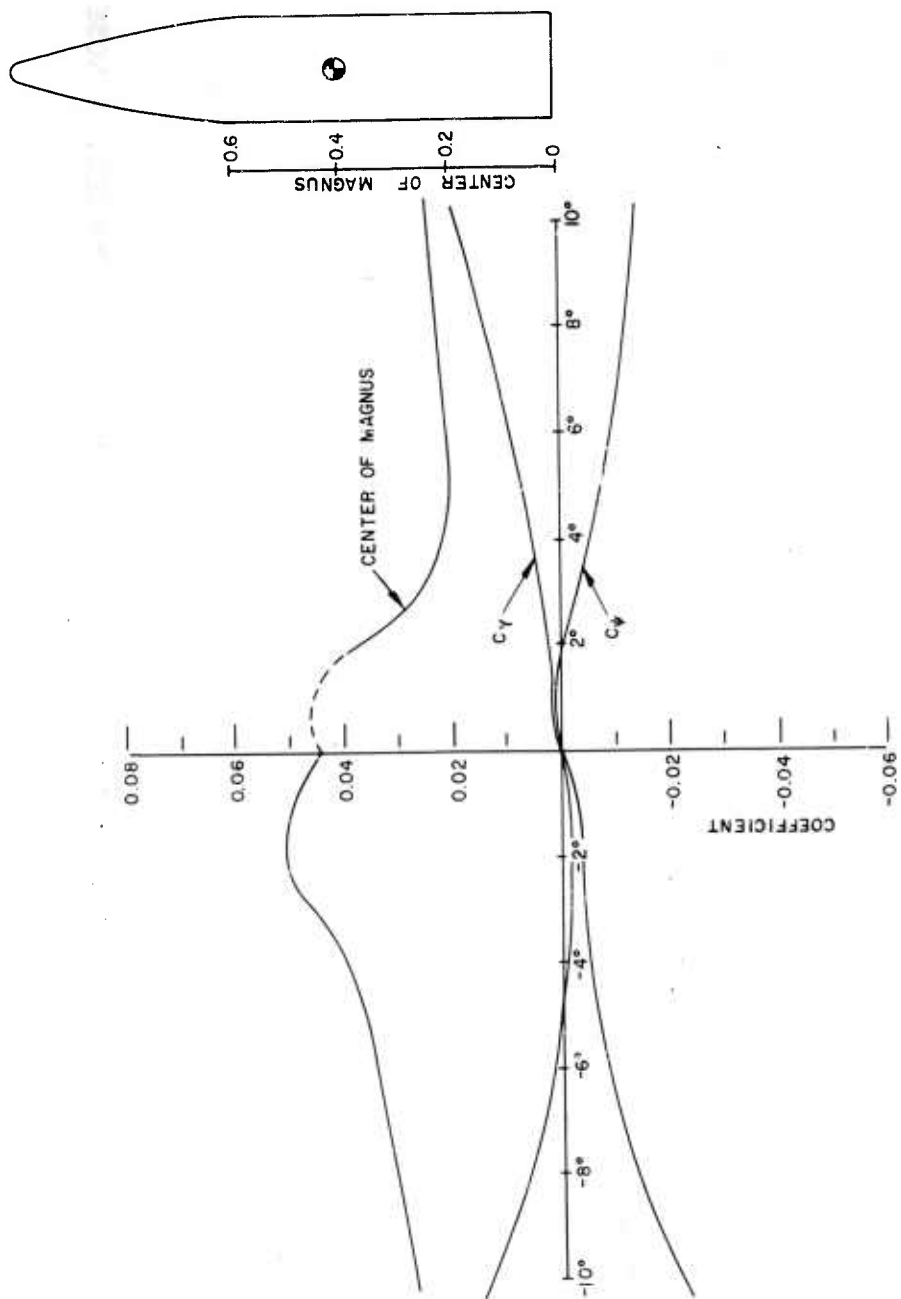

FIG. 45 C_Y , C_ψ , AND CENTER OF MAGNUS VS α_1 FOR THE TYPICAL PROJECTILE NOSE (P=169 RPS)

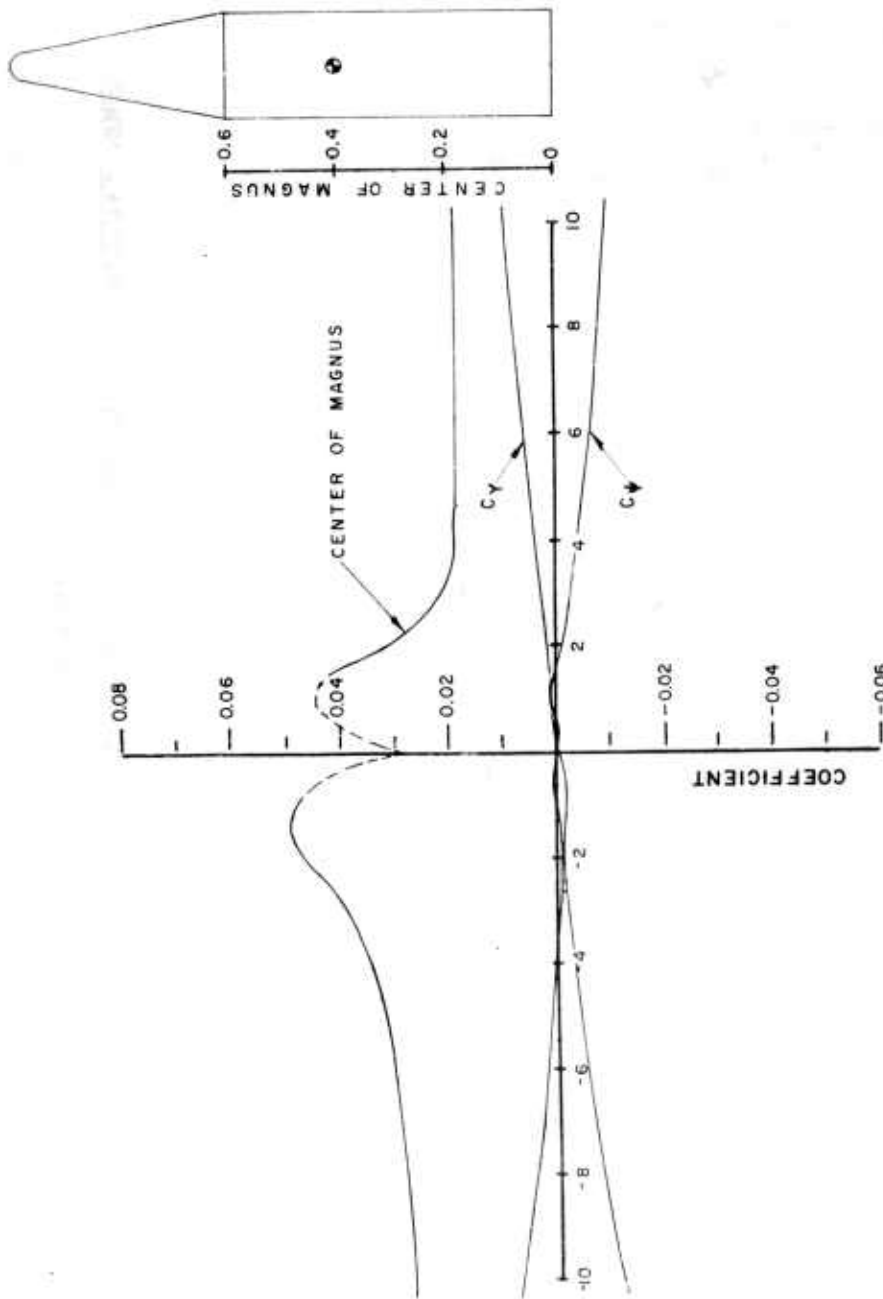

FIG. 46 C_γ , C_ψ , AND CENTER OF MAGNUS VS α_1 FOR THE TYPICAL PROJECTILE NOSE
(P=86 RPS)

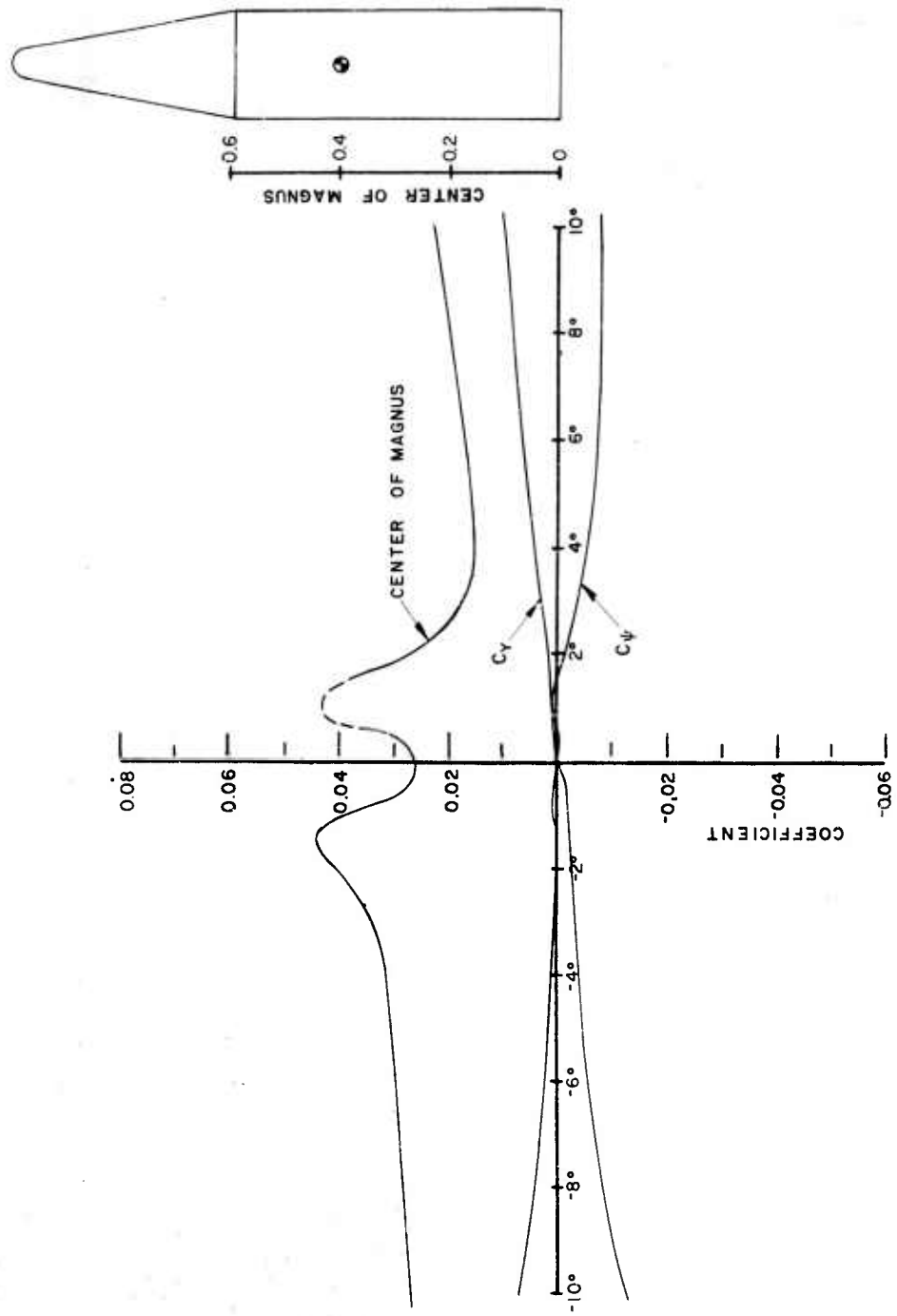

FIG. 47 C_Y , C_ψ , AND CENTER OF MAGNUS VS α_1 FOR THE TYPICAL PROJECTILE NOSE (P-92 RPS)

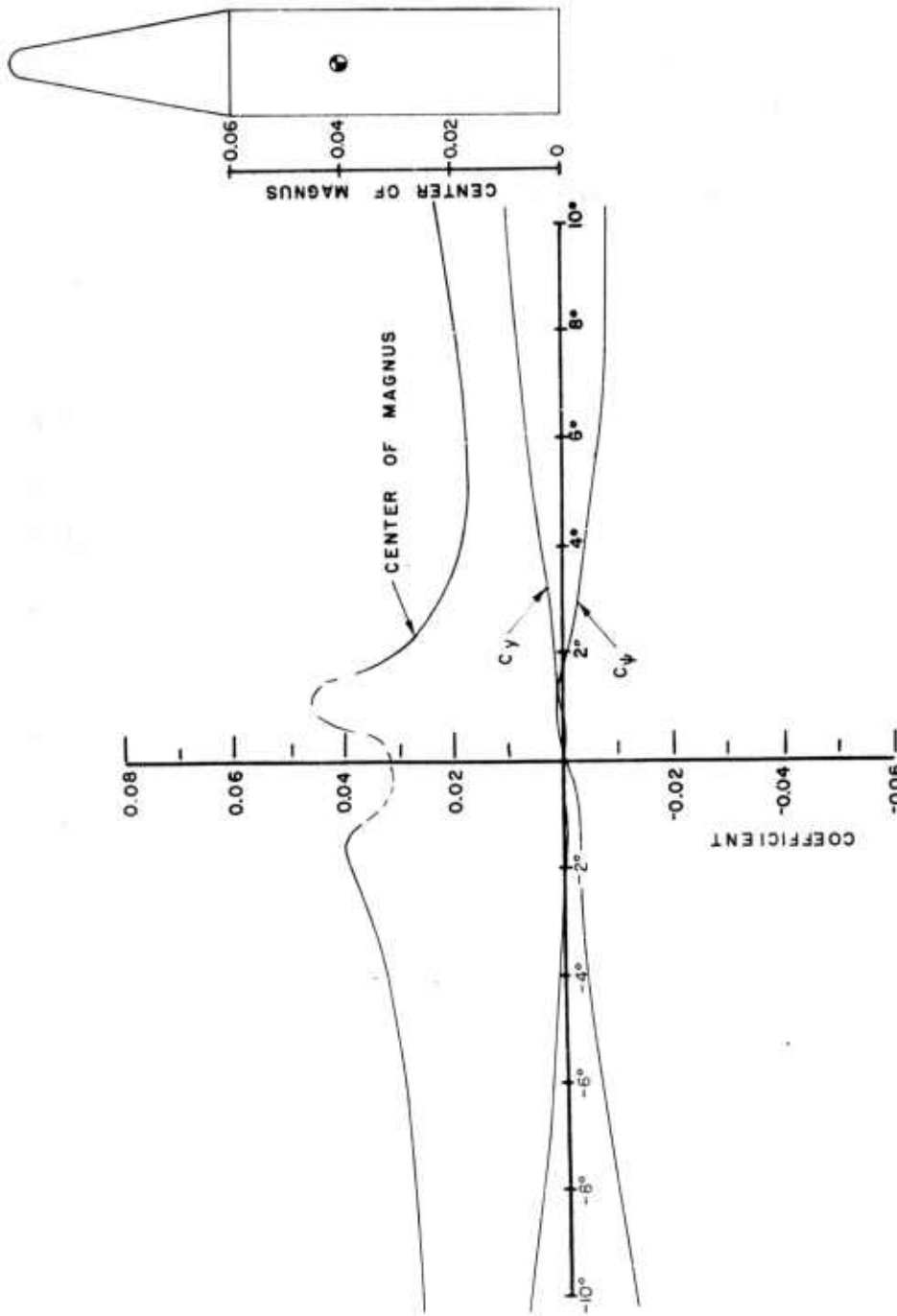

FIG. 48 C_Y , C_X , AND CENTER OF MAGNUS VS α_1 FOR THE TYPICAL PROJECTILE NOSE (P-94 RPS)

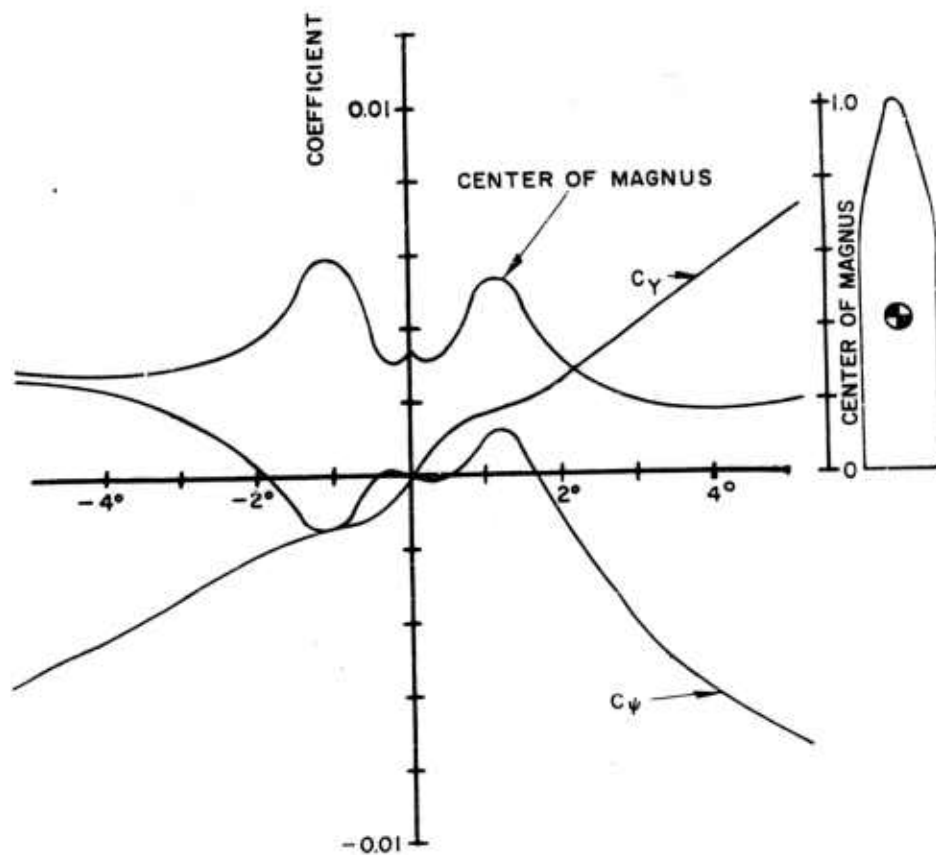

FIG.49 C_Y, C_ψ , AND CENTER OF MAGNUS VS α_1 FOR THE TYPICAL PROJECTILE NOSE (P=90 RPS)

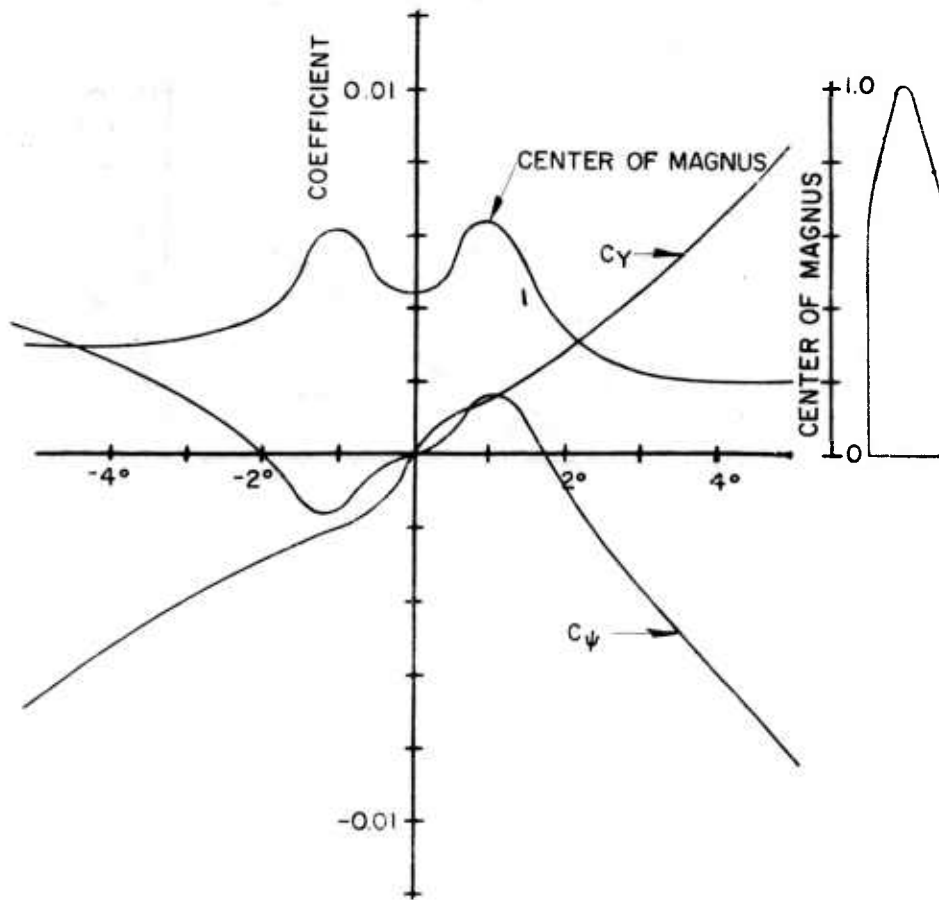

FIG. 50 C_Y , C_ψ AND CENTER OF MAGNUS VS α_1 FOR THE TYPICAL PROJECTILE P=122 RPS

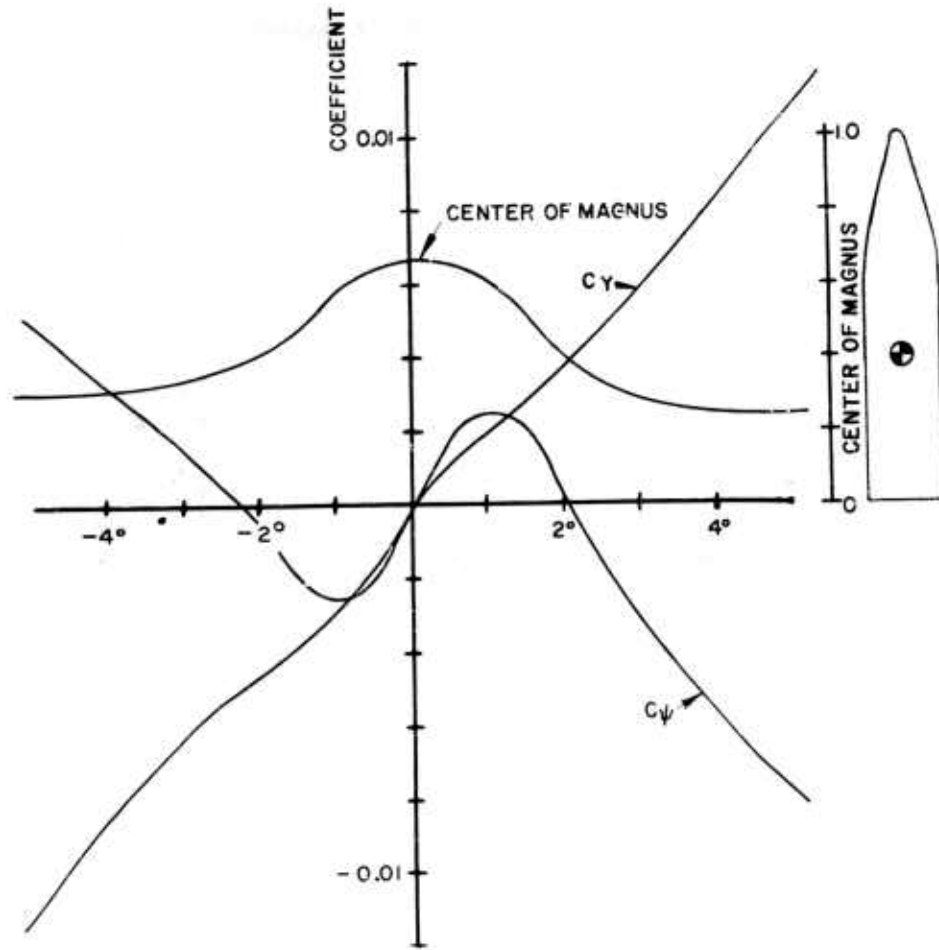

FIG. 51 C_Y, C_Ψ , AND CENTER OF MAGNUS VS α_1 FOR THE TYPICAL PROJECTILE NOSE (P = 211 RPS)

NAVORD REPORT

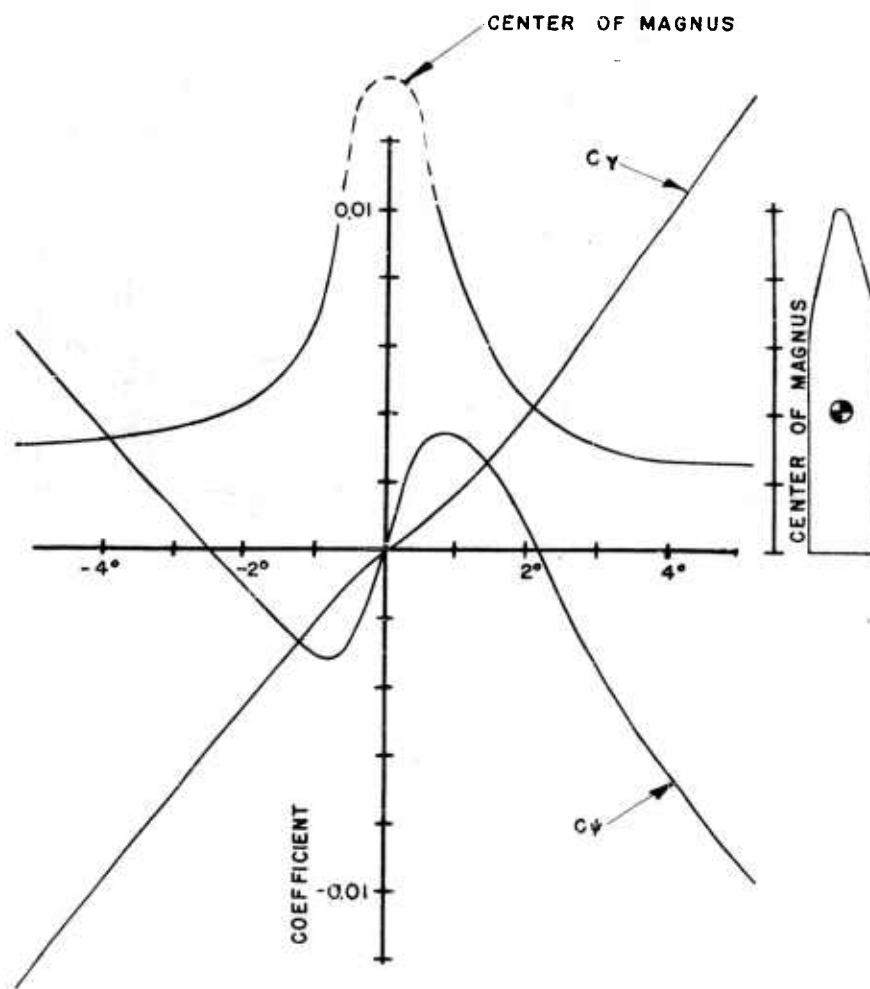

FIG. 52 C_Y , C_ψ , AND CENTER OF MAGNUS VS α_1
FOR THE TYPICAL PROJECTILE NOSE P=263, RPS

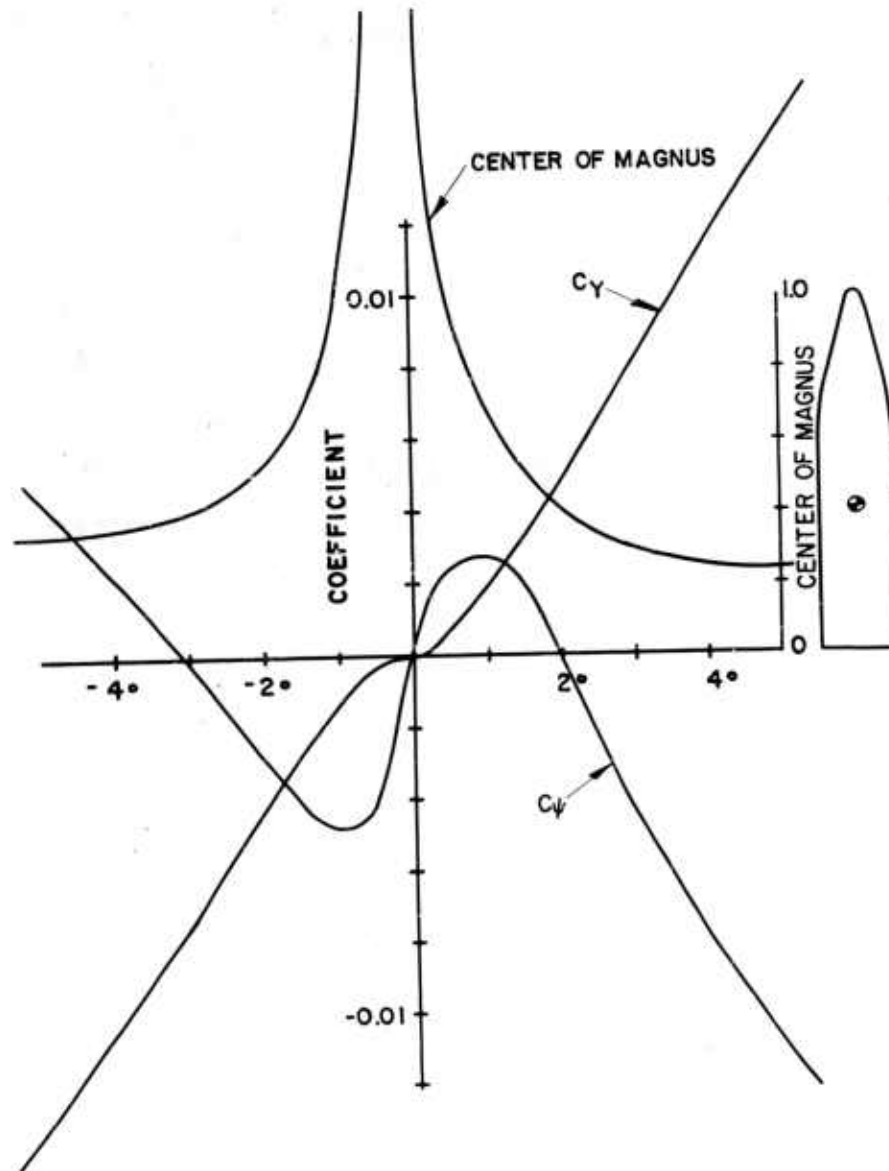

FIG. 53 C_Y , C_Ψ , AND CENTER OF MAGNUS VS α_1 FOR THE TYPICAL PROJECTILE NOSE (P=309 RPS)

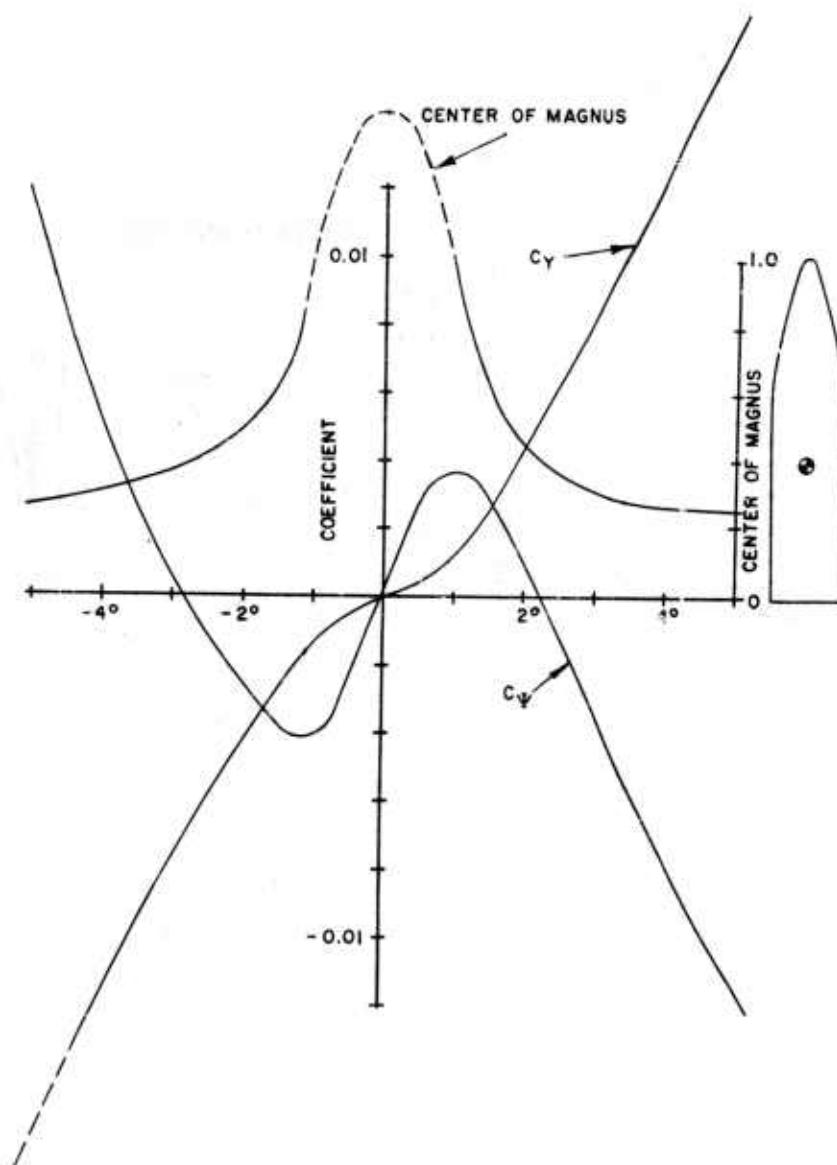

FIG. 54 C_Y , C_ψ AND CENTER OF MAGNUS VS α_1 FOR THE TYPICAL PROJECTILE P=373RPS

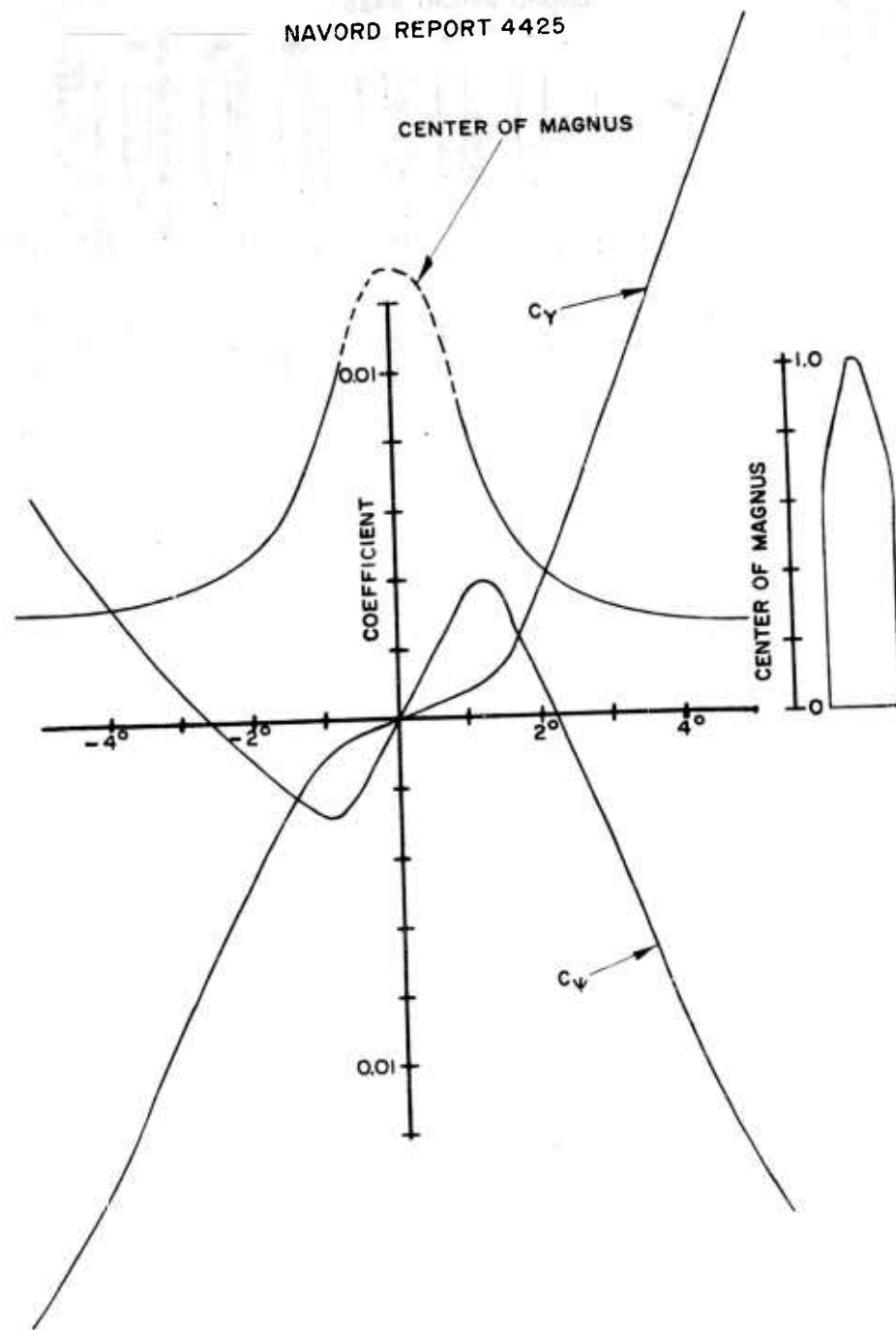

FIG. 55 C_Y , C_Ψ AND CENTER OF MAGNUS VS α_1 FOR THE TYPICAL PROJECTILE NOSE P=468 RPS

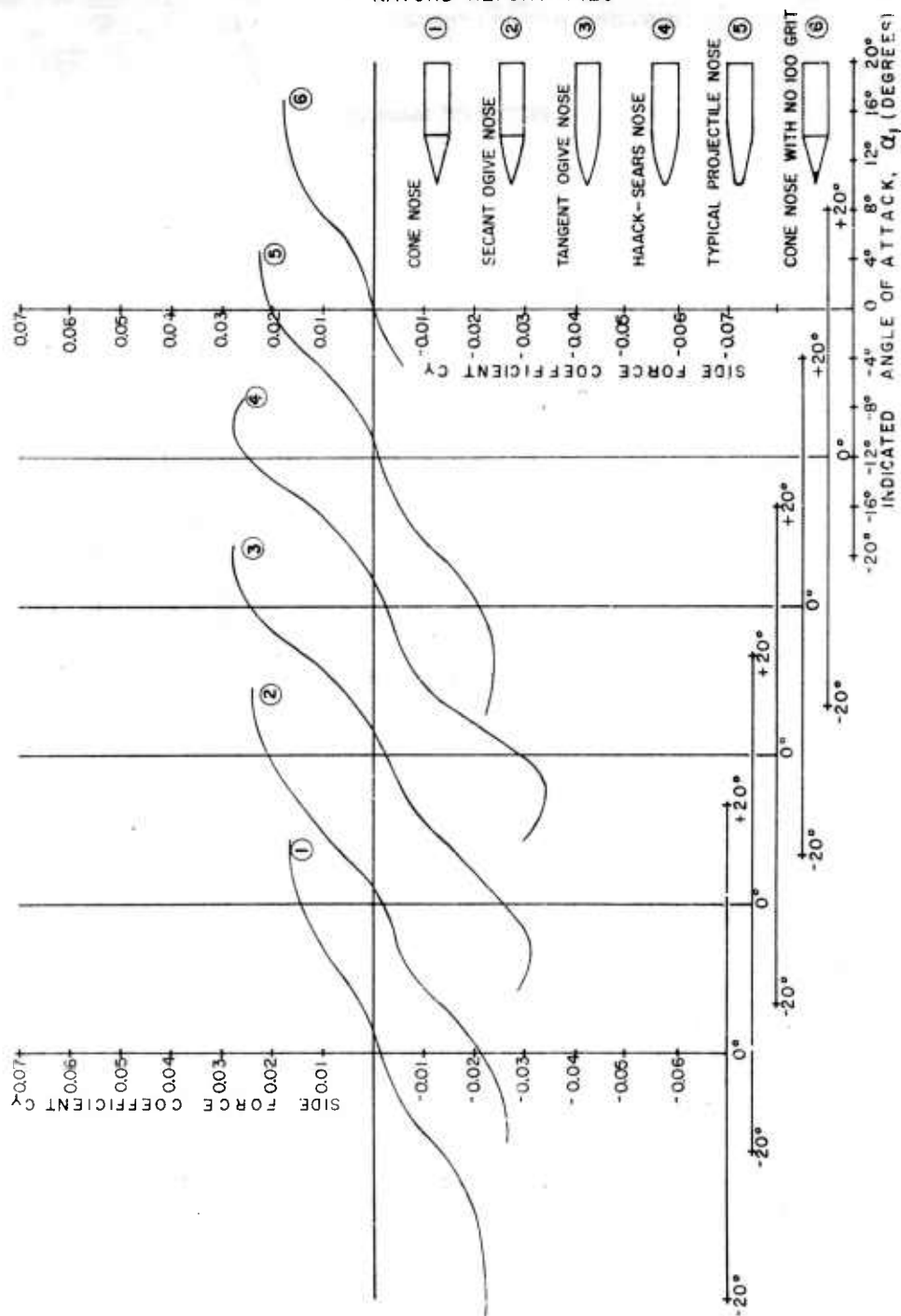

FIG. 56 THE EFFECT OF NOSE SHAPE ON THE SIDE FORCE COEFFICIENT, C_y
($P=153$ RPS)

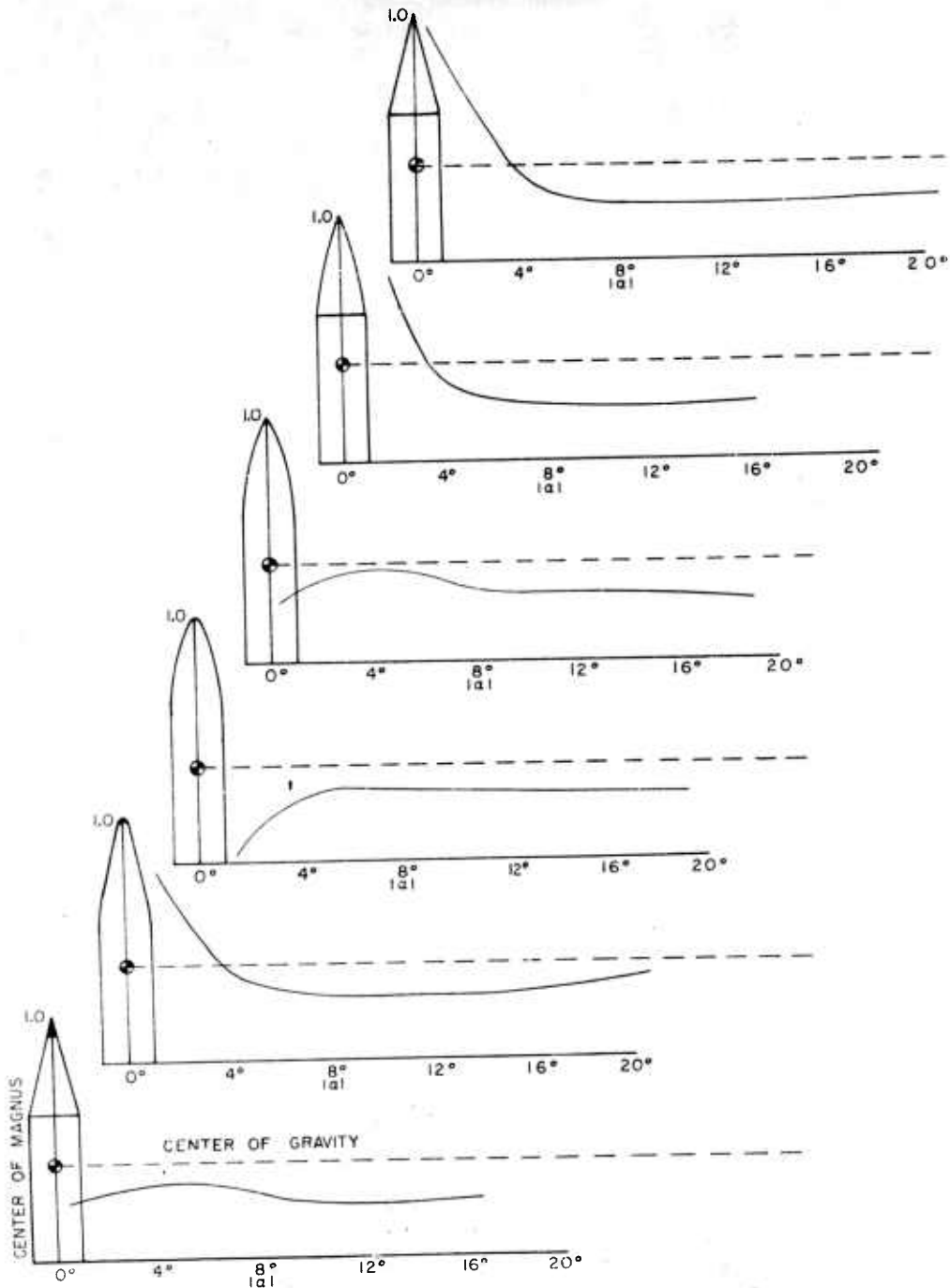

FIG. 58 THE EFFECT OF NOSE SHAPE ON THE CENTER OF MAGNUS
(P=153 RPS)

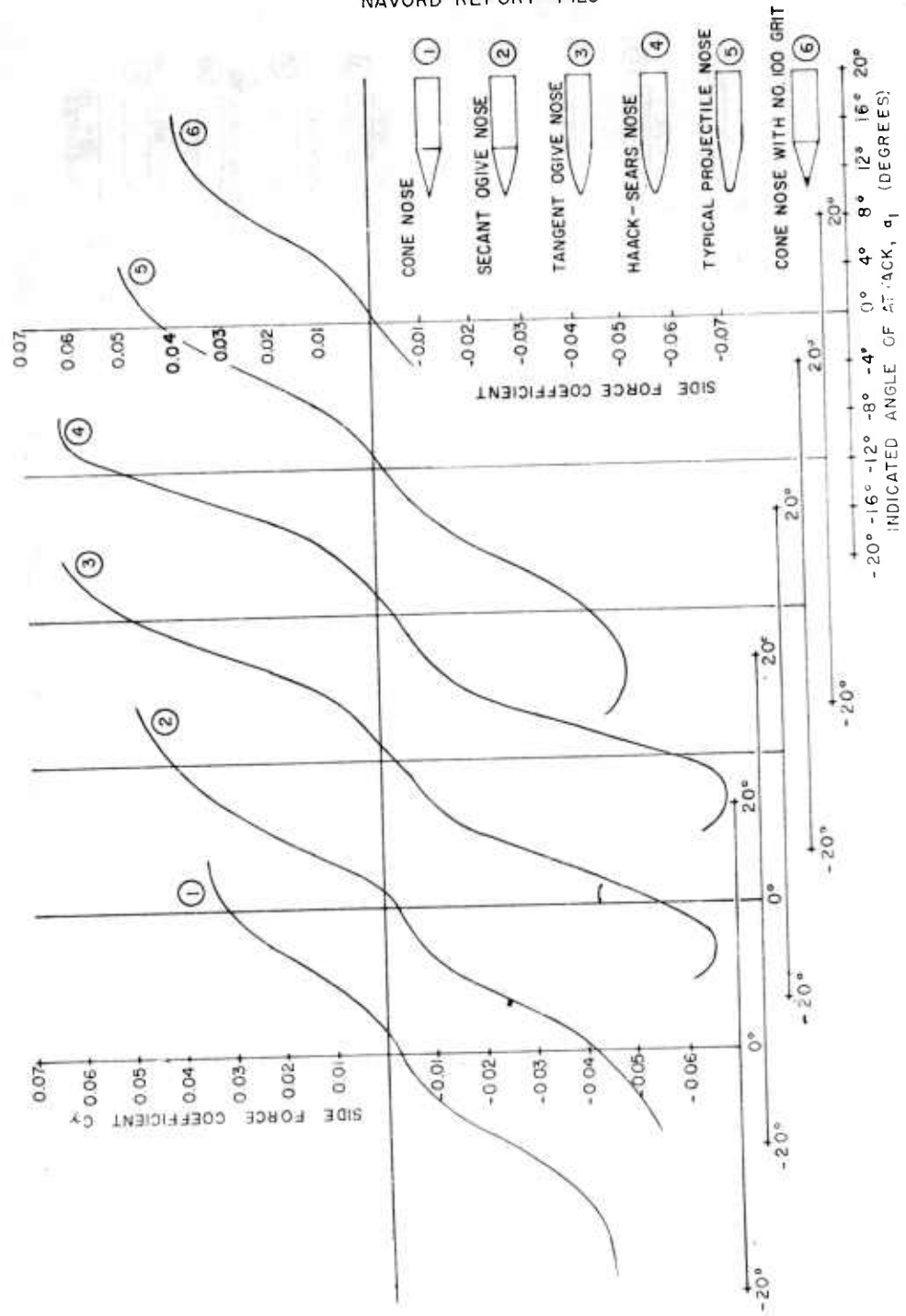

FIG. 59 THE EFFECT OF NOSE SHAPE ON THE SIDE FORCE COEFFICIENT, C_y (P=305 RPS)

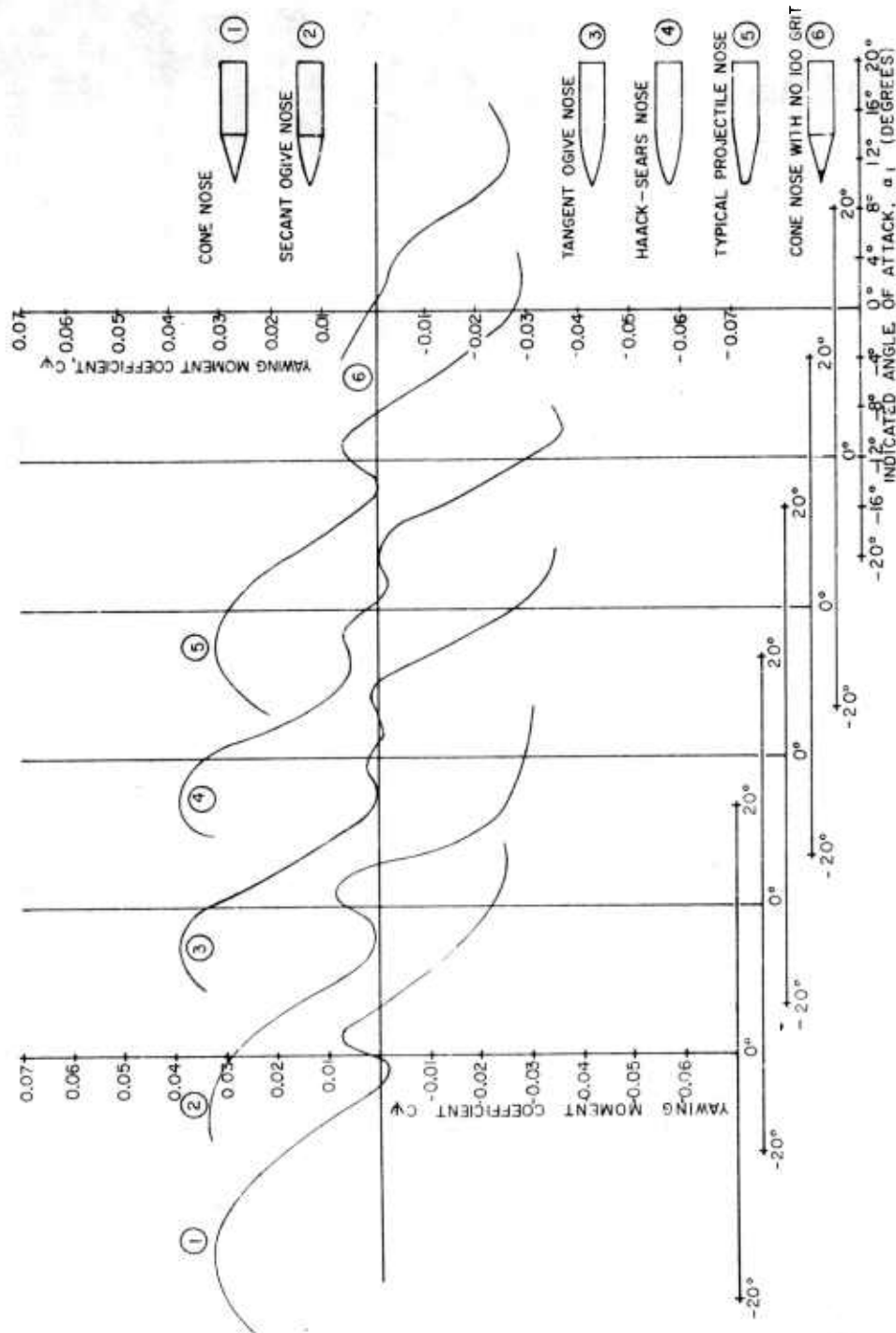

FIG. 60 THE EFFECT OF NOSE SHAPE ON THE YAWING MOMENT COEFFICIENT, C_y
(P-305 RPS)

NAVORD REPORT 4425

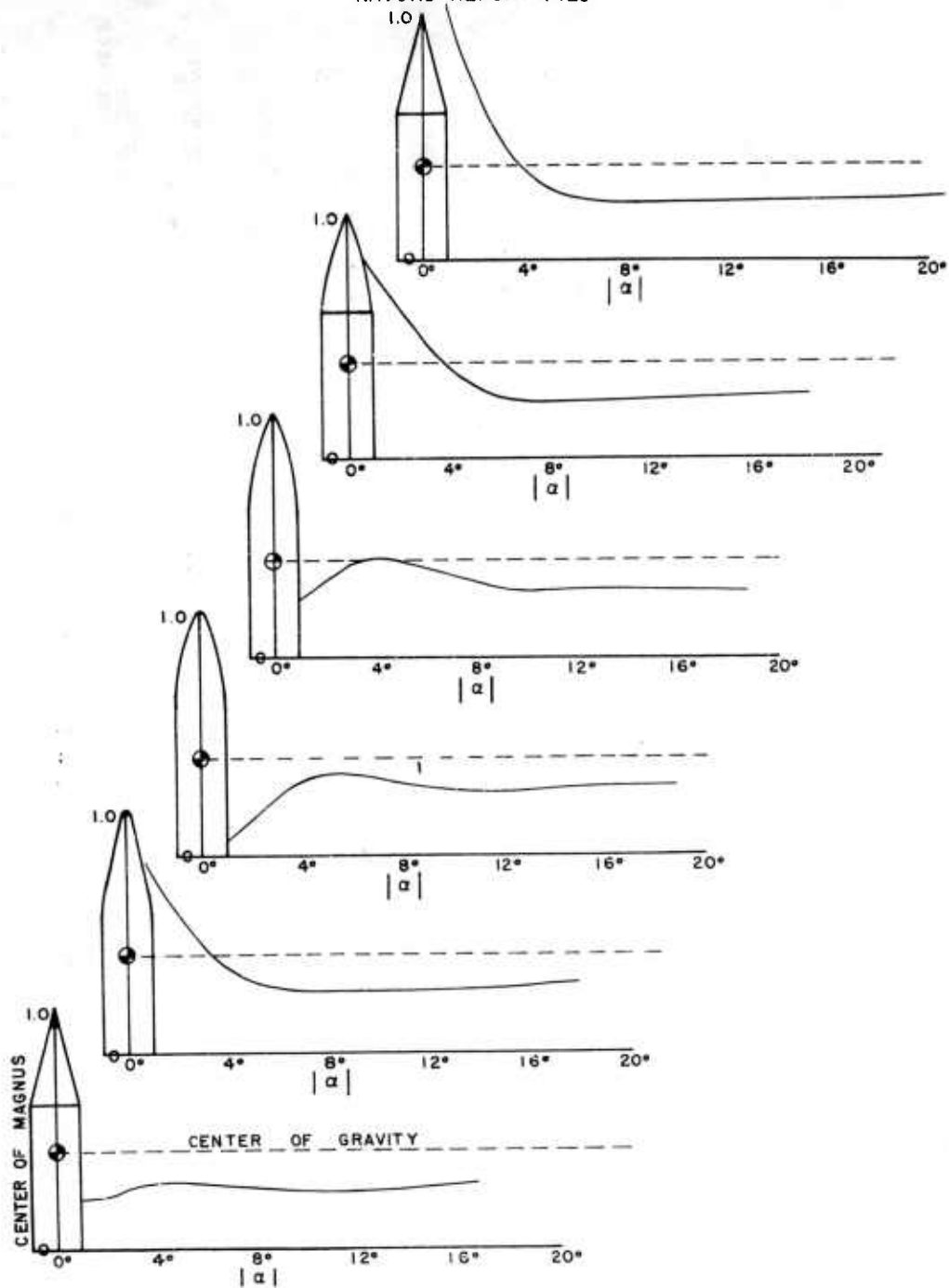

FIG. 61 THE EFFECT OF NOSE SHAPE ON THE CENTER OF MAGNUS (P=305 RPS)

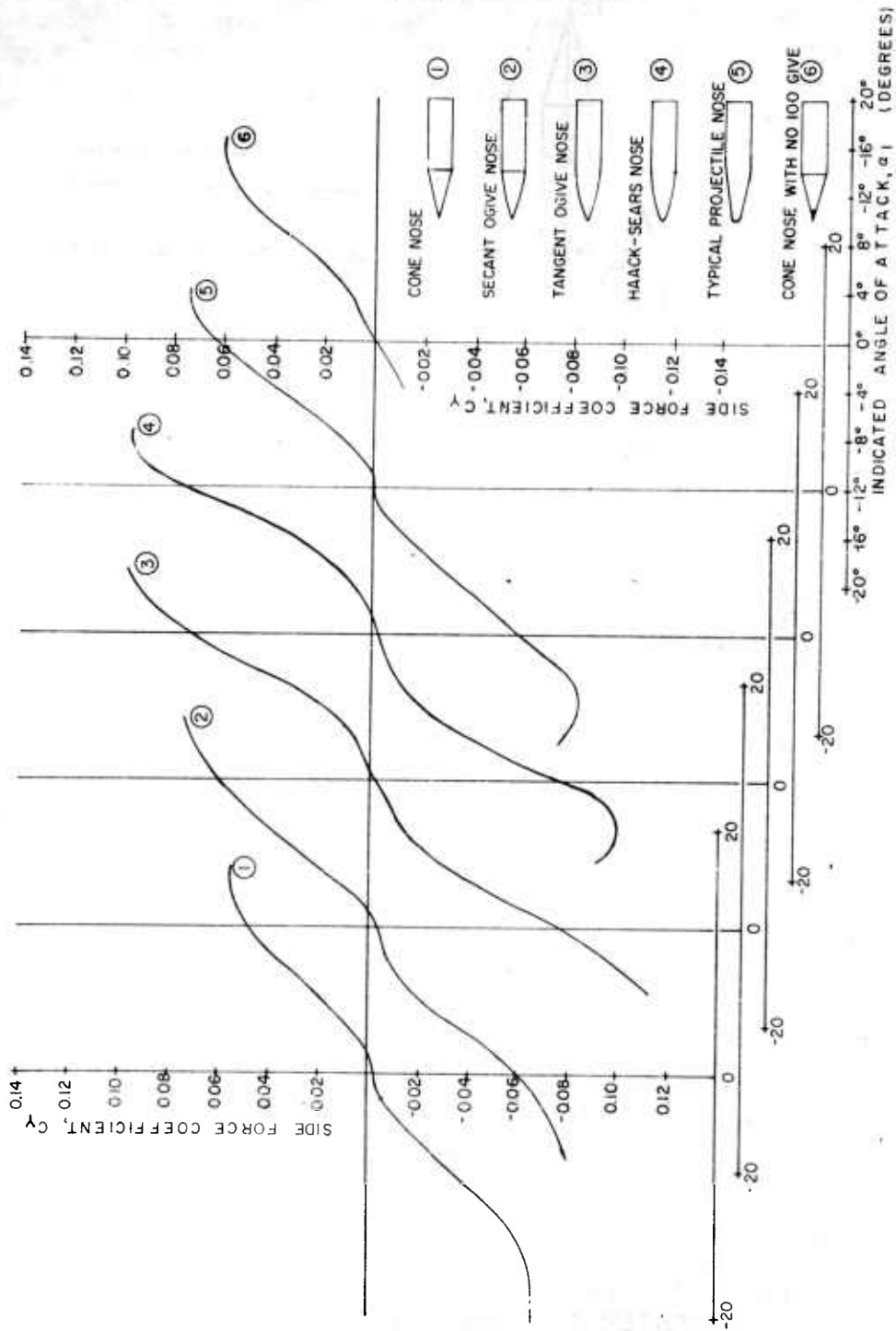

FIG. 62 THE EFFECT OF NOSE SHAPE ON THE SIDE FORCE COEFFICIENT, C_y
(P=458 RPS)

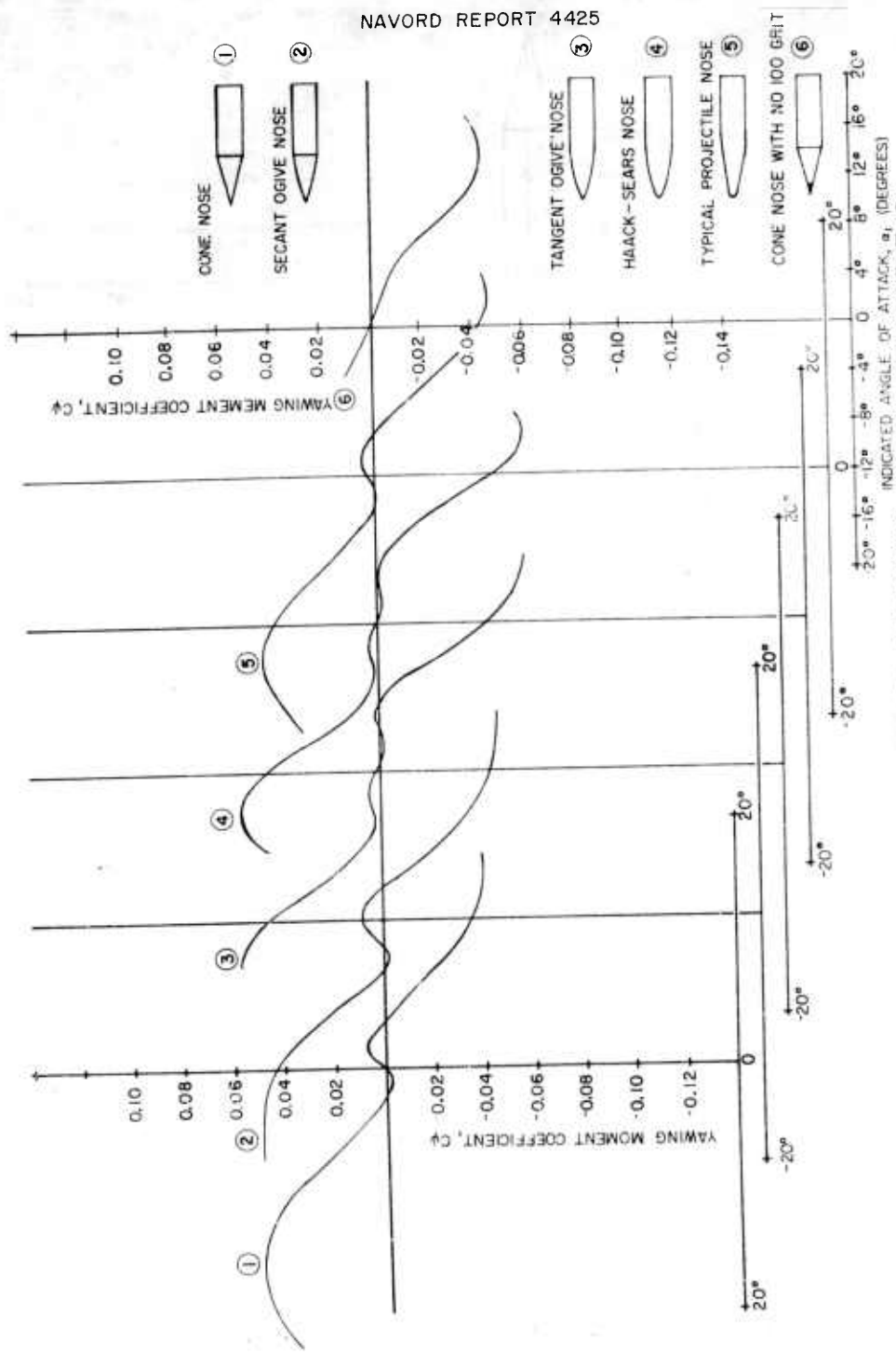

FIG 63 THE EFFECT OF NOSE SHAPE ON THE YAWING MOMENT COEFFICIENT C_ψ
(P=458 RPS)

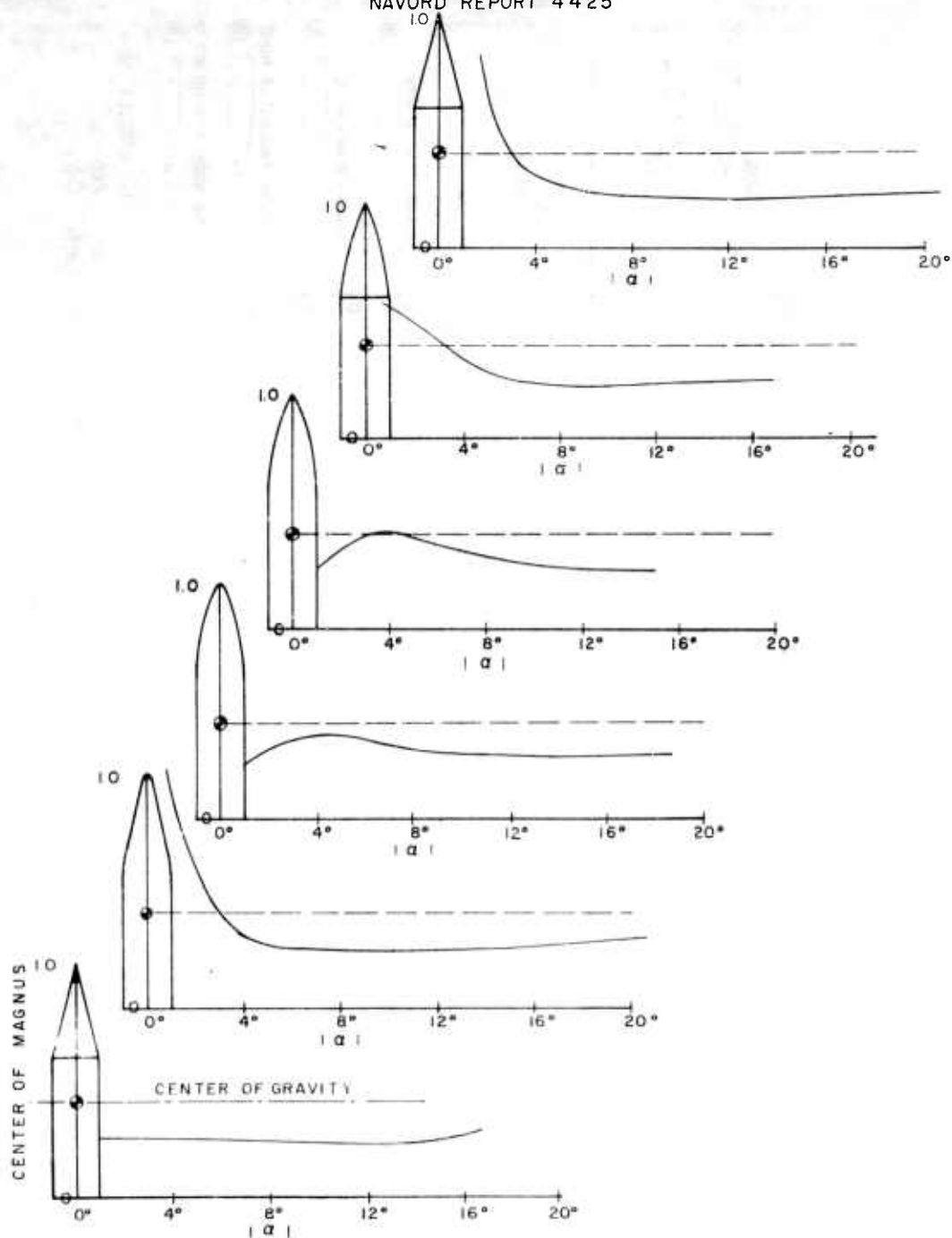

FIG.64 THE EFFECT OF NOSE SHAPE ON THE CENTER OF MAGNUS
(P = 458 RPS)

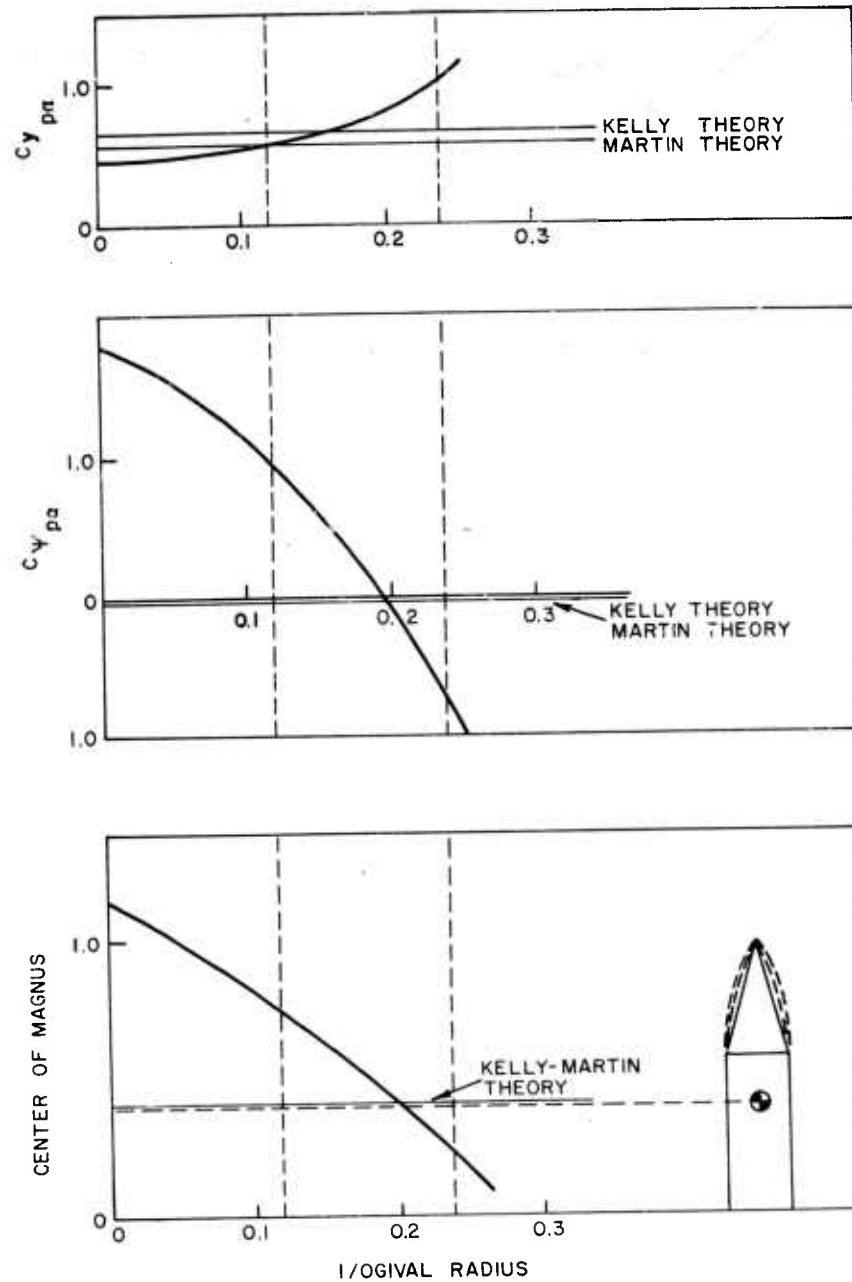

FIG. 65 THE EFFECT OF OGIVAL RADIUS ON THE INITIAL MAGNUS CHARACTERISTICS OF BODIES OF FINENESS RATIO 5 AT P=305 (RPS)

NAVORD REPORT 4425

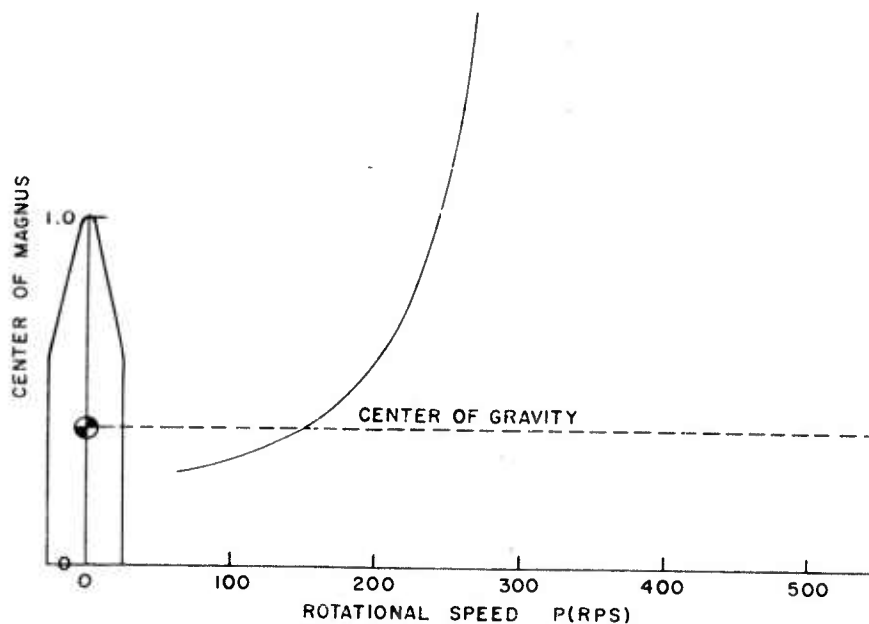
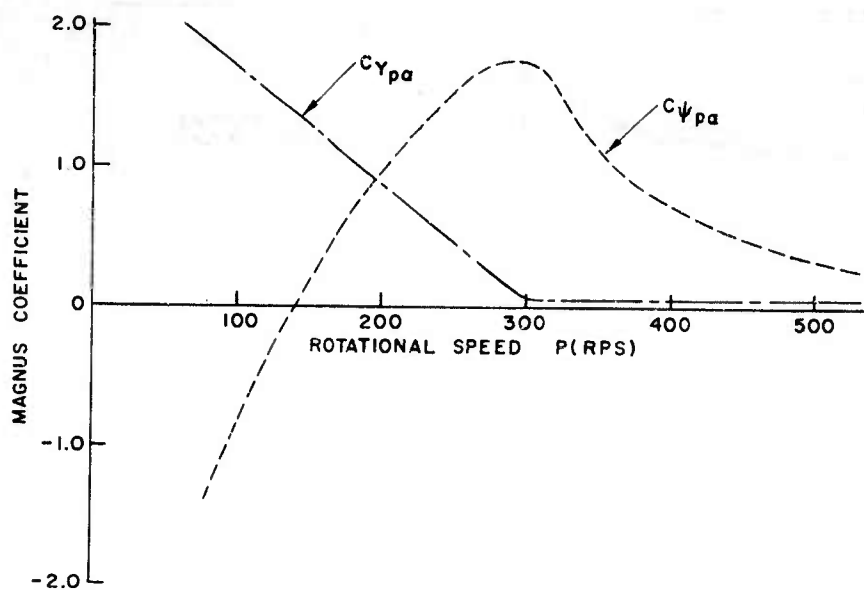

FIG. 66 THE EFFECT OF SPIN ON THE INITIAL MAGNUS CHARACTERISTICS OF THE TYPICAL PROJECTILE NOSE

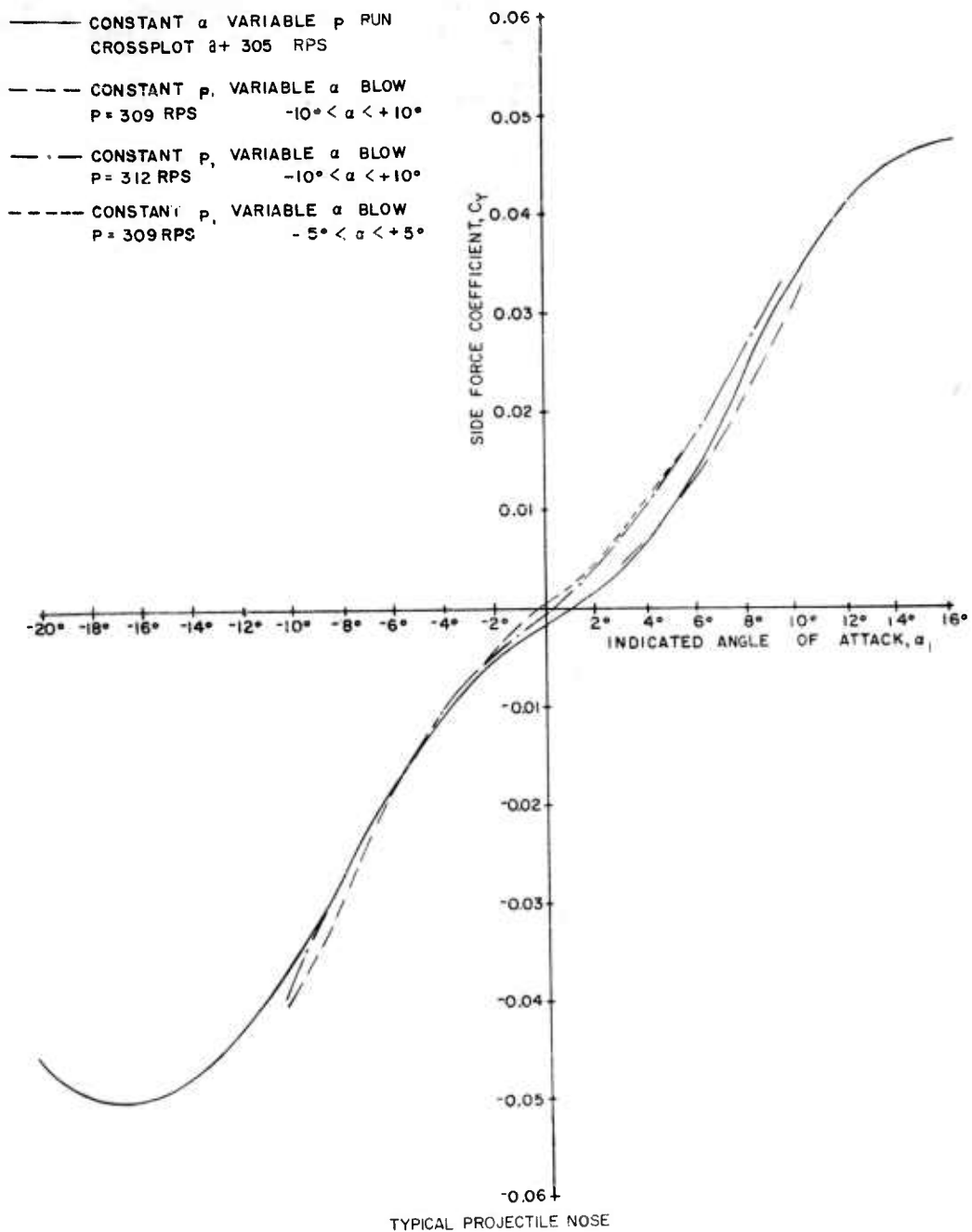

FIG. 67 COMPARISON OF THE SIDE FORCE COEFFICIENTS OBTAINED BY TWO TEST TECHNIQUES

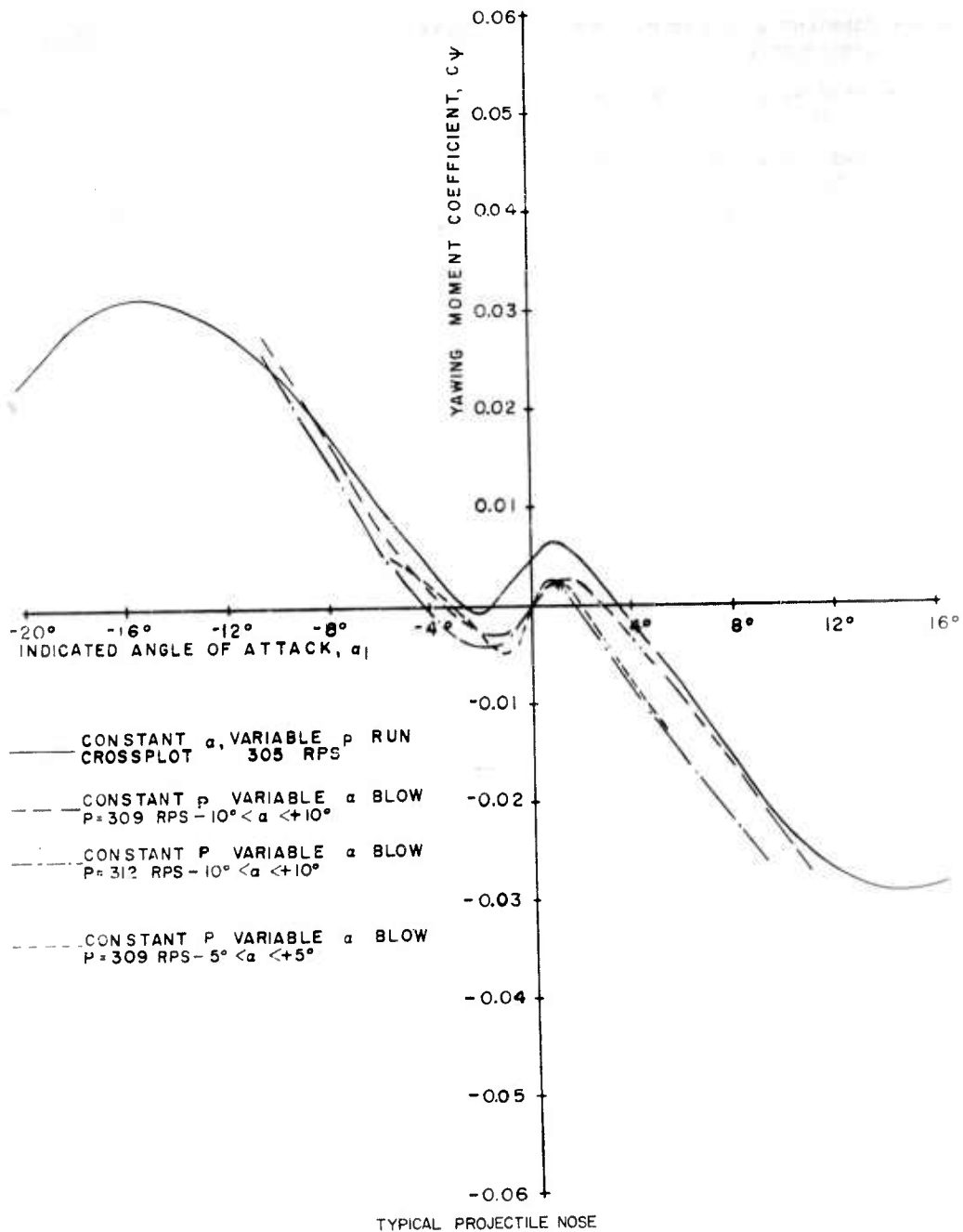

FIG. 68 COMPARISON OF THE YAWING MOMENT COEFFICIENTS
OBTAINED BY TWO TEST TECHNIQUES

241	01	1 01						
02	2.00	26.5	.0090	.0004	.4009			
03	2.00	63.2	.0168	.0063	.4670			
04	2.00	10.0	.0206	.0161	.5483			
05	2.00	136.8	.0212	.0294	.6694			
06	2.00	173.5	.0212	.0429	.7967			
07	2.00	210.3	.0218	.0552	.8984			
08	2.00	247.0	.0220	.0638	.9720			
09	2.00	283.8	.0228	.0672	.9815			
10	2.00	320.6	.0243	.0680	.9517			
11	2.00	357.4	.0260	.0656	.8966			
12	2.00	394.1	.0297	.0578	.7812			
13	2.00	430.9	.0330	.0488	.6878			
14	2.00	467.6	.0362	.0396	.6108			
15	2.00	504.4	.0404	.0273	.5271			

241	01	1 02			
02	4.00	174.3	.0642	.0386-	.2718
03	4.00	247.8	.0917	.0570-	.2677
04	4.00	321.3	.1181	.0791-	.2580
05	4.00	394.9	.1344	.0926-	.2542
06	4.00	468.4	.1436	.0987-	.2545
07	4.00	505.2	.1464	.0999-	.2555

241	01	1 03			
02	6.00	16.9	.0101	.0076-	.2415
03	6.00	53.7	.0335	.0279-	.2254
04	6.00	90.4	.0573	.0485-	.2227
05	6.00	127.2	.0827	.0709-	.2205
06	6.00	164.0	.1146	.1013-	.2152
07	6.00	200.7	.1470	.1328-	.2113
08	6.00	237.5	.1788	.1651-	.2073
09	6.00	274.3	.2054	.1911-	.2059
10	6.00	311.0	.2285	.2125-	.2060
11	6.00	347.8	.2469	.2263-	.2087
12	6.00	384.6	.2630	.2376-	.2113
13	6.00	421.3	.2781	.2458-	.2152
14	6.00	458.1	.2910	.2513-	.2193
15	6.00	494.8	.3041	.2573-	.2228

241	02	1 04			
02	8.00	39.7	.0319	.0203-	.2647
03	8.00	76.5	.0653	.0496-	.2401
04	8.00	113.2	.0997	.0798-	.2319
05	8.00	150.0	.1384	.1160-	.2244
06	8.00	186.8	.1836	.1641-	.2132
07	8.00	223.5	.2232	.1952-	.2171
08	8.00	260.3	.2599	.2292-	.2156
09	8.00	297.1	.2929	.2568-	.2167
10	8.00	333.8	.3215	.2807-	.2174
11	8.00	370.6	.3455	.2948-	.2213
12	8.00	407.4	.3640	.2981-	.2282
13	8.00	444.1	.3847	.3074-	.2322
14	8.00	480.9	.4099	.3265-	.2327

B

241	02	1 05		
02	10.00	280.1	.3136	.2263-
03	10.00	600.0	.6490	.4836-
				.2477
				.2430

241	02	1 06			
02	12.00	268.3	.3665	.2514-	.2548
03	12.00	600.0	.7955	.5638-	.2503

O
O
O
O
O
B

NAVORD Report 4425

241	02	1 07		
02	14.00	600.0	.8808	.5858
				.2590

241	02	1 08		
02	15.80	600.0	.9489	.6323
				.2587

241	02	1 09			
02	3.00	46.4	.0104	.0007	.4055
03	3.00	83.2	.0178	.0023	.4178
04	3.00	120.1	.0256	.0022	.4092
05	3.00	156.9	.0324	.0032	.4118
06	3.00	193.7	.0384	.0075	.4311
07	3.00	230.5	.0458	.0091	.4317
08	3.00	267.4	.0531	.0107	.4323
09	3.00	304.2	.0588	.0105	.4277
10	3.00	341.0	.0642	.0059	.4104
11	3.00	377.9	.0705	.0021-	.3860
12	3.00	414.7	.0732	.0076-	.3712
13	3.00	451.5	.0736	.0092-	.3670
14	3.00	488.3	.0760	.0130-	.3578
15	3.00	525.2	.0778	.0174-	.3473
16	3.00	562.0	.0801	.0211-	.3393
17	3.00	598.8	.0819	.0255-	.3297

NAVORD Report 4425

241	02	1 10							
02	1.00	57.9	.0088-	.0241	.1557-				
03	1.00	94.7	.0102-	.0268	.1335-				
04	1.00	131.6	.0069-	.0220	.2457-				
05	1.00	168.4	.0001-	.0146	8.8080-				
06	1.00	205.3	.0007	.0197	6.0206				
07	1.00	242.1	.0039-	.0356	1.4336-				
08	1.00	278.9	.0161-	.0645	.4092-				
09	1.00	315.8	.0251-	.0864	.2964-				
10	1.00	352.6	.0307-	.1034	.2816-				
11	1.00	389.4	.0284-	.0996	.3094-				
12	1.00	426.3	.0236-	.0859	.3360-				
13	1.00	463.1	.0190-	.0761	.4091-				
14	1.00	500.0	.0182-	.0728	.4080-				
15	1.00	536.8	.0187-	.0722	.3802-				
16	1.00	573.6	.0222-	.0748	.2819-				
17	1.00	602.2	.0244-	.0724	.2014-				

0

B

241	02	1 11				
02	1.00-	41.2	.0202-	.0329	.0663	
03	1.00-	77.9	.0377-	.0603	.0721	
04	1.00-	114.7	.0505-	.0780	.0831	
05	1.00-	151.5	.0580-	.0826	.1072	
06	1.00-	188.2	.0612-	.0812	.1266	
07	1.00-	225.0	.0531-	.0627	.1558	
08	1.00-	261.8	.0401-	.0305	.2399	
09	1.00-	298.5	.0283-	.0032	.3694	
10	1.00-	335.3	.0228-	.0076-	.4587	
11	1.00-	372.1	.0300-	.0014	.3827	
12	1.00-	408.8	.0454-	.0290	.2642	
13	1.00-	445.6	.0576-	.0495	.2201	
14	1.00-	482.4	.0628-	.0649	.1853	
15	1.00-	519.1	.0595-	.0685	.1617	
16	1.00-	555.9	.0503-	.0657	.1308	

NAVORD Report 4425

241	02	1	12				
02	2.00-	42.7	.0356-	.0352	.1942		
03	2.00-	79.5	.0588-	.0545	.2066		
04	2.00-	116.2	.0738-	.0636	.2196		
05	2.00-	153.0	.0765-	.0545	.2495		
06	2.00-	189.8	.0734-	.0367	.2920		
07	2.00-	226.6	.0672-	.0203	.3316		
08	2.00-	263.4	.0629-	.0060	.3729		
09	2.00-	300.2	.0638-	.0009	.3892		
10	2.00-	337.0	.0720-	.0110	.3614		
11	2.00-	373.8	.0846-	.0332	.3135		
12	2.00-	410.5	.0976-	.0570	.2752		
13	2.00-	447.3	.1086-	.0787	.2471		
14	2.00-	484.1	.1121-	.0897	.2320		
15	2.00-	520.9	.1108-	.0931	.2239		

241	02	1 13			
02	4.00-	52.3	.0505-	.0550	.1742
03	4.00-	89.1	.0830-	.0893	.1768
04	4.00-	125.9	.1123-	.1188	.1804
05	4.00-	162.7	.1402-	.1456	.1843
06	4.00-	199.5	.1679-	.1746	.1840
07	4.00-	236.3	.1947-	.2026	.1839
08	4.00-	273.1	.2166-	.2253	.1840
09	4.00-	309.9	.2365-	.2459	.1841
10	4.00-	346.7	.2521-	.2628	.1835
11	4.00-	383.6	.2647-	.2765	.1831
12	4.00-	420.4	.2763-	.2892	.1827
13	4.00-	457.2	.2841-	.2977	.1824
14	4.00-	494.0	.2889-	.3030	.1822
15	4.00-	530.8	.2856-	.2982	.1832
16	4.00-	567.6	.2798-	.2918	.1834

NAVORD Report 4425

241	03	1 16	.0063-	.0004-	.4047
02	5.00-	13.8	.0376-	.0044	.3686
03	5.00-	86.4	.0685-	.0137	.3520
04	5.00-	159.1	.0968-	.0238	.3428
05	5.00-	231.7	.1222-	.0369	.3316
06	5.00-	304.4	.1430-	.0486	.3240
07	5.00-	377.0	.1586-	.0595	.3170
08	5.00-	449.6	.1686-	.0679	.3115
09	5.00-	522.3			

241	03	1	15					
02	3.00-	58.1		.0217-	.0020-	.4104		
03	3.00-	94.4		.0285-	.0092-	.4566		
04	3.00-	130.8		.0337-	.0170-	.4929		
05	3.00-	167.1		.0358-	.0256-	.5350		
06	3.00-	203.4		.0384-	.0326-	.5618		
07	3.00-	239.7		.0388-	.0394-	.5951		
08	3.00-	276.0		.0395-	.0423-	.6062		
09	3.00-	312.3		.0411-	.0418-	.5954		
10	3.00-	348.7		.0416-	.0424-	.5958		
11	3.00-	385.0		.0422-	.0430-	.5958		
12	3.00-	421.3		.0416-	.0424-	.5958		
13	3.00-	457.6		.0405-	.0412-	.5955		
14	3.00-	493.9		.0398-	.0384-	.5850		

241	03	1 18			
02	8.00-	33.5	.0315-	.0173	.2822
03	8.00-	106.4	.0960-	.0607	.2655
04	8.00-	179.3	.1581-	.1004	.2650
05	8.00-	252.2	.2170-	.1414	.2617
06	8.00-	325.2	.2690-	.1749	.2620
07	8.00-	398.1	.3179-	.2075	.2615
08	8.00-	471.0	.3645-	.2425	.2589
09	8.00-	543.9	.4030-	.2735	.2563

241	03	1 17			
02	7.00-	40.7	.0305-	.0162	.2858
03	7.00-	113.5	.0808-	.0430	.2856
04	7.00-	186.2	.1310-	.0721	.2819
05	7.00-	258.9	.1775-	.1008	.2784
06	7.00-	331.6	.2188-	.1288	.2743
07	7.00-	404.4	.2583-	.1524	.2740
08	7.00-	477.1	.2954-	.1806	.2697
09	7.00-	549.8	.3198-	.2011	.2662

241	03	1 19			
02	10.00-	65.7	.0753-	.0468	.2677
03	10.00-	138.6	.1585-	.1021	.2632
04	10.00-	211.0	.2366-	.1543	.2616
05	10.00-	284.0	.3101-	.2052	.2597
06	10.00-	257.0	.3849-	.2611	.2563
07	10.00-	43.0	.4531-	.3111	.2547
08	10.00-	503.0	.5169-	.3575	.2537
09	10.00-	576.0	.5728-	.3953	.2540

NAVORD Report 4425

241	03	1 20			
02	10.00-	83.1	.1024-	.0666	.2619
03	10.00-	156.0	.1886-	.1251	.2593
04	10.00-	228.9	.2715-	.1850	.2557
05	10.00-	301.8	.3518-	.2433	.2537
06	10.00-	374.7	.4236-	.2960	.2522
07	10.00-	447.6	.4891-	.3406	.2527
08	10.00-	520.5	.5551-	.3930	.2504
09	10.00-	593.4	.6082-	.4339	.2493

241	03	1 21			
02	12.00-	72.9	.1052-	.0721	.2549
03	12.00-	145.8	.2101-	.1424	.2564
04	12.00-	218.7	.3116-	.2142	.2545
05	12.00-	291.6	.4097-	.2833	.2537
06	12.00-	364.5	.5015-	.3443	.2547
07	12.00-	437.4	.5938-	.4132	.2528
08	12.00-	510.3	.6880-	.4843	.2512
09	12.00-	583.2	.7800-	.5578	.2490

NAVORD Report 4425

241	03	1 22			
02	12.00-	42.3	.0635-	.0424	.2585
03	12.00-	115.3	.1695-	.1116	.2603
04	12.00-	188.2	.2732-	.1832	.2579
05	12.00-	261.2	.3702-	.2512	.2563
06	12.00-	334.1	.4672-	.3216	.2543
07	12.00-	407.1	.5628-	.3954	.2515
08	12.00-	480.0	.6497-	.4595	.2506
09	12.00-	552.9	.7321-	.5263	.2482

241	03	1 23		
02	14.00-	352.1	.5336-	.3672
03	14.00-	600.0	.8950-	.6343
				.2544
				.2503

NAVORD Report 4425

241	03	1 24		
02	16.00~	600.0	.9715-	.6373 .2608

0
0
0
0
0
8

241	03	1 25		
02	18.00-	600.0	1.0489-	.6521 .2677

241	04	2 01			
02	4.00	79.8	.0206	.0078-	.3163
03	4.00	152.9	.0392	.0134-	.3236
04	4.00	226.1	.0588	.0201-	.3236
05	4.00	299.3	.0769	.0263-	.3236
06	4.00	372.4	.0917	.0339-	.3181
07	4.00	445.6	.1014	.0384-	.3163
08	4.00	518.8	.1090	.0430-	.3131
09	4.00	555.4	.1110	.0452-	.3106

241	04	2	02				
02	8.00	61.6		.0279	.0170-	.2701	
03	8.00	135.0		.0745	.0544-	.2460	
04	8.00	208.3		.1252	.0937-	.2423	
05	8.00	281.7		.1760	.1331-	.2407	
06	8.00	355.0		.2222	.1688-	.2401	
07	8.00	428.4		.2644	.2002-	.2406	
08	8.00	501.7		.3075	.2350-	.2392	
09	8.00	575.1		.3491	.2693-	.2377	

241	04	2 04			
02	15.80	70.2	.0710	.0517-	.2464
03	15.80	143.2	.1541	.1118-	.2469
04	15.80	216.3	.2429	.1743-	.2485
05	15.80	289.4	.3317	.2369-	.2492
06	15.80	362.5	.4199	.3000-	.2491
07	15.80	435.6	.5136	.3679-	.2487
08	15.80	508.6	.6163	.4432-	.2482
09	15.80	600.0	.7562	.5468-	.2474

241	04	2 05							
02	14.00	68.6	.0623	.0398	.2642				
03	14.00	141.6	.1370	.0918	.2580				
04	14.00	214.6	.2283	.1645	.2479				
05	14.00	287.6	.3187	.2337	.2453				
06	14.00	360.6	.4101	.3041	.2437				
07	14.00	433.6	.5039	.3782	.2419				
08	14.00	506.6	.5989	.4512	.2413				
09	14.00	600.0	.7308	.5570	.2396				

NAVORD Report 4425

241	04	2 06			
02	10.00	36.5	.0244	.0058-	.3445
03	10.00	73.1	.0533	.0239-	.3023
04	10.00	146.2	.1147	.0688-	.2720
05	10.00	219.2	.1795	.1187-	.2597
06	10.00	292.3	.2515	.1800-	.2489
07	10.00	365.4	.3162	.2322-	.2451
08	10.00	438.5	.3763	.2806-	.2429
09	10.00	511.6	.4320	.3254-	.2414
10	10.00	600.0	.4914	.3682-	.2421

241	04	2 07	.0106	.0007	.4052
02	6.00	47.6	.0224	.0037-	.3590
03	6.00	84.1	.0510	.0177-	.3226
04	6.00	157.3	.0835	.0384-	.3000
05	6.00	230.5	.1161	.0630-	.2835
06	6.00	303.7	.1439	.0823-	.2776
07	6.00	376.8	.1691	.1000-	.2737
08	6.00	450.0	.1908	.1151-	.2714
09	6.00	523.2	.2065	.1260-	.2700
10	6.00	600.0			

241	04	2 08			
02	4.00	39.6	.0047	.0071	.6941
03	4.00	112.8	.0142	.0152	.6061
04	4.00	186.1	.0300	.0150	.4920
05	4.00	259.3	.0490	.0077	.4234
06	4.00	332.6	.0634	.0018	.3977
07	4.00	405.9	.0732	.0004-	.3909
08	4.00	479.1	.0799	.0039-	.3822
09	4.00	552.4	.0844	.0076-	.3740
10	4.00	600.0	.0849	.0070-	.3755

241	04	2	09						
02	3.00	45.8	.0014	.0058	1.2206				
03	3.00	119.0	.0061	.0129	.8150				
04	3.00	192.3	.0154	.0187	.6349				
05	3.00	265.6	.0267	.0222	.5583				
06	3.00	338.8	.0336	.0233	.5307				
07	3.00	412.1	.0349	.0268	.5456				
08	3.00	485.3	.0332	.0249	.5420				
09	3.00	522.0	.0311	.0248	.5515				

241	04	2 10			
02	2.00	49.2	.0024	.0133	1.5003
03	2.00	122.6	.0042	.0322	1.9253
04	2.00	196.1	.0046	.0476	2.4616
05	2.00	269.5	.0054	.0590	2.5772
06	2.00	343.0	.0037	.0657	3.9434
07	2.00	416.4	.0012-	.0711	1.4580-
08	2.00	489.8	.0041-	.0680	2.9251-
09	2.00	563.3	.0072-	.0604	1.2858-
10	2.00	600.0	.0081-	.0553	.9734-

241	05	2 11			
02	1.00	65.9	.0046-	.0207	.5080-
03	1.00	139.2	.0105-	.0442	.4499-
04	1.00	212.5	.0155-	.0609	.3938-
05	1.00	285.7	.0193-	.0705	.3386-
06	1.00	359.0	.0240-	.0731	.2172-
07	1.00	432.2	.0314-	.0754	.0883-
08	1.00	505.5	.0351-	.0706	.0103-
09	1.00	578.8	.0335-	.0570	.0517
10	1.00	600.0	.0321-	.0526	.0643

241	05	2 14			
02	2.00-	34.4	.0101-	.0032-	.4554
03	2.00-	107.6	.0311-	.0086-	.4473
04	2.00-	180.7	.0501-	.0119-	.4395
05	2.00-	253.9	.0619-	.0152-	.4411
06	2.00-	327.1	.0647-	.0190-	.4507
07	2.00-	400.2	.0650-	.0133-	.4329
08	2.00-	473.4	.0655-	.0020-	.3981
09	2.00-	546.6	.0653-	.0110	.3583
10	2.00-	600.0	.0650-	.0224	.3231

241	05	2	15				
02	3.00-	45.4		.0218-	.0116	.2856	
03	3.00-	118.5		.0536-	.0261	.2946	
04	3.00-	191.7		.0770-	.0351	.3008	
05	3.00-	264.9		.0921-	.0377	.3101	
06	3.00-	338.1		.1017-	.0385	.3163	
07	3.00-	411.2		.1067-	.0400	.3170	
08	3.00-	484.4		.1105-	.0486	.3040	
09	3.00-	557.6		.1148-	.0645	.2796	
10	3.00-	600.0		.1170-	.0757	.2626	

241	06	2 16			
02	4.00-	56.0	.0209-	.0032	.3614
03	4.00-	129.1	.0460-	.0061	.3655
04	4.00-	202.3	.0703-	.0142	.3516
05	4.00-	275.5	.0910-	.0197	.3487
06	4.00-	348.7	.1101-	.0332	.3317
07	4.00-	421.8	.1258-	.0442	.3217
08	4.00-	495.0	.1333-	.0511	.3153
09	4.00-	531.6	.1361-	.0566	.3088

3

241	06	2 17			
02	5.00-	30.8	.0379-	.0169	.3028
03	5.00-	154.2	.0711-	.0347	.2944
04	5.00-	227.7	.1025-	.0542	.2862
05	5.00-	301.1	.1308-	.0729	.2805
06	5.00-	374.5	.1555-	.0912	.2747
07	5.00-	448.0	.1772-	.1063	.2720
08	5.00-	521.4	.1945-	.1240	.2645
09	5.00-	600.0	.2022-	.1348	.2587

241	06	2 18			
02	6.00-	33.0	.0208-	.0117	.2800
03	6.00-	106.4	.0636-	.0363	.2778
04	6.00-	179.7	.1028-	.0582	.2788
05	6.00-	253.1	.1407-	.0836	.2732
06	6.00-	326.4	.1774-	.1103	.2676
07	6.00-	399.8	.2072-	.1317	.2649
08	6.00-	473.1	.2348-	.1532	.2615
09	6.00-	546.5	.2591-	.1761	.2561
10	6.00-	600.0	.2672-	.1824	.2555

241	06	2 19			
02	8.00-	57.6	.0526-	.0353	.2578
03	8.00-	131.0	.1161-	.0801	.2540
04	8.00-	204.4	.1765-	.1240	.2515
05	8.00-	277.8	.2312-	.1677	.2469
06	8.00-	351.2	.2821-	.2048	.2468
07	8.00-	424.6	.3273-	.2394	.2457
08	8.00-	498.0	.3686-	.2698	.2456
09	8.00-	571.4	.4073-	.3071	.2412
10	8.00-	600.0	.4217-	.3215	.2395

241	06	2 20			
02	10.00-	56.5	.0638-	.0488	.2390
03	10.00-	129.8	.1433-	.1085	.2406
04	10.00-	203.2	.2226-	.1705	.2388
05	10.00-	276.5	.2961-	.2323	.2351
06	10.00-	349.9	.3647-	.2888	.2336
07	10.00-	423.2	.4287-	.3438	.2316
08	10.00-	496.6	.4885-	.3969	.2295
09	10.00-	533.3	.5178-	.4251	.2278

241	06	2 21			
02	12.00-	51.5	.0700-	.0507	.2471
03	12.00-	124.6	.1639-	.1163	.2501
04	12.00-	197.7	.2519-	.1817	.2477
05	12.00-	270.8	.3362-	.2491	.2438
06	12.00-	343.8	.4231-	.3243	.2387
07	12.00-	416.9	.5050-	.3941	.2359
08	12.00-	490.0	.5886-	.4644	.2342
09	12.00-	563.1	.6691-	.5314	.2332
10	12.00-	600.0	.7121-	.5685	.2323

NAVORD Report 4425

241	06	2 22			
02	14.00-	252.4	.3515-	.2646	.2414
03	14.00-	362.2	.5010-	.3835	.2389
04	14.00-	600.0	.8169-	.6436	.2344

241	06	2 23		
02	16.00-	600.0	.8549-	.6433 .2432

NAVORD Report 4425

241	06	2	24				
02	18.00-	345.4		5065-	3627	2488	
03	18.00-	455.1		6707-	4744	2505	
04	18.00-	600.0		9049-	6282	2532	

241	06	2 25			
02	18.00-	311.3	.4507-	.3202	.2499
04	18.00-	459.7	.6753-	.4758	.2511
03	18.00-	386.6	.5643-	.3988	.2507
05	18.00-	532.7	.7940-	.5574	.2516
06	18.00-	600.0	.9069-	.6304	.2530

NAVORD Report 4425

241	06	2 26				
02	18.00-	280.6	.4090-	.2882	.2511	
03	18.00-	355.9	.5175-	.537	.2514	
04	18.00-	429.0	.6290-	.424	.2513	
05	18.00-	502.1	.7497	.5239	.2522	
06	18.00-	574.4	.8697-	.5020	.2536	
07	18.00-	600.0	.9152-	.6321	.2539	

241	06	2 27			
02	18.00-	352.0	.5087-	.3369	.2595
03	18.00-	425.1	.6197-	.4139	.2584
04	18.00-	497.6	.7291-	.4842	.2592
05	18.00-	570.7	.8594-	.5725	.2588
06	18.00-	600.0	.9100-	.6057	.2589

241	06	2 28			
02	18.00-	297.4	.4307-	.3033	.2512
03	18.00-	370.5	.5412-	.3809	.2512
04	18.00-	442.9	.6570-	.4571	.2529
05	18.00-	516.0	.7789-	.5374	.2540
06	18.00-	600.0	.9232-	.6299	.2555

241	06	2 29			
02	20.00-	53.3	.0726-	.0522	.2482
03	20.00-	128.5	.1825-	.1304	.2491
04	20.00-	201.5	.2917-	.2030	.2528
05	20.00-	273.7	.4026-	.2738	.2560
06	20.00-	346.7	.5174-	.3489	.2571
07	20.00-	419.7	.6410-	.4274	.2586
08	20.00-	492.7	.7694-	.5050	.2607
09	20.00-	565.0	.9072-	.5916	.2616
10	20.00-	600.0	.9740-	.6351	.2616

NAVORD Report 4425

241	06	2	30			
02	22.00-	335.1	.5671-	.5938	.1826	
03	22.00-	408.3	.6004-	.3537	.2742	
04	22.00-	480.7	.8264-	.8656	.1825	
05	22.00-	553.4	.8429-	.5093	.2712	
06	22.00-	600.0	.9307-	.5707	.2694	

0

0

0

0

8

241	07	3 01	.0095	.0005	.3815
02	4.00	59.8	.0231	.0031	.3652
03	4.00	132.8	.0311	.0055	.4274
04	4.00	205.8	.0528	.0051	.4113
05	4.00	278.8	.0619	.0149	.4401
06	4.00	351.8	.0680	.0279	.4741
07	4.00	424.8	.0754	.0358	.4870
08	4.00	497.8	.0773	.0399	.4952
09	4.00	534.3			

NAVORD Report 4425

241	07	3	02		
02	8.00	62.8	.0461	.0084-	.3556
03	8.00	135.8	.1155	.0325-	.3357
04	8.00	208.8	.1872	.0628-	.3249
05	8.00	281.8	.2510	.0930-	.3179
06	8.00	354.7	.2999	.1069-	.3207
07	8.00	427.7	.3417	.1243-	.3192
08	8.00	500.7	.3709	.1315-	.3211
09	8.00	600.0	.4104	.1427-	.3225

241	07	3 03			
02	12.00	41.6	.0594	.0328	.2816
03	12.00	78.1	.1160	.0663	.2777
04	12.00	151.1	.2387	.1361	.2780
05	12.00	224.1	.3635	.2058	.2788
06	12.00	297.1	.4908	.2856	.2756
07	12.00	370.1	.6069	.3582	.2740
08	12.00	443.1	.7065	.4249	.2717
09	12.00	516.1	.7990	.4864	.2702
10	12.00	552.6	.8337	.5070	.2704

NAVORD Report 4425

241	07	3 04				
02	15.80	54.7	.0382	.0088	.4381	
03	15.80	127.3	.2275	.1202-	.2863	
04	15.80	200.7	.3843	.2113-	.2820	
05	15.80	273.7	.5415	.2955-	.2829	
06	15.80	346.7	.7094	.4047-	.2779	
07	15.80	419.7	.8644	.5062-	.2749	
08	15.80	492.7	1.0133	.6058-	.2724	
09	15.80	529.2	1.0872	.6593-	.2707	

24.1	07	3 05							
02	14.00	82.0	.1262	.0639-	.2907				
03	14.00	155.1	.2619	.1369-	.2875				
04	14.00	228.3	.4091	.2211-	.2839				
05	14.00	301.5	.5604	.3160-	.2792				
06	14.00	374.6	.7079	.4105-	.2760				
07	14.00	447.8	.8457	.5091-	.2716				
08	14.00	521.0	.9746	.5980-	.2693				
09	14.00	557.6	1.0413	.6486-	.2674				

NAVORD Report 4425

241	07	3 06			
02	10.00	31.5	.0285	.0102-	.3204
03	10.00	62.9	.0694	.0241-	.3225
04	10.00	94.4	.1128	.0419-	.3177
05	10.00	136.1	.1596	.0646-	.3110
06	10.00	209.3	.2533	.1140-	.3020
07	10.00	282.4	.3460	.1646-	.2969
08	10.00	313.9	.3905	.1897-	.2948
09	10.00	392.9	.4598	.2161-	.2980
10	10.00	466.1	.5344	.2754-	.2889

241	07	3 07			
02	6.00	52.9	.0291	.0010-	.3851
03	6.00	126.3	.0655	.0026-	.3841
04	6.00	199.8	.0959	.0001-	.3918
05	6.00	273.2	.1224	.0005	.3928
06	6.00	346.6	.1427	.0030	.3962

241	07	3 08				
02	5.00	49.1	.0123	.0025	.4327	
03	5.00	122.5	.0338	.0062	.4287	
04	5.00	195.8	.0594	.0016	.3974	
05	5.00	269.2	.0800	.0086	.4135	
06	5.00	342.5	.0955	.0188	.4314	
07	5.00	415.9	.1129	.0182	.4242	
08	5.00	489.2	.1266	.0242	.4302	

241	07	3 09	.0319	.0065-	.3512
02	3.00	260.6	.0416	.0038	.4103
03	3.00	365.0	.0613	.0314	.4944
04	3.00	600.0			

NAVORD Report 4425

241	07	3 10			
02	2.00	30.7	.0004	.0103-	4.7580-
03	2.00	67.2	.0038-	.0020-	.4973
04	2.00	103.7	.0061-	.0044-	.5363
05	2.00	140.2	.0071-	.0033-	.4850
06	2.00	176.6	.0096-	.0018-	.4295
07	2.00	213.1	.0022	.0147-	.9444-
08	2.00	249.6	.0059	.0151-	.1199-
09	2.00	322.6	.0157	.0196-	.1423
10	2.00	395.6	.0219	.0215-	.1957
11	2.00	468.6	.0245	.0144-	.2744
12	2.00	541.6	.0264	.0017-	.3791
13	2.00	600.0	.0205	.0219	.6057

241	07	3 11			
02	1.00	51.2	.0084-	.0017	.3515
03	1.00	80.5	.0111-	.0010	.3740
04	1.00	153.7	.0088-	.0051-	.5079
05	1.00	226.8	.0077-	.0039-	.4933
06	1.00	300.0	.0030-	.0053-	.7453
07	1.00	373.2	.0007-	.0029-	1.2206
08	1.00	446.3	.0016.	.0005-	.3295
09	1.00	519.5	.0024	.0047	.7837
10	1.00	600.0	.0018-	.0216	2.0080-

NAVORD Report 4425

241	07	3 12			
02	0.00	69.7	.0088-	.0034	.3147
03	0.00	106.4	.0169-	.0098	.2760
04	0.00	143.0	.0225-	.0123	.2827
05	0.00	216.4	.0272-	.0137	.2913
06	0.00	289.7	.0280-	.0171	.2699
07	0.00	363.1	.0289-	.0204	.2508
08	0.00	436.4	.0293-	.0221	.2411
09	0.00	509.7	.0277-	.0217	.2353

241	07	3	13			
02	1.00-	46.8		.0138-	.0003	.3877
03	1.00-	80.5		.0217-	.0003	.3892
04	1.00-	117.1		.0330-	.0053	.3599
05	1.00-	153.7		.0421-	.0127	.3317
06	1.00-	190.2		.0523-	.0189	.3197
07	1.00-	263.4		.0615-	.0240	.3140
08	1.00-	336.6		.0636-	.0239	.3168
09	1.00-	409.8		.0673-	.0242	.3201
10	1.00-	482.9		.0692-	.0201	.3339
11	1.00-	556.4		.0729-	.0204	.3360
12	1.00-	600.0		.0743-	.0232	.3296

NAVORD Report 4425

241	07	3 14				
02	2.00-	60.1	.0253-	.0264	.1833	
03	2.00-	133.5	.0508-	.0505	.1932	
04	2.00-	206.8	.0725-	.0679	.2047	
05	2.00-	280.2	.0846-	.0763	.2116	
06	2.00-	353.4	.0933-	.0820	.2162	
07	2.00-	426.2	.0988-	.0782	.2337	
08	2.00-	499.5	.0976-	.0646	.2596	
09	2.00-	600.0	.1317-	.2014	.0862	

241	07	3 15			
02	3.00-	54.3	.0267-	.0292	.1733
03	3.00=	127.6	.0563-	.0553	.1956
04	3.00-	201.0	.0746-	.0678	.2102
05	3.00-	274.3	.0924-	.0787	.2217
06	3.00-	347.7	.0997-	.0730	.2456
07	3.00-	421.0	.1052-	.0607	.2766
08	3.00=	494.4	.1115-	.0540	.2951
09	3.00-	600.0	.1131-	.0287	.3412

NIVORD Report 4425

241	07	3 16			
02	4.00-	79.8	.0245-	.0027-	.4140
03	4.00-	152.9	.0513-	.0007	.3893
04	4.00-	226.1	.0757-	.0088	.3668
05	4.00-	299.3	.0912-	.0072	.3762
06	4.00-	372.4	.1050-	.0011-	.3941
07	4.00-	445.6	.1142-	.0131-	.4149
08	4.00-	518.8	.1233-	.0143-	.4152

3

241	07	3 17			
02	5.00-	71.2	.0473	.0135-	.3349
03	5.00-	144.5	.0870	.0224-	.3405
04	5.00-	217.8	.1310	.0395-	.3317
05	5.00-	291.2	.1409	.0246-	.3571
06	5.00-	364.5	.1597	.0217-	.3648
07	5.00-	437.9	.1771	.0222-	.3669
08	5.00-	511.3	.1930	.0224-	.3688
09	5.00-	600.0	.2085	.0208-	.3720

241	07	3 18			
02	6.00-	60.2	.0497-	.0174	.3220
03	6.00-	133.5	.1088-	.0376	.3229
04	6.00-	206.8	.1568-	.0505	.3276
05	6.00-	280.2	.1908-	.0568	.3325
06	6.00-	353.5	.2201-	.0618	.3358
07	6.00-	424.0	.2452-	.0670	.3374
08	6.00-	503.2	.2662-	.0702	.3393

241	07	3 19			
02	8.00-	70.4	.0864-	.0402	.2989
03	8.00-	143.8	.1733-	.0820	.2974
04	8.00-	217.1	.2447-	.1082	.3036
05	8.00-	290.5	.3035-	.1330	.3044
06	8.00-	363.8	.3511-	.1505	.3063
07	8.00-	437.2	.3953-	.1717	.3051
08	8.00-	510.5	.4312-	.1825	.3074
09	8.00-	600.0	.4705-	.1897	.3114

NAVORD Report 4425

241	07	3 20			
02	10.00-	79.3	.1160-	.0577	.2925
03	10.00-	152.8	.2182-	.1088	.2923
04	10.00-	226.2	.3224-	.1684	.2875
05	10.00-	299.6	.4206-	.2152	.2897
06	10.00-	373.1	.5006-	.2558	.2898
07	10.00-	446.5	.5657-	.2825	.2921
08	10.00-	520.0	.6239-	.3079	.2933
09	10.00-	600.0	.6795-	.3340	.2937

241	07	3 21			
02	12.00-	49.1	.0693-	.0436	.2662
03	12.00-	122.5	.2027-	.1276	.2661
04	12.00-	195.8	.3362-	.2007	.2726
05	12.00-	269.2	.4673-	.2637	.2791
06	12.00-	342.5	.5933-	.3556	.2721
07	12.00-	415.9	.7097-	.4236	.2726
08	12.00-	484.1	.8015-	.4708	.2745
09	12.00-	600.0	.9302-	.5385	.2762

NAVORD Report 4425

241	07	3 22			
02	14.00-	58.0	.1153-	.0592	.2720
03	14.00-	131.3	.2657-	.1521	.2775
04	14.00-	204.6	.4303-	.2455	.2779
05	14.00-	278.0	.5935-	.3447	.2758
06	14.00-	351.3	.7452-	.4327	.2759
07	14.00-	424.7	.8915-	.5308	.2729
08	14.00-	498.0	1.0178-	.6009	.2739
09	14.00-	600.0	1.1404-	.6301	.2815

241	07	3	23				
02	16.00-		30.7	.0516-	.0304	.2742	
03	16.00-		67.3	.1211-	.0694	.2774	
04	16.00-		10.9	.1967-	.1125	.2776	
05	16.00-		140.5	.2851-	.1634	.2774	
06	16.00-		213.7	.3599-	.1540	.3064	
07	16.00-		286.8	.5982-	.3290	.2820	
08	16.00-		360.0	.7877-	.4643	.2741	
09	16.00-		433.2	.9239-	.5367	.2758	
10	16.00-		508.5	1.0505-	.6194	.2741	

241	07	3 24		
02	18.00-	32.2	.0500-	.0299
03	18.00-	105.4	.1943-	.1172
04	18.00-	178.5	.3578-	.2119
05	18.00-	251.0	.5152-	.2938
06	18.00-	324.1	.6711-	.3815
07	18.00-	397.3	.8163-	.4636
08	18.00-	433.9	.8839-	.5004
				.2724
				.2714
				.2736
				.2779
				.2783
				.2784
				.2788

241	07	3 25			
02	9.00-	40.3	.0551-	.0330	.2722
03	9.00-	113.7	.1469-	.0803	.2827
04	9.00-	187.0	.2315-	.1245	.2844
05	9.00-	260.4	.3143-	.1707	.2834
06	9.00-	333.7	.3896-	.2121	.2831
07	9.00-	407.1	.4495-	.2443	.2833
08	9.00-	480.4	.4972-	.2680	.2842
09	9.00-	551.6	.5353-	.2850	.2855
10	9.00-	600.0	.5632-	.3044	.2839

241	07	3	26						
02	7.00-	45.5	.0415-	.0133	.3279				
03	7.00-	118.8	.1052-	.0372	.3213				
04	7.00-	192.2	.1681-	.0640	.3159				
05	7.00-	265.5	.2232-	.0885	.3127				
06	7.00-	338.9	.2647-	.1018	.3151				
07	7.00-	412.2	.3000-	.1132	.3165				
08	7.00-	485.6	.3300-	.1239	.3169				
09	7.00-	558.9	.3558-	.1348	.3162				
10	7.00-	600.0	.3584-	.1277	.3207				

NAVORD Report 4425

241	06	4 01	0001	.0023	4.9920
02	4.00	23.4	.0082	.0040-	.2944
03	4.00	59.9	.0228	.0077-	.3245
04	4.00	132.9	.0351	.0051-	.3629
05	4.00	205.8	.0458	.0045-	.3723
06	4.00	278.8	.0531	.0051-	.3728
07	4.00	351.8	.0540	.0001	.3924
08	4.00	424.8	.0571	.0009-	.3888
09	4.00	497.8	.0597	.0024-	.3840
10	4.00	568.6	.0602	.0018-	.3860
11	4.00	600.0			

NAVORD Report 4425

241	08	4 02			
02	8.00	75.3	.0568	.0312-	.2821
03	8.00	148.4	.1206	.0676-	.2799
04	8.00	221.4	.1782	.0936-	.2869
05	8.00	294.5	.2255	.1071-	.2970
06	8.00	367.6	.2683	.1255-	.2984
07	8.00	440.7	.3055	.1391-	.3009
08	8.00	513.8	.3390	.1546-	.3008
09	8.00	600.0	.3691	.1715-	.2991

241	08	4 03			
02	12.00	38.0	.0487	.0248-	.2902
03	12.00	74.5	.1031	.0522-	.2907
04	12.00	110.9	.1649	.0865-	.2871
05	12.00	183.9	.2971	.1630-	.2823
06	12.00	256.9	.4297	.2413-	.2797
07	12.00	330.0	.5528	.3276-	.2735
08	12.00	402.9	.6569	.3981-	.2708
09	12.00	475.2	.7481	.4607-	.2688
10	12.00	548.2	.8320	.5227-	.2664
11	12.00	600.0	.8864	.5672-	.2640

241	08	4 04				
02	15.80	23.4	.0338	.0172-	.2902	
03	15.80	59.9	.0882	.0446-	.2909	
04	15.80	96.4	.1543	.0786-	.2901	
05	15.80	132.8	.2265	.1168-	.2889	
06	15.80	205.8	.3955	.2138-	.2839	
07	15.80	278.8	.5597	.3032-	.2837	
08	15.80	351.1	.7260	.4096-	.2792	
09	15.80	424.1	.8918	.5228-	.2748	
10	15.80	497.1	1.0493	.6344-	.2711	
11	15.80	600.0	1.2187	.7417-	.2703	

241	08	4	05			
02	14.00	43.1	.0757	.0408-	.2842	
03	14.00	116.1	.1989	.1014-	.2900	
04	14.00	189.1	.3654	.1969-	.2842	
05	14.00	262.0	.5329	.2998-	.2795	
06	14.00	335.0	.6858	.3927-	.2775	
07	14.00	410.2	.8442	.5225-	.2682	
08	14.00	483.2	.9697	.6127-	.2656	
09	14.00	556.2	1.0785	.6908-	.2639	
10	14.00	600.0	1.1580	.7554-	.2615	

241	08	4 06			
02	10.00	21.2	.0232	.0094-	.3110
03	10.00	57.3	.0682	.0339-	.2926
04	10.00	94.3	.0999	.0065	.4050
05	10.00	167.4	.2119	.1131-	.2853
06	10.00	240.4	.3048	.1677-	.2820
07	10.00	313.5	.3883	.2194-	.2790
08	10.00	386.6	.4619	.2690-	.2755
09	10.00	460.4	.5234	.3078-	.2744
10	10.00	532.8	.5762	.3433-	.2728
11	10.00	600.0	.6252	.3807-	.2702

8

241	08	4	07				
02	6.00	38.0	.0115	.0027-	.3450		
03	6.00	110.9	.0374	.0113-	.3316		
04	6.00	183.9	.0676	.0196-	.3340		
05	6.00	256.9	.0939	.0213-	.3466		
06	6.00	329.9	.1174	.0261-	.3475		
07	6.00	402.9	.1371	.0328-	.3442		
08	6.00	476.6	.1537	.0386-	.3418		
09	6.00	550.4	.1734	.0539-	.3298		
10	6.00	600.0	.1838	.0641-	.3223		

241	08	4 08				
02	3.00	48.9	.0044	.0026	.5102	
03	3.00	85.4	.0079	.0001-	.3895	
04	3.00	158.4	.0200	.0107-	.2850	
05	3.00	231.4	.0352	.0200*	.2784	
06	3.00	304.4	.0453	.0199-	.3041	
07	3.00	377.4	.0458	.0130-	.3352	
08	3.00	450.4	.0438	.0023-	.3815	
09	3.00	524.1	.0389	.0117	.4522	
10	3.00	600.0	.0369	.0224	.5134	

241	08	4 09			
02	2.00	23.4	.0033-	.0014-	.4768
03	2.00	59.9	.0061-	.0044-	.5363
04	2.00	96.4	.0058-	.0084-	.6817
05	2.00	169.3	.0009	.0182-	3.6524-
06	2.00	242.3	.0106	.0250-	.0797-
07	2.00	315.3	.0195	.0262-	.1233
08	2.00	388.3	.0263	.0274-	.1836
09	2.00	461.3	.0301	.0255-	.2226
10	2.00	534.3	.0350	.0246-	.2514
11	2.00	600.0	.0375	.0176-	.2981

241	08	4 10			
02	1.00	23.4	.0069-	.0010-	.4210
03	1.00	59.9	.0133-	.0014-	.4131
04	1.00	96.4	.0176-	.0017-	.4113
05	1.00	169.3	.0180-	.0086-	.4876
06	1.00	242.3	.0145-	.0112-	.5465
07	1.00	315.2	.0109-	.0139-	.6470
08	1.00	388.3	.0126-	.0071-	.5047
09	1.00	461.3	.0087-	.0114-	.6541
10	1.00	534.3	.0084-	.0068-	.5539
11	1.00	607.3	.0048-	.0095-	.7878
12	1.00	666.4	.0061-	.0044-	.5363

241	08	4	11				
02	0.00	36.5	.0133-	.0071	.2852		
03	0.00	73.0	.0211-	.0095	.3020		
04	0.00	109.5	.0272-	.0137	.2913		
05	0.00	182.5	.0338-	.0172	.2902		
06	0.00	255.5	.0340-	.0149	.3044		
07	0.00	328.5	.0331-	.0116	.3219		
08	0.00	401.5	.0323-	.0082	.3412		
09	0.00	473.0	.0319-	.0065	.3512		
10	0.00	546.0	.0310-	.0031	.3720		
11	0.00	600.0	.0302-	.0002-	.3933		

NAVORD Report 4425

241	08	4	12				
02	1.00-	18.2		.0062-	.0105	.0533	
03	1.00-	91.2		.0226-	.0357	.0761	
04	1.00-	164.2		.0353-	.0520	.0974	
05	1.00-	237.2		.0444-	.0594	.1244	
06	1.00-	310.2		.0498-	.0579	.1595	
07	1.00-	383.2		.0495-	.0454	.2086	
08	1.00-	456.2		.0483-	.0317	.2607	
09	1.00-	529.2		.0398-	.0066	.3588	

241	08	4	13			
02	2.00-	57.1		.0212-	.0243	.1628
03	2.00-	30.2		.0418-	.0493	.1561
04	2.00-	203.4		.0588-	.0653	.1699
05	2.00-	276.6		.0706-	.0720	.1880
06	2.00-	349.8		.0771-	.0693	.2122
07	2.00-	422.9		.0791-	.0543	.2547
08	2.00-	499.0		.0773-	.0413	.2851
09	2.00-	600.0		.0659-	.0129	.3528

241	08	4 14			
02	3.00-	29.3	.0020-	.0022	.1720
03	3.00-	65.9	.0123-	.0146	.1546
04	3.00-	102.4	.0259-	.0258	.1928
05	3.00-	175.6	.0505-	.0465	.2078
06	3.00-	248.8	.0671-	.0522	.2364
07	3.00-	322.0	.0739-	.0449	.2705
08	3.00-	395.1	.0752-	.0328	.3048
09	3.00-	468.3	.0721-	.0147	.3512
10	3.00-	541.5	.0659-	.0043-	.4051
11	3.00-	600.0	.0582-	.0238-	.4738

241	08	4 15			
02	4.00-	61.5	.0282-	.0233	.2268
03	4.00-	134.6	.0580-	.0448	.2375
04	4.00-	207.8	.0822-	.0553	.2575
05	4.00-	281.0	.0995-	.0581	.2752
06	4.00-	354.2	.1048-	.0418	.3122
07	4.00-	427.3	.1085-	.0250	.3459
08	4.00-	501.2	.1084-	.0101	.3734
09	4.00-	600.0	.1077-	.0041-	.3996

241	08	4 16			
02	5.00-	58.7	.0361-	.0234	.2624
03	5.00-	132.0	.0824-	.0530	.2634
04	5.00-	205.4	.1059-	.0577	.2830
05	5.00-	278.7	.1262-	.0553	.3044
06	5.00-	352.1	.1394-	.0475	.3239
07	5.00-	425.4	.1476-	.0344	.3454
08	5.00-	498.8	.1526-	.0141	.3735
09	5.00-	572.1	.1593-	.0177	.3698
10	5.00-	600.0	.1629-	.0266	.3593

241	08	4	17		
02	6.00-	15.4	.0004-	.0017	.4580-
03	6.00-	52.8	.0113-	.0136	.1513
04	6.00-	89.4	.0339-	.0321	.2026
05	6.00-	126.0	.0564-	.0444	.2346
06	6.00-	199.3	.1027-	.0654	.2646
07	6.00-	272.5	.1264-	.0592	.2983
08	6.00-	345.8	.1488-	.0566	.3159
09	6.00-	419.0	.1695-	.0559	.3260
10	6.00-	492.3	.1875-	.0558	.3325
11	6.00-	565.6	.2004-	.0527	.3394
12	6.00-	600.0	.2092-	.0561	.3384

241	08	4 18					
02	7.00-	30.8	.0181-	.0023-	.4174		
03	7.00-	104.2	.0581-	.0066-	.4147		
04	7.00-	177.5	.0995-	.0004	.3912		
05	7.00-	250.9	.1359-	.0020	.3891		
06	7.00-	324.2	.1691-	.0050	.3861		
07	7.00-	397.6	.1966-	.0055	.3864		
08	7.00-	470.9	.2228-	.0095	.3835		
09	7.00-	544.3	.2414-	.0089	.3846		
10	7.00-	600.0	.2551-	.0091	.3849		

241	08	4	19				
02	7.00-	66.7		.0526-	.0143	.3376	
03	7.00-	140.1		.1055-	.0303	.3346	
04	7.00-	213.4		.1535-	.0409	.3387	
05	7.00-	286.8		.1936-	.0514	.3389	
06	7.00-	360.2		.2142-	.0444	.3505	
07	7.00-	433.5		.2496-	.0535	.3491	
08	7.00-	504.6		.2709-	.0521	.3535	

241	08	4 20							
02	8.00-	71.9	.0779-	.0407	.2875				
03	8.00-	145.2	.1512-	.0862	.2780				
04	8.00-	217.8	.2128-	.0994	.2986				
05	8.00-	291.2	.2649-	.1206	.3009				
06	8.00-	364.5	.3132-	.1523	.2947				
07	8.00-	437.2	.3452-	.1479	.3063				
08	8.00-	509.8	.3741-	.1512	.3112				
09	8.00-	600.0	.4056-	.1560	.3151				

241	08	4 21							
02	9.00-	56.3	.0759-	.0385	.2906				
03	9.00-	129.5	.1673-	.0817	.2943				
04	9.00-	202.7	.2571-	.1439	.2801				
05	9.00-	275.9	.3200-	.1536	.2960				
06	9.00-	349.0	.3791-	.1800	.2970				
07	9.00-	424.4	.4249-	.1930	.3012				
08	9.00-	497.6	.4648-	.2059	.3034				
09	9.00-	600.0	.5162-	.2300	.3029				

NAVORD Report 4425

241	08	4 22			
02	10.00-	29.3	.0471-	.0244	.2884
03	10.00-	102.6	.1624-	.0849	.2874
04	10.00-	175.8	.2673-	.1416	.2861
05	10.00-	249.1	.3659-	.1963	.2847
06	10.00-	322.3	.4425-	.2319	.2872
07	10.00-	395.6	.5100-	.2687	.2866
08	10.00-	468.9	.5709-	.3019	.2862
09	10.00-	542.1	.6164-	.3195	.2883
10	10.00-	600.0	.6477-	.3352	.2885

NAVORD Report 4425

241	08	4 23							
02	12.00-	60.1	.1176-	.0644	.2825				
03	12.00-	133.3	.2613-	.1437	.2820				
04	12.00-	206.6	.4051-	.2292	.2788				
05	12.00-	279.9	.5377-	.3075	.2776				
06	12.00-	353.8	.6553-	.3804	.2759				
07	12.00-	427.1	.7519-	.4353	.2762				
08	12.00-	500.4	.8360-	.4779	.2777				
09	12.00-	600.0	.9293-	.5256	.2789				

NAVORD Report 4425

241	08	4 24			
02	14.00-	80.6	.1859-	.0983	.2862
03	14.00-	153.8	.3492-	.1842	.2865
04	14.00-	227.1	.4990-	.2591	.2882
05	14.00-	300.4	.6681-	.3625	.2835
06	14.00-	372.2	.8131-	.4468	.2821
07	14.00-	445.4	.9499-	.5334	.2797
08	14.00-	517.9	1.0671-	.6046	.2787
09	14.00-	600.0	1.1601-	.6483	.2802

241	08	4 25			
02	16.00-	32.3	.0589-	.0396	.2575
03	16.00-	68.9	.1312-	.0841	.2638
04	16.00-	104.9	.2161-	.1386	.2637
05	16.00-	178.2	.3873-	.2269	.2748
06	16.00-	251.6	.5658-	.3245	.2773
07	16.00-	324.2	.7366-	.4175	.2786
08	16.00-	397.6	.9041-	.5140	.2783
09	16.00-	470.9	1.0550-	.5963	.2790
10	16.00-	544.3	1.1808-	.6561	.2809
11	16.00-	600.0	1.2564-	.6821	.2834

241	08	4 26			
02	19.00-	45.5	.0821-	.0490	.2726
03	18.00-	82.3	.1567-	.0910	.2759
04	18.00-	119.0	.2405-	.1381	.2772
05	18.00-	192.4	.4092-	.2226	.2832
06	18.00-	265.9	.5743-	.3068	.2852
07	18.00-	339.3	.7289-	.3808	.2875
08	18.00-	412.7	.8747-	.4514	.2888
09	18.00-	486.2	1.0033-	.5105	.2902

3

NAVORD Report 4425

241	09	5 01			
02	4.00	38.1	.0028	.0030	.6063
03	4.00	74.8	.0066	.0050	.5435
04	4.00	111.5	.0125	.0070	.5040
05	4.00	184.8	.0324	.0013-	.3840
06	4.00	258.2	.0539	.0101-	.3545
07	4.00	330.8	.0736	.0207	.3357
08	4.00	404.2	.0903	.0304	.3247
09	4.00	477.5	.1061	.0452-	.3068
10	4.00	550.1	.1171	.0547	.2986
11	4.00	600.0	.1190	.0568-	.2965

NAVORD Report 4425

241	09	5 02			
02	8.00	45.5	.0328	.0199	.2707
03	8.00	118.8	.0826	.0450	.2830
04	8.00	192.2	.1477	.0917	.2678
05	8.00	265.5	.2123	.1390	.2611
06	8.00	338.9	.2737	.1877	.2548
07	8.00	412.2	.3336	.2336	.2520
08	8.00	486.3	.3860	.2749	.2496
09	8.00	559.7	.4297	.3043	.2504
10	8.00	600.0	.4474	.3151	.2511

241	09	5 03			
02	12.00	65.9	.0914	.0631-	.2539
03	12.00	139.0	.1899	.1292-	.2559
04	12.00	212.2	.3007	.2159-	.2484
05	12.00	285.4	.4095	.3005-	.2452
06	12.00	358.5	.5154	.3820-	.2438
07	12.00	431.7	.6169	.4597-	.2430
08	12.00	506.1	.7128	.5327-	.2425
09	12.00	600.0	.8269	.6181-	.2425

NAVORD Report 4425

241	09	5 04			
02	15.80	35.9	.1622	.0953-	.2745
03	15.80	109.0	.2796	.1686-	.2714
04	15.80	182.2	.3312	.1981-	.2724
05	15.80	255.4	.3990	.2441-	.2696
06	15.80	327.8	.5453	.3500-	.2636
07	15.80	401.0	.6623	.4217-	.2647
08	15.80	474.1	.7914	.5101-	.2631
09	15.80	547.3	.9294	.6058-	.2616
10	15.80	600.0	1.0307	.6773-	.2606

NAVORD Report 4425

241	09	5	05				
02	4.00	21.6	.0024-	.0038	.0753		
03	4.00	57.5	.0098	.0107-	.1736		
04	4.00	95.6	.0174	.0153-	.2161		
05	4.00	131.5	.0268	.0158-	.2741		
06	4.00	203.4	.0554	.0275-	.2927		
07	4.00	275.2	.0826	.0365-	.3036		
08	4.00	347.1	.1046	.0447-	.3065		
09	4.00	418.9	.1248	.0570-	.3007		
10	4.00	490.8	.1419	.0683-	.2957		
11	4.00	600.0	.1602	.0762-	.2969		

NAVORD Report 4425

241	09	5 06				
02	8.00	48.1	.0300	.0145-	.2953	
03	8.00	121.3	.0905	.0513-	.2786	
04	8.00	193.1	.1554	.0940-	.2710	
05	8.00	264.1	.2213	.1379-	.2674	
06	8.00	335.9	.2814	.1815-	.2630	
07	8.00	407.7	.3341	.2183-	.2613	
08	8.00	479.2	.3814	.2480-	.2620	
09	8.00	551.2	.4246	.2781-	.2610	
10	8.00	600.0	.4540	.3016-	.2591	

241	09	5 07			
02	12.00	45.2	.0537	.0293-	.2829
03	12.00	117.0	.1451	.0840-	.2762
04	12.00	188.8	.2412	.1462-	.2708
05	12.00	260.5	.3538	.2289-	.2626
06	12.00	332.3	.4546	.3010-	.2596
07	12.00	404.1	.5508	.3695-	.2578
08	12.00	475.8	.6435	.4376-	.2560
09	12.00	547.6	.7334	.5065-	.2539
10	12.00	619.4	.8132	.5692-	.2520

NAVORD Report 4425

241	09	5	08				
02	15.80		79.7	.1052	.0673-	.2641	
03	15.80		151.4	.2143	.1327-	.2682	
04	15.80		224.6	.3350	.2046-	.2699	
05	15.80		295.7	.4555	.2789-	.2695	
06	15.80		367.5	.5505	.3338-	.2707	
07	15.80		439.2	.6737	.4158-	.2686	
08	15.80		511.7	.8013	.5015-	.2668	
09	15.80		600.0	.9688	.6123-	.2656	

241	09	5 09			
02	14.00	55.9	.0590	.0364-	.2686
03	14.00	127.6	.1575	.0939-	.2728
04	14.00	199.3	.2796	.1771-	.2653
05	14.00	273.8	.3997	.2582-	.2628
06	14.00	344.8	.5073	.3293-	.2622
07	14.00	416.5	.6065	.3925-	.2626
08	14.00	488.2	.7164	.4697-	.2609
09	14.00	599.1	.8333	.5583-	.2580
10	14.00	600.0	.9069	.6214-	.2550

241	09	5	10			
02	10.00	53.6	.0563	.0456-	.2300	
03	10.00	125.0	.1291	.0884-	.2551	
04	10.00	196.4	.2105	.1431-	.2560	
05	10.00	267.9	.2936	.2045-	.2527	
06	10.00	339.3	.3755	.2671-	.2497	
07	10.00	410.7	.4485	.3224-	.2482	
08	10.00	482.1	.5113	.3653-	.2491	
09	10.00	600.0	.6090	.4512-	.2438	

B

O

O

O

O

O

241	09	5 11				
02	8.00	68.0	.0461	.0247-	.2848	
03	8.00	139.6	.0970	.0486-	.2918	
04	8.00	211.2	.1563	.0889-	.2782	
05	8.00	282.8	.2177	.1291-	.2734	
06	8.00	354.4	.2719	.1663-	.2697	
07	8.00	426.0	.3285	.2158-	.2606	
08	8.00	497.6	.3652	.2230-	.2699	
09	8.00	600.0	.4217	.2664-	.2657	

241	09	5 12			
02	6.00	41.5	.0088	.0011-	.3670
03	6.00	113.1	.0347	.0074-	.3493
04	6.00	184.7	.0736	.0292-	.3127
05	6.00	256.3	.1116	.0499-	.3026
06	6.00	327.9	.1478	.0747-	.2909
07	6.00	401.0	.1808	.0986-	.2829
08	6.00	472.6	.2087	.1132-	.2835
09	6.00	544.2	.2327	.1235-	.2859
10	6.00	600.0	.2499	.1326-	.2859

241	09	5	13				
02	5.00	49.6	.0111	.0072-	.2623		
03	5.00	121.4	.0327	.0137-	.3082		
04	5.00	193.3	.0596	.0188-	.3289		
05	5.00	265.1	.0890	.0338-	.3160		
06	5.00	337.0	.1162	.0513-	.3037		
07	5.00	408.9	.1391	.0628-	.3017		
08	5.00	480.7	.1588	.0734-	.2996		
09	5.00	552.6	.1747	.0798-	.3006		
10	5.00	600.0	.1835	.0809-	.3038		

NAVORD Report 4425

241	09	5 14			
02	4.00	23.7	.0014-	.0027	.0063
03	4.00	59.6	.0022-	.0061	.1625-
04	4.00	95.5	.0007	.0114	3.6491
05	4.00	167.2	.0178	.0085	.4875
06	4.00	239.0	.0393	.0003-	.3905
07	4.00	310.8	.0573	.0065-	.3693
08	4.00	382.5	.0734	.0167-	.3465
09	4.00	454.3	.0863	.0199-	.3459
10	4.00	528.2	.0964	.0260-	.3381
11	4.00	600.0	.1021	.0262-	.3407

NAVORD Report 4425

241	09	5	15			
02	3.00	59.8	.0045	.0048	.6053	
03	3.00	131.8	.0148	.0095	.5204	
04	3.00	203.8	.0291	.0121	.4752	
05	3.00	275.9	.0433	.0124	.4493	
06	3.00	347.9	.0511	.0124	.4405	
07	3.00	420.0	.0535	.0171	.4559	
08	3.00	493.4	.0580	.0134	.4382	
09	3.00	600.0	.0614	.0085	.4197	

241	09	5	16						
02	2.00		71.9	.0038-	.0150	.3975-			
03	2.00		143.7	.0009-	.0265	5.4969-			
04	2.00		215.6	.0042	.0405	2.3206			
05	2.00		287.4	.0090	.0498	1.4987			
06	2.00		359.3	.0122	.0512	1.2313			
07	2.00		431.1	.0116	.0506	1.2644			
08	2.00		503.0	.0104	.0471	1.2978			
09	2.00		600.0	.0131	.0331	.8973			

NAVORD Report 4425

241	09	5 17			
02	1.00	43.1	.0029-	.0117	.4149-
03	1.00	114.8	.0036-	.0343	1.5136-
04	1.00	186.6	.0010-	.0497	9.5480-
05	1.00	258.4	.0008-	.0605	4.7330-
06	1.00	330.1	.0021-	.0655	5.8461-
07	1.00	401.9	.0083-	.0674	1.2321-
08	1.00	473.7	.0125-	.0671	.6816-
09	1.00	546.9	.0118-	.0530	.5063-
10	1.00	629.4	.0051-	.0263	.6394-

NAVORD Report 4425

241	09	5 18			
02	1.00	62.6	.0013-	.0282	3.9465-
03	1.00	132.9	.0025	.0471	4.1600
04	1.00	203.3	.0065	.0599	2.2351
05	1.00	273.6	.0061	.0700	2.6871
06	1.00	344.0	.0037	.0738	4.3812
07	1.00	415.7	.0009-	.0752	6.3191-
08	1.00	485.3	.0025-	.0672	4.9840-
09	1.00	555.7	.0023-	.0548	4.3732-
10	1.00	609.0	.0061	.0425	5.3920

241	09	5	19				
02	0.00		57.7	.0117-	.0213	.0279	
03	0.00		128.0	.0185-	.0311	.0558	
04	0.00		198.4	.0224-	.0438	.0009	
05	0.00		268.7	.0212-	.0450	.0325-	
06	0.00		339.0	.0211-	.0473	.0563-	
07	0.00		409.4	.0232-	.0472	.0149-	
08	0.00		479.7	.0242-	.0482	.0063-	
09	0.00		550.1	.0242-	.0482	.0063-	
10	0.00		600.0	.0221-	.0484	.0460-	

NAVORD Report 4425

241	09	5	20			
02	1.00-	51.1		.0133-	.0133	.1920
03	1.00-	121.1		.0184-	.0091-	.4909
04	1.00-	193.2		.0284-	.0092-	.4568
05	1.00-	263.2		.0312-	.0122-	.4702
06	1.00-	333.3		.0278-	.0171-	.5150
07	1.00-	402.6		.0232-	.0185-	.5515
08	1.00-	472.6		.0221-	.0088-	.4716
09	1.00-	542.6		.0230-	.0093	.3111
10	1.00-	600.0		.0279-	.0316	.1655

241	09	5 21			
02	2.00-	44.4	.0122-	.0025-	.4330
03	2.00-	113.9	.0267-	.0074-	.4474
04	2.00-	183.3	.0414-	.0084-	.4326
05	2.00-	252.8	.0510-	.0101-	.4316
06	2.00-	320.8	.0562-	.0093-	.4251
07	2.00-	390.3	.0530-	.0165-	.4543
08	2.00-	459.7	.0525-	.0096-	.4286
09	2.00-	529.2	.0537-	.0039	.3775
10	2.00-	600.0	.0550-	.0259	.2978

241	09	5 22			
02	3.00-	67.8	.0209-	.0009	.3834
03	3.00-	137.0	.0421-	.0058	.3644
04	3.00-	206.2	.0574-	.0042	.3774
05	3.00-	275.4	.0742-	.0116	.3607
06	3.00-	343.3	.0804-	.0050	.3796
07	3.00-	412.5	.0962-	.0198	.3508
08	3.00-	481.7	.0884-	.0112	.3667
09	3.00-	550.2	.0919-	.0223	.3435
10	3.00-	600.0	.0844-	.0239	.3354

241	09	5	23			
02	4.00-		51.8	.0217-	.0042	.3533
03	4.00-		121.0	.0474-	.0128	.3380
04	4.00-		190.1	.0714-	.0231	.3273
05	4.00-		259.2	.0914-	.0291	.3283
06	4.00-		328.3	.1108-	.0381	.3232
07	4.00-		397.5	.1272-	.0523	.3098
08	4.00-		466.6	.1388-	.0589	.3071
09	4.00-		537.8	.1409-	.0588	.3085
10	4.00-		600.0	.1457-	.0664	.3009

241	09	5 24				
02	5.00-	63.7	.0313-	.0110	.3217	
03	5.00-	132.2	.0638-	.0270	.3074	
04	5.00-	200.7	.0948-	.0425	.3023	
05	5.00-	269.2	.1241-	.0599	.2955	
06	5.00-	337.7	.1517-	.0790	.2878	
07	5.00-	406.2	.1748-	.0945	.2839	
08	5.00-	474.7	.1925-	.1052	.2827	
09	5.00-	543.2	.2053-	.1168	.2782	
10	5.00-	600.0	.2123-	.1220	.2771	

241	09	5 25			
02	6.00-	56.9	.0399-	.0229	.2772
03	6.00-	124.6	.0796-	.0418	.2870
04	6.00-	192.3	.1186-	.0636	.2847
05	6.00-	262.1	.1574-	.0877	.2806
06	6.00-	329.8	.1924-	.1137	.2738
07	6.00-	397.5	.2212-	.1317	.2729
08	6.00-	465.2	.2474-	.1481	.2723
09	6.00-	533.0	.2628-	.1442	.2823
10	6.00-	600.0	.2826-	.1633	.2764

NAVORD Report 4425

241	09	5 26			
02	7.00-	59.9	.0461-	.0247	.2848
03	7.00-	127.7	.0967-	.0531	.2822
04	7.00-	194.2	.1456-	.0834	.2774
05	7.00-	260.8	.1926-	.1199	.2675
06	7.00-	327.3	.2328-	.1468	.2659
07	7.00-	393.8	.2681-	.1682	.2665
08	7.00-	459.6	.2999-	.1871	.2672
09	7.00-	526.2	.3264-	.1990	.2701
10	7.00-	600.0	.3532-	.2148	.2704

241	09	5 27			
02	8.00-	64.9	.0611-	.0362	.2735
03	8.00-	131.1	.1195-	.0732	.2695
04	8.00-	197.4	.0074	.0895-	2.0269-
05	8.00-	263.6	.2339-	.1540	.2603
06	8.00-	329.8	.2839-	.1915	.2571
07	8.00-	396.0	.3258-	.2166	.2590
08	8.00-	462.3	.3953-	.2777	.2515
09	8.00-	527.1	.4030-	.2715	.2573
10	8.00-	600.0	.4403-	.2952	.2579

NAVORD Report 4425

241	09	5 28			
02	9.00-	78.1	.0835-	.0546	.2612
03	9.00-	144.4	.1527-	.1033	.2567
04	9.00-	210.6	.2180-	.1477	.2565
05	9.00-	276.8	.2807-	.1929	.2546
06	9.00-	343.0	.3383-	.2350	.2531
07	9.00-	409.3	.3914-	.2734	.2523
08	9.00-	475.5	.4386-	.3055	.2527
09	9.00-	540.4	.4831-	.3382	.2520
10	9.00-	600.0	.5233-	.3735	.2493

241	09	5 29			
02	10.00-	62.9	.0816-	.0524	.2636
03	10.00-	129.1	.1630-	.1071	.2606
04	10.00-	195.4	.2416-	.1649	.2555
05	10.00-	261.6	.3171-	.2217	.2522
06	10.00-	327.8	.3856-	.2732	.2503
07	10.00-	394.0	.4468-	.3157	.2507
08	10.00-	460.3	.5075-	.3587	.2506
09	10.00-	526.5	.5609-	.3926	.2520
10	10.00-	600.0	.6210-	.4362	.2515

NAVORD Report 4425

241	09	5 30			
02	12.00-	73.8	.0948-	.0510	.2844
03	12.00-	140.2	.1776-	.1000	.2794
04	12.00-	206.6	.2869-	.1863	.2621
05	12.00-	273.1	.3751-	.2484	.2596
06	12.00-	339.5	.4628-	.3112	.2575
07	12.00-	406.6	.5419-	.3706	.2552
08	12.00-	473.1	.6200-	.4267	.2544
09	12.00-	539.5	.6968-	.4800	.2542
10	12.00-	600.0	.9778-	1.3714	.1115

241	09	5 31			
02	14.00-	84.3	.1245-	.0700	.2796
03	14.00-	150.7	.2325-	.1428	.2692
04	14.00-	219.0	.3499-	.2246	.2636
05	14.00-	285.4	.4504-	.2928	.2620
06	14.00-	351.8	.5405-	.3509	.2622
07	14.00-	417.5	.6309-	.4129	.2611
08	14.00-	483.2	.7291-	.4835	.2594
09	14.00-	549.5	.8342-	.5616	.2574
10	14.00-	600.0	.9188-	.6235	.2563

241	09	5 32			
02	16.00-	68.4	.1099-	.0772	.2515
03	16.00-	137.4	.2157-	.1439	.2586
04	16.00-	201.1	.3257-	.2103	.2629
05	16.00-	267.5	.4407-	.2883	.2612
06	16.00-	333.8	.5428-	.3485	.2636
07	16.00-	399.6	.6388-	.4045	.2654
08	16.00-	465.9	.7477-	.4721	.2657
09	16.00-	532.3	.8644-	.5483	.2651
10	16.00-	600.0	.9920-	.6340	.2642

241	09	5 33					
02	18.00-	46.4	.0671-	.0404	.2716		
03	18.00-	112.7	.1721-	.1037	.2715		
04	18.00-	179.0	.2858-	.1705	.2727		
05	18.00-	245.3	.4002-	.2344	.2749		
06	18.00-	311.6	.5030-	.2894	.2769		
07	18.00-	377.9	.5996-	.3363	.2798		
08	18.00-	444.2	.7094-	.3988	.2796		
09	18.00-	509.8	.8298-	.4668	.2795		
10	18.00-	600.0	.9920-	.5536	.2804		

NAVORD Report 4425

241	09	5 34			
02	18.00-	57.6	.0914-	.0546	.2725
03	18.00-	123.7	.1990-	.1172	.2742
04	18.00-	189.9	.3154-	.1833	.2758
05	18.00-	256.0	.4292-	.2478	.2765
06	18.00-	322.2	.5280-	.3008	.2781
07	18.00-	387.0	.6296-	.3508	.2806
08	18.00-	453.1	.7374-	.4026	.2828
09	18.00-	519.3	.8549-	.4674	.2827
10	18.00-	600.0	1.0042-	.5596	.2805

3

241	09	5 35			
02	20.00-	80.8	.1108-	.0466	.3079
03	20.00-	147.0	.2177-	.1036	.2968
04	20.00-	213.2	.3282-	.1632	.2925
05	20.00-	279.5	.4312-	.2159	.2919
06	20.00-	345.0	.5274-	.2612	.2929
07	20.00-	411.3	.6236-	.3064	.2937
08	20.00-	478.8	.7263-	.3552	.2942
09	20.00-	545.0	.8284-	.4069	.2938
10	20.00-	600.0	.9210-	.4580	.2925

241 09 6 02
02 8.00 600.0 1.3330 .8111- .2703

241 09 6 01
02 4.00 600.0 .2197 .0658 .4519

NAWORD Report 4425

241	09	6 03		
02	6.00	600.0	.3834	.0357
				.4106

NAVORD Report 4425

241	09	6 04		
02	12.00	557.7	1.2499	.3580-
				.3347

241	09	6 05		
02	15.80	530.6	1.2873	.3878-
				.3317

NAVORD Report 4425

241	09	6 06			
02	2.00	600.0	.0930	.0445	.4877

241	10	7 01			
01	6.00-	125.0	.0723-	.0273	.3165
02	5.00-	125.0	.0605-	.0206	.3239
03	4.80-	125.0	.0590-	.0201	.3239
04	4.00-	125.0	.0477-	.0152	.3283
05	3.20-	125.0	.0365-	.0007-	.3958
06	2.40-	125.0	.0301-	.0002-	.3933
07	1.70-	125.0	.0228-	.0095-	.4753
08	1.00-	125.0	.0176-	.0188-	.6056
10	.52	125.0	.0189	.0096-	.2904
11	1.40	125.0	.0296	.0004-	.3893
12	2.20	125.0	.0403	.0231-	.2774
13	2.90	125.0	.0516	.0366-	.2501
14	3.70	125.0	.0633	.0518-	.2283
15	4.50	125.0	.0775	.0686-	.2150
16	5.20	125.0	.0871	.0754-	.2189
17	5.90	125.0	.1055	.0856-	.2297

NAVORD Report 4425

241	10	7 02			
01	10.00-	126.0	.1683-	.1124	.2584
02	8.90-	126.0	.1480-	.0914	.2685
03	7.40-	126.0	.1169-	.0649	.2810
04	5.80-	126.0	.0865-	.0440	.2903
05	5.00-	126.0	.0797-	.0428	.2846
06	4.30-	126.0	.0597-	.0258	.3056
07	3.50-	126.0	.0396-	.0088	.3476
08	2.80-	126.0	.0386-	.0078	.3516
09	2.00-	126.0	.0325-	.0036	.3698
10	1.20-	126.0	.0272-	.0035-	.4177
11	.50-	126.0	.0202-	.0232	.1623
13	.30	126.0	.0331	.0287-	.2186
14	1.10	126.0	.0241	.0044	.4285
15	1.90	126.0	.0294	.0027-	.3736
16	2.70	126.0	.0441	.0297-	.2573
17	3.40	126.0	.0548	.0438-	.2321
18	4.90	126.0	.0753	.0539-	.2488
19	5.00	126.0	.0900	.0724-	.2311
20	6.50	126.0	.1021	.0893-	.2171
21	8.00	126.0	.1249	.1055-	.2231
22	9.50	126.0	.1450	.1053-	.2468
23	10.00	126.0	.1506	.1078-	.2488

NAVORD Report 4425

241	10	7 03		
01	10.00-	126.0	.1552-	.0944
02	7.90-	126.0	.1151-	.0519
03	6.60-	126.0	.0864-	.0378
04	5.10-	126.0	.0604-	.0229
05	5.00-	126.0	.0602-	.0252
06	3.60-	126.0	.0422-	.0104
07	2.80-	126.0	.0368-	.0033
08	2.00-	126.0	.0356-	.0131
09	1.20-	126.0	.0314-	.0048
10	.50-	126.0	.0151-	.0030
13	.30	126.0	.0076	.0046-
14	1.00	126.0	.0122	.0173
15	1.80	126.0	.0176	.0017
16	2.60	126.0	.0274	.0176-
17	4.10	126.0	.0487	.0482-
18	5.00	126.0	.0513	.0241-
19	5.60	126.0	.0559	.0021-
20	7.20	126.0	.0679	.0127-
21	8.00	126.0	.0764	.0036-
22	8.90	126.0	.0862	.0090
23	10.00	126.0	.0984	.0264
				.2704
				.3018
				.3045
				.3162
				.3083
				.3427
				.3741
				.3184
				.3614
				.3523
				.2709
				.6756
				.4113
				.2635
				.1941
				.2980
				.3845
				.3546
				.3826
				.4129
				.4457

NAVORD Report 4425

241	10	7 05			
01	10.00-	204.0	.2593-	.1687	.2619
02	7.90-	204.0	.1941-	.1061	.2827
03	6.40-	204.0	.1363-	.0591	.3053
04	5.00-	204.0	.0960-	.0274	.3349
05	4.90-	204.0	.0929-	.0265	.3349
06	4.10-	204.0	.0778-	.0149	.3537
07	3.30-	204.0	.0647-	.0055	.3750
08	2.50-	204.0	.0538-	.0063-	.4154
09	1.80-	204.0	.0250-	.0353-	.6744
10	1.00-	204.0	.0209-	.0288-	.6676
12	.50	204.0	.0102	.0109	.6057
13	1.30	204.0	.0203	.0196	.5851
14	2.10	204.0	.0217	.0083	.4685
15	2.90	204.0	.0385	.0186-	.2954
16	4.40	204.0	.0740	.0574-	.2369
17	6.00	204.0	.1089	.0905-	.2258
18	7.50	204.0	.1379	.1086-	.2345
19	9.00	204.0	.1896	.1515-	.2322
20	10.00	204.0	.2109	.1650-	.2355

241	10	7 06		
01	10.00-	203.0	.2607-	.1896
02	8.30-	203.0	.2092-	.1348
03	6.80-	203.0	.1601-	.0912
04	5.30-	203.0	.1107-	.0459
05	3.70-	203.0	.0760-	.0190
06	3.10-	203.0	.0587-	.0010-
07	2.20-	203.0	.0494-	.0038-
08	1.50-	203.0	.0404-	.0112-
09	.70-	203.0	.0245-	.0113-
11	.80	203.0	.0104	.0304
12	1.50	203.0	.0282	.0195
13	2.30	203.0	.0430	.0052-
14	3.90	203.0	.0776	.0515-
15	5.40	203.0	.1231	.0925-
16	7.00	203.0	.1531	.1179-
17	8.60	203.0	.2033	.1603-
18	10.00	203.0	.2420	.1829-
				.2473
				.2631
				.2781
				.3091
				.3420
				.3954
				.4074
				.4474
				.4842
				.9766
				.5303
				.3678
				.2593
				.2417
				.2380
				.2343
				.2408

241	10	7 07			
01	10.00-	255.0	3090-	.1860	.2716
02	7.90-	255.0	.2211-	.1135	.2893
03	6.40-	255.0	.1550-	.0562	.3195
04	4.80-	255.0	.1002-	.0123	.3674
05	3.30-	255.0	.0640-	.0173-	.4461
06	2.50-	255.0	.0522-	.0302-	.5077
07	1.80-	255.0	.0414-	.0358-	.5649
08	1.00-	255.0	.0226-	.0477-	.8141
09	.30-	255.0	.0074-	.0165-	.8379
11	.50	255.0	.0077	.0125	.7167
12	1.30	255.0	.0214	.0122	.5060
13	2.00	255.0	.0340	.0064-	.3544
14	2.80	255.0	.0510	.0201-	.3132
15	4.50	255.0	.1009	.0756-	.2421
16	5.90	255.0	.1405	.1250-	.2141
17	7.40	255.0	.1977	.1727-	.2173
18	8.90	255.0	.2452	.2073-	.2229
19	10.00	255.0	.2790	.2331-	.2249

241	10	7 08			
01	10.00-	309.0	.3866-	.2609	.2570
02	8.10-	309.0	.2869-	.1755	.2697
03	6.50-	309.0	.1996-	.1023	.2895
04	5.00-	309.0	.1314-	.0451	.3234
05	3.50-	309.0	.0797-	.0022	.3865
06	2.00-	309.0	.0459-	.0235-	.4944
07	1.30-	309.0	.0247-	.0393-	.7102
10	.50-	309.0	.0204-	.0219-	.6067
12	.30	309.0	.0106	.0093	.5675
13	1.00	309.0	.0233	.0249	.6057
14	1.80	309.0	.0234	.0272	.6245
15	2.50	309.0	.0338	.0085	.4423
16	4.00	309.0	.0703	.0337-	.2961
17	5.60	309.0	.1215	.0834-	.2547
18	7.10	309.0	.1787	.1311-	.2453
19	8.60	309.0	.2460	.1872-	.2398
20	10.00	309.0	.3158	.2364-	.2423

241	10	7 09			
01	10.00-	312.0	3645-	.2355	.2628
02	8.20-	312.0	.2732-	.1495	.2826
03	6.70-	312.0	.2013-	.0920	.3006
04	5.10-	312.0	.1364-	.0248	.3556
05	3.60-	312.0	.0479-	.0385-	.5528
06	2.10-	312.0	.0474-	.0379-	.5519
07	1.30-	312.0	.0379-	.0384-	.5946
08	.60-	312.0	.0172-	.0291-	.7304
10	1.00	312.0	.0153	.0250	.7188
11	1.80	312.0	.0334	.0016	.4016
12	2.50	312.0	.0573	.0305-	.2855
13	4.00	312.0	.1059	.0873-	.2271
14	5.60	312.0	.1684	.1443-	.2206
15	7.10	312.0	.2291	.1946-	.2221
16	8.60	312.0	.2937	.2429-	.2266
17	10.00	312.0	.3107	.2418-	.2364

NAVORD Report 4425

241	10	7	10				
01	10.00-		370.0	.4207-	.2735	.2620	
02	8.70-		370.0	.3427-	.2118	.2684	
03	7.10-		370.0	.2536-	.1342	.2862	
04	5.60-		370.0	.1707-	.0671	.3134	
05	4.10-		370.0	.1150-	.0285	.3424	
06	2.50-		370.0	.0693-	.0176-	.4504	
07	1.80-		370.0	.0267-	.0457-	.7343	
08	1.90-		370.0	.0266-	.0348-	.6537	
10	.50		370.0	.0044	.0197	1.2875	
11	1.20		370.0	.0185	.0240	.6515	
12	2.00		370.0	.0409	.0032	.4076	
13	3.50		370.0	.1010	.0734-	.2467	
14	5.10		370.0	.1656	.1217-	.2450	
15	6.60		370.0	.2202	.1764-	.2318	
16	8.20		370.0	.3130	.2542-	.2296	
17	10.00		370.0	.4117	.3238-	.2347	

NAVORD Report 4425

241	10	7 11			
01	10.00-	432.0	.4717-	.3193	.2566
02	8.00-	432.0	.3470-	.2115	.2701
03	6.50-	432.0	.2484-	.1334	.2846
04	4.90-	432.0	.1589-	.0605	.3159
05	3.40-	432.0	.0890-	.0051	.3805
06	2.50-	432.0	.0513-	.0250-	.4895
07	1.80-	432.0	.0308-	.0351-	.6199
08	1.10-	432.0	.0082-	.0451-	1.4920
09	.30-	432.0	.0010-	.0161-	3.6120
11	.40	432.0	.0007-	.0228	6.1223-
12	1.20	432.0	.0175	.0251	.6789
13	1.90	432.0	.0223	.0260	.6252
14	2.80	432.0	.0761	.0339-	.3029
15	4.30	432.0	.1448	.0991-	.2551
16	5.80	432.0	.2214	.1666-	.2415
17	7.40	432.0	.3035	.2303-	.2402
18	8.90	432.0	.3968	.3076-	.2370
19	10.00	432.0	.4616	.3536-	.2388

NAVORD Report 4425

241	10	7 12			
01	10.00-	508.0	.5558-	.3830	.2537
02	8.10-	508.0	.3911-	.2412	.2687
03	6.50-	508.0	.2711-	.1411	.2879
04	5.00-	508.0	.1714-	.0642	.3171
05	3.40-	508.0	.0896-	.0045	.3820
06	1.90-	508.0	.0334-	.0187-	.5040
07	1.20-	508.0	.0168-	.0222-	.6563
08	.40-	508.0	.0071-	.0033-	.4850
10	1.20	508.0	.0167	.0136	.5549
11	1.90	508.0	.0268	.0052	.4308
12	2.70	508.0	.0760	.0424-	.2804
13	4.20	508.0	.1583	.1125-	.2499
14	5.80	508.0	.2478	.1831-	.2442
15	7.30	508.0	.3494	.2644-	.2407
16	8.80	508.0	.4609	.3799-	.2271
17	10.00	508.0	.5530	.4693-	.2223

NAVORD Report 4425

241	10	7 13			
01	10.00-	169.0	.2121-	.1381	.2618
02	8.60-	169.0	.1343-	.0569	.3073
03	7.00-	169.0	.1056-	.0342	.3272
04	5.50-	169.0	.0579-	.0043-	.4069
05	3.90-	169.0	.0542-	.0039	.3776
06	2.30-	169.0	.0346-	.0199-	.5070
07	1.50-	169.0	.0325-	.0198-	.5138
08	.80-	169.0	.0218-	.0106-	.4892
10	.80	169.0	.0133	.0186	.6717
11	1.50	169.0	.0191	.0098	.4946
12	2.30	169.0	.0294	.0112-	.3158
13	3.90	169.0	.0581	.0510-	.2164
14	5.40	169.0	.1382	.1360-	.1952
15	6.90	169.0	.1181	.1042-	.2155
16	8.40	169.0	.1463	.1252-	.2208
17	10.00	169.0	.1805	.1441-	.2323

241	10	7	14	.1133-	.0708	.2670
01	10.00-	86.0	86.0	.0763-	.0379	.2927
02	7.60-	86.0	86.0	.0556-	.0238	.3064
03	6.10-	86.0	86.0	.0386-	.0163	.3075
04	4.60-	86.0	86.0	.0173-	.0057-	.4579
05	3.00-	86.0	86.0	.0184-	.0069-	.4670
06	2.20-	86.0	86.0	.0147-	.0072-	.4900
07	1.50-	86.0	86.0	.0172-	.0114	.2594
08	.70-	86.0	86.0	.0080	.0171	.8195
10	.90	86.0	86.0	.0153	.0007-	.3828
11	1.60	86.0	86.0	.0282	.0296-	.1821
12	3.10	86.0	86.0	.0442	.0445-	.1906
13	4.70	86.0	86.0	.0628	.0673-	.1777
14	6.20	86.0	86.0	.0734	.0751-	.1874
15	7.80	86.0	86.0	.0936	.0984-	.1817
16	10.00	86.0	86.0			

241	10	7 15			
01	10.00-	92.0	.1128-	.0715	.2652
02	7.30-	92.0	.0706-	.0205	.3339
03	5.80-	92.0	.0544-	.0250	.3001
04	4.20-	92.0	.0407-	.0162	.3124
05	2.70-	92.0	.0282-	.0062	.3480
06	1.90-	92.0	.0245-	.0027-	.4140
07	1.20-	92.0	.0253-	.0006	.3873
08	.60-	92.0	.0153-	.0093	.2704
10	.40	92.0	.0096	.0068-	.2503
11	1.20	92.0	.0092	.0120	.6529
12	2.00	92.0	.0188	.0119-	.2654
13	3.50	92.0	.0388	.0460-	.1549
14	5.10	92.0	.0576	.0665-	.1611
15	6.60	92.0	.0723	.0764-	.1807
16	8.10	92.0	.0753	.0453-	.2717
17	10.00	92.0	.0953	.0794-	.2254

241	10	7	16			
01	10.00-	94.0	94.0	.1196-	.0727	.2704
02	8.70-	94.0	94.0	.1004-	.0591	.2743
03	7.10-	94.0	94.0	.0717-	.0193	.3382
04	5.60-	94.0	94.0	.0556-	.0238	.3064
05	4.10-	94.0	94.0	.0397-	.0151	.3159
06	2.50-	94.0	94.0	.0273-	.0028	.3715
07	1.50-	94.0	94.0	.0286-	.0007-	.3969
08	1.00-	94.0	94.0	.0270-	.0074	.3372
09	.70-	94.0	94.0	.0243-	.0167	.2546
11	.50	94.0	94.0	.0110	.0010-	.3738
12	1.30	94.0	94.0	.0108	.0115	.6050
13	2.00	94.0	94.0	.0180	.0085-	.2976
14	3.60	94.0	94.0	.0357	.0365-	.1875
15	5.20	94.0	94.0	.0555	.0580-	.1830
16	6.70	94.0	94.0	.0727	.0780-	.1774
17	8.20	94.0	94.0	.0852	.0818-	.2000
18	10.00	94.0	94.0	.0987	.0844-	.2210

3

NAVORD Report 4425

241	10	7 17			
01	5.00-	90.0	.0527-	.0268	.2903
02	3.90-	90.0	.0434-	.0240	.2814
03	2.90-	90.0	.0298-	.0129	.3054
04	1.90-	90.0	.0211-	.0009	.3835
05	1.30-	90.0	.0152-	.0141-	.5775
06	.80-	90.0	.0133-	.0100-	.5424
07	.30-	90.0	.0082-	.0040	.2944
09	.20	90.0	.0057	.0025-	.3043
10	.70	90.0	.0160	.0022	.4195
11	1.20	90.0	.0172	.0120	.5315
12	1.80	90.0	.0229	.0054-	.3448
13	2.30	90.0	.0309	.0203-	.2606
14	3.30	90.0	.0472	.0477-	.1899
15	4.30	90.0	.0721	.0787-	.1737
16	5.00	90.0	.0705	.0719-	.1880

NAVORD Report 4425

241	10	7 18			
01	5.00-	122.0	.0672-	.0327	.2947
02	4.30-	122.0	.0568-	.0288	.2906
03	3.20-	122.0	.0424-	.0144	.3241
04	2.20-	122.0	.0310-	.0031	.3720
05	1.70-	122.0	.0287-	.0030-	.4129
06	1.20-	122.0	.0203-	.0196-	.5851
07	.70-	122.0	.0173-	.0057-	.4579
08	.10-	122.0	.0062-	.0019	.3307
10	.40	122.0	.0098	.0041	.4757
11	.90	122.0	.0132	.0163	.6390
12	1.40	122.0	.0204	.0133	.5224
13	1.90	122.0	.0272	.0051-	.3545
14	3.00	122.0	.0436	.0366-	.2241
15	4.00	122.0	.0623	.0593-	.2016
16	5.00	122.0	.0836	.0813-	.1975

NAVORD Report 4425

241	10	7	19			
01	5.00-	211.0	211.0	.1079-	.0489	.3014
02	3.90-	211.0	211.0	.0816-	.0301	.3182
03	2.90-	211.0	211.0	.0590-	.0116	.3527
04	1.80-	211.0	211.0	.0423-	.0090-	.4346
05	1.30-	211.0	211.0	.0332-	.0227-	.5287
06	.80-	211.0	211.0	.0221-	.0237-	.6065
07	.30-	211.0	211.0	.0085-	.0091-	.6061
09	.20	211.0	211.0	.0078	.0062	.5510
10	.80	211.0	211.0	.0158	.0233	.6869
11	1.30	211.0	211.0	.0243	.0238	.5879
12	1.80	211.0	211.0	.0381	.0088	.4382
13	2.80	211.0	211.0	.0544	.0250-	.3001
14	3.80	211.0	211.0	.0780	.0532-	.2556
15	5.00	211.0	211.0	.1081	.0786-	.2466

241	10	7 20				
01	5.00-	263.0	.1243-	.0570	.3003	
02	3.90-	263.0	.0916-	.0300	.3265	
03	2.80-	263.0	.0661-	.0083	.3669	
04	1.80-	263.0	.0426-	.0136-	.4558	
05	1.30-	263.0	.0308-	.0265-	.5641	
06	.80-	263.0	.0138-	.0340-	.8848	
07	.30-	263.0	.0043-	.0088-	.8013	
09	.30	263.0	.0028	.0264	2.2777	
10	.80	263.0	.0128	.0351	.9404	
11	1.40	263.0	.0255	.0273	.6061	
12	1.90	263.0	.0374	.0144	.4690	
13	2.90	263.0	.0663	.0294-	.3033	
14	3.90	263.0	.0950	.0606-	.2644	
15	5.00	263.0	.1275	.0899-	.2510	

241	10	7	21			
01	5.00-	309.0	309.0	.1310-	.0349	.3387
02	4.20-	309.0	309.0	.1061-	.0274	.3404
03	3.10-	309.0	309.0	.0744-	.0014	.3882
04	2.10-	309.0	309.0	.0445-	.0263-	.5102
05	1.60**	309.0	309.0	.0315-	.0380-	.6333
06	1.10**	309.0	309.0	.0158-	.0490-	1.0123
07	.60-	309.0	309.0	.0022-	.0430-	4.3011
09	.50	309.0	309.0	.0084	.0240	.9634
10	1.00	309.0	309.0	.0203	.0281	.6688
11	1.50	309.0	309.0	.0325	.0198	.5138
12	2.00	309.0	309.0	.0487	.0009	.3957
13	3.00	309.0	309.0	.0807	.0439**	.2832
14	4.00	309.0	309.0	.1159	.0810-	.2522
15	5.00	309.0	309.0	.1462	.1104-	.2410

NAVORD Report 4425

241	10	7 22		
01	5.00-	373.0	.1399-	.0446
02	4.20-	373.0	.1286-	.0630
03	3.10-	373.0	.0783-	.0080
04	2.10-	373.0	.0473-	.0208-
05	1.60-	373.0	.0325-	.0284-
06	1.10-	373.0	.0154-	.0421-
07	.60-	373.0	.0066-	.0284-
09	.40	373.0	.0037	.0254
10	1.00	373.0	.0124	.0368
11	1.50	373.0	.0263	.0302
12	2.00	373.0	.0436	.0125
13	3.00	373.0	.0819	.0341-
14	4.00	373.0	.1245	.0781-
15	5.00	373.0	.1672	.1136-
				.3282
				.2940
				.3716
				.4799
				.5668
				.9388
				1.2526
				1.7650
				.9855
				.6217
				.4493
				.3087
				.2665
				.2561

241	10	7 23			
01	5.00-	468.0	.1611-	.0603	.3171
02	4.00-	468.0	.1260-	.0295	.3452
03	2.90-	468.0	.0788-	.0074	.3732
04	1.90=	468.0	.0391-	.0162-	.4749
05	.90=	468.0	.0081-	.0279-	1.0809
07	1.20	468.0	.0086	.0434	1.4013
08	2.20	468.0	.0509	.0053=	.3712
09	3.20	468.0	.0998	.0512-	.2894
10	4.20	468.0	.1604	.1038=	.2626
11	5.00	468.0	.1956	.1323=	.2567

241	11	8 02				
02	8.00	68.1	.0460	.0342-	.2433	
03	8.00	126.7	.0901	.0639-	.2502	
04	8.00	189.7	.1351	.0970-	.2484	
05	8.00	252.7	.1807	.1295-	.2487	
06	8.00	315.8	.2231	.1610-	.2477	
07	8.00	378.8	.2609	.1911-	.2455	
08	8.00	441.2	.2994	.2184-	.2461	
09	8.00	504.2	.3366	.2491-	.2440	
10	8.00	535.7	.3553	.2633-	.2438	

241	11	8 01			
02	4.00	69.3	.0049	.0054	.1716
03	4.00	132.4	.0165	.0144	.2175
04	4.00	194.7	.0284	.0187	.2603
05	4.00	257.8	.0444	.0251	.2789
06	4.00	320.8	.0600	.0384	.2640
07	4.00	383.8	.0727	.0461	.2652
08	4.00	446.8	.0877	.0600	.2552
09	4.00	509.9	.1033	.0647	.2667

8

241	11	8 03			
02	12.00	56.7	.0577	.0494-	.2208
03	12.00	119.7	.1262	.1044-	.2265
04	12.00	182.8	.1962	.1599-	.2290
05	12.00	245.8	.2718	.2201-	.2300
06	12.00	310.1	.3463	.2793-	.2307
07	12.00	373.1	.4203	.3391-	.2306
08	12.00	436.1	.4964	.3988-	.2313
09	12.00	499.2	.5697	.4615-	.2300
10	12.00	562.2	.6387	.5159-	.2305

241	11	8 04			
02	15.80	66.8	.0754	.0454-	.2716
03	15.80	129.8	.1470	.0928-	.2657
04	15.80	194.7	.2312	.1502-	.2621
05	15.80	257.8	.3186	.2085-	.2611
06	15.80	320.2	.3992	.2633-	.2601
07	15.80	383.2	.4872	.3273-	.2576
08	15.80	446.2	.5808	.3961-	.2556
09	15.80	509.2	.6727	.4645-	.2539
10	15.80	540.8	.7215	.5042-	.2522

241	11	8 05			
02	14.00	80.1	.0850	.0608-	.2489
03	14.00	143.2	.1583	.1149-	.2468
04	14.00	206.3	.2383	.1726-	.2471
05	14.00	269.4	.3218	.2329-	.2473
06	14.00	332.5	.4035	.2950-	.2458
07	14.00	395.6	.4932	.3658-	.2437
08	14.00	458.7	.5842	.4417-	.2408
09	14.00	521.8	.6771	.5111-	.2410
10	14.00	553.3	.7265	.5502-	.2405

NAVORD Report 4425

241	11	8 06			
02	10.00	309.5	.2808	.2276-	.2299
03	10.00	600.0	.5298	.4229-	.2324

241	11	8 07			
02	6.00	64.3	.0190	.0096-	.2909
03	6.00	127.3	.0413	.0242-	.2748
04	6.00	189.7	.0667	.0420-	.2661
05	6.00	252.7	.0965	.0635-	.2604
06	6.00	315.8	.1244	.0828-	.2589
07	6.00	378.8	.1484	.1041-	.2517
08	6.00	411.8	.1729	.1185-	.2549
09	6.00	504.8	.1953	.1331-	.2557
10	6.00	536.3	.2051	.1376-	.2578

NAVORD Report 4425

241	11	8 08		
02	2.00	600.0	.0610	.0395-
				.2625

NAVORD Report 4425

241	11	8 09		
02	0.00	600.0	.0180-	.0171 .2020

NAVORD Report 4425

241	11	8 10		
02	1.00-	600.0	.0652-	.0564 .2190

241	11	# 11			
02	3.00-	53.4	.012-	.0094	.2428
03	3.00-	117.8	.030-	.0232	.2389
04	3.00-	182.2	.0480-	.0347	.2433
05	3.00-	248.5	.0621-	.0468	.2413
06	3.00-	317.9	.0721-	.0547	.2433
07	3.00-	377.3	.0790-	.0603	.2430
08	3.00-	441.8	.1021-	.0718	.2440
09	3.00-	505.4	.1169-	.0844	.2475