

UNCLASSIFIED

AD **252 267**

*Reproduced
by the*

ARMED SERVICES TECHNICAL INFORMATION AGENCY
ARLINGTON HALL STATION
ARLINGTON 12, VIRGINIA



UNCLASSIFIED



NOTICE: When government or other drawings, specifications or other data are used for any purpose other than in connection with a definitely related government procurement operation, the U. S. Government thereby incurs no responsibility, nor any obligation whatsoever; and the fact that the Government may have formulated, furnished, or in any way supplied the said drawings, specifications, or other data is not to be regarded by implication or otherwise as in any manner licensing the holder or any other person or corporation, or conveying any rights or permission to manufacture, use or sell any patented invention that may in any way be related thereto.

CATALOGED BY ASTIA
AS AD No. 252

267

OPERATIONS OF THE FALLOUT GROUP OF PROJECT 50.3

W. J. Richards

B. F. Watson

XEROX

15 August 1960



ASTIA
RECEIVED
MAR 15 1961

82400

U. S. ARMY SIGNAL RESEARCH AND DEVELOPMENT LABORATORY
FORT MONMOUTH, NEW JERSEY

15 August 1960

USASRD L Technical Report 2088

OPERATIONS OF THE FALLOUT GROUP OF PROJECT 50.3

W. J. Richards

B. F. Watson

DA Task 3A99-07-001-01

U. S. ARMY SIGNAL RESEARCH AND DEVELOPMENT LABORATORY
FORT MONMOUTH, NEW JERSEY

ABSTRACT

The Fallout Group was a part of Project 50.3 at Operation Plumbbob, held in Nevada from April to September, 1957. The fallout group was engaged in evaluating, under field conditions, the Signal Corps method of fallout prediction. The group collected the meteorological data necessary to make fallout forecasts, and made plots on a daily basis for each currently scheduled shot. Other duties included conferences and liaison activities. The Signal Corps method of fallout prediction is found to have several shortcomings despite its numerous virtues. The dose rates forecast by the Signal Corps method are compared with the observed dose rates by means of contour charts and graphs of dose rate versus distance along the hot line.

OPERATIONS OF THE FALLOUT GROUP OF PROJECT 50.3

CONTENTS

Abstract	
PURPOSE	1
BACKGROUND	1
DISCUSSION	1
Facilities and Operations	1
Conferences and Liaison	4
USAEPG GMD Team	4
Evaluation of the Signal Corps Method	4
Results of Fallout Predictions	9
CONCLUSION	13
RECOMMENDATIONS	13

FIGURES

	1. Map of Nevada Test Site and Surrounding Area	3
	2. Map of the Upper Wind Network in the Testing Region	4
	3. Wafers Plotted Under Conditions of Nominal Wind Speed, Nominal Wind Shear	6
H	4. Wafers Plotted Under Conditions of Low Wind Speed, High Wind Shear	7
	5. Wafers Plotted Under Conditions of High Wind Speed, Nominal Wind Shear	8
	6. Observed Contour Pattern, Shot Boltzman	14
	7. Observed Contour Pattern, Shot Wilson	15
	8. Observed Control Pattern, Shot Priscilla	16
	9. Observed Contour Pattern, Shot Hood	17
	10. Observed Contour Pattern, Shot Diablo	18
	11. Observed Contour Pattern, Shot Kepler	19
	12. Observed Contour Pattern, Shot Owens	20
	13. Observed Contour Pattern, Shot Stokes	21
	14. Observed Contour Pattern, Shot Shasta	22
	15. Observed Contour Pattern, Shot Doppler	23
	16. Observed Contour Pattern, Shot Smoky	24
	17. Observed Contour Pattern, Shot Franklin Prime	25
	18. Observed Contour Pattern, Shot Galileo	26
	19. Observed Contour Pattern, Shot Newton	27
	20. Forecast Contour Pattern, Shot Boltzman	28
	21. Forecast Contour Pattern, Shot Wilson	29
	22. Forecast Contour Pattern, Shot Priscilla	30
	23. Forecast Contour Pattern, Shot Hood	31
	24. Forecast Contour Pattern, Shot Diablo	32
	25. Forecast Contour Pattern, Shot Kepler	33
	26. Forecast Contour Pattern, Shot Owens	34
	27. Forecast Contour Pattern, Shot Stokes	35

CONTENTS (Contd.)

28. Forecast Contour Pattern, Shot Shasta	36
29. Forecast Contour Pattern, Shot Doppler	37
30. Forecast Contour Pattern, Shot Smoky	38
31. Forecast Contour Pattern, Shot Franklin Prime	39
32. Forecast Contour Pattern, Shot Galileo	40
33. Forecast Contour Pattern, Shot Newton	41
34. Dose Rate Intensity Along the Hot Line, Shot Boltzman	42
35. Dose Rate Intensity Along the Hot Line, Shot Wilson	43
36. Dose Rate Intensity Along the Hot Line, Shot Priscilla	44
37. Dose Rate Intensity Along the Hot Line, Shot Hood	45
38. Dose Rate Intensity Along the Hot Line, Shot Diablo	46
39. Dose Rate Intensity Along the Hot Line, Shot Kepler	47
40. Dose Rate Intensity Along the Hot Line, Shot Stokes	48
41. Dose Rate Intensity Along the Hot Line, Shot Owens	49
42. Dose Rate Intensity Along the Hot Line, Shot Shasta	50
43. Dose Rate Intensity Along the Hot Line, Shot Doppler	51
44. Dose Rate Intensity Along the Hot Line, Shot Smoky	52
45. Dose Rate Intensity Along the Hot Line, Shot Franklin Prime	53
46. Dose Rate Intensity Along the Hot Line, Shot Galileo	54
47. Dose Rate Intensity Along the Hot Line, Shot Newton	55
48. Time of Arrival of First Fallout Along Hot Line, Shot Boltzman	56
49. Time of Arrival of First Fallout Along Hot Line, Shot Wilson	57
50. Time of Arrival of First Fallout Along Hot Line, Shot Priscilla	58
51. Time of Arrival of First Fallout Along Hot Line, Shot Hood	59
52. Time of Arrival of First Fallout Along Hot Line, Shot Diablo	60
53. Time of Arrival of First Fallout Along Hot Line, Shot Kepler	61
54. Time of Arrival of First Fallout Along Hot Line, Shot Stokes	62
55. Time of Arrival of First Fallout Along Hot Line, Shot Owens	63
56. Time of Arrival of First Fallout Along Hot Line, Shot Shasta	64
57. Time of Arrival of First Fallout Along Hot Line, Shot Doppler	65
58. Time of Arrival of First Fallout Along Hot Line, Shot Smoky	66
59. Time of Arrival of First Fallout Along Hot Line, Shot Franklin Prime	67
60. Time of Arrival of First Fallout Along Hot Line, Shot Galileo	68

OPERATIONS OF THE FALLOUT GROUP OF PROJECT 50.3

PURPOSE

The purpose of this report is to describe the activities of the Fallout Group during Operation Plumbbob, and to report its findings on testing the Signal Corps method of fallout prediction.

BACKGROUND

The "Fallout Group" of Project 50.3 was primarily concerned with field-testing and evaluating the Signal Corps fallout-prediction method. The group was composed of personnel from the Meteorological Techniques Branch, Meteorological Division, USASRDL.

Operations commenced at Camp Desert Rock, Nevada, during the early part of May 1957 and lasted until mid-September. During this period the group participated in twenty-three nuclear detonations and made fallout forecasts based on varying degrees of information.

DISCUSSION

Facilities and Operations

The daily routine of the Fallout Group was usually spent in gathering data necessary to make fallout plots and, using this data, field-testing and evaluating plots made by the Signal Corps method of fallout prediction. These plots were compared with post-shot radiological data and with plots made by other methods.

1. *Facilities.* The collection of the necessary data with which to make fallout plots was difficult in the first few weeks of operation because of the location of the group's operations at Camp Desert Rock, which is outside the operating area of the Mercury Weather Station and the Mercury Fallout Prediction Unit (FOPU) (Figs. 1 and 2). Wind data for making the plots in the initial weeks were obtained from a USAEPG GMD team attached to Project 50.3 at Camp Desert Rock.

In the early part of July, however, the Fallout Group secured a van inside the Mercury compound. The van was located between the weather station and the FOPU headquarters. Here it became possible to easily obtain the needed meteorological and radiological information. Wind data were available at all times from the special wind network maintained by the Mercury weather station. Radiological data were obtainable immediately upon their arrival at the FOPU, so the Signal Corps method forecast could be verified quickly.

2. *Operations.* Winds-aloft data from the special network maintained by the Mercury weather station were copied by Thermofaxing the observation records. In some instances, the Mercury weather station provided mimeographed sheets of the wind data taken at Yucca Flat. Radiological data from the FOPU were copied by hand, as were cloud-height data furnished by the Civil Aeronautics Administration.

The usual routine for making fallout predictions was to construct plots from observed winds for each run after 2300 PDT, plus one plot for the forecast shot-time winds. Usually, wind runs were made at Yucca Flat at 2300, 0200, 0500, and shot time. These runs were subject to cancellation if the shot were called off prior to observation time.

Conferences and Liaison

During periods when wind and radiological data were not being gathered and plots were not being constructed, the fallout group was occupied with duties such as conferences, report writing, and liaison activities.

Frequent meetings were held with the personnel of the FOPU, who were themselves meteorologists from the U. S. Weather Bureau, Los Alamos Scientific Laboratories, and the University of California Radiation Laboratories. Topics of discussion included rainout, time and space variability, topographical influence, fall rates, and variations in the fallout fraction.

Conferences also were held with personnel of CONARC, USAEPG, and the Command and General Staff College to discuss military aspects of the fallout problem. The group also occasionally met with non-meteorological radiological personnel to discuss particle sizes, and with observation personnel of the Civil Aeronautics Administration to discuss means of obtaining cloud dimensions.

The Fallout Group also served as Liaison to send wind information by telephone to operating units of CONARC. The group also sent fallout-danger-area information by radio to the observation personnel of Project 50.3

USAEPG GMD Team

The Fallout Group accomplished a considerable amount of work with a USAEPG GMD team which was attached to Project 50.3. This team was initially stationed at Camp Desert Rock, where it provided the group with data with which to make fallout plots. When the Fallout Group moved to Mercury, the GMD team was relocated to the eastern shore of Pahranaagat Lake, eight miles south of Alamo, where it provided rawinsonde data to the Mercury wind network and to the Fallout Group. The Pahranaagat Lake station made flights in accordance with the schedule of the Mercury network. This GMD station was especially valuable since it provided data in a region which was previously not covered by a pibal or GMD station.

The GMD team was temporarily recalled from Pahranaagat Lake during the third week of August in order to participate in a wind-variability project conducted in cooperation with three CONARC GMD units based at Camp Desert Rock. The purpose of the project was to study the variability of the wind in time and space. The four GMD teams made observations at various short-time intervals, and CONARC was given the data and the responsibility for their analysis.

Evaluation of the Signal Corps Method

Despite the lack of completely reliable observational data to verify the results obtained by the Signal Corps prediction method, it is possible to analyze its shortcomings and its virtues. The continuous use of the method over a long period of time and under field conditions brought out several points which might not otherwise have been completely evident. It is not the intention of this report to give a detailed description of the method, since this has been done in Engineering Report E-1217.* For a complete understanding of the following paragraphs, that report should be consulted.

* USASRDLE Engineering Report 1217, "Signal Corps Method of Prediction of Radioactive Fallout Patterns," 5 Apr 57.

TOOELE COUNTY

JUAB COUNTY

MILLARD COUNTY

Di

SNAKE RANGE

SHELL CREEK RANGE

McGill

Ely

EGAN RANGE

WHITE PINE COUNTY

BUTTE MOUNTAIN



REKA COUNTY

Eureka

1

2



WHITE PINE
COUNTY

MILLARD COUNTY

Springs Nyala

Sunnyside

MI

BEAVER COUNTY

LINCOLN
COUNTY

Tempiute Hiko

IRON COUNTY

Ced
Cit

Alamo Elgin

Pahrangat

WASHINGTON COUNTY



Lake

RANGF

Lake

Card

St. George

SNAKE RAN
SHELL CREEK

ELY

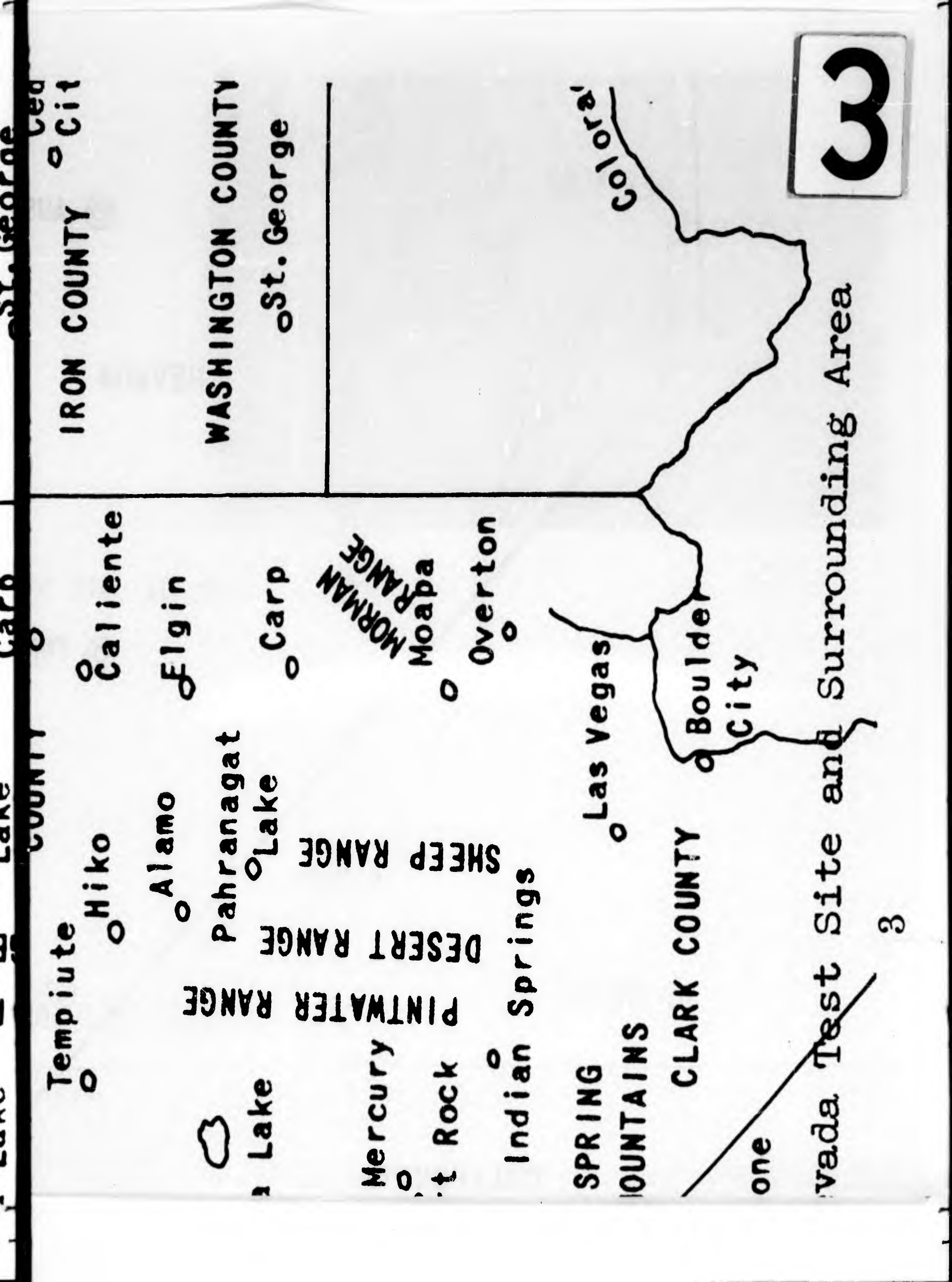

IRON COUNTY

WASHINGTON COUNTY

St. George

Caliente

Elgin

Pahrangat

Carp

NORMAN RANGE
Moapa

Overton

Hiko

Alamo

Lake

Lake

SHEEP RANGE

Mercury

Hot Rock

Indian Springs

Las Vegas

Boulder

City

SPRING MOUNTAINS

CLARK COUNTY

one

Nevada Test Site and Surrounding Area

LANDER
COUNTY

o Austin

EUREKA
COUNTY

o Eureka

EGAN RANGE

o Ely

o Mc

WHITE PINE
COUNTY

BUTTE MOUNTAIN

4

x Mt. Jefferson



x Mt. Jefferson

NYE COUNTY

Warm Springs

Nyala

Sunny

Tonopah CACTUS RANGE

ESMERALDA COUNTY

Goldfield

x Mt. Helen

Scotty's Junction

LINCOLN COUNTY

Tempiute

Hiko

Alamo

Pahrangat

RANGE

EUREKA

FGAN

Ely

WHITE PINE COUNTY



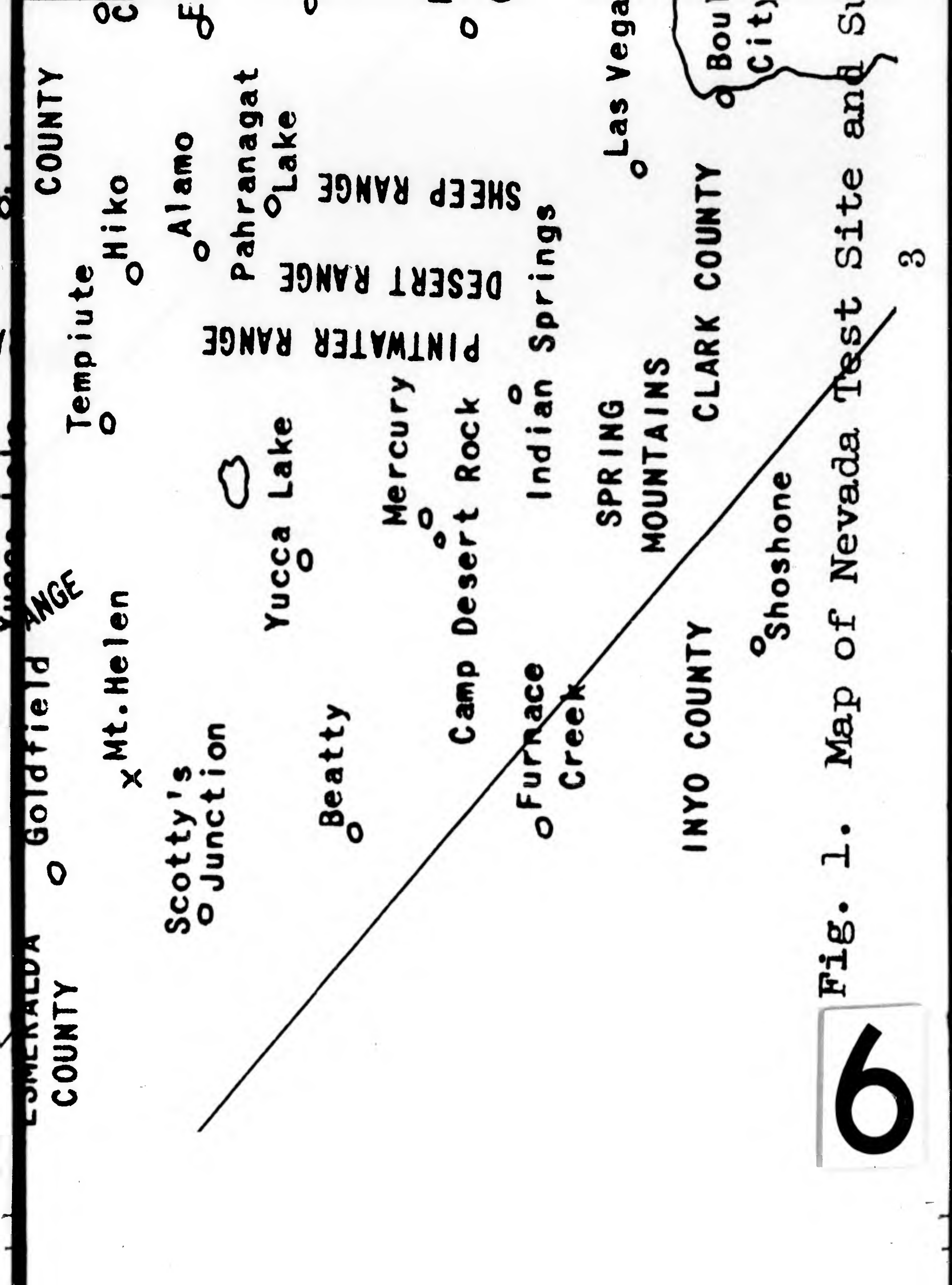

Fig. 1. Map of Nevada Test Site and Surrounding Area

⊙ RENO

⊙ AUST

NEVADA

⊙ TONO

LI

⊙ BISHOP

⊙ FRESNO

⊙ BEA

1

CALIFORNIA

© AUSTIN

© ELY

NEVADA

2

© TONOPAH

CALIENTE

LINCOLN MINE ©

©

YUCCA LAKE

©

©

PAHRANAGAT LAKE

©

©

BEATTY

INDIAN SPRINGS

©

©

OVERTON

◎ ELY

◎ MILFORD

CALIENTE

UTAH

NE ◎

◎

CA LAKE

◎

◎ ST. GEORGE

PAHRANAGAT LAKE

INDIAN SPRINGS

ARIZONA

◎

◎

OVERTON

3

© FRESNO

© BISHOP

© BE

CALIFORNIA

SHOSHO

© INTERYOKEN

4

FIGURE 2. MAP OF THE UP

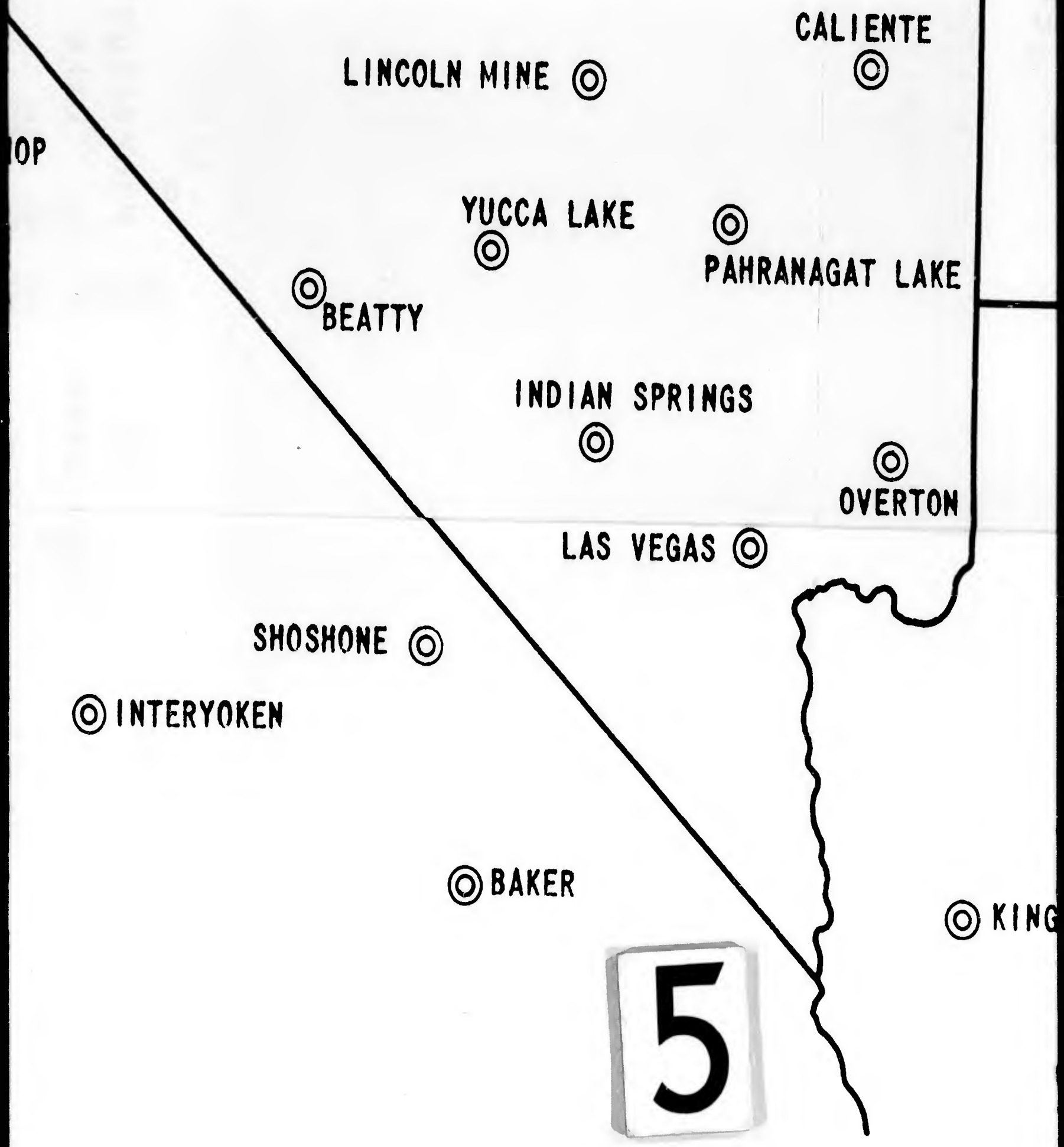

2. MAP OF THE UPPER WIND NETWORK IN THE TESTING REGION

CALIENTE

UTAH



LAKE



PAHRANAGAT LAKE



ST. GEORGE

AN SPRINGS



OVERTON

ARIZONA

AS VEGAS



KINGMAN

6

NETWORK IN THE TESTING REGION

1. *Use of the Method.* Since the Signal Corps method attempts to ascribe quantitative results to a fallout prediction, it is necessarily more complicated than many other methods and consequently there is more room for error in making an analysis. It was found that the average person making his first analysis required as long as four hours to complete all the steps, and that the finished product contained many inadvertent mistakes. However, both the time and accuracy elements were considerably improved after the procedure had been performed several times. With experience, fallout predictors were capable of turning out a neat and accurate analysis in about half an hour.

2. *Cloud Dimensions.* One of the basic requirements in making a fallout forecast is a knowledge of the shape and dimensions of the radioactive cloud. The Signal Corps method as used in Nevada assumed cloud heights and radii to be a function of yield. In practice, it developed that these dimensions were often in disagreement with those actually observed. Results were improved somewhat by assuming a higher tropopause than actually existed, but this was a stop-gap measure at best. Increased information on actual cloud dimensions as observed at Operation Plumbbob will undoubtedly permit the use of more realistic values in making a pre-shot forecast.

3. *Activity Distribution.* Conclusive data are lacking on the true division of radioactivity between the mushroom cap and the stem of the cloud. Observational data are scarce and theoretical data are often conflicting. Estimates range from the order of 90 percent in the mushroom cap and 10 percent in the stem to 10 percent in the mushroom cap and 90 percent in the stem. The Signal Corps method as used in Nevada assumed that the former estimate was correct for the highest-yield (megaton) weapons and the latter for the lowest-yield (kiloton) weapons.

Recent findings indicate that this is probably not the true picture and that, regardless of yield, the greater percentage of activity lies in the mushroom cap. The distribution assumed in Nevada, concerned as it was with low-yield weapons, would place too much activity in the stem with a resulting increase of radiation intensities near ground zero.

4. *Wind Speed and Shear Effect.* The Signal Corps method arrives at a prediction of fallout intensity contours by tracking an array of "wafers" from their place of origin in the cloud to the ground. Each of these wafers is assigned a radiation dosage and the contours are found by summing up the dosages where wafers overlap. In cases of considerable wind velocity or wind shear, however, the distances between the wafers on the ground increase, resulting in little or no overlapping. This condition was aggravated in Nevada by the fact that the low-yield weapons, which were predominant, generate wafers of relatively small size; overlapping is therefore restricted even further.

Figure 3 illustrates a condition of nominal wind shear. The wafers are close together and, since each has an intensity of 45 roentgens per hour, a 45r/hr contour enclosing them may be drawn with confidence. In Fig. 4, however, the same wafers are spread by wind shear over a much larger ground area. Since there is only as much radioactivity available as there was in the previous example, it is not realistic to again enclose the wafers by a 45r/hr contour since this would be equivalent to saying that there is more radioactivity available than in the first case.

As an alternative to drawing the normal contour values, problems were handled in a subjective manner by roughly computing the ratio between the area covered by the wafers and the area enclosed by the contour. The result was then applied to the contour value in order to decrease it. However, it is more difficult to draw contours under conditions of considerable wind velocity. This is demonstrated in Fig. 5 which includes, for simplicity,

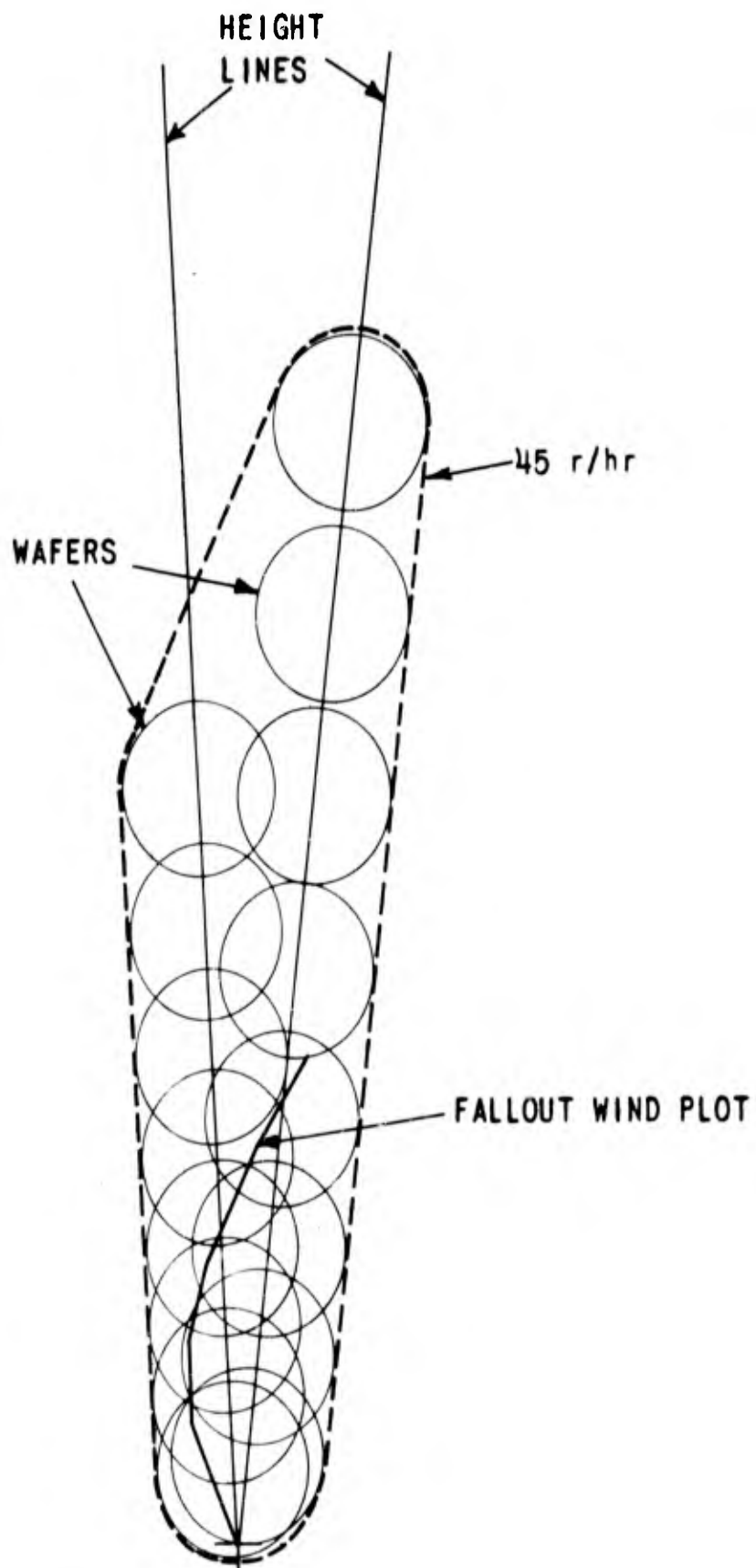

FIGURE 3. WAFERS PLOTTED UNDER CONDITIONS OF NOMINAL WIND SPEED, NOMINAL WIND SHEAR

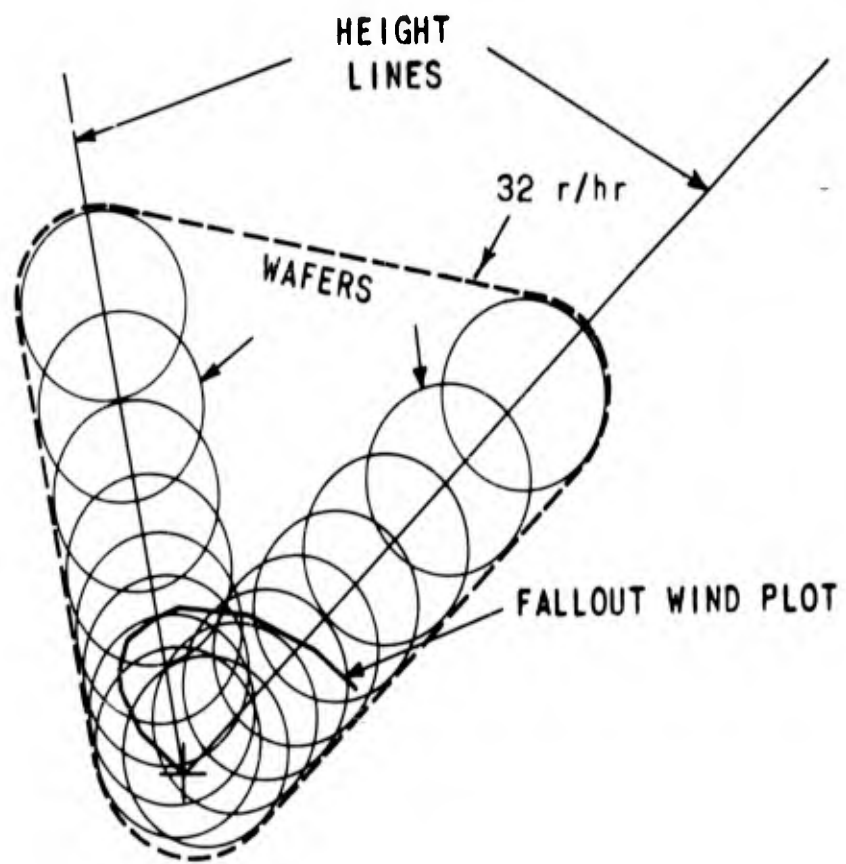

FIGURE 4. WAFERS PLOTTED UNDER CONDITIONS OF LOW WIND SPEED, HIGH WIND SHEAR

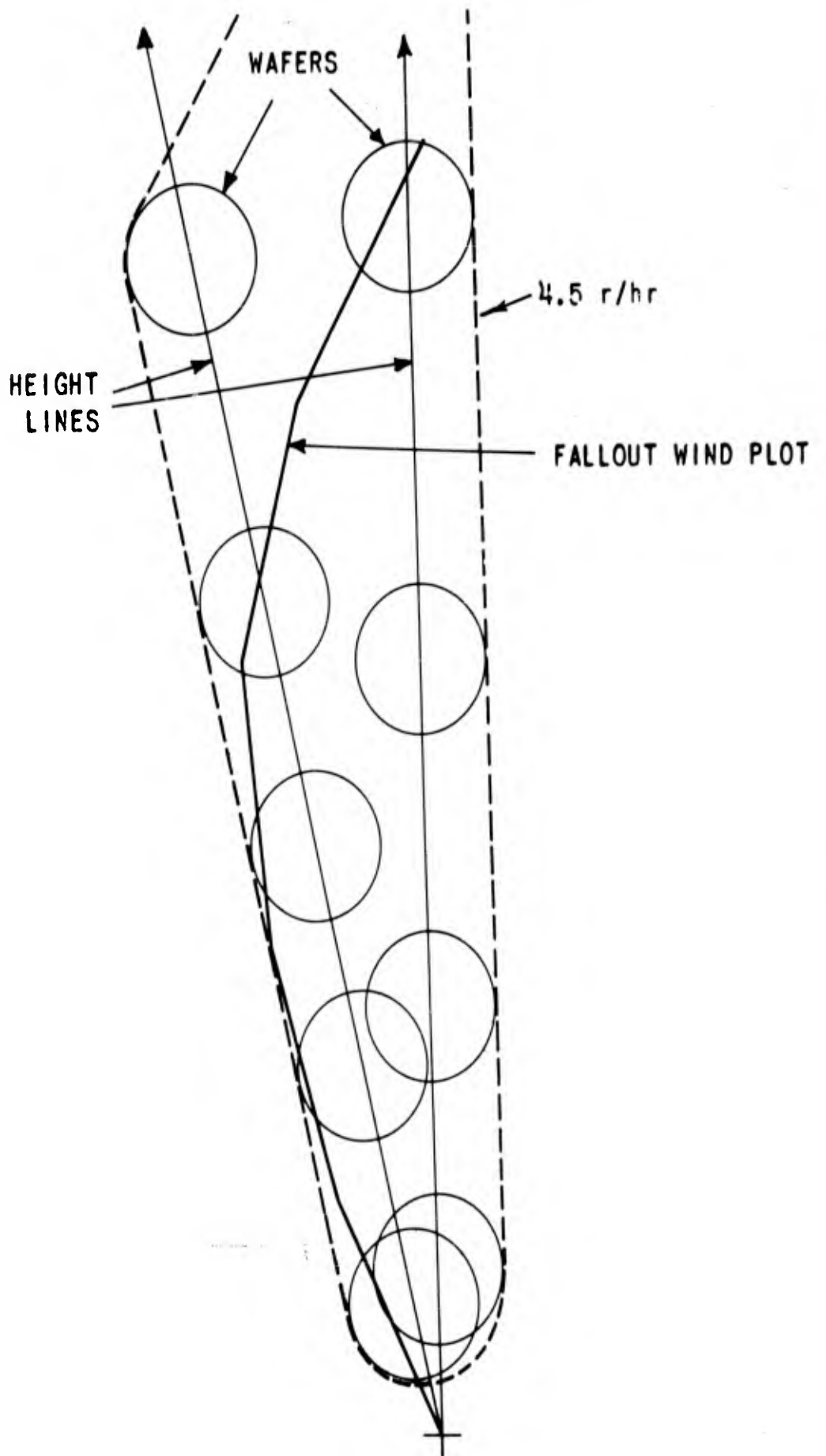

FIGURE 5. WAFERS PLOTTED UNDER CONDITIONS OF HIGH WIND SPEED, NOMINAL WIND SHEAR

only mushroom wafers. Application of a procedure similar to that used in Fig. 4 results in a decrease in value of the outer contour from 45r/hr to 4.5r/hr. In Fig. 4 this results in a decrease in value from 45r/hr to 32r/hr. Such a procedure is effective in a case as simple as this, but when both mushroom cap and stem wafers of various sizes and degrees of overlap must be considered, the problem becomes more complicated and time-consuming, particularly when more than one contour is involved.

An alternative solution would be to increase the number of wafers (and reduce the intensity of each) in order to fill, or nearly fill, the contour area regardless of the amount of wind shear. This too, would complicate the plotting procedure to such an extent that an automatic computer would be required to make a plot within a reasonable time.

Probably the best solution for a manual method of this kind would be to keep the number of wafers to a minimum and devise a scheme or tool to compute the area factors objectively and quickly.

5. *Topographic Influences.* No evaluation of a fallout prediction system in Nevada would be complete without mention of the problems imposed by that state's rugged topography. Even if all the other possible sources of error were eliminated, perfect agreement would not be expected between a forecast and an observed pattern as long as mountains exist which intercept part of the fallout which would otherwise travel farther. The mountains may therefore cause either "hot spots" or "cold spots," depending on their height, shape, and distance from ground zero. In addition, the presence of mountains causes strong fluctuations in the mesometeorological wind field. While these fluctuations affect the winds measured by the upper air network, the relatively coarse upper wind network is not sufficiently dense to permit reliable analysis of the meso-scale wind field. Thus, the point winds, which are a necessary input for a simple manual fallout prediction method affording reasonable speed of operation, contain a relatively high "noise level."

Results of Fallout Predictions

As stated previously, 23 of the 29 shots were covered by the fallout group. For 14 of these shots, adequate data were obtained to make comparisons between the observed patterns and the patterns obtained by the Signal Corps method. Of the other 9 shots covered, either a measurable dose rate pattern did not exist, or the fallout fraction could not be determined.

Drawn on the same map scale as the map in Figure 1 (1:1,100,000), the forecast and observed patterns are illustrated in figures 6 to 33. Both forecast and observed patterns are drawn for dose rate patterns at $H \pm 1$ hour for selected values in roentgens per hour. These intervals are those given for $H \pm 1$ in the observed data; the Signal Corps method contours were interpolated to conform to these values. The lowest-valued contour obtained by the Signal Corps method was retained, however, since interpolation beyond the outermost contour is not possible. Also, contours for dose-rate values below the lowest-valued contour obtained by the Signal Corps method are not included on the observed patterns, since no comparison is possible.

In figures 34 to 47, graphs of the predicted and observed dose rates at $H \pm 1$ versus distance from ground zero along the hot line are given. By using the predicted and observed contour patterns, the dose rates were plotted to the distance from ground zero to which the last contour line extended. Because of the uncertainties involved in smoothing the data from the small number of points available from contours, the points were all connected by straight lines.

Finally, in figures 48 to 60, the times of arrival of the first fallout along the hot line as forecast are compared to those observed (except for Shot Newton, for which there were no data available).

1. *Shot Boltzman*. Boltzman was fired on 28 May 1957 after 13 days' postponement. Fallout occurred between the northwest and north-northwest by north of ground zero. The hot line ran in the direction of Austin, with a hot spot appearing just to the west of Warm Springs. The hot line divided to the east of Belmont, with one fork running in the direction of Austin, the other in the direction of Lovelock. The predicted pattern was oriented to the northwest, in a direction between Lovelock and Fallon, and did not display the widening as did the actual pattern. A Fallout Plot was constructed at the Forward Area, and the shot was observed there by the Fallout Group.

2. *Shot Wilson*. Wilson was detonated from a 500-foot balloon on 18 June 1957 at 0445, after 8 days' postponement. The cloud rose to 34,500 feet mean sea level (MSL) and drifted in two opposite directions: the upper portion drifted to the northeast, while the lower portion drifted to the southwest. The hot line extended to the northeast approximately in the direction of Hilo, and to the southwest in the direction of Beatty.

The forecast pattern predicted the major hot line would be to the east-northeast with a minor hot line to the southwest. The predicted fallout did not extend as far to the southwest as the observed fallout, partly because of the fact that the winds changed to more easterly directions in their lower layers shortly after shot time. It also appears that northerly winds prevailing at Yucca Flat in the lower layers did not prevail on the other side of the mountains to the west of the flat; otherwise the fallout would have occurred more to the south than it did. Having made the plot at the forward area, the members of the Fallout Group drove through the lower portion of the cloud as it moved to the southwest. They could see that the cloud was moving toward the west more than had been expected from the prediction based on Yucca Flat shot-time winds.

3. *Shot Priscilla*. The only shot to be fired at Frenchman Flat, Priscilla, was detonated at 0630 on 24 June 1957 after only two days' postponement. The burst occurred on a balloon 700 feet above the dry lake-floor. The cloud rose to 43,000 feet (MSL), which made it the third highest cloud of Operation Plumbbob. The cloud drifted to the northeast, with the hot line running toward Carp, thence to Pintura, Utah, and turned irregularly eastward thereafter. The forecast hot line ran in the direction of Alamo, which was practically straight northeast of ground zero. The explanation for the difference is the change in the winds aloft with time. The upper-level winds shifted, in general, to more westerly components after shot time. The path of the fallout was relatively narrow, and the forecast pattern predicted this feature quite well.

4. *Shot Hood*. Hood, whose cloud rose to 48,000 feet (MSL), highest of all the clouds of the entire operation, was fired from a 1500-foot balloon at 0440 on 5 July 1957 after three days of delay. The cloud drifted generally toward the northeast, causing the hot line to be oriented slightly to the west of Lincoln Mine. Because of time and space wind variability, the hot line curved toward the east as it increased in distance from ground zero. The forecast pattern also had its hot line just west of Lincoln Mine, but of course the forecast hot line did not curve because the method does not account for the wind's time and space variability.

5. *Shot Diablo*. Diablo was fired on a 500-foot tower at 0430 on 15 July 1957 after five days of postponement. The cloud rose to a height of 31,500 feet (MSL) above the point of burst. The upper portion of the cloud moved generally northeastward, while the lower portion moved toward the north. Part of the upper portion of the cloud, however, moved in a southeasterly direction. The resulting hot line was somewhat complex, with the main branch moving over Lincoln Mine, then forking. One prong moved along the Shell Creek Range, the other prong

moved over Baker. A minor hot line extended northward, while another minor hot line extended toward the east-northeast for a short distance (about 20 miles). The predicted pattern showed a vague hot line traveling toward Caliente; and the predicted pattern, like the measured pattern, indicated a widespread dispersion of the fallout.

6. *Shot Kepler*. Kepler, detonated on a 500-foot tower, was fired at 0450, 24 July 1957, after only a few days' postponement. The higher part of the cloud, top at 28,000 feet (MSL), moved northeast, while the lower part moved to the northwest. The resulting hot line was oriented toward the northwest, curving clockwise so that it moved south of Goldfield, over Coaldale, thence toward Fallon. The orientation of the forecast plot was similar to that of the measured pattern. The great amount of wind shear present at shot time was conserved with time, with the result that the measured pattern showed widely scattered fallout, as did the forecast plot.

7. *Shot Owens*. With favorable winds two days in a row, Owens was fired one day after Kepler. The shot took place on 25 July 1957 at 0630. The cloud rose to 35,000 feet (MSL). The higher parts of the cloud moved slightly west of north; the lower parts moved northeast. The hot line ran north-northeast through Currant, then forked, with one prong moving toward Ely, the other toward Cherry Creek. The forecast pattern indicated a hot line running toward Eureka, or practically straight north of ground zero. Indications from the forecast were that there would not be great dispersal of the fallout due to wind shear; however, fallout actually was dispersed rather widely, so time and space changes exerted a fairly strong influence on this fallout pattern.

8. *Shot Stokes*. A 1500-foot balloon shot, Stokes, was fired on 7 August 1957 at 0525. The fallout from this shot occurred almost straight north of ground zero, with the hot line oriented in the direction of Eureka. However, the fallout from this shot was very insignificant. There was considerable directional shear in the lower winds; however, between 10,000 feet and 37,000 feet (MSL), the height of the cloud top, the winds were all between 170 and 190 degrees and did not substantially change in either speed or direction with time or space. Hence, the forecast pattern was in excellent agreement with observed pattern, with both patterns oriented in the same direction.

9. *Shot Shasta*. Detonated from a 500-foot tower on 18 August 1957 at 0500, Shasta's cloud rose to 32,000 feet (MSL) and deposited a considerable amount of fallout between a general north-northwesterly to a north-northeasterly direction from ground zero. The lower part of the cloud moved northeastward, the middle part northwestward, and the upper part eastward. The resulting fallout pattern was rather distorted in shape, with the hot line having many forks and branches. The main hot line moved in a weaving fashion toward Eureka. Time and space variabilities obviously played a vital role in the shaping of this pattern. The forecast pattern would have oriented the hot line more in the direction of Austin, and plotted a course in a non-weaving manner; however, the forecast pattern did indicate the acute directional shearing of the fallout.

Rainout occurred with this shot at Lincoln Mine and in the Alamo-Hiko area. The rainout from this shot most likely came from the activity in the lower part of the cloud which moved in the direction of Lincoln Mine and Alamo. However, the radioactivity of the rainout was not great since the stem was much "cleaner" than would be the stem of a surface burst.

10. *Shot Doppler*. Burst from a 1500-foot balloon on 23 August 1957 at 0530, Doppler's cloud rose to a height of 38,000 feet (MSL). In the lower layers, the cloud moved north, while relatively strong southwesterly winds carried debris toward the northeast into a shower area in White Pine County. As a result, it is not possible to determine whether the radioactive intensity pattern of Doppler is due primarily to fallout or rainout; the shape of the pattern, with its peak of intensity in White Pine County just southeast of Ely, would indicate that rainout must have played the leading role in this area. The forecast pattern would have placed most of the fallout in the vicinity of ground zero, with the hot line running almost straight north. In contrast, the measured radioactivity took place almost wholly outside the forecast area. The actual fallout was practically negligible at ground zero, while the forecast called for intensities far above those actually experienced. The fact that the winds changed so must after shot time, and the fact that rainout must have been considerable, illustrate the limitations of any method which does not consider all factors. Indeed, even the topography in White Pine County must have played no small role in distorting the pattern even further, since the mountains in that county are generally higher than the mountains to the north and south.

11. *Shot Franklin Prime*. Franklin Prime, burst on a 750-foot balloon on 30 August 1957 at 0540, resulted in very little fallout. The top of the cloud reached 32,000 feet (MSL) and traveled to the northeast, while the lower part of the cloud moved to the northwest. Most of the fallout came from the cap, and the measured pattern formed a little area to the north of the site between about 20 and 70 miles from ground zero. The predicted pattern was oriented to about 10 degrees, in general agreement with the observed pattern's orientation.

12. *Shot Smoky*. Smoky, detonated on a 700-foot tower, produced a cloud that rose to 37,000 feet (MSL). It was detonated on 31 August 1957 at 0530. The lower part of the cloud traveled towards the south-southeast, while the upper part of the cloud left the test site traveling in a southeasterly direction. A low-pressure system to the northeast of the test site caused the cloud to travel toward the northeast through Utah. The resulting hot line ran near Carp; thence just north of St. George, Utah; south of Cedar City, Price, and Vernal, Utah; thence to Rock Springs, Wyoming; and northward to Lander, Wyoming. The forecast pattern ran south-eastward to Lake Mead and in the direction of Flagstaff, Arizona. Time and space considerations, of course, explain the wide discrepancy. Within 50 miles of ground zero the two patterns agreed rather well, but then separated so that they eventually ran 90 degrees to one another.

13. *Shot Galileo*. Galileo was detonated on a 500-foot tower on 2 September 1957 at 0540. The cloud rose to 37,000 feet (MSL); its higher portion drifted toward the northwest, and the lower portion toward the southwest. The hot line ran toward the north-northwest. The pattern did not exhibit any irregular features, and closely resembled the predicted pattern in its shape. However, the hot line of the predicted pattern ran more west of north-northwest than did the observed pattern.

14. *Shot Newton*. Newton was fired from a 1500-foot balloon on 16 September 1957 at 0550. There was no delay in the firing of this shot. The cloud rose to 32,000 feet (MSL) and drifted toward the northeast. The pattern was comparatively smooth except for a hot spot in the vicinity of the House Range in Utah. The forecast pattern was quite similar to the observed pattern in its shape and orientation, although the observed pattern "fanned out" more than the predicted pattern.

15. *Shots Franklin, Lassen, Columb A, Columb B, John, Saturn, Pascal B, and Ranier.* There was either no appreciable fallout or no fallout at all from these shots.

16. *Shots Fizeau, Whitney, Morgan, and Charleston.* Fizeau was fired on 14 September 1957, but there was no information available as to the fallout fraction from this burst, hence a plot cannot be made. Whitney, Morgan, and Charleston were detonated after the Fallout Group left Camp Desert Rock, so there is no adequate data available with which to make fallout forecasts for these shots.

CONCLUSION

The Fallout Group of Project 50.3 succeeded in establishing the fact that the Signal Corps method can forecast the contours of dose rate to a reasonable degree of success for weapons under 100 KT, provided adjustments are made for the fallout fraction and for the failure of the wafers to overlap.

It is apparent that improved input data (cloud-height estimation, distribution of radioactivity in the cloud, total available radioactivity, etc.) would contribute to a better forecast. Dose-rate contours resulting from tower shots were more accurately forecast by the method than were those resulting from balloon shots. It appears that the particle sizes assumed in the cloud model were not appropriate for clouds produced by balloon shots.

The method has a shortcoming common to all methods which attempt to predict dose-rate contours from a point wind: Time and space variability of the wind frequently causes the patterns to lie in a direction departing considerably from the forecast direction. Outside of this, despite the discrepancies due to terrain, it can be said that the method, as applied to the tower shots of Operation Plumbbob, forecasts the dose-rate contours rather well.

RECOMMENDATIONS

If the Signal Corps method is to be used for small-yield weapons, it will be necessary for the method to account for the fact that the wafers do not overlap in most cases. Since the way in which non-overlapping was accounted for in Operation Plumbbob is time-consuming, it would be desirable to revise the method so that calculations of area between non-overlapping wafers will not be necessary.

Distribution of particle sizes and radioactivity in the cloud needs to be investigated further, and better estimations of cloud dimensions need to be made.

The results of the project clearly indicate that time and space variability of the wind, rainout, and terrain effects cannot be ignored if a prediction of dose rate is to be made to a desirable degree of accuracy. All avenues to solve these problems should be explored.

Dose Rate, MR/HR, H+1
Map Scale 1:1,100,000

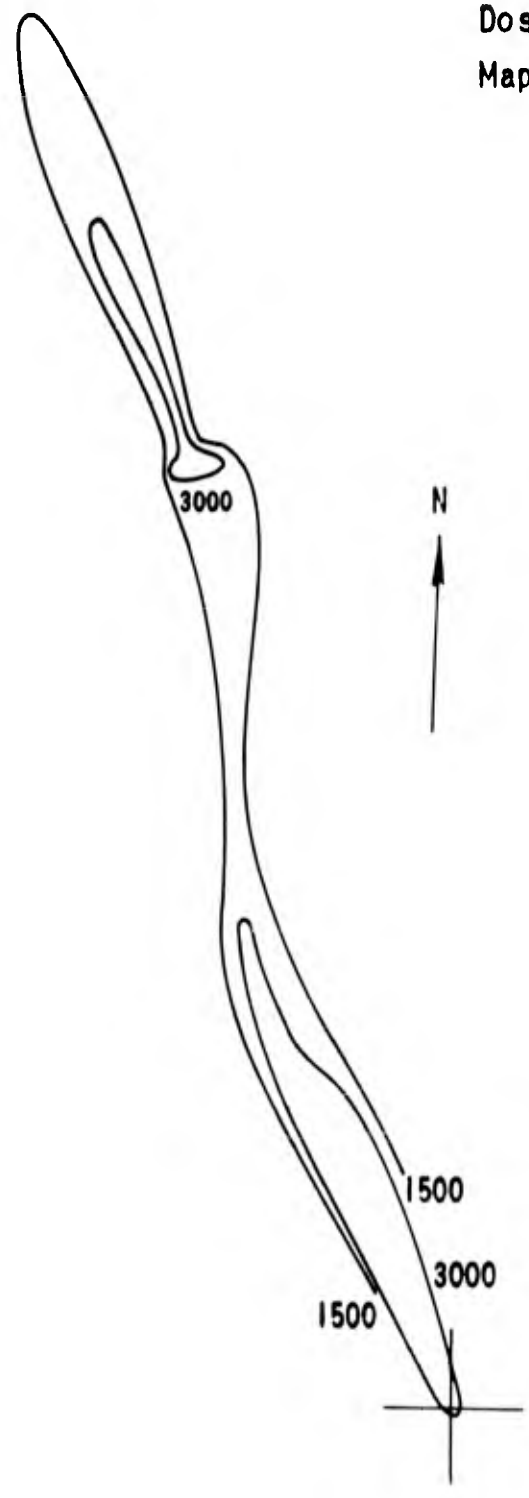

FIGURE 6. OBSERVED CONTOUR PATTERN, SHOT BOLTZMAN

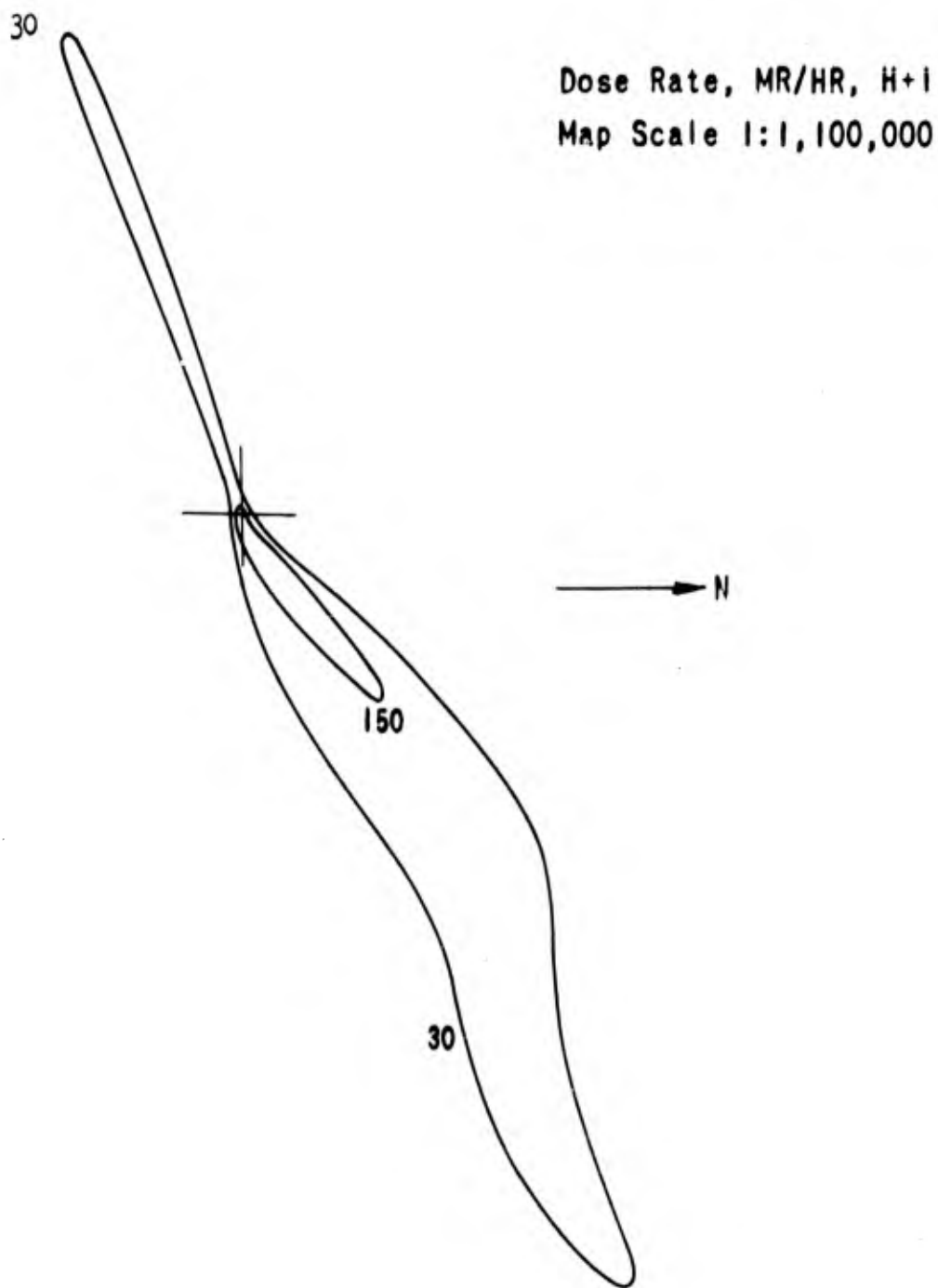

FIGURE 7. OBSERVED CONTOUR PATTERN, SHOT WILSON

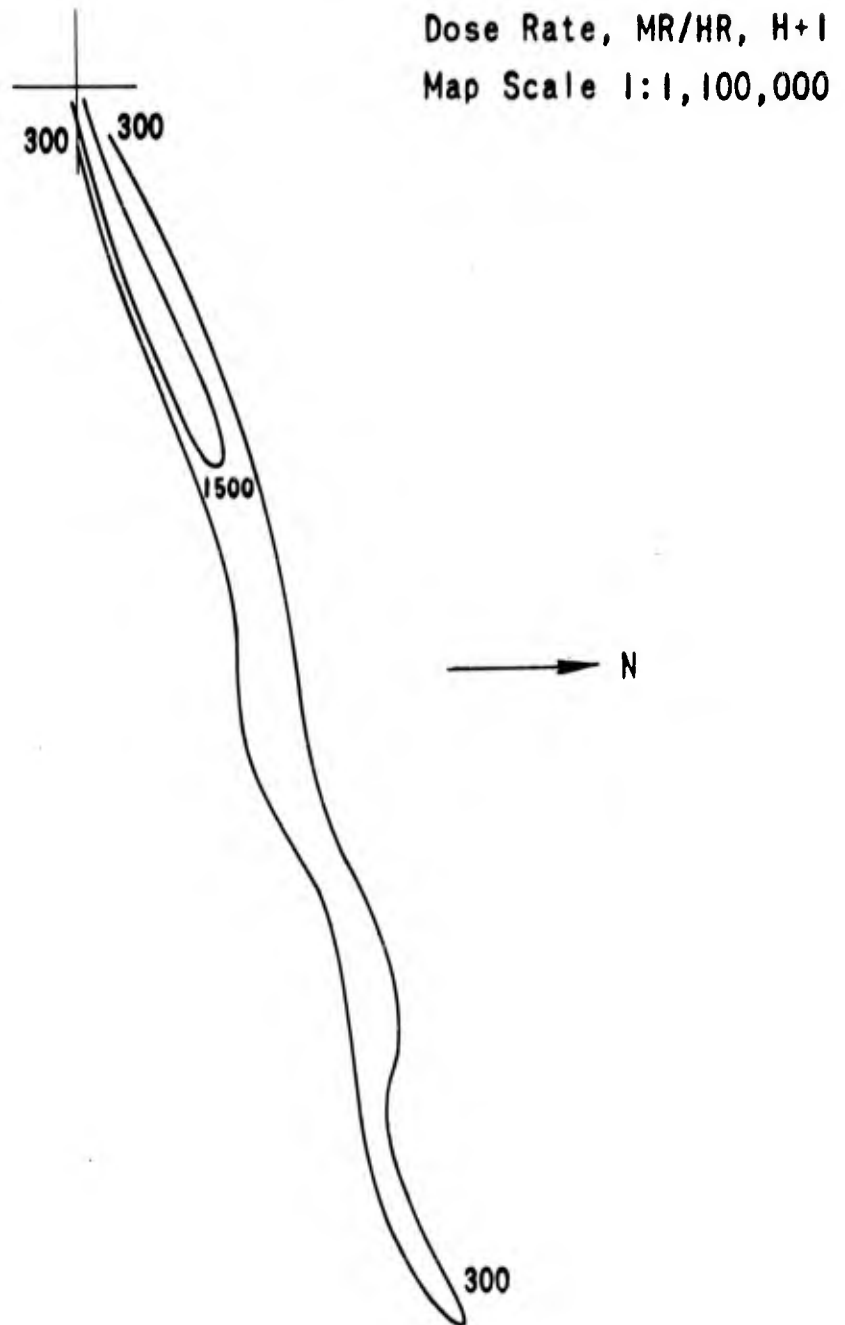
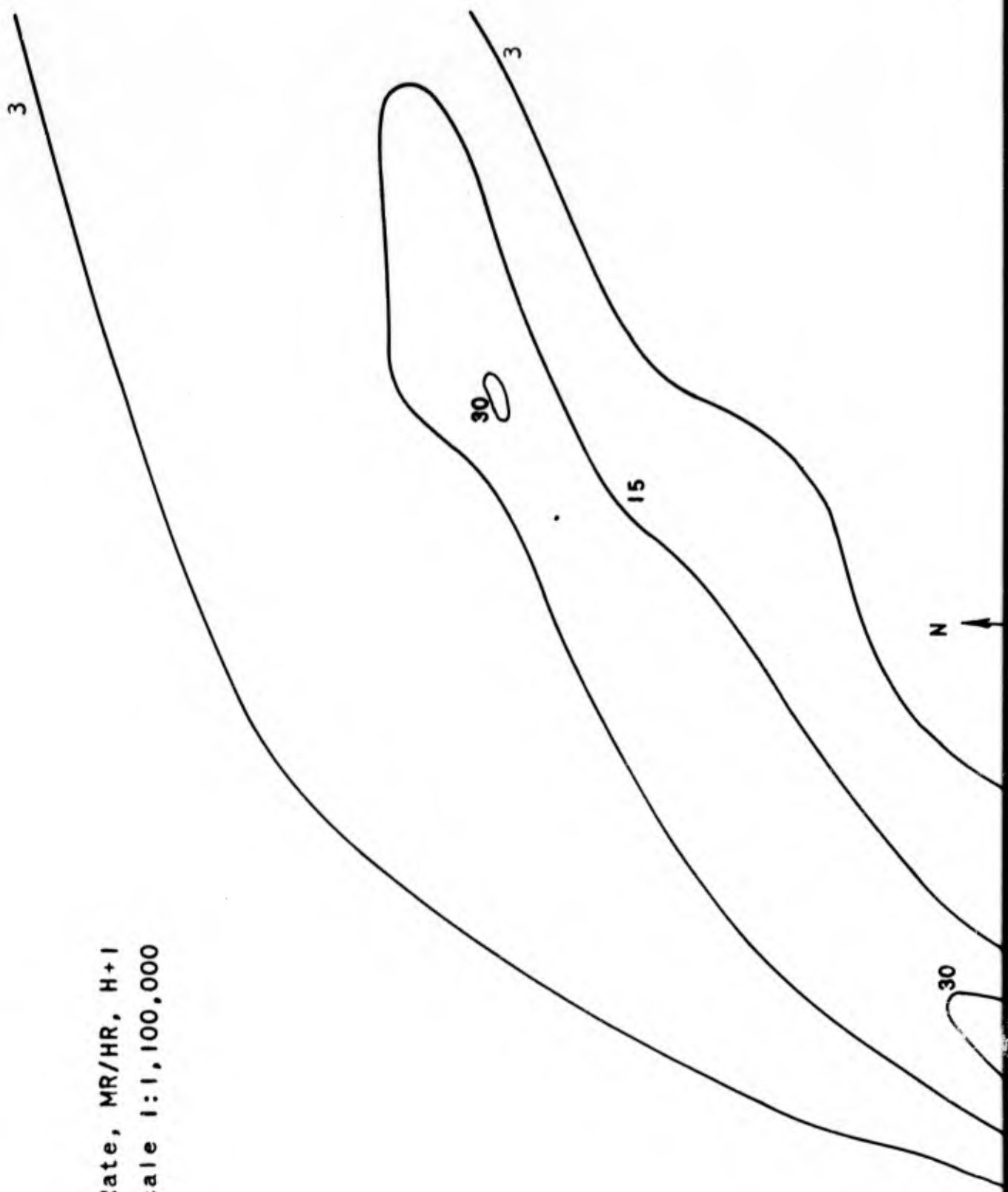

FIGURE 8. OBSERVED CONTOUR PATTERN, SHOT PRISCILLA

Dose Rate, MR/HR, H+1
Map Scale 1:1,100,000



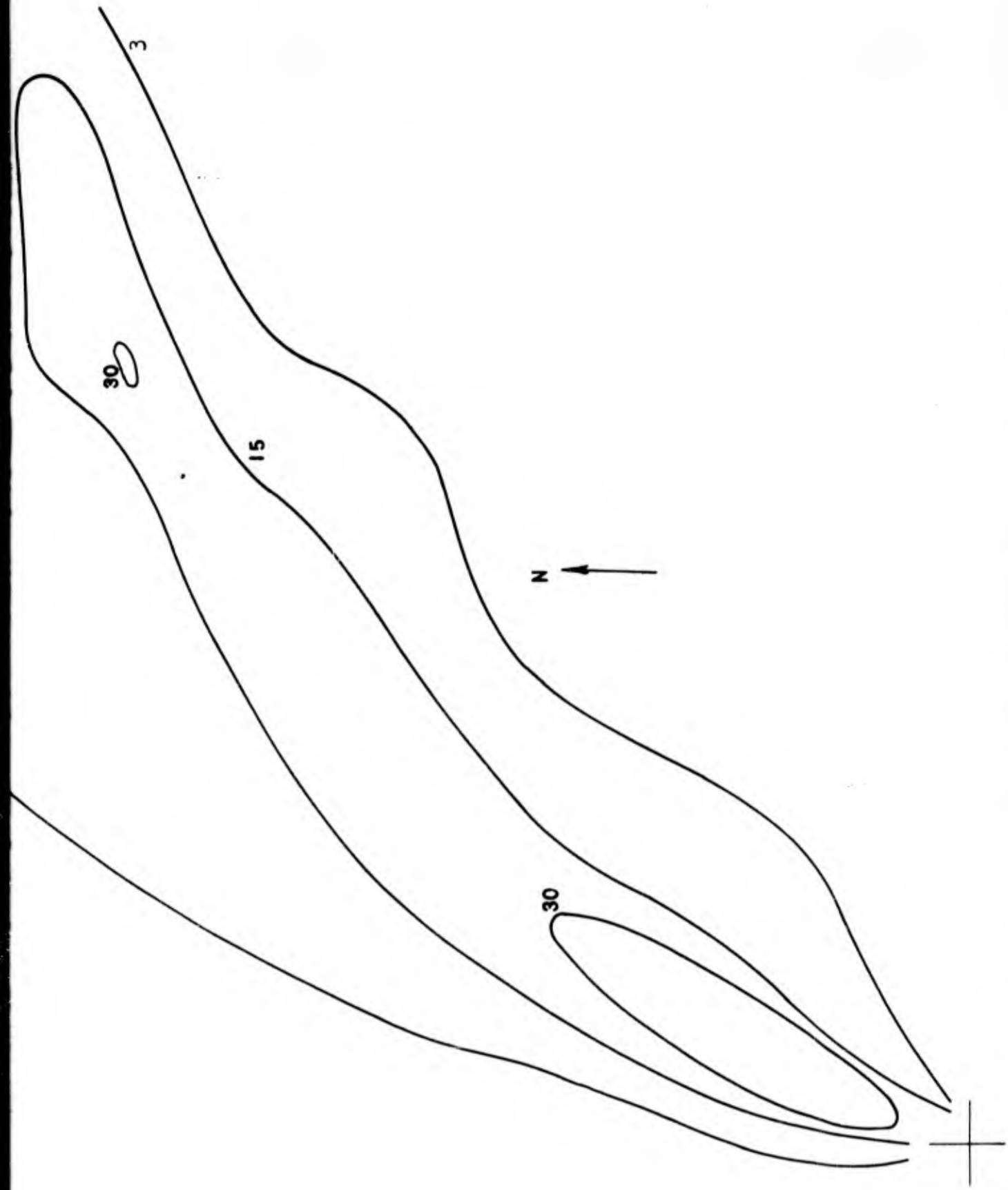

FIGURE 9. OBSERVED CONTOUR PATTERN, SHOT HOOD

17

2

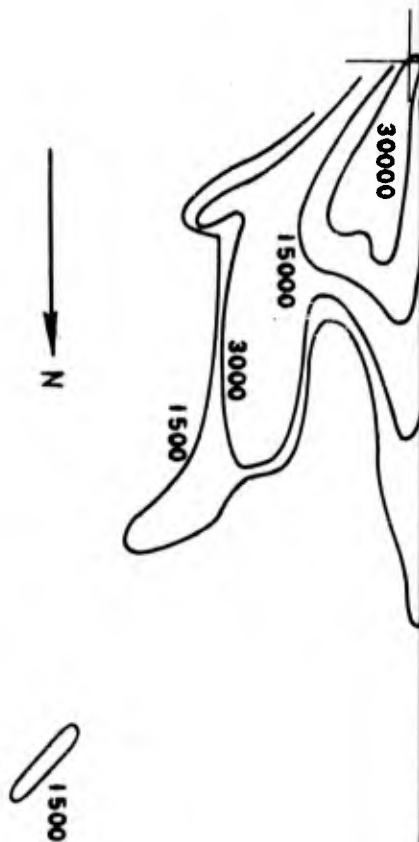

FIGURE 10. OBSERVED CONTOUR PATTERN, SHOT DIABLO



Dose Rate, MR/HR, H+1
Map Scale 1:1,100,000

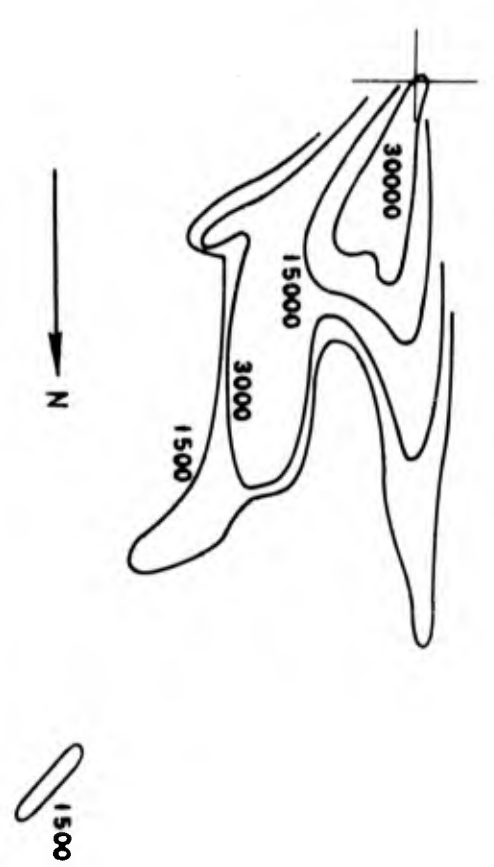

FIGURE 10. OBSERVED CONTOUR PATTERN, SHOT DIABLO

Dose Rate, MR/HR, H+1
Map Scale 1:1,100,000

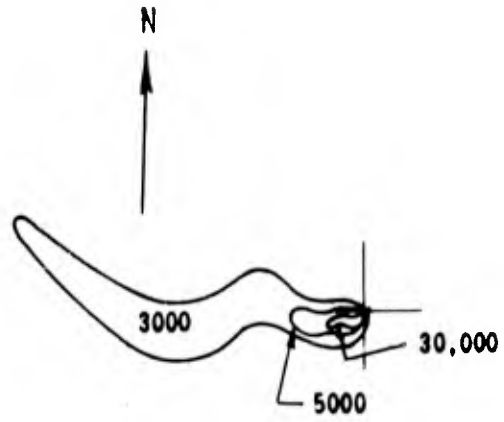

FIGURE 11. OBSERVED CONTOUR PATTERN, SHOT KEPLER

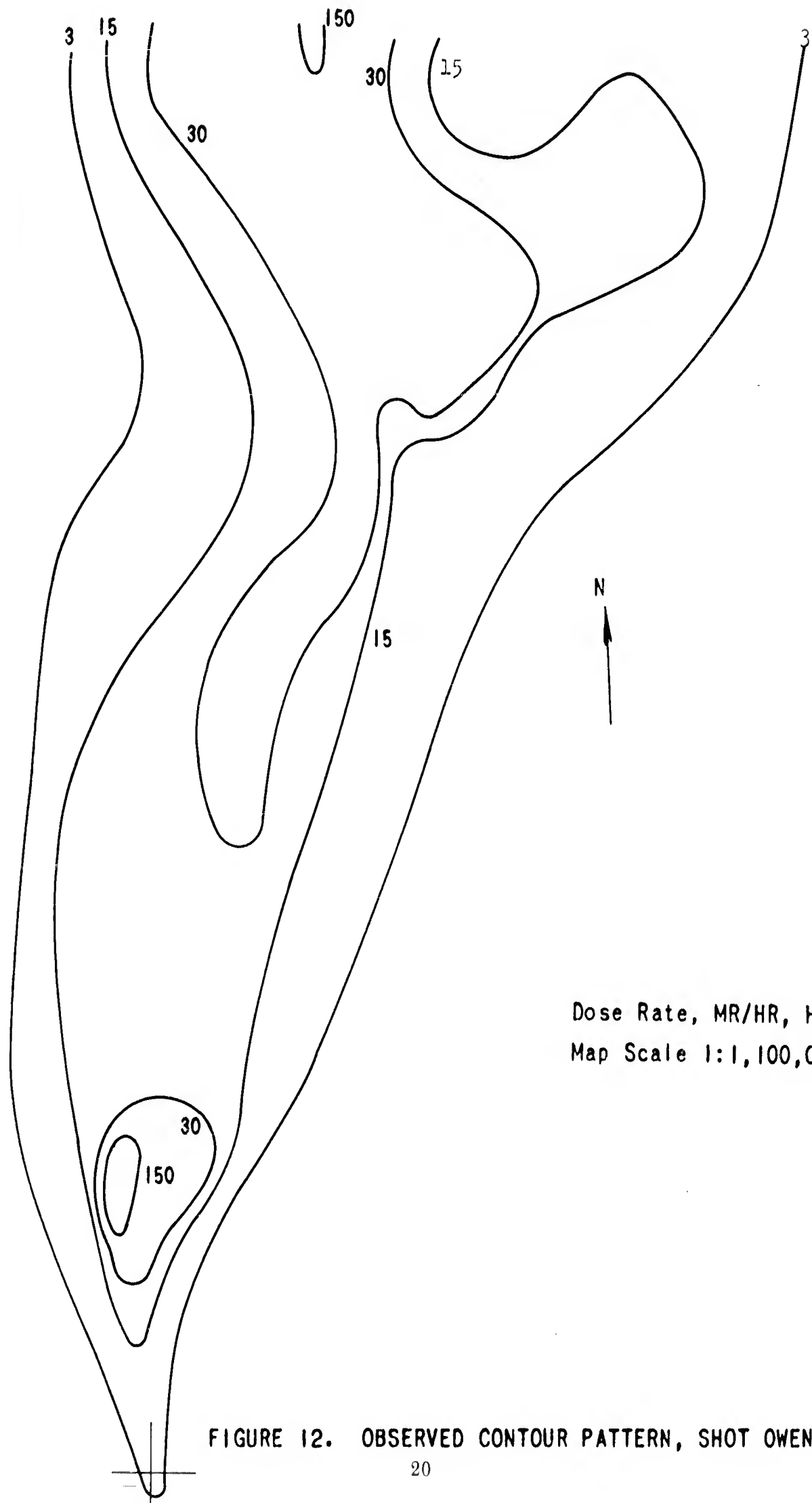

FIGURE 12. OBSERVED CONTOUR PATTERN, SHOT OWENS

Dose Rate, MR/HR, H+1
Map Scale 1:1,100,000

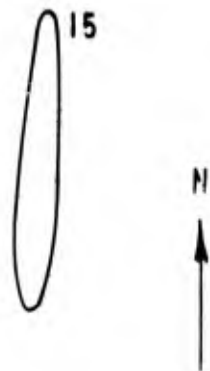

FIGURE 13. OBSERVED CONTOUR PATTERN, SHOT STOKES

Dose Rate, MR/HR, H+1
Map Scale 1:1,100,000

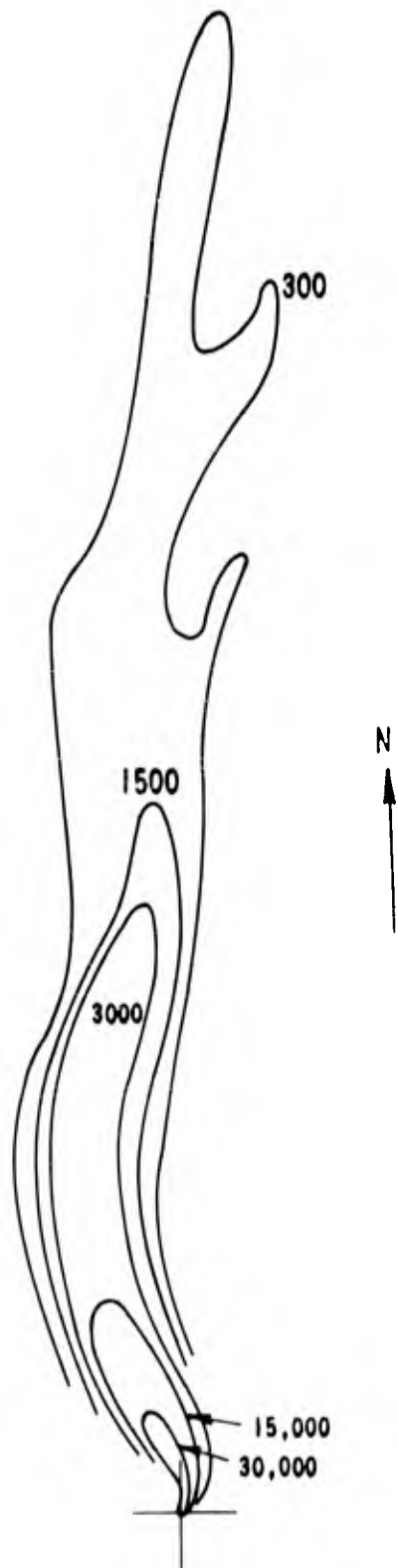

FIGURE 14. OBSERVED CONTOUR PATTERN, SHOT SHASTA

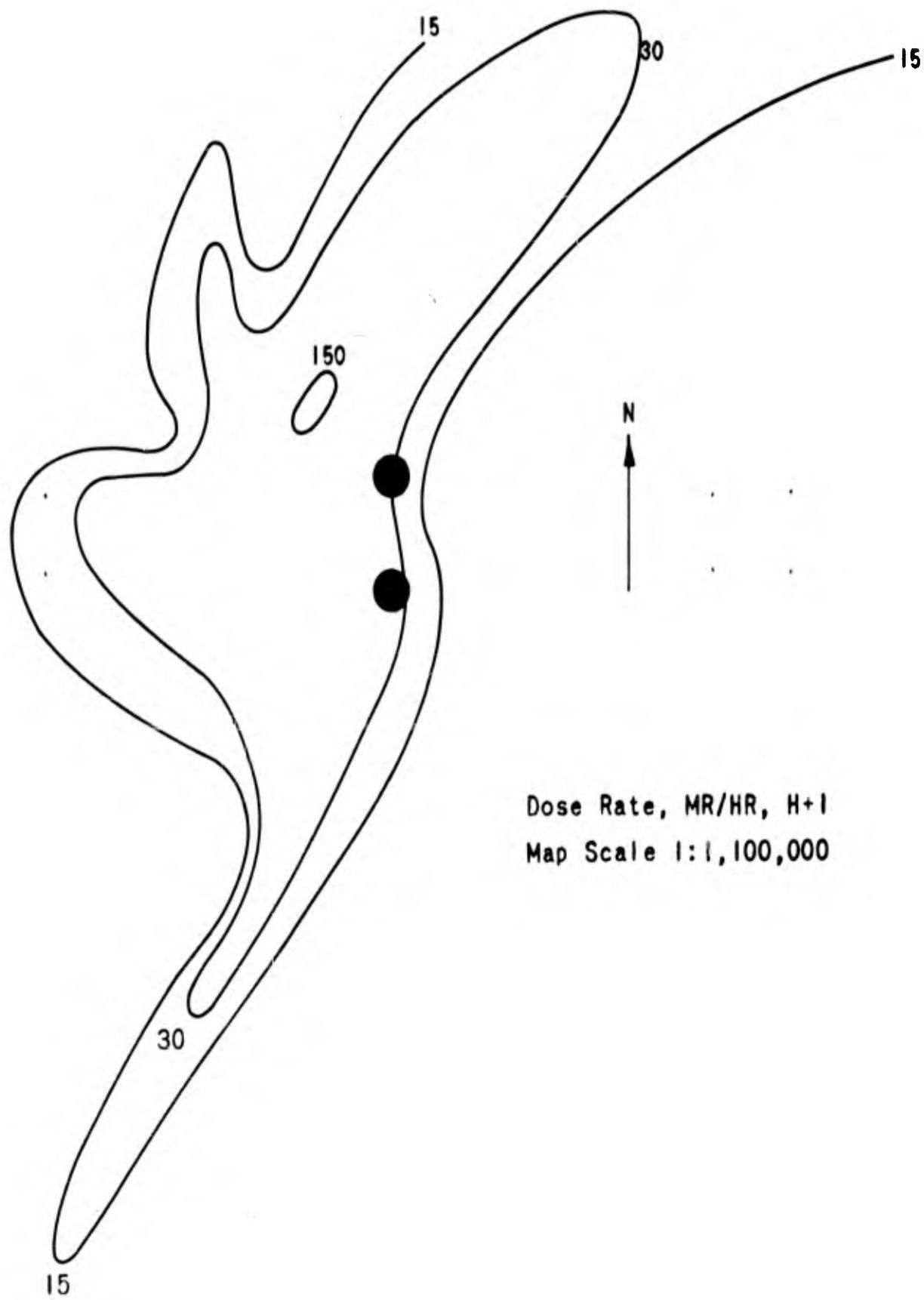

FIGURE 15. OBSERVED CONTOUR PATTERN, SHOT DOPPLER

Dose Rate, MR/HR, H+1
Map Scale 1:1,100,000

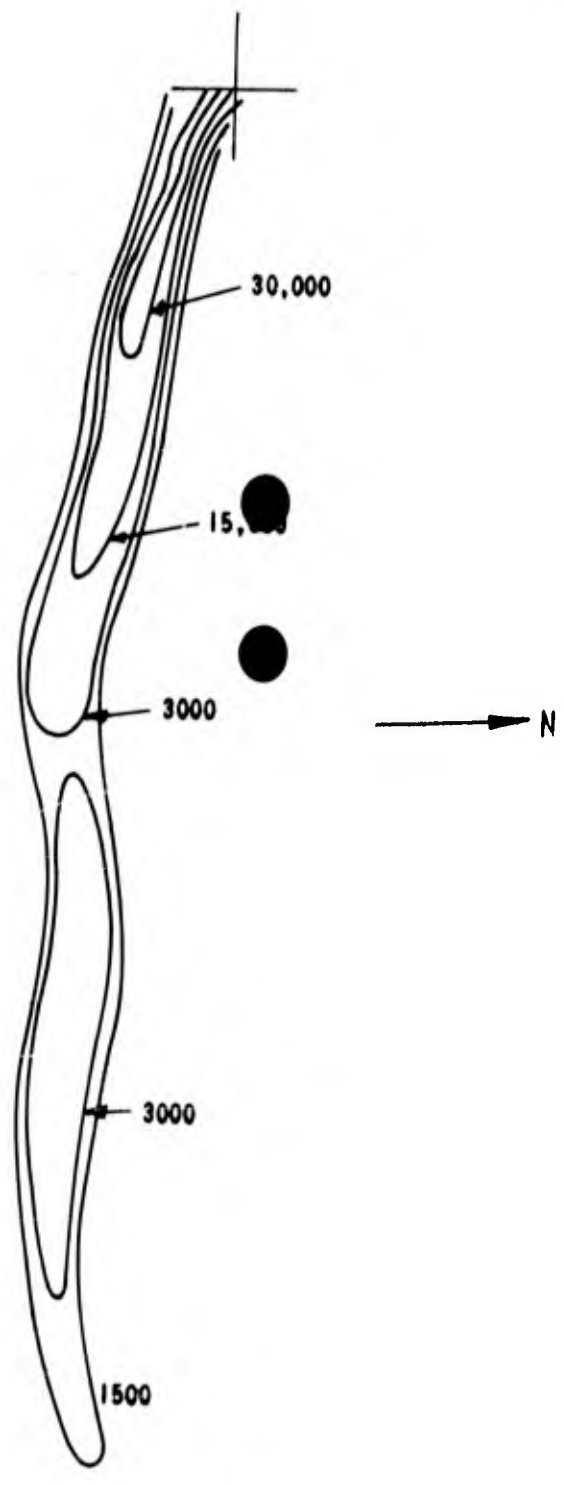

FIGURE 16. OBSERVED CONTOUR PATTERN, SHOT SMOKY

Dose Rate, MR/HR, H+1
Map Scale 1:1,100,000

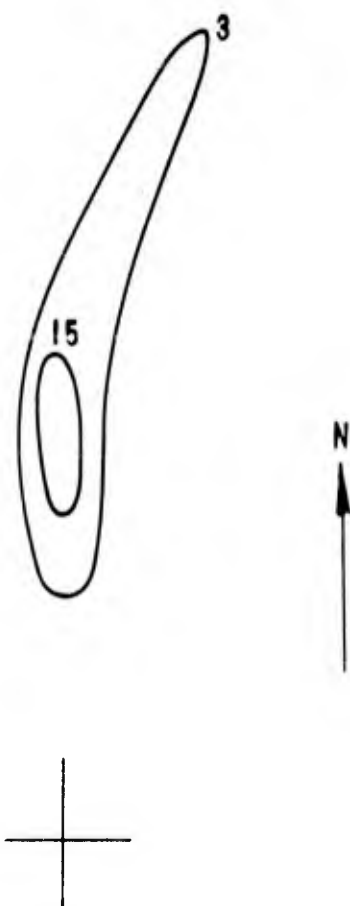

FIGURE 17. OBSERVED CONTOUR PATTERN, SHOT FRANKLIN PRIME

Dose Rate, MR/HR, H+1
Map Scale 1:1,100,000

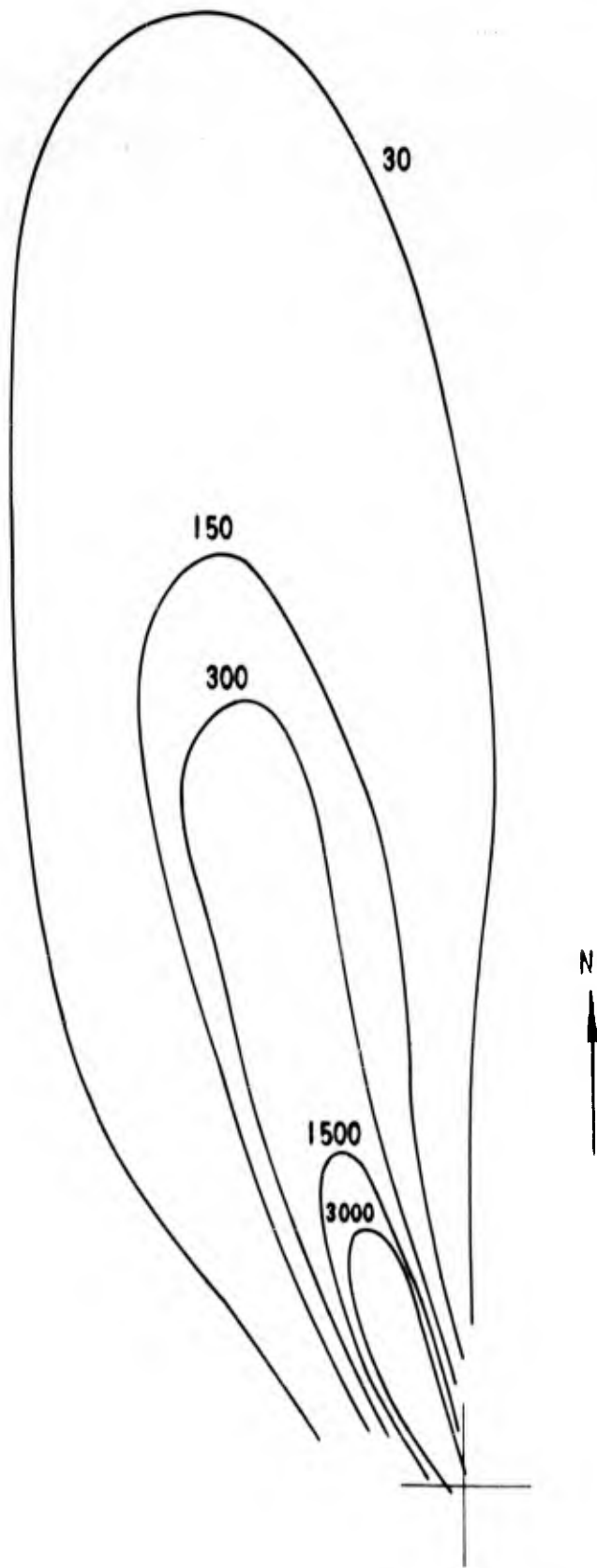
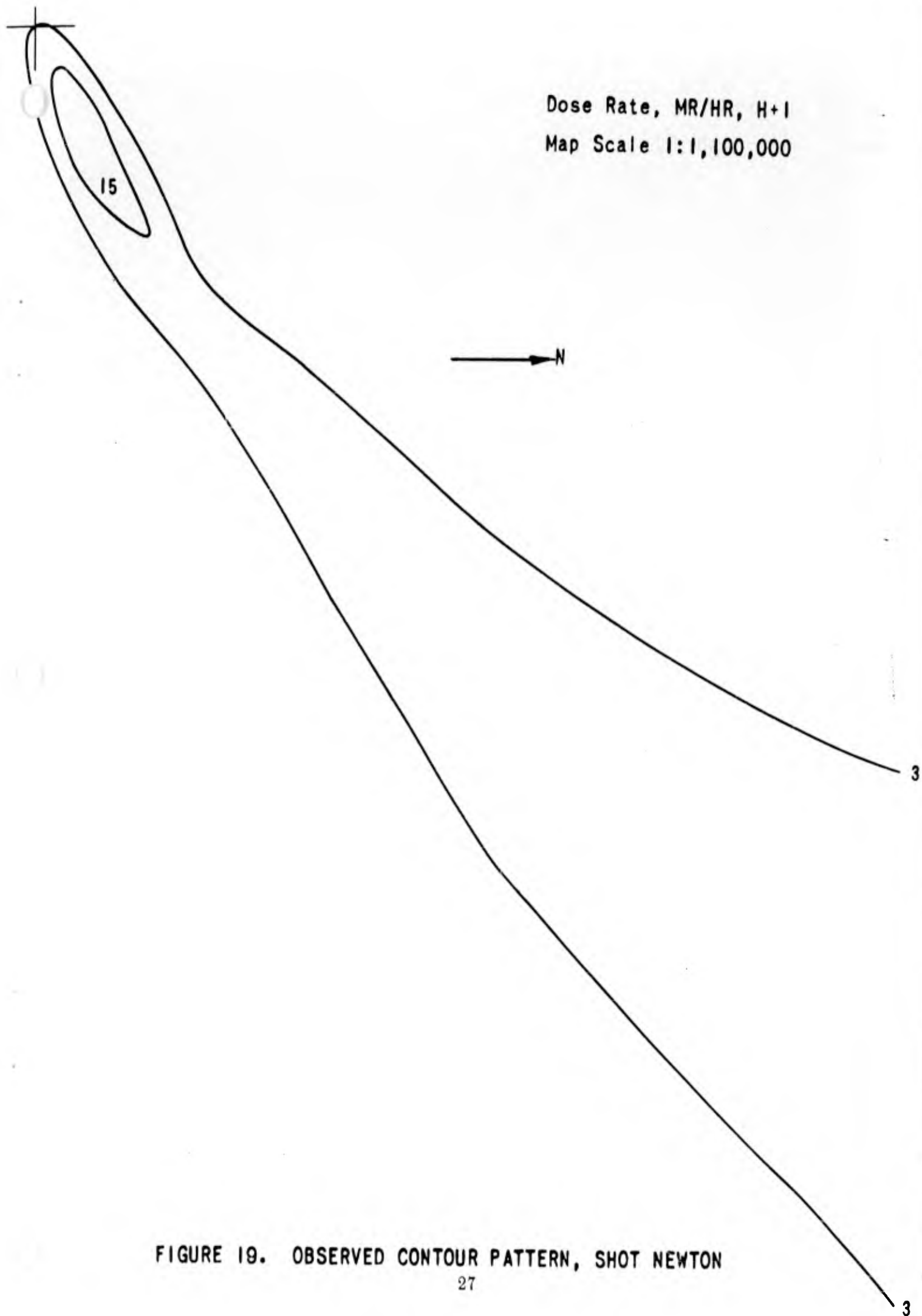

FIGURE 18. OBSERVED CONTOUR PATTERN, SHOT GALILEO



Dose Rate, MR/HR, H+1
Map Scale 1:1,100,000

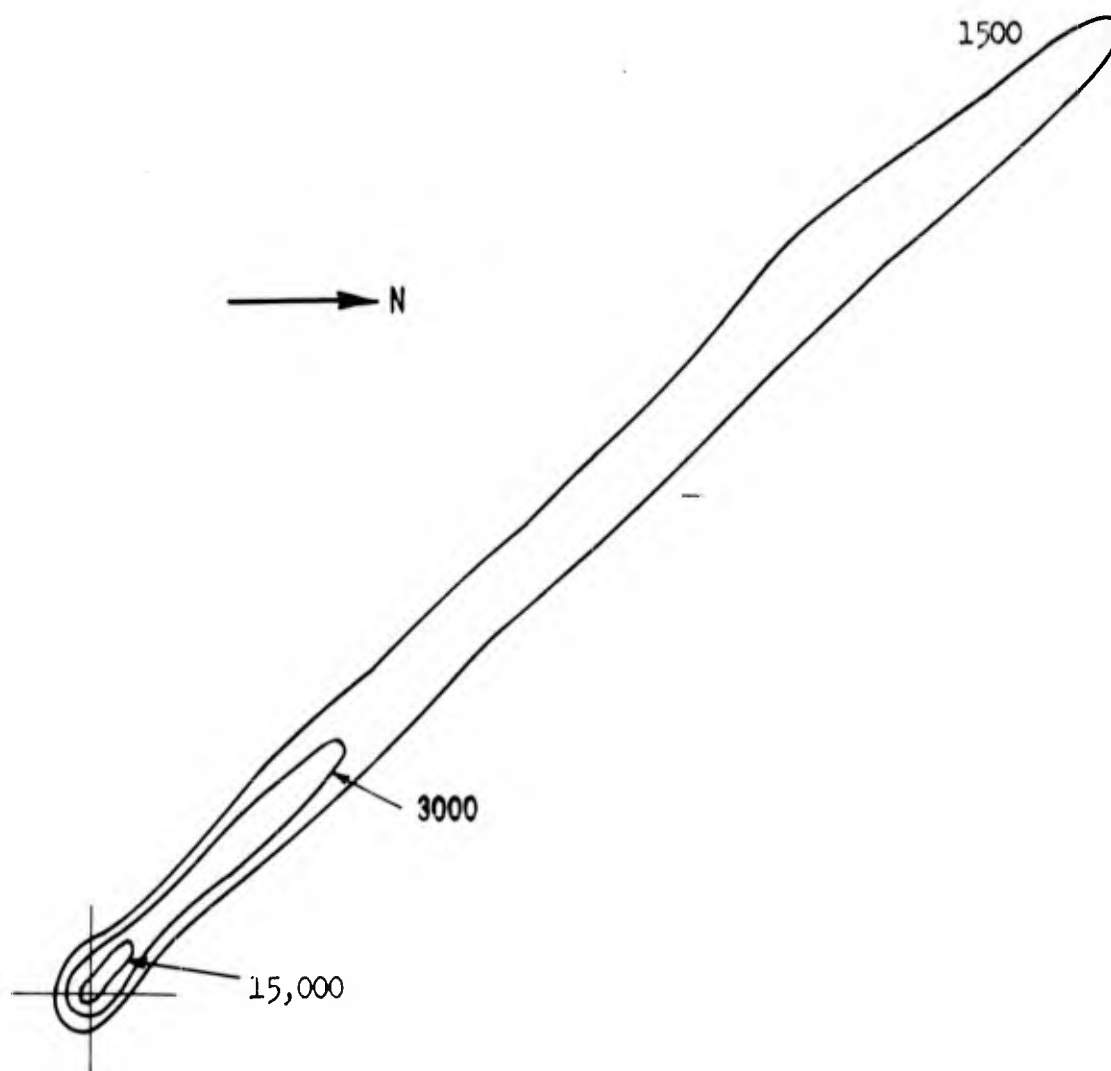

FIGURE 20. FORECAST CONTOUR PATTERN, SHOT BOLTZMAN

Dose Rate, MR/HR, H+1
Map Scale 1:1,100,000

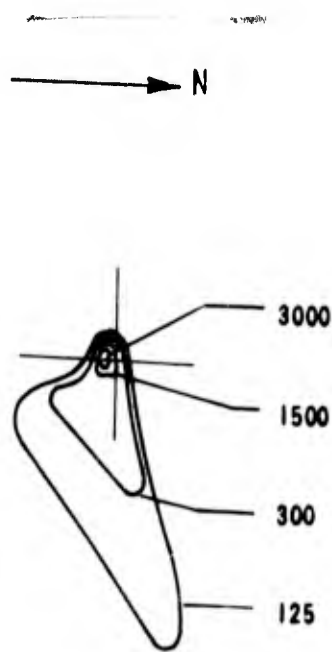

FIGURE 21. FORECAST CONTOUR PATTERN, SHOT WILSON

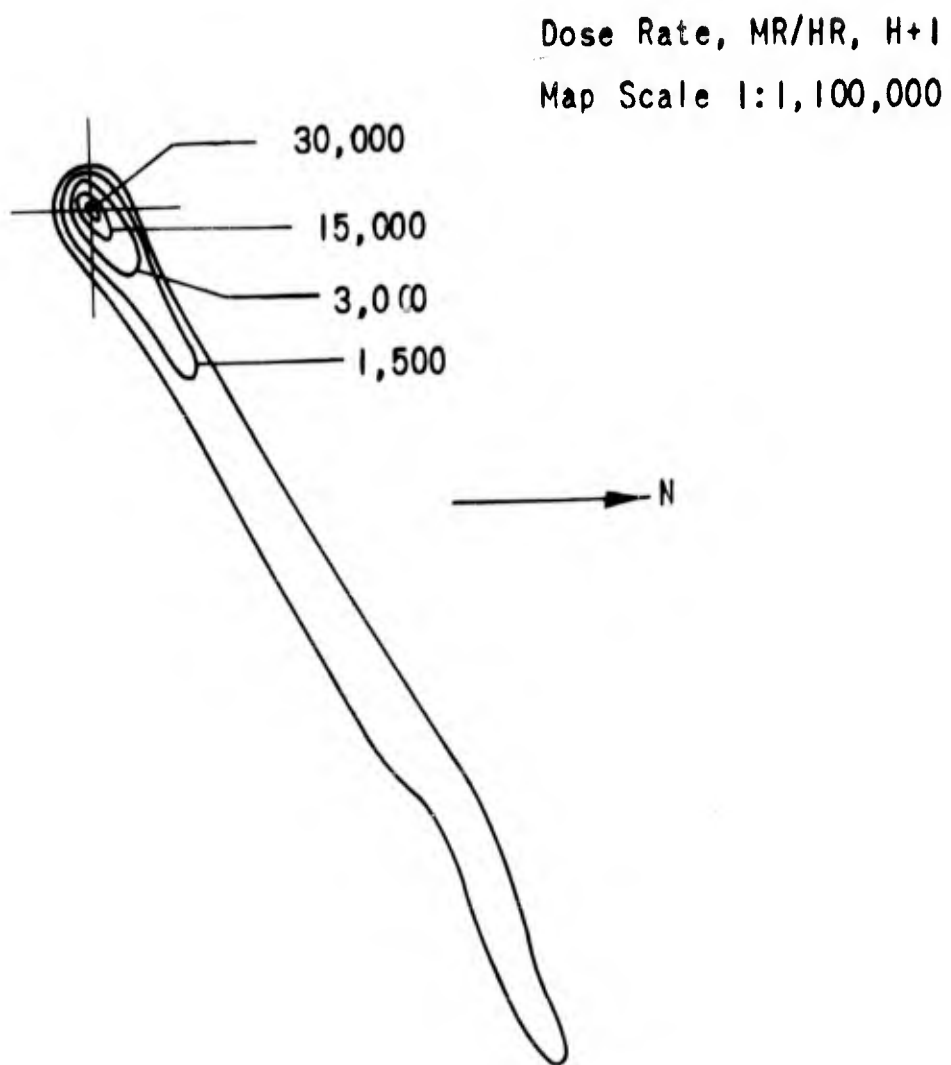

FIGURE 22. FORECAST CONTOUR PATTERN, SHOT PRISCILLA

Dose Rate, MR/HR, H+1

Map Scale 1:1,100,000

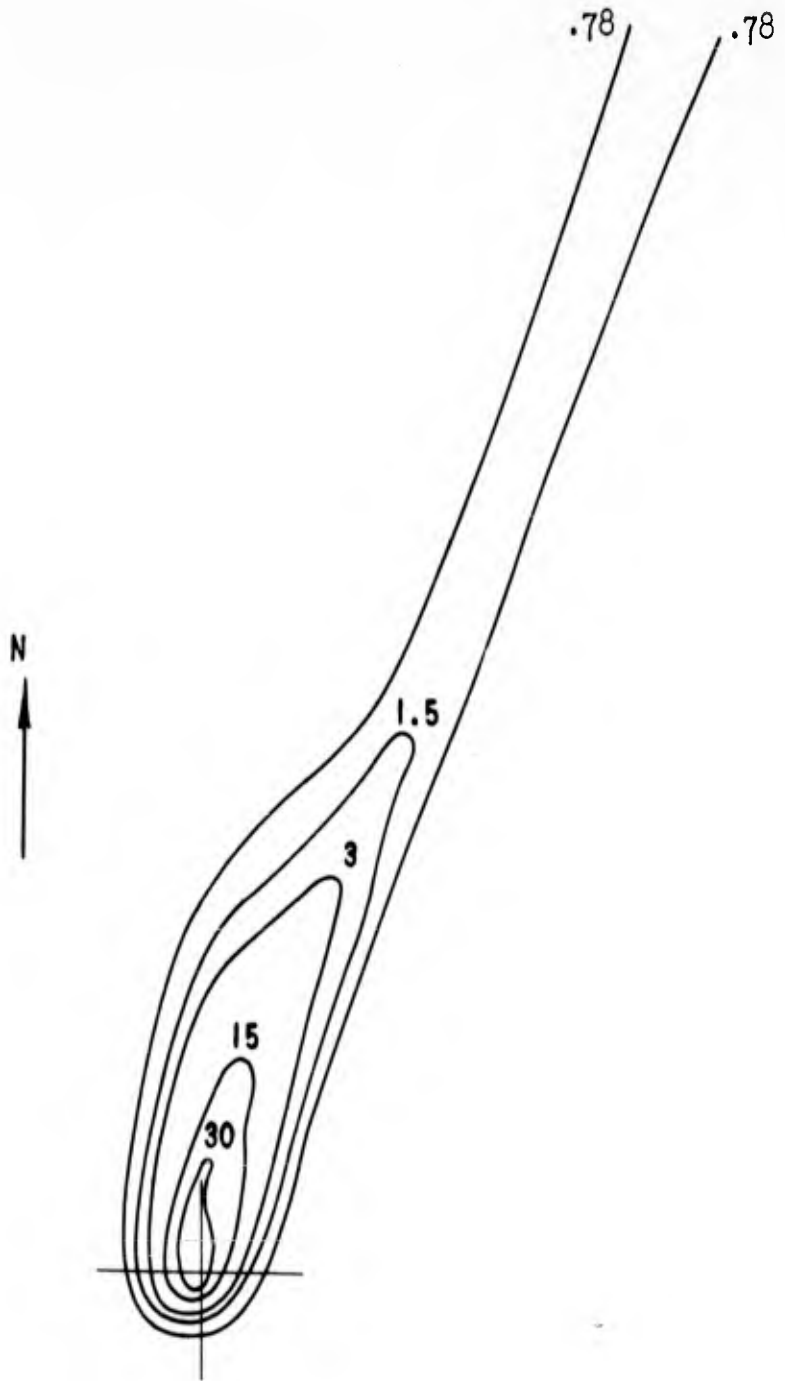

FIGURE 23. FORECAST CONTOUR PATTERN, SHOT HOOD

Dose Rate, MR/HR, H+1
Map Scale 1:1,100,000

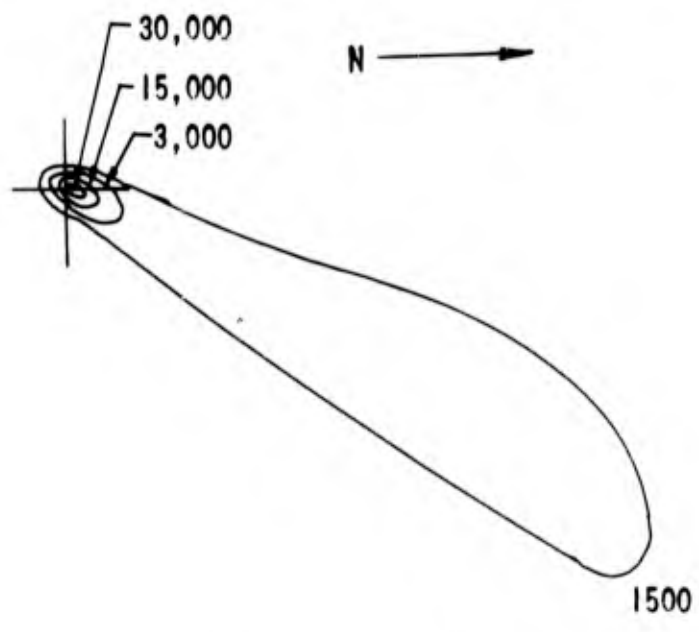

FIGURE 24. FORECAST CONTOUR PATTERN, SHOT DIABLO

Dose Rate, MR/HR, H+1
Map Scale 1:1,100,000

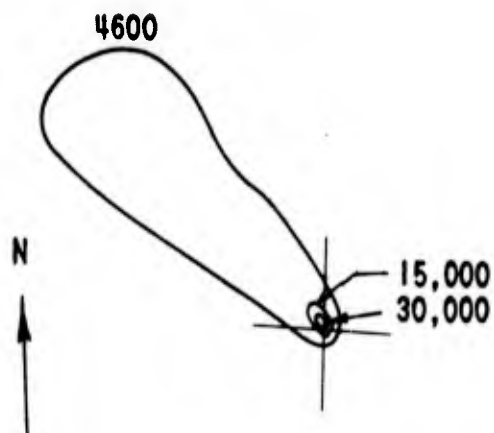

FIGURE 25. FORECAST CONTOUR PATTERN, SHOT KEPLER

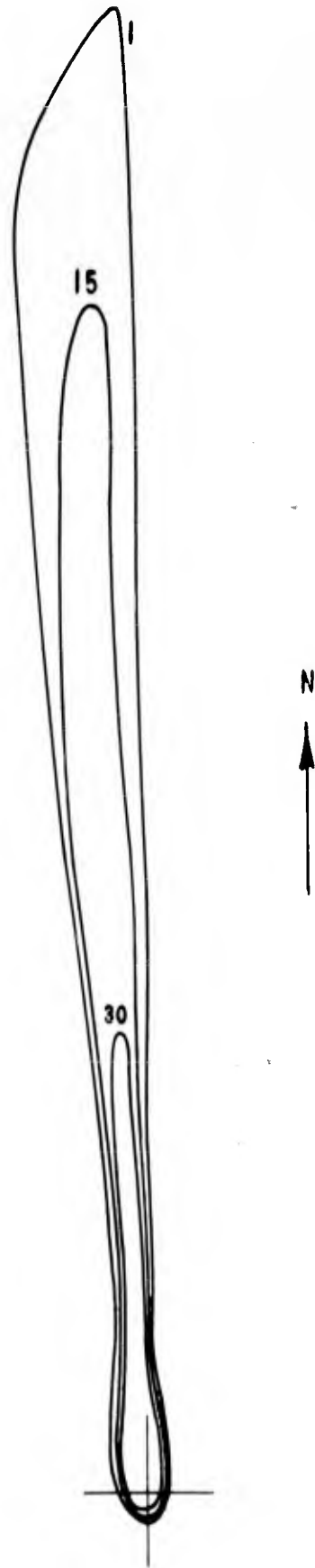
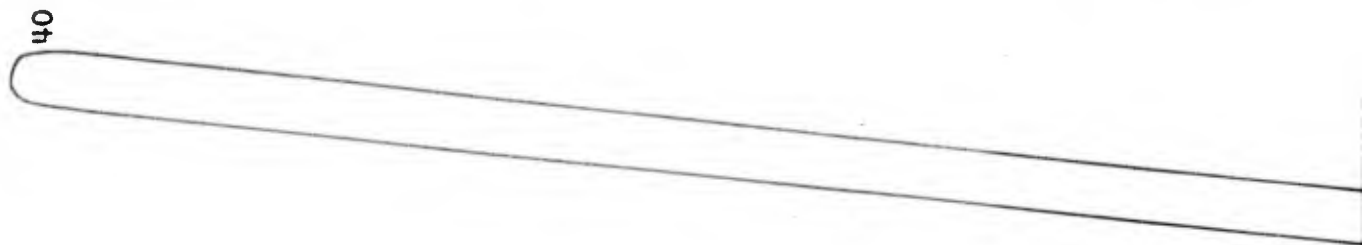

FIGURE 26. FORECAST CONTOUR PATTERN, SHOT OWENS

Dose Rate, MR/HR, H+I
Map Scale 1:1,100,000



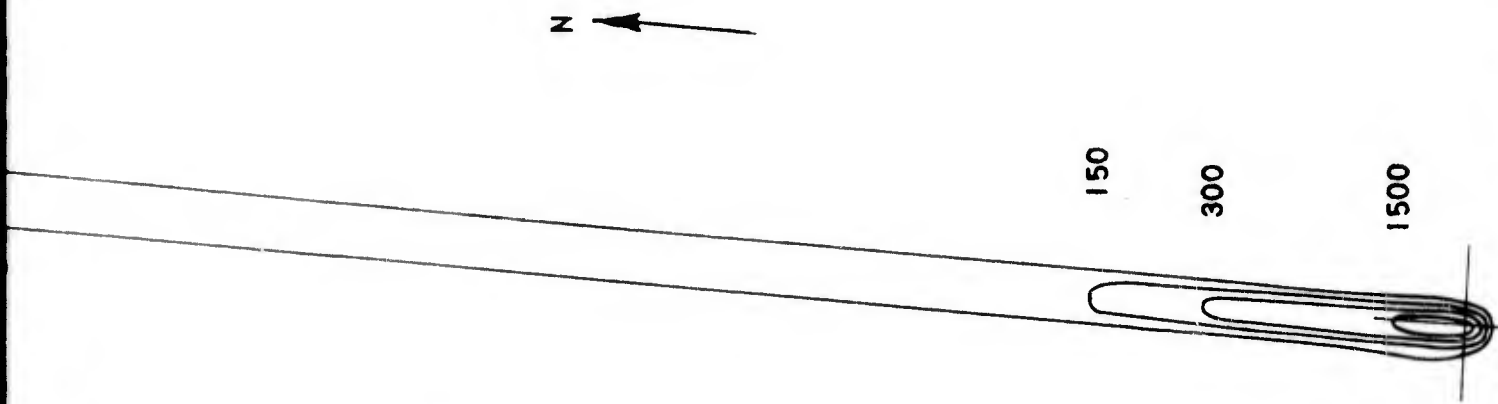

FIGURE 27. FORECAST CONTOUR PATTERN, SHOT STOKES

85

2

1

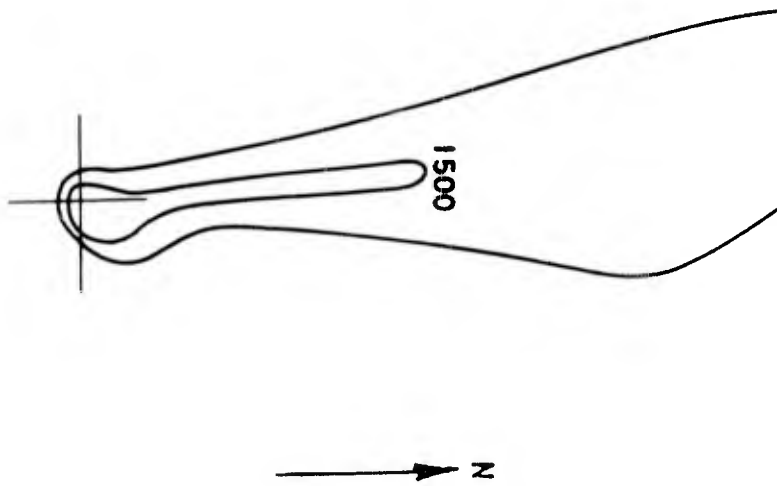
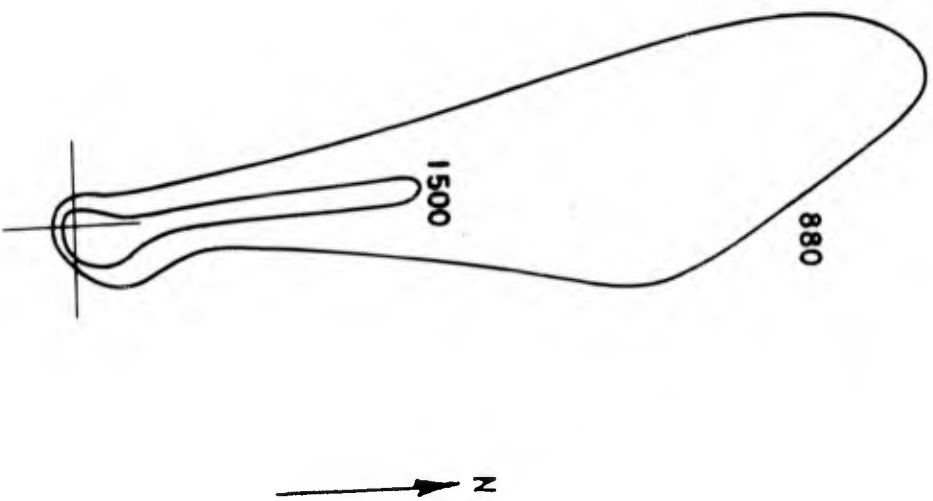

FIGURE 28. FORECAST CONTOUR PATTERN, SHOT SHASTA

Dose Rate, MR/HR, H+1
Map Scale 1:1,100,000



Dose Rate, MR/HR, H+1
Map Scale 1:1,100,000

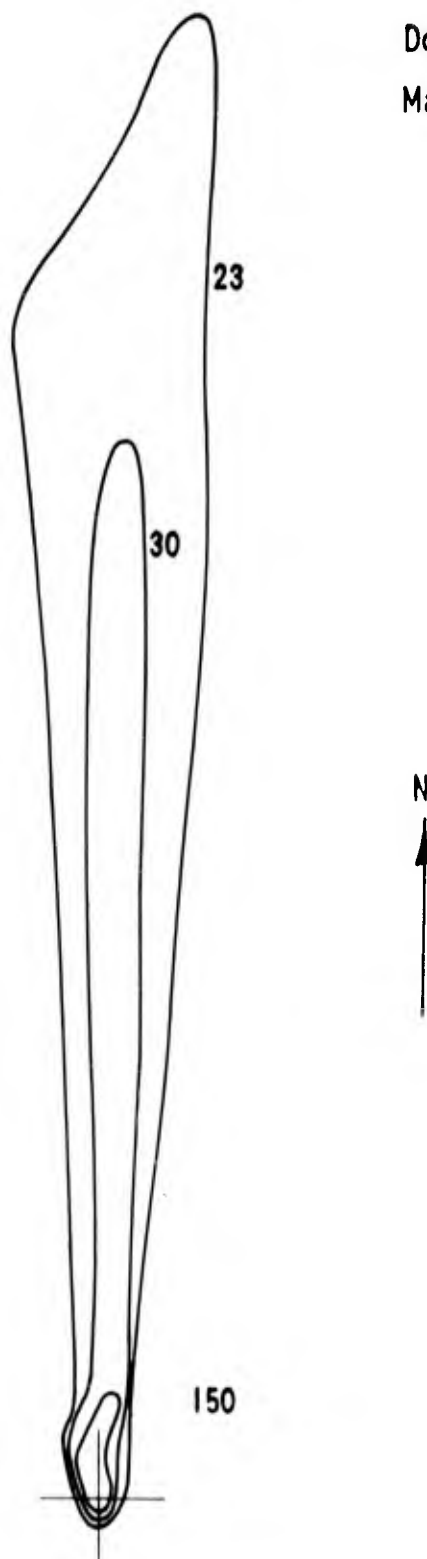

FIGURE 29. FORECAST CONTOUR PATTERN, SHOT DOPPLER

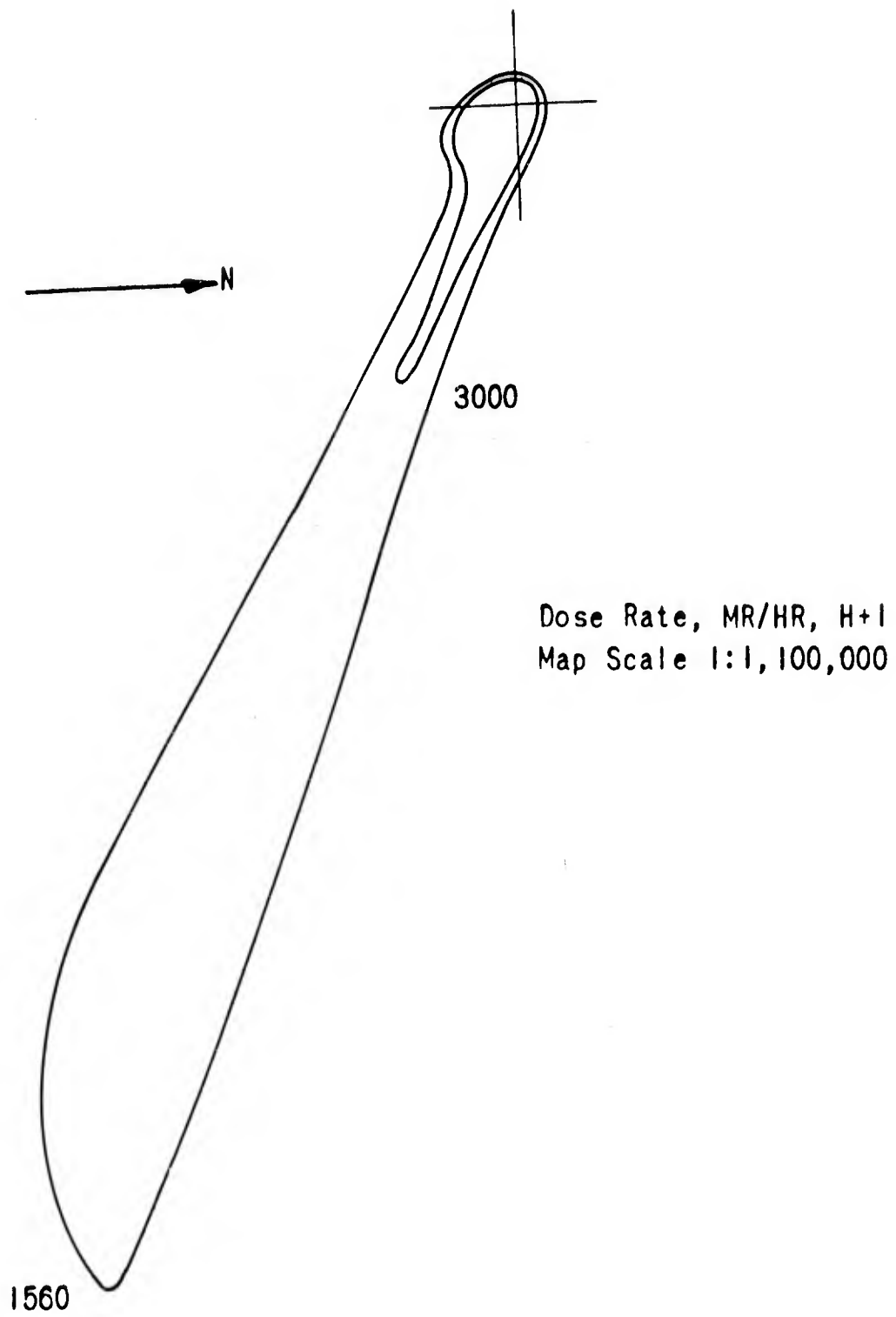

FIGURE 30. FORECAST CONTOUR PATTERN, SHOT SMOKY

Dose Rate, MR/HR, H+1
Map Scale 1:1,100,000

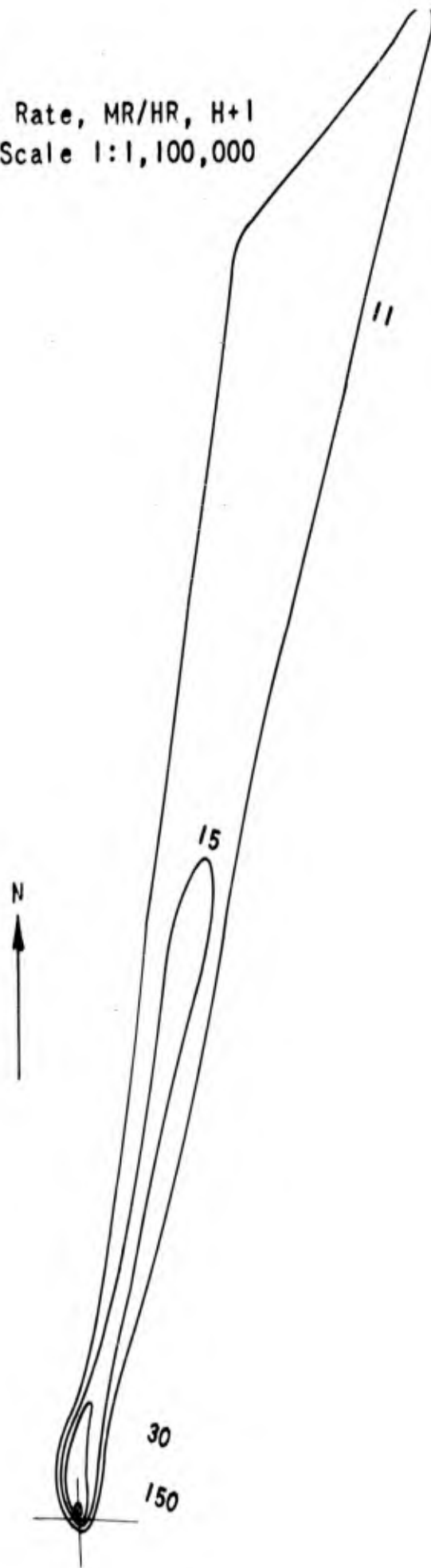

FIGURE 31. FORECAST CONTOUR PATTERN, SHOT FRANKLIN PRIME

Dose Rate, MR/HR, H+1
Map Scale 1:1,100,000

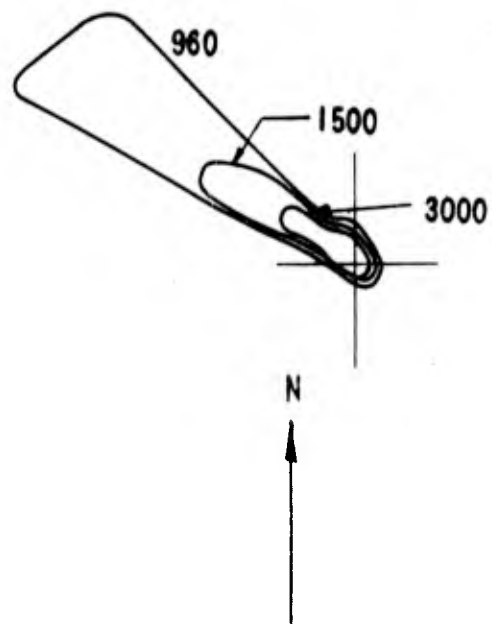

FIGURE 32. FORECAST CONTOUR PATTERN, SHOT GALILEO

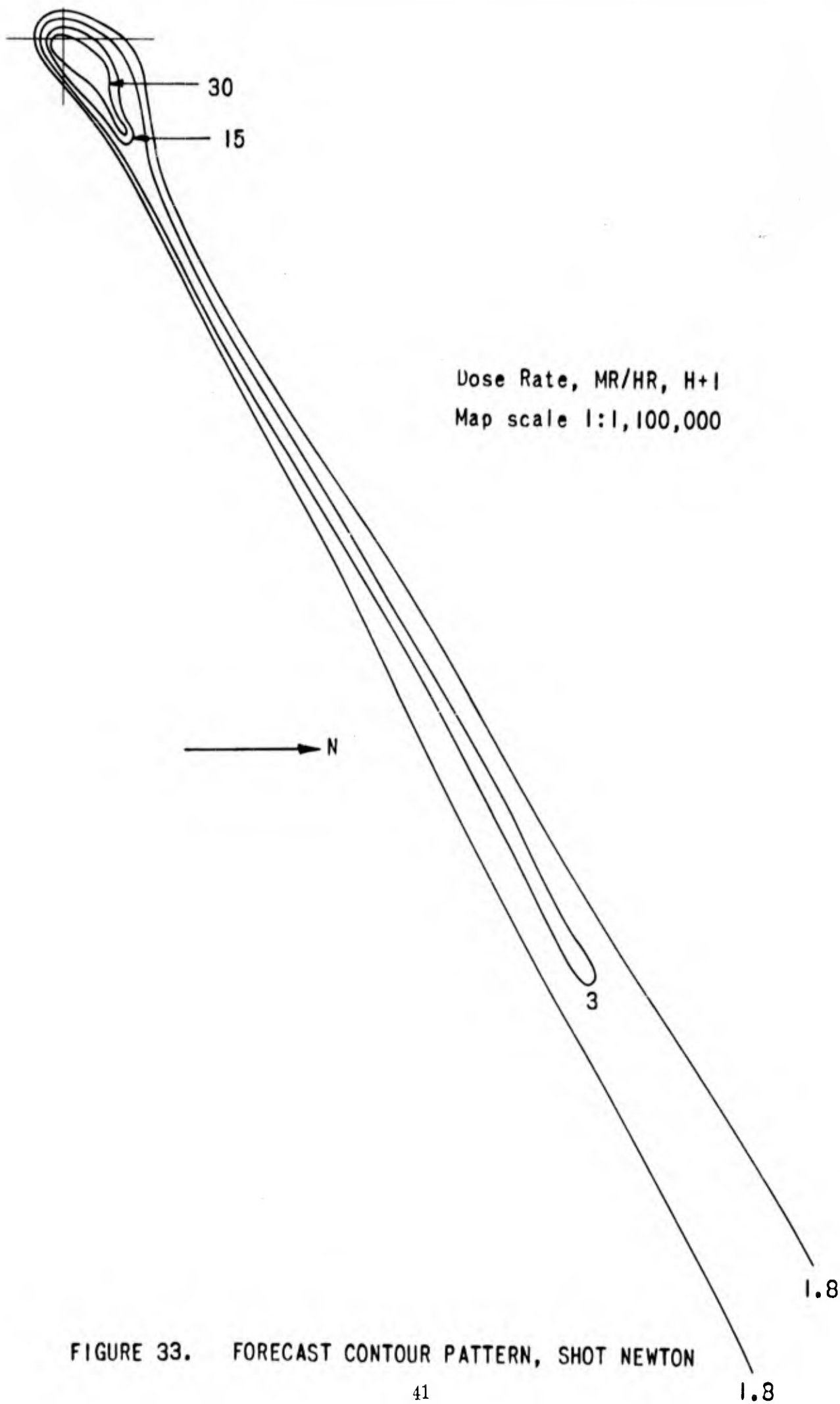

FIGURE 33. FORECAST CONTOUR PATTERN, SHOT NEWTON

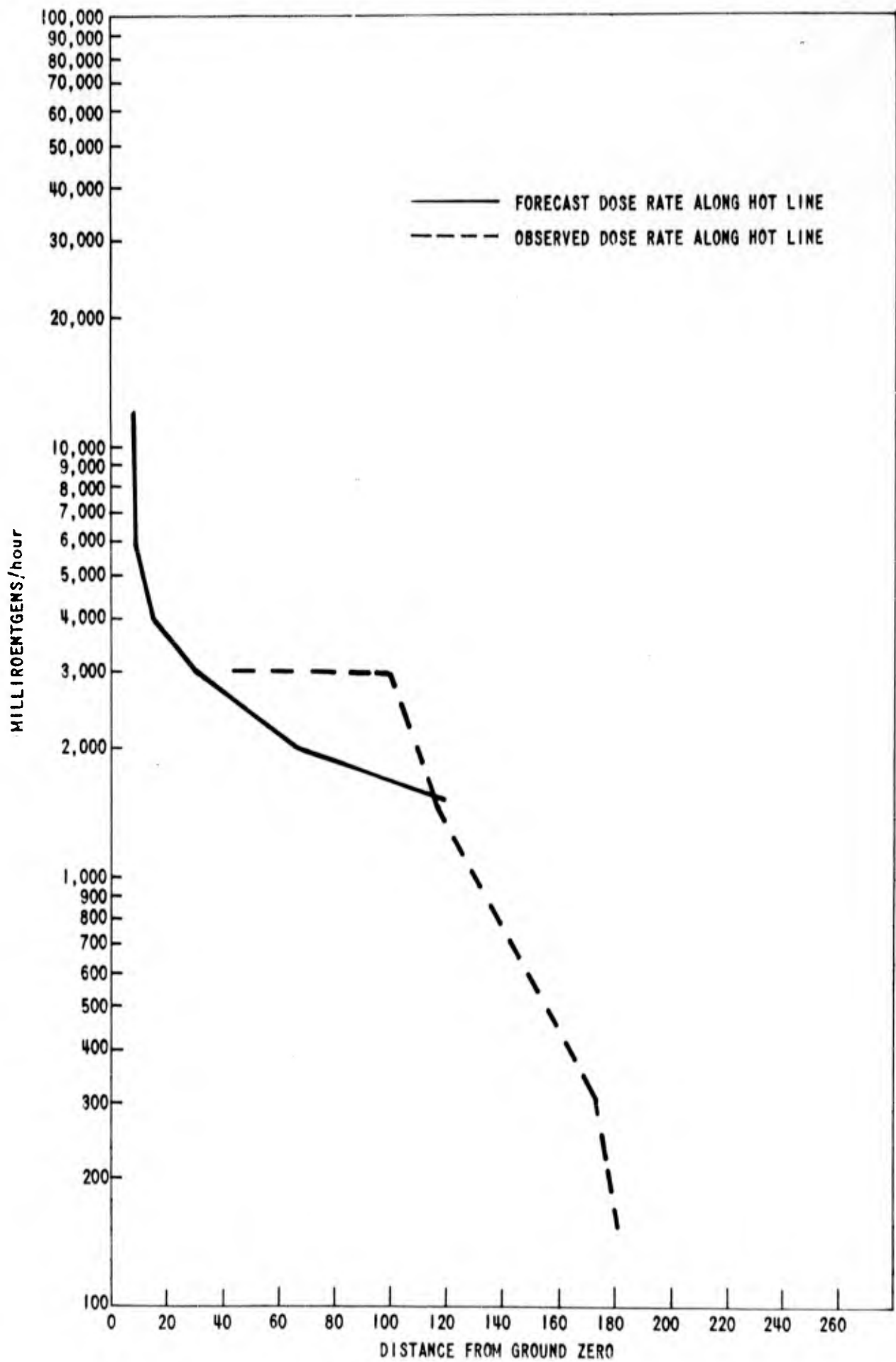

FIG. 34. DOSE RATE INTENSITY ALONG THE HOT LINE, SHOT BOLTZMAN

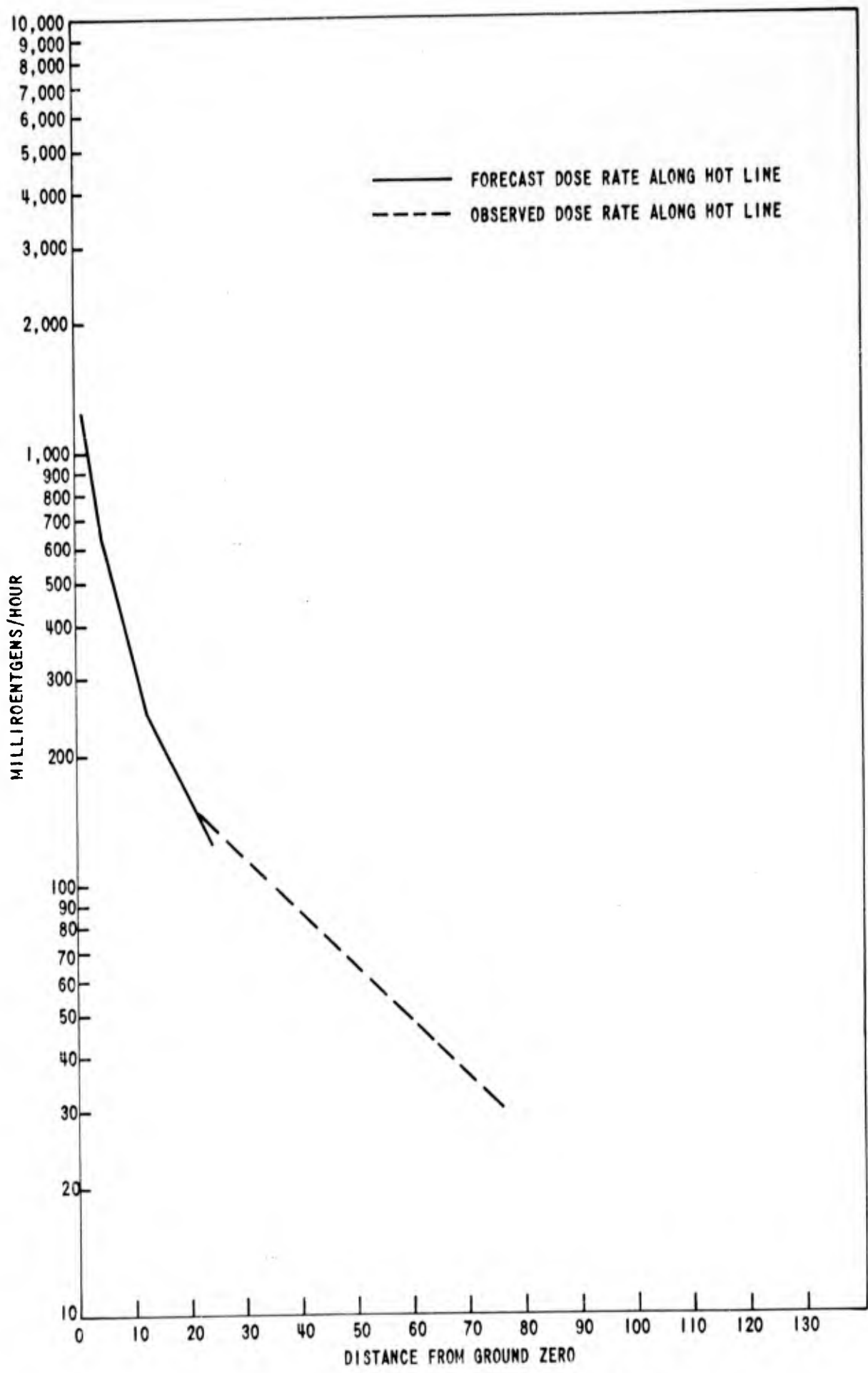

FIG. 35. DOSE RATE INTENSITY ALONG THE HOT LINE, SHOT WILSON

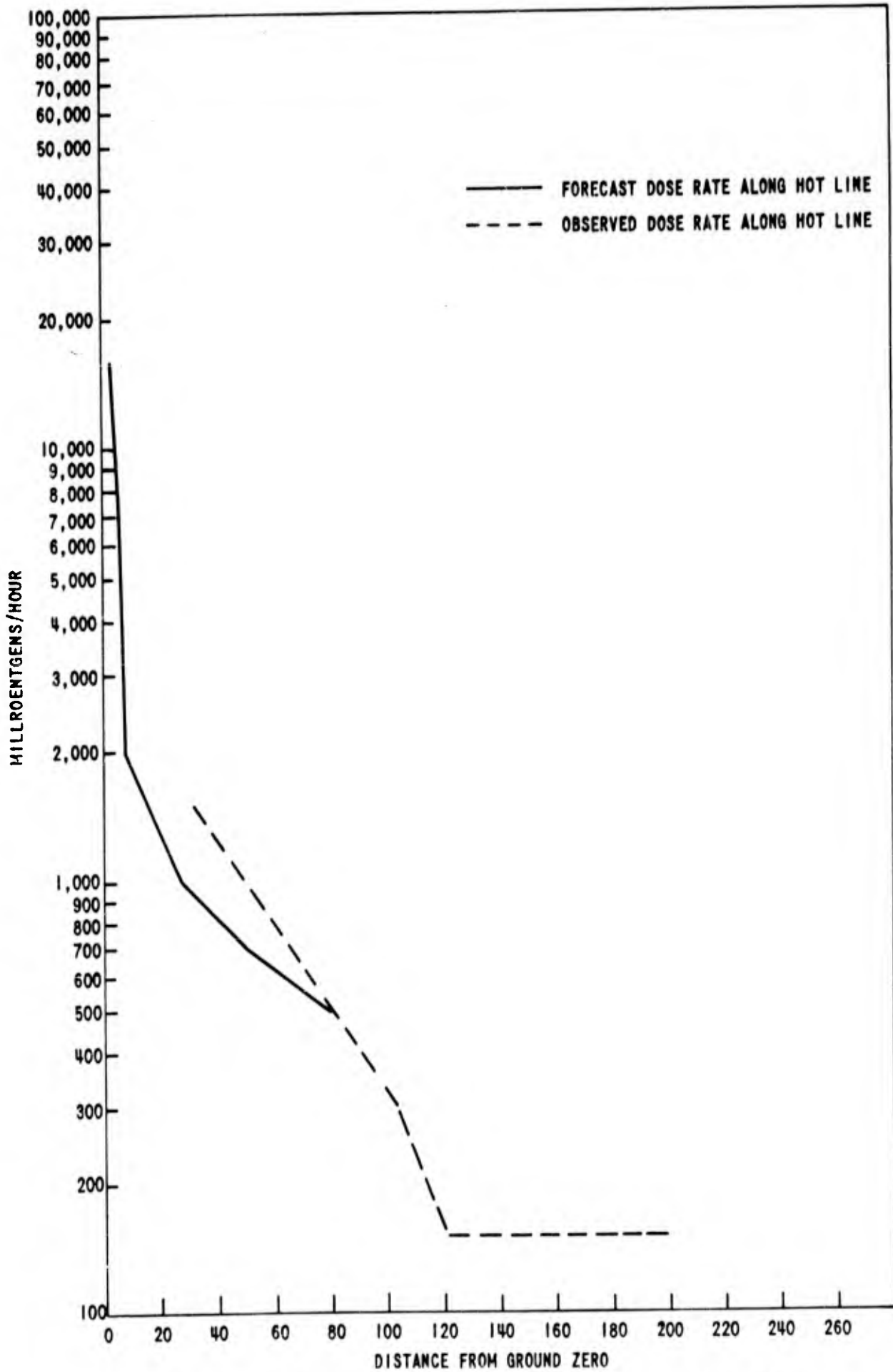

FIG. 36. DOSE RATE INTENSITY ALONG THE HOT LINE, SHOT PRISCILLA

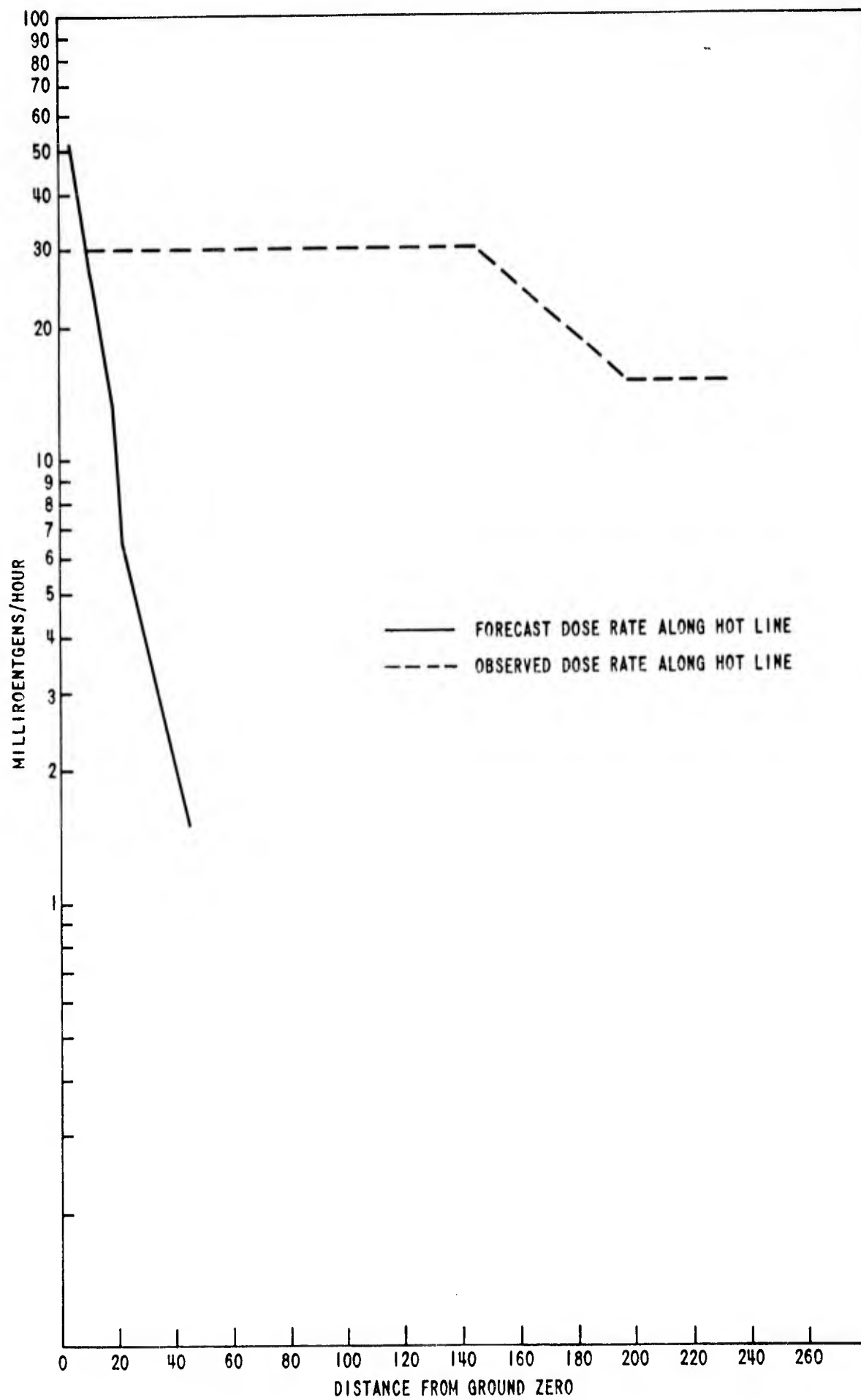

FIG. 37. DOSE RATE INTENSITY ALONG THE HOT LINE, SHOT HOOD

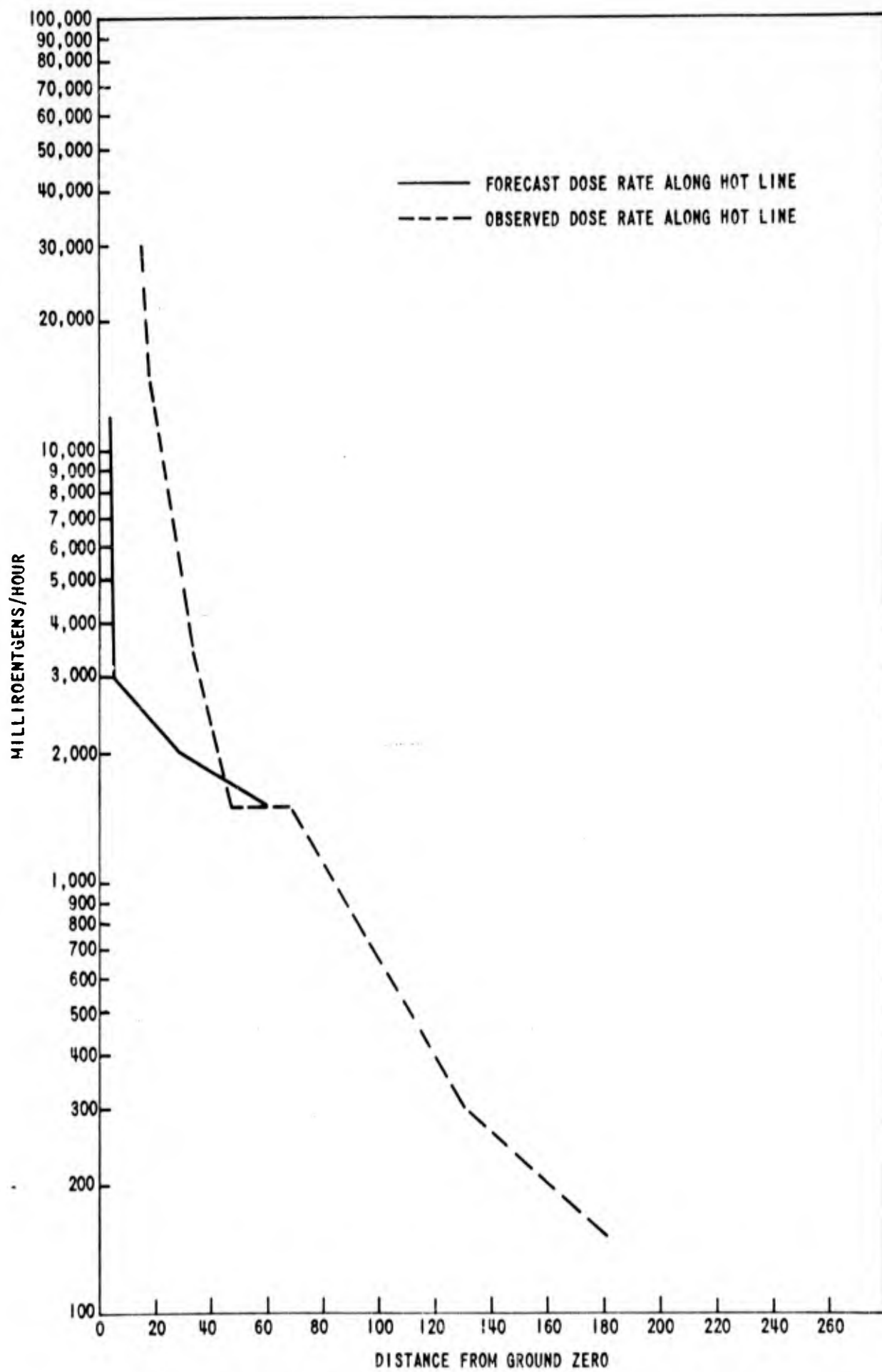

FIG. 38. DOSE RATE INTENSITY ALONG THE HOT LINE, SHOT DIABLO

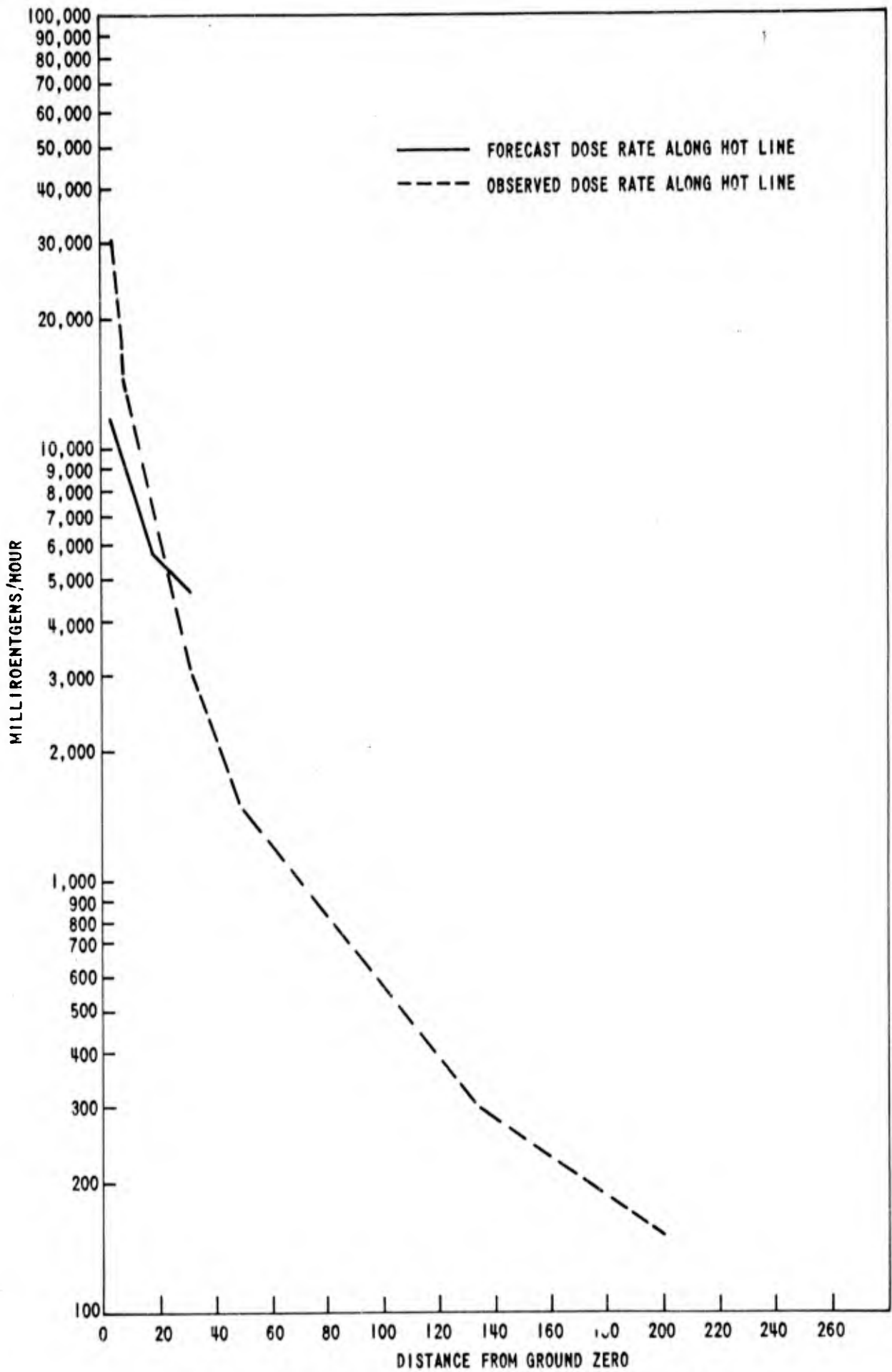

FIG. 39. DOSE RATE INTENSITY ALONG THE HOT LINE, SHOT KEPLER

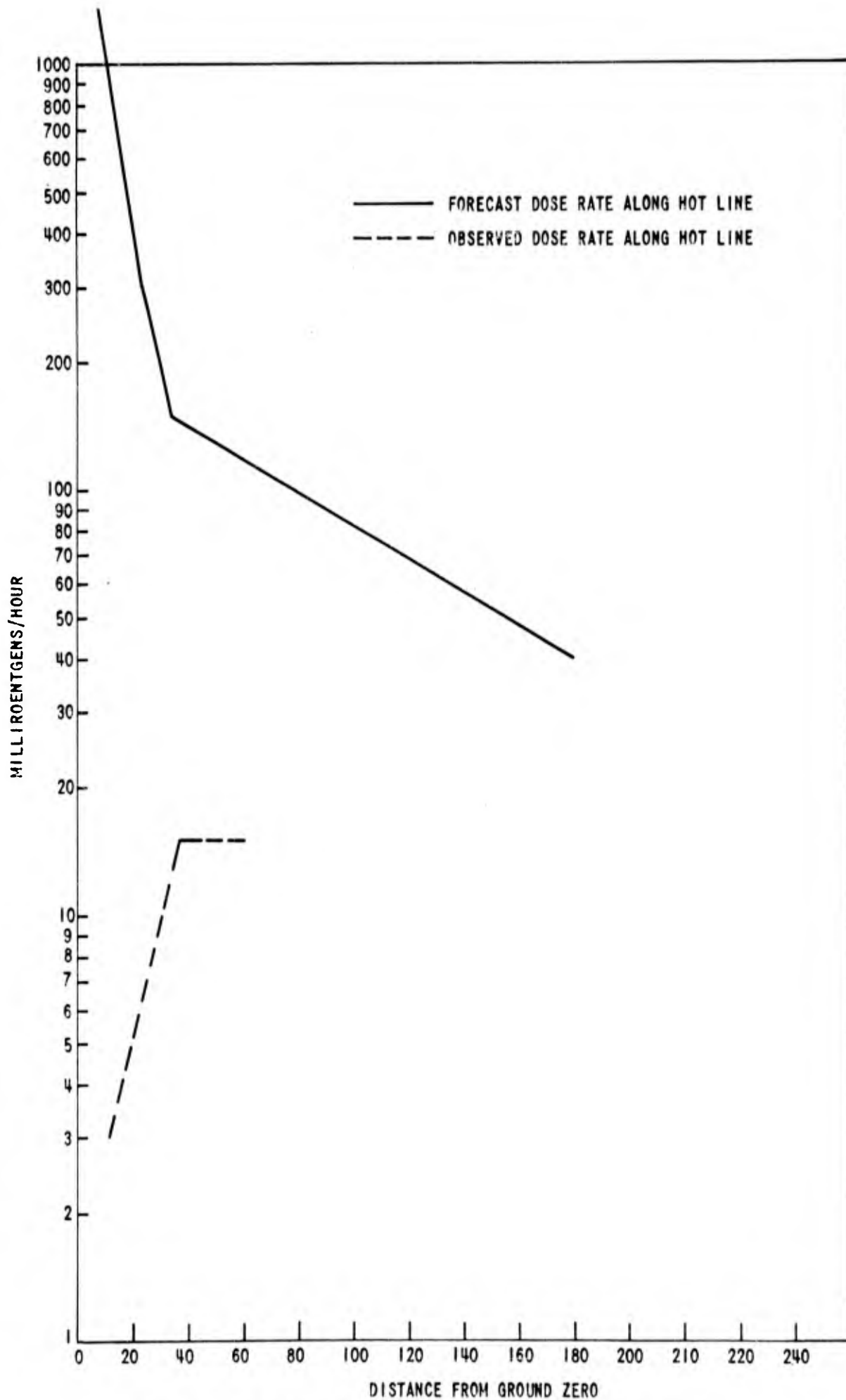

FIG. 40. DOSE RATE INTENSITY ALONG THE HOT LINE, SHOT STOKES

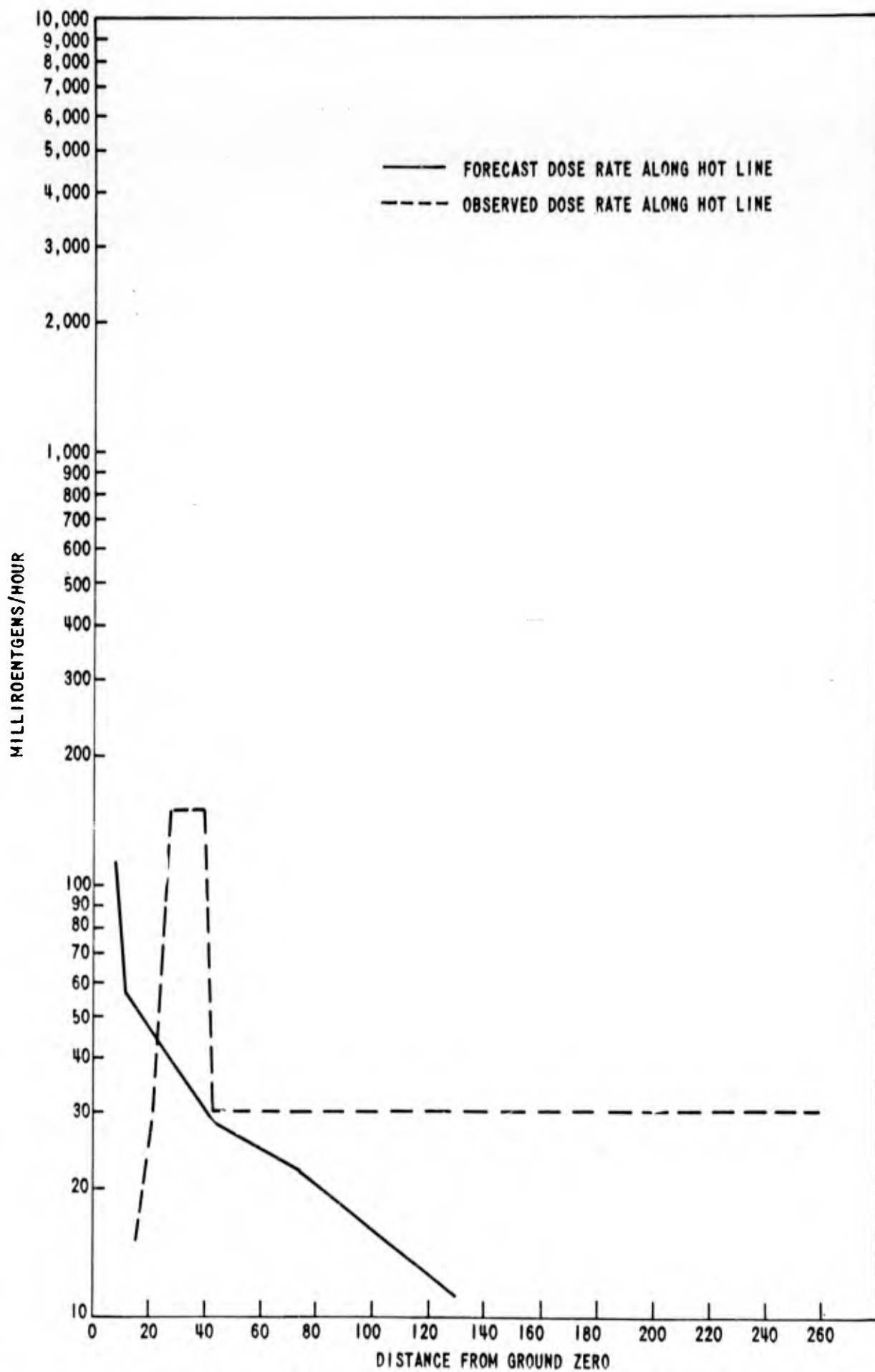

FIG. 41. DOSE RATE INTENSITY ALONG THE HOT LINE, SHOT OWENS

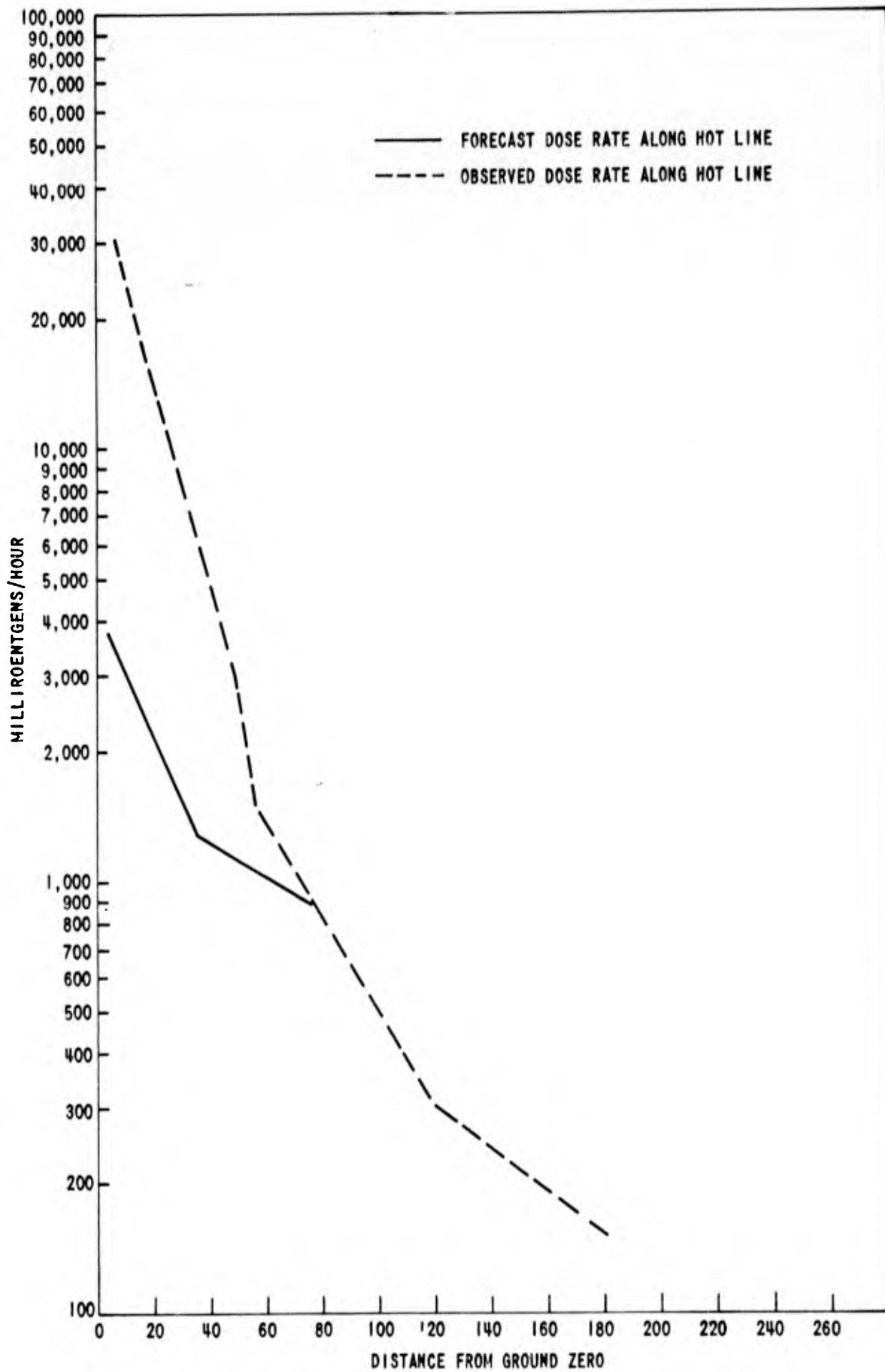

FIG. 42. DOSE RATE INTENSITY ALONG THE HOT LINE, SHOT SHASTA

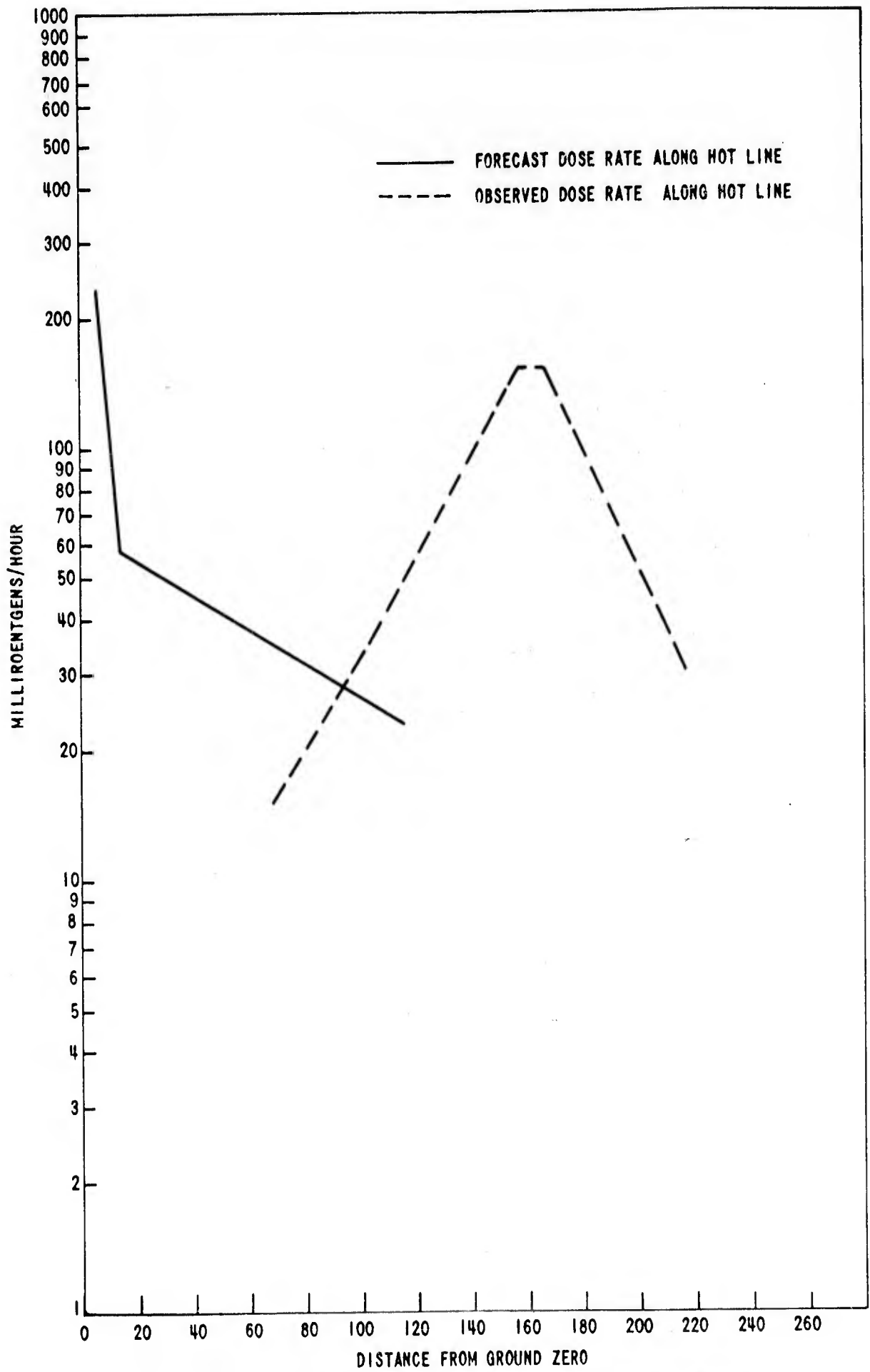

FIG. 43. DOSE RATE INTENSITY ALONG THE HOT LINE, SHOT DOPPLER

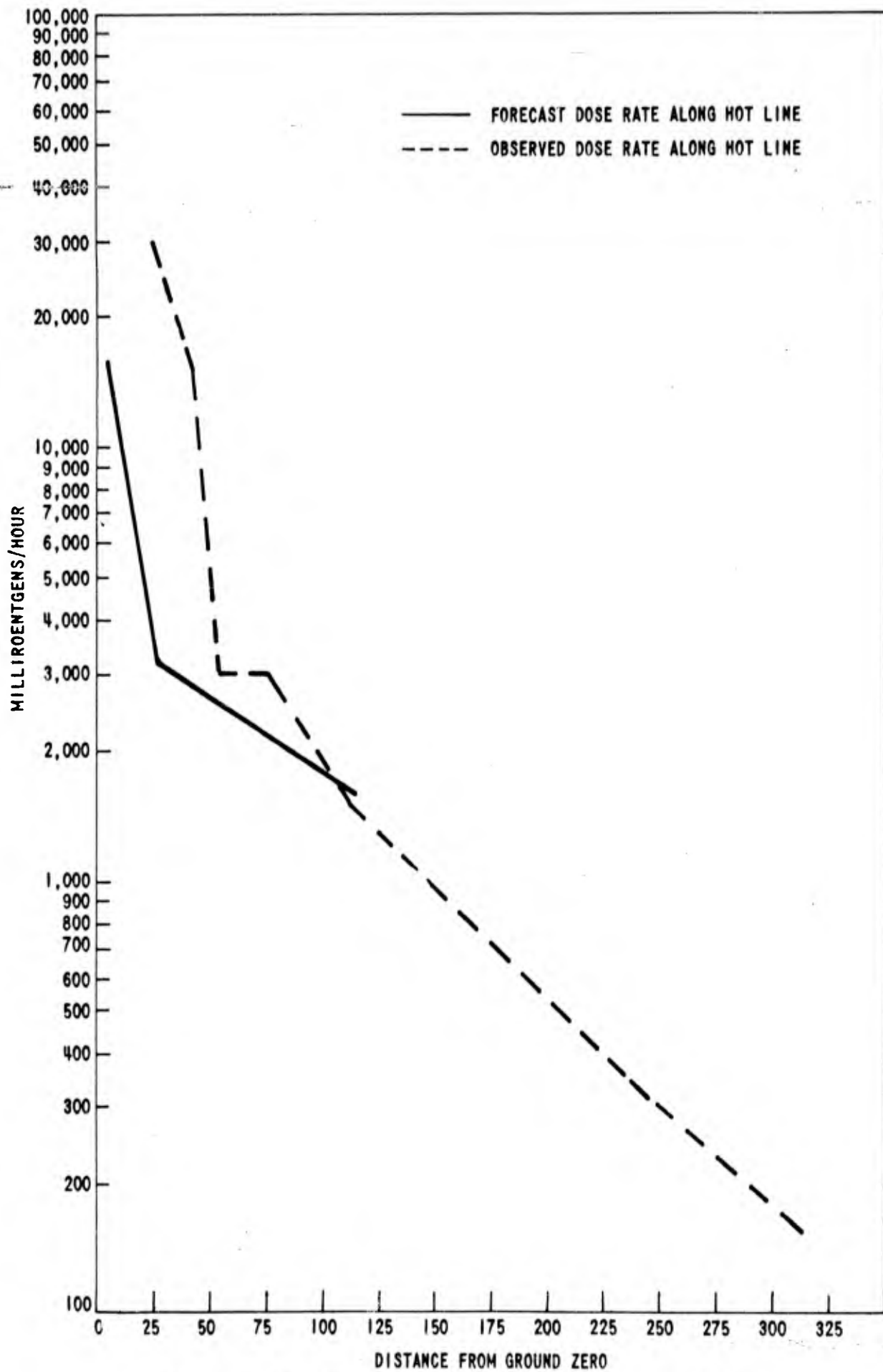

FIG. 44. DOSE RATE INTENSITY ALONG THE HOT LINE, SHOT SMOKY

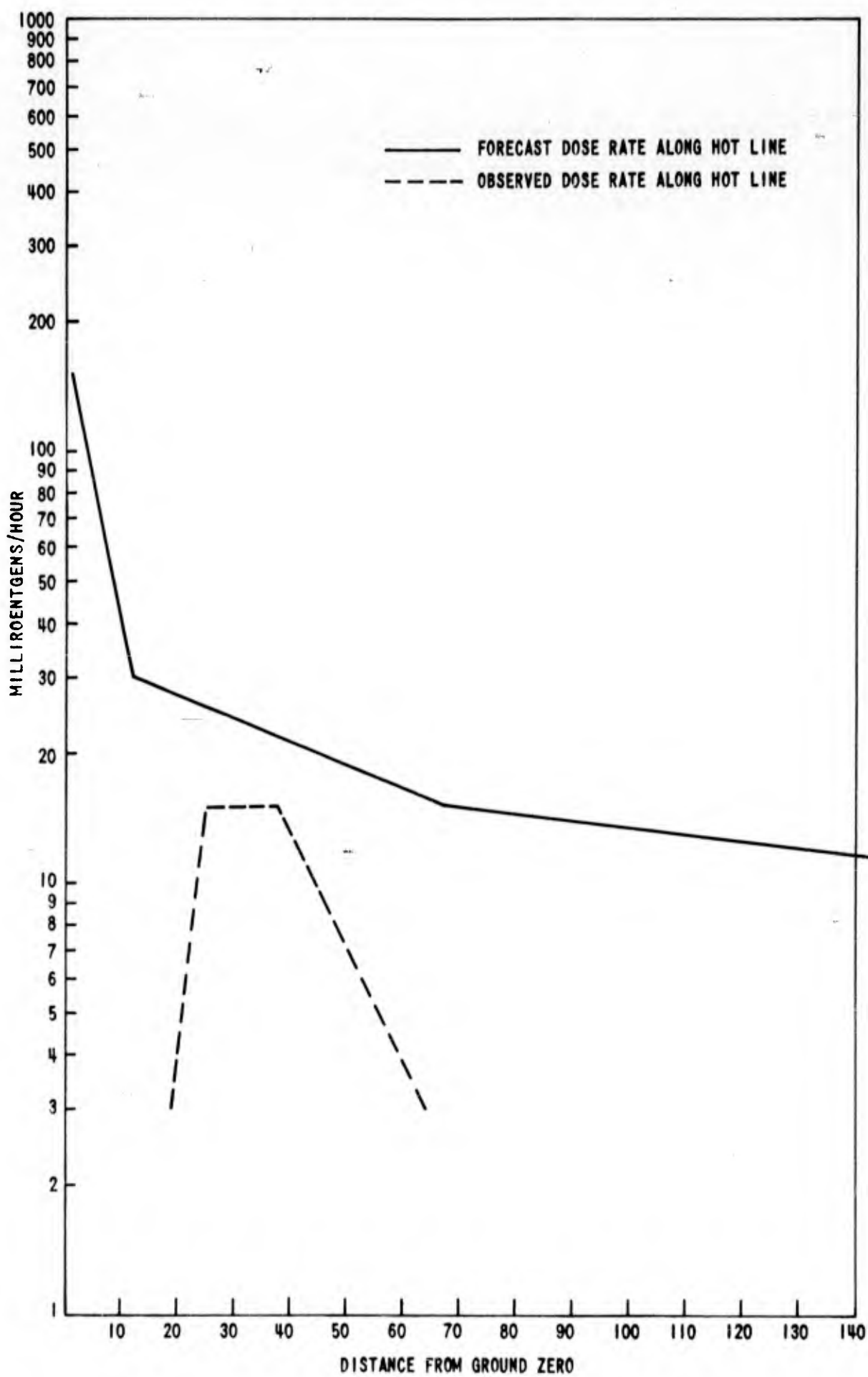

FIG. 45. DOSE RATE INTENSITY ALONG THE HOT LINE, SHOT FRANKLIN PRIME

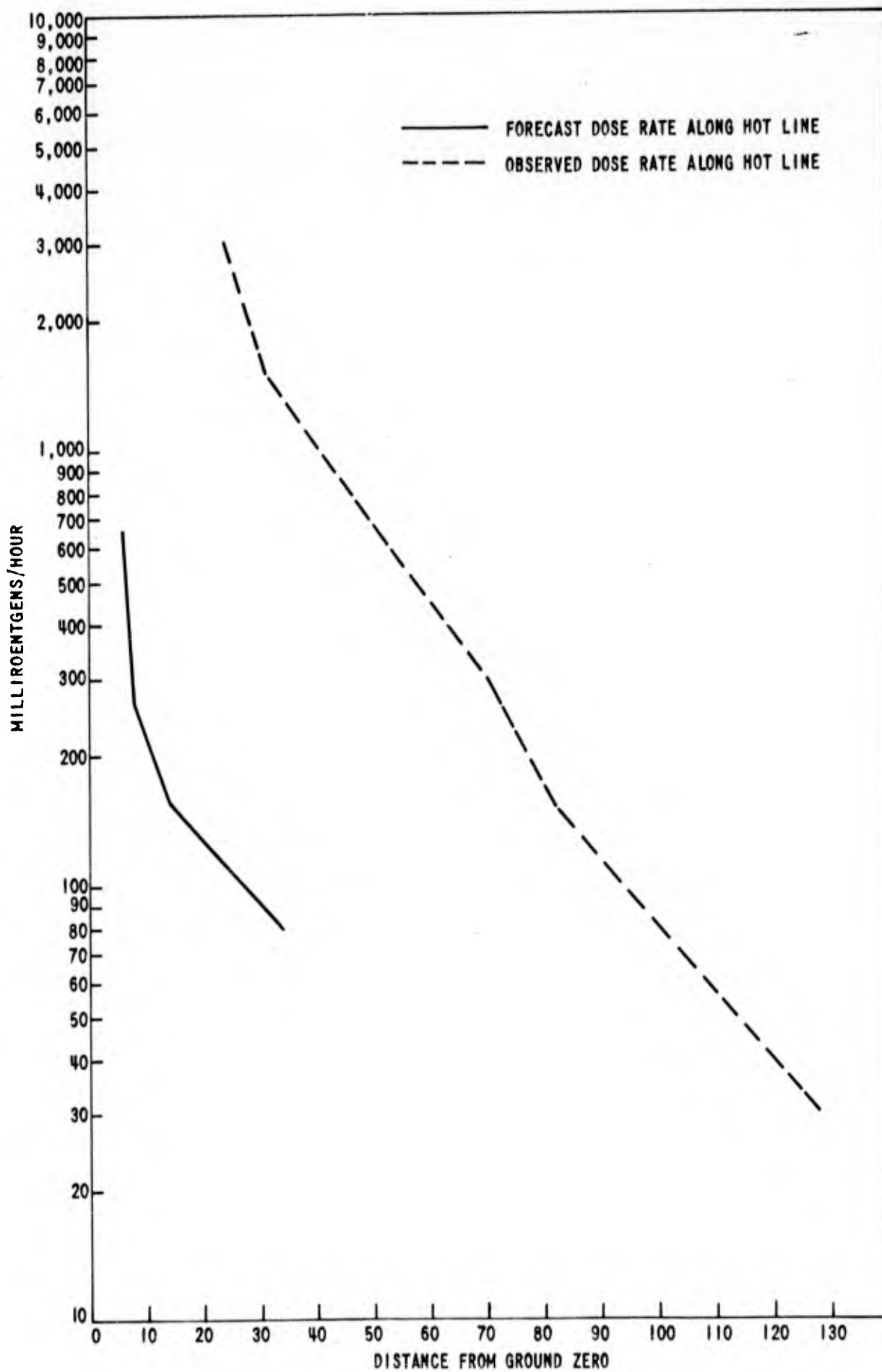

FIG. 48. DOSE RATE INTENSITY ALONG THE HOT LINE, SHOT GALILEO

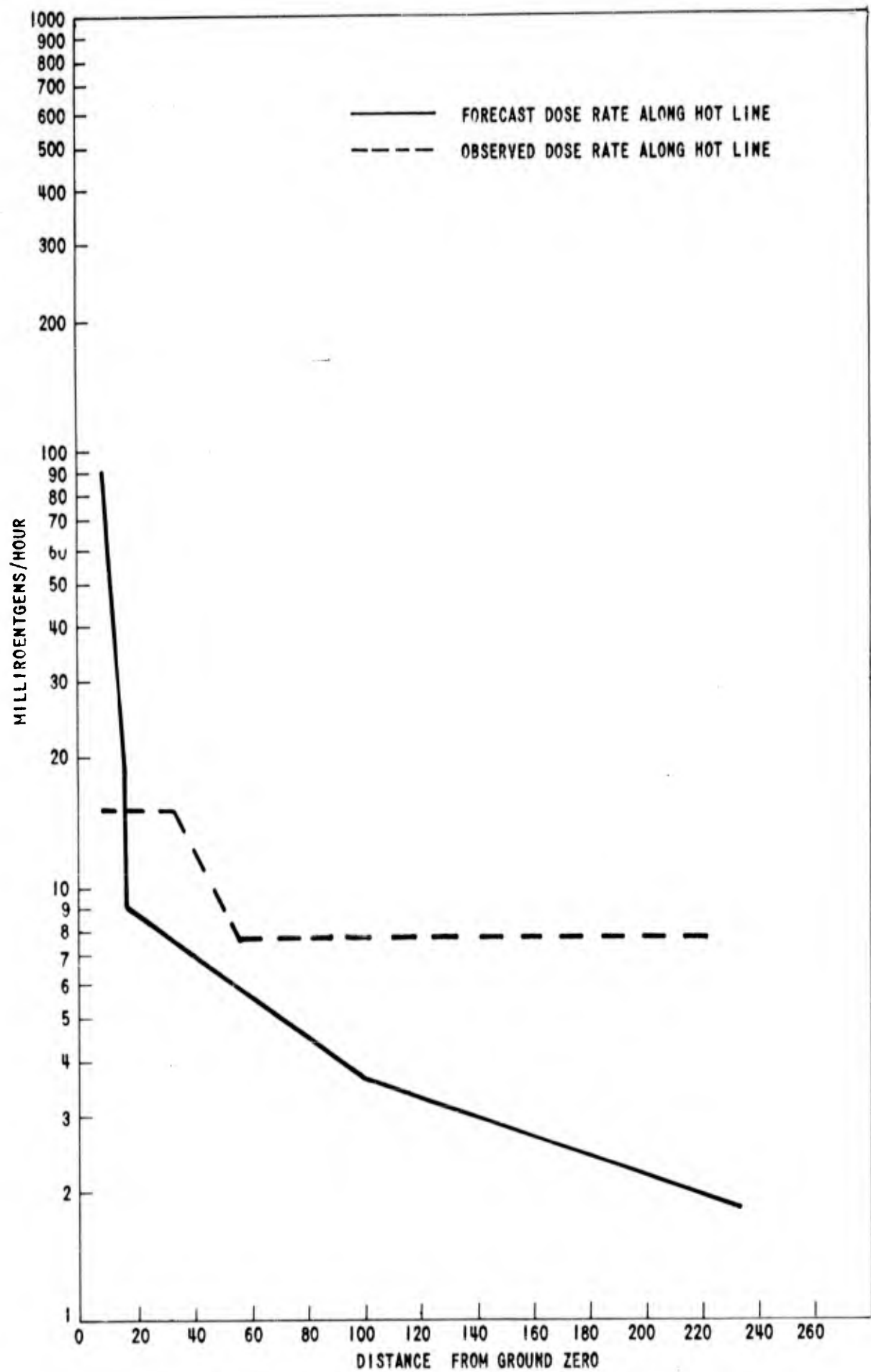

FIG. 47. DOSE RATE INTENSITY ALONG THE HOT LINE, SHOT NEWTON

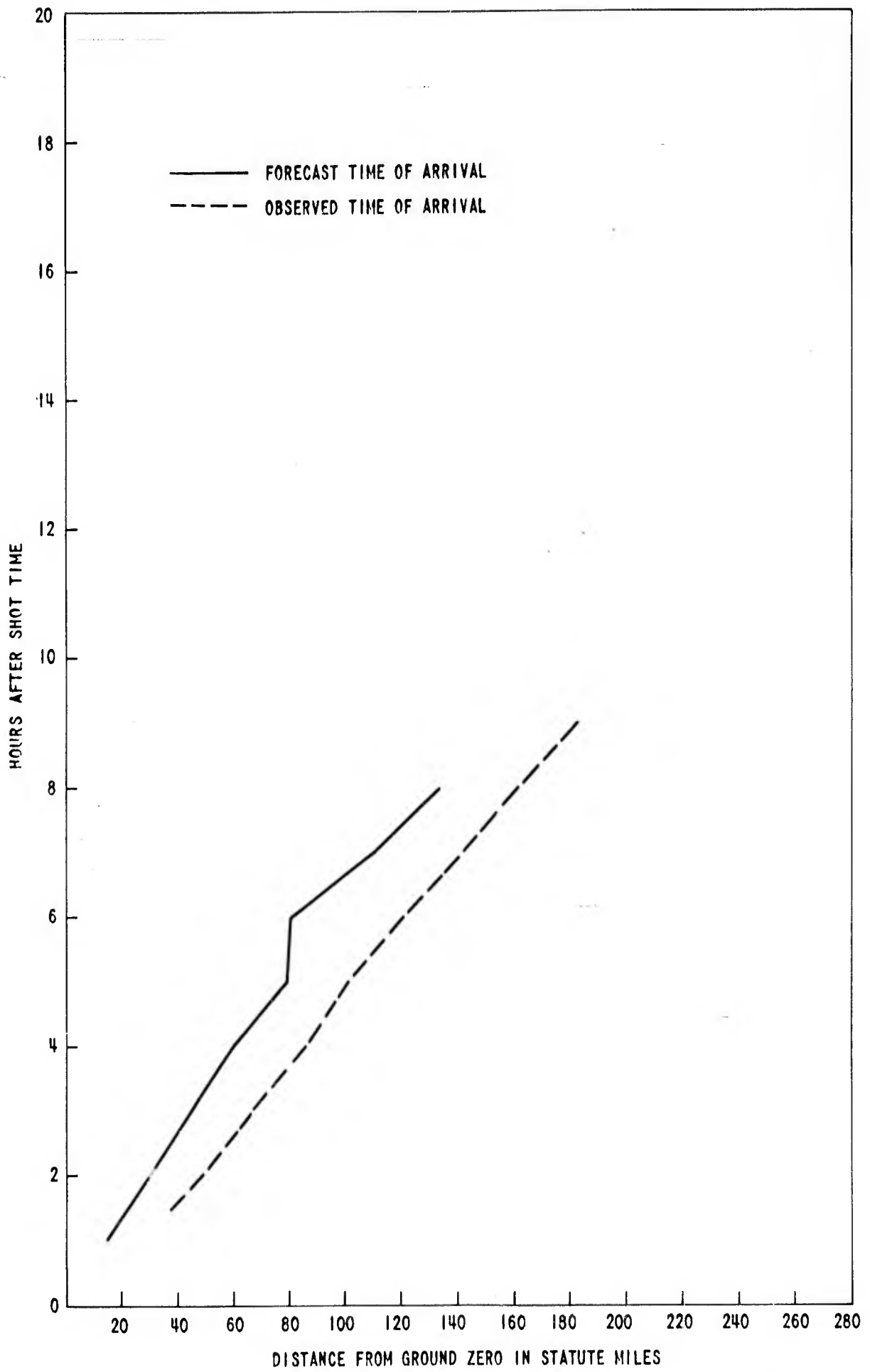

FIG. 48. TIME OF ARRIVAL OF FIRST FALLOUT ALONG HOT LINE, SHOT BOLTZMAN

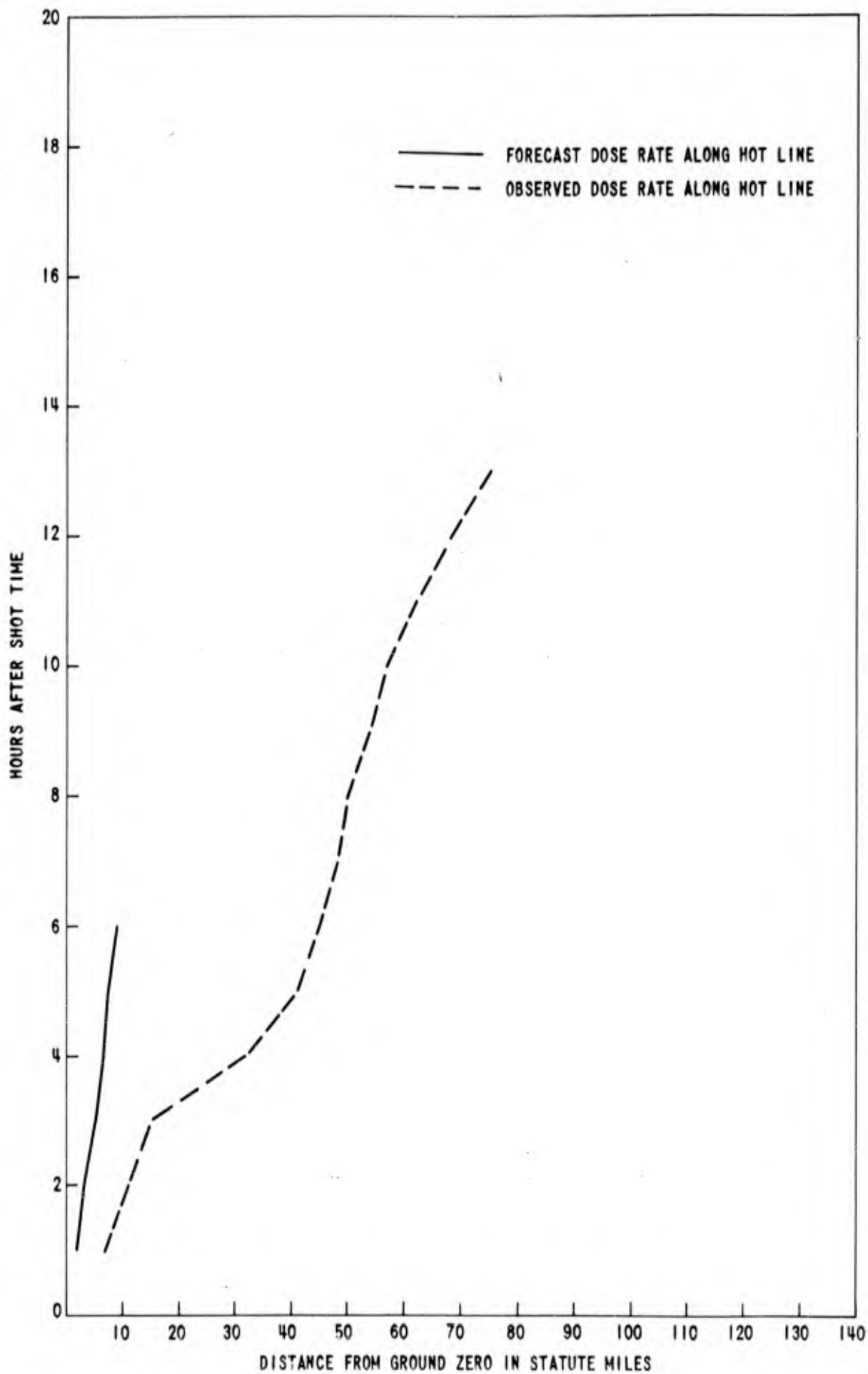

FIG. 49. TIME OF ARRIVAL OF FIRST FALLOUT ALONG HOT LINE, SHOT WILSON

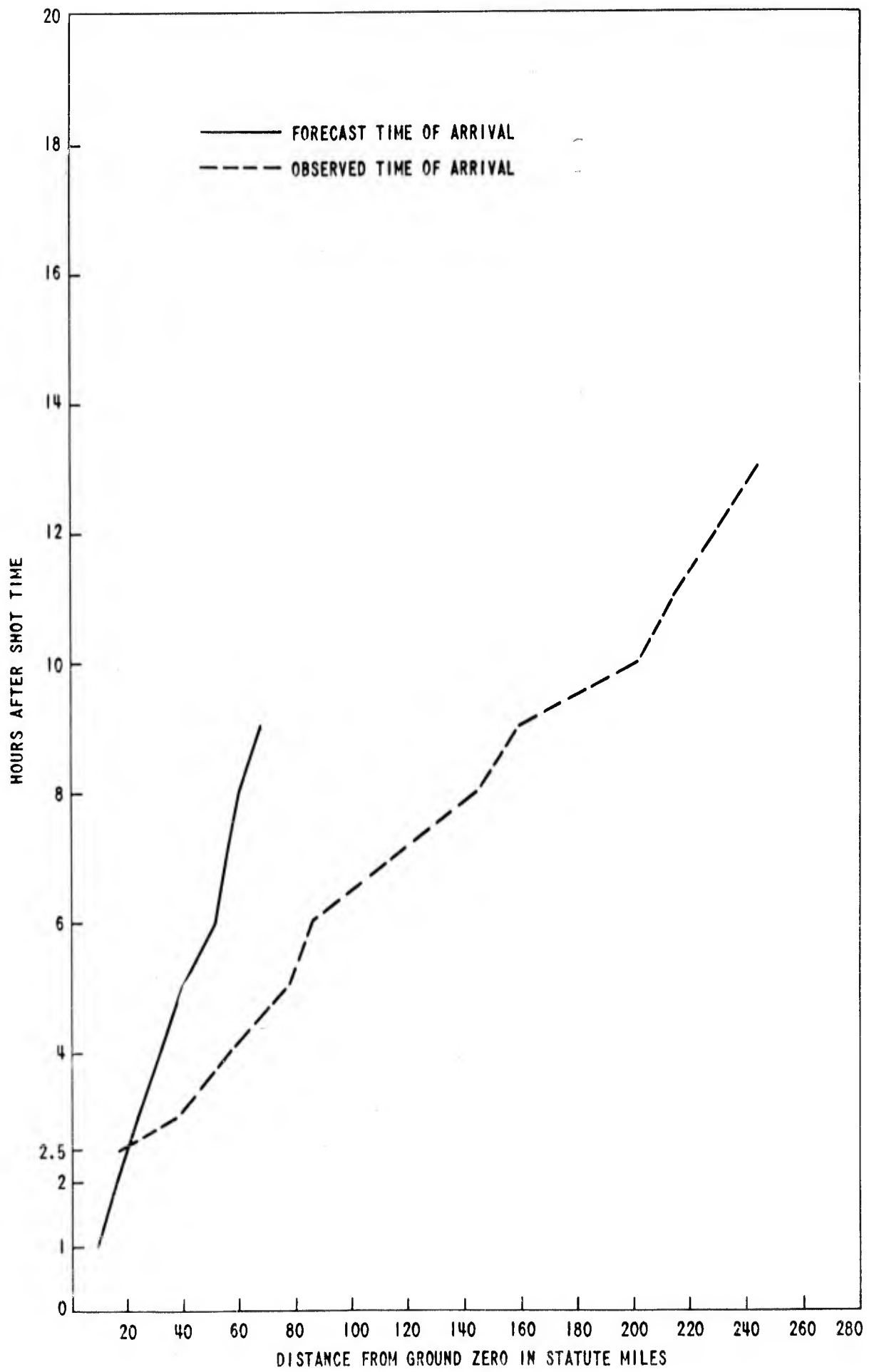

FIG. 50. TIME OF ARRIVAL OF FIRST FALLOUT ALONG HOT LINE, SHOT PRISCILLA

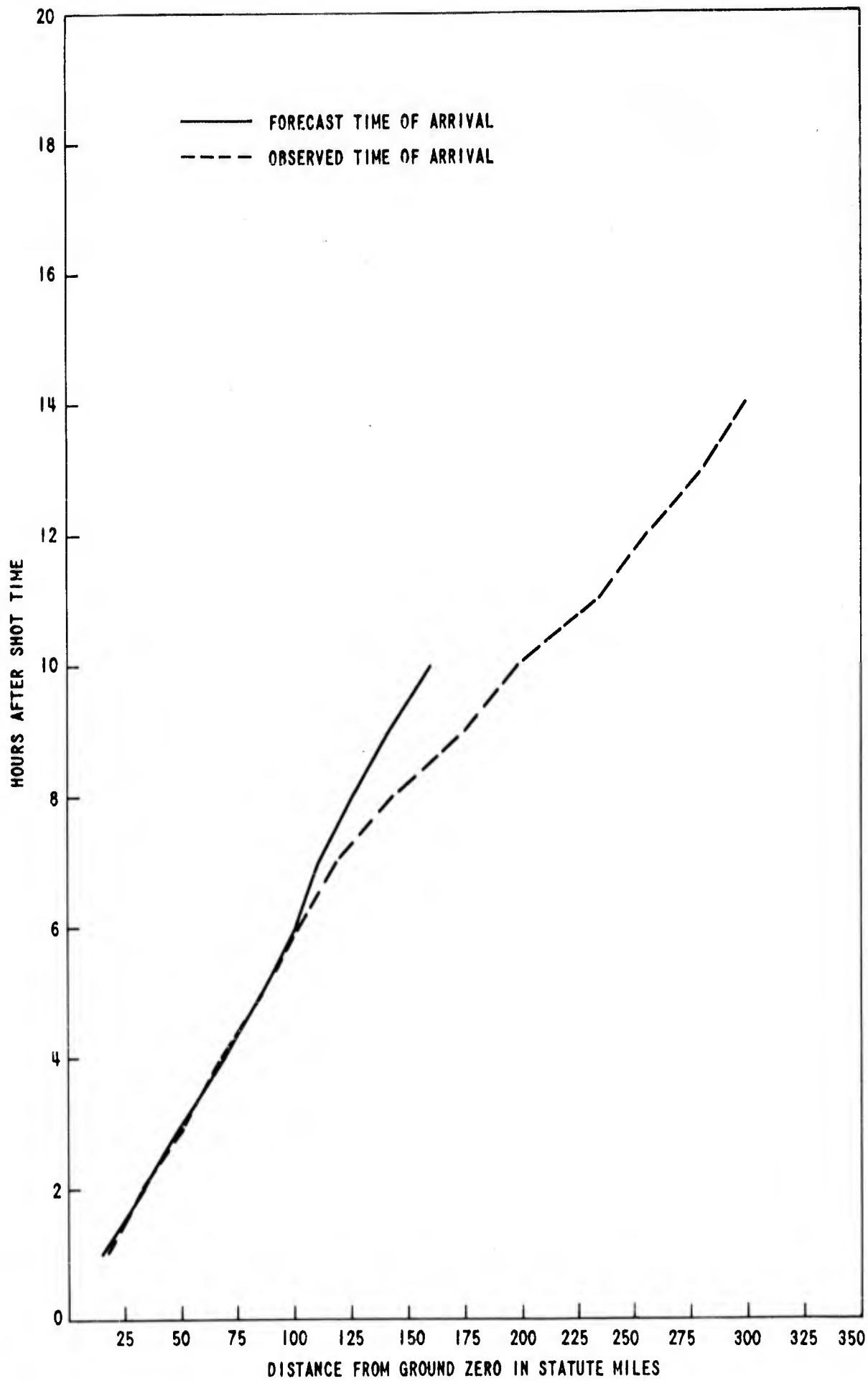

FIG. 51. TIME OF ARRIVAL OF FIRST FALLOUT ALONG HOT LINE, SHOT HOOD

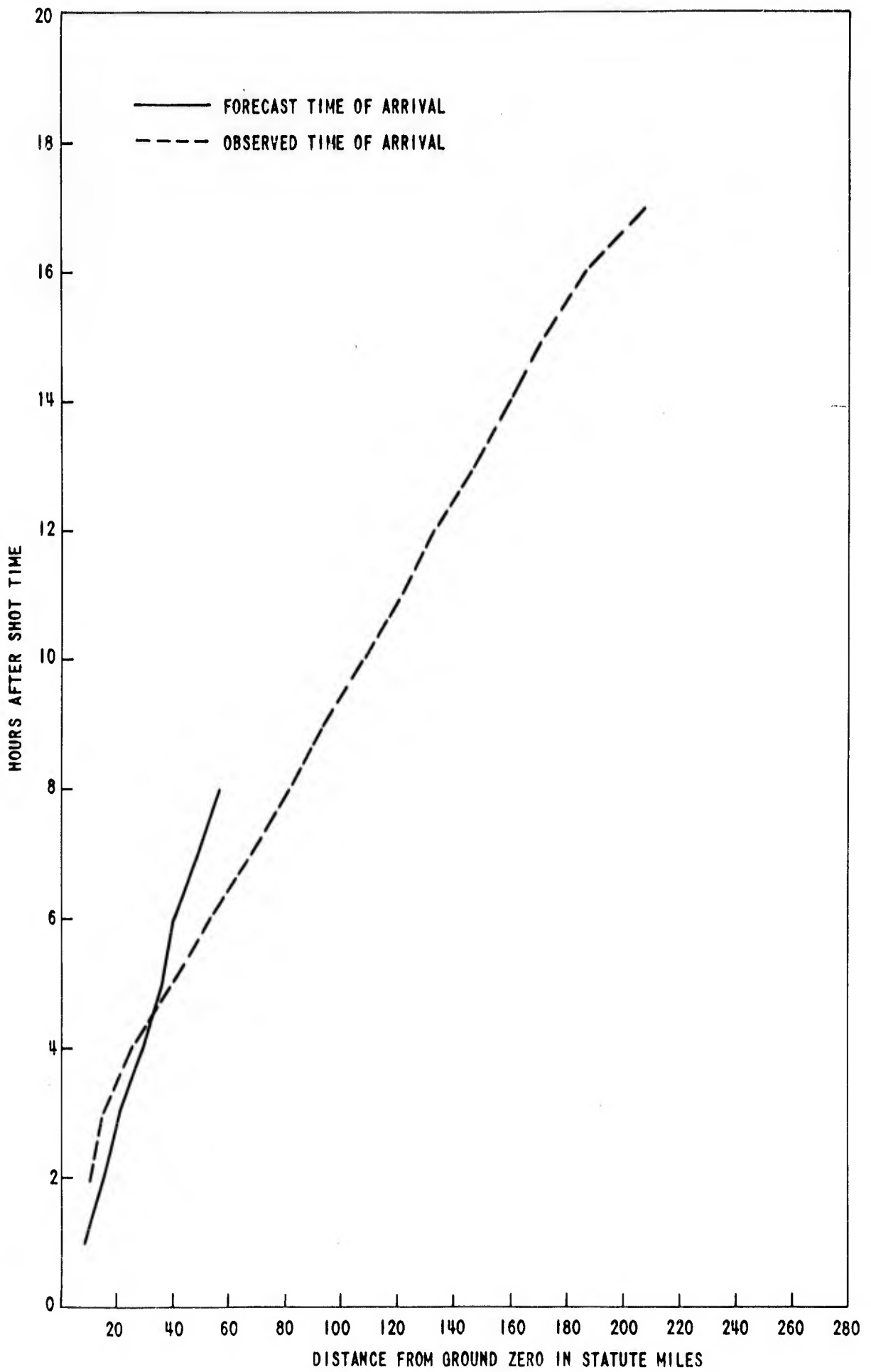

FIG. 52. TIME OF ARRIVAL OF FIRST FALLOUT ALONG HOT LINE, SHOT DIABLO

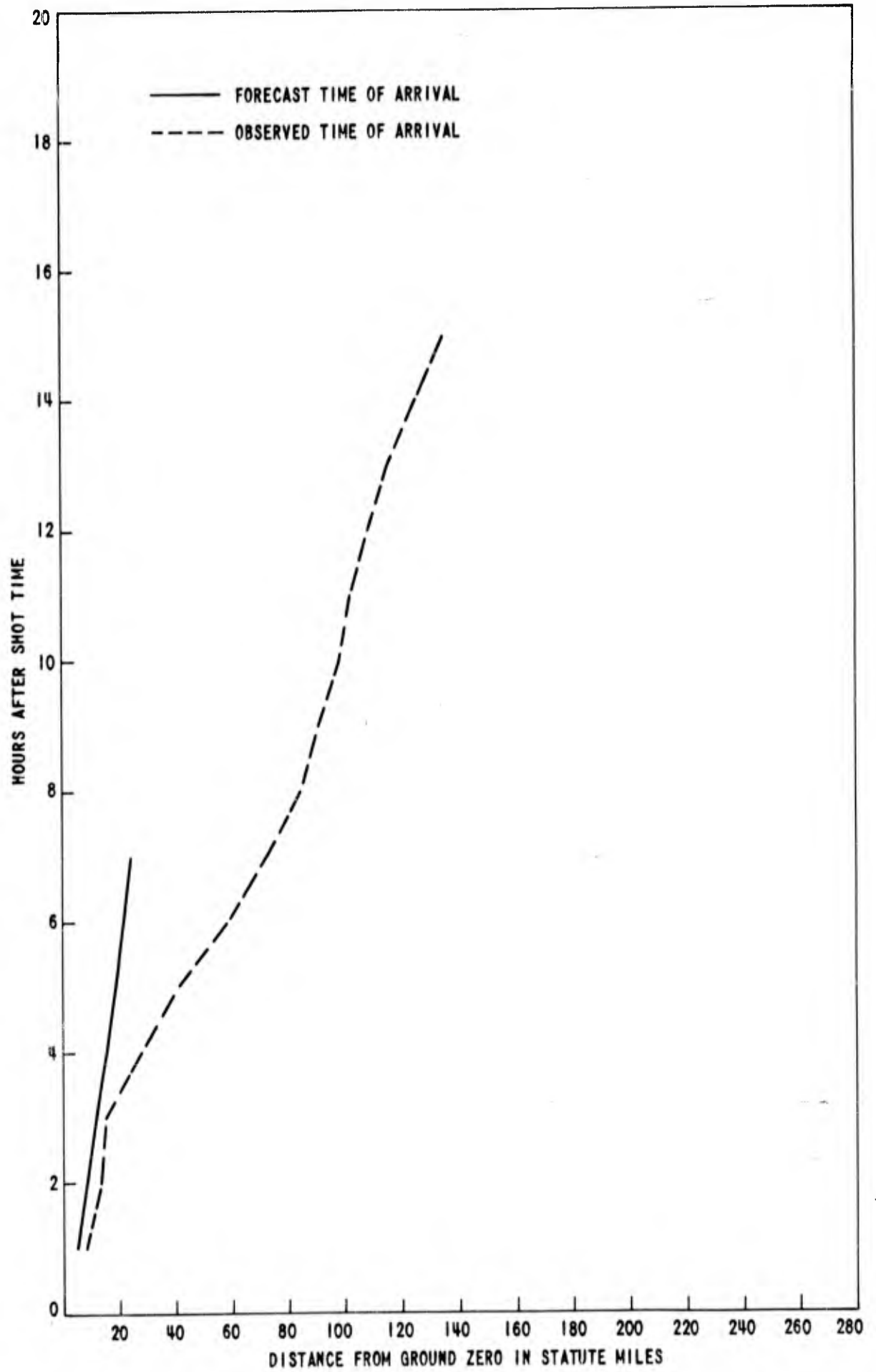

FIG. 53. TIME OF ARRIVAL OF FIRST FALLOUT ALONG HOT LINE, SHOT KEPLER

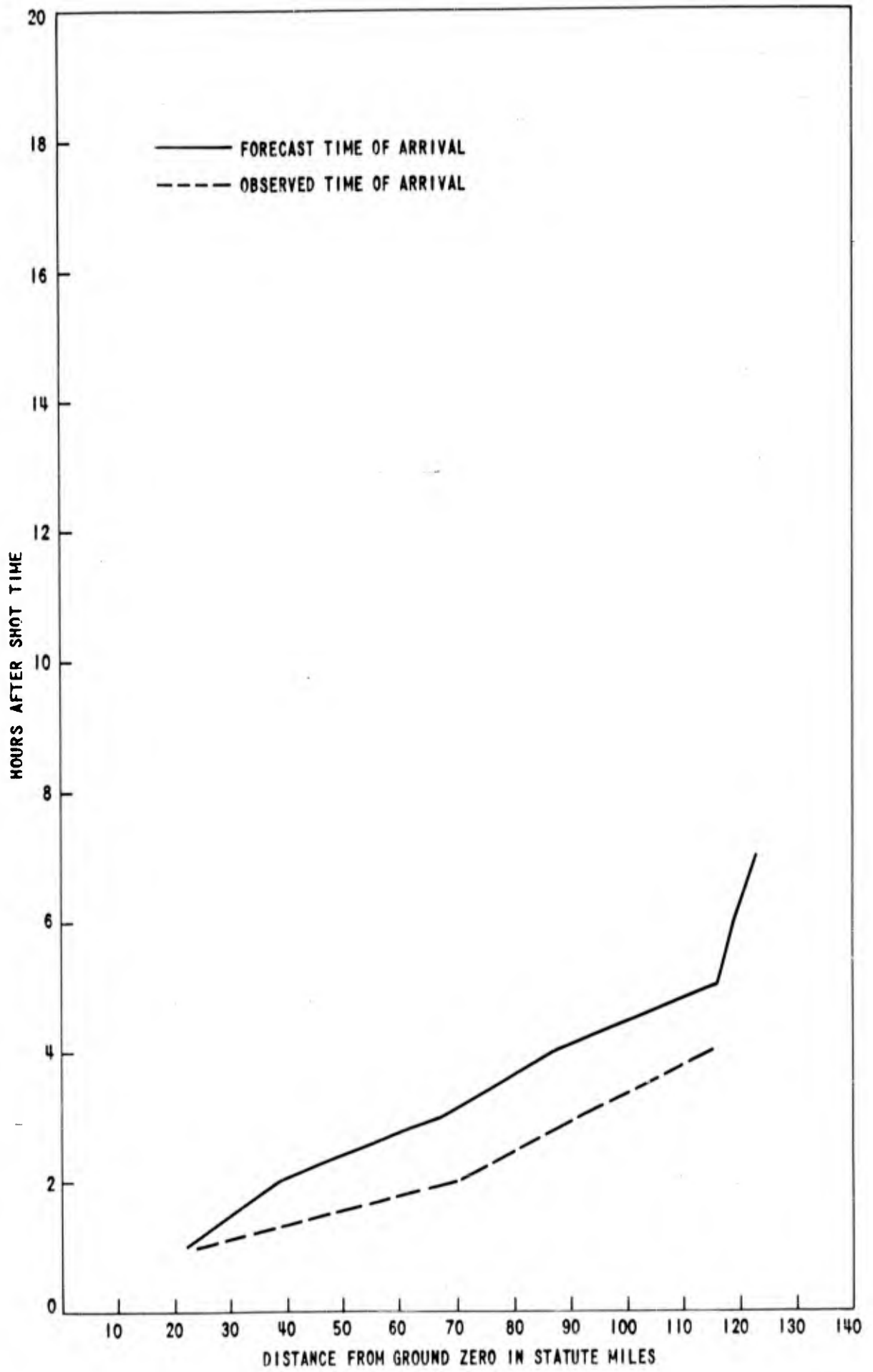

FIG. 54. TIME OF ARRIVAL OF FIRST FALLOUT ALONG HOT LINE, SHOT STOKES

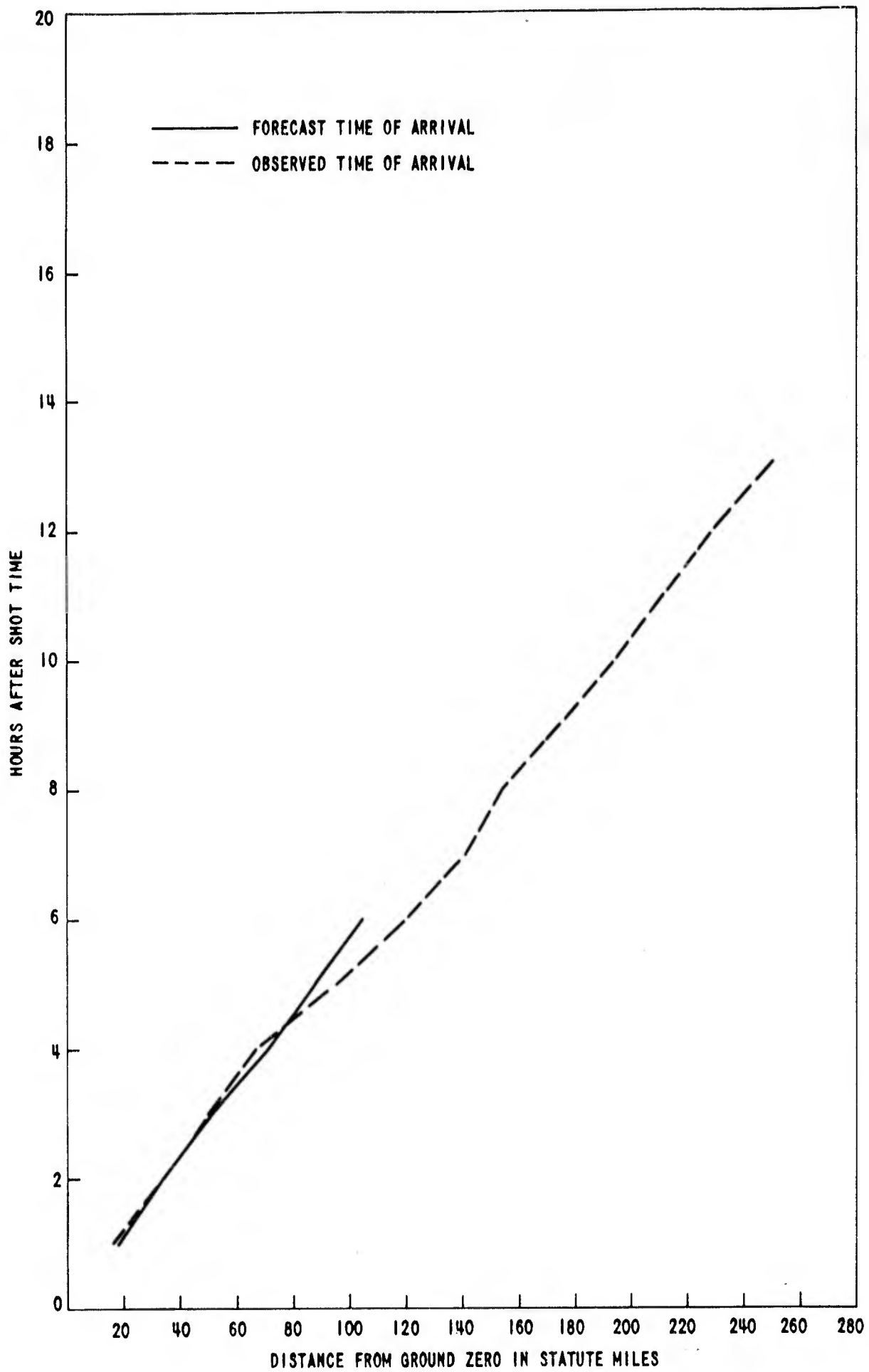

FIG. 55. TIME OF ARRIVAL OF FIRST FALLOUT ALONG HOT LINE, SHOT OWENS

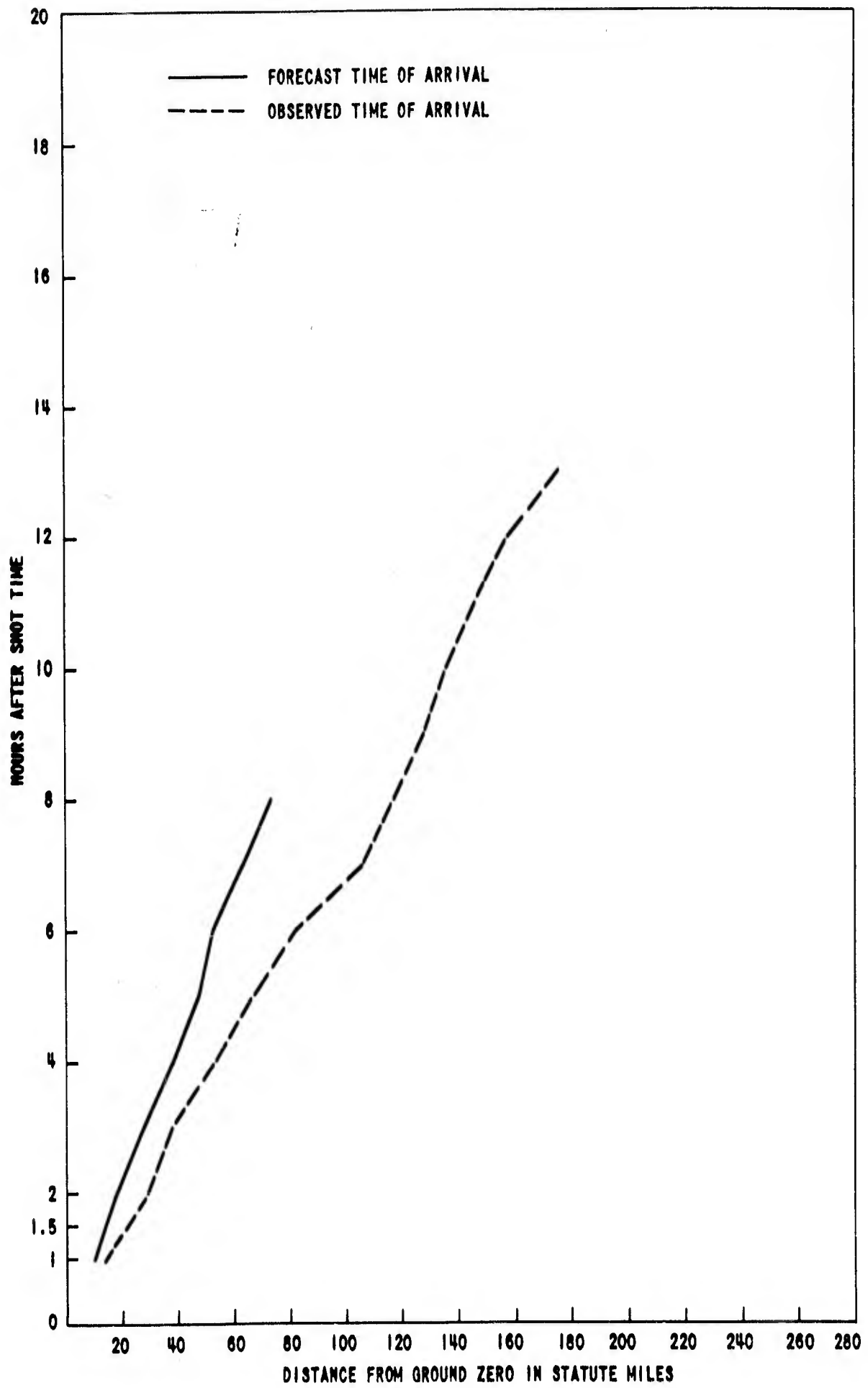

FIG. 56. TIME OF ARRIVAL OF FIRST FALLOUT ALONG HOT LINE, SHOT SHASTA

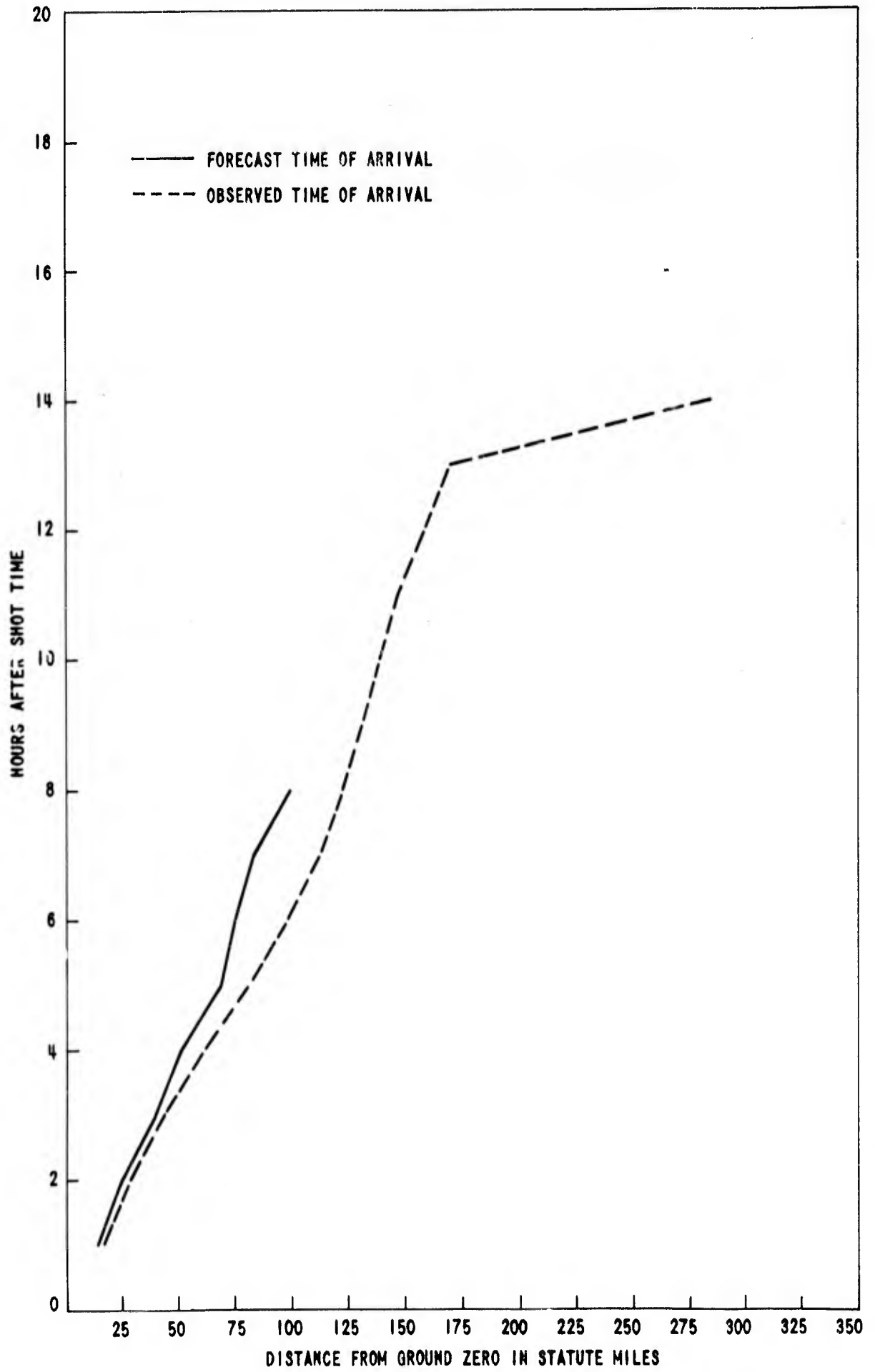

FIG. 57. TIME OF ARRIVAL OF FIRST FALLOUT ALONG HOT LINE, SHOT DOPPLER

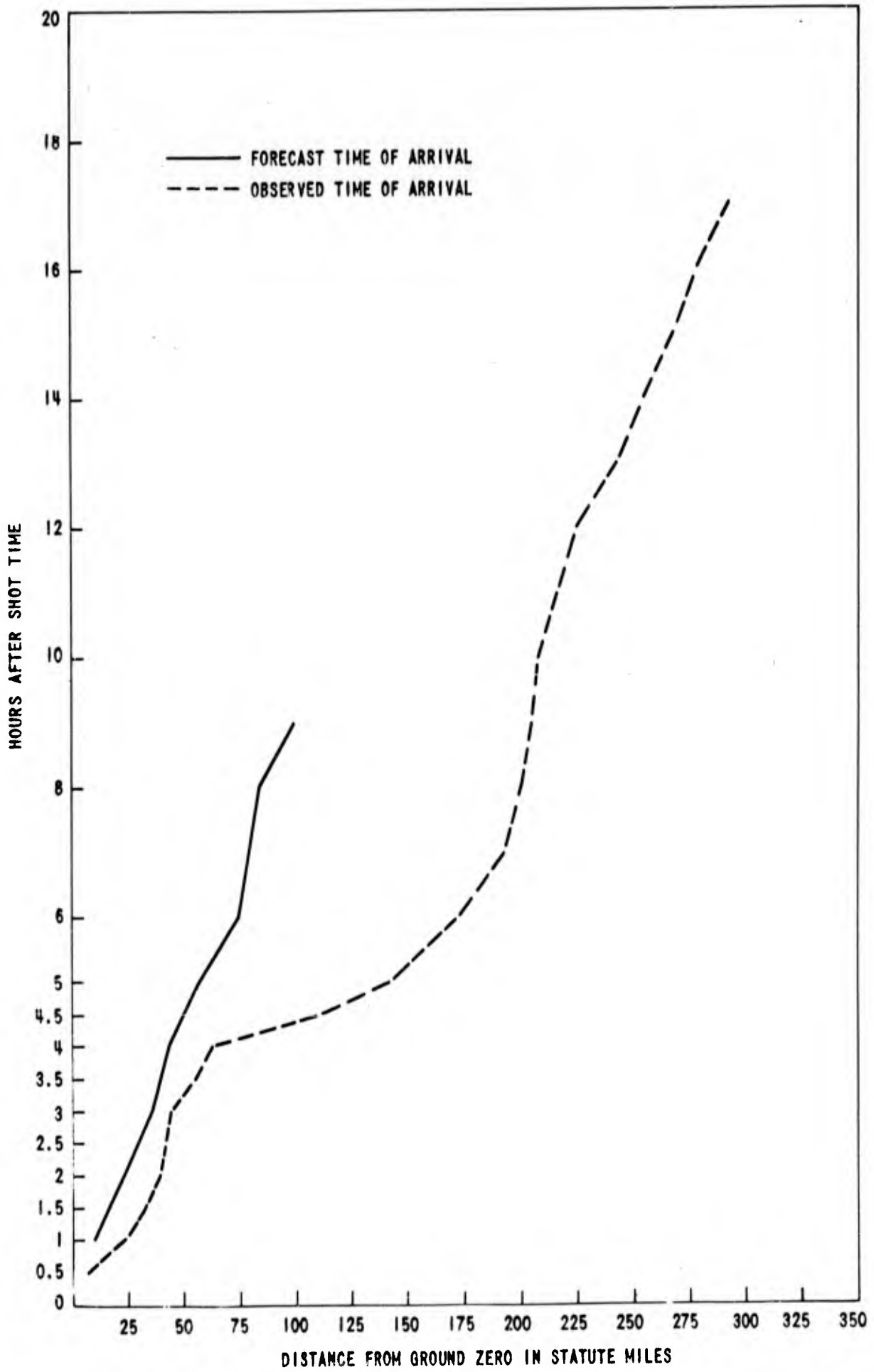

FIG. 58. TIME OF ARRIVAL OF FIRST FALLOUT ALONG HOT LINE, SHOT SMOKY

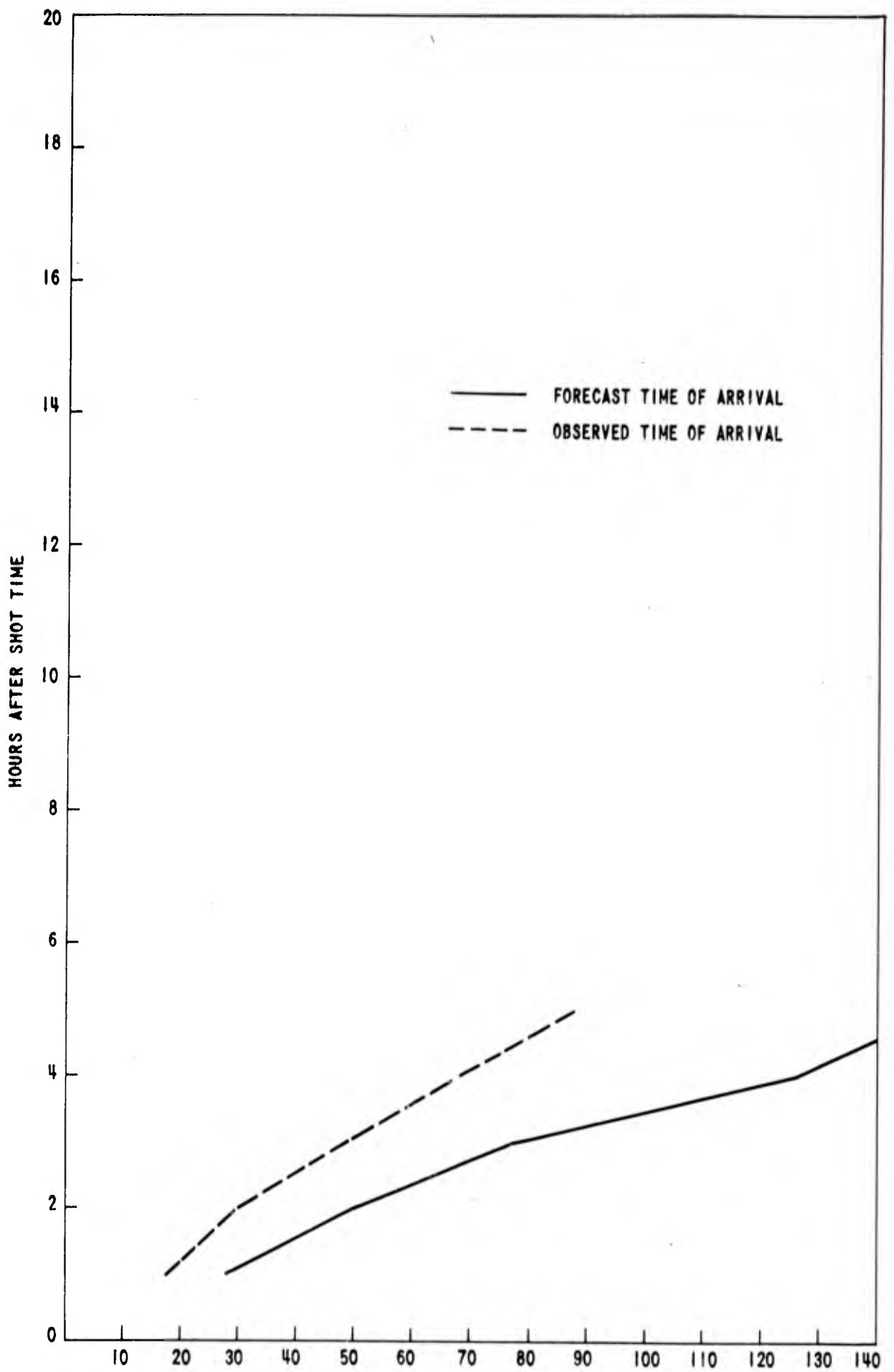

FIG. 59. TIME OF ARRIVAL OF FIRST FALLOUT ALONG HOT LINE, SHOT FRANKLIN PRIME

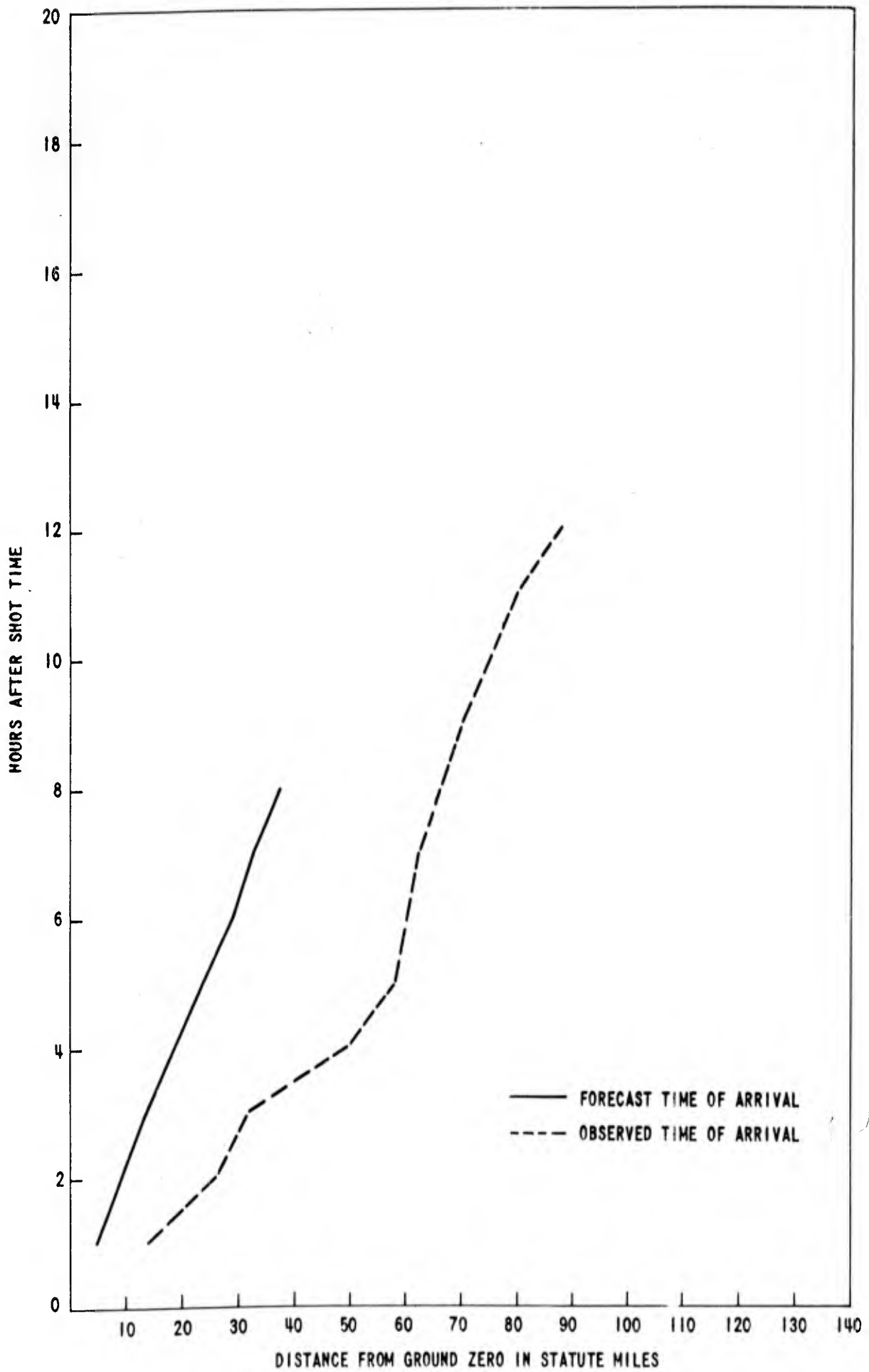

FIG. 60. TIME OF ARRIVAL OF FIRST FALLOUT ALONG HOT LINE, SHOT GALILEO

UNCLASSIFIED

UNCLASSIFIED