

**UNCLASSIFIED**

---

---

**AD 267 199**

*Reproduced  
by the*

**ARMED SERVICES TECHNICAL INFORMATION AGENCY  
ARLINGTON HALL STATION  
ARLINGTON 12, VIRGINIA**



---

---

**UNCLASSIFIED**

NOTICE: When government or other drawings, specifications or other data are used for any purpose other than in connection with a definitely related government procurement operation, the U. S. Government thereby incurs no responsibility, nor any obligation whatsoever; and the fact that the Government may have formulated, furnished, or in any way supplied the said drawings, specifications, or other data is not to be regarded by implication or otherwise as in any manner licensing the holder or any other person or corporation, or conveying any rights or permission to manufacture, use or sell any patented invention that may in any way be related thereto.

# DISCLAIMER NOTICE

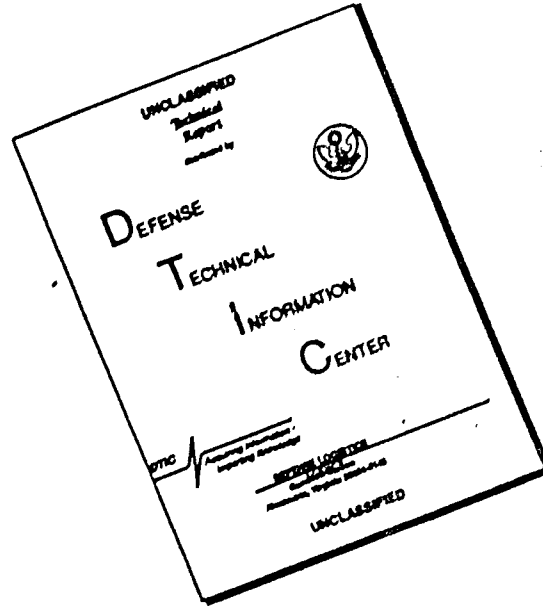

THIS DOCUMENT IS BEST QUALITY AVAILABLE. THE COPY FURNISHED TO DTIC CONTAINED A SIGNIFICANT NUMBER OF PAGES WHICH DO NOT REPRODUCE LEGIBLY.

AIR FORCE  
TECHNICAL DATA CENTER

TECHNICAL LIBRARY

Document No. 61-05-649

Copy No. 24

1

AD NO. \_\_\_\_\_  
ASTIA FILE COPY 267199

267 199

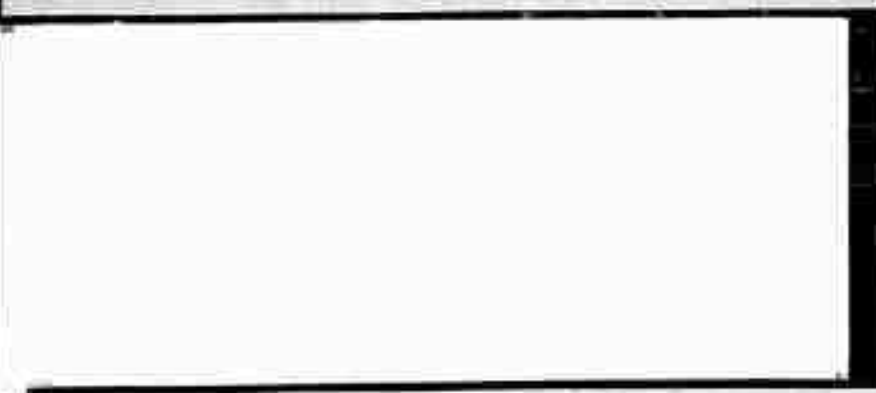

FILE COPY  
ASTIA  
ASTIA  
ARLINGTON HALL STATION  
ARLINGTON 12, VIRGINIA  
Aim: TIRS

ASTIA  
RECEIVED  
TEMPOR



\$3.60

6-2-1-4  
XEROX

---

FOR ERRATA

AD 267199

THE FOLLOWING PAGES ARE CHANGES

TO BASIC DOCUMENT

ACOUSTICA ASSOCIATES, INCORPORATED  
Los Angeles, California

DO 5389B  
29 September 1961  
Amendment 1

267199

267199

12

SPECIFICATION FOR  
AEROSPACE GROUND EQUIPMENT  
PROPELLANT UTILIZATION SUBSYSTEM  
MODEL PU 136, WS107A-1 WEAPON SYSTEM  
SM 65 "F" SERIES, SILO LIFT, MISSILE

AIR FORCE CONTRACT  
AF04 (647)- 625

Approved by: M M. Allen  
Manager, Logistics

Approved by: Allan Maxwell  
Manager, Product Support

Approved by: [Signature]  
Program Director

NOTE: Do not return  
to DDC Destroy  
according to applicable  
security regulations

(a) Page ii (Table of Contents)

Add

3.2.5 SENSOR REPLACING TOOL, MODEL SRT100 9

MAINTENANCE FUNCTIONAL FLOW CHARTS 28A thru 28D

(b) Page 9:

Add paragraph:

3.2.5 SENSOR REPLACING TOOL, MODEL SRT100. This tool is provided at the MAMS for removal and insertion of roll pins which secure the sensors in their pods on the stillwell assemblies. It provides an efficient reliable means of removing and replacing the pins. The tool weighs approximately 1/2 pound and is fabricated of stainless steel. Action is that of a screw press.

(c) Page 28:

Remove and replace this page with the maintenance functional flow charts attached. (28A, 28B, 28C and 28D).



1



2



1

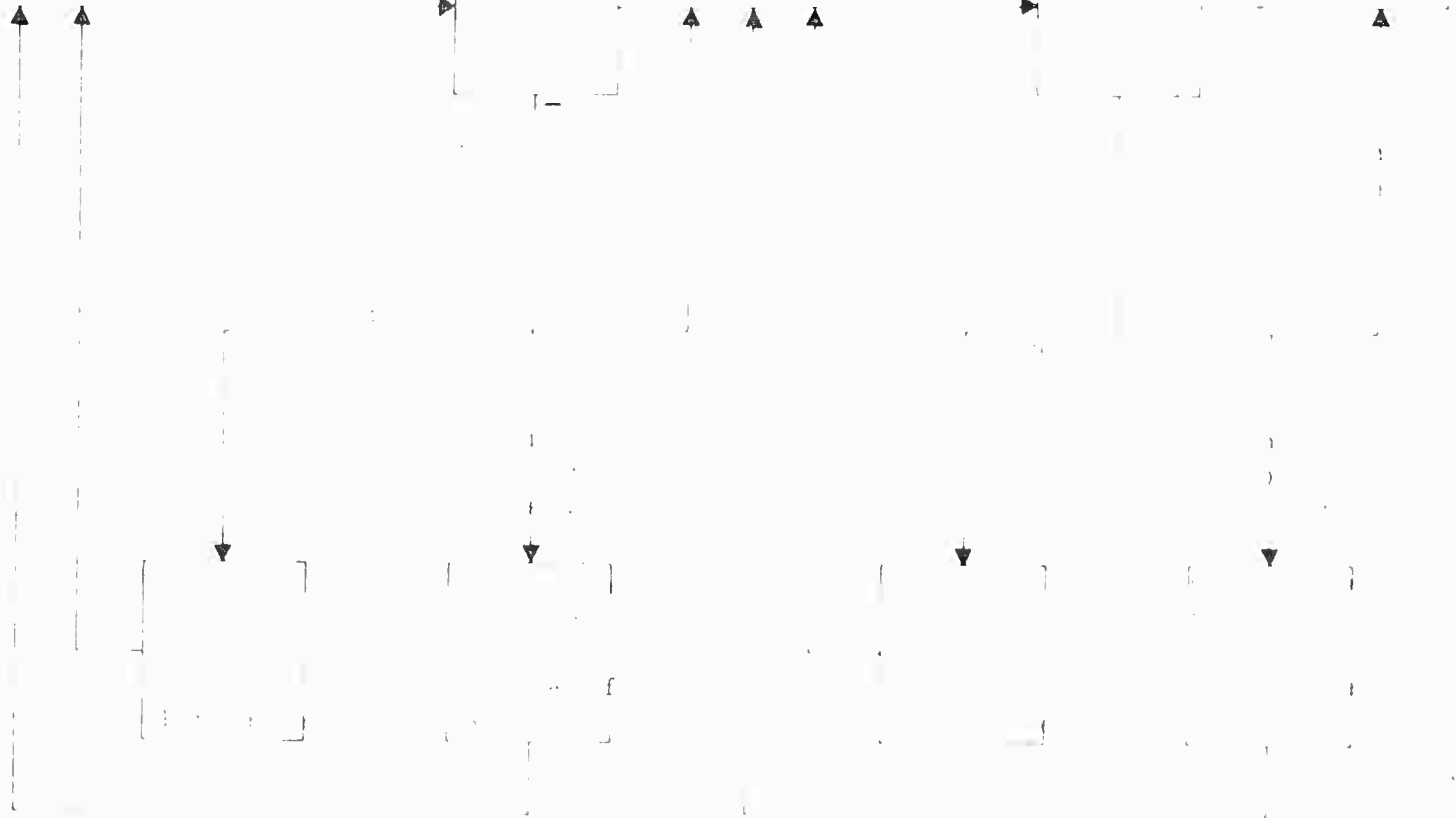
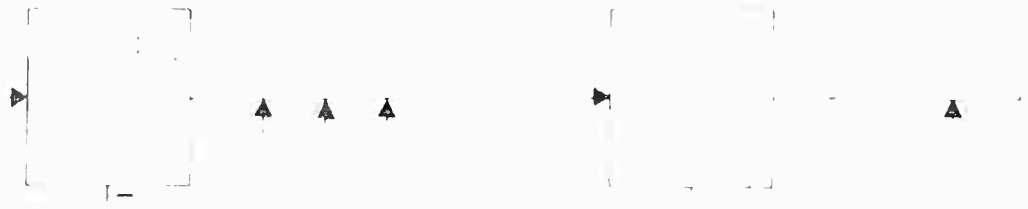

2

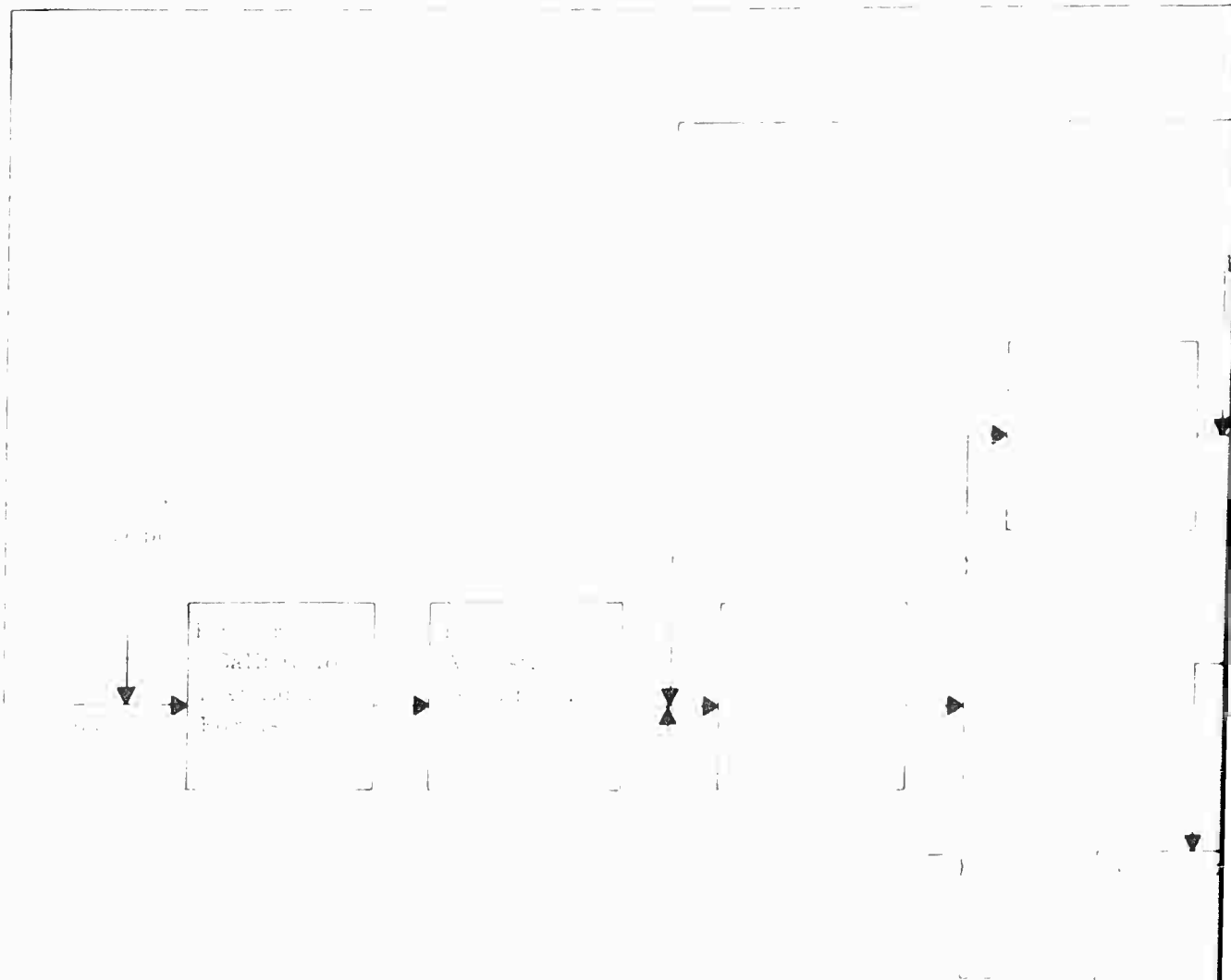

1

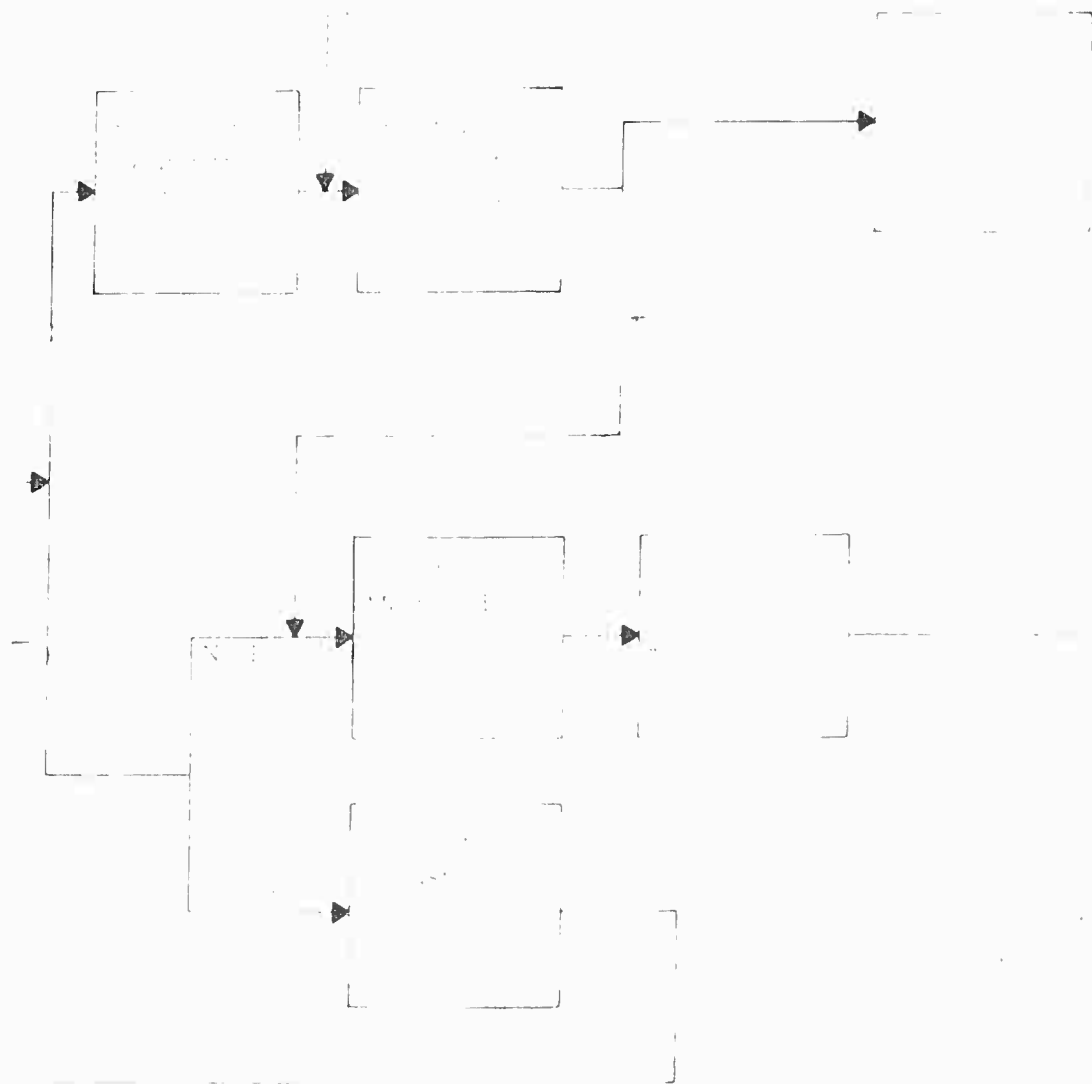

2

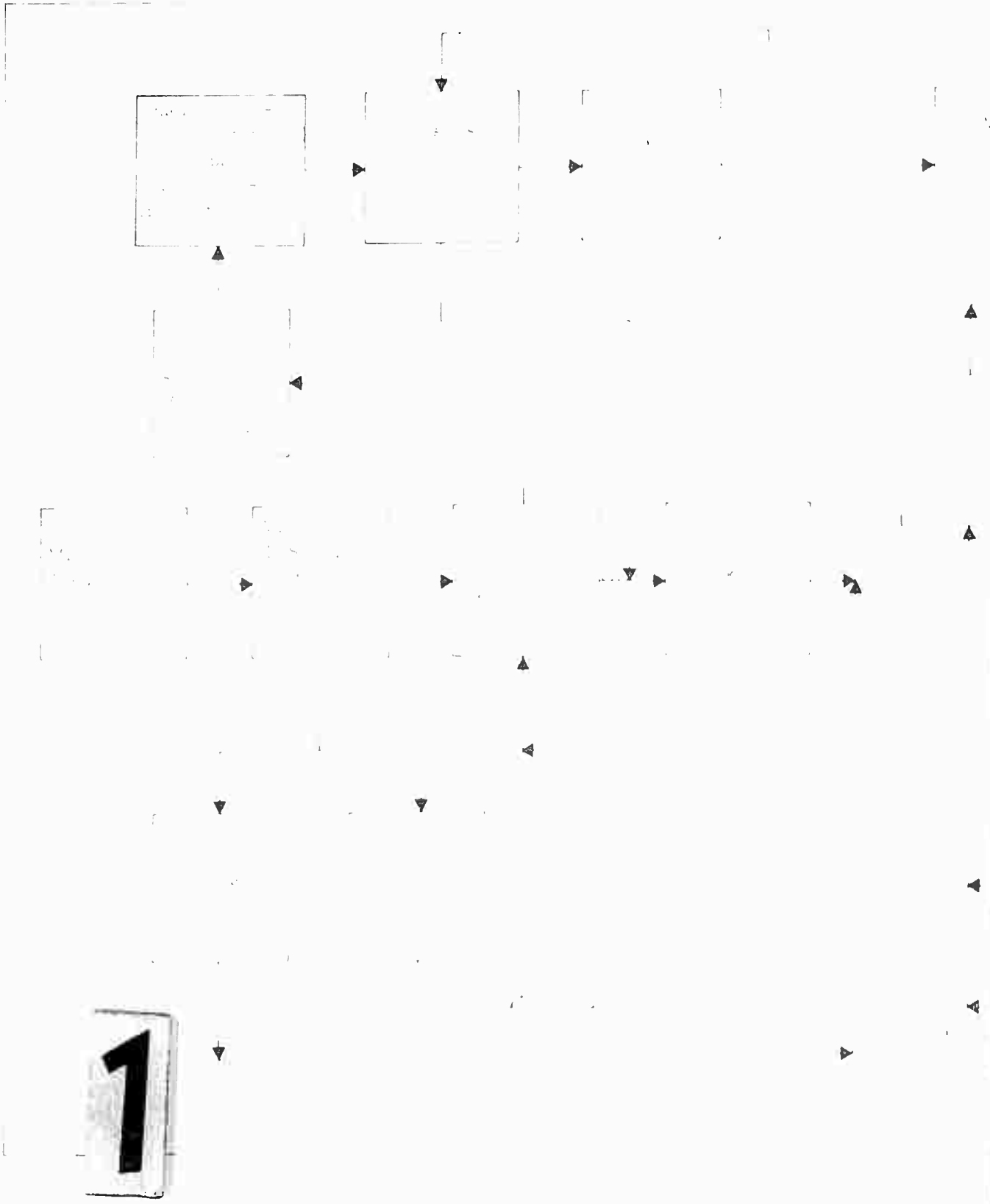

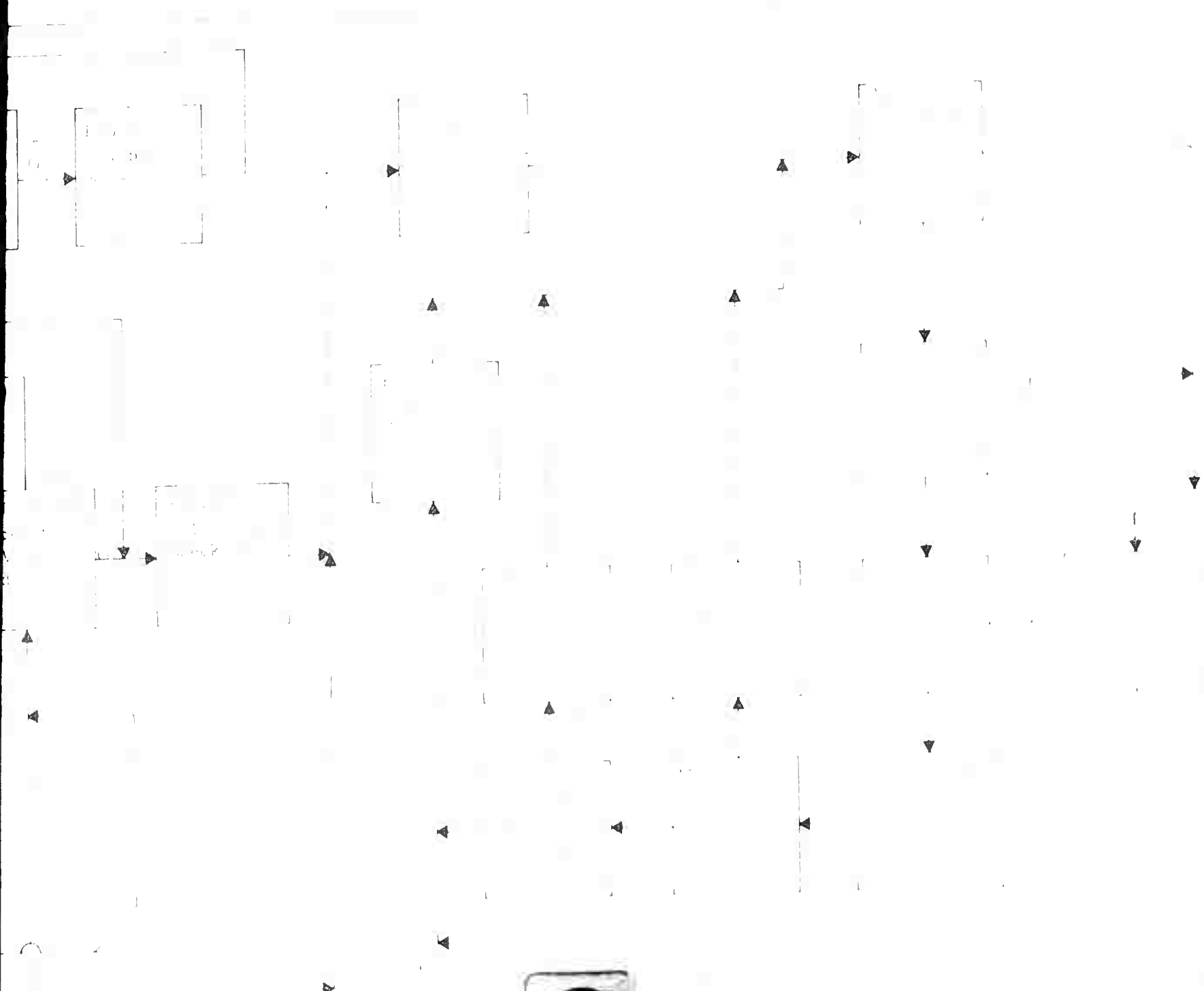

2

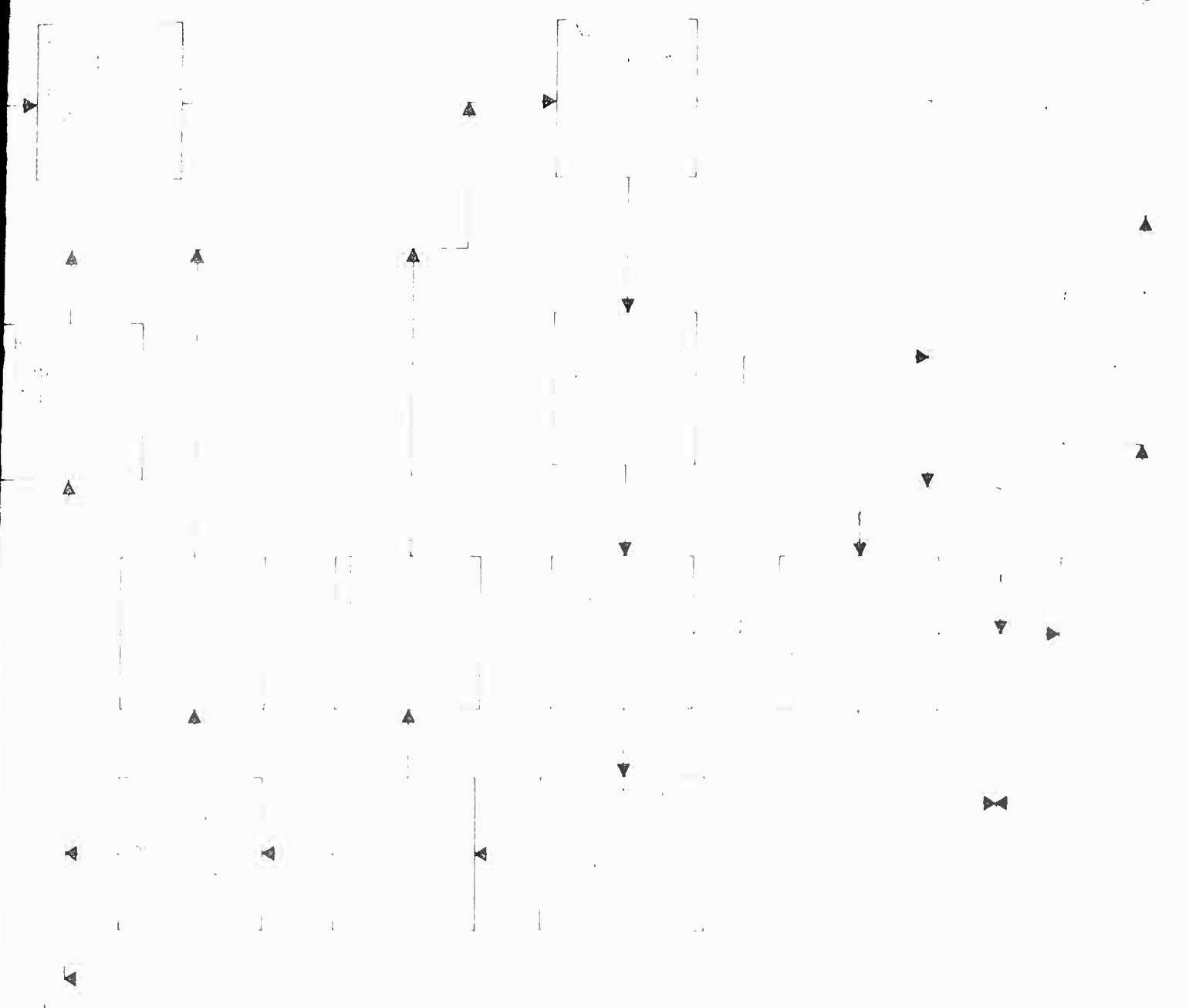

DO 5389B

✓  
SPECIFICATION FOR  
AEROSPACE GROUND EQUIPMENT  
PROPELLANT UTILIZATION SUBSYSTEM  
MODEL PU 136, WSI07A-1 WEAPON SYSTEM  
SM 65 "F" SERIES, SILO LIFT, MISSILE

15 May 1961

AIR FORCE CONTRACT  
AF04 (647)-625

ACOUSTICA ASSOCIATES, INCORPORATED  
10400 AVIATION BOULEVARD  
LOS ANGELES 45, CALIFORNIA

Prepared by

*Stanford*  
Writer, Logistics

Approved by

*Sam J. Mason*  
Chief Project Engineer

Approved by

*Lester Bond Jr.*  
Manager, Logistics

Approved by

*RJ Hurlb*  
Program Director

6105

649

## FORWARD

1. This document outlines the specifications and procedures covering the Acoustica Associates, Inc. Propellant Utilization Missileborne Subsystem and its supporting Aerospace Ground Equipment (AGE).
2. The AGE required to support the PUI36 Subsystem at the CV-A factory is incorporated herein for reference purposes only to further clarify the receiving inspection, missile assembly, and composite checkout phases. This AGE is provisioned in accordance with WDT Exhibit 55-8 and recommended in Acoustica's Test Ground Support Equipment List, DO 5358, Section III.
3. This document supercedes in its entirety Acoustica Document DO 5389A, Specification for Operational Ground Support Equipment System, Propellant Utilization Subsystem Model PUI36, WS107A-1 Weapon System, SM65 "F" Series, Silo Lift Missile, dated 1 December 1960.

## TABLE OF CONTENTS

SECTION I		Page
1.0	Scope	1
SECTION II		
2.0	Applicable Documents	2
2.1	Military Specifications	2
2.2	Bulletins	2
2.3	Exhibits	2
2.4	Non-Government Documents	3
SECTION III		
3.0	The PUI36 Subsystem and Supporting Aerospace Ground Equipment	5
3.1	PUI36 Subsystem	5
3.1.1	Sensor Stillwell Assemblies	5
3.1.2	Computer Assembly	5
3.1.3	Wiring Harness and Tankwall Connector Assemblies	6
3.1.4	Summary of the PU Subsystem Operation	6
3.1.4.1	Input Power Requirements	6
3.1.4.2	Operating Parameters	6
3.2	Aerospace Ground Equipment	8
3.2.1	Computer Analyzer, Model GCA305	8
3.2.2	Portable Sensor Simulator, Model PSS120	9
3.2.3	Portable Sensor Verifier, Model PSV140	9
3.2.4	Computer Holding Fixture, Model CHF100	9
3.3	Support Phases - AGE Requirements	9
3.3.1	Acoustica Factory Bonded Area, Storage and Ship- ment	9
3.3.2	CV-A Factory	11
3.3.3	Missile Assembly and Maintenance Shop	18
3.3.4	Launch Complex	21
3.3.5	Depot	22

SECTION IV		Page
4.0	Quality Assurance Provisions	29
4.1	Design Engineering and Drafting	29
4.2	Government Source Inspection	29
4.3	Material Review Board	29
4.4	In-Process Inspections	29
Appendix A-	Special Test Equipment	30
Appendix B-	Hand Tools	31

## LIST OF ILLUSTRATIONS

<u>FIGURE</u>	<u>TITLE</u>	<u>PAGE</u>
1	Propellant Utilization Subsystem, Model PUI36	7
2	Packaging and Handling Equipment	11
3	Stillwell Test Set, Model TS103	15
4	Computer Test Set, Model TS202MD1	16
5	Calibration Test Set, Model TS206	17
6	System Test Set, Model TS201MD1	19
7	Logistics Support Chart	20
8	Portable Sensor Simulator, Model PSSI20	24
9	Portable Sensor Verifier, Model PSV140	25
10	Computer Analyzer, Model GCA305	26
11	Computer Holding Fixture, Model CHF100	27
12	Flow Chart, PU Subsystem Checkout	28

ABSTRACT

The Propellant Utilization Subsystem <sup>(PUS)</sup>, composed of two <sup>2</sup> sensor stillwell assemblies (fuel and liquid oxygen) and an analog computer, is a propellant management system providing for the simultaneous emptying of both missile propellant tanks. The outlined "factory-to-launch" sequence requires various serviceability and verification tests at specific locations. ~~In order~~ to accomplish these tests, Acoustica Associates, Inc. has developed Aerospace Ground Equipment, thereby ensuring that the end result of maintaining its PU Subsystem in the "first readiness" state is achieved.

SPECIFICATION FOR THE  
PROPELLANT UTILIZATION SUBSYSTEM  
MODEL PU136, WS107A-1 WEAPON SYSTEM  
AND SUPPORTING AEROSPACE GROUND EQUIPMENT

SECTION I

1.0 SCOPE- Acoustica Associates, Inc. has specified herein the requirements for the Aerospace Ground Equipment required to support the "F" Series Operational Propellant Utilization Subsystem, Model PU136. This document outlines the "factory to launch" sequence for the PU Subsystem and its supporting Aerospace Ground Equipment requirements.

## SECTION II

2.0 APPLICABLE DOCUMENTS- The latest issue of the following government specifications, exhibits, and publications shall form a part of this specification.

## 2.1 MILITARY SPECIFICATIONS

MIL-F-25576A	Military Specification Fuel, Rocket Engine, Grade RP-1.
MIL-M-9864A (USAF)	Technical Manuals: Operation and Organizational Maintenance (Missile and Space Weapon Systems).
MIL-M-9891 (USAF)	Technical Manuals: Field Maintenance and Depot overhaul (Missile and Space Weapon Systems).
MIL-O-25508A	Oxygen, Liquid Non Breathing
MIL-P-116C	Preservation, Methods of

## 2.2 BULLETINS

USAF Specification Bulletin 93	Specifications and Related Documents Applicable to Guided Missiles.
--------------------------------	---------------------------------------------------------------------

## 2.3 EXHIBITS

WDTLG Exhibit 56-23C	Electrical Power Coordination Specification for XSM-65, Revision 9, dated 2 September 1959.
WDT Exhibit 57-1	Ground Support Equipment Selection and Provisioning Document for OC Ballistic Missiles.
WDT Exhibit 57-7	Hardware Analysis Program for Ballistic Missile Weapon Systems and Advanced Space Systems.

WDT Exhibit 57-16	Missile/System/Equipment Operational and Maintenance Records.
WDT Exhibit 57-17	Instructions for Serialization Ballistic Missile Components and Assemblies.
WDTC Exhibit 57-29	Test Ground Support Equipment, Spare Parts therefore...; and Pre-Operational Supplies and Services Support for the Activation of Operational Complexes/Squadrons.
WDTC Exhibit 57-36	Specification and Development and Test Program Plan Operational Ground Support Equipment System, Requirements for the Preparation of.
AFBM Exhibit 58-10	Reliability Program for Ballistic Missile and Spare Systems.
AFBM Exhibit 59-6	Contractor Responsibilities for Activation of WS107A-1 All Inertial Training and Operational Sites.
AFBM Exhibit 59-17B	Training Equipment Provisioning for Air Force Ballistic Missile and Weapon Systems.
AFBM Exhibit 59-30	Atlas Unitary Silo Lift, All Inertial Weapon System Specification.

#### 2.4 NON-GOVERNMENT DOCUMENTS

The following Non-Government Documents, of the latest revision in effect on the date of system approval, form a part of this Specification to the extent specified herein.

STL Document GM6300. 4-45	Minimum Environmental Design and Test Requirements for WS107A-1 Silo Lift Weapon System.
STL Document GM6300. 5-653	Personnel Subsystem Basic Data Program for the Atlas Missile.
STL Document GM6300. 5-043	Function Analysis Program-WS107A-1 "Atlas"

CV-A Document  
AP60-0414B

Inspection Requirements Manuals,  
Inspection Sequence Charts, Master  
Sequence Charts, and Special Opera-  
tional Control Requirements, Work  
Card, and Sequence Charts for  
Ballistic Missile Weapon System  
WS107A-1.

CV-A Document  
AP60-0967

Style Guide for preparation of  
Operational Checklist for WS107A-1.

Acoustica Document  
DO 5357A

Propellant Utilization Subsystem,  
Model PUI36, Model Specification  
for

Acoustica Document  
DO 5372

Model Specification, "F" Series  
Ground Support Equipment (R&D  
and Operational).

Acoustica Document  
DO 5383

Detail Specification, Fuel Stillwell,  
Model SF191

Acoustica Document  
DO 5384

Detail Specification, Liquid Oxygen  
Stillwell, Model SL192

Acoustica Document  
DO 5385

Detail Specification, Computer,  
Model CA108

Acoustica Document  
DO 5386

Detail Specification, Portable  
Sensor Simulator, Model PSS120

Acoustica Document  
DO 5387

Detail Specification, Portable  
Sensor Verifier, Model PSV140

## SECTION III

3.0 THE PUI36 SUBSYSTEM AND AEROSPACE GROUND EQUIPMENT

## 3.1 PUI36 SUBSYSTEM

The Propellant Utilization Subsystem provides for the simultaneous emptying of the fuel and liquid oxygen propellant tanks of the missile, with an accuracy to ensure that when either the liquid oxygen or fuel tank becomes empty, the residual propellant will not exceed, by weight, one part in two thousand. The PUI36 Subsystem is comprised of the following major missileborne assemblies:

- a. Sensor Stillwell Assembly, Fuel, Model SF191
- b. Sensor Stillwell Assembly, Liquid Oxygen, Model SL192
- c. Computer Assembly, Model CA108

3.1.1 **SENSOR STILLWELL ASSEMBLIES-** The Fuel and Liquid Oxygen Stillwells (fig. 1) provide rigid mountings for accurate locations and support of the ultrasonic sensors. The sensors detect the receding propellant levels as they are consumed during missile flight. A stilling action within the tubular member of each stillwell assembly minimizes propellant sloshing and provides a sample of the propellant level in each tank. The ultrasonic sensors are placed on each stillwell assembly at seven points (stations), including a location midway between stations 4 and 5 on the lower part of each stillwell, to compensate for variations in booster engine cutoff time. The determination of optimum sensor locations is a critical factor in eliminating errors in the engine mixture ratio. A total of 14 ultrasonic sensors in two independent strings of seven each are employed on each stillwell assembly. These sensors are set in seven dual pods welded to the stillwell, each pod containing one sensor from each string. Only one string utilizing 6 sensors is connected during missile flight; the second, (or alternate) string is available for pre-launch maintenance, or on a stand by and replacement basis if any sensor on the primary string is unserviceable.

3.1.2 **COMPUTER ASSEMBLY-** The Propellant Utilization Subsystem employs a Model CA108 Computer Assembly (fig. 1) to compute and correct errors in the propellant mixture ratio. The computer contains the necessary electronic circuits to accept impulses from the ultrasonic sensors, and to send the appropriate commands to the coil controlling the propellant mixture valve. The circuits are pre-programmed, with sufficient capability to reject false signals. In the event of a computer failure while the missile is in flight, limit switch circuits provide a "fail-safe" feature that prevents excessive correction of the propellant flow rates. Typical functional.

elements of the computer assembly include: Monostable and bistable multivibrators, oscillators, gate circuits, switching matrices, binary-to-analog converters, and a differential amplifier. The computer assembly, weighing approximately 20 pounds, is mounted in the pod compartment of the missile.

### 3.1.3 WIRING HARNESS AND TANKWALL CONNECTOR ASSEMBLIES-

Each sensor string is connected to a separate tankwall connector assembly, mounted on the side of the propellant tanks (fig. 1). One Fuel and one Liquid Oxygen tankwall connectors are connected to the computer assembly by an electrical harness outside the propellant tanks.

### 3.1.4 SUMMARY OF THE PU SUBSYSTEM OPERATION-

The ultrasonic sensors mounted on the stillwell assemblies exhibit a marked change in impedance as the propellant recedes below the sensitive surface of its vibrating crystal. This change in impedance is detected by the computer at each sensor station and converted into error signals. The error signals, indicating the difference in fuel and liquid oxygen levels in the respective propellant tanks, are then modified to provide suitable commands to the control coil of the sustainer engine propellant mixture valve. These commands set the valve at the necessary angle to correct the ratio of propellant consumption. As the propellants pass each level of sensors, the computer switches itself to successive fuel and liquid oxygen sensor stations at the lower levels in the tanks. Since nominal flow rates are known, the computer is designated to reject false commands which indicate the need for excessive correction. The computer determines the amount of correction needed to compensate for the discrepancy in the levels of the two propellants by comparing the actual flow rates with the nominal flow rates. The simultaneous emptying of both propellant tanks is assured.

#### 3.1.4.1 Input Power Requirements-

The missileborne components of the PU136 Subsystem require a power input of 20 watts at 28 volts dc, (maximum).

#### 3.1.4.2 Operating Parameters-

The PU136 Subsystem shall operate within the following parameters, as established in Acoustica Document DO 5357A.

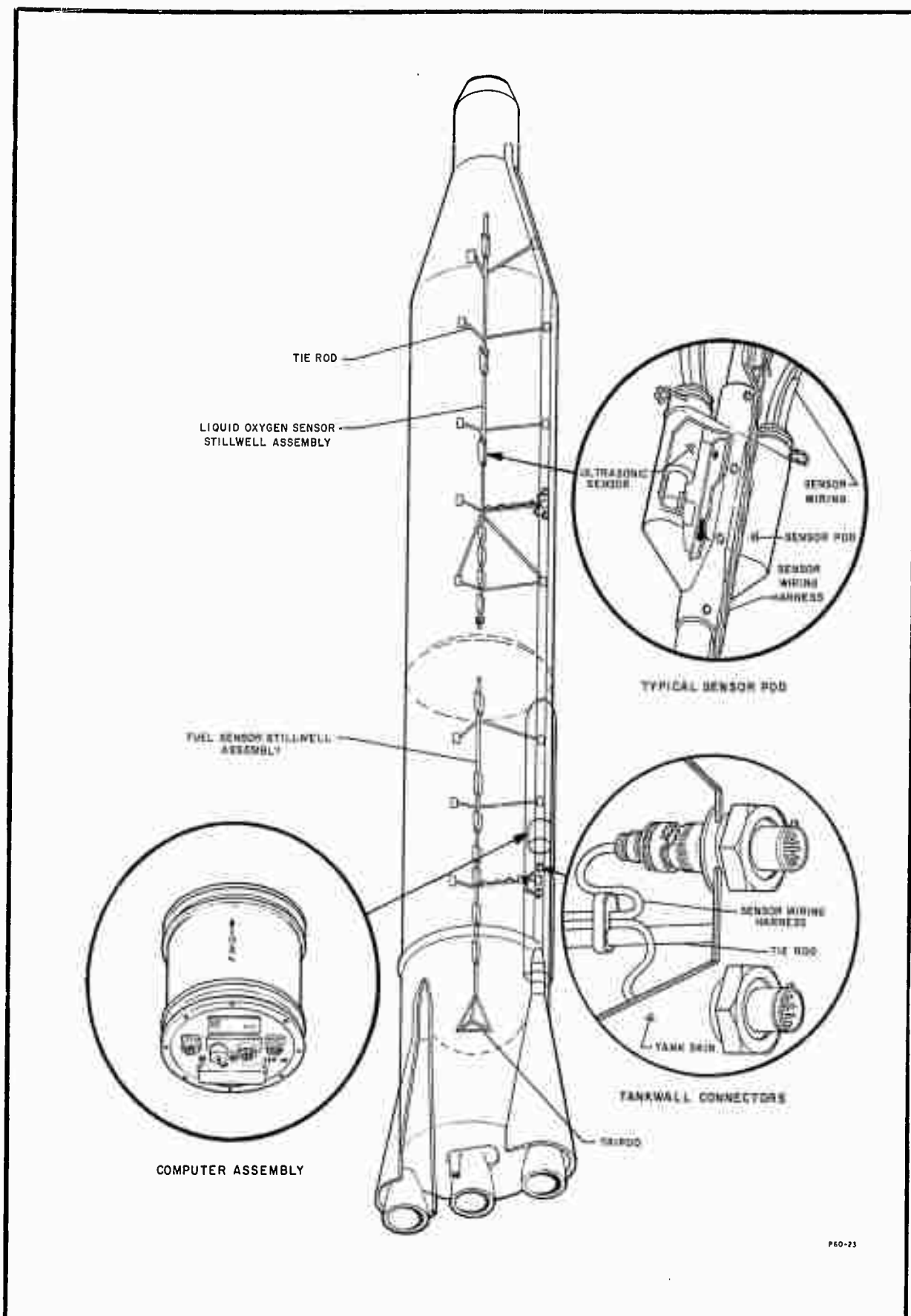

Figure 1 - Propellant Utilization Subsystem

#### 3.1.4.2.1 Ultrasonic Sensor-Fuel, Model AT11M

- a. Unloaded resonant frequency - from 77.0 to 86.0 kc
- b. Unloaded resonant impedance - 16 ohms (maximum)
- c. Loaded resonant impedance - 40 ohms (minimum)

#### 3.1.4.2.2 Ultrasonic Sensors - Liquid Oxygen, Model AT20

- a. Unloaded resonant frequency - from 84.0 to 96.0 kc
- b. Unloaded resonant impedance - 13 ohms (maximum)
- c. Loaded resonant impedance - 30 ohms (minimum)

#### 3.1.4.2.3 Computer Assembly, Model CA108

- a. Utilization response time - 0.5 second (maximum)
- b. Transducer drive voltage - from 40 to 60 vdc
- c. Error counter output voltage - 8 vdc at zero degrees valve angle
- d. Servo feedback voltage - 8 vdc at zero degrees valve angle

### 3.2 AEROSPACE GROUND EQUIPMENT

The following Acoustica Aerospace Ground Equipment is required to support the PU136 Subsystem:

- a. Computer Analyzer, Model GCA305
- b. Portable Sensor Simulator, Model PSS120
- c. Portable Sensor Verifier, Model PSV140
- d. Computer Holding Fixture, Model CHF100

3.2.1 COMPUTER ANALYZER, MODEL GCA305- The Computer Analyzer (fig. 10) an item of Operating Ground Equipment (OGE) is a transistorized console unit designed to perform functional and troubleshooting checks on the computer. The Analyzer will check the computer as a closed system and will tentatively isolate any malfunction to individual modularized computer cards or combinations thereof. Troubleshooting checks to be performed are directed to two major areas of the computer. They are: harness testing and individual card testing. The following commercial test equipment is required with Computer Analyzer:

- (1) Beckman/Berkeley Model 7360 Electronic Counter
- (2) Hewlett-Packard Model 410B VTVM
- (3) Tektronix Model 545 Dual Beam Oscilloscope

3.2.2 PORTABLE SENSOR SIMULATOR, MODEL PSS120- The Portable Sensor Simulator (fig. 8) is a static unit of AGE used to simulate both the mid-range frequency of the fuel and liquid oxygen sensors and the respective maximum sensor unloaded impedances in order to differentiate between a computer and a sensor malfunction. The Portable Sensor Simulator contains seven fuel and seven liquid oxygen sensor simulators, four switch positions, a two foot long cable used to connect the PSS with the computer 2J1 plug, and sensor harness connections.

3.2.3 PORTABLE SENSOR VERIFIER, MODEL PSV140- The Portable Sensor Verifier (fig. 9) is a transistorized item of AGE used to test individual fuel and liquid oxygen sensors on the stillwell assembly in either the "loaded" or "unloaded" condition in order to ascertain whether the sensors' impedance is within governing specifications (see paragraphs 3.1.4.2.1 and 3.1.4.2.2). The PSV's prime purpose and capability is to isolate an unserviceable sensor in either the primary or alternate string of the sensor stillwell assembly.

3.2.4 COMPUTER HOLDING FIXTURE, MODEL CHF100- The Computer Holding Fixture (fig. 11) an item of Maintenance Ground Equipment is a bench-mounted fixture used to hold a computer subassembly in place while it is undergoing detail checkout, troubleshooting, repair, or bench calibration.

### 3.3 SUPPORT PHASES - AGE REQUIREMENTS

The indicated AGE is capable of supporting missileborne hardware, from initial delivery to the Air Force at the Acoustica Factory, to launch operations. Figure 7 reflects the "factory to launch" cycle for the PU136 Subsystem. The phases to be supported in the sequence shown are as follows:

- a. AA Factory Bonded Area, Storage and Shipment.
- b. CV-A Factory (Missile Assembly Area).
- c. Missile Assembly and Maintenance Shops (Operational Base).
- d. Launch Complex.
- e. Depot.

#### 3.3.1 ACOUSTICA FACTORY BONDED AREA, STORAGE AND SHIPMENT

3.3.1.1 Requirements- While stored in the Acoustica bonded area, the PU Subsystem must be properly packaged for protection against environmental hazards, such as dust and humidity. While in transit to the CV-A factory, they must be further protected against shocks.

3.3.1.2 Methods

- a. The sensor stillwell assemblies are mounted on reusable stillwell support fixtures during assembly, storage, and shipment. The tankwall connectors are packed in a sealed polyethylene bag as a loose item. Immediately after Air Force acceptance, each stillwell assembly and support fixture is enveloped in a polyethylene bag, which is sealed, and purged with dry nitrogen. The stillwell assembly and the tankwall connectors are then placed in a metal shipping container for the protection of the sensor stillwell assembly against shock and vibration.
- b. The units are packaged for immediate use.
- c. The computer assembly is placed in an aluminum alloy shipping container which is inside-lined at the top and bottom with plastic foam for protection of the computer against shock and vibration.
- d. The PU Subsystem will be transported to the CV-A factory in accordance with Government transportation documents (DD form 1149).

3.3.1.3 Equipment- The equipment necessary to support the storage and transportation phase is listed in Table 1.

TABLE 1  
PACKAGING AND HANDLING EQUIPMENT

NOMENCLATURE	PART NO.	FIGURE NO.	MODEL SPECIFICATION
Fuel Stillwell Support Fixture, Model HSF503	100325	2	DO 5238
Liquid Oxygen Stillwell Support Fixture, Model HSL504	100335	2	DO 5240
Fuel Stillwell Shipping Container, Model CSF300	50007021-5	2	DO 5028
Liquid Oxygen Stillwell Shipping Container, Model CSL400	50007021-43	2	DO 5028
Computer Shipping Container Assembly, Model AN8026	AN8026	2	DO 5024

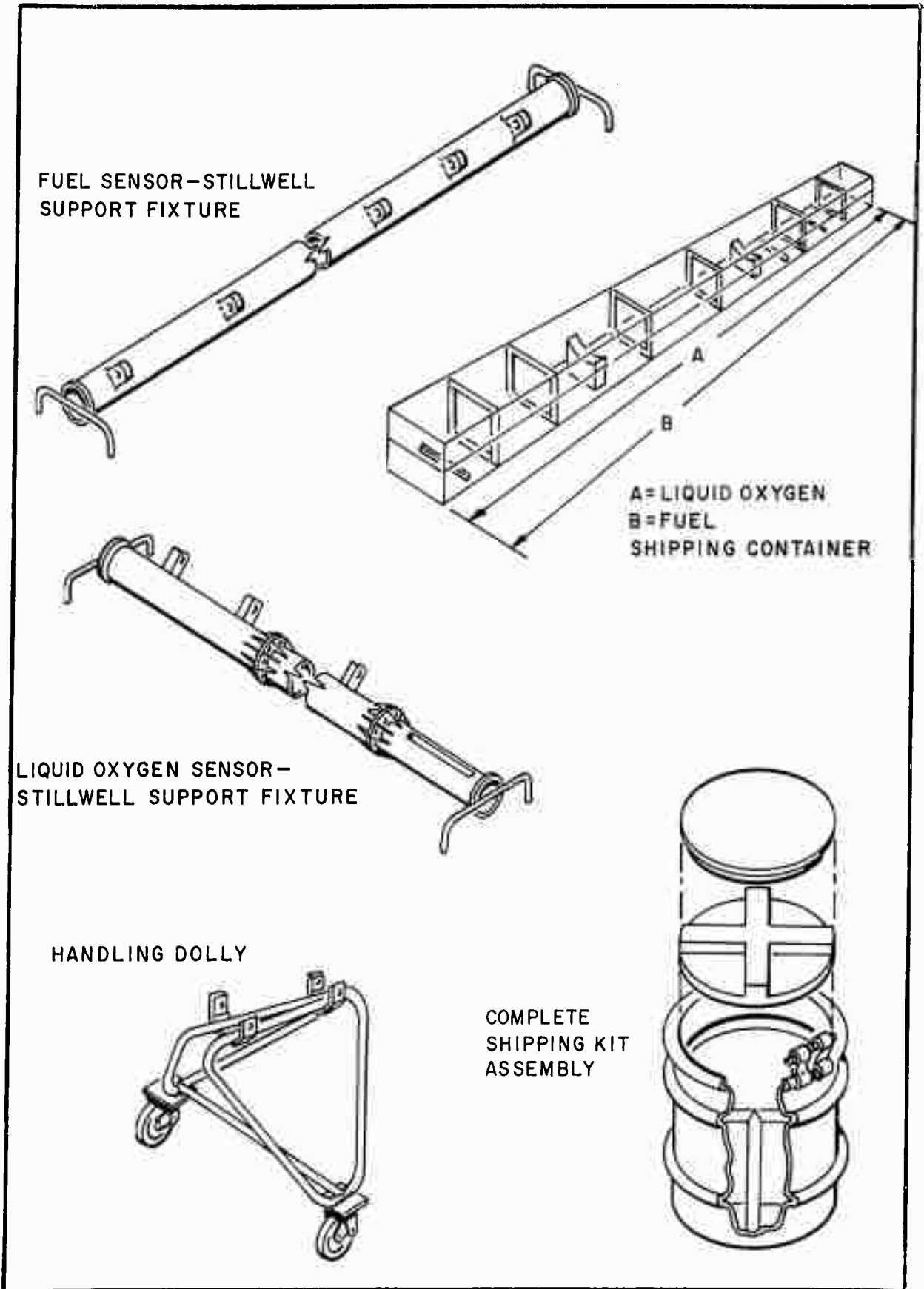

Figure 2 - Packaging and Handling Equipment

3.3.1.3.1 Support fixtures and shipping containers are reusable items, recycled between the Acoustica and CV-A factory bonded areas. These items are required for proper support and packaging of the PU subsystem components and to provide for the necessary protection of these components against damage which may be incurred in transit.

3.3.2 CV-A FACTORY- The PU subsystem undergoes two phases at the CV-A factory. They are:

- a. Receiving Inspection
- b. Missile Assembly and Checkout

3.3.2.1 Requirements - Receiving Inspection- During the receiving inspection phase, Aerospace Ground Equipment is required to support, protect, and functionally check out the PU subsystem assemblies. In addition, a requirement exists to calibrate that test equipment used to support this phase.

3.3.2.2 Methods - Receiving Inspection

- a. At the inspection station, stillwell shipping containers are opened and the stillwells visually inspected. The polyethylene bag is slit to grant access to the harness connectors for functional checkout. The Stillwell Test Set, Model TS103 (fig. 3) is used to perform this functional check. After checkout has been completed, the polyethylene bag is resealed and the shipping containers closed to prevent contamination. The entire assembly is then placed in the CV-A bonded area.
- b. At the inspection station, the computer shipping container is opened, the computer removed, and visually inspected. A functional checkout, utilizing the Computer Test Set, Model TS202MD1 (fig. 4) is then accomplished. The computer is then replaced in its shipping container and transferred to the CV-A bonded area.
- c. The Calibration Test Set, Model TS206 (fig. 5) is used to calibrate the Stillwell and Computer Test Sets at scheduled intervals. Standard commercial test equipment (portable) is employed for periodic test and checkout of the Calibration Test Set.

3.3.2.3 Equipment- AGE required to perform functional checks of the PU Subsystem in the receiving inspection area is listed in Table 2.

TABLE 2  
AGE REQUIRED DURING CV-A RECEIVING INSPECTION

NOMENCLATURE	PART NO.	FIGURE NO.	MODEL SPECIFICATION
Stillwell Test Set, Model TS103	500071001	3	DO 5372
Computer Test Set Model TS202MD1	101396	4	DO 5372
Calibration Test Set, Model TS206	100030	5	DO 5372

3.3.2.4 Requirements - Missile Assembly Area- Aerospace Ground Equipment is required in the CV-A Missile Assembly Area to provide for handling, installation, and functional checkout of the PU subsystem assemblies. In addition, a requirement exists to calibrate those items of test AGE that are used to support this phase at periodic intervals.

3.3.2.5 Methods

- a. Sensor stillwell assemblies are removed from their shipping containers in the CV-A bonded area and mounted, together with their support fixtures, onto handling dollies for ease of transportation to the missile. Polyethylene bags are removed and the stillwell assemblies installed into the missile propellant tanks. When the tie-rods of each stillwell have been attached to the appropriate mounting brackets in the tanks, and the location of each stillwell has been carefully inspected, the support fixtures are removed. Tankwall connectors are then installed. The stillwells are now ready for post-installation checkout, to be performed with a Stillwell Test Set, Model TS103.
- b. At a later stage of overall missile buildup, the computer assembly is removed from its shipping container and installed in the missile's accessory pod. The computer then undergoes post-installation checkout, utilizing a Computer Test Set, Model TS202MD1.

- c. After the missile has been completely assembled, the Propellant Utilization Subsystem undergoes composite testing. This is accomplished by the System Test Set, Model TS201MD1. (fig. 6).
- d. The Calibration Test Set, used in the receiving inspection station at CV-A is employed to calibrate the Stillwell Test Set, Computer Test Set, and System Test Set at regular intervals.
- e. Prior to final Air Force acceptance at the CV-A Factory the missile and all major subsystems including the installed PU Subsystem undergoes functional APCHE checkout (open and closed loop). The APCHE will indicate either a "GO" or "NO GO" condition. If a "GO" status is obtained, the PU checkout is considered completed. If the APCHE indicates "NO GO", the PU subsystem will be rechecked, utilizing the Portable Sensor Simulator, Model PSS120, to isolate the malfunction either to the computer or to the stillwell assemblies.
- f. An unserviceable computer will be removed and returned to the Acoustica factory for repair. If the APCHE "NO GO" condition is due to an unserviceable stillwell assembly, the Portable Sensor Verifier, Model PSV140 will be employed to isolate the specific sensor or sensors that have malfunctioned. Elimination of the unserviceable sensor (s) from the system will be accomplished by replacing the sensor with a like serviceable item. Sensor-Stillwell Assemblies will-after any repair meet the cleanliness requirements of Acoustica DO 5383 or DO 5384, as applicable. Unserviceable sensors will be scrapped.

3.3.2.6 Equipment- AGE required to support the missile assembly and composite checkout phases are listed in Table 3. (see page 18)



Figure 3 - Stillwell Test Set

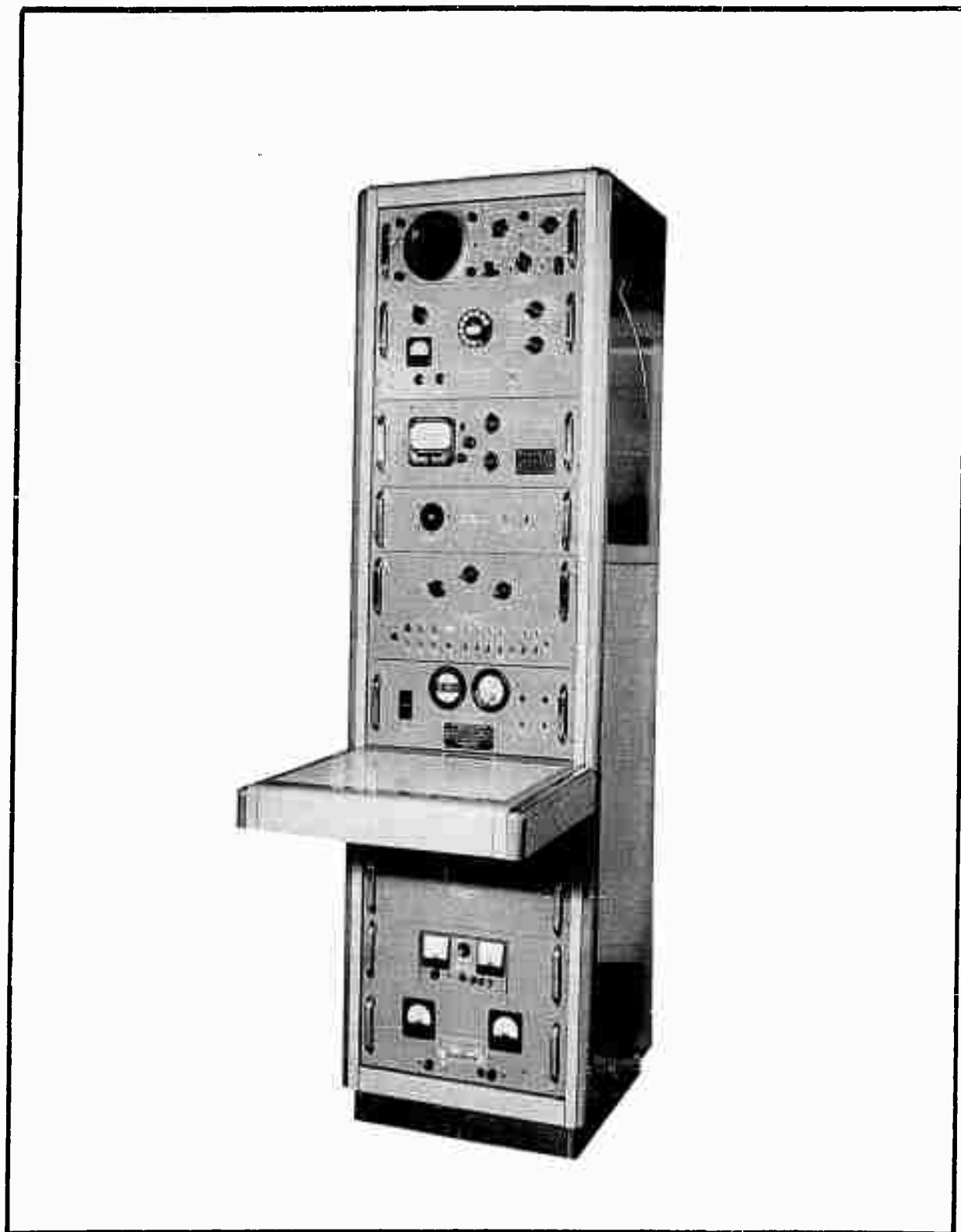

Figure 4 - Computer Test Set



Figure 5 - Calibration Test Set

TABLE 3  
AGE REQUIRED DURING MISSILE ASSEMBLY AND COMPOSITE  
CHECKOUT

NOMENCLATURE	PART NO.	FIGURE NO.	MODEL SPECIFICATION
Handling Dolly, Model HD203	50007002	2	DO 280
Stillwell Test Set, Model TS103	500071001	3	DO 5372
Computer Test Set, Model TS202MD1	101396	4	DO 5372
System Test Set, Model TS201MD1	101395	6	DO 5372
Portable Sensor Simulator, Model PSS120	101516	8	DO 5372
Portable Sensor Verifier, Model PSV140	101515	9	DO 5372

3.3.3 MISSILE ASSEMBLY AND MAINTENANCE SHOP-OPERATIONAL AIR FORCE BASE- After the missile has successfully undergone APCHE checkout in the CV-A factory, and is accepted by the Air Force, it is transported to the Missile Assembly and Maintenance Shop (Squadron Maintenance Area). Since the PU subsystem will already be aboard, this phase is accomplished under appropriate CV-A specifications, and Acoustica furnished AGE will not be required.

3.3.3.1 Missile Checkout-Receiving Inspection

3.3.3.1.1 Requirements- Upon arrival from the CV-A factory, the missile and all major installed subsystems must undergo composite checkout in the SMA receiving inspection area prior to its transfer to the launch complex.

3.3.3.1.2 Methods- The PU Subsystem undergoes functional APCHE checkout (open and closed loop), employing the method used during missile final inspection at the CV-A factory.

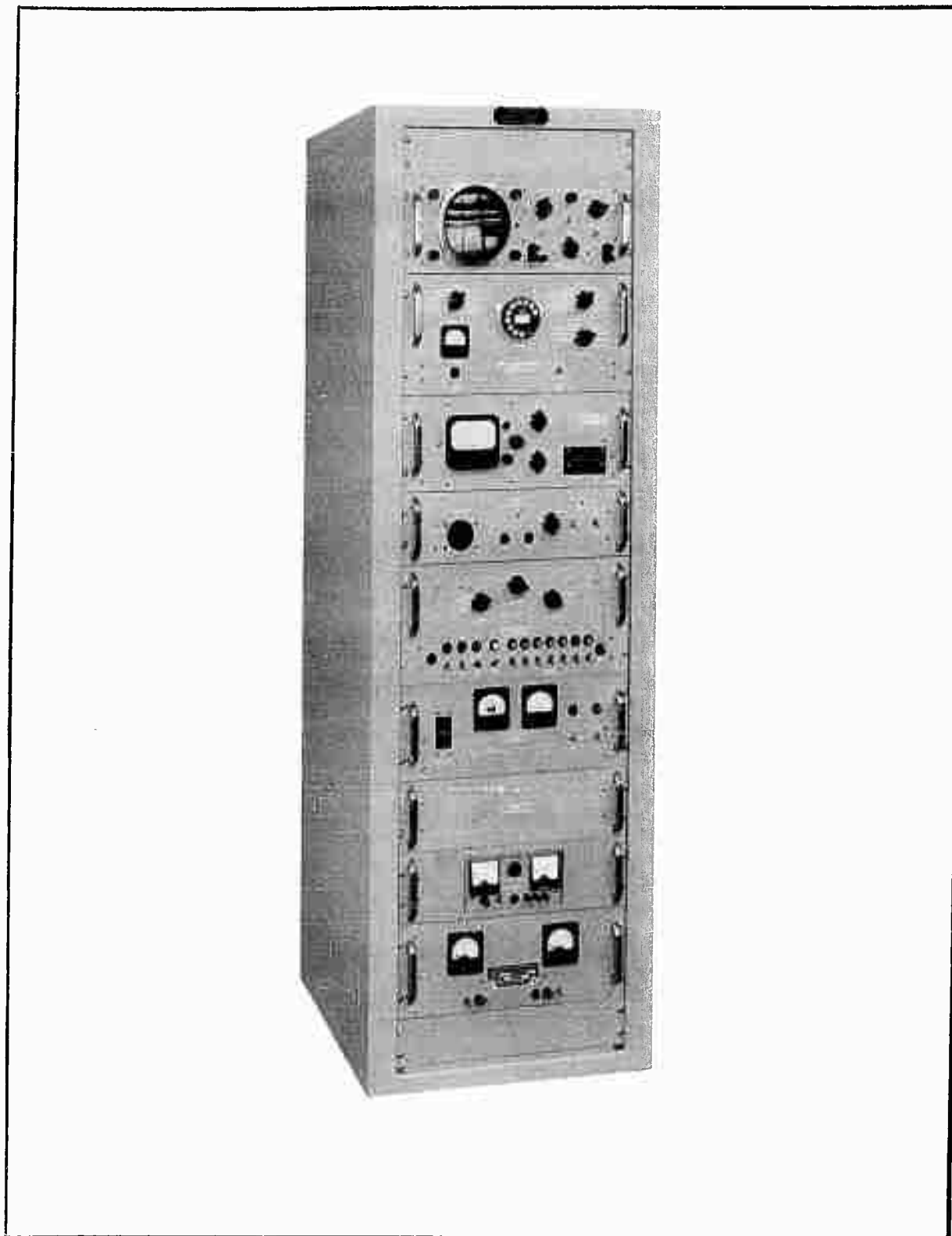

Figure 6 - System Test Set

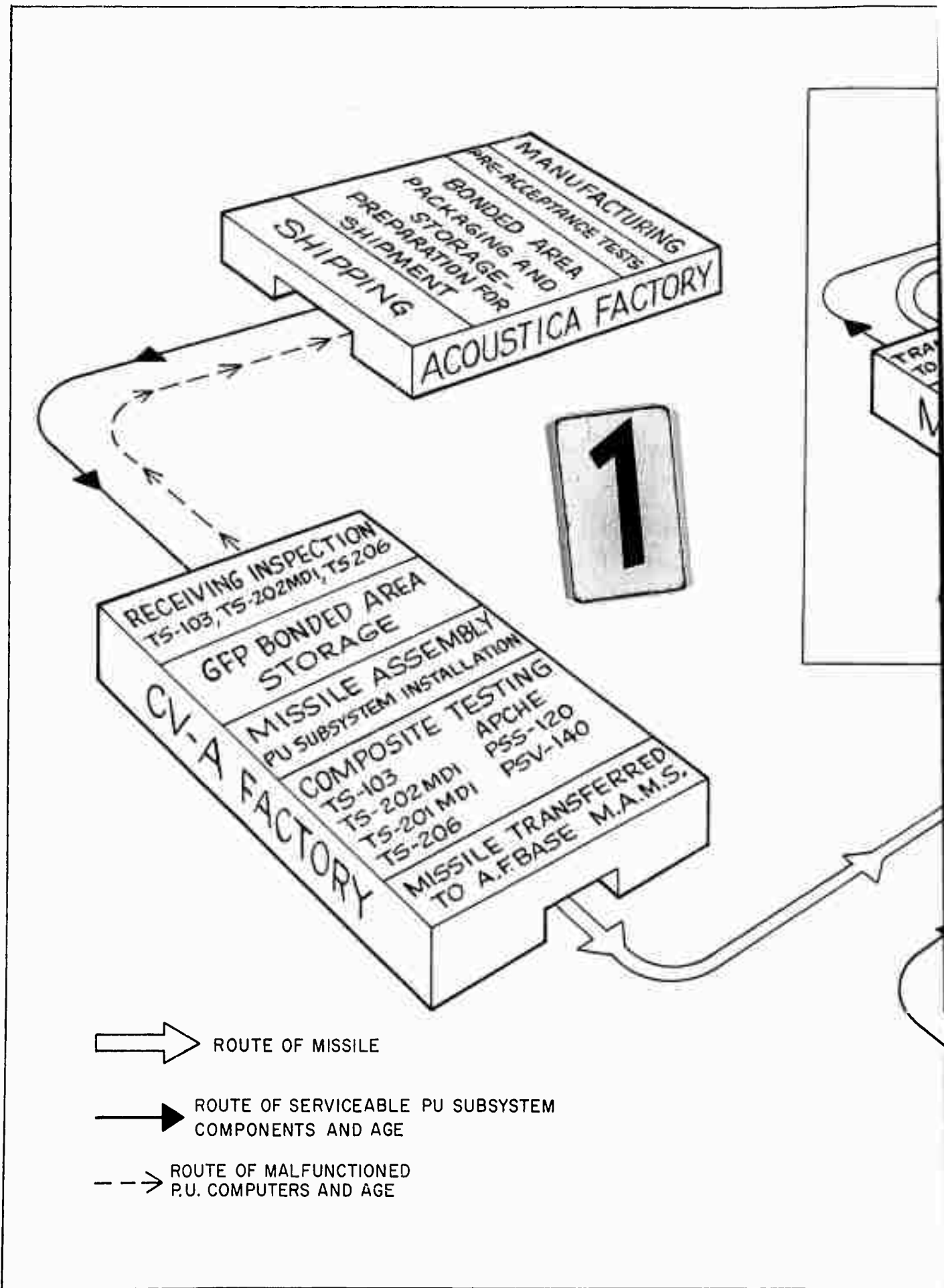

Figure 7. Logistics Support

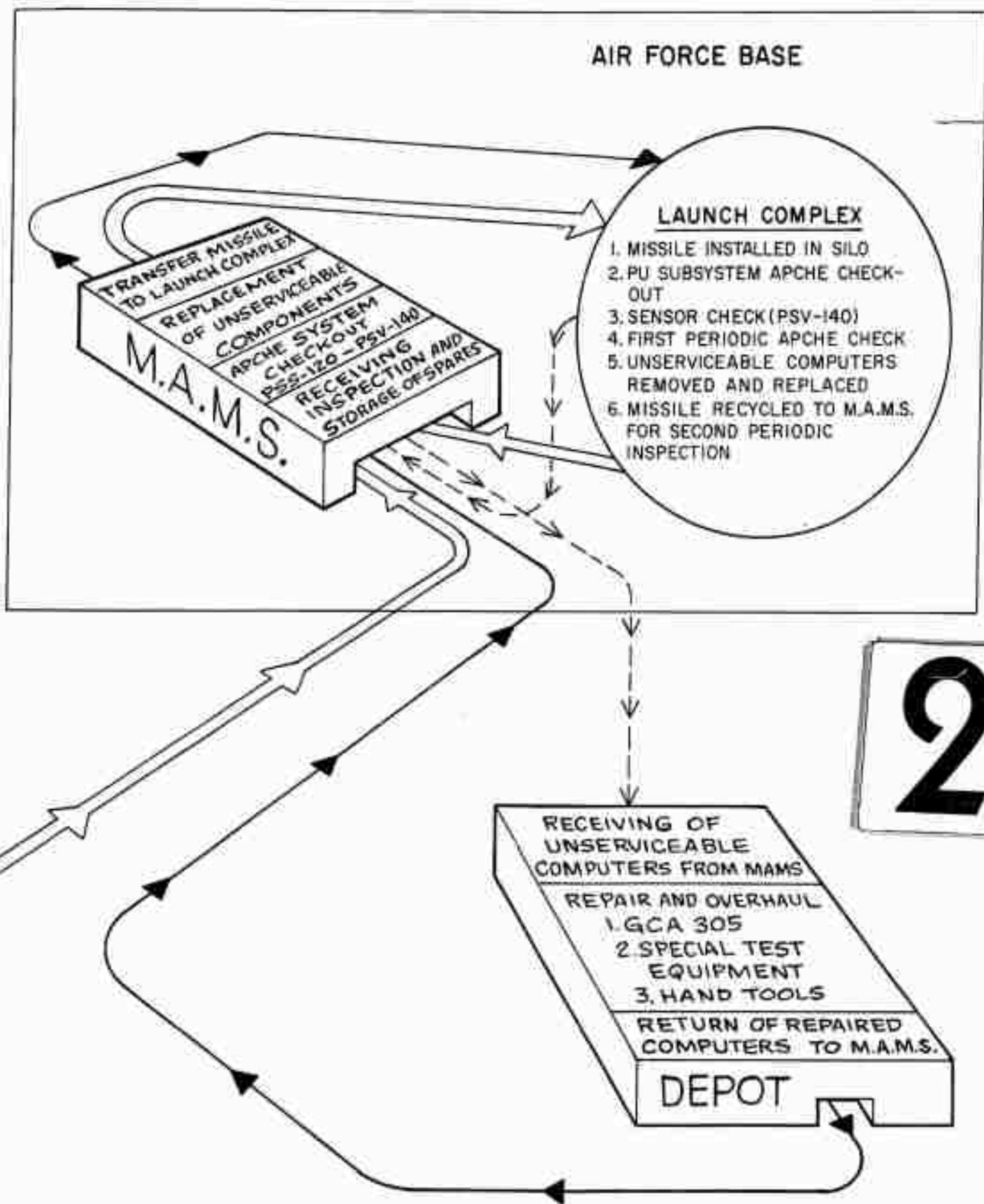

Figure 7. Logistics Support Flow Chart

3.3.3.1.3 Equipment- AGE required to support the SMA checkout phase is listed in Table 4.

3.3.3.1.4 Maintenance- Unserviceable Portable Sensor Verifiers and Portable Sensor Simulators will be periodically checked and repaired, as necessary to the component level at the base MAMS employing available Government furnished (AFS) hand tools and test equipment. (see Appendix A and B). Unserviceable sensors will be replaced at the MAMS by a mobile depot maintenance team. The cleanliness requirements stated in Acoustica DO 5383 or DO 5384 will be maintained and/or reestablished after any repair to the Sensor Stillwell Assemblies. Unserviceable computers will be removed and replaced, and forwarded to the Depot for repairs.

TABLE 4

## AGE REQUIRED DURING SMA MISSILE CHECKOUT

NOMENCLATURE	PART NO.	FIGURE NO.	MODEL SPECIFICATION
Portable Sensor Simulator, Model PSS120	101516	8	DO 5372
Portable Sensor Verifier, Model PSV140	101515	9	DO 5372

3.3.4 LAUNCH COMPLEX- All operations at the launch complex are directed towards maintaining the "first readiness" state of the missile. Consequently, periodic schedules of missile subsystem checkouts, utilizing the mobile CV-A APCHE have been established.

3.3.4.1 Requirements- AGE required to support this phase is transported in the mobile CV-A APCHE trailer, and is identical to that required to support the MAMS missile receiving inspection phase.

3.3.4.2 Method- The PU subsystem aboard each silo-installed missile undergoes APCHE checkout every 90 days (first periodic inspection). The method employed is the same as that used during missile receiving inspection at the Squadron Maintenance Area. All required maintenance will be restricted to the "remove and replace" and "verification" concept. Each missile is recycled to the MAMS area every 180 days for subsystems checkout, servicing, and overhaul (second periodic inspection). The PU subsystem undergoes APCHE checkout, employing the same methods and AGE used during initial missile receiving inspection (see para. 3.3.3.1.2).

- 3.3.4.3 Equipment- See Table 4 for the AGE required to support this phase.
- 3.3.4.4 Maintenance- Unserviceable Computers will be removed and replaced, and forwarded to the MAMS for ultimate transfer to the Depot for repair. Unserviceable sensors will be eliminated from the system in one of two ways:
- a. By switching to the alternate stillwell sensor string (external to the propellant tanks, at the tankwall).
  - b. By substituting a serviceable sensor in the alternate string for the malfunctioned sensor in the operational string utilizing a patch board and cable.
- 3.3.5 DEPOT- All repairs performed on computers will be accomplished at the Depot.
- 3.3.5.1 Requirements- Acoustica AGE, Government-furnished (AFS) test equipment, and selected hand tools are required to support the depot repair and overhaul phase.
- 3.3.5.2 Methods
- a. Repairable computers will be transported to the Depot from the Missile Assembly and Maintenance Shops. The Computer Analyzer, Model GCA305 will be employed to check out and troubleshoot the computer assembly. Necessary repairs will be accomplished to the component card level. Dessicant indicators and dessicant bags will be removed and replaced each time the cannister is opened. After repairs have been completed, the cannister will be closed, purged with dry nitrogen, sealed, and safety-wired. Computer calibration and adjustment will be accomplished as required.
  - b. Unserviceable AGE on which repairs cannot be accomplished at the MAMS will undergo checkout, utilizing special test equipment outlined in Appendix A. AGE will be repaired and/or overhauled to the component level as required, re-assembled, and rechecked. Calibration and adjustment will be accomplished, if required.
  - c. When the serviceability of PU subsystem end items and AGE has been re-attained, they will be packaged for storage and transportation in accordance with paragraph 3.3.1.2.
- 3.3.5.3 Equipment- The AGE listed in Table 5 is required to support the Depot phase.

TABLE 5  
ACOUSTICA AGE REQUIRED TO SUPPORT DEPOT PHASE

NOMENCLATURE	PART NO.	FIGURE NO.	MODEL SPECIFICATION
Computer Analyzer, Model GCA305	101180	10	None
Computer Holding Fixture, Model CHF100	102035	11	None

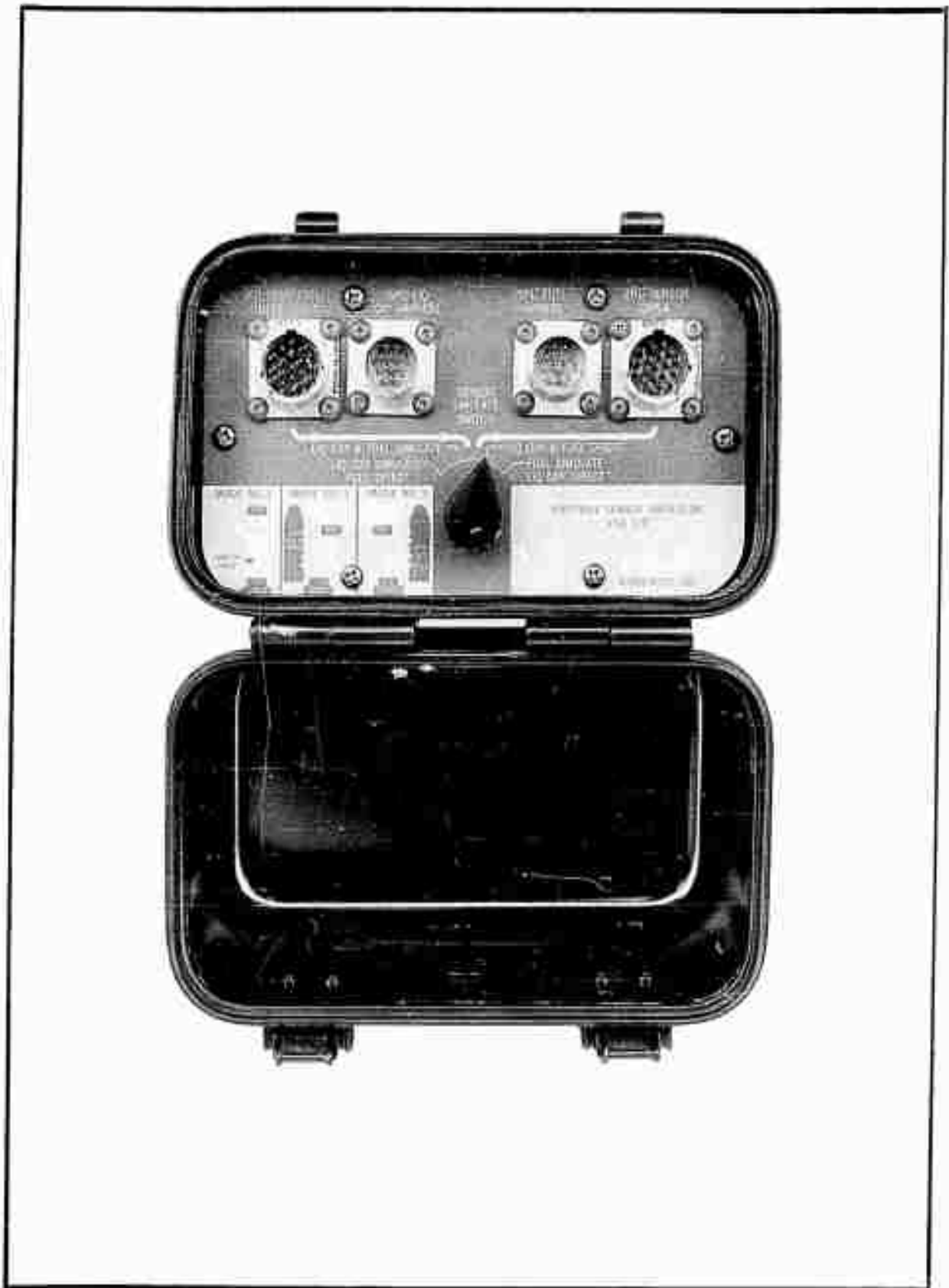

Figure 8 - Portable Sensor Simulator

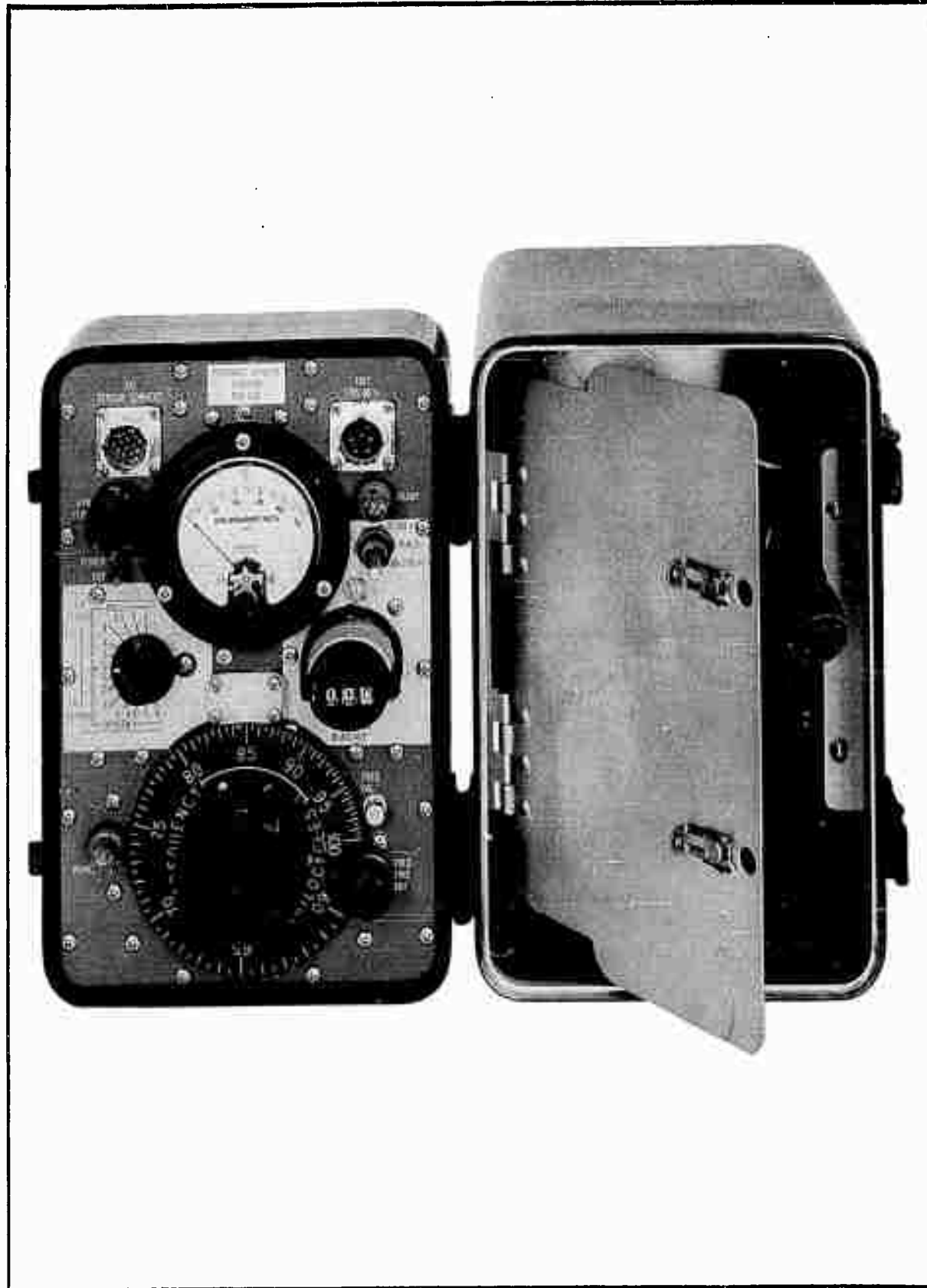
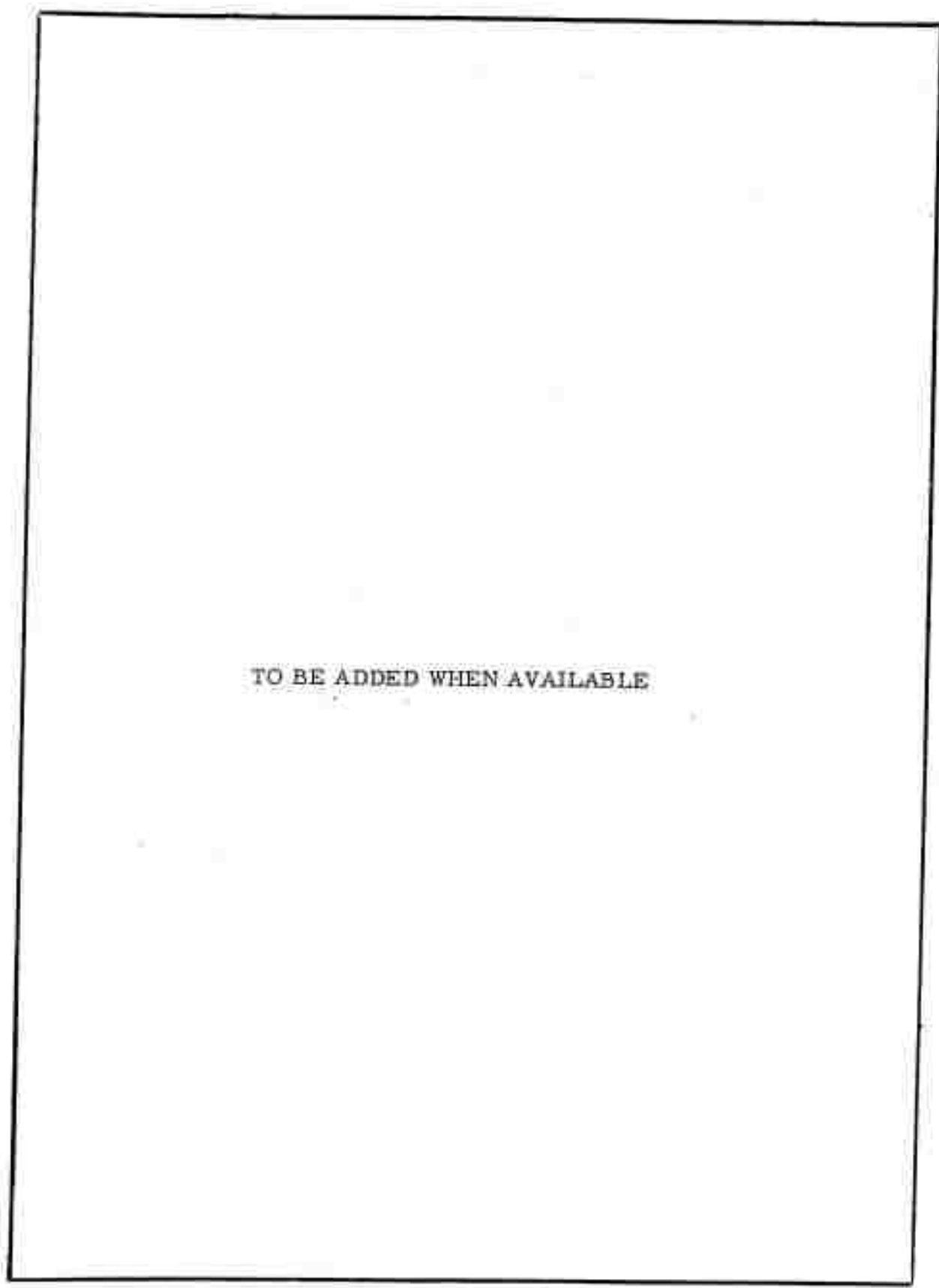

Figure 9 - Portable Sensor Verifier



TO BE ADDED WHEN AVAILABLE

Figure 10 - Computer Analyzer

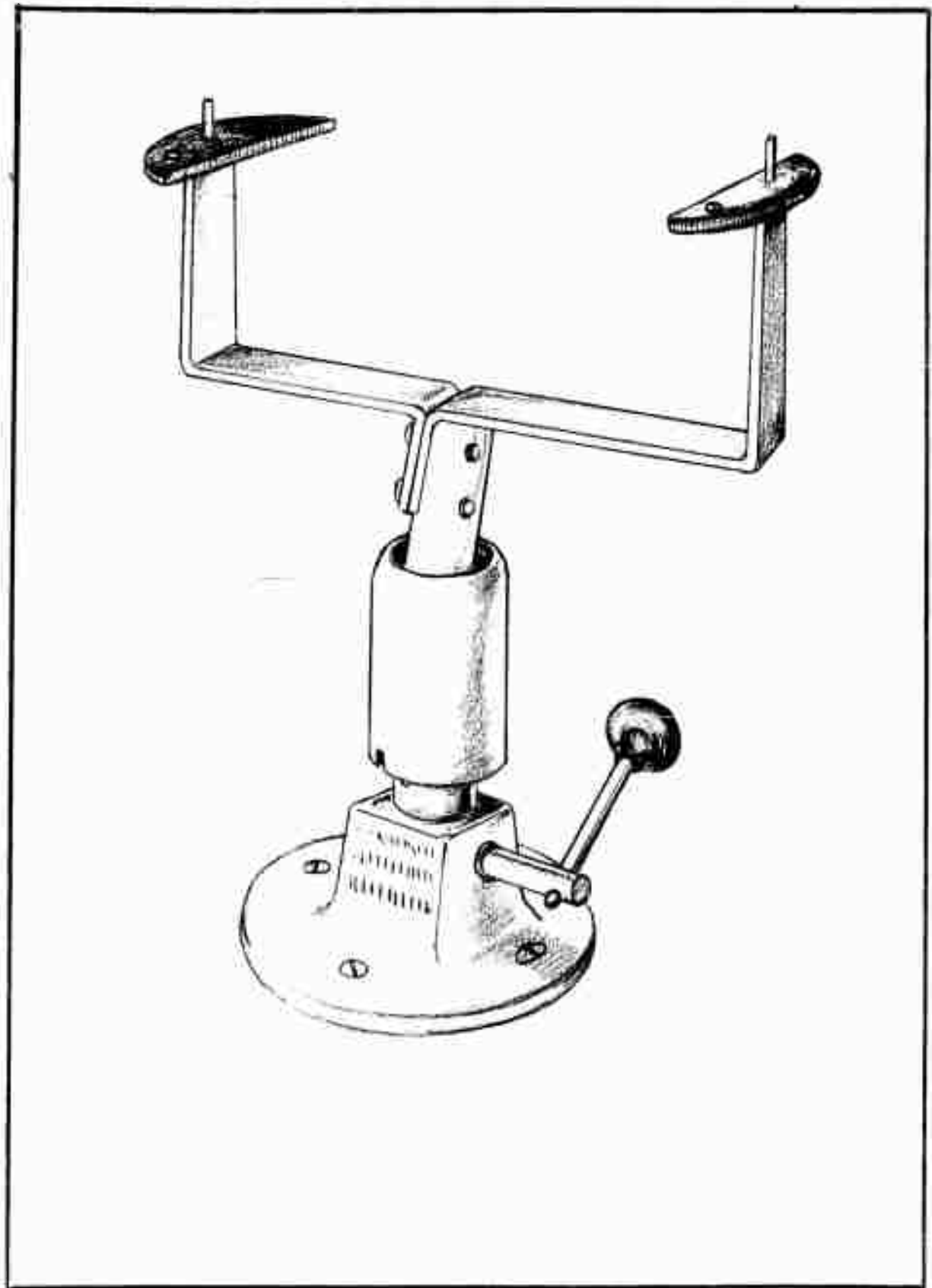
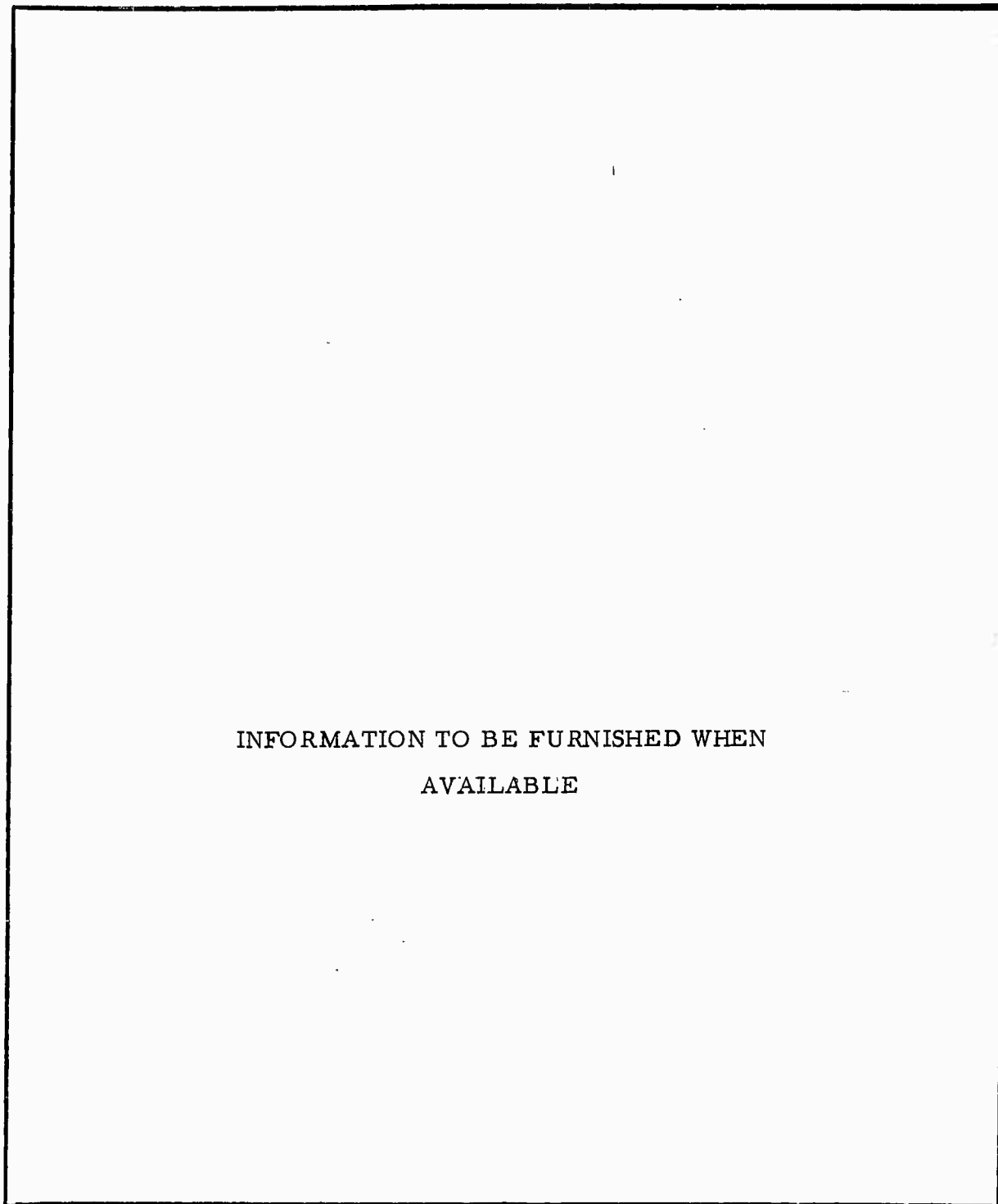

Figure 11 - Computer Holding Fixture



INFORMATION TO BE FURNISHED WHEN  
AVAILABLE

Figure - 12 Flow Chart, PU Subsystem Checkout

## SECTION IV

4.0 QUALITY ASSURANCE PROVISIONS

In order to ensure that contractor furnished equipment is manufactured and delivered to the Air Force under the highest possible conditions of reliability and quality, Acoustica Associates, Inc. has established policies in regards to the following dependent factors of quality assurance:

- a. Design Engineering and Drafting
- b. Government Source Inspection
- c. Material Review Board
- d. In-process Inspections

## 4.1 DESIGN ENGINEERING AND DRAFTING

Design Engineering is the starting point of the product's reliability and quality. It is the responsibility and the policy of the Acoustica Design Engineering group to ensure that all products designed for a military application conform to appropriate military specifications and customer requirements, and that provisions for reliability are engineered into the product's basic designs and finalized prints.

## 4.2 GOVERNMENT SOURCE INSPECTION

The resident Air Force Quality Control Representative establishes policy lists of those purchased components that must be Government source-inspected at the vendor or subcontractor. It is mandatory that such purchased items bear certification of government acceptance at the vendor prior to acceptance by Acoustica Associates, Inc.

## 4.3 MATERIAL REVIEW BOARD

It is a responsibility of the Material Review Board to ensure the maintaining of product quality. This is accomplished in the following ways:

- a. By continuous surveys of material received to assure conformance by specifications, tolerance, and standards.
- b. By rejection of materials or items not conforming to specifications and tolerances, and items on which required Government Source Inspection is lacking.
- c. By recommendations to the Design and Engineering groups of suitable substitutes of material having a high rejection rate.

## 4.4 IN-PROCESS INSPECTIONS

It is the responsibility of the Acoustica Quality Control Department to conduct manufacturing in-process inspections to ensure that the fabrication or manufacture of a military product is consistent with customer requirements. Proper application of Quality Control techniques serves as a preventative tool to avoid serious production and technological problems that may affect the product's quality and reliability.

APPENDIX A  
SPECIAL TEST EQUIPMENT

1.0 The following Special Test Equipment is Government furnished (AFS) and is required in the Depot and MAMS.

NOMENCLATURE	MANUFACTURER AND MODEL NO.	USEAGE-MAAMS AREA	USEAGE, DEPOT
Oscilloscope, Dual Beam	Tektronix, Model 545	Measure wave forms of PSV140	In conjunction with GCA305 for computer checkout
Voltmeter, Electronic	Hewlett-Packard Model 410B	Calibrate and troubleshoot PSV120 and PSV140	In conjunction with GCA305 for computer checkout
Electronic Counter	Beckman/Berkeley Model 7360	Troubleshoot PSV140	In conjunction with GCA305 for computer checkout
Transistor Tester	Sierra Model 219A	Test PSV140 transistors	Test GCA305 transistors
Oscillator, wide Range	Hewlett-Packard Model 200CD	Calibreate PSV 120 following repairs	Adjust VFO on computer card #1 during repairs
Decade Resistance Box	General Radio Corp. Model 1432F	Calibrate PSV140 following repairs	Detail computer card checkout
Oscilloscope Dolly		Hold and transport Oscilloscope	Hold and transport Oscilloscope

APPENDIX B  
HAND TOOL REQUIREMENTS

- 1.0 The following Hand Tools are Government furnished (AFS) and are required in the Launch Area, MAMS, and the Depot.

NOMENCLATURE	LOCATION
Torque wrench, 1/2 in. drive, 0-100 in. lb. capacity	Silo, MAMS, Depot
Adapter, socket wrench, 3/8M to 1/2 F square	Silo, MAMS, Depot
Crowfoot attachment, non ratcheting open end, 3/8 in. square drive, 7/16 in. opening	Silo, MAMS, Depot
Pliers, long nose, W/cutter, 6 in. nominal size	Silo, MAMS, Depot
Screwdriver, crosstip, Phillips No. 1 and 2	Silo, MAMS, Depot
Diagonal cutting pliers	Silo, MAMS, Depot
Flat tip screwdriver 3/8 in. width tip	Silo, MAMS, Depot
Flat tip screwdriver 5/16 in. width tip	Silo, MAMS, Depot
Open end wrench, fixed double style 15 deg. angle 11/32 and 3/8 openings	Silo, MAMS, Depot
Open end wrench, double head, 5/8 and 11/16 in. openings	Silo, MAMS, Depot

## Hand Tools (Continued)

NOMENCLATURE	LOCATION
Open end wrench, double head, 3/8 and 7/16 inch openings	Silo, MAMS, Depot
Open end wrench, double head, 9/16 and 3/4 inch openings	Silo, MAMS, Depot
Open end wrench, box, single head, 7/8 in. opening	Silo, MAMS, Depot
Spin-tite wrench set, 3/16" to 5/8"	Silo, MAMS, Depot
Electric Soldering Iron, 3/4 lb. 110v 25w ac.	Silo, MAMS, Depot
Wire Strippers, thermal, with transformer box and nichrome heating element	Silo, MAMS, Depot
Safety wire pliers M80-57	Silo, MAMS, Depot
Soldering Aid, fork type, spade reamer tip	MAMS and Depot
Soldering Iron, 6v, 25w, with assorted tips	MAMS and Depot
Soldering Iron Transformer	MAMS and Depot

FOR ERRATA

AD 267 199

THE FOLLOWING PAGES ARE CHANGES

TO BASIC DOCUMENT

ACOUSTICA ASSOCIATES, INCORPORATED  
Los Angeles, California

DO 5389B  
29 September 1961  
Amendment 1

12

267199

267199

SPECIFICATION FOR  
AEROSPACE GROUND EQUIPMENT  
PROPELLANT UTILIZATION SUBSYSTEM  
MODEL PU 136, WS107A-1 WEAPON SYSTEM  
SM 65 "F" SERIES, SILO LIFT, MISSILE

AIR FORCE CONTRACT  
AF04 (647)- 625

Approved by: M. M. Allen  
Manager, Logistics

Approved by: [Signature]  
Manager, Product Support

Approved by: [Signature]  
Program Director

**NOTE:** Do not return  
to TDC Destroy  
according to applicable  
security regulations.

(a) Page ii (Table of Contents)

Add

3.2.5 SENSOR REPLACING TOOL, MODEL SRT100 9

MAINTENANCE FUNCTIONAL FLOW CHARTS 28A thru 28D

(b) Page 9:

Add paragraph:

3.2.5 SENSOR REPLACING TOOL, MODEL SRT100. This tool is provided at the MAMS for removal and insertion of roll pins which secure the sensors in their pods on the stillwell assemblies. It provides an efficient reliable means of removing and replacing the pins. The tool weighs approximately 1/2 pound and is fabricated of stainless steel. Action is that of a screw press.

(c) Page 28:

Remove and replace this page with the maintenance functional flow charts attached. (28A, 28B, 28C and 28D).

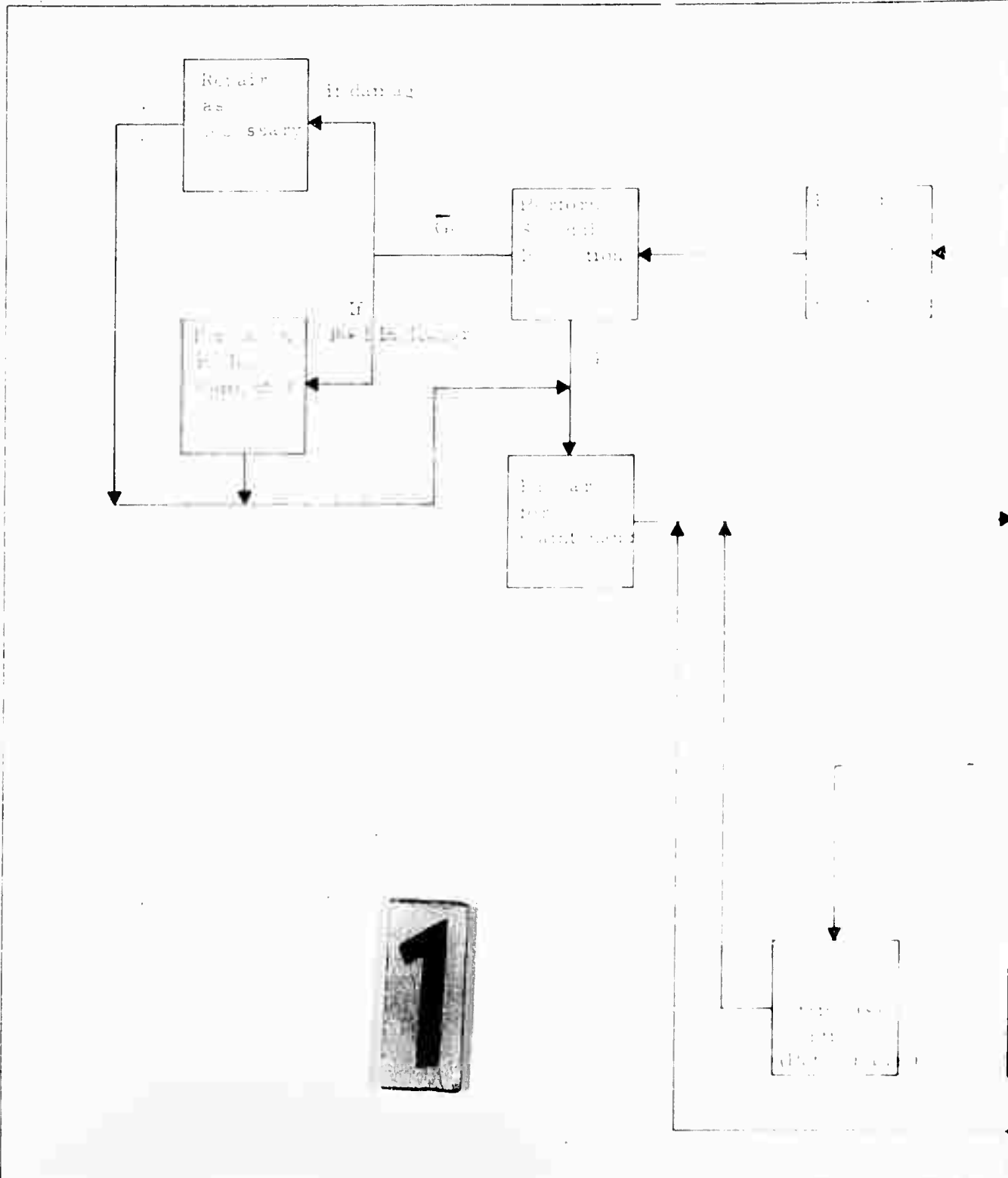

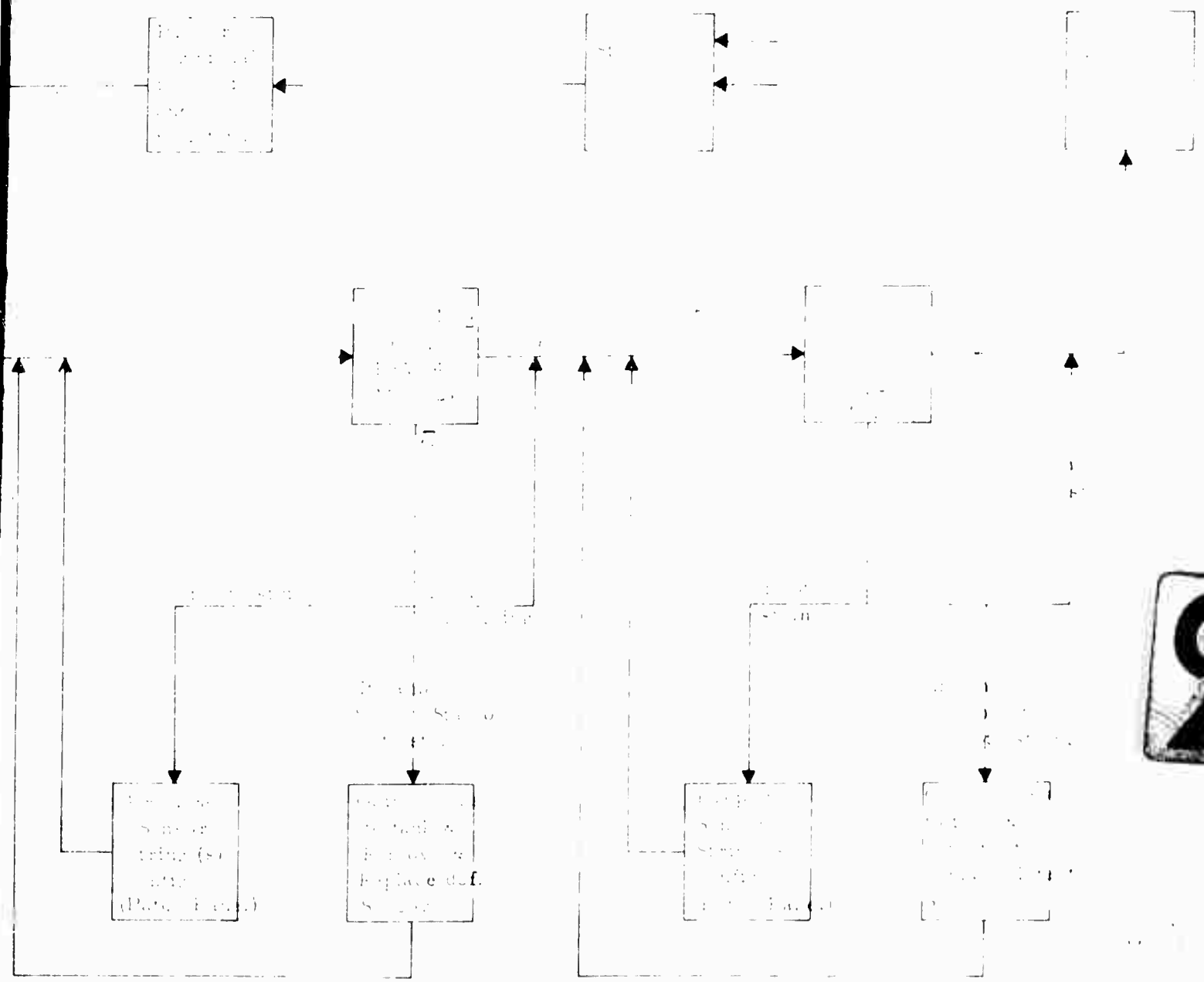

2

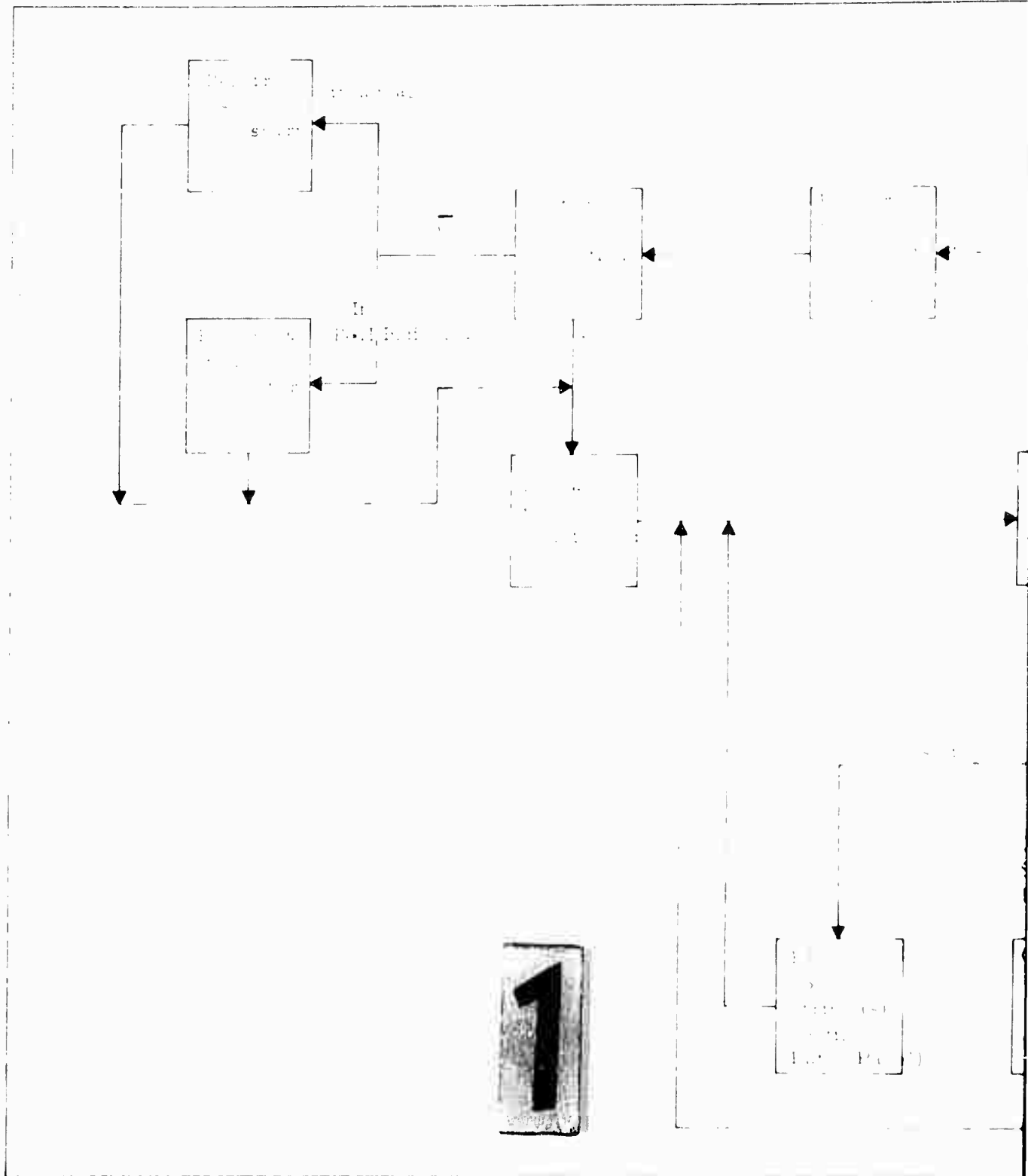

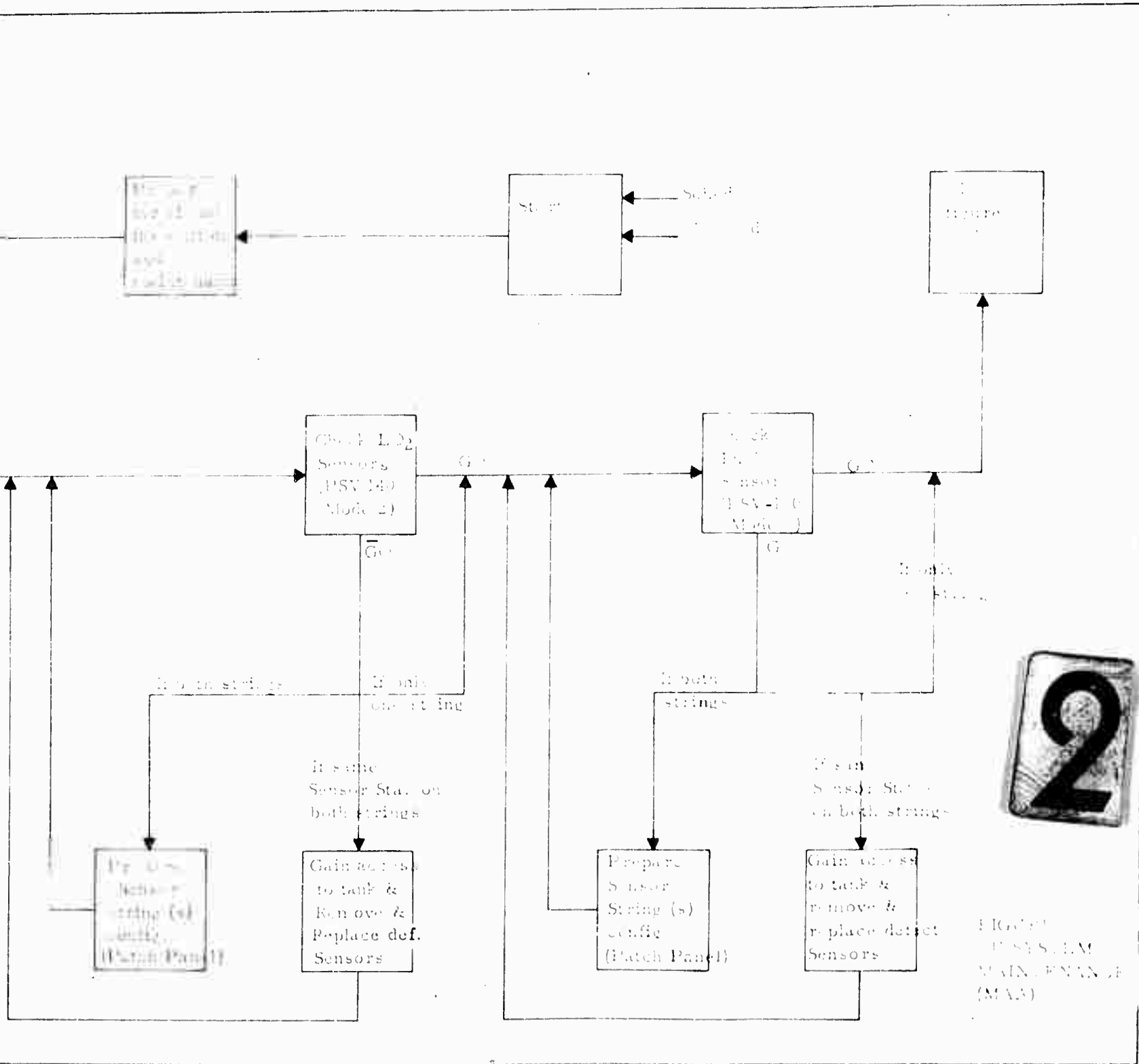
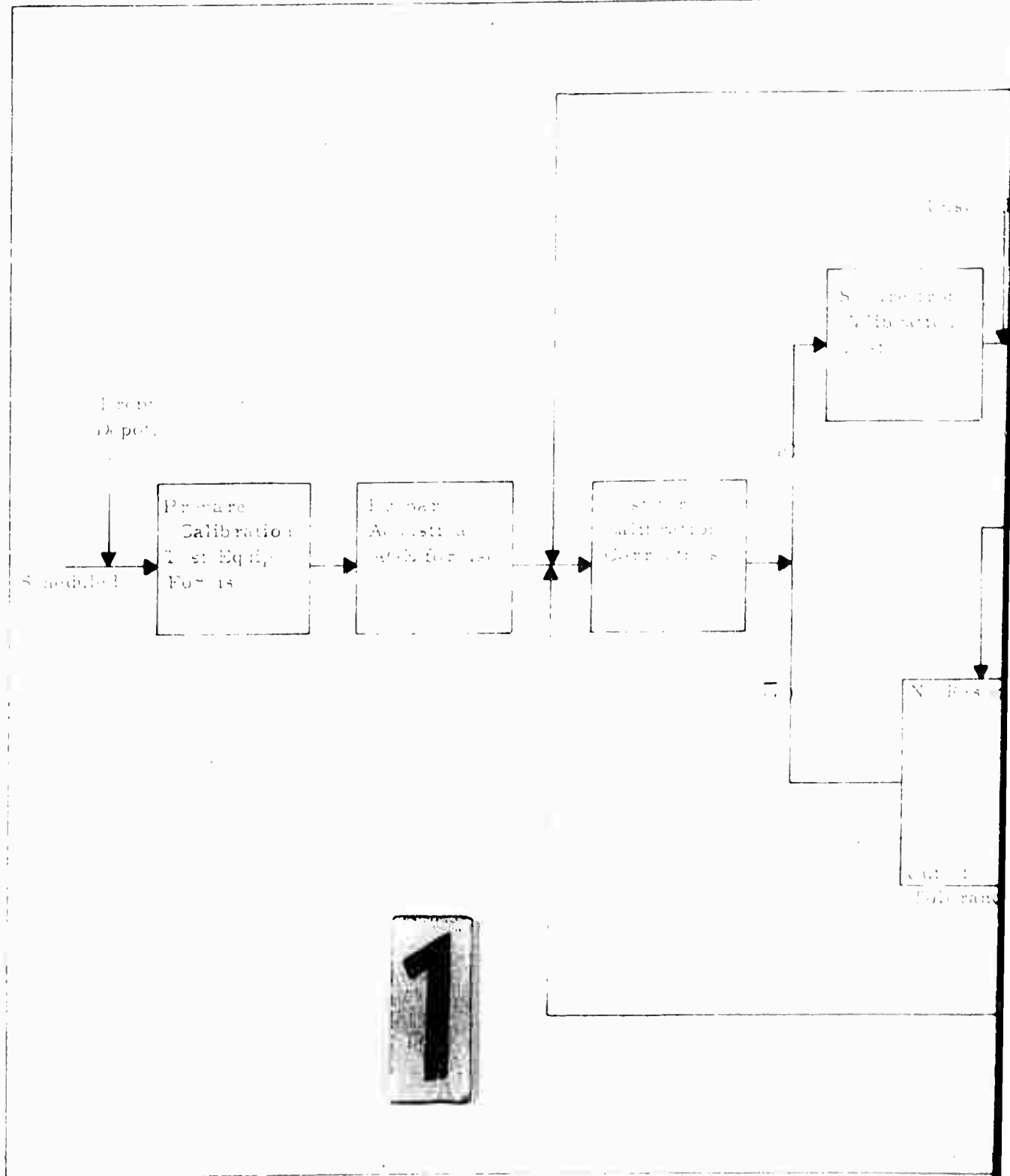
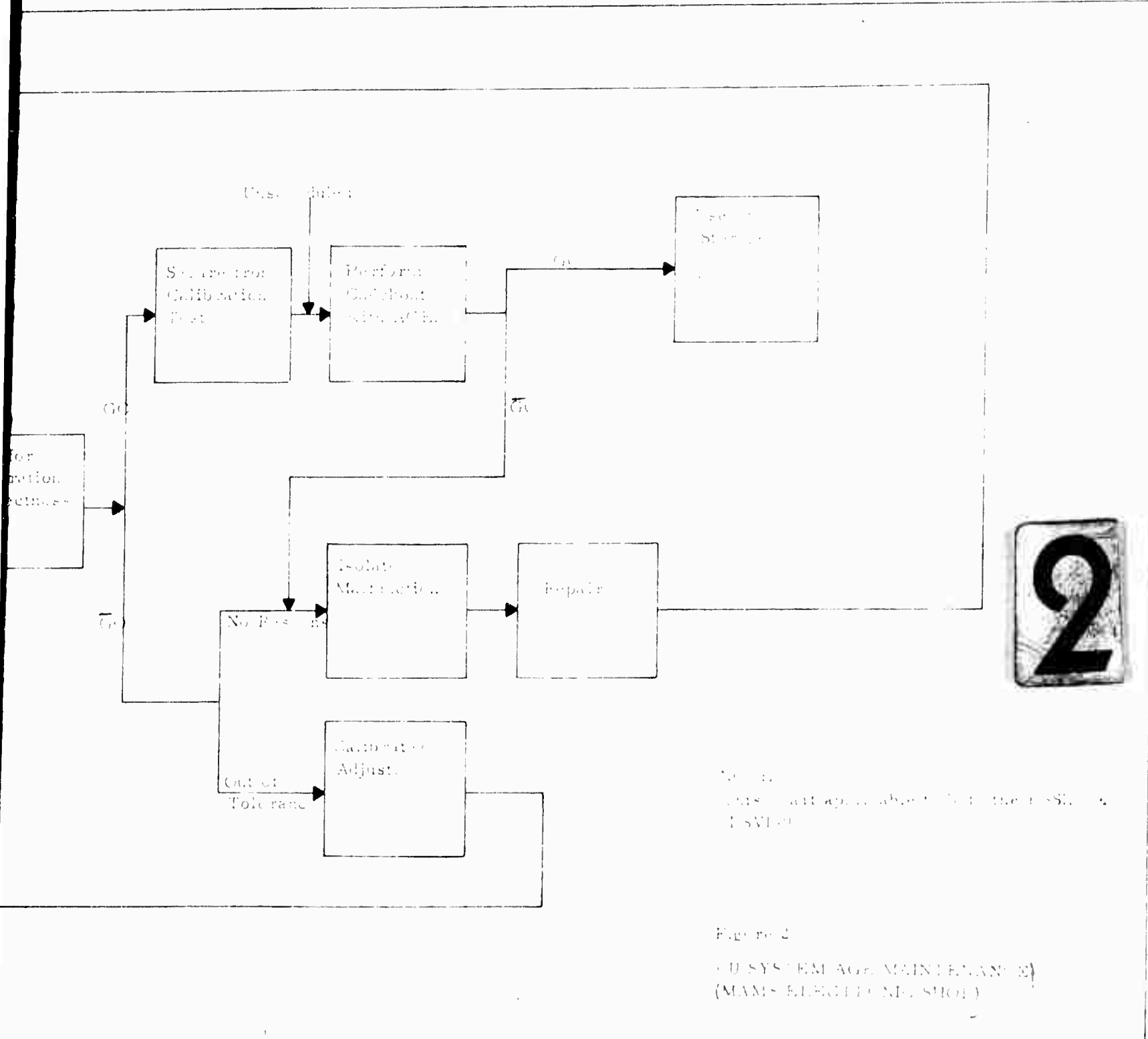

FIGURE 2  
PSY-140  
MAINTENANCE  
(MA3)



1



2

FIGURE 2  
MAM-5 ELEMENT SHOP FOR THE USSS (MAM-5V1.0)

Figure 2  
MAM-5 ELEMENT SHOP  
(MAM-5V1.0)







AD 267199

END CHANGE PAGES