

UNCLASSIFIED

AD 272 994

*Reproduced
by the*

ARMED SERVICES TECHNICAL INFORMATION AGENCY
ARLINGTON HALL STATION
ARLINGTON 12, VIRGINIA



UNCLASSIFIED

NOTICE: When government or other drawings, specifications or other data are used for any purpose other than in connection with a definitely related government procurement operation, the U. S. Government thereby incurs no responsibility, nor any obligation whatsoever; and the fact that the Government may have formulated, furnished, or in any way supplied the said drawings, specifications, or other data is not to be regarded by implication or otherwise as in any manner licensing the holder or any other person or corporation, or conveying any rights or permission to manufacture, use or sell any patented invention that may in any way be related thereto.

AFCL 1049

62-2-4
NOX

CATALOGED BY ASTIA 272994
AS AD NO.

GRD RESEARCH NOTES

No. 71

MICROMETEORITE COLLECTION FROM A RECOVERABLE
SOUNDING ROCKET

Edited by
R. K. Soberman

November 1961



GRD

GEOPHYSICS RESEARCH DIRECTORATE
AIR FORCE CAMBRIDGE RESEARCH LABORATORIES
OFFICE OF AEROSPACE RESEARCH
UNITED STATES AIR FORCE
BEDFORD, MASSACHUSETTS

AFCL 1049

GRD Research Notes
No. 71

MICROMETEORITE COLLECTION FROM A RECOVERABLE
SOUNDING ROCKET

edited by
R. K. Soberman

November 1961

Project 6694
Task 669407

Photochemistry Laboratory
GEOPHYSICS RESEARCH DIRECTORATE
AIR FORCE CAMBRIDGE RESEARCH LABORATORIES
OFFICE OF AEROSPACE RESEARCH
UNITED STATES AIR FORCE
Bedford, Massachusetts

ABSTRACT

This report contains three articles regarding the "Venus Flytrap" collector rocket. The first article discusses the experimental details and rocket performance. The second and third articles present the results obtained to date and an interpretation of these results, respectively.

ARTICLE I

MICROMETEORITE COLLECTION FROM A RECOVERABLE SOUNDING ROCKET

R. K. Soberman^{a, d}, C. L. Hemenway^{b, c}, T. G. Ryan^a,
S. A. Chrest^d, J. Frissora^d, and E. F. Fullam^{e, b}

ABSTRACT

The "Venus Flytrap" micrometeorite collector rocket was fired from White Sands, New Mexico on 6 June 1961 at 05:31 a. m. local time. Specially prepared particle impactors were exposed between the altitudes of 88 and 168 km and successfully recovered. The rocket design and performance is discussed. The experimental surfaces consisted of 0.24 m² of 6-micron-thick mylar foil for impact and cratering studies and 0.13 m² of sealed boxes which were loaded with high purity materials and surfaces suitable for electron microscopy. In all, eight different materials were used to permit an evaluation of the effectiveness of different materials and techniques for the collection and study of micrometeoritic particles. Some of these materials were shadowed with aluminum before and after the flight to aid in the discrimination of micrometeorite particles from contaminants.

On 6 June 1961 at 5:31 a. m. MST an Aerobee 150 rocket, descriptively christened the "Venus Flytrap," was successfully fired from the White Sands Proving Grounds in New Mexico. Figures 1, 2, and 3 are photographs of the nose cone or "payload" section of that rocket. In Fig. 1 the nose cone is shown in the fully closed position in which it was fired and traveled up through the lower atmosphere. An electric motor then raised the outer skin or ogive assembly (Fig. 2); and finally another motor, aided by the 2 rps spin which was applied to the rocket, extended the eight "leaves" outward to complete the opening cycle (Fig. 3). The nose cone was designed to fly in this last position through the upper atmosphere, exposing collectors

Authors' Affiliations

- a. Geophysics Research Directorate
- b. Dudley Observatory, Albany, N. Y.
- c. Union College, Schenectady, N. Y.
- d. Northeastern University, Boston, Mass.
- e. Ernest F. Fullam, Inc. Schenectady, N. Y.



Fig. 1. Fully closed.



Fig. 2. Partly open.

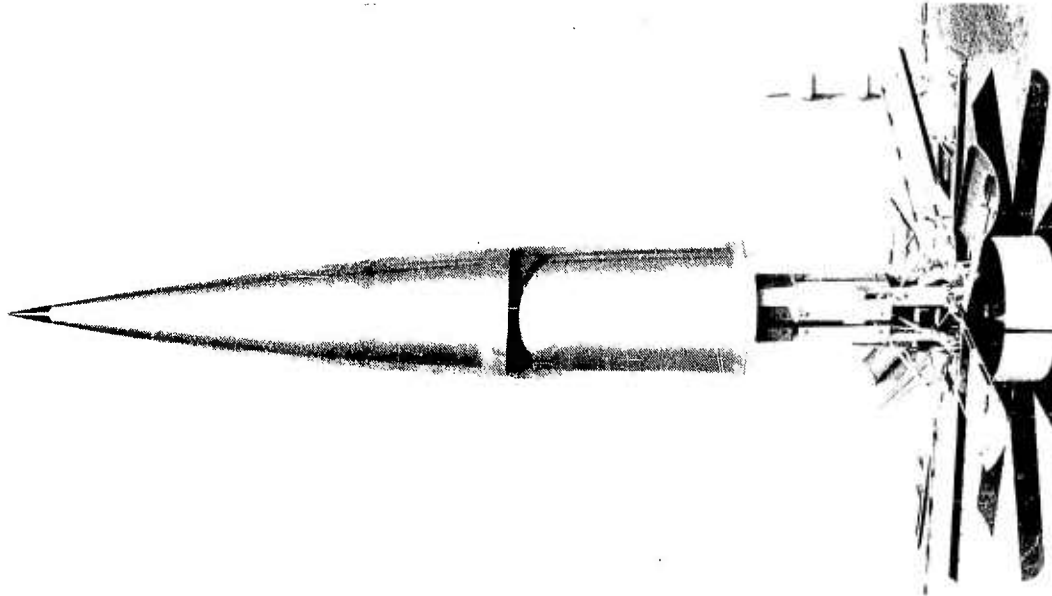

Fig. 3. Fully open.

VENUS FLYTRAP NOSECONE

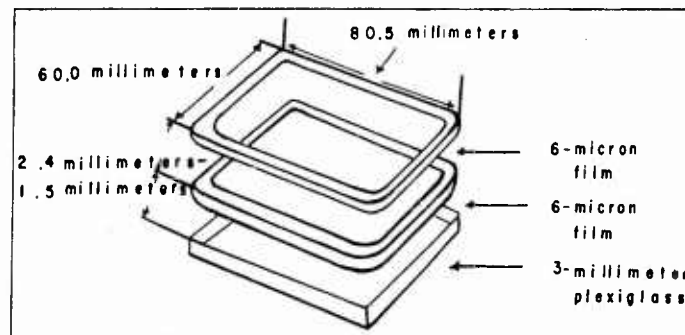

Fig. 4. Penetration experiment.

mounted on the tops of the leaves and on the internal structure. Prior to re-entry the rocket was "de-spun," thus allowing the nose cone to be resealed, and the booster section was severed explosively from the payload. At an altitude of 6 km a parachute was deployed and the nose cone descended to the ground where recovery was effected.

Four of the leaves carried a penetration experiment (sketched in Fig. 4) which covered a total area of 0.24 m^2 . The first two layers were mylar films 6 microns thick. Prior to the flight these films were examined, using a helium leak detector, to make sure that there were no holes. In addition to flux, penetration, and cratering data, it was hoped that this experiment might yield some zenith angle information if more than one layer were penetrated by the impinging particles.

A second type of experiment carried on the vehicle were surfaces which were intended to trap particles of lesser momentum (that is, submicron particles if such existed or somewhat larger particles which had been sufficiently slowed down in the atmosphere). These surfaces were mounted in aluminum boxes for cleanliness.

Eight such boxes, each having an open area of 160 cm^2 , were mounted on four of the leaves of the nose cone. The lids of the boxes, on which more collection surfaces were mounted, were fastened to the internal structure of the nose cone. The boxes and their covers were prepared with high-purity materials. All boxes were treated and loaded in an identical fashion and were completely interchangeable.

Since the fabrication left the inside of the boxes extremely rough it was found to be impractical to try to clean the internal surfaces. To prevent the collection surfaces from being contaminated with debris from the box, the debris was sealed to the surface with a plastic coating of high-purity nitrocellulose. All of the covers, clamps, screws and washers were cleaned in benzine to remove grease and other contaminants. The open area inside the gasket on the cover was covered with a nitrocellulose film 0.003 inch thick. This film was held in place with 10-mesh stainless-steel screening.

A total of eight different surfaces were loaded in the boxes. There were seven lucite slides, each $\frac{3}{4}$ inch by 2 inches by $\frac{1}{16}$ inch, covered with various substrates. The eighth surface was a large piece of bare lucite, $1\frac{5}{8}$ inches by 5 inches by $\frac{1}{16}$ inch. Figure 5 is a schematic of the positioning for the various substrates used. All of the thin films, which were approximately 200 A thick, were supported with 200-mesh copper screening. The coated screening and the self-supporting, thick, nitrocellulose films (0.003 inch thick) were glued to the lucite slides which were held in place by clamps. Since there was no past experience to go by, several substrate materials and handling techniques were tried in an attempt to find the most effective and unambiguous collection system. Figure 6 is a photograph of a typical box and cover. As can be seen in this photograph, the boxes and their lids were protected by sealed plastic covers.

Extreme care was necessary in handling these boxes to insure that contamination would be kept to a minimum. Therefore the nose cone was thoroughly cleaned prior to the installation of all the experiments. After the experiments were installed, the nose cone operation was checked by cycling it twice in a precleaned room. During these operations the protective covers were still on the boxes and lids. Finally a large sealed plastic tent was erected over the nose cone, and the air in the tent was allowed to stagnate for some two hours. Then the nose cone was cycled for the final ground test and, during this test, the protective covers were removed from the boxes and lids.

Fig.5. Location of substrates for collection experiment.

- A. Lucite slide shadow-cast with aluminum
- B. Silicon monoxide on thin formvar
- C. Thick nitrocellulose film
- D. Thin formvar
- E. Thick nitrocellulose coated with carbon
- F. Thin formvar shadow-cast with aluminum
- G. Thin nitrocellulose shadow-cast with aluminum
- H. Bare lucite

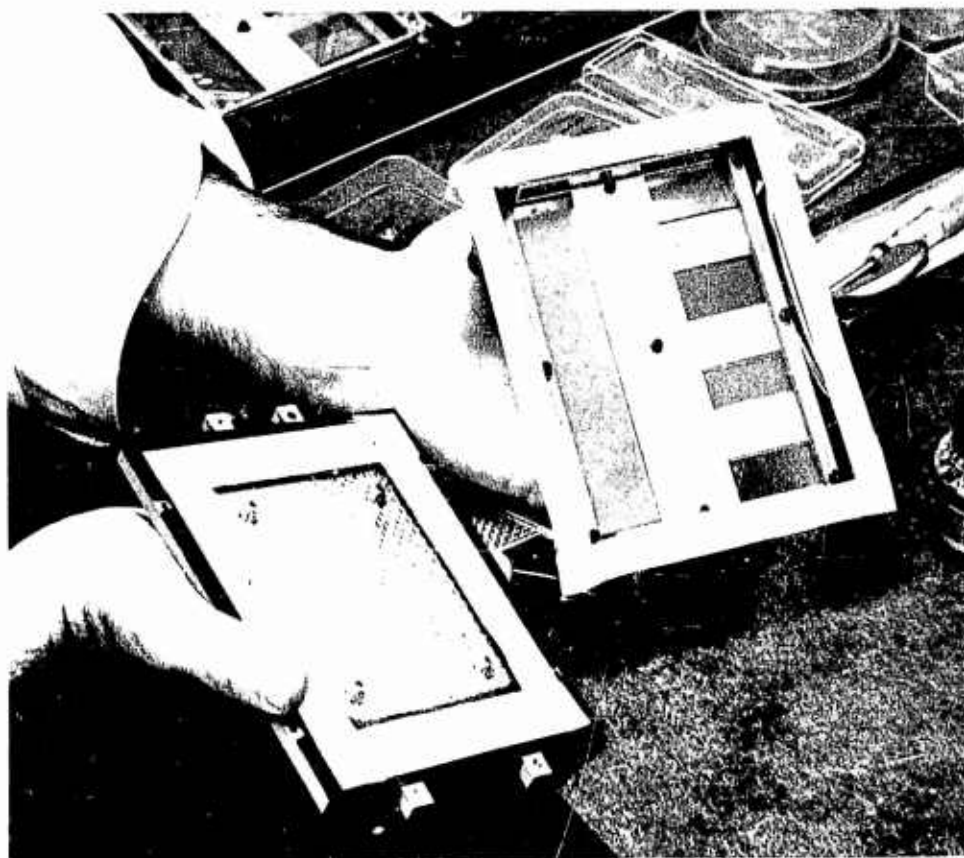
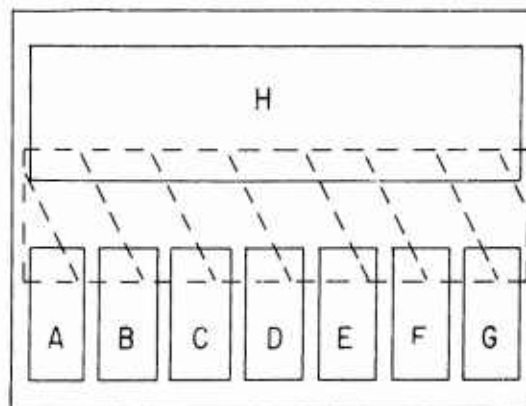

Fig. 6. Typical micrometeorite collecting box.

The boxes and lids were exposed for less than 30 sec in the tent before being sealed in the nose cone. An identical box was exposed in the handling room to serve as controls for contamination. Further, as can be seen from Figs. 5 and 6, there were controls mounted in each box. These controls consisted of an area approximately one-fourth of the surface and which was protected by an aluminum shield placed 0.5 mm above the surface so that air could freely flow under the shield. These shielded surfaces were exposed in the same environments and subjected to the same handling procedures, but could not be impinged upon from above.

The boxes were opened and closed during the flight by the action of the leaves. Upon descent of the nose cone, the boxes were sealed by atmospheric pressure. Filtered ports at the base of the nose cone allowed pressure equalization inside the skin of the nose cone. The boxes, however, were designed to maintain a vacuum inside.

These extreme precautions were not taken with the penetration experiments, but care was exercised to protect the film surfaces from any direct contact.

The "Venus Flytrap" system performed as planned. The telemetry record which was used only to monitor the rocket functions indicated that everything operated perfectly and at approximately the preset times. From this telemetry record, the angles at which the leaves were exposed were determined. The four leaves containing the penetration experiments were exposed at an angle of 73.5° with respect to the vertical axis of the rocket. The four leaves on which the boxes were mounted were exposed at an angle of 66.5° with respect to this same axis.

An aspect camera was installed to record the attitude of the rocket. These data have not yet been fully reduced. However, it appears that the rocket axis precessed from about 10° on one side of the vertical to about 45° on the other side of the vertical during the portion of the flight where the nose cone was open. The spin of the rocket was reduced from 2 rps to 1.4 rps by the opening of the leaves. A device

known as a "yo yo" which threw off two weights reduced the spin to essentially zero just before the nose cone was closed. This was necessary since the motor did not have sufficient power to close the leaves while the rocket was spinning.

A curve of altitude versus time is shown in Fig. 7. Rocket burnout occurred at an altitude of 35 km as shown. (Note: At burnout the fuel and oxidizer tanks were valved shut in accordance with standard rocket procedure.) The opening of the nose cone was accomplished in about one second at an altitude of 88 km. The rocket then ascended for 131 sec to an apogee of 168 km, and then descended for 105 sec to 116 km where closing was accomplished, again in about one second. During this entire exposure time the rocket remained in a near vertical attitude (that is, it precessed but did not turn over).

Figure 8 is a curve of velocity versus time for the rocket. As can be seen from the curve, the rocket approximated a free-fall trajectory during the time that the nose cone was open.

The nose cone was found sealed and intact. It lay in the desert for about one hour after landing before being placed in a protective plastic bag. Samples of the desert sand were taken for control purposes. On return to the handling room the outer skin was washed down with acetone and the nose cone was wrapped in a clean plastic bag for shipment. One week later in a "dust-free" environment the nose cone was opened for examination. Five of the eight boxes were found to still be under sufficient vacuum to require opening by injection of clean air with a hypodermic syringe.

The details of this experiment have been described at length since they are felt to have important bearing upon the validity of the results which are presented in the next paper.

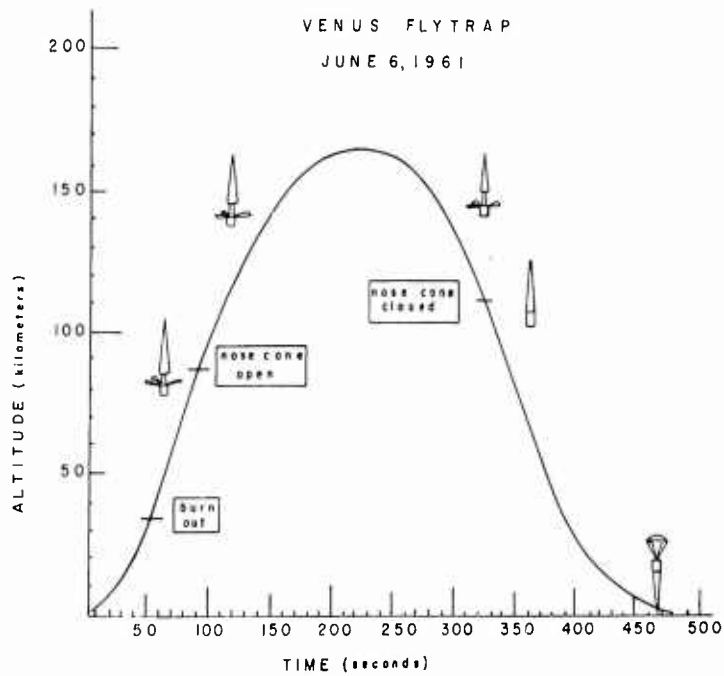

Fig. 7. Vehicle altitude versus time.

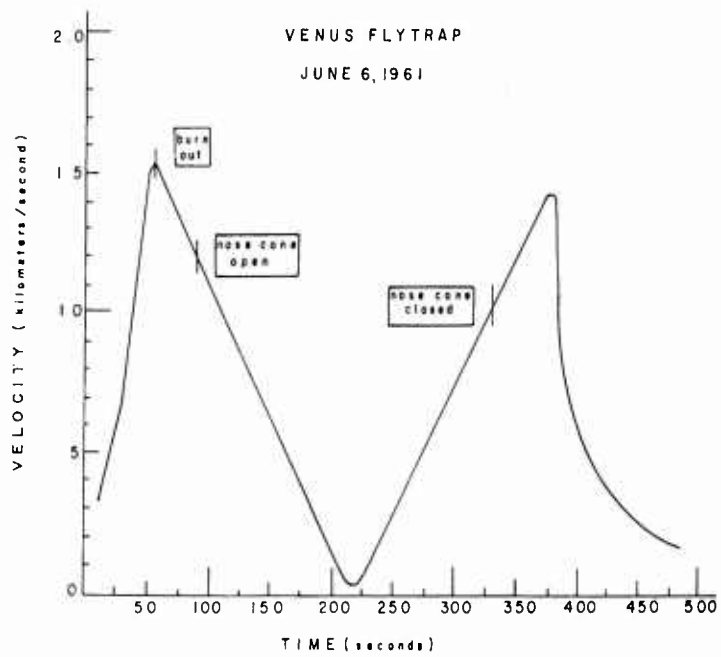

Fig. 8. Vehicle velocity versus time.

ACKNOWLEDGMENTS

The authors would like to acknowledge the debt that this project owes to Mr. H. A. Cohen who originally began this program. Further, we acknowledge the assistance of Mssrs. R. Skrivanek and P. Gustafson of the Geophysics Research Directorate at the Air Force Cambridge Research Laboratories. We also express our thanks to the staff at Aerojet General Corporation, particularly Mssrs. N. Migdal, J. Smith, and J. McCabe who fabricated the nose cone and assisted in the preparations for the experiment. Finally we would like to thank Capt. Thomas H. Smith, Jr.(USAF) and Lt. Joseph F. Turpel(USN) and the officers and men of the U.S. Navy Missile Testing Center at White Sands, New Mexico for their wonderful co-operation and assistance. But for the help of these and many other support groups the experiment described above would still be "on the drawing boards."

ARTICLE II

MICROMETEORITE COLLECTION FROM A RECOVERABLE SOUNDING ROCKET

C.L. Hemenway^{b, c}, R.K. Soberman^{a, d}, E. F. Fullam^{e, b},
J.J. Balsamo^f, J. Cole^{b, c}, D. Hallgren^e, P. Yedinak^b,
A. Goodman^b, G. Hoff^{b, c}

ABSTRACT

Three independent electron microscopes and observer teams have been used to evaluate, count, electron micrograph, and measure the micrometeorite particles. Typical particles and size distributions are shown. Particles have been found in structures and sizes similar to those obtained at lower altitudes with U-2 aircraft and balloon collection techniques. Approximately 7 particles/mm² were collected during the flight. Most of the particles were submicron in size and generally fell into three types: high density spheres, medium density irregular particles, and extremely irregular medium-density particles (fluffy particles). Some of the larger particles had sufficient momentum to rupture exposed films. Laboratory and nose-cone controlled surfaces were carefully studied to permit identification of micrometeorite particles.

As described in the first article, two types of experiments were carried on the "Venus Flytrap" rocket (that is, the penetration and the trapping experiments). This paper presents the results obtained to date from these experiments.

The mylar films from the penetration experiment were tested by a helium leak detector after return to the laboratory. Three holes were found in top layer films; but there was no evidence of damage on the second layer films beneath these holes. Figures 1, 2, and 3 show the three holes. The holes shown in Figs. 1 and 2 were found on the same mylar film. The first hole (Fig. 1) measures 90 microns across the

-
- a. Geophysics Research Directorate
 - b. Dudley Observatory, Albany, N. Y.
 - c. Union College, Schenectady, N. Y.
 - d. Northeastern University, Boston, Mass.
 - e. Ernest F. Fullam, Inc., Schenectady, N. Y.
 - f. Control Equipment Corp., Needham, Mass.

short axis and 330 microns across the long axis. The second hole (Fig. 2) measures 450 microns across the short axis and 1160 microns across the long axis. The final hole (Fig. 3) found on another film which was mounted on the same leaf measures 330 microns across the short axis and 550 microns across the long axis. Note the flap structure and curling of the mylar in all three photographs.

This flap structure and curling are believed to be indicative of low velocity impact. From the appearance of the holes it is hypothesized that they were caused by particles comparable in dimension to the hole size which impacted at relative velocities of less than about 2 km/sec. Laboratory studies are presently being carried out to verify these hypotheses and to determine the strength of these films under low-velocity impact conditions. Two holes found in an equal number of control films appear to have been caused by handling, and careful examination shows no similarity with the holes that were found on the flight samples.

A careful microscopic examination of the top layer mylar films was made in the hope of finding imbedded particles or craters. It was immediately noticed that the upper layer of films had more particles on them than the second layer or the controls. But as was mentioned in the previous paper, extreme cleanliness had not been maintained with these films and therefore this information could not be exploited. This scanning did not turn up any further unambiguous information, since the experiment was designed to look for punctures and no records were kept of film defects.

There have been many attempts in the past to collect micrometeorite particles at ground level, on mountain tops, by balloons, and by high-altitude aircraft. However all of these techniques have been open to criticism because of contamination by terrestrial particles. Since this is a very serious problem, we next discuss the various safeguards which were built into the "Venus Flytrap" experiment to assure reliable identification of micrometeorites. There were five controls for this portion of the experiment. Some have been described in the first article of this

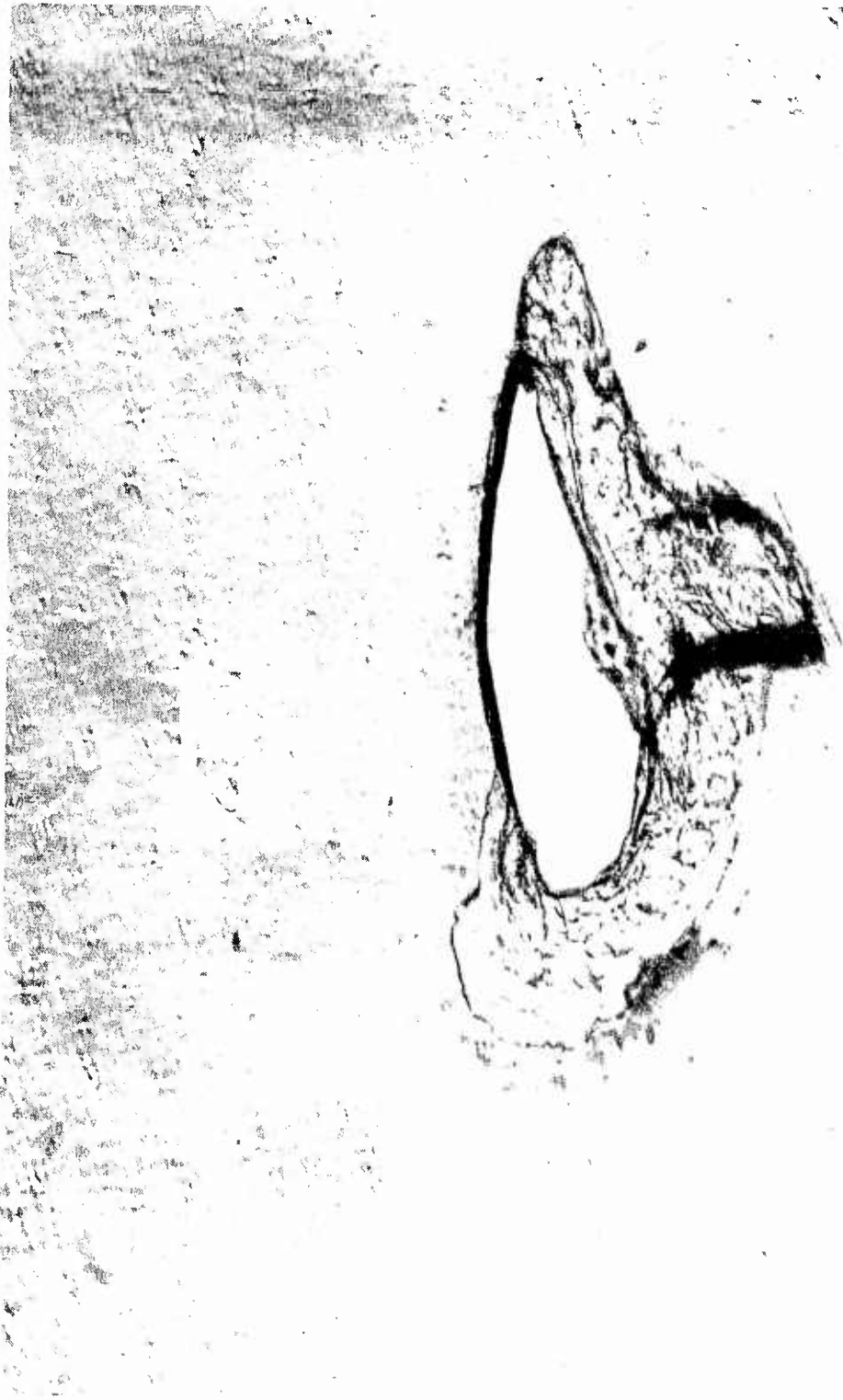

Fig. 1. Micrometeorite caused hole in Mylar film.

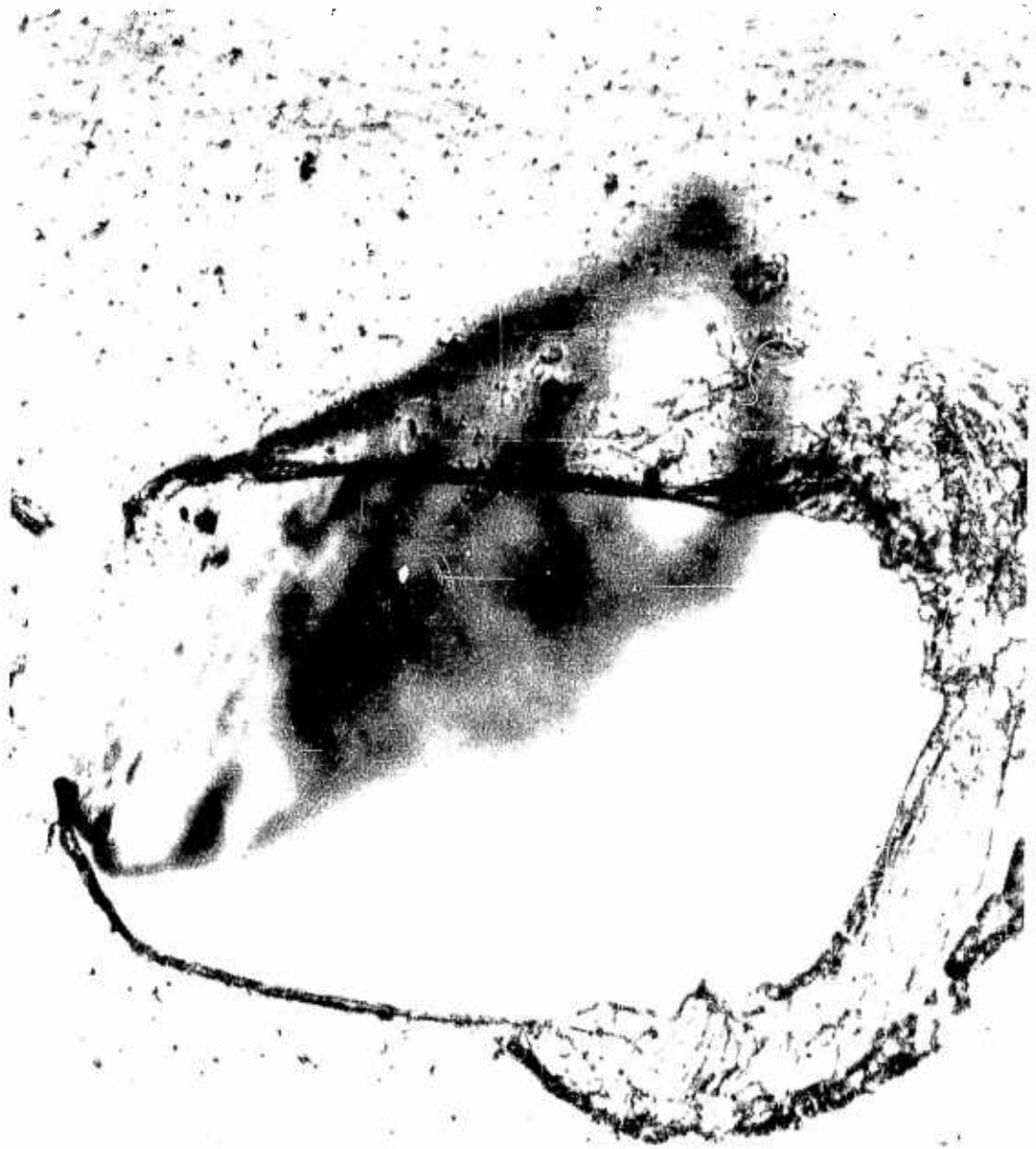

Fig. 2. Micrometeorite caused hole in Mylar film.



Fig. 3. Micrometeorite caused hole in Mylar film.

report. All five controls are listed below with brief comments:

1. Laboratory exposures: These were spare boxes prepared at the same time and in the same way as the flight boxes. One of these spares was exposed in the laboratory for an extended period to study contaminating particles from the laboratory. Micrometeorite particles as described below were not found in the laboratory controls.
2. Rocket preparation exposure: A spare box was exposed at White Sands during final rocket testing. As described in Article I it was necessary to remove the mylar covers from the boxes at the time the nose cone was sealed. The boxes had to be fabricated in such a way that the nose cone could be opened and closed and yet not contaminate the samples while the final checkouts were being carried out on the nose cone. In the room where the nose cone was being cycled for the final time a spare box was opened for the full time during which the mylar covers were off prior to the final sealing. This operation was carried out in a plastic tent as previously described.
3. Desert dust examination: A sample of desert dust was examined to see what kind of particles could be expected from the air at White Sands. To minimize desert dust contamination, the outside of the nose cone was thoroughly cleaned in the laboratory and kept in a plastic bag until one hour before flight and removed only when the rocket was pressurized. No evidence of desert dust contamination was detected.
4. Rocket particle examination: In a clean environment wipings were made of the inside of the nose cone and were mounted on electron microscope screens for examination. Some metal chips and some oil were found. None of the types of particles considered to be micrometeorites were found in these wipings.
5. Shielded flight samples: The best controls were the shielded areas inside each box. Approximately one quarter of the area of each box was blocked off in such a way that air flow was allowed beneath the shield by separating the shield approximately a half millimeter from the control surfaces. Thus if small particles were drifting around in the air, they could wander be-

neath the shield; yet any particles that would hit at high altitude would be prevented from hitting these control surfaces. Figure 6 of Article I (page 5) shows the metal shield in the middle of an open box.

This study utilized three independent teams of electron microscopists using three electron microscopes. Some of the characteristics of electron microscopes are presented here for those readers not familiar with this instrument. The magnification of an electron microscope is generally very high by comparison with optical techniques and one can only scan a few square millimeters per day. With an electron microscope, the limit of resolution is in the order of 10A to 200A, which is a factor of 100 or more better than the resolution possible with optical microscope techniques. With an electron microscope, one is able to distinguish surface details and textures of particles, can measure particle sizes accurately, and can see how transparent the particles are to electrons. Finally, while optical microscopes can scan large areas it is generally extremely difficult to distinguish one small particle from another. When one studies micrometeorites, one is always working with a "noise" or "background" level, and contaminant particles will always be present. It will be shown that if the textures of the particle surfaces, the shapes and sizes of the particles, etc., can be studied, contaminants can be recognized and readily ruled out of consideration.

Perhaps the most effective technique used in this experiment for micrometeorite identification is the shadowing technique wherein, just before the boxes were loaded, certain of the slides had a coating of aluminum evaporated on the collection surface at an angle of approximately 80° from the normal to the surface. Thus any particles that were on the collection surface before the boxes were loaded would cast a shadow in the direction the aluminum was deposited. After the flight, another shadowing at 75° was put on at roughly right angles to the previous shadowing. If a particle was deposited between the two

shadowings, it should have only the second shadow; and if it was deposited during the scanning process, it should have no shadows. Contaminant particles within the films will also be shadowless. This shadowing or "flagging" technique is a useful way of reducing the ever present contamination level. The flagging techniques had disadvantages. For example, if one attempts electron diffraction analyses, then one may be bothered by the presence of the aluminum, although it may be convenient for some purposes to have a calibration standard on the same sample.

After a preliminary examination of the various collecting surfaces it was decided, for the initial study of the particles, to concentrate on the surfaces on which the flagging technique was used. The observer scans first with a magnification of the order of 2000 to 5000 times. He looks for single flagged particles. However a single flag is considered to be a necessary but not a sufficient requirement since it was possible for contaminant particles to be deposited between the two flaggings. The single flagged particle is examined to determine whether it can be recognized as a contaminant at low magnification. If not, then the magnification is increased to between 15,000 and 20,000 times, and the particle is examined very carefully. To be counted as a micrometeorite the particle has to be of a type that could not be found on any of the controls.

There are three types of particles that did not appear on the controls. These were dense spheres with sharp edges ranging in size down to a few tenths of a micron or even less, irregular submicron particles, and extremely irregular particles which were termed "fluffy." In addition some smashed fluffy particles were found, and also several holes were found in some of the thin collecting surfaces. The results described here were obtained with surfaces of nitrocellulose and formvar (approximately 200A thick).

Figure 4 shows an optical micrograph of a portion of a 200-mesh per inch copper screen which has an open area roughly 100 microns along an edge. The succeeding figures (Figs. 5 to 16) are electron

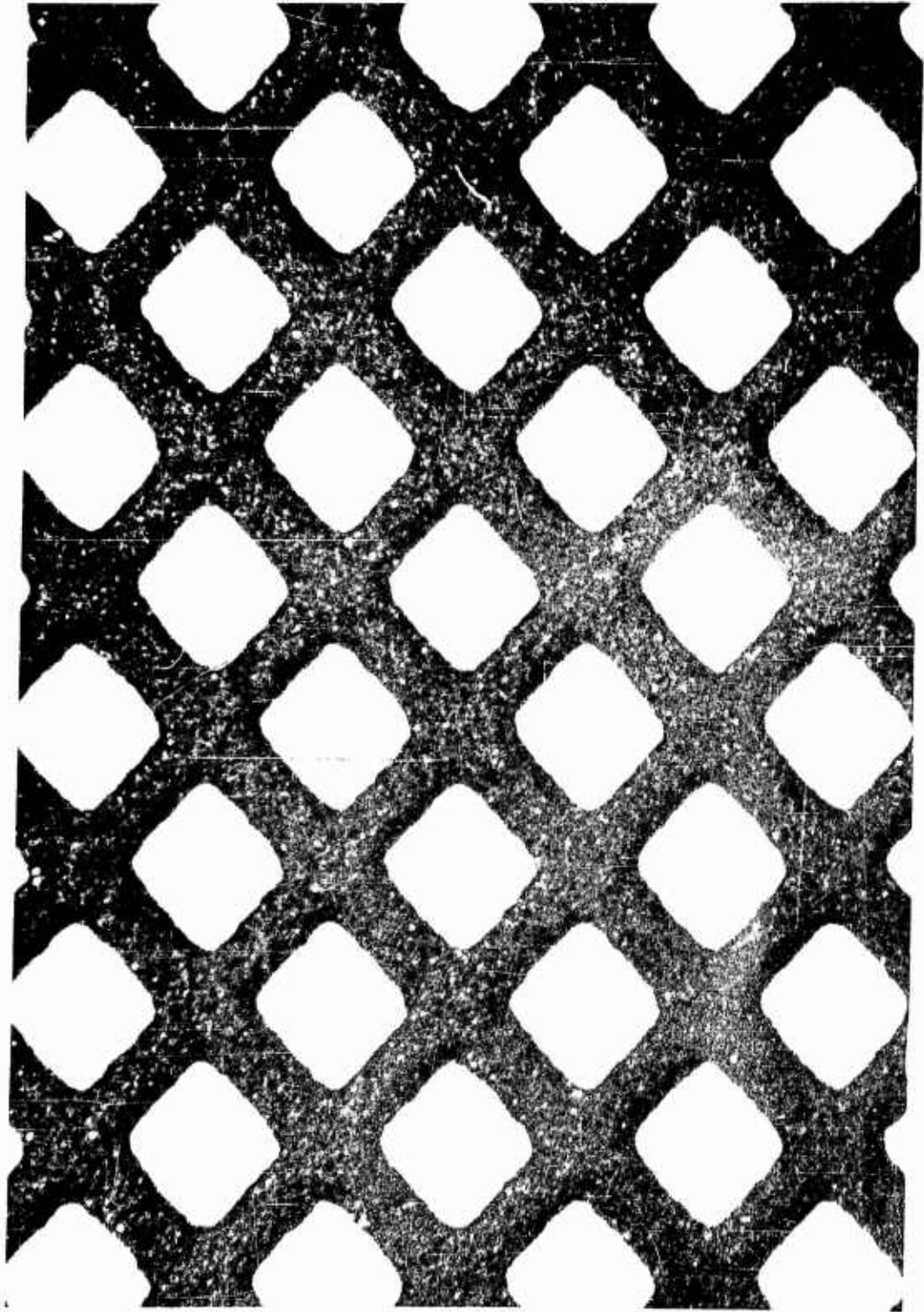

Fig. 4. 200 mesh per inch copper screen used to support collecting surfaces.

micrographs of a small portion of these open areas in the mesh screen. Unless otherwise indicated, the scale represents 1 micron.

Figure 5 shows the flagging technique described above. The particle on the right has two shadows and is therefore clearly a contaminant; the particle on the left has one shadow and was identified as an irregular type submicron micrometeorite.

Figure 6 shows mica-like contaminants. This type is found on all electron microscope slide materials and apparently is in the air we breathe. There have been no successful techniques to eliminate this type of contaminant from electron microscope specimens. These particles can be readily identified; they are flat, of low density, and have sharp edges.

Figure 7 shows a rounded, medium-density, submicron particle of the type initially difficult to identify as a contaminant. Notice the fuzzy edge on this particle. These types of submicron particles were found on both the controls and the flight samples. One reason for high magnification to aid in the identification of micrometeorites was to find out whether such particles had sharp or fuzzy edges.

Figure 8 shows a small spherical micrometeorite with a sharp edge and high density. Notice that it can be readily distinguished from the fuzzy-edge spherical particle shown in Fig. 7.

Figure 9 shows a large irregular type of particle which almost looks like a museum meteorite. Notice that the surface is characterized by rounded irregularities and is partially transparent to electrons (medium density). This particle was counted as a large irregular micrometeorite; in fact, it is one of the largest single-flagged particles found to date.

Figure 10 shows an extremely irregular particle which is termed a "fluffy" particle. All particles not having a compact structure were labeled "fluffy." This type, as well as the others obtained in the Venus Flytrap experiment, are found in U-2 aircraft collections. Figure 11 shows a fluffy particle obtained from a U-2 collection.



Fig. 5. Illustration of flagging technique used to identify micrometeorites (scale = 1 micron).



Fig. 6. Mica-like contaminant particles (scale = 1 micron).

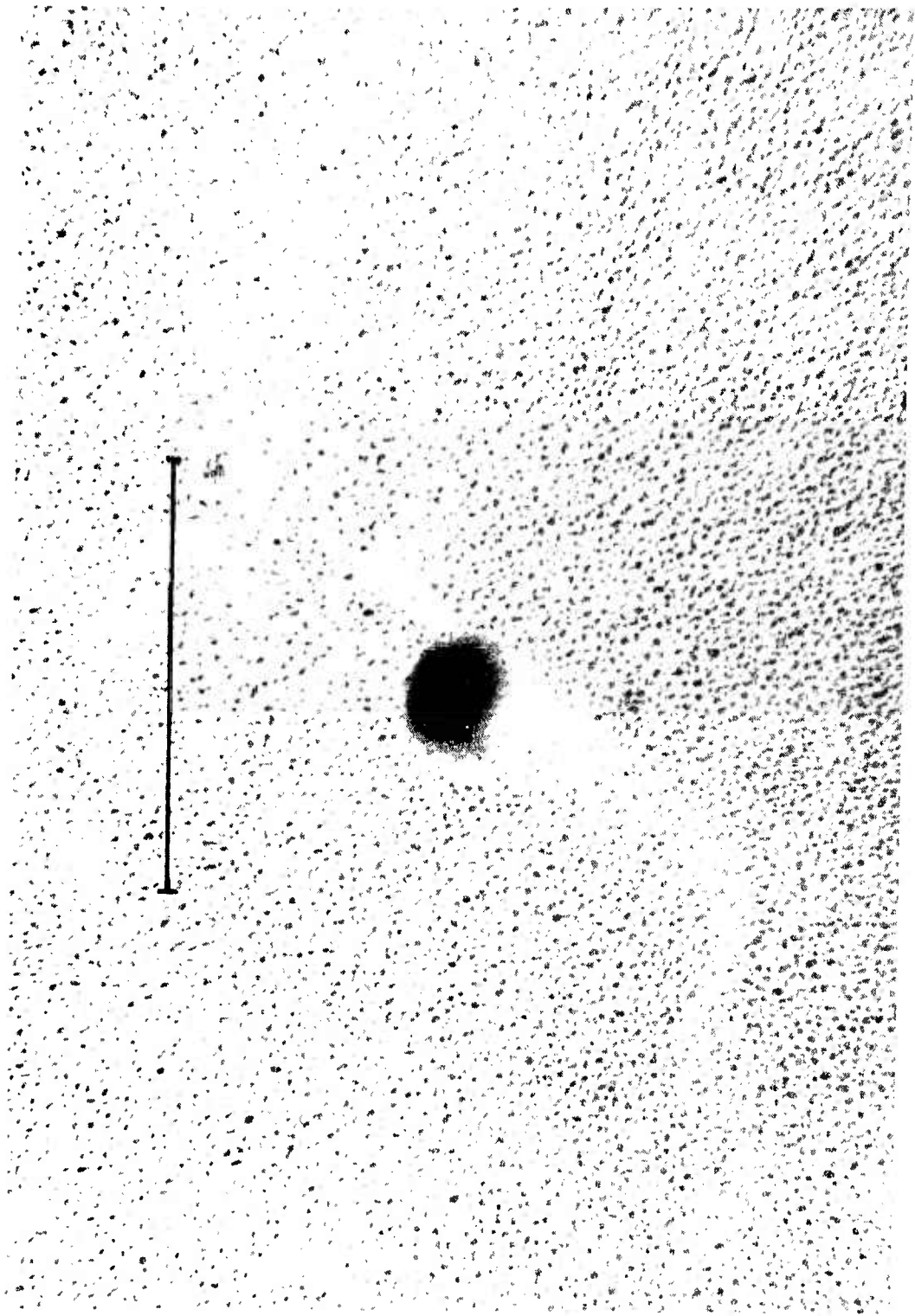

Fig. 7. Sub-micron contaminant particle (scale = 1 micron).

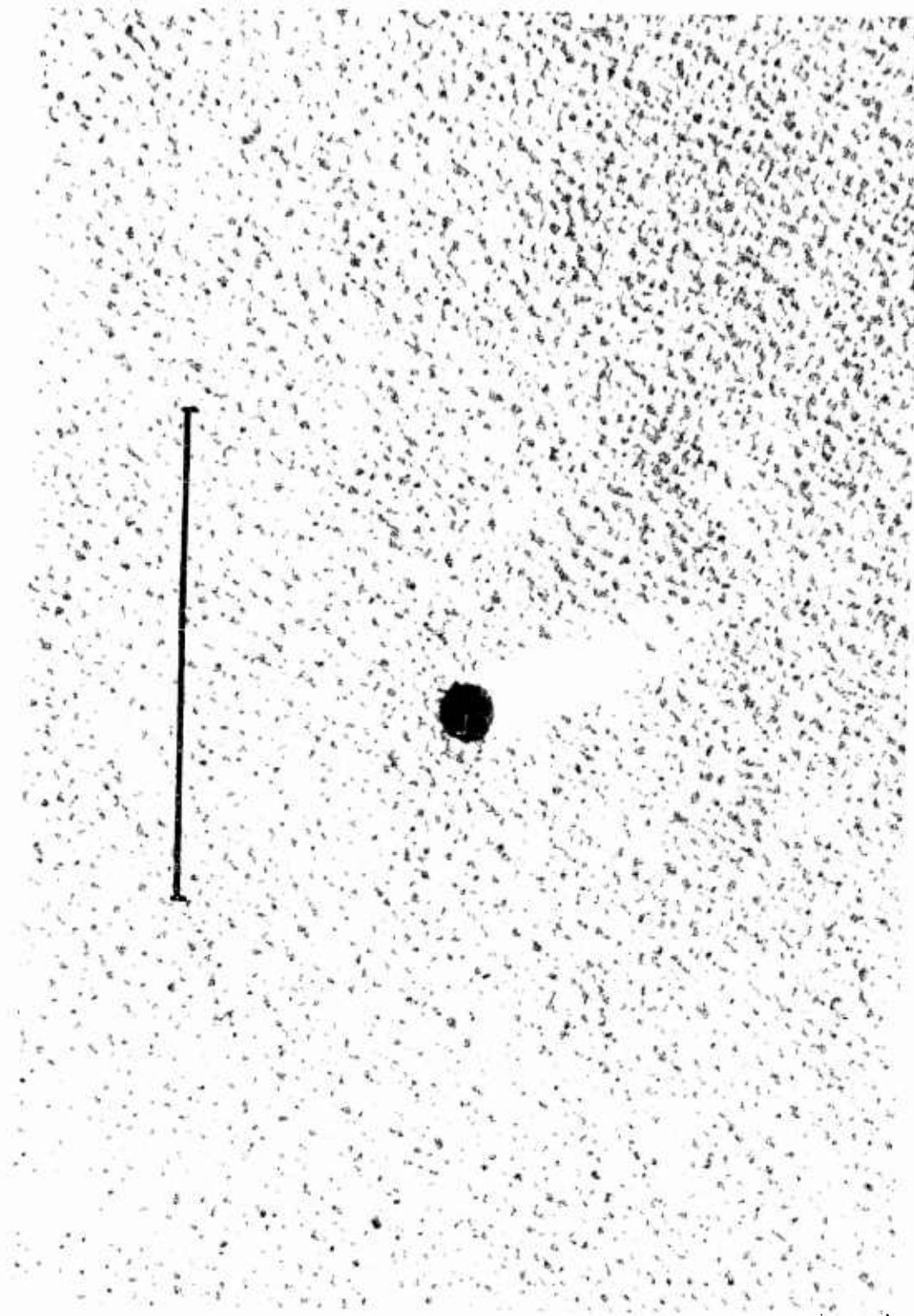

Fig. 8. Sub-micron spherical micrometeorite (scale = 1 micron).

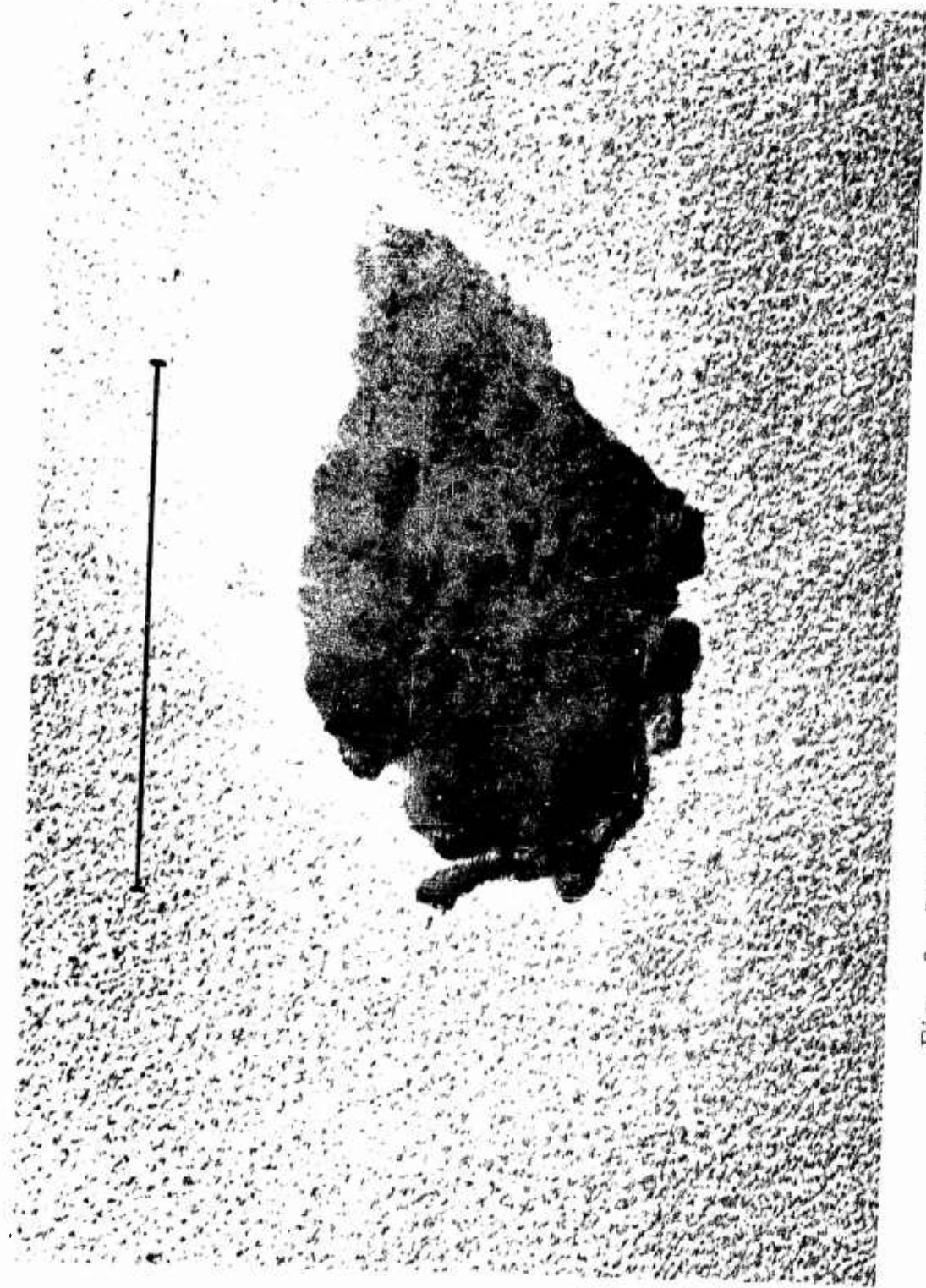

Fig. 9. Irregular micrometeorite (scale = 1 micron).

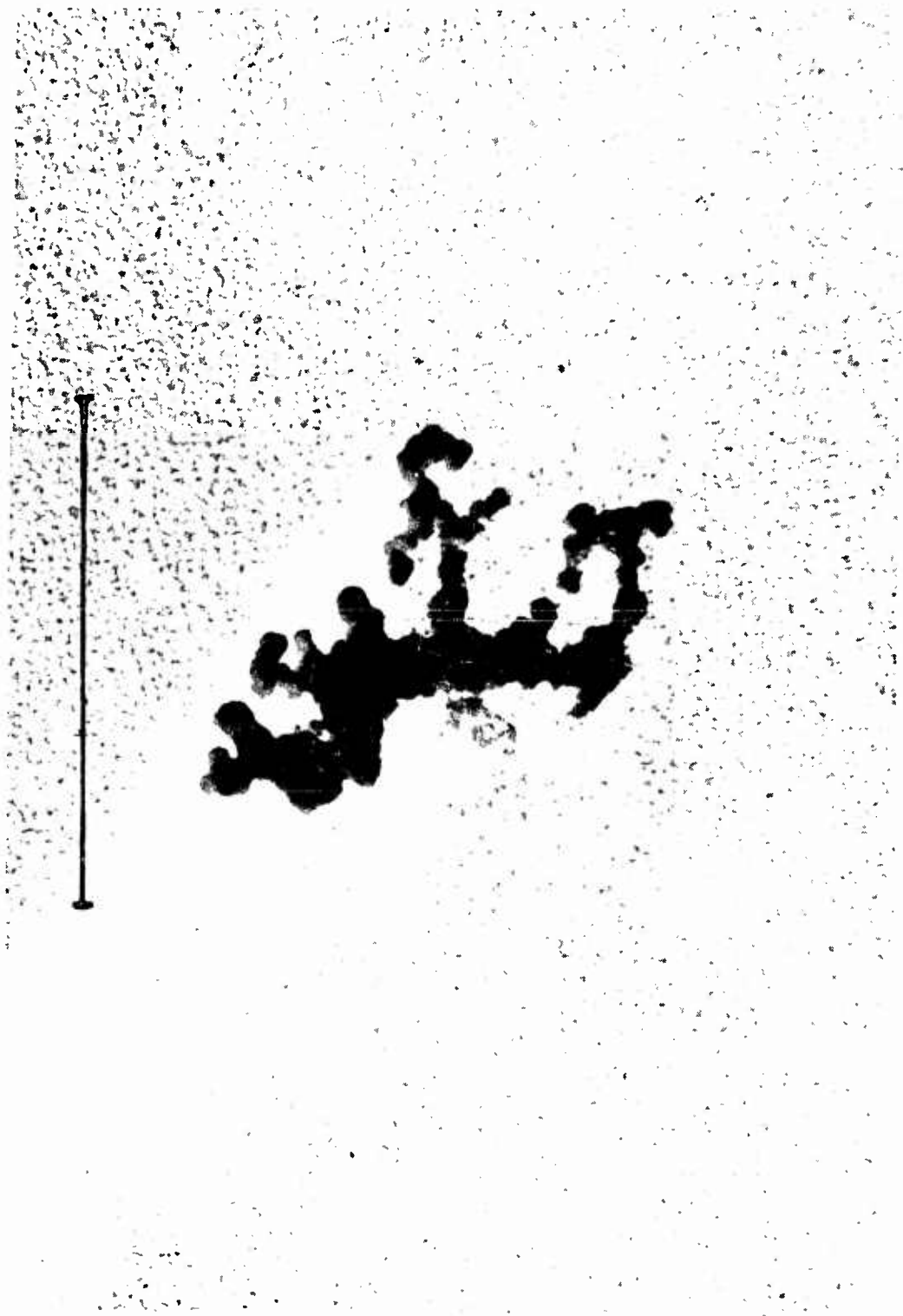

Fig. 10. "Fluffy" micrometeorite (scale = 1 micron).

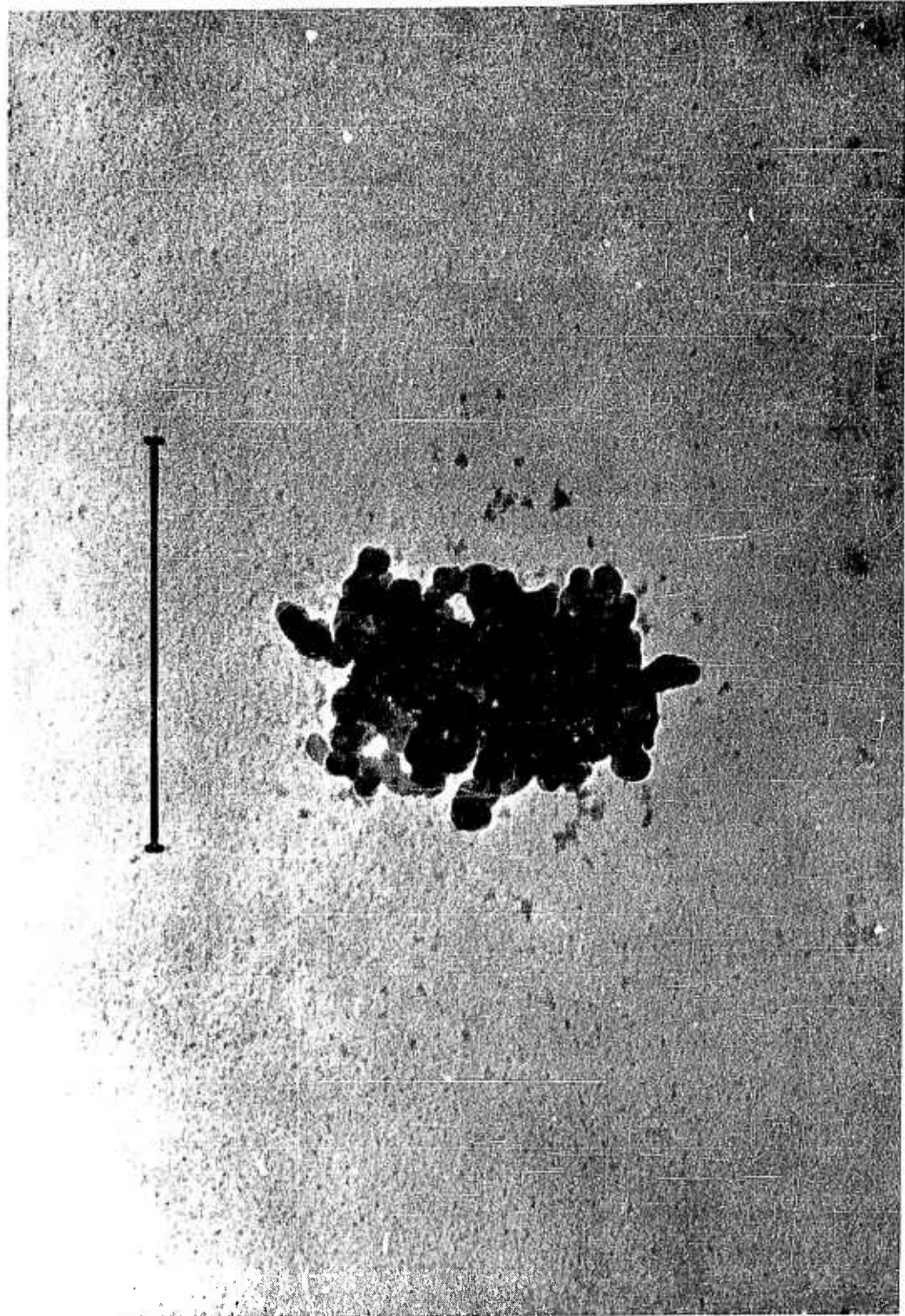

Fig. 11. "Fluffy" particle obtained from U-2 collection (scale = 2.5 micron).

Figure 12 shows a "sphere" with a hole. Notice that the "sphere" is not quite spherical. It is approximately 2.25 microns in diameter and is the largest of the spheres found thus far. The hole is about 2.4 microns in diameter. Apparently the sphere bumped into this 200A shadowed nitrocellulose film, didn't get through, and made a flapped hole about the same size and shape as its own body. A number of flapped holes of this type have been found.

Figure 13 shows a flapped hole where a smaller spherical particle broke through the thin nitrocellulose completely. Apparently the flapped hole phenomenon appears over a wide range of dimensions when one is dealing with low velocity collisions.

Figure 14 shows an elliptical hole where the particle apparently penetrated the thin film at an angle to the surface. Notice the flaps as well as the cracks radiating from the ends of the hole.

Figure 15 shows a portion of a smashed particle, probably a fluffy type. The debris extended over a length of more than 100 microns. Several of these smashed particles have been observed. Such particles are also found on impact-type collections made with U-2 aircraft. An attempt will be made to measure the breaking strength of fluffy particles to determine whether the values obtained correspond to those required to crumble cometary meteoroids.

Figure 16 shows a group of particles. Since it was uncertain whether such particle groups represented debris from the breakup of a larger particle, in the determination of size distributions this type of particle group was not considered.

Figure 17 shows a distribution function for the irregular type of particles. In Fig. 17, only particles in the region of 0.1 to 1 microm have been plotted. A few larger and smaller individual particles were found.

Figure 18 shows a distribution of the "diameters" of the fluffy-type particles. It is rather difficult to determine mean diameters. For this determination, the diameters in two perpendicular directions were measured and the particle was assumed to be ellipsoidal.



Fig. 12. Spherical micrometeorite and hole (scale = 1 micron).

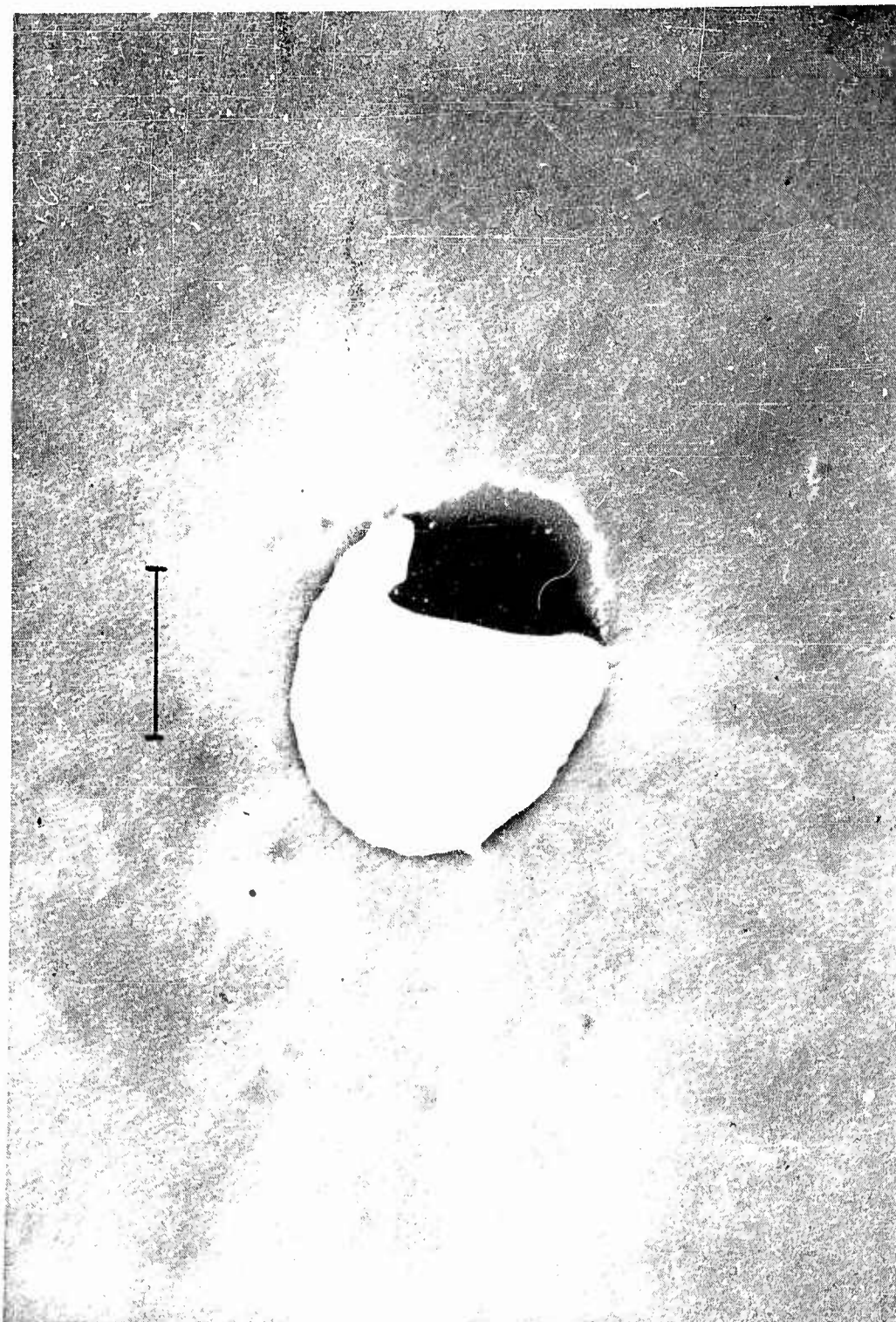

Fig. 13. Circular hole created in 200 A film by micrometeorite (scale = 1 micron).

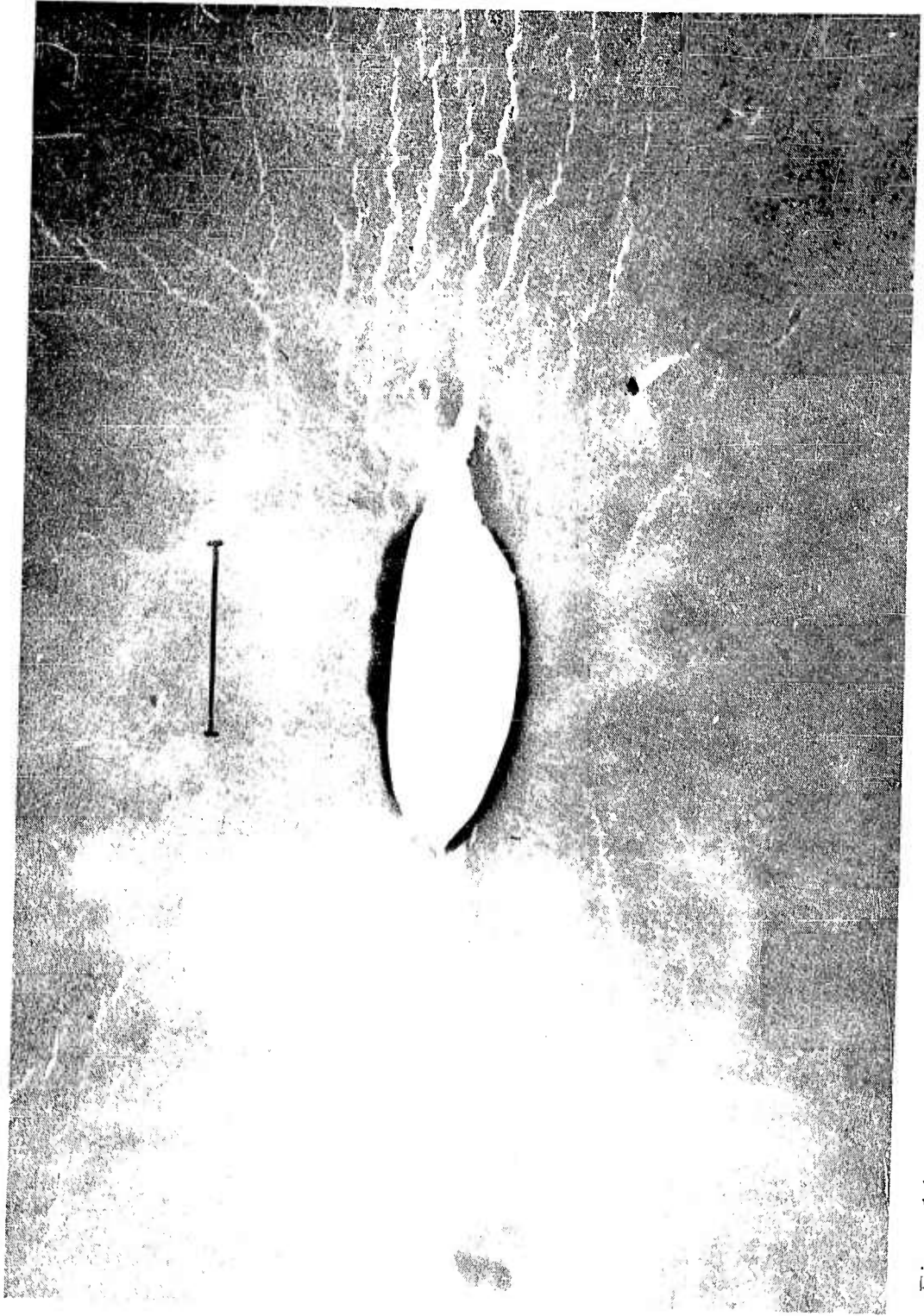

Fig. 14. Elliptical hole created in 200 A film by micrometeorite (scale = 1 micron).

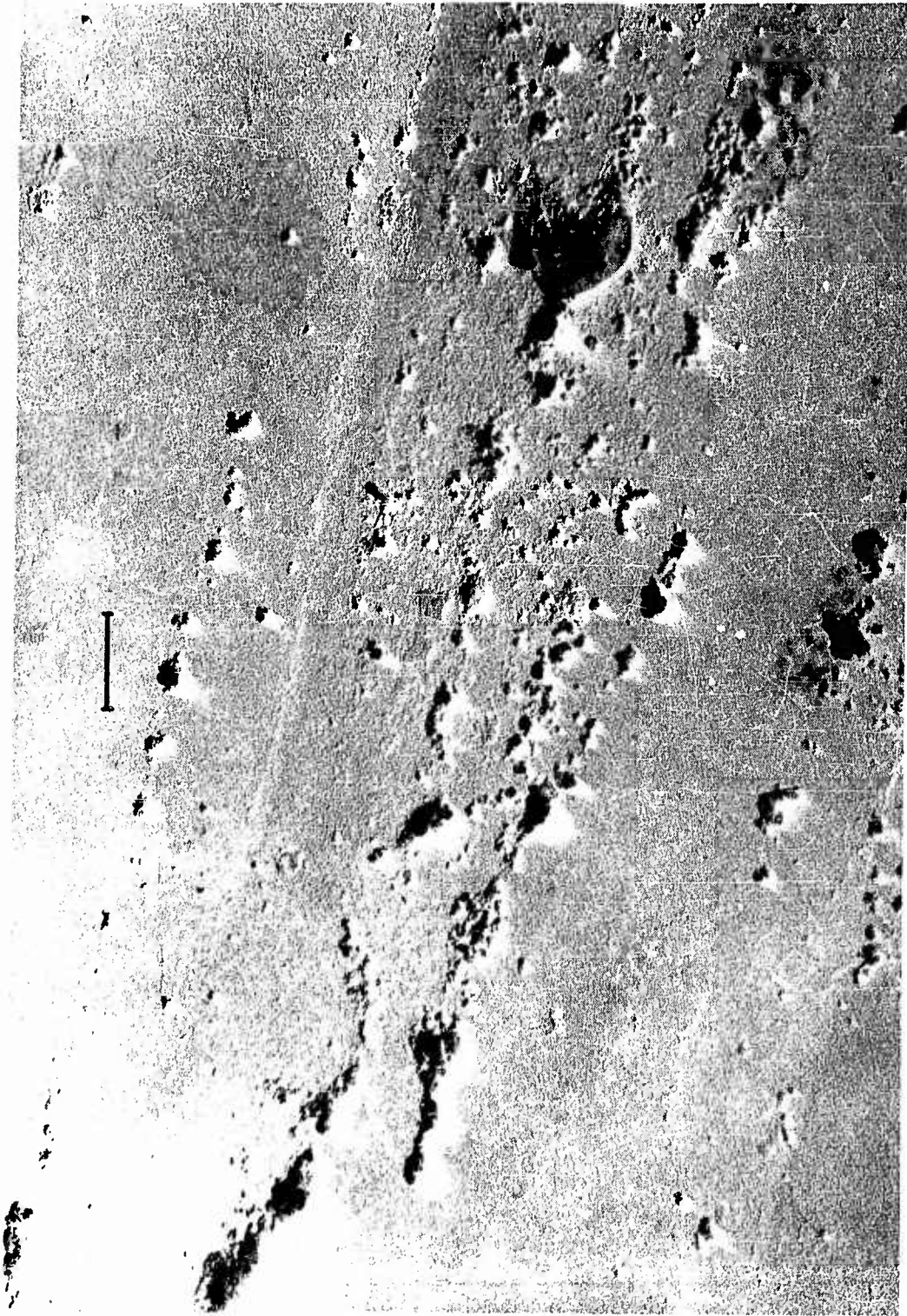
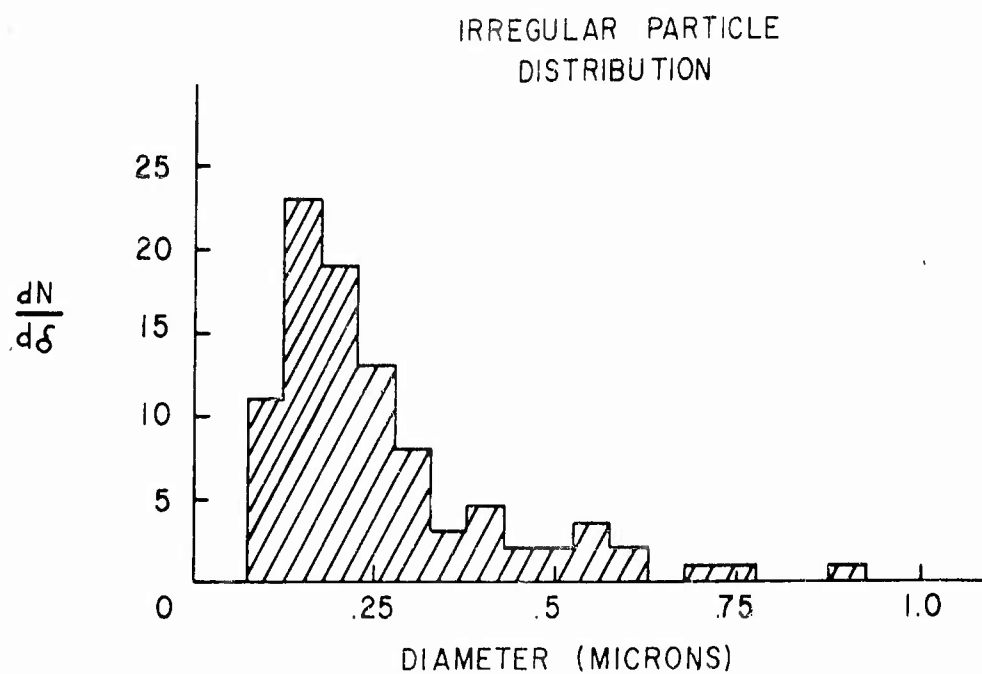

Fig. 15. Remnants of a smashed micrometeorite (scale = 1 micron).

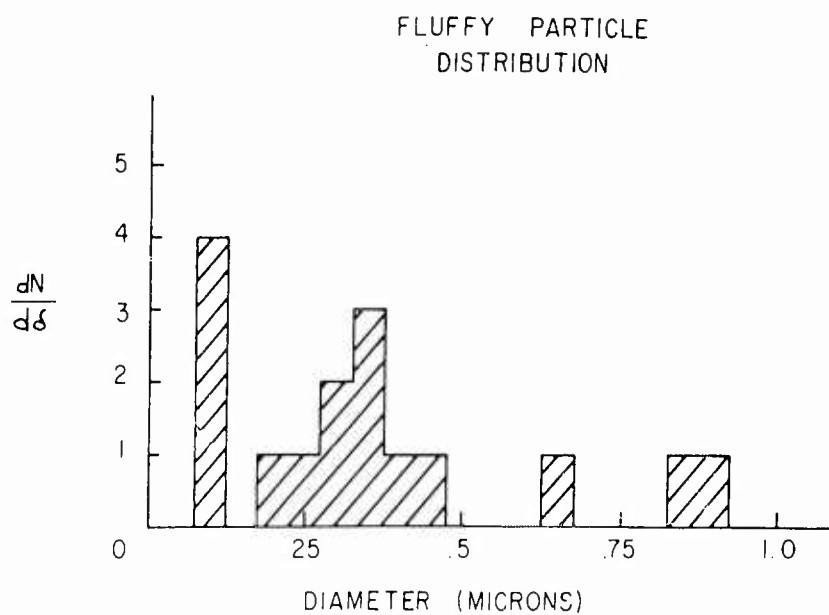

Fig. 16. Cluster of irregular micrometeorites (scale = 1 micron).



VENUS FLYTRAP JUNE 6, 1961

Fig. 17. Size distribution of irregular micrometeorites (0.1 to 1 micron).



VENUS FLYTRAP JUNE 6, 1961

Fig. 18. Size distribution of "fluffy" micrometeorites (0.1 to 1 micron).

In Fig. 19 the size distribution of the spherical-type particles has been plotted. Notice that the size extends down to a tenth of a micron and apparently the number per size range is still increasing at that point. There are also some larger spherical particles which are not shown on this distribution.

Figure 20 shows the distribution of spherical holes. Notice that there appears to be a cutoff at about 0.3 micron. The fact that the hole distribution extends down to sizes this small, and that spherical particles much larger than the minimum size hole are observed, indicates that there must have been a diversity in the velocities of particles hitting the surfaces.

To date, 133 particles which are believed to be of extraterrestrial origin have been found in the range of 0.1 to 1 micron in diameter. They were found in a total area of 17.84 mm². Eleven particles larger than 1 micron have been found in an area of 18.52 mm². This latter area is a little larger because the less serious laboratory contamination problem associated with larger particles permitted faster scanning. The total number of particles larger than 0.1 micron per unit area was 7.3 particles/mm². If we separate these particles according to type, 72 percent are irregular with sharp edges and rounded texture, 16 percent are high-density spheres, and 12 percent are of the fluffy type. Of the single flagged particles examined, 2 out of every 3 were judged to be micrometeorites although this number varied somewhat from sample to sample. In a few cases there was some difficulty in deciding whether or not a particle was a micrometeorite. Each of the observers was polled independently. The largest answer given by anyone of these for the frequency of such cases was 10 percent. All observers followed the rule: "When in doubt throw it out." Actually a few particles which really came from beyond the earth's atmosphere were probably discarded by this conservative policy.

The analysis of these particles is just now beginning. There are three techniques which offer hope for determining the composition

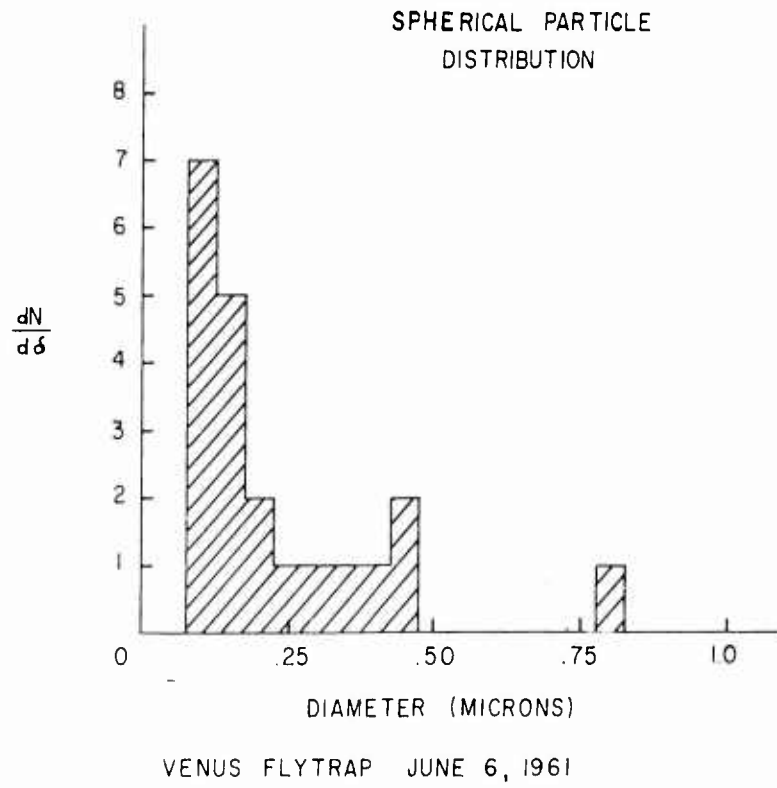

Fig. 19. Size distribution of spherical micrometeorites (0.1 to 1 micron).

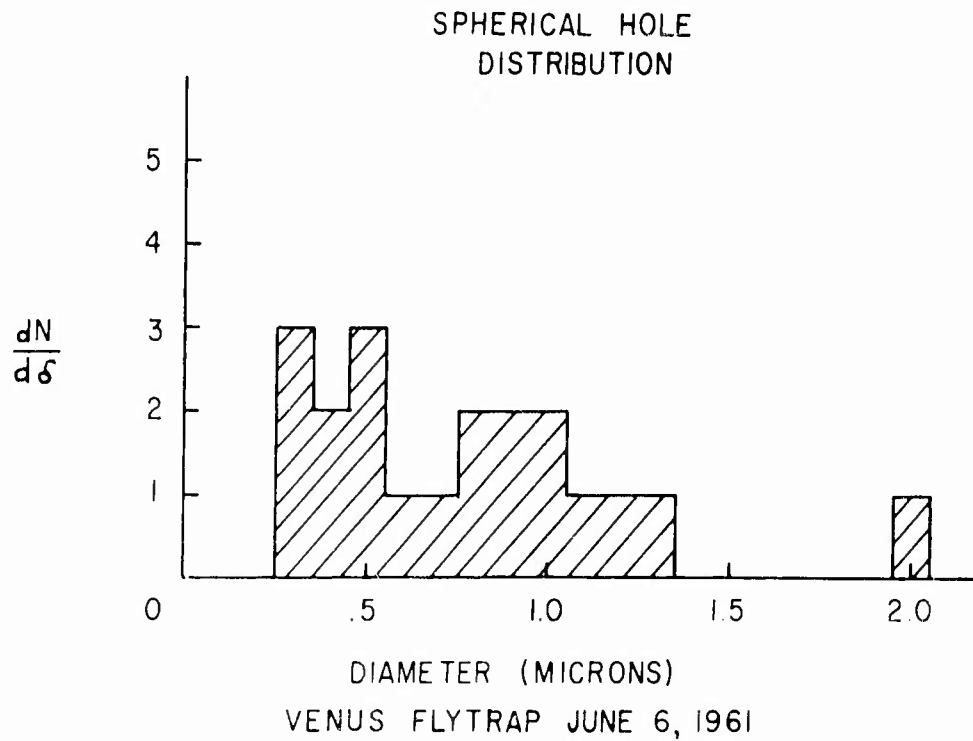

Fig. 20. Spherical hole size distribution from 200A films.

of these particles: electron diffraction, neutron activation, and electron-beam probe techniques.

The first technique, electron diffraction, thus far has not produced positive results. We are beginning to suspect that micrometeorite particles do not have a crystal structure and that any original crystal structure has been scrambled by cosmic-ray bombardment. It may turn out that the lack of crystal structure is an appropriate criterion for distinguishing micrometeorites. More work is needed to establish this point.

The second type of analysis involves neutron activation. Gamma-ray spectra studies of activated samples are now in progress. The third technique which will be used is the electron-beam probe wherein the particles are used as X-ray targets. The wavelengths of the characteristic X-radiation are used to identify the composition of the particle.

In summary, we believe that extraterrestrial particles have been collected. Several points form the foundation of this belief. The experiment had a number of controls which were carefully chosen and which lend confidence to the results. Secondly, the particles were collected at altitudes where terrestrial particles are very unlikely to reside for any length of time. The third fact is the distribution of holes found. By dropping particles through a 2-meter long vacuum tube, it was determined that particles of the order of 7 to 10 microns diameter will just break through 200A thick nitrocellulose collection film with a velocity of 3 m/sec. Figure 20 showed holes 0.3 micron in diameter in the flight collection films. If the strength of the films is energy sensitive this would suggest relative velocities of the order of 1 or 2 km/sec for a particle comparable in size to the smallest holes found. Finally, the observers have had considerable experience looking at the high-altitude particles and at the contaminants which appear in electron microscopy. In fact, four of the observers among them have had a total of 40 years experience in electron microscopy.

This experience increases our confidence that the particles described and shown in this paper are indeed nonterrestrial in origin.

Although there is much more to be done, particularly on particle analysis, and these results are only preliminary, we feel that the further study is not likely to change the present numerical results significantly.

REFERENCES

1. Richards, L. G. and J. W. Gehring, Jr., "Hypervelocity Micro-particle Impact on Thin Foils," BRL Technical Note No. 1380, BRL Aberdeen Proving Ground, Md., (Feb 1961).
2. Kells, M. C., and D. D. Keough, "Impact of High Speed Particles with Solids and Gases," SRI Technical Report, AFCRL-TR-59-219, Stanford Research Institute, Menlo Park, Calif. (Dec 1958).

ACKNOWLEDGMENTS

The authors wish to thank Miss L. Della Lucca and Messrs. P. Manning and R. Oppenheim for their assistance and cooperation in obtaining some of the results described in this paper.

ARTICLE III
MICROMETEORITE COLLECTION FROM A RECOVERABLE
SOUNDING ROCKET

R. K. Soberman^{a, d} and C. L. Hemenway^{b, c}

ABSTRACT

The interpretation of the preliminary results obtained from the "Venus Flytrap" rocket is presented. These results are compared with those from satellite observations. The possible existence of a dust layer is discussed.

The preceding articles have presented experimental details and preliminary results of the Venus Flytrap experiment, and the reasons for confidence in these results. This present paper introduces interpretations, tentative conclusions, and speculations.

The results indicate first, the apparent existence of submicron particles in the extraterrestrial flux. To account for this, one must hypothesize a breakup mechanism for larger particles or speculate on the apparent inefficiency of radiation pressure in removing submicron particles from the solar system.

A second surprising result is the low velocity with which the particles impinged on the collectors. Table 1 lists terminal velocities of various diameter particles over the altitude range covered by the Venus Flytrap Rocket. If one argues that the particles should be arriving at the earth with large radial velocities, then the numbers presented in Table 1 (particularly for the larger diameter particles) are much lower than those one would observe at the corresponding altitudes. However if one assumes that the particles had been in orbit about the earth, then tangential deceleration at altitudes of the order

-
- a. Geophysics Research Directorate
 - b. Dudley Observatory, Albany, N. Y.
 - c. Union College, Schenectady, N. Y.
 - d. Northeastern University, Boston, Mass.

TABLE 1. Particle terminal velocities (km/sec).

ALTTITUDE (km)	168	1.5	4.7	v_{∞}	v_{∞}
	148	1.0	3.2	v_{∞}	v_{∞}
	128	0.52	1.6	5.2	v_{∞}
	108	0.15	0.47	1.5	4.7
	88	0.021	0.066	0.21	0.66
		0.1	1.0	10.0	100
		DIAMETER (microns)			

of 500 km or less would result in radial velocities equal to or even less than the terminal velocities at the altitudes shown. From the lack of high-velocity impacts observed in the experiment, one must accept some form of orbital trapping or else seek a mechanism of radial deceleration or "slow down" which is more effective than atmospheric drag for micrometeoritic particles. Electrostatic deceleration by the ionosphere could conceivably be such a mechanism and should be investigated. Whatever the mechanism, it will be assumed for the present analysis that the particles observed were moving downward with approximately terminal velocities.

The third result is the size distribution and numbers of particles collected per unit area. Figure 1 is a plot of the preliminary results from the collectors which were mounted in the boxes. The curve plots the number of particles found, larger than a given diameter, versus the diameter. The points have been normalized to a total area of 1 square meter. A line with slope of -1.3 has been fitted by eye. One can see from the ordinate values that the assumption of low velocities is practically a necessity if one is to understand these results in the light of other meteoric and micrometeoritic work.

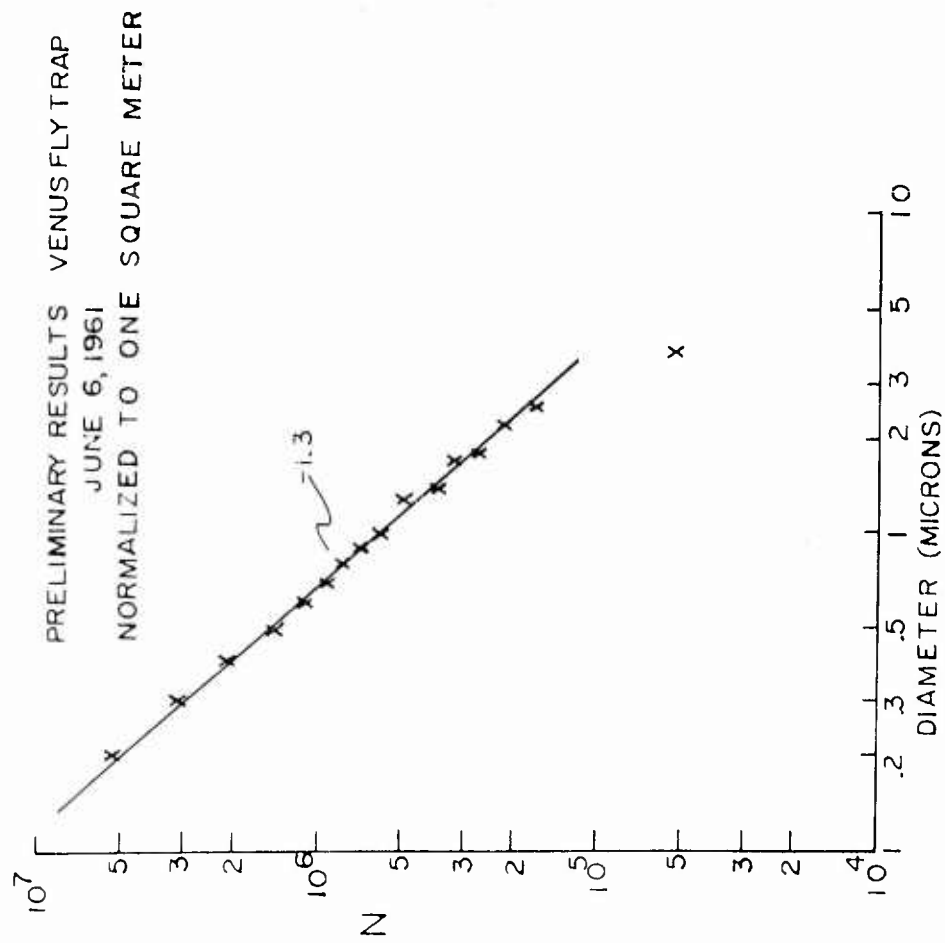

Fig. 1. Size distribution of all particles found to date from Venus Flytrap experiment.

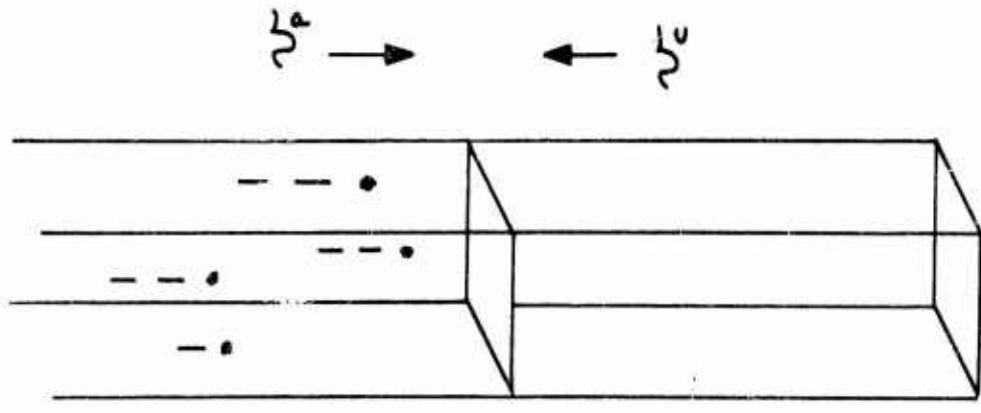

Fig. 2. Moving collector in unit area column.

With certain assumptions, a value for the extraterrestrial flux can be calculated. If one has a collector moving through a column of unit area in which particles are falling (Fig. 2), then the number of particles of given size collected can be written as:

$$N = \int \varphi_c dt = \int \varphi_c \frac{dz}{v_c} \quad (1)$$

where φ_c is the flux on the collector and v_c is the velocity of the collector. This can also be written

$$N = \int n_a \left[v_p \pm v_c \right] \frac{dz}{v_c} \quad (2)$$

where v_p is the velocity of the particles and n_a is the ambient particle density. The minus sign is used when the collector is moving downward. If one assumes a constant ambient flux φ_a , then one obtains:

$$N = \varphi_a \left[\int \frac{dz}{v_c} \pm \int \frac{dz}{v_p} \right] \quad (3)$$

The first integral is the exposure time of the collector. The second term can be evaluated if one assumes that v_p is the terminal velocity of the particles. That is

$$v_p = \sqrt{\frac{mg}{\rho_a \sigma}} \quad (4)$$

where ρ_a is the ambient air density and σ is the cross-sectional area of the particles. Assuming spherical particles one can write:

$$N = \varphi_a \left[\int dt \pm \int \left(\frac{3\rho_a}{2\delta \rho_p g} \right)^{1/2} dz \right] \quad (5)$$

where δ and ρ_p are the diameter and density of the particles. For

an exponential atmosphere this equation on integration yields:

$$N = \varphi_a \left[t \pm 2H \left(\frac{3}{2\delta \rho_p g} \right)^{1/2} \left(\rho_{ai}^{1/2} - \rho_{af}^{1/2} \right) \right] \quad (6)$$

where H is the scale height and the subscripts i and f refer to initial and final values. The quantity in the brackets (the effective exposure time of the collectors) is plotted in Fig. 3.

A mean particle density of 3 grams/cm³ has been assumed. The calculation was performed by summing Eq. (6) over regions where the scale height remained reasonably constant. Densities, scale heights, and gravitational accelerations were obtained from the standard atmosphere tables.¹ The summation was cut off where $v_p = v_c$ when the collector was moving downward. Implicit in these calculations was the assumption of 100 percent collection efficiency. Theoretically this should be true for particles larger than 0.01 micron at the altitudes of interest here. The number of particles of each size collected per square meter divided by the effective collection time for that size is then the flux at all altitudes. The results are plotted in Fig. 4. The ordinate is the integrated flux (that is, the flux of particles larger than a given diameter is plotted as a function of the diameter). The correction factors for the exposure angle and any shielding effect of the ogive assembly have been neglected. In the lower right-hand corner of Fig. 4 the three points from the mylar films (that is, the particle sizes assumed to have caused the holes) have been plotted. These points were normalized in the same manner as the others. Notice that the upper slope has changed to -1.2. For particle diameters larger than 2 or 3 microns (the solar radiation cut-off) a shaded area with slope -3.6 (which is the best estimate from satellite data for these sizes)² has been somewhat arbitrarily drawn. Thus from the foregoing a flux estimate of approximately 300 particles/m²/sec larger than 3 microns in diameter is obtained. This estimate is based,

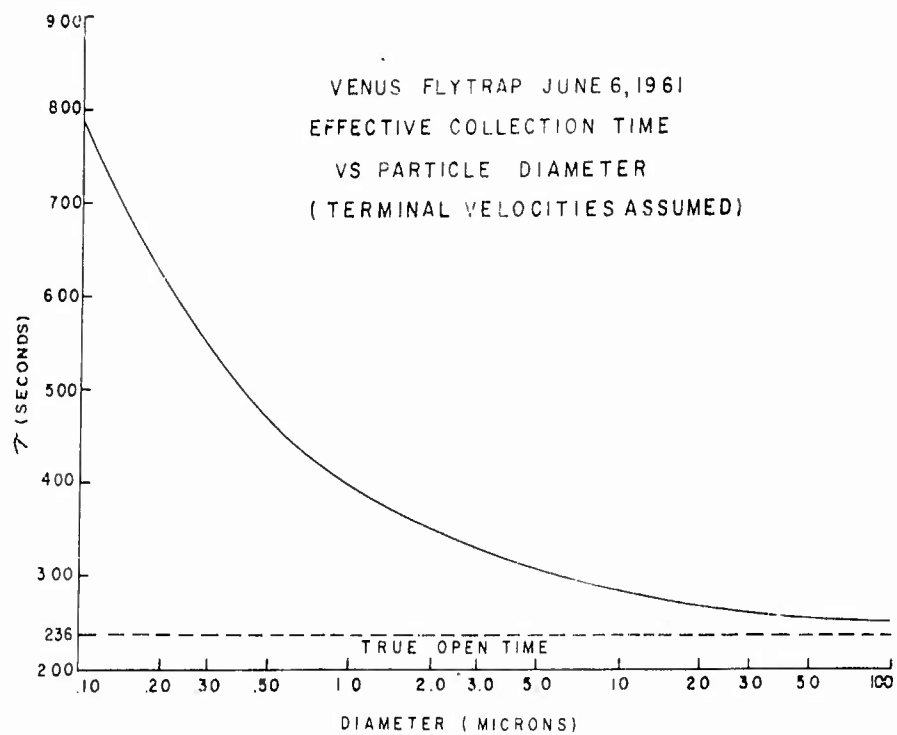

Fig. 3. Effective collection time for Venus Flytrap experiment.

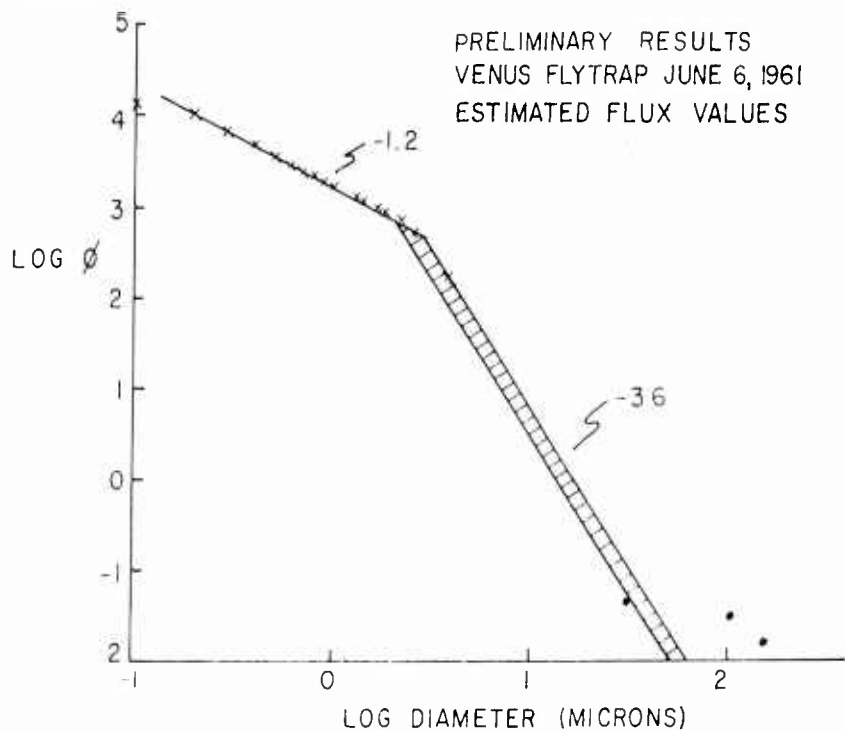

Fig. 4. Micrometeorite flux as calculated from Venus Flytrap results.

of course, on preliminary data and may change slightly. However, one must remember that the calculation is based on the assumption of particles moving at terminal velocity. Were the velocities substantially higher, the flux estimate would be low by the ratio of the assumed effective exposure time to the actual open time of the collector. That is, the flux estimate for particles 3 microns and larger would be multiplied by a factor of approximately 4/3. On the other hand, if it were shown that the actual particle velocities were lower than terminal velocities in this altitude range, then the estimated flux would be too high. It should also be noted that the present flux estimate does not include the particles which penetrated the 200A films and were not recovered. This, if included, would increase the flux by approximately 20 percent.

At this point the present estimated fluxes can be compared with measurements made from satellites. At first glance the derived flux value appears to be orders of magnitude higher than any recent measurements or extrapolations. However, one might compare the present values with a curve for a geocentric distribution of particles. Such a curve is shown in Fig. 5. This curve, presented earlier,³ is similar to that presented by Whipple.⁴ For an assumed spherical particle with uniform density of 3 grams/cm³, this curve represents particles 9 microns in diameter and larger. The curve in Fig. 5 would predict a flux of such particles of 0.25/m²/sec at 100 km. From Fig. 4, the present estimate would be about 6 particle/m²/sec. If one assumes, however, that the particles measured from satellites were low-density loose agglomerates and if one uses a density of 0.1 gm/cm³, then a particle with a mass of 10⁻⁹ gm would have a diameter of 27 microns. The present estimate (from Fig. 4) of this particle size would be 0.1 m⁻²sec⁻¹, in much better agreement with the satellite observations.

To speculate briefly on the source of these particles, it is felt that terrestrial origin can be ruled out. A cataclysmic event immediately prior to the firing would be required to raise particles of this size to a 90-km altitude. No such event was observed or reported.

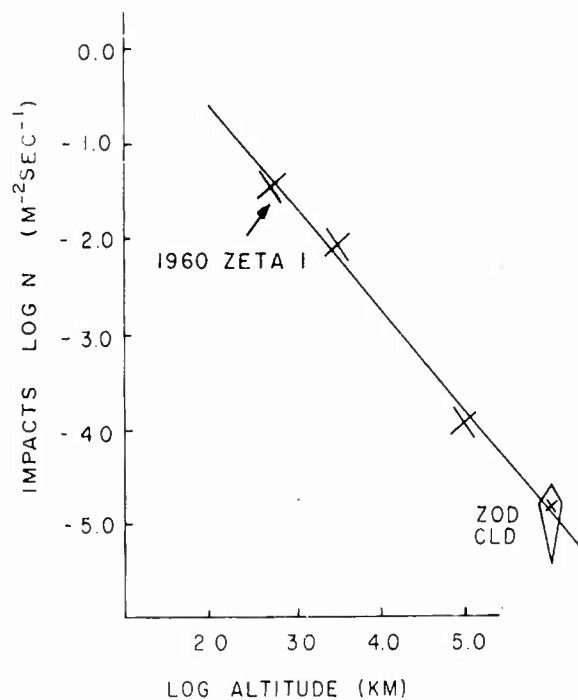

Fig. 5. Meteoritic impact (mass = 10^{-9} gm) versus altitude from the earth. (Revised from Whipple, F. L.⁴)

A possibility which cannot be ruled out at the moment is that of a sharp increase in flux during the time of the experiment. On 6 June, two daylight radio-meteor showers were in progress, the Arietids which peak on 8 June and the Zeta Perseids which peak on 9 June. No unusually high activity has been reported for this period. If the present experiment was performed during a period of relatively normal activity (future experiments of the same type will decide this question), then one is forced to look for either a radial "slow down" or orbital trapping mechanism. Whatever the choice, one appears to be led to the conclusion that a dust layer (either moving orbitally or settling slowly) exists about the earth. This conclusion follows from the number of particles observed and the low relative velocities. The possible origin or origins of such a dust layer have been discussed by Whipple⁴ and shall not be treated here.

In summary, the three observed results of this experiment are (1) a preponderance of submicron particles, (2) the particles were apparently falling at low velocity, and (3) an unexpectedly large number of particles were collected. These results are consistent with one or both of

the following hypotheses: (1) the breakup of larger low-density "fluffy" particles, and (2) the existence of a dust layer or a geocentric distribution of micrometeoritic particles about the earth.

REFERENCES

1. Minzner, R. A., K.S.W. Champion, and H. L. Pond, "The ARDC Model Atmosphere, 1959," AF Surveys in Geophysics No. 115, Geophysics Research Directorate, Air Force Cambridge Research Center, (Aug 1959).
2. Whipple, F. L., Particulate Contents of Space, "Medical and Biological Aspects of the Energies of Space," edited by Paul Campbell, Columbia Univ. Press, N. Y., (June 1961).
3. Soberman, R.K. and L. E. Della Lucca, "Micrometeorite Measurements from the Midas II (1960 Zeta I)" GRD Research Notes No. 72, and Smithsonian Contributions to Astrophysics (in press).
4. Whipple, F. L., "The Dust Cloud about the Earth, Nature 189, 127 (1961).

ACKNOWLEDGMENTS

The authors wish to thank Miss P. Burnham and Mr. R. Sarkesian for their assistance with the computations described in this paper.

GRD RESEARCH NOTES

- No. 1. Contributions to Stratospheric Meteorology, *edited by George Ohring, Aug 1958.*
- No. 2. A Bibliography of the Electrically Exploded Wire Phenomenon, *W. G. Chace, Nov 1958.*
- No. 3. Venting of Hot Gases Through Temperature Inversions, *M. A. Estoque, Dec 1958:*
- No. 4. Some Characteristics of Turbulence at High Altitudes, *M. A. Estoque, Dec 1958.*
- No. 5. The Temperature of an Object Above the Earth's Atmosphere, *Marden H. Seavey, Mar 1959.*
- No. 6. The Rotor Flow in the Lee of Mountains, *Joachim Kuettner, Jan 1959.*
- No. 7. The Effect of Sampler Spacing on Basic Analyses of Concentration Data, *Duane A. Haugen, Jan 1959.*
- No. 8. Natural Aerosols and Nuclear Debris Studies, Progress Report I, *P. J. Drevinsky, C. E. Junge, I. H. Blifford, Jr., M. I. Kalkstein and E. A. Martell; Sep 1958.*
- No. 9. Observations on Nickel-Bearing Cosmic Dust Collected in the Stratosphere, *Herman Yagoda, Mar 1959.*
- No. 10. Radioactive Aggregates in the Stratosphere, *Herman Yagoda, Mar 1959.*
- No. 11. Comments on the Ephemerides and Constants for a Total Eclipse of the Sun, *R. C. Cameron and E. R. Dyer, May 1959.*
- No. 12. Numerical Experiments in Forecasting Air and Soil Temperature Profiles, *D. W. Stevens, Jun 1959.*
- No. 13. Some Notes on the Correlation Coefficient, *S.M. Silverman, May 1959.*
- No. 14. Proceedings of Military Geodesy Seminar, December 1958, Air Force Cambridge Research Center (U), *edited by O. W. Williams, Apr 1959. (SECRET Report)*
- No. 15. Proceedings of the First Annual Arctic Planning Session, November 1958, *edited by Joseph H. Hartshorn, Apr 1959.*
- No. 16. Processes for the Production and Removal of Electrons and Negative Ions in Gases, *S.M. Silverman, Jun 1959.*
- No. 17. The Approximate Analysis of Zero Lift Trajectories, *Charles Hoult, Aug 1959.*
- No. 18. Infrared Measuring Program 1958 (IRMP 58) - Activities, Achievements, and Appraisal (U), *M.R. Nagel, Jul 1959. (SECRET Report)*
- No. 19. Artificial Radioactivity from Nuclear Tests up to November 1958, *E. A. Martell, Sep 1959*
- No. 20. A Preliminary Report on a Boundary Layer Numerical Experiment, *M.A. Estoque, Oct 1959.*
- No. 21. Recent Advances in Contrail Suppression, (U), *S. J. Birstein, Nov 1959. (CONFIDENTIAL Report)*
- No. 22. A Note Comparing One Kilometer Vertical Wind Shears Derived from Simultaneous AN/GMD-1A and AN/GMD-2 Winds Aloft Observations, *H. A. Salmela and N. Sissenwine, Oct 1959.*
- No. 23. Atmospheric Refraction of Infrared Radiation, *T. P. Condron, Oct 1959.*
- No. 24. Natural Aerosols and Nuclear Debris Studies, Progress Report II, *M. I. Kalkstein, P. J. Drevinsky, E. A. Martell, C. W. Chagnon, J. E. Manson, and C. E. Junge, Nov 1959.*
- No. 25. Observations of Jupiter Missile Re-Entry, (U), *R. G. Walker, R. E. Ellis and R. E. Hunter, Dec 1959. (SECRET Report)*
- No. 26. Space Probes and Persistence of Strong Tropopause Level Winds, *H. Salmela and N. Sissenwine, Dec 1959.*
- No. 27. A Relativistic Treatment of Strong Shock Waves in a Classical Gas, *A. W. Guess, Dec 1959.*
- No. 28. Measurements of Flux of Small Extraterrestrial Particles, *H. A. Cohen, Jan 1960.*
- No. 29. Proceedings of the Second Annual Arctic Planning Session, October 1959, *edited by Vivian C. Bushnell, Dec 1959.*
- No. 30. Atmospheric Pressure Pulse Measurements, (U), *Elisabeth F. Hiff, Jan 1960. (SECRET Report - Formerly Restricted Data)*

GRD RESEARCH NOTES (Continued)

- No. 31. A Discussion of the Calder Equation for Diffusion from a Continuous Point Source, *W. P. Elliott, May 1960.*
- No. 32. Lagrangian and Eulerian Relationships in the Absence of Both Homogeneity and Time Steadiness, *M. L. Barad and D. A. Haugen, May 1960.*
- No. 33. Thermal Radiation from Rocket Exhausts at Extreme Altitudes, (U) *R. G. Walker, R. E. Hunter, and J. J. Neu, Jun 1960. (SECRET Report)*
- No. 34. Thermal Radiation Measurement from an Aerobee Hi Research Rocket, *R. G. Walker, and R. E. Hunter, Dec 1960.*
- No. 35. Additional Note -- Strong Vertical Wind Profiles and Upper-Level Maximum Wind Speeds Over Vandenberg Air Force Base. *H. A. Salmela and N. Sissenwine, May 1960.*
- No. 36. Contributions to Satellite Meteorology, Vol. I., edited by *W. K. Widger, Jr., Jun 1960.*
Vol. II., edited by *F. R. Valocin, Apr 1961.*
- No. 37. IRMP Participation in Operation Big Arm -- Activities, Results and Appraisal (U), Final Report, *M. R. Nagel, et al, Jun 1960. (SECRET Report)*
- No. 38. Examples of Project Tiros Data and Their Practical Meteorological Use, *W. K. Widger, Jr., July 1960.*
- No. 39. Exploration of the Ionosphere with Telemetering Monochromators and Retarding Potential Analyzers, *H. E. Hinteregger, Aug 1960.*
- No. 40. Proceedings of the Second Annual AFCRC Seminar on Military Geodesy, edited by *T. E. Wintner, (SECRET Report) Nov 1960.*
- No. 41. Tangential Velocity Measurements -- An Independent Approach to Geodesy, *B. C. Murray and N. H. Diger, Sep 1960.*
- No. 42. Topographic Charts at One-Degree Intersections for the Entire Earth, *L. Berkofsky and E. A. Bedford, Sep 1960.*
- No. 43. Cosmic-Ray Monitoring of the Manned Stratolab Balloon Flights, *Ilerman Yagoda, Sep 1960.*
- No. 44. Methods for the Evaluation of the Green's Function Arising in the Linear Barotropic Numerical Weather Prediction Theory, *L. Berkofsky, Nov 1960.*
- No. 45. Observation of Thor Missile Re-entry, (U) *R. Ellis, Oct 1960. (SECRET Report)*
- No. 46. Background Measurements During the Infrared Measuring Program 1956 (IRMP 56) (Unclassified excerpts from the proceedings of the symposium on IRMP-56), edited by *Max R. Nagel, Nov 1960.*
- No. 47. Wind Speeds from GMD-1 Ascents Computed Electronically Compared to Plotting Board Results, *H. A. Salmela, Oct 1960.*
- No. 48. The Numerical Solution of Fredholm Integral Equations of the First Kind, *J. T. Jefferies and F. J. Orrall, Nov 1960.*
- No. 49. Infrared Spectra of High Altitude Missile Plumes, (U), *Lt. R. E. Hunter, Jan 1961. (SECRET Report)*
- No. 50. Aids for Computing Stratospheric Moisture, *Murray Gutnick, Jan 1961.*
- No. 51. Some Applications of the Method of Least Squares to Estimating the Probability of a Future Event, *L. A. Lund, Jan 1961.*
- No. 52. Winds and Circulations in the Mesosphere, *T. J. Keegan, Feb 1961.*
- No. 53. Gravity Observations Along the Northern Coast of Ellesmere Island, *F. A. Crowley, Feb 1961.*
- No. 54. Radiation Studies from Nuclear Emulsions and Metallic Components Recovered from Polar Satellite Orbits, *H. Yagoda, Mar 1961.*

GRD RESEARCH NOTES (Continued)

- No. 55. Proceedings of the Third Annual Arctic Planning Session, November 1960, *edited by G. Rigsby and V. Bushnell, April 1961.*
- No. 56. Horizontal Sounding Balloon Feasibility Study, *Maj. T. Spalding and S. B. Solot, May 1961.*
- No. 57. Instability and Vertical Motions in the Jet Stream, *J. P. Kuettner and G. S. McLean, May 1961.*
- No. 58. A Study of Sacramento Peak Flares II: Flare Areas and Importance Classifications, *(to be published).*
- No. 59. A Study of Sacramento Peak Flares I: Distribution, Areas, and Growth Curves, *H. J. Smith, April 1961.*
- No. 60. Hourly Rawinsondes for a Week, *A. Court and H. A. Salmela, July 1961.*
- No. 61. New Vacuum Ultraviolet Emission Continua in the Rare Gases, *R. E. Huffman, W. W. Hunt, Y. Tanaka, R. L. Novak, and J. C. Larrabee, July 1961.*
- No. 62. Bibliography of Lunar and Planetary Research - 1960 (With Annotations), *J. W. Salisbury and L. T. Salisbury, Jul 1961.*
- No. 63. Flight Information and Experimental Results of Inflatable Falling Sphere System for Measuring Upper-Air Density, *G. A. Faucher, R. W. Proconier and C. N. Stark, Aug 61.*
- No. 64. Maximum Winds and Missile Responses, *H. A. Salmela and A. Court, Aug 61.*
- No. 65. Meteorological Evaluation and Application of Rainfall Radioactivity Data, *Per B. Storebø, Aug 1961.*
- No. 66. The Formation of Ions in the Upper Atmosphere, *R. E. Huffman, (to be published).*
- No. 67. Studies in Lunar Topography, *Zdenek Kopal, (to be published).*
- No. 68. An Example of Chromospheric Striation Obscuration by a Great Flare, *H. J. Smith and W. D. Booton, Aug 61.*
- No. 69. A Numerical Method for Computing Radiative Temperature Changes Near the Earth's Surface, *W. P. Elliott and D. W. Stevens, Sep 61.*
- No. 70. Location of a Lunar Base, *J. W. Salisbury and C. F. Campen, Jr., (to be published).*

<p>AD Geophysics Research Directorate AF Cambridge Research Laboratories, (OAR) 1. G. Hanscom Field, Bedford, Mass.</p> <p>MICROMETEORITE COLLECTION FROM A RECOVERABLE SOUNDING ROCKET, edited by R. K. Soberman, Nov 1961. 50 pp incl table and illus. (GRD Research Notes No. 71; AFCRL 1049). Unclassified Report</p> <p>This report contains three articles regarding the "Venus Flytrap" collector rocket. The first article discusses the experimental details and rocket performance. The second and third articles present the results obtained to date and an interpretation of these results, respectively.</p>	<p>UNCLASSIFIED</p> <p>1. Micrometeorology 2. Collecting methods (general concepts) I. edited by R. K. Soberman</p>	<p>AD Geophysics Research Directorate AF Cambridge Research Laboratories, (OAR) 1. G. Hanscom Field, Bedford, Mass.</p> <p>MICROMETEORITE COLLECTION FROM A RECOVERABLE SOUNDING ROCKET, edited by R. K. Soberman, Nov 1961. 50 pp incl table and illus. (GRD Research Notes No. 71; AFCRL 1049). Unclassified Report</p> <p>This report contains three articles regarding the "Venus Flytrap" collector rocket. The first article discusses the experimental details and rocket performance. The second and third articles present the results obtained to date and an interpretation of these results, respectively.</p>	<p>UNCLASSIFIED</p> <p>1. Micrometeorology 2. Collecting methods (general concepts) I. edited by R. K. Soberman</p>
<p>AD Geophysics Research Directorate AF Cambridge Research Laboratories, (OAR) 1. G. Hanscom Field, Bedford, Mass.</p> <p>MICROMETEORITE COLLECTION FROM A RECOVERABLE SOUNDING ROCKET, edited by R. K. Soberman, Nov 1961. 50 pp incl table and illus. (GRD Research Notes No. 71; AFCRL 1049). Unclassified Report</p> <p>This report contains three articles regarding the "Venus Flytrap" collector rocket. The first article discusses the experimental details and rocket performance. The second and third articles present the results obtained to date and an interpretation of these results, respectively.</p>	<p>UNCLASSIFIED</p> <p>1. Micrometeorology 2. Collecting methods (general concepts) I. edited by R. K. Soberman</p>	<p>AD Geophysics Research Directorate AF Cambridge Research Laboratories, (OAR) 1. G. Hanscom Field, Bedford, Mass.</p> <p>MICROMETEORITE COLLECTION FROM A RECOVERABLE SOUNDING ROCKET, edited by R. K. Soberman, Nov 1961. 50 pp incl table and illus. (GRD Research Notes No. 71; AFCRL 1049). Unclassified Report</p> <p>This report contains three articles regarding the "Venus Flytrap" collector rocket. The first article discusses the experimental details and rocket performance. The second and third articles present the results obtained to date and an interpretation of these results, respectively.</p>	<p>UNCLASSIFIED</p> <p>1. Micrometeorology 2. Collecting methods (general concepts) I. edited by R. K. Soberman</p>
<p>AD Geophysics Research Directorate AF Cambridge Research Laboratories, (OAR) 1. G. Hanscom Field, Bedford, Mass.</p> <p>MICROMETEORITE COLLECTION FROM A RECOVERABLE SOUNDING ROCKET, edited by R. K. Soberman, Nov 1961. 50 pp incl table and illus. (GRD Research Notes No. 71; AFCRL 1049). Unclassified Report</p> <p>This report contains three articles regarding the "Venus Flytrap" collector rocket. The first article discusses the experimental details and rocket performance. The second and third articles present the results obtained to date and an interpretation of these results, respectively.</p>	<p>UNCLASSIFIED</p> <p>1. Micrometeorology 2. Collecting methods (general concepts) I. edited by R. K. Soberman</p>	<p>AD Geophysics Research Directorate AF Cambridge Research Laboratories, (OAR) 1. G. Hanscom Field, Bedford, Mass.</p> <p>MICROMETEORITE COLLECTION FROM A RECOVERABLE SOUNDING ROCKET, edited by R. K. Soberman, Nov 1961. 50 pp incl table and illus. (GRD Research Notes No. 71; AFCRL 1049). Unclassified Report</p> <p>This report contains three articles regarding the "Venus Flytrap" collector rocket. The first article discusses the experimental details and rocket performance. The second and third articles present the results obtained to date and an interpretation of these results, respectively.</p>	<p>UNCLASSIFIED</p> <p>1. Micrometeorology 2. Collecting methods (general concepts) I. edited by R. K. Soberman</p>
<p>AD Geophysics Research Directorate AF Cambridge Research Laboratories, (OAR) 1. G. Hanscom Field, Bedford, Mass.</p> <p>MICROMETEORITE COLLECTION FROM A RECOVERABLE SOUNDING ROCKET, edited by R. K. Soberman, Nov 1961. 50 pp incl table and illus. (GRD Research Notes No. 71; AFCRL 1049). Unclassified Report</p> <p>This report contains three articles regarding the "Venus Flytrap" collector rocket. The first article discusses the experimental details and rocket performance. The second and third articles present the results obtained to date and an interpretation of these results, respectively.</p>	<p>UNCLASSIFIED</p> <p>1. Micrometeorology 2. Collecting methods (general concepts) I. edited by R. K. Soberman</p>	<p>AD Geophysics Research Directorate AF Cambridge Research Laboratories, (OAR) 1. G. Hanscom Field, Bedford, Mass.</p> <p>MICROMETEORITE COLLECTION FROM A RECOVERABLE SOUNDING ROCKET, edited by R. K. Soberman, Nov 1961. 50 pp incl table and illus. (GRD Research Notes No. 71; AFCRL 1049). Unclassified Report</p> <p>This report contains three articles regarding the "Venus Flytrap" collector rocket. The first article discusses the experimental details and rocket performance. The second and third articles present the results obtained to date and an interpretation of these results, respectively.</p>	<p>UNCLASSIFIED</p> <p>1. Micrometeorology 2. Collecting methods (general concepts) I. edited by R. K. Soberman</p>