

**UNCLASSIFIED**

---

---

**AD 295 475**

*Reproduced  
by the*

**ARMED SERVICES TECHNICAL INFORMATION AGENCY  
ARLINGTON HALL STATION  
ARLINGTON 12, VIRGINIA**



---

---

**UNCLASSIFIED**

NOTICE: When government or other drawings, specifications or other data are used for any purpose other than in connection with a definitely related government procurement operation, the U. S. Government thereby incurs no responsibility, nor any obligation whatsoever; and the fact that the Government may have formulated, furnished, or in any way supplied the said drawings, specifications, or other data is not to be regarded by implication or otherwise as in any manner licensing the holder or any other person or corporation, or conveying any rights or permission to manufacture, use or sell any patented invention that may in any way be related thereto.

CATALOGED BY ASTIA  
AS AD NO 295475

ASD TDR-62-907

# 295 475

## Vapor Plating of Aluminum on Steel

Jesse J. Crosby

TECHNICAL DOCUMENTARY REPORT NO. ASD-TDR-62-907  
December 1962

Directorate of Materials and Processes  
Aeronautical Systems Division  
Air Force Systems Command  
Wright-Patterson Air Force Base, Ohio

ASTIA  
FEB 5 1963

Project 7312, Task 731201

## NOTICES

When Government drawings, specifications, or other data are used for any purpose other than in connection with a definitely related Government procurement operation, the United States Government thereby incurs no responsibility nor any obligation whatsoever; and the fact that the Government may have formulated, furnished, or in any way supplied the said drawings, specifications, or other data, is not to be regarded by implication or otherwise as in any manner licensing the holder or any other person or corporation, or conveying any rights or permission to manufacture, use, or sell any patented invention that may in any way be related thereto.

Qualified requesters may obtain copies of this report from the Armed Services Technical Information Agency, (ASTIA), Arlington Hall Station, Arlington 12, Virginia.

This report has been released to the Office of Technical Services, U.S. Department of Commerce, Washington 25, D.C., in stock quantities for sale to the general public.

Copies of this report should not be returned to the Aeronautical Systems Division unless return is required by security considerations, contractual obligations, or notice on a specific document.

FOREWORD

This report was prepared by the Electrochemical Section, Physical Metallurgy Branch, Metals and Ceramics Laboratory, Directorate of Materials and Processes, Deputy for Technology, Aeronautical Systems Division. It was initiated under Project No. 7312, "Finishes and Materials Preservation," Task No. 731201, "Surface Treatments and Coatings," with Mr. Jesse J. Crosby as Project Engineer.

This report covers work conducted from August 1960 to August 1962. Technical Memorandum Report No. WWRCM-TM-60-12 covers initial progress under this project.

The author is indebted to Messrs. H. Stevens, O. O. Srp, R. J. Barton, N. Geyer, P. Faust, and W. Lawless of Metals and Ceramics Laboratory for their invaluable guidance, assistance and helpful suggestions during the course of this investigation. The author is particularly indebted to the personnel of the Zone Shop Branch and Analytical Branch and to the many unnamed people of the Directorate who both directly and indirectly contributed to and assisted this program.

ABSTRACT

Adherent coatings of aluminum were deposited on low carbon steel specimens by vapor (gas) plating using the metal-organic compound triisobutyl aluminum. In the process liquid triisobutyl aluminum was mixed with isobutylene and argon, vaporized, then thermally decomposed at a heated steel specimen into metallic aluminum plus volatile decomposition effluents. As a result of this reaction the aluminum was deposited on the steel substrate and the volatile decomposition products were swept out the exhaust. Uniform, ductile coatings, 2 mils thick, were obtained. The capability of obtaining thicker deposits was indicated.

Significantly, the deposition of aluminum by vapor plating was not limited to mild steel or metal substrates in general. Other materials including copper, magnesium, titanium, stainless steel, glass, and graphite were also plated by this process.

This technical documentary report has been reviewed and is approved.



I. PERLMUTTER  
Chief, Physical Metallurgy Branch  
Metals and Ceramics Laboratory  
Directorate of Materials & Processes

## TABLE OF CONTENTS

	Page
INTRODUCTION	1
THE PLATING PROCESS	1
SURFACE PREPARATION OF PLATING SPECIMENS	3
EVALUATION OF ALUMINUM COATING	4
COATING THICKNESS	5
COATING UNIFORMITY	6
OTHER MATERIALS COATED	6
ANALYSIS OF COATING AND DECOMPOSITION PRODUCTS	6
PLATING STUDIES WITH RECENTLY DEVELOPED GAS PLATING APPARATUS	7
SUMMARY	8
LIST OF REFERENCES	8

## LIST OF ILLUSTRATIONS

Figure	Page
1 Schematic of Plating Apparatus	11
2 Schematic of Plating Chamber Reactions	12
3 Schematic of Copper Tube Plating Apparatus	13
4 Photograph of Copper Tube Section	14
5 Photograph of Sandblasted Specimens	15
6 Photograph of Polished Specimens	16
7 Photograph of Plated Bolt, Nut, and Cylinder	17
8 Photomicrographs Showing Cross Section of Plated Specimens	18
9 Electron Micrograph (8000X) of Aluminum Coating Over Sandblasted Steel Surface	19
10 Schematic of Recently Developed Plating Apparatus	20
11 Photograph of Recently Developed Plating Apparatus	21

## LIST OF TABLES

Table	Page
1 Plating Compound Properties and Characteristics	9
2 Properties of Isobutylene	10
3 Coating Thickness Measurements	10

## INTRODUCTION

Aluminum as a coating affords protection from corrosion to the less noble metals and can serve as a base for the production of a non-conductive oxide layer by anodizing. It has found considerable application as a coating for mild steel, particularly in the area involving moderately high temperatures. From a protective standpoint it is very significant that aluminum naturally forms a thin, tightly adherent film of oxide on its surface that greatly slows down the rate of corrosion. The highly electropositive aluminum constitutes a good coating medium for the lesser electropositive metals. In terms of performance this means that a break in the coating would not accelerate an attack on the base metal.

There has been no entirely satisfactory method for applying aluminum to steel. Roll cladding is restricted to the primary forms of steel stock and leaves exposed edges after subsequent fabrication. Hot dipping is difficult for shapes more complicated than simple sheet or wire. Flame-sprayed coatings are notably porous, bulky, and limited to line-of-sight application. Electrodeposition of aluminum (ref 1) has the usual throwing power limitations of the electrolytic processes. Vacuum deposition techniques recently developed are somewhat more successful for small parts and relatively simple shapes, but require careful jiggling of the work pieces to insure uniform coverage of complex shapes, again because of the line-of-sight plating limitation of the coating process. Potentially, the most versatile technique for applying aluminum can be considered that process known as vapor plating or gas plating.

Vapor plating should not be confused with vacuum deposition, mentioned previously, in which case the pure metal is introduced into the system, raised to a temperature sufficient to vaporize it, and condensed on a cold specimen. In the vapor plating process, the metal is introduced in the form of a volatile compound often mixed with other gases. A pyrolytic decomposition reaction takes place at a specimen surface heated to the decomposition temperature of the plating mixture vapors and result in the deposition of the desired metal onto the specimen.

In June 1957, work was initiated by ASD personnel to accomplish the vapor plating of aluminum. This initial effort was carried out by Hiler and Jenkin (ref 2) who succeeded in depositing aluminum on copper substrates from the metal-organic compound triisobutyl aluminum (TIBA)\*. This process as further developed and applied to steel substrates by the Metals and Ceramics Laboratory of ASD is described in this report.

## THE PLATING PROCESS

In this investigation liquid TIBA was mixed with isobutylene and argon, vaporized, and directed to a chamber containing the steel workpiece heated by induction to the decomposition temperature of the TIBA vapors. Upon decomposition, aluminum was deposited on the workpiece and the volatile effluents swept out the exhaust. An illustration of the plating apparatus is presented in figure 1.

---

\* Throughout this report the symbol TIBA will be used to denote triisobutyl aluminum.

Previous work conducted on TIBA (refs 2, 3) indicated that the thermal decomposition of the compound was not straightforward:

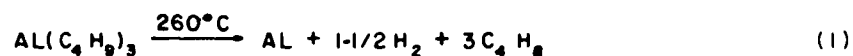

but that an undesirable side reaction occurred at 120°C resulting in the formation of diisobutyl aluminum hydride:

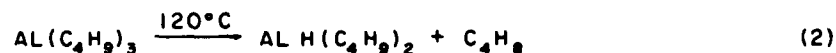

The formation of diisobutyl aluminum hydride was undesirable since it has a higher boiling point than TIBA. Isobutylene was ordered to the system (ref 2) to suppress this reaction. The gas flow was adjusted so that the calculated volumes of vaporized TIBA equaled the gas volume of isobutylene. The ratio of TIBA to isobutylene constituted the rate controlling factor for TIBA decomposition. A decrease in isobutylene resulted in premature TIBA decomposition. An increase resulted in poor plating efficiency and low plating rates. Argon was used as a carrier for the vaporized TIBA in an approximate 7:1 volume ratio respectively. A graphic and somewhat oversimplified illustration of the plating chamber reaction is presented in figure 2. Properties of TIBA and diisobutyl aluminum hydride that are of primary concern are listed in table 1; those for isobutylene in table 2.

At the very outset of this investigation it was felt that the plating temperature range and vaporization temperature for the process needed to be definitely established; so a system was set-up as shown in figure 3 using the interior of a ½-inch I.D. copper tube as the prime plating target. Prior to installation the interior of the copper tube was abraded by sandblasting to assure good adhesion. The tube was heated in increasing increments from 200° to 340°C along its length. Liquid TIBA was metered to this heated section at 0.83 ml/min, for a 20-minute period. Upon completion of the run the tube was removed and slit in half lengthwise. A continuous deposit of aluminum was observed starting initially at the 220°C point through the 260° point. A photograph showing this area is presented in figure 4. It was noted that above 270°C the coating became dark, puffy, and carbonaceous. At exactly 260°C the coating appeared best. Since aluminum was deposited initially at 220°C it was apparent that vaporization temperatures held below this point should not result in premature decomposition of TIBA with resulting malfunctioning of the plating system due to clogging of the lines. With this information subsequent experiments were conducted in the main plating apparatus (fig 1) varying the vaporizer temperature from 180° to 220°C. As result of these studies a vaporizer temperature of 200°C was established as being optimum.

Essentially, the plating process consisted of placing the workpiece into the plating chamber and purging the system with argon. During preliminary heating of the workpiece, argon was continuously metered through the plating chamber with the valve from the vaporizer closed. When the vaporizer, workpiece, and other critical control points were at temperature, the TIBA, isobutylene, and argon were turned on, directed through the vaporizer, and passed through the plating chamber. Aluminum was deposited on the workpiece and the volatile decomposition effluents and spent gases were condensed in the container submerged in a dry ice-methanol bath, maintained at approximately -76°C. The latter provision enabled the condensate to be collected for subsequent analysis. A mineral oil trap was used after the condenser to prevent the atmosphere from backing into the system, since TIBA burns spontaneously in air. The plating system itself was operated at atmospheric pressure.

Annealed copper tubing with  $\frac{1}{4}$ -inch O.D. and 0.032-inch wall, Spec. WW-T-799, was used throughout the system (fig. 1). The vaporizer consisted of a stainless steel tank (6 inches high with a 3-inch I.D.) heated by nichrome resistance wire. Since the vaporizer was located some distance from the plating chamber the tubing between these two units was maintained at 200°C, essentially the same temperature as the vaporizer. This was necessary to keep the plating compound in a saturated vapor state. The plating chamber consisted of a  $1\frac{1}{2}$ -inch I.D. pyrex glass cylinder, jacketed by a 2-inch I.D. pyrex cylinder. The wall thickness of each was  $\frac{1}{8}$  inch. Oil heated and maintained at 175°C was continuously circulated within the area between these two pyrex cylinders. This was done to prevent condensation of the plating vapors on the inner cylinder wall.

A 1-inch-by-2-inch test specimen (workpiece) was suspended in the plating chamber from Type K Chromel-alumel thermocouple wire. The piece was secured by a small brass nut and bolt through a  $\frac{3}{16}$ -inch-diameter hole near the top of the specimen, and an eyelet soldered to the end of the thermocouple wire. Heat source for the workpiece was a water-cooled copper induction coil wound around the outside of the plating chamber, and attached to a 2 kva induction heater.

The plating-process parameters used and established as result of this investigation for gas plating with TIBA are as follows:

System Pressure, mm Hg	Atmospheric, 760
Specimen Temperature, °C	260
Vaporizer Temperature, °C	200
Plating Chamber Temperature, °C	175
Mixed Gas (Argon and Isobutylene), °C	175
Line Between Vaporizer and Plating Chamber, °C	200
TIBA Flowrate, ml/min.	0.83
Argon Flowrate, ml/min.	515
Isobutylene Flowrate, ml/min.	75

#### SURFACE PREPARATION OF PLATING SPECIMENS

Principally, four methods of specimen surface preparation were used in the investigation: sandblasting, polishing, electroetching, and acid etching. The sandblast method consisted of abrading the substrate with very fine white sand at a constant air pressure. After blasting, the specimens were thoroughly wiped and rubbed with a clean cloth and placed in boiling methanol for 10 seconds. In the polishing procedure the mild steel specimens were hand buffed with 180-grit then 240-grit aluminum oxide cloth followed by the same rubbing and methanol cleaning sequence used in the sandblast method. The electroetching was performed in a 50-percent phosphoric acid bath at 150°F and 75-150 amp/ft<sup>2</sup>. A 1:4 hydrochloric acid solution was used as the chemical etchant for the steel specimens. The specimens were immersed for 10 seconds in the solution, rinsed in distilled water, and dried.

## EVALUATION OF ALUMINUM COATING

In general, surface preparation has a definite bearing on the physical appearance of the coating. The actual substrate surface finish is reproduced in the coating in a direct relationship. For example, the coating on an abraded or roughened surface takes on the same irregular contour as the base metal, while the coating on a polished surface assumes the same smooth, even profile. From a visual standpoint the coatings appear to be virtual extensions or continuations of the original surface.

The steel specimens plated during this study were subjected to the following tests: thermal shock, adhesion and ductility, porosity (anodizing) and salt spray. The thermal shock treatment consisted of heating the specimens to 1000°F then quenching in cold water. The coatings on the sandblasted specimens did not spall, crack or peel when subjected to this treatment. However, the coated, polished specimens blistered and peeled when subjected to the same treatment. The electroetched and acid-etched specimens were not subjected to this test.

A check for adhesion and ductility was made by bending the specimens around a mandrel whose diameter was equal to the specimens' thickness ( $\frac{1}{8}$  inch). The coating on the sandblasted specimens remained adherent and did not spall or peel. Photographs of these specimens are shown in figure 5. The coatings on the polished specimens were not adherent as evidenced by peeling and spalling of the coatings. This is shown in the photograph in figure 6. The coatings on the electroetched and acid-etched specimens remained adherent after subsection to this test.

Since the most consistent and favorable results, particularly from an adhesion standpoint, were obtained on sandblasted specimens, the investigation was continued using primarily sandblasted specimens.

Sandblasted aluminum coated steel specimens were successfully anodized in a 10-percent chromic acid bath. In this method the solution was maintained at 95±4°F. The time for treatment was 30 minutes at 40 volts. With the specimen as the anode and a lead piece as the cathode, low voltage was applied initially and increased to 40 volts. A coating as thin as 0.3 mil was successfully anodized.

Aluminum coated, sandblasted steel specimens were exposed in a salt-spray cabinet operated in accordance with Federal Standard 151 (20-percent salt spray). After over 240 hours in the environment there was no significant pitting or corrosive attack in evidence on the specimens.

It is very significant that in all cases during preliminary heating of the workpiece prior to plating, a thin oxide coating was formed on the surface of the steel specimens. Poor adhesion of aluminum on the polished steel specimens can possibly be attributed to this oxide formation. The other surface preparation methods, sandblasting, electroetching, and acid etching, left the specimen with a roughened surface providing a base for mechanical keying of the deposited coating which could account for the good adhesion.

Mass spectrometric analysis of the argon used in this study was as follows: oxygen 0.023 percent nitrogen 0.35 percent, and water vapor 0.13 percent. The high oxygen and water vapor contents were considered to be the cause of the surface oxidation of the specimens during the preliminary heating period. However, an adequate purifying media for the argon can be expected to prevent or reduce this formation. In addition, any oxide

films formed on a specimen could be reduced by raising the specimen temperature sufficiently and metering in hydrogen for a specific period prior to plating. The low capacity of the induction heater used in this investigation would not permit any significant specimen temperature elevation to prove this latter point.

The seemingly unlimited throwing power of the gas plating process is probably its most outstanding advantage. This is evidenced by the uniform deposits of aluminum obtained on sandblasted steel cylinders, nuts, and bolts (fig 7).

### COATING THICKNESS

The thickest deposit obtained on a single sandblasted steel specimen was approximately 2 mils for a 20-minute plating period. In general, the thickness varied from 0.9 to 2.0 mils. This anomaly was attributed mainly to the inability to maintain a specimen temperature of 260°C throughout the plating period. The specimen temperature decrease for a typical run using the 2 kva induction heater available for this investigation was as follows:

Specimen temperature at start	260°C
Upon introduction of plating vapors, after 5 minutes	249°C
after 10 minutes	238°C
after 15 minutes	224°C
after 20 minutes	217°C

It has previously been shown that plating starts initially at 220°C. Consequently, below 220°C the test could be discontinued since for all practical purposes deposition had stopped. Photomicrographs showing the cross section of plated steel specimens sandwiched together to facilitate preparation and polishing are presented in figure 8. An electron micrograph of the aluminum coating over a sandblasted steel surface is shown in figure 9.

An experimental modification was devised to obtain an indication of the thickness of the deposit attainable when the specimen temperature was maintained at the optimum value of 260°C. This was accomplished by sandwiching two 1-inch-by-2-inch steel specimens together with a 1-inch-by-2-inch copper specimen located approximately  $\frac{1}{8}$ -inch from the steel pieces. The copper in this case was heated primarily by radiation from the steel specimens. (Copper could not be heated alone to the necessary plating temperature by the induction heater used in this investigation.) A temperature of 260°C was maintained throughout this run. This can probably be explained by the fact that the inner steel surfaces in contact with each other were not plated with aluminum and consequently continued to receive the heat producing inductive action from the primary coil. As a result, a deposit of 6.0 mils was obtained on the copper specimen during a 20-minute plating run.

## COATING UNIFORMITY

An indication of the good coating uniformity obtained from the gas plating process is shown by thickness measurements made from a sandblasted steel, aluminum plated specimen presented below. A total of eight readings were made, four on either side from top to bottom on a 1-inch-by-2-inch specimen using a Magne-Gage. From table 3 we see that

N = 8, Total of individual measurements

Arithmetic Mean,  $\bar{x} = \frac{8.10}{8} = 1.01$

Standard Deviation,  $S = \sqrt{\frac{\text{Sum of } x^2}{N-1}} = \sqrt{\frac{0.0012}{7}}$

$S = \pm 0.01$

Thickness  $= 1.01 \pm 0.01 = 1.00 \text{ or } 1.02 \text{ mils}$

## OTHER MATERIALS COATED

In addition to mild steel, adherent deposits of aluminum were obtained on the following materials: copper, magnesium, titanium, glass, and graphite. In all cases except graphite, the specimen surfaces were abraded and each specimen was suspended together with a mild steel specimen and heated primarily by radiation from the steel piece.

From this it is demonstrated that any material that can be either directly or indirectly heated to the decomposition temperature of the plating vapors can be plated with aluminum by this process.

## ANALYSIS OF COATING AND DECOMPOSITION PRODUCTS

Analysis of the aluminum coatings by emission spectroscopy indicated that the coating contained .003-percent silicon, less than .01-percent magnesium, .077-percent iron, .001-percent nickel, .001-percent copper, less than .05-percent chromium, and less than .01-percent calcium. This indicated an aluminum deposit of approximately 99.849-percent purity.

Analysis by infrared of the plating effluents trapped and condensed in a container submerged in the dry ice-methanol bath indicated that the condensate was TIBA and contained a small amount of dissolved isobutylene. The TIBA in this case resulted from condensation of unused plating vapors. Mass spectrometer analysis of vapors from the condensate indicated isobutylene with a trace amount of hydrogen.

Upon placing the condensate in an open container, a fuming, effervescent type of reaction took place, exhausting the liquid, leaving a hard white deposit on the upper part of the container and a greyish-appearing dust or powder in the bottom of the container. Analysis of these by X-ray diffraction indicated that the white deposit was aluminum oxide and the greyish powder, aluminum.

Pure mineral oil was used in the oil trap (which followed the cold trap). Infrared analysis of the oil after several runs showed that it contained some dissolved isobutylene.

#### PLATING STUDIES WITH RECENTLY DEVELOPED GAS PLATING APPARATUS

During the course of this investigation a more advanced and versatile apparatus (ref 4) was developed to perform experimental vapor phase coating research capable of plating many of the metals and ceramic materials which can be deposited by the vapor phase process, as well as alloy and composite coatings. A schematic of the apparatus is shown in figure 10. The system utilizes a 5-kw induction heater as the heat source for the specimen. This unit provides stepless power control for heating with practically 100-percent regulation which is very important where critical specimen temperatures must be maintained. A photograph showing the front view of the apparatus is shown in figure 11.

Essentially, this plating system consists of a pyrex plating chamber with two separate resistance heated vaporizer sections. The plating compound mixture enters the plating chamber via either one or both of the vaporizers, depending upon the type of coating desired (composite, alloy, or intermetallic) and is exhausted through a single high-capacity cold trap. With this apparatus a variety of plating tasks can be investigated.

Realizing the limitations of the previous gas plating system (fig 1), particularly with regard to specimen heating, additional tests were conducted using mild steel specimens, and the plating conditions and parameters previously established. Research grade argon of 99.998-percent purity was used. The specimens during this phase of the investigation were subjected to the following surface preparations: sandblasting, polishing, 1:4 hydrochloric acid etching, and solvent cleaning. The solvent cleaning method consisted of degreasing in acetone followed by immersion in boiling methanol for 10 seconds. In this procedure the specimen surface was not abraded or otherwise disturbed, the primary objective being to remove all traces of soil or nonmetallic impurities from the metal surface. The first three methods were the same as those used earlier in the investigation and reported previously in this report. The specimens were checked for adhesion by the thermal shock and bend tests. Upon subsection to these tests the aluminum coatings on the polished, etched, and solvent-cleaned as well as the sandblasted specimens remained adherent, as there was no evidence of cracking, spalling, or peeling of the coatings. From this it was indicated that unusual surface preparation procedures are not necessary for mild steel in this process and that conventional methods will suffice. This is very significant, since from a practical standpoint it would probably not be desirable or feasible to sandblast or abrade all surfaces before plating.

## SUMMARY

This investigation has shown that adherent deposits of substantially pure aluminum of low porosity can be deposited on mild steel and other materials by thermally decomposing vapors of TIBA using argon as a carrier gas and isobutylene to suppress undesirable side reactions.

Conventional surface preparation procedures for the steel specimens were adequate to insure good adhesion. The process is not limited to line-of-sight deposition as demonstrated by the uniform coating of irregular shaped objects.

Substrate temperature must be closely regulated to provide the best deposit and optimum plating rate. Temperatures too high can cause loose, non-adherent, powdery-like deposits and possible fracturing of the carbon-to-carbon bond resulting in carbonaceous deposits; while temperatures too low can result in little or no deposition. With proper substrate temperature control, it was indicated that the process is capable of a plating rate of about 18 mils per hour.

The technique is not necessarily limited to the coating of mild steel alone. Indications are that any or most materials that can withstand the plating temperature (260°C) can be plated with aluminum by this method.

## LIST OF REFERENCES

1. Cooke, E. W., and Kritzer, S., Electrodeposition of Aluminum on Magnesium, WADC Technical Report 59-465, Aeronautical Systems Division, Wright-Patterson AFB, Ohio, November 1959.
2. Hiler, M. J., and Jenkin, W. C., Development of a Method to Accomplish Aluminum Deposition by Gas Plating, WADC Technical Report 59-88, Aeronautical Systems Division, Wright-Patterson AFB, Ohio, June 1959.
3. Ziegler, K., Angewandte Chemie, Vol. 67, July-December 1955, p. 424, C. A. 50:6303 (German).
4. Marinow, I., Gellar, C. A., and Bakish, R., All-Purpose Plating Apparatus for Research on Vapor Phase Coatings, ASD Technical Documentary Report 62-499, Aeronautical Systems Division, Wright-Patterson AFB, Ohio, June 1962.

TABLE 1

## PLATING COMPOUND PROPERTIES AND CHARACTERISTICS

	<u>Triisobutyl Aluminum</u>	<u>Diisobutyl Aluminum Hydride</u>
Melting Point, °C	0°C	----
Density, 20°C	0.8	0.775
Boiling Point, °C	Began to decompose when distilled above 90°C at 1 atm. B. P. 40°C at 0.1 mm Hg.	Stable when heated to 200°C at 1 atm. B. P. 105°C at 0.1 mm Hg.
Physical Appearance	Clear colorless liquid.	Clear, colorless liquid.
Other Characteristics	Commercial composition is 90% TIBA and 10% diisobutyl aluminum hydride. Soluble aluminum (wt. %) is 14.2%. Readily oxidizable; fumes and becomes hot in open air. Must be handled under cover of inert gas. Reacts violently with water. Fires should be extinguished with powder type (CO <sub>2</sub> generating) extinguisher. CO <sub>2</sub> snow is less effective. Toxicology: mildly toxic, sharp, acrid odor precludes possibility of accidental exposure to dangerous quantities.	

TABLE 2  
 PROPERTIES OF ISOBUTYLENE

Synonym	2-methyl-propene-1
Formula	$(\text{CH}_3)_2\text{C} = \text{CH}_2$
Formula wt., grams	56.10
Crystalline form and color	Colorless gas
Specific gravity, 20°C	Liquid, 0.59
Melting point, °C	-140.4
Boiling point, °C	-6.9

TABLE 3  
 COATING THICKNESS MEASUREMENTS

<u>X</u> (Individual Measurements)	<u>x = (X-x)</u> (Deviation from the Mean)	<u>x<sup>2</sup></u> (Square of Deviation)
1.02	0.01	0.0001
1.01	0.00	0.0000
1.00	-0.01	0.0001
1.03	0.02	0.0004
0.99	-0.02	0.0004
1.02	0.01	0.0001
1.01	0.00	0.0000
1.02	0.01	0.0001
<hr/> 8.10		<hr/> Sum of x <sup>2</sup> = 0.0012

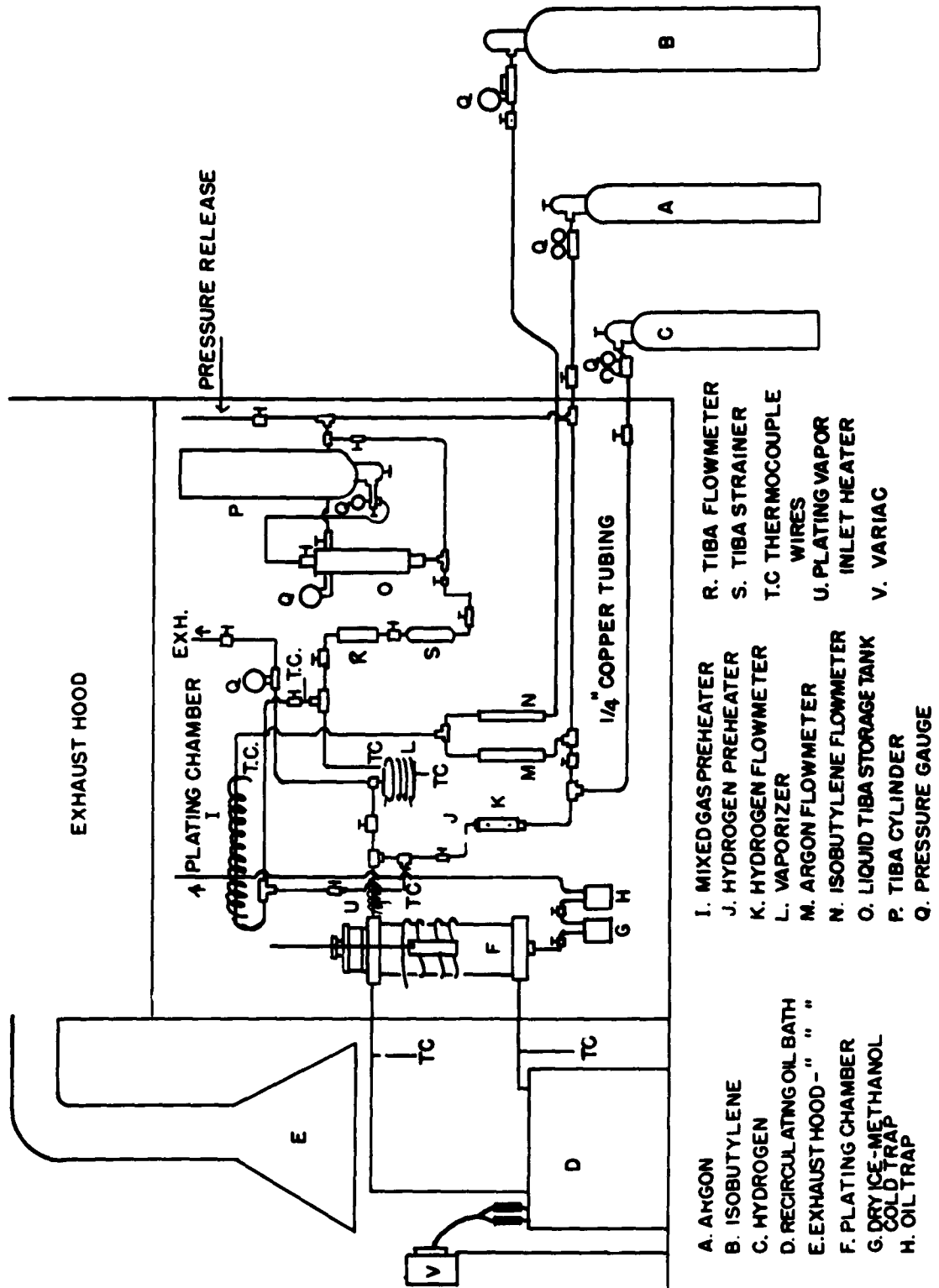

- I. MIXED GAS PREHEATER
- J. HYDROGEN PREHEATER
- K. HYDROGEN FLOWMETER
- L. VAPORIZER
- M. ARGON FLOWMETER
- N. ISOBUTYLENE FLOWMETER
- O. LIQUID TIBA STORAGE TANK
- P. TIBA CYLINDER
- Q. PRESSURE GAUGE

- A. ARGON
- B. ISOBUTYLENE
- C. HYDROGEN
- D. RECIRCULATING OIL BATH
- E. EXHAUST HOOD - " " "
- F. PLATING CHAMBER
- G. DRY ICE-METHANOL COLD TRAP
- H. OIL TRAP

- R. TIBA FLOWMETER
- S. TIBA STRAINER
- T.C. THERMOCOUPLE WIRES
- U. PLATING VAPOR INLET HEATER
- V. VARIAC

Figure 1. Schematic of Plating Apparatus

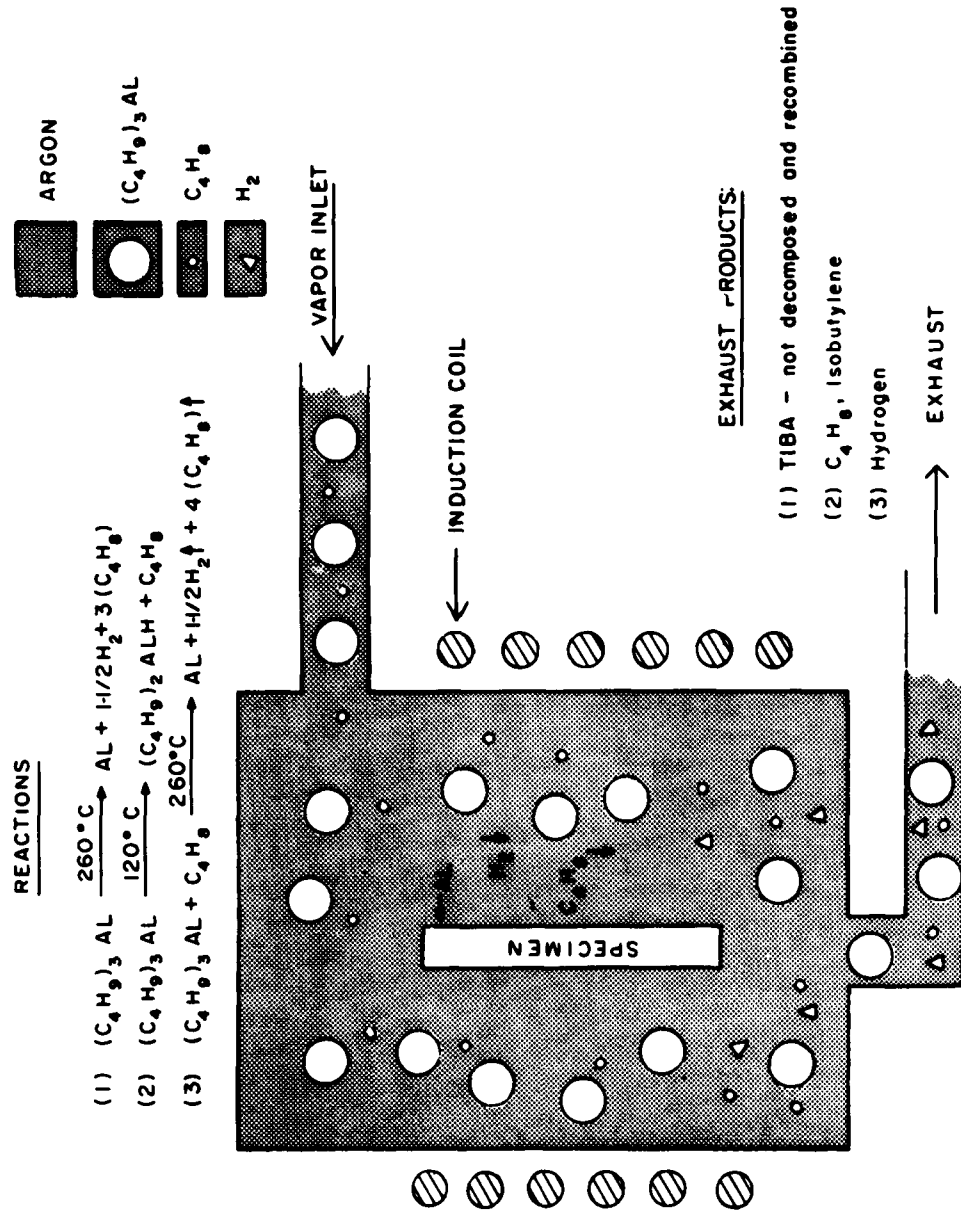

Figure 2. Schematic of Plating Chamber Reactions

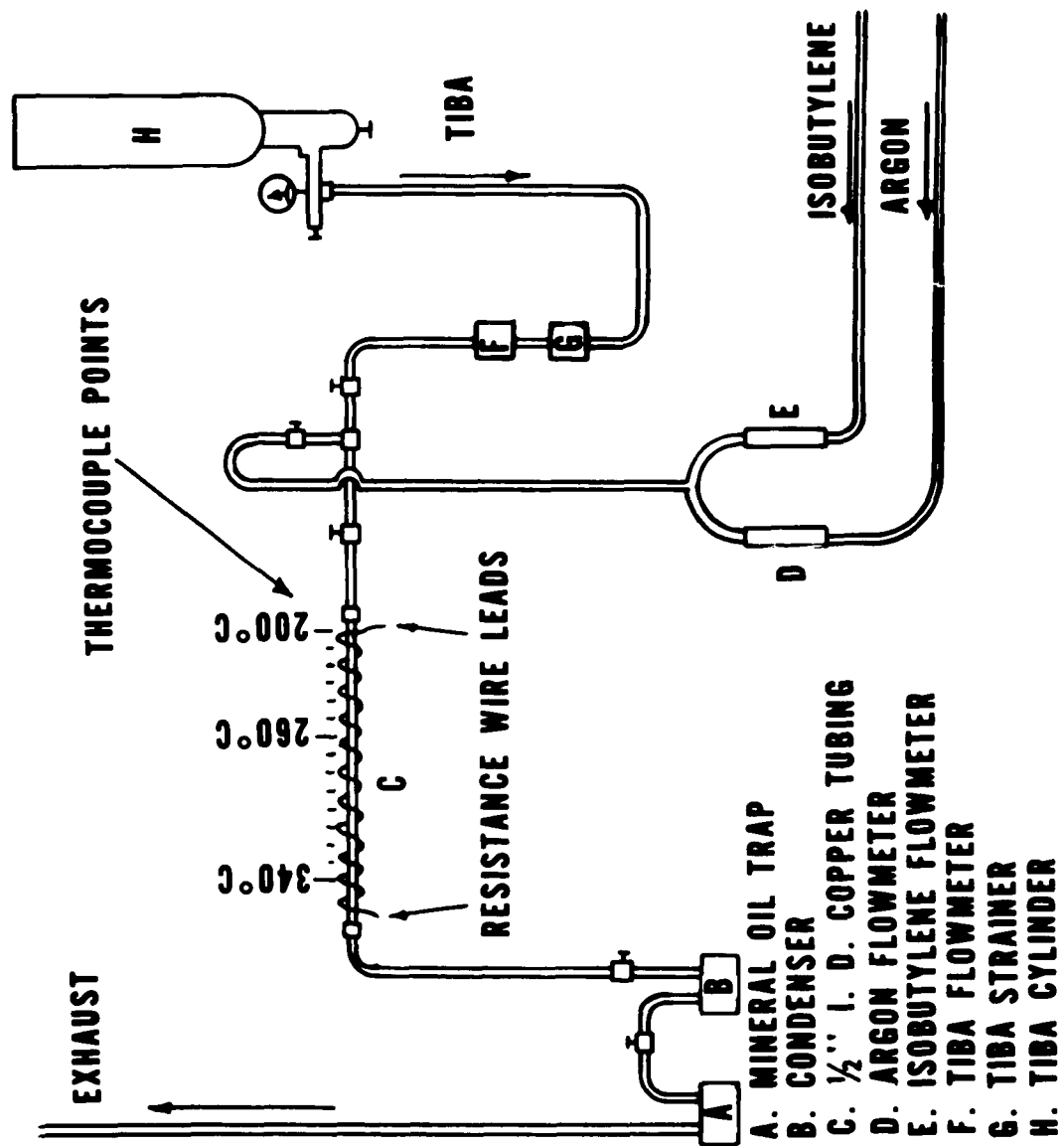

Figure 3. Schematic of Copper Tube Plating Apparatus



Figure 4. Photograph of Copper Tube Section

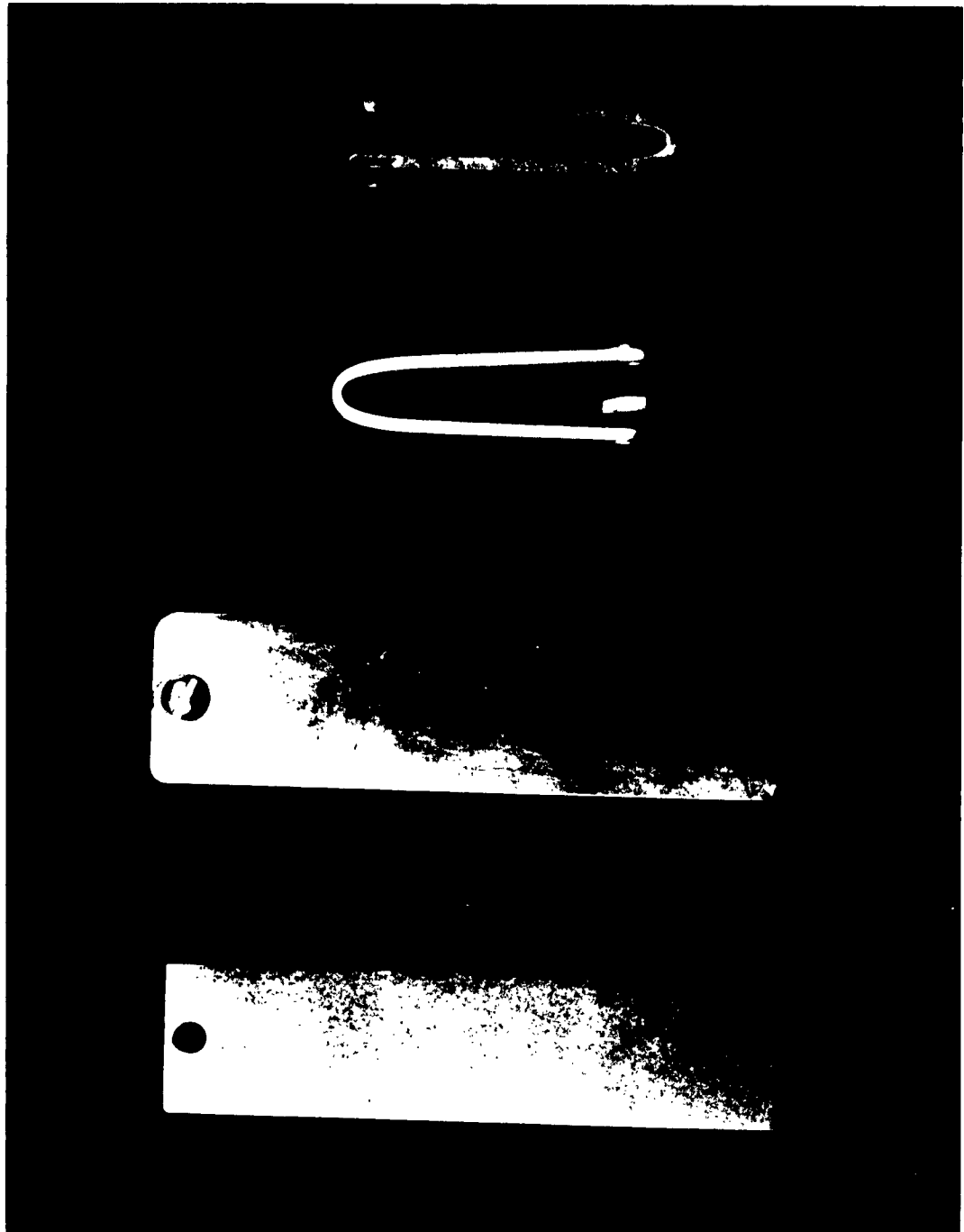

Figure 5. Photograph of Sandblasted Specimens. Specimens Left to Right: Unplated, Plated, After Bend Test

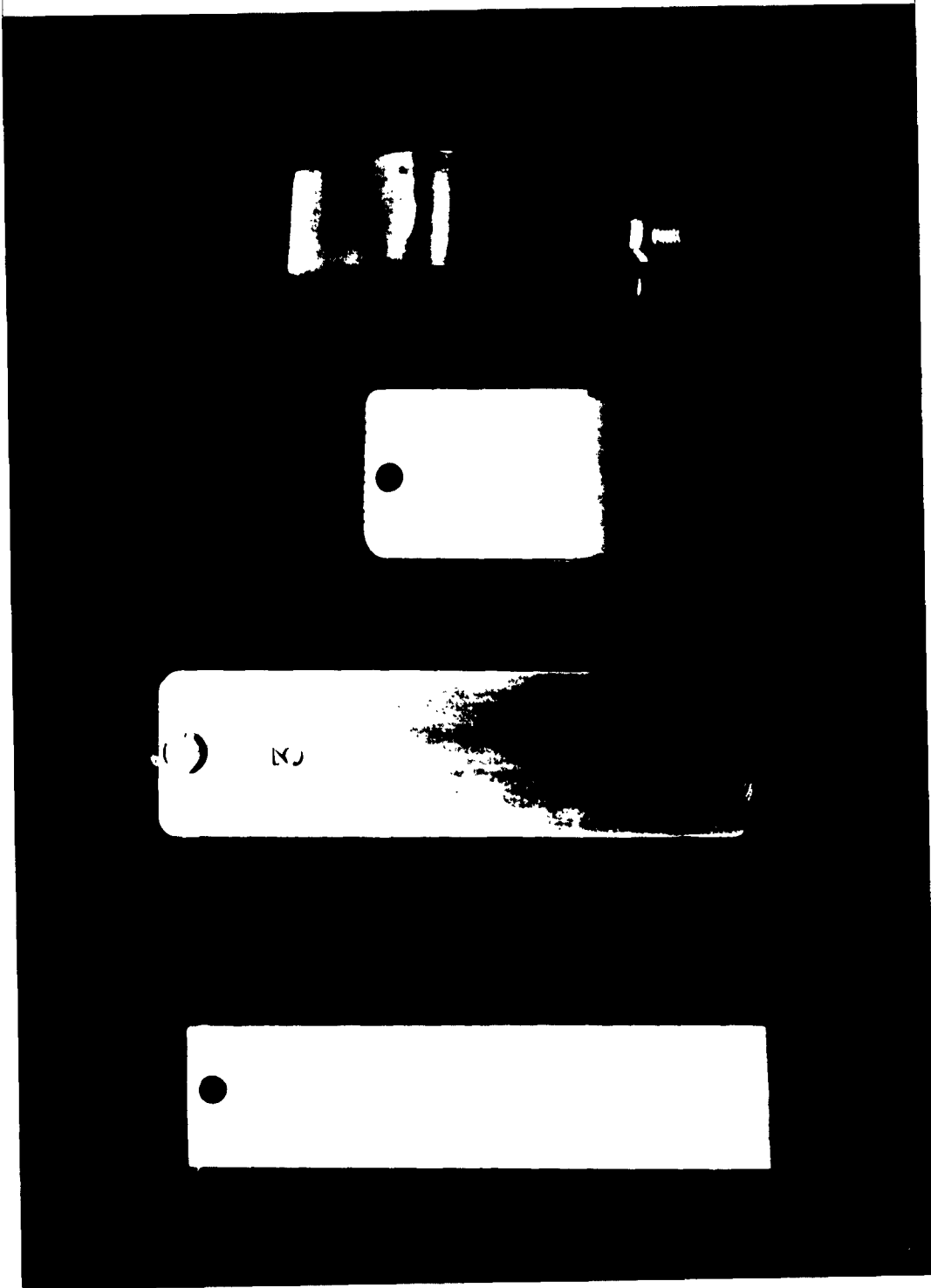

Figure 6. Photograph of Polished Specimens. Specimens Left to Right: Unplated, Plated, After Bend Test

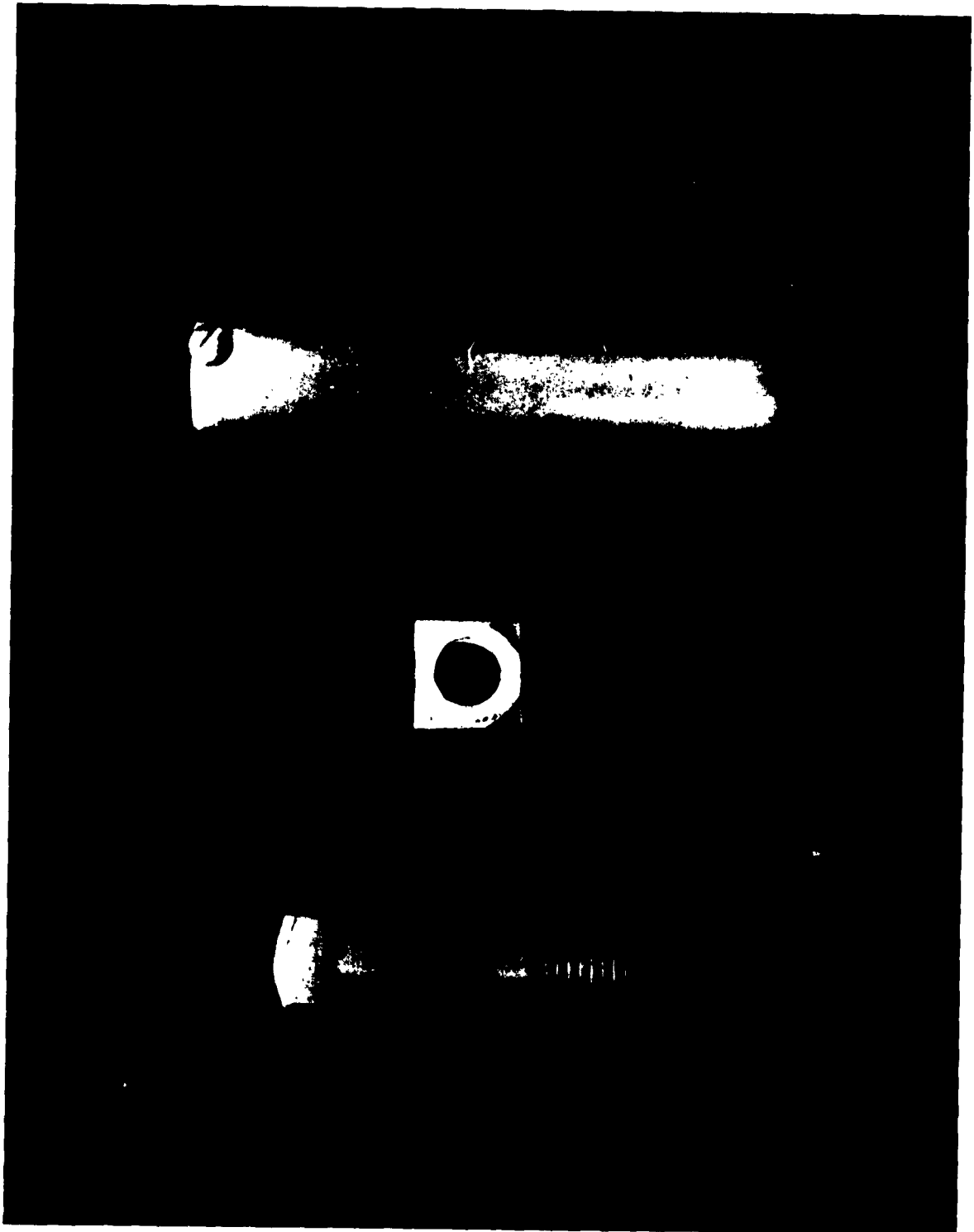

Figure 7. Photograph of Plated Bolt, Nut, and Cylinder



Top Specimen: 500X, 25% HNO<sub>3</sub> Etchant  
Bottom Specimen: 250X, Unetched, Polarized Light

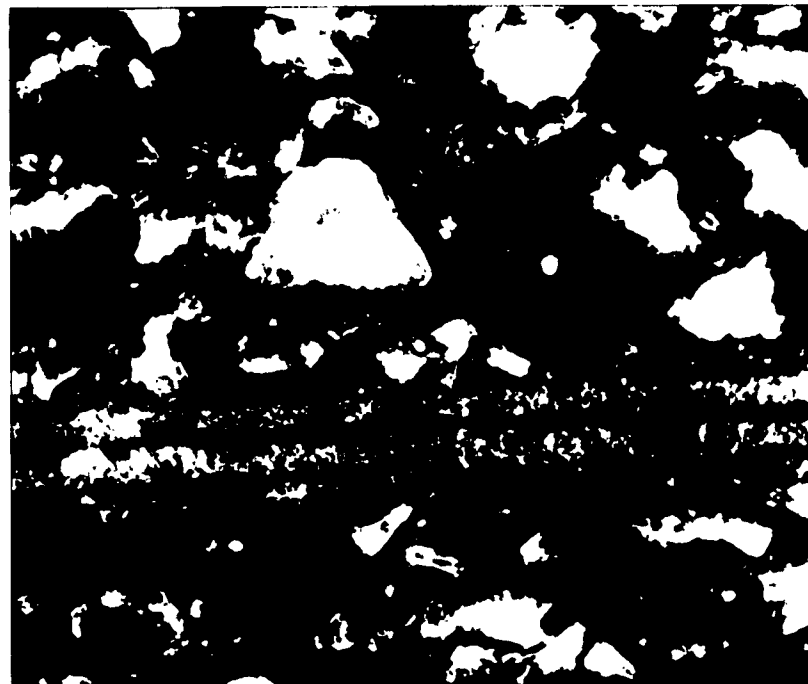

Figure 8. Photomicrographs Showing Cross Section of Plated Specimens



NOTE: POSITIVE CARBON REPLICA ROTARY SHADOWED WITH GERMANIUM

Figure 9. Electron Micrograph (8000X) of Aluminum Coating Over Sandblasted Steel Surface

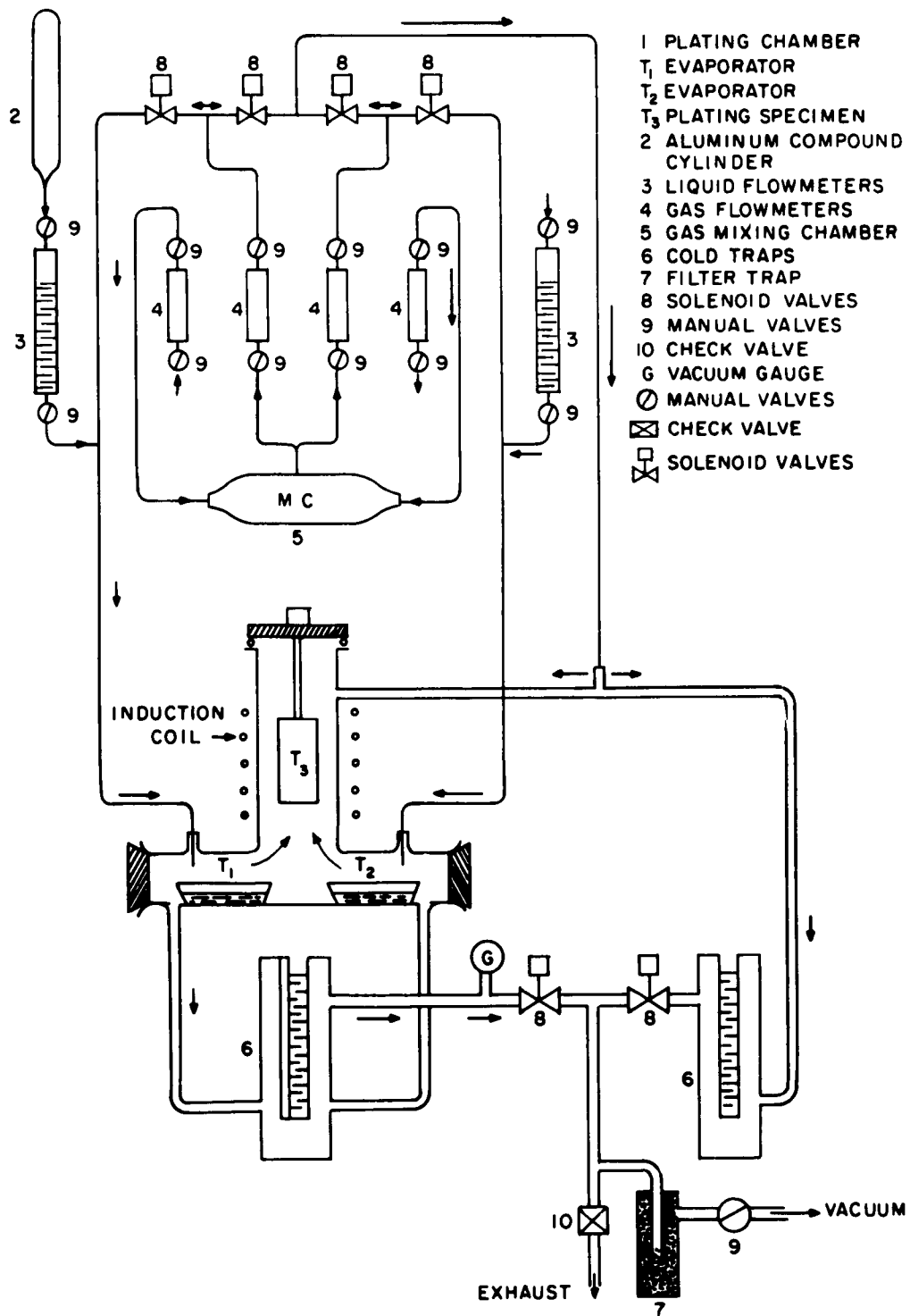

Figure 10. Schematic of Recently Developed Plating Apparatus

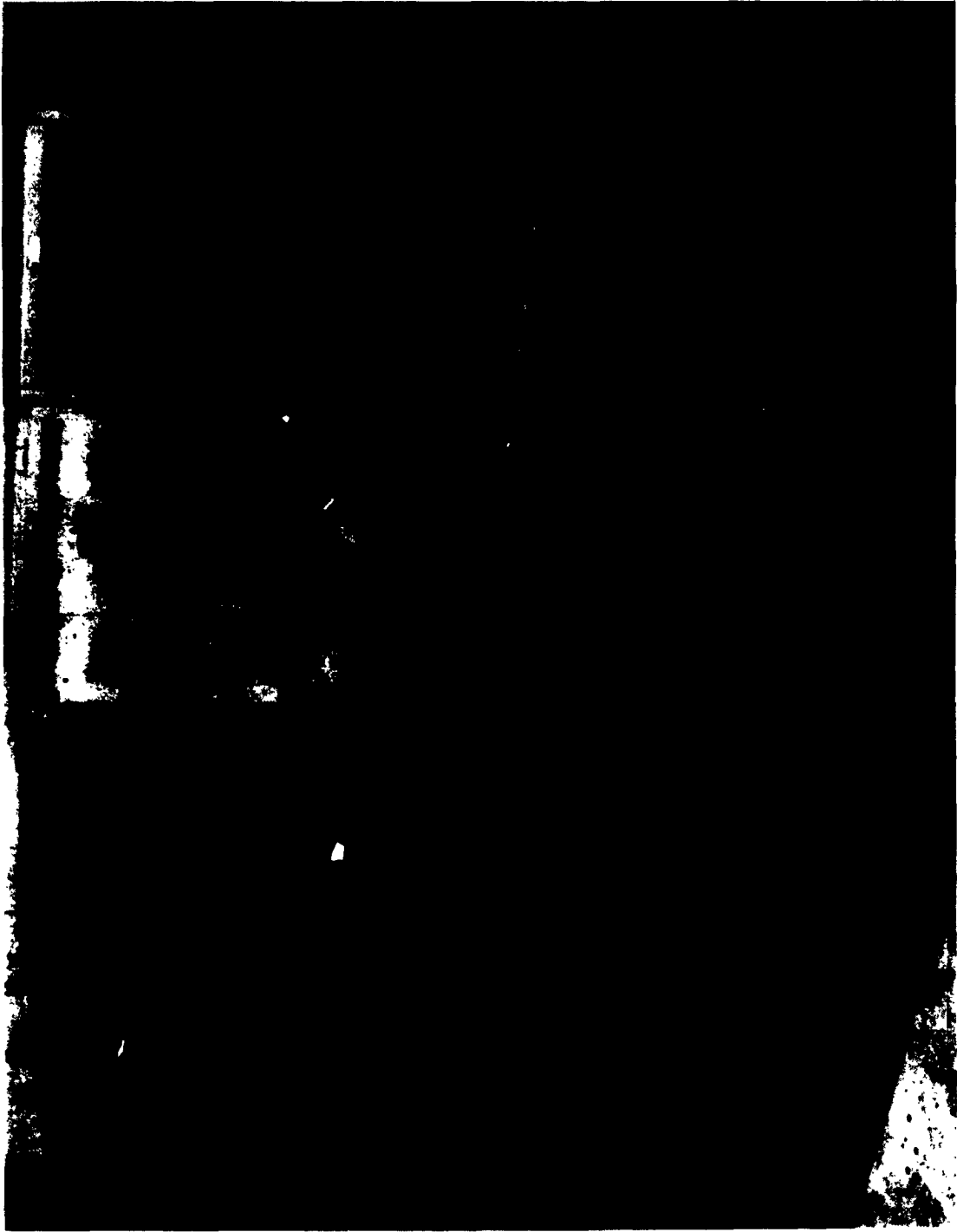

Figure 11. Photograph of Recently Developed Plating Apparatus

1. Vapor Plating
  2. Aluminum Plating
  3. Aluminum Coating
  4. Metalorganic Compound
  5. Plating
- I. AFSC Proj 7312, Task 731201
  - II. Crosby, Jesse J.
  - III. Aval fr OTS
  - IV. In ASTIA collection

Aeronautical Systems Division, Dir/Materials & Processes, Metals & Ceramics Lab, Wright-Patterson AFB, Ohio.  
Rpt No. ASD-TDR-62-907. VAPOR PLATING OF ALUMINUM ON STEEL. Final report, Dec 62, 21p.incl illus., tables, 4 refs.  
Unclassified Report

Adherent coatings of aluminum were deposited on low carbon steel specimens by vapor (gas) plating using the metalorganic compound triisobutyl aluminum. In the process liquid triisobutyl aluminum was mixed with isobutylene and argon, vaporized, then thermally decomposed at a heated steel specimen into

( over )

Aeronautical Systems Division, Dir/Materials & Processes, Metals & Ceramics Lab, Wright-Patterson AFB, Ohio.  
Rpt No. ASD-TDR-62-907. VAPOR PLATING OF ALUMINUM ON STEEL. Final report, Dec 62, 21p.incl illus., tables, 4 refs.  
Unclassified Report

Adherent coatings of aluminum were deposited on low carbon steel specimens by vapor (gas) plating using the metalorganic compound triisobutyl aluminum. In the process liquid triisobutyl aluminum was mixed with isobutylene and argon, vaporized, then thermally decomposed at a heated steel specimen into

( over )

metallic aluminum plus volatile decomposition effluents. As a result of this reaction the aluminum was deposited on the steel substrate and the volatile decomposition products were swept out the exhaust. Uniform, ductile coatings, 2 mils thick, were obtained. The capability of obtaining thicker deposits was indicated.

Significantly, the deposition of aluminum by vapor plating was not limited to mild steel or metal substrates in general. Other materials including copper, magnesium, titanium, stainless steel, glass, and graphite were also plated by this process.

Aeronautical Systems Division, Dir/Materials & Processes, Metals & Ceramics Lab, Wright-Patterson AFB, Ohio.  
Rpt No. ASD-TDR-62-907. VAPOR PLATING OF ALUMINUM ON STEEL. Final report, Dec 62, 21p.incl illus., tables, 4 refs.  
Unclassified Report

Adherent coatings of aluminum were deposited on low carbon steel specimens by vapor (gas) plating using the metalorganic compound triisobutyl aluminum. In the process liquid triisobutyl aluminum was mixed with isobutylene and argon, vaporized, then thermally decomposed at a heated steel specimen into

( over )

metallic aluminum plus volatile decomposition effluents. As a result of this reaction the aluminum was deposited on the steel substrate and the volatile decomposition products were swept out the exhaust. Uniform, ductile coatings, 2 mils thick, were obtained. The capability of obtaining thicker deposits was indicated.

Significantly, the deposition of aluminum by vapor plating was not limited to mild steel or metal substrates in general. Other materials including copper, magnesium, titanium, stainless steel, glass, and graphite were also plated by this process.

1. Vapor Plating
2. Aluminum Plating
3. Aluminum Coating
4. Metalorganic Compound
5. Plating
  - I. AFSC Proj 7312, Task 731201
  - II. Crosby, Jesse J.
  - III. Aval fr OTS
  - IV. In ASTIA collection

Aeronautical Systems Division, Dir/Materials & Processes, Metals & Ceramics Lab, Wright-Patterson AFB, Ohio.  
 Rpt No. ASD-TDR-62-907. VAPOR PLATING OF ALUMINUM ON STEEL. Final report, Dec 62, 21p. incl illus., tables, 4 refs.  
 Unclassified Report

Adherent coatings of aluminum were deposited on low carbon steel specimens by vapor (gas) plating using the metalorganic compound triisobutyl aluminum. In the process liquid triisobutyl aluminum was mixed with isobutylene and argon, vaporized, then thermally decomposed at a heated steel specimen into

( over )

1. Vapor Plating
2. Aluminum Plating
3. Aluminum Coating
4. Metalorganic Compound
5. Plating
  - I. AFSC Proj 7312, Task 731201
  - II. Crosby, Jesse J.
  - III. Aval fr OTS
  - IV. In ASTIA collection

Aeronautical Systems Division, Dir/Materials & Processes, Metals & Ceramics Lab, Wright-Patterson AFB, Ohio.  
 Rpt No. ASD-TDR-62-907. VAPOR PLATING OF ALUMINUM ON STEEL. Final report, Dec 62, 21p. incl illus., tables, 4 refs.  
 Unclassified Report

Adherent coatings of aluminum were deposited on low carbon steel specimens by vapor (gas) plating using the metalorganic compound triisobutyl aluminum. In the process liquid triisobutyl aluminum was mixed with isobutylene and argon, vaporized, then thermally decomposed at a heated steel specimen into

( over )

metallic aluminum plus volatile decomposition effluents. As a result of this reaction the aluminum was deposited on the steel substrate and the volatile decomposition products were swept out the exhaust. Uniform, ductile coatings, 2 mils thick, were obtained. The capability of obtaining thicker deposits was indicated.

Significantly, the deposition of aluminum by vapor plating was not limited to mild steel or metal substrates in general. Other materials including copper, magnesium, titanium, stainless steel, glass, and graphite were also plated by this process.

metallic aluminum plus volatile decomposition effluents. As a result of this reaction the aluminum was deposited on the steel substrate and the volatile decomposition products were swept out the exhaust. Uniform, ductile coatings, 2 mils thick, were obtained. The capability of obtaining thicker deposits was indicated.

Significantly, the deposition of aluminum by vapor plating was not limited to mild steel or metal substrates in general. Other materials including copper, magnesium, titanium, stainless steel, glass, and graphite were also plated by this process.