

UNCLASSIFIED

AD NUMBER

AD350318

CLASSIFICATION CHANGES

TO: unclassified

FROM: confidential

LIMITATION CHANGES

TO:

Approved for public release, distribution unlimited

FROM:

Distribution authorized to U.S. Gov't. agencies and their contractors; Administrative/Operational Use; APR 1964. Other requests shall be referred to Directorate of Armament Development, Det, 4. Research and Technology Div., AFSC, Eglin AFB, FL.

AUTHORITY

31 Dec 1972, per doc markings; USADTC ltr, 5 Jun 1979

THIS PAGE IS UNCLASSIFIED

AD-3503/8

THIS REPORT HAS BEEN DELIMITED
AND CLEARED FOR PUBLIC RELEASE
UNDER DOD DIRECTIVE 5200.20 AND
NO RESTRICTIONS ARE IMPOSED UPON
ITS USE AND DISCLOSURE.

DISTRIBUTION STATEMENT A

APPROVED FOR PUBLIC RELEASE;
DISTRIBUTION UNLIMITED.

GENERAL DECLASSIFICATION SCHEDULE

**IN ACCORDANCE WITH
DOD 5200.1-R & EXECUTIVE ORDER 11652**

THIS DOCUMENT IS:

CLASSIFIED BY _____

**Subject to General Declassification Schedule of
Executive Order 11652-Automatically Downgraded at
2 Years Intervals- DECLASSIFIED ON DECEMBER 31, 1972**

BY

**Defense Documentation Center
Defense Supply Agency
Cameron Station
Alexandria, Virginia 22314**

NO CLASSIFIED

AD 350318

DEFENSE DOCUMENTATION CENTER

FOR

SCIENTIFIC AND TECHNICAL INFORMATION

CAMERON STATION, ALEXANDRIA, VIRGINIA

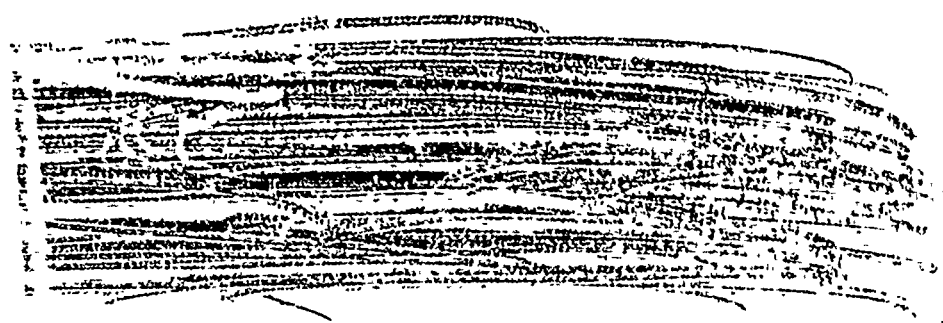
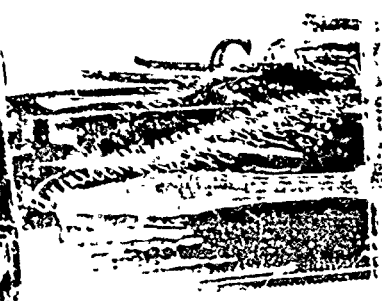

DISCLAIMER NOTICE

**THIS DOCUMENT IS BEST QUALITY
PRACTICABLE. THE COPY FURNISHED
TO DTIC CONTAINED A SIGNIFICANT
NUMBER OF PAGES WHICH DO NOT
REPRODUCE LEGIBLY.**

NOTICE: When government or other drawings, specifications or other data are used for any purpose other than in connection with a definitely related government procurement operation, the U. S. Government thereby incurs no responsibility, nor any obligation whatsoever; and the fact that the Government may have formulated, furnished, or in any way supplied the said drawings, specifications, or other data is not to be regarded by implication or otherwise as in any manner licensing the holder or any other person or corporation, or conveying any rights or permission to manufacture, use or sell any patented invention that may in any way be related thereto.

NOTICE:

THIS DOCUMENT CONTAINS INFORMATION
AFFECTING THE NATIONAL DEFENSE OF
THE UNITED STATES WITHIN THE MEAN-
ING OF THE ESPIONAGE LAWS, TITLE 18,
U.S.C., SECTIONS 793 and 794. THE
TRANSMISSION OR THE REVELATION OF
ITS CONTENTS IN ANY MANNER TO AN
UNAUTHORIZED PERSON IS PROHIBITED
BY LAW.

CONFIDENTIAL

350318

ATL-TDR-64-25

Copy of 180 Copies

CATALOGED BY DDC
AS AD No. _____

(Unclassified Title)
AUTOMATIC LIGHT GAS GUN DEVELOPMENT

Technical Documentary Report No. ATL-TDR-64-25
April 1964
Project No. 9850
Task 985001

DDC
JUN 10 1964
NSA D

Directorate of Armament Development
Det 4, Research and Technology Division
Air Force Systems Command
Eglin Air Force Base, Florida

350318

(Prepared under Contract No. AF O&G(635)-2799 by the Missile and Armament Department, General Electric Company, Burlington, Vermont)

GROUP-4
Downgraded at 3 year intervals;
Declassified after 12 years.

00316

CONFIDENTIAL

Qualified requesters may obtain copies from DDC. Orders will be expedited if placed through the librarian or other person designated to request documents from DDC.

This document contains information affecting the national defense of the United States within the meaning of the Espionage Laws (Title 18, U.S.C., sections 793 and 794). Transmission or revelation in any manner to an unauthorized person is prohibited by law.

When US Government drawings, specifications, or other data are used for any purpose other than a definitely related government procurement operation, the government thereby incurs no responsibility nor any obligation whatsoever; and the fact that the government may have formulated, furnished, or in any way supplied the said drawings, specifications, or other data is not to be regarded by implication or otherwise, as in any manner licensing the holder or any other person or corporation, or conveying any rights or permission to manufacture, use, or sell any patented invention that may in any way be related thereto.

This document may be reproduced to satisfy official needs of US Government agencies.

Do not return this copy. When not needed, destroy in accordance with pertinent security regulations.

KEYWORD LIST

Listed below are keywords which serve as an index to the contents of this report (AFR 80-29).

Hypervelocity guns
Hypervelocity projectiles

CONFIDENTIAL

FOREWORD

The present test data and ultimate application of the weapon system are classified **CONFIDENTIAL**. However, exterior views of the system are not classified unless accompanied by a written description.

Appreciation is expressed to the following for their assistance during the development:

- **The Armour Research Foundation**
Chicago, Illinois
... for helpful consultation at the outset of the program, and for the cooperative provision of technical information regarding light gas gun development.
- ◆ **Industrial Engineering Division**
Lake City Ordnance Plant
Independence, Missouri
... for their advice and assistance in preparing the special ammunition required for the experimental firings.
- **Mr. Paul G. Baer**
Ballistics Research Laboratories
Aberdeen, Maryland
... for his generous contribution of time and effort in conducting a number of computed performance simulations based on the G. E. launcher data.

CONFIDENTIAL

CONFIDENTIAL

ABSTRACT

This abstract is classified Confidential

The basic feasibility of a hypervelocity weapon concept, evolved from the operating principles and techniques of the light gas gun, was experimentally investigated. Initial efforts were directed toward the preliminary design and experimental proof of the mechanisms essential to the implementation of the concept. Those phases of the operation which could be treated separately were tested first, to reveal and mitigate basic difficulties. Following these preliminary studies, a launcher was constructed which embodied all critical aspects of the weapon concept; and a series of single-round firings was made to discover, study, and appraise the fundamental problem areas. Subsequent efforts were concerned with the revision or modification of certain design features to improve the functioning and reliability of the single-shot operation.

From the results of this work, it may be concluded that the basic feasibility of the concept is established. Several problem areas remain to be eliminated, however, and most of these must be resolved before a launcher capable of automatic repeated fire can be constructed.

PUBLICATION REVIEW

This Technical Documentary Report has been reviewed and is approved.

Noble E Brown

NOBLE E. BROWN
Lt Colonel, USAF
Acting Chief,
Weapons Division

CONFIDENTIAL

TABLE OF CONTENTS

Section		Page
I.	INTRODUCTION	1-1
II	DESCRIPTION OF WEAPON CONCEPT	2-1
III	DESIGN AND FABRICATION	3-1
	Selection of Launcher Dimensions	3-1
	Design of Critical Components	3-2
	Helium Injection System	3-3
	Check Valve	3-4
	Projectile and Carrier Design	3-4
	Gas Seal at High-Pressure Section	3-7
	Bolt Unlock and Case Extraction	3-7
	Pneumatic Ejection	3-7
	Design and Construction of Remaining Areas	3-9
	General	3-9
	Breech Area	3-11
	Piston	3-11
	Launcher Assembly	3-11
IV	EXPERIMENTS AND RESULTS	4-1
	Preliminary Tests	4-1
	General	4-1
	Transparent Pump Tube	4-1
	Piston Retention and Projectile Release	
	Pressure	4-11
	Open-End Calibration Firings	4-13
	Complete Assembly Test Firings	4-18
	General	4-18
	Description of Firing Operation	4-18
	Instrumentation	4-23
	Test Data and Results	4-26
	Enlarged Caliber Firings	4-44
	Carrier Elimination Studies	4-52
	General	4-52
	Design Considerations	4-52
	Testing	4-58
	Results	4-61
V	CONCLUSIONS AND RECOMMENDATIONS	5-1
	Conclusions	5-1
	Recommendations	5-2
	LIST OF REFERENCES	A-1

CONFIDENTIAL

CONFIDENTIAL

LIST OF ILLUSTRATIONS

Figure	Title	Page
2-1	Sequence of Operation	2-2
2-2	Cross Sectional View of Complete Round	2-4
3-1	Helium Injection System	3-3
3-2	Check Valve	3-5
3-3	Cross Sectional View of Carrier Seated in Firing Position	3-6
3-4	Pneumatic Assembly for Bolt Unlock, Case Extraction	3-8
3-5	Overall View of Launcher Assembly	3-10
4-1	Transparent Pump Tube Apparatus	4-2
4-2	Carrier Deformation Caused by Charging Impact (Initial Carrier Design)	4-4
4-3	Various Projectile and Carrier Configurations Tested	4-5
4-4	Shortened Carrier Design Before and After Charging Impact (Approx. 400 psi Reservoir Pressure)	4-7
4-5	Carrier Transit Time vs. Reservoir Pressure	4-9
4-6	Projectile Deformation Caused by Charging Impact	4-10
4-7	Projectile After Shear-Out (Static Hydraulic Pressure)	4-12
4-8	Partially Assembled Launcher Set Up for Calibration Firings	4-14
4-9	Measured Piston Velocity Vs. Propellant Mass	4-16
4-10	Measured Piston Velocity Vs. Measured Peak Pressure	4-17
4-11	Hypervelocity Round and Components (Present Configuration)	4-20
4-12	Block Diagram, Hypervelocity Gun Control Circuit	4-22
4-13	Pressure Transducer Installation at High Pressure Section	4-24
4-14	Typical Pressure Records	4-25
4-15	Typical Velocity Record (Coil and Screen Technique)	4-26
4-16	Cartridge Case Collapse	4-29
4-17	Piston Before and After Firing (Round No. 1)	4-31
4-18	Carrier Before and After Firing (Round No. 1)	4-32
4-19	Carrier From Round No. 1, Sectioned After Firing	4-33
4-20	Carrier Before and After Firing	4-36
4-21	Fastax Film Record of Muzzle Blast	4-37
4-22	Piston Materials Tested: Before Firing	4-39
4-23	Piston Materials Tested: After Firing	4-40
4-24	Launch Tube (0.150 Caliber) and Forward Portion of Coupling After Completion of Firing Tests	4-42
4-25	Wear and Deformation of 0.150 Caliber Launch Tube Bore	4-43

CONFIDENTIAL

LIST OF ILLUSTRATIONS (Cont)

Figure	Title	Page
4-26	Sequence of Operation, Shuttle Valve	4-45
4-27	Shuttle Valve Secured in Position	4-49
4-28	Expended Aluminum/Lexan Pistons (0.220 Caliber Firings)	4-50
4-29	Final Carrier Modification	4-51
4-30	Target Plate	4-53
4-31	Launch Tube (0.220 Caliber) and Forward Portion of Coupling After Completion of Firing Tests	4-54
4-32	Wear and Deformation of 0.220 Caliber Launch Tube Bore	4-55
4-33	Projectile Geometry (Carrier Elimination Study)	4-57
4-34	Projectile Seat and Launch Tube Entrance (Carrier Elimination Study)	4-59
4-35	Projectile and Various Piston Housing Configurations Tested (Carrier Elimination Study)	4-60

LIST OF TABLES

Table	Title	Page
3-1	Initial Selection of Values for Launcher Parameters . . .	3-2
4-1	Transparent Pump Tube Data: Time Required for Carrier Seating vs. Reservoir Pressure	4-6
4-2	Open-End Calibration Firings	4-15
4-3	Launcher Design Characteristics at Beginning of Firing Trials	4-18
4-4	Initial Conditions, Peak Helium Pressures, Projectile Velocity Phase I Firings (0.150 inch Dia. Projectile)	4-27
4-5	Summary of Changes Made in Components for Phase II Firings	4-46
4-6	Initial Conditions, Projectile Velocity Phase II Firings (0.220 inch Dia. Projectile)	4-47
4-7	Test Results	4-61

CONFIDENTIAL

SECTION I

INTRODUCTION

This report describes a basic feasibility study directed toward the development of an automatic hypervelocity weapon. The work was conducted under contract AF08(635)-2799, for Detachment 4, RTD, Weapons Division (ATWR), Eglin AFB. The work was performed during the period May 1962 through December 1963.

Weapons firing projectiles at hypervelocities may prove useful in space. High muzzle velocities simplify fire control at the large ranges characteristic of space intercept problems, and the increased damage potential of high velocity impact makes a given projectile weight more effective.

The light gas gun is one means for firing projectiles at high velocities. Such guns have been used extensively as laboratory tools, and have been developed for firing a wide range of projectile sizes at velocities from those of normal gun practice to over 30,000 feet per second (fps). Without exception, laboratory guns are single shot projectors. They are customarily assembled for each shot, hand loaded and fired, and afterwards disassembled in preparation for subsequent firings.

The basic principles of light gas projection techniques are well established. In a study performed for Detachment 4, RTD, the Armour Research Foundation suggested adaption of those principles to automatic weapons. The present work grew out of this recommendation.

In response to Request for Proposal ASQW 62-109, the Missile and Armament Department of the General Electric Company proposed a concept for an automatic hypervelocity weapon based on the light gas gun. The study described in this report has had the objective of proving the concept's feasibility.

Emphasis has been placed upon evaluation of the basic mechanism. Analytical work which would duplicate the work of other agencies has been avoided. Equipment has been designed to permit study of separate sequences of the firing cycle.

This report describes in detail the basic concept originally proposed and presents the details of design and experimental programs. Completion of this phase of the program provides a basis for continued development, now more directly oriented toward an actual weapon configuration.

One note on presentation is warranted. The reader is assumed to be familiar with the conventional terminology used to describe light gas gun

CONFIDENTIAL

operation; no glossary defining terms such as "pump section," "piston," or "launch tube" has been included. New terms describing items or operations unique to this launcher are defined in the report as they appear.

CONFIDENTIAL

SECTION II

DESCRIPTION OF WEAPON CONCEPT

The scheme proposed as a basis for a practical automated hypervelocity weapon is illustrated in Figure 2-1. It may be seen that the concept is derived from conventional light gas gun operation: the projectile is driven by a light gas which has been compressed to high pressure and temperature by a rapidly moving piston; the piston is driven by a relatively fast burning propellant in a standard cartridge case; and the barrel sections are similar in configuration to those of existing laboratory guns.

Certain distinguishing features are apparent which render the proposed scheme more suitable than the conventional light gas gun for automatic repeated fire. In the standard laboratory launcher, projectile and piston are loaded individually, in separate areas of the gun; that is, to place the projectile and shear flange in position requires a manual operation, and also requires that the high-pressure section be opened to expose the launch tube entrance. To simplify the loading operation, and to avoid repeated opening and closing of the high-pressure section (with the associated sealing problems), a means was contrived to have the projectile loaded at the breech end of the gun along with the rest of the round and then carried forward into firing position as the helium is injected into the pump tube. This is accomplished by the addition of a projectile "carrier" to the conventional components of the light gas gun round. Referring to Figure 2-1 it may be seen that the carrier serves a number of functions in the operation:

- a) it joins the projectile to the rest of the round for storage handling and feeding.
- b) it carries the projectile down the pump tube as helium is injected and guides it into firing position.
- c) it provides a gas seal during charging, seating and compression, preventing excessive leakage of the light gas.
- d) it contains the shear flange, which releases the projectile at the desired shot-start pressure.
- e) it acts to some extent as a shield or liner (which is replaced after each firing) for the forward breech area*.

*The term "forward breech" is used in this report to refer to the launch tube entrance and the pump tube area just behind it

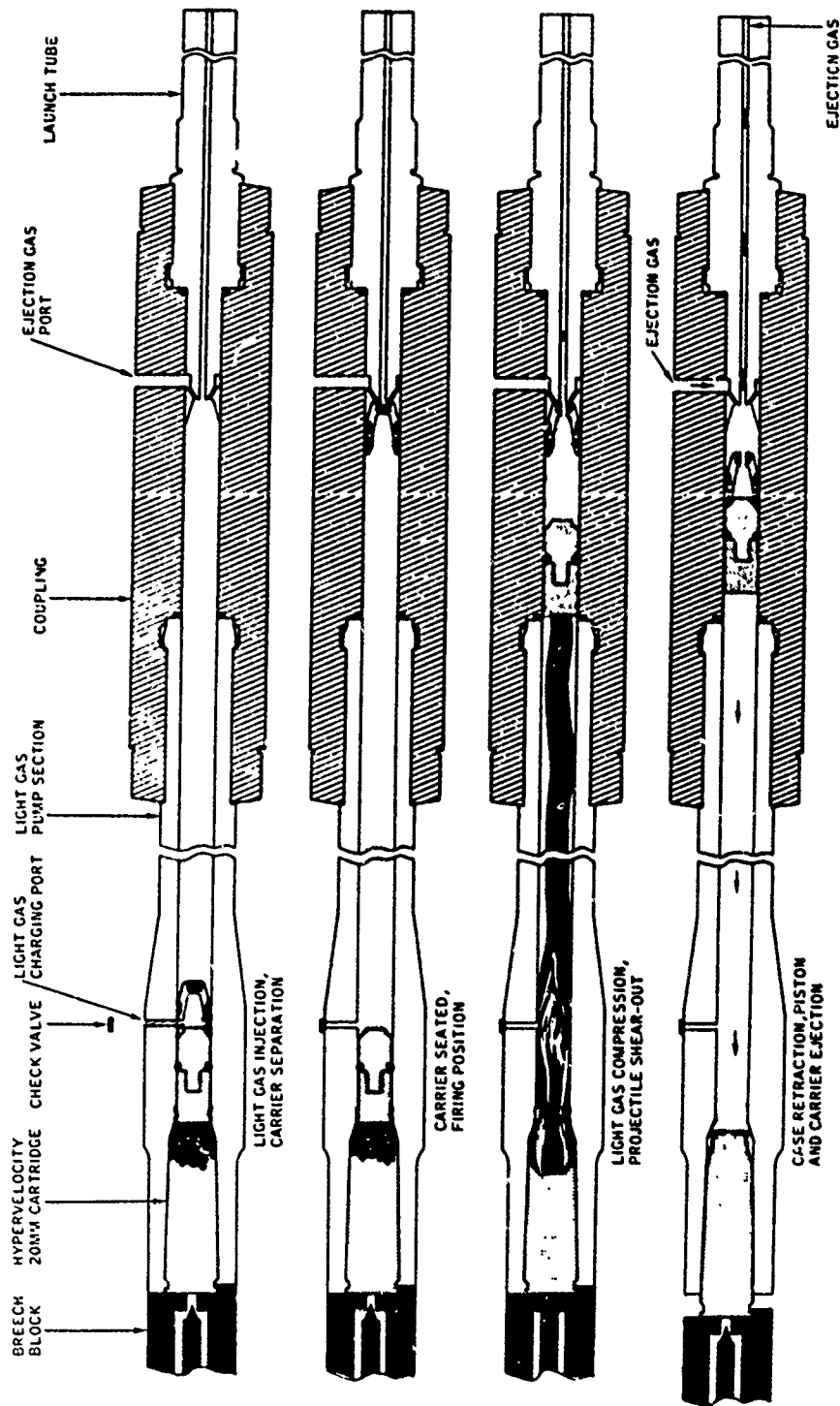

Figure 2-1. Sequence of Operation

CONFIDENTIAL

The carrier is shown in somewhat more visible detail as part of the complete round in Figure 2-2; the reasons for the particular shape shown will be discussed in detail in later sections.

The proposed scheme also differs from the conventional light gas gun in the means used to remove the expended components from the pump tube after the projectile has been launched. In order to prepare the laboratory launcher for reloading, the high-pressure section must again be disassembled and the expended piston and shot-start device (usually a shear disc or flange) removed mechanically, or in the case of certain high-performance launchers, a portion of the forward breech area is discarded and replaced by a new assembly. For the present concept, pneumatic ejection is proposed. As is shown in Figure 2-1, pressurized gas from an external source is introduced into the launch tube, driving the expended piston and carrier back through the pump tube and out the breech end of the gun (the cartridge case having been extracted by conventional means). This technique can function with some rapidity, and it eliminates the need for disturbing the high-pressure assembly, except for barrel replacement.

The firing sequence proposed by this concept, then, may be summarily described as follows (refer to Figure 2-1). An integral round is fed into the pump section chamber ahead of a conventional bolt. With the bolt locked, helium is injected through a one-way valve into the pump section, separating the carrier from the piston and driving the carrier down the pump tube. The carrier is forcibly seated at the forward breech, and the seating of the carrier aligns the contained projectile with the launch tube entrance, ready to fire. The propellant in the cartridge case is then ignited, driving the piston into the trapped pocket of light gas, and the projectile is launched. As the compressed helium is vented behind the projectile, the piston lodges in the base of the carrier. The cartridge case is extracted, and simultaneously pressurized gas is applied through the muzzle and auxiliary ejection ports, driving piston and carrier out the breech behind the case. The gun is then ready for the next round to be chambered and fired.

CONFIDENTIAL

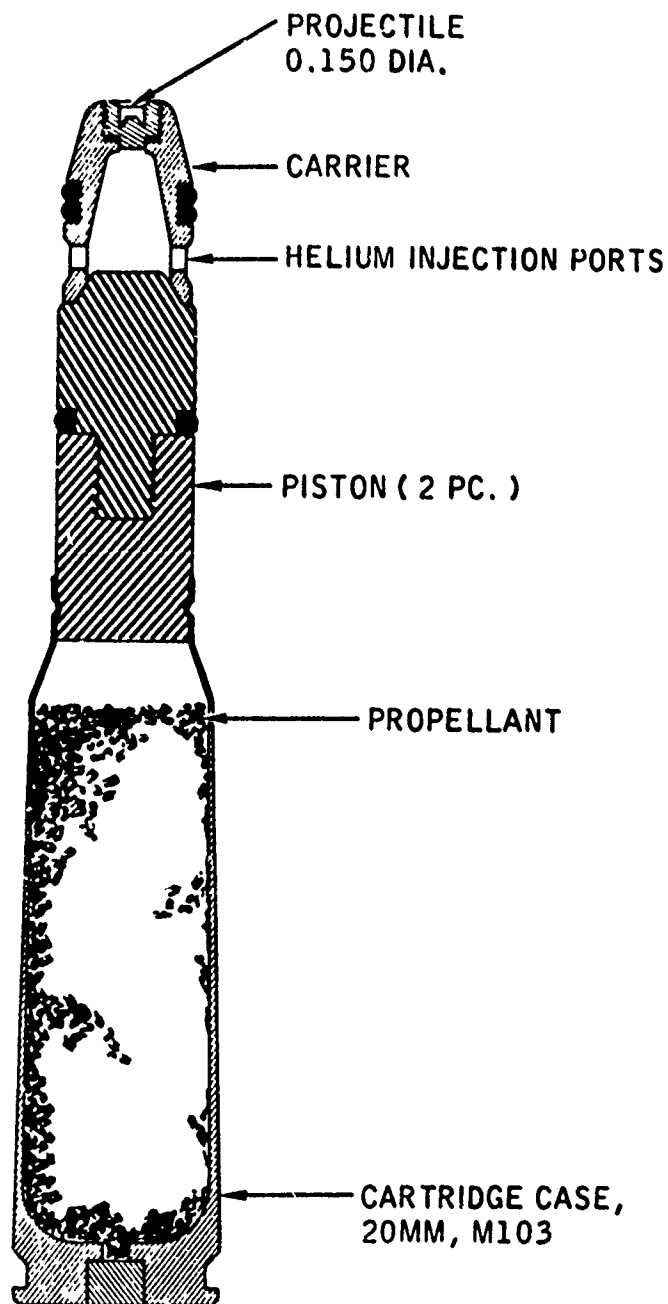

Figure 2-2. Cross Sectional View of Complete Round

CONFIDENTIAL

CONFIDENTIAL

SECTION III

DESIGN AND FABRICATION

SELECTION OF LAUNCHER DIMENSIONS

The first step in designing a launcher for the feasibility investigation was the selection of the critical mass, length and area ratios which determine how efficiently the energy of propellant combustion is transferred to acceleration of the projectile. Since the proposed firing operation is identical to that of standard light gas guns between propellant ignition and projectile launch, existing parametric data and theoretical performance analyses were fully applicable. Therefore, a literature search was made, from which was obtained a comprehensive survey of the significant dimensional characteristics of existing launchers.

The pump tube bore diameter was first fixed at 20mm. This value was chosen because of the availability of 20mm hardware and technology from the M61 Vulcan program. In addition, a 20mm pump tube diameter would lead to the overall test assembly being of practical and convenient size. Once this dimension was established, launch tube diameter, pump tube length, and launch tube length were selected from a consideration of existing launchers and from attention to practical weapon requirements.

It remained to select values, or a range of values, for piston mass, initial helium pressure, projectile mass, and projectile release pressure. For this purpose, a simplified analytical program was written to roughly simulate light gas gun performance, based on the chosen barrel dimensions and varying the remaining parameters. The development of a more rigorous analysis was beyond the scope of the contracted effort; and the use of existing computer programs at other establishments was not felt to be necessary or desirable at this stage, in view of the amount of time and attention required. The program, as finally used, was based upon the assumption of reversible adiabatic processes in all phases of compression and launch, and made use of available interior ballistics data which was not accurately applicable to the propellant eventually chosen. However, in spite of these approximations and inaccuracies, the simplified approach possessed the advantage of speed, both in setting up the program and in obtaining results; and the parametric values assigned from these results, while doubtless not optimum for the configuration, proved none the less, to be quite satisfactory for the purposes of the feasibility study (Table 3-1).

CONFIDENTIAL

Table 3-1. Initial Selection of Values for Launcher Parameters

Diameter of pump tube	20mm
Length of pump tube	40 inches
Diameter of launch tube	0.150 inch
Length of launch tube	15 inches
Mass of piston	225 grains (14.6 grams)
Mass of projectile	5 grains (0.32 gram)
Initial helium pressure	200 to 1000 psi
Projectile release pressure	30,000 to 50,000 psi

DESIGN OF CRITICAL COMPONENTS

With the basic launcher dimensions established, preliminary design studies proceeded rapidly. Attention was focused on the areas which were expected to cause difficulties in the implementation and functioning of the concept, primarily the following:

- helium injection system -- a means was required of rapidly and repeatedly charging the pump tube to the correct initial pressure, independently of the decreasing pressure in the storage reservoir due to diminishing supply.
- check valve -- a heavy duty check valve was required at the helium charging port, permitting rapid passage of the light gas into the pump tube, but capable of containing the high pressures and temperatures generated impulsively by the fast-burning propellant.
- projectile alignment -- a method was required of insuring that when the carrier had seated, the projectile would be properly aligned with the launch tube entrance for firing.
- gas seal at forward breech -- an essential requirement was the prevention of helium leakage in the high-pressure section during compression; at the same time it seemed desirable, from a practical weapon standpoint, to avoid the heavy, bulky flanges and bolts generally used in this area.
- bolt-unlock under residual pressure -- it was anticipated that after firing a residual pressure of a few thousand psi would be trapped in the pump tube between the cartridge case and the piston (lodged in the forward breech); a sturdy and reliable bolt-unlock mechanism was required to permit case extraction.
- pneumatic ejection -- the whole ejection scheme, and especially the initial dislodging of carrier and piston after firing, was felt to be the most critical and difficult problem to be overcome in establishing the feasibility of the concept.

CONFIDENTIAL

After experimental evaluation was begun, it was found that in most of these areas the original design solution was successful or adequate. However, in certain cases it was not, and revisions were necessary. In addition, several new problem areas were revealed throughout the course of testing which had not been anticipated, and each of these required trial-and-error modifications to the original components. A description of the initial hardware is of value in understanding the eventual changes dictated by the experimental results. Therefore, the design solution originally formulated for each of these anticipated problem areas is discussed in the following paragraphs.

Helium Injection System

The method decided upon for charging the pump tube to the desired initial pressure utilized two gas storage bottles with a pressure regulator between them (Figure 3-1). In principle, the larger bottle contains the high-pressure supply of helium gas, and the regulator is adjusted to maintain a constant pressure level in the smaller bottle. Thus a small reservoir of light gas at the desired charging pressure is available to supply the pump tube. Since each firing requires a relatively small amount of gas, the reservoir pressure does not drop critically if a number of firings are made in rapid succession. A high-flow regulator assists in maintaining the reservoir pressure constant. The reservoir is extended by a (preferably short) length of hose to a solenoid valve, which controls the admission of gas to the pump tube. When the solenoid valve is opened, charging gas flows through the check valve into the pump section; after allowing sufficient time (a small fraction of a second) for the flow of gas to seat the carrier and develop full charging pressure, the solenoid valve is closed and the check valve retains the gas in the barrel.

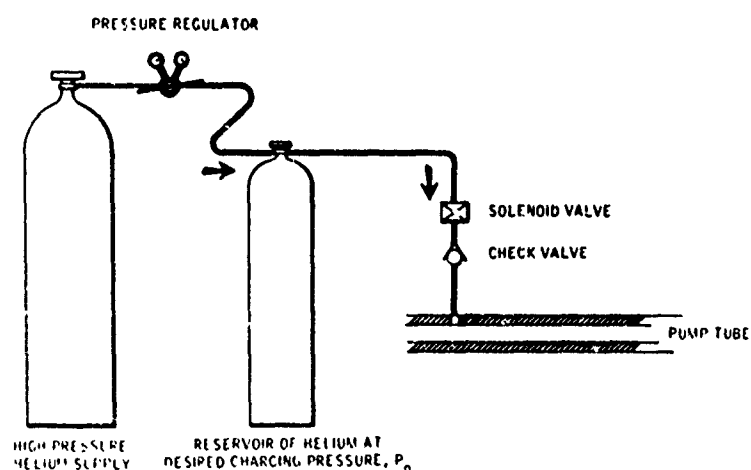

Figure 3-1. Helium Injection System

CONFIDENTIAL

The injection system did not require modification during the program. In application, since isolated single-shot firings were made rather than a number of shots in rapid sequence, the large supply bottle was shut off once the small reservoir was set at the desired charging level, and the reservoir pressure was therefore, slightly reduced after each firing. Hence the injection scheme has not been tested in successive firings. In addition, a long connecting hose was used between the reservoir and the solenoid valve, which would be undesirable if the fastest possible development of charging pressure in the pump section were required.

Check Valve

The design of the check valve is illustrated in Figure 3-2. It may be seen that sealing is accomplished by the use of metallic E-rings, which are especially designed to withstand and contain high temperatures and pressures. To allow the passage of gas through the valve into the pump section, the sealing plate and the spring plate are cut as shown in Figure 3-2. Pressurized gas entering the check valve forces the spring plate and attached shaft down while flowing around the spring plate. With the shaft forced down, the gas flows around the O-ring and sealing plate and into the pump tube. As the pressure in the pump tube builds up, the flow rate through the check valve decreases; and when the downstream pressure is nearly equal to the incoming pressure, the spring begins to return the shaft to the position shown. As soon as charging pressure is established (and this may be while the sealing plate is returning, and not completely seated) the propellant is ignited. The hot, high-pressure powder gas generated expands through the charging port and slams the sealing plate tightly against its supporting annulus. Any gas which gets by the sealing plate is contained by the metallic E-ring on the shaft. (The small O-ring higher on the shaft insures that any initial gas which gets by the sealing plate and the E-ring will help to seat the sealing plate and bring the E-ring into effect.) Two additional metallic rings are used to seal off small escape routes between the adjoining component surfaces.

This check valve design proved to be quite successful on the whole, although a few minor changes will be incorporated in models used for subsequent testing. The sealing plate will be made thicker for increased bending resistance; a "bottoming" surface will be provided for the shaft at its upper end so that gas leakage acting in an upward direction on the small O-ring will not tend to stretch the shaft at the narrow O-ring groove; and the check valve housing will be more firmly held in position on the pump tube O.D. (recoil motion of the pump tube combined with the inertia of the housing resulted in a relative slippage between the two components upon firing).

Projectile and Carrier Design

In order to insure that carrier seating would result in correct projectile alignment with the launch tube entrance, the carrier nose was given a

CONFIDENTIAL

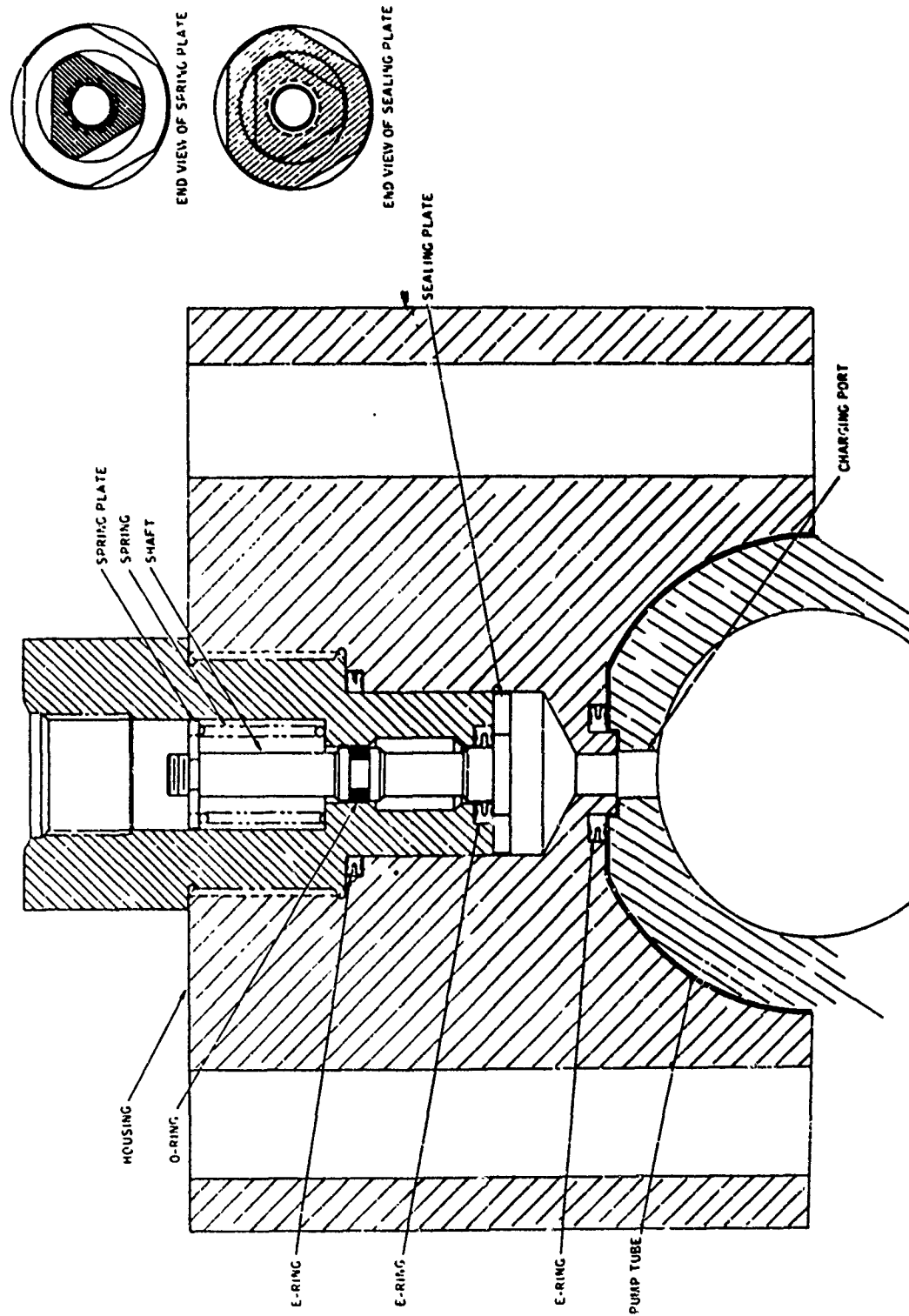

Figure 3-2. Check Valve

CONFIDENTIAL

CONFIDENTIAL

conically tapered portion which, when forced firmly into the corresponding taper of the carrier seat, enforced the proper orientation and alignment (Figure 3-3). The initial helium pressure was depended upon to forcibly mate the conical surfaces, and accurate centering of the projectile in the carrier nose was assumed. It was decided to recess the projectile in the carrier rather than have it protrude, since there was possibility that a slight misalignment of the projectile might damage the launch tube entrance when the carrier impacted the carrier seat. However, since the projectile was recessed, there was some uncertainty as to the manner in which it would move from its recessed position into the bore upon shearing free; even if it were perfectly aligned initially. (In view of recent evidence, there appears, in fact, to be some disadvantage in the recessed configuration. A protruding projectile, which is already in the bore when it is released, may be preferable. Alignment at charging impact could be assured by a pointed projectile nose which would guide the projectile into line as it entered.)

Figure 3-3 shows a cross-sectional view of the present projectile configuration. The original design called for the projectile and flange to be inserted in the carrier nose as a press fit rather than threaded in as shown. Several changes were made in projectile and carrier design during the course of testing, and these changes will be described as the test results are discussed.

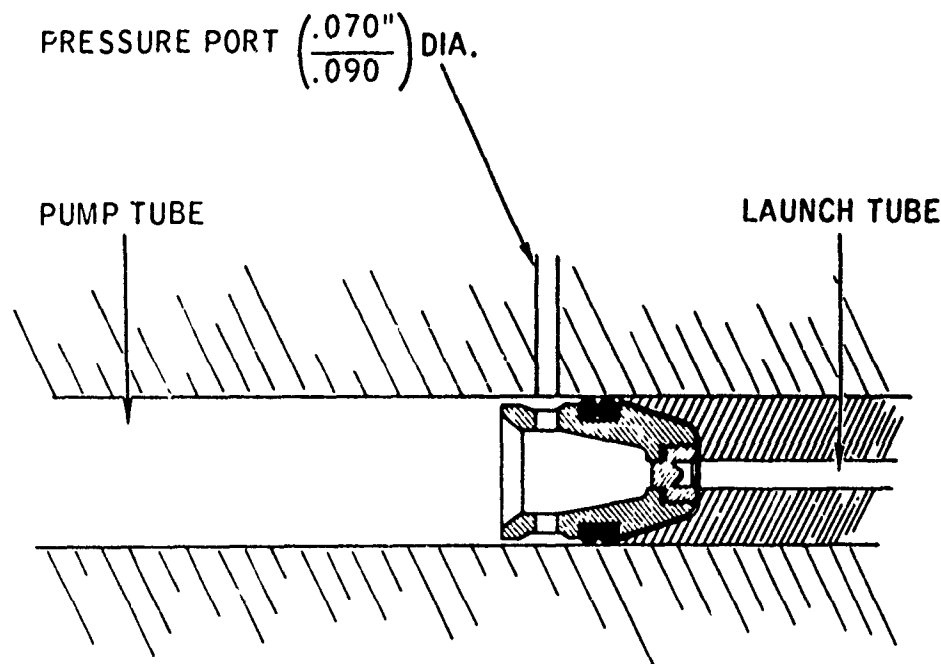

Figure 3-3. Cross Sectional View of Carrier Seated in Firing Position

CONFIDENTIAL

Gas Seal at High-Pressure Section

In the forward breech area, peak pressures in excess of 100,000 psi and peak temperatures of several thousand °K were anticipated. To contain this high-temperature, high-pressure gas, a thick-walled, hardened barrel section was used in conjunction with metallic sealing rings at the interfaces. The design can be seen in Figure 2-1. The thick-walled barrel, or "coupling section" was machined from AISI4340 steel and heat-treated to a hardness of Rockwell C-50/55, giving it an approximate tensile strength of 200,000 psi. Outer diameter of this section was 3.00 inches, with a bore diameter of 0.786/0.789 inch. A thick-walled coupling section is common to most conventional light gas guns; however, the barrel sections are then usually held together by heavy flanges and large, heavy bolts that provide additional reinforcement. It was felt desirable to avoid the bulkiness and weight of this arrangement in view of the proposed launcher application; hence the barrel sections were threaded together directly, in the manner shown in Figure 2-1.

Bolt Unlock and Case Extraction

As mentioned previously, it was expected that after firing, a residual pressure of substantial magnitude would be trapped in the pump tube, creating a rearwards force against the bolt which would make unlocking difficult. In terms of the standard M61 (Vulcan) bolt, which was used, an upward force was required to lift the lock block against the restraining frictional forces caused by the load upon it. To describe briefly the means employed without needless detail: a pneumatic charger (0.50 caliber M50A) was used to drive a wedge, forcing two guided pins upward against the bottom surface of the lock block. In the event that bolt and case were not then driven back by the residual pressure, a second charger was made available to thrust the bolt rearwards against a shock-absorbing stop. The chargers were supplied and controlled by the arrangement of lines and valves shown in Figure 3-4.

This somewhat makeshift operation functioned perfectly throughout the tests. It was found that the second charger was, in fact, necessary, since the pump tube was vented by collapse of the cartridge case before the bolt was unlocked.

Pneumatic Ejection

The means originally conceived for the expulsion of the piston and carrier from the pump tube after firing was discussed briefly in Section II. The proposed location of the ejection gas ports (Figure 2-1) and the difficulties expected deserve further comment. In order to dislodge the carrier from its seat, it was felt necessary to bring pneumatic pressure to bear directly against the carrier face. Gas injected through the muzzle would pass through the hole in the carrier nose (left by the projectile) and act upon

CONFIDENTIAL

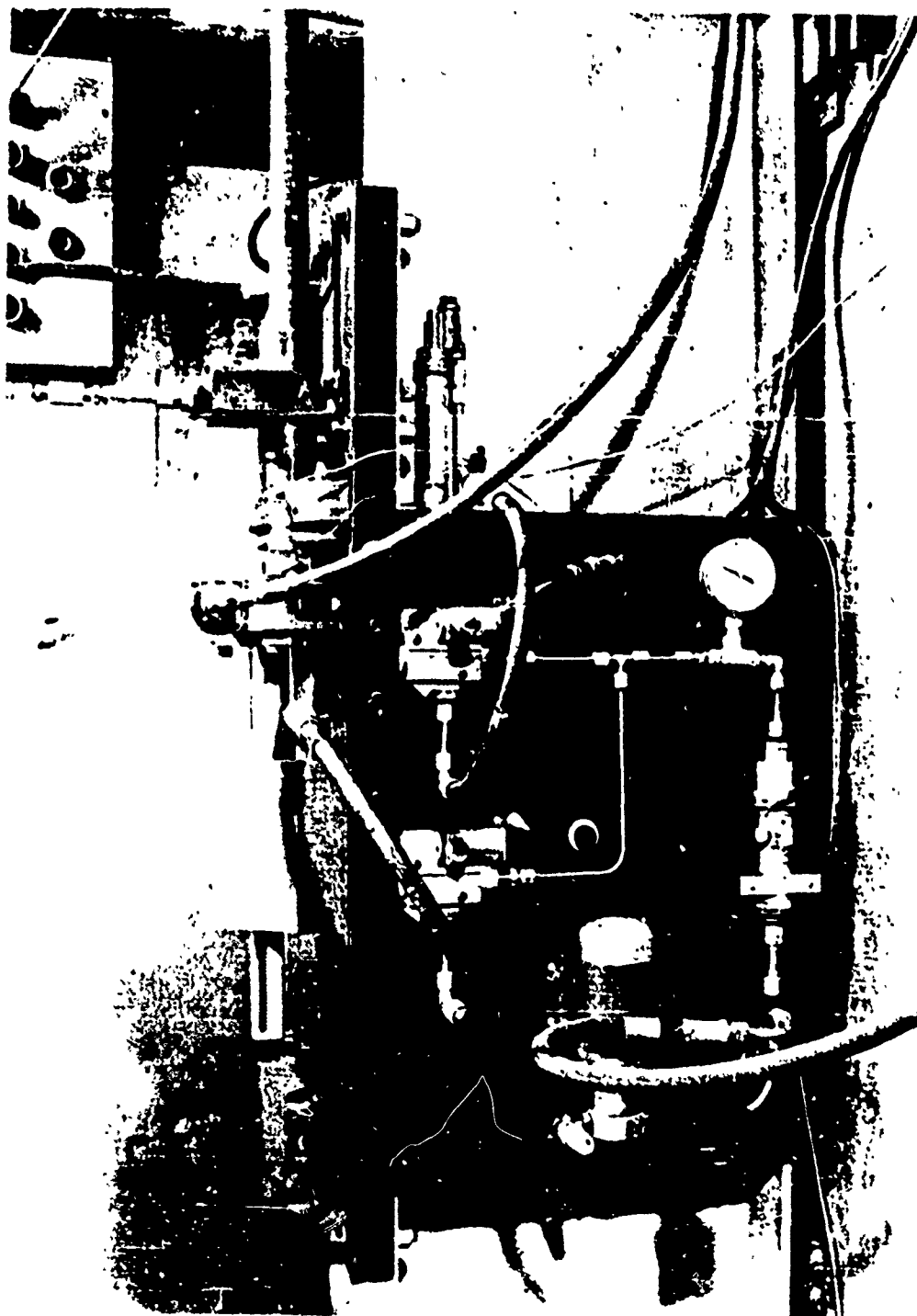

Figure 3-4. Pneumatic Assembly for Bolt Unlock, Case Extraction

CONFIDENTIAL

CONFIDENTIAL

the piston face, but muzzle pressure was not expected to be effective in starting the carrier rearwards. For this reason, gas ports at the forward breech, located as was shown in Figure 2-1, were proposed. Ejection gas would be fed through a single port in the heavy wall of the coupling section into an annular space surrounding the launch tube insert. From this area the gas would be forced through four small holes leading to the face of the seated carrier. With the application of sufficient pressure, the carrier would be dislodged; and the higher-flow-rate muzzle gas would then be able to act against the carrier face, driving carrier and piston out the rear of the pump tube. During the charging and compression stages of the firing cycle, the four small ports would be sealed by the interposition of the carrier. Consequently, no helium leakage was expected to occur as a result of this porting at the high-pressure region of the gun. However, the four small gas passages did present somewhat of a problem concerning choice of size. If the holes were too small, tremendous ejection gas pressure might be required to create enough force to dislodge the carrier; if the holes were too large, the carrier face might extrude into them upon charging impact; and, in addition, the carrier seat area would be weakened by the removal of material.

A possible solution which did not require these ejection ports in the forward breech area was to design the piston of a material and shape such that it would extrude into the carrier. With the piston then firmly bound to the carrier, muzzle pressure driving the piston rearwards would force the carrier to move as well. However, it was suspected (and the suspicion later proved to be correct) that the forces involved in the extrusion process would result in piston and carrier being much more tightly wedged in the forward breech than if severe piston impact and deformation were avoided.

The ejection scheme of Figure 2-1 was subsequently prepared for use, but was never actually employed as shown. Muzzle pressure alone proved surprisingly effective in ejecting both carrier and piston, without requiring piston extrusion or auxiliary gas ports for successful functioning. Attention was then concentrated on testing and improving the reliability of this method.

DESIGN AND CONSTRUCTION OF REMAINING AREAS

General

The preceding discussion of anticipated problem areas and related component design has furnished the more important details of launcher construction and operation. A brief discussion of the remaining components will complete the description of the test assembly. An overall view of the launcher (omitting the helium storage bottles and the remote instrumentation panel) is shown for reference (Figure 3-5).

CONFIDENTIAL

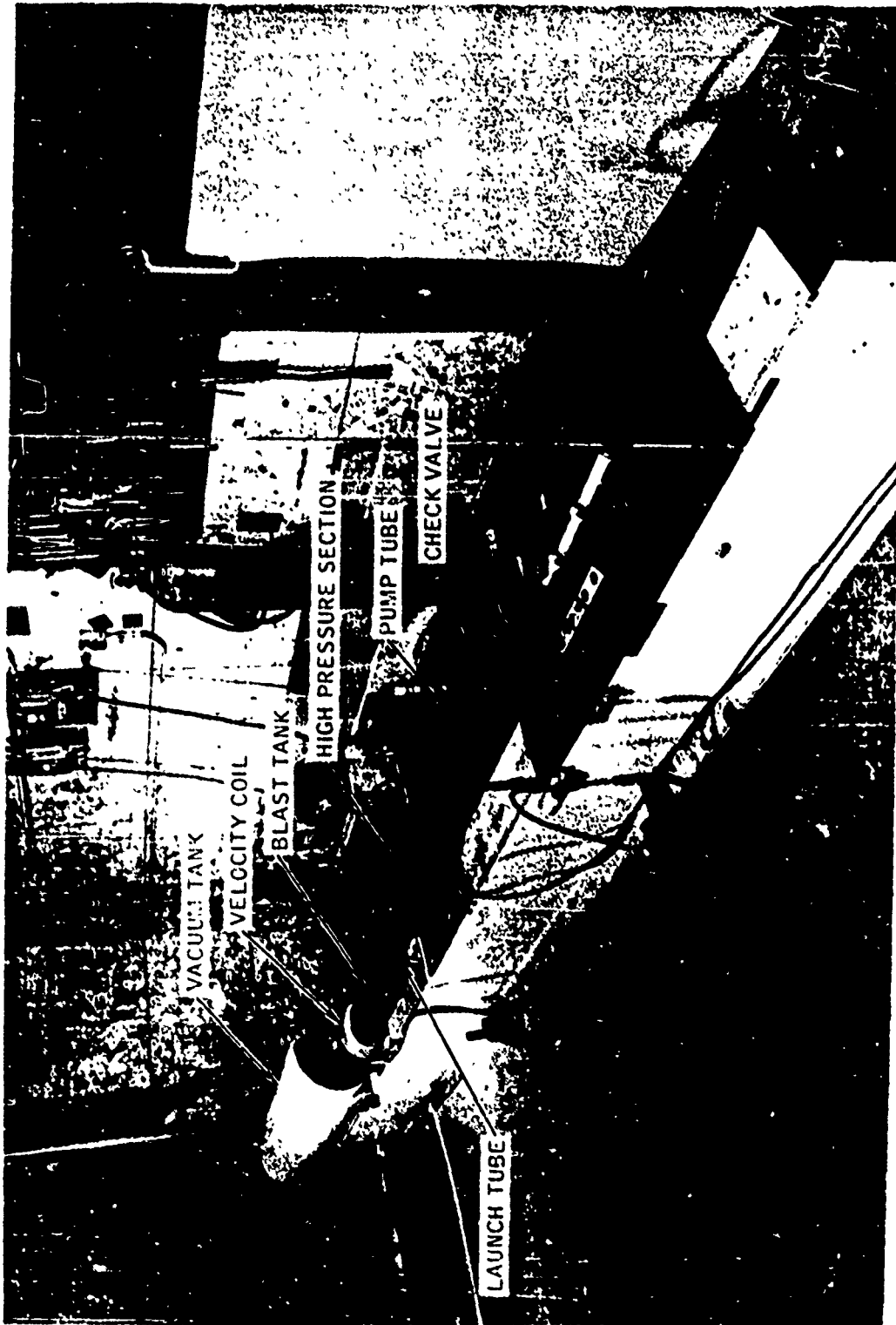

Figure 3-5. Overall View of Launcher Assembly

CONFIDENTIAL

CONFIDENTIAL

Breech Area

As previously mentioned, the 20mm pump tube diameter was chosen primarily because of the availability of hardware from the 20mm M61 program. A standard M61 barrel was used for the pump section of the launcher, being modified to obtain an unrifled bore, increased strength at the muzzle end, and a means of attachment to the coupling section. The standard M61 bolt was used, with an extension provided to permit bolt retraction by the charger. For the support and guidance of the bolt, a single track of the six-bolt M61 rotor was employed; the rotor was cut in half to provide a flat bottom surface for mounting purposes.

An overhead firing contact was designed to transmit firing voltage to the electrical primer; this contact could be remotely motivated as well as energized, and was swung clear of the bolt after firing to permit bolt unlock and case extraction.

Piston

The design of the hypervelocity round (Figure 2-2) has already been described in part. Carrier and projectile configuration was discussed, and the standard cartridge case requires no comment. The propellant used was IMR 4895, a relatively fast-burning rifle propellant, which was suggested by B. R. L. personnel during a consultation visit to that facility.

Piston design was largely determined by the piston mass required, and by the shape of the carrier base for attachment purposes. Originally, no O-ring was used with the piston. This feature was added after it was discovered that helium injected into the pump tube ahead of the piston escaped around the chambered cartridge case.

The piston material chosen was Lexan, on the basis of its reported superiority in compressing the helium gas without permitting excessive leakage.⁽²⁾ A solid Lexan piston was originally used, but after erosion of the forward face was found to be severe, the two-piece piston design shown in Figure 2-2 was adopted to permit testing of different materials for the front section. The Lexan base was retained for its sealing ability, and the final piston consisted of the Lexan aft portion with an aluminum forward section.

Launcher Assembly

At the high-pressure section, additional support and strength were provided by a heavy, rigidly mounted barrel clamp. Just ahead of the clamp, a large housing for the pressure-sensing instruments was attached. The pressure passage monitored by these instruments was the only port in the forward breech area, since, as previously mentioned, the method of introducing ejection gas at this region was never used.

CONFIDENTIAL

The smooth-bore launch tube was machined with a carefully held 0.001 inch tolerance on the 0.150 inch bore diameter, to insure a minimum of gas leakage past the projectile during the launching run. The steel designated for this section was the special-composition electric furnace steel used in the manufacture of the M61 barrel. In addition, the launch tube was heat treated to a hardness of Rockwell C-32 to 37. In order to increase the resistance of the bore surface to the severe erosive conditions expected, chromium plating on the bore walls was specified. However, since no facility for the application of the chromium plating was immediately available, nickel plating was accepted as a substitute. Plating was also called for on the walls of the 20mm barrel sections, and this proved to be unfortunate in view of the later firing results with plated barrels. However, the first set of barrels used (which served for most of the firings) were fabricated without plating to expedite delivery.

Ahead of the launch tube in Figure 3-5 are shown a small expansion chamber (or "blast tank"), a velocity coil, and a vacuum tank.

The blast tank was not part of the system originally, but was added when difficulty was experienced with the functioning of the coil. (The coil had been located directly ahead of the muzzle, and it was believed that the hot ionized gas surrounding the emerging projectile was causing a disturbance of the coil's output signal. The blast tank, although small and only partially effective in detaining the muzzle blast, did apparently eliminate most of this disturbance.)

The vacuum tank was provided to simulate the high-altitude or space environments contemplated for the eventual weapon application. Pumping down the tank also evacuated the connecting barrel sections. Considering the sequence of operations, it is obvious that if the pump tube bore were not initially evacuated, carrier motion down the tube would be impeded, and a longer time would be required to seat the carrier in firing position. Hence it may be noted that a high-altitude environment is necessary for rapid fire to be achieved with this concept. *

The downrange end of the vacuum tank (not visible in Figure 3-5) was provided with a 3-inch diameter opening, covered and sealed off before evacuation by a thin aluminum plate. The perforation of this plate by the projectile furnished a second signal for velocity measurement.

Usually no attempt was made to stop or recover the projectile. After passing through the aluminum sheet it entered the atmosphere and traveled

* Of course, any hypervelocity gun will suffer a severe reduction in effectiveness at low altitudes, if the projectile has to travel far, because of the ablation and velocity decay of the projectile in the atmosphere.

CONFIDENTIAL

down the range. During the test firings it was often found to be expedient or preferable to remove the vacuum tank and fire into the atmosphere, depending upon which aspect of the firing operation was being studied. It will be clearly specified, in presenting the results, whether or not an evacuated environment was used.

CONFIDENTIAL

This page has been left blank intentionally.

CONFIDENTIAL

CONFIDENTIAL

SECTION IV

EXPERIMENTS AND RESULTS

PRELIMINARY TESTS

General

Concurrently with the design and construction of the launcher, and prior to the initial firings, certain preliminary studies were made of those areas of the operation which could be treated separately. The general purpose of these studies was twofold: 1) to obtain numerical data which would be of interest in assessing and analyzing the overall performance of the launcher, and which could be obtained more conveniently in this manner than during the actual firings; and 2) to check the functioning of certain design features, so that those revisions which were found to be necessary could be incorporated.

Transparent Pump Tube

The most important of the preliminary studies was the investigation of the charging phase of the firing sequence; that is: helium injection, motion of the carrier down the pump tube, and carrier seating at the launch tube entrance.

The apparatus used for this experiment is shown in Figure 4-1. The pump tube was simulated by a Lucite cylinder, of the same bore length and bore diameter as the actual barrel section. This transparent tube permitted the charging and seating operation to be witnessed and recorded by a Fastax camera. A time-scale for the events was provided by a Strobotac pulsing light.

The contour of the carrier seat area and launch tube entrance was accurately machined in the end fitting to duplicate this portion of the actual launcher. Tube and end fittings were supported and held together by two brackets which were drawn tight by tie rods and then bolted fast to an I-beam. The helium injection method was identical to that employed with the launcher, except that no check valve was used.

The experimental procedure is described in the following paragraphs.

With the transparent tube removed from the assembly, the carrier was placed in the bore in correct position relative to the charging port. End fittings and brackets were then secured in place at the ends of the tube, and the brackets bolted to the I-beam. With the tube thus supported, the pneumatic line from the solenoid valve was affixed to the charging port entrance, and the vacuum pump hose was connected to the downstream end fitting. The

CONFIDENTIAL

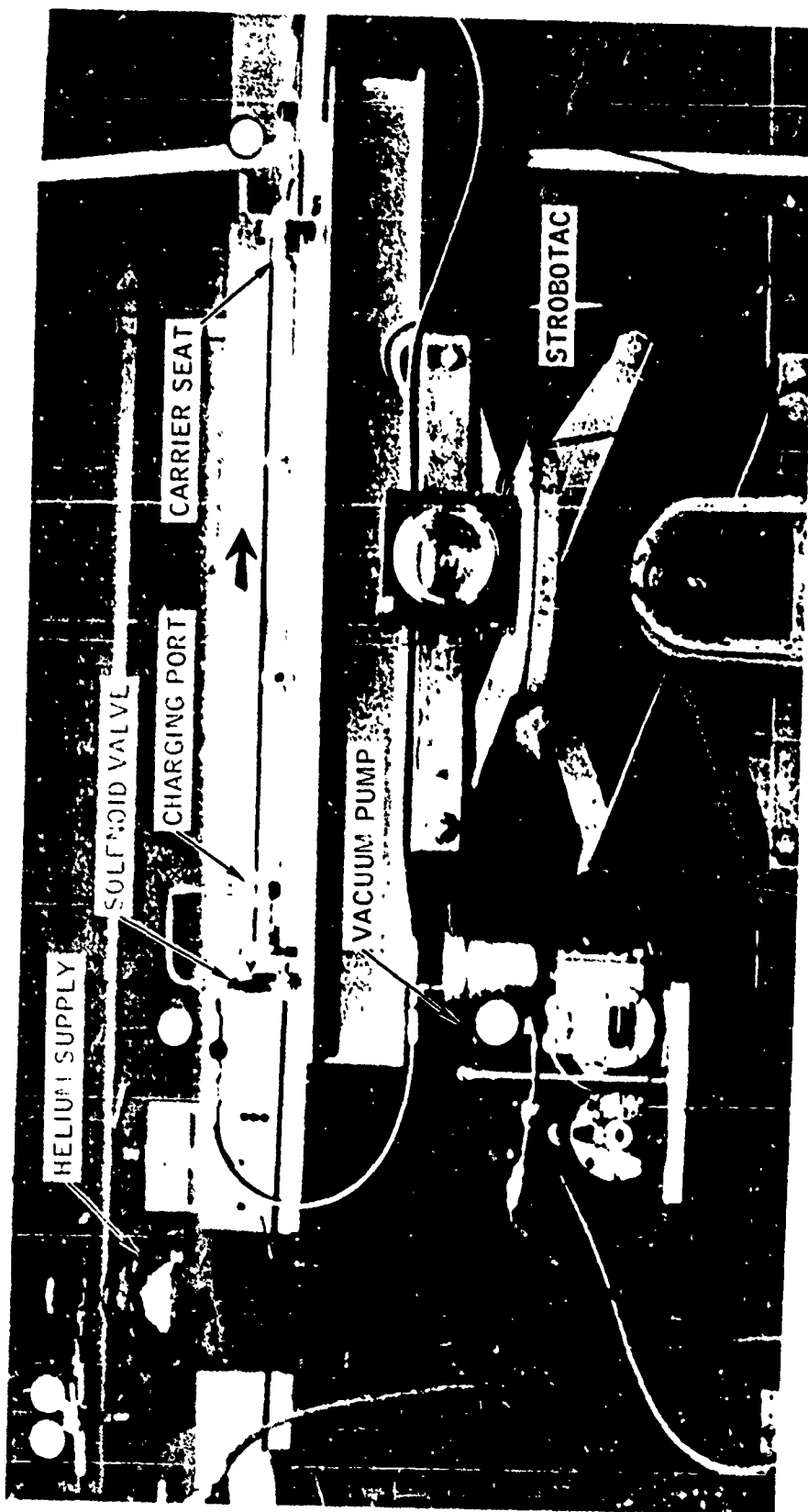

Figure 4-1. Transparent Pump Tube Apparatus

CONFIDENTIAL

CONFIDENTIAL

bore of the simulated pump tube was then evacuated. (Since the carrier was not restrained by attachment to the piston, as it would be in normal operation, the charging line was also evacuated so that the carrier would not move down the tube prematurely due to the pressure differential.) The Fastax camera was focused on the bore of the transparent tube, viewing its entire length, with backlighting arranged to permit the carrier to be photographed in silhouette. The Strobotac was positioned so as to be visible on the film below the illuminated area, and the pulsing rate was set at an appropriate frequency (usually 12,000/min.). Finally, the pressure in the gas reservoir was checked and adjusted to the desired level. With preparations complete, the camera control unit was actuated, starting the camera, and after 0.5 second, opening the solenoid valve to initiate the charging event.

After each trial, the downstream pressure gauge was checked to determine if leakage of the charging gas past the carrier had occurred. The tube was then vented and disassembled, and the carrier and carrier seat were inspected for wear and deformation. Subsequently, the Fastax film was processed and viewed to analyze the results.

The initial tests of the charging process were made at low reservoir pressures. Nevertheless, two basic difficulties were immediately apparent:

- 1) Upon impact with the seat area, the carrier sustained considerable deformation in the area between the front and rear O-rings (Figure 4-2). This axial compression resulted in a diametral expansion, which caused the carrier to be tightly bound in the bore after seating. At the higher reservoir pressures that might be required in the actual launcher, this condition would have been more severe; and the extremely high pressures generated during helium compression would have increased the deformation, if anything. Subsequent ejection of the carrier by pneumatic pressure would have been difficult or impossible.
- 2) The second problem revealed by these initial tests, was the tendency of the projectile and flange (a single unit-originally designed as shown in Figure 4-3) to become dislodged from its position in the nose of the carrier upon carrier impact. The projectile flange unit was, at this time, held in the carrier nose by means of a controlled press fit. To strengthen the press fit, and to aid in sealing, various adhesives and sealing compounds, such as Eastman 910 and Loc-Tite, were applied to the unit before insertion. However, in each case the shock of carrier impact at the forward breech caused the insert to become dislodged, permitting helium leakage.

To remedy these difficulties required a certain amount of trial and error, as indicated in Figure 4-3. In order to reduce carrier deformation at the ported section, the number of ports was reduced from six to three. However,

CONFIDENTIAL

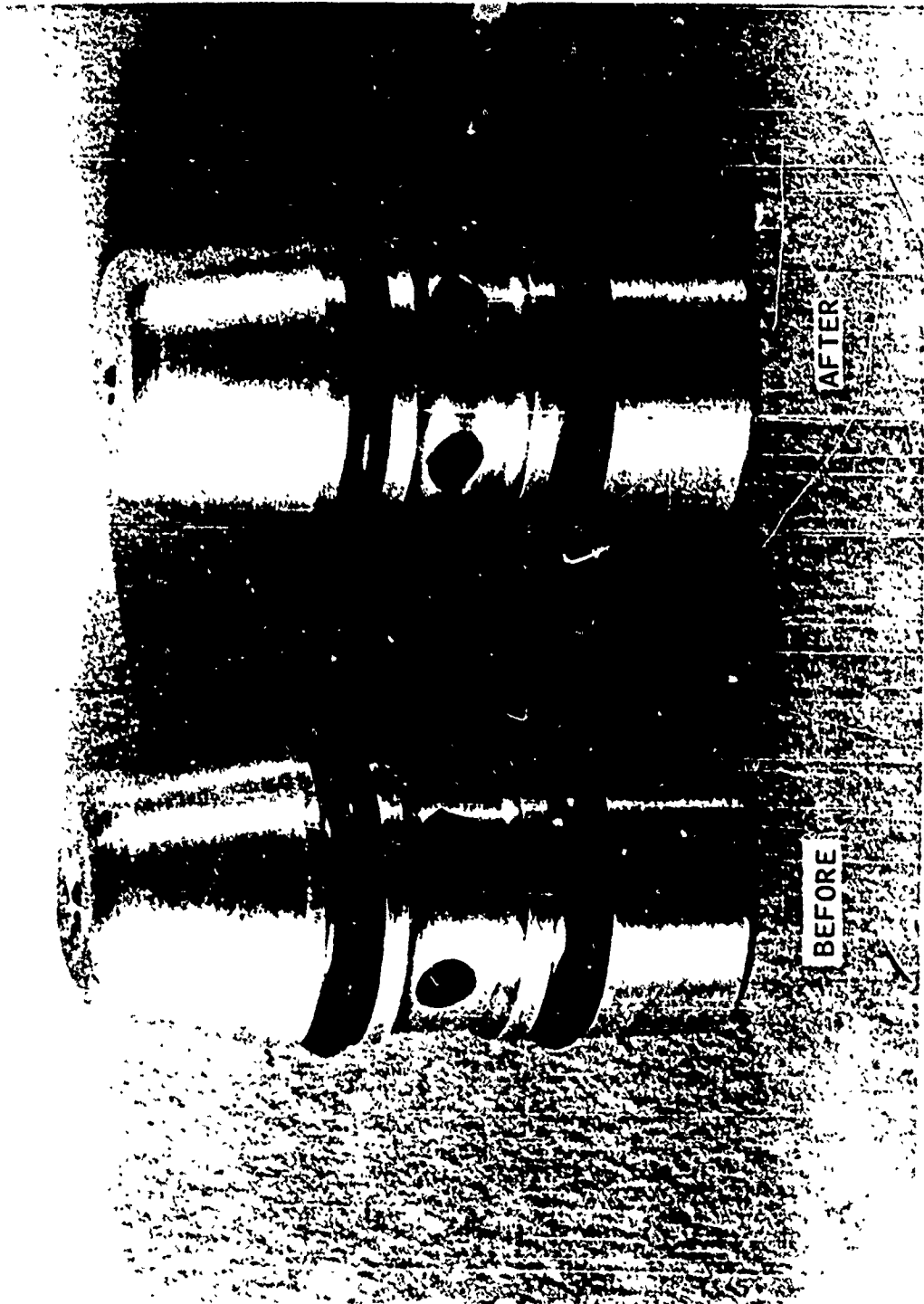

Figure 4-2. Carrier Deformation Caused by Charging Impact (Initial Carrier Design)

CONFIDENTIAL

CONFIDENTIAL



Figure 4-3. Various Projectile and Carrier Configurations Tested

CONFIDENTIAL

CONFIDENTIAL

when this proved to be ineffective, the six ports were restored. Finally it was decided to try eliminating the aft portion of the carrier, thus reducing the mass tending to continue forward against the weak middle section when the carrier nose was suddenly halted by the impact. This modification was tested and proved to be quite effective in reducing carrier deformation (Figure 4-4). The revised design required that the carrier ride on a single O-ring; excessive balloting of the carrier in the pump tube bore was prevented by making the carrier diameter at the base sufficiently close to the bore diameter.

While investigating solutions to the problem of carrier deformation, the problem of retaining the projectile-flange unit in the carrier nose at impact (and maintaining a tight seal to prevent leakage of the charging gas) was solved by the adoption of a threaded flange design. It was discovered that a set screw, threaded into the carrier nose with Eastman 910 adhesive used as a sealant, held firmly upon impact without permitting leakage. The projectile-flange configuration shown in Figure 3-3 (and previously discussed in Section III) was then fabricated, and tested. This configuration proved successful in preventing leakage, and was accepted as the best overall solution then available.

In addition to the qualitative data obtained during these studies, an indication of the time required for the charging phase, as a function of reservoir pressure, was obtained from the Fastax records. The camera was not utilized for most of the earlier trials, and incomplete instrumentation caused the loss of some additional data. However, the figures presented in Table 4-1 are felt to be accurate, and are sufficient to establish the rate at which charging may be accomplished.

Table 4-1. Transparent Pump Tube Data:
Time Required for Carrier Seating vs. Reservoir Pressure

P_o (psi)	t_o (millisec)	t_1 (millisec)	t_{tot} (millisec)	\bar{v}_c (fps)
170		14.3		233* ($v_i = 330$ fps)
255		12.8		261
265		12.8		261
320	11.5	11.9	23.4	280
330	13.2	12.2	25.4	273
375	11.6	11.0	22.6	303

*For this particular case, a careful analysis of the film record was made to obtain the velocity of the carrier just prior to impact at the seat. This "impact velocity," $v_i = 330$ fps, implies an approximate value for each of the other cases.

CONFIDENTIAL

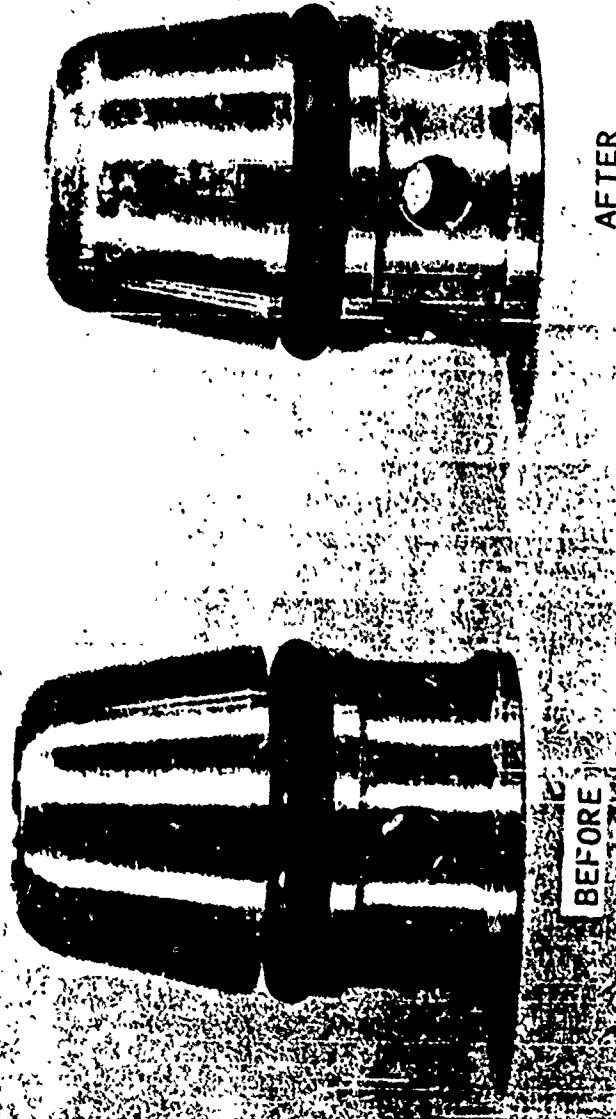

Figure 4-4. Shortened Carrier Design Before and After Charging Impact
(Approx. 400 psi Reservoir Pressure)

CONFIDENTIAL

CONFIDENTIAL

Definitions of symbols:

- p_0 = reservoir pressure
 t_0 = time between actuation of solenoid valve and start of carrier motion (i. e. time required for valve to open and gas to flow to carrier)
 t_1 = time between start of carrier motion and carrier seating
 t_{tot} = total time required for carrier seating
 \bar{v}_c = average carrier velocity over the distance traveled (not impact velocity)

Of this data, the time required for the carrier to move down the tube and seat (t_1) is the most significant, since t_0 could be shortened by a more rapidly acting solenoid valve. A plot of t_1 versus p_0 is presented in Figure 4-5.

It may be noted that there is a conspicuous absence of data at the higher levels of charging pressure (400 to 1000 psi). No tests were made at these higher pressures for the following reasons:

- At the highest pressure tested (400 psi - not recorded by the camera); carrier deformation was beginning to become excessive, even with the improved carrier design. Moreover, the projectile-flange unit was also becoming deformed upon impact (Figure 4-6), and showed signs of partial failure at the shear area due to the force of the impact.
- It was anticipated that for the actual firings, optimum initial helium pressure would be in the lower range (100 to 400 psi) to permit a higher compression ratio and hence a higher muzzle velocity.
- It was reasoned that if an initial helium pressure above 400 psi were eventually found to be required, a flow-limiting device could be incorporated into the scheme which would permit the carrier to be seated less forcibly. (This might be simply a smaller charging orifice.) In this case, a longer amount of time would be required to develop full charging pressure in the pump section, but the difference might not be of great consequence, in view of the rapid charging times demonstrated at the lower reservoir pressures.

In summary, the transparent pump tube investigations revealed essentially one basic problem area; the severity of carrier impact at the forward breech. This remains as one of the problems requiring further study and experimentation before a final solution can be evolved. At charging pressures below 400 psi, carrier impact did not produce excessive deformations, although cumulative damage to the carrier seat might become excessive in repeated fire operation. Finally, it may be noted that the total charging phase of the firing sequence was found to be accomplished quite rapidly, and thus presents no barrier to the eventual attainment of satisfactory firing rates.

CONFIDENTIAL

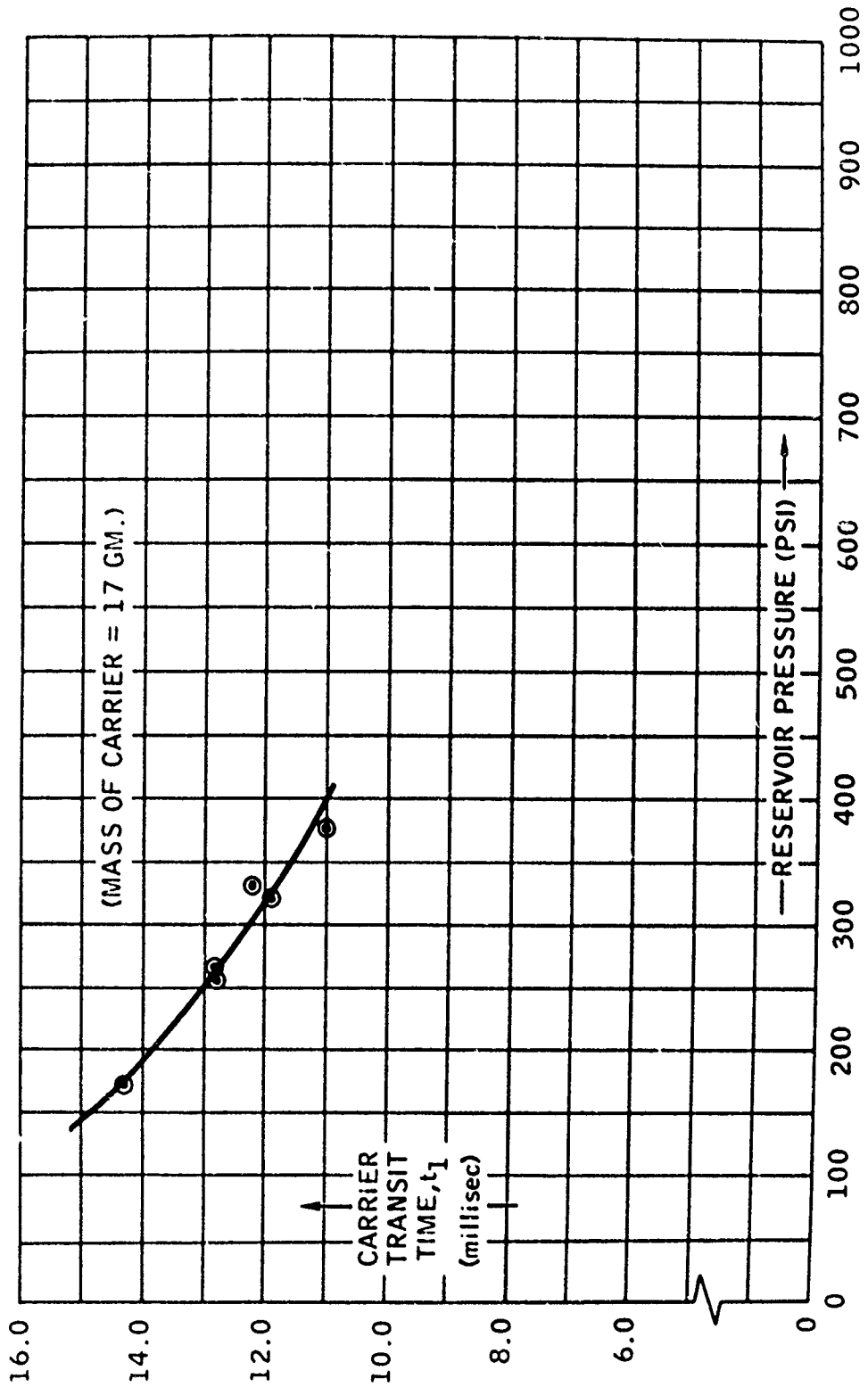

Figure 4-5. Carrier Transit Time vs. Reservoir Pressure

CONFIDENTIAL

CONFIDENTIAL

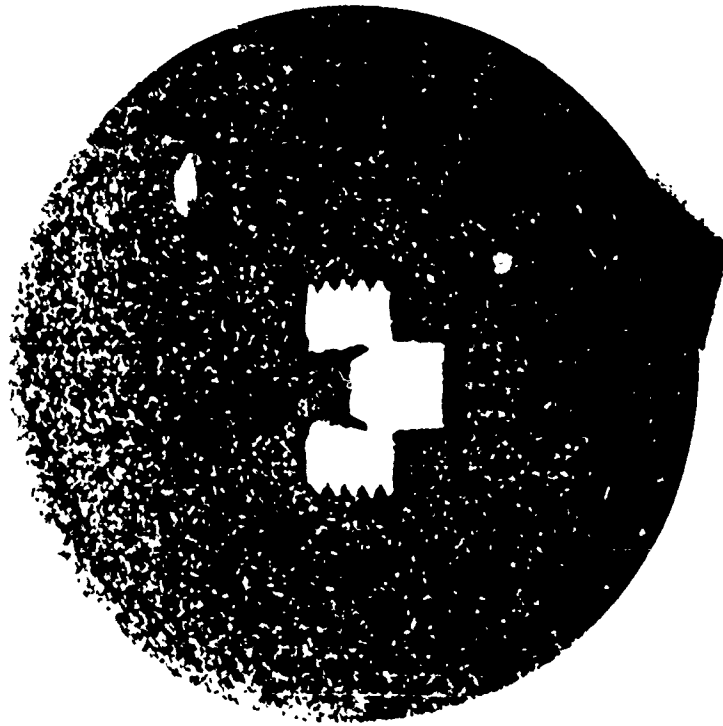

Figure 4-6. Projectile Deformation Caused by Charging Impact

CONFIDENTIAL

CONFIDENTIAL

Piston Retention and Projectile Release Pressure

Following the transparent pump tube studies, two brief and straightforward experimental investigations were conducted to determine: 1) how much pressure the piston could withstand at its forward face, during helium injection, without being driven back into the cartridge case; and 2) at what approximate pressure the projectile, as designed, would shear away from its supporting flange during helium compression.

In the case of the piston, it was merely a question of measuring the "bullet pull" for various depths of case-crimp. The base of the Lexan piston was sized to an interference fit of 0.004 inch with the neck of the M103 brass cartridge case. After the piston was pressed into position, a roller crimping tool was applied to force the brass into the groove at the base. Depth of the groove was easily controlled, and a number of rounds were prepared with groove depth varying between 0.007 inch and 0.032 inch. The force required to separate case and piston was then measured for each round and the results plotted. From this data it was determined that a groove depth between 0.023 inch and 0.027 inch would provide a comfortable margin of holding power against the maximum injection pressure contemplated (1000 psi). No trouble was experienced in this area during the subsequent firings.

To determine the projectile release pressure, some compromise was made with reality. In the actual launcher, the piston which compresses the helium is moving forward at high velocity, and the pressure build-up is correspondingly rapid. It would have been impossible to approach these dynamic conditions in a laboratory test, and the measurements of release pressure during the actual firings would have involved a difficult instrumentation installation. Moreover, since the pressure build-up did occur so rapidly, and since peak pressures were expected to be well in excess of the release pressure, it was assumed that muzzle velocity would not depend critically upon the exact pressure level at which shear-out did occur. Consequently, no attempt was made to simulate the dynamic conditions of firing. A simple fixture was machined to hold the projectile-flange unit in a manner similar to its support by the carrier and forward breech. Hydraulic pressure was then gradually applied to the projectile base by means of a pressure intensifier (regularly used for the calibration of high-pressure transducers). A quantity of five projectiles was tested in this manner. Values of pressure at which shear-out occurred ranged from 60,000 psi to 80,000 psi, with an average value of 67,000 psi. The projectiles were recovered and examined to determine the manner in which failure had occurred and the resulting surface characteristics of the projectile diameter. A photograph of a projectile recovered after being sheared out by hydraulic pressure is shown in Figure 4-7.

CONFIDENTIAL



Figure 4-7. Projectile After Shear-Out (Static Hydraulic Pressure)

CONFIDENTIAL

CONFIDENTIAL

Open-End Calibration Firings

In order to select the amount of IMR4895 propellant necessary to achieve the desired piston motion in the launcher, a standard technique of "calibrating" piston energy versus propellant mass was employed. As generally practiced, the procedure is as follows: Using the pump section as a standard gun barrel, with the forward (small bore) barrel section removed, the piston is fired like a conventional bullet into the atmosphere or into an evacuated range. Piston velocity is measured at or near the muzzle; and, by varying the amount of propellant used to drive the piston, a curve of piston energy versus propellant mass is obtained. Values of piston energy determined in this manner may be converted analytically to equivalent light gas gun performance, or vice-versa, thus permitting the selection of the proper amount of propellant to produce the desired results. Of course the energy imparted to the piston by propellant burning may be computed theoretically, but the empirical method described has the advantages of simplicity, speed, and (if properly applied) realistic simulation of the actual conditions.

The calibration firings were made, as were the subsequent complete assembly firings, at the General Electric Company's outdoor range near Underhill, Vermont. The launcher was installed in one of the five test lanes as shown in Figure 4-8, with launch tube, coupling and vacuum tank removed. The pistons were fired into the atmosphere, the velocity of the piston in air being measured a few feet from the muzzle by means of break-wires. (Hence piston velocity as recorded here does not represent the so-called "free-piston velocity" associated with calibration firings, since that term implies an evacuated range and pump tube bore. However, air resistance was taken into account in converting the measured data to light gas gun performance.) Pressure was monitored at the port drilled for helium injection, the port being located about two inches forward of the cartridge case neck. (Hence peak pressure as recorded here does not represent true "chamber pressure," but is an indication of the relative magnitudes of peak chamber pressure for the different powder loadings.)

The rounds for the calibration firings were prepared at Lake City Ordnance Plant. Piston mass at the time was 14.9 grams, but was subsequently revised to 17.9 grams, necessitating an additional adjustment in the later conversion of the data. Propellant mass was varied between 300 and 600 grains, with four rounds furnished of each powder charge to be tested. The results are summarized in Table 4-2.

In Figure 4-9 measured piston velocity is plotted as a function of propellant mass. Figure 4-10 shows piston velocity plotted against measured peak pressure.

CONFIDENTIAL

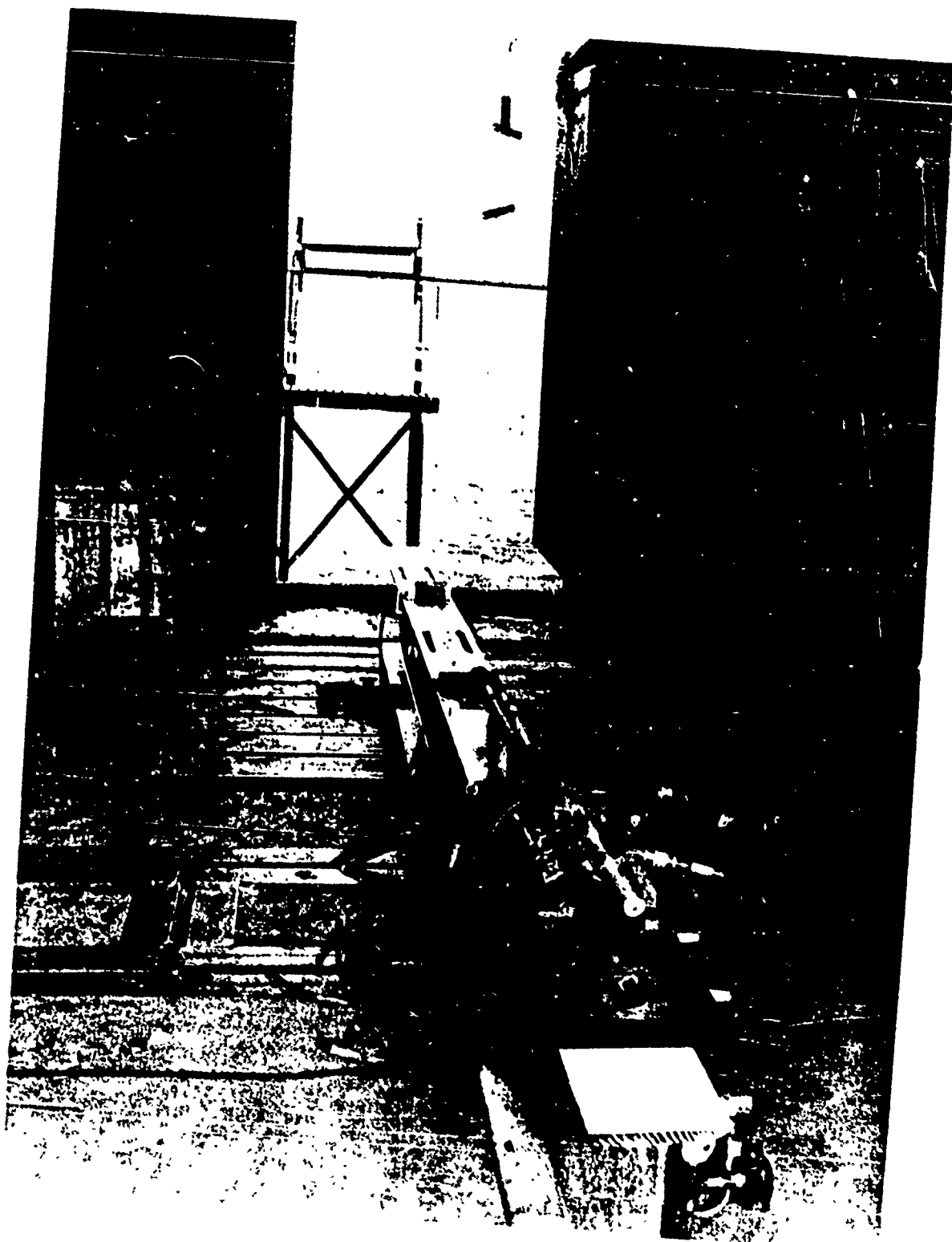

Figure 4-8. Partially Assembled Launcher Set Up for Calibration Firings

4-14

CONFIDENTIAL

CONFIDENTIAL

Table 4-2. Open-End Calibration Firings

Piston Mass M_p (grams)	IMR4895		Measured Velocity (avg.) U_p (fps)	Measured Peak Pressure (avg.) $P_{max.}$ (psi)
	Propellant Mass M_c (grains)	Number of Rds. Fired		
14.9	300	4	3154	6730
	400	4	4294	16560
	500	4	4906	23030
	600	4	5611	30550

During these calibration firings, it was discovered that the propellant which had been selected was not sufficiently fast-burning for use with such a light piston. Piston velocities were high enough, but much unburnt propellant was found scattered along the top surface of the I-beam after each firing. This fact made the analytical conversion to closed-end performance of uncertain accuracy, since the retardation of the piston by the helium gas during compression would give the propellant more time to burn, thus imparting more total energy to the piston. However, there was not time to select a different propellant and conduct another set of calibration firings. The IMR4895 propellant was accepted; closed-end performance calculations were generated; and, from these, a propellant mass of 500 grains was chosen for the final test rounds.

At this time, calculations made in conjunction with the calibration data conversion indicated that piston bounce-back would be excessive for the piston mass which had been chosen. If the piston rebounds too rapidly from the position of maximum helium compression, expansion waves propagated by this recession may catch up with the projectile during the early phase of its acceleration. Ultimate muzzle velocity is reduced as a consequence of the drop in base pressure at this critical time. In order to obtain a more reliable prediction of this aspect of the performance and to check the propellant mass selected, the Ballistics Research Laboratory, Aberdeen, Md., was requested to perform a limited number of computed simulations of launcher performance, using the General Electric Company's gun data.* Propellant mass and initial helium pressure were the parameters varied. These computer studies generally confirmed the trends suggested by the previous calculations; i. e. that piston bounce-back did occur too rapidly, that the IMR4895 propellant was not sufficiently fast-burning for the piston mass chosen, and that the selected propellant charge of 500 grains would furnish a suitable piston kinetic energy.

*Mr. Paul G. Baer, of the Interior Ballistics Lab., B. R. L., was extremely generous and cooperative in conducting these computer studies at a time when he was heavily scheduled with other commitments.

CONFIDENTIAL

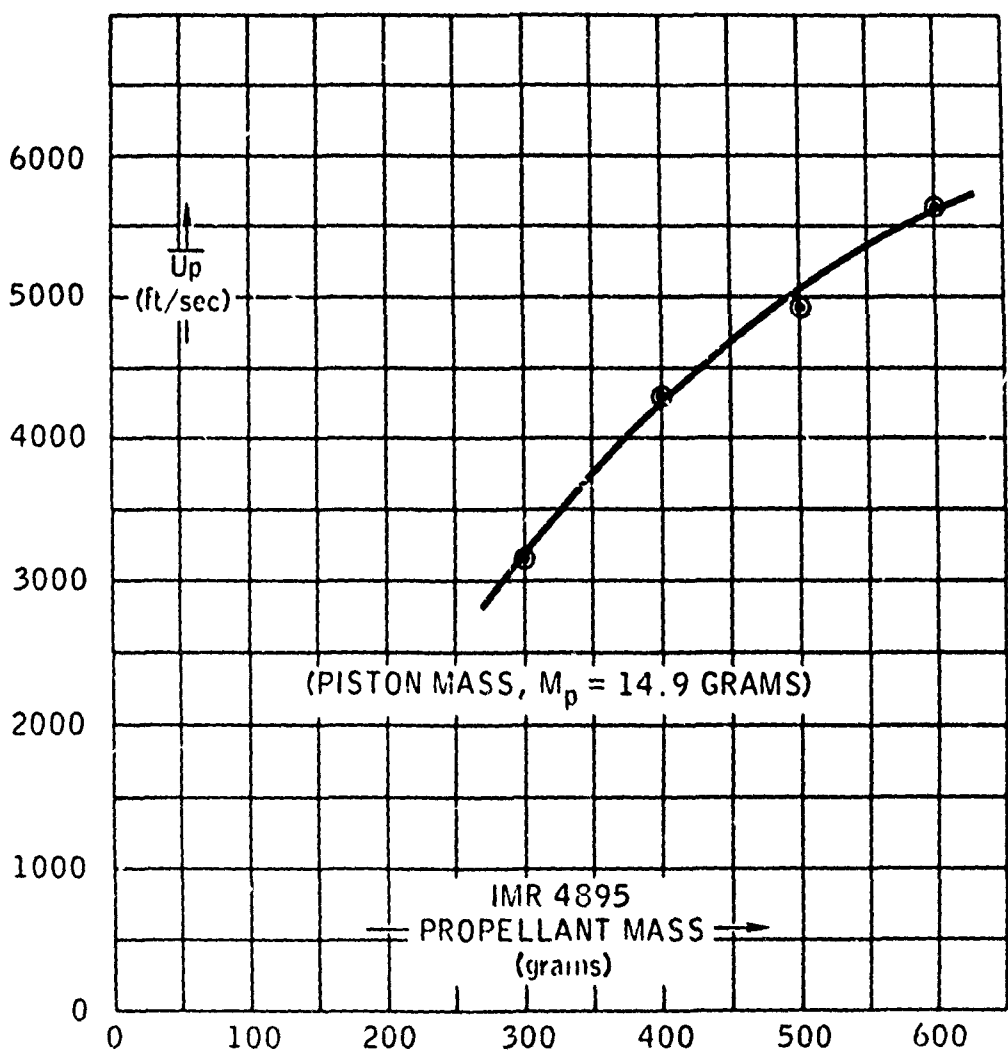

Figure 4-9. Measured Piston Velocity vs. Propellant Mass

CONFIDENTIAL

CONFIDENTIAL

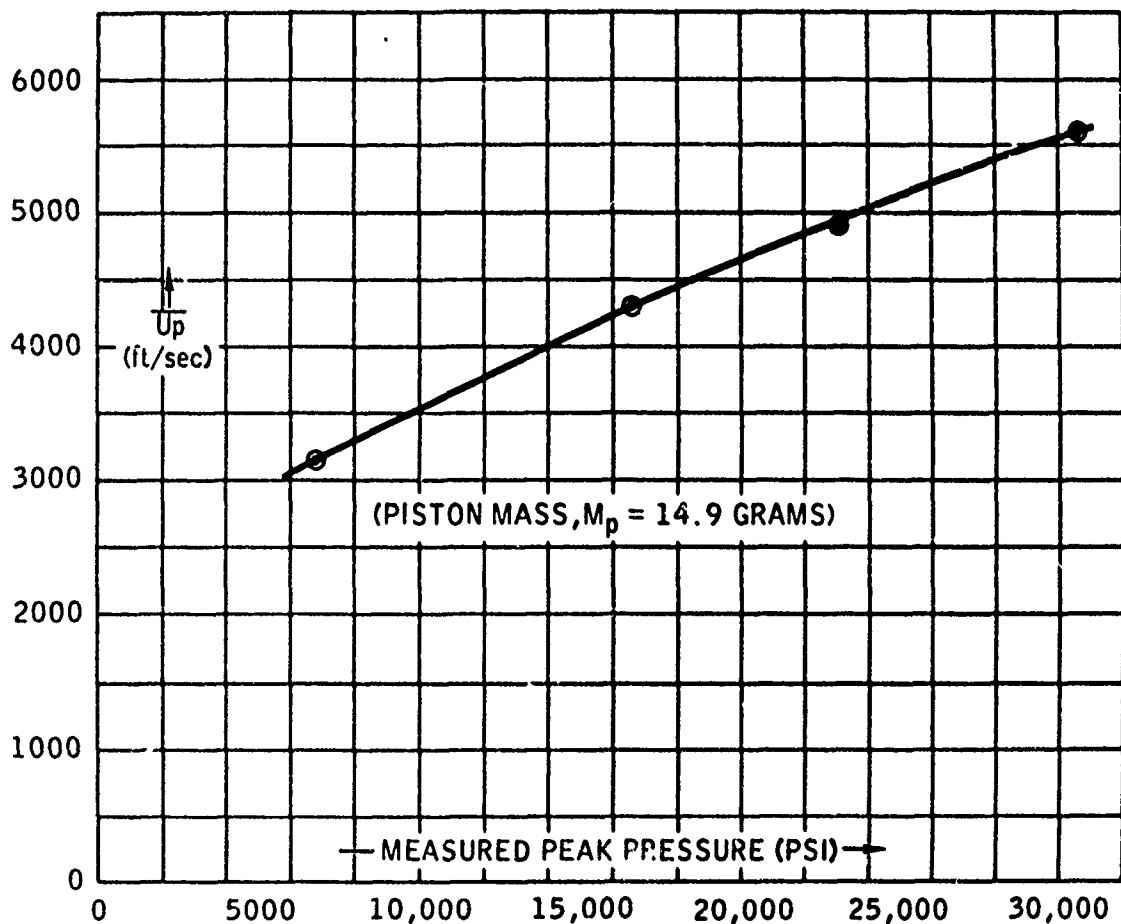

Figure 4-10. Measured Piston Velocity Vs. Measured Peak Pressure

CONFIDENTIAL

CONFIDENTIAL

Delays had already been encountered in preparing for the complete assembly firings, and in order to avoid additional program slippage, it was decided not to change to a heavier piston and/or a faster propellant at this time. The projectile velocities predicted by the computer studies were adequate for the purposes of the mechanism study. Later in the firing program, piston mass was varied in connection with the testing of different materials for the front portion of the piston. (Surprisingly, the projectile velocities obtained with the heavier pistons did not show a consistent or substantial increase over those obtained with the original piston mass.) A faster-burning propellant has not yet been tested in the launcher.

COMPLETE ASSEMBLY TEST FIRINGS

General

Preliminary tests and calculations having been completed, a number of rounds were loaded, according to the newly determined specifications, for the initial trials of the complete operational concept. A list of the significant design characteristics, as they were established at the beginning of these firing tests, is presented in Table 4-3. This list includes the revisions and additions which were made as a result of the preliminary experiments just described.

Table 4-3. Launcher Design Characteristics at Beginning of Firing Trials

Diameter of pump tube	20mm (0.786 to 0.789 inch)
Length of pump tube	40 in.
Diameter of launch tube	0.150 in.
Length of launch tube	15 in.
Mass of piston	276 grains (17.9 grams)
Mass of projectile	5.5 grains (0.36 grams)
Initial helium pressure	200 to 1000 psi
Projectile release pressure	67,000 psi (approx.)
Chamber volume	2.73 cu. in.
Mass of propellant	500 grains
Propellant used	IMR4895
Piston material	Lexan (entire piston)
Projectile material	Steel (AISI 1020)

Description of Firing Operation

It is important, as a background for the final test data and results, that the operational procedure followed during the tests be made clear. Certain details of the operation constitute notable limitations to the feasibility study; other details may provide clues to some of the unexplained problem areas discussed later.

CONFIDENTIAL

With the launcher assembled as shown in Figure 3-5, alignment of the vacuum tank and blast tank (when employed) was checked by careful bore-sighting. Helium charging pressure (Figure 3-1) was set at the desired level, and the high-pressure bottle was closed. A complete round (such as is shown in Figure 4-11) was placed in the bolt and chambered manually; with the bolt locked, the overhead firing contact was allowed to swing into firing position, pushing the firing pin into contact with the electrical primer. The vacuum pump was then started, and evacuation of the tank and connecting barrel sections was begun.

At this time an important point should be brought out. It had been planned to begin the firings at a fairly high initial helium pressure (approx. 1000 psi), for the sake of safety. According to the calculations, an initial helium pressure at this level would result in a peak helium pressure of 75,000 to 100,000 psi during compression. If this peak pressure were not greatly exceeded during the first few trials, successively lower initial pressures could be employed until a peak pressure of around 200,000 psi was reached. Calculations of barrel strength at the high-pressure section indicated that an internal pressure of 200,000 psi (under static conditions) was the maximum which could be contained without material failure. (The effect of dynamic, or impulsive pressures in regards to barrel failure was not known, but it was believed that pressures much in excess of 200,000 psi could not be tolerated, whether gradually or impulsively applied.) Therefore, when the first four recorded peak pressures ranged from 120,000 psi to 320,000 psi, all with the same initial pressure of 1000 psi, two conclusions were apparent: 1) some aspect of the launching technique, or of the pressure-sensing apparatus, was defective, producing round-to-round inconsistency of the measured results; and 2) peak pressures were already near the maximum limit for the gun, making the use of lower initial pressures impossible while these trends continued. (The general level of the peak pressures being created at the forward breech was later indicated more concretely and directly by the development of increasing bore enlargement at the high-pressure section, and the measured values continued to average around 220,000 psi.) Consequently, initial helium pressure was maintained at the 900 to 1000 psi level throughout the entire test program.

It should now be recalled that during the transparent pump tube experiments, projectile and carrier deformation upon charging impact was becoming severe as charging pressures approached 400 psi. Higher charging pressures were not investigated, one of the reasons being that low initial helium pressures were expected to be used, ultimately, in the actual launcher. The high initial helium pressures found to be necessary could not, therefore, be used to seat the carrier without causing excessive damage to the carrier and projectile, and probably to the gun as well.

CONFIDENTIAL

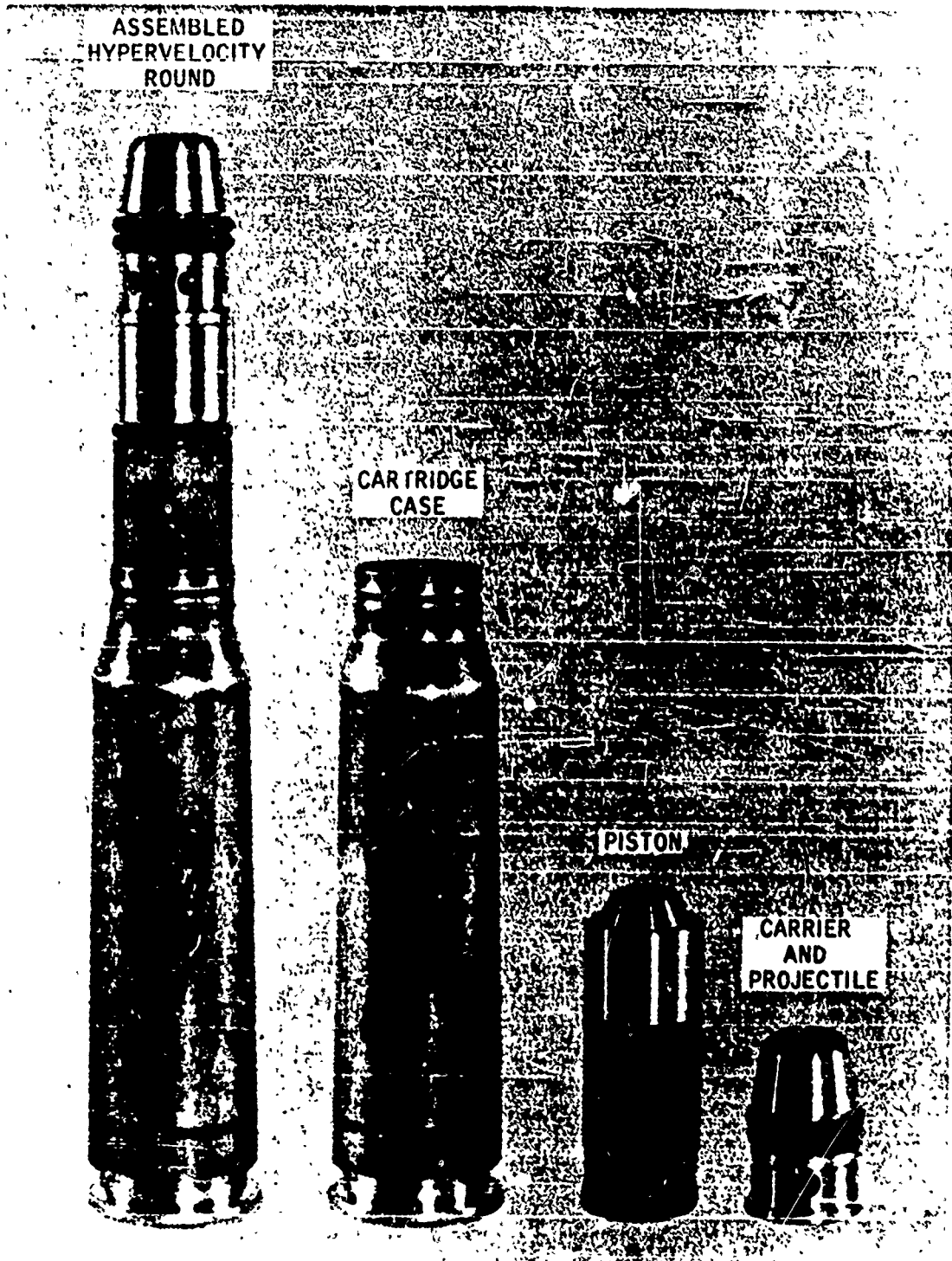

Figure 4-11. Hypervelocity Round and Components
(Present Configuration)

CONFIDENTIAL

CONFIDENTIAL

The purpose of presenting these facts at this point is to clarify the following aspect of the operational procedure. As the vacuum pump reduced the pressure in the 20mm bore ahead of the chambered round, the carrier was permitted to be moved down the pump tube by the pressure differential thus created. No bonding was employed to secure the carrier to the piston until helium injection occurred, as would normally be done. When the vacuum tank was not used, and the barrels were not evacuated prior to firing, the carrier was mechanically seated at the forward breech or placed about half-way down the pump tube before the charging operation was initiated.

This obviously represents an important deficiency in the experimental feasibility study. Testing of the complete firing cycle, including carrier separation and seating, will not be possible until lower initial helium pressures can be used, or until the effectiveness of a flow-limiting device at high charging pressures has been demonstrated.

With this limitation clearly stated, description of the firing procedure may be continued. The vacuum pump was permitted to operate until the tank was evacuated. The tank was then sealed off from the line and the pump stopped. At this point in the procedure, the carrier was poised at or near the forward breech. The launch tube bore ahead of the carrier was, of course, evacuated. However, the pump tube bore between the carrier and the piston was then filled with air at atmospheric pressure, or perhaps at somewhat less than atmospheric pressure. (The air initially behind the carrier was not removed by the vacuum pump, due to the carrier O-rings; as the carrier inched down the tube, the pressure of this air pocket would have been reduced, unless additional air was able to leak in by the check valve.) Since a high initial helium pressure was used, the ratio of air to helium in the pump tube after charging was quite small, and probably had no measurable effect on projectile velocity.

Before charging and firing, final instrumentation check-outs were made. The lane safety doors were then closed, (the launcher was still completely visible through observation windows) and the door to the outside range was opened. (On cold days, a slight drop in the initial helium temperature may have resulted from this exposure to the outside air a few minutes before firing.) All preparations having been completed, the firing switch was closed, remotely charging and firing the gun in programmed sequence. After the projectile had been launched, a second switch was manually actuated, remotely controlling bolt-unlock and case-extraction in a second programmed sequence. The methods and mechanisms employed in these operations have already been described. The electrical control circuitry employed is shown schematically in Figure 4-12.

After the gun had been cleared, the lane safety doors were opened and the launcher assembly was inspected for signs of gas leakage or externally visible component damage. In most cases, pneumatic ejection of the expended piston and carrier from the pump tube was then attempted. This important

CONFIDENTIAL

aspect of the feasibility study will be separately discussed in detail later. If the carrier was not ejected by pneumatic means, it was mechanically extracted after disassembly of the barrel sections. The condition of the bore surfaces was noted; the barrels were thoroughly cleaned; and the launcher was re-assembled for the next firing.

Instrumentation

In view of the emphasis on mechanism study and feasibility evaluation, elaborate instrumentation such as that required for most light gas gun applications was avoided. Projectile velocity was of interest, as was peak helium pressure, in order to determine the level of performance and the level of deformation forces acting on each round. Timing studies were of great importance to determine what rates of fire might be achieved with the concept eventually. However, timing studies of feeding, case-extraction, and pneumatic ejection could be meaningful only after high-speed mechanisms had been developed to perform these operations. Timing of the pump tube charging and carrier seating could best be obtained separately as in the transparent pump tube experiments, and timing of the compression and launch phase would be furnished indirectly by the pressure and velocity measurements. Hence, instrumentation of the launcher was largely confined to recording helium pressure at the forward breech section and projectile velocity near the muzzle.

A quartz pressure transducer (Kistler Model 605B), in conjunction with a piston-type high-pressure adaptor (Kistler Model 635B), was employed to monitor the pressures generated by helium compression. These models were designed by the Kistler Instrument Corporation especially for the measurement of high-intensity, high-frequency pressure pulses such as are encountered in explosives research, shock tubes, and light gas gun experimentation. The combination is rated for measurement of pressures to 200,000 psi, with a rise time of less than 10 microseconds, and an ability to withstand intermittent peak gas temperatures up to 3000°F. (This pressure-temperature range should not have been exceeded, according to the calculated predictions of performance. However, as previously stated, peak pressures in the vicinity of 300,000 psi were sometimes recorded during the firings, and the transient gas temperature corresponding to such a pressure peak would reach over 5000°F, assuming adiabatic compression.)

An entirely different type of pressure transducer was frequently used during the early firings to provide a check on the readings obtained with the Kistler instrument. This second transducer used a bonded strain gage to provide the electrical response signal, and also required a piston-type adaptor for its application at the extreme pressure levels encountered. When readings were obtained from both strain gage and quartz transducers on the same round, agreement of the pressure curves was fairly good, considering the severity of the conditions. The strain gage transducer consistently recorded a slightly lower peak pressure. (After the early firings, the strain gage transducer was replaced by a second Kistler quartz transducer.)

CONFIDENTIAL

The two transducers were orthogonally mounted in a heavy block (Figure 4-13) which was clamped around the high-pressure section opposite a drilled port in the 1-1/8-inch thick barrel wall. The port entered the 20mm bore over the position of the gas entry holes in the carrier when the latter was seated in firing position at the forward breech (Figure 3-3). Thus the pressure-sensing elements of the transducers were considerably recessed from the pressure chamber, connected by a 0.070 inch to 0.090 inch diameter passage approximately two inches in length. This is not ideal for the accurate measurement of high-frequency pressures. However, this arrangement left the barrel wall at the high-pressure section more or less intact for maximum strength. In addition, it also permitted flexibility in changing to different instrumentation or installation techniques, since only the transducer block had to be re-machined rather than the expensive and hardened (Rockwell C-54) barrel section.

A typical pressure trace is shown in Figure 4-14. One of the pressure records with a peak in excess of 300,000 psi is shown in B of Figure 4-14.

Projectile velocity near the muzzle was measured by a coil and screen combination (in the case of firing through the evacuated tank) or by a series of fine wire grids mounted along the trajectory (in the case of firing into the atmosphere with the tank removed). During the early firings, when difficulty was experienced with coil functioning, the vacuum tank was infrequently used. The functioning of the coil was improved by the adoption of a larger "primary" winding to create a strong initial magnetic field when energized at 28 volts dc, coaxially coupled with a low-inductance "secondary" winding to

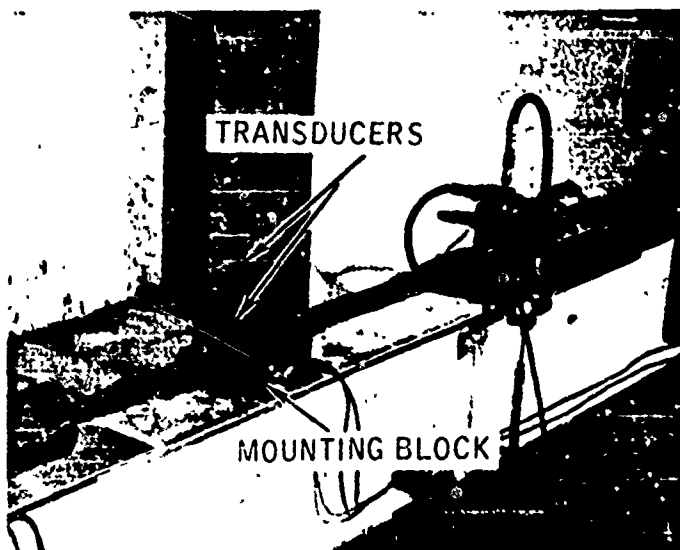
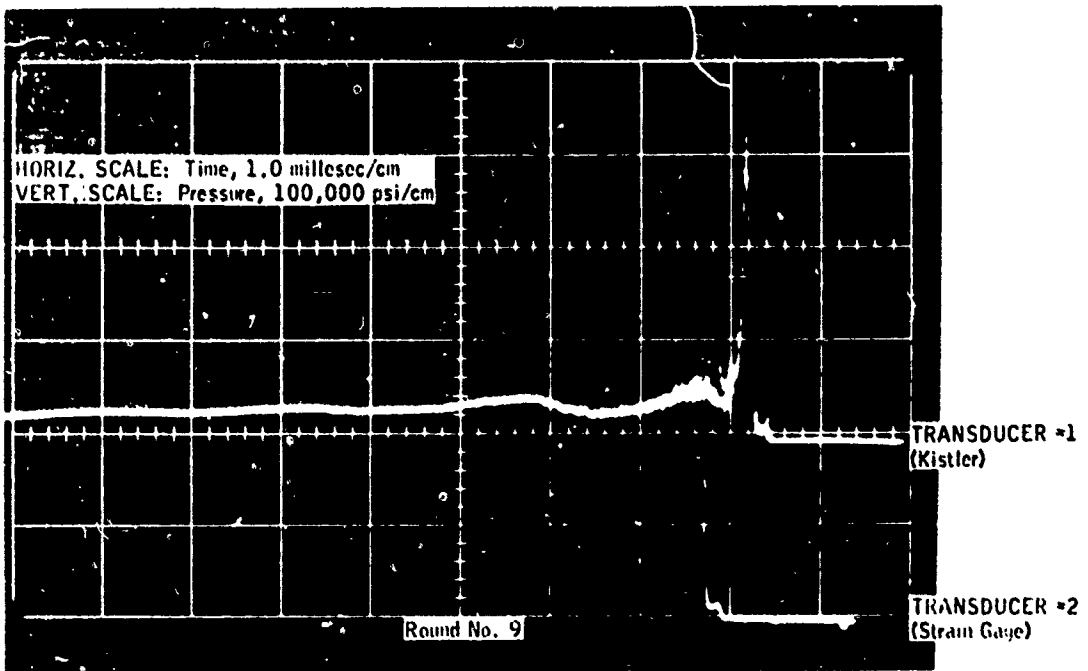
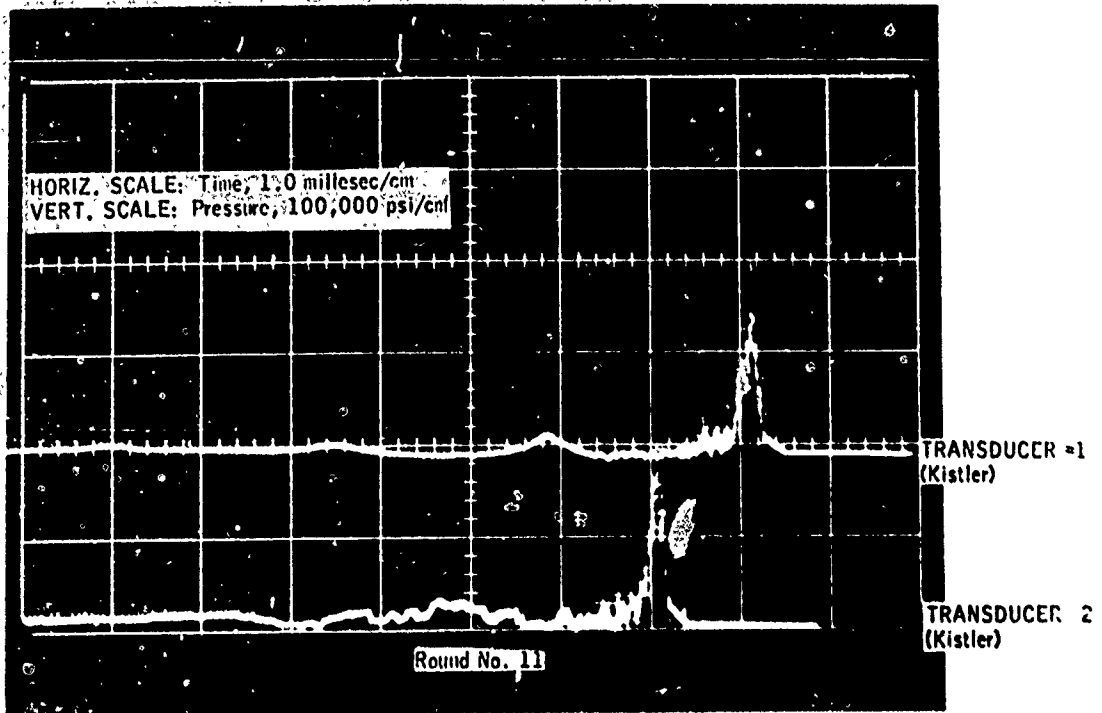

Figure 4-13. Pressure Transducer Installation at High Pressure Section

CONFIDENTIAL



NOTE: Traces move from RIGHT to LEFT and Trace No. 2 is started 1.0 millesec. ahead of Trace No. 1 for visual clarity.

Figure 4-14. Typical Pressure Records

CONFIDENTIAL

CONFIDENTIAL

relay the projectile pulse to the oscilloscope. The addition of a small blast tank between the muzzle and the coil also improved the clarity of the output signal. In using the coil and screen to measure the projectile velocity, the signal from the coil and the signal from the penetration of the aluminum plate and velocity screen at the downrange end of the tank were recorded photographically from the oscilloscope on the same time base. Thus a measurement of the distance between the signals on the photograph was related to the time interval between the signals, according to the oscilloscope sweep speed, which was the same for both traces.

A typical velocity record is shown in Figure 4-15. This record indicates a time interval of 0.490 millisecond between signals; with the known distance interval of 5 feet between the coil and the screen, this indicates a projectile velocity of 10,200 fps.

Test Data and Results

A total of eighteen single firings was made during the first phase of the final tests. Table 4-4 presents a round-by-round tabulation of the data as measured. Any specifications not included may be found in Table 4-4.

The numerical data will not be discussed in detail, since the qualitative results are of primary interest. It is sufficient to point out the round-to-round pressure and velocity data inconsistency, which remains unexplained to any degree of certainty. The first four peak pressures recorded

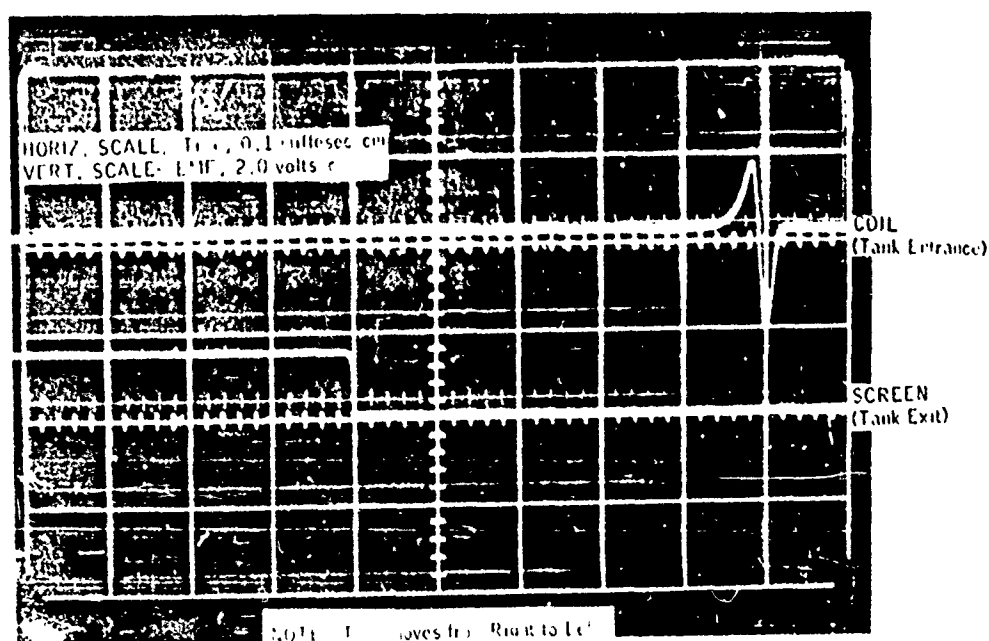

Figure 4-15. Typical Velocity Record (Coil and Screen Technique)

CONFIDENTIAL

Table 4-4. Initial Conditions, Peak Helium Pressure, Projectile Velocity
Phase I Firings (0.150 inch Dia. Projectile)

Round No.	Piston Material (Nose Base)	Piston Mass (grams)	Initial Helium Pressure (psi)	Peak Compression Pressure (psi)	Muzzle Velocity in Air (fps)	Muzzle Velocity in Vacuum (fps)
1	Lexan	17.9	1000	120,000	8850	
2	Lexan	17.9	1000	170,000	--	
3	Lexan	17.9	1150	--	8500	
4	Lexan	17.9	1000	250,000	3150	
5	Lexan	17.9	1000	320,000		--
6	Lexan	17.9	950	320,000	6700	8400 ^x
7	Lexan/Lexan	17.9	975	340,000		
8	Lexan/Lexan	17.9	900	240,000	8680	
9	Teflon	24.3	900	320,000		(10,000) ^A
10	Alum./Lexan	28.0	1000	250,000		(9,000) ^A
11	Alum./Lexan	28.0	1000	230,000		(9,900) ^A
12	Graphite/Lexan	20.5	900	120,000		(7,700) ^A
13	Alum./Lexan	28.0	900	--		10,060
14	H. D. P. /Lexan	16.1	920	--		(7,000) ^A
15	Kel-F/Lexan	23.8	900	180,000	9000	
16	H. D. P./Lexan	16.1	880	220,000	6740	
17	Polyprop./Lexan	15.9	940	130,000	5400	
18	Bronze/Lexan	67.6	900	210,000	10,600	

X - velocity measurement uncertain

A - velocity approximate, estimated by adding an experimentally determined average increment of 1000 ft/sec to the velocity of the projectile as measured in air downrange of the vacuum tank, after the projectile had ruptured the 0.032 inch thick aluminum plate

^xH. D. P.

- High-density polyethylene

CONFIDENTIAL

CONFIDENTIAL

have already been cited as one example of this inconsistency, and the later rounds also failed to exhibit a settled trend or pattern (allowing for the variation of piston mass employed).

There is, of course, a possibility that the measured peak pressures are not an accurate reflection of the actual or effective pressure conditions during firing. The maximum pressure and temperature limits stated for the Kistler transducers were exceeded repeatedly. Moreover, the method of installation of the transducers, as previously described, did not fully conform to recommended practices. Finally there is the possibility of helium leakage during compression. Sealing techniques were in some instances inadequate during the early firings. Leakage is known to have occurred twice at the interface between the transducer block and the outer barrel wall through the pressure port; also, difficulty was experienced in maintaining a seal at the base of the strain gage transducer. Sealing techniques were quickly corrected and improved as the firings proceeded, and only rarely were there any visible signs of significant leakage having occurred. Nevertheless, there is a possibility that varying amount of helium leakage during the compression and launch phases may have been responsible for the variations and inconsistencies apparent in the measured data. There may also have been some helium leakage past the projectile, while the projectile was entering and travelling down the launch tube. The reasons for this supposition will be presented later.

Of greater importance, in respect to the overall evaluation of concept feasibility, are the general qualitative results observed and the improvements made in the operational functioning during the firing tests.

Round No. 1

The firing of the first round resolved many unanswered questions concerning the concept and the mechanisms employed. The helium injection system, including the check valve, worked well under firing conditions; the check valve allowed free and rapid helium injection, and contained the fairly high powder gas pressures without leakage. Some leakage of the injected helium was audible at the breech, indicating failure of the cartridge case to seal the pump tube. However, full initial pressure was developed within a few per cent. The metallic sealing rings used to contain the pressures at the junctions of the barrel sections were apparently completely effective. The only real failure, permitting considerable helium loss during compression, was the means used to seal the area around the pressure port at the interface between the transducer block, and the barrel. This was corrected with little difficulty.

The bolt-unlock/case-extraction mechanism functioned well, but it was discovered that the cartridge case was collapsed at the neck upon removal from the chamber after firing (Figure 4-16). Case deformation of this type proved to be a consistent occurrence, and was attributed to the effect of the

CONFIDENTIAL



Figure 4-16. Cartridge Case Collapse

CONFIDENTIAL

CONFIDENTIAL

rebouncing piston, which sends a shock wave traveling back up the pump tube ahead of it. * It appeared certain, on this round and on all of the following rounds, that the piston itself had not struck the case during bounce-back. Since the collapse of the case neck permitted the trapped propellant gas to escape, simplifying bolt-unlock, the phenomenon was welcomed.

In order to insure that the projectile would "find the bore" on the first few shots, it was not fired from its standard recessed position in the carrier as shown in Figure 3-3. Instead, the projectile was reversed in the carrier, such that it protruded into the launch tube entrance when the carrier was seated. The projectile then moved down the launch tube "base-first" upon firing. This procedure was not employed after Round No. 3.

Two basic problem areas were established by the results of the first firing; piston erosion during compression (resulting in the distribution of a glutinous residue on the bore walls in the area of the forward breech) and diametral expansion of the carrier sides due to the high internal pressures sustained (resulting in the carrier becoming "wedged" in the forward breech). Both of these problems tended to increase the difficulty of removing the expended components from the bore after firing, and threatened the feasibility of pneumatic ejection.

The condition of the first piston after firing is shown in Figure 4-17. ** The erosion and deformation of the forward face became increasingly severe on the rounds which followed, and resulted in the decision to try different materials for the forward section of the piston, to see if cleaner operation and easier piston and carrier ejection could be achieved.

The outward expansion of the carrier due to the pressure sustained is illustrated in Figure 4-18. A careful comparison of the areas just ahead of the O-rings will provide the most visible indication of this expansion. Where the conical portion of the carrier was enclosed by the conical seat no expansion was possible. Just ahead of the O-ring, however, a small circumferential band of material was not supported by the conical seat, and this band of material is seen to have bulged. This bulging is also visible in the cross-section photograph of the same carrier shown in Figure 4-19. It should be

*Cartridge case collapse has also been observed in standard gun firings when a tapered bore is used. The neck-down of the bore at the beginning of the tapered section also causes a shock-wave to be reflected back up the barrel into the case. (3)

**As previously mentioned, the pistons used in the initial firings were of a one-piece design, solid Lexan, and did not include the O-ring later added to insure sealing of the rear of the pump tube during helium injection. The O-ring was used on all pistons fired after Round No. 5.

CONFIDENTIAL

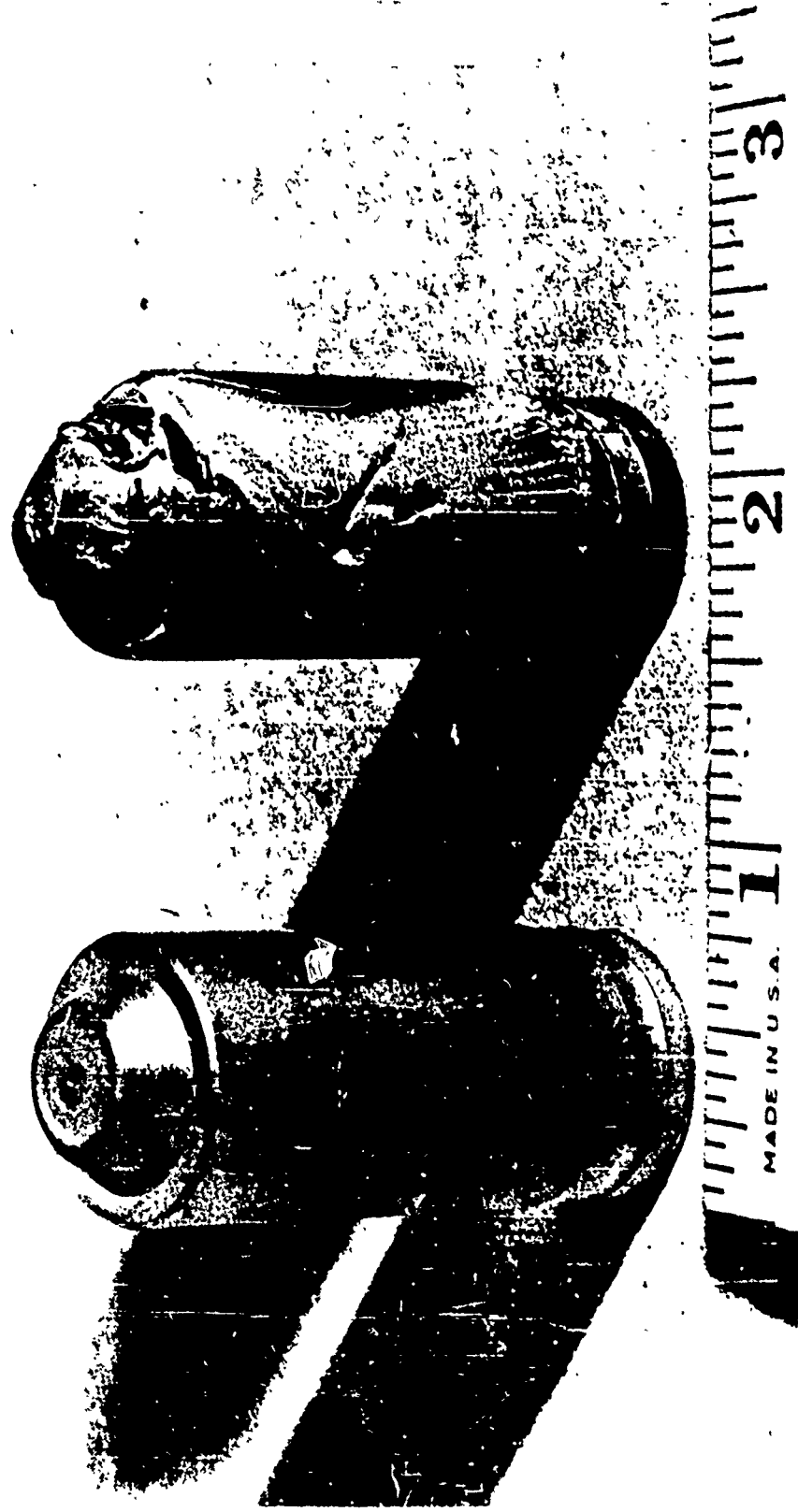

Figure 4-17. Piston Before and After Firing (Round No. 1)

CONFIDENTIAL

CONFIDENTIAL

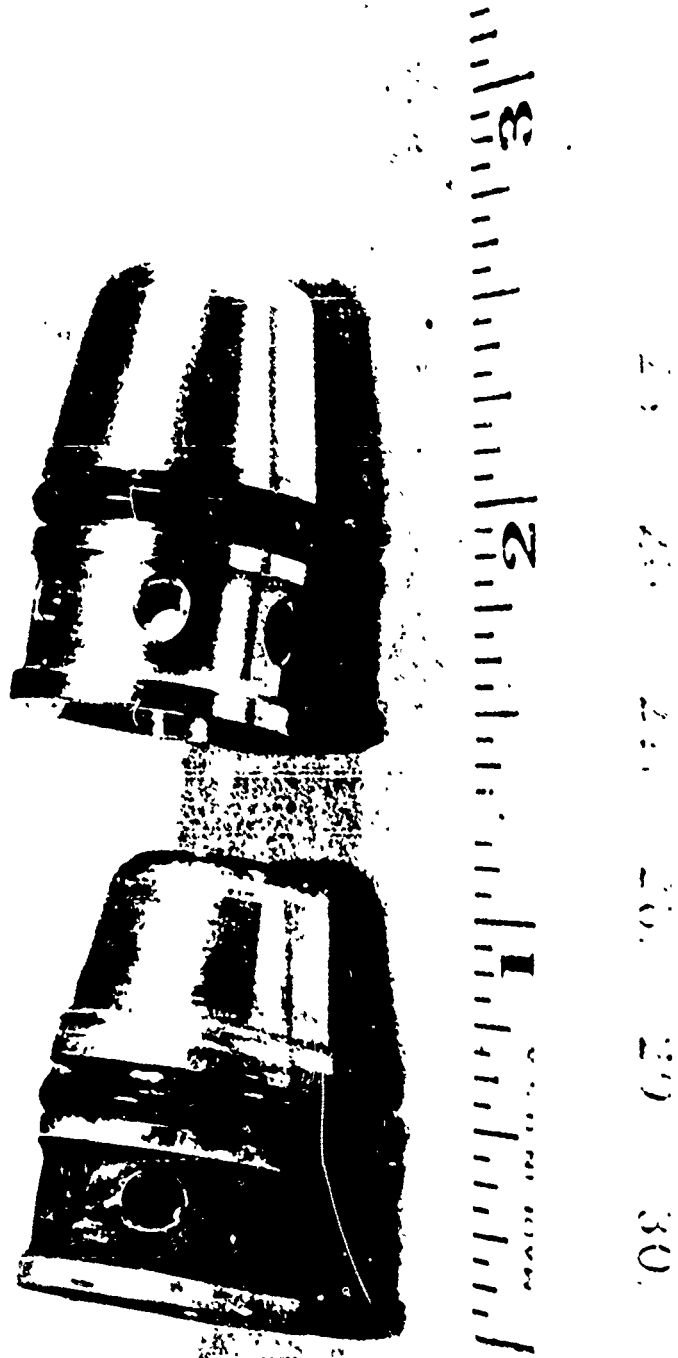

Figure 4-18. Carrier Before and After Firing (Round No. 1)

CONFIDENTIAL

CONFIDENTIAL



Figure 4-19. Carrier From Round No. 1, Sectioned After Firing

CONFIDENTIAL

CONFIDENTIAL

pointed out that the expansion of the carrier walls was not limited to this small area forward of the O-ring groove. The expansion was most severe at this point, due to the shielding effect of the O-ring, which prevented any equalization of the inner pressure by a corresponding build-up of pressure on the outer wall; but the entire aft portion of the carrier was swelled out to some extent.

Rounds No. 2 through 7

The first firing had demonstrated that the carrier and the piston were not as badly deformed, nor as tightly wedged in the forward breech by the firing process as had been feared possible. Removal of the expended components was accomplished with some effort by mechanical means. Nevertheless pneumatic ejection seemed within the limits of possibility if certain improvements could be made in carrier and piston design. The next group of test firings, Rounds No. 2 through 7, were concerned with improving launcher operation in general, and with improving carrier design in particular, working towards pneumatic ejection.

Round No. 2 was devoted to the correction of sealing techniques and to some changes in the instrumentation. No changes were made in the carrier configuration, and mechanical removal of piston and carrier was slightly more difficult, probably due to the higher peak pressure generated.

Prior to Round No. 3, the O-ring groove on the carrier (Figure 4-19) was extended forward, making the overall groove width 0.25 inch. This resulted in the remaining outer surface, forward of the groove, being completely enclosed in the conical seat during compression. Consequently, the pronounced expansion just forward of the groove, which occurred previously, was no longer possible. Mechanical removal of the carrier from the pump tube was found to be less difficult. This modification was incorporated on all carriers subsequently used.

For Round No. 4 a second O-ring was added to fill the space created by widening the groove. (A single O-ring had been used in the widened groove on Round No. 3.) It seemed preferable to continue to widen the groove forward rather than to relocate the single groove at a slightly forward position, since the latter alternative would have required machining new carriers.* In addition, the diameter of the carrier wall just behind the O-ring was turned down for this firing, leaving the wall just high enough to support the O-rings satisfactorily during carrier motion down the pump tube. The

*This matter of expedience is the only reason for the double O-ring shown on the final carrier configuration, although it is possible that the double O-ring might possess slightly better sealing properties or better "riding" properties as the carrier is driven down the pump tube during charging.

CONFIDENTIAL

combination of widening the groove and reducing the diameter of the carrier at the O-ring wall proved to be quite effective in facilitating carrier removal after firing, and this carrier configuration was used for all of the remaining rounds. Figure 4-20 illustrates a typical carrier of this configuration after firing.

Round No. 5 employed the vacuum tank for the first time. An attempt to measure projectile velocity by means of two energized detection coils was made. These coils were located at the tank entrance and at the tank exit. However, the projectile did not pass through the 1-inch diameter opening in the second coil, indicating poor boresighting or a projectile deflection of about 10 mils.

In preparation for Round No. 6, special care was taken in boresighting and aligning the coils. Despite these precautions, the projectile again failed to pass within the 1-inch opening, suggesting that an unusual amount of deflection or dispersion was causing the difficulty. Two significant additions were incorporated on this round. An O-ring was added to the piston to insure proper sealing during helium injection; and consequently, charging and firing were sequenced automatically for the first time, with a 0.5-second delay programmed between actuation of the charging solenoid and delivery of voltage to the firing pin. An oscillograph record of the build-up of charging pressure in the pump tube made on this round indicated that full reservoir pressure (950 psi) was established in the pump tube approximately 0.1 second after actuation of the solenoid valve. A full half-second delay was retained, nevertheless, throughout the firings.

Round No. 7 was devoted to a study of the muzzle blast characteristic of the launcher. The vacuum tank was not used, and a Fastax camera was positioned to record the events at the muzzle as the projectile was launched into the atmosphere. The critical sequence of the film record is reproduced in Figure 4-21. The eight frames shown are consecutive, and were taken at approximately 3000 frames/second. In the third frame (counting from the top down) the luminous trail of the projectile is visible.

After Round No. 7 had been fired, the barrels were removed from the launcher with the expended piston and carrier lodged in the forward breech, as usual. A pneumatic fitting was installed at the muzzle of the launch tube; and using a solenoid valve, gas from a 1000 psi reservoir was impulsively introduced through the launch tube bore. The expended piston was immediately ejected. The carrier had to be extracted mechanically because the special ejection ports had not yet been machined.

Round No. 8

The first seven rounds had been fired from the same barrel assembly. The launch tube at this point showed signs of internal damage to the bore

CONFIDENTIAL



Figure 4-20. Carrier Before and After Firing (Double O-Ring)

CONFIDENTIAL

CONFIDENTIAL

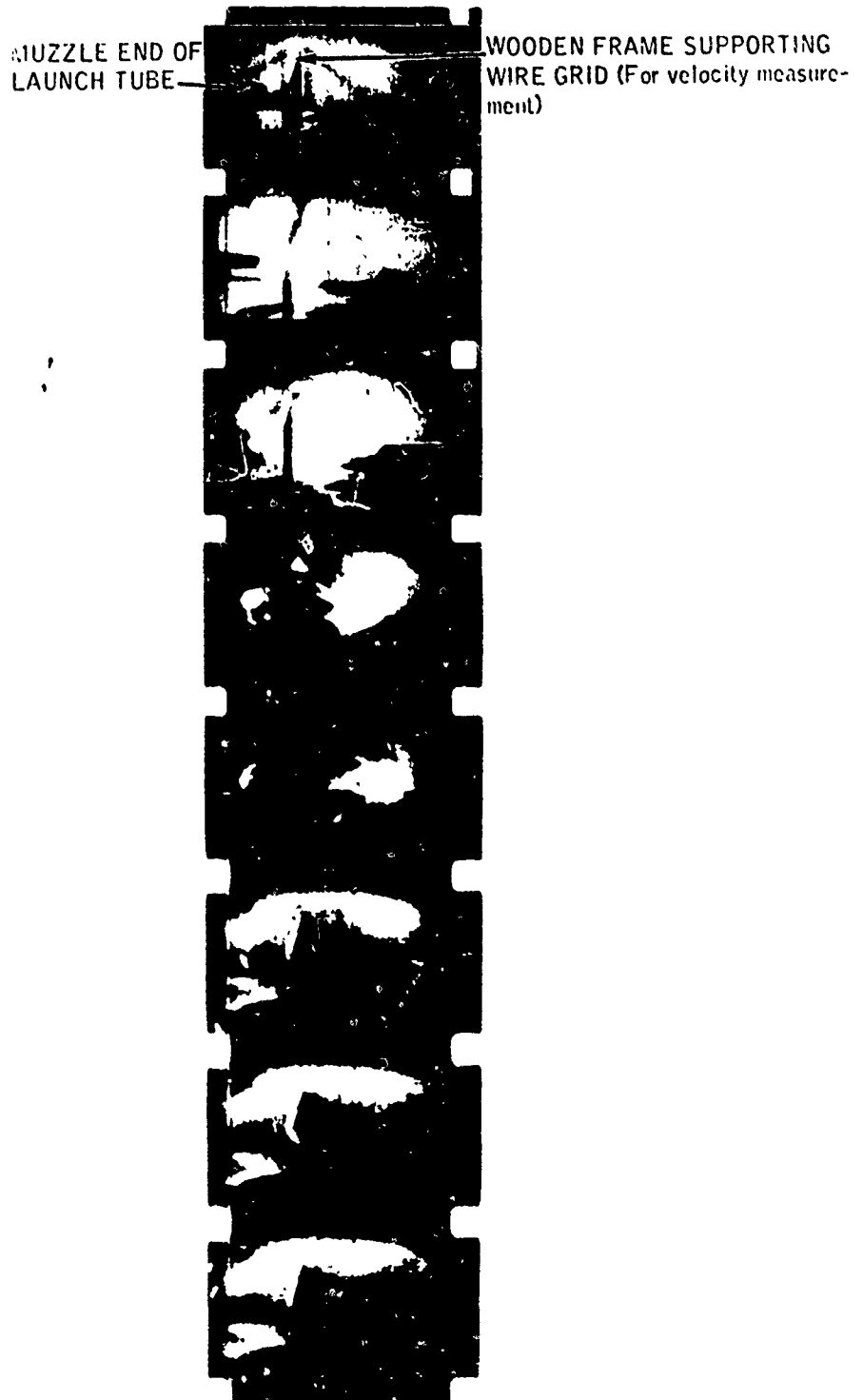

Figure 4-21. Fastax Film Record of Muzzle Blast

4-37

CONFIDENTIAL

CONFIDENTIAL

surface, from unknown causes. It was thought advisable to continue the firings using the second launch tube, in case the bore damage in the initial launch tube was adversely affecting projectile velocity. A new pump tube and coupling section were also used for this round. All three of these new components (pump tube, coupling section, and launch tube) had nickel plating applied to the bore walls.

After firing Round No. 8, it was discovered that nearly all of the nickel plating had been peeled from the bore of the pump tube by the shot. The bore was clogged with a nest of tiny chips and curls of metal. As a result of damage, the barrels were useless for additional firings, until they could be reworked. Since only two pump tubes and two launch tubes had been procured for the development, it was necessary to revert to the original barrel sections, in spite of the condition of the initial launch tube bore.

Rounds No. 9 through 18

With the carrier design greatly improved by the minor modifications described, it was felt that the next step in facilitation ejection was the reduction of piston erosion and residue formation during helium compression. For this purpose, a number of materials were selected to be tested as forward sections of the piston. (The Lexan base section was retained for its sealing properties, and also because it kept total piston weight, and hence total round weight, down.) The materials selected, and the resulting piston configurations, are shown in Figure 4-22.

Figure 4-23 pictorially summarizes the results of the piston material investigation. Aluminum was found to be by far the most satisfactory material for the application. Graphite and high-density polyethylene, as used, exhibited interesting characteristics which might conceivably be used to good advantage. The graphite nose was apparently completely pulverized during firing. If a completely frangible piston was desired, to eliminate the need of ejection or to facilitate ejection, a form of graphite might be suitable. As tested, however, the graphite apparently disintegrated too soon after propellant ignition to be effective in compression (refer to Table 4-4). Moreover, if the graphite becomes pulverized during the initial compression stroke, it will mix with the light gas and thereby reduce muzzle velocity. The high-density polyethylene nose, tested twice, tended to extrude into the base of the carrier, becoming firmly bound to it without causing excessive carrier expansion at the base. If the piston is bound in this manner to the carrier, pneumatic ejection by means of muzzle pressure is facilitated. The remaining materials tested did not appear to be as promising. (In the case of the bronze, the test was not entirely fair, however, since poor performance resulted because of the heavy total piston weight, and not because of the material properties.)

CONFIDENTIAL

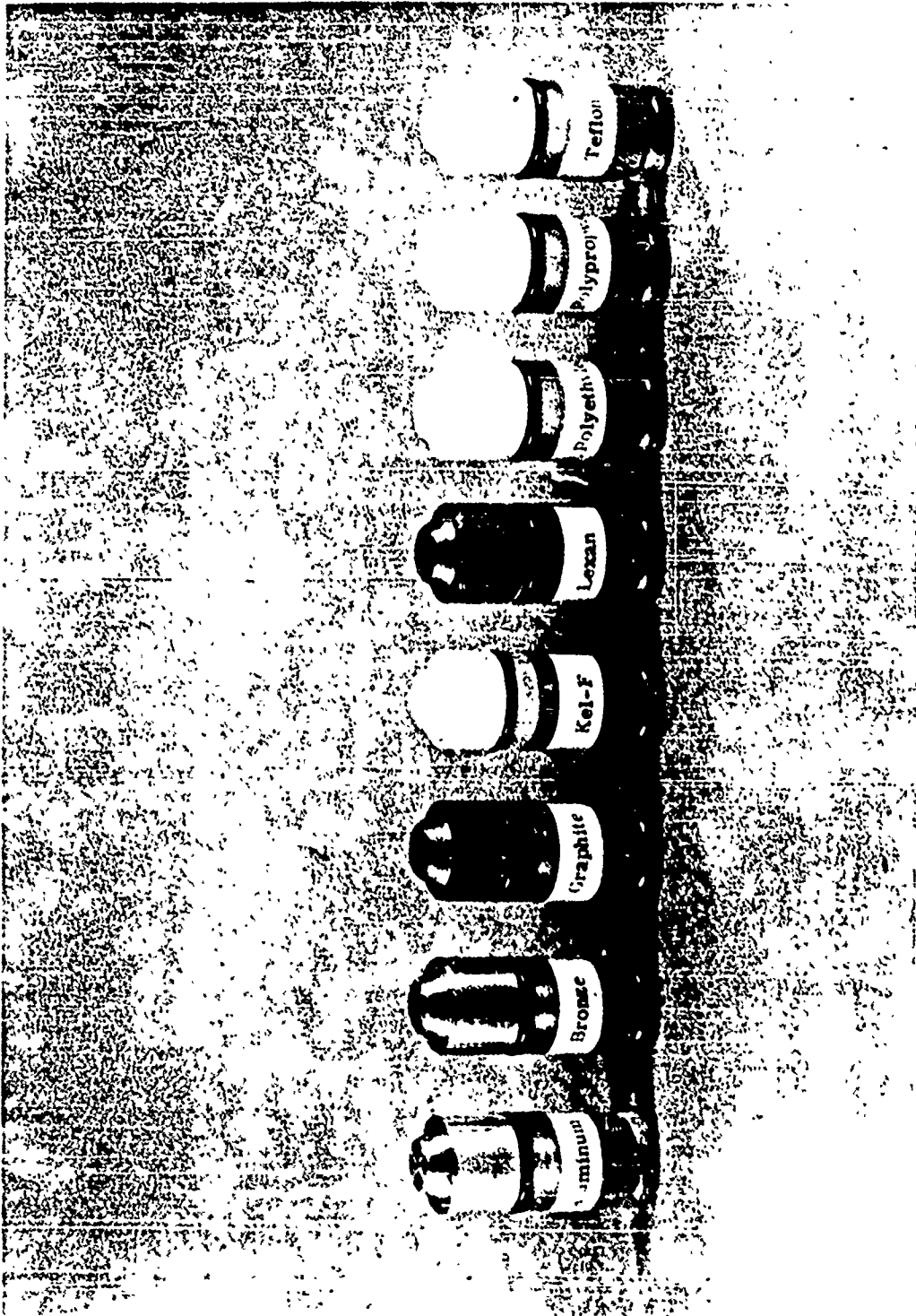

Figure 4-22. Piston Materials Tested: Before Firing

CONFIDENTIAL

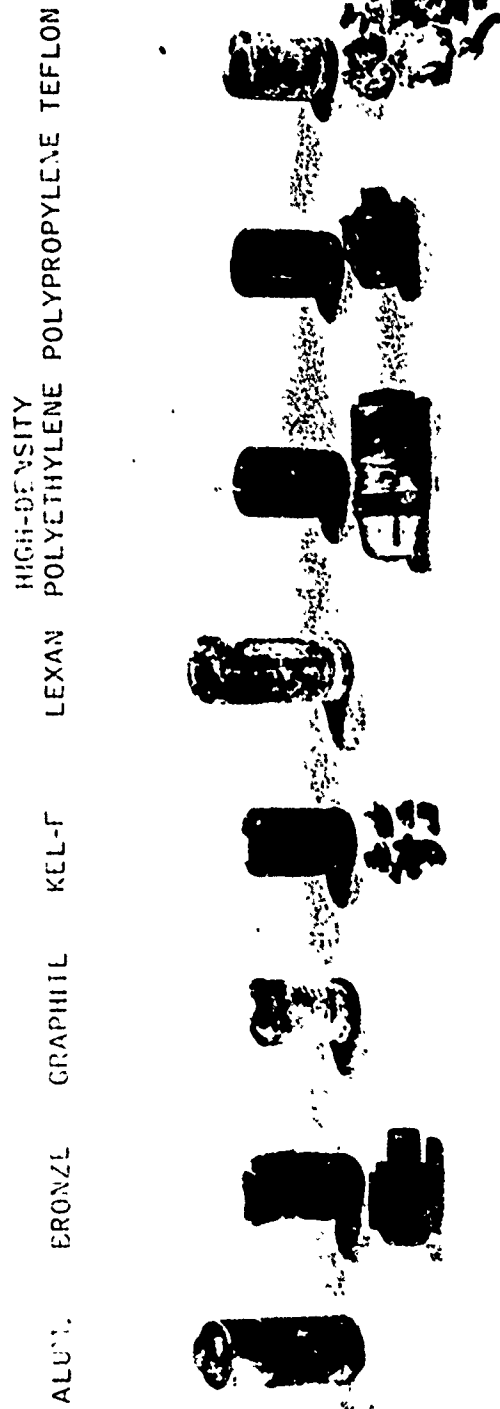

Figure 4-23. Piston Materials Tested: After Firing

CONFIDENTIAL

In addition to this investigation of piston materials, Rounds No. 9 through 18 produced a number of significant results and discoveries.

The pneumatic fitting installed at the muzzle of the launch tube after Round No. 7 was again employed after Round No. 10. In this case, when pneumatic pressure (at 900 psi) was discharged into the launch tube bore, not only the piston, but the carrier as well was ejected. This surprising result was attributed to the fact that the sudden flow of gas through the hole in the carrier creates a small force to pull the carrier slightly away from its seated position (provided that the carrier is not tightly wedged). Once the carrier is drawn away just slightly from its seat, the gas can expand out to the O-rings and create a large force against the carrier to expel it along with the piston. (It was subsequently discovered that the pump tube bore had become slightly enlarged at the forward breech area by the repeated high pressure. This enlargement was then regarded as one reason for the carrier being less tightly wedged in the bore after firing than previously.) This same method of ejection was used with complete and consistent success on Rounds No. 11 through 16. Apparently the technique did not depend critically upon piston material.

No attempt at pneumatic ejection was made on Round No. 17 or Round No. 18. Bore enlargement at the forward breech had become noticeable, in that the seated carrier would no longer seal the forward end of the pump tube as helium was injected. The carrier O-rings were not making sufficient contact with the bore walls at that point. Consequently, the original coupling and launch tube were replaced by an unused coupling and the reworked nickel-plated launch tube for the last two firings.

The initial coupling and launch tube had been used to fire a total of fifteen rounds. As was mentioned, a number of surface defects had been visible in the launch tube bore since the early firings. In order to study the nature of these defects, and to assess also the magnitude of the bore expansion in the forward breech, the coupling and launch tube were later sectioned along the bore axis. A photograph of the barrels after sectioning is shown in Figure 4-24. A carrier is included for reference as it would be positioned prior to firing. Figure 4-25 shows, in somewhat more detail, the wear and deformation sustained by the barrels. Expansion of the 20mm bore diameter at the position of the carrier O-ring was determined to be on the order of 0.020 inch; not a great increase considering the magnitudes of the peak pressures sustained. However, this slight expansion was sufficient to ruin the seal at the forward end of the pump tube. A means of sealing on the conical surface of the carrier now seems preferable, since a seal of that type would not be affected by slight increases in bore diameter.

The damage suffered by the launch tube bore was severe, and has not yet been explained with any certainty. The apparent constriction of the launch

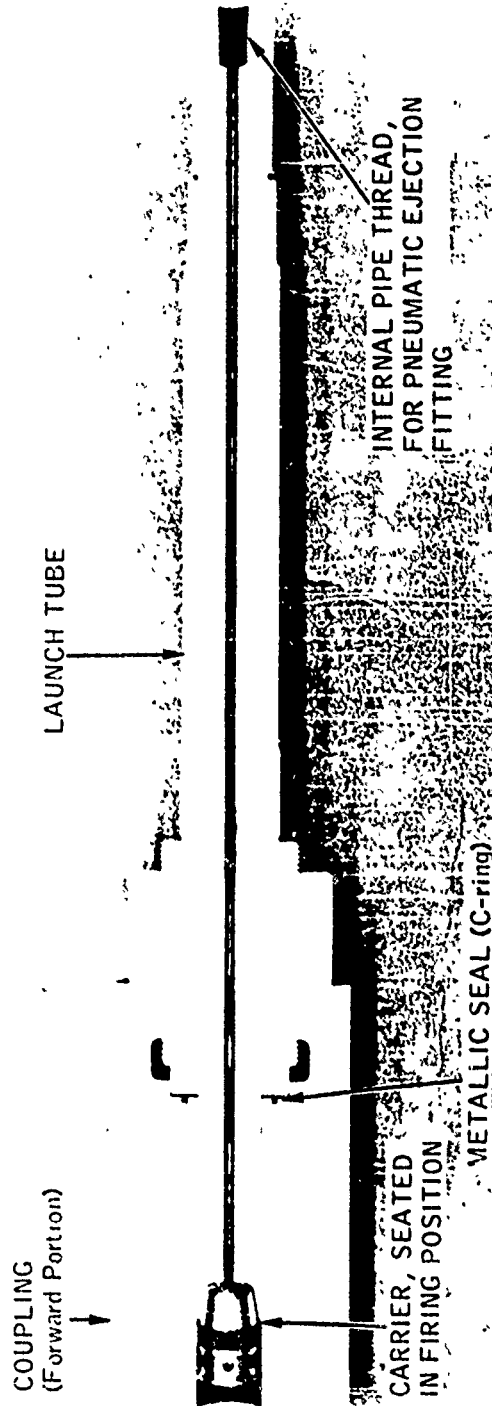

Figure 4-24. Launch Tube (0.150 Caliber) and Forward Portion of Coupling After Completion of Firing Tests

CONFIDENTIAL

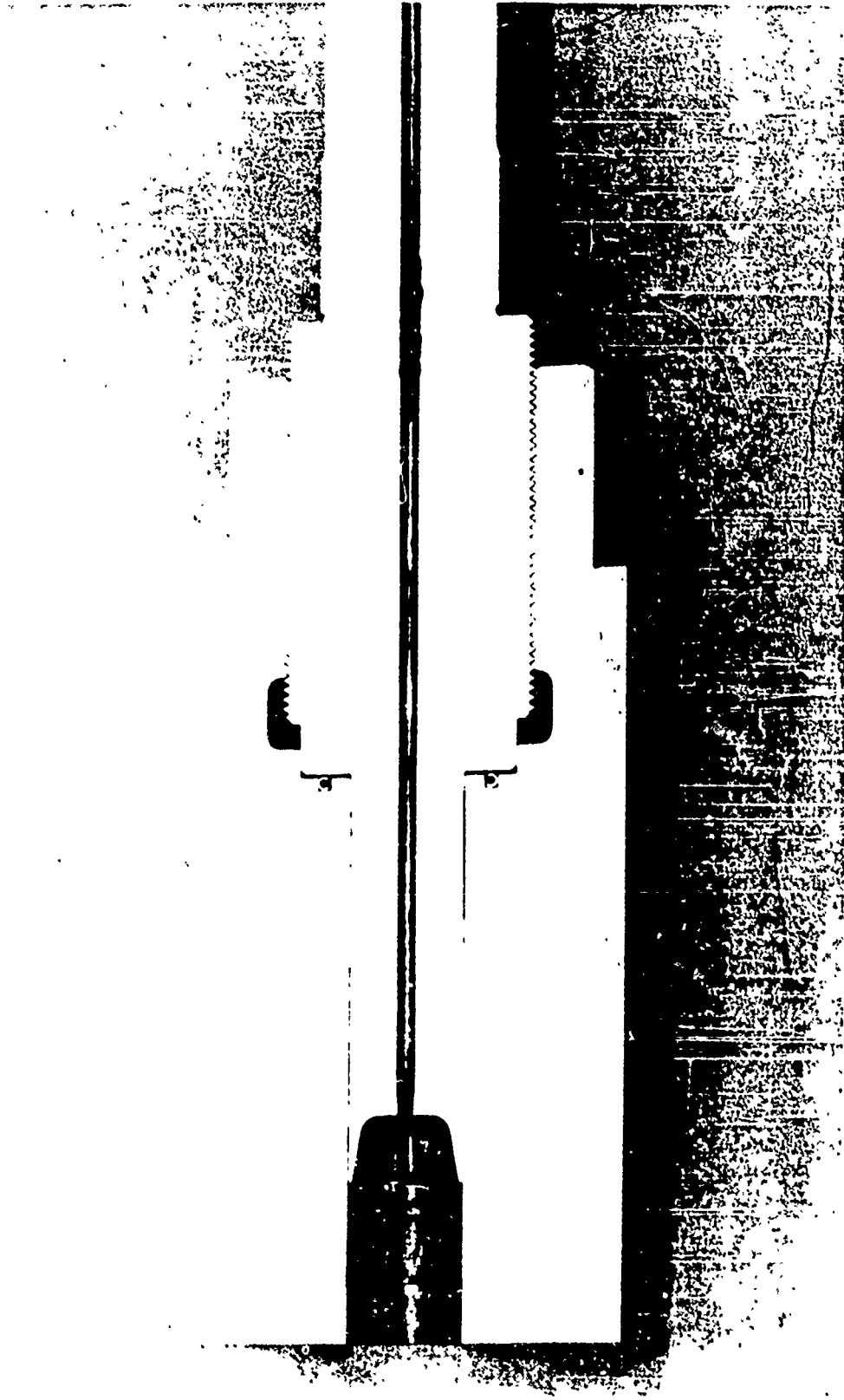

Figure 4-25. Wear and Deformation of 0.150 Caliber Launch Tube Bore

CONFIDENTIAL

CONFIDENTIAL

tube entrance (see Figure 4-25) is probably caused by the extreme force with which the projectile flange bears against the material around the entrance during helium compression. If the launch tube entrance is thus constricted, the projectile, starting from a recessed position in the carrier would be made undersized by being forced through the constriction. (The projectile is made of a steel of less hardness than the Rockwell C-32 to 37 steel of the launch tube.) An undersized projectile in the bore would be able to ballot considerably as it is driven and might tend to "catch" on any imperfections, eventually resulting in the gouged and eroded areas exhibited by the sectioned launch tube. If this explanation is correct, it may be preferable to allow the projectile to protrude from the carrier, so that the projectile is started into the launch tube bore before shear-out. Redesign of the launch tube entrance is also required, to prevent the formation of the constriction shown in Figure 4-25.

Shuttle Valve Ejection System

During the series of firings just discussed, consistent success was experienced with the use of muzzle pressure alone in clearing the pump tube bore after firing. As a result of this success, a fixture was designed to permit the rapid application of pressure through the launch tube bore without requiring that the fixture be removed from the muzzle during firing. The method of operation of this device, called a "shuttle-valve" because of the reciprocating action by means of which admission of pressure to the bore is controlled, is illustrated in Figure 4-26. It is evident that fairly rapid rates of firing and ejection are possible with the shuttle-valve, while it presents none of the sealing problems and other difficulties associated with the originally proposed ejection system. The advantage of the new method depends upon the continued effectiveness and reliability of muzzle pressure as a means of clearing the pump tube bore after firing.

At this point in the development program, a limited number of firings were planned using a larger caliber projectile and launch tube. The primary purpose of these supplemental firings was to assess the effect of increased projectile mass and diameter upon muzzle velocity and overall launcher performance. It was decided to fabricate the shuttle-valve for testing in conjunction with these rounds.

Enlarged Caliber Firings

A projectile diameter of 0.220 inch was selected for this investigation. This diameter provided a convenient bore size, permitting the use of standard tools for cleaning, which had been a problem with the 0.150 inch diameter barrel. More importantly, this diameter resulted in a projectile-flange configuration as large as could conveniently be used with the existing carriers. The new projectile-flange units and two new launch tubes (one of which was not fired) were the only components which had to be procured for this study, aside from the shuttle-valve just mentioned.

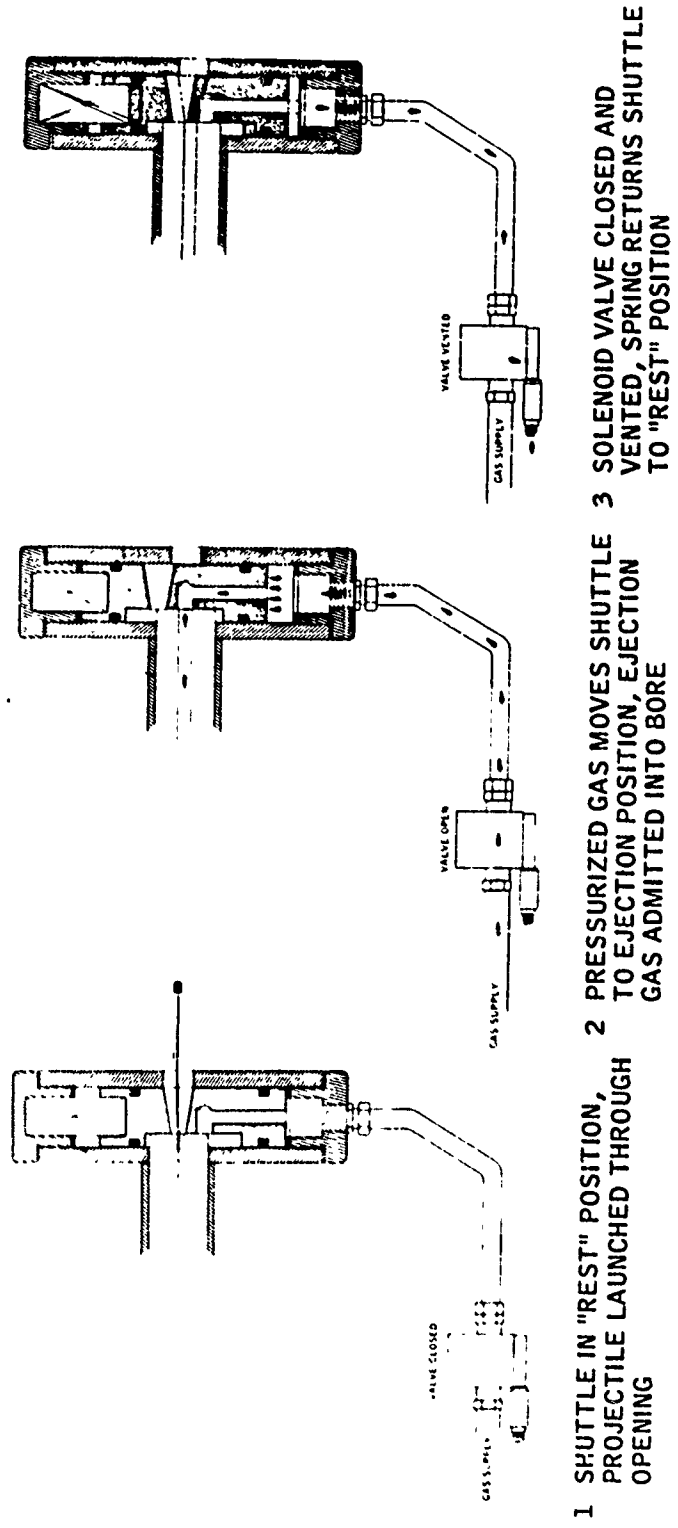

Figure 4-26. Sequence of Operation, Shuttle Valve

CONFIDENTIAL

Upon receipt of 0.220 caliber projectile-flange units, a sample of four were sheared hydraulically to determine the approximately shot-start pressure which could be expected in the launcher. An average value of 50,000 psi was obtained, with variation among the four units tested being very slight. The projectiles were carefully weighed after recovery from the shear tests, and an average projectile mass of 17.2 grains was measured. This represented an increase of 300% over the original projectile mass of 5.5 grains.

In view of the excellent performance of the aluminum Lexan pistons during the previous test phase, it was decided to adopt this configuration for the 0.220 caliber firings. The piston mass with this configuration was 28.0 grams, as compared with 17.9 grams for the original Lexan piston.

The 0.220 caliber launch tube fabricated for these firings was assigned a bore length of 22 inches, resulting in the same length-to-diameter ratio as the 0.150 inch diameter barrels. In view of the unfavorable results obtained with the nickel-plated barrel sections, no plating was called for on the new launch tubes.

In order to determine whether the inconsistency of the measured data observed in the 0.150 inch diameter firings was primarily due to helium leakage at the pressure port, the unused coupling section installed for the 0.220 caliber firings was not fitted with pressure instrumentation. The wall of the high-pressure section was left intact, with no port drilled for monitoring helium compression.

A summary of the changes made in preparation for the enlarged caliber firings is presented in Table 4-5.

Table 4-5. Summary of Changes Made in Components
for Phase II Firings

	Phase I	Phase II
Projectile Diameter	0.150 inch	0.220 inch
Projectile Mass	5.5 grains	17.2 grains
Launch Tube Length	15.0 inches	22.0 inches
Projectile Shot-Start Pressure	67,000 psi	50,000 psi
Pressure Port in Forward Breech	Yes	No

In the time remaining, five single rounds were fired using the new projectiles and barrels. The firing data is listed in Table 4-6.

Round No. 1 and Round No. 2 were fired into atmosphere with the vacuum tank and associated components removed. The carrier was placed in firing position with the projectile reversed in the carrier. The projectile was thus started into the bore before shear-out, and subsequently traveled

Table 4-6. Initial Conditions, Projectile Velocity Phase II Firings (0.220 inch Dia. Projectile)

Round No.	Piston Material (Nose Base)	Piston Mass (grams)	Initial Helium Pressure (psi)	Peak Compression Pressure (psi)	Muzzle Velocity in Air (fps)	Muzzle Velocity in Vacuum (fps)
(19) 1	Alum. Lexan	26.0	900	(Not measured)	10,300	
(20) 2	Alum. Lexan	28.0	900		10,200	
(21) 3	Alum. Lexan	28.0	970			10,400
(22) 4	Alum. Lexan	28.0	900			13,800X
(23) 5	Alum. Lexan	28.0	900			10,200

X - Velocity uncertain

CONFIDENTIAL

down the bore base-first. Visual inspection of the launch tube after the first two rounds revealed that defects similar to those previously encountered had already begun to form in the bore. Moreover, the new coupling section already showed signs of 20mm bore enlargement at the forward breech area. This failure of the high-pressure section to contain the peak pressures without permanent yield was surprising, since the pressures generated should not have been more severe than those of the Phase I firings. Failure was attributed to the fact that there was no attached transducer block to provide additional barrel reinforcement as there had been for the Phase I firings.

The expended piston and carrier were removed mechanically after Rounds No. 1 and 2, since the shuttle-valve fixture planned for this use had not been completed in time.

The shuttle-valve was completed before Round No. 3. However, since the last three rounds were fired through the evacuated tanks, it was not possible to fire with the shuttle-valve in place. After firing, the tanks were removed, and the shuttle-valve was clamped securely to the muzzle as shown in Figure 4-27. Reservoir pressures between 900 and 1000 psi were used for ejection.

The somewhat bulky clamp shown in Figure 4-27 was used for its simplicity and convenience. Both the means of attachment and the shuttle-valve itself could be considerably reduced in size and weight without losing effectiveness.

No difficulty was encountered in ejecting the expended pistons by this means. The aluminum/Lexan pistons consistently showed only minor erosion and deformation upon removal from the pump tube, and were not tightly wedged in the forward breech. The condition of the pistons, as recovered from the pump section after firing, is illustrated in Figure 4-28.

Pressure applied through the muzzle was not as effective in ejecting the expended carriers as it had been in the Phase I firings. The reason for this is not definitely known. It is possible that the 20mm bore at the forward breech was not quite as enlarged (relative to the pre-fired carrier diameter) as was the bore of the original coupling used for most of Phase I. Phase I had been frequently subjected to extremely high pressures before pneumatic ejection was consistently successful. On Round No. 5, the last of these 0.220 caliber firings, the carrier was modified as shown in Figure 4-29. The base diameter of the carrier was turned down to 0.040 inch less than bore diameter and three cuts were made in the base to provide some degree of flexibility. This modification proved successful. Using the shuttle-valve after firing, piston and carrier were ejected with 1000 psi reservoir pressure.

CONFIDENTIAL

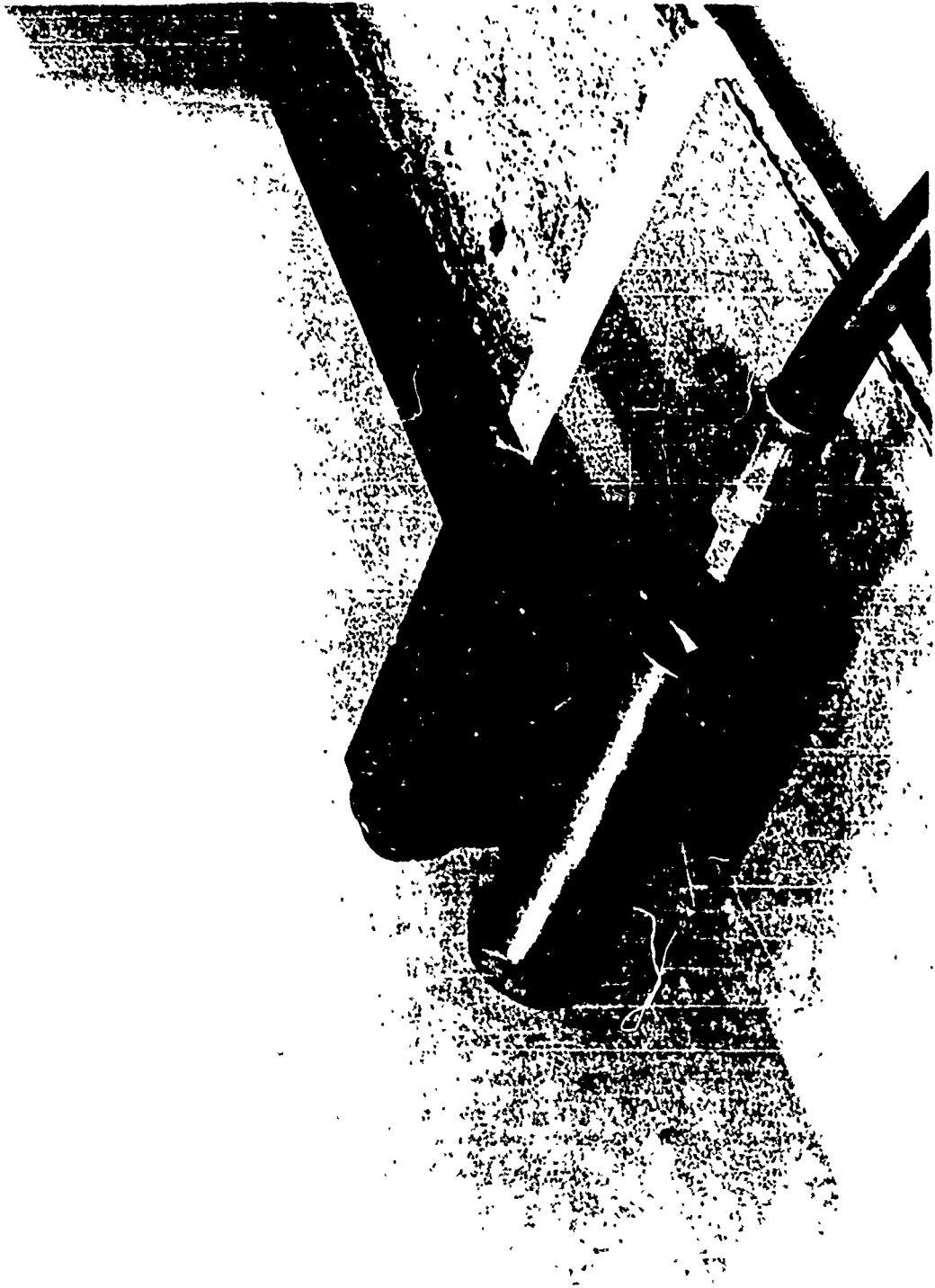

Figure 4-27. Shuttle Valve Secured in Position

CONFIDENTIAL



Figure 4-28. Expended Aluminum/Lexan Pistons
(0.220 Caliber Firing:)

CONFIDENTIAL



Figure 4-29. Final Carrier Modification

CONFIDENTIAL

CONFIDENTIAL

On the last three rounds, the coil and screen technique was used to measure projectile velocity. The 0.032 inch thick aluminum plate used to seal the opening at the end of the vacuum tank also served as a witness of projectile integrity, as evidenced in Figure 4-30. The pattern of perforations shown is typical of that encountered after most of the firings, in Phase I as well as in Phase II, when the coil and screen technique was utilized. It is not known for certain what created the number of tiny perforations visible. However, in view of the bore damage previously mentioned, and the "squeezing" of the projectile through the constricted launch tube entrance, it seems possible that the small holes were made by particles of steel scraped from the projectile and/or launch tube bore and accelerated along with the main projectile mass to high velocities.

The bore damage and constriction of the bore entrance observed in the 0.150 inch diameter launch tube after sectioning was found to be equally severe in the 0.220 inch diameter barrel. Figures 4-31 and 4-32 show the deformation, gouging and erosion of the bore discovered when the barrel was sectioned after completion of the firings.

CARRIER ELIMINATION STUDIES

General

During the early phases of testing, it became evident that the most difficult problem to be solved in establishing the basic feasibility of the proposed concept was the ejection of the expended carrier from the pump tube after firing. The expended piston proved to be capable of easy and consistent expulsion by pneumatic pressure directly applied; but the carrier, although frequently ejected successfully during the program, required continuous attention and modification to accomplish its removal from the bore. When the complete firing cycle is tested, including rapid seating of the carrier by the charging gas (with the resultant carrier impact at the forward breech), final carrier deformation may be more severe than at present, increasing the difficulty of removal.

It is still believed that, through continued testing and modification, consistent and reliable ejection of the carrier by pneumatic pressure can be achieved. However, as an alternative, the possibility of eliminating the carrier from the operational scheme entirely seems to warrant consideration. This possibility was made the subject of a limited study to assess the feasibility of the idea, and to weigh the resulting advantages and disadvantages in regard to the overall weapon concept.

Design Considerations

The functions that are performed by the carrier in the present operation are listed in Section II. In order to retain the basic features and advantages

CONFIDENTIAL

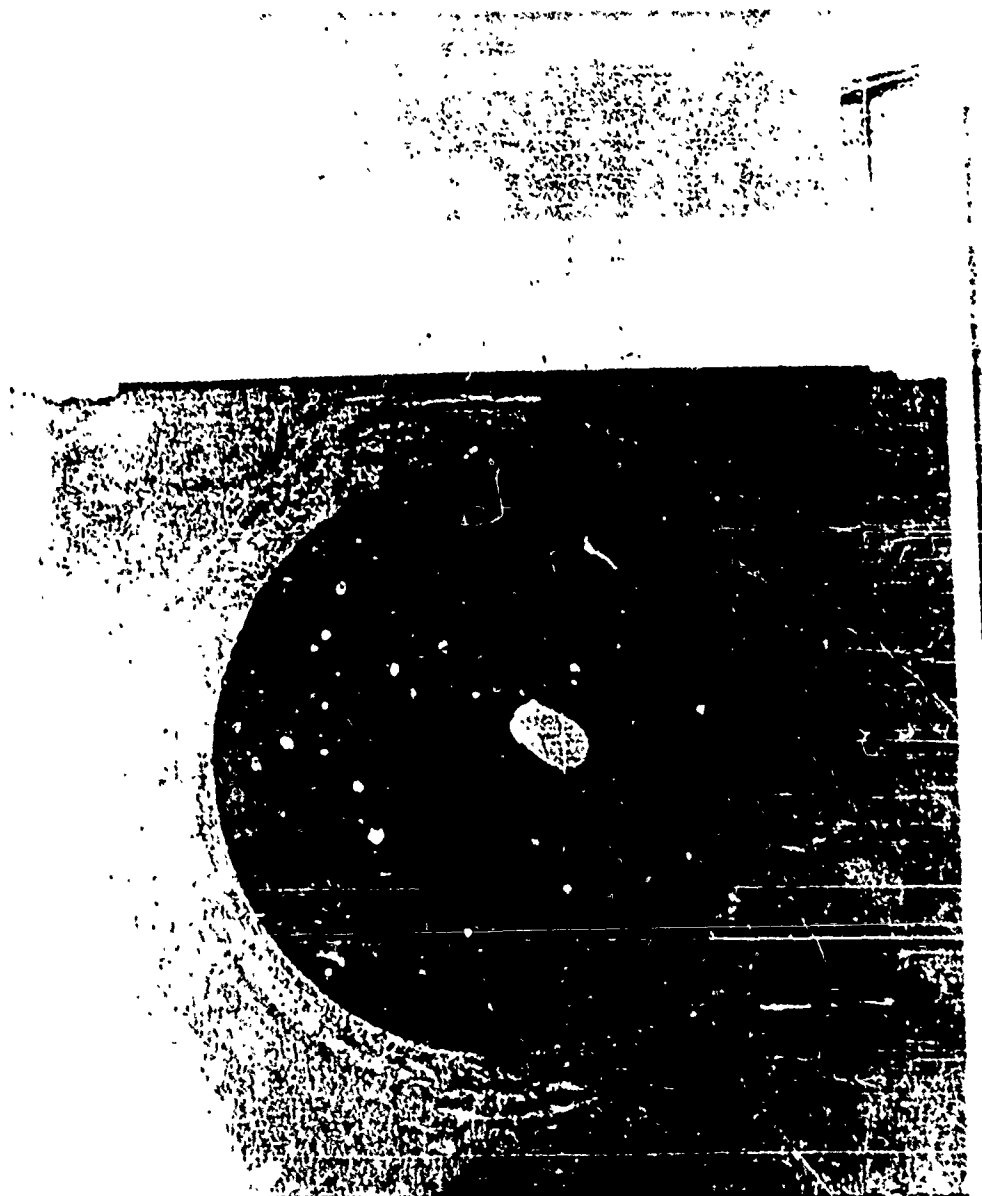

Figure 4-30. Target Plate

CONFIDENTIAL



Figure 4-31. Launch Tube (0.220 Caliber) and Forward Portion of Coupling After Completion of Firing Tests

CONFIDENTIAL

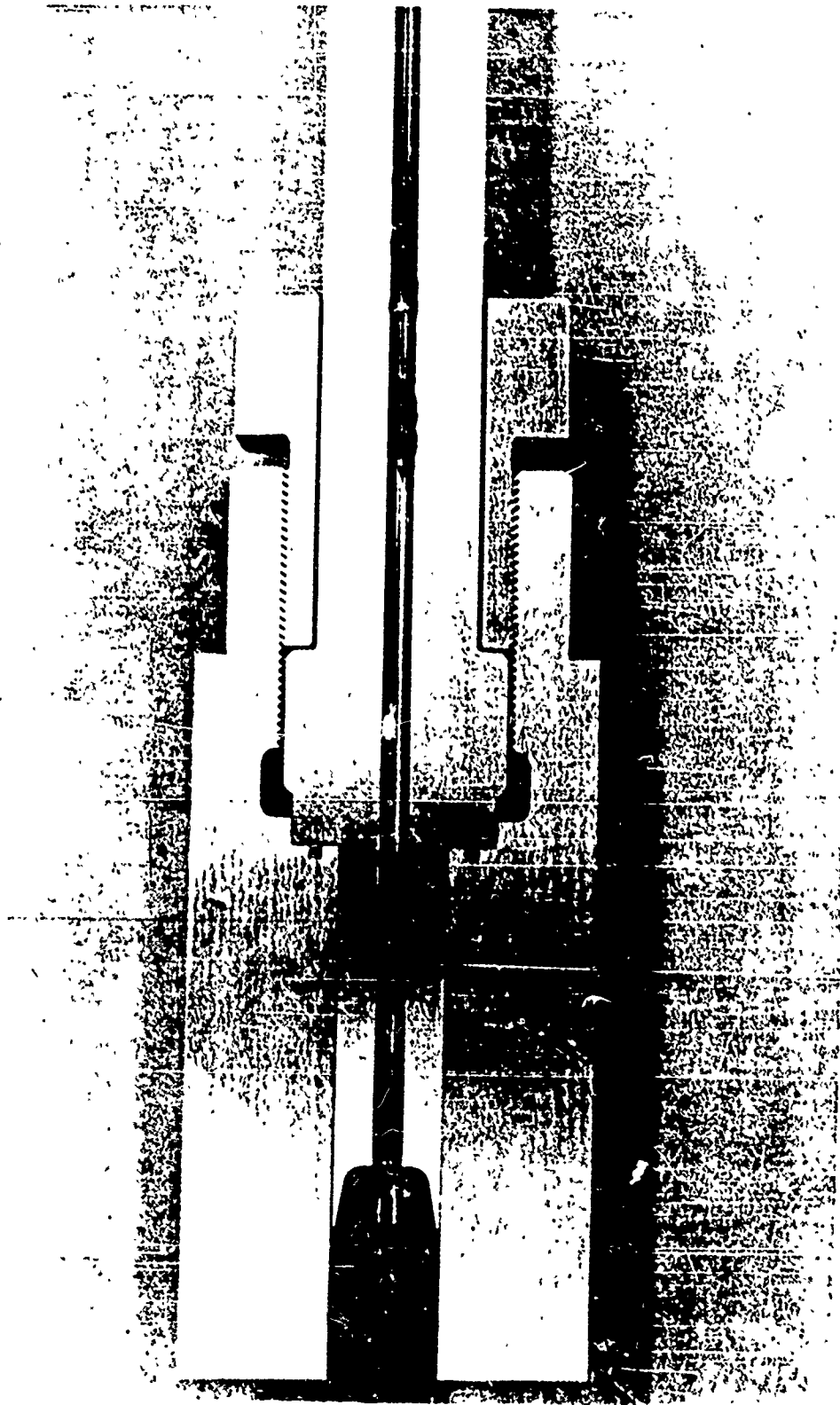

Figure 4-32. Wear and Deformation of 0.220 Caliber Launch Tube Bore

CONFIDENTIAL

CONFIDENTIAL

of the original weapon concept, it was necessary that certain of these functions be duplicated by whatever scheme was devised to replace the carrier. In particular, 1) it was essential that the projectile initially be attached to the rest of the round for ammunition handling and feeding as an integral unit; and 2) it was also essential that the projectile be placed into firing position by some means, starting from its initial position in the chambered round. In addition, it was necessary that the projectile, once in firing position, be capable of sealing the front end of the pump tube during compression, allowing sufficiently high pressures and temperatures to be created before the start of the launching run.

Upon studying these requirements, it became evident that the primary problem was that of getting the projectile into firing position in the proper orientation. If the projectile diameter is considerably smaller than the pump tube bore diameter, as is usually required for the attainment of satisfactory velocities, the projectile is free to tumble as it moves down the pump tube. Tumbling could be prevented by making the projectile longer than the diameter of the pump tube bore; if the launch tube diameter was not much smaller than the pump tube diameter, this would be a simple and attractive solution. However, for the diameter ratios characteristic of most existing light gas guns, this solution would be somewhat awkward, in view of the projectile length-to-diameter ratios which would be required. Another means of preventing tumbling is to support the projectile during its motion down the pump tube on a number of thin, flexible spokes, the ends of which are bent to ride on the walls of the pump tube bore. These thin supports would collapse as the projectile was extruded into the launch tube during compression, following the projectile out the muzzle; or, if a shear flange were used to restrain the projectile, as at present, the spokes would be easily ejected with the flange and the expended piston after firing.

Both of these means were considered, but neither was tested during the investigation described. It was decided that the most promising solution to the problem of seating the projectile in the correct orientation was to choose the geometry of the projectile and the projectile seat such that proper orientation was assured as an inherent feature of the geometrical relationships. Two examples of projectile design which would accomplish this are shown in Figure 4-33. A projectile of this type could be housed in the piston, with a means provided for channelling the injected helium through the piston, driving the projectile out ahead of the gas. This initial impulse, and the continued flow of gas, would carry the projectile down the pump tube into the forward breech. At the forward breech, a tapered transition from the pump tube diameter to the launch tube diameter would funnel the projectile to the seat provided at the launch tube entrance. The projectile would initially be slightly larger than the launch tube bore. It was determined that a plastic flow process of releasing the projectile into the bore could replace the present shearing process, which requires a parent material that is left behind, and which also complicates orientation requirements. Some of the injected helium

CONFIDENTIAL

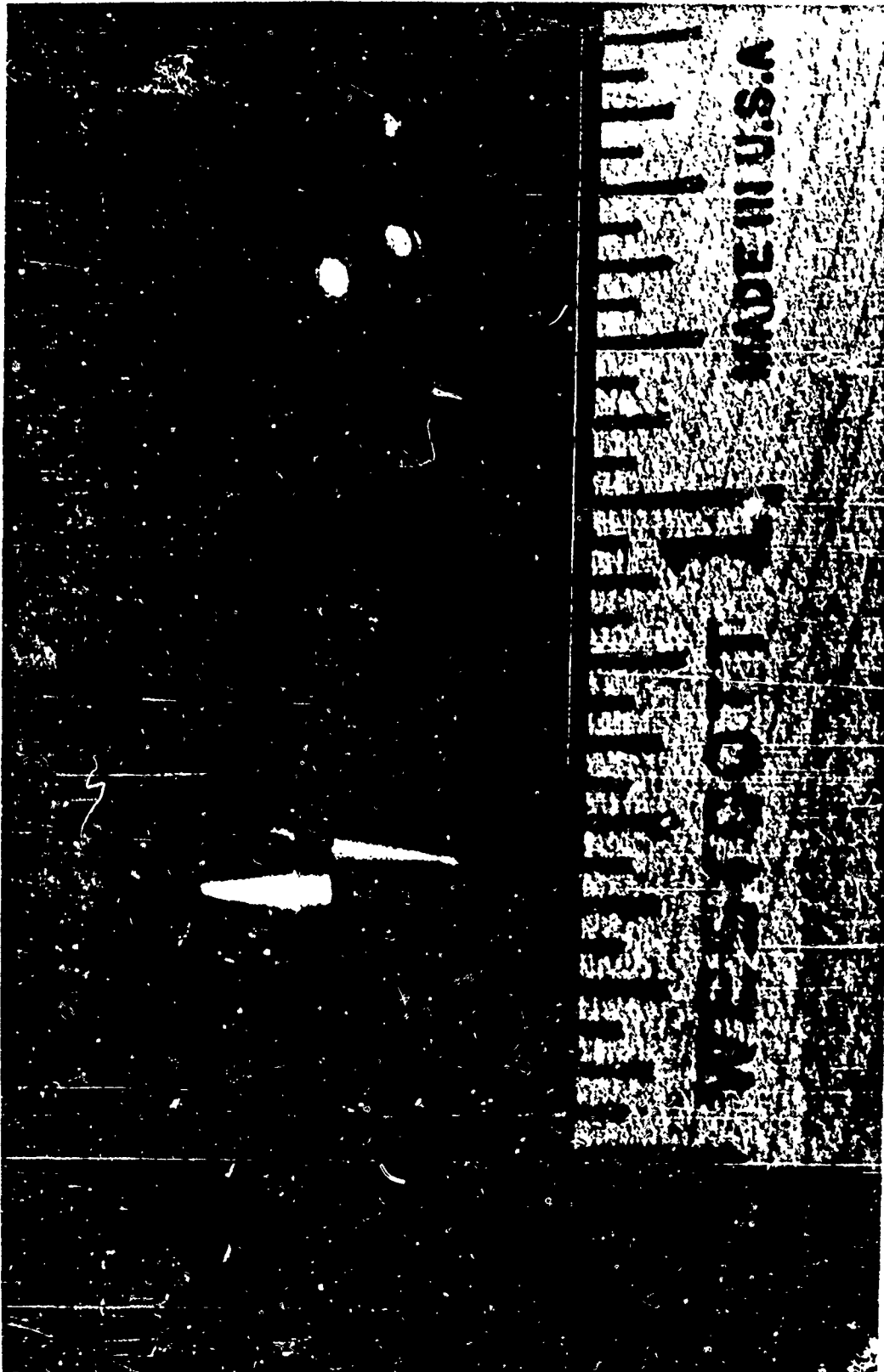

Figure 4-33. Projectile Geometry (Carrier Elimination Study)

CONFIDENTIAL

CONFIDENTIAL

would be lost on each round, since the forward end of the pump tube would not be sealed until the projectile had seated. This waste of helium, and the undetermined effect of the extrusion process upon useful life of the launch tube, constitute the primary objections to this approach.

Testing

The scheme just described was selected, despite these objections, for primary consideration in the experimental work which followed. Tests were initiated using the transparent pump tube apparatus previously described and shown in Figure 4-1. A 1/4 inch diameter ball bearing was used as the projectile, and the projectile seat and launch tube entrance were simulated in clear plastic at the downstream end fitting (Figure 4-34). Various piston configurations were tried to determine the effect of the initial projectile housing upon initial impulse, motion down the pump tube, and seating (Figure 4-35). A Fastax camera was used in the same manner as in the original transparent pump tube investigations to make a time study of helium injection and projectile seating.

The parameters which were varied during these tests were:

- Injection pressure
- Back pressure (pump tube pressure before injection)
- Piston length

Test Group #1 - consisted of varying the injection pressure from 50 psi to 500 psi using a piston length of 3 inches and a back pressure of 1 atm.

Test Group #2 - consisted of varying the injection pressure using a piston length of 1 inch and a back pressure of 1 atm.

Test Group #3 - consisted of varying the injection pressure using a piston length of 1-5/8 inches, but cutting bypass orifices to allow the light gas to bypass the projectile into the pump tube

CONFIDENTIAL

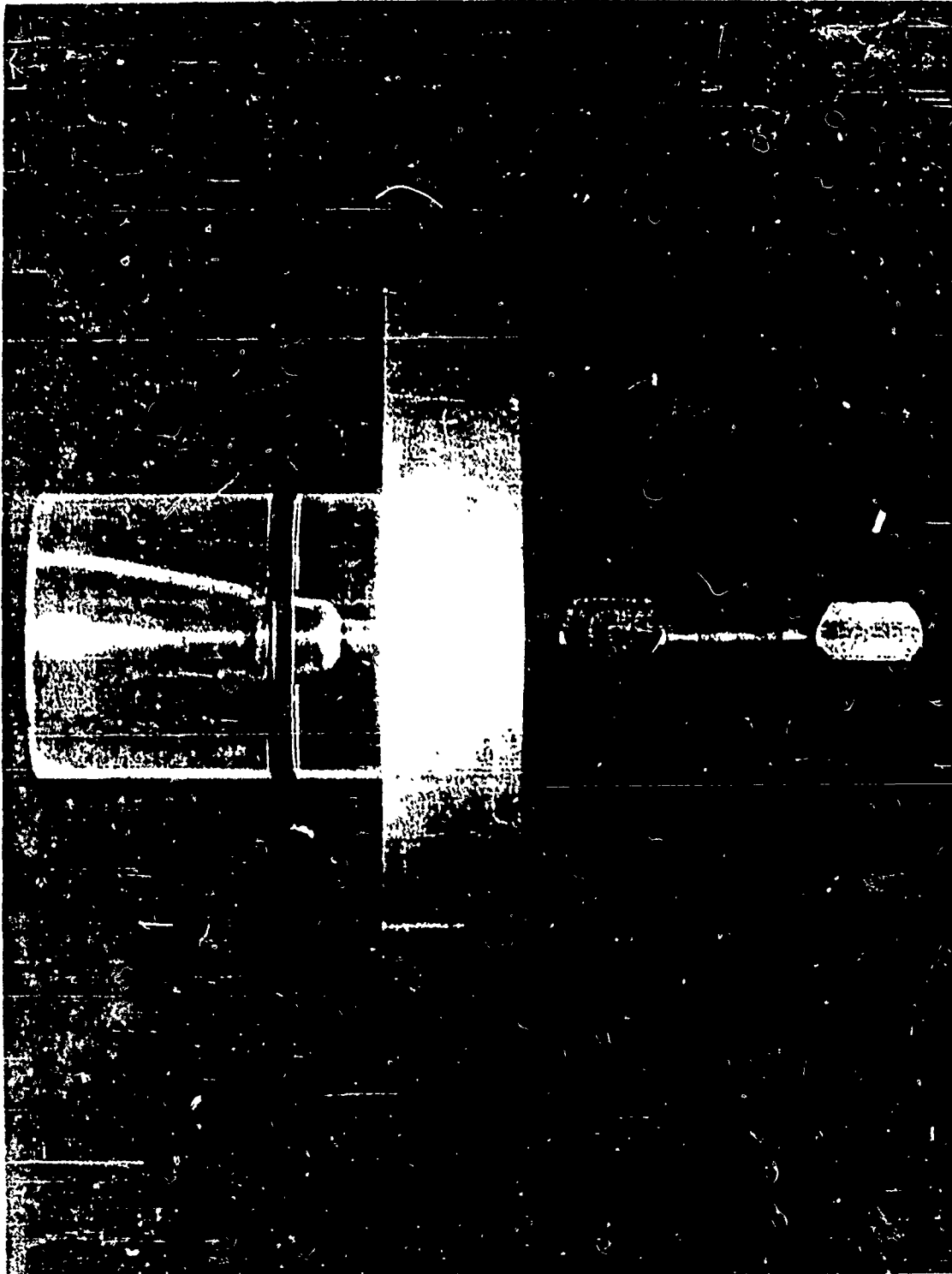

Figure 4-34. Projectile Seat and Launch Tube Entrance
(Carrier Elimination Study)

4-59

CONFIDENTIAL

CONFIDENTIAL

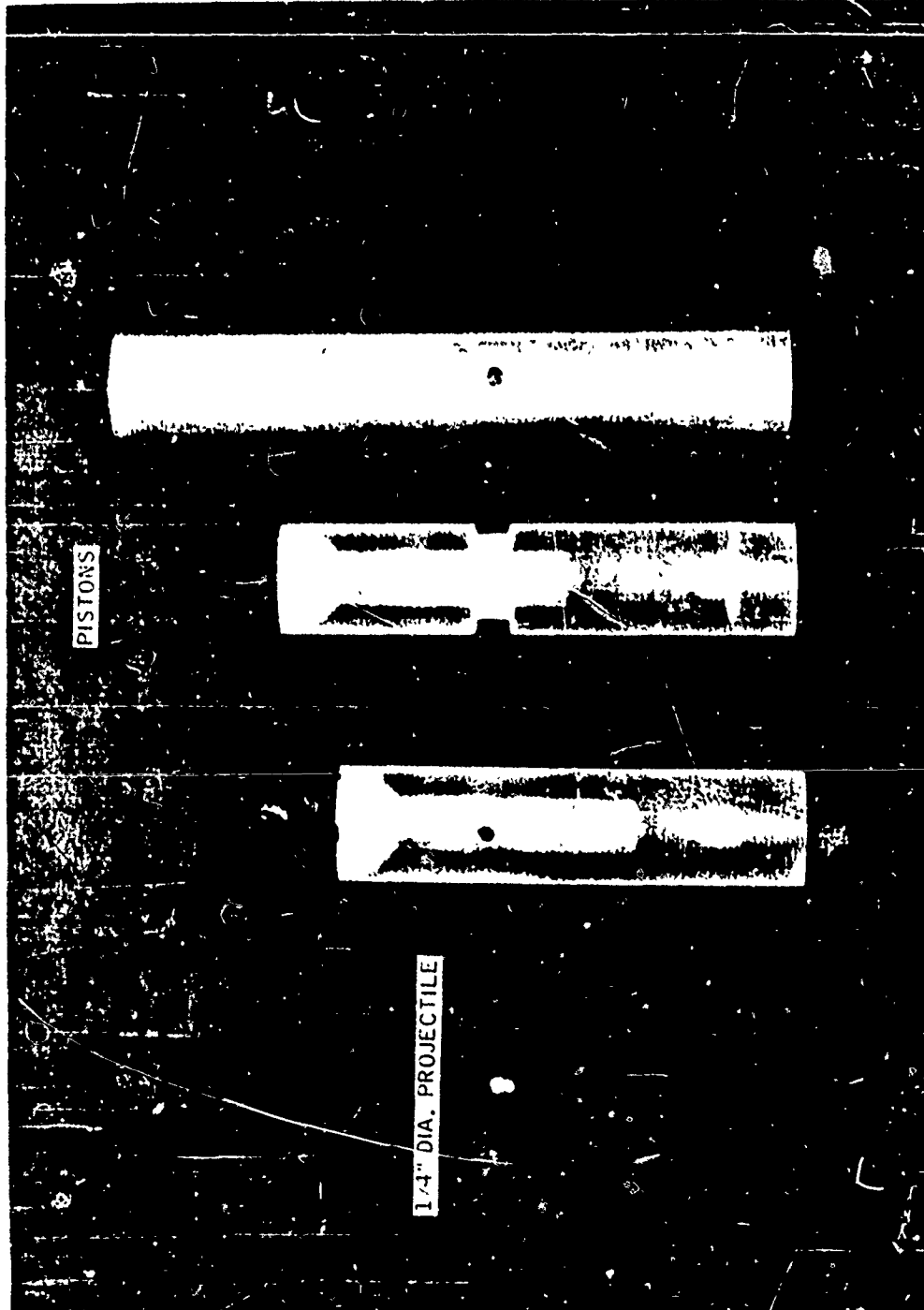

Figure 4-35. Projectile and Various Piston Housing Configurations Tested (Carrier Elimination Study)

CONFIDENTIAL

CONFIDENTIAL

Results

The results of each test group are shown in Table 4-7.

Table 4-7. Test Results

<u>Test Group #1</u>	<u>Piston Length 3 inch</u>		<u>Pb = 14.7 psi</u>
<u>Injection Pressure (psig)</u>	<u>Static Pressure (psig)</u>	<u>Time to Seat (sec)</u>	<u>Velocity (fps)</u>
125	65	3.0	--
135	74	.6	--
210	130	1.9	--
330	210	.7	72
455	300	.9	80
455	300	1.25	80
<u>Test Group #2</u>	<u>Piston Length 1 inch</u>		<u>Pb = 14.7 psi</u>
300	205	.4	103
500	358	.8	120
525	368	1.0	42.3
<u>Test Group #3</u>	<u>Piston Length 1-5/8 inch with 2 bypass orifices</u>		
100	17.5	4.3	Pb = -12 psig
150	90.0	.65	
150	90.0	2.3	
35	15.0	1.3	
35	15.0	2.3	
65	30.0	.8	
65	30.0	.6	
100	50.0	.85	
100	50.0	.9	
150	90.0	1.0	
150	90.0	1.2	
150	90.0	1.4	

"Time to seat" represents the total time elapsed from solenoid actuation until the projectile established a leak-tight seal at the launch tube entrance. The relatively long time required for seating was caused by the projectile rebounding from the tapered section on its first rapid approach, then slowly returning again and seating. This rebounding was seen to occur in each of the trails, but from the variations in the data it is evident that the phenomenon is not consistent, or predictable. The tests did show that it is possible to obtain more consistent results using the bypass orifices and low injection pressures.

CONFIDENTIAL

A final test was conducted using a different approach. An electromagnet was used to pull a double-frustum projectile (Figure 4-33) down the pump tube and into the projectile seat. Alignment of the projectile is inherently controlled by the electromagnet if projectile length-to-diameter ratio is greater than unity. ($\frac{l}{d} > 1$). Testing was limited, since a complex system of automatic controls is required to move the electromagnet the length of the pump tube as is necessary. Using the fairly crude experimental apparatus available, however, the projectile was easily drawn from the piston to the seat.

Based on the results of this preliminary study, the feasibility of eliminating the carrier from the present operation must be regarded as uncertain. The primary advantage of the scheme tested, in respect to the weapon concept, is that the critical problem of pneumatic ejection is greatly simplified. The disadvantages of the scheme are: 1) the loss of helium during charging; 2) the undetermined effect of the extrusion shot-start process upon useful barrel life; and 3) the loss of the shielding effect of the carrier on the forward breech bore surfaces.

If the feasibility of carrier elimination is to be pursued further, the following specific areas of investigation are suggested:

- The effect of projectile and projectile seat geometry upon the reduction of projectile rebound. (A more gradual transition zone from pump tube diameter to launch tube diameter might be beneficial in this respect, and could be used in conjunction with an extrudable piston to achieve "accelerated reservoir" light gas gun performance.)
- The dependence of projectile velocity upon shot-start pressure. (Due to the rapidity of the compression using a light piston, it might be possible to achieve satisfactory muzzle velocities with a low shot-start pressure. This would reduce the amount of extrusion required.)
- The effect of projectile extrusion upon useful barrel life. (This should include the consideration of different projectile and barrel materials, relative hardness factors, various rates of extrusion, etc.)
- The preferability of using a number of thin spokes to guide and support the projectile. (Due to the fabrication problems involved, this method was not tested during this initial study.)

As a final observation, it should be stated that the methods considered in this study do not exhaust the possibilities for achieving carrier elimination. Continued thought in this area may produce a novel and practical scheme capable of effecting a significant improvement in the overall functioning of the weapon concept.

CONFIDENTIAL

SECTION V

CONCLUSIONS AND RECOMMENDATIONS

CONCLUSIONS

The experimental program described in the following paragraphs, has been primarily directed towards the evaluation of a basic concept for an automatic hypervelocity weapon. The general feasibility of the concept has been demonstrated through a series of single-round firings.

Initial and subsequent problem areas have been accorded special attention as they were recognized. The significant resolved and unresolved problem areas, (at the present state of the development), are summarized in the following paragraphs.

Problem Areas Resolved - Functioning Established

- At low injection pressures, pump tube charging and carrier seating are accomplished smoothly and rapidly.
- Upon carrier seating, the projectile is unfailingly aligned with the launch tube entrance.
- The carrier and projectile assembly effectively seals the forward end of the pump tube during helium compression and maintains a seal until projectile shear-out.
- Both piston and carrier are capable of withstanding the total combined stresses of firing without suffering extensive deformation or heat damage.
- Pneumatic pressure is a sufficient means of clearing the pump tube bore after firing. During the test program, piston and carrier were repeatedly ejected from the forward breech by a gas pressure of 900 to 1000 psi applied through the bore of the launch tube.

Unresolved Problem Areas - Further Study Required

- At high injection pressures ($p_0 > 400$ psi), carrier and projectile deformation upon impact at the forward breech is excessive, making firing and ejection uncertain.
- Pump tube bore enlargement at the forward breech is difficult to prevent, unless a heavy barrel section or relatively low peak pressures are used. With the present configuration, slight bore enlargement is

CONFIDENTIAL

sufficient to ruin the seal at the carrier O-rings, resulting in helium leakage during injection.

- The high peak pressures generated during firing cause the carrier and projectile flange to bear against the launch tube entrance with great force, tending to constrict the launch tube entrance.
- Perhaps as a result of this constriction, the projectile causes severe gouging deformation in the launch tube bore. This explanation of the extensive bore damage encountered has not been verified.
- A continuing problem is the accumulation of combustion residue on the bore surfaces in the forward breech area and in the launch tube.
- The pressure and velocity data recorded during the test firings exhibited large round-to-round variations and inconsistencies.

RECOMMENDATIONS

- Before continuing and refining the present development of critical components and mechanisms, a fairly thorough analytical study should be made to optimize, and thus establish, the basic launcher dimensions. If revisions in the weight, pressure, diameter, and length ratios are to be required for improved performance and higher projectile velocities, incorporation of these revisions at this time will put subsequent mechanism and component development on a firmer basis.
- The effect of increased projectile mass, in particular, should be experimentally as well as analytically investigated, to determine what velocities are achievable at the higher mass values without excessive increase in overall weapon weight and bulk.
- The unresolved problem areas listed should be investigated further, design solutions sought, and confirmatory tests conducted. Those problems related to the pressure magnitudes presently encountered, should be re-examined in the light of the revised launcher characteristics resulting from the optimization study.
- In working towards a practical, fully automated weapon system, certain critical design areas (such as required bolt action-firing sequence timing-recoilless operation) should be studied to better define the basic mechanisms and technology upon which the final weapon configuration will be based.

CONFIDENTIAL

LIST OF REFERENCES

1. Simplified Analysis of Light Gas Hypervelocity Weapon, Eugene Ashley, General Electric Company, Missile and Armament Department, Report No. 62APB25 dated 31 August 1962
2. Hypervelocity Capability and Impact Research, ARPA Order 70, C. D. Porter, U. S. Naval Research Laboratory, NRL Memorandum Report 1348 dated July 1962
3. Hypervelocity Guns and the Control of Gun Erosion, Volume I, Section 30.3.5, Office of Scientific Research and Development, National Defense Research Committee, Division I