

UNCLASSIFIED

AD NUMBER

AD390962

CLASSIFICATION CHANGES

TO: UNCLASSIFIED

FROM: CONFIDENTIAL

LIMITATION CHANGES

TO:  
Approved for public release; distribution is unlimited.

FROM:  
Distribution authorized to U.S. Gov't. agencies and their contractors;  
Administrative/Operational Use; JUN 1967. Other requests shall be referred to Army Assistant Chief of Staff for Force Development, Washington, DC 20310.

AUTHORITY

30 jun 1979, dodd 5200.10, gp-4; per AGO D/A ltr 29 Apr 1980

THIS PAGE IS UNCLASSIFIED

UNCLASSIFIED

AD NUMBER

AD390962

CLASSIFICATION CHANGES

TO:

CONFIDENTIAL

FROM:

SECRET

AUTHORITY

30 jun 1970, dodd 5200.10, gp-4

THIS PAGE IS UNCLASSIFIED

# **SECURITY**

---

# **MARKING**

**The classified or limited status of this report applies to each page, unless otherwise marked.**

**Separate page printouts MUST be marked accordingly.**

---

**THIS DOCUMENT CONTAINS INFORMATION AFFECTING THE NATIONAL DEFENSE OF THE UNITED STATES WITHIN THE MEANING OF THE ESPIONAGE LAWS, TITLE 18, U.S.C., SECTIONS 793 AND 794. THE TRANSMISSION OR THE REVELATION OF ITS CONTENTS IN ANY MANNER TO AN UNAUTHORIZED PERSON IS PROHIBITED BY LAW.**

**NOTICE: When government or other drawings, specifications or other data are used for any purpose other than in connection with a definitely related government procurement operation, the U. S. Government thereby incurs no responsibility, nor any obligation whatsoever; and the fact that the Government may have formulated, furnished, or in any way supplied the said drawings, specifications, or other data is not to be regarded by implication or otherwise as in any manner licensing the holder or any other person or corporation, or conveying any rights or permission to manufacture, use or sell any patented invention that may in any way be related thereto.**

# DISCLAIMER NOTICE

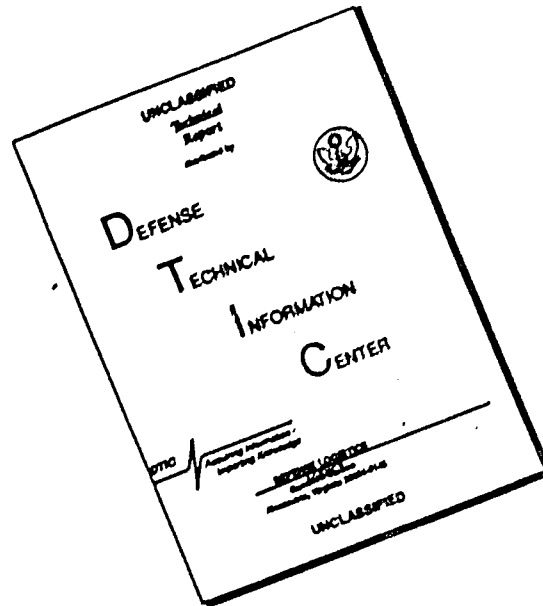

THIS DOCUMENT IS BEST QUALITY AVAILABLE. THE COPY FURNISHED TO DTIC CONTAINED A SIGNIFICANT NUMBER OF PAGES WHICH DO NOT REPRODUCE LEGIBLY.

**SECRET**

**DEPARTMENT OF THE ARMY  
OFFICE OF THE ADJUTANT GENERAL  
WASHINGTON, D.C. 20310**

①



AD3909C2

IN REPLY REFER TO  
AGAM-P (M) (12 Jun 67) FOR OT

19 June 1967

SUBJECT: Operational Report - Lessons Learned, HQ, I Field Force Vietnam

TO: SEE DISTRIBUTION

This document contains information of a classified nature. Its transmission is controlled by the Department of the Army.

1. Forwarded as inclosure is Operational Report - Lessons Learned, Headquarters, I Field Force Vietnam for quarterly period ending 31 January 1967. Information contained in this report should be reviewed and evaluated by CDC in accordance with paragraph 6f of AR 1-19 and by CONARC in accordance with paragraph 6c and d of AR 1-19. Evaluations and corrective actions should be reported to ACSFOR OT within 90 days of receipt of covering letter.

2. Information contained in this report is provided to the Commandants of the Service Schools to insure appropriate benefits in the future from lessons learned during current operations, and may be adapted for use in developing training material.

BY ORDER OF THE SECRETARY OF THE ARMY:

*Kenneth G. Wickham*

KENNETH G. WICKHAM  
Major General, USA  
The Adjutant General

1 Incl  
as

DISTRIBUTION:

- Commanding General
  - US Army Combat Development Command
  - US Continental Army Command
- Commandants
  - US Army Command and General Staff College
  - US Army War College
  - US Army Air Defense School
  - US Army Artillery and Missile School
  - US Army Armor School
  - US Army Chemical Corps School
  - US Army Engineer School
  - US Army Military Police School
  - US Army Infantry School
  - US Army Intelligence School
  - US Army Medical Field Service School

JUL 10 1968

REGRADED UNCLASSIFIED  
WHEN SEPARATED FROM  
CLASSIFIED INCLOSURE

2707610

DECLASSIFIED AT 3 YEAR INTERVALS;  
DECLASSIFIED AT THE 12 YEARS  
DATE 11/18/80

(Continued on page 2)

FOR OT RD  
670227

**SECRET**

DDC CONTROL  
NO. 82935



SECRET

# I FFORCEV OPERATIONAL REPORT

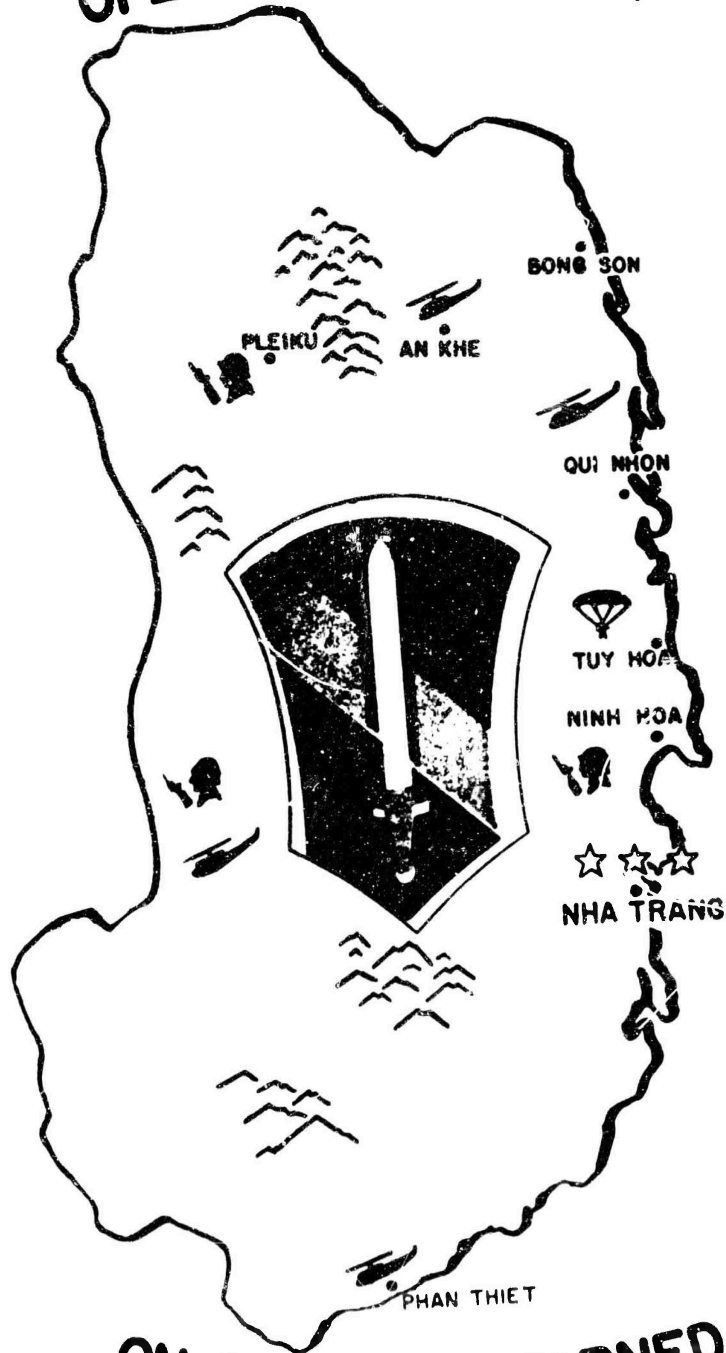

## ON LESSONS LEARNED

SECRET

DDC CONTROL  
NO. 82935

AVC-67 & *[Signature]*

**SECRET**

OPERATIONAL REPORT ON LESSONS LEARNED

	Para	Page
<b>SECTION I Significant Organizational or Unit Activities</b>		
General .....	1-1b	1
Intelligence .....	2-2h	1
Operations and Training Activities .....	3-3h	9
Plans .....	3a	9
Operational Activities .....	3b	11
G3 Air Operations .....	3c	22
Army Aviation Operations.....	3d	25
Organization and Training Activities.....	3e	28
Revolutionary Development .....	3f	30
Psychological Operations .....	3g	35
Chemical .....	3h	39
Logistical Activities .....	4-4d	45
Personnel and Administrative Action .....	5-5g	46
Artillery .....	6-6q	53
Engineer .....	7-7b	57
Signal .....	8-8p	60
Information Office .....	9-9t	62
Inspector General .....	10-10b	64
<b>SECTION II</b>		
Part I - Observations (Lessons Learned)		
Operations .....	1-1m	65
Intelligence .....	2-2b	68
Logistics .....	3-3b	69
Other .....	4-4d	70
Part II - Recommendations		
Operations .....	1-1b	71
Training .....	2	71
Logistics .....		

**SECRET**

Doc 028-67

REGRADED UNCLASSIFIED  
WHEN SPARATED FROM  
CLASSIFIED INCLOSURES

5  
**SECRET**

DEPARTMENT OF THE ARMY  
HEADQUARTERS - I FIELD FORCE VIETNAM  
APO San Francisco 96350

AVFA-GC-OT

11 Mar 67

SUBJECT: Operational Report/Lessons Learned for Quarterly Period  
Ending 31 January 1967

TO: SEE DISTRIBUTION

1274

18 OACSFOR 19 OT-RD-670227

SECTION I - SIGNIFICANT ORGANIZATION OR UNIT ACTIVITIES

1. (A) General:

a. In November, December 1966 and January 1967, United States and Free World Military Forces (FWMF) with 41 maneuver battalions, 23 US and 18 ROK, supported by 23 artillery battalions, and Army Vietnam (ARVN) with 30 maneuver battalions supported by 6 artillery battalions, continued operations primarily in the west along the Cambodian-Republic of Vietnam (RVN) border in Darlac, Pleiku and Kontum Provinces; and along the east coast in Binh Dinh, Phu Yen and Binh Thuan Provinces. Along the Cambodian/RVN border, combat operations were primarily oriented toward interdiction of enemy infiltration routes. On the east coast operations were oriented on search and destroy and revolutionary development.

b. During the reporting period US/FWMF in II Corps Tactical Zone kill ratio was 10.2 to 1. Enemy losses for the period were 4,269 KIA (8C), 1203 captives and 1709 individual and 134 crew served weapons captured.

2. (C) Intelligence:

a. General: During the past quarter new staff activities organized by the close of the previous report, to improve the production and dissemination of intelligence continued to function within the scope of the initial guide line. On 29 Nov 66, an intelligence conference hosted by G2, I FFORCEV was held at this headquarters. Conferrees included representatives of II Corps ARVN G2, II Corps Advisory Group and J2 ROK Field Command Vietnam. The scope and results of the conference are attached as inclosure 1. A second conference hosted by II Corps was held in Pleiku on 25 Jan 67. Results will included in the next report. On 17 Dec 66, the C-2 Detachment, Company B, 5th Special Forces Group came under OPCON to HQ I FFORCEV. Once again, the scope of the intelligence effort of this headquarters was expanded. No reporting requirement changes were effected by this expansion; however, the flow of information with Special Forces units will be direct and will result in an improved overall intelligence picture.

b. Significant Sources, Agencies, and Techniques:

(1) Ground reconnaissance continued to provide the most reliable means of confirming the presence and actual locations of enemy troops in the area of operations, with special agent reports providing the most timely information of general locations, movements, and indications of future operations.

Handwritten scribbles and initials.

**SECRET**

DOWN GRADED AT 3 YEAR INTERVALS  
DECLASSIFIED AFTER 12 YEARS  
DDC DIR 5200.10

FOROTRD  
67 0227

- 1 -

DDC CONTROL  
NO. 82935

*CONFIDENTIAL*

6

AVFA-GC-OT

SUBJECT: Operational Report for Quarterly Period Ending 31 January 1967,  
RCS CSFOR-65 (U)

(2) Captured documents, enemy captives, and ralliers continued to be the primary sources of reliable order of battle information. Four ralliers during December confirmed the presence of the 1st Bn Regt in Khanh Hoa Province, northwest of Nha Trang. The most significant identification was the confirmation of the 10th NVA Division and 95th Regt in the western highlands. This was based on captives and documents all taken during Operation PAUL REVERE II and IV. Based on captured documents and a rallier, the 551st Signal Bn has been accepted as a support battalion of the 3d NVA Division. Captives taken by the Cap ROK Inf Div were identified as stragglers from all three battalions of the 95th NVA Regt in Phu Yen. Two captives taken during Operation FARRAGUT substantiated the numerous agent reports of integration of NVA into VC Main Force and Local Force units. Timely and accurate exploitation of the vast amount of information continues to be slowed by the inadequate number of US personnel proficient in the Vietnamese language; and the lack of photo copiers at division level to reproduce captured documents. An indication of the shortage of US personnel proficient in Vietnamese is shown by comparing the number of authorized interrogators (linguists) in the 55th MI Det versus assigned. Although there are 10 interrogators assigned against 11 authorized positions, only one is Vietnamese proficient.

(3) Poor weather in the eastern half of the II CTZ severely restricted aerial surveillance throughout the period. In some areas, particularly in Binh Dinh and Phu Yen Provinces, many targets were not covered during the entire quarter. Maximum advantage must be taken of periods of good weather to reduce large gaps in the coverage of a given area. Sufficient reconnaissance aircraft were not available to cover all targets requested. Care must be taken to insure that the most lucrative targets receive priority on coverage. Strict adherence to priorities and dates no longer of value (DNLV) is mandatory. Maximum use must be made of prior coverage to fill photo requests to reduce the requirements on resources available. Care must be taken to avoid excessive photo coverage of any given area since this overloads production and analysis facilities. In most areas, photo coverage every two to four weeks is sufficient to determine changes in enemy activity. Only the most critical targets should be photographed more frequently. However, repetitive Red Haze coverage can be used to provide a data base for determining the significance of items noted on new missions. Coordination between II Corps Advisory Group and US/FWMAF units on reconnaissance in TAORs and AOs was much improved during the period. Requests submitted through advisory channels must be coordinated with the US/FWMAF unit in the TAOR/AO to prevent conflict with tactical operations. When this coordination has not been made, the request is delayed at I FFORCEV until coordination can be made. Several administrative changes were made to improve the operational efficiency of the G2 Air Section. MACV request numbers allocated to I FFORCEV were sub-allocated to OPCON units. This will allow faster processing of requests and will simplify coordination. A new aerial surveillance log was adopted, combining all data previously maintained in two separate logs. This greatly reduces the chance of error in processing requests. Immediate Photo Interpretation Reports (IPIR) are now disseminated by TWX rather than by courier, providing more timely intelligence information to the using units.

(4) The integration of the Order of Battle and Editorial Sections of the 55th MI Det into the operations division continued to produce excellent results. Although the collection division has been in existence for only a short period of time, the collection and dissemination of enemy information has shown a marked improvement.

*CONFIDENTIAL*

7

CONFIDENTIAL

AVFA-GC-OT

SUBJECT: Operational Report for Quarterly Period Ending 31 January 1967,  
RCS CSFOR-65 (U)

(5) The Intelligence Exchange Center reported as newly formed in the last quarter, has been functioning according to expectations. Experience now indicates that the most active using agencies of the facility other than this headquarters are: CRD, CSD, ROK MI Det in support of ROKFV-FC, JTAD, Intelligence Advisor to Khanh Hoa Sector, Intelligence Advisor to Coastal Surveillance Group - Navy, 5th SFGA S2, and 524th CI Det. This center has proven to be a convenient method for local agencies to disseminate information and request essential elements of information.

(6) During the period, 62 individual weapons, 12 crew-served weapons, 445 pounds of uniforms and equipment, and 955 pounds of medical supplies were evacuated to Saigon for technical intelligence examination. Interrogation teams in support of combat operations were deployed to Phan Thiet, Tuy Hoa, Pleiku, and Hammond. These teams screened 794 detainees and interrogated 133 PWs. Captured documents were screened and 65 feet, one inch of documents were forwarded to Saigon for exploitation.

c. Deviations from current intelligence doctrine: No changes from previous quarter.

d. Significant changes from previous report: None

e. Enemy Order of Battle:

(1) Disposition of NVA and VC main force is shown at inclosure 2; VC local force at inclosure 3.

(2) NVA and VC regular and irregular forces continued to suffer heavy losses throughout the VI CTZ during the reporting period. Despite these losses, evidence indicates that the enemy is capable of rebuilding his troop strength by means of infiltration of NVA, upgrading of VC irregular to VC main force and local force, recruiting and/or forced conscription. This is further amplified by a PW and agent report that the 2d VC Regt had received 1300 replacements during December. Additionally two PWs taken in Ninh Thuan Province, one of whom was an NVA stated that NVA personnel are being integrated into VC main and local force units. There is continuing evidence that the enemy is upgrading his efforts evidenced by the confirmation of the 10th NVA Division in the western highlands and the 7th NVA Division in Phuoc Long Province adjacent to the Quang Duc Province border. At the local level, evidence continues to be received indicating formation of new units particularly in the Military Region VI Provinces of II CTZ where enemy activity has increased over the previous reporting period.

(3) Enemy losses during the period:

NOVEMBER 1966

<u>FORCES</u>	<u>TOTAL KIA</u>	<u>VCC/NVAC</u>	<u>INDIV WPNS</u>	<u>C/S WPNS</u>
US	1272	113	280	60
FWMAF	491	186	176	8
TOTAL	1763	299	456	68

CONFIDENTIAL

CONFIDENTIAL

8

AVFA-GC-OT

SUBJECT: Operational Report for Quarterly Period Ending 31 January 1967,  
RCS CSFOR-65 (U)

DECEMBER 1966

<u>FORCES</u>	<u>TOTAL KIA</u>	<u>VCC/NVAC</u>	<u>INDIV WPNS</u>	<u>C/S WPNS</u>
US	800	101	300	28
FWMAF	147	103	332	3
TOTAL	947	204	632	31

JANUARY 1967

<u>FORCES</u>	<u>TOTAL KIA</u>	<u>VCC/NVAC</u>	<u>INDIV WPNS</u>	<u>C/S WPNS</u>
US	864	123	222	4
FWMAF	695	577	399	31
TOTAL	1559	700	621	35

(4) Enemy strength within II CTZ as of 31 Jan 67.

21,225 - NV Troops

11,345 - VC Regulars

3,400 - Combat Support Troops

16,900 - Militia (VC Irregulars)

12,585 - Political Cadre

65,455 - TOTAL

f. Weather:

(1) During the first three weeks of November II Corps experienced generally good weather. Days were characterized by light northeast monsoonal weather. Northern coastal sections had ceilings of 1500-2000 feet broken to overcast and a few light rain-showers until late morning. Ceilings lifted to 2500 feet by mid-afternoon. Interior sections and coastal sections south of Nha Trang had patchy morning fog until 0900 hours and only isolated light rainshowers in the morning and late afternoons. On 24 Nov 66, tropical storm "Nancy" brought three days of heavy rainshowers, low ceilings of 300 to 500 feet, visibilities of 1/4 to 1/2 mile and gusty surface winds of 30 to 40 knots to coastal and interior sections. A cold front following the storm brought ceilings of 500 to 1500 feet overcast and heavy rain to the coastal sections from 1-3 Dec 66. Surface winds gusted to 40 to 50 knots. Bad weather continued for the next week along the coast with 500 to 1000 foot ceilings and 1/2 to 3 mile visibility in rainshowers. Patchy fog lowered visibilities to 1/4 to 3 miles in the interior section until 0900 hours. For the rest of December coastal sections north of Tuy Hoa experienced typical monsoonal weather characterized by ceilings of 1000 to 1500 weather except for ceilings of 500 feet and visibilities of three to seven miles in rain and fog during the period 11-18 Dec 66. During the first week in January coastal sections had 800 to 1500 foot ceilings and low visibility due to moderate rainshowers. Surface winds 1-2 Jan 67 had ceilings of 1500 to 300 feet and visibilities of three to seven miles. Good weather prevailed throughout

CONFIDENTIAL

*CONFIDENTIAL*

AVFA-GC-OT

SUBJECT: Operational Report for Quarterly Period Ending 31 January 1967,  
RCS CSPOR-65 (U)

II Corps for the week 8-15 Jan 67. From 15 January to the end of the month northern coastal section had ceilings of 1000 to 2000 feet and visibilities of one to four miles in rainshowers until late morning. Afternoons were generally good except for strong gusty surface winds of 30 to 50 knots from 14-18 Jan 67. Interior sections had good weather during the last part of January except for widespread fog from 22-29 Jan 67 which restricted visibilities to 1/4 mile until 0900 hours.

(2) Effects of weather on operations were numerous during the period. A total of five troop movements were delayed and four cancelled due to heavy rains and fog along the coast north of Tuy Hoa. Over 1200 photo reconnaissance missions were either cancelled or ineffective due to heavy cloud cover and low ceilings. A total of 493 tactical air support missions were cancelled, with 362 cancellations coming during January. Seven hundred seventeen Red Haze missions were cancelled with 307 cancellations in November, 238 in December and 172 in January.

(3) Detachment 31, 5th Weather Squadron has the mission of supporting I FFORCEV and USARV tactical units in II CTZ. This support consist of:

## (a) I FFORCEV

1. Staff Weather Officer
2. Forecast Center for II CTZ
3. Climatological Support

## (b) 1st Cavalry Division Airmobile)

1. Forecaster support at base camp
2. Forecaster support at the Division Forward CP
3. Observation at An Khe airfield
4. Observation at Brigade Tactical CPs and Division Forward CP.
5. Climatological Support

## (c) 4th Infantry Division

1. Forecaster Support at base camp
2. Observation at base camp
3. Observation at base camps of subordinate brigades.
4. Observations at Brigade Tactical CPs
5. Climatological Support

## (d) 3/25 Infantry Division

1. Observations at the Brigade Tactical CP
2. Climatological Support

*CONFIDENTIAL*

CONFIDENTIAL

10

AVFA-GC-07

SUBJECT: Operational Report for Quarterly Period Ending 31 January 1967,  
RCS CSFOR-65 (U)

(e) 1/101 Airborne Division

1. Climatological Support
2. Direct weather support is not desired by this unit

g. Significant Enemy Activities:

(1) As the reporting period began, Operation PAUL REVERE IV continued with heavy contact in the Plei Trap valley. Elements of four regiments; 32, 33d, 88th, 95B and possibly the 101C were identified in contact. On 12 Nov 66, friendly elements came under intense mortar attack from 1800-1900 hours. An estimated 500-600 mortar rounds fell during the one hour period. This was followed by a coordinated attack from the north by an estimated two NVA battalions. Moderate to heavy contact continued in the western highlands until 19 Nov 66, when, after a sharp engagement on that date the enemy lost 166 KIA (BC). In late November evidence indicated that the enemy was withdrawing to the west into Cambodia and to the north in Plei Trap Valley area. 1st Bde, 101st Abn Div was committed on Operation PICKETT in the northern Plei Trap Valley area on 9 Dec 66 in an attempt to block enemy escape routes to the north. Contacts were light and sporadic. In an attempt to locate the 24th NVA Regt and exploit the base areas on 27 Dec 66, the 1st Bde, 101st Abn Div initiated operations in Dak Akoi Valley area. Although contact was light and sporadic, a large number of food caches were discovered and denied to the enemy. One large training area consisting of 50 structures was discovered and destroyed. Enemy casualties for Operation PICKETT were 63 KIA BC, 3 NVAC. Operation PAUL REVERE IV terminated on 31 Dec 66. Enemy casualties for the operation were 977 KIA (BC) and 90 VCC/NVAC.

(2) In Binh Dinh light to heavy contact continued with elements of the 18th and 22d NVA Regt. The 2d VC Regt reportedly located in southern Quang Ngai is believed to be once again in a position to launch offensive operations after a period of refitting and retraining of 1300 replacements. Activities in Binh Dinh have been characterized by a series of sharp engagements with battalion or smaller size forces. The 18th NVA Regiment remains in the vicinity of Eagles Claw-Soui Ca Valley area widely dispersed and combat ineffective. It is possible that command elements of the 18th Regiment have moved north to An Lao Valley area. The 22d NVA Regiment after suffering 212 KIA (BC) in late December possibly in an attempt to extricate the 18th Regiment, withdrew to its normal AO north of Bong Son. On 19 Jan 67, TF 3d Bde, 25th Inf Div, operating in the Soui Ca Valley uncovered numerous tunnel and cave complexes. Many types of ammunition, weapons, clothing, communication equipment, medical supplies and equipment as well as a large number of documents were captured. On 23 Jan 67 charges detonated in one cave, resulting in six or seven massive secondary explosions and blew a gap in the side of a hill 100 meters long. On 27-28 Jan 67, the 1st Cav Div (AM) reacting to reliable intelligence, made contact with the 7th and 8th Bns of the 22d NVA Regiment north of Bong Son. Cumulative enemy losses from these contacts were 77 KIA (BC).

(3) In Phu Yen during the period, activity was characterized by sporadic contacts with elements of the 5th NVA Division, the 95th Regiment and local VC units. In Khanh Hoa Province after many months of very little hard intelligence on enemy order of battle, four ralliers provided significant information regarding the location and future intentions of the

CONFIDENTIAL

CONFIDENTIAL

AVFA-CC-JF

SUBJECT: Operational Report for Quarterly Period Ending 31 January 1967,  
RCS CSFOR-65 (U)

18B NVA Regiment in northern and central Khanh Hoa Province. The information indicated that the 18B was stockpiling food and preparing for offensive operations in the Ninh Hoa and Nha Trang areas against ROK and ARVN installations.

(4) Enemy activity in the five southern provinces of II CTZ has increased significantly over the last reporting period. On 24 Nov 66 in Tuyen Duc Province a communications convoy was ambushed resulting in 9 friendly killed. In Lam Dong Province on 29 Nov 66, an ARVN convoy 5 kilometers east of Bao Loc was ambushed resulting in 27 ARVN killed. There were continuing reports that the enemy would attempt to attack district towns RF/PF outposts and other isolated facilities almost at will. The last significant action was on 17 Jan 67, when elements of the 482d Bn attacked Fort Pitt north of Phan Thiet while at the same time an unknown size enemy force enroute to mortar Phan Thiet airfield sprang a friendly ambush south of the airfield.

(5) As the period came to a close, once again, there were indications that elements of the 1st NVA Division were deploying into southern Kontum. Additionally it is possible that elements of the 10th NVA Division have re-entered this area or northwestern Pleiku. There have been agent reports and sightings that indicate the possibility of a new NVA Regiment infiltrating into Binh Dinh Province, although there was no hard intelligence available to substantiate these reports. On 7 Jan 67, Holloway Airfield in Pleiku Province was attacked by the enemy. The enemy using mortar, hand grenade and small arms fire, penetrated to the center of the airfield and placed satchel charges and grenades in bunkers. As estimated 207 82mm mortar rounds were received from 10 enemy firing positions within 20 minutes. Friendly casualties were six US KIA, 51 WIA. Twenty-three aircraft were damaged. The enemy used telephone deception prior to and during the attacks. During the primary attack, an unidentified person, speaking fluent English, free of any accent, made numerous telephone calls in the Holloway complex designate to create confusion and indecision. Guerrillas and terrorist activities have increased in Pleiku. One report stated that a company from the 95B Regiment had been left behind in Pleiku Province to conduct guerrilla warfare. This may account for the increase in this type activity throughout the province.

h. Enemy Capabilities, Vulnerabilities and Probable Courses of Action: Based on the enemy's order of battle and trends at the end of the period, the enemy's capabilities, vulnerabilities and probable courses of action were viewed as follows:

(1) Enemy Capabilities:

(a) In Binh Dinh Province, attack separate objectives with two comb. effective regiments, and one combat ineffective regiment supported by elements of division support units. Attack in Khanh Hoa with one combat effective regiment supported by district forces. Attack in northern Phu Yen with one combat ineffective regiment, in conjunction with division attacks by LF and MF units, supported by divisional support elements. Attack in southwestern Kontum, western Pleiku, and northern Darlac with one division of two combat effective regiments, and one understrength regiment, a second division of two combat effective regiments, and one possible combat ineffective regiment in separate attacks of up to multiregimental strength. Attack in the remainder of II CTZ with local forces and main forces units of up to multibat-talion strength supported by guerrilla forces.

(b) Attack isolated outposts, installations, and units with up to reinforced battalion strength in any province in conjunction with attempts to ambush relief forces.

CONFIDENTIAL

*CONFIDENTIAL*

12

AVFA-GC-OT

SUBJECT: Operational Report for Quarterly Period Ending 31 January 1967,  
RCS CSFOR-65 (U)

(c) Conduct holding or diversionary attacks against I FORCEV OPCON units anywhere in II CTZ in support of offensive operations in II CTZ or in other Corps areas.

(d) Continue harassment, sabotage, assassination and probing activities throughout the II CTZ.

(2) Enemy Vulnerabilities:

(a) The enemy is generally short of medical and food supplies, and in the coastal areas is experiencing difficulties in providing individual replacements for NVA and VC units.

(b) Enemy LOCs are extended and insecure, with the exception of those traversing neutral countries or international waters where some degree of security exists.

(c) Low enemy morale is vulnerable to exploitation by friendly psychological warfare operations.

(3) Discussion and Analysis: As discussed and analyzed in paragraph (5) above, in the western highlands, there is strong evidence that elements of the 1st and 10th NVA Division are once again deploying from their Cambodian sanctuary into southern Kontum and western Pleiku Province. In Binh Dinh the 18th NVA Regiment continues to suffer heavy casualties and is combat ineffective, while the 22d NVA Regiment after suffering heavy losses in late December and January is considered marginally combat effective. The 2d VC regiment in southern Quang Ngai once again possesses an offensive capability after refitting and retraining. Elsewhere in II CTZ, continued reports and minor contacts indicate that the enemy will continue in his efforts to control the population and agricultural resources within II CTZ with emphasis possibly shifting to the southern part of the Corps zone.

(4) Relative Probability of Adoption:

(a) Avoid decisive contact with major US/RVN/PWMAF forces, unless a favorable opportunity for success become apparent, while continuing to harass vulnerable units and installations, overrun RF/PP outposts and district towns, where the chance of success is greatest, and continue low level guerrilla attacks.

(b) Attack in up to multiregimental strength in separate locations in northern Pleiku, southern Kontum and northern Darlac, possibly supported by artillery.

(c) Attack in up to regimental strength in northern Khanh Hoa Province, supported by local force and main force units.

(d) Attack in up to regimental strength in southern Quang Ngai, northern Binh Dinh Provinces, supported by local force and main force units.

*CONFIDENTIAL*

SECRET

AVFA-CC-OT

SUBJECT: Operational Report for Quarterly Period Ending 31 January 1967,  
RCS CSFOR-65 (U)

## 3. (S) Operation and Training Activities:

a. Plans: Based on guidance, intelligence and the overall concept of strategy for conducting operations, the G3 Plans Division formulated and published three OPLANS and two Frag Orders during the reporting period. In addition to these operations, the Combined Campaign Plan for Military Operations in II CTZ, Fall 1966 - 30 June 1967 (U), was published and distributed. Also, one Frag Order and seven other plans are in the initial stages of development.

## (1) Scheduled Operations:

(a) FRAG ORDER 42-66, msg A-1526, dtg 030647Z Nov 66,  
(BLACK HAWK).

A reconnaissance, surveillance and patrolling operation conducted by Project OMEGA, 5th Special Forces Group, along the Cambodian/RVN border. OMEGA was scheduled for Operation BLACK HAWK during the period 14 Nov to 3 Dec 66. Planning for this operation was initiated through receipt of intelligence reports indicating continued use of the west central portion of Darlac Province as an infiltration route for troops and equipment into RVN.

## (b) OPLAN 51-66 (GERONIMO II)

Tasked the 1st Bde, 101st Abn Div to conduct search and destroy operations, oriented on the enemy, in the area of Dong Tre. This operation, following Operation GERONIMO I, and second in a three operation series, was planned in order to exert pressure against the 95th NVA Regt, suspected to be within the AO. D-Day was planned for o/a 1 Dec 66 for a duration of approximately 30 days. Cancellation on 8 Dec 66 was necessitated by requirement for 1st Bde, 101st Abn Div to be placed in the PICKETT AO (Msg B-3432, DTG 080641Z Dec 66).

## (c) OPLAN 52066 (GERONIMO III).

Tasked 1st Bde, 101st Abn Div to conduct search and destroy operations, oriented on the enemy, in the area of Van Canh. Planned as the final operation in a series of three, this operation was to continue pressure against the 95th NVA Regt and to uncover the 5th NVA Div HQ and VC/NVA base locations. D-Day was planned for o/a 1 Jan 67 for a duration of approximately 30 days. Cancellation on 8 Dec 66 was necessitated by requirement for 1st Bde, 101st Abn Div to be placed in the PICKETT AO (MSG B-3432, DTG 080641Z Dec 66).

## (d) OPLAN 130-66 (GEORGIA).

To support USARV Contingency Plan 68-67, Operation GEORGIA, provided for the diversion, while enroute from CONUS, of the 9th US Inf Div or elements thereof, to Qui Nhon for staging and transshipment to Chu Lai. I FFORCEV responsibilities were to exercise OPCON of 9th Inf Div elements while in II CTZ, provide for security of staging areas and routes, and in coordination with 1st Log Comd elements, to provide other support as necessary. The plan was cancelled because the 9th Inf Div, with all elements, was directed to areas outside of II CTZ (MACV msg (S) 03536, DTG 291201Z Jan).

SECRET

SECRET

14

AVFA-OC-OT

SUBJECT: Operational Report for Quarterly Period Ending 31 January 1967  
RCS CSFOR-65 (U)

(e) FRAG ORDER 3-67, Msg (S) A-0143, DTG 110650Z Jan 67  
(DAWES)

A reconnaissance, surveillance, and patrolling operation conducted by the OMEGA force, Det 50, 5th SFG along the Cambodian/Laotian/RVN border commencing c/a 22 Jan 67 for a period of approximately 30 days. Planning was initiated by intelligence which indicated that NVA troops and equipment were being infiltrated into II CTZ across the Laos/NW Kontum Province border. This operation is being held in abeyance.

(f) FRAG ORDER 1-67 (BYRD)

A three phase operation involving replacement of 2d Bn, 7th Cav (AM) by the 2d Bn, 5th Cav (AM). The first and third phases were exchange movement of units. During the second phase, the 2d Bn, 7th Cav (AM), would conduct a search and destroy operation in the MR-6 area in the northeast BYRD AO. The operation was scheduled to begin on 23 Jan 67, phase II being conducted from 25 Jan to 1 Feb 67. This operation has not been published and is being held in abeyance.

(g) FRAG ORDER 6-67 (PICKETT).

A cover and deception order written to screen the movement of the 1st Bde, 101st Abn Div into the Bao Loc area. The plan provided for the movement of one battalion (actual) and the brigade (-) (simulated) to Phan Thiet. Implementation of Operation GATLING I on 1 Feb 67 cancelled Operation PICKETT.

(h) FRAG ORDER 7-67 (GATLING I).

Provided for the employment of two battalions 1st Bde, 101st Abn Div, five MDE Force companies from Co B, 5th Special Forces Group and two CIDG companies from Tan Rai Special Forces Camp A-232 (in direct support) in an area 10 km northwest of Bao Loc.

(2) Outline plans are being developed for I FFORCEV operations in the following areas:

- (YCRK).
- (a) Southern Quang Ngai - Northern Binh Dinh Province
  - (b) Military Region 6.
  - (c) Central Darlac Province.
  - (d) Southeastern Darlac Province.
  - (e) Hanoi Base Area (HAMILTON).
  - (f) Contingency plan for reinforcing in western Kontum Provinces.

(3) Combined Campaign Plan for Military Operations in II CTZ, Fall 1966 - 30 June 1967 (U):

(a) In November 1966, HQ, I FFORCEV received from USMACV their Combined Campaign Plan 1967, AB 142. Coordinating instructions in

SECRET

SECRET

15

AVFA-GC-07

SUBJECT: Operational Report for Quarterly Period Ending 31 January 1967  
RCS CSFOR-65 (U)

this plan directed that I FFORCEV prepare and submit supporting plans to USMACV by 15 Dec 66. In view of this requirement and the necessity to achieve maximum efficient utilization of combat resources, G3, I FFORCEV, directed that a combined campaign plan be prepared. This plan would coordinate ARVN, ROK and US operations during the remaining weeks of 1966 and the first half of CY 1967. In order to insure full coordination of ARVN, ROK, and US operations, it was further directed that tasks outlined in the Combined Campaign Plan 1967 (MACV) and specific missions being assigned each national force, be outlined in increasing degrees of specificity. As a result, not only the overall mission and concept were given, but also the priority of general missions for each national force and specific goals to be achieved on a quarterly basis. A meeting of the G3's from II Corps, ROKFV FC, and I FFORCEV was held on 19 Nov 66 at HQ, I FFORCEV. A draft combined campaign plan was reviewed, with appropriate changes being made by all G3's. Following this meeting, copies of the plan were taken under further study by each headquarters.

(b) On 1 Dec 66 a second meeting was held at HQ, II Corps. The G3's resolved additional issues, proposed some minor changes, and generally agreed to the substance of the plan. Review of the plan by ARVN JGS during the first week of December, caused additional minor changes. These changes were incorporated and printing was accomplished. Unsigned copies were distributed to the headquarters involved as well as MACV J3 on 14 Dec 66. The G3's were unable to conduct a joint ceremony for signing the plan. On 26 Dec 66, COL Sohn G3 ROKFV FC and COL Hannum, G3, I FFORCEV affixed their signatures. When the document was carried to HQ, II Corps, LTC Cuong stated that CG, II Corps desired to make additional changes prior to the document's being signed. These changes were agreed to by all forces and included in the final printing. The document was signed on 2 Jan 67 by LTC Cuong, G3, II CTZ and on 10 Jan 67 the Combined Campaign Plan for Military Operations in II CTZ, Fall 1966 - 30 June 1967, was distributed.

b. Operational Activities:

(1) Frag Order Msg A-0584, DTG 250845 Aug 66 (BYRD).

(a) Operation BYRD, (Incl 4), which began on 25 Aug 66, continued in Binh Thuan Province with Task Force 2d Bn, 7th Cav, 1st Cav Div (AM) conducting military operations in support of the Revolutionary Development program (Op HOP LUC). Op HOP LUC began on 16 Nov 66 with two battalions of the ARVN 44th Inf Regt and RF/PF force in the area concentrating their efforts on the TRIANGLE area north of Phan Thiet, generally astride Highway 8. Elements of the 44th Regt have patrolled to the east and west of Highway 8, with Task Force 2d Bn, 7th Cav operations characterized by numerous company sized helicopter assaults and search operations.

(b) Elements of the VC Local Force 482d Bn, although fragmented by aggressive offensive action by both US and ARVN forces, continue to maintain the capability of regrouping for company sized or larger attacks on RF/PF outposts and sub-sector headquarters.

(c) Effectiveness of operations in the vicinity of Phan Thiet have resulted in the neutralization of a recognized VC secret base area just north of the city.

(d) On 29 Dec 66 for the first time since the operation began, B-52 strike was placed into a suspected VC location. The strike

SECRET

SECRET

16

AFSA-43-07

SUBJECT: Operational Report for Quarterly Period Ending 31 January 1967  
RCS CSFOR-65 (U)

was exploited by a three company heli-assault by elements of Task Force 2d Bn, 7th Cav. Assessment of the target area showed damage to a VC CP area, 1 VC killed (BC) and indication of several other wounded or killed, 4 small arms and a number of documents captured.

(\*) On 5 Jan 67 Co B, 2d Bn, 7th Cav with one Co, 3d Bn, 44th Regt ARVN conducted a combined helicopter assault and search/patrolling operation astride Highway 1 southwest of Phan Thiet. Contact with an unknown size VC force resulted in no friendly losses and 7 VC KIA, 2 VC PW, 2 detainees, 7 small arms and 15 tons of rice captured.

(f) On 11 Jan 67 Co A, 2d Bn, 7th Cav with one platoon 3d Bn 44th Regt ARVN found and destroyed a VC training center vicinity ZT 243365. During the same day Co C, 2d Bn, 7th Cav found classrooms and sleeping quarters for 40 - 50 men vicinity ZT 213378. A battalion size mess hall, blacksmith shop and sleeping quarters were discovered in vicinity ZT 213376. At ZT 213376 a manufacturing area for hand grenades and rifle stocks were destroyed and at ZT 212374 several bunkers, huts, documents, small arm ammunition, and 200 pounds of milled rice were found. A captured VC in the area stated that a battalion size unit had occupied the complex six days earlier.

(g) Extensive patrolling and ambushes produced no significant contact or results until 16 Jan 67 when a series of small contacts were made. In one action vicinity AN 7917 gunships engaged an estimated VC squad killing 7 VC. The total results for the day were 5 friendly WIA and 9 VC KIA, 3 VCC and 5 detainees.

(h) On 19 Jan 67, one contact by Co D, 2d Bn, 7th Cav with 15 VC vicinity AN 7424 resulted in 5 VC KIA, 3 small arms and 1 complete 60mm mortar captured with only 1 US WIA. In the same area, the company found a company plus size camp site with 50 fires still burning; however, search and ambush operation produced no results.

(i) Co B, 2d Bn, 7th Cav with one platoon 4th Bn, 44th ARVN Regt, while conducting a joint long range patrol found a battalion-size fortified living complex vicinity EN 0619. The complex, which included 80 - 85 structures with roofs flush with the ground and many tunnel entrances, was destroyed by burning and caving in buildings.

(j) Combat losses for the operation at the end of the reporting period are:

<u>ENEMY LOSSES</u>	<u>FRIENDLY LOSSES</u>
KIA 351	KIA 8
Captured 154	WIA 31
Detainees 491	
Small Arms 85	
C/S Weapons 1	

(2) Operation Hooker (TF 777)

SECRET

17

SECRET

AVFE-GC-OT

SUBJECT: Operational Report for Quarterly Period Ending 31 January 1967  
RCS CSFOR-65 (U)

(a) Operation HOOKER II (TF 777) began 10 Oct 66 and ended 9 Nov 66. TF 777 composed of one MIKE Force, one reconnaissance platoon and 1 USSF "A" Detachment had the mission to infiltrate the area of the border southwest of Kontum City. The TF was to conduct border surveillance, interdiction of infiltration routes, and guerrilla operations against VC installations.

(b) On 10 Oct 66 TF 777 was airlifted into the area vicinity YA 9080 without contact. The force then infiltrated into the northern Plei Trap area, but there was no significant contact until 5 Nov 66 when the TF 777 had 4 small contacts. These contacts resulted in the discovery of a so-called main infiltration route running from northwest to southeast from YA 7186. They were extracted from the AO on 9 Nov 66. Although this operation had no major contacts, it provided significant information as to a possible supply route being used by the enemy from Cambodia. Total casualties: Friendly: 3 KIA; Enemy: 11 killed, 1 small arm captured.

(3) OPLAN 19-66 (PAUL REVERE IV)

(a) Operation PAUL REVERE IV (Incl 5), a continuation of border surveillance in the western highlands, began 18 Oct 66 and ended 31 Dec 66. Mission of the six maneuver battalion size force (4th Inf Div - 1/12, 1/22, 2/8; and 3d Bde, 25th Inf Div - 1/14, 1/35, 2/35) was to reconnoiter and maintain surveillance of the Cambodian border, conduct ambushes and block enemy penetration into assigned AO.

(b) On 8 Nov 66 TF PRONG with two CIDG companies and one MIKE Force was committed west of the Nam Sathay River to conduct screening operation along the border. At 10440H one CIDG company made contact with an estimated three company size enemy force in the vicinity YA 605515. Co B, 1st Bn, 2d Inf committed to reinforce at 1130H. The fire fight continued until 1905H when the enemy broke contact.

(c) At 11105H Nov 66 elements of TF PRONG were again reported heavily engaged with an unknown size enemy force in the vicinity YA 565542. Co A and Co C, 1st Bn, 12th Inf were committed to reinforce at 1210H; however, contact was broken at 1310H. Results of actions on 9 - 11 Nov 66 were: 2 USSF KIA, 8 USSF WIA, 13 CIDG KIA, 20 CIDG WIA; Enemy: 49 KIA, 2 NVAC. During the action on 11 Nov 66, six helicopters were lost. Five (2 UH-1D, 2 UH-1B) were hit by enemy ground fire west of the Nam Sathay, and one HU-1D crashed at Plei Djereng after being hit by ground fire in the vicinity of the contact. The aircraft losses resulted in 7 KIA and 6 WIA.

(d) At 121805H Nov 66, Headquarters Command element, Co A and Co C, 1st Bn, 12th Inf and Btry B, 4th Bn, 42d Arty were subjected to an intensive mortar attack in the vicinity of YA 592568 until 1915H. Some 500 - 600 82mm mortar rounds were received, followed by coordinated ground attack from the west and north by a force estimated to be two NVA battalions. Units were engaged until 2340H when the enemy broke contact. At the time the attack began, the two infantry companies of 2d Bn, 12th Inf and the supporting artillery had been in the position approximately 28 - 31 hours. Result of the action: Friendly: 6 KIA, 21 WIA; Enemy: 76 NVA KIA, 2 NVAC.

(e) At 131200H Nov 66, Co A, 1st Bn, 14th Inf became engaged with a company size NVA force in the vicinity of YA 565410. Fighting

SECRET

SECRET

18

AVFA-CC-OT

SUBJECT: Operational Report for Quarterly Period Ending 31 January 1967  
RCS CSFOR-65 (U)

continued until 1245H. At 1530H the company again was in contact with a two-company size NVA force. Co C, 1st Bn, 14th Inf was committed to reinforce, and linked-up at 1700H. At 1705H contact was broken by the enemy. Results of the two engagements: Friendly: 15 KIA, 38 WIA; Enemy: 34 KIA.

(f) At 191200H Nov 66, Recon Platoon, Co B, 1st Bn, 14th Inf and one CIDG company were searching with the Recon Platoon in the center, Co B, 1st Bn, 14th Inf on the east and the CIDG company on the west. The force became engaged with an estimated two-company sized NVA force in the vicinity YA 6150. Initial contact was made by the CIDG company which subsequently, had to withdraw. Co C, 1st Bn, 14th Inf was committed to reinforce and deployed to the west flank where the CIDG company had been deployed, and immediately came under fire from the south. Within one hour the unit was receiving heavy fire from the west, Co B, 1st Bn, 14th Inf maneuvered to the west to assist and became heavily engaged. At this point the enemy force was estimated to be greater than two companies. Heavy contact continued until 1640H and then, during a period of sporadic contact, the two companies reorganized and began to sweep. Again, they immediately became engaged with contact continuing until 1800H. Co B and Co C, 2d Bn, 14th Inf began moving west after all firing ceased by 1945H. During the action it was noted that the enemy had many personnel in trees and employed very few hand grenades and mortars. Results of action were: Friendly: 19 KIA, 47 WIA, 1 USSF KIA, 1 CIDG KIA, 5 CIDG WIA; Enemy: 166 NVA KIA, 1 NVA PW.

(g) On 21 Nov 66, Co C, 1st Bn, 5th Inf was searching for what was believed to be new NVA forces just north of the Chu Pong area. After a brief contact by the lead platoon of a company sweep, the center platoon of the echelon left formation came up in the rear of a deployed enemy platoon and engaged. Additional NVA forces appeared rapidly and started working around both flanks. As the trailing platoon moved forward to assist, it became heavily and closely engaged. Two assaults on their position were repelled, but third assault, by an NVA force estimated by a survivor to number between 150 and 200 men, swept through the platoon. During the mop up, the enemy killed all the wounded they could find. Co A, 1st Bn, 5th Cav was air assaulted into blocking positions; however, it had only light contacts as the enemy moved west across the border. The enemy route of withdrawal was located by aerial observers and was brought under artillery fire. Results of the action: Friendly: 34 KIA, 11 WIA; Enemy: 147 KIA.

(h) Combat losses for the operation were:

<u>ENEMY LOSSES</u>		<u>FRIENDLY LOSSES</u>	
KIA	977	KIA	156
Captured	90	WIA	466
Detainees	331		
Small Arms	280		
Crew Served Wpns	28		

SECRET

SECRET

19  
AVFA-OC-OT

SUBJECT: Operational Report for Quarterly Period Ending 31 January 1967  
RCS CSFOR-65 (U)

(4) OPLAN 42-66 (THAYER II)

(a) Operation THAYER II (Incl 6), which began on 25 Oct 66, continues in Binh Dinh Province. 1st Cav Div (AM) continued operations to accomplish search and destroy mission with forces ranging in size from 2 to 6 maneuver battalions. Operations have been designed to seek out and destroy elements of the 3d NVA Div. Energetic ground and helicopters operations continued to destroy the enemy forces piecemeal.

(b) During the period 13 Nov 66 to 21 Nov 66, a combined operations was conducted with four battalions 22d ARVN Div. The mission of the operation was to clear the recent area west of Dam Tra O Lake. US elements conducted blocking and search operation in the Nui Mieu Mountains and along the high ground west of the lake. ARVN elements conducted search operations to the south toward the US blocking positions. This operation failed to produce significant results.

(c) On 17 Dec 66 Co C, 1st Bn, 8th Cav surprised and routed a VC squad in the Suoi Ca Valley. In the pursuit, contact was made with a strong enemy force and elements of two battalions were deployed into the area. The enemy force was found to be a reinforced battalion in well prepared bunkers and field fortifications. The primary effort on 17 Dec 66 was to encircle the enemy while attacking with forces in contact. Artillery supported the action with approximately 2,300 rounds, and nine sorties of tactical air attacked in the target area. Active contact ceased at 1800H; however, on the morning of the 18 Dec 66 light and sporadic contacts were made throughout the area. A NVA PW revealed the enemy force to be elements of the 7th and 8th Battalions, 18th NVA Regt. Combat losses for this action were: Friendly: 34 KIA, 70 WIA, 5 UH-1D and 20 OH-13 damaged by enemy fire; Enemy: 116 NVA killed, 3 NVA PW, 10 small arms and 3 crew served weapons captured. Most of the friendly casualties occurred during the time the enemy position was being developed.

(d) On 27 Dec 66, a fire support base manned by Btry C, 6th Bn, 16 Arty (155 How), Btry B, 2d Bn, 19th Arty (105 How) and Co C, 1st Bn, 12th Inf was attacked by the 22d NVA Regt (-). At 0100H the base was attacked with mortar and heavy weapons fire from the northeast and southwest. Close in fighting continued with enemy elements outside the perimeter until 0200H when the enemy broke contact and withdrew. Results of this action were: Friendly: 24 KIA, 48 WIA, one 155mm destroyed and two 155mm damaged.

(e) On 17 Jan 67, 2d Bde, 1st Cav Div (AM) conducted operations in conjunction with the 40th ARVN Regt north of Bong Son. Significant casualties were inflicted upon the enemy through sporadic fighting on 18 Jan 67, resulting in 32 enemy KIA, 2 NVA PW and 23 VC PW. In a subsequent combined US/ARVN operation north of Bong Son, Co B, C and D, 1st Bn, 12th Cav assaulted into LZ 1A and swept south toward blocking positions established by the 40th ARVN Regt and an ARVN Airborne Task Force in vicinity BS 9101, BS 9200 and BS 9401. Results for the combined 2 days action on 19 and 20 Jan 67 were: 45 VC KIA, 55 VC PW and 2 NVA PW.

(f) In the Kim Son area during this same period 1st Bde, 1st Cav Div (AM) with two battalions began an intensive Psy Ops campaign to capitalize on the upcoming TET holiday. Throughout January, the 1st Bde was engaged in sporadic fighting in the Kim Son Valley and Highway 506 Valley; however, no significant contacts were made. Co B, 1st Bn, located a large tunnel complex on 19 Jan 67 in vicinity BR 7265. The search of

SECRET

SECRET

20

AVFA-GC-CT

SUBJECT: Operational Report for Quarterly Period Ending 31 January 1967  
RCS CSFOR-65 (U)

this area resulted in several actions wherein 18 NVA were killed, and one officer captured along with a vast quantity of material, including 11 small arms and 10.5 million piasters.

(g) On 26 Jan 67 the ARVN Airborne Task Force was replaced at English Airfield by an ARVN Marine Task Force of comparable size.

(h) Based on intelligence reports, the 2d Bde, 1st Cav Div with two companies air assaulted into the vicinity of the Bull Eye BS 9105, on 27 Jan to conduct reconnaissance in force. Heavy contact was made by Cos B and C, 2d Bn, 12th Cav immediately upon closing into their LZ's at 1356H. By 271700H Co A, 1st Bn, 5th Cav, 2 battalions from the 40th Regt and the 3d and 4th battalions 4th ARVN Marine Task Force were committed into positions north and south of the area of contact. The enemy, which intelligence reports indicate were the 7th and 8th Bns, 22d NVA Regt, broke contact at 2000H. Results of the contact and the following days search of the same area were: Friendly: 4 KIA, 29 WIA; Enemy: 71 KIA, 10 VC PW, 1 NVA PW, 1 IMG, 8 small arms and 20 82mm mortar rounds captured.

(i) Combat losses for this operation to date are:

<u>ENEMY LOSSES</u>		<u>FRIENDLY LOSSES</u>	
KIA	1529	KIA	184
Captured	102	WIA	747
Small Arms	331	MIA	2
Crew Served Wpns	28		

(5) OPLAN 49-66 (ADAMS)

(a) Operation ADAMS (Incl 7) began 260000H Oct 66 with the 1st Bde, 4th Inf Div committing three battalions 1/8, 3/8 and 2/12 in zone. Initially, the operation was a continuation of the rice harvest mission in the Tuy Hoa/Tuy An area. When the autumn rice harvest ended, the primary mission of the brigade became search and destroy. Very light contact was experienced through 5 Nov 66. At this time reliable intelligence had confirmed the location of the 95th NVA Regt in the "HUB" area south of Dong Tre. The decision was made to commit the 1st Bde, 101st Abn Div in the Dong Tre area (ADAMS AO). The plan envisioned joining combat forces available in Operation ADAMS and GERONIMO I into a coordinated operation to destroy the 95th NVA Regt. The scheme of maneuver was to block on the south (north of the Song Ba River) with three battalions of the 47th ARVN Regt; and to conduct combat assault with two battalions of the 1st Bde, 101st Abn Div (1/327 and 2/502) in the west in an attempt to encircle the enemy forces. At 060615H Nov 66, the coordinated Operation ADAMS/GERONIMO I was launched.

(b) There were no major contacts; however, significant losses were inflicted on the enemy by means of series of small contacts. The effectiveness of the 95th NVA Regt was seriously reduced. On 6 Dec 66, the 1st Bde, 101st Abn Div was extracted and committed into the western highlands.

SECRET

SECRET

AFPA-9C-07

SUBJECT: Operational Report for Quarterly Period Ending 31 January 1967  
RCS CSFOR-65 (U)

(c) On 14 Jan 67 Co C, 3d Bn, 12th Inf moved from the western portion of the AO by airlift to the vicinity of CQ 0371 and began combined operations with elements of the 47th ARVN Regt. On 15 Jan 67 the 3d Bn, 8th Inf Long Range Patrol sighted 100 NVA vicinity BQ 8656 moving northwest, artillery and TAC air was called in. Aerial reconnaissance of results indicated an estimated 30 NVA KIA. Herbicide missions were conducted on 21 Jan 67 on 600 hectares of an area containing rice seedlings vicinity BQ 7373 and BQ 7586.

(d) The 1st Bn, 8th Inf was withdrawn from the ADAMS AO and beginning 260730H Jan 67 redeployed to SAM HOUSTON AO for OPCON of 4th Inf Div.

(e) Small and scattered contacts with enemy forces continue, small unit helicopter assaults, saturation patrolling, rice crop protection and search operations characterized the activities.

(f) Combat losses for this operation to date:

<u>ENEMY LOSSES</u>		<u>FRIENDLY LOSSES</u>	
KIA	261	KIA	25
Captured	153	WIA	187
Small Arms	126		
Crew Served Wpns	1		

(6) OPLAN 50-66 (GERONIMO I)

(a) Operation GERONIMO I (Incl 8), with 1st Bde, 101st Abn Div began 310001H Oct 66 with the mission to locate and destroy elements of the 18 B NVA Regt believed to be operation in southern Phu Yen Province. The area of operation (AO) was from CQ 062000, west to BQ 500000, north to BQ 500500, east to the coast at CQ 172000.

(b) Three Army Republic of Vietnam (ARVN) battalions worked in coordination with the 1st Bde, 101st Abn Div in the operation. The brigade executed two battalions sweeps, with ARVN forces blocking likely routes of exfiltration.

(c) GERONIMO I started with the 2d Bn, 502d Inf and 1st Bn, 327th Inf conducting a night airmobile clandestine infiltration overland to Cung Son with the 2d Bn, 327th Inf as the brigade reserve reaction force.

(d) Upon closing, the 2d Bn, 502d Inf and 1st Bn, 327th Inf remained in their clandestine position southeast of Cung Son for three days. They began a sweep on converging axes with a search and destroy mission. Contact with the enemy throughout this period was light.

(e) Based on intelligence, the 1st Bde, 101st Abn Div was committed to a new portion of the AO on 6 Nov 66 confirming the presence of elements of the 95th NVA Regt in the "HUB" area southeast of Dong Tre. 1st Bde, 4th Inf Div, was conducting Operation ADAMS in an

SECRET

SECRET

22

AVFA-GC-OT

SUBJECT: Operational Report for Quarterly Period Ending 31 January 1967  
RCS CSPOR-65 (U)

adjoining AO east of Operation GERONIMO. The brigade joined forces with 1st Bde, 101st Abn Div and encircled the enemy. The 1st Bde, 101st Abn Div closed to the east while three (3) ARVN battalions blocked likely avenues of escape to the south.

(f) No large contacts occurred; however, there was a significant number of engagements with small groups. This indicated the enemy had fragmented and attempted exfiltration from the combined ADAMS/GERONIMO AO. Interrogation of PW's confirmed the report that the enemy was short on supplies and food.

(g) On 042400H Dec 66, Operation GERONIMO I ended because intelligence on Kontum Province caused the immediate commitment of 1st Bde, 101st Abn Div to the area. GERONIMO II and III which were to follow GERONIMO I, were cancelled because of the deployment of the 1st Bde, 101st Abn Div to Kontum.

(h) Combat losses for this operation were:

<u>ENEMY LOSSES</u>	<u>FRIENDLY LOSSES:</u>
KIA 150	KIA 16
Captured 76	WIA 78
Detainees 67	
Small Arms 111	

(8) OPLAN 46-66 (PICKETT)

(a) 1st Bde, 101st Abn Div deployed to Kontum by air on 6 Dec 66 and subsequently deployed to the west on a search and destroy mission between Polei Kleng and the RVN/Cambodian border (Incl 9).

(b) The southern portion of the PICKETT AO is contiguous to the northern portion of PAUL REVERE IV AO and the 1st Bde, 101st Abn Div worked in coordination with forces of the 4th Inf Div to destroy the enemy in the Plei Trap area YA 7487. Intelligence indicated that the enemy was moving north into the Plei Trap Valley from the PAUL REVERE IV AO.

(c) On 090722 Dec 66, 1st Bn, 327th Inf and 2d Bn, 327th Inf conducted airmobile assaults into LZ's Lee and Meade, vicinity YA 7886 and YA 7496 respectively, and swept south in the AO with deliberate, methodical searches, of secondary and tertiary trails, paths, and stream beds to detect caches, base camps and trail networks. Simultaneously, 2d Bn, 502d Inf moved overland vicinity Polei Kleng during daylight hours and was the brigade's reserve/reaction force.

(d) The 2d Bn, 502d Inf air assaulted into LZ Sherman, vicinity YA 860910 on 3 Dec 66. The battalion conducted operations in zone on multiple axes east and west of the Dat Mo River until 260700H Dec 66 when the 1st Bde returned to Kontum. There were no significant contacts throughout this period. The most significant incident in the PICKETT Operation occurred on 11 Dec 66 when Co A, 1st Bn, 327th Inf discovered a weapons cache of 59 small arms, all old and in poor condition. On 27 Dec 66 1st Bde, 101st Abn Div began to conduct airborne training and combat

SECRET

*SECRET*

AVFA-3C-0T

SUBJECT: Operational Report for Quarterly Period Ending 31 January 1967  
RCS CSPOR-65 (U)

operations in the area northwest of Kontum.

(e) In a major violation to the New Year truce, Co C, 2d Bn, 502d Inf was attacked by an unknown size enemy force on 1 Jan 67 and suffered 6 KIA and 4 WIA. Enemy losses were unknown.

(f) The 1st Bn, 327th Inf was extracted from field operations on 2 Jan 67 and began airborne refresher training at Kontum. On the same day 2d Bn, 327th Inf air assaulted into the Dak Aoi region vicinity AS 8525.

(g) The 2d Bn, 502d Inf and 2d Bn 327th Inf continued search operations in the Dak Aoi region from 4 to 8 Jan 67 experiencing small contacts and locating abandoned enemy camp sites.

(h) On 5 Jan 67 the 23d ARVN Ranger Battalion joined the 1st Bde, 101st Abn Div in direct support of a three day combined search operation north of Kontum.

(i) 1st Bn, 327th Inf rejoined the brigade forces in the field on 9 Jan 67 and air assaulted into the northeast portion of the AP, conducting search operations vicinity AS 9226. On 13 Jan 67, 2d Bn 327th Inf air assaulted further north to vicinity AS 8634.

(j) 2d Bn, 502d Inf was heli-lifted to Kontum airfield on 14 Jan 67 and was the last battalion to undergo airborne refresher training.

(k) No further significant activity occurred and the 1st Bn, 327th Inf and 2d Bn, 327th Inf returned to Kontum airfield on 18 Jan 67. The airborne refresher training of the 2d Bn, 502d Inf was completed on 19 Jan 67.

(l) Operation PICKETT ended 192400H Jan 67. Except for the attack on Co C, 2d Bn, 502d Inf on 1 Jan 67, action during the period was characterized by light sporadic contact with the enemy.

(m) Combat losses for the operation were:

<u>ENEMY LOSSES</u>		<u>FRIENDLY LOSSES</u>	
KIA	63	KIA	23
Captured	18	WIA	104
Detainees	14		

(9) BLACK JACK 22.

(a) Operation BLACK JACK 22 (Incl 10) began 10 Dec 66 and ended 12 Jan 67. The guerrilla operation was conducted by TF 768 with the mission to perform interdiction of infiltration routes, conduct operations against known VC installation, and develop targets to be attacked by air and conventional FWMAF.

(b) A company size guerrilla force, led by a US Special Forces A Detachment, infiltrated the BLACK JACK AO in the Boung Valley,

*SECRET*

SECRET

24

AVFA-GC-OT

SUBJECT: Operational Report for Quarterly Period Ending 31 January 1967  
RCS CSFOR-65 (U)

moving southeast into the valley toward the headwaters of the Ki Boung River.

(c) During the period 1 to 8 Jan 67, the force made no significant contacts with the enemy; however, they did destroy numerous rice houses and rice fields. As a result of a fire fight with an unknown size VC force vicinity BP 342827, the guerrilla force commander was wounded and evacuated. The XO assumed command. Additional results of this contact were 1 USSF KIA and 2 friendly guerrillas KIA with the enemy suffering 11 VC KIA.

(d) On 11 Jan 67 the Buon Mi Ga Way Station 5 which was the main station supporting sub-stations 1,2,3, and 4 was destroyed. The sub-stations were also destroyed. These stations were very elaborate to include classrooms, mess halls and training areas. Also destroyed was 200 kilos of rice. On the same morning, the force ambushed 12 VC killing 4 of them. Along with assorted documents and rucksacks, they captured maps of Ban Me Thout area with 24 enemy locations marked on them and a transistor radio locked on 25 megacycles. The captured documents indicated enemy forces in the area to be two battalions, or elements thereof, and that the enemy had full details of the BLACK JACK Operation. The documents included planned offensive operation against our forces.

(e) By early afternoon on 12 Jan 67, the BLACK JACK force, located vicinity BP 336826 and BP 338825 reported they could not move without being ambushed. Although no significant contact was reported, in consideration of the critical tactical situation the guerrilla force was extracted from the AO.

(f) Cumulative results are: Friendly: 1 USSF KIA, 1 USSF WIA and 2 guerrilla KIA; Enemy: 11 KIA.

(10) OPERATION FARRAGUT.

(a) 1st Bde, 101st Abn Div began Operation FARRAGUT in the southern portion of II CTZ on 26 Jan 67. Mission for the operation was to locate and destroy enemy within secret base 35.

(b) On 26 Jan 67 Co C, 2d Bn, 502d Inf (-) moved to vicinity EN 7060 as part of a feint toward base area 35. On 27 Jan 67, 2d Bn, 502d Inf reoriented its direction of movement, deployed to vicinity EN 6868 and established blocking positions on the east side of base area 7.

(c) Also on 27 Jan 67 1st Bn, 327th Inf conducted multiple heli-assaults into the west of base area 7. 1st Bn, 327th Inf assaulted vicinity EN 5089 and 2d Bn, 327th Inf vicinity EN 5276. The two battalions then searched toward the east in an effort to trap the enemy against the blocking forces of the 2d Bn, 502d Inf.

(d) Results to date: 2 US WIA; Enemy: 3 KIA, 1 detainee and one small arm captured.

(11) OPERATION BLACK HAWK.

(a) Operation BLACK HAWK (Incl 11) began 14 Nov 66 and ended 12 Jan 67. The mission of BLACK HAWK was long range reconnaissance and surveillance of known enemy infiltration routes.

SECRET

SECRET

AVFA-GJ-OT

SUBJECT: Operational Report for Quarterly Period Ending 31 January 1967  
RCS CSFOR-65 (U)

(b) During the period 1 to 12 Jan 67, OMEGA teams were infiltrated into 8 areas in the vicinity of the Chu Pong Mountains. Approximately 3 teams were operational in the AO throughout the period. There was one major sighting of an unknown size NVA force and two immediate air strikes were called into the area; no results were reported. The teams found several bunkers, trails, and 3 way stations. Indications were that this area had not been used as a major infiltration route in the past three to four months. Teams were extracted 12 Jan 67.

## (12) OPLAN 19-66 (SAM HOUSTON).

(a) Operation SAM HOUSTON (Incl 5), a continuation of border surveillance in the western highlands began 1 Jan 67. The primary missions of the 4th Inf Div is to reconnoiter and maintain surveillance of the Cambodian Border, conduct ambushes and block enemy penetration into assigned AO. 3d Bde, 25th Inf Div with two battalions became OPCON to 1st Cav Div (AM) effective 3 Jan 67, and moved to THAYER II, leaving the 4th Inf Div with four Inf Bns and one tank Bn. There has been little contact since the operation began. Maneuver battalions performed security and surveillance missions by ground and aerial reconnaissance of areas bounded by the Cambodian border, Nam Sathay and Se San Rivers and along Highway 19 west to the Cambodian border.

(b) On 3 Jan 67 the 2d Bde CP located at YA 8445 was mortared. Approximately 50 rounds of 82mm mortar shells landed in and around the CP. The fire came from the south-southeast. Countermortar radar was employed with friendly mortars and artillery firing 873 rounds. Results: Friendly: 12 WIA; Enemy: Unknown.

(c) On 17 Jan 67 Co C, 2d Bn, 8th Inf while on a search mission located a hospital complex consisting of 45 huts vicinity YA 6853. The complex was destroyed.

(d) On 22 Jan 67 in a test to determine the division capability to reinforce the Duc Co CIDG Camp, the 1st Bn, 69th Armor was alerted for movement to the camp at 0540H to move two companies and a platoon from C Btry, 5th Bn, 16 Arty. This force closed Duc Co at 0700H.

(e) Threat of enemy attack west of the Se San River resulted in deployment of 1st Bn, 8th Inf from the ADAMS AO to SAM HOUSTON AO on 26 Jan 67. 1st Bn, 8th Inf closed Oasis 26183CH.

(f) There were no major contacts. CG, 4th Inf Div elected to continue engineer work on Highway 509B west of the Se San River since the 1st Bn, 8th Inf moved to a position vicinity Duc Co where it can be reinforced if needed.

## (13) FRAG ORDER 4-67 (STARK).

(a) Operation STARK began 22 Jan 67 and is still in progress. The mission of STARK is long range reconnaissance and surveillance of known enemy infiltration routes; employing TAC air strikes and artillery on enemy forces and installations as appropriate. The AO is located YA 8007 east to ZA 0009, south to SV 0077 southwest to the Cambodian border YV 8270, north along the border to YA 8007.

(b) During the period 22-27 Jan OMEGA teams were infil-

SECRET

SECRET

26

AVFA-GC-OT

SUBJECT: Operational Report for Quarterly Period Ending 31 January 1967  
RCS CSFOR-65 (U)

trated into 5 different areas maintaining 1 to 3 teams in the AO throughout the period.

(c) On 27 Jan 67 an OMEGA team with the mission of capturing a PW engaged a small VC force in the northern section of the AO. Two VMC prisoners were taken. The team and PW's, one of whom died later of wounds, were extracted from the area without friendly losses. On 27 Jan 67 an OMEGA team with one MIKE Force company infiltrated by air into the southern portion of the AO and began search east in overland return to the Phu Nhon Fob. The search is still in progress.

c. G3 Air Operations:

(1) Tactical Air Support: The number of sorties flown daily varied from 7 to 101 with a mean of 62 daily for the reported period. The most frequent missions were:

- (a) Direct support of friendly forces in contact.
- (b) Preparation fires on landing zones and objective areas.
- (c) Harassment and interdiction of enemy base areas, assembly areas and infiltration routes.
- (d) Night illumination and strike.
- (e) Landing zone construction.

(2) During the period 32% of approximately 5,761 missions flown for I FFORCEV were COMBAT PROOF. In December the COMBAT PROOF system at Pleiku was modified to extend the range to 200 nautical miles, providing overlapping coverage throughout most of the II CTZ.

(3) Tactical air sorties flown in support of major operations during the period were:

<u>OPERATION</u>	<u>TOTAL STRIKES</u>	<u>SORTIES/DAY</u>	<u>REMARKS</u>
ADAMS	272	2.5	3 sec exp, 114 structures, 1 KIA
BYRD	215	2.3	19 bunkers, 42 structures
DAZZLEM	395	4.3	4 sec exp
FARRAGUT	10	1.3	
PAUL REVERE IV	2445	40.5	45 sec exp, 248 KIA, est 227 structures
PICKETT	56	1.2	4 sec fires, 1 sec exp
SAM HOUSTON	174	12.4	17 bunkers, 30 structures, 1 gun emplacement
THAYER	1743	18.8	5 sec fires, 151 structures

SECRET

*SECRET*

AVFA-GC-OT

SUBJECT: Operational Report for Quarterly Period Ending 31 January 1967  
RCS CSFOR-65 (U)

(4) While flares remained in relatively short supply during the period, flares have been dropped in support of tactical operations. A total of 3,014 were expended during the period with a daily mean average of 32.8.

(5) Strategic Air Support: There were 489 B-52 sorties flown this quarter compared with 252 last quarter in support of ground operations and on suspected enemy concentrations:

<u>DATE</u>	<u>CODE NAME</u>	<u>SORTIES</u>	<u>OPERATION OR TARGET</u>
011900Z Nov	ALFA 59	9	PAUL REVERE IV
022300Z Nov	ALFA 80	9	PAUL REVERE IV
041600Z Nov	ALFA 2	6	PAUL REVERE IV
040300Z Nov	ALFA 11	9	PAUL REVERE IV
040300Z Nov	ALFA 40	9	THAYER II
051400Z Nov	ALFA 18	9	PAUL REVERE IV
071630Z Nov	ALFA 14	15	PAUL REVERE IV
072130Z Nov	ALFA 4	6	THAYER II
130340Z Nov	ALFA 33	6	PAUL REVERE IV
140630Z Nov	ALFA 98	9	PAUL REVERE IV
150500Z Nov	ALFA 15	9	THAYER II
161000Z Nov	ALFA 48	6	PAUL REVERE IV
180920Z Nov	ALFA 65	6	PAUL REVERE IV
190015Z Nov	ALFA 45	6	PAUL REVERE IV
200700Z Nov	ALFA 96	6	PAUL REVERE IV
210330Z Nov	ALFA 55	9	THAYER II
220010Z Nov	ALFA 67	9	PAUL REVERE IV
222000Z Nov	BRAVO 51	6	PAUL REVERE IV
231100Z Nov	ALFA 99	9	THAYER II
240100Z Nov	BRAVO 17	6	PAUL REVERE IV
240500Z Nov	BRAVO 10	6	PAUL REVERE IV
241100Z Nov	BRAVO 37	6	PAUL REVERE IV
250430Z Nov	BRAVO 4	9	PAUL REVERE IV

*SECRET*

SECRET

28

AVFA-GC-OT

SUBJECT: Operational Report for Quarterly Period Ending 31 January 1967  
RCS CSFOR-65 (U)

261200Z	Nov	BRAVO 86	6	PAUL REVERE IV
270400Z	Nov	BRAVO 30	9	PAUL REVERE IV
282235Z	Nov	BRAVO 15	12	PAUL REVERE IV
292200Z	Nov	BRAVO 20	9	PAUL REVERE IV
300600Z	Nov	BRAVO 64	15	PAUL REVERE IV
022245Z	Dec	BRAVO 54	9	PAUL REVERE IV
032300Z	Dec	BRAVO 50	6	PAUL REVERE IV
040700Z	Dec	BRAVO 67	6	DO XA Area
040700Z	Dec	BRAVO 34	6	DO XA Area
040700Z	Dec	BRAVO 58	6	DO XA Area
040700Z	Dec	BRAVO 14	6	DO XA Area
060700Z	Dec	ALFA 36	12	THAYER II
070030Z	Dec	BRAVO 40	12	THAYER II
071000Z	Dec	BRAVO 76	12	PAUL REVERE IV
092330Z	Dec	BRAVO 53	15	PAUL REVERE IV
110140Z	Dec	BRAVO 36	6	THAYER II
152300Z	Dec	BRAVO 84	9	PAUL REVERE IV
162300Z	Dec	BRAVO 77	9	1st Cav TAOR
262300Z	Dec	BRAVO 25	12	HAROI Base
280400Z	Dec	BRAVO 28	9	HAROI Base
292330Z	Dec	BRAVO 38	9	BYRD
292000Z	Dec	BRAVO 21	6	H&I DO XA Area
292030Z	Dec	BRAVO 13	6	H&I DO XA Area
300500Z	Dec	CHARLIE 60	6	THAYER II
032400Z	Jan	CHARLIE 95	6	THAYER II
090100Z	Jan	CHARLIE 78	12	ARVN
160100Z	Jan	CHARLIE 87	6	THAYER II
160100Z	Jan	CHARLIE 69	6	THAYER II
220100Z	Jan	CHARLIE 37	15	SAM HOUSTON

SECRET

*SECRET*

AVFA-GC-OT

SUBJECT: Operational Report for Quarterly Period Ending 31 January 1967  
RCS CSFOR-65 (U)

242230Z Jan	CHARLIE 13	6	SAM HOUSTON
252300Z Jan	CHARLIE 17	12	THAYER II
260400Z Jan	CHARLIE 6	3	THAYER II
262200Z Jan	CHARLIE 86	6	SAM HOUSTON
270100Z Jan	CHARLIE 8	9	FARRAGUT
282230Z Jan	CHARLIE 84	12	BAEK MA I
301200Z Jan	CHARLIE 76	3	SAM HOUSTON
302300Z Jan	CHARLIE 55	3	DO XA Area

## d. Army Aviation Operations:

(1) During the period 1 Nov 66 through 31 Jan 67, this headquarters received operational control of the 196th Aslt Hel Co which is assigned to the 11th Cbt Avn Bn, 17th Cbt Avn Gp. Personnel and equipment, less aircraft, closed this quarter. Aircraft have been delayed with expected arrival time in late February.

(2) The 180th Aslt Sup Hel Co (CH-47) became fully operational on 4 Dec 66, and is stationed at Tuy Hoa under command of the 10th Cbt Avn Bn, 17th Cbt Avn Gp.

(3) Aviation units under OPCON I FFORCEV participated in the following significant US operations in II CTZ during the reported period:

<u>NAME OF OPERATION</u>	<u>AVIATION UNITS</u>	<u>DATE</u>	<u>MAJOR UNIT</u>
PAUL REVERE IV & V	155th Aslt Hel Co 119th Aslt Hel Co 170th Aslt Hel Co 117th Aslt Hel Co 179th Aslt Sup Hel Co	18 Oct - 31 Dec	4th Inf Div
BYRD	1st Cav Div (AM)	25 Aug - Cont	2d Bn, 7th Cav
DAZZLEM	1st Cav Div (AM)	01 Oct - Cont	1st Cav Div (AM)
PICKETT	117th Aslt Hel Co 129th Aslt Hel Co 180th Aslt Spt Hel Co	08 Dec - 20 Jan	1/101st Abn Div
GERONIMO I	148th Aslt Hel Co 129th Aslt Hel Co 117th Aslt Hel Co	15 Oct - 10 Nov	1/101st Abn Div

*SECRET*

SECRET

30

AVFA-GC-OT

SUBJECT: Operational Report for Quarterly Period Ending 31 January 1967  
RCS CSFOR-65 (U)

ADAMS	48th Aslt Hel Co	20 Oct - Cont	1/4th Inf Div
	117th Aslt Hel Co		
	129th Aslt Hel Co		
	180th Aslt Sup Hel Co		
FARRAGUT	129th Aslt Hel Co	26 Jan - Cont	1/101st Abn Div
	117th Aslt Hel Co		
	180th Aslt Sup Hel Co		
TRAYER I	1st Cav Div (AM)	13 Sep - 24 Oct	1st Cav Div (AM)
TRAYER II	119th Aslt Hel Co	25 Oct - Cont	1st Cav Div (AM)
	179th Aslt Sup Hel Co		3/25th Inf Div (-)
ATTLEBORO	170th Aslt Hel Co	10 Nov - 20 Nov	1st Inf Div
	117th Aslt Hel Co		

ROK OPERATIONS

DUEL KUK HWA	161st Aslt Hel Co	23 Sep - 5 Oct	Cap ROK Inf Div
	174th Aslt Hel Co		
MAENG HO C	161st Aslt Hel Co	13 Oct - 22 Oct	Cap ROK Inf Div
	174th Aslt Hel Co		
MAENG HO B	161st Aslt Hel Co	03 Jan - Cont	Cap ROK Inf Div
	174th Aslt Hel Co		
MA DOO 1	48th Aslt Hel Co	21 Jan - Cont	9th ROK Div
	174th Aslt Hel Co		
BAEK MA 1	161st Aslt Hel Co	28 Jan - Cont	9th ROK Div
	174th Aslt Hel Co		
BI MA III	48th Aslt Hel Co	17 Jan - 19 Jan	9th ROK Div
	161st Aslt Hel Co		
	174th Aslt Hel Co		
BI MA II	174th Aslt Hel Co	28 Jan - Cont	9th ROK Div
BI MA I	161st Aslt Hel Co	20 Jan - 23 Jan	9th ROK Div
	174th Aslt Hel Co		

SECRET

*SECRET*

AVFA-GC-OT

SUBJECT: Operational Report for Quarterly Period Ending 31 January 1967  
RCS CSFOR-65 (U)

JUMA I	161st Aslt Hel Co	16 Jan - 21 Jan	9th ROK Div
	174th Aslt Hel Co		
TAE PUNG III	161st Aslt Hel Co	16 Jan - 21 Jan	Cap ROK Inf Div
	174th Aslt Hel Co		
VUNG KAW 66-11	161st Aslt Hel Co	16 Jan - 21 Jan	Cap ROK Inf Div
DO KE BI	18th Aslt Hel Co	25, 26 & 28 Nov	9th ROK Div

(4) Concurrently with the above FWMAF operations, the following ARVN operations were accomplished. ARVN heli-assault operations have been reduced greatly due to the changing role of ARVN troops as well as the greatly increased tempo of FWMAF operations and resupply activities. On numerous occasions, ARVN request for aviation support did not allow sufficient time to properly plan for shifting of assets resulting in cancellation of the proposed ARVN operation. Two emergency evacuations of USSF "A" Teams with CIDG personnel were accomplished as well as heli-assaulting over 1,000 RVN troops for reinforcing a CIDG unit surrounded by a superior hostile force.

<u>OPERATION</u>	<u>UNIT SUPPORTED</u>	<u>DATE(S)</u>
PHI LONG	22d ARVN Div	21 Nov
DAN THAN 107	24th Special Tac Zone	27 Nov
DAN THAN 114	24th Special Tac Zone	09 Dec - 23 Jan
PHI LONG 511	22d ARVN Div	15 Dec
THANG LONG 256	23d ARVN Div	19 Dec - 01 Jan
QUYET TIEN 6	23d ARVN Div	02 Jan - 08 Jan
PHI HOA 521	22d ARVN Div	07 Jan
QUANG DUC 2	23d ARVN Div	10 Jan - 12 Jan
SWITCHEROO	22d ARVN Div	12 Jan - 14 Jan
QUANG TRUNG	22d ARVN Div	16 Jan
NINH THUAN 1/67	23d ARVN Div	22 Jan
TF LUAT	22d ARVN Div	28 Jan

(5) I FFORCEV reinforced I Corps and III MAF with Army aviation support on numerous occasions. CH-54 "CRANE" support was furnished by the 1st Cav Div (AM).

(6) Administrative requirements for helicopters continue to detract from combat helilift capability. Efforts are made to shift requirements to fixed wing resources, also in short supply, or to utilize USAF

*SECRET*

SECRET

32

AVFA-OC-OT

SUBJECT: Operational Report for Quarterly Period Ending 31 January 1967  
RCS CSFOR-65 (U)

transport for transport, airfield to airfield, then utilize helicopters from nearest unit if such is required.

(7) Aircraft crew shortage is no longer a major problem in II CTZ. Total number of aircraft committed to support other than direct combat has been reduced.

(8) Transfer of all US Army CV-2 "CARIBOU's" to the USAF was accomplished 1 Jan 67.

(9) The increasing Revolutionary Development activities, enlarging of TAOR's, stepped-up tempo of combat operations throughout the entire zone have placed extreme demands upon supporting aviation units. Administrative, command and control, logistical and VIP support have been curtailed drastically. The only relief to this critical situation acceptable to the war plan, is to provide additional aviation units within II CTZ. Two aviation companies are scheduled to arrive in-country during 1st Quarter 1967. This will relieve, but not eliminate the overall shortage of aviation assets. Current aviation plans indicate that adequate aviation units to support present strength maneuver forces will be in-country by Oct - Nov 67.

e. Organization and Training Activities:

(1) Inclosure 12, I FFORCEV Task Organization, shows all assigned and attached units, and those under operational control of I FFORCEV, as of 31 Jan 67.

(2) The command relationship of major US and FWMA forces within II CTZ is shown in Inclosure 12A.

(3) Arrivals, departures, and reorganizations of units.

(a) The following units were assigned to I FFORCEV by USARV GO 6524, 27 Nov 66, and were further attached to III MAF for OPCON, administrative and logistical support, less Army peculiar administrative and logistical support:

1. 1st Bn (105mm) (SP) 40th Arty.

2. 2d Bn (175mm) (SP) 94th Arty with Btry B 6th Bn (8") (SP) 27th Arty attached.

3. 1st Bn (AW)(SP) 44th Arty with Btry G (Machine Gun) 65th Arty attached.

(b) I FFORCEV GO 543, 12 Dec 66, placed the 1st Bde, 4th Inf Div OPCON this headquarters.

(c) The following units were released from attachment I FFORCEV and assigned to I FFORCEV by USARV GO 57, 5 Jan 67:

1. 52d Arty Gp.

2. 2d Bn (105mm) (T) 17th Arty.

3. 3d Bn (105mm) (SP) 6th Arty.

SECRET

SECRET

AVFA-GC-OT

SUBJECT: Operational Report for Quarterly Period Ending 31 January 1967  
RCS GSFOR-65 (U)

(d) This headquarters MTOE 52-1D, requesting 78 additional personnel spaces, was officially cancelled on 2 Jan 67 because of imposed force ceilings. A study is underway to determine possible trade-offs and additional justification so that submission may be accomplished immediately on return of MTOE from USARPAC to this headquarters.

## (4) Training.

(a) As a result of a MACV plan to extend long range patrol activities in RVN, a survey was conducted to determine the current status of organic and provisional Long Range Patrol Assets. The survey revealed that OPCON units had employed long range patrols on 244 separate missions and that assets vary from unit to unit. Current expansion plans are for each division to organize two long range patrol platoons with eight provisional reconnaissance teams each. Separate brigades are to organize one long range patrol platoon with eight provisional reconnaissance teams. To assist in this expansion program, the MACV Recondo School capacity was increased from 60 students to 120 students per month. I FFORCEV OPCON units are allocated 36 quotas per month. Republic of Korea forces in II CTZ are allocated 12 quotas per month. At the end of January 1967, the following assets were available:

<u>ORGANIZATION</u>	<u>NR LRMP TMS</u>	<u>STRENGTH</u>	<u>RECONDO SCHOOL GRADUATES PARTICIPATING</u>
1st Cav Div (AM)	27	153	20
4th Inf Div	15	90	23
1st Bde 101st Abn Div	5	35	13
3de Bde, 25th Inf Div	4	24	9

(b) US Army Materiel Command sent four New Equipment Training Teams into I FFORCEV area during the period.

1. A two man team instructed unit cadres on proper care and maintenance of the M-16 rifle.

2. A two man team visited the 1st Cav Div (AM) and 17th Avn Gp and presented instruction on care, maintenance, and storage of the XM-47 mine dispersing sub-system. The team also gave advice and assistance in modifying the UH-1B helicopter for mounting of the mine dispersing sub-system.

3. A team visited OPCON units and gave instruction on functioning, care, and maintenance of the XM-148 grenade launcher.

(c) 1st Bde, 101st Abn Div underwent refresher airborne training during the period. This training included mass personnel jumps and heavy equipment drops.

(d) Units continued to send personnel to the MACV/USAID/JUSPAO Advisor Orientation Course, based on monthly allocation of nine quotas provided by USARV for I FFORCEV and OPCON units.

(5) Research and Development: During the period 17 qualitative materiel requirements (QMR) were processed. The QMR's covered a variety

SECRET

SECRET

34

AVFA-GC-OT

SUBJECT: Operational Report for Quarterly Period Ending 31 January 1967  
RCS CSFOR-65 (U)

of equipment from lightweight countermortar radars for the 1968 - 72 time frame to mobile vehicles for the 1985 - 90 time frame.

(5) Doctrine and Analysis:

(a) In coordination with DSA, II CTZ the Organization and Training Division completed a detailed analysis of the ARVN force structure and of ARVN effectiveness. Conclusions were:

1. Additional forces were needed to accomplish required tasks.

2. No additional forces would be authorized for CY 67.

3. More effective use must be made of forces currently authorized and their effectiveness must be improved.

b. One possible way of improving ARVN effectiveness would be through increased US/ARVN combined operations at the platoon and company level.

(b) A Mechanized/Armor Combat Operations Vietnam (MACOV) evaluation team from USACDC arrived on 10 Jan 67. This team will stay in-country approximately 90 days studying and evaluating mechanized and armor operations. Evaluators are currently with units in the field where they are collecting data from actual combat operations.

(c) Morale and discipline in small units received special attention during the reporting period. In order to prevent small, isolated units from being overlooked while attention is focused on large tactical units, I FFORCEV initiated a program of monthly staff visits and inspections to all small units. These monthly visits will be followed up by quarterly command inspections.

f. Revolutionary Development:

(1) In November 1966 the G5 Section of I FFORCEV was incorporated within the Revolutionary Development Division of the G3 Section and redesignated the Revolutionary Development Support Division (RDSD). This reorganization was directed by the CG, I FFORCEV with the rationale that civil affairs activities and the revolutionary development program are so closely related and intertwined that their activities should be combined to insure coordination, central direction and continuity. This division remains under the general staff supervision of the Assistant Chief of Staff, G3, due to the importance of, and the emphasis being placed on, support of the GVN revolutionary development program.

(2) During the reporting period the activities and areas of responsibility of the Revolutionary Development Support Division have expanded considerably. In addition to assuming all former G5 responsibilities RDSD participated in the 1967 RD planning for the II Corps area. This included representation and contribution at the Embassy, Corps, Division (Zone) and Provincial level. Representatives of RDSD attended the Embassy meetings in Saigon and visited each province in II Corps for this purpose. Copies of the Division (Zone) and provincial RD plans were obtained and are being monitored to insure a coordinated overall plan. RDSD monitored and

SECRET

SECRET

35

AVFA-GC-OT

SUBJECT: Operational Report for Quarterly Period Ending 31 January 1967  
RCS CSFOR-65 (U)

consolidated all Revolutionary Development Reports to determine the progress being made in this program. This included coordination with and integration of all RD activities with the Region II Country Team.

(3) The reorganization of the civilian agencies in December 1966 created one point of contact between the military and civilian agencies. Region II USAID, JUSPAO and OSA have been incorporated under the Region II Office of Civil Operations (OCC) to establish a centrally controlled and coordinated civilian effort. At Province level, Provincial Representatives have been appointed with responsibilities for the overall provincial civilian effort

(4) Other new responsibilities assumed by RDSO included the responsibility for the status of railroads within II Corps and the monitoring of the ARVN Mobile Training Team (MTT) program. Three ARVN battalions (1/42, 2/47 and 4/44) have completed their MTT training and it appears the training will be successful. The mission of the Mobile Training Teams is to train each ARVN battalion in RD Support and Civic Action. Command emphasis by senior ARVN officers has been noteworthy and is deemed a significant indication of the importance being placed on this program by GVN. The effectiveness of this program will be long term results that cannot be determined at this time.

(5) RDSO prepared a staff study during the reporting period that indicated an additional 193 Regional Force (RF) companies and 138 Popular Force (PF) platoons would be required in II CTZ to adequately support RD and the objectives of the 1967 Campaign Plan. A request for these additional units was denied by MACV with rationale that the economy would not support the additional spending. An alternate solution is being studied whereby existing RF/PF spaces that are unfilled would be transferred between provinces.

(6) The RDSO plans division participated in the planning of several future operations to be conducted in early 1967. The importance of RD planning in future operations has been recognized and is an integral part of the I FFORCEV planning cycle. The planning phase for Operation FARRAGUT was of significance. Three coordination meetings were held between military and civilian elements. In December representatives from RDSO met with OCC and discussed the concept of the operation and potential problem areas. In January a meeting was held between 1st Bde, 101st Abn Div personnel and OCC representatives from Binh Thuan and Ninh Thuan Provinces. The primary purpose of this meeting was to allow the 1st Bde, 101st Abn Div to present the general concept and detailed plan to the civilian agencies. A final coordination meeting was held on 24 Jan 67. As a result of these meetings detailed plans were developed for the handling and processing of detainees, Hoi Chanh, refugees and POW's. This planning should result in smoother processing and more favorable treatment of Vietnamese personnel as they return to GVN control.

(7) The former G5 Section was reconstituted within G3 RDSO as the Civil Affairs Branch. The CA Branch remained responsible for the staff supervision of civil affairs operations, under the direction of the RDSO Chief, in support of the commanders several assigned missions.

(8) The Revolutionary Development Program in II CTZ, while showing progress, fell behind the 1966 programmed schedule. This is attributed to unrealistic planning by GVN officials. A special effort was placed on 1967 planning to arrive at realistic attainable goals.

SECRET

AVFA-GC-OT

SUBJECT: Operational Report for Quarterly Period Ending 31 January 1967  
RCS CSFOR-65 (U)

During the period 1 Nov to 31 Dec 66, 81 hamlets were raised to a secure status. Darlac, Khanh Hoa, Kontum, Ninh Thuan, Phu Bon and Phu Yen Provinces showed satisfactory progress during the quarter. The charts attached (Incl 13) show the hamlet status by province as of 31 Oct and 31 Dec 66. A new hamlet evaluation system begun 1 Jan 67 precluded the figures for January from being included in this report.

(9) There were a total of 847 Road Runner operations conducted during the reporting period that resulted in 21,799 kilometers of roads being traversed, 11 enemy KIA and 10 weapons captured.

(10) Seventy-two County Fair type operations were conducted within II CTZ with the following results:

(a) Enemy KIA:	2
(b) VCC:	89
(c) Weapons captured	0

(11) I FFORCEV Anti-Extortion operations showed no significant increase in activities. Considerable thought was given to disrupting VC tax extortion along Route 20; however, sufficient military forces were not available at that time to insure security of key bridges along the route. This plan is being held in abeyance until some future date.

(12) RD Reports:

(a) The RD report program was reevaluated during January 1967. Both the Special Joint Report on RD and the MACV Monthly Report on RD were revised with an improved format to show a more objective measurement of RD progress.

(b) A new RD Hamlet Evaluation Report (RDHER) was placed in effect to better classify the degree of control and evaluate the classification of GVN hamlets and population. It is anticipated that several months will be required before this system is effective.

(c) A new Special Joint Report was also placed in effect. It will be prepared by the SA, II Corps and the Region II Director OGO with the purpose of evaluating support for RD by the various GVN agencies and forces and to identify GVN officials whose performance is detrimental to the RD effort.

(13) Binh Thuan Field Representative Activities:

(a) During the month of November 1966 the Field Representative for Binh Thuan Province, and, in particular, for pilot RD Project HOP LUC was designated. The Field Representative accompanied the Ministry of Revolutionary Development Team to Binh Thuan, Lam Dong, Tuyen Duc, Quang Duc and Darlac Provinces for review of the respective 1967 RD programs.

(b) On 15 Dec 66, OPLAN HOP LUC was ordered executed. TF 2/7 Cav and the two battalions of the 44th ARVN Regt continued to conduct search and destroy operations and saturation patrolling. To effect

SECRET

*SECRET*

AVFA-GC-CT

SUBJECT: Operational Report for Quarterly Period Ending 31 January 1967  
RCS CSFOR-65 (U)

better coordination of effort and to improve the effectiveness of tactical operations, combined US/ARVN company size operations were implemented. These operations have now resulted in combining one ARVN platoon with each of three US rifle companies. The combining of forces has been beneficial to both US and ARVN forces. The ARVN personnel have gained experience in airmobile, night ambush and patrolling techniques, while the US forces have benefited through "on-the-spot" interrogation of detainees and translation of captured documents.

(c) At the instigation of RD Division, the 41st Civil Affairs Company completed a study to deploy Civil Affairs Teams on an area basis. Three teams are planned for deployment in support of Revolutionary Development and will operate in direct support of the Sector Advisor.

(d) The RD cadres are deployed throughout the province and have begun to function. Several of the teams have been in the hamlets only a short time and are starting on the initial steps of the RD program. Although four teams were visited during the reporting period, it was difficult to determine their exact progress and the results of their actions. The OCO Province Representative is developing plans and methods to improve supervision and direction of the cadre efforts.

(14) Binh Dinh Field Representatives Activities:

(a) Operation Irving, which terminated on 24 Oct 66, returned a large area of southern Phu My District, Binh Dinh Province, to GVN control. This area had not been included in the planning for RD for 1967. Action was initiated to carry out minimum pacification measures until the area could be brought into the GVN RD program. RDSD monitored the deployment of the plan prepared by provincial authorities, 22d ARVN Div, and MACV Advisory personnel in Binh Dinh Province. The result of this effort was the formation of twelve "Civilian/Military Teams" (Đoàn Quan Chỉnh), programmed to pacify 36 hamlets in southern Phu My District in 1967. Teams were formed from RF/PF platoons and locally available technical and administrative cadre. They received a two-week training program, completing it on 23 Jan 67, and will be deployed to hamlets in Phu My District in February.

(b) G3 RDSD continues to monitor the 22d ARVN Div "Hamlet Adoption Program". Division headquarters has adopted five hamlets nearby, and is conducting extensive civic action. The success of the program is indicated by large numbers of persons returning to hamlets, such as Loc Ngai which initially had only 8 families. To date over 600 persons have returned to this hamlet.

(15) Region II Country Team Meetings were held on 8 November, 5 December, 28 December and 12 January. These meetings continue to be a success, fostering better understanding between the military and civilian elements and insuring continuity of effort at the Region/ I FFORCEV level. Region II Country Team Meetings have resulted in:

(a) Interim pacification measures being developed and implemented for Phu My District on Binh Dinh Province.

(b) Improved coordination and procedures for the handling of Hoi Chanhs.

*SECRET*

AVFA-GC-OT

SUBJECT: Operational Report for Quarterly Period Ending 31 January 1967  
RCS CSFOR-65 (U)

(c) Joint Civilian/Military agreement on the distribution of RD assets available in II Corps.

(d) Current up-to-date knowledge by all concerned of each elements activities.

(16) Civil Affairs Operations.

(a) In the field of Civil Affairs Operations RDS monitored civil affairs activities of the OPCON units and DSA, II Corps/II Corps Advisory Group. This monitorship included the dissemination of information and guidance concerning the conduct of military civic action, the surveillance of civic action progress and the reporting and evaluation of the civic action program of II CTZ. Additionally, it was effectively extended over the II CTZ Installation Coordinator system through the offices of the Zone Coordinator (CG, I FFORCEV) and Deputy Zone Coordinator (DSA, II Corps).

(b) During the reported period civic action by US units continued. Effective as of 31 Dec 66 reports were rendered on a monthly basis. Efforts were made in staff contacts between MACV, USARV, and this headquarters to plan future civic action reporting around US/FWMAF and RVNAF civic action activities in support of the RD program.

(c) Updating of all province area surveys continued throughout the quarter. The surveys for Binh Dinh, Phu Yen and Lam Dong Provinces were completed and published by the 41st Civil Affairs Company and priorities established for the early completion of Ninh Thuan, Khanh Hoa and Darlac. (Binh Thuan had been completed the previous quarter).

(d) Emphasis continued to be placed on evacuation of captured rice, when at all possible, in lieu of destruction. Because of the non-availability of rice containers, units had to procure bags and other containers in order to evacuate as much captured rice as possible. A limited number of rice bags were obtained by USAID during the latter part of the quarter for use by tactical units.

(e) A study on rubber, tea and coffee plantations in II CTZ was conducted in December for consideration as a pilot project for the preservation and rehabilitation of plantations under VC influence. It was determined that the rubber and tea plantations in Darlac and Lam Dong Provinces would make suitable pilot projects except that US tactical units were not located nearby. The Gatecka Tea Plantation in Pleiku Province was selected for the pilot project since tactical units were located closely enough to meet the prerequisites of the project.

(f) The Area Real Estate Office (AREO) was organized in November. This office was established to eliminate competition in the leasing of facilities; to minimize inflationary rental practices; and to provide economical, equitable facilities to all US personnel in government service or on contract to the US Government. This office has coordinated the efforts of all US elements using Vietnamese facilities and has reduced the rental costs to within the US Embassy ceilings.

(g) The 41st Civil Affairs Co, CA assets for HQ, I FFORCEV, continued to operate less seven teams employed in adjacent CTZ's. The company completed a study for the redistribution and reorientation of teams in

SECRET

AVFA-GC-OT

SUBJECT: Operat. onal Report for Quarterly Period Ending 31 January 1967  
RDS CSFOR-65 (U)

the II CTZ. Included in this study was a case study of civil affairs operations in the Phan Thiet Project Hop Luc. At the close of the reporting period, results of these studies were presented to the command for decision.

(h) The 11st Civil Affairs Co received and employed four company grade ARVN CA officers for one month during December. Although coordination left room for improvement, the activity was the first such attempt at mutually supporting US and ARVN efforts.

(17) The community relations councils continued to meet monthly. There were no significant changes in the activities of the councils. Councils continued to support civic action projects in coordination with Sector Advisors. Emphasis was placed on support of Christmas programs for local communities which involved assistance to orphanages and gifts to Vietnamese civilians and military. Friendship Councils met at several installations resulting in an effective exchange of ideas between the US and Vietnamese representatives on local problem areas.

g. Psychological Operations:

(1) General.

(a) From 1 Nov 66 to 31 Jan 67, psychological operations (PsyOp) were conducted by FVMAF and GVN in II Corps Tactical Zone (CTZ) supported by the 245th PsyOp Co (-) Nha Trang and Pleiku (15 officers and 44 enlisted men), the 5th Air Commando Squadron (ACS), the 6th PsyOp Bn, Saigon, the 7th PsyOp Gp, Okinawa, the US Coastal "Junk and Swift" fleet, the 20th PsyWar Bn (ARVN) and the 111th Liaison Squadron (VNAF).

(b) In II CTZ operations, 145,415,000 leaflets were disseminated of which 15,657,000 were printed by the 245th PsyOp Co and 3,480,500 were printed by the 20th PsyWar Bn (ARVN). A total of 126,277,500 leaflets were disseminated in II CTZ from the 6th PsyOp Bn and 7th PsyOp Gp. In addition 552.25 hours of aerial loudspeaker time was directed to targets in enemy areas.

(c) Leaflet and loudspeaker operations were in support of tactical and Revolutionary Development operations; BYRD; PICKETT, FAR-RAGUT, THAYER II, DAZZLEM, PAUL REVERE IV, ADAMS, SAM HOUSTON, MAENG HO 8 and GERONIMO I in II CTZ.

(d) The objective of leaflets used before tactical and Revolutionary Development operations were generally:

1. Population control.
2. Cause population to deny support to VC/NVA elements.
3. Describe to VC/NVA and local populace, the terms of the Chieu Hoi Program.
4. Cause populace of VC/NVA controlled areas to expose VC/NVA personnel.

SECRET

AFPA-GC-OT

SUBJECT: Operational Report for Quarterly Period Ending 31 January 1967  
RCS CSFOR-65 (U)

5. Cause populace in contested areas to accept and support the cause of the GVN.

(e) The objectives of leaflet and loudspeaker operations during tactical operations were to:

1. Demoralize VC and NVA troops.
2. Cause defections in VC/NVA ranks.
3. Assure potential prisoners and returnees of fair treatment.
4. Exploit returnees to effect desertion of VC/NVA personnel.
5. Alienate the VC/NVA forces from the populace.
6. Create a fear of impending doom in VC/NVA personnel should they continue to fight.

(f) Leaflets used prior to an operation gave safety instructions to the populace and rallying instructions to VC/NVA sympathizers and troops.

(g) For examples of leaflets used in tactical operations in II CTZ, see:

1. Incl 14, quick reaction and special leaflets.
2. Incl 15, demoralization leaflets.
3. Incl 16, pacification leaflets.

(h) Results of psychological operations show 3,549 returnees (Hoi Chanh) for the reporting period. An increase of 2,090 over last quarter. The returnee total since 1 Jan 66 is 10,042 in II CTZ.

(i) Aerial loudspeaker missions were flown in conjunction with and in support of separate operations down to and including platoon size units. A total of 854 aerial loudspeaker sorties were flown by the 5th ACS and 99 loudspeaker sorties were flown by Army aircraft in II CTZ.

(j) Six two-man loudspeaker teams, from the 245th PsyOp Co, were attached to US OPCON units for major operations in II CTZ. The direct support role of loudspeaker teams was effective in population control and in support of the Chieu Hoi Program when employed in and near villages and/or hamlets, used in search and clear, and Revolutionary Development operations.

(2) Support:

(a) Leaflets disseminated in II CTZ during the reporting period were provided by:

- |                         |            |
|-------------------------|------------|
| 1. 6th PsyOp Bn, Saigon | 38,960,000 |
|-------------------------|------------|

AVFA-GC-OT

SUBJECT: Operational Report for Quarterly Period Ending 31 January 1967  
RCS CSFOR-65 (U)

- 2. 7th PsyOP Gp, Okinawa: 89,789,000
- 3. 245th PsyOp Co, Nha Trang/Pleiku 15,657,000

(b) The 5th ACS flew a total of 629 psyop missions, disseminating 132,599,000 leaflets and provided 483 hours of loudspeaker broadcasts. There were no cancelled flights due to aircraft non-availability; however, there were 403 cancelled flights of the 1,032 requested due to weather or maintenance.

(c) Boats of the Junk and Swift Fleet, equipped with loudspeakers, completed 30.30 hours of loudspeaker broadcasts and disseminated 301,000 leaflets to selected target audiences in operations along the II CTZ coastal areas.

(3) Operations and Training:

(a) Psyop annexes of contingency plans for three proposed operations in II CTZ have been prepared with maximum emphasis being placed on the use of accurate, timely intelligence to develop meaningful propaganda materials, rather than use of standard, nation-wide materials.

(b) A leaflet dissemination course was given to the Pleiku Det of the 245th PsyOp Co, in November 1966, following the class given in Nha Trang during the last quarter. Representatives of the 20th PsyOp Bn (ARVN), 4th Inf Div (US), 5th ACS, and DSA, II Corps attended the course.

(4) Enemy Propaganda:

(a) Enemy propaganda creditability remains low with continued anti-American and anti-GVN themes. Slogans of "Johnson's War", "McNamara's War" continue to be the most prevalent themes. Photos of peace marches and draft incidents in the United States are used on leaflets.

(b) Several copies of leaflets directed toward the Koreans were analyzed during the period. The theme was "Yankees are using Koreans as shields, don't fight against us (VC) and we won't hurt you (Koreans)".

(c) One leaflet directed towards negro soldiers was found, the theme being, "The negro soldier is fighting to protect the KKK."

(d) There have been increasing examples of VC leaflets which have been written by either an American or some one with an excellent knowledge of American military mannerisms and expressions.

(e) Example of VC propaganda:

1. Side 1: What's in it for you, GI? McNamara says Americans will have to learn to accept casualties. And that means you, brother; you won't find him sweating in the jungle or going home in a coffin. There aren't any bombs planted in the Pentagon, like there will be in your barracks, your base or the local bar.

CONFIDENTIAL

42

AVFA-OC-OT

SUBJECT: Operational Report for Quarterly Period Ending 31 January 1967  
RCS CSFOR-65 (II)

2. Side 2: So what's in it for you? Combat pay and a Purple Heart if you're one of the lucky ones..... and what about the others? The Marines who don't come out of the jungle; the pilots who don't make it back from their missions; the guys going home who got hit in the Saigon Airport! Their combat pay doesn't do them much good when they go home in a box. Better think it over, soldier . . . There's not much in it for you!

(f) In the future we can expect VC propaganda to be directed toward exploitation of VC victories, any news-worthy incident in the United States, civil rights demonstrations and draft card burning, etc. There is also an increasing indication that Viet Cong propaganda is directed mainly toward countering American propaganda rather than creating new themes for their own use.

(5) Problem Areas:

(a) A lack of coordination and communications between civilian and military agencies at the province level in some cases preclude maximum exploitation of returnees.

(b) A lack of adequately trained personnel to handle the jobs peculiar to psyop has continually plagued psyop support elements. This is especially so in the field of logistics, where repair personnel are not authorized by TO&E nor are they available in local maintenance support units.

(c) VNAF psyop aircraft are not equipped with loudspeaker equipment, therefore limiting the overall capability of VNAF to support ARVN units.

(d) Lack of replacement parts for non-standard equipment, adversely affects the overall propaganda campaign in II CTZ. At present, none of the five US mobile audio-visual units are operational. Two of the three assigned presses in the 245th PsyOp have for the most part been operational; however, breakdowns occur frequently and quality reproduction is difficult.

(e) Plans for the 1967 TET Campaign did not reach their intended effectiveness because instructions were distributed in a piecemeal manner, thereby causing confusion among the participating agencies.

(f) The 20th Psy Op Bn (ARVN) located at Pleiku, has not received printing materials, that have been on request, since June 1966. For the most part, printing work for this period by the 20th Psy Op Bn has been accomplished with supply items from the 245th PsyOp Co, Pleiku Det.

(g) A shortage of qualified psyop personnel for psyop field loudspeaker teams (HB) has become apparent with the increase in numbers of brigade size operations. At present, the 245th PsyOp Co has six field loudspeaker teams in the field with a seventh programmed for February 1967. By TOE, only four such teams are authorized. The extra teams are made up from other sections within the company, thereby causing curtailment of operations with 245th PsyOp Co.

(h) Adverse weather renders the U-10 aircraft inadequate for aerial psyop support, as it cannot take off and land in cross winds in

CONFIDENTIAL

AVFA-GC-OT

SUBJECT: Operational Report for Quarterly Period Ending 31 January 1967  
RCS CSFOR-65 (U)

excess of 15 knots. In addition, Air Force Regulations (5th Air Commando Squadron Regulation 55-47) limit the use of the U-10 to a minimum of 1,500 feet above the ground and visibility of three miles.

## (6) Miscellaneous Activities:

(a) Requests for logistical support for the 245th PsyOp Co have been submitted through the G4, I FFORCEV and the Nha Trang Sub Area Command, where a study is presently underway to determine a solution for the logistical problems of the 245th PsyOp Co.

(b) The 6th PsyOp Bn has initiated a monthly psyop conference to be held in each of the four corps tactical zones on a rotational basis. This conference is designed to be a coordination vehicle for psyop activities throughout SVN.

(c) Phase I of the 1967 TET Campaign in II CTZ was completed on 27 Jan 67. In excess of 16 million TET leaflets were disseminated by the 5th ACS. Four million TET leaflets were delivered to DSA, II Corps for dissemination by ARVN.

## h. Chemical

## (1) General

(a) On 14 Oct 66 a letter from CG, 1st Bde, 101st Abn Div, subject: VC Crop Destruction was forwarded by 1st Ind, this headquarters, to COMUSMACV. (See item 3g (1)(c) of Operational Report -- Lessons Learned for August - October 1966). This letter indicated that the system of herbicide operations was not responsive to the needs of the field commanders. On 29 Nov 65 this headquarters received a reply from COMUSMACV stating that the system was established in accordance with specific guidance from the State Department and DOD. No changes in policy are foreseeable.

(b) On 25 Dec 66 a message was received from CG, USARV suspending use of all E158/E159 Cluster, Canister, Riot Control, CS munitions pending application of a reliability fix. All items on hand were to be turned in to the supporting ASP.

(c) An intelligence report from an official Vietnamese Security Service Field Office states that the Viet Cong in Tuy An District, Phu Yen Province, are experiencing a shortage of food as a result of Allied and GVN Herbicide Operations. The VC were forced to temporarily suspend collection of agricultural taxes from the people because the rice fields had been destroyed by defoliant.

(d) A Document Report, Document Log Number 1357-66, 55th Military Intelligence Detachment, 15 Dec 66, indicates that two poisons are being introduced into RVN. One poison furnished to the VC by Communist China is to be spread on clothing to enter the body through the pores. Death will supposedly occur within 30 minutes. The other poison is furnished to the VC by Czechoslovakia. This poison is mixed with water in rivers and streams. It, too, enters the body through the skin and supposedly will kill within ten hours. The report evaluation is C/3.

SECRET

44

AVFA-GC-OT

SUBJECT: Operational Report for Quarterly Period Ending 31 January 1967,  
RCS CSFGR-65 (U)

(e) On 23 Dec 66 USAKV notified this headquarters of progress toward providing 4.2 inch, 105mm and 155mm CS rounds. The message indicated ballistics for the 4.2 inch and 155mm rounds were similar to those of HE rounds. The ballistics for the 105mm rounds required modified firing tables. Units indicated that the changed ballistics were acceptable and that the rounds are still required.

(2) Crop Destruction Operations: (Incl 17)

(a) The following six projects were active during this reporting period:

1. Project 2-22 consisted originally of six target areas in Phu Yen Province. Targets 4, 5, and 6 were reinitiated for the period August 1966 through January 1967. Two UC123-B spray aircraft sorties have been flown in this project as of this report. In addition, rice seedling beds in an 11 sq. km. area were sprayed by Phu Yen Province personnel using ground based equipment and helicopter mounted spray rigs.

2. Project 2-31 consists of two target areas in Tuyen Duc Province containing approximately 800 hectares of rice. The project was approved for the period September 1966 through February 1967. No sorties have been flown and the crops have been harvested.

3. Project 2/2R/02/66 consists of three target areas in Binh Thuan Province containing approximately 2,500 hectares of various crops. This project was approved for the period July 1966 through 31 March 1967 and is approximately 80 percent completed.

4. Project 2/2R/05/66 consists of three target areas in Darlac Province containing 115 hectares of rice. The project was approved on 15 Jan 67 for the period February 1967 through December 1967.

5. Project 2/2R/06/66 consists of five target areas in Ninh Thuan Province containing approximately 10,000 hectares of rice, corn and manioc. The project was approved on 5 Jan 67 for the period January 1967 through December 1967.

6. Project 2/2R/1/67 consists of seven target areas in Binh Dinh Province containing various crops. This project (formerly Project 2-18) was reinstated and renumbered on 5 Jan 67. Project execution was approved for CY 67.

(b) The following eight projects requested are currently being processed:

1. Project 2-22 consists of six target areas in Phu Yen Province (see paragraph (2)(a)1 above) containing approximately 6,000 hectares of rice. All six targets were requested for reinitiation by message, this headquarters, to MACV on 22 Jan 67. The proposed project is currently being processed for COMUSMACV and US Embassy approval.

2. Project 2/2R/03/66 consists of four target areas in Phu Ron Province containing approximately 850 hectares of rice and corn. The Deputy Senior Advisor's Position was forwarded to MACV on 18 Oct 66 recommending project approval through December 1967. The proposed project is currently awaiting US Embassy approval.

SECRET

AVFA-GC-OT

SUBJECT: Operational Report for Quarterly Period Ending 31 January 1967,  
RCS CSFOR-65 (U)

3. Project 2/2R/07/66 consists of a single consolidated target area in Pleiku Province containing approximately 2,500 hectares of various crops. The Deputy Senior Advisor's Position was forwarded to MACV on 19 Nov 66 recommending project approval through December 1967.

4. Project 2/2R/2/67 consists of four target areas in Binh Thuan Province containing rice, corn, potatoes, peanuts and sesame. This project is the same as active project 2/2R/02/66 with an additional target (see paragraph (2)(a) 3 above). The Deputy Senior Advisor's Position was forwarded to MACV on 17 Jan 67 recommending project approval through December 1967.

5. Project 2/2R/5/67 consists of four target areas in SW Ninh Thuan Province containing approximately 40 hectares of rice, corn and manioc. The Deputy Senior Advisor's Position was forwarded to MACV on 17 Jan 67 recommending approval as a supplement to Project 2/2R/06/66 (see (2)(a) 5 above).

6. Project 2/2R/7/67 consists of four target areas covering approximately sixty percent of Kontum Province and containing approximately 6,000 hectares of rice, potatoes, manioc and corn. This project was formerly designated 2/2R/01/66 and had expired on 31 Oct 66. The Deputy Senior Advisor's Position was forwarded to MACV on 17 Jan 67 recommending project approval. The proposed project is currently being staffed through MACV.

7. Project 2/2R/8/67 consists of eleven target areas in Khanh Hoa Province containing approximately 850 hectares of rice, corn and manioc. The Deputy Senior Advisor's Position was forwarded to MACV on 14 Jan 67 recommending approval.

8. Project 2/2R/9/67 consists of six target areas in Eastern Pleiku Province containing 1332 hectares of paddy rice. The Deputy Senior Advisor's Position was forwarded to MACV on 14 Jan 67 recommending that the six target areas be consolidated into one. The proposed area is maintained by a large VC work force and is the most important enemy crop complex in Pleiku Province.

(3) Defoliation Operations:

(a) The following four projects were active during this reporting period:

1. Project 20-50 originally consisted of 10 target areas along Highway 1 and the National Railroad in Binh Thuan Province. Eight targets were initially approved for the period June 1966 through January 1967 with a subsequent extension through 30 June 1967. Spraying was started in June 1966 but was suspended in July 1966 by the Province Chief. The VC were capitalizing on the spraying with propaganda that spraying was poisoning the populace. The project is approximately 25 percent completed.

2. Project 2/20/03/66 originally consisted of three target areas near the Dong Ba Thin - Cam Ranh Bay Complex in Khanh Hoa Province. Two targets were initially approved for the period August 1966 through December 1966 with a subsequent extension through 30 June 67.

SECRET

SECRET

46

AVFA-OC-OT

SUBJECT: Operational Report for Quarterly Period Ending 31 January 1967,  
RCS CSFOR-65 (U)

One target was cancelled. Spraying was started in August 1966 and is approximately 75 percent completed.

3. Project 2/20/04/66 originally consisted of eleven target areas along Highways 7B and 2E and provincial roads north of Cheo Reo in Phu Bon Province. Eight targets were initially approved for the period September 1966 through December 1966 with a subsequent extension through 30 June 67. Spraying was started in October 1966 and is approximately 15 percent completed.

4. Project 2/20/05/66 consists of four target areas around the Dak Pek Special Forces Camp in NW Kontum Province. The project is approved for the period July 1966 through 1 March 1967, and is approximately 35 percent completed.

(b) The following eight defoliation projects are currently being processed:

1. Project 20-60 consists of six target areas along Highway 1 and the National Railroad in Phu Yen Province and was completed in August 1966. This headquarters requested reinitiation of all targets on 12 Sept 66. The proposed project is currently awaiting approval at the US Embassy.

2. Project 20-65 consists of four target areas along Highway 19 and the western portion of the Mang Yang Pass in Pleiku Province. This project was completed in April 1966. This headquarters requested reinitiation of all targets on 12 Sept 66. The proposed project is currently awaiting approval at the US Embassy.

3. Project 20-77 consists of ten target areas along Highway 1 and 21 in Khanh Hoa Province and was completed in May 1966. This headquarters requested project reinitiation on 12 Sept 66. The proposed project is currently awaiting approval at the US Embassy.

4. Project 2/20/06/66 consists of five target areas along Highway 20 and Provincial Road 8 in Lam Dong Province and was requested by the Province Chief. However, USAID representatives at sector and Deputy Senior Advisor, II CTZ did not concur in the project since tea and rubber plantations in the area may be affected. The project was forwarded to MACV by this headquarters on 22 Sept 66 recommending disapproval on the basis of USAID non-concurrence. A new ARVN request was submitted on 16 Nov 66. Project requires new Senior Advisor's Position.

5. Project 2/20/07/66 consists of three target areas in the mountainous regions in Northern Khanh Hoa Province. The project was requested by this headquarters on 14 Sept 66, in support of proposed operations and is currently awaiting approval at the US Embassy.

6. Project 2/20/1/67 consists of fourteen targets comprising approximately 420 square kilometers of area along lines of communications, around installations and in proposed areas of operations in Binh Dinh Province. The Deputy Senior Advisor's Position was forwarded to MACV on 14 Jan 67 recommending project approval for one year from date of approval.

7. Project 2/20/4/67 consists of ten target areas along major roads, Viet Cong Secret bases and the RVN-Cambodian border in

SECRET

*SECRET*

AVFA-GC-OT

SUBJECT: Operational Report for Quarterly Period Ending 31 January 1967,  
RCS CSFOR-65 (U)

Pleiku Province. The Deputy Senior Advisor's Position was forwarded to MACV on 14 Jan 67 recommending that Project 20-69 (Chu Pong Mountain) be incorporated as target number eleven of the proposed project. The Chu Pong Mountain area serves as a Viet Cong base area and respraying is required.

8. Project 2,20/6/67 consists of six target areas along Highways 14 and 8 and provincial roads in Quang Duc Province. The Deputy Senior Advisor's Position was forwarded to MACV on 17 Jan 67 recommending project approval for one year from date of approval.

(c) The following ground based defoliation was completed during the period of this report:

1. The 633rd Combat Support Group sprayed approximately five hectares of grass and bushes around the New Pleiku Airfield with hand and compressed air sprayers during December 1966. This operation cleared heavy foliage on fence lines with excellent results.

2. The 4th Inf Div used mity mites and a power driven decontamination apparatus to defoliate along the extension of Highway 509B in Pleiku and Kontum Provinces during December 1966. Heavy foliage along this route prevented adequate defoliant dissemination and limited the project effectiveness.

3. The 1st Cav Div (AM) used helicopter spraying and hand sprayers to clear approximately 150 hectares of grass from the base camp perimeter at An Khe. Operations were conducted from October through December 1966 with satisfactory results.

(4) Riot Control Agent (RCA) Operations.

(a) Use of CS Grenades: During the period of this report in Operations THAYER II, PAUL REVERE IV and DAZZLEM the 1st Cavalry Division (AM) expended 12,096 CS Grenades using the Adapter Kit, Troop Landing Smoke Screen System for XM3 2.75 - inch Rocket Launcher. The 4th Inf Div made a single drop of 336 CS Grenades during Operation PAUL REVERE IV in November 1966. The 1st Bde, 101st Abn Div made only one drop of 126 CS Grenades in January 1967 during Operation PICKETT.

(b) Use of Bulk CS-1: The 1st Cav Div dispensed 2,400 pounds of bulk CS-1 during Operation THAYER, BYRD, and PAUL REVERE IV using a helicopter mounted M5 Riot Control Agent Dispenser. In Operation THAYER II the 1st Cav Div dropped 30 drums of bulk CS-1 with M10 Destructors to provide a more persistent effect. The 4th Inf Div using the same technique as above, dropped 30 drums of bulk CS-1 during Operation PAUL REVERE IV.

(c) Tunnel Operations: During Operation THAYER II the 1st Cav Div (AM) used CS and smoke grenades for clearing tunnels. In addition some bulk CS-1, disseminated with detonation cord, was used to contaminate the tunnels. Similarly, the 4th Inf Div used bulk CS-1 to contaminate caves in Operation SAM HOUSTON and a tunnel complex in Operation ADAMS.

*SECRET*

SECRET

48

AVFA-CC-OT

SUBJECT: Operational Report for Quarterly Period Ending 31 January 1967,  
RCS CSFOR-65 (U)

(5) Summary.

(a) Herbicide Operations: Adverse weather hampered herbicide operations within II CTZ. However, crop destruction continues to be effective in reducing the availability of food in VC controlled areas. VC tax collection efforts were curtailed in Phu Yen Province because of the shortage of crops with which to pay. In Binh Thuan Province the shortage of rice in VC controlled areas has nearly doubled the normal price. Approval of pending projects will greatly enhance the crop destruction program.

(b) Defoliation Operations: Forty defoliation sorties were flown during the period of this report along LOC's in Phu Bon Province and around the perimeter of the Dak Pek Special Forces Camp. Ground based defoliation was performed around base camp perimeter and along the extension of Highway 509B.

(c) Riot Control Agent Operations: CS-1 Grenades were used in nearly all major operations within II CTZ. Bulk Agent CS-1 was used for a persistent effect along trails, LOC's and MSR's and in tunnel denial operations.

SECRET

44

CONFIDENTIAL

AVFA-GC-OT

SUBJECT: Operational Report for Quarterly Period Ending 31 January 1967,  
RCS CSPOR-65 (U)

## 4. (C) Logistical Activities:

## a. General:

(1) During the reporting period I FFORCEV G4 placed major emphasis on the planning, coordinating and monitoring of logistical support of I FFORCEV tactical operations.

(2) The G4 Section presently monitors the coordination between tactical support units and resolves any problem by dealing either with the 1st Log Comd or one of the two support commands located within II CTZ. Excellent cooperation and support have been experienced during the past period. During the initial phases of an operation and as required thereafter, a liaison representative from G4, I FFORCEV was sent to the field to insure tactical units were receiving the support requested and assisted, where possible, in resolving logistical problems.

## b. General Supply:

(1) The success of tactical operations was not affected by shortages in the supply system. Light weight airmobile construction equipment and water purification units have an expected availability date of August 1967. Rough terrain fork lifts, certain cargo nets, small generators, and generator repair parts remain in short supply. The stockage of generators is expected to improve in the later part of February 1967.

(2) Class I, III, and IIIA supplies have been adequate to support all operations.

(3) Available supply rate (ASR) at the end of the reporting period established by USARV was as followings:

<u>DODAC</u>	<u>NOMENCLATURE</u>	<u>ASR</u>
B568	Ctg, 40mm M406	1 Rd/wpn/day
B626	Ctg, 60mm HE	1 Rd/wpn/day
B-627	Ctg, 60mm Illum	.5 Rd/wpn/day
C222; C223 C225, C232	Ctg, 81mm HE (all types)	5 Rd/wpn/day
C226	Ctg, 81mm Illum	.5 Rd/wpn/day
C249	Ctg, 81mm Smk Wp	1 Rd/wpn/day
C445	Ctg, 105mm How HE (All types)	30 Rds/wpn/day
C449	Ctg, 105mm Illum	2 Rds/wpn/day: Increase of 1.36 since last report
C705	Ctg, 4.2 HE w/o fuze	12 Rds/wpn/day: Increase of 10 since last report

CONFIDENTIAL

CONFIDENTIAL

50

AVFA-GC-OT

SUBJECT: Operational Report for Quarterly Period Ending 31 January 1967,  
RCS CSFOR-65 (U)

<u>DODAC</u>	<u>NOMENCLATURE</u>	<u>ASR</u>
G	Gen, Hand, Frag, M26A (All types)	130 Bde/day; Increase of 30 since last report
H	Rkt, 2.75 HE (All types)	.25 Rd/tube/day
H555	LAW, M72, 66	6 Bde/day
K	Mine, AP M18 (All types)	25 Bde/day; Increase of 10 since last report
L	Sig, illum, Ground, white star, cluster M159	5 Bde/day; decrease of 1 since last report
L	Sig, illum, Ground, green star, para, M19A1	9 Bde/day; Increase of 4 since last report
I311	Sig, illum, Ground, red star, para M126	7 Bde/day; Increase of 5 since last report
I312	Sig, illum, Ground, White star, para M127	6.5 Bde/day; Decrease of 3.5 since last report
I314	Sig, illum, Ground, Green star, cluster, M125	5 Bde/day
I323	Sig, smk, green, red, para M129Z1	2 Bde/day
L407	Flare, aircraft, para MK24	8 Bde/day; Increase of 4 since last report
L495	Flare, surface, trip, M49	35 Bde/day; Increase of 5 since last report

c. Service and Support: Cam Ranh Bay and Qui Nhon Support Commands, under the 1st Logistical Command, continue to provide support to I FFORCEV tactical operations.

d. Transportation: Increased use of highways to support tactical operations resulted in an average increase of 500 short tons per day in November and 220 short tons per day in December. An average of 2342 short tons per day was being moved in January.

5. (C) Personnel and Administrative Action:

a. Maintenance of Unit Strengths:

(1) HQ, I FFORCEV key personnel and FWMAF senior commanders are shown at inclosure 18.

CONFIDENTIAL

CONFIDENTIAL

51

AVFA-GC-OT

SUBJECT: Operational Report for Quarterly Period Ending 31 January 1967,  
RCS CSFOR-65 (U)

(2) Authorized and assigned strength of assigned and attached units have been generally satisfactory throughout the reporting period. The present for duty strengths of the OPCON units approximate 100% of authorized. However, within these strengths there are many MOS and grade imbalances. The most critical shortage is in the Infantry MOS (11B). There is overage in the common specialist skills. This situation is further aggravated by the requirement to operate base camps, provide local security and long range reconnaissance patrols. During the months of December and January, only 53% of all infantry and artillery MOS's which were programmed actually arrived in country. The continuing shortage of basic combat MOS's has caused a significant impact on the number of personnel available for commitment in a normal search and destroy operation.

(3) This headquarters will continue to review the alignment of our present manpower resources, with a view toward making any changes which could improve or alleviate this problem.

(4) Personnel strengths of assigned, attached and operational control units are shown at inclosure 20. Present for duty percentages of assigned strength of maneuver battalions is shown at inclosure 19.

b. Personnel Management:

(1) Although receipt of assignment instructions for personnel nearing rotation continues to be somewhat sporadic, significant improvement has been noted.

(2) Qualification and motivation of personnel within the assigned, attached, and under the operational control of this headquarters continues to be excellent. Replacement personnel from CONUS training bases are arriving in excellent physical condition and with a good general knowledge of the guerrilla tactics normally encountered in this command.

c. Civilian Personnel: Civilian personnel management procedures continued to improve. Pay procedures have been significantly improved since the transfer of disbursing responsibilities from Saigon to the 22d Finance Disbursing Section, Nha Trang. All local national employees began receiving bi-weekly pay effective 1 Dec 66. Civilian personnel status of this headquarters is shown below:

Aid in Kind (AIK) employees authorized	91
AIK employees on hand 1 Nov 66	76
Release during reporting period	12
Released for cause (8)	
Released for individual request (4)	
Transferred	0
Employed during period	12
Number of employees on hand 31 Jan 67	76

CONFIDENTIAL

CONFIDENTIAL

52

AVFA-GC-CT

SUBJECT: Operational Report for Quarterly Period Ending 31 January 1967,  
RCS CSFOR-65 (U)

d. Enlisted promotion allocations for assigned and attached units are shown at inclosure 21. Utilization of allocations is excellent. One December E8 allocation was returned to USARV. This was due to a requisitioning error at USARV. One 94250 E8 was allotted against a 91250 E7 requisition, however, there was no penalty resulting as the vacancy was filled by in-country reassignment. In January, two E8 allocations were returned to USARV. One position vacancy was filled by an in-country transfer and the other was the result of an erroneous requisition by the unit. All unit requisitions are now being verified by this headquarters prior to forwarding to USARV.

e. Development and maintenance of morale:

(1) The morale of all assigned and attached units remained excellent throughout the reporting period. Morale services within the command continued to improve.

(2) R&R quotas for assigned and attached units were received, distributed and utilized as shown at inclosure 22 and 23. No significant difficulties were experienced. The establishment of the R&R center for II CTZ at Cam Ranh Bay has greatly facilitated travel. Sufficient reallocations from Da Nang are being obtained.

(3) Awards and decorations approved during the period are shown at inclosure 24.

(4) Mail service increased in volume during the holiday season. However, apparently because of the increased volume, mail service was sporadic. Personal letters mail was delayed during shipment from CONUS often as much as seven to ten days. In early December, some wet and damaged mail was received by this headquarters. The cause appeared to be the lack of adequate sorting and storage facilities at the new aerial mail terminal at Cam Ranh Bay. A letter was dispatched advising CG, USARV of the situation and requesting that an investigation be made and corrective action be taken to prevent further recurrences. There have been no recent incidents of damaged or wet mail. Incoming personal mail decreased in volume during the month of January and all Christmas mail was cleared by the middle of the month. The total volume of personal letter mail varies greatly from day to day. The monsoon weather is attributed to be the principal cause of mail delay. Dates on which personal letter mail was not received are shown at inclosure 25.

(5) Chaplain Activities.

(a) In II CTZ there are 146 US military chaplains:

	<u>ARMY</u>	<u>AIR FORCE</u>
Protestant	101	9
Catholic	29	6
Jewish	1	0
TOTAL	131	15
GRAND TOTAL	146	

CONFIDENTIAL

*CONFIDENTIAL*

AVFA-GC-OT

SUBJECT: Operational Report for Quarterly Period Ending 31 January 1967,  
RCS CSFOR-65 (U)

## (b) Religious Services:

1. Protestant service in OPCON units and in combat support and service support units, with the exception of Advisory Teams, are adequate. Advisory Teams must depend on the presence of other US units in the vicinity. The number of Advisory Teams and their disposition renders regular weekly services by advisory chaplains an impossibility.

2. Catholic services in OPCON units are adequate. In combat support and service support units the coverage has improved. Further improvement is expected through implementation of area coordination procedures.

3. Jewish services are adequate. Services are conducted by the Jewish chaplain in 13 locations once a month and in Nha Trang every week on the Sabbath. Lay leaders conduct weekly Jewish services at the 13 locations. One Jewish chaplain, assigned to this Hq, has responsibility for II CTZ.

4. In Nha Trang the following services are scheduled.

a. Sunday: 12 Protestant, 11 Catholic.

b. Friday: Jewish Sabbath service.

c. Daily: 3 Catholic services.

5. Services are conducted at the following locations:

HQ I FFORCEV	17th Avn Gp	Camp McDermott
54th Sig Bn	Hq NTSAC	5th SFG
459th Sig Bn	8th Field Hosp	US Air Force Base

6. On 18 Jan 67, a one day retreat for Protestant chaplains was conducted at Cam Ranh Bay with 32 chaplains in attendance.

(c) During January I FFORCEV chaplains made the following contributions to assist civilian organizations in the Nha Trang area.

## 1. Protestant:

a. Evangelical Bible Institute: Offering from services on 1st Sunday of the month. Amount 1,693.26 \$VN.

b. Evangelical Medical Clinic: 2d Sunday of the month. Amount 1,693.36 \$VN.

c. Christian Servicemen's Center: 3d Sunday of the month. Amount 990.16 \$VN

*CONFIDENTIAL*

CONFIDENTIAL

54

AVFA-GC-OT

SUBJECT: Operational Report for Quarterly Period Ending 31 January 1967,  
RCS CSFOR-65 (U)

2. Catholic:

a. Holy Family Church: Offering from services on 1st and 3d Sundays of the month. Amount 2932.08 \$VN

b. St Joseph's School: 2d Sunday of the month. Amount 2952.96 \$VN

(d) Coordination:

1. A letter on coordination of religious activities and implementation of I FFORCEV Regulation 10-3, is being staffed by this headquarters.

2. Visits of religious or church affiliated VIP's: Official visits by VIP's with religious or church affiliated significance should be planned by protocol at higher headquarters and coordinated through protocol channels. Protocol may designate the chaplain as project officer, or will at least coordinate with the chaplain, but for efficiency and avoidance of confusion, visits in this class of VIP's require the same procedure as other VIP's.

f. Maintenance of Discipline, Law and Order:

(1) Discipline, Law and Order: Tuy Hoa village, Tin City (Adjacent to Tuy Hoa South Airfield) and the village of Phan Rang were placed off limits by USARV, 22 Dec 66. A query was forwarded to USARV requesting the reasons for the off limits restriction. USARV completed a study and survey at field level on the impact of troop behavior and plaster expenditures with a view toward determining the desirability of restricting liberty for US Armed Forces personnel. The study resulted in a recommendation to COMUSMACV that the current off limits restriction in Tuy Hoa and Phan Rang be removed and a curfew of 1830 hours be imposed. The recommendation is awaiting approval. No unusual law and order problems developed during the period of this report. Command rates by unit (assigned, attached and OPCON) were generally lower than USARV rates for offenses and incidents as indicated at Inclosure 26.

(2) Traffic Safety Program: MACV directed military convoy regulation on highway # 1 between Dien Khanh (in the vicinity of Nha Trang) and Vung Ro Bay, effective 27 Jan 67. Highway regulating points established at Bien Khanh and entrance to Vung Ro Bay are manned by one TMA representative and one MP. Plans call for US Military Police patrols on Highway #1 and TCPs on the south and north end of Vung Ro Bay pass. ROK MPs are currently manning TCPs at Highway # 421 and Highway # 1 South, Highway # 421 and Highway # 1 north; Highway # 1 and Highway # 21 in Ninh Hoa. The highway is open from 0600 to 1800 hours daily. TMA has established a traffic control center located at their headquarters in Nha Trang, which will move to the Nha Trang Military Police Station on or about 10 Feb 67. Traffic has been running smoothly with an average of five convoys a day. Future plans call for expansion of convoy regulation on Highway # 1 from Dien Khanh to Qui Nhon and Phan Rang.

(3) Police Officers Conference: The monthly Police Officers Conference was held on 25 Jan 67. Attendees included representatives from US Forces Police, ROK Military Police, GVN National Police and Customs, and Provincial Representative; Public Safety, Khanh Hoa Province. Participation was excellent. Items discussed included the jurisdiction of Vietnamese Police and the US Military Police over military personnel and Vietnamese

CONFIDENTIAL

55

CONFIDENTIAL

AVFA-GC-OT

SUBJECT: Operational Report for Quarterly Period Ending 31 January 1967,  
RCS CSFOR-65 (U)

citizens, assistance that is provided the National Police by the ROK and US Military Police during the TET period, control of blackmarket items, and prevention of outdated and spoiled food being disposed by US Forces on dumps where Vietnamese may obtain the food and sell it on the blackmarket or for personal use.

(4) VIP Security: A meeting of representatives from 5th SF Group, 55th MI Det, 272d MP Co, Air Police, Long Van AFB, Nha Trang Sub Area Command PM, I FFORCEV Protocol Officer, Headquarters Commandant and PM was held to establish security measures for VIP visitors to Headquarters, I FFORCEV. The I FFORCEV PM assumes overall responsibility for the security of the VIP, the coordination of security, I FFORCEV Aviation Section services, and GVN Military Security Service. There were five visitors to Hq, I FFORCEV during January 1967 that required VIP security.

(5) Villa Security: The problem of villa security in Nha Trang arose when approximately one-third of the security force quit. Coordination was made with CO, Nha Trang Sub Area Command to insure that villas occupied by senior officers and officers with special security clearances remain guarded. CO, NTSAC is also making special effort to provide security to other billets by establishing area, rather than fixed post security. An active recruiting program is in progress.

(6) Prisoners of War:

(a) A survey team comprised of MACV, JGS, and I FFORCEV PM representatives met in Qui Nhon to select a site for the proposed PW Camp in Binh Dinh Province. The team selected a site approximately 10 miles south of Qui Nhon on Highway # 1, (Coordinates BR999227). The site has been approved by JGS, and 10 million piasters have been funded for the project. Construction material for the camp has been shipped from Saigon to Qui Nhon. Construction is scheduled to begin on or about 1 March 1967 and be completed by 30 June 1967.

(b) Planned expansion of the present PW Camp at Pleiku has been approved by the JGS. Ground preparation for the expansion by ARVN Engineers began 24 Jan 67. Construction will begin the last week of February and is scheduled for completion by 30 June 1967.

(c) At 2045 hours 14 Jan 67, approximately 200 prisoners at the ARVN II Corps Combat Captive (PW) Camp, Pleiku gathered inside the compound and threw small gravel and stones at the camp guards. Reaction forces consisting of three platoons of ARVN Military Police, an ARVN Company and two M8 vehicles from an ARVN Cav unit were alerted and quickly surrounded the PW Camp compound. Small arms were fired in the air and a canister of CS gas was thrown into the compound. The camp Commander entered the compound, ordered the PW to assemble in formation and listened to their complaint. He then ordered them to their barracks, where they returned without further activity. The incident was caused when the ARVN duty Officer entered the compound under arms and assaulted a prisoner. The quick reaction of the alert force and camp personnel prevented a possible serious incident.

CONFIDENTIAL

*CONFIDENTIAL*

56

AVFA-GC-OT

SUBJECT: Operational Report for Quarterly Period Ending 31 January 1967,  
RCS CSFOR-65 (U)

(7) Joint Vietnamese National Police and US Military Police patrols: As a means of assisting the Vietnamese National Police (VNP) and the Revolutionary Development Program, three joint VNP and Military Police patrols were established in Nha Trang. The patrols primary mission is to assist the VNP in control of the civilian population. Its secondary mission are to train VNP in US police methods and to train US MPs and VNP in joint patrol procedures. Three patrols are presently operating from 1800 to 0600 hours daily. Each patrol is composed of one VNP and one MP in a radio equipped jeep. To facilitate rapid deployment of the patrols and provide a means of direct communications, a radio was installed in the National Police Headquarters. The patrols also assist in resolving jurisdictional issues that may arise. The VNP deals with Vietnamese citizens while his American counterpart deals only with US personnel. These patrols have been of benefit by increasing the proficiency of the VNP and in improving control over the civil population, particularly during the hours of darkness. Joint Vietnamese National Police and US military police patrols, formed to train the National Policemen and assist in control of both civilian/military population, are beneficial and should become an integral part of law enforcement activities in major Vietnam cities.

g. Headquarters Internal Arrangements:

(1) Internal re-arrangement of headquarters.

(a) Work is being completed to number all buildings within the Grand Hotel compound, thus alleviating confusion as to location of various staff section activities.

(b) Construction of Headquarters Company dayroom is tentatively scheduled to commence on 13 Feb 67, with a projected completion date of 31 March 1967.

(c) The SJA and IG sections are preparing proposals for possible relocation to the building presently occupied by the Area Engineer.

(d) Construction of three 20X48 foot quonset type troop billets is scheduled to be completed by 8 Feb 67 for occupancy by enlisted personnel assigned and or attached to this headquarters.

(e) The Headquarters Top Secret Repository has been renovated, thereby enhancing the overall security of this sensitive facility.

(f) Construction of a 50X50 conference room was completed 9 Jan 67.

(g) Construction of the chapel was completed.

(2) Physical Security: Work on the security fence around the 69th Signal Detachment complex will resume on 13 Feb 67 with a projected completion date of 28 Feb 67.

(3) Status of Enlisted Mess: There have been no significant changes in the mess during this period.

(4) Storm drainage: Construction of the Grand Hotel compound drainage system has been completed and is operable.

*CONFIDENTIAL*

57

CONFIDENTIAL

AVFA-CC-OT

SUBJECT: Operational Report for Quarterly Period Ending 31 January 1967,  
RCS CSFOR-65 (U)

6. (C) Artillery.

a. A Battery, 2d Battalion, 320th Artillery, 1st Brigade, 101st Airborne Division fired one shell APERS-T XM546, (Beehive), round during an attack by Viet Cong on its position on 7 Nov 66. This is the first instance in II CTZ in which this ammunition has been used in combat. No enemy casualties or body count was made, but the firing of the round is regarded as being highly instrumental in halting the attack.

b. Colonel Ashley A. Blinn assumed command of I Field Force Vietnam Artillery from Colonel Linton S. Boatwright on 13 Nov 66.

c. The 7th Battalion, 13th Artillery received its equipment and became fully operational on 15 Nov 66. Since this date, the 7th Battalion, 13th Artillery has participated in Operation PAUL REVERE IV with the 1st Cavalry Division (AM) and the 4th Infantry Division, Operation Dazzlem with the 1st Cavalry Division (AM), Operation THAYER II with the 1st Cavalry Division (AM) and Operation MAENG HO VIII with the Capital ROK Infantry Division. The battalion has completed air mobility training and has participated in heliborne missions in a direct support role. The unit is stationed at Hammond Army Air Field near Phu Cat.

d. The II Corps Naval Gunfire Liaison Officer was relocated on 1 Dec 66 from HQ, II Corps in Pleiku to HQ, I FFORCEV Artillery in Nha Trang. The relocation action was initiated and staffed at HQ, I FFORCEV Artillery. The purpose of this relocation is to facilitate and enhance the employment of naval gunfire by US, ROK, and ARVN forces conducting operations in coastal areas.

e. HQ, I FFORCEV Artillery (Forward) (Dong Ha) was established at Dong Ha on 3 Dec 66 to exercise command and control of the US Army Artillery Battalions stationed in I CTZ. The three battalions, 1st Battalion, 40th Artillery; 1st Battalion, 44th Artillery with G Battery, 65th Artillery attached; and 2d Battalion, 94th Artillery with B Battery, 6th Battalion, 27 Artillery attached, are attached to I FFORCEV Artillery and under operational control of the III Marine Amphibious Force. The mission of this forward command post is to act as an extension of HQ, I FFORCEV Artillery, provide command and control, less operational control, of US Army artillery units in I CTZ and to monitor administrative and logistical support provided respectively by III MAF, HQ, I FFORCEV, and 1st Logistical Command.

f. On 7 Dec 66 Colonel Jerry F. Dunn assumed command of I FFORCEV Artillery from Colonel Ashley A. Blinn.

g. On 19 Dec 66 Brigadier General Edward H. deSaussure Jr., assumed command of I Field Force Vietnam Artillery from Colonel Jerry F. Dunn. A change of command ceremony was held at 5th Special Forces Group (Airborne) Quadrangle, Nha Trang. Massed Colors from the 52d Artillery Group and the battalions attached to I FFORCEV Artillery were in attendance. Captain Donald Borden, Commanding Officer, Headquarters Battery, I FFORCEV Artillery was Commander of Troops.

h. Headquarters, I Field Force Vietnam Artillery (FWD) (Qui Nhon) was established on 29 Dec 66 and became operational 5 Jan 67.

CONFIDENTIAL

CONFIDENTIAL

57

AVFA-GC-OT

SUBJECT: Operational Report for Quarterly Period Ending 31 January 1967,  
RCS CSOR-65 (U)

The mission of this forward command post is to act as an extension of HQ, I FFORCEV artillery and to provide command and control of three battalions in the Qui Nhon, An Khe, Phu Cat area. The units under control of this headquarters are: 7th Battalion, 13th Artillery; 3d Battalion, 18th Artillery; 1st Battalion, 30th Artillery; and Battery B, 29th Artillery (Searchlight). HQ, I FFORCEV Artillery (Forward) (Qui Nhon) is collocated with 1st Battalion, 30th Artillery.

i. Headquarters Battery, 8th Battalion, 26th Artillery (Target Acquisition) arrived in II Corps Tactical Zone for employment under I FFORCEV Artillery. The advance party arrived on 8 Jan 67 with the main body following on 19 Jan 67. Unit equipment and impedimenta have been received and, as of the end of the reporting period, the unit was nearing operational readiness. Plans have been completed at HQ, I FFORCEV Artillery for mission assignments for the unit's two metro sections, six AN/MPQ-10A countermortar radar sections and three survey sections. The battery is stationed at Qui Nhon, RVN and has been attached to 1st Battalion, 30th Artillery for quarters, rations, and administration. Operational Control has been retained by I FFORCEV Artillery.

j. Artillery units assigned or attached to I FFORCEV during the reporting period were:

(1) Non-divisional:

HQ, I FFORCEV Artillery (Forward Command Posts located at Qui Nhon and Dong Ha)

52d Artillery Group

3d Battalion, 6th Artillery (105mm SP)

7th Battalion, 13th Artillery (105mm T)

6th Battalion, 14th Artillery (175mm/8-inch SP)

3d Battalion, 18th Artillery (175mm/8-inch SP)

5th Battalion, 27th Artillery (105mm T)

1st Battalion, 30th Artillery (155mm T)

1st Battalion, 40th Artillery (105mm SP)

1st Battalion, 44th Artillery (AWSP)

2d Battalion, 94th Artillery (175mm SP)

Headquarters Battery, 8th Battalion, 26th Artillery (Target Acquisition)

Battery B, 6th Battalion, 27th Artillery, (175mm SP) (attached to 2d Battalion, 94th Artillery)

Battery B, 29th Artillery (Searchlight)

Battery G, 65th Artillery (MG), (Attached to 1st Battalion, 44th Artillery).

CONFIDENTIAL

59

CONFIDENTIAL

AVFA-GC-OT

SUBJECT: Operational Report for Quarterly Period Ending 31 January 1967,  
RCS CSFCR-65 (U)

(2) Divisional

1st Cavalry Division Artillery (Air Mobile)

2d Battalion, 17th Artillery (105mm T) (Attached)

2d Battalion, 19th Artillery (105mm T)

2d Battalion, 20th Artillery (ARA)

1st Battalion, 21st Artillery (105mm T)

1st Battalion, 77th Artillery (105mm T)

Battery C, 6th Battalion; 16th Artillery (155mm T)  
(attached)

4th Infantry Division Artillery

5th Battalion, 16th Artillery (155mm/8-Inch SP)

6th Battalion, 29th Artillery (105mm T)

4th Battalion, 42d Artillery (105mm T)

3d Brigade, 25th Infantry Division

2d Battalion, 9th Artillery (105mm T)

1st Brigade, 101st Airborne Division

2d Battalion, 320 Artillery (105mm T)

k. Artillery Statistics for reporting period, I FFORCEV:

(1) Missions Fired:	<u>NOV</u>	<u>DEC</u>	<u>JAN</u>
Neutralization, destruction, etc.	5327	5744	8196
H & I	<u>41,649</u>	<u>50,522</u>	<u>51,803</u>
TOTAL	46,976	56,266	59,999
Observed	4391	4183	5284
Unobserved	42,585	52,078	54,715

CONFIDENTIAL

*CONFIDENTIAL*

60

AVFA-OC-OT

SUBJECT: Operational Report for Quarterly Period Ending 31 January 1967.  
RCS CSFOR-65 (U)

(2) Ammunition Expended:	<u>NOV</u>	<u>DEC</u>	<u>JAN</u>
(a) 2.75 HE	8460	9475	12,667
(b) 105 HE	14,920	108,139	116,346
105 ILL	1836	2048	2727
105 WP	18,215	17,479	20,305
105 Smk	4066	3237	5252
105 other	10	0	200
TOTAL	139,047	130,903	145,830
(c) 155 HE	22,729	24,577	25,055
155 ILL	1210	856	1753
155 WP	1970	1923	1635
155 Smk	<u>455</u>	<u>455</u>	<u>493</u>
TOTAL	26,364	27,811	28,936
(d) 8-inch HE	8490	9721	7807
(e) 175mm HE	5743	8401	7001

1. Periodic Logistics Report

(1) The value of the Periodic Logistic Report (RCS AVHGD-35), required by USARV Regulation 700-6, became more apparent during this reporting period. Non-divisional artillery units both in I CTZ and II CTZ started to receive reports of actions taken by the responsible support command, and in some instances from 1st Logistical Command, on problem areas contained in subject reports.

(2) Feedback received from support facilities also enabled reporting units to purify their outstanding PIL requisition list at support facilities by resubmission of request that rendered invalid due to faulty records maintenance by either the requesting unit or the supporting unit.

(3) In order to increase the effectiveness of the Periodic Logistics Report, the frequency of the reporting period should be changed from the present weekly requirement to a biweekly requirement. This would allow support facilities to react to reported problem areas in a more detailed manner, as well as to enable follow-up action by all concerned before the next report is due. Decreasing the frequency of reporting periods would also save valuable manhours, and would permit realistic comparisons of progress made by both reporting and supporting units between reporting periods.

*CONFIDENTIAL*

CONFIDENTIAL

AVFA-CC-OT

SUBJECT: Operational Report for Quarterly Period Ending 31 January 1967,  
RCS CSFOR-65 (U)

m. The lack of the following maintenance float items at USASC, Qui Nhon and Cam Ranh continue to adversely affect the support of artillery units in II CTZ:

- (1) Panoramic Telescope, M115 (8" How and 175mm Gun).
- (2) Panoramic Telescope, M117 (105mm How) (SP)
- (3) Generator Set, PU 107 (AN/MPQ-4A Radar)

n. The absence of adequate numbers of float items listed above substantially increases the down time of combat essential equipment, decreases the capability of artillery units during tactical operations, and results in the expenditure of considerable time and effort by the support agencies in expediting repair of critical items. Availability of float items would not only assist user units in maintaining the required state of combat readiness but would allow for a more orderly accomplishment of functions at support facilities.

o. The shortage of radiosonde system expendable items (radiosondes, parachutes, balloons, calcium hydride and BA 259 batteries) has caused the deadline of several of these systems in II CTZ, thereby precluding the accumulation of required meteorological data for artillery operations.

p. Aerial shipment of critical supplies to US Army Artillery units in II CTZ continue to be adversely affected because of the unavailability of aircraft for the US Army Support Command, Qui Nhon.

q. The long lines of communications between US Army Support Command, Qui Nhon, to the Da Nang Sub Area Command (275KM), and from that facility to the FSA at Dong Ha (145KM) makes it imperative to have aircraft immediately available for the transportation of artillery weapons repair parts required to remove equipment from deadline, as well as for shipment of other critical supplies to support combat operations.

#### 7. (C) Engineer.

##### a. General:

(1) Requirement for Engineer Combat Support continued to increase during the reporting period. The arrival of the 35th Engineer Battalion (Combat) in Qui Nhon on 20 Nov 66 increased the engineer effort available to the 45th Engineer Group.

(2) On 10 Nov 66, 18th Engineer Brigade directed the realignment of the three engineer group boundaries within II Corps Tactical Zone to provide a more equitable distribution of engineer forces in accordance with current and planned engineer combat support requirement within the respective engineer group areas of responsibility.

(3) The 18th Engineer Brigade (North) Command Post was established at Dong Ba Thin on 19 Nov 66. The 18th Engineer Brigade (North) assumed command of the 35th, 45th, and 937th Engineer Groups and has the responsibility for all non-divisional engineer support throughout the II Corps Tactical Zone.

CONFIDENTIAL

*CONFIDENTIAL*

62

AVFA-GC-OT

SUBJECT: Operational Report for Quarterly Period Ending 31 January 1967,  
RCS CSPOR-65 (U)

b. The majority of the effort of the engineer section during the reporting period was devoted to the planning, coordination and supervision of the engineer combat support provided by the 18th Engineer Brigade units in support of I FFORCEV tactical operations. Engineer combat support effort expended by units of the 18th Engineer Brigade on I FFORCEV directed projects in support of current or future operation included:

(1) English Airfield (BSP 013). Construction of an all weather C-130 capable airfield was initiated on 19 Sept 66 by the 84th Engineer Battalion. The project consisted of lengthening the existing C-123 airfield to 3500 feet and constructing a parking area for five C-130 aircraft. Installation of M8A1 landing mat was started on 19 Nov 66 by elements of the 19th Engineer Battalion. Installation of the matting was completed on 15 Dec 66. This facility was utilized to support Operation THAYER II.

(2) Nhon Co Airfield (YU805254). Elements of the 20th Engineer Battalion completed the runway repair and expansion facilities at Nhon Co on 9 Dec 66. Scope of the project included the application of a seal coat on the runway, and construction and clearing of sufficient area for a brigade bivouac area and parking for three airmobile companies.

(3) Sao Loc Airfield (Vicinity ZTU80790). The scope of this project includes the construction of a new all weather C-130 capable T-17 membrane airfield with parking for five aircraft, parking facilities for three airmobile companies and a FSA complex. Construction of this complex was accomplished by elements of the 62d Engineer Battalion and the ARVN 202d Engineer Battalion. This project was completed on 30 Dec 66.

(4) Phu Tuc Airfield (BQ490590). This project encompasses lengthening the existing runway to 3500 feet (C-130 capable), construction of parking for five C-130 aircraft, surfacing runway and parking area with T-17 membrane, clearing areas for FSA and for parking for three airmobile companies. Earthwork continues on the runway and parking apron. Air shipment of T-17 membrane to the site has been completed.

(5) Cung Son Airfield (BQ808424). This project involves extending the existing runway to accommodate C-123 aircraft, construction of parking area for three C-123 aircraft and surfacing the runway and parking area with T-17 membrane. Adverse weather has caused this project to be deferred until after the northeast monsoon season. It is estimated that this facility will be completed by 1 March 1967.

(6) Nha Trang By-Pass. This project is a joint US-ARVN engineer project to construct an all-weather two-way CL 35 by-pass road around the city of Nha Trang. Wet weather and high water has hindered construction effort on this project.

(7) Tuy Hoa Tactical Road Net. Construction of this road net in the Tuy Hoa Valley is the responsibility of the 39th Engineer Battalion and the 612th ARVN Engineer Company. The ARVN 612th Engineer Company has been re-deployed to provide engineer support to the ARVN 47th Regiment in Operation Bac Binh Vuong 802 which is an operation designed to open RT 1 from Tuy An to Song Cau for CL 12 traffic. This road net when completed will permit rapid deployment of troops overland to insure security of the valley. The 39th Engineer Battalion is providing material and troop support to this operation as required.

*CONFIDENTIAL*

63

CONFIDENTIAL

AVFA-GC-OT

SUBJECT: Operational Report for Quarterly Period Ending 31 January 1967,  
RCS CSFCH-65 (U)

(8) Repair of Phan Thiet Airfield (ANSO2071). Elements of the 14th Engineer Battalion have replaced the elements of the 87th Engineer Battalion at Phan Thiet and continue to provide engineer support to the 2d Bn, 7th Cav, conducting Operation BYRD. Patching of the runway continues on an as required basis. Elements of the ARVN 203rd Engineer Battalion in conjunction with the 14th Engineer Battalion are currently engaged in the repair and upgrading of bridges on RT 8B from Phan Thiet to Thien Giao (AN870252).

(9) Construction of New Plei Djereng CIDG Camp and C-130 airfield (YA970455). The C-130 airfield at New Plei Djereng was completed and open to C-130 traffic on 26 Jan 67. Included in the project was the construction of a new CIDG fighting camp with four 175mm/8-inch artillery positions to include personnel and ammunition bunkers and a mess facility. The new C-130 airfield was surfaced with MX-19 airfield landing mat. This airfield will be utilized to support Operation SAM HOUSTON and also for resupply of the new CIDG Camp.

(10) Extension of Route 509B. Scope of the project includes the construction of a one-lane CL 12 route with turnouts from vicinity of YA665555. This project was deferred on 6 Dec 66 as a result of the withdrawal of tactical forces for other combat operations. The project was resumed on 2 Jan 67 and completed 31 Jan 67.

(11) Song Mao Airfield (BN270449). Elements of the 87th Engineer Battalion initiated the upgrading of this airfield to C-130 capability, the construction of parking facilities for three airmobile companies and a FSA on 20 Nov 66. Also included in this project is the construction of a landing site for two LCU's in the vicinity of Phan Ki (BN352356). Completion of the runway is scheduled for 15 Feb 67. This airfield will be used in support of Operation PARRAGUT.

(12) Ban Blech Airfield (AQ990615). Elements of the 937th Engineer Group moved to Ban Blech on 24 Dec 66 to begin rehabilitation of the T-17 membrane C-130 airfield at that location. Scope of the project included removal of the membrane, recompaction, and reshaping of the runway and parking apron and replacement and patching of the T-17 membrane. This project was completed 30 Jan 67.

(13) In support of Operation PICKETT, elements of the 937th Engineer Group upgraded RT 511 from Kontum to Polei Kleng to two way CL 31, maintained Kontum airfield and improved aircraft parking facilities, and upgraded Polei Kleng to C-123 capability. T-17 membrane was allocated for this airfield to provide an all-weather capability. This project was completed on 20 Jan 67.

(14) Construction of a new C-130 airfield at An Khe. Construction of this airfield is being accomplished by the 84th Engineer Battalion. This permanent airfield is scheduled for completion in February 1967, and will replace the old PSP runway at An Khe which has been rehabilitated and will be utilized as a taxiway for the new runway when completed.

(15) ARVN Operation Bac Binh Vuong 802. This operation was designed to open QL-1 to CL 1A traffic between Tuy An (vicinity of junction of QL-1 and RT 6B) and Song Cau. Elements of the 45th Engineer Group supported the ARVN 612th Engineer Company and the ARVN 217th Float Bridge Company in this operation with materials and equipment assistance.

CONFIDENTIAL

CONFIDENTIAL

64

AVFA-GC-CT

SUBJECT: Operational Report for Quarterly Period Ending 31 January 1967,  
RCS CSFOR-65 (U)

The critical point on this route is the crossing of the Song Cai River. The 6th ARVN Engineer Group currently is planning to install CL 18 Eiffel bridges on the existing piers at this site. Elements of the 19th Engineer Battalion will furnish material and equipment assistance.

(16) Operation Maeng Ho 8. This operation was initiated on 2 Jan 67 by the Capital ROK Infantry Division and was designed to open QL-1 from the southern boundary of the CRID TACR to Song Cau. A Company, 19th Engineer Battalion, 45th Engineer Group provided the engineer support to the Capital ROK Infantry Division to open QL-1. Support consisted of repair and replacement of bridges and the repair of road cuts. This portion of QL-1 was opened to CL 18 traffic on 20 Jan 67. The 45th Engineer Group is currently developing plans to upgrade this portion of QL-1 to CL 31 capability.

(17) Oasis Airfield. This project encompasses the rehabilitation of the existing T-17 membrane C-130 airfield at Oasis to include recompaction and reshaping of the runway, installation of MX-19 or MBAL landing mat and construction of a parking apron for five C-130 aircraft. D Company, 35th Engineer Battalion closed on Oasis on 31 Jan 67.

(18) Route Maintenance: Elements of the 927th Engineer Group continued to upgrade and maintain RT 509 and RT 19 to two-way all weather CL 35 (one-way CL 50 bridges) capability. In the THAYER II AO, elements of the 45th Engineer Group continued upgrading and maintenance of QL-1 from Hammond to English airfield. QL-1 from Hammond to English was opened to CL 31 dry weather capability on 29 Jan 67.

#### 8. (U) Signal

a. Maintenance and upgrading of all I NFORCEV Communications continue to be the major activities of the Signal Section. Continual redistribution of the 54th Signal Battalion assets to meet constant changing tactical situations are the foremost and most critical task. Maintenance of signal equipment and associated communication outages continue to be a daily problem. Some relief has been gained in the status of operational signal equipment, however, the status of the HF radios remains crucial with the operational equipment available just meeting operational demands.

b. 54th Signal Battalion supported Operations PICKETT, FA - RAGUT, PAUL REVERE/THAYER, BYRD AND ADAMS/GERONIMO.

c. In conjunction with 21st Signal Group and MCA-SAM, action was initiated to upgrade local telephone service in Nha Trang. A proposal was presented to MACV to upgrade the Air Force dial central Office in Nha Trang to 800 lines and to install additional Army switchboard equipment. As a result of this action, installation of an Army 800 line mobile dial central office to replace the existing TORCH and GOLDFINCH switchboards has been programmed.

d. The initial phase of "The Time Phased Implementation Plan for Telephone Service in Southeast Asia" was instituted in II CTZ during

CONFIDENTIAL

UNCLASSIFIED

65  
AVFA-OC-OT

SUBJECT: Operational Report for Quarterly Period Ending 31 January 1967,  
RCS CSFOR-65 (U)

the month of November. Long distance switchboards at Nha Trang and Pleiku were placed into operation and are interconnected with Saigon, Qui Nhon, Cam Ranh and Danang ID switches. An increasing number of trunks between these ID switches will become available as the expansion of the Southeast Asia Wideband System (SEAWBS) progresses.

e. In order to meet the demand for communications to the Tuy Hoa area, micro-wave and VHF communication systems are being installed to Tuy Hoa with relay points at Hon Tre Island, Ninh Hoa, and Vung Ro Bay.

f. Considerable effort was expended to improve delivery time of electrically transmitted messages. A multiple call processing unit was installed in the I FFORCEV Communication Center which allows rapid processing of multiple addressee messages. Additionally, emphasis has been placed on maximum use of courier service for low precedence traffic.

g. I FFORCEV assumed responsibility for the operation and maintenance of the Nha Trang AFRS station. The station was relocated from Long Van Air Base to the Grand Hotel area on 28 Nov 66. Power output of the station was improved from 15 to 35 watts. Additionally, the AFRS signal is being simultaneously broadcasted on AM and FM.

h. In conjunction with Operation PICKETT, a I FFORCEV tactical CP was established at Pleiku. Cable was installed by the 54th Signal Battalion to extend circuits from the SEAWBS site at Pleiku to the tactical CP. Telephone and teletype circuits were provided from the tactical CP of the 1st Bde, 101st Abn Div, the 4th Inf Div, 1st Cav Div (AM), and I FFORCEV Headquarters at Nha Trang.

i. The C-2 Detachment, 5th Special Forces Group (Abn) was placed under operational control of I FFORCEV in December. One secure teletype and one semi-user voice circuit were required to satisfy the demand for adequate and responsive communications. Due to lack of terminal equipment in the unit, the 54th Signal Battalion was required to provide secure teletype equipment at the C-2 Detachment. In addition, a secure radio-teletype team remains on operational standby at the C-2 Detachment to enter the I FFORCEV net if required.

j. Action continued to obtain additional equipment to enable the 54th Signal Battalion to better perform its current mission. Requests were submitted to USARV for teletype equipment to replace that removed from mobile vans and installed in the fixed center, AN/VSC-2 SSB radio-teletype equipment to replace the AN/MRC-95 equipment previously authorized and for replacement of some of the battalions aircraft with heavier aircraft. Two switchboards AN/TCC-7 were received to replace those permanently installed at Headquarters I FFORCEV. Plans were made to install these switchboards in mobile vans.

k. The 167th Signal Company (Radio Relay - VHF) arrived at Nha Trang from Fort Gordon, Georgia, between 18-22 Dec 66. This unit was attached to the 54th Signal Battalion, and will double the battalion's capability to provide 12 channel VHF systems supporting I FFORCEV radio-telephone requirements.

l. In response to the request from Signal Officer, 4th Inf Div, this office conducted a survey of internal division telephone communications. Findings and recommendations were furnished to Signal Officer, 4th Inf Div on 7 Jan 67.

UNCLASSIFIED

UNCLASSIFIED

66

AVFA-GC-OT

SUBJECT: Operational Report for Quarterly Period Ending 31 January 1967,  
RCS CSFOR-65 (U)

m. In conjunction with 21st Signal Group and DCA-SAM, action continues to upgrade local telephone service in the Nha Trang Area. 21st Signal Group activated GOLDFINCH Dial Switchboard and cut over of army subscribers continue.

a. Long distance switchboards at Nha Trang and Pleiku are operational and interconnected with Saigon, Qui Nhon, Cam Ranh, and Da Nang LD switchboards. Increased interconnecting trunks will become available as the expansion of the Southeast Asia Wideband System progresses.

c. A 200 pairs underground cable was installed between I FFORCEV MDF and SEAWBS to provide expansion and alternate capability. Termination and testing of 100 pairs were completed 19 Jan 67 and placed in service.

p. A 12 channel VHF radio system was established 25 Jan 67 between Arty Hill, Pleiku and LAVA rear Pleiku to provide additional circuits to 52d Arty Gp to satisfy increased communications requirements of I FFORCEV Artillery.

9. Information Office:

a. Major emphasis during November was placed in the employment of small (2-3 man) teams in the field primarily in support of assigned and attached units. These teams greatly increased the flow of Home Town News items, concentrating their efforts in the area of Christmas tapes for use by radio station managers in the United States. Five trips were made during the month. The first was to the ADAMS/GERONIMO I area of operations from 31 Oct 66 to 3 Nov 66, and included stops at the 1st Bde, 101st Airborne Division, the 1st Bde, 4th Infantry Division; and the 10th Aviation Battalion. The second trip was the covering of a motor vehicle convoy from Nha Trang to Ban Me Thout and return 8-9 Nov 66. The third trip involved the coverage of 272d Military Police Company operation in the THAYEP II area between 11-16 Nov 66. The fourth trip involved coverage of the 52d Artillery Group and other units in the Pleiku area between 13-21 Nov 66. The fifth trip was to the Phu Cat area and coverage of the 7th Battalion, 13th Artillery during the period 24-28 Nov 66.

b. Liaison with higher headquarters was carried out by the Information Officer through trips to Qui Nhon on 18 Nov 66, where he conferred with the Information Officer of MACV, and to Saigon during the period 12-23 Nov 66, where he visited HQ, MACV, and HQ, USARV.

c. On 10 Nov 66, Colonel Bankson, Information Officer, MACV, visited Nha Trang conferring with the Chief of Staff, HQ, I FFORCEV, and the Commanding Officer, 5th Special Forces Group; and visiting the 11th PID Press Camp.

d. There was one press interview with the Commanding General, during the month, by Mr. Merton Perry of Newsweek on 16 Nov 66.

UNCLASSIFIED

UNCLASSIFIED

67  
AVFA-GC-OT

SUBJECT: Operational Report for Quarterly Period Ending 31 January 1967,  
RCS CSFOR-65 (U)

e. The major project of the information office during November 1966 was the initial planning for a monthly magazine to be published by this headquarters. As the month ended, the problem of funding had not yet been wholly solved.

f. On 11 Nov 66 coverage was given to a Veterans Day ceremony held in front of HQ, I FFORCEV, at which General Lareen addressed assembled troops from the 54th Signal Battalion and the 272d Military Police Company.

g. During the month, the 11th Public Information Detachment Press Camp handled fifty-five news media representatives and information personnel. On 27 Nov 66 the detachment took possession of the second of two buildings in its compound.

h. The 11th Public Information Detachment continued employing its PI teams in the field as it prepared for its conversion to an FA team.

i. The major area of concern for the month of December 1966 was the securing of final approval for the publication of a monthly I FFORCEV magazine and the making of arrangements for the printing of the initial edition (January 1967). Cover format and name (The Typhoon) were approved, having been chosen by the Commanding General from a variety submitted. The Commanding General himself was interviewed to provide material for the writing of a monthly column to be set aside for his use. Finally, two officers travelled to Okinawa during the period 7-10 Dec 66 to select a printing firm and to make initial arrangements.

j. A major ceremony at HQ I FFORCEV, on 21 Dec 66, in which the Chief of state of the Republic of Vietnam decorated thirteen officers and enlisted men of the staff, received full coverage by the Information Office to include both still and motion picture coverage.

k. A second area of coverage centered on Christmas. On 24 Dec 66 two taping teams gathered interviews from headquarters personnel and personnel from assigned and attached units in Nha Trang. These tapes were rushed to the Information Office, MACV, to be sent immediately to CONUS for possible use on Christmas Day. On 25 Dec 66 four Christmas parties given by units in Nha Trang for Vietnamese children were covered by writers and, in some cases, photographers.

l. The most important of the visitors to HQ, I FFORCEV, covered during the month were the Rev. Billy Graham, and Major General Keith L. Ware, OCINFO, DA, both on 23 Dec 66; Cardinal Spellman, on the 25th; General Harold K. Johnson, Chief of Staff, US Army, on the 27th; and Senator Stuart Symington (Dem., Mo.), on the 28th.

m. The visit of Major General Ware, OCINFO, involved a conference attended by all information officer in the Nha Trang area, at which ideas were interchanged and Maj Gen Ware set forth his views on the information effort in Vietnam.

n. During December, the 5th Public Information Detachment concentrated almost exclusively on the preparation of the first two editions of the new I FFORCEV magazine for publication.

UNCLASSIFIED

UNCLASSIFIED

68

AVFA-GC-OT

SUBJECT: Operational Report for Quarterly Period Ending 31 January 1967,  
RCS CSFOR-65 (U)

o. The 11th Public Information Detachment continued to billet and in other ways aid correspondents and visiting information personnel, handling a total of thirty-eight during the month. On the 4th day of the month renovation of the main villa was completed and was opened for use.

p. Two major ceremonies were covered by the Information Office during January 1967. The first, in front of the headquarters on 2 Jan 67, was the presentation of the official colors of I FFORCEV by General Westmoreland, COMUSMACV, to LTG Larsen, CG, I FFORCEV (Incl 27), the second attended by Acting CG, MG Norton, was a ROK FV ceremony on the 30th dedicating its headquarters building, also located in Nha Trang.

q. Plans for the first three editions of (The Typhoon), I FFORCEV's magazine, moved ahead with Major Smith, Asst. Information Officer, I FFORCEV, and Major Rapp, Commanding Officer, 5th Public Information Detachment travelling to Okinawa for additional consultation with the printer during the period 14-19 Jan 67 and then departing once more on 31 Jan 67 to pick up the January edition and arrange for the pick up of the February edition two weeks later.

r. The major activities of subordinate units supported during the month were the motor march of a convoy of the 1st Bde, 101st Abn Div, from Kontum to Phan Rang during the period 23-26 Jan 67, and the extended contact of the 3d Bde, 25th Inf Div, in uncovering an enemy tunnel complex in Operation THAYER II during the final day of the month. In both instances the information office actively solicited civilian press coverage and succeeded in gaining more press coverage than would otherwise have been possible. In addition, arrangements were made for the appearance of the convoy commander at a MACV Saigon press briefing.

s. During January the 5th Public Information Detachment continued its major effort in making final preparations for the first two editions of the magazine (The Typhoon).

t. The 11th Public Information Detachment continued to billet and in other way aid correspondents and visiting information personnel, handling a total of sixty-five during the month.

10. (U) Inspector General Activities:

a. Ten complaints and twenty-five requests for assistance, advice or information were received during the period. Six of the complaints were unjustified and none indicated any trends, wide spread irregularities, or problems detrimental to the efficiency or reputation of the command.

b. Two fund inspections were conducted during January. On 17 Dec 66 a complaint period was held for "B" Btry, 3d Bn, 18th Arty.

UNCLASSIFIED

69

CONFIDENTIAL

AVFA-GC-OT  
SUBJECT: Operational Report for Quarterly Period Ending 31 January 1967,  
RCS CSFOR-65 (U)

SECTION II (U) - COMMANDER'S OBSERVATIONS AND RECOMMENDATIONS:

Part I: Observations (Lessons Learned)

1. (C) Operations:

a. Item: Propaganda Targeting.

Discussion: During November 1966, controls on printing were established enhancing the quality of propaganda production and dissemination as opposed to quantity production and dissemination. This added emphasis came about as a result of a study on propaganda targeting techniques as practiced in II CTZ. It was found that many units would request large number of leaflets for a "suspected" enemy area, with little thought for such things as size of enemy units, terrain features of the target or wind direction. In short, the "shotgun" effect was covering up the lack of prior planning and targeting.

Observation: Selection of specific propaganda targets using the latest information available has caused a decrease in the amount of propaganda materials expended in II CTZ. As a result of specific targeting, a variety of themes beamed at specific audiences are being developed and disseminated in smaller quantities. The results of these efforts can be measured by the steadily increasing number of Hoi Chanh in II CTZ.

b. Item: Loudspeaker Operations.

Discussion: Loudspeakers have been adapted to, and used with, everything from a backpack to aircraft in II CTZ with varying degrees of success. Most of the returnees interviewed in II CTZ have stated that they have heard and understood at one time or another, loudspeaker broadcasts by the US/FWMAF elements. Loudspeakers in the field have proven to be very effective when used with search and clear; search and destroy missions. This extension of face to face communication is invaluable when the message is personalized and/or the literacy of the target audience is unknown or considered low. Loudspeakers can be used to inform the populace of changes in local ordinances or curfews and Civil Affairs Teams. The role of the loudspeaker in reducing the number of non-combatant casualties is becoming more important all the time. The mobility of the loudspeakers when used with US/FWMAF units enables the commander to employ psychological operations whenever a potential target audience may be found.

Observation: It has been found in II CTZ that loudspeaker broadcasts are a most successful means of pin-pointing target audiences and disseminating specific propaganda messages. The development of this media in all tactical units, especially the "Musk and Swift" fleet should be encouraged and monitored.

c. Item: Logistical Support of Psychological Operations.

Discussion: During the reporting period, reproduction equipment and reproduction support equipment was inoperative much of the time because of a lack of repair parts and qualified maintenance personnel at second and third echelon. Although required parts have been placed on requisition and requests for maintenance support have been submitted, psychological operations support in II CTZ has been adversely affected.

CONFIDENTIAL

CONFIDENTIAL

70

AVFA-GC-OT

SUBJECT: Operational Report for Quarterly Period Ending 31 January 1967,  
RCS CSFOR-65 (U)

Observation: Logistical support for the 245th Psychological Company has been hampered by lack of non-standard repair parts in sufficient quantities in the supply channels. Unless this situation is corrected, psychological support in II CTZ cannot be expected on a sustained basis.

d. Item: Coordination between office of Civil Operations (OCO) and Tactical Units on Operations.

Discussion: Tactical units operating in an area are involved with handling many Vietnamese people, who must be processed and classified as detainees, refugees, PW's, etc. The tactical unit can only initially screen these individuals and the GVN, with the assistance of OCO representatives, is required for detailed screening and interrogation.

Observation: Detailed coordination meetings are required with tactical units and OCO representatives for the handling of Vietnamese personnel in order to gain the maximum benefit from an operation. Also the prompt and efficient handling of innocent civilians will reduce the ill-feelings toward the GVN and US military in the area.

e. Item: Naval Gunfire in Support Operations.

Discussion: There are many areas of tactical importance in II Corps Tactical Zone in which naval gunfire can be used to support ground operations. The II Corps Tactical Zone Naval Gunfire Liaison Officer has been transferred from Pleiku to Headquarters, I Field Force Artillery to facilitate liaison between the Navy and Army forces on shore and to simplify ship to shore communications. The US Navy will provide fire support to ARVN and FVMAF; however, US observers/spotters must adjust and control the fire.

Observation: Field Artillery forward observers and key personnel to platoon leader level should receive service school training in the control and adjustment of naval gunfire.

f. Item: Fire Support Coordination:

Discussion: The presence of friendly forces and civilians in the combat zone of operations has required the establishment of coordination and notification procedures to avoid conflict between units and to preclude wounding or killing of non-combatants. Some of the agencies with which liaison and coordination must be effected are; adjacent US and FVMAF units, Subsector and Sector headquarters, ARVN Division Headquarters, ARVN Corps Headquarters, MACV Advisors, and RVN and FVMAF Air Force.

Observation: A coordination and liaison problem similar to that outlined above would be a worth-while addition to tactics classes in US Army Service Schools. It would acquaint the students with one more of the peculiarities experienced in the war in Vietnam.

g. Item: Frequent Displacement of Artillery Units.

Discussion: Failure to relocate artillery units on a timely basis allows the enemy time to detect weaknesses in the defense of the unit, reconnoiter routes of approach and withdrawal, and pre-plan mortar attacks by registering on one location and planning a shift onto the artillery position.

CONFIDENTIAL

CONFIDENTIAL

AVFA-GC-OT

SUBJECT: Operational Report for Quarterly Period Ending 31 January 1967,  
RCS CSPOR-65 (U)

Observation: Frequent movement of artillery units denies the enemy the time to prepare attacks in detail and disrupts his planned avenues of approach and withdrawal. In addition, friendly personnel are kept alert by continually preparing new defenses without being allowed to become lax.

h. Item: Lack of Combat Support Coordination Centers at Critical Installations.

Discussion: Critical installations with more than one lodger unit cannot have a coordinated defense without a Combat Support Coordination Center to serve as a communications center to keep all elements aware of the situation and tie together all defensive assets.

Observation: Operation of a Combat Support Coordination Center at critical installation with each lodger unit represented provides for coordinated defense.

i. Item: Protection of Survey Parties from Minefields.

Discussion: Experience has indicated that previously established survey control points are often located in minefields. The existence of these minefields may be unknown to survey parties and injury or death could result during operations.

Observation: Survey officers and party chiefs should exploit all available sources for minefield data prior to initiating survey operations.

j. Item: Shell APERS-T XM-546 (Beehive)

Discussion: Beehive ammunition proved extremely effective against enemy personnel targets during the attack at Landing Zone Bird on 27 Dec 66. Units occupying this LZ were Battery B, 2d Battalion, 19th Artillery (105mm Towed) and Battery C, 6th Battalion, 16th Artillery (155mm Towed). Two rounds of beehive ammunition were expended and though enemy KIA directly attributable to this munition could not be determined, it was credited with greatly assisting in breaking the attack. NVA forces suffered 82 KIA in this attack.

Observation: The beehive round in direct fire is extremely effective and should be made more universally available.

k. Item: Interdiction Fires.

Discussion: The attack on Pleiku on 7 Jan 67 demonstrated that interdiction fires on likely routes of approach and exit are required to disrupt enemy movement into and about critical installations. Such fires are required not only to forestall or prevent attack, but, also to inflict casualties on withdrawing enemy elements following an attack.

Observation: Active interdiction fire plans based on sound intelligence are useful and should be employed in the defense of base camps and critical installations.

CONFIDENTIAL

SECRET

72

AVFA-GC-CT

SUBJECT: Operational Report for Quarterly Period Ending 31 January 1967,  
RCS CSFOR-65 (U)

1. Item: Combat Support Coordination Centers.

Discussion: During the attack of Pleiku on 7 Jan 67 and again on 8 Jan 67, countermortar fire by available artillery was seriously hindered because of uncontrolled firing by friendly mortars of illumination rounds. Countermortar radars in the area could not discern which tracks were friendly and which represented enemy rounds.

Observation: Combat Support Coordination Centers must be capable of exercising complete control of all available fire power during attacks. In addition, on-call artillery and aircraft illumination should be provided to preclude interference with countermortar radar operations by friendly mortars within the attack area.

m. Item: Position Security and Defense.

Discussion: The recent damaging attacks on Pleiku on 7 Jan 67 and on Landing Zone Bird on 27 Dec 66, though entirely different in scale, maneuver and objectives are similar in many respects. In both instances units had been in position for extended periods during which complete and thorough reconnaissance by the enemy had been accomplished. In both instances, perimeter defense and local area security had been allowed to become lax and precautionary measures to insure denial of freedom of enemy movement in the environs had not been enforced.

Observation: After prolonged and uneventful occupation of positions, individuals and units tend to become complacent toward the threat of enemy attack. Where possible, units should displace at frequent intervals and, if required to remain in position, improvement of defenses should be continuous. Adjustment and relocation of perimeter bunkers and other installations in semi-permanent camp sites hinders the compilation of intelligence by the enemy on unit facilities, weaknesses, and capabilities. Relocating a command bunker, re-arrangement of heavy weapons and artillery pieces and repositioning of radio antennas within an artillery position, for instance, will disrupt enemy plans and "sand table" attack rehearsals. Another tactic which discourages night infiltration by the enemy is to periodically, and at random, fire final protective fires on portions of the perimeter.

2. (3) Intelligence:

a. Item: Trail overlays issued to tactical units were bulky and difficult to handle.

Discussion: Trail overlays have been issued on overlay paper to tactical units. The information on the overlay had to be transcribed to a map thereby increasing the opportunity for error. CO, 64th Eng Det (T) was assigned the task of overprinting maps with trails and other transitory information of tactical value. Pilot maps have been issued to the 1st Cav Div for evaluation. Reports received at this HQ indicates a high degree of acceptance of this product at small unit level.

Observation: Overprinting of maps with trails and other information of tactical value reduces the possibility of error in transcribing information. Periodic updating of the overprint insures the product is current.

SECRET

SECRET

AVFA-CC-OT

SUBJECT: Operational Report for Quarterly Period Ending 31 January 1967,  
RCS CSFCR-65 (U)b. Item: Utilization of Province Reconnaissance Units.

Discussion: PRUs are ostensibly responsive to the Province Chief; however, through proper coordination with the US Advisory Agency (CSD) they may be made available to support US military intelligence requirements. PRUs are equipped, trained and controlled by CSD and can be found in most provinces in the II Corps Zone. This headquarters recently requested and coordinated a PRU operation to acquire intelligence concerning the suspected location of the 188 Regiment in Khanh Hoa Province. The operation plan was designed to kidnap a local inhabitant of the area in which the 188 was presumably located. Due to coordinating problems and tactical airstrikes being placed in the PRU area by the 9th ROK Division while the operation was being conducted, the mission was aborted. However, it has been determined that such an operation can be successful if properly planned and executed.

Observation: PRUs are available in most provinces and can be used to support US Military intelligence requirements on a time available basis.

## 3. (S) Logistics:

a. Item: Control of Ammunition Allocation Below Army Level.

Discussion: During the past year the system of controlling expenditures of ammunition in limited supply imposed a burden upon tactical units OPCON this Hq. The system lacked the necessary flexibility essential for the tactical commander to manage his limited assets. Expenditures exceeding the one-day ASR necessitated advance approval from USARV. In cases of tactical emergency, which required expenditures above the allocation, immediate notification was required. At a conference conducted by the headquarters with OPCON units, it was recommended that control over ASR items be exercised by Field Force Headquarters. This suggestion was made to USARV and was accepted effective 15 Nov 66. USARV provides a bulk allotment for a 30 day period based on rds/wps/per day for tube fired munitions and Bde/day for bulk allocated items such as grenades and pyrotechnics. G3 determines the extent of corps reserve and priorities in allocation among assigned, attached and OPCON units. The G4 then allocates, and maintains the records of ammunition expenditures. At present, I FFORCEV control periods are on six day increments for each month. Tactical units are not authorized to accumulate savings from period to period. At I FFORCEV level these are added to corps reserve for use in emergency or heavy contact with enemy forces.

Observation: The present system of I FFORCEV allocating and controlling expenditure of ammunition gives the tactical commander the necessary flexibility to manage his limited assets.

b. Item: Movement of 1st Bde 101st Abn Div.

Discussion: Upon completion of Operation PICKETT the 1st Bde, 101st Abn Div was returned to its base camp in Phan Rang from Kontum utilizing air, land and sea transportation. The movement started at 210700 Jan 67 and was completed 241200 Jan 67. The movement required 71 C-130 and four LSTs. Approximately 25-30 vehicles and cargo moved by land LOC from Qui Nhon to Phan Rang. This was the first time within the II Corps tactical zone that a full brigade size unit moved utilizing the various modes of transportation. The movement proceeded smoothly and proved to be practical, efficient and a more economical utilization of the transportation assets within II Corps tactical zone.

SECRET

CONFIDENTIAL

74

AVFA-GC-CI

SUBJECT: Operational Report for Quarterly Period Ending 31 January 1967,  
RCS CSPCR-65 (U)

Observation: When movement of a sizeable force is contemplated, consideration should be given to utilizing various modes of transportation in order to improve the efficiency and economy of available transportation assets.

4. (C) Other:

a. Item: Common-user, Long Distant Trunking Circuits.

Discussion: The "Time Phased Implementation Plan for Telephone Service in Southeast Asia" has been implemented for II CTZ with resultant loss of I PFCRCEV dedicated switchboard to switchboard circuits.

Observation: Although the concept of the long distant trunking scheme is valid, it is not feasible for this headquarters to be solely dependent upon common user circuits to higher headquarters and OPCON units. Tactical communications must be flexible and immediately responsive to the requirements of tactical command. This support cannot be provided through a common-user system. Tactical requirements must be satisfied before adequate service can be realized through the common-user system.

b. Item: On 31 Dec 66 one of the two 100 pair buried cables which carry circuits to the Grand Hotel Compound was cut by a trench digging machine.

Discussion: This headquarters was aware of the trench construction being done by the Page Communications Corporation near Long Van AFB. Coordination had been made with representatives of the company to prevent such an occurrence. As a result of a similar cable break in August, another 100 pairs of cable were installed to serve as a spare backup. High priority circuits were quickly transferred to this new cable and minimum outages resulted.

Observation: Alternate means must be provided for all communications systems to insure continuous, reliable communications.

c. Item: Selection of Site for Radio Relay Stations.

Discussion: To accomplish the primary mission of improving communication, maximum advantage must be taken of the terrain in the area of operation to facilitate the objective. A through map reconnaissance, and whenever possible a ground reconnaissance, must be conducted prior to selection of a site for a radio relay station. Additionally, the characteristics of the communications equipment must also be considered.

Observation: The requirement for close coordination in combat cannot be effected without a reliable and continuous means of communication.

d. Item: Compatibility of communication equipment between division/separate brigade military police units and corps military police company.

Discussion: TOE of military police units organic to Infantry, armored, airborne and air cavalry division, the corps and army are generally authorized communication equipment which is identical at each level. In practice, because of supply shortages and other factors, individual units assigned to the same theater or operational area may not be so equipped. The Corps military police unit organic to I PFCRCEV is utilized in the direct support role or portions of the unit (squad and

CONFIDENTIAL

CONFIDENTIAL

75

AVFA-GC-OT

SUBJECT: Operational Report for Quarterly Period Ending 31 January 1967,  
RCS CSFOR-65 (U)

platoons) are attached to the divisions or separate brigades under OPCON of this headquarters when combat operations require. Until recently the I FFORCEV military police unit was equipped with radios that did not have the same range capability as those of the unit to which they were attached. This deficiency led to an irritating communication, supply and maintenance problem which could have been avoided had priorities for issue of new equipment been established, based upon the support unit's mission rather than traditional functional responsibilities.

Observation: A corps military police company should be authorized and provided the same type communication equipment that is issued to the military police units organic to the combat elements supported.

Part II: Recommendations:

1. (C) Operation.

a. Reference para 1b Part I, Section II. Equip VNAF aircraft and the "Junk and Swift" boat fleet with loudspeaker capability to improve psychological operations.

b. Reference para 1c Part I, Section II. Organize a maintenance team to provide second and third echelon maintenance for non-standard and commercial items of equipment used in psychological operations.

2. (U) Training. Reference para 1e Part I, Section I. Service schools should provide training in control and adjustment of naval gunfire to forward observers and key personnel to platoon leader level.

3. (C) Logistics: Reference para 3d Part I, Section I. Corps military police companies should be authorized and provided the same type communication equipment that is issued to military police units organic to the combat element supported.

FOR THE COMMANDER:

2X Incl  
as

*Intentional*  
HINTON S. BOATWRIGHT  
Colonel, GS  
Chief of Staff

INCL # 4, 5, 6, 7, 8, 9, 10, 11, 15, 16, + 27 W/D AT DA

DISTRIBUTION:

2-CINCUSARPAC  
6-USARV  
1-CG II FFORCEV  
1-CG 1st Cav Div  
1-CG 4th Inf Div  
1-CG 1st Bde, 101st Abn Div  
1-CG I FFORCEV Arty  
1-CO 3d Bde, 25th Inf Div  
1-DSA, II Corps  
1-ACofS, G1  
1-ACofS, G2  
3-ACofS, G3  
1-ACofS, G4  
1-US Army War College ATTN: Library Q-2149  
1-Comsit, USA C&GSC, Ft Leavenworth  
2-13th Mil Hist Det

CONFIDENTIAL

**CONFIDENTIAL**

AVHGC-DST (6 Mar 67) 1st Ind  
 SUBJECT: Operational Report - Lessons Learned for the Period Ending 31 Jan  
 1967 (RCS CSFOR-65) (U)

HEADQUARTERS, UNITED STATES ARMY VIETNAM, APO San Francisco 96307

17 May 1967

TO: Commander in Chief, United States Army, Pacific, ATTN: GPOP-OT  
 APO 96558

Assistant Chief of Staff for Force Development, Department of the Army,  
 Washington, D. C. 20310

1. (U) This headquarters has reviewed the Operational Report - Lessons Learned for the period ending 31 January 1967 from Headquarters, I Field Force Vietnam.

2. (C) Pertinent comments follow:

a. (U) Reference paragraph 6l(3), page 56, concerning the frequency of the periodic logistics report (PLR): Concur. PLR's are now submitted on the 5th and 20th days of each month, rather than weekly.

b. (C) Reference, paragraphs 6m, n, and o, page 57, concerning shortages of equipment: The production of M115 and M117 panoramic sights is still not sufficient to meet requirements. Frequent followups have been made to the 2d Logistical Command and CONUS. This headquarters will take follow-up action on generator problems. A meteorological specialist will visit I Field Force Vietnam (I FORCEV) during the month of May 1967 to assist in establishing monthly consumption factors for meteorology supplies, as well as to assist Qui Nhon and Cam Ranh Bay in the inventory of these supplies.

c. (C) Reference paragraphs 6p and q, page 57, concerning the requirement for aircraft: Normally one aircraft (C7-A, formerly CV-2) is made available to the 1st Logistical Command on a sole user basis to service and support Qui Nhon Support Command and units in II Corps Tactical Zone (CTZ). All other aircraft must be obtained from the MACV Common User Aircraft System (SEA System). Due to the critical nature of airlift in RVN, aircraft must be centrally controlled to insure maximum utilization.

d. (U) Reference paragraph 1b, page 65, and paragraph 1a, page 71, concerning loudspeaker operations with the Vietnamese Air Force (VNAF) and the Junk and Swift fleets: equipment support for VNAF and the Junk and Swift fleets is outside the purview of this headquarters. MACV Psychological Operations Directorate has been contacted and will take necessary action to equip VNAF and the boat fleets with loudspeakers.

e. (U) Reference paragraph 1c, pages 65 and 66, and paragraph 1b, page 71, concerning logistical support for psychological operations: DA assistance has been requested of USARPAC to help alleviate this problem. USARPAC initiated follow-up action with DA on 20 April 1967.

f. (U) Reference paragraphs 1e and f, page 66, and paragraph 2, page 71, concerning the requirement for additional training in fire support coordination, to include the adjustment and control of naval gunfire: Recommend that the observations and recommendation of the reporting command be forwarded to appropriate CONUS agencies for consideration.

**CONFIDENTIAL**

CONFIDENTIAL

28

AVMGC-DST (6 Mar 67)

SUBJECT: Operational Report - Lessons Learned for the Period Ending 31 Jan 1967 (RCS CSFOR-65) (U)

g. (U) Reference paragraph 1h, page 67, concerning combat support coordination centers (CSCC): Concur. However, when a large number of units are stationed at a critical installation, or when a unit has a minor responsibility for the defense of the installation, all need not be represented. Reliable communications with all units, the fire support headquarters, and higher headquarters are essential.

h. (C) Reference paragraph 1j, page 67, concerning Beehive ammunition: Beehive ammunition (105mm, 106mm, and 90mm) is still in limited production. USARV operational requirements for Beehive ammunition were forwarded to DA in January 1967. Until CONUS production can meet USARV requirements, a limited supply status will prevail.

i. (C) Reference paragraph 4d, pages 70 and 71, and paragraph 3, page 71, concerning communications equipment authorizations for military police units: Combat support unit radios should have sufficient range, and be compatible with the radios of combat units supported. It appears that the problem is one of conversion from the old series to the new series tactical voice radios. Priority for conversion was to combat units, then to combat support, and finally to combat service support units. There have been insufficient assets on hand to make a simultaneous conversion in all units.

FOR THE COMMANDER:

28 Incl  
rc

E. L. KENNEDY  
CPT, AGC  
Asst Adjutant General

CONFIDENTIAL

73

# CONFIDENTIAL

79

DEPARTMENT OF THE ARMY  
HEADQUARTERS, I FIELD FORCE VIETNAM  
Office of the Assistant Chief of Staff, G2  
APO 96350

## COMBINED INTELLIGENCE CONFERENCE

(29 November 1966 - NHA TRANG)

### LIST OF ATTENDEES

Colonel Williams	ACofS, G2	HQ, I FFORCEV
Lieutenant Colonel Kin	Deputy J2	ROK FORCEV
Lieutenant Colonel Binh	G2, II Corps	(Designate)
Lieutenant Colonel Johnson	SIA, II Corps	Ad Gp
Lieutenant Colonel Catlin	G2 Chief Ops	HQ I FFORCEV
Major Sinh	MID Commander	II Corps
Lieutenant Colonel Song	J2-CMBT Intel	ROK FORCEV
Lieutenant Colonel Martin	G2 Collection O	HQ I FFORCEV
Major Yun	J2-Sit Officer	ROK FORCEV
Major Park		ROK FORCEV
Major Rollins	Asst G2 Ad	II Corps Ad Gp
Major Bolcar		Asst LNO to ROK FORCEV
Captain Cho		ROK FORCEV

DOWN GRADFD AT 3 YEAR INTERVALS  
DECLASSIFIED AFTER 12 YEARS  
DOD DIR 5200.10

CONFIDENTIAL

*Inc # 2 (P. 1)*

**CONFIDENTIAL**

80

**ITEM 1:** Spot Reports; presented by LTC Catlin, G2 Chief Ops, HQ I FFORCEV.

**PROBLEM:** There is a need for more timely exchange of information between HQs I FFORCEV, HQs II Corps and HQs ROKFORCEV (FC), as this information is obtained.

**DISCUSSION:** The use of the spot report, both telephonic (unless classified) and TWI, must be increased to provide information on a more timely and useful basis. The providing of information in INTSUMs and PERINTREPs is important but often too slow to meet the requirement for information to assist in tactical decisions. Within the II Corps structure, it was strongly recommended that all echelons be made aware of the communications problems, and that the use of relay between intelligence officers at all echelons be instituted. Additionally, the rendering of a complete report and dissemination on a timely basis was stressed.

**CONCLUSION:** All conferees agreed that a major requirement exists to provide and exchange information on a more timely basis, and that the use of complete spot reports is the best tool to accomplish the task. Although complete agreement on the relay system within II Corps was not obtained, LTC Johnson indicated that he would attempt to establish a more responsive reporting system with higher headquarters being provided info copies of messages from province to division.

**CONFIDENTIAL**

81

## CONFIDENTIAL

ITEM 2: Exploitation of Documents; presented by Major Anderson, Asst Collection Officer, G2 Section, I FFORCEV

PROBLEM: What can be done to insure full exploitation of captured documents and proper dissemination of intelligence obtained?

DISCUSSION: MACV Directive 381-11 prescribes proper procedure for handling and evacuating captured documents. The importance of this directive is the proper identification of documents and channels of evacuation which are set forth. However, full exploitation depends upon other elements. The first of these is timeliness. Intelligence personnel at each level should know their own capabilities and limitations and not attempt to exploit documents which require more time and effort than is feasible. Immediate evacuation to the next higher headquarters will, in the end, result in more efficient exploitation. This does not preclude the extraction of information of immediate value at any level. The second is conscientious evacuation of documents. The tendency to hold on to documents which appear to be of special interest delays full exploitation and final dissemination. CDEC has the assets to properly exploit a large volume of documents and make timely dissemination of published reports.

CONCLUSION: It was determined that original documents captured by ROK forces were not being disseminated to I FFORCEV and II Corps. As a result it was agreed that ROKFORCEV would turn over to G2 I FFORCEV documents that have been exploited by the ROKFORCEV. G2 I FFORCEV will disseminate to II Corps and CDEC. It was also determined that II Corps turns documents into CDEC through ARVN Intelligence channels. A check will be made with CDEC to determine distribution of translations of documents captured by ARVN forces.

## CONFIDENTIAL

# CONFIDENTIAL

82

ITEM 3: OB Differences; presented by Major Miller, OB Officer, G2 Section HQ I FFORCEV.

PROBLEM: To resolve differences in Order of Battle holdings of the following selected units:

84A Artillery Regt	101C NVA Regt
Gang Thap Regt	102D NVA Regt
9th NVA Regt	Quyot Tien Regt
36th NVA Regt	Nguyen Trai Regt
48th NVA Regt	Nong Truong 6
209th NVA Regt	Nong Truong 10
24th NVA Regt	

DISCUSSION: It has been found that ARVN II Corps and I FFORCEV generally have the same intelligence on which to base their conclusions. There are some variances in the categories in which certain units are carried; however, there are no significant differences. Most of the variances are on holdings where both ARVN II Corps and I FFORCEV lack hard intelligence to corroborate speculation. It was agreed that the meeting was beneficial to all parties as it allowed them to compare and determine if they possessed the same intelligence on enemy units reportedly in South Vietnam. Major Sinh, CO of the ARVN II Corps MID, stated that he would exploit any EKI through interrogation of captives in order to collect Order of Battle information.

CONCLUSIONS: Differences in categorizing the status of units were as follows:

<u>Unit</u>	<u>ARVN Holding</u>	<u>I FFORCEV Holding</u>
101C Regt	Prob	Reported
Nong Truong 6	Conf	Reported
Nong Truong 10	Conf	Possible
102d Regt	Prob	Reported

It was agreed that a similar meeting should be held monthly, and that an agenda should be published and disseminated at least seven days prior to the meeting.

# CONFIDENTIAL

**CONFIDENTIAL**

**ITEM 4:** Exploitation of CHIEU HOI; presented by LTC Martin, Collection Officer, O2 Section, HQ I PFORCEV

**PROBLEM:** What can be done to insure that the maximum number of returnees in Chieu Hoi Centers are interrogated and exploited for information of intelligence value?

**DISCUSSION:** It is known that the majority of returnees are not interrogated, yet because of their inherent cooperative attitude they should be exploited to the fullest extent. In a recent check of two Chieu Hoi Centers it was discovered that in one center only 4 out of 16 had been interrogated and in the other 11 out of 33. The lack of ARVN interrogation capability is considered a valid reason for this situation. Therefore, it appears that it is necessary for units located in a particular province to join forces in insuring that the maximum number of returnees are interrogated. It must be kept in mind that these centers are the responsibility of USAID and proper channels for contact must be made through the local sector headquarters.

**CONCLUSIONS:** It was agreed that each sector S2 should maintain a list of all returnees in the Chieu Hoi Center to include basic rallying data and a notation of those interrogated. This list should be made available to all interested units in the area so that interrogations can be arranged when desired. It was also agreed that a standard distribution list should be established for all returnee interrogation reports to include complete distribution within the sector to all US, ARVN and ROK units as well as all higher headquarters. It was pointed out that this is impossible at the present due to lack of reproduction facilities at sector level. LTC Johnson pointed out that pressure is now being put on sector to exploit returnees and that ROK units should be made aware of the Chieu Hoi problem.

**CONFIDENTIAL**

**CONFIDENTIAL**

84

**ITEM 5:** Province Interrogation Centers; presented by LTC Martin, Collection Officer, G2 Section, HQ I FFCRCEV

**PROBLEM:** What can be done to derive maximum benefit from Provincial Interrogation Centers.

**DISCUSSION:** At the present time there are seven PICs in operation. They are in BINH DINH, PHU YEN, KHANH HOA, BINH THUAN, PLEIKU, DARIAC, and TUYEN DUC. The one in NINH THUAN is 90 percent complete. These centers are run by the National Police with advice and supervision from CAS. Selected PW are interrogated at these centers for exploitation. Normally the PICs can accommodate 28 PW at one time. As a rule CAS personnel work in close coordination with Sector Headquarters. The benefit of the centers is available to all units through the proper channels. Thru Sector S2 to CAS, units can request interrogation of a specific PW or feed EEI to the center for various PWs. Chieu Hoi returnees can also be interrogated at the PIC. It was pointed out that the PIC is the primary source of information on local infrastructure.

**CONCLUSIONS:** It was agreed that a list should be maintained at Sector S2 of all PW in local PIC with basic capture data. This list can be provided by CAS. All units should be notified of this list and encouraged to check for PW of special interest. They should then be encouraged to furnish EEI thru sector S2 for a special PW or on a continuing basis. It was further agreed that distribution of PIC reports should be made to all units within the sector and to all higher headquarters.

**CONFIDENTIAL**

CONFIDENTIAL

ITEM 6: Sector Operations Intelligence Center (SOIC); presented by Maj Shafelt Asst G2, HQ I FFORCEV

PROBLEM: Based on the recommendation of the II CTZ Intelligence Conference, 29-30 July 66, What actions have been taken to upgrade the intelligence coordinating responsibilities of the Sector Operations and Intelligence Center (SOIC)?

DISCUSSION: Recommendations proposed at the 29-30 July conference held in FLEIKU were outlined. LTC BINH, G2, II Corps (designate) presented a proposed directive which is currently being staffed at II Corps. LTO VINH LOC has directed that action be taken to strengthen the SOIC system. This directive clarifies the mission of the combined operations and Intelligence Center (COIC) at II Corps Headquarters, COIC at Division Tactical Area Headquarters, and the SOIC at sector level. The COIC at II Corps Headquarters will include representatives from the ARVN/US/PWMAF operating in the II CTZ. A discussion followed on what military and civilian representatives were desired at II Corps COIC. LTC SONG, ROKFORCEV indicated there would be no difficulty in providing a representative. HQ I FFORCEV will utilize the Intelligence Advisory Group as its representative. The II Corps COIC will serve as an intelligence exchange center for II Corps, ROKFORCEV, I FFORCEV, and the 12 Sectors. At the Div Tactical Area (DTA) level, the division and tactical units operating within the division area of responsibility, will establish a COIC. The SOIC will be directed by the Deputy Province Chief for Internal Security. LTC BINH's proposed directive will aim at the integration of all collection agencies' activities into the SOIC operations. Processing of captured documents was discussed with the following recommendations being made by LTC BINH:

- a. Documents of tactical importance should be evacuated through the SOIC or COIC at div level.
- b. Important documents evacuated to COIC at II Corps HQs then to SAIGON, I FFORCEV and ROKFORCEV-FC when appropriate.

CONCLUSION: It appears that positive steps are being taken to implement the recommendations of the July conference. The goal is to have the SOIC and COIC at the DTA function as the clearing house for all information within the area of responsibility. Collection agencies will use the SOIC as a coordinating agency to avoid duplication of effort and to insure that the total intelligence picture is available to those agencies and units who need it. Tactical units will be able to obtain an up-to-date intelligence picture in their AO's. Finally, timeliness of reporting was discussed. Until such time as the mechanical deficiencies of a secure means of rapid communications are solved, G2 I FFORCEV stressed that all levels of command, both tactical and advisory, must do everything possible to insure expeditious transmission of information. All concerned should lend their full support to the SOIC's and help them to function more effectively.

CONFIDENTIAL

**CONFIDENTIAL**

86

**ITEM 7: Infrastructure; presented by Major Morrison, CI Officer, G2 Section, HQ I PFORCEV**

**PROBLEM: How can military intelligence and counterintelligence activities better contribute to the elimination of the VC Infrastructure?**

**DISCUSSION:** Past experience has proven that military operations conducted by ARVN and Free World Forces are very effective means of eliminating the infrastructure. The degree of success achieved in this effort is consistent with the amount of assistance provided to the military forces by Vietnamese law enforcement and counterintelligence agencies; i.e., the National Police and Military Security Service. In this respect, it was stated by Major SINH that ARVN, at all levels, has a direct interest in destroying the infrastructure. Their mission includes territorial responsibilities as well as the conduct of military operations. It was further stated that the National Police do not always support ARVN to the degree possible in the effort toward elimination of members of the infrastructure. Planning of military operations must include targeting the infrastructure. Close coordination is essential between the military unit which will conduct the operation and the National Police, Special Branch National Police, Military Security Service and local ARVN units while planning and executing the operation.

**CONCLUSIONS:** The most successful and quickest method of eliminating the infrastructure is during the conduct of military operations provided surprise is achieved and proper planning has taken place ahead of time. Every source of information available on the composition of the infrastructure must be exploited during the planning phase and actual conduct of the operation. The assistance of the National Police is essential to insure that actual apprehension is accomplished to the maximum extent possible.

**CONFIDENTIAL**

CONFIDENTIAL

NVA AND VC MAIN FORCES IN II CTZ

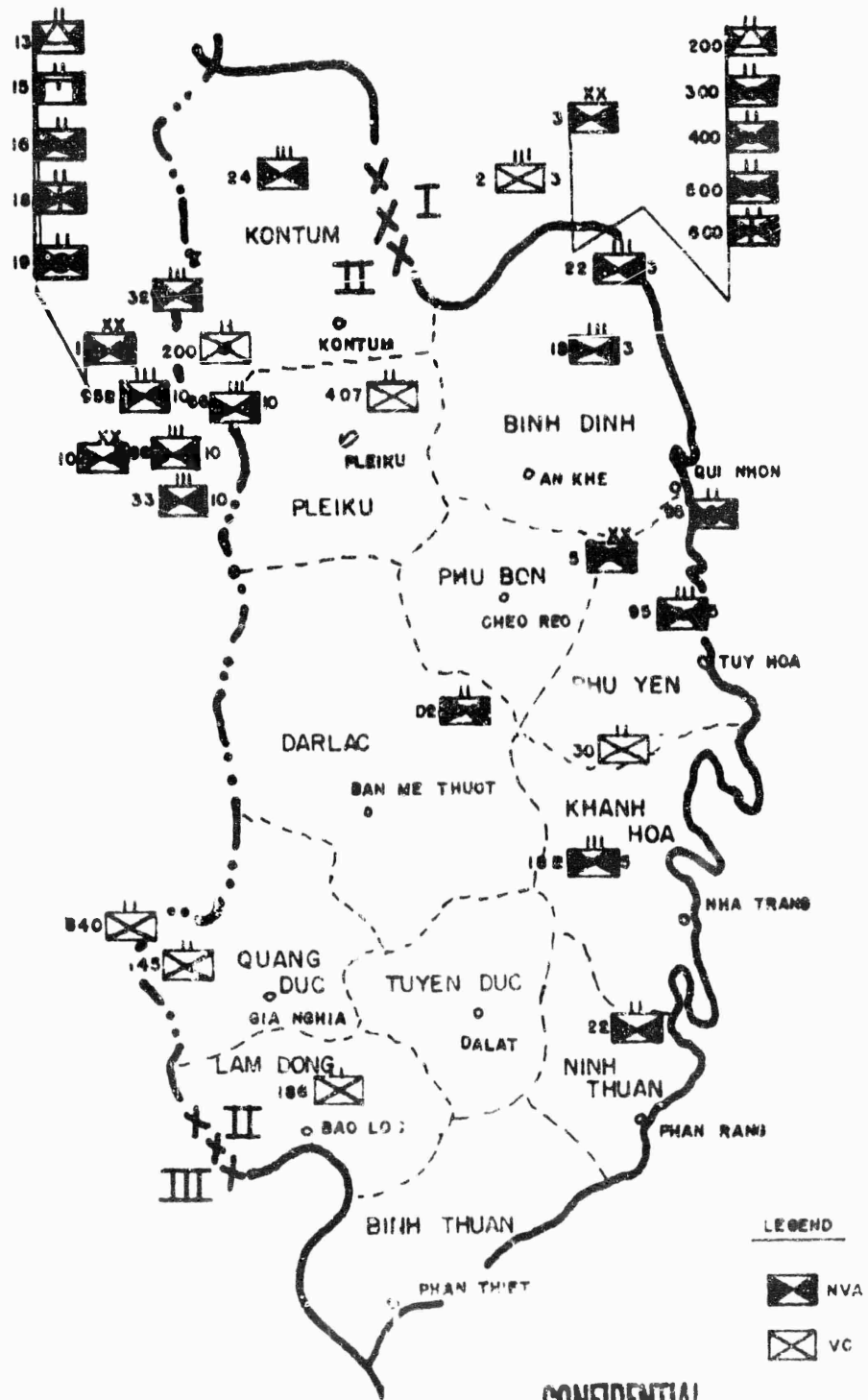

CONFIDENTIAL

Sheet # 2

# VC LOCAL FORCES IN II CTZ

CONFIDENTIAL

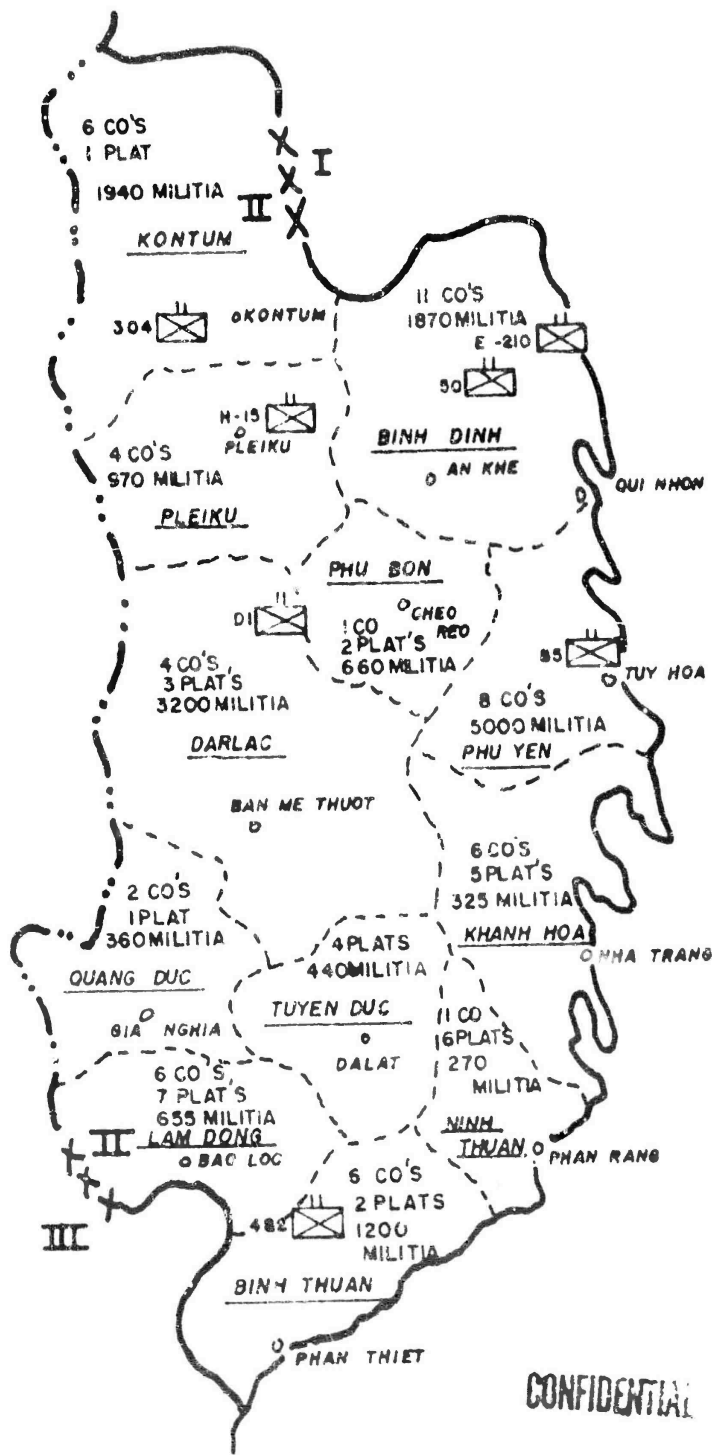

CONFIDENTIAL

*Incl #3*

**CONFIDENTIAL**

**HEADQUARTERS I FORCEV TASK ORGANIZATION**

AVFA-OC-07

31 January 1967

ASSIGNED UNITS	AUTHORITY	STATUS	AUTHORITY	LOC
HQ, Co I FORCEV	USARPAC 00 56, 11 Mar 66	Attached HQ I FORCEV Arty	I FORCEV 00 391, 9 Oct 66	WHA
HQ & HQ Btry I FORCEV	USARPAC 00 56, 11 Mar 66	Attached HQ I FORCEV Arty	I FORCEV 00 4, 3 Jan 67	FKU
52d Arty Group	USARV 00 57, 5 Jan 67	Attached 1st Cav Div (AH)	I FORCEV 00 16, 25 Oct 65	QRB
1st Bn (155) (T) 30th Arty	USARV 00 1868, 12 Dec 65	Attached 52d Arty Gp	I FORCEV 00 287, 29 Jul 66	ARE
2d Bn (105) (T) 17th Arty	USARV 00 57, 5 Jan 67	Attached HQ I FORCEV Arty	I FORCEV 00 4, 3 Jan 67	ARE
3d Bn (105) (SP) 6th Arty	USARV 00 57, 5 Jan 67	Attached HQ I FORCEV Arty	I FORCEV 00 397, 14 Oct 66	FKU
3d Bn (8*) (SP) 18th Arty	USARV 00 1205, 26 Oct 65	Attached HQ I FORCEV Arty	I FORCEV 00 287, 29 Jul 66	FKU
5th Bn (105) (T) 27th Arty	USARV 00 1762, 30 Nov 65	Attached HQ I FORCEV Arty	I FORCEV 00 4, 3 Jun 67	QBR
6th Bn (175) (SP) 14th Arty	USARV 00 1205, 26 Oct 65	Attached HQ I FORCEV Arty	I FORCEV 00 532, 5 Dec 66	ARE
7th Bn (105) (T) 13th Arty	USARV 00 6208, 31 Oct 66	Attached HQ I FORCEV Arty	I FORCEV 00 532, 5 Dec 66	ARE
HQB, 8th Bn 26th Arty	USARV 00 361, 25 Jan 67	Attached III MAP*	I FORCEV 00 532, 5 Dec 66	ARE
1st Bn (105) (SP) 40th Arty	USARV 00 6524, 27 Nov 66	Attached III MAP*	I FORCEV 00 532, 5 Dec 66	ARE
2d Bn (175) (SP) 94th Arty w/Btry	USARV 00 6524, 27 Nov 66	Attached III MAP*	I FORCEV 00 532, 5 Dec 66	ARE
B 6th Bn (8*) (SP) 27th Arty Atchd	USARV 00 6524, 27 Nov 66	Attached III MAP*	I FORCEV 00 532, 5 Dec 66	ARE
1st Bn (ANSP) 44th AD w/Btry G	USARV 00 6524, 27 Nov 66	Attached III MAP*	I FORCEV 00 532, 5 Dec 66	ARE
(Quad 50) 65th AD atchd	USARV 00 6524, 27 Nov 66	Attached III MAP*	I FORCEV 00 532, 5 Dec 66	ARE
Btry B 29th Arty (Searchlight)	USARV 00 1205, 26 Oct 65	Attached HQ I FORCEV Arty	I FORCEV 00 4, 3 Jan 67	ARE
235th FA Det (Radar)	USARV 00 1913, 28 Mar 66	Attached 52d Arty Gp	I FORCEV 00 287, 29 Jul 66	FKU
237th FA Det (Radar)	USARV 00 1913, 28 Mar 66	Attached 52d Arty Gp	I FORCEV 00 612, 31 Dec 66	WHA
238th FA Det (Radar)	USARV 00 1913, 28 Mar 66	Attached 17th Arty Gp	I FORCEV 00 136, 15 Apr 66	DBT
77th FA Det (Radar)	USARV 00 1913, 28 Mar 66	Attached 52d Arty Gp	I FORCEV 00 287, 29 Jul 66	QRB
68th Inf Det (Radar)	USARV 00 1913, 28 Mar 66	Attached 52d Arty Gp	I FORCEV 00 415, 25 Oct 66	FKU
54th Inf Det (Ord Svlnce)	USARV 00 3137, 27 May 66	Attached 52d Arty Gp	I FORCEV 00 200, 9 Jun 66	ARE
54th Sig Bn (Corps)	USARV 00 668, 20 Sep 65	Attached 1st Cav Div (AH)	I FORCEV 00 25, 16 Nov 65	WHA
272 MP Co	USARV 00 668, 20 Sep 65			WHA
64th Engr Det (Recon)	USARV 00 159, 13 Jan 66			WHA
55th MI Det	USARV 00 1229, 27 Oct 65			WHA
209th Sig Det (KA)	USARV 00 1590, 15 Nov 65			WHA
297th TC Co (Car)	USARV 00 5953, 6 Oct 66			WHA
13d APU (APO 96350)	USARV 00 5953, 6 Oct 66			WHA

NOTE: \*Atchd to III MAP for OPCODE, admin and logistical apt.; less Army peculiar admin and logistical apt. Obtain Army peculiar logistical apt from 1st Log Comd.

*Atch #12 (4 Pages)*

CONFIDENTIAL  
 COMPROCESSED BY THE JCS  
 SECURITY INFORMATION  
 DEC DIR 5200.10



~~CONFIDENTIAL~~

HEADQUARTERS I FORCEV TASK ORGANIZATION

<u>ATTACHED UNITS</u>	<u>AUTHORITY</u>	<u>STATUS</u>	<u>AUTHORITY</u>	<u>LOC</u>
180th Chem Plat	USARV GO 1056, 16 Oct 65	Attached 1st Cav Div (AM)	I FORCEV GO 16, 25 Oct 65	AKX
26th Chem Det (CBR CTR)	USARV GO 1056, 16 Oct 65	Attached 1st Cav Div (AM)	I FORCEV GO 16, 25 Oct 65	AKX
1st MI Det	USARV GO 1056, 16 Oct 65	Attached 1st Cav Div (AM)	I FORCEV GO 16, 25 Oct 65	AKX
13th Mil Hist Det	USARV GO 2181, 28 Dec 65	Attached 1st Cav Div (AM)	I FORCEV GO 16, 25 Oct 65	NHA
1st CA Co (-)	USARV GO 4079, 22 Jun 66			NHA
11th PI Det	USARV GO 4878, 21 Jul 66			NHA
5th PI Det	USARV GO 5587, 8 Sep 66			NHA
313 RR Bn	509th RR Gp GO 78, 29 Jul 66			NHA
310 RR Co	509th RR Gp GO 78, 29 Jul 66			PKU

~~CONFIDENTIAL~~

CONFIDENTIAL  
PROPERTY OF THE ARMY  
HEADQUARTERS I FORCEV  
TAGO  
TAGO 100-100-100

**CONFIDENTIAL**

MACV LTR MACOC 4, HQ USARV  
20 JUL 66, SUBJ: ARMY AVN ALLOCATIONS (U)  
PLACES THE FOLLOWING ALLOCATIONS (CURRENTLY  
UNDER CONTROL OF THE 17TH AVN GP) IN SUPPORT  
OF HQ I FFORCEV

52d AVN Bn HHD

119th AVN Co (AML)  
155th AVN Co (AML)  
170th AVN Co (AML)  
179th AVN Co (AML)

14th AVN Bn HHD

161st AVN Bn (AML)  
174th AVN Co (AML)  
Det 282d AVN Co (AML) 15 OH-1a

10th AVN Bn HHD

148th AVN Co (AML)  
117th AVN Co (AML)  
129th AVN Co (AML)  
180th AVN Co (MEIHHEL)

223d AVN Bn HHD

18th AVN Co (OTTER)  
183d AVN Co (OBSN LT)  
219th AVN Co (RAC)

**CONFIDENTIAL**

92  
DOWNGRADED AND DECLASSIFIED  
DECLASSIFIED AFTER 100  
DOD DIR 5800.10

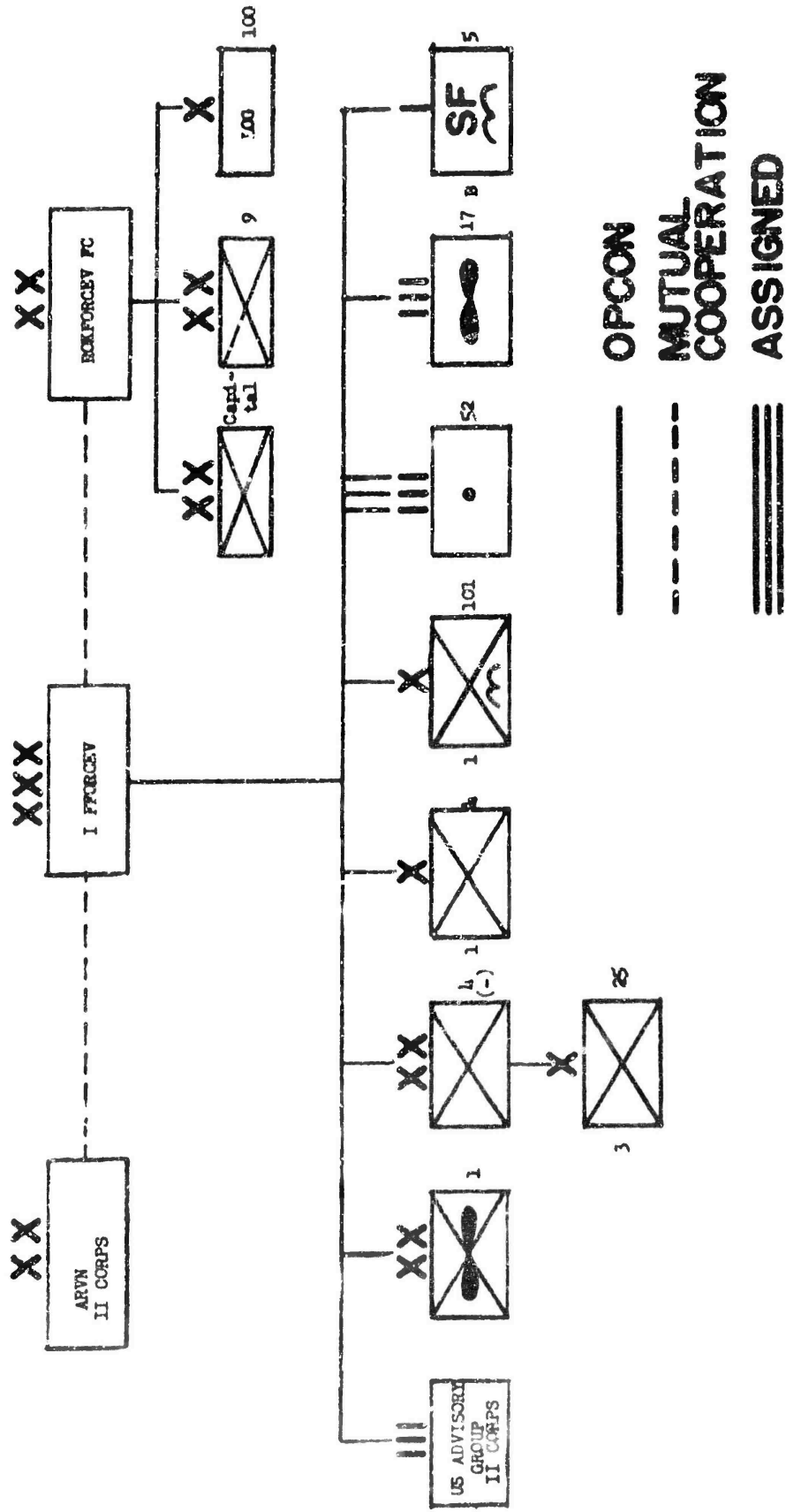

INCL 12A

# CONFIDENTIAL

HAMLET STATUS  
As of 31 Oct 65

95

PROVINCE	TOTAL PLANNED	GOAL FOR THIS CY	BEING SECURED	SECURED THIS CY	% SECURED THIS CY	TOTAL NOW SECURED	CLEARED
Binh Dinh	675	119	19	57	48%	122	282
Binh Thuan	181	58	9	36	62%	117	55
Darlac	519	47	12	34	72%	34	153
Khánh Hòa	261	28	11	8	29%	141	101
Kontum	273	31	23	5	16%	53	116
Liên Đông	82	27	0	14	52%	36	35
Ninh Thuận	119	23	8	10	43%	95	15
Phu Bon	139	33	7	24	73%	56	63
Phu Yên	257	33	13	30	91%	38	97
Pleiku	198	46	5	10	22%	42	53
Quảng Đức	81	19	5	14	73%	40	15
Tuyên Đức	160	52	7	30	58%	162	45
Cần Ranh	<u>31</u>	<u>5</u>	<u>29</u>	<u>0</u>	<u>0</u>	<u>0</u>	<u>0</u>
TOTALS	2776	521	148	272	52%	936	1030

HAMLET STATUS  
As of 31 Dec 65

PROVINCE	TOTAL PLANNED	GOAL FOR THIS CY	BEING SECURED	SECURED THIS CY	% SECURED THIS CY	TOTAL NOW SECURED	CLEARED
Binh Dinh	675	116	21	58	50%	123	275
Binh Thuận	173	58	13	36	62%	117	43
Darlac	285	47	8	51	109%	51	130
Khánh Hòa	262	23	4	22	78%	140	110
Kontum	173	31	4	27	87%	66	133
Liên Đông	81	27	5	14	52%	33	33
Ninh Thuận	119	18	4	13	72%	98	16
Phu Bon	144	33	1	31	94%	68	60
Phu Yên	257	33	26	37	112%	37	85
Pleiku	198	46	5	10	22%	42	48
Quảng Đức	61	19	4	15	79%	38	18
Tuyên Đức	160	52	8	30	57%	121	30
Cần Ranh City	31	5	29	0	0%	0	0
Điện Biên Phủ City	<u>43</u>	<u>10</u>	<u>1</u>	<u>9</u>	<u>90%</u>	<u>42</u>	<u>0</u>
TOTALS	2662	523	133	333	67%	976	931

INCL # 13

97

FRONT

LEAFLET NUMBER: 245N-20-67 AMOUNT: 25,000 REQUESTOR: 245th Cont.  
 THEME: Nguyen Van Thanh - Rallier  
 TARGET: 482nd VC Battalion  
 REASON FOR DEVELOPMENT: Influence men of 482nd VC Battalion to Rally;  
 A message from their Procurement Officer to also show them how short of  
 needed supplies they are.



BÂY LÀ NGUYỄN VĂN THANH, TỰ ANH, SĨ QUAN QUẢN LÝ TIỂU ĐOÀN VIỆT CONG 482,  
 BÃ BỊ THƯƠNG VÀ BỊ RẮT BỎI LỰC LƯỢNG CỦA SƯ ĐOÀN 1 KỸ BINH KHÔNG VẠN HOA KỲ.  
 NHƯ CÁC BẠN THẦY TRONG HÌNH, PHÒNG SỰ ĐƯỢC SẴN SÓC DẦY ĐỦ THUỐC MEN. CÁC BẠN  
 HÃY TRỞ VỀ NGAY VỚI CHÍNH PHỦ NGAY BÂY GIỜ VÀ CÁC BẠN CŨNG ĐƯỢC CUNG CẤP THUỐC  
 MEN NHƯ THẾ.  
 245N-20-67

*THIS IS NGUYEN VAN THANH, ALIAS ANH, 482 VC. BN.  
 PROCUREMENT OFFICER WHO WAS WOUNDED  
 AND CAPTURED BY THE 1ST AIR CAV. FORCES.  
 AS YOU CAN SEE, HE IS BEING WELL CARED  
 FOR AND BEING GIVEN THE BEST OF MEDICAL  
 AID. RALLY NOW AND RECEIVE THE SAME  
 MEDICAL TREATMENT.*

*Incl #14 (3 pages)*

BOCK

98

~~-Thiếu úy quân lý-~~

Cùng các bạn thân mến

Tôi tên là Nguyễn Văn Thành là Anh, thiếu úy quân lý tiểu đoàn chủ lực quân 482, đã bị thương và bị bắt ngày 21/12/1966 tại ấp Bắc Ốc, xã Tân Hưng, quận Thiên Giáo, tỉnh Bình Thuận do lực lượng của sư đoàn 5 kỵ binh không vận Hoa Kỳ. Hiện tôi đang được điều trị tại một trong những bệnh viện lớn của Mỹ tại Nha Trang - Chính tôi cũng không ngờ được nằm điều trị tại một bệnh viện như vậy - Thoạt tiên bị bắt tôi tưởng họ sẽ giết tôi vì khi còn ở trường hàng ngày v.v; các cán bộ thường nói binh sĩ Đàng-Minh sẽ giết nếu người nào bị bắt. Nay tôi bị thương, tôi nhận thấy rằng những điều họ nói đến là quá khướt vậy tôi có vài lời tâm huyết kêu gọi các bạn sau đây:

Là một sĩ quan quân lý tiểu đoàn tôi hiểu rõ về số lượng tài liệu của tiểu đoàn nhiều hơn các bạn - Hiện nay, lượng thực phẩm gạo, quần áo và quân trang của tiểu đoàn không đủ cung cấp cho các bạn nữa vì những cuộc hành quân liên tiếp của lực lượng Đàng-Minh - nay tôi kêu gọi các bạn hãy trở về với chiến trường quốc gia ngay bây giờ - các bạn sẽ được tiếp đãi tử tế

Nay kêu gọi:

Thiếu úy quân lý



To: members of the 482d VC Bn

I, Nguyen van Thanh, alias Anh, 482d VC Bn procurement officer, was wounded and captured by the 1st Air Cav forces at the Bao Oe hamlet, Tam Hung village, Thien Giao District, Binh Thuan Province on 21 Dec 66. I have been hospitalized in one of the largest U.S. hospitals in Nha Trang. I was very surprised to see them bringing me to such a hospital, because while in the VC unit our cadres always said they would kill us if we were captured. Today, I got wounded and I know now that what our cadres talked about was not true. And that's why today I am sending to you this heartfelt message:

Being a procurement officer I know the quantities of supplies of the Bn much better than you. Due to the successful operations of the allied forces the Bn does not have sufficient rice, salt, clothing and equipment to be distributed to you. So I call all of you to return to the national cause, because if you don't you all will be killed very soon. Your families are waiting for you. Come in now.

# FRONT

LEAFLET NUMBER: 245(P)-103-67 AMOUNT: 50,000 REQUESTOR: 101<sup>ST</sup> A.C.V.

THEME: CHIÊU HỒI

TARGET: N/A

REASON FOR DEVELOPMENT: URGE VC TO RALLY

99



CÁC BẠN THÂN MẾN  
BẠN PHẢI QUYẾT ĐỊNH NGAY TỪ BÂY GIỜ ĐI. BẠN MUỐN  
SỐNG HAY CHẾT YẾU? (C BẠN ĐANG BỊ ĐỀ NHẤT SỰ ĐOÀN  
KHÔNG KÝ. BAO VÂY R

245 103-67

BACK

PRINTED BY THE 245 & PSYOPCO. PLAKU, DET.

IN SUPPORT OF THE AMERICAN FIGHTING MAN

100

**CÁC ĐỒNG CHÍ THÂN MIẾN**

Tôi đã tử bỏ cuộc chiến đấu trong sự khổ cực. Tôi hy-vọng để ra guy chính với quân-đội Đồng Minh.

**TÔI ĐƯỢC HQ TIẾP ĐÁI NỔNG HẬU.**

Não thức ăn đầy đủ ngày 3 bữa, não quần áo mới nhất là có áo len mặc thật ấm, cũng được chăm sóc thuốc men chu-áo.

Vì thế, tôi muốn các đồng-chí hãy rút-sống ra guy chính, để hướng sự sung-sướng ấy cùng với tôi. Chúng ta đã phí bao nhiêu ngày tháng trong sự khổ cực cũng thiếu thốn đủ mọi phương diện. Tôi hy-vọng các đồng chí đứng chiến đấu trong sự tuyệt-vọng mà phí cả tương lai tuổi sáng đang chờ đón các bạn.

**CÁC ĐỒNG CHÍ THÂN MIẾN.**

Khi ra guy chính, các đồng chí hãy mang theo súng ống, đạn dược sẽ được tiếp đãi trong hậu.

Tôi không lừa dối các bạn đâu, đó là sự thật. Tôi nghĩ sáng đây là dịp may để các đồng chí tìm lại sự-sống và trong tương lai sẽ được sống gần gia-đình thân yêu.

Tôi tin tưởng các bạn cũng được hưởng niềm vui đó. Vì thế tôi nói. Do đó các bạn hãy rút-sống với tinh thần cởi mở ra guy Chính với quân đội Đồng Minh.

Tôi đang chờ đón các bạn

*Nguyễn Đình Thanh*

Trung đội 2, Đại đội 22. Văn tá thực tiễn Đoàn 4, Trung Đoàn 11.

TRANSLATION FOR LEAFLET 245 (P) 163-67

Dear Comrades

Why do you continue to fight for such a hopeless cause? Can't you see that you have been lied to by our cadre. I give up the hopeless fight, and come in. I have been treated very good, plenty of food, medical care, new and warm clothes. I will live to see my loved ones again. Isn't it better to give up this hopeless fight and come in to the GVN and allied forces and receive the same good treatment that I have had be rejoined with your loved ones than to be killed and buried in an unmarked grave far away from home and your loved ones, for a worthless cause. You don't have a chance to live fighting against the GVN. So give up now while you are still alive and have a chance to live.

Your comrad

101

Translation of Special Leaflet 245(P) 74 67

To my dear Comrades in Company 19:

I am Mai Dinh Phuong, a soldier of Company 19, Regiment 33.

I was captured on 14 November 1966 and was well-treated by the U.S. Soldiers. They gave me good food, C-rations, and cigarettes. I recognized that everything written in the leaflets is correct.

Do not be afraid of the Chieu Hoi Policy anymore.



FRONT

103

LEAFLET NUMBER: 245P-113-57 AMOUNT: 100,000 REQUESTOR: 1/101st.

THEME: Follow Instructions

TARGET: Civilian populace in OP FARREGUT AO

REASON FOR DEVELOPMENT: Instruct populace to minimize civilian casualties and fear.



BACK

104

**Công đồng bào lưu ý.**

Chính phủ VNCH về quân lực đồng minh sẽ có mặt nổi  
khu vực đồng bào trong khoảng thời gian ngắn. Chúng tôi  
yêu cầu đồng bào hãy theo sự chỉ dẫn chúng tôi mà chúng  
tôi sẽ phóng thanh an, đồng bào sẽ không bị thiệt hại.  
Hãy cẩn thận những gì mà đồng bào làm để cho VC không thể  
có những hành động trả thù với đồng bào vô tội. Các viên  
cứu địa phương sẽ được di chuyển ra khu an toàn nếu họ  
muốn. Chỉ làm theo những lời chỉ dẫn về đồng bào sẽ không  
bị thiệt hại. Hãy ủng hộ chính phủ VNCH.

245P-113-67

**ATTENTION VILLAGERS**

The GVN and Allied forces will be in your area for only a  
short time. We ask that you follow our instructions which  
will be given you by loudspeaker you will not be harmed. Be  
careful of what you do so that the Viet Cong will not take  
retalitory action against innocent people. Local leaders  
will be evacuated to safety if they desire. Simply obey in-  
structions and you will not be harmed. Support your GVN.

245P-113-67

105

FRONT

LEAFLET NUMBER: 245N-117-67 AMOUNT: 100,000 REQUESTOR: 1/101st Abn Bn.  
THEME: VC Use You  
TARGET: VC/Civilian populace in OP FARRECAT AO  
REASON FOR DEVELOPMENT: Emphasize VC means a life of sadness and misery

Under GVN control

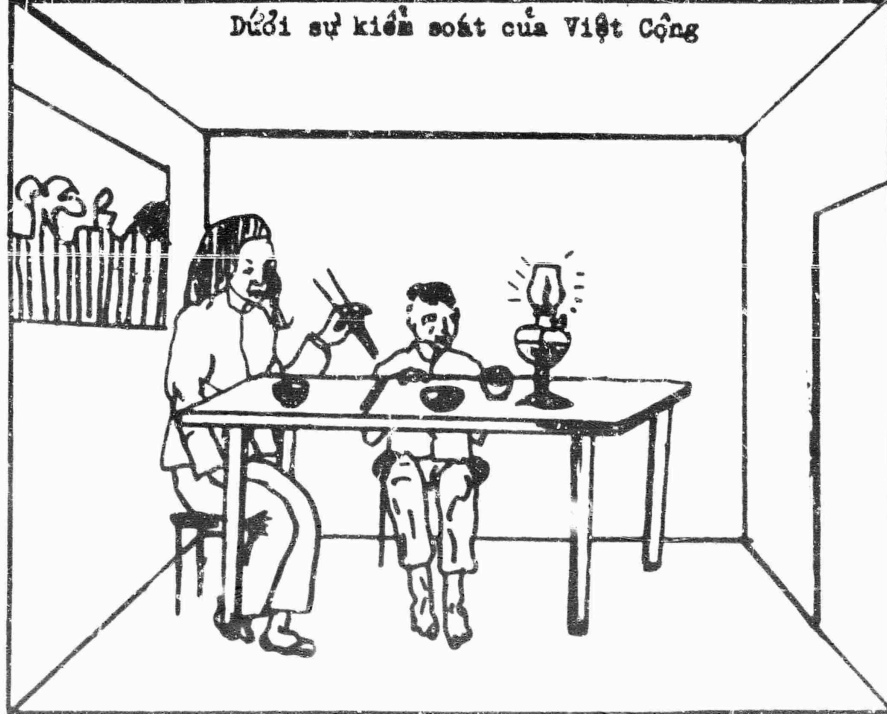
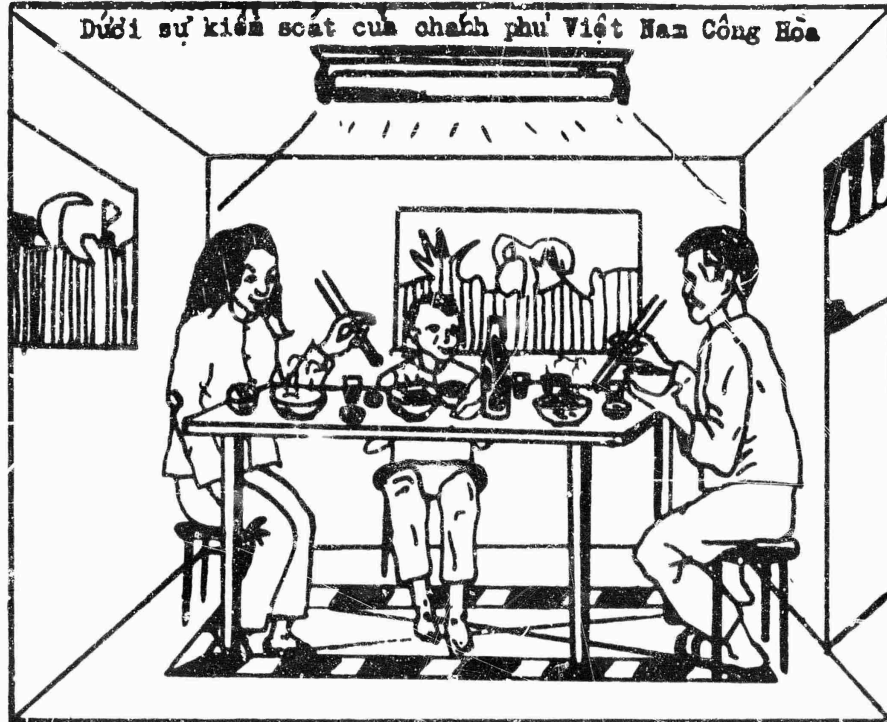

Under Viet Cong control

(BE TRAI)

## CUNG TOAN THE DONG BAO MIEN NAM VIETNAM.

Viet Cong dang dung dong bao de yem tro cuoc chien tranh phi nghĩa của họ để chống lại chính phủ hợp pháp của đông bào. VC cướp đoạt ruộng của đông bào. Họ cướp lúa gạo của đông bào ở ngoài đồng ruộng, họ bắt buộc đông bào làm việc phi nghĩa cho họ. Họ đã bắt con cái đông bào đi chiến đấu và chết cho sự phi nghĩa của họ. Viet Cong phá hoại bất cứ việc gì trong đời sống hàng ngày của đông bào. Các bạn thiếu lương thực và hạnh phúc gia đình cũng vì Viet Cong. Đây có phải là đời sống mà đông bào ao ước? Hãy giúp đỡ Việt Nam Cộng Hòa để đánh bại Viet Cong và xây lại một đời sống được hạnh phúc thật sự.

245N-117-67

(BACK)

## PEOPLE OF SOUTH VIETNAM

The Viet Cong are using you to support their futile war against your legal government. The Viet Cong take your life's work --- they take the rice you raise in your fields, they force you to work for their unjust cause, they steal your sons and daughters to fight and die for a lost cause. The Viet Cong ruin everything you have worked for all your life --- your home is empty of food, family and happiness because of the Viet Cong. Is this the kind of life you want --- support your GVN to defeat the Viet Cong and build a life of true happiness.

245N-117-67

# SPECIAL MAP

II CTZ RVN

SCALE 1:1,000,000



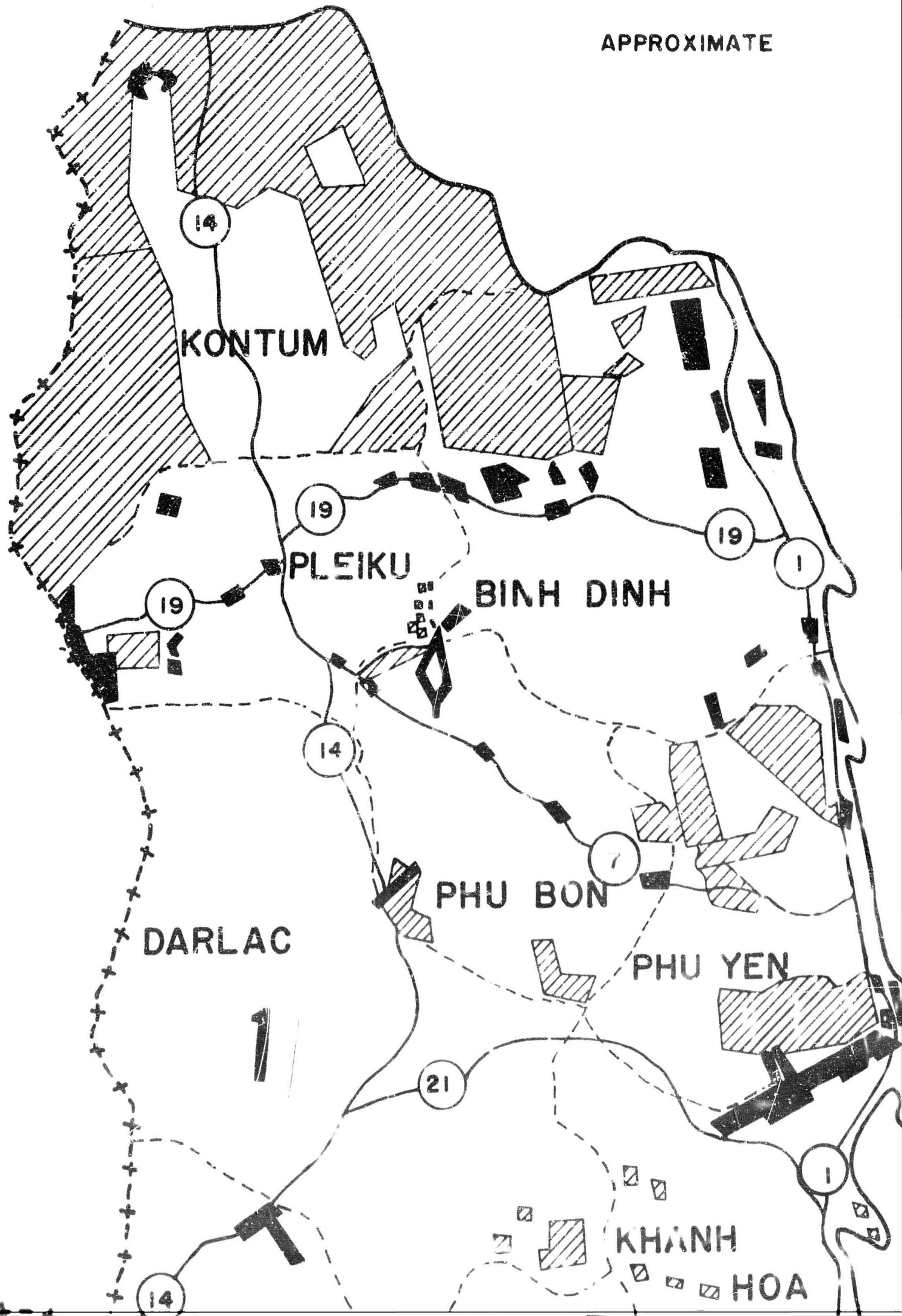

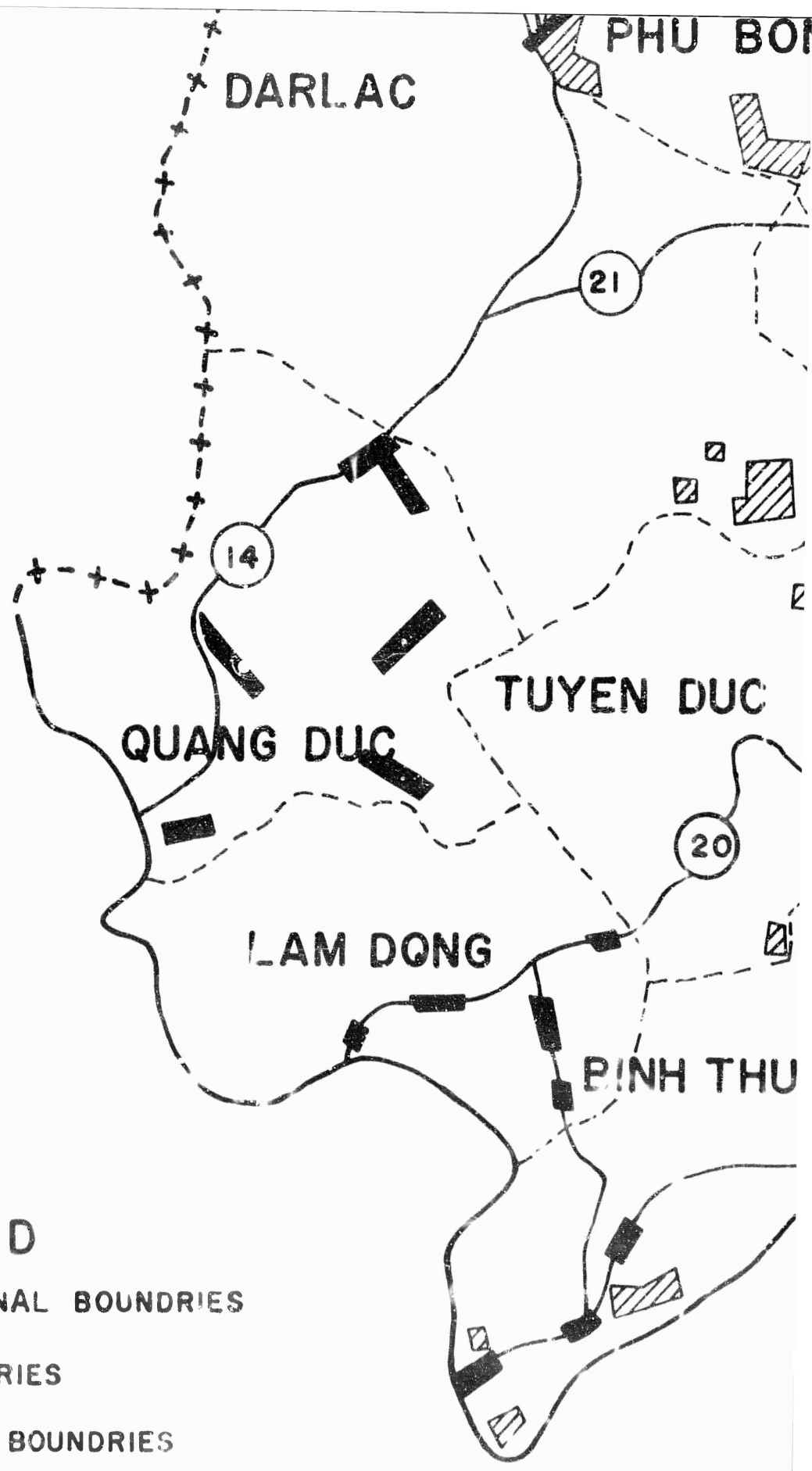

APPROXIMATE



2



### LEGEND

-  INTERNATIONAL BOUNDRIES
-  CTZ BOUNDRIES
-  PROVINCIAL BOUNDRIES
-  ROADS
-  CROP DESTRUCTION OPERATIONS
-  DEFOLIATION OPERATIONS

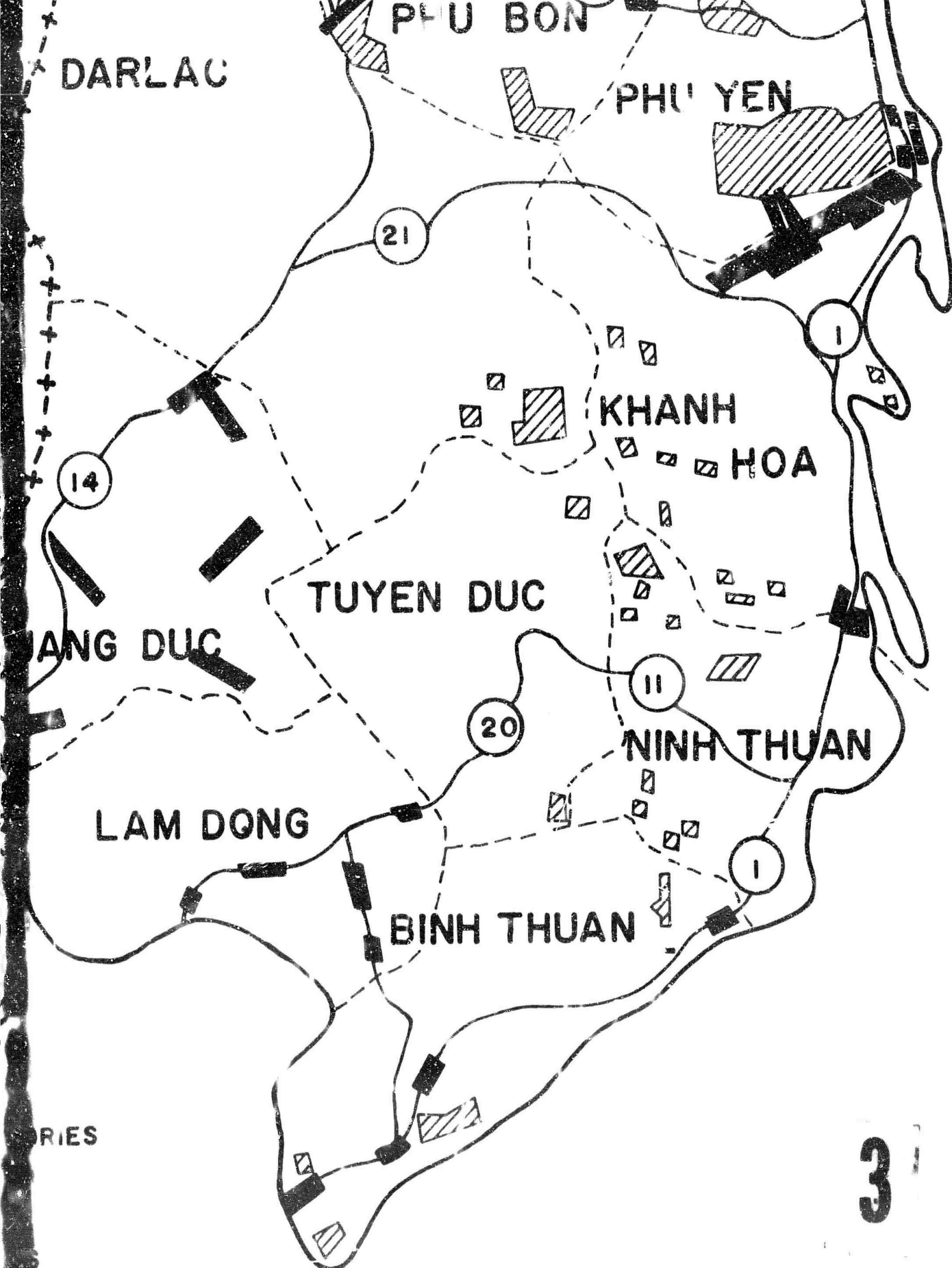

RIES

PERATIONS

IONS

HQ I FORCEV KEY PERSONNEL  
and  
MAJ SENIOR COMMANDERS ON DATES INDICATED

TITLE	1 Nov 66	31 Jan 67
Commanding General	LTC 3.R. Larsen	NO CHANGE
Deputy Commanding General	VACANT	VACANT
Chief of Staff	COL (P) D.P. Bolton	COL (P) L.S. Boatwright
Deputy Chief of Staff	COL R. T. Fairfield	NO CHANGE
Artillery Officer	COL (P) L.S. Boatwright	BG E.H. de Saussure Jr
Secretary General Staff	LTC R.H. Milan	LTC W.R. Healey
Information Officer	LTC D.A. Williams	NO CHANGE
Inspector General	LTC J.H. Glandorf	NO CHANGE
Judge Advocate	LTC R.W. Kennedy	NO CHANGE
AC of S, G1	COL G.A. Bone	NO CHANGE
AC of S, G2	COL R.W. Williams	NO CHANGE
AC of S, G3	COL C.F. Hannum	NO CHANGE
AC of S, G4	COL V. Kovalevsky	NO CHANGE
AC of S, G5	COL R.H. Renwans	VACANT
Adjutant General	COL J.H. James	NO CHANGE
Provost Marshal	COL J.J. O'Donnell	NO CHANGE
Signal Officer	COL J.P. Coe, Jr	NO CHANGE
Engineer Officer	COL H.C. Beaty	NO CHANGE
Chaplain	COL T.E. Waldie	NO CHANGE
HQ Commandant	LTC C.W. Dryer	MAJ C.W. Rock
Aviation Officer	COL J.W. Marr	NO CHANGE
Chemical Officer	LTC J.P. Crispell	LTC S.E. Anderson
Director, DASC	LTC P.P. Acza (USAF)	NO CHANGE
CG, 1st Cav Div (AM)	MG J. Norton	NO CHANGE
CG, 4th Inf Div (-)	MG A.S. Collins, Jr	MG W.R. Peers
CC, 1st Bde, 101st Abn Div	BG W. Pearson	BG S.H. Matheson
CO, 3d Bde, 25th Inf Div	COL J.G. Shanahan	NO CHANGE
CG, Capital ROK Inf Div	MG B.H. Yoo	NO CHANGE
CC, 9th ROK Inf Div	MG S.D. Lee	NO CHANGE

*Jack # 1B*

CONFIDENTIAL

MANEUVER BATTALION STRENGTHS

<u>UNIT</u>	<u>AU HORIZED STRENGTH</u>	<u>PERCENT PDY/AUTH 30 Nov 66</u>	<u>PERCENT PDY/AUTH 28 Dec 66</u>	<u>PERCENT PDY/AUTH 26 Jan 67</u>
1st Cav Div (AM)				
1st Bn, 5th Cav	767	89.8	95.6	91.3
2d Bn, 5th Cav	767	91.9	97.4	90.2
1st Bn, 7th Cav	767	87.2	96.7	93.0
2d Bn, 7th Cav	767	100.8	95.6	88.3
5th Bn, 7th Cav	767	102.7	96.3	93.9
1st Bn, 8th Cav	767	106.3	93.2	86.4
2d Bn, 8th Cav	767	107.2	91.4	90.0
1st Bn, 12th Cav	767	103.1	97.5	88.7
2d Bn, 12th Cav	767	107.4	100.3	92.8
1st Bn, 9th Cav	792	115.2	111.6	112.9
4th Inf Div (-)				
1st Bn, 8th Inf	789	93.0	94.3	93.9
2d Bn, 8th Inf	789	95.8	96.8	97.6
3d Bn, 8th Inf	789	94.0	92.5	89.0
1st Bn, 12th Inf	789	99.7	95.6	95.3
2d Bn, 12th Inf	789	97.2	95.3	92.4
1st Bn, 22d Inf	789	96.1	90.2	99.0
1st Bn, 69th Arm	571	95.4	91.9	79.9
3d Bde, 25th Inf Div				
1st Bn, 35th Inf	829	96.5	84.8	87.7
2d Bn, 35th Inf	829	102.2	103.9	92.6
1st Bn, 14th Inf	829	99.4	104.9	91.4

CONFIDENTIAL

Incl # 19 (2 ~~pages~~)

## MANEUVER BATTALION STRENGTHS

<u>UNIT</u>	<u>AUTHORIZED STRENGTH</u>	<u>PERCENT PLY/AUTH 30 Nov 66</u>	<u>PERCENT PLY/AUTH 28 Dec 66</u>	<u>PERCENT PLY/AUTH 26 Jan 67</u>
1st Bde, 101st Abn Div				
1st Bn, 327th Inf	834	96.6	80.4	92.9
2d Bn, 327th Inf	834	96.9	83.3	86.4
2d Bn, 502d Inf	834	97.3	78.3	92.3

CONFIDENTIAL

**CONFIDENTIAL**

113

1 November 1966 - 31 January 1967

UNIT	AUTH	% PDY/AUTH	KIA	MIA	PFA	DEAD	NON-BATTLE KIA	SICK	OTHER	RETURN TO DUTY	REPLACEMENT
HC, I FORCECV (1)	507	109.8						50	490	111	542
HRB, I FORCECV Arty	195	83.6						1	23	17	73
52d Arty Cp (2)	1797	87.4		4		1	2	45	810	565	412
5/27th Arty	516	109.1				1	1	4	188	179	276
I FORCECV Arty Adv (Qui Rhon) (3)	1483	93.8					1	4	137	27	136
54th Sig Bn (4)	1029	93.7							139	64	85
41st CA Co	98	69.4					1		83	13	46
55th MI Det	72	90.3						5	48	21	19
272d MP Co	182	100.0						2	150	33	54
297th Trans Car Co	107	102.8						2	16	4	8
2nd Cav Div (AM)	1691.5	103.3	178	611	2	16	104	1139	12655	9275	5624
1st Cav ATCH	954	92.1	2	30			2	20	741	249	321
4th Inf Div	11939	98.7	56	301		10	43	843	4433	3854	2577
4th Inf ATCH	598	84.3					2	33	544	231	238
3d Bde, 25th Inf Div	3981	101.9	66	171		3	34	594	3501	1935	2223
1st Bde, 101st Abn Div	4576	103.9	39	225		4	85	464	1878	1233	1097
II Corps Adv Cp	1310	93.8	3						160		155

**CONFIDENTIAL**

Incl # 20 (2 pages)

**CONFIDENTIAL**

UNIT	AUTH	% PDY/AUTH	BATTLE		DEAD	FROM BATTLE		OTHER	RETURN TO DUTY	REPLACEMENT
			KIA	MIA		KIA	MIA			
17th Avn Cp	5057	99.0	20	13	4	6	7	72	2637	1681
Cap BOK Div	14161	102.2	39	105		9	44	720	2097	1723
9th RC Div	13916	101.5	14	54		19	51	308	12	201

- (1) Includes HQ, I FORCEV, HQ Co, I FORCEV, 64th Engr Det (Terrain), 5th PI Det (Press Camp), 11th PI Det (Press Camp), and 13th Military History Det.
- (2) Includes Rq Btry 52d Arty Cpl; 3 Bn, 6th Arty; 6th Bn, 14th Arty; 3d Bn, 18th Arty; 77 FA Radar Det; 235 FA Radar Det; and 227 FA Radar Det
- (3) Includes 7th Bn, 13th Arty; 1st Bn, 30th Arty; HIB 8th Bn, 26th Arty; and Btry B 29th Arty.
- (4) Includes 54th Sig Bn, 167th Sig Co, and 209th Sig Det.

2 OF 2 *164*

**CONFIDENTIAL**

PROMOTION ALLOCATIONS

	NOVEMBER					DECEMBER					JANUARY					
	E9	E8	E7	E6	E4	E9	E8	E7	E6	E4	E9	E8	E7	E6	E5	E4
HQ 1 FORCIV		1		1	5	13		1(1)	2	1	9		1	1	4	2
Hqs 1 FORCEV ARTY				1	1	5								1	1	16
Hq Co I FORCFV				5	1	10					1			1	2	5
52d Arty Gp			1	5	1	10		1		1	6			1	1	12
1st Bn 30th Arty			2	5	8	39			5	7	18			1	4	19
3d Bn 6th Arty		1		5	7	35			2	9	33			3	7	31
3d Bn 18th Arty				6	8	38			4	10	41			5	5	16
5th Bn 27th Arty				16	4	46			2	8	40			3	12	45
6th Bn 14th Arty				5	8	37			4	6	40			4	5	15
7th Bn 13th Arty	1			4	4	15		1	3	3	12			2	8	17
54th Sig Bn				1	9	25				2	5			1	9	52
2d Bn 9th Arty					10	10			2	4	2		1	2	2	11
1st Bn 40th Arty					65	65			6	4	4		1	3	42	50
1st Bn 44th Arty								1								
5th PI Det																
11th PI Det					1	1										
13th MI Hist Det																
List CA Co					2	2										
55th MI Det			1	1	2	7										
64th Engr Det					3	24				1	4			1	5	18
272d MP Co				1	3	6				1	4					7
297th Trans Co																
	1	2	4	40	63	281		2(1)	3	32	87					

EXCEL #

Sheet # 21

	<u>HAWAII</u>	<u>BANGKOK</u>	<u>HONG KONG</u>	<u>TOKYO</u>	<u>TAIPEI</u>	<u>SINGAPORE</u>	<u>PENANG</u>	<u>KUALA LUMPUR</u>	<u>MANTILA</u>
HQ I FORCEV 49.24	14	14(3)	14(4)	9(2)	1		1	1	3
HQB I FORCEV ARTY	1	2	3	6					1
Hq o I FORCEV		2	4	1	1				
52d Arty Gp	4	7	3	6	3	2			3
1st Bn 30th Arty	12	10	13	16	32	1	10	5	6
3d Bn 6th Arty	17	15	18	26	29	4	17	15	9
3d Bn 18th Arty	13	13	21	13	13	2	5	3	3
5th Bn 27th Arty	13	12	15	18	12	3	6	4	6
6th Bn 14th Arty	12	15	13	14	13	2	5	3	3
7th Bn 13th Arty	11	6	5	15	12	1	5	3	2
54th Sig Bn	14	14	15	15	17	2	7	2	3
2d Bn 94th Arty	9	9	7	10	11	3	2	4	1
1st Bn 44th Arty									
1st Bn 40th Arty	6	5	5	7	7	2	3	6	1
5th PI Det					1		1		
11th PI Det	1	1	2						
13th Mil Hist Det									
44st CA Co	2	4	2	3					
55th MI Det	1	3(4)	3(1)	1(1)					
64th Engr Det	1								
272d MP Co	3	4(1)	4	5	2		1		1
297th Trans Co	2	1	1	2					
<b>TOTAL</b>	<b>134</b>	<b>135(8)</b>	<b>148(5)</b>	<b>167(3)</b>	<b>154</b>	<b>22</b>	<b>63</b>	<b>48</b>	<b>42</b>

D'CL #

116

Sub # 32

( ) - STANDEY

R&R QUOTAS UTILIZED \*

	R&R QUOTAS RECEIVED						R&R QUOTAS UTILIZED *								
	NOVEMBER		DECEMBER		JANUARY		NOVEMBER		DECEMBER		JANUARY				
	OFF	WO	OFF	WO	OFF	WO	OFF	WO	OFF	WO	OFF	WO			
HQ I FORCEVF	16		18		23			16		11		16		12	
HQB I FORCEVF ARMY	2		3		3			2		2		2		3	
Hq Co I FORCEVF	4		4		6			2		2		2		2	
52d Arty Cp	6		7		8			6		6		1		7	
1st Bn 30th Arty	26		26		40		1		1		1		35		45
3d Bn 6th Arty	26		30		36		1		1		1		52		37
3d Bn 18th Arty	26		26		40		1		1		1		24		33
5th Bn 27th Arty	30		32		37		1		3		1		24		34
6th Bn 14th Arty	26		26		41		2		2		2		16		37
7th Bn 13th Arty	-		25		36		1		1		1		23		36
54th Sig Bn	30		30		43		2		1		1		27		30
2d Bn 9th Arty	-		8		50		1		1		1		7		45
1st Bn 44th Arty	-		-		-		-		-		-		-		-
1st Bn 40th Arty	-		1		40		-		-		-		2		37
5th PI Det	-		-		1		-		1		1		2		1
11th PI Det	-		-		1		-		1		1		2		1
13th MI1 Hist Det	-		-		-		-		-		-		-		-
41st CA Co	4		3		6		3		1		1		1		5
55th MI Det	3		3		5		1		1		1		1		1
64th Engr Det	-		-		1		-		-		-		1		1
272d MP Co	6		6		13		6		6		6		6		11
297th Trans Co	-		-		6		-		-		-		-		4
<b>TOTAL</b>	<b>205</b>		<b>249</b>		<b>436</b>		<b>40</b>		<b>24</b>		<b>236</b>		<b>50</b>		<b>380</b>

\* Where quotas utilized exceeds quotas received is due to the filling of vacancies received during the reporting period. The booking cut-off date and personnel utilization will be placed on file as available.

ENC #

*Jul # 23*

AWARDS AND DECORATIONS  
NOVEMBER

	<u>SM</u>	<u>BS</u>	<u>BS(V)</u>	<u>AM</u>	<u>AM(V)</u>	<u>ACE</u>	<u>ACE(V)</u>
HQ 1 FFORCEV							
OFF	2			5			
WO							
EM		4				7	
HQ CO 1 FFORCEV							
OFF		1		9			
WO							
EM						2	
HQB 1 FFORCEV ARTY							
OFF	1	1					
WO							
EM						1	
HQ 52ND ARTY GP							
OFF				1			
WO							
EM							
1ST BN 30TH ARTY							
OFF		1		1		2	
WO							
EM						13	
3RD BN 18TH ARTY							
OFF							
WO							
EM			4				
5TH BN 27TH ARTY							
OFF							
WO		1		1			
EM							
3RD BN 6TH ARTY							
OFF						1	
WO							
EM							
54TH SIG BN							
OFF				1			
WO				1			
EM	2	1		1		2	
41ST CA CO							
OFF		20	2			5	
WO							
EM		1				5	
55TH MI DET							
OFF							
WO							
EM						1	
13TH MIL HIS							
OFF		1					
WO							
EM		1		1			
272ND MP CO							
OFF							
WO							
EM						1	
TOTALS	3	2	32	6	21	0	60

Incl # 24 (A. Shaw)

AWARDS AND DECORATIONS  
DECEMBER

120

	<u>SM</u>	<u>SM</u>	<u>BS</u>	<u>RS(V)</u>	<u>AM</u>	<u>AM(V)</u>	<u>ACH</u>	<u>ACH(V)</u>
HQ 1 FORCEV								
OFF	1		20		11		1	
WO								
EM			4		1		10	
HQ CO 1 FORCEV								
OFF					3			
WO					5			
EM					1			
III B 1 FORCEV ARTY								
OFF	1		2					
WO								
EM								
1ST BN 30TH ARTY								
OFF			1					
WO								
EM							3	
6TH BN 14TH ARTY								
OFF			1		1			
WO								
EM								
3RD BN 6TH ARTY								
OFF		1			1			
WO								
EM		1	2				2	
3RD BN 18TH ARTY								
OFF								
WO								
EM							4	
5TH BN 27TH ARTY								
OFF			1					
WO								
EM							2	
54TH SIG BN								
OFF			1		3		9	
WO							4	
EM					10		3	
41ST CA CO								
OFF							1	
WO								
EM			2				3	
55TH MI DET								
OFF			1					
WO								
EM							1	
272ND MP CO								
OFF								
WO								
EM				1			3	2
TOTALS	2	2	35	1	36	0	45	2

2 of 3 PAGES



123

NON RECEIPT OF PERSONAL LETTER MAIL

The following is a breakdown of periods of non-receipt of personal letter mail by units assigned, attached, HQ I FORCEV during the period 1 Nov 66 - 31 Jan 67.

UNIT	DATES PERSONAL LETTER MAIL NOT RECEIVED
HQ I FORCEV (includes Hq & Hq Battery I FFV Arty, 55th MI Det, & Hq Co)	10 days - Dates unavailable
1st Bn (155) (T) 30th Arty	None
3d Bn (87) (SP) 18th Arty	27, 28, 29 Jan
5th Bn (105) (T) 27th Arty	7 days - Dates unavailable
6th Bn (175) (SP) 14th Arty	1, 7, 16, 18, 24 Jan
1st Bn (105) (SP) 40th Arty	10 days - Dates unavailable
2d Bn (175) (SP) 94th Arty	10 days - Dates unavailable
1st Bn (AMSP) 44th AD	10 days - Dates unavailable
54th Sig Bn (Corps)	10 days - Dates unavailable
272d M.P. Co	15 days - Dates unavailable
297th T.C. (Car)	15 days - Dates unavailable
43d AFU	5 days - Dates unavailable
52d Arty Gp	10 days - Dates unavailable
3d Bn (105) (SP) 6th Arty	5, 10, 18 Nov, 29 Dec
41st Civic Affairs Co	5 days - Dates unavailable

INCL #

Incl # 23

RATE OF OFFENSES PER 1000 TROOPS

Major Command	Class I		Class II		Traffic	
	1 Qtr FY 67	2 Qtr FY 67	1 Qtr FY 67	2 Qtr FY 67	1 Qtr FY 67	2 Qtr FY 67
1. USARV	1.48	1.52	28.76	25.80	11.47	12.91
2. I FORCEV (Asgd & Atch Units)	1.24	0.83	20.12	12.07	9.28	7.91
3. 1st Cav Div (AM)	1.86	1.37	13.72	17.34 <sup>1</sup>	4.86	6.72 <sup>2</sup>
4. 1/101st Abn Div	1.03	0.93	29.10	23.71	4.79	2.69
5. 3/25th Inf Div	0.44	1.87 <sup>2</sup>	29.91	32.51 <sup>4</sup>	11.27	9.12
6. 4th Inf Div <sup>5</sup>	0.36	1.76	26.03	16.62	3.59	7.17

1. Increased rate in comparison with previous quarter attributed mainly to curfew violations.

2. Speeding violations accounted for this increase over previous quarter.

3. Assaults and larcenies attributed to this increase over previous quarter.

4. Rate increase due mainly to offenses of AWOL.

5. This is the first report for the Division, previous quarter included only the 2d Bde, 4th Inf Div.

Information extracted from USARV letter, AVHPM-PO, dtd 22 Jan 66, SUBJECT: "Offender Statistics, 2d Quarter, FY 67".

*Chel. # 26*

125

VIP VISITORS TO HEADQUARTERS I FIELD FORCE VIETNAM

<u>TITLE</u>	<u>NAME</u>	<u>DATE OF VISIT</u>
Mech Armor Combat Operations in Vietnam	MG Arthur L. West	2 Nov 66
Dep Dir, Defense Communications Agency	MG George E. Pickett Party of 6	3 Nov 66
Dir of Facilities, Office of Chief Engr	EG John C. Dalrymple	3 Nov 66
Commander, 834 Air Div	EG William Moore (USAF)	8 Nov 66
Dir CBR and Nuclear Ops OACBPOR, DA	EG James A. Hobbeler Party of 4	10 Nov 66
MACV J3	MG John Tillson	13 Nov 66
London Daily Telegraph	EG (Ret) W. F. K. Thompson	14 Nov 66
COMUSMACV	Gen William C. Westmoreland	16 Nov 66
COMUSMACV THAI	MG Richard G. Stilwell Party of 10	17 Nov 66
MACV J5	MG J. N. Eubank	17 Nov 66
Royal Thai Army	LTG Lek Nasmali	17 Nov 66
ADC 1st Inf Div (Designate)	EG Bernard Rogers	21 Nov 66
Australian Ambassador to Vietnam	Mr. Lewis Border	22 Nov 66
Dep Commanding General, 1st MAW	EG Hugh Kilwood	29 Nov 66
House Committee on Ways/Means	Rep. William Pat Jennings (D-VA)	1 Dec 66
House Committee on Agriculture	Rep. Graham Furcell (D-Texas)	1 Dec 66
J4 SERICOM	EG C. J. Long	3 Dec 66
OI, USARPAC	EG J. J. Irvin	8 Dec 66
ROKA CofS	Gen Kim Kne Wom	8 Dec 66
USARV Engr	MG Robert R. Ploger	14 Dec 66
DCS P&O USARV	EG Frank Miller	14 Dec 66
USARV Sig Off	EG Robert D. Terry	14 Dec 66
CofS US Army	Gen Harold K. Johnson	27 Dec 66

INCL # 28  
2 pages

<u>TITLE</u>	<u>NAME</u>	<u>DATE OF VISIT</u>
Senator	Mr. Stuart Symington. (D-Mo)	28 Dec 66
Representative	Mr. Joseph Y. Resnick (D-NY)	31 Dec 66
CG, 4th Inf Div (Designate)	MG William R. Peers	1 Jan 67
COMUSMACV	Gen William C. Westmoreland	2 Jan 67
Chairman Joint Chief of Staff	Gen Earle G. Wheeler	9 Jan 67
Secretary of the Army	Hon. Stanley R. Resor	11 Jan 67
Chief Avn, OACS FOR	BG R. Williams	13 Jan 67
COMUSMACV	Gen William C. Westmoreland	16 Jan 67
MG (Reserve - USAF)	Mr. Barry Goldwater	18 Jan 67
CG, 100th ROK Log Cnd	BG Rhee, Bomb June	21 Jan 67
CINCUSARPAC	Gen Dwight E. Beach	23 Jan 67
CG, 1/101st Abn Div (Designate)	BG Salva M. Matheson	27 Jan 67