

UNCLASSIFIED

AD NUMBER

AD391484

CLASSIFICATION CHANGES

TO: UNCLASSIFIED

FROM: CONFIDENTIAL

LIMITATION CHANGES

TO:
Approved for public release; distribution is unlimited.

FROM:
Distribution authorized to U.S. Gov't. agencies and their contractors;
Administrative/Operational Use; 15 FEB 1967.
Other requests shall be referred to Office of the Adjutant General (Army), Washington, DC 20310.

AUTHORITY

AGO ltr 29 Apr 1980 ; AGO ltr 29 Apr 1980

THIS PAGE IS UNCLASSIFIED

THIS REPORT HAS BEEN DELIMITED
AND CLEARED FOR PUBLIC RELEASE
UNDER DOD DIRECTIVE 5200.20 AND
NO RESTRICTIONS ARE IMPOSED UPON
ITS USE AND DISCLOSURE,

DISTRIBUTION STATEMENT A

APPROVED FOR PUBLIC RELEASE;
DISTRIBUTION UNLIMITED,

GENERAL DECLASSIFICATION SCHEDULE

IN ACCORDANCE WITH
DOD 5200.1-R & EXECUTIVE ORDER 11652

THIS DOCUMENT IS:

CLASSIFIED BY ~~XXXXXXXXXX~~

Subject to General Declassification Schedule of
Executive Order 11652-Automatically Downgraded at
2 Years Intervals- DECLASSIFIED ON DECEMBER 31, 73.

BY

Defense Documentation Center
Defense Supply Agency
Cameron Station
Alexandria, Virginia 22314

SECURITY

MARKING

The classified or limited status of this report applies to each page, unless otherwise marked.

Separate page printouts MUST be marked accordingly.

THIS DOCUMENT CONTAINS INFORMATION AFFECTING THE NATIONAL DEFENSE OF THE UNITED STATES WITHIN THE MEANING OF THE ESPIONAGE LAWS, TITLE 18, U.S.C., SECTIONS 793 AND 794. THE TRANSMISSION OR THE REVELATION OF ITS CONTENTS IN ANY MANNER TO AN UNAUTHORIZED PERSON IS PROHIBITED BY LAW.

NOTICE: When government or other drawings, specifications or other data are used for any purpose other than in connection with a definitely related government procurement operation, the U. S. Government thereby incurs no responsibility, nor any obligation whatsoever; and the fact that the Government may have formulated, furnished, or in any way supplied the said drawings, specifications, or other data is not to be regarded by implication or otherwise as in any manner licensing the holder or any other person or corporation, or conveying any rights or permission to manufacture, use or sell any patented invention that may in any way be related thereto.

**Best
Available
Copy**

CONFIDENTIAL



DEPARTMENT OF THE ARMY
OFFICE OF THE ADJUTANT GENERAL
WASHINGTON, D.C. 20310

18
OACSFOR

AGAM-P (M) (9 May 67) FOR OT-RD-670235

16 May 1967

SUBJECT: Operational Report - Lessons Learned, Headquarters, 173d Airborne Brigade (Separate) ← All Upper Case

TO: SEE DISTRIBUTION

1. Forwarded as inclosure is Operational Report - Lessons Learned, Headquarters. 173D Airborne Brigade (SEPARATE) for quarterly period ending 31 January 1967. Information contained in this report should be reviewed and evaluated by CDC in accordance with paragraph 6f of AR 1-19 and by CONARC in accordance with paragraph 6c and d of AR 1-19. Evaluations and corrective actions should be reported to ACSFOR OT within 90 days of receipt of covering letter.

⑨ Operational rept. for period ending 31 JAN 67.

2. Information contained in this report is provided to the Commandants of the Service Schools to insure appropriate benefits in the future from lessons learned during current operations, and may be adapted for use in developing training material.

BY ORDER OF THE SECRETARY OF THE ARMY:

Kenneth G. Wickham

KENNETH G. WICKHAM
Major General, USA
The Adjutant General

11 15 Feb 67

12 19 1p.

Incl
as

DISTRIBUTION:

- Commanding General
 - US Army Combat Development Command
 - US Continental Army Command
- Commandants
 - US Army Command and General Staff College
 - US Army War College
 - US Army Air Defense School
 - Army Artillery and Missile School
 - Army Armor School
 - US Army Chemical Corps School
 - US Army Engineer School
 - US Army Military Police School
 - US Army Infantry School
 - US Army Intelligence School
 - US Army Medical Field Service School

REGRADED UNCLASSIFIED
WHEN SEPARATED FROM
CLASSIFIED INCLOSURE

(Continued on page 2)

FOR OT RD
670235 ✓

(003 650)

CONFIDENTIAL

JUL 31 1968

AD391484

FILE COPY

elf

[Signature]

CONFIDENTIAL

DISTRIBUTION (Cont'd)

US Army Ordnance School
US Army Quartermaster School
US Army Security Agency School
US Army Transportation School
US Army Signal School
US Army Special Warfare School
US Army Civil Affairs School

Copies furnished:

Office, Chief of Staff, US Army
Assistant Chief of Staff for Force Development
Research Analysis Corporation (Library)
Security Office, Los Alamos Scientific Laboratory
South East Asia Forces, OSD (SA)
Director of Defense Research and Engineering, ODDRE (OT&E)
National Aeronautics and Space Administration, Office of Defense Affairs

[Faint, illegible markings and a large handwritten '9' are visible in this area.]

CONFIDENTIAL

**173D AIRBORNE BRIGADE (SEPARATE)
OPERATIONAL REPORT LESSONS LEARNED**

✓ (1 November 1966 - 31 January 1967)



CONFIDENTIAL

3
CONFIDENTIAL

DEPARTMENT OF THE ARMY
HEADQUARTERS 173D AIRBORNE BRIGADE (SEPARATE)
APO San Francisco 96250

AVBE-SC

15 February 1967

SUBJECT: Operational Report Lessons Learned
(1 November 1966 - 31 January 1967)

THRU: Commanding General
II FFORCEV
ATTN: G3 D & T
APO 96227

TO: Assistant Chief of Staff
For Force Development
Department of the Army
Washington, D. C. 20310

The inclosed Operational Report Lessons Learned is forwarded in compliance with USARV Reg 1-19 and AR 1-19.

FOR THE COMMANDER:

E. B. ROBERSON

1 Incl
as

E. B. ROBERSON
CPT, AGC
Asst AG

DISTRIBUTION:

3 - ACSFOR, DA
2 - CINCUSARPAC
3 - USARV

DOWNGRADED AT 3 YEAR INTERVALS
DECLASSIFIED AFTER 12 YEARS
DOD DIRECTIVE 5200.10

FOR OT RD
670235

CONFIDENTIAL

5
CONFIDENTIAL

AVRE-SC
SUBJECT: Operational Report Lessons Learned

15 February 1967

TABLE OF CONTENTS:

- I. Significant Organizational and Unit Activities
 1. Introduction;
 2. Organization;
 3. Intelligence;
 4. Combat Operations;
 5. Training;
 6. Psychological Operations and Civic Action;
 7. Logistics;
 8. Personnel Administration;
 9. Chemical Operations;
- II. Commanders Observations - Lessons Learned
- III. Maps of Combat Operations - See Section I, Part 4 (Tabulated by Arabic Numerals)
 - No. 1 - Map of Operation ATTLEBORO
 - No. 2 - Map of Operation WACO
 - No. 3 - Map of Operation CANARY/DUCK
 - No. 4 - See Inclosure 6 (Combat After Action Report Operation NIAGARA/CEDAR FALLS)
- IV. Inclsures
 1. Roster of Key Personnel
 2. Organization Chart
 3. Switchboard Designator
 4. V.I.P. Visitors
 5. Supply and Combat Service Activities
 6. Combat Operations After Action Report (Operation NIAGARA/CEDAR FALLS)

CONFIDENTIAL

CONFIDENTIAL

AVHE-SC
SUBJECT: Operational Report Lessons Learned

15 February 1967

I. Significant Organizational and Unit Activities

1. Introduction:

This Operational Report Lessons Learned covers the period 1 November 1966 to 31 January 1967. During this period, the 173d Airborne Brigade (Separate) continued to conduct operations aimed at locating and destroying the Viet Cong and North Vietnamese Armed Forces and installations. Operations were also continued within the Base Camp TAOR (Tactical Area of Responsibility). The Civic Action/Revolutionary Development program continued to play a key role in the Brigade's counterinsurgency effort.

Again, to best accomplish its mission the Brigade conducted four (4) Battalion size or larger operations in addition to the pacification program. During this reporting period, the Brigade once again assisted new units arriving in-country. These units were the 199th Light Infantry Brigade and the 9th Infantry Division.

2. Organization:

During this reporting period, the internal structure of the 173d Airborne Brigade continued to remain the same, however, a new platoon (12th AA Platoon, which is a civil affairs unit), was attached to the Brigade and several units were detached and reassigned from the Brigade. The 12th AA Platoon was attached to the Brigade by VOCCO on 15 December 1966. The verbal order was followed by a General Order (II FFORCEV General Order 34) dated 19 January 1967. This General Order was rescinded by General Order 213 and General Order 206 dated 13 February 1967 was issued which is still in effect. Immediately upon attachment to the Brigade, the 12th AA Platoon was incorporated into the Brigade S5 Section. Since 15 December 1966, the platoon has accompanied the Brigade on Operations CANARI/DUCK and NIAGARA/CEDAR FALLS.

The 335th AMCL with attachments, the 25th Medical Detachment, 166th Transportation Platoon and the 234th Signal Detachment were detached from the Brigade and assigned to the 1st Aviation Brigade by USAFV General Order 237 dated 17 January 1967. These units were further reassigned to the 145th Aviation Battalion of the 12th Aviation Group.

3. Intelligence:

a. The enemy's order of battle in the TAOR remains the same. The following units continued to conduct sporadic harassing small unit tactics in and around the Brigade's TAOR against ARVN and US Forces.

(1) 270th Guerrilla Platoon

(2) 260th Local Platoon

b. Probable reinforcements continue to include elements from the 800th Dong Nai Battalion and the 3d Battalion, 165th "A" Regiment.

c. The accepted location remains the same since the last reporting period.

CONFIDENTIAL

CONFIDENTIAL

AVEE-SC
SUBJECT: Operational Report Lessons Learned

15 February 1967

<u>Units</u>	<u>Locations</u>
270th Guerrilla Plt	Cong Thanh District (Bien Hoa Province)
260th Local Plt	Duc Tu District (Bien Hoa Province)
800th Dong Nai Bn	War Zone "D" (Bien Hoa Province)
3d Bn, 165th "A" Regiment	Di An District (Bien Hoa Province)

d. The enemy situation before and during each operation for this reporting period:

(1) Operation ATTLEBORO

(a) Enemy situation before operation: Route 13, which extends from SAIGON to the CAMBODIAN BORDER, a distance of 71 kilometers, is bordered on both sides along the eastern edge of the Brigade's Area of Operation in which guerrilla units of squad, platoon and company size were known to have operated. The 1st Infantry Division had contacted the 271st, 272d and 273d Main Force Regiments of the 9th VC Main Force Division on Route 13 during June 1966. The 9th VC Division sustained heavy casualties as a result of these contacts. The 272d VC MF Regiment had been known to operate, reinforce and train its elements with the Brigade's assigned AO. In the area where Route 13 traverses BINH DUONG PROVINCE, the following enemy units have operated in the past year: C-61st Ben Cat Company, C-62d Chan Thon Company, C-63d Lai Thieu Company and C-30d Phu Giao Company. The Phu Loi Battalion and the Provincial Battalion of BINH DUONG also have operated along Route 13.

(b) During Operation ATTLEBORO, thirty-three (33) enemy contacts were made with enemy forces, twenty-seven (27) of which were initiated by the VC. The largest single enemy force encountered was an estimated fifty (50) Viet Cong (181035H November at XT 621516). Documents captured on 17 November at XT 605461 at a VC base camp contained the following letter box numbers:

<u>Sender</u>	<u>Addressee</u>
HT 61/300 VT	HT 61/340 VT
HT 61/304 VT	HT 61/320 VT
HT 61/320 VT	HT/H52
HT 61/330 VT	Village D-17
HT 61/320 VT	HT 61/340 VT
HT 130/386 5A	Civilian Named Ba Luam
HT 22/386 5A	HT 130D
HT 130D	HT 1960B

Elements represented by numbers 61/300 VT to 61/399VT are located within BINH DUONG PROVINCE. Number 1960B is the rear service section for the LONG HUYEN SECRET ZONE.

(2) Operation WACO

(a) Enemy situation before operation: Prior to the commencement of Operation WACO in an area which lies east of and adjacent to the 173d Airborne Brigade Tactical Area of Responsibility, the Viet Cong U1 Headquarters, the U1 Security Force Company and an undetermined number of unidentified company and Battalion

CONFIDENTIAL

9

CONFIDENTIAL

AVEE-SC
SUBJECT: Operational Report Lessons Learned

15 February 1967

size elements were believed to be located in the AO. In an attempt to confirm or reject the belief that the enemy was using the major infiltration/supply route running generally from WAR ZONE "D" north of the DONG NAI RIVER, southeast of the MAO TAO SECRET AREA, several six-man Long Range Reconnaissance Patrols were introduced into the AO both by helicopter and as stay behind elements of ground maneuver units. Sporadic contacts between these elements and from one to five VC indicated that the area was being used by the enemy. The D-800th Main Force Battalion (the security providing unit for the western and southwestern approaches to WAR ZONE "D") were believed to be located northwest of the Brigade area of operation, north of the DONG NAI RIVER. There were no known Main Force units located in the AO. The enemy was believed to have been capable of reinforcing with units which infiltrate from time to time through the area.

(b) During Operation WACO, elements of the Brigade failed to make contact with enemy forces larger than squad size. Several company and platoon size base camps were found, none of which indicated that large size enemy units had in fact been using the area recently. Along the eastern edge of the area of operation along the major north/south trail system from the DONG NAI RIVER, numerous garden plots were being cultivated by friendly Vietnamese residents. Throughout the operation, nothing was detected which would indicate that the Viet Cong were using the area as a major resupply/infiltration route.

(3) Operation CANARY/DUCK

(a) Enemy situation prior to the operation: prior to Operation CANARY/DUCK, in an area bounded by HIGHWAY 15 on the west, HIGHWAY 1 on the north to the vicinity of NAI CHUA CHAN (XT 604102), then extending southward to a point approximately 10 kilometers east of BINH GIA, back to HIGHWAY 15, this area had been used extensively by elements of the 5th VC Division (especially the 274th Main Force Regiment), the 860th Local Force Battalion, one Local Force Company and three Local Force Platoons. There was a major infiltration route that traversed the AO. The enemy was believed to have been capable of reinforcing with units of the 275th VC Main Force Regiment, the D800th Main Force Battalion and the 860th Local Force Battalion. The enemy was attributed with the capability of:

1. Attacking with the 274th VC Main Force Regiment supported by guerrillas and Local Force units up to Battalion strength.
2. Reinforcing an attack with the 275th VC Main Force Regiment, the D800th Main Force Battalion and the 860th Local Force Battalion.
3. Defending his base areas with the forces listed above.
4. Ambushing friendly convoys, patrols or isolated units with up to one or more Battalion at a time of his choosing.
5. Conducting harassing mortar fire, sniping, mining and sabotage attacks against friendly military forces and installations.

(b) During Operation CANARY/DUCK, elements of the Brigade failed to make contact with enemy forces larger than platoon size. Several battalion and platoon size base camps were found, indicating that large size enemy units had been using the area recently. The discoveries of large scattered and varied supply caches throughout the area confirmed the suspicion that the area was an infiltration route. Since no large amounts of food or material stores were discovered in

CONFIDENTIAL

CONFIDENTIAL

AVEE-SC
SUBJECT: Operational Report Lessons Learned

25 February 1967

the actual base camp locations in the immediate area, it was believed that the 274th Main Force Regiment was in the process of moving from the "HOT DICH" base camp area to an unknown location east of HIGHWAY 2.

(4) Operation NIAGARA/CEDAR FALLS

(a) Prior to Operation NIAGARA FALLS (5 - 7 January 1967), in the area consisting of the southern tip of the infamous IRON TRIANGLE, the Phu Loi Battalion (LF) and the C-63d VC Local Main Force Battalion of the 165th A VC Main Force Regiment were believed to be operating. The enemy's morale was believed to have been lowered by poor living conditions coupled with friendly artillery and air strikes in the area.

(b) During the Operation, the Brigade failed to make contact with enemy forces larger than five men. One small base camp was found and a few small food and equipment caches were discovered.

(c) Prior to the commencement of Operation CEDAR FALLS, it was strongly believed that the 272d VC Main Force Regiment, the 7th Battalion of the 165th A Regiment, the Phu Loi Battalion, the Local Force VC companies C-61, C-62, and C-63 were operating in the areas of interest.

(d) During Operation CEDAR FALLS (8 - 25 January 1967), elements of the 173d Airborne Brigade (Separate) and the 11th Armored Cavalry Regiment maintained daily contact with the enemy. The sporadic contacts were usually initiated by friendly forces and terminated with VC withdrawal. The largest contact was on 16 January 1967, by C/4/503d Infantry with a VC platoon. Numerous VC base camps, rice caches and tunnel systems were destroyed. The large amount of rice extracted from the operational area has reduced the VC logistical abilities. The enemy's low morale was reflected by the large number of ralliers who surrendered after US Forces entered the Triangle. Prisoners were taken from the following units: the C61st Local Force Company, the 2d Company of the Phu Loi Battalion, Group 83 (Rear Service of the Military Region IV) and the I-4 (subordinate committee of the MR IV). An estimated 25,000 documents were captured during the Operation. On several occasions, Chieu Hoi Ralliers lead friendly troops to previously undiscovered tunnels, weapons and rice caches.

e. The Viet Cong tactics during this reporting period have not changed. They still avoid major or large scale battles or contacts. They have continued their terrorism and harassment activities throughout the reporting period.

f. VC losses for the period 1 November 1966 to 31 January 1967 are as follows:

Personnel

KIA (BC)	230
KIA (poss)	47
VCC	68
VCS	147
Ralliers	72

CONFIDENTIAL

AVBE-SC
SUBJECT: Operational Report Lessons Learned

15 February 1967

Enemy Equipment Losses:

Weapons

Crew Served Weapons	2
Individual Weapons	228

Ammunition

Small Arms Rounds	21,069
M-79 Rounds	10
M-26 Hand Grenades	10
Rifle Grenades	21
VC Grenades	727
Claymores	26
Assorted Mortar Rounds	69
Miscellaneous Mines	195

Transportation

Outboard Motors	10
Bicycles	52
Sampans/Boats	116

Installations

Huts	312
Tunnels	193
Base Camps	21
Bunkers	317

Food

Rice	1,313.1 tons
Salt	4.1 tons
Wheat	850 lbs

4. Combat Operations

CONFIDENTIAL

AVBE-SC

15 February 1967

12

SUBJECT: Operational Report Lessons Learned

General: The 173d Airborne Brigade (Separate) continued to conduct Combat and Revolutionary Development (Civil Affairs and Civic Action) operations designed to locate and destroy Viet Cong Forces, logistical installations and to further reduce his hold on the Vietnamese people.

November

The 173d Airborne Brigade (Separate) conducted normal security operations in and around the BIEN HOA Area, initiated two major operations and a Battalion size training parachute operation during the month of November.

On 6 November 1966, the 2d Battalion, 503d Infantry conducted SKY SOLDIER VIII, a battalion size training parachute jump at TU DUC DZ. The first lift departed BIEN HOA at 0745 hours. Twelve (12) sorties were flown with 784 personnel conducting jumps. There were no heavy equipment drops as in SKY SOLDIER VII. SKY SOLDIER VIII terminated at 1400 hours with the 2d Battalion closing back at BIEN HOA.

On 7 November, the 173d Airborne Brigade (Separate) was directed to deploy one battalion to MINH THANH Airstrip to act as II FFORCEV reserve for units committed on Operation ATTLEBORO. The Commanding General elected that the 2d Battalion deploy to the operational area. The 1/503d Infantry remained at BIEN HOA on alert. At 1520 hours on this day, the 2d Battalion, 503d Infantry and "A" Battery, 3/319th Artillery departed by C-130 and C-123 aircraft to MINH THANH on Operation MERIDIAN. The force closed at 1915 hours with supplies and equipment airlifts continuing throughout the night. The 2d Battalion completed movement to MINH THANH at 0230 hours, 8 November 1966. The Brigade (-) remained at BIEN HOA and continued to be on alert for movement to MINH THANH on order. On the morning of 10 November, Task Force RANGER, consisting of the 33d and 35th Ranger (ARVN) Battalions, were deployed to MINH THANH and placed under the operational control of the 173d Airborne Brigade. Also on the morning of 10 November, the Brigade (less the 1st and 4th Battalions) displaced to the area of operation to conduct operations along likely enemy crossing sites along the SAIGON RIVER in zone. On 11 November, instructions were received from II FFORCEV to change the code name from Operation MERIDIAN to Operation ATTLEBORO. The 1/503d Infantry remained at BIEN HOA as II FFORCEV reserve and the 4th Battalion, 503d Infantry continued operations in the 1st Corps Tactical Zone under the OPCON of the 1st Marine Division. The Brigade (-) terminated their phase of Operation ATTLEBORO when the units involved closed back into BIEN HOA. Operation ATTLEBORO was characterized by light contact with two large rice caches being captured and a large base camp being destroyed. On 25 November, the Brigade initiated Operation WACO in the III Corps Tactical Zone, east of and adjacent to the Brigade's Tactical Area of Responsibility (TAOR). This was a Battalion size search and destroy operation conducted by the 1/503d Infantry in coordination with the 33d Ranger (ARVN) Battalion. Operation WACO continued into the month of December and terminated on the 2d day of that month. This operation was also characterized by light contact. Operations during the month were supported by 58 TAC sorties and 139 FAC sorties dropping a total of 63.8 tons of ordnance. Artillery fired 2,110 missions expending 11,887 rounds. Army Aviation (335th AMCL) supported the Brigade during the month flying a total of 7,055 combat sorties, transporting 11,464 passengers and 243 tons of cargo. Operations During the month of November resulted in the following VC and Friendly Losses:

VC Losses

KIA 15
KIA (poss) 13

US Losses

KIA 3
WIA 12

CONFIDENTIAL

CONFIDENTIAL

AVBE-SC
SUBJECT: Operational Report Lessons Learned

15 February 1967

VC Losses (cont)

VCC 0
VCS 1
Ralliers None
Refugees None

US Losses (cont)

MIA 0
Non-Battle Dead 2
Non-Battle Injured 13

December:

During the month of December, the Brigade continued to conduct normal security operations. In addition, the 173d terminated one Battalion size operation and initiated a Brigade size operation. Task Force 4/503d Infantry was released from the Operational Control of the 1st Marine Division (Operation WINCHESTER), and returned to BIEN HOA from DA NANG.

Operation WACO was terminated on 2 December 1966. Further on this day, the 4th Battalion, 503d Infantry and "C" Battery, 3/319th Artillery began extraction from DA NANG to BIEN HOA by C-130 aircraft. The first aircraft arrived at BIEN HOA at 1210 hours. The battalion and supporting battery completed their movement from DA NANG to BIEN HOA at 0245 hours on 4 December. Thirty-five (35) C-130 sorties were flown for the movement. On 7 December, the 173d Airborne Brigade joined forces already involved in Operation CANARY/DUCK, a road security operation astride HIGHWAY 15 from PHU MY to BEAR CAT to insure the safe introduction of the 199th Light Infantry Brigade and the 9th Infantry Division. Operation CANARY/DUCK was conducted in two Phases. Phase I (Operation CANARY) was a road security mission for the safe passage of the convoy of the 199th Light Infantry Brigade which terminated on 14 December. At this time, the code name of the operation was changed to Operation DUCK, which was a continuation of the security operation for the safe introduction of convoys from the 9th Infantry Division. Operation DUCK terminated on 5 January 1967. Operations during the month of January were supported by 239 TAC sorties, 61 FAC sorties, dropping a total of 381.25 tons of ordnance. Artillery fired 2,019 missions expending 15,163 rounds. Army Aviation continued to support the Brigade by flying 8,330 combat sorties, transporting 12,031 passengers and 177 tons of cargo. Operations during the month of December resulted in the following US and VC losses:

VC Losses

KIA (BC) 29
KIA (poss) 24
VCC 0
VCS 0
Ralliers None
Refugees None

US Losses

KIA 3
WIA 31
MIA 0
Non-Battle Dead 0
Non-Battle Injured 5

CONFIDENTIAL

AVBE-SC
SUBJECT: Operational Report Lessons Learned

25 February 1967

January 1967

The 173d Airborne Brigade conducted normal security operations, terminated a road security operation astride HIGHWAY 15 and conducted a counterinsurgency operation in BINH DUONG PROVINCE.

The Brigade terminated Operation CANARY/DUCK on 5 January 1967. In addition, on 5 January the Brigade deployed the 1st Battalion, 503d Infantry (Airborne) from a staging area at PHU LOI into the dense forest known as the CAU DINH Jungle located north of a rubber plantation between NATIONAL HIGHWAY 13 and the THI TINH RIVER. The mission given to the 1/503d Infantry on Operation NIAGARA FALLS was to conduct a deception or feint into the Jungle and conduct search and destroy operations in preparation for the larger scale, multi-division Operation CEDAR FALLS. The Operation (NIAGARA FALLS) produced light contact, but its significance lies in the fact that the deceptive feint had been achieved. On 8 January 1967, the remainder of the Brigade became involved in Operation CEDAR FALLS, augmenting the 1st Infantry Division, 25th Infantry Division, the 196th Light Infantry Brigade, elements of the 11th Armored Cavalry Regiment, the 18th Engineer Battalion and elements of the 5th ARVN Division already engaged in the IRON TRIANGLE Operation. The Brigade moved to BEN CAT by road convoy, helilift and C-130 aircraft. The mission of Operation CEDAR FALLS was to seal off the Triangle and annihilate the enemy within, destroying his fortifications and generally crushing the power of the Military Region IV Headquarters. The pressure brought upon the VC within the area was tremendous. The Air Force pounded the Triangle daily using high explosives and napalm. In addition, B-52 strikes were used to expose and destroy the Viet Cong bases. Operation CEDAR FALLS terminated on 25 January at 0700 hours when the Brigade was released from the Operational Control of the 1st Infantry Division. The 173d Airborne Brigade then returned to Base Camp in 3 serials, clearing the CEDAR FALLS AO at 0945 hours. The final elements closed into BIEN HOA at 1327 hours. During the period 25 - 31 January 1967, the Brigade conducted normal security of its TAOR, refresher airborne training and maintenance of equipment. Operations during the month were supported by 220 TAC sorties, 33 FAC sorties, 63 air strikes, 74 visual reconnaissance missions, 10 escort and 12 combat control missions dropping a total of 668.1 tons of ordnance. 3/319th Artillery fired 887 missions, expending a total of 33,367 rounds. Army Aviation flew 10,578 combat sorties, transporting 17,299 passengers and 596 tons of cargo. Operations during the month of January resulted in the following losses:

<u>VC Losses</u>	<u>US Losses</u>
KIA (BC) <u>185</u>	KIA <u>14</u>
KIA (poss) <u>10</u>	WIA <u>163</u>
VCC <u>65</u>	MIA <u>1</u>
VCS <u>146</u>	Non-Battle Dead <u>3</u>
Ralliers <u>72</u>	Non-Battle Injured <u>17</u>
Refugees <u>Unk</u>	

25 February 1967

5. Training

Training within the 173d Airborne Brigade (Separate) continued to be excellent. Replacement training continued in base camp for replacement personnel to insure that they are acclimated and properly prepared prior to being introduced into combat. This instruction is required for enlisted personnel in grades E1 to E7 and officer personnel O1 and O2.

During the month of January, the 2/503d Infantry conducted airborne refresher training from 26 - 31 January. This training as during the month of October 1966 contained technical as well as physical training to increase the individual and unit proficiency in parachute operations.

6. Psychological Operations and Civic Action

a. Psychological Operations

(1) The responsiveness of Tactical Psychological Operation support continued during this reporting period. 2,281,000 leaflets were distributed during November, December and January.

(2) During Operation CEDAR FALLS (8 - 25 January), a major portion of the Psy Ops effort was devoted toward encouraging the enemy to defect under the Chieu Hoi Program. During the course of the Operation, intelligence sources revealed that 72 ralliers in BINH DUONG PROVINCE were prompted to rally by the Psy Ops warfare.

b. Civic Action

(1) All elements of the Brigade continued to engage in Civic Action projects in the BIEN HOA vicinity. Significant progress has been observed in the construction and repair of local hamlet dwellings and various other construction projects.

(2) During the month of January 1967, MEDCAP teams treated 11,185 patients along with 540 patients in the BIEN HOA Area. In addition, field MEDCAP teams treated 1,496 and 430 Dentcap patients. Throughout the reporting period, the Brigade's S5 Section organized medical classes in conjunction with MEDCAP once weekly. At these classes, Vietnamese were given instruction on modern medical equipment at the 3d MASH and 93d Evacuation Hospital. In addition, the Children's Hospital served a total 1,638 meals to a daily average of 26 in-patients. The 4/503d Infantry while operating in the I Corps Tactical Zone on Operation WINCHESTER prepared Thanksgiving Dinner for 210 PF soldiers. A total of 60 village chiefs and elders were invited for the Thanksgiving dinner.

7. Logistics:

During the period 1 November 1966 to 31 January 1967, the logistical posture of the Brigade remained excellent. Tactical operations were supported by air and land lines of supply. A logistical summary by classes of supply is furnished in Inclosure 5.

9. Personnel and Administration

a. Personnel

(1) Brigade Casualties:

	<u>Battle Casualties</u>			<u>Non-Battle Casualties</u>	
	KIA	WIA	MIA	DIED	INJURED
November	3	42	0	1	15
December	3	33	0	0	9
January	<u>14</u>	<u>163</u>	<u>1*</u>	<u>3</u>	<u>17</u>
Total	20	238	1	4	41

*MIA later changed to KIA

(2) Brigade Strength

AUTHORIZED AND ASSIGNED STRENGTH

	AUTHORIZED				ASSIGNED 1 NOV				ASSIGNED 31 JAN			
	OFF	WO	EM	AGG *	OFF	WO	EM	AGG *	OFF	WO	EM	AGG
Asgn Units	242	38	3968	4248 *	278	25	4737	5040 *	260	40	4468	4768
1/Atchd Units	13	2	73	88 *	50	31	284	365 *	15	1	82	98
Aggregate	255	40	4041	4336 *	328	56	5021	5405 *	275	41	4550	4866

GAINS AND LOSSES BY MONTH

	NOVEMBER				DECEMBER				JANUARY			
	OFF	WO	EM	AGG	OFF	WO	EM	AGG	OFF	WO	EM	AGG
2/ Gains	19	4	255	278	8	1	162	171	9	1	154	164
3/ Losses	15	2	221	238	3	2	157	162	24	3	213	240
NET	+4	+2	+34	+40	+5	-1	+5	+9	-15	-2	-59	-76

1/ During the reported period, the attached units strength of the Brigade decreased. The decrease was the result of the attachment of the following units being changed from the 173d Airborne Brigade (Separate) to the 145th Aviation Battalion on 15 January 1967:

335th Aviation Company
166th Transportation Detachment
25th Medical Detachment
234th Signal Detachment

2/ Represents all assigned gains to include both in-country and out-country.

AVHE-SC
 SUBJECT: Operational Report Lessons Learned

15 February 1967

17

b. Discipline, Law and Order:

(1) The discipline in the Brigade has been excellent during the reporting period. There were no stragglers.

(2) During the reporting period, there were 2 General Court Martials, 37 Special Court Martials, 10 Summary Court Martials and 408 Article 15's.

(3) The Brigade IG handled five (5) complaints and fourteen (14) requests for assistance during the quarter.

c. Development and Maintenance of Morale:

(1) The state of morale within the Brigade remains excellent resulting from improved services and facilities.

(2) Finance: The Brigade Finance Section continued to provide outstanding financial support throughout the reporting period. The Soldier's Savings Program, open to both enlisted men and officers, had 194 personnel participating in the saving at the close of the period, an increase of over 80% from the previous quarter. In addition, three finance newsletters were published throughout the Brigade to further acquaint personnel with various financial options and allotments. Incoming personnel were also given a briefing concerning finance matters, allotments, etc.

(3) Chaplain: During the reporting period there were 601 religious services conducted (all faiths with a total attendance of 17,730).

(4) Special Services: In-Country R & R increased during this reporting period. Brigade R & R allocations during the reporting period are as follows:

	<u>NOVEMBER</u>		<u>DECEMBER</u>		<u>JANUARY</u>
Vung Tau (In-Country)	40	Vung Tau (In-Country)	40	Vung Tau (In-Country)	40
Bangkok	69	Bangkok	97	Bangkok	80
Hawaii	22	Hawaii	32	Hawaii	83
Hong Kong	62	Hong Kong	85	Hong Kong	83
Kuala Lumpur	13	Kuala Lumpur	25	Kuala Lumpur	0
Manilla	19	Manilla	30	Manilla	21
Penang	24	Penang	31	Penang	26
Singapore	11	Singapore	16	Singapore	19
Taipei	77	Taipei	91	Taipei	80
Tokyo	<u>82</u>	Tokyo	<u>102</u>	Tokyo	<u>93</u>
TOTAL	419		549		525

AVBE-SC
 SUBJECT: Operational Report Lessons Learned

15 February 1967 ¹⁸

(5) Red Cross: There were a total of 609 new and/or reopened during this reporting period. 138 emergency leaves were issued through the Red Cross during this quarter.

(6) Awards and Decorations: There were a total of 1,200 awards given for valor and meritorious services during November, December and January, a breakdown of which follows:

APPROVED AWARDS AND DECORATIONS

	<u>NOVEMBER</u>	<u>DECEMBER</u>	<u>JANUARY</u>
Distinguished Service Cross	-	-	-
Silver Star	1	6	5
Legion of Merit	1	1	1
Distinguished Flying Cross	-	-	1
Bronze Star Medal (Valor)	15	16	49
Bronze Star Medal (Merit/Achieve)	23	38	41
Air Medal (Valor)	2	3	38
Air Medal (Service)	192	309	134
Soldiers Medal	-	1	-
Army Commendation Medal (Valor)	6	9	52
Joint Services Commendation Medal	-	-	-
Army Commendation Medal (Merit/Achieve)	25	17	18
Purple Heart	<u>82</u>	<u>64</u>	<u>108</u>
TOTAL	347	414	447

9. Chemical Operations

The 51st Chemical Detachment provided chemical support during operation whenever requested. For a detailed analysis of this detachments operations, see Combat Operations After Action Report - Operation NIAGARA/CEDAR FALLS paragraph 10-1, and page 41, Special Equipment/Techniques.

II. Commander's Observations and Recommendations

1. Observations (Lessons Learned)

During this reporting period, many new lessons were learned. The following are considered to be the most significant. In addition, Operation NIAGARA/CEDAR FALLS produced several new, unique and revolutionary techniques. These lessons learned appear in Inclosure 6, Operation NIAGARA/CEDAR FALLS After Action Report.

CONFIDENTIAL

AVEE-SC
SUBJECT: Operational Report Lessons Learned

15 February 1967

Item: Rapid Deployment

Discussion: The rapid deployment of the 2/503d Infantry to MINH THANH for participation in Operation ATTLEBORO indicates that a unit, even while in a base camp situation, can be rapidly deployed to a trouble zone in a matter of a few hours. The coordination necessary for a Battalion size movement must be quick and efficient. In addition, the troops were prepared, assembled, and in transit within a four hour period after the initial alert.

Observation: Units must remain prepared for rapid deployment at all times.

Item: Forces Operating in Close Proximity

Discussion: Although all forces must be mutually supported, if two or more forces are allowed to operate in close proximity to one another, confusion in activity could result in friendly forces firing on one another. This may occur when a VC unit is situated between two units, causing the friendly forces to indirectly place fire upon each other. This is due, in part, to the limited vision in jungle areas, friendly forces being unaware of each other's position(s). Artillery fire may also be accidentally misdirected upon friendly forces.

Observation: Commanders must insure that units under their control do not operate in AO's other than their own, unless called in for support of another unit. All personnel should be briefed and aware of their boundaries and the location(s) of all friendly units within or adjacent to their area.

Item: Mortar Aerial Delivery (MAD) System

Discussion: The MAD System is basically a modification of a UH-1B helicopter which enables the air ship to deliver 81mm mortar rounds or 20-pound fragmentary bombs. The utilization of the MAD System is limited however, owing to its need for smoke, and ground units not always being oriented on the use of aerial mortar support. In addition, it is necessary to cease ground artillery and TAC Air fire when helicopters are in the area of contact.

Observation: The limitations as well as advantages of the MAD system must be thoroughly understood to insure its proper employment. It should be utilized when artillery and/or TAC air are not available, or upon the decision of the unit commander based upon the tactical situation involved.

Item: Utilization of LRRP Personnel as Guides

Discussion: On Operation WACO, the 1st Battalion, 503d Infantry (Task Force Brownlee) was charged with the mission of locating and destroying a VC sampans dock and base camp which had been reported by an LRRP at an earlier date. The elements of the Task Force operating in this vicinity were unable to locate the dock and base camp. Their knowledge as to the location was furnished from a LRRP debriefing. The Task Force requested that a member of the LRRP who discovered the dock and base camp be made available to the operating unit as a guide. This request was granted and the guide was attached. At first the guide was unable to locate the dock and was unsure of its exact location. At this time, they conducted an air reconnaissance with the guide and he spotted the introduction and extraction landing zones used by the LRRP. The base camp and dock were located and subsequently destroyed shortly thereafter.

CONFIDENTIAL

AVBF-SC
SUBJECT: Operational Report Lessons Learned

15 February 1967

Item: Use of Aero Scouts

Discussion: As previously stated, during Operation CANARY/DUCK the Brigade extensively used for the first time the Aero Scout Concept (the Aero Scout itself consists of two armed OH-13's).

Observation: Aero Scouts were highly effective in spotting enemy bunkers, base camps and in making bomb damage assessments immediately following an air strike.

Item: Organization of Rifle Companies

Discussion: The organization of the rifle company has been modified somewhat to suit the guerrilla-type war in Vietnam, however, the capability of the weapons squads and platoons must be retained owing to the varied missions an Infantry Battalion may be called upon to perform. The jungle and rice paddy terrain has also necessitated certain modifications in the organization and employment of Infantry units. With these changes in mind, the following general statements are made.

Discussion: The primary change in the employment of the rifle company in this Brigade has been in the weapons platoon and weapons squad. For example, in the weapons squad and rifle platoon, neither the 3.5" rocket launcher nor the 90mm recoilless rifle are carried. The weapon designated to take the place of these weapons is the light, anti-tank weapon, the M-67, which is carried by the rifle squad (normally 2 per squad). The four men normally assigned in the weapons squad to man the 3.5" rocket launcher or 90mm Recoilless Rifle (2 gunners and two assistant gunners) are also qualified to operate and fire the M-60 machine-gun and therefore serve as ammo bearers and assistant machine gunners. These personnel are necessary to assist in carrying the minimum load of 1,500 rounds of ammunition per gun as required by the Brigade. In the weapons platoon, the anti-tank squads are not normally employed as such, except on road clearing operations. Therefore, these personnel are used to augment the platoon's rifleman strength and assist in carrying mortar ammo for the 81mm mortar squads. While moving on search and destroy operations, the weapons platoon normally carries one or two mortars with a minimum of 30 rounds per tube. The third mortar (or the second and third if the company carries one) is brought in by helilift when the company is in a defensive posture. In regard to the employment of the weapons platoon, the 81mm mortar is used both in search and destroy operations and on unit defensives. While on the move, they are positioned so that they can provide fire support for any element of the company. In defense, they are part of the company's defensive plan and are used extensively for H & I fires. The weapons platoon is also employed as a rifle element when the situation requires. This unit must be prepared to maneuver as a rifle element when the company is in the process of moving since they are equally vulnerable to ambushes as the rifle platoon and many times in the jungle, the canopy will not allow for the employment of mortars. As a matter of day to day use, however, the weapons platoon's primary mission remains to give indirect fire support to rifle elements.

CONFIDENTIAL

AVBE-SC
SUBJECT: Operational Report Lessons Learned

15 February 1967

21
Observation: LRRP guides should be made available to operating units when their mission involves intelligence information provided by the platoon. The guide should conduct an air reconnaissance of the specific area during the initial stage of the operation. The pilots supporting the LRRP should be debriefed.

Item: Utilization of Air Radio Relay

Discussion: Communication difficulties were encountered during Operation WACO. Two significant factors which were instrumental in causing the difficulties were the dense wet foliage which was dominant in the AO and the distance between units. These difficulties were greatly reduced by the use of air radio relay.

Observation: An aircraft should be made available to Task Force and Battalion size units for use as radio relay ships.

Item: Selection and Preparation of Approach and Departure Routes to and from Landing Zones Known to be Hot

Discussion: An LZ was used on two separate occasions for introduction and extraction of Battalion sized units on Operation CANARY/DUCK (LZ STUMP). On the first introduction and extraction, despite air and artillery preparation, heavy enemy ground fire was encountered. The approach and departure routes were altered in every direction, resulting in no let up in hostile fire. The extraction phase was halted several times for further preparation on the flight routes within 500 - 800 meters of the LZ. The decision was made to put heavy air and artillery on the west side on the LZ only and have helicopters approach, make the pickup, reverse themselves (i.e. lead ship becomes tail ship, and exit over the same route.

Observation: This technique allowed the route preparation to be highly concentrated in one area. A great reduction in enemy fire was derived from this maneuver. The routes were also prepared between flights by TAC Air and Artillery as soon as the helicopters cleared the impact area. The above technique was used on the second introduction and extraction of a battalion size unit on the same LZ and only isolated cases of hostile fire were reported.

Item: Aero Cavalry Concept

Discussion: The Aero Cavalry concept was first fully employed by E/17th Cavalry during Operation CANARY/DUCK. Basically, the concept was employed by the Cavalry consisted of checkerboarding twelve man groups from one point to another to engage targets of opportunity or to search a suspicious area. Normally, the operation is open rice paddy areas. The aircraft involved in this type maneuver are one UH-1D for Command and Control, one Aero Scout Team (consisting of two armed OH-13 helicopters) two light fire teams and from two to six UH-1D troop carriers. From an aviation standpoint, this type operation is excellent because it can be conducted with a minimum of aircraft and all aircraft receive maximum utilization.

Observation: At no time should an aircraft land or fly at low level without gunship support. All hits sustained by aircraft, during Aero Cavalry Operations, were sustained when an aircraft attempted to land. Two light fire teams are optimum for this technique, however, one is sufficient when only one team is available.

CONFIDENTIAL

1

A CO
12 NOV

2/503d
11 NOV

E/17 CAV
12 NOV

PSN PANT

B/2/503d

MINH THANH
TF 2/503d

NOV 66

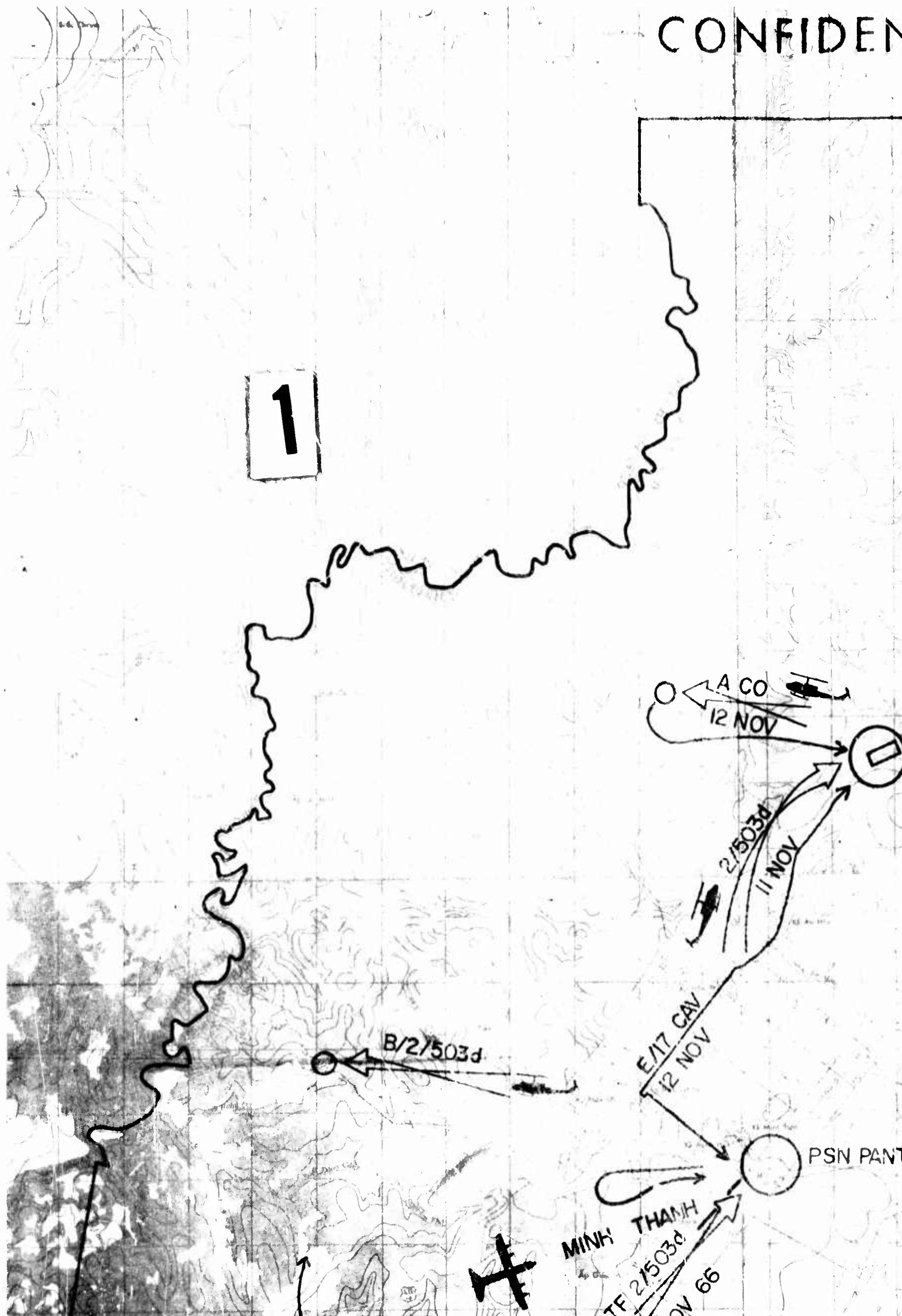

CONFIDENTIAL

OPN ATTLEBORO
7 NOV TO 20 NOV 66

2

CO
NOV

PSM TIGER

5/503d
NOV 11

PSN PANTHER

QUAN AN LOC
QUAN CHON THANH

84
83
82
81
80
79
78
77
76
75
74
73
72
71
70
69
68
67
66
65

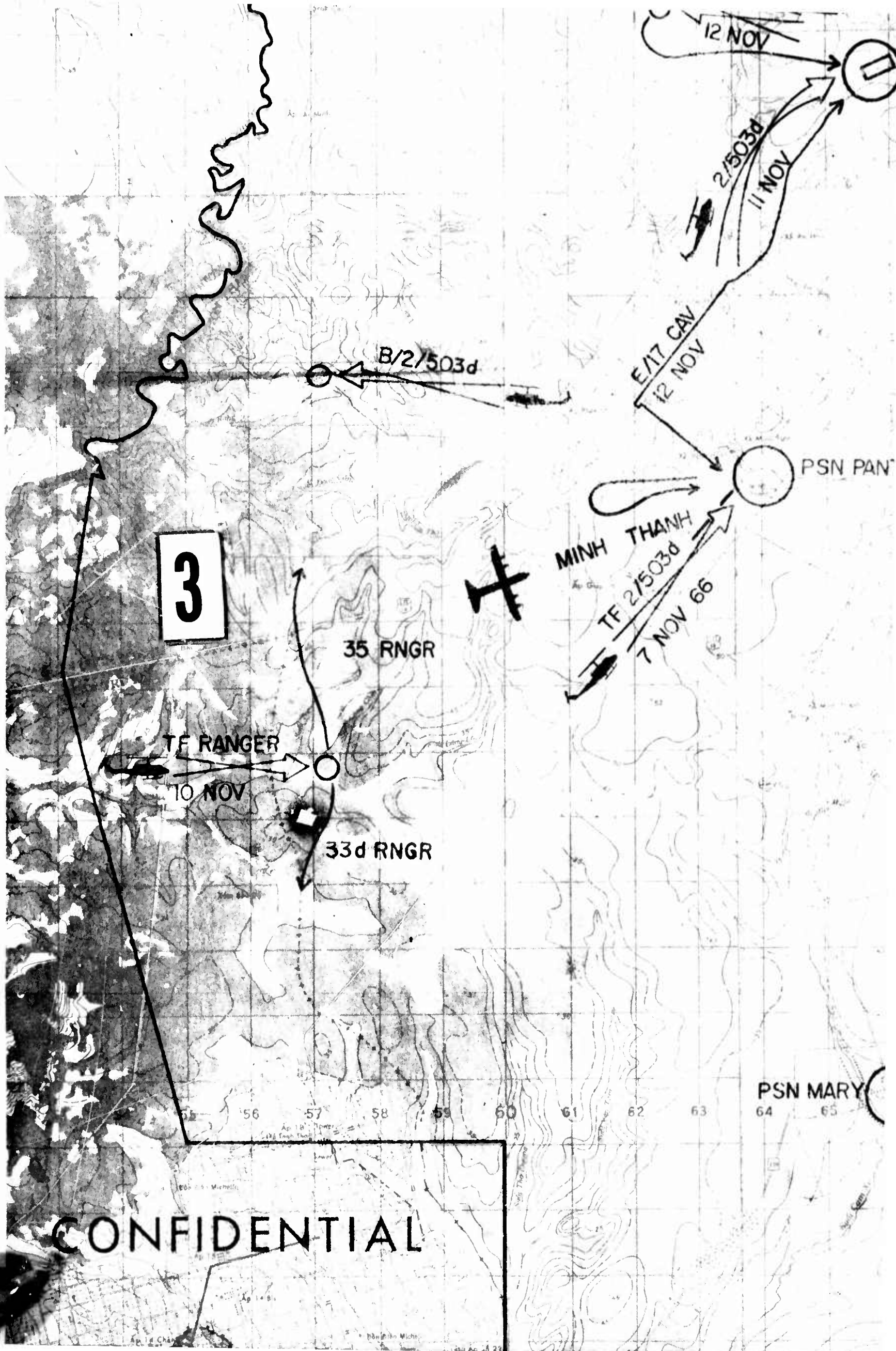

3

B/2/503d

12 NOV

2/503d

11 NOV

E/17 CAV
12 NOV

PSN PAN

MINH THANH

TF 2/503d
7 NOV 66

35 RNGR

TF RANGER
10 NOV

33d RNGR

PSN MARY

CONFIDENTIAL

56 57 58 59 60 61 62 63 64 65

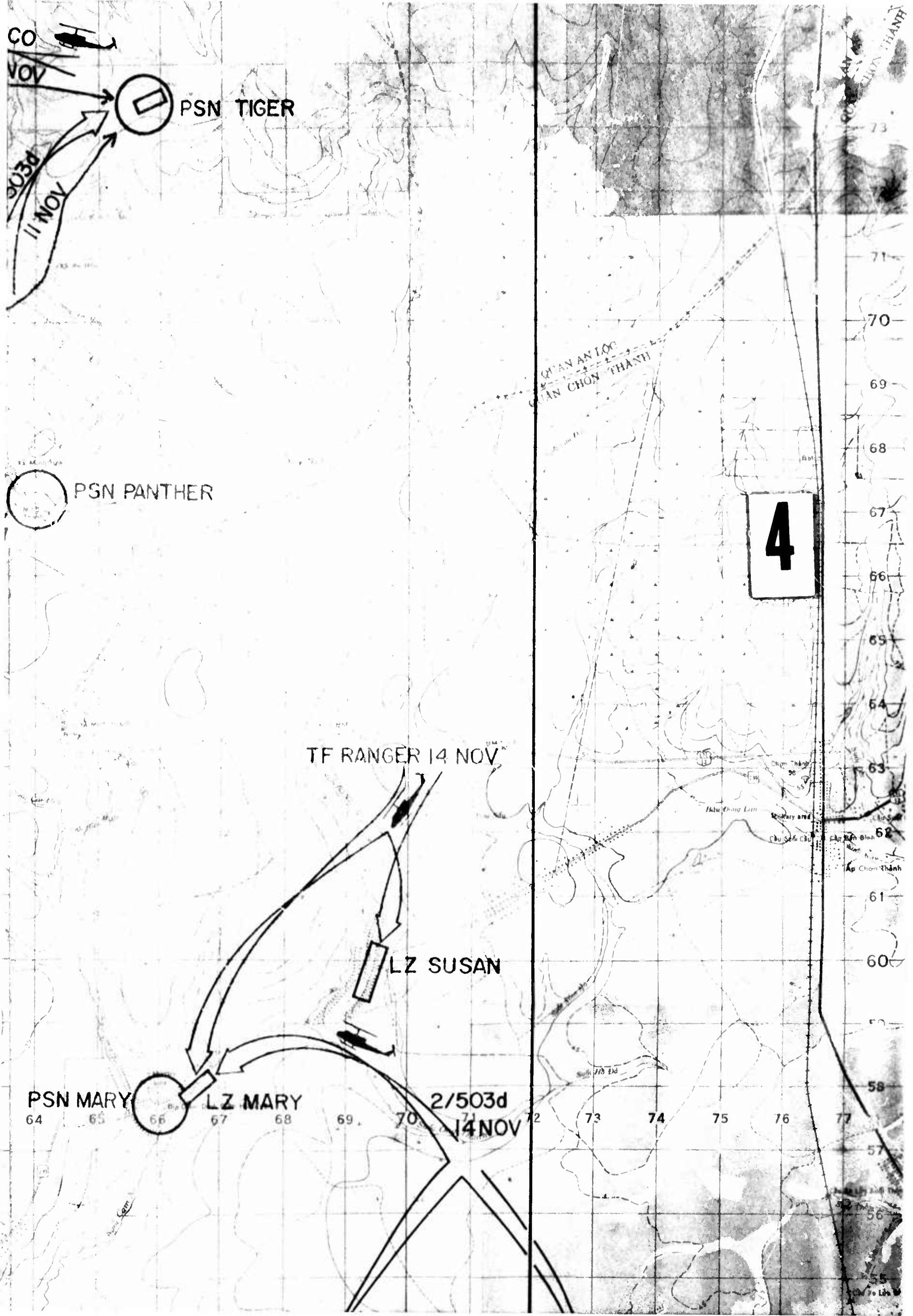

CO
VOV



PSN TIGER



PSN PANTHER

TF RANGER 14 NOV

LZ SUSAN

PSN MARY

LZ MARY

2/503d
14 NOV

4

QUAN AN LOC
AN CHON THANH

QUAN AN THANH
73
71
70
69
68
67
66
65
64
63
62
61
60
59
58
57
56
55

64 65 66 67 68 69 70 71 72 73 74 75 76 77

B/2/503d

E/1
12 NOV

PSN PANTH

MINH THANH

TF 2/503d

7 NOV 66

35 RNGR

TF RANGER

10 NOV

33d RNGR

PSN MARY

64 65 66

CONFIDENTIAL

5

TỈNH SƠN LƯƠNG
TỈNH BÌNH LONG
TỈNH BÌNH DƯƠNG
QUẬN CHỢ THẠNH
QUẬN BẾN CÁT

PSN PANTHER

TF RANGER 14 NOV

PSN MARY LZ MARY

2/503d
14 NOV

LZ SUSAN

LZ VICKI

LZ ANN

6

TỈNH BÌNH LONG QUẬN CHƠN THÀNH
TỈNH BÌNH DƯƠNG QUẬN BẾN CÁT

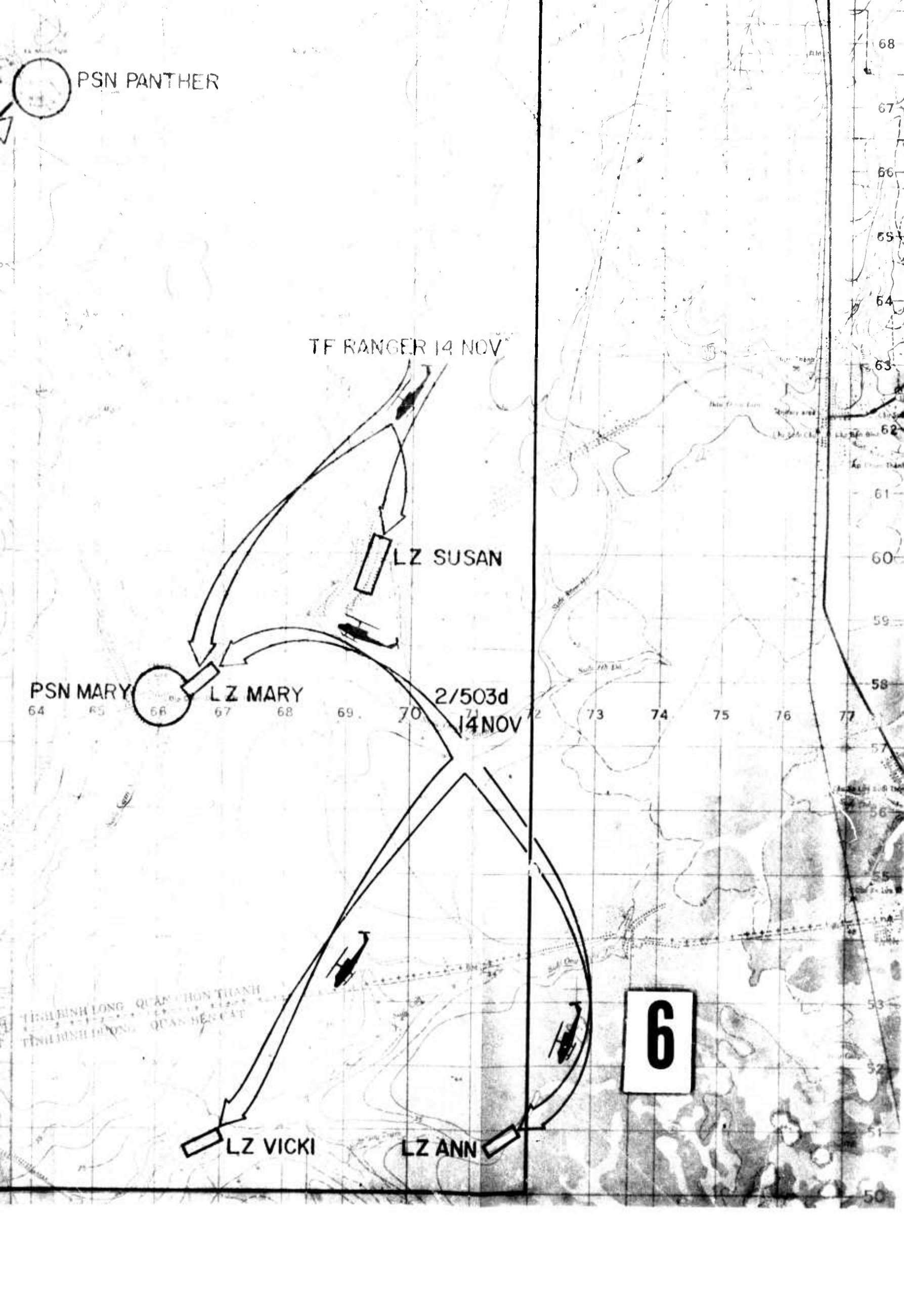

CONFIDENTIAL

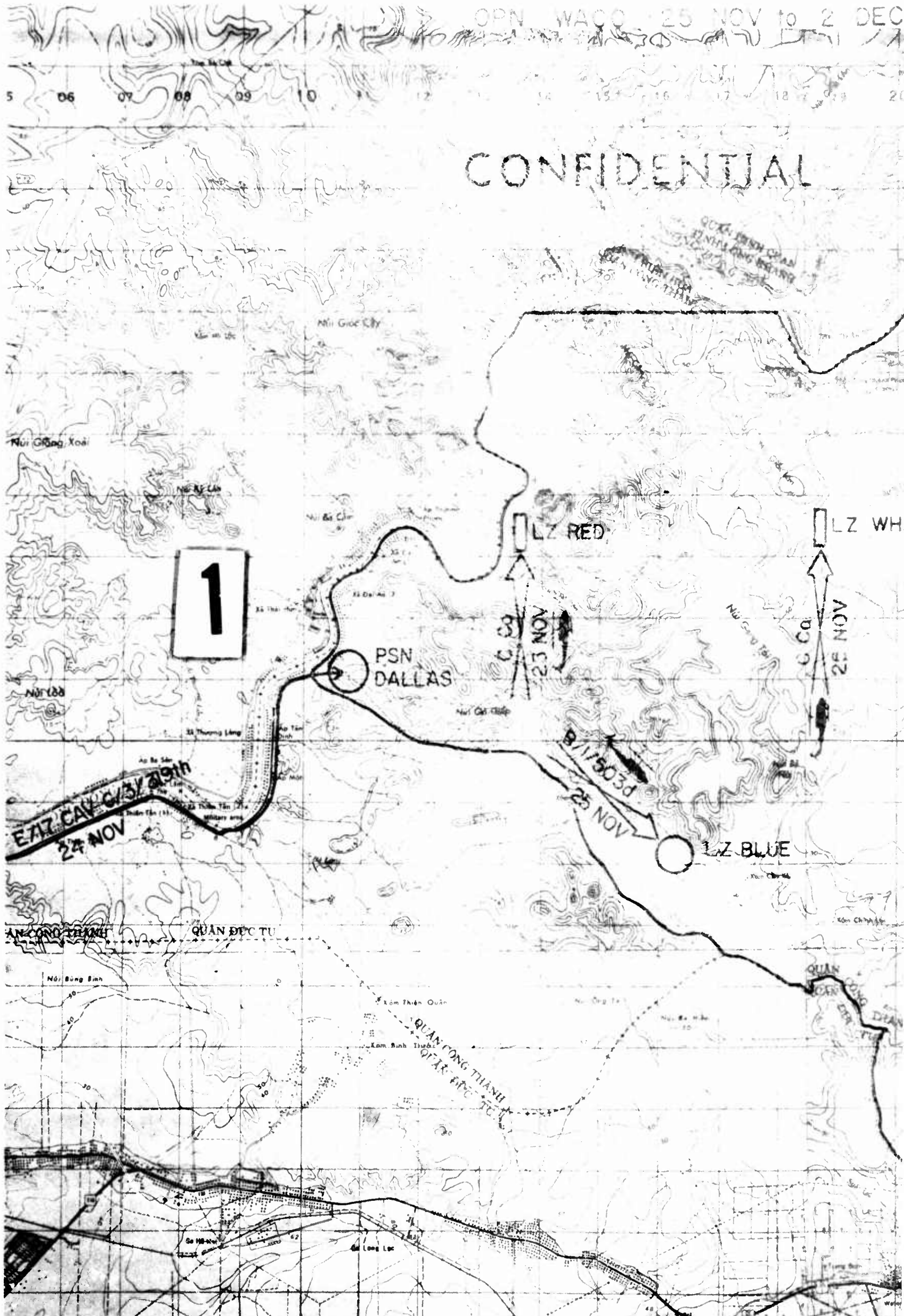

OV to 2 DEC 66

JAL

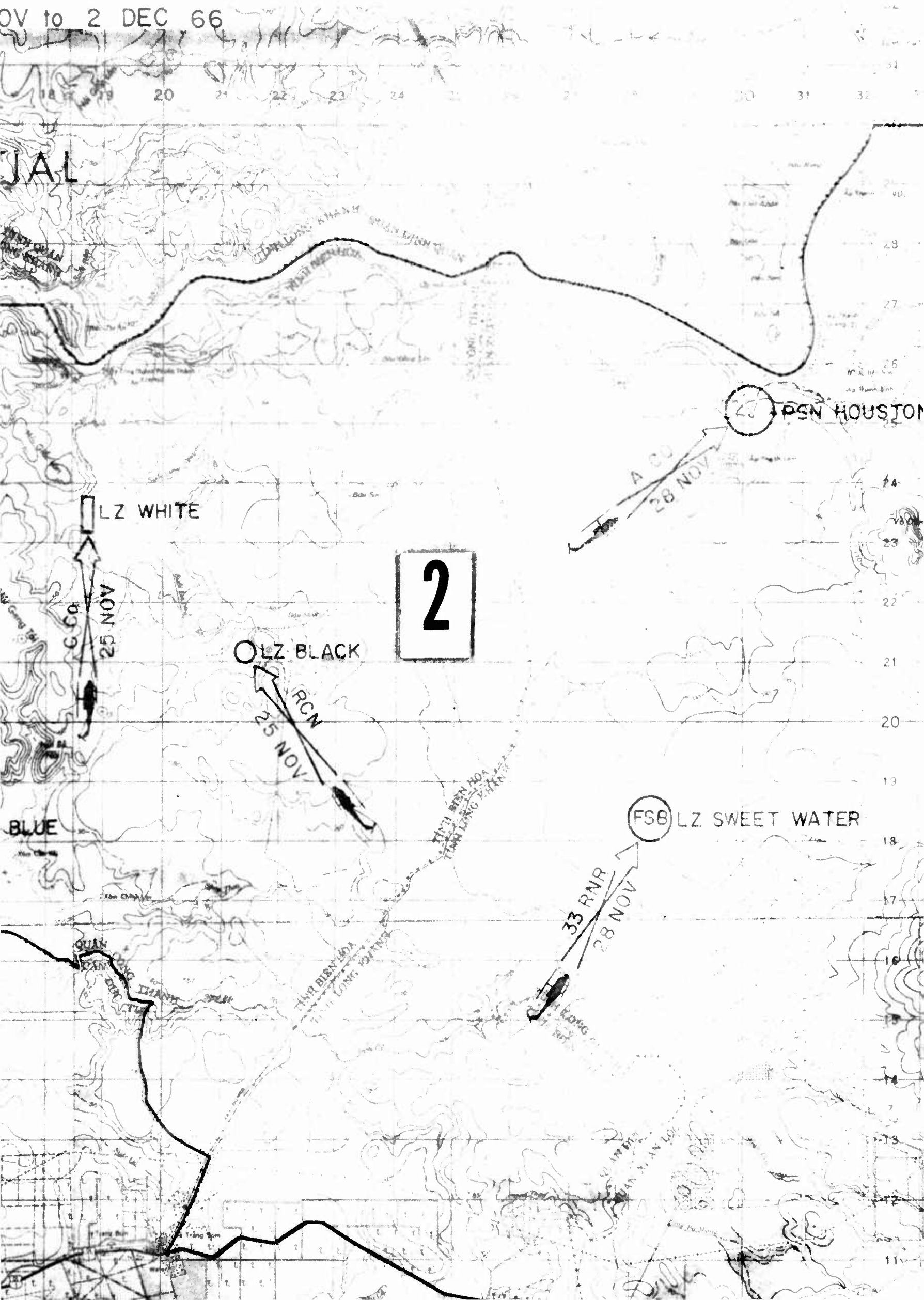

2

LZ WHITE

LZ BLACK

FSB LZ SWEET WATER

PSN HOUSTON

G-60
25 NOV

RCN
25 NOV

A-1J
28 NOV

33 RNR
28 NOV

BLUE

QUAN

THANG LONG KHANG
THANG LONG PHU

THANG LONG KHANG
THANG LONG PHU

25 26 27 28 29 30 31 32 33 34 35 36 37 38 39 40

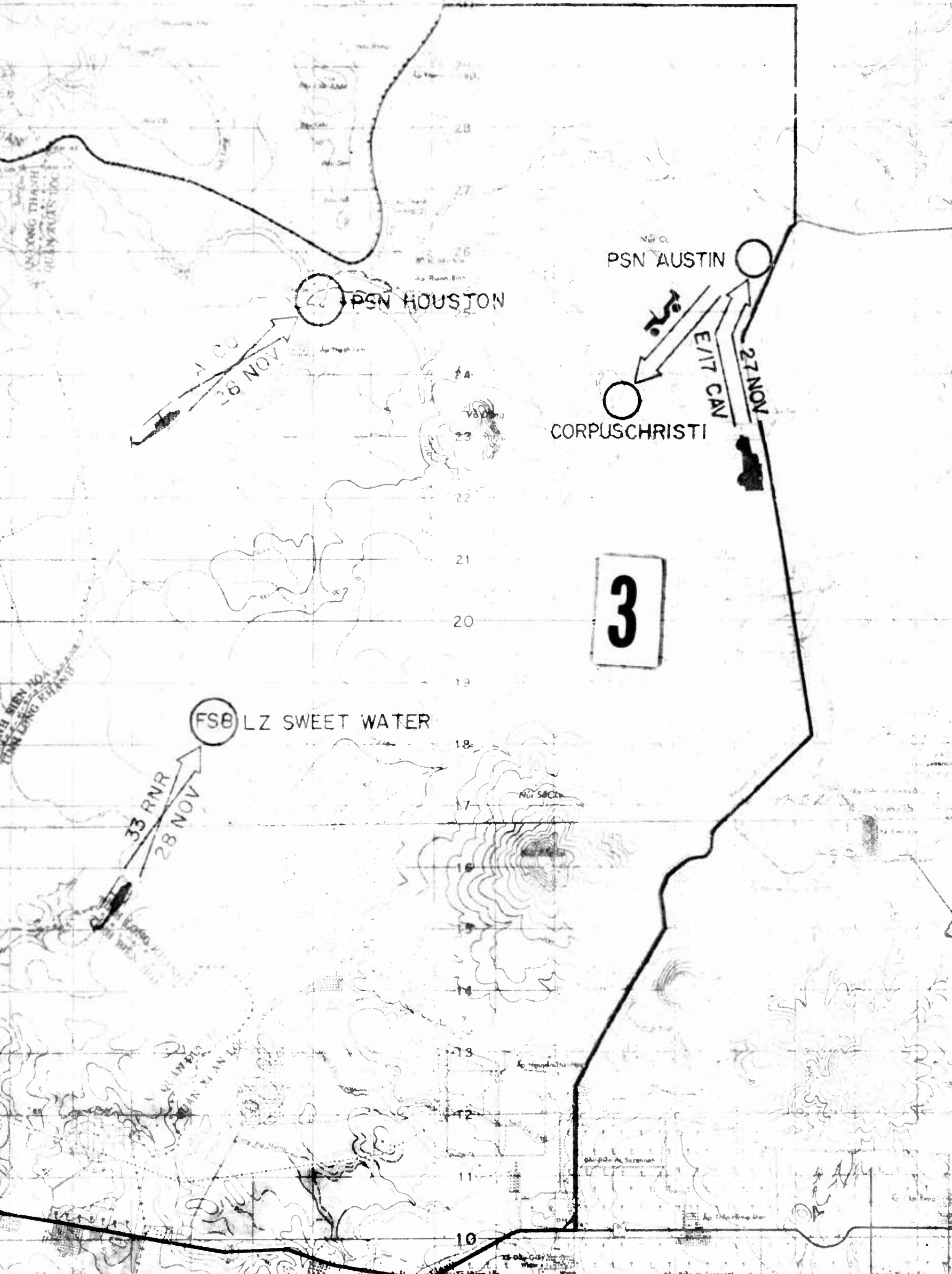

PSN HOUSTON

A CO
26 NOV

PSN AUSTIN

CORPUSCHRISTI

E/I7 CAN
27 NOV

3

FSB LZ SWEET WATER

33 RNR
28 NOV

TRƯỜNG THẠCH
QUẬN QUẢNG TRUNG

TRƯỜNG BIÊN HOÀ
TRƯỜNG LƯƠNG THÁNH

QUẬN QUẢNG TRUNG
TRƯỜNG BIÊN HOÀ

TRƯỜNG NGUYỄN

TRƯỜNG HÙNG LÃN

TRƯỜNG BIÊN HOÀ

TRƯỜNG BIÊN HOÀ

TRƯỜNG BIÊN HOÀ

TRƯỜNG BIÊN HOÀ

Núi Giag, Xoài

Núi Rê Lâ

Núi Bả Cầm

LZ RED

LZ WHITE

PSN DALLAS

88
C 25 NOV

C 25 NOV

EAT CAV C/3/19th
24 NOV

B/1/503d
25 NOV

LZ BLUE

AN CONG THANH

QUAN ĐỨC TỬ

QUAN LONG THANH
QUAN ĐỨC TỬ

QUAN LONG THANH
QUAN ĐỨC TỬ

4

LZ WHITE

25 NOV

C CO

FS6 LZ SWEET WATER

33 RVR

28 NOV

OLZ BLACK

25 NOV

RCA

5

CONF

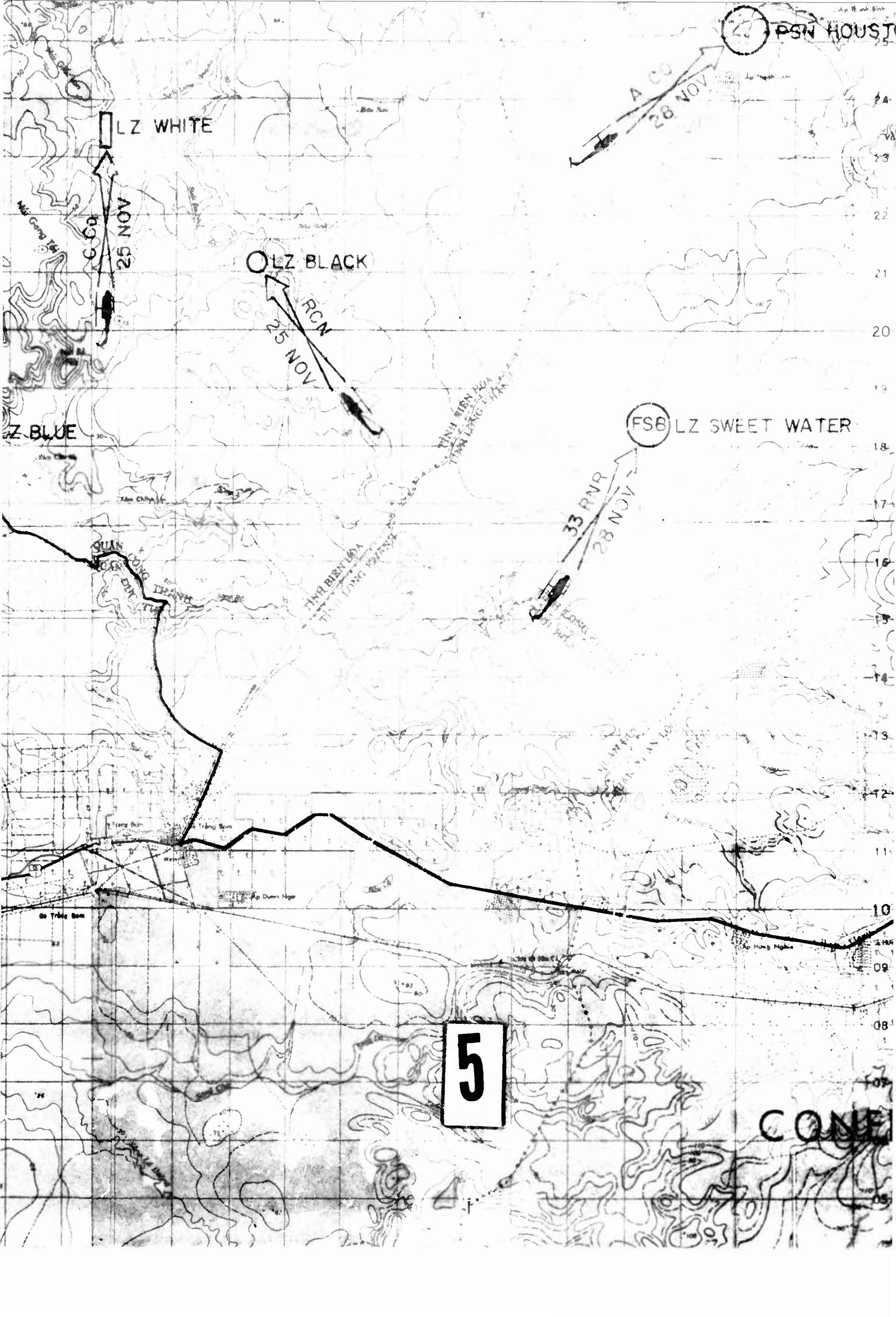

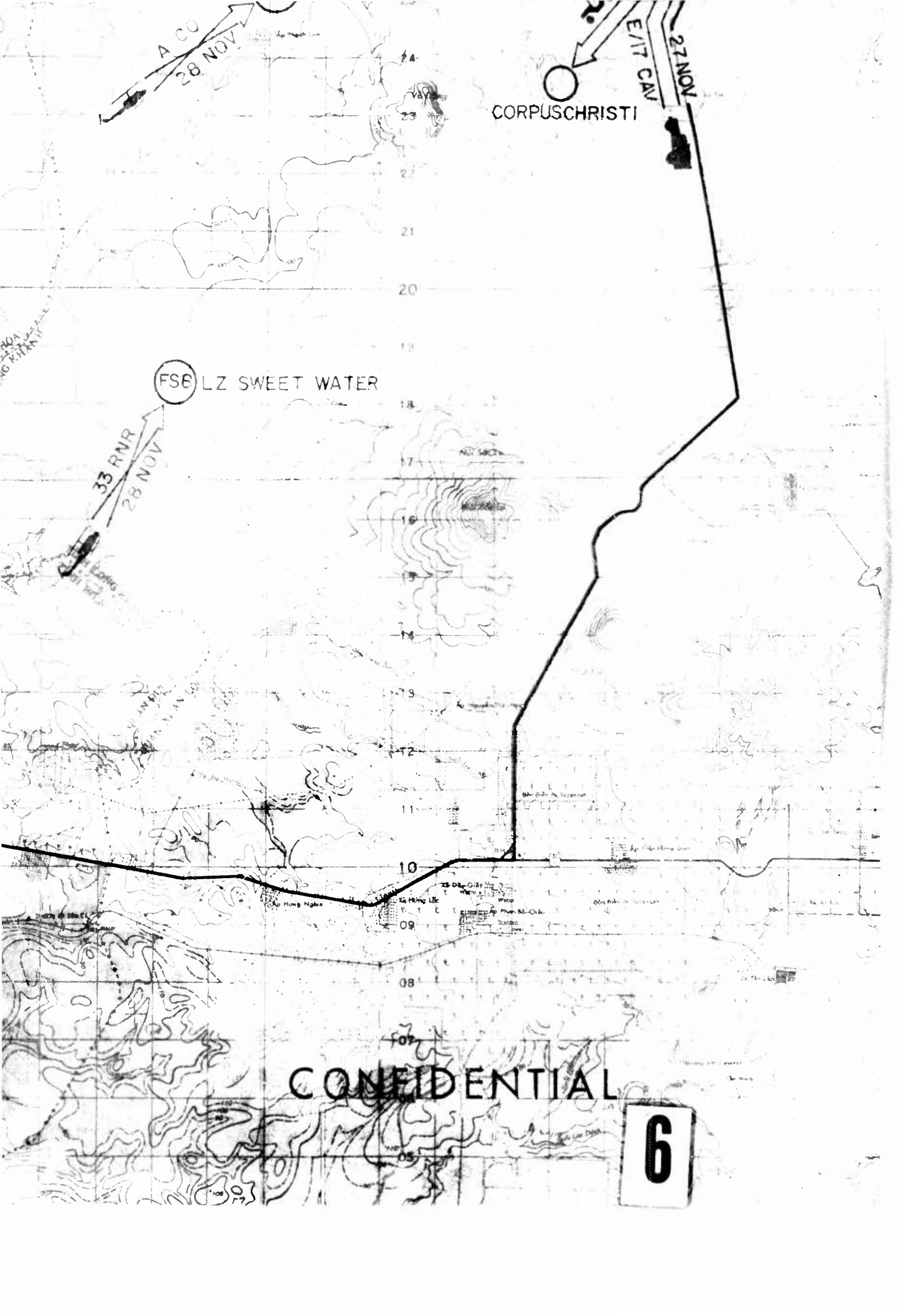

F58 LZ SWEET WATER

CORPUS CHRISTI

33 RNR
28 NOV

A CO
28 NOV

E/17 CAM
27 NOV

CONFIDENTIAL

6

CONFIDENTIAL

OPN CANARY / DUCK
7 DEC 66 to 5 JAN

10700

1

2/11 AC
SECURI
AREA

E/17 CAV
AERO/RIFLE PLT
OPERATION
26 DEC to 30 DEC

CONFIDEN

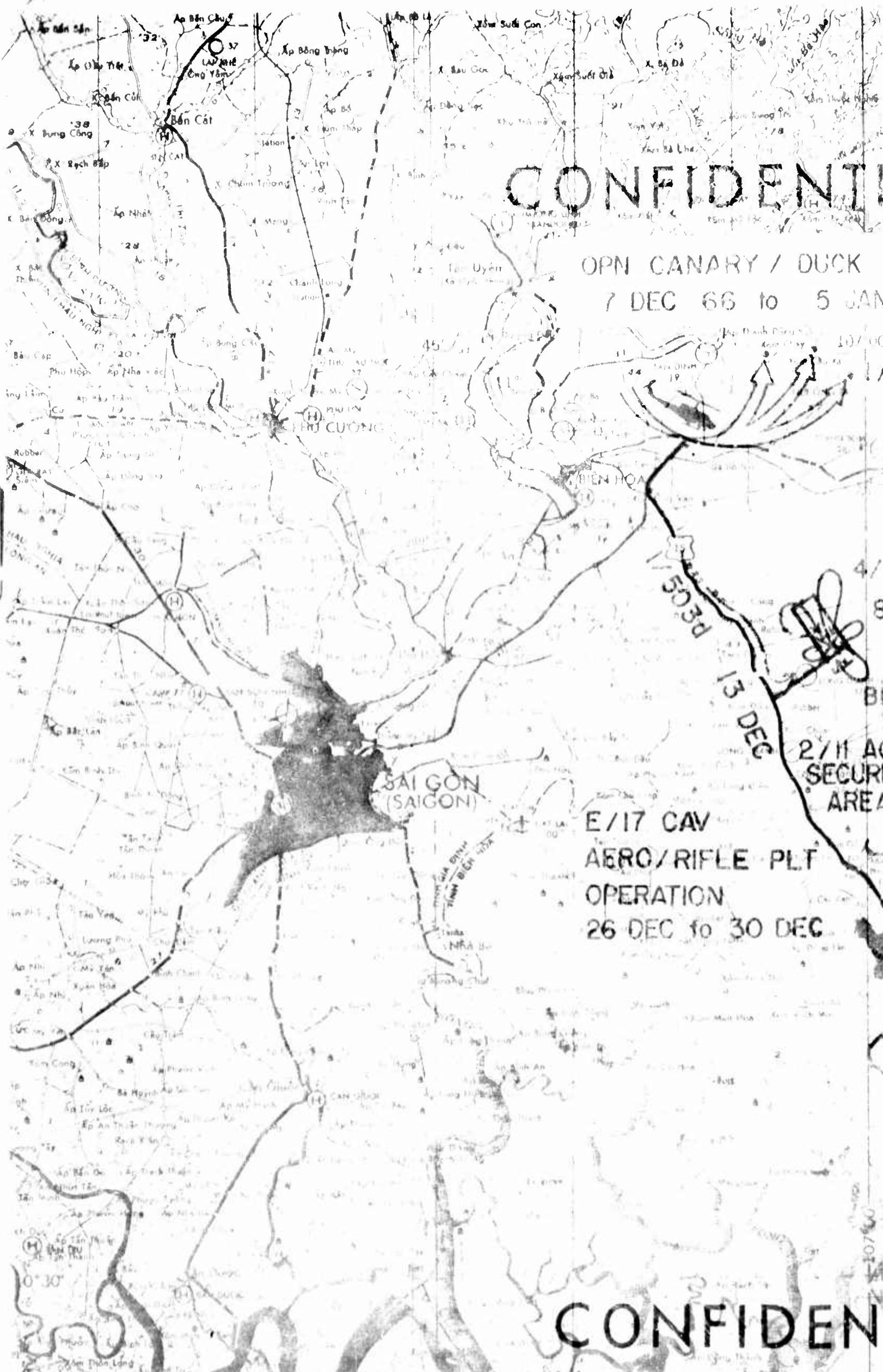

CONFIDENTIAL

OPN CANARY / DUCK
7 DEC 66 to 5 JAN 67

1/503d (NASHVILLE)
29 DEC

4/503d COGAC SECURITY
8 DEC 66 to 10 DEC 66

BEAR CAT

2/11 ACR
SECURITY
AREA

E/17 CAV
AERO/RIFLE PLT
OPERATION
26 DEC to 30 DEC

2/503
27 DEC
4/503d
21 DEC

LZ STUMP

173d SECURITY
AREA

PHU MY
I ATF
SECURITY
AREA

CONVOY
ROUTE

CONFIDENTIAL

2

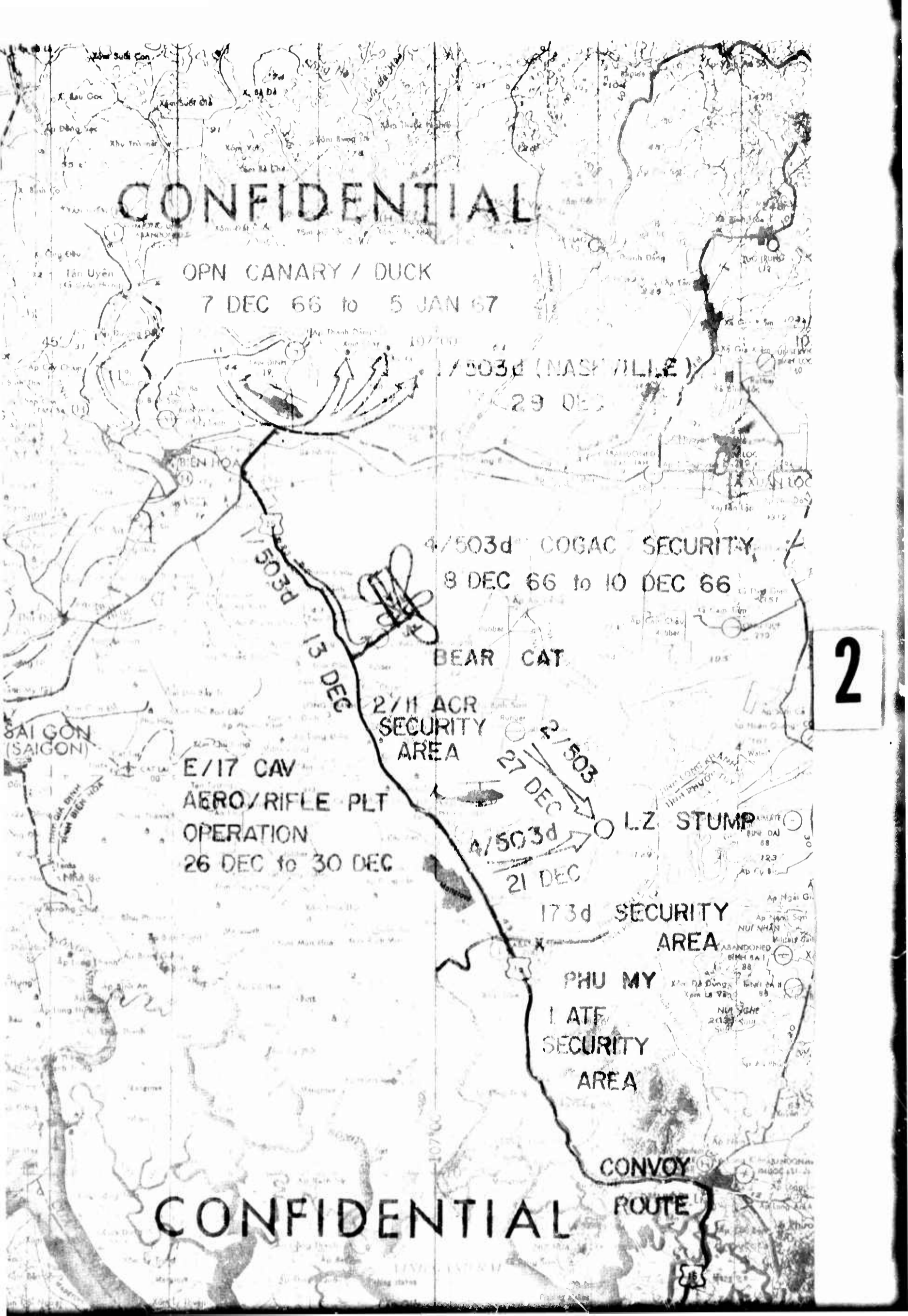

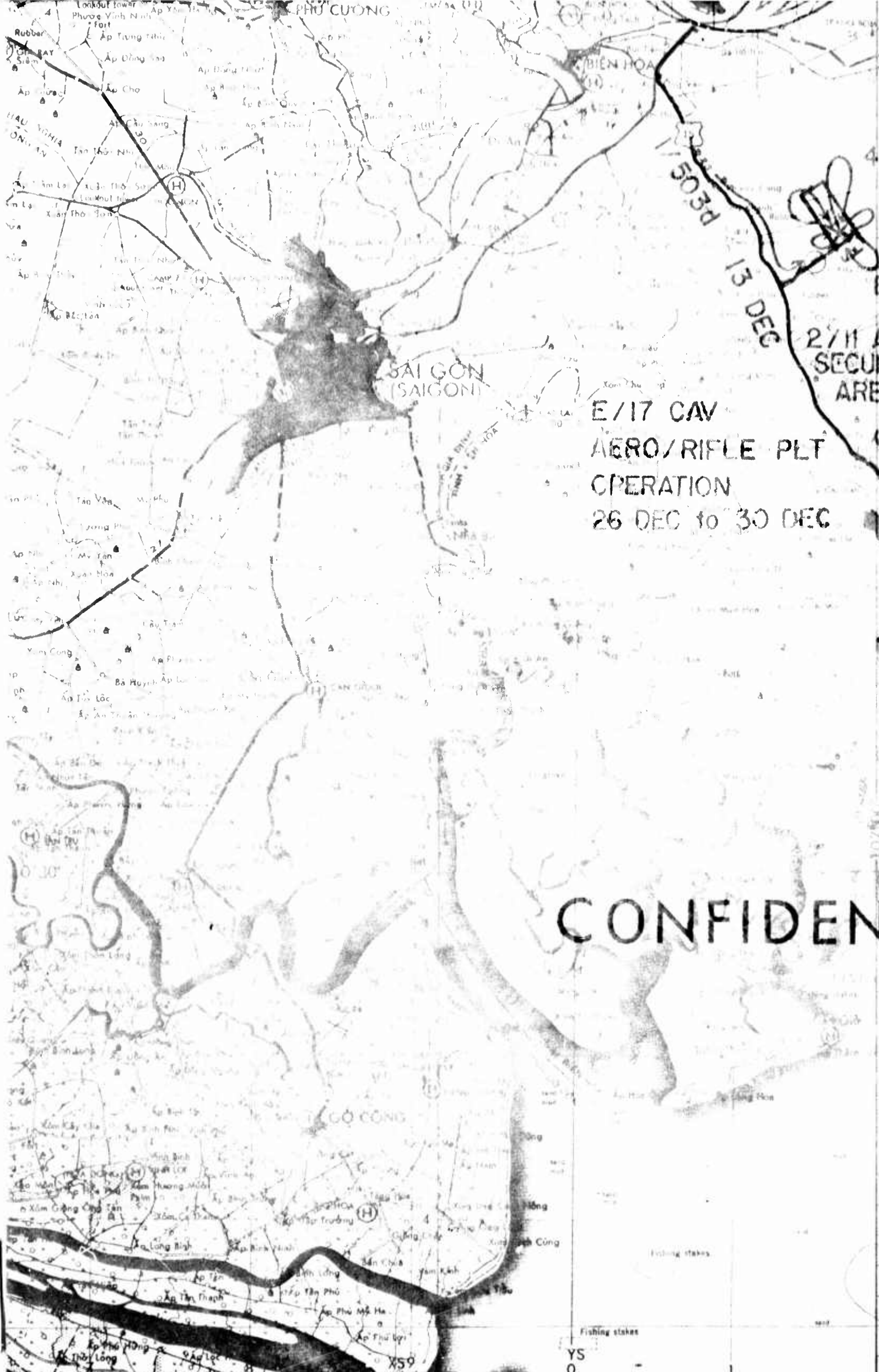

E/17 CAV
AERO/RIFLE PLT
OPERATION
26 DEC to 30 DEC

CONFIDEN

3

YS
0

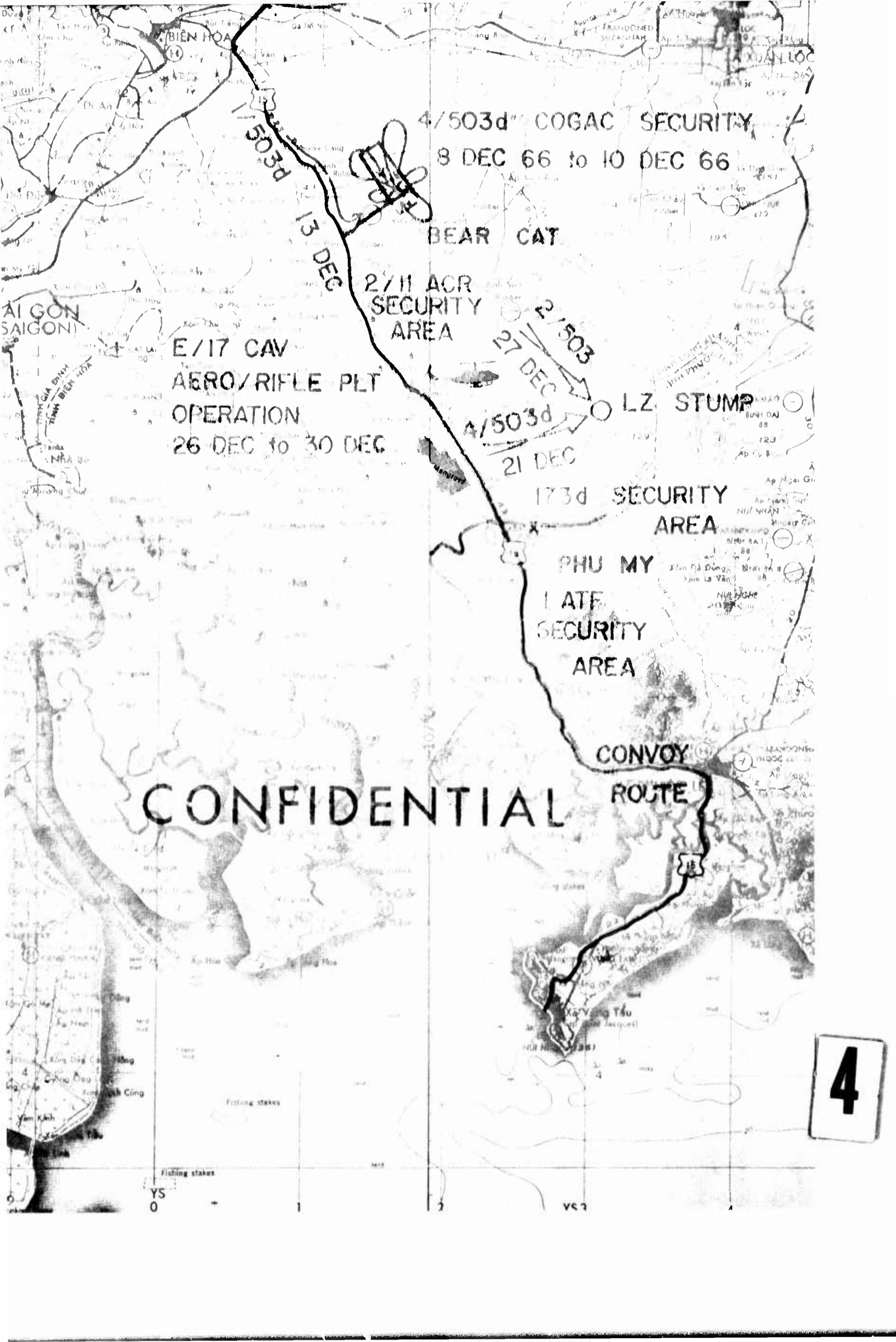

4/503d COGAC SECURITY
8 DEC 66 to 10 DEC 66

BEAR CAT

2/11 ACR
SECURITY
AREA

E/17 CAV
AERO/RIFLE PLT
OPERATION
26 DEC to 30 DEC

2/503
27 DEC

4/503d
21 DEC

LZ STUMP

173d SECURITY
AREA

PHU MY
I ATF
SECURITY
AREA

CONVOY
ROUTE

CONFIDENTIAL

4

Y5
0

VC 7

CONFIDENTIAL

INCLOSURE 1

ROSTER OF KEY PERSONNEL

CONFIDENTIAL

CONFIDENTIAL

AVBE-SC
SUBJECT: Roster of Key Personnel

15 February 1967 ³⁰

UNIT/DUTY	NAME/BRANCH/SERVICE NUMBER	AUTH/ACT
1. BRIGADE COMMANDER	DEANE, JOHN R JR GO 024 835	BRIG/BRIG GEN /GEN
2. Deputy Bde Comdr	SHAW, ROBERT C INF 033 626	COL/COL
3. Bde/S-3	PETERS, ELMER B INF 059 198	LTC/LTC
4. Bde/S-1	BETHKE, GERALD H INF 075 927	MAJ/MAJ
5. Bde/S-2	MC COY, GEORGE V INF 092 486	MAJ/MAJ
6. Bde/S-4	PALMER, WILLIAM T INF 076 488	MAJ/MAJ
7. Bde/S-5	ANDERSON, JAMES L INF 066 656	MAJ/MAJ
8. Bde/Avn Off	UTZMAN, CHARLES D INF 082 373	MAJ/MAJ
9. Bde/Sig Off	DARLING, GREGORY SIGC 099 812	MAJ/MAJ
10. Bde/Surgeon	HIMMA, EINAR MC 088 395	MAJ/MAJ
11. Bde/Provost Marshall	FRIEND, BERNARD D MPC 094 927	MAJ/MAJ
12. HHC/Comdr	DANKERT, DERALD T INF 090 804	CPT/CPT
13. 1/503d Inf/Bn Comdr	BROWNLEE, ROBERT W INF 066 138	LTC/LTC
14. 2/503d Inf/Bn Comdr	SIGHOLTZ, ROBERT H INF 087 614	LTC/LTC
15. 4/503d Inf/Bn Comdr	HEALY, MICHAEL D INF 070 368	LTC/LTC
16. 3/319th Arty/Bn Comdr	NORDIN, WILLIAM H ARTY 059 137	LTC/LTC
17. 173d Spt Bn/Bn Comdr	WEISINGER, SHERMAN QMC 059 057	LTC/LTC
18. Troop E, 17th Cav/Comdr	SUTTON, BRYAN J INF 106 389	CPT/MAJ

CONFIDENTIAL

CONFIDENTIAL

31

AVBE-SC
SUBJECT: Roster of Key Personnel

15 February 1967

UNIT/DUTY	NAME/BRANCH/SERVICE NUMBER	AUTH/ACT
19. Co D/16th Armor/Comdr . . .	WATERS, JOHN K JR ARM 098 331	CPT/CPT
20. 173d Engr Co/Comdr	LEHRER, GLEEN H CE 090 921	CPT/CPT
21. Co A Admin/Bde Chap	GIGIELLO, XAVIER J CHC 0 997 810	MAJ/LTC
22. 172d MI Det/Comdr	BOWEN, HARRY R AIS 05 320 333	MAJ/CPT
23. 24th Mil Hist Det/Comdr . . .	SANGSTER, JAMES H INF 05 208 865	MAJ/CPT
24. 51st Chem Det/Comdr	CARR, MILTON B OMLC 089 804	CPT/CPT
25. 39th Inf Platoon (Scout Dog)	MEDLEN, MICHAEL K INF 05 329 234	LT/LT

CONFIDENTIAL

INCLOSURE 2
ORGANIZATION CHART

CONFIDENTIAL

ORGANIZATION 173D AIRBORNE BRIGADE (SEPARATE)

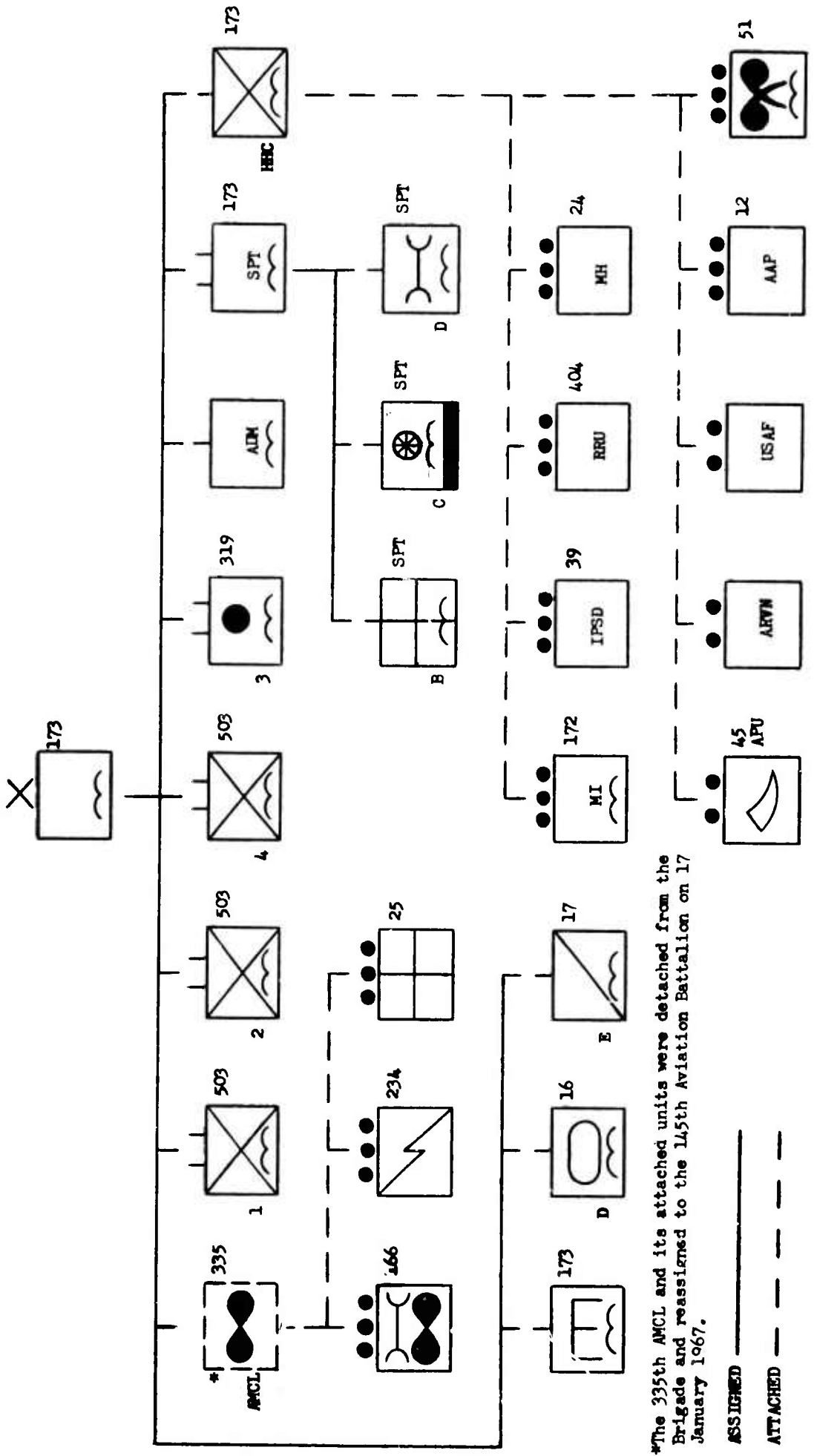

*The 335th AMCL and its attached units were detached from the Brigade and reassigned to the 145th Aviation Battalion on 17 January 1967.

ASSIGNED ———
 ATTACHED - - -

CONFIDENTIAL

INCLOSURE 3
SWITCHBOARD DESIGNATOR

CONFIDENTIAL

CONFIDENTIAL

AVEE-SC
SUBJECT: Switchboard Designators

15 February 1967

56

UNIT	SWITCHBOARD DESIGNATOR
173D AIRBORNE BRIGADE (SEPARATE)	BIEN HOA ARMY
1st Bn/503d Inf	Paramount
2nd Bn/503d Inf	Paragon
4th Bn/503d Inf	Parablast
3d Bn/319th Arty	Propel
173d Support Battalion	Provide
Co D/16th Armor (forward area only)	Punch
Troop E/17th Cavalry (forward area only)	Precede
173d Engineer Company (forward area only)	Prepare
145th Avn Bn	Rotor
6th Bn/27th Arty	Haymaker

TELEPHONE INSTALLATION . . . Call BIEN HOA ARMY 28

BIEN HOA ARMY LOCALS

HEADQUARTERS 173D AIRBORNE BRIGADE (SEPARATE)

UNIT	BIEN HOA ARMY NUMBER	UNIT	BIEN HOA ARMY NUMBER
CG	6	404th RRU	42
DCO/XO	5	CBRE	12
SMJ	54	TOC	38,39
S-1	1	172d MI	41
S-2	2	Awards & Decorations	72
S-3	3	Chaplain & Red Cross	19
S-4	4	PIO	20
S-5	49	Engr Officer	15
Bde AG	7	Bde Surgeon	16
Signal Officer	10	Officers Record Section	79
Pers Mgmt	71	PMO	27

CONFIDENTIAL

CONFIDENTIAL

37

AVBE-SC
SUBJECT: Switchboard Designators

15 February 1967

<u>UNIT</u>	<u>BIEN HOA ARMY NUMBER</u>	<u>UNIT</u>	<u>BIEN HOA ARMY NUMBER</u>
Pers Acts	72	SJA	17
Pers Rcds	73	IG	21
Admin Svc Div	74	FSCC	22
Bde Finance Officer	75	Air LO (Air Force)	24
Reenlistment Officer	77	Hqs Comdt	113
Admin Co	40	24th Mil Hist Det	89

CONFIDENTIAL

INCLOSURE 4
V.I.P. VISITORS

CONFIDENTIAL

CONFIDENTIAL

AVHE-SC
SUBJECT: V.I.P. Visitors

15 February 1967

40

NOVEMBER - DECEMBER - JANUARY

6 November 1966

COL P. B. Watson, Director of Plans, USACDC
LTC Beck, USARV CDG LNO
LTC Hoffman, USAFV Project Officer

PURPOSE OF VISIT: Briefing and visit with troops.

14 November 1966

COL Lawton Magruder, MACV IG
COL F. J. Petrilli, USARV IG
COL G. B. Woodworth, 1st Logistical Command IG
LTC S. T. Porterfield, Chief Inspection Division, USARV IG

PURPOSE OF VISIT: Orientation of the newly arrived MACV IG

15 November 1966

LT GEN Lek Naeomali, RTA (Royal Thai Army) Director of Operations and Senior Thai Officer
COL Nark Narmsongneon, RTA
COL Sombhund Ruangvaidya, RTA
COL Suraset Ramasompop, RTA
COL Luean Pongstabhon, RTA
CPT Pleng Lowchalern, RTN
CPT Charm Nitamarn, RTN
GP CPT Prasort Tongyou, RTAF
GP CPT Chamaran Phatarnyodhin, RTAF
MAJ Sadabphong Soothiwongsa, RTA

PURPOSE OF VISIT: Orientation, Briefing and visit of company size units.

16 November 1966

BG Bernard W. Rogers, ADC, 1st Infantry Division
Aide de Camp

PURPOSE OF VISIT: Briefing on Brigade organization and orientation.

22 November 1966

BG John R. Dean Jr., USA

PURPOSE OF VISIT: To discuss policies of the Brigade with Major General Smith prior to assuming command on 28 December 1966.

26 November 1966

BG William G. Moore Jr., USAF, CG 834th Air Division

PURPOSE OF VISIT: Visit with Commanding General 173d Airborne Brigade (Separate)

CONFIDENTIAL

41

CONFIDENTIAL

15 February 1967

AVBE-SC
SUBJECT: V.I.P. Visits

1 December 1966

BG Charles W. Ryder Jr.
LTC Koder
MAJ Augur

PURPOSE OF VISIT: Orientation/Visit

4 December 1966

COL Edward E. Beda, Ordnance Corp
MAJ Alex J. LeBlanc

PURPOSE OF VISIT: CONARC Liaison Visit

5 December 1966

Senator Henry M. Jackson (Dem-Washington), Senate Committee on Armed Services
Mr. Glen A. Smith, Professional Staff Man
LTC Everett L. Harper, USAF Escort Officer
LTC Clifford E. Skolglund, USARV Escort Officer

PURPOSE OF VISIT: To review military posture of US Troops

6 December 1966

COL Wood, Team Chief CONARC Training Liaison Team
LTC Thiel, USAIS Representative
MAJ Donald Souza, USARV Escort Officer
CPT Walker, USARV Escort

PURPOSE OF VISIT: Orientation on Combat Operations at platoon and Company level.

9 December 1966

Mr. W. M. Hurst, Australian Research Scientist
CPT McCallum, Australian Staff

PURPOSE OF VISIT: Orientation on the use of helicopters in support of Army operations and the importance of aircraft being under the control of the Army Tactical Commander.

12 December 1966

Major General John H. Hay, Department of the Army

PURPOSE OF VISIT: Orientation/Visit

13 December 1966

Mr. Larry W. Coker, USARV Surgeon Office

PURPOSE OF VISIT: Orientation and visit of medical facilities

CONFIDENTIAL

CONFIDENTIAL

AVBE-SC
SUBJECT: V.I.P. Visitors

15 February 1967

42

18 December 1966

Mr. Leo Anderson, National Commander of American Veteran's Organization

PURPOSE OF VISIT: To gain first hand knowledge of the situation in Vietnam.

23 December 1966

Honorable George W. Gruder, US Representative (Dem-Tenn)
CDR Chesky, MACV Escort

PURPOSE OF VISIT: To obtain first hand knowledge of the current situation

24 December 1966

GEN Harold K. Johnson, Chief of Staff, US Army
LT GEN Harry J. Lemley, DCSOPS
MAJ GEN Keith L. Ware, Chief of Information
COL Jasper J. Wilson, Aide to COFSA
COL B. H. Hill, USARV Escort Officer
LTC R. R. Liday, USARV Project Officer
CPT J. C. Kern
SGM William O. Wooldridge, SGM of the Army

PURPOSE OF VISIT: First hand discussion of major problem areas, in depth briefings of Army needs, and visit to units and facilities.

28 December 1966

MAJ GEN K. L. Ware, Chief of Information, United States Army
LTC C. M. Bushee, Deputy USARV IO

PURPOSE OF VISIT: Briefing of current operations, discussion of entire scope of information activities with Information Offices and to observe operations.

30 December 1966

GEN William C. Westmoreland, COMUSMACV
Aide De Camp

PURPOSE OF VISIT: Lunch, updated operational briefing and visit with troops.

5 January 1967

MAJ GEN C. H. Dunn, J4 MACV
COL Coombs, J4 Office, MACV
LTC McCane, G4 Office, USARV

PURPOSE OF VISIT: To discuss and observe logistic support to combat units.

10 January 1967

GEN Earle G. Wheeler, Chairman, Joint Chiefs of Staff
Mr. (GS-17) Daniel Z. Henkin, Director of Operations, ASD (DA)
COL J. H. Elder, Executive to CJCS
COL A. S. Edmunds, Executive of CJCS
MAJ G. B. Crist, Aide

43
CONFIDENTIAL

AVBE-SC
SUBJECT: V.I.P. Visitors

15 February 1967

PURPOSE OF VISIT: To gain first hand knowledge of the current situation

13 January 1967

Mr. Stanley Resor, Secretary of the Army
MAJ GEN Charles Pl Brown
BG Lloyd B. Ramsey, Dep IO, DA
COL, C. N. Compf
COL, R. H. Graves
MAJ J. S. Johnson

PURPOSE OF VISIT: To gain first hand knowledge of the current situation

19 January 1967

LTC Morse, Deputy Senior Advisor, 18th Infantry Division (ARVN)
Mr. Jones, Senior Civilian Advisor, 18th Infantry Division (ARVN)

PURPOSE OF VISIT: Orientation/Briefing

20 January 1967

LT GEN Nguyen Van Thieu, Chairman, National Leadership Council
LT GEN Gao Van Vien, Chief JGS, RVNAF
LT GEN Le Nguyen Khang, CG, III Corps
BG Pham Quoc Thuan, CG, 5th Infantry Division (ARVN)
LT GEN J. O. Seaman, CG, II FFORCEV, Escort Officer
COL Johnson, Assistant Deputy Senior Advisor, III Corps

PURPOSE OF VISIT: General Orientation and visit.

21 January 1967

GEN Dwight E. Beach, Commander in Chief, United States Army, Pacific
LTC Jack L. Leggett, Aide de Camp
MAJ GEN Depuy, CG, 1st Infantry Division
COL P.-L. Dal Ponte, USARPAC
COL W. B. Sandlin, USARV Escort Officer

PURPOSE OF VISIT: An updated operational briefing and visit with units of the 173d Airborne Brigade (Separate) and 11th Armored Cavalry Regiment.

22 January 1967

BG Joseph Joseph A. McChristian, Assistant Chief, J2 MACV
COL Robert McMahon, Chief IODMACV J2
COL Junichi Buto, Chief CI Division, MACV J2
CPT James Strachan, Admin Asst

PURPOSE OF VISIT: General Orientation, and to receive a current intelligence estimate of situation on Operation CEDAR FALLS.

23 January 1967

CONFIDENTIAL

CONFIDENTIAL

AVBE-SC
SUBJECT: V.I.P. Visitors

15 February 1967

44

BG Salne H. Matheson, Commanding General Designate, 1st Brigade, 101st Airborne
Division

PURPOSE OF VISIT: Initial Orientation

27 January - 1 February

BG S. L. A. Marshall, (RET), Noted Historian
LTC David H. Hackworth

PURPOSE OF VISIT: To train selected personnel from the 173d Airborne Bri-
gade (Separate), the 11th Armored Cavalry Regiment, 9th
Infantry Division and the 1st Aviation Brigade in the
techniques of conducting combat interviews.

CONFIDENTIAL

45

CONFIDENTIAL

INCLOSURE 5

SUPPLY AND COMBAT SERVICE ACTIVITIES

CONFIDENTIAL

CONFIDENTIAL

AVBE-SC
SUBJECT: Supply and Combat Support Activities

15 February 1967

46

Logistical Situation: During this reporting period (1 November to 31 January) four battalion size or larger operations were conducted as during the previous quarter. Each operation will be discussed chronologically.

1. Operation ATTLEBORO: To support Operation ATTLEBORO, a Brigade supply office (BSO) liaison team was established at MINH THANH Airstrip and two days later, a Brigade Support Operation Center (BSOC) was established in the same general location. Security from the BSOC was provided by D/1st Armor and unit resources.

a. Supply and Transportation: Resupply of the Brigade was accomplished daily by Air Force airlift from BIEN HOA. The 173d Support Battalion furnished all classes of supply. Resupply of the forward elements of the Brigade was accomplished by UH-1's and CH-47's utilizing a total of 152 and 20 sorties respectively. A total of 475.8 short tons (ST) of supplies were handled during the operation.

b. Breakdown by class of supply are listed below:

Class I	62.3 tons
Class II & IV	29.0 tons
Class III & IIIA	206.0 tons
Class V.	178.5 tons

c. A graves registration team was attached to the Brigade and provided graves registration coverage.

b. Maintenance: A contact team from Company "D" Maintenance, 173d Support Battalion provided direct support maintenance employing one officer and eight enlisted men. Backup maintenance was provided via air from BIEN HOA. A total of 40 jobs were received during the Operation, a detailed breakdown of which follows:

<u>Section</u>	<u>Jobs Received</u>	<u>Jobs Completed</u>	<u>Jobs Incompleted</u>
Mechanical Maintenance	2	2	0
Armament	5	4	1
Signal	33	33	0

d. Medical: Company "B" Medical provided medical support employing four officers and thirty-eight enlisted men offering full surgical, medical and dental support. The clearing station served as the primary evacuation facility for casualties. A 20-bed holding facility was maintained for minor wounds, injuries and illnesses. Backup support was provided by the 3d MASH, 7th Surgical Hospital, and the 93d Evacuation Hospital. Dustoff was provided by the 254th Dustoff Detachment. A total of 79 patients/casualties were treated during the entire operation.

2. Operation WACO: The 1st Battalion, 503d Infantry provided LOC (trains) from BIEN HOA. Supplies from the Battalion BSO were sent to the forward area by helicopter or truck. Seven 2½-ton trucks were employed to transport one company (+) to the operational area. Helicopters flew 27 sorties in support of the 1st Battalion Operation.

CONFIDENTIAL

CONFIDENTIAL

47

AVBE-SC
SUBJECT: Supply and Combat Support Activities

15 February 1967

3. Operation CANARY/DUCK: The Brigade elements deployed on Operation CANARY/DUCK were resupplied by road convoy from BIEN HOA. A forward Brigade Supply Office liaison team consisting of two officers and three enlisted men was established in the vicinity of the Brigade Command Post (Position LARK).

a. Supply and Transportation: The following is a total of all supplies delivered by the 173d Support Battalion. Resupply convoy was run each day of the operation (7 December 1966 to 5 January 1967).

Class I	213.4 (ST)
Class II & IV	14.1 (ST)
Class III	364.3 (ST)
Class V	<u>177.8 (ST)</u>
TOTAL	796.6 (ST)

A total of 517.24 short tons of Class V was issued at Base Camp during the period of Operation CANARY/DUCK.

b. Maintenance: A small detachment of maintenance personnel from HHC, 173d Airborne Brigade (Separate) furnished maintenance for vehicles in the vicinity of the Brigade CP. Vehicles and equipment requiring maintenance beyond 2d Echelon were evacuated by highway to base camp.

c. Medical: Company "B" (Medical) of the 173d Support Battalion again provided a primary evacuation facility at base camp. The Brigade surgeon was located at the Brigade CP (Position LARK) and provided surgical aid as required in addition to participating in MEDCAP operations.

4. Operation NIAGARA/CEDAR FALLS: To support this operation, a Brigade Supply Office forward element was established at PHU LOI for the first phase of the operation (NIAGARA FALLS), and at Position MED (HEN CAT) for the second phase of the operation (CEDAR FALLS), along with a Brigade Supply Operations Center (BSOC).

a. Supply and Transportation: Resupply was accomplished daily by road convoy from BIEN HOA. This was supplemented by drawing from the 1st Logistical Command stock of Class V and Class III from LIA KHE. Thirty (30) 2½-ton trucks of the 48th Transportation Group moved elements of the Brigade to positions at PHU LOI from the AO of Operation CANARY/DUCK. Sixty (60) more 2½-ton trucks were employed to move the remainder of the maneuver elements to PHU LOI for airlift into an assembly area. A total of ninety (90) 2½-ton trucks from the 48th Group were used to extract the maneuver elements from the operational area at the termination of the operation. A total of 1,322.2 short tons of supplies were handled on this operation. Of this amount 74 short tons were used for Operation NIAGARA FALLS and 1,248.2 short tons were used on Operation CEDAR FALLS. A breakdown by class of supply follows:

NIAGARA FALLS

Class I	19.3 ST
Class II5 ST

CONFIDENTIAL

AVIE-SC
SUBJECT: Supply and Combat Support Activities

15 February 1967

48

Class III2 ST
Class V54.0 ST
TOTAL 74.0 ST

CEDAR FALLS
Bien Hoa

Class I 260.07 ST
Class II & IV 52.75 ST
Class III 574.69 ST
Class V 164.79 ST
TOTAL 1,052.30 ST

CEDAR FALLS
Lai Khe

Class III 8.1 ST
Class V 187.8 ST
TOTAL 195.9 ST

A total of 739 UH-1D sorties and five (5) CH-47 sorties were flown from the BSOC to forward elements of the Brigade.

b. Maintenance: A maintenance contact team consisting of two officers and twenty enlisted men from Company "D" Maintenance, 173d Support Battalion was located forward at Position RED and provided direct support maintenance. Back up support and resupply of repair parts was accomplished by road convoy resupply. A breakdown of support provided follows:

	<u>Jobs Received</u>	<u>Jobs Completed</u>	<u>Jobs Incompleted</u>
Mechanical Maintenance	37	37	0
Armament	141	140	1
Signal	92	92	0
Engineer	9	9	0
Service and Evacuation	17	17	0

A noticeable improvement in organizational maintenance was observed.

c. Medical: Company "B" (Medical) again provided medical support, employing four officers and thirty-five enlisted men, offering full surgical, medical and dental support. The clearing station service was used as the primary evacuation facility for casualties. Dustoff coverage was provided through the 1st Division clearing station. Daily routine evacuation was accomplished via 3/4-ton ambulance by road convoy and LOC helicopters returning to BIEN HOA for the night. A total of 382 patients were treated during the operation.

CONFIDENTIAL

49

173^D AIRBORNE BRIGADE (SEP)

IRON TRIANGLE OPERATION



NIAGARA - CEDAR FALLS

5-25 Jan 67

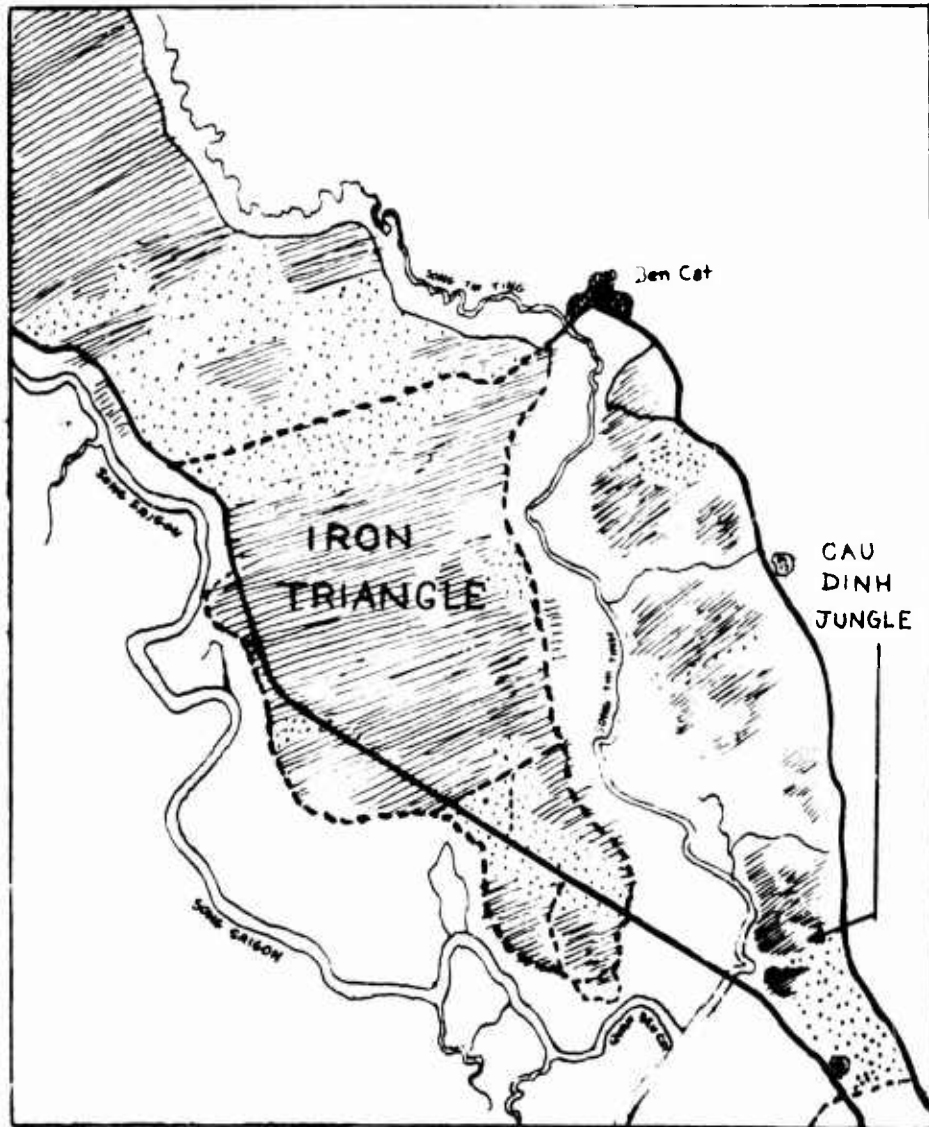

CONFIDENTIAL

CONFIDENTIAL

TABLE OF CONTENTS

51

TAB

PAGE

Tab A - Combat Operations After Action Report

1. General	1
2. Name of Operation	2
3. References	2
4. Type of Operation	2
5. Date of Operation	2
6. Location	2
7. Command Headquarters	2
8. Reporting Officer	2
9. Task Force Organization	2
10. Supporting Forces	2
a. USAF	3
b. Army Aviation	4
c. Artillery	5
d. E/17th Cavalry	6
e. Company D/16th Armor	8
f. 173d Engineer Company	8
g. 173d Military Police	10
h. 39th Infantry Platoon Scout Dog	11
i. 51st Chemical Detachment	11
11. Intelligence	12
12. Mission	16
13. Concept of Operation	16
14. Execution	18
15. Revolutionary Development	33
16. Logistics/Administrative Activities	36
17. Special Equipment/Techniques	39
18. Results of Operation	43
19. Commander's Analysis & Lessons Learned	49

Tab B - Maps of Area of Operation NIAGARA/CEDAR FALLS, 5 - 25 Jan 67

Tab C - Small Unit Actions - E/17th Cavalry

Introduction	1
Day Time Activities	2
Night Ambush (LRRP) 16 Jan 67	14
Night Ambush (LRRP) 17 Jan 67	15
Results	16

Tab D - Small Unit Actions - 2/503d Infantry

Night Ambush - 9 Jan 67	1
Night Ambush - 15 Jan 67	3

Tab E - Annexes to Tab C & D

Tab F - Tunnel Complex Drawings

Tab G - Photographs of Chieu Hoi Ralliers and Psy Ops Leaflets/Opn NIAGARA/CEDAR FALLS

CONFIDENTIAL

CONFIDENTIAL

DEPARTMENT OF THE ARMY
HEADQUARTERS 173D AIRBORNE BRIGADE (SEPARATE)
APO San Francisco 96250

53 AVBE-SC

25 February 1967

SUBJECT: Combat Operations After Action Report (Operation NIAGARA/CEDAR FALLS)

TO: Commanding General
1st Infantry Division
ATTN: ABVB-T
APO 96345

The following report is submitted in accordance with MACV Directive Number 335-8.

1. General: The wide spread terrorism in the SAIGON-CHOLON Area perpetrated the conception of Operation NIAGARA/CEDAR FALLS, one of the largest, most complex and one of the most effective operations in the VIETNAM WAR. Intelligence reports fed to MACJ2 indicated that the source of these terrorist activities, along with the location of the Viet Cong Military Region IV Headquarters was in fact located in the heretofore impenetrable IRON TRIANGLE* north of SAIGON. The mission of Operation NIAGARA/CEDAR FALLS: to seal off the Triangle and annihilate the enemy within, destroying his fortifications and generally crushing the power of the MR IV Headquarters.

The Operation was the first planned multi-division Operation in VIETNAM, employing the 1ST INFANTRY DIVISION, the 25TH INFANTRY DIVISION, the 196TH LIGHT INFANTRY BRIGADE, the 5TH ARVN DIVISION, elements of the 11TH ARMORED CAVALRY REGIMENT, the 18TH ENGINEER BRIGADE, and the 173D AIRBORNE BRIGADE (SEPARATE).

This marks the second time the Brigade has operated in the IRON TRIANGLE (OPORD 25-65, 8 - 14 October 1965). The task given to the 173D AIRBORNE BRIGADE (SEPARATE) was to conduct a deception or feint from a staging area near PHU LOI in the CAU DINH JUNGLE, an island of dense forest, north of a Rubber Plantation between NATIONAL HIGHWAY 13 and the THI TINH RIVER. (XT 7723).

*The IRON TRIANGLE was named in early 1963 by UPI writer Peter Arnett, a native of NEW ZEALAND and a veteran news correspondent, who noticed a basic similarity in enemy concentration between this area and the IRON TRIANGLE of the KOREAN CONFLICT. Both areas seemed virtually impenetrable owing to their difficult terrain. The people of VIETNAM refer to the area as "AN SON NORTH" meaning "new hamlet". The area has been a center of Viet Cong activity since early 1950. It is a transit area for VC moving from the north through the western edge, while local units move through the eastern edge. It was infested with local base camps, medical complexes and tunnel communication liaison areas. From the Triangle, the VC has been able to operate on HIGHWAY 13 to the east as well as conduct mortar and claymore mine attacks against friendly forces.

DOWNGRADED AT 3 YEAR INTERVALS
DECLASSIFIED AFTER 12 YEARS
DOD DIRECTIVE 5200.10

CONFIDENTIAL

CONFIDENTIAL

AVHE-SC

25 February 1967

SUBJECT: Combat Operations After Action Report (Operation NIAGARA/CEDAR FALLS)

54

2. Name of Operation: Operation NIAGARA/CEDAR FALLS
3. References: Map Sheets, VIETNAM, Series L - 7014, Sheets 6330 I, IV 6331 I, II, & IV, 6231 I, II, 6230 I.
4. Type of Operation: Search and Destroy
5. Date of Operation: 5 January 1967 to 25 January 1967
6. Location: BINH DUONG PROVINCE, THANH DIEN FOREST RESERVE, and IRON TRI-ANGLE west of BEN CAT and the CAU DINH JUNGLE.
7. Command Headquarters: 173d Airborne Brigade (Separate)
8. Reporting Officer: Brigadier General John R. Deane Jr.
9. Task Force Organization:

Operation NIAGARA FALLS

Task Force ALPHA

1/503d Inf
1 Engr Sqd
3 Scout Dog Tms
B/2/34th Armor
C/3/319th Arty (Dir Spt)
Tnk Plt/1/4th Cav - OPCON

35th Ranger Bn (ARVN) supported
the Operation

Operation CEDAR FALLS

Task Force DEANE

1/503d Inf - LTC BROWNLEE

1 Tnk Plt - 2/11th ACR
A/5/2d Arty (AW)
1 Engr Sqd
1 MP Sqd
3 Scout Dog Tms

4/503d Inf - LTC HEALY

D/16th Armor
1 Engr Sqd
1 MP Sqd
3 Scout Dog Tms

1/4th Cav, (1st Inf Div) - LTC FIFE

C/5/2d Arty (AW)

2/503d Inf - LTC SIGHOLTZ

1 Engr Sqd
1 MP Sqd
3 Scout Dog Teams

11th ACR (-) - COL COBB

2/11th ACR
3/11th ACR
1 MP Sqd

35th Ranger Bn (ARVN)

CONFIDENTIAL

CONFIDENTIAL

AVBE-SC

25 February 1967

SUBJECT: Combat Operations After Action Report (Operation NIAGARA/CEDAR FALLS)

Bde Control

1 Rifle Co - 4/503d Inf
E/17th Cav
3/319th Arty (+ 2d & 3d How Btry/11th ACR)
173d Engr Co (-)
335th AMCL
173d MP Plt (+ 2/A/72d MP Bn)
HHC (-)

10. Supporting Forces:

a. USAF

(1) Size of Force:

(a) 7th Air Force

1. 3d Tactical Fighter Wing
2. 12th Tactical Fighter Wing
3. 31st Tactical Fighter Wing
4. 8th Tactical Fighter Wing
5. 35th Tactical Fighter Wing

(b) The 19th Tactical Air Support Squadron of the 504th Tactical

Control Group

(2) How and When Employed:

(a) TAC Sorties:

3d TFW	77
12th TFW	7
31st TFW	17
8th TFW	11
35th TFW	<u>62</u>
TOTAL SORTIES	174

(b) FAC Sorties:

19th TASS 25

(c) VNAF Sorties 2

(d) Tons of Ordnance 206

(e) Visual Reconnaissance 35

(f) Escort Missions 9

CONFIDENTIAL

AVBE-SC

25 February 1967

56

SUBJECT: Combat Operations After Action Report (Operation NIAGARA/CEDAR FALLS)

(3) Results and Effectiveness:

Bomb Damage Assessments were limited due to smoke and foliage in the AO. No reports were made of ground assessments, however, numerous Viet Cong bodies were found in the areas subjected to airstrikes. Airstrikes also uncovered previously hidden VC installations.

(4) Timeliness: All sorties provided arrived within a usable time frame and most were effectively employed. Two flights were released because of ground action at the time of their arrival precluded their use. Two additional flights were released owing to the use of artillery fire also being employed in the target area.

(5) FAC (Forward Air Control) Pilots:

- (a) LTC Henry W. Burrow
- (b) CPT James T. Callaghan
- (c) CPT Eric E. Miller
- (d) CPT Arthur Roberts

b. Army Aviation:

(1) Size of Force:

During Operation CEDAR FALLS, the Brigade was supported by the following aviation units:

- (a) 11th Aviation Battalion
- (b) 145th Aviation Battalion
- (c) 335th Aviation Company (Air Mobile Light)
- (d) Brigade Aviation Platoon (Casper Platoon)

(2) How and When Employed:

<u>Mission</u>	<u>Sorties</u>
Aerial Observer	51
Armed Helicopter	1,010
Command and Liaison	752
Medical Evacuation	9
Aerial Reconnaissance	485
Resupply	2,956
Troop Combat Assault	2,006
Miscellaneous	<u>2,622</u>
TOTAL	9,717

(3) Aviation rendered normal support to the Brigade during Operation NIAGARA/CEDAR FALLS. The highlight of the Operation was the employment of the Sky Cavalry concept as developed by the Brigade. This concept involves movement of small units (12 men) in the checkerboard fashion with the AO.

CONFIDENTIAL

CONFIDENTIAL

57

AVBE-SC

25 February 1967

SUBJECT: Combat Operations After Action Report (Operation NIAGARA/CEDAR FALLS)

(4) A total of 2,245 hours were flown in support of the Operation. Aircraft flew an average of 112 hours per day.

(5) A total of 15,853 passengers were carried during the Operation.

(6) A total of 682 tons of cargo was moved during the Operation for a daily average of 34 tons.

(7) Results and Effectiveness:

(a) The Aero Scouts proved to be highly effective in spotting enemy positions, personnel and rice caches and structures.

(b) The Aero Scout section captured 2 VC on two separate occasions.

(c) The team of scouts, gunships and slicks used in the Sky Cavalry operations proved to be very flexible and the configuration of the light elements may be tailored to fit any requirement.

(8) Timeliness: In no case did the aviation elements fail to respond rapidly to meet a new or changing situation.

c. Artillery

(1) Size of Force:

Btry A, 3d Bn, 319th Arty (6 105mm How)
Btry B, 3d Bn, 319th Arty (6 105mm How)
Btry C, 3d Bn, 319th Arty (6 105mm How)
How Btry, 2d Sqdn, 11th ACR (6 105mm SP) OPCON
How Btry, 3d Sqdn, 11th ACR (6 105mm SP) OPCON
Btry C, 2d Bn, 35th Arty (155mm SP) GSR (17 Jan 67 to 25 Jan 67)
Btry A, 2d Bn, 35th Arty, (155mm SP) GSR (8 Jan 67 to 25 Jan 67)
Additional Artillery from Div Arty, 1st Inf Div (8", 155mm & 175mm) also utilized throughout the operation.

(2) How and When Employed:

(a) On call missions were fired daily throughout the Operation by both ground and air observers. The air observer was used for registrations and missions as requested by ground elements. The ground observer attached to the infantry company fired contact missions and defensive concentrations in support of their units.

(b) H & I fires were planned daily by forward observers, battalion liaison officers and the battalion S3.

(c) Preparation of Landing Zones:

LZ #5 - 091051 to 091100H January 1967
LZ #6 - 091211 to 091231H January 1967
XT 719271, XT 716276, XT 721280, XT 717277, XT 720279 - 130730 to 130746H January and 130820 to 120830H January 1967.

CONFIDENTIAL

CONFIDENTIAL

58

AVBE-SC

25 February 1967

SUBJECT: Combat Operations After Action Report (Operation NIAGARA/CEDAR FALLS)

XT 692246 to XT 711250 - 150930 to 151002H January 1967
XT 737256 to XT 738254 - 160805 to 160903H January 1967
XT 721260 to XT 729260 - 180725 to 180906H January 1967
LZ #2 - 181645 to 181743H January 1967
LZ #3 - 181645 to 181700H January 1967
LZ #4 - 181705 to 181730H January 1967
LZ MIKE - 200700 to 200835H January 1967
LZ BOB - 200700 to 200835H January 1967
LZ TOM - 200700 to 200730H January 1967
Preparation for route of advance 200915 to 201040H Jan 67

(3) Results and Effectiveness: Preparatory fires on landing zones and routes of advance were very effective. Numerous secondary explosions were observed during the preparations of landing zones and routes indicated destruction of enemy mines and boobytraps. Enemy resistance was generally light and consisted mainly of harassing actions. Artillery support was therefore characterized by numerous missions of brief duration which were intended to seal off the enemy route of escape or to reduce small fortified points of resistance. H & I fires were active by day and night, restricted only by the amount of terrain not occupied by friendly elements. The effectiveness of this program is indicated by the numerous bodies with shrapnel wounds found during the operation.

(4) Timeliness:

Coordination between Artillery, TAC Air and gunships was very effective. On call fire missions were processed quickly, delays occurring only when several adjacent units were required to approve missions in the operational area to insure troop safety through verification of unit locations.

(5) Missions and Rounds Fired:

(a) 3d Battalion, 319th Artillery

Missions - 789
Rounds Expended - 28,593

(b) Operational Control Units

1. Howitzer Battery/2/11th ACR

Missions-190
Rounds Expended - 7,528

2. Howitzer Battery/3/11th ACR

Missions - 210
Rounds Expended - 7,815

d. E Troop, 17th Cavalry

(1) Size of Force:

3 Cavalry Platoons (Can be employed as Aero Rifle Platoons)
1 LRRP Platoon
1 Aero Scout Section (Less OH-13's and Pilots)

CONFIDENTIAL

CONFIDENTIAL

59

AVHE-SC

25 February 1967

SUBJECT: Combat Operations After Action Report (Operation NIAGARA/CEDAR FALLS)

(2) How and When Employed:

(a) The unit's mission was to conduct air mobile search and destroy operations in the rice paddies in the southwestern portion of the IRON TRIANGLE, along the SAIGON RIVER.

(b) The area of operations was confined to the rice paddies and adjacent areas along the SAIGON RIVER. Weather throughout the operation was relatively cool and dry. The terrain was characterized by inundated rice paddies cut by many deep tree lined canals varying in width from 3 to 40 feet. None of this area was considered trafficable for the surface type vehicles organic to the Cavalry Troop. Numerous straw thatched huts containing log and mud or (occasionally) concrete bunkers were located in the canal tree lines.

(c) The unit used none of its organic vehicles during the operation and organized each armored cavalry platoon into three (3) 12-man squads for airmobile operations. Each squad was normally armed with one (1) M-60 machine-gun, one (1) M-79 grenade launcher, and ten (10) M-16 rifles. Each man carried both smoke (colored) and M-26 fragmentary grenades. Aircraft for the operation were attached for varying lengths of time on a day to day basis. The number and type of aircraft varied but the normal organization was as follows:

- 2 - OH-13 Aero Scouts
- 2 - UH-1B Gun Ships
- 4 - UH-1D Slicks
- 1 - Command and Control Aircraft (UH-1B)

(d) The enemy encountered was at no time larger than squad size and normally consisted of 2 to 3 man elements. Initially, (1st and 2d day) the enemy encountered were primarily small work parties of about 3-man sized who were living along the tree lined canals with the probable mission of harvesting as much rice as possible from the surrounded rice paddies. As the main force closed in on the IRON TRIANGLE, the enemy encountered were transient groups attempting to infiltrate or exfiltrate the TRIANGLE area along the canals and through the rice paddies. Few weapons were captured and where possible, the enemy fled without a prolonged fire fight. Contact seldom lasted more than 2 to 5 minutes.

(e) The basic scheme of maneuver was as follows:

1. During the day time, 2 platoons were placed on the ground to search selected tree lines and move from one to another by helicopter as deemed necessary. The 3d platoon was held as a quick reaction force with one 12-man team (2 A/C) airborne near or over the area of operations. The armed helicopters were used to support the ground elements as follows:

a. The OH-13 Scouts performed low and slow armed recon of the area to select and mark landing sites and to detect any enemy who might be attempting to flee from the ground elements.

b. The gun ships provided fire support for the UH-1D troop carriers while they were landing and taking off by firing suppressive fire when the situation permitted or by being ready to return enemy fire during this critical period. They also supported the movement of the ground elements and destroyed targets of opportunity with their quickly responsive fire power.

CONFIDENTIAL

CONFIDENTIAL

AVRE-SC

25 February 1967

60

SUBJECT: Combat Operations After Action Report (Operation NIAGARA/CEDAR FALLS)

c. During the hours of darkness, 12-man stay behind ambush patrols were placed in selected locations with preplanned artillery support to deny enemy freedom of movement and inflict maximum casualties.

d. All orders for the operation were verbal and Frag orders were frequently used.

(3) Results and Effectiveness: See Tab C, page 16 & 17

(4) Timeliness: N/A

e. Company D, 16th Armor

(1) Size of Force:

(a) 3 APC Platoons (4 APC's per platoon)

(b) 1 Mortar Platoon (4 4.2" mortar tracks, one (1) FDC APC)

(c) 1 Command APC

(2) How and When Employed:

(a) The mission for this unit on 9 January was to provide a screen. On 11 through 24 January 1967, the mission was to seize and hold OBJECTIVE 5 and OBJECTIVE 6.

(b) This unit was under the operational control of the 4/503d Infantry Battalion through the duration of the operation. Supporting units consisted mainly of artillery batteries, to include 3/319th Artillery. Army Aviation (335th AMCL), organic to the 173d Airborne Brigade (Separate), USAF, and the 4.2" mortar platoon also provided necessary support. Reaction forces were at all times available if operational requirements had made it necessary to call on them, and on one occasion, it was necessary to call on elements of the 11th ACR to aid this unit in its mission.

(3) Results and Effectiveness:

Operation CEDAR FALLS was an excellent operation as far as the use and deployment of this company's armored capabilities are concerned. On all occasions, maximum use of shock-action and fire power of the APC were utilized. The company was also used in perimeter defense, however, due to the close proximity of the other units, the caliber .50 machinegun could not be used, thus reducing the effectiveness of the company's basic weapon/vehicle, the M113 APC. The company reacted well to all types of enemy contact, and where engaged, the volume of fire returned was timely and well controlled.

(4) Timeliness: N/A

f. 173d Engineer Company

(1) Size of Force:

Two (2) Line Platoons (Combat Engineers)

One (1) Bridge Platoon (Boats)

One (1) Maintenance Platoon

CONFIDENTIAL

CONFIDENTIAL

AVRE-SC

25 February 1967

SUBJECT: Combat Operations After Action Report (Operation NIAGARA/CFDAR FALLS)

(2) How and When Employed: The 173d Engineer Company deployed on Operation CEDAR FALLS with the company (-) attached to three Infantry battalions. The Engineers supported the Brigade with "Tunnel Rat" Teams, demolition teams, road reconnaissance and repair, mine clearing and water point operations in addition to aiding in the securing of the northwest portion of the Brigade's perimeter. A day by day outline of the Engineer Company's activities follows:

(a) 7 - 13 January 1967:

Conducted river patrolling, river traffic control and resupply operations for the 1/503d Infantry.

(b) 8 - 10 January 1967:

1. Arrived at Position RED and established perimeter security. A water point was established in the vicinity of XT 745336.

2. Cleared TOC area, insuring that it was free of mine boobytraps, etc.

3. Constructed TOC Command bunker

4. Conducted river reconnaissance with pneumatic assault boats, vicinity XT 738328.

5. Constructed a Refugee Center (100 meters x 150 meters) vicinity XT 733323.

(c) 11 January 1967:

1. Repaired road leading to the Refugee Center.

2. Hauled, tamped and graded laterite

(d) 12 January 1967:

1. Deployed as Infantry - sent out night ambush patrol, having negative results.

2. Destroyed a quantity of VC ammunition and grenades whose location was supplied by the 172d MI Detachment.

(e) 14 January 1967:

1. Cleared fields of fire for the 1/503d Infantry with heavy equipment.

2. Cleared laterite pit of mines at Position RED.

3. Supported the repair of ARVN Bulldozers

4. Sent out a night ambush patrol having negative results.

(f) 15 January 1967:

Cleared a 1,500 meter section of HIGHWAY 14.

CONFIDENTIAL

(g) 16 January 1967:

Engaged in light enemy contact on perimeter resulting in 1 VC KIA (BC) and 1 US WIA.

(h) 14 - 21 January 1967:

1. Constructed a floating mine barrier on river vicinity of bridge XT 737332. See Special Equipment/Techniques.

2. Picked up eight (8) Chieu Hoi detainees, vicinity XT 682275.

3. Picked up three (3) Chieu Hoi detainees, vicinity XT 677290.

(i) 22 January 1967:

Discovered 30 tons of paddy rice which was evacuated to the BSC.

(j) 23 January 1967:

Conducted Civic Action Projects, vicinity of BEN CAT.

(k) 8 - 23 January 1967:

1. Explored, mapped, and destroyed 9,000 meters of VC tunnel network, 200 separate bunkers, and 500 meters of trench in the IRON TRIANGLE.

2. Produced and distributed 139,000 gallons of potable water to units in the 173d Airborne Brigade (Separate), 1st Infantry Division and the 11th Armored Cavalry Regiment.

(3) Results and Effectiveness:

Operation NIAGARA/CEDAR FALLS found the 173d Engineer Company expending most of its effort on tunnel exploration, mapping and destruction of tunnels. By using small caliber pistols and flashlights, and by maintaining communication by wire at all times, the "Tunnel Rat" Teams were able to move quickly with confidence while relaying information to other teammates. (See Tab F - Tunnel Complex Drawings)

g. 173d Military Police Platoon

(1) Size of Force: The 173d Military Police Platoon consists of 1 Officer and 50 enlisted men. During Operation NIAGARA/CEDAR FALLS, the men were employed as follows:

Brigade CP	1 Officer, 29 EM
1/503d Inf	7 EM
2/503d Inf	7 EM
4/503a Inf	7 EM

CONFIDENTIAL

AVBE-SC

25 February 1967

SUBJECT: Combat Operations After Action Report (Operation NIAGARA/CEDAR FALLS)

(2) How and When Employed:

(a) To provide necessary traffic control points for movement of the Brigade to and from the tactical area of operations.

(b) To establish, operate and secure a Refugee Collection Point, vicinity of BEN CAT, RVN.

(c) Secured two bridges, vicinity of BEN CAT and provided de-file control during daylight hours.

(d) Provided escort and security for daily Brigade resupply convoys to and from BIEN HOA.

(e) Maintained a PWCP (Prisoner of War Collection Point) at the Brigade Forward Base Camp.

(f) Performed other missions as required.

h. 39th Infantry Platoon Scout Dog

(1) Size of Force:

(a) 3 squads of six (6) dog teams per squad

(b) HQ section with Platoon Leader, Platoon Sergeant and a Veterinary Animal Specialist.

(2) How and When Employed:

The Scout Dog is trained to detect and give silent warning of the presence of any strange individual or group. He will prove especially useful in warning of ambushes and attempts at infiltration. The scout dog is worked by one (1) man, the handler, who has been especially trained in this type of work. The dog works on a short or long leash most of the time, however, being off the leash entirely. The dogs work in daylight or darkness, in any kind of weather and in jungle or open country. The scout dogs were employed in the following manner:

(a) Reconnaissance Patrols

(b) Combat Patrols - Search and Destroy

(c) Outposts, Listening and Observation

(d) Night Attacks

(3) Results and Effectiveness:

During Operation NIAGARA/CEDAR FALLS, the scout dog teams attached to the Infantry units were instrumental in detecting VC positions, tunnels, base camps, rice and supply caches. There were twelve (12) teams deployed on the operation, participating in eighty (80) patrols. During the Operation, one dog was lost which has not been recovered.

i. 51st Chemical Detachment:**CONFIDENTIAL**

CONFIDENTIAL

AVBE-SC

25 February 1967 64

SUBJECT: Combat Operations After Action Report (Operation NIAGARA/CEDAR FALLS)

(1) Size of Force: 1 Officer and 4 Enlisted Men

(2) How and When Employed: The 51st Chemical Detachment employed an 18 HP BUFFALO TURBINE (See Special Equipment/Techniques) mounted either on an APC or on a sling load of a UH-1D helicopter to aid in the exploration of VC tunnels. The turbine weighs 800 pounds and is capable of displacing 8,500 cubic feet per minute of air, smoke or CS into a tunnel entrance. For a complete analysis of the employment of this turbine, see page 4L.

(3) Results and Effectiveness: The BUFFALO TURBINE proved to be highly effective in the following missions:

(a) Flushing VC from tunnels by pumping smoke into the shaft.

(b) Locating tunnel entrances and ventilation holes and thus tracing the configuration of the tunnel by blowing smoke into known entrances, while aerial observers mark the various exits of the smoke.

(c) Flushing smoke and Riot Control Agent (RCA) vapors from a tunnel to enable entrance of tunnel exploration teams.

(d) Furnishes fresh air in badly ventilated tunnels to aid the exploration parties.

(4) Timeliness: Few delays were experienced due to easy transportability of the equipment by helicopter or APC.

11. Intelligence

a. Operation NIAGARA FALLS - 5 January to 7 January 1967

(1) Enemy Situation Before Operation: Prior to the commencement of Operation NIAGARA FALLS, in an area consisting of the southern tip of the IRON TRIANGLE, the PHU LOI Viet Cong Local Force Battalion and the C-63d Viet Cong Companies were believed to be operating in addition to the 2d and 3d Viet Cong Main Force Battalions of the 165/A VC Main Force Regiment. The enemy's morale was believed to have been lowered by poor living conditions coupled with friendly artillery and air strikes. The enemy was attributed with the capability of:

(a) Initiating harassing attacks in the Brigade's AO and interdicting ROUTE 13 at his choosing.

(b) Reinforcing guerrilla elements with elements of the PHU LOI Local Force Battalion and the 2d and 3d Battalions of the 165/A Regiment.

(c) Defense in a limited area for a short period of time.

(d) Withdrawing from or avoiding contact at anytime and place of his choosing.

(2) Enemy Situation During Operation: During Operation NIAGARA FALLS, elements of the Brigade failed to make contact with enemy forces larger than five (5) men. One small base camp was found and a few small food and equipment caches were discovered, none of which indicated that a large size unit had used the area recently. It was believed, however, that when US or ARVN troops are not present, the VC will continue to infiltrate both men and supplies through the area.

CONFIDENTIAL

CONFIDENTIAL

65

AVBE-SC

25 February 1967

SUBJECT: Combat Operations After Action Report (Operation NIAGARA/CEDAR FALLS)

(3) Area of Operations:

(a) Weather and Climate: The northeast monsoon influenced the weather during Operation NIAGARA FALLS. Precipitation during the operation was light and was normal for the season. There was no morning fog. The weather did not appear to aid the enemy in any specific manner.

(b) Terrain: The AO was characterized by flat land with minor changes in elevation. The highest point of elevation in the AO is a gentle slope, 28 meters in height, located vicinity XT 801232. The SONG SAIGON and the SONG THI TINH form the major drainage pattern for the AO. There are numerous small streams, tributaries, and intermittent streams interlaced throughout the entire area. The RACH ONG MARG (XT 766191 to XT 770175) provided an irrigation channel for the extensive rice fields located in the southwestern portion of the AO. The two large rivers formed major obstacles to the west and portions of the south. A relatively large number of rubber plantations were centered at XT 785210. Small islands of dense forest were located throughout the AO. The largest of these dense forests was located north of a rubber plantation between NATIONAL HIGHWAY 13 and SONG THI TINH.

b. Operation CEDAR FALLS - 8 January to 25 January 1967

(1) Enemy Situation Before Operation: Prior to the commencement of Operation CEDAR FALLS, the 272d VC Main Force Regiment, the 7th Battalion of the 165th/A Regiment, the PHU LOI Battalion, the local force companies C61, C62 and C63 were believed to be operating within the areas of operation and interest. The 2d and 3d VC Main Force Battalions of the 165/A Regiment were believed to be within the area surrounding the Triangle, but the exact location was not known. The enemy's morale had been lowered by TAC airstrikes and intensive artillery preparations. The enemy was attributed with the following capabilities:

(a) Initiating harassing attacks within the AO and interdicting ROUTE 13 at his choosing.

(b) Reinforcing guerrilla elements with the PHU LOI Battalion and/or the 2d and 3d Battalions of the 165/A Regiment.

(c) Conducting a limited defense at his choosing.

(d) Withdrawing from or avoiding contact with US Forces.

(2) Enemy Situation During Operation: From 8 January to 25 January 1967, elements of the 173d Airborne Brigade (Separate) and the 11th Armored Cavalry Regiment (-) maintained daily contact with the enemy. The sporadic contacts were usually initiated by friendly forces and terminated by VC withdrawal. The largest contact was on 16 January by C/4/503d Infantry with a VC platoon. Numerous VC base camps, rice caches, and tunnel systems were destroyed. The large amount of rice extracted from the operational area has reduced the VC logistical abilities. The quartered carcass of an animal which had been dead for four days was found in the operational area. This was an indication of the effects of the operation on the enemy logistical base. The enemy's low morale was reflected by the large number of ralliers who surrendered after US Forces entered the IRON TRIANGLE. Prisoners were taken from the following units: C61 LF Company, 2d Company of the PHU LOI Battalion, Group 83 (Rear Services of the MR IV), and I-4 (subordinate committee of the MR IV). An estimated 25,000 documents were captured

CONFIDENTIAL

CONFIDENTIAL

AVBE-SC

25 February 1967

66

SUBJECT: Combat Operations After Action Report (Operation NIAGARA/CEDAR FALLS)

during the operation. The majority of these have not been fully exploited for intelligence value since only the initial tactical screening was conducted. On several occasions, Chieu Hoi's lead friendly troops to previously undiscovered tunnels, weapons caches and rice caches. Without their assistance, these installations probably would not have been found.

(3) Area of Operations:

(a) Weather and Climate: The Northeastern Monsoon was in effect during the operation. The weather was predominantly clear, cool and dry. Two thunderstorms occurred but these did not interfere with tactical operations. A combination of gusty winds and lower nocturnal temperatures produced noticeable cold spells during one week of the operation. The weather hindered no tactical operation during the period.

(b) Terrain: The area of operations, commonly called the IRON TRIANGLE was bounded by the SONG SAIGON on the west and the SONG THI TINH on the east. The highest point of elevation in the AO was a 28 meter hill located at XT 80L232. A relatively large rubber plantation was located at XT 785-210. A large dense forest area was located north of a rubber plantation between NATIONAL HIGHWAY 13 and the SONG THI TINH. NATIONAL HIGHWAY 13 was the main route in the area. The operational area was found to contain numerous underground tunnels and dwellings. The majority of these were destroyed.

c. Sources of Intelligence:

(1) General: Attached to the 173d Airborne Brigade (Separate) is a Military Intelligence Section (172d Military Intelligence), which works under the supervision of the Brigade S2 Section, and provides an Order of Battle Section, an Imagery Interpretation Section, an Interrogation Section and a Counterintelligence Section.

(2) During Operation NIAGARA/CEDAR FALLS, the 172d Military Intelligence Detachment contributed significantly to the overall success enjoyed by the Brigade. As the operation developed, it became apparent that a large percentage of the caches and installations discovered were a direct result of intelligence gained through agent reports, reconnaissance and interrogation. Of particular interest during the operation was the co-location of the 541st Military Intelligence Detachment (11th ACR) with the 172d. This resulted in improved coordination between the units and a larger pool of IPW teams and CI personnel which kept the backlog of prisoners in the VCCCP to a minimum. Further it enabled the cross utilization of information. Also of significance was the number of refugees screened. In the clearing of the AO, hundreds of families were evacuated from their homes. The detachment had the responsibility of screening these people to determine those that were VC or active VC sympathizers. In total, 1,000 families were processed including 950 women, 870 children and 55 men. Through the screening process, 16 VC, 11 civil defendants, and 9 ralliers were uncovered. The civil defendants were released to the National Police and the VC ralliers were sent to the VCCCP for further exploitation. During the six days that this point was in operation, much valuable information was gained concerning VC activities in the AO. Additionally, refugees that would have ordinarily been overlooked were screened and found to be VC or ralliers. This discovery was only through the efforts of trained interrogation personnel.

CONFIDENTIAL

CONFIDENTIAL

67

AVBE-SC 25 February 1967
SUBJECT: Combat Operations After Action Report (Operation NIAGARA/CEDAR FALLS)

(a) Imagery Interpretation Section

1. Imagery Interpretation support for Operation NIAGARA/CEDAR FALLS consisted of preparation of immediate, detailed and route reconnaissance reports. Mosaics, weather and aerial reconnaissance and photography support were also furnished. The detail and scope of the Imagery Interpretation effort was greater on this operation than any previous operation primarily because of the relatively long lead time available. This time allowed for necessary planning which permitted both greater accuracy and wider coverage. Extensive photo support was obtained from the ASTA Platoon of the 1st Infantry Division which covered the entire operational area, including all primary access routes. The photo support obtained from the 1st Division was prompt and the photography was of uniformly high quality. A larger number of targets were discovered through aerial photography on this operation.

2. Aerial reconnaissance support was flown by both Army and Air Force Aircraft. During the second week of the operation, the recon area became quite limited due to heavy artillery and air strike activity. Although there were no enemy personnel sighted on any of the recons, numerous installations such as bunkers, tunnels, foxholes, etc. were reported. FAC aircraft were used extensively in providing recon support for Operation CEDAR FALLS.

2. Imagery Interpretation support for Operation CEDAR FALLS consisted of the following items:

<u>AERIAL RECONNAISSANCE</u>	<u>MISSIONS</u>	<u>HOURS</u>
Army (UH-1B)	45	12
Air Force (L-19)	31	7
Mosaics Completed		12
<u>Photo Interpretation Reports</u>		
Immediate		13
Detailed		2
Route Recon		2

(b) Counterintelligence

During Operation NIAGARA/CEDAR FALLS, the Counterintelligence efforts were greatly enhanced by the co-location of the CI team with the IPW team. This co-location enabled immediate CI response to information obtained in the interrogation of prisoners, refugees, and Chieu Hoi returnees. Close CI liaison with counterpart elements of other units participating in the operation resulted in the acquisition and subsequent exploitation of considerably valuable target information not available through other channels. The immediate liaison efforts of the USARV Augmentation Team resulted in timely and accurate intelligence available for quick combat response.

(c) Interrogation: A statistical summary of personnel, documents and material processed during Operation CEDAR FALLS follows:

Detainees:

VC 50

CONFIDENTIAL

AVBE-SC

25 February 1967

68

SUBJECT: Combat Operations After Action Report (Operation NIAGARA/CEDAR FALLS)

Civilians	118
Civil Defendants	42
Chieu Hoi	69
TOTAL	279

Documents	20,000
Weapons	187
Mortars	3
Ammunition	9,000 rnds
Mines	31
Grenades	189
Clothing	205 lbs
Web Gear/uniforms	140 lbs
Medical Supplies	105 lbs

Radio Equipment

PRC/10	5
HT-1 Walkie Talkies	1
Homemade Radios	1

12. Mission: Operation NIAGARA/CEDAR FALLS

The mission of the 173d Airborne Brigade (Separate) during this operation was two fold as follows:

a. The Brigade CP deployed directly from Operation CANARY/DUCK, a road security operation astride HIGHWAY 15 to PHU LOI on 4 January 1967. The Brigade passed from the Operational Control of II FFORCEV to the 1st Infantry Division. On 5 January, the Brigade deployed the 1st Battalion, 503d Infantry on Operation NIAGARA FALLS. The mission was to conduct a deceptive feint into the CAU DINH Jungle and conduct search and destroy operations in preparation for the larger scale, multi-division Operation CEDAR FALLS.

b. Operation CEDAR FALLS (8 January to 25 January 1967) had the mission of conducting search and destroy operations in the vicinity of the THANH DIEN FOREST RESERVE and in the IRON TRIANGLE, to kill or capture military and/or political elements of the VC Military Region IV Headquarters, Local Force Infrastructure and VC/NVA Forces. In addition, the Brigade was assigned the task of clearing the area of inhabitants, cutting belts across the IRON TRIANGLE and clearing selected LZ's within the Area of Operation. The Brigade's Task Force (TF DEANE) was under the Operational Control (OPCON) of the 1st Infantry Division throughout Operation NIAGARA/CEDAR FALLS.

13. Concept of Operation: The 173d Airborne Brigade (Separate) conducted Operation NIAGARA/CEDAR FALLS in five (5) phases as follows:

a. PHASE I: Operation NIAGARA FALLS - D - 3 to D - 1 (5 to 7 January 1967)

TF 1st Battalion, 503d Infantry (Abn), 1st Squadron, 4th Cavalry (-) and 35th Ranger Battalion (ARVN), initiated Operation NIAGARA FALLS at 0730 hours under the Operational Control of the 1st Infantry Division. The Task Force searched for the enemy in the CAU DINH JUNGLE and the THI TINH RIVER to HIGHWAY 13 Area. When Operation NIAGARA FALLS terminated at 1500 hours, 7 January, the 1/503d Infantry and the 35th Ranger Battalion were in blocking positions to support Operation CEDAR FALLS. The Operation produced light enemy contact, but its significance lies in the fact that a deceptive feint had been achieved.

CONFIDENTIAL

CONFIDENTIAL

69
AVBE-SC

25 February 1967

SUBJECT: Combat Operations After Action Report (Operation NIAGARA/CEDAR FALLS)

b. PHASE II - Pre-Positioning of Forces - D Day (8 January 1967)

(1) 1/503d Infantry and 35th Ranger Battalion (ARVN) remained in position from Operation NIAGARA FALLS to serve as a blocking force at the confluence of the THI TINH and SAIGON RIVER.

(2) 2/503d Infantry and 4/503d Infantry road marched to PHU LOI and were helilifted to Position BLUE, vicinity XT 8328.

(3) The 11th Armored Cavalry Regiment road marched to the vicinity of the CAU DINH JUNGLE (XT 7823).

(4) The 1/4th Cavalry (-) moved from their AO of Operation NIAGARA FALLS to the vicinity of BEN CAT.

c. PHASE III - Attack into the IRON TRIANGLE and the THANH DIEN FOREST RESERVE - D + 1, D + 2, 9 through 10 January 1967.

(1) The 1/503d Infantry remained in its present position

(2) 2/503d Infantry and 4/503d Infantry conducted heliborne assaults into LZ's 4 and 6 in the TANH DIEN FOREST RESERVE.

(3) The 11th ACR initiated attacks across BEN CAT Bridges west into the IRON TRIANGLE.

(4) 1/4th Cavalry conducted screening of NATIONAL HIGHWAY 13.

d. PHASE IV-Attack South into IRON TRIANGLE - D + 3 through D + 16 11 January through 24 January 1967.

(1) During this Phase, the 1/503d Infantry:

(a) Served as a blocking and reserve force in position.

(b) Conducted thorough Search and Destroy Operations in the western portion of the IRON TRIANGLE.

(c) Conducted platoon sized Eagle Flights in AO.

(2) The 2/503d Infantry attacked south into the IRON TRIANGLE on the west side including airmobile assault on suspected enemy locations.

(3) The 4/503d Infantry with D/16th Armor under its OPCON attacked south into the southeastern portion of the IRON TRIANGLE.

(4) During this phase, the 11th ACR (-):

(a) Attacked south into the IRON TRIANGLE along the west flank, and then conducted search and destroy operations in the southern portion of the AO. This was conducted by 3/11th ACR.

(b) The 2/11th ACR continued security missions along the northern edge of the IRON TRIANGLE.

(c) The 2/11th ACR and 3/11th ACR linked up in the southern portion of the IRON TRIANGLE.

CONFIDENTIAL

CONFIDENTIAL

AVBE-SC

25 February 1967

70

SUBJECT: Combat Operations After Action Report (Operation NIAGARA/CEDAR FALLS)

e. PHASE V - Extraction of elements of the 173d Airborne Brigade (Separate) from the AO of Operation CEDAR FALLS.

(1) The 11th ACR (-) with the 2/503d Infantry OPCON left the AO of Operation NIAGARA/CEDAR FALLS by road march on 24 January 1967, with a major portion of the 173d Engineer Company.

(2) The remaining elements of the Brigade departed the operational area and closed at BIEN HOA on 25 January 1967.

14. Execution: This Combat After Action Report will be handled day by day with an accompanying map (located in TAB B) to show the major unit movements of maneuver elements during the period. Additionally, changes in the basic Task Force will be included on the days that change occurred.

a. D - 3 (5 January 1967) - Operation NIAGARA FALLS

Task Force Organization: See page 2, Paragraph 9

Operational Summary: The 173d Airborne Brigade (Separate) initiated Operation NIAGARA FALLS at 0607 hours in the CAU DINH JUNGLE. The 1/503d Infantry conducted a heliborne assault from its assembly area at PHU LOI to LZ LOIS (XT 774237) with Company A and elements of the Battalion's HQ. The remainder of the Battalion followed, closing at 0852 hours. Team BRAVO and Team ARMOR, consisting of B/2/34th Armor (-) and recon platoon conducted search and destroy operations in the CAU DINH AO (vic XT 7723). The Battalion CP and Company C displaced from LZ LOIS at 1100 hours and proceeded to their proposed CP area at XT 773224. B/2/34th Armor was released OPCON 1/503d Infantry at 1700 hours.

The 1/4th Cavalry (-) moved by road at 0700 hours with A/5-2d Arty (AW) and secured blocking positions along HIGHWAY 13 from XT 798227 to the road junction at XT 801223. B/1/4th Cavalry conducted Search and Destroy operations in the CAU DINH JUNGLE.

The 1st Engineer Battalion made the only contact of the day at 0925 hours, killing 4 VC (BC).

b. D - 2 (6 January 1967)

Changes in Task Force Organization: no changes

Operational Summary: The 173d Airborne Brigade (Separate) continued to operate in the CAU DINH JUNGLE in preparation for Operation CEDAR FALLS. The 1/503d Infantry continued its search and destroy operations in the AO.

The 35th Ranger Battalion (ARVN) maintained blocking positions at the confluence of the SAIGON and THI TINH RIVERS. The 1/4th Cavalry continued to block along HIGHWAY 13 and secure the 1st Division Engineers work parties who were clearing areas in the jungle.

There were no engagements on this day with the enemy.

c. D - 1 (7 January 1967)

Changes in Task Force Organization: no change

CONFIDENTIAL

CONFIDENTIAL

71

AVBE-SC

25 February 1967

SUBJECT: Combat Operations After Action Report (Operation NIAGARA/CEDAR FALLS)

Operational Summary: Operation NIAGARA FALLS was terminated at 0900 hours with the 173d Airborne Brigade (Separate) moving with OPCON units into position for Operation CEDAR FALLS.

The 1/503d Infantry established blocking positions along the THI TINH RIVER with Company A in the north, Company B in the center and Company C in the south. A/5-2d Artillery, equipped with automatic weapons, were also positioned to command the river escape routes.

At 0930 hours, 1/4th Cav (-) was released of OPCON of the 173d Airborne Brigade (Separate) and returned to PHU LOI. The 35th Ranger Battalion maintained its blocking position at the confluence of the THI TINH and SAIGON RIVERS.

d. D - Day (8 January 1967) - Operation CEDAR FALLS

Task Force Organization: see page 2, paragraph 9. The Serial March into the AO was conducted as follows:

<u>SERIAL #1</u>	<u>SERIAL #2</u>	<u>SERIAL #3</u>
HHC (-)	E/17th Cav (-) D/16th Armor Co/4/503d Inf 3/319th Arty (-) 173d Engr Co	2/503d Inf 4/503d Inf (-)
<u>SERIAL #4</u>	<u>SERIAL #5</u>	
173d BSOC	Plt/E/17th Cav C/3/319th Arty	

Operational Summary: The 173d Airborne Brigade (Separate) and OPCON units initiated Operation CEDAR FALLS by conducting movement to the vicinity of BEN CAT and PHU LOI by road convoy, helilift and Air Force Cargo aircraft. The Brigade positioned its forces for the coordinated attack (3 battalion) on D + 1. The Brigade's Task Force PEANE became OPCON of the 1st Infantry Division at 0800 hours.

The Brigade Headquarters elements began a motor march from PHU LOI to Position RED (See overlay, D - Day), using HIGHWAY 13, closing at 0915 hours. The 1/503d Infantry remained in its blocking position assumed during Operation NIAGARA FALLS.

The 2/503d Infantry and 4/503d Infantry departed BIEN HOA at 1000 hours and were flown by Air Force Aircraft to PHU LOI, closing at 1138 hours. At 1300 hours, the 2/503d Infantry and 4/503d Infantry began a helilift to Position BLUE (See Overlay). The 2/503d Infantry closed at 1333 hours. At 1700 hours the Recon Platoon of the 2d Battalion engaged 2 VC at XT 848282, wounding one before they fled south. The troops of the Recon Platoon followed the blood trail, discovering 2 more VC in the process. The VC fired 8 - 10 rounds of semi-automatic fire, fired 1 rifle grenade and threw 1 hand grenade. The Recon Platoon returned fire with unknown results. There were negative friendly casualties.

At 1410 hours, the 4/503d Infantry closed at the assembly area at Position BLUE. At the same time, the 3/319th Artillery "B" and "C" Batteries arrived at Position WHITE from PHU LOI. The E/17th Cavalry had the responsibility of securing Position WHITE. Alpha Battery, 3/319th Artillery was stationed at the Brigade CP Area, Position RED. They arrived at the CP at 1210 hours.

CONFIDENTIAL

CONFIDENTIAL

AVHF-SC

25 February 1967

SUBJECT: Combat Operations After Action Report (Operation NIAGARA/CEDAR FALLS)

The 35th Ranger Battalion (ARVN) remained at their blocking position held during Operation NIAGARA FALLS. The 1/4th Cavalry of the 1st Infantry Division assumed a screening mission along HIGHWAY 13 at 0800 hours. They made negative contact until 1330 hours when they killed 1 VC (BC) at XT 856226.

e. D + 1 (9 January 1967)

Changes in Task Force Organization: D/4/503d Inf became OPCON to
3/11th ACR

Operational Summary: The 173d Airborne Brigade's TF DEANE attacked suspected VC formation and installation areas in the IRON TRIANGLE and the THANH DIEN FOREST RESERVE. At 0800 hours, the 11th ACR (-) attacked west from BEN CAT and secured the bridge located at XT 738328. The Regiment then pushed further west siezing Objectives 1 (at 0912 hours), 1-A (at 0950 hours) and Objective 2 (at 1105 hours). The Regiment also provided security for elements of the 1st Engineer Battalion (of the 1st Infantry Division) who were clearing the road west from BEN CAT to Objective 2, and Engineer elements clearing the area of Objective 1 and LZ 6 (See Overlay - D + 1).

At 0804 hours, Company D/16th Armor, reinforced with one rifle Company from 4/503d Infantry screened the area northwest of BEN CAT from XT 708333 to XT 685244.

The 2/503d Infantry initiated a heliborne assault into LZ 4 from Position BLUE beginning at 1055 hours (XT 670365). The assault was completed at 1115 hours and the 2/503d Infantry linked up with the 1st Division elements to the north approximately 1/2-hour later.

At 1215 hours, the 4/503d Infantry (-) departed Position BLUE by helicopter and at 1235 hours, they assaulted LZ 6 (XT 680250). One hour and ten minutes later, the 4th Battalion and the 2d Battalion linked together and at 1430 hours, D/16th Armor (+) became under the Operational Control of the 4th Battalion. The 2/503d Infantry and 4/503d Infantry established blocking positions in their respective LZ's and conducted limited search and destroy operations in their zones. At 2105 hours, elements of C/2/503d Infantry engaged 5 VC moving east at XT 662367. Two more VC were engaged in the same area shortly thereafter. The action resulted in 2 VC KIA (BC) and 2 Chicom Carbines captured. There were no Friendly casualties, (see overlay D + 1).

The 1/503d Infantry and 35th Ranger Battalion (ARVN) with elements of the 1/4th Cavalry remained in their blocking positions, held since the termination of Operation NIAGARA FALLS. There were no significant contacts during the day.

f. D + 2 (10 January 1967)

Changes in Task Force Organization: 1/4th Cav went OPCON to 11th ACR (-)
A/5/2d Arty (AW) went OPCON to
2/11th ACR

Operational Summary: The 173d Airborne Brigade (Separate) under the Operational Control of the 1st Infantry Division continued its sweep of the area north of the IRON TRIANGLE, west of BEN CAT. The 1/503d Infantry maintained their blocking position and conducted Search and Destroy operations in the area. The 1/4th Cavalry was relieved of its screening mission along HIGHWAY 13, south of BEN CAT at 1540 hours by the 4/7th ARVN Regiment (working in conjunction with II FFORCEV), and the 2/8th ARVN Regiment. The 1/4th Cavalry then motor marched to

CONFIDENTIAL

CONFIDENTIAL

78

AVBE-SC

25 February 1967

SUBJECT: Combat Operations After Action Report (Operation NIAGARA/CEDAR FALLS)

a blocking position vicinity of LZ 4 and LZ 6, thereby relieving the 2/503d Infantry and 4/503d Infantry (-) in that area. At 1440 hours, the 1/4th Cavalry (-) went under the Operational Control of the 11th Armored Cavalry Regiment (-).

At 0823 hours, C/2/503d Infantry engaged 2 VC at XT 662370. This contact took place near to the ambush site employed on the night of the 9th of January. Four (4) Americans received wounds resulting from this action with VC casualties unknown. Later that day, after being relieved from by the 1/4th Cav, the 2/503d Infantry began to move into harbor positions (night defense) in preparation for an attack south into the IRON TRIANGLE. This was accomplished by 1645 hours.

The 4/503d Infantry moved into its staging area after it was relieved while Company D/16th Armor returned to the Brigade CP (Position RED) to aid in its defense.

The 11th ACR continued Search and Destroy in addition to Security missions in AO HOTEL and the immediate vicinity. At 1900 hours, a tank of B/1/4th Cavalry struck a mine at XT 669359 resulting in 1 trooper being wounded and 4 road wheels being blown off the tank (Location 2, Overlay D + 2).

g. D + 3 (11 January 1967)

Changes in Task Force Organization: No Change

Operational Summary: On this day, the 173d Airborne Brigade (Separate) TF DEANE commenced its attack south into the IRON TRIANGLE at 0900 hours. The 2/503d Infantry initiated search and destroy operations in the western portion of the Triangle while the 4th Battalion crossed into the AO on the east, also conducting search and destroy operations while moving to the south. At 1500 hours, A/4/503d Infantry discovered a boobytrapped base camp at XT 724304. The camp measured 100 meters by 200 meters and contained 40 bunkers with overhead cover. Surrounding the area was a horse shoe trench measuring 2' wide by 2' deep. Company A found nine boobytraps in the compound which were all detonated in place (Location 1). D/16th Armor attacked along the western portion toward Objective 5.

The 3/11th ACR attacked south into the IRON TRIANGLE moving down the western edge along HIGHWAY 14. In addition to clearing the road, they also seized Objectives 1 (XT 715240), 2 (XT 723240), 3 (XT 743240), and 4 (XT 744218), while simultaneously conducting search and destroy operations along the Route. All objectives were secured by 1645 hours.

Early in the morning before the attack was initiated, M/3/11th ACR engaged 5 VC at XT 702296 (Location 2). The VC fled without returning fire. The skirmish resulted in one (1) VC WIA being captured. He was subsequently evacuated to the 172d Military Intelligence Detachment for interrogation. At 1930 hours, M/3/11th ACR engaged 3 VC at XT 750231. The contact resulted in 1 VC KIA and 1 US Carbine being captured (Location 3).

1/503d Infantry Battalion was relieved of its original blocking mission by the 35th Ranger Battalion (ARVN) at 1200 hours. The Battalion then deployed to the Brigade CP at Position RED.

The 2/11th and the 1/4th Cavalry continued security and screening missions north of the IRON TRIANGLE under the OPCON of the 11th Armored Cavalry Regiment (-).

CONFIDENTIAL

SUBJECT: Combat Operations After Action Report (Operation NIAGARA/CEDAR FALLS)

h. D + 4 (12 January 1967)Changes in Task Force Organization: 2/11th ACR & 1/4th Cav became OPCON to 3d Bde, 1st Inf DivOperational Summary: TF DEANE continued search and destroy operations in the IRON TRIANGLE with its strength being expanded now that the 1/503d Infantry was relieved of its blocking position and could now function with the Brigade.

The 1/503d Infantry (-) moved by road from Position RED to the western portion of the IRON TRIANGLE at 0735 hours. The mission was to make a thorough search of the area along HIGHWAY 14. At this time, Company A/503d Infantry remained at Position RED to secure the Brigade CP and Fire Support Base.

At 1010 hours, the Recon Platoon/1/503d Infantry killed 2 Viet Cong at (T 677296 (Location 1). The weapons belonging to the VC were lost in the river, however, one (1) M-26 grenade and two (2) Chicom grenades were captured. At 1525 hours at XT 682235 (Location 2) the Recon Platoon of the 1st Battalion found 3 VC, one of whom had been wounded, in a bunker. Shortly thereafter, at the same location, they found 4 dead VC and 1 Chicom Carbine.

Throughout the day, the 2/503d Infantry and 4/503d Infantry continued a detailed search of their AO's with no significant contact. D/16th Armor, reinforced with Company C/4/503d Infantry, moved by APC to the vicinity of Objective 5 under the OPCON of 4/503d Infantry. At 1605 hours, the remainder of Company C joined D/16th Armor, via helilift.

The 11th Armored Cavalry Regiment (-) continued its search and destroy operations in the southern portion of the IRON TRIANGLE with the 3d Squadron. At 1120 hours, an element of 3/11th ACR pursued 5 VC at XT 746234. The VC led them into a claymore ambush which resulted in 3 US WIA and 4 US KIA. The VC fled before a retaliatory act could be executed, (Location 3). At 1635 hours, K/3/11th ACR received heavy semi-automatic and automatic fire from an ambush at XT 703253 (Location 4). The VC, who were estimated to be at platoon strength, damaged 1 APC with 3 rounds of 57mm Recoilless Rifle fire. There were no US casualties and enemy losses were unknown. At 2040 hours, M/3/11th ACR observed a VC attempting to tamper with one of their claymore mines. The claymore was detonated, killing the VC (XT 748230).

The 2/11th ACR and the 1/4th Cavalry were released to the Operational Control of the 3d Brigade, 1st Infantry Division at 0700 hours.

E Troop, 17th Cavalry secured the Fire Support Base at Position WHITE and conducted Air Cavalry Operations under the OPCON of the 1/503d Infantry in the southern portion of the AO.

i. D + 5 (13 January 1967)Changes in Task Force Organization: 2/11th ACR reverts OPCON 11th ACR (-)Operational Summary: The 173d Airborne Brigade (Separate) and OPCON units continued to comb the IRON TRIANGLE destroying VC, their installations and supplies. The 1st and 2d Battalions of the 503d Infantry continued their detailed search of the Operational Area, making no significant contact.

CONFIDENTIAL

AVBE-SC

25 February 1967

SUBJECT: Combat Operations After Action Report (Operation NIAGARA/CEDAR FALLS)

At 1640 hours, PFC Duane Simpson, a member of the 39th Infantry Platoon Scout Dog, and working with C/4/503d Infantry, alerted his patrol to the presence of an unknown number of VC at XT 725269. Simpson's Scout Dog in fact gave the silent warning. Immediately after the warning was spread, heavy automatic fire commenced. Simpson quickly returned the fire to gain superiority, killing one (1) VC. The remainder of the patrol then moved up to engage the enemy. The contact resulted in 2 VC KIA (BC) and 1 weapon being captured, thanks only to the quick action of the attached scout dog team.

At 1400 hours, A/4/503d Infantry received 30 to 40 rounds of semi-automatic fire at XT 728268 (Location 5 - D + 4, D + 5 Overlay). Fire was returned resulting in 2 VC KIA (BC) with no US casualties.

The 11th ACR (-) continued to search its AO. At 1800 hours, the 2d Squadron reverted back to the control of the 11th Armored Cavalry Regiment.

On this day, E Troop, 17th Cavalry had the mission of securing artillery elements at Position WHITE in addition to conducting Air Mobile Cavalry Operations. The Cavalry killed 10 VC in a series of actions throughout the day. At 1043 hours, at XT 714212 (Location 7) they contacted and killed 2 VC. Fifteen minutes later, another element killed 1 VC at XT 688236 (Location 8). At 1320 hours, they killed 2 VC and captured 1 VC WIA at XT 710233, also capturing one (1) US carbine and a .45 caliber pistol. Throughout the day, various elements of E/17th Cav killed 5 more of the enemy throughout their AO, in addition to discovering large quantities of rice and several sampans.

The 173d Engineer Company provided Tunnel Exploration Teams "Tunnel Rats" throughout the Operational Area for tunnel search and destruction.

j. D + 6 (14 January 1967)

Changes in Task Force Organization: No Change

Operational Summary: The Brigade's Task Force DEANE continued a detailed search of the IRON TRIANGLE, destroying VC and Viet Cong Installations and supplies throughout the day.

The 1/503d Infantry conducted search and destroy operations in the northern portion of the Triangle, west of HIGHWAY 14. At the same time, elements of E Troop, 17th Cavalry were working with the 1st Battalion in that area. The Battalion's activities were highly successful on this day for they discovered and destroyed 30.5 tons of Paddy Rice, 300 pounds of Chiccom explosives and 36 anti-personnel mines.

In the meantime, the Cavalry Troop killed a total of 12 VC in a series of small contacts. In addition, they captured 3 VC, destroyed 63.7 tons of paddy rice, evacuated an additional 11 tons of rice, destroyed 10 sampans and several huts, (See Tab C, Small Unit Actions - E/17th Cavalry).

The 2/503d Infantry, while conducting search and destroy operations in the central portion of the IRON TRIANGLE found and destroyed several small bunkers, tunnels and a base camp area. Within the camp, a hand grenade shop was found and 25 grenades were confiscated.

The 4th Battalion, 503d Infantry conducted a thorough search of the eastern portion of the IRON TRIANGLE. At 1000 hours, Company C/4/503d Infantry discovered a 100 meter tunnel, 6 feet below the surface at XT 727265 (Location 5).

CONFIDENTIAL

CONFIDENTIAL

AVBE-SC

25 February 1967

76

SUBJECT: Combat Operations After Action Report (Operation NIAGARA/CEDAR FALLS)

A search of the tunnel revealed 3 rooms, 5 feet by 8 feet with wooden floors. In addition, 45 tons of paddy rice, 3.4 tons of salt, 16 rifle grenades, 22 60mm mortar rounds and 2,300 feet of electrical wire were found within. At 1415 hours, an element of C/4/503d Infantry with Company D/16th Armor made contact with an estimated VC squad. The VC fired 150 - 200 rounds of semi-automatic and automatic fire. The engagement was characterized by the troopers as being extremely heated, owing not only to the enemy fire, but also the large numbers of anti-personnel and anti-tank mines encountered. The action resulted in 14 US WIA with unknown VC casualties (XT 737259 - Location 6).

The 2/11th ACR and 3/11th ACR conducted search and destroy operations in the southern portion of the IRON TRIANGLE. Throughout the day's activities, they discovered and destroyed 17 tunnels, one trench system and 18 bunkers. In addition, 500 pounds of polished rice was found and evacuated.

The 173d Engineer Company "Tunnel Rat" teams explored a total of 1,300 meters of tunnel within the AO. A total of 2,500 meters of tunnel were destroyed leaving an untold number of VC trapped within.

k. D + 7 (15 January 1967)

Changes in Task Organization: No Changes

Operational Summary: TF DEANE continued Operation CEDAR FALLS conducting methodical search and destroy operations within the IRON TRIANGLE AO. Moving behind a massive TAC Air preparation consisting of 14 sorties dropping a total of 19,000 pounds of High Explosives, the 1/503d Infantry located and extracted a medical cache at XT 672281 containing 300 tablets of Penicillin, 10 bottles of powdered Penicillin, one bottle of alcohol, 20 bottles of latercain and 5 bottles of sterile water. At 1210 hours, elements of the 1/503d Infantry killed 3 VC (BC) at 672281 (Location 7) and captured one (1) US carbine, ammunition, documents and several maps. They also located 1 grenade, 10 bunkers, 3 sampans, 3 huts, 1 tunnel, 1 AT mine and 100-pound bomb during the day's activities.

The 2d Battalion, 503d Infantry moved south through the central portion of the IRON TRIANGLE. Boobytraps at XT 693263 and XT 688266 wounded 4 men on the days operations. The Battalion located and destroyed 11 huts and 4 bunkers. At 1210 hours, Bravo Company engaged 2 VC who were busy emplacing a mine in the road at XT 712247 (Location 9). The men fired at the enemy resulting in 1 VC KIA (BC) and 1 US M-2 carbine being captured.

During their search of the eastern portion of the Triangle, the 4/503d Infantry (-) came across a triangular shaped base camp, 100 meters on each side. 35 bunkers were located on the perimeter and an additional 20 were found within the encampment. All of the bunkers were interconnected with trenches. Warm coals in the cooking fires indicated recent habitation by an estimated VC Platoon.

The 11th ACR (-) with Company D/4/503d Infantry under their Operational Control searched the southern area of the IRON TRIANGLE. At 1149 hours, an element of D/4/503d Infantry engaged 3 VC at XT 736217 (Location 10). One of the VC was killed and the remaining 2 escaped into a tunnel after firing approximately 10 rounds. One (1) sub-machinegun, 2 carbines and one (1) DH-10 claymore mine was captured. Friendly casualties were: 1 US KIA and 1 US WIA. At 1310 hours, an APC from E Troop/2/11th ACR struck a mine at XT 736248 (Location 11) resulting in 6 US WIA. At 1530 hours, seven (7) personnel from M/3/11th ACR were wounded in action and 2 APCs were damaged by two (2) command detonated mines at XT 733231 (Location 12).

24

CONFIDENTIAL

CONFIDENTIAL

77

AVBE-SC

25 February 1967

SUBJECT: Combat Operations After Action Report (Operation NIAGARA/CEDAR FALLS)

E Troop/17th Cavalry was fired on by Viet Cong snipers at XT 695218 (Location 13) resulting in 2 US WIA. 40 minutes later, at XT 695218, a VC wearing black pajamas was killed at XT 095219. In addition, 6 bunkers, 6 punji pits, 1 hut, 6 sampans and 3.75 tons of rice were destroyed.

1. D + 8 (16 January 1967)

Changes in Task Force Organization: D/4/503d Infantry released OPCON of 11th ACR (-) returning 4/503d Inf

Operational Summary:

Task Force DEANE continued Operation CEDAR FALLS conducting search and destroy operations within the IRON TRIANGLE with 1/503d Infantry (-) in the western sector, 2/503d Infantry in the center and 4/503d Infantry in the east. The 11th Armored Cavalry Regiment (-) was operating in the southern tip of the Triangle.

The 1st Battalion 503d Infantry in the western sector of the Triangle conducted search and destroy operations to the south. Company C and Company B were located on east and the west side of HIGHWAY 14 respectively. At 0843 hours, at XT 683255, Bravo Company made contact with 2 VC who immediately fled to the west. Shortly thereafter, B/1/503d Infantry captured one VC at XT 685255. The VC was subsequently evacuated. At XT 681278, the 1st Battalion's Recon Platoon located and destroyed a tunnel complex, 4 huts, an 8 foot sampan dock and a bunker. At 1015 hours, Bravo Company received 5 - 7 rounds of automatic weapons fire at XT 685255. Three (3) Viet Cong were captured after a brief exchange of fire, with 2 - 3 VC escaping to the south. Five minutes later, Company C located two (2) machinegun mounts, one bunker and 4 CBU's employed as boobytraps. All was destroyed with the exception of the machinegun mounts which were evacuated. Bravo Company sustained 5 casualties at 1335 hours as a direct result of an activated boobytrap at XT 685255. Four of these casualties required litters for evacuation. Shortly before this occurred, Charlie Company had discovered an extensive tunnel complex, showing signs of having been used as a hospital. One company of the 1st Battalion was employed in the security of the Brigade CP at Position RED.

The companies of the 2d Battalion 503d Infantry continued to conduct search and destroy missions, sweeping to the southeast. Company B encountered one (1) VC at XT 698262, shortly after 1100 hours. Company B suffered one KIA and 1 WIA as a result of the contact, with the VC escaping to the northeast. The Dust-off helicopter received semi-automatic ground fire during the evacuation, resulting in one of the medical personnel being wounded. Company C killed one (1) VC at 1200 hours while operating in the area XT 702246. The VC was found in a tunnel. The 2d Battalion's Recon Platoon operating in conjunction with elements of E/17th Cavalry, captured one (1) VC at XT 692237. The POW was extracted to the S2 for questioning. At 1330 hours, Charlie Company returned to the tunnel where it had previously killed one VC. At this time, a second VC was killed in the same vicinity. During the night, the Recon Platoon established ambush patrols around the Brigade TOC (vicinity 696307). At 2100 hours, they ambushed and killed one (1) VC, capturing one Canadian pistol.

At 0715 hours, Airstrikes commenced on targets XT 735260, XT 740260, XT 736255 and XT 740254 in preparation for the 4th Battalion, 503d Infantry's search and destroy mission. Company A and Company B operated in the area XT 720285 to XT 734265. C/4/503d Infantry with Company D/16th Armor (-) OPCON screened the AO in the vicinity of Objective 5. At 1055 hours, Bravo Company located what appeared

CONFIDENTIAL

CONFIDENTIAL

AVBE-SC

25 February 1967

78

SUBJECT: Combat Operations After Action Report (Operation NIAGARA/CEDAR FALLS)

to be a claymore mine factory at XT 723272. Search of the factory revealed large quantities of metal and canisters for WP rounds. An hour and a half later, Bravo Company located a tunnel with several rooms capable of standing in. The rooms contained 500 pounds of rice and a rusted .38 caliber pistol. At 1245 hours, Company D reported one (1) WIA and called for a Dustoff. The casualty, SGT Mario Ramirez, died enroute to the hospital. 45 minutes later, Bravo Company made contact with an estimated reinforced platoon at XT 725268. Artillery was called in on the position and contact was broken 15 minutes later. The results of this action are as follows: 5 VC KIA, 10 VC WIA (possibly 15). US casualties were: two (2) US KIA (SP4 Arthur Wilkie and PFC Frank Smith) and eleven (11) US WIA, nine of whom were evacuated by helicopter. At 1435 hours, an element of D/16th Armor hit a mine at XT 734265 resulting in six (6) WIA.

The 11th ACR (-), operating in the southern portion of the IRON TRIANGLE, located and marked for destruction one tunnel at XT 740218. They also destroyed one (1) DH-10 claymore mine at the same location. At 1245 hours, an APC struck a mine at XT 725262 resulting in one (1) US WIA. Two hours later, M/3/11th received approximately 20 rounds of semi-automatic fire from a tunnel at XT 740-221. Two (2) US personnel pursued the enemy into the tunnel resulting in the death of one and the injury of the other. In contacts that took place at 1530 and 1605 hours, the 11th ACR (-) killed 2 VC (BC) and 1 possibly in addition to capturing 1 US carbine, one (1) .45 caliber pistol and one (1) Russian automatic weapon.

m. D + 9 (17 January 1967)

Changes in Task Force Organization: 2/11th ACR returned to 11th ACR (-)
& 173d Abn Bde (Sep) OPCON
2/11th ACR was released from 3d
Bde, 1st Inf Div

D/4/503d Inf attached to 11th ACR
E/17th Cav OPCON 1/503d Inf

Operational Summary: Task Force DEANE continued Operation CEDAR FALLS conducting search and destroy operations within the IRON TRIANGLE. The 1/503d Infantry (working in conjunction with E/17th Cav) conducted operations in the western Triangle near the SAIGON RIVER. The 2d Battalion, 503d Infantry and the 4th Battalion (-) with D/16th Armor (OPCON) operated in the center and east respectively. The 11th Armored Cavalry Regiment (-) with Company D/4/503d Infantry attached were in the southern sector of the AO.

The 1/503d Infantry secured the Brigade CP and Fire Support Base at Position RED with Alpha Company. The remainder of the Battalion conducted search and destroy operations within the AO. At XT 695245 (Location 1) one (1) VC exchanged fire with 1st Battalion elements, wounding 2 paratroopers. At 1910 hours, B/1/503d Infantry engaged 3 Viet Cong at XT 688247 resulting in one (1) VC KIA (BC) and an additional VC KIA (possible). The dead VC was in a green shirt, black trousers and a bush hat. There was one (1) US KIA and 3 WIA as a result of this contact.

E Troop, 17th Cavalry engaged three (3) Viet Cong at 1330 hours killing 2 of the enemy (BC) and capturing the third at XT 671244. During a night ambush patrol, the Cavalry troopers engaged 6 VC at XT 672245 (Location 15). The action resulted in 2 VC killed and 2 weapons captured. The contact took place at 2010 hours.

CONFIDENTIAL

CONFIDENTIAL

79

AVHE-SC
SUBJECT: Combat Operations After Action Report (Operation NIAGARA/CEDAR FALLS) 25 February 1967

The 2d Battalion, 503d Infantry located a tunnel complex at XT 708-242 containing two (2) Chicom Carbines and one (1) US Carbine. At 1120 hours, Bravo Company engaged two (2) Viet Cong at XT 713253 (Location 16) killing one of the enemy. A trench 1,800 meters in length was later located running from XT 688-247 to 695241.

Elements of the 4/503d Infantry received 1 WIA from a sniper at XT 725267. Later that day, the Battalion discovered a large weapons cache at XT 727-269. The cache contained 2 Russian Rifles, one (1) 60mm mortar, two (2) M60 machine-guns, two (2) US M-1 rifles, 24 Chicom rifles, two (2) US Browning Automatic rifles, 2 French machineguns, and three (3) .45 caliber sub-machineguns.

At 0900 hours, the 3/11th ACR reported killing one (1) VC when he detonated a friendly boobytrap at XT 740221. The trap was set by elements of M Troop, 3/11th ACR. At 1030 hours, an M48-A3 tank of K Troop/3/11th ACR lost four (4) road wheels as a result of having struck a pressure type land mine at XT 739-216. Other Regimental units made no significant contact during the day.

n. D + 10 (18 January 1967)

Changes in Task Force Organization: 1/4th Cav was released from 3d Bde, 1st Inf Div OPCON & became OPCON to TF DEANE

Operational Summary: TF DEANE continued to conduct a detailed search and destroy operation within the AO of Operation CEDAR FALLS. The 1/503d Infantry with E Troop, 17th Cavalry was given the responsibility of maintaining security of Position WHITE. At 1725 hours, B/1/503d Infantry engaged 2 VC at XT 693245 (Location 1). One (1) VC was killed (BC) and one (1) AK-47 rifle was captured. The VC wore a light green uniform and a pistol belt. At 1938 hours, Bravo Company again made contact with 2 Viet Cong at XT 693244 (Location 1), resulting in 1 VC KIA (BC) and an additional VC possibly killed. The dead VC wore a light blue uniform and was armed with a bolt action rifle. In the early morning hours, elements of E/17th Cavalry were probed by an unknown number of Viet Cong at XT 716227. The Cavalry Troop opened fire on the enemy resulting in 4 VC KIA (BC).

The 2d Battalion, 503d Infantry continued its search in their assigned AO, progressing toward the eastern area of the IRON TRIANGLE. At 1145 hours, C/2/503d Infantry discovered an old .45 caliber pistol (US) at XT 726258 (Location 3). During the search of the area, three (3) paratroopers were wounded by an enemy boobytrap.

The 4/503d Infantry continued to search in their AO during the day, however, their first contact was at 0330 hours in the morning. Battalion elements received several rounds of small arms fire at XT 736268 (Location 4). Artillery was called in on the enemy. Following the artillery barrage, patrols were sent forth to acquire an estimate of damage done by Artillery. It was reported that two (2) VC were killed and one (1) M-1 rifle and one (1) homemade shotgun were captured. Activities during the day consisted primarily of the discovery/destruction of numerous tunnel complexes. Exploration of two of these tunnels revealed a sizeable weapons cache. One tunnel yielded one (1) Browning Automatic Rifle, one (1) flare pistol, one (1) 60mm mortar bipod and base plate, eight (8) Chicom rifles, one (1) M-1 rifle and several rounds of assorted ammunition. This tunnel was located at XT 724267. Another tunnel/cache at XT 727269 contained two (2) US Carbines, three (3) M-1 rifles, four (4) Thompson machineguns, one (1) Browning Automatic Rifle, 41 bolt action weapons and one (1) M-3 sub-machinegun.

CONFIDENTIAL

CONFIDENTIAL

AVBE-SC

25 February 1967

80

SUBJECT: Combat Operations After Action Report (Operation NIAGARA/CEDAR FALLS)

The 11th ACR (-) continued operations in the southern portion of the IRON TRIANGLE and secured the engineer work parties to the north. At 1330 hours they were released of the security responsibility by 1/4th Cavalry. The 1/4th Cavalry became OPCON of the 173d Airborne Brigade (Separate) at this time.

o. D + 11 (19 January 1967)

Changes in Task Force Organization: No Change

Operational Summary: The 173d Airborne Brigade's Task Force DEANE continued operations throughout the IRON TRIANGLE. The 1st Battalion's Company A continued to secure Position RED while the rest of the Battalion conducted screening operations in the western portion of the IRON TRIANGLE. The 1/503d Infantry met with little contact, however, 21 plastic type anti-personnel mines were destroyed at XT 688243. At 1005 hours, a Chieu Hoi returnee pointed out a 100 meter trench to elements of the 1/503d Infantry at XT 694249. The trench and connecting tunnel with room were destroyed by Bravo Company. Throughout the morning, B/1/503d Infantry located several caches of rice totalling approximately 10 to 12 tons. At 1300 hours, four (4) VC (3 of whom were carrying Chieu Hoi passes) were captured by the Commo Platoon south of the Brigade CP. That afternoon, the Battalion CP was displaced by foot to XT 703244 and closed at 1605 hours.

The 2d Battalion, 503d Infantry searched the central portion of the IRON TRIANGLE progressing eastward. At 1530 hours, 4 VC were detained by elements of the 2d Battalion, one of whom died of a heart attack. The capture of these VC occurred at XT 733252. The Recon Platoon set ambushes that night at two sites, XT 743258 and XT 744256. On two separate occasions, each ambush killed one VC, however, no weapons were captured.

The 4th Battalion with Company D/16th Armor (OPCON) conducted a sweep in the eastern portion of the Triangle. At 0950 hours, B/4/503d Infantry engaged 3 Viet Cong in a tunnel at XT 724261. One of the enemy was killed, however, the other two managed to escape. The Battalion located and extracted one (1) Thompson sub-machinegun, one (1) US carbine and one (1) Mauser rifle from a tunnel at XT 726-203.

I/3/11th ACR, while conducting search and destroy operations in the southern sector of the IRON TRIANGLE, killed two (2) VC in a tunnel which was constructed of reinforced concrete at XT 725225.

The 1/4th Cavalry continued to secure the northern portion of the Brigade's Area of Operation. At 0725 hours, a damaged APC, being towed, struck a pressure type mine at XT 696343 and burned, resulting in the total loss of the vehicle and 3 US WIA. At 0855 hours, an Aero Scout team found 1 VC (BC) at XT 671356. In the process of confirming the KIA, the team made contact with 3 VC. The action resulted in one of the hostiles being killed (BC). At 1345 hours B/1/4th Cavalry contacted a Viet Cong Squad at XT 643328. The enemy returned semi-automatic and automatic fire on the friendly troops. Two VC were killed and two were wounded as a result of this action. The VC wore light green shirts and black trousers. One Chicom carbine was captured.

E Troop, 17th Cavalry conducted Aero Rifle Platoon Operations in the southwestern portion of the IRON TRIANGLE. At 2130 hours, they killed 3 VC at XT 679239 in addition to capturing 1 US carbine and 1 Russian carbine.

CONFIDENTIAL

CONFIDENTIAL

AVHE-SC

25 February 1967

SUBJECT: Combat Operations After Action Report (Operation NIAGARA/CEDAR FALLS)

p. D + 12 (20 January 1967)

Changes in Task Force Organization: H/2/11th ACR became OPCON 4/503d Inf

Operational Summary: The 173d Airborne Brigade (Separate) continued Operation CEDAR FALLS within the IRON TRIANGLE. The 1st Battalion, 503d Infantry, having completed sweeping the west flank, moved to the southern portion of the AO. Alpha Company was relieved of the Brigade base security/reaction force mission and joined the Battalion at their CP location at 1025 hours. The heavy mortar platoon however, remained at Position RED. At 0930 hours, A/1/503d Infantry located and destroyed a 200-pound bomb at XT 711244. Charlie Company, at XT 703244, located 18 - 20 tons of rice. The majority of this rice was destroyed in place, however, 15,800 pounds were evacuated. Throughout the day, the paratroopers of the 1st Battalion made numerous discoveries of rice, bunkers, bicycles, tunnels and medical supplies. At 2040 hours, Company A killed one (1) VC at XT 709228.

At 0815 hours, Companies A and B/2/503d Infantry conducted a heli-borne assault employing eight (8) helicopters to an LZ vicinity XT 699270. Company C remained at the Battalion CP (XT 735248). After completing the lift, Companies A and B/2/503d Infantry conducted local saturation in the vicinity of the CP. Company A encountered three (3) VC at 1350 hours, killing one (XT 698272). Shortly after 1800 hours, the two companies were helilifted to the Battalion CP, closing at 1845 hours.

The 4th Battalion (-) with D/16th Armor and H/2/11th ACR OPCON moved northwest to seize Objective MIKE (XT 700273). The attack was preceded by TAC Air and Artillery preparations. The Battalion and attached units made no significant contact during the day.

The 1/4th Cavalry (1st Infantry Division) (-) attacked south from their AO to Objective TOM (XT 695277). The position was reported secure at 0909 hours. Due to the absence of significant contact, the 1st Squadron returned to its AO in the northern sector of the IRON TRIANGLE and continued to conduct search and destroy operations in addition to providing security for Engineer work parties in the area. At 0805 hours, B/1/4th Cavalry encountered 19 Chieu Hoi Rallyers at XT 679205 (Location 2). The ex-VC were prompted to rally by recent air strikes and artillery fire, coupled with hunger and generally poor living conditions. At 0953 hours, A/1/4th Cavalry killed one (1) VC at 683313 (Location 3).

The 11th Armored Cavalry Regiment (-) continued to conduct search and destroy operations in the southern portion of the IRON TRIANGLE. K/3/11th ACR assumed responsibility for the security of the Brigade CP and Fire Support Base at Position RED.

Troop E/17th Cavalry continued their primary mission of securing Position WHITE in addition to conducting Aero Rifle Platoon operations. At 0039 hours, elements of the Cavalry Troop killed 2 VC in a sampan at XT 689223 (Location 4). Eleven minutes later, they contacted and killed a second VC in the same vicinity. The troopers accounted for two (2) more enemy KIA before daybreak.

q. D + 13 (21 January 1967)

Changes in Task Force Organization: No Changes

CONFIDENTIAL

CONFIDENTIAL

82

AVBE-SC

25 February 1967

SUBJECT: Combat Operations After Action Report (Operation NIAGARA/CEDAR FALLS)

Operational Summary: TF DEANE continued Operation CEDAR FALLS conducting intensive search and destroy operations within the IRON TRIANGLE. The 1st Battalion, 503d Infantry continued to conduct operations in the southwest portion of the AO between the SAIGON RIVER and HIGHWAY 14 employing road patrols and platoon sized Eagle Flights. The Battalion also initiated heliborne assaults on small LZ's used as short range patrol bases. At 2118 hours, A/1/503d Infantry engaged 15 Viet Cong at XT 686242 (Location 1). The VC returned the fire before fleeing southwest. The action resulted in one (1) US KIA with unknown enemy casualties.

The 2d Battalion, 503d Infantry continued its operations in the east/central portion of the IRON TRIANGLE, west of the THI TINH RIVER. At 2010 hours, A/2/503d Infantry spotted 3 VC at XT 742253 (Location 2). The enemy fired 10 - 12 rounds of semi-automatic fire. The VC subsequently fled and the pursuit was taken up by elements of Alpha Company. One (1) US paratrooper was killed in the process. The Dustoff ship that was summoned to the scene also received fire during its departure.

The 4/503d Infantry with Company D/16th Armor and H/2/11th ACR OPCON continued search and destroy operations through the heart of the IRON TRIANGLE, linking up with 2/503d Infantry 6 kilometers south of BEN CAT. At 1130 hours, C/4/503d Infantry contacted 3 - 5 VC at XT 702267 (Location 3). Two of the hostiles dropped when fired upon. One body was observed being dragged away. The other VC was confirmed KIA (BC). At 1300 hours, B/4/503d Infantry contacted two enemy personnel at XT 683257 (Location 4). The VC managed to escape after wounding one (1) US trooper.

The 11th ACR (-) conducted operations in the southern portion of the IRON TRIANGLE at the confluence of the THI TINH and SAIGON RIVERS. At 1245 hours, L/3/11th ACR detained 3 Viet Cong who stated that they were influenced into surrender. They added that the Psy War speaker mission flown on the 20th of January near XT 723236 (Location 5) convinced them to rally. F Troop, 2/11th ACR killed two (2) VC on two separate occasions on this day at 1300 hours and at 1600 hours. All four hostiles killed were clad in black pajamas.

The 1/4th Cavalry patrolled the rubber plantation and jungle area west of BEN CAT, thereby blocking the northern escape path of those enemy elements trapped within the IRON TRIANGLE. In addition, the 1/4th Cavalry provided security for the Engineer work parties operating in the northern sector of the AO. Between 1150 and 1200 hours, C/1/4th Cavalry captured 19 detainees in the vicinity of XT 731312 and XT 735315.

E Troop, 17th Cavalry conducted platoon sized Aero Rifle Operations along the west bank of the SONG THI TINH being free of intra-Task Force boundaries.

Of special interest were the Psychological Operations conducted in the Area of Operations. As a result of the leaflet drop on 21 January, six (6) Viet Cong rallied. The circumstances behind this are as follows: on the 19th of January, two VC rallied to the GVN cause. On the following day, they were photographed together and gave the names of six of their friends among the VC ranks. The two men, who happened to be brothers, composed a message aimed directly to their six friends. On the same day, the leaflets were dropped. Shortly thereafter, the six Viet Cong rallied, following the good advice of their comrades. In addition, a woman refugee was permitted at her own request to broadcast a message to her husband and brother. Three hours after her plea, both men turned themselves in under the Chieu Hoi Program. See TAB G for leaflet mentioned above and photographs of Psy Ops.

30

CONFIDENTIAL

CONFIDENTIAL

83

AVHE-SC

25 February 1967

SUBJECT: Combat Operations After Action Report (Operation NIAGARA/CEDAR FALLS)

r. D + 14 (22 January 1967)

Changes in Task Force Organization: 2/503d Inf became OPCON to 11th ACR (-)

Operational Summary: The 173d Airborne Brigade's TF DEANE continued Operation CEDAR FALLS within the IRON TRIANGLE. The 1st Battalion, 503d Infantry began moving north along the west flank of the Triangle. Search and destroy operations were conducted with the three rifle companies deployed abreast of one another. Company A was on the west flank, Company C on the east flank and Company B was located in the center. At 0913 hours, at XT 714258, Charlie Company located and destroyed a small tunnel containing explosives and detonating devices. Later that day, Alpha Company located and destroyed a 500-pound bomb at XT 689245. During the day, the Battalion discovered 26 tons of rice, a large quantity of galvanized metal and miscellaneous weapons and fire arms. Four (4) Viet Cong bodies were also discovered by elements of 1/503d Infantry during the day's sweep. Contact results for the day's operation were negative.

Commencing at 0700 hours, The 2d Battalion, 503d Infantry became under the Operational Control of the 11th Armored Cavalry Regiment (-). There were no contacts made with elements of the 2/503d Infantry however, several company sized base camps were located during the day's sweep. None of these encampments showed indications of recent use. The Cavalry Troops served primarily as blocking forces for the Infantry maneuvers.

The 4th Battalion, 503d Infantry was concerned primarily with the destruction of tunnels within their Area of Operation. At 1130 hours, Companies C and B began blowing tunnels. At 1615 hours, Company A reported that two men had entered a tunnel after it was exploded to acquire an estimate of damage. The men then became overcome by gas. One of the troopers was unable to escape. At 1630 hours, PFC Ronald L. Fendergist was recovered from the underground trap. He died enroute to the hospital. It should be mentioned here that the infantrymen who enter these tunnels are strictly volunteers.

The 1/4th Cavalry continued to secure engineer work parties operating west of PEN CAT and south along HIGHWAY 14. In addition, they continued to block the VC escape rout at the northern sector of the IRON TRIANGLE. At 1545 hours, B/1/4th Cavalry fired on 30 VC at XT 666314 (Location 1). Nine (9) of the hostiles were captured, 6 of whom were evacuated to the 172d Military Intelligence Detachment, the other three needing medical attention.

s. D + 15 (23 January 1967)

Changes in Task Force Organization: Recon Plt/1/503d OPCON until 1800 hrs to 1/4th Cav
H/2/11th ACR released OPCON 2/503d Inf

Operational Summary: The 173d Airborne Brigade (Separate) continued Operation CEDAR FALLS within the IRON TRIANGLE. The 1st Battalion conducted search and destroy operations on the west flank of the Triangle astride INTERPROVINCIAL HIGHWAY 14. At 1200 hours, Charlie Company located and destroyed a 200 meter tunnel at XT 685275. The Battalion CP began displacement at 1430 hours, closing at XT 677278 at 1515 hours without incident.

51

CONFIDENTIAL

CONFIDENTIAL

AVBE-SC

25 February 1967 84

SUBJECT: Combat Operations After Action Report (Operation NIAGARA/CEDAR FALLS)

The 4th Battalion, 503d Infantry released H/2/11th ACR from Operational control at 0700 hours. The Battalion then swept north to the east of the Triangle. At 0940 hours, Company A located in a tunnel (vicinity XT 729270) one (1) sniper rifle, three (3) pistols, one (1) Chicom carbine, ten (10) French bolt action rifles, six (6) cans of tar and fourteen (14) rolls of roofing tin. The Battalion made no significant contact during the day and were primarily concerned with the evacuation and destruction of rice caches.

The 11th ACR (-) with 2/503d Infantry OPCON continued mechanized and foot operations in the southern tip of the IRON TRIANGLE. They explored tunnels, conducted patrolling along lines of communication and secured the Engineer work parties who were clearing the area.

The 1/4th Cavalry with elements of E/17th Cavalry patrolled the northern portion of the IRON TRIANGLE meeting with no significant contact with the enemy. These units were situated west of BEN CAT blocking escape routes and securing Engineer work parties in the area.

t. D + 16 (24 January 1967)

Changes in Task Force Organization: B/1/503d Inf became OPCON to 1/4th Cav

Operational Summary: The 173d Airborne's Task Force DEANE continued to conduct Search and Destroy Operations in the IRON TRIANGLE and began to redeploy its forces to Base Camp in preparation for the termination of Operation NIAGARA/CEDAR FALLS. The 1st Battalion, 503d Infantry continued operations on the west flank of the IRON TRIANGLE proceeding northward. At 1057 hours at XT 670274, the Recon Platoon of 1/503d Infantry located and destroyed 3 tons of paddy rice. Shortly thereafter, they discovered a dead VC at XT 667302. The unit continued its movement and at XT 671271 they located and destroyed 25 additional tons of paddy rice and four (4) huts. Bravo Company was released from the Operational Control of the 1/4th Cavalry and returned to the Battalion CP at 1730 hours.

The 4th Battalion with D/16th Armor (OPCON) continued to conduct search and destroy operations to the north from XT 714289 to XT 720320. The Battalion CP and D/4/503d Infantry moved by track vehicle with D/16th Armor beginning at 0805 hours. At 1245 hours, Company D/16th Armor and two (2) platoons of D/4/503d Infantry were released from Brigade OPCON.

The 11th ACR (-) and 2/503d Infantry departed the Area of Operation at 0930 hours, clearing the IRON TRIANGLE at 1229 hours. The elements then proceeded to their respective base camps at XUAN LOC and BIEN HOA.

The 1/4th Cavalry continued its screening mission along the northern portion of the IRON TRIANGLE with B/1/503d Infantry OPCON. At 1300 hours, B/1/503d Infantry and 1/4th Cavalry contacted an estimated Viet Cong Squad at XT 669-323 (Location 1). The skirmish resulted in 8 VC KIA (EC) and 3 enemy WIA who were captured. Two (2) .38 caliber pistols were confiscated. At 1410 hours, as a direct result of this action, three (3) additional Viet Cong were captured at XT 669301.

u. D + 17 (25 January 1967)

Changes in Task Force Organization: Serials employed during redeployment of Brigade follows:

CONFIDENTIAL

85 AVEE-SC 25 February 1967
 SUBJECT: Combat Operations After Action Report (Operation NIAGARA/CEDAR FALLS)

<u>SERIAL #1</u>	<u>SERIAL #2</u>	<u>SERIAL #3</u>
LTC HEALY - Cndr	MAJ WINDSOR - Cndr	LTC NORDIN - Cndr
1/503d Inf	D/16th Armor	E/17th Cav
4/503d Inf	HHC (-)	B & C Btry
HQ & A Btry/3/319th Arty	1 Plt Engr	3/319th Arty
	BSOC	

The 173d Airborne Brigade (Separate) terminated Operation NIAGARA/CEDAR FALLS at 0700 hours when it was released from the Operational Control of the 1st Infantry Division. The Brigade returned to Base Camp in three Serials, clearing the CEDAR FALLS AO at 0945 hours. The final elements of the Brigade closed at BIEN HOA at 1327 hours. The movement was executed without incident.

15. Revolutionary Development

a. Civic Action Activities:

- (1) Construction of Refugee Center (100 meters x 150 meters at location XT 733323, BEN CAT).
 - (a) A double concertina wire protective barrier was erected around the perimeter.
 - (b) Erected four (4) ea tents, GP large.
 - (c) Constructed two (2) ea latrines, slit trench, 8 hole
- (2) Constructed a Boy Scout Den/Schoolroom, 16' x 24' using logs, 1" planking and corrugated metal roof.
- (3) Constructed 1 ea Soccer Field, 100 meters x 40 meters.
- (4) Constructed 3 ea Volley Ball courts.
- (5) Installed 36' of 24" corrugated metal culvert under access road leading to church vicinity XT 740329, BEN CAT.
- (6) Distributed to BEN CAT District Advisor the following:
 - (a) 450' of chicken wire.
 - (b) 45' - 50' ea miscellaneous corrugated metal culvert.
- (7) The above items were accomplished by the 173d Engineer Company.

b. Brigade S5 Activities:

- (1) During Operation CEDAR FALLS, the S5 Section centered its activities in the BEN CAT DISTRICT, BINH DUONG PROVINCE. The following are totals of various S5 Activities:
 - (a) MEDCAP and DENTCAP

CONFIDENTIAL

AVEE-SC

25 February 1967

56

SUBJECT: Combat Operations After Action Report (Operation NIAGARA/CEDAR FALLS)

<u>DATE</u>	<u>LOCATION</u>	<u>COORDINATES</u>	<u>MEDCAP</u>	<u>DENTCAP</u>
6 Jan 67	XOM RACH NAI	XT 777185	67	18
9 Jan 67	AN DIEN	XT 727318	22	6
10 Jan 67	AN DIEN	XT 727318	157	65
11 Jan 67	AN DIEN	XT 727318	154	34
12 Jan 67	MUONG CIAO	XT 730340	84	20
12 Jan 67	CHU MUI	XT 745335	15	5
13 Jan 67	MUONG CIAO	XT 730340	55	15
13 Jan 67	XOM XOAI	XT 755320	50	25
16 Jan 67	BEN CAT	XT 741330	143	38
17 Jan 67	BEN CAT	XT 741330	198	44
18 Jan 67	MY THANH	XT 765304	117	31
18 Jan 67	BEN CAT	XT 745328	56	33
19 Jan 67	BEN CAT	XT 740329	52	18
19 Jan 67	HUONG DAY	XT 750325	67	12
20 Jan 67	LO THANH	XT 734334	82	21
20 Jan 67	CHU MUI	XT 745336	28	18
21 Jan 67	AN DIEN	XT 733329	62	16
23 Jan 67	AN DIEN	XT 727318	87	12
		TOTAL	1,496	430

(b) Psychological Operations:

1. Speaker and Leaflet Missions:

<u>DATE</u>	<u>MISSION</u>	<u>THEME</u>	<u>TIME/AMOUNT</u>
9 Jan 67	Speaker	"Control of Refugees/MEDCAP Instructions"	5 Hrs
10 Jan 67	Speaker	"Control of Refugees/MEDCAP Instructions"	8 Hrs
11 Jan 67	Speaker	"Control of Refugees/MEDCAP Instructions"	5 Hrs
12 Jan 67	Speaker	"Control of Refugees/MEDCAP Instructions"	7 Hrs
13 Jan 67	Speaker	"Control of Refugees/MEDCAP Instructions"	5 Hrs
14 Jan 67	Speaker	"Control of Refugees/MEDCAP Instructions"	7 Hrs
16 Jan 67	Speaker	"MEDCAP Instructions"	1 1/2 Hrs
16 Jan 67	Handouts	"Calendars 1967"	210
17 Jan 67	Leaflet	"Chieu Hoi/Safe Conduct"	95,000
17 Jan 67	Speaker	"MEDCAP Instructions"	1/2 Hr
17 Jan 67	Handouts	"Calendar 1967"	210
18 Jan 67	Speaker	"MEDCAP Instructions"	1 Hr
18 Jan 67	Handouts	"Calendar 1967"	210
19 Jan 67	Speaker	"MEDCAP"	1 1/2 Hrs
20 Jan 67	Leaflet	"Chieu Hoi/Safe Conduct"	150,000
20 Jan 67	Speaker	"Chieu Hoi Special"	1 1/2 Hrs
20 Jan 67	Speaker	"Why You Should Rally"	2 Hrs
20 Jan 67	Speaker	"Chieu Hoi/Rally Now"	5 1/2 Hrs
21 Jan 67	Leaflet	"Chieu Hoi/Safe Conduct"	79,000
21 Jan 67	Speaker	"Rally Instructions"	1 Hr
22 Jan 67	Leaflet	"173d Good Guy"	100,000
22 Jan 67	Speaker	"173d Power"	1 Hr

TOTAL Leaflets Dropped - 424,000
 TOTAL Air Speaker Hours - 4.25 Hrs
 TOTAL Air Missions Flown - 5
 TOTAL Ground Speaker Hours - 51.75 Hrs
 TOTAL Handouts (Calendars) - 630

CONFIDENTIAL

CONFIDENTIAL

87

AVBE-SC

25 February 1967

SUBJECT: Combat Operations After Action Report (Operation NIAGARA/CEDAR FALLS)

2. Most noticeable Psychological Operations occurred on 19 January, when two Vietnamese brothers were united in the Chieu Hoi Compound. In an effort to get other VC to rally, they wrote a message on a leaflet that also had their picture on it and the names of six of the members of their militia squad. This leaflet was printed that night and dropped the next morning. That day, the 6 members listed on the leaflet turned themselves in as ralliers. See TAB H for leaflet.

3. In addition, 18 VC arrived at the Chieu Hoi Center with serial numbered Safe Conduct Passes that were dropped by the 173d Airborne Brigade's Psy Ops Team during this operation.

4. The following distributions were made during Operation CEDAR FALLS:

Rice (100 lb Bags)	2,081 bags
Bubble Bath	120 boxes
Cooking Oil	18 cans
Keen Drink	108 bottles
Milk, Dry	36 boxes
Bulgar Wheat (100 lb Bags)	6 bags
C-Rations (Surplus)	2 large boxes
Ammo Boxes (Empty)	235 boxes

5. Imprest Fund purchases in the amount of 6,030 \$VN were made to support Civic Action projects during Operation CEDAR FALLS.

6. A refugee collection point was operated by the Brigade S5 Section at BEN CAT, BINH DUONG PROVINCE. Refugees from the IRON TRIANGLE were processed through this point to enable them to consolidate their personal belongings, livestock and travel to the main refugee collection point at PHU CONG in family groups. 2,740 refugees were processed by the Brigade S5.

7. During the final days of Operation CEDAR FALLS, the refugee collection point at BEN CAT was converted into an athletic field containing a soccer field, a volleyball court and a Boy Scout Hut. This was named "Sky Soldier Field" and the facility built there was dedicated for the use of the children of the BEN CAT District.

8. On Saturday, 21 January, a Rice Passing Festival was held at the BEN CAT District Headquarters. During this event, captured VC rice was distributed to 1,128 families in the BEN CAT area.

9. Ammunition boxes from the 3/319th Artillery Battalion were taken daily to the 3 permanent refugee housing areas than encompass the village of BEN CAT. These boxes were used by the Vietnamese families for floors in their homes and for firewood.

c. Summary: Civil Affairs activities in Operation CEDAR FALLS were the most productive of any operation conducted by the 173d Airborne Brigade (Separate) to date.

CONFIDENTIAL

CONFIDENTIAL

AVBE-SC

25 February 1967

88

SUBJECT: Combat Operations After Action Report (Operation NIAGARA/CEDAR FALLS)

16. Logistics/Administrative Activities:

a. General: To support Operation NIAGARA/CEDAR FALLS a Brigade Supply Office forward element was established at PHU LOI for Operation NIAGARA FALLS, and at Position RED (HEN CAT) for CEDAR FALLS along with a Brigade Supply Operations Center (BSOC).

b. Supply and Transportation: Resupply of the Brigade was accomplished daily by road convoy from BIEN HOA. This was supplemented by drawing from the 1st Logistical Command stocks of Class V and Class III from LIA KHE. Thirty (30) 2½-ton trucks of the 48th Transportation Group moved elements of the Brigade to positions at PHU LOI from the AO of Operation CANARY/DUCK. Sixty (60) more 2½-ton trucks were employed to move the remainder of the maneuver elements to PHU LOI for airlift into an assembly area. A total of 90 2½-ton trucks from the 48th Group were used to extract the maneuver elements from the operational area at the termination of the operation. A total of 1,322.2 short tons of supplies were handled during the operation. Of this amount, 74 short tons were used for Operation NIAGARA FALLS and 1,248.2 short tons for Operation CEDAR FALLS. A breakdown by Class of Supply for each operation follows:

NIAGARA FALLS

Class I	19.3 ST
Class II & IV5 ST
Class III2 ST
Class V	<u>54.0 ST</u>
TOTAL	74.0 ST

CEDAR FALLS Bien Hoa

Class I	260.07 ST
Class II & IV	52.75 ST
Class III	574.69 ST
Class V	<u>164.79 ST</u>
TOTAL	1,052.30 ST

CEDAR FALLS Lai Khe

Class III	8.1 ST
Class V	<u>187.9 ST</u>
TOTAL	195.9 ST

A total of 739 UH-1D and 5 CH-47 resupply sorties were flown from the BSOC to forward elements of the Brigade.

CONFIDENTIAL

CONFIDENTIAL

29

AVBE-SC

25 February 1967

SUBJECT: Combat Operations After Action Report (Operation NIAGARA/CEDAR FALLS)

c. Maintenance: A maintenance contact team consisting of two officers and twenty enlisted men from Company "D" (Maintenance), 173d Support Battalion was located forward at Position RED and provided direct support maintenance to Brigade elements. Back up support and resupply of repair parts was accomplished daily by road convoy. A breakdown of support provided follows:

<u>SECTION</u>	<u>JOBS RECEIVED</u>	<u>JOBS COMPLETED</u>	<u>JOBS UNCOMPLETED</u>
Mechanical Maintenance	37	37	0
Armament	141	140	1
Signal	92	92	0
Engineer	9	9	0
Service & Evacuation	17	17	0

A noticeable improvement in organizational maintenance was observed.

d. Medical: Company "B" (Medical), 173d Support Battalion, provided medical support employing four officers and thirty-five enlisted men, offering full surgical, medical and dental support. The clearing station served as the primary evacuation facility for casualties. Dustoff coverage was provided through the 1st Division Clearing Station. Daily routine evacuation was accomplished via 3/4-ton ambulance by road convoy and LOC helicopters returning to BIEN HOA for the night. A total of 382 patients were treated. Casualty and patient breakdown follows (KIA, WIA and Non-Battle Injuries will be covered in Operation Results).

FUO	31
Dermatological	44
ENT	14
Eye	4
Cardio Respiratory	4
Gastro Intestinal	23
Genitourinary	77
Neuro Psychiatric	0
Other Medical	9
Dental	48
Viet Cong Medical	8

g. Communications:

(1) The Brigade CP moved directly from Operation CANARY/DUCK astride ROUTE 15 to PHU LOI on 4 January 1967. The Brigade then passed from OPCON II FFORCEV (Hurricane) to the 1st Infantry Division (Danger). UHF communications were established from the Brigade CP at PHU LOI to DANGER FORWARD at LAI KHE. The Brigade at this time entered the 1st Division voice secure FM Radio Net. This Net was used to pass classified traffic throughout Operation NIAGARA/CEDAR FALLS. Heaviest usage was mostly in the early evening when plans for the next day's operations were being coordinated. This was the first time the Brigade made use of the FM Voice Secure Radio Equipment and the employment of this equipment continued on a day to day basis. On 8 January 1967, the CP moved from PHU LOI to a location due east of BEN CAT for the commencement of Operation CEDAR FALLS. VHF was quickly established to the 1st Infantry Division Forward at LAI KHE. Although operational communications as planned were adequate between the 1st Infantry Division and the 173d Airborne Brigade (Separate), some problems developed in circuit routing for telephone communication between BRIGADE FORWARD and BRIGADE REAR. Circuits from PARACHUTE to BIEN HOA ARMY switchboard were routed from BEN CAT to LAI KHE to HURRICANE. The

CONFIDENTIAL

CONFIDENTIAL

AVRE-SC
SUBJECT: Combat Operations After Action Report (Operation NIAGARA/CEDAR FALLS)

25 February 1967 90

leg from LIA KHE to PHU LOI was over an Army (USARV) system and problems developed in coordination and reaction times. Several days later, the circuits were placed on a 1st Division system from LAI KHE to PHU LOI and this improved circuit stability and quality considerably.

(2) Communications within the Brigade were primarily by FM voice radio. Those units within or on the perimeter were fed into PARACHUTE switchboard by wire. Arrangements had been made to provide 4-channel VHF system to the 11th ACR which had been placed OPCON to the 173d Airborne Brigade (Separate) on Operation CEDAR FALLS. The 11th ACR (-) placed its main tactical CP at BEN CAT with the Brigade CP. The plan was to displace from there if necessary. With this in mind, the 4-channel VHF system (AN/MRC-112) was established with the BEN CAT perimeter. It should be noted that it took 2½ days to get this 100 yard shot working due to problems in frequency interference. During this, wire line was employed between the two CP's. Once established, the AN MRC-112 system proved to be quite stable and was utilized between the 173d Brigade CP and the 11th ACR (-) for the duration of the operation.

(3) It was during this operation that the concept of commanding from the air was fully employed. Upon direction of the CG, action was initiated to provide five command and control (C & C) helicopters at any one time. Upon examination of the Brigade resources, it was determined that five FM Radios, one UHF radio, one AN/ASC-6 modified to provide 2 FM radios each. All the above consoles are designed to provide inter-communications between the commander and the pilot. In line with this program, arrangements were made to install an external FM radio antenna on each of the six (6) OH-13 helicopters in Casper Platoon. This would facilitate the enabling of passengers to board the aircraft with their own AN/PRC-25 and connect it to the installed antenna, by using a vehicle-type headset and H-138 handset. This system proved quite workable.

f. Public Information Office:

(1) On 8 January 1967, the PIO commenced operation of a Field Press Center at the 173d Airborne Brigade CP at Position RED, vicinity of BEN CAT. The center assisted 9 newsmen on the first day of Operation CEDAR FALLS. These men were:

Mr. John Linzel, Associated Press
Mr. Bruce Morton, and two man crew, CBS
Mr. George Page, NBC
Mr. Jim Eury, NBC
Mr. Hans Peshke, NBC
Mr. Jim Comparo, United Press International
Mr. Ron Gallagher, a free lance writer/photographer.

(2) The reporters covered various aspects of the Operation such as the operations of the 11th Armored Cavalry Regiment (-), refugee evacuation, and tunnel exploration. General Deane was interviewed by Newsmen Page, Eury and Peshke. Other news correspondents who covered the Brigade's operation were:

CONFIDENTIAL

CONFIDENTIAL

41

AVHE-SC

25 February 1967

SUBJECT: Combat Operations After Action Report (Operation NJAGARA/CEDAR FALLS)

Miss Henny Schante, representing Dutch media

Mr. Gerald Forken, Stars and Stripes

Mr. Phil Stit, Stars and Stripes

Mr. Carl Furnell, representing Pennsylvania Papers

Mr. John Sach, Esquire Magazine

Mr. Everett Manning, Newsweek Magazine

Mr. Leon Daniels, and his crew, United Press International

SFC William Lebus, Armed Forces Radio and Television

17. Special Equipment/Techniques:

The unique and revolutionary characteristics of Operation NIAGARA/CEDAR FALLS as a multi-force operation led to the use of many pieces of special equipment in addition to the new techniques employed by Infantry and Support elements within the Brigade. The following techniques/equipment are considered to be the most significant.

a. Aero Cavalry Operations (Sky Cavalry Concept): In later September 1966, the E Troop, 17th Cavalry Commander and the Aviation Officer of the Brigade flew to the 1st Cavalry Division (Airmobile) for a first hand evaluation of the limits and capabilities of employing airmobile tactics. They returned highly enthusiastic that such a mission could greatly improve the combat flexibility of the Brigade.

The aero rifle platoon concept was adopted in October 1966 with the approval and support of the Commanding General. Extensive classes and training were given to each platoon of the Troop E/17th Cavalry. Senior NCO's from each of the Cav's platoon were sent to AN KHE for first hand experience on the employment of Aero Scout techniques.

In order to initiate this concept, several principal guidelines were established. The personnel comprising the Aero Rifle squad and observers for the Aero Scouts, along with the platoon headquarters element come from the resources of the Cavalry Troop. Personnel were available within the Recon Platoon of E/17th Cavalry to form 3 - 12 man squads in addition to the platoon Headquarters element, usually consisting of three men.

In addition, the Aero Scout section was reorganized utilizing enlisted scout observers from the Troop who had already undergone extensive training in these techniques. The concept was first employed on Operation ATTLEBORO, as a reaction force for a Long Range Reconnaissance Patrol team. The mission was successful, however, not until Operation CANARY/DUCK was the Aero Cavalry concept proven. During Operation NIAGARA/CEDAR FALLS, this concept was used extensively by almost all Infantry elements within the Cavalry Troop.

The techniques employed are as follows. The Aero Scout Section (employing CH-13's) fly over a predesignated area in pairs (lead and chase ships) looking for trails, canals, or recently used campsites and enemy activity. After the scouts have made a significant discovery, a call is sent back to the stand by Aero Rifle

CONFIDENTIAL

CONFIDENTIAL

AVBE-SC

25 February 1967 7.5

SUBJECT: Combat Operations After Action Report (Operation NIAGARA/CEDAR FALLS)

platoon and they are issued forth to a suitable landing position near the location by armed helicopter. The area is suppressed before the landing is initiated so that friendly troops do not run head on into hostile elements. For further analysis of this technique, see Small Unit Actions (E/17th Cav - Operation CEDAR FALLS).

b. Tunnel Rat Teams: The Tunnel Rat Team consists of six to ten men including one OIC or NCOIC. The individual in charge has the responsibility of drawing the sketch of the underground complex from the information relayed from the team within. The lead elements of the Tunnel Rat Team is armed with a .22 caliber pistol equipped with a silencer, a TA-1 telephone or skull mike, a flashlight, compass and probe. An azimuth is taken, paces are counted off and the information is relayed to administrative elements above.

The major problem encountered during tunnel exploration is one of communications. The skull mike apparatus (consisting of a transmitter strapped to the back of the skull) often becomes inoperative after a short period of time necessitating repair. In addition, WD-1 wire had to be employed in lieu of light weight Canadian Assault Wire, which had become scarce. The heavier wire added a considerable amount of weight and bulk to the Tunnel Rat Team.

c. Mine Detecting Operations: The mine detector (Aural Indicating) was the primary piece of equipment employed in this type of operation. This detector will pick up any metallic object within its area of sensitivity. It can detect objects as small as one strand of commo wire up to four feet below the surface of the ground. However, this capability also proves to be a deterrent to mine detecting operations since the machine will pick up tin foil, empty shell cases, nails or any other thing containing metal as well as mines.

d. River Patrols: River Patrols employed during Operation NIAGARA/CEDAR FALLS consisted of 15 men, two of them being Engineers, with the remainder being Infantrymen. The craft utilized were 15-man pneumatic assault boats. One of the Engineers on board was a motor operator while the second was in charge of holding the boat to the shore during loading and unloading and also casting the boat off shore. The actual patrol was assigned the task of checking all Vietnamese river traffic. The boats were additionally employed in the ferrying of supplies to outposts along the river.

e. Floating Mine Barrier Techniques: Floating mine barriers proved to be the answer to the problem of tidal effect on inland waterways. Cables are stretched across the river and are allowed to sag below the water level. The bridging timbers are then attached to these cables so that they float. When the river is under tidal influence, the floating barrier rises and falls with the tide. Barriers often had to be constructed on both sides of the bridge since the tide often causes the waterway to flow in both directions.

f. Efficiency of AN/PRC-25: The AN/PRC radio with long antenna was employed on a command and liaison helicopter as a radio relay for the Battalion operations. It proved to be an extremely effective link between the CP and the front line companies.

g. Infra-Red: APC's with their organic Infra-red periscopes provided augmentation to the use of Starlight Scopes on night perimeter defense.

h. Bulldozers: Bulldozers furnished by the 1st Infantry Division Engineers were of great assistance in providing new avenues of approach to areas where the Viet Cong had heavily mined existing approaches. They were also of invaluable assistance in preparing defensive positions when they cleared LZ and fields of fire for Infantry elements.

CONFIDENTIAL

CONFIDENTIAL

93

AVEE-SC

25 February 1967

SUBJECT: Combat Operations After Action Report (Operation NIAGARA/CEDAR FALLS)

i. Employment of the Armor Vehicle Launched Bridge: An Armor Vehicle Launched Bridge was employed to span a section of bridge that had collapsed at BEN CAT, making it possible to recommence road movement, and hence, normal operations, with minimum delay.

j. Weapons Used at River Blocking Positions: Twin 40mm anti-aircraft weapons were used in blocking positions along the THI TINH and SAIGON RIVERS during the operation. Quad .50 caliber machineguns were also used in similar positions and were mounted on Engineer Boats to block the river exits utilized by the enemy.

k. The following is a chronological sequence of the employment of Special Tunnel Clearing Equipment (8,500 c.f.m. BUFFALO TURBINE) on Operation CEDAR FALLS.

(1) 14 January 1967: Elements of Company M, 3/11th ACR had earlier located a tunnel entrance within their operational area, the first tunnel confirmed by a Brigade element. The Turbine was helilifted by UH-1D helicopter from the Brigade CP at Position RED with the operator crew of the 51st Chemical Detachment (Airborne) to vicinity XT 746230. The machine was mounted inside an APC of Mike Company and was utilized to ventilate the tunnel shaft for the 173d Engineer Company's "Tunnel Rat" search party. Several tunnel entrances were discovered by the party and the APC was displaced several times following their progress from entrance to entrance. The turbine and crew remained overnight with Company M.

(2) 15 January 1967: The turbine was displaced from the base area of M/3/11th ACR by helicopter to support an Engineer Platoon of the 173d Engineer Company searching a tunnel in the 1/503d Infantry area of operation. The UH-1 sling loaded turbine was set down into the bed of an Engineer Dump Truck and was moved by truck to tunnel entrance vicinity XT 683271. Tunnel smoke tracing operations were begun at 1100 hours and continued until 1430 hours. M5, 30-pound smoke pots were used as a smoke source and were introduced into the tunnel entrance with air from the turbine forcing the smoke down the shaft. A recon patrol of E/17th Cavalry was airborne in a helicopter for aerial observation of emitted smoke while engineer elements on the ground moved to and marked the smoke exits. A total of eight (8) additional surface openings were located during the operation both north and south of the original location. The Engineer platoon returned the following day and collapsed the tunnel openings. The evening of the 15th, the turbine and crew returned to the Brigade CP with the Engineer Platoon's dump truck.

(3) 16 January 1967: The turbine and crew returned to the 1/503d Infantry area (XT 683271) still mounted on the dump truck and was further transported by road to the Squadron CP of 2/11th ACR vicinity XT 726248. Movement was delayed due to mine clearing operations on ROUTE 14 between the 1/503d Infantry and the 2/11th ACR. The machine was scheduled for work at a tunnel opening vicinity XT 736250 but did not arrive in time to be placed in operation and remained overnight at the Squadron CP.

(4) 17 January 1967: During the previous afternoon (16 January) a tunnel search party of Company M/3/11th ACR sustaining 1 KIA and 1 WIA from VC automatic weapons fire while proceeding down a tunnel shaft vicinity XT 740221. On the morning of 17 January, the turbine and crew was displaced by vehicle from 2/11th ACR to the 3/11th ACR area and loaded onto an APC attached to Company M of the 3d Squadron. The turbine was utilized for smoke tracing at the above opening. Eight additional tunnel openings were identified by smoke emissions from XT 740-218 - XT 740221 - ST 738222 - XT 737221. An Engineer Platoon from the 173d Engineer Company collapsed all openings with demolition charges and detonated CS-1

CONFIDENTIAL

CONFIDENTIAL

AVBE-SC

25 February 1967 94

SUBJECT: Combat Operations After Action Report (Operation NIAGARA/CEDAR FALLS)

into the shafts connecting the entrances. A Recon Patrol of E/17th Cavalry again spotted from the air, smoke emission, however, no VC were observed to exit during smoke operations. The crew and turbine remained with Company M overnight.

(5) 18 January 1967: The turbine was moved by vehicle from 3/11th ACR to 2/11th ACR and conducted smoke tracing operations from 1400 hours to 1445 hours. They continued to pump fresh air from 1530 to 1700 hours for an engineer tunnel search party from the 173d Engineer Company. At 1800 hours, the turbine and crew were displaced by UH-1 sling load to 4/503d Infantry's CP area and were mounted on an APC of D/16th Armor (OPCON 4/503d Inf) in preparation for support of Company A/4/503d Infantry. Elements of Company A while on security saw a movement and located a trap door covering a tunnel opening at the vicinity of XT 728265. Members of the 3d Platoon entered the tunnel and encountered VC a short distance from the tunnel opening. PFC Pondergist, SGT Spencer, SP4 Sprague and PFC Walden were repeatedly opposed by VC for the remainder of the afternoon and although they engaged the VC with M-79's, .38 and .45 caliber pistols, the VC continued to contest the tunnel. In the late afternoon, burning type CS grenades were thrown into the shaft of the tunnel to flush the VC. The 4/503d Infantry troopers continued to hear VC activity and could hear sounds believed to have been respiration of individuals wearing VC expedient "gas masks".

(6) 19 January 1967: On the morning of 19 January, the turbine was moved to the tunnel entrance by APC and conducted smoke flushing operations from 1050 hours to 1145 hours. At 1130 hours, 7 VC (3 males, 4 females) exited a tunnel opening at vicinity XT 721259 in Bravo Company, 2/503d Infantry's AO and were immediately apprehended. All 7 VC were suffering effects of smoke inhalation and experienced difficulty in breathing. Two of the females subsequently expired from unknown causes. The turbine continued operation from 1145 to 1245 hours flushing the smoke with fresh air. At 1300 hours, a tunnel search team of A/4/503d Infantry entered the opening. Smoke was not encountered, however, a concentration of CS gas (from the previous day's attempt to flush out VC) effused from the walls of the tunnel whenever the turbine was shut down. The concentration was sufficient to require search personnel to remain masked. From 1300 hours to 1530 hours, the search team negotiated the tunnel, identified 5 separate shafts, capturing 3 individual weapons, and exited the tunnel in the B/2/503d Infantry's area. They were informed by members of that unit of the capture of 7 VC. At no time was VC opposition encountered. In addition, several tunnel entrances were identified by spotting smoke 300 meters north of the original entrance.

(7) 20 January 1967: The turbine remained in the 4/503d Infantry area. An element of Company B escorted the equipment to the location of the previous day's operation and smoke operations were again resumed. HC smoke was continuously pumped into the tunnel from 1130 - 1430 hours, expending a total of 12 30-lb smoke pots with the turbine running at maximum capacity. Smoke was observed at locations much more distant and in greater volume than the previous day, largely as a result of greatly extended operating time. This is attributed to the fact that an extensive network will require a long period of sustained operation to displace a sufficient volume of air to fill the network and build pressure sufficient to force the smoke out exits in volume sufficient to be observed from the air. During the two days of operation, a total of 15 VC harboring inside the tunnel were captured while exiting or apprehended by search parties underground, all being taken by Company B/2/503d Infantry. Most VCC were attributed to smoke flushing operations in the 4/503d Infantry area and all at least partially so.

CONFIDENTIAL

CONFIDENTIAL

AVHE-SC

25 February 1967

95

SUBJECT: Combat Operations After Action Report (Operation NIAGARA/CEDAR FALLS)

(8) 20 January - 22 January 1967: The BUFFALO TURBINE and crew remained with 4/503d Infantry and was utilized to provide fresh air for search parties from Company B. On 22 January, the equipment was helilifted back to the Brigade CP at Position RED. See TAB F for drawings of VC tunnel complexes.

18. Results of Operation NIAGARA/CEDAR FALLS:

a. Friendly Losses

Casualties sustained by the 173d Airborne Brigade and OPCON Units, 11th ACR (-), 1/4th Cav of the 1st Infantry Division:

173d Airborne Brigade (Separate) Casualties:

	<u>1st Bn</u>	<u>2d Bn</u>	<u>4th Bn</u>	<u>3/319th Arty</u>	<u>E/17th Cav</u>	<u>D/16th Armor</u>	<u>173d Engr</u>	<u>39th Inf SD</u>	<u>HHC (-)</u>	<u>335th AML</u>	<u>TOTAL</u>
KIA	3	3	8	0	0	0	0	0	0	0	14
WIA*	27	23	48	1	8	7	1	1	2	0	118
MIA	0	0	0	0	0	0	0	0	0	0	0
NBD ¹	1	0	0	0	0	0	0	0	0	0	0
NBI ²	1	0	2	4	0	0	3	0	1	1	12

*Two (2) WIA accounted for above died later in the hospital as a result of wounds received in action. These men were, SP4 Collins of E/17th Cavalry and SP4 Lonnie Floyd of C/4/503d Infantry.

¹NBD = Non-Battle Dead

²NBI = Non-Battle Injured

Of the 118 WIA received by the Brigade during the Operation, 21 were returned to duty, 103 had minor injuries and 6 had serious injuries.

Equipment Lost and/or Damaged - None

11th Armored Cavalry Regiment (-) Casualties:

KIA	8
WIA	57
MIA	0
Non-Battle Dead	0
Non-Battle Injured	0

Equipment Damaged - 11th ACR (-)

APCs	8
----------------	---

CONFIDENTIAL

AVBE-SC

25 February 1967

96

SUBJECT: Combat Operations After Action Report (Operation NIAGARA/CEDAR FALLS)

Tanks 4

Wheeled Vehicles 4

Equipment Destroyed - 11th ACR (-)

APC's 2

Tank 1

1/4th Cavalry (-) Casualties:

KIA 2

WIA 35

MIA 0

Non-Battle Dead 0

Non-Battle Injured 0

Equipment Destroyed - 1/4th Cavalry (-)

Tank Recovery Vehicle 1

Tanks 1

APC's 3

M42 1

b. Enemy Losses: Operation NIAGARA/CEDAR FALLS - TF DEANE

Personnel Losses Inflicted by Elements of the 173d Abn Bde (Sep)

KIA (BC) 185

KIA (poss) 10

Detainees 146

Ralliers 72

VCC 65

Personnel Losses Inflicted by Elements of 11th ACR (-)

KIA (BC) 26

KIA (poss) 13

Detainees 74

VCC 8

Ralliers 12

CONFIDENTIAL

91

AVBE-SC

2, February 1967

SUBJECT: Combat Operations After Action Report (Operation NIAGARA/CEINAR FALLS)

Personnel Losses Inflicted by Elements of 1/4 Cavalry

KIA	37
VCC	65
Detainees	26
Ralliers	38

Weapons Captured by Elements of the 173d Atn Bde (Sep)

60mm Mortars	2
3.5" Rocket Launcher	2
B-40 Rocket Launcher	1
M-60 Machineguns	2
Browning Automatic Rifles	8
French Machineguns	2
Thompson SMG	7
.45 Caliber SMG's	5
Russian AW	1
Russian Carbines	17
Russian Rifles	3
SKS Rifle	1
Chicom SMG	1
Chicom Bolt Action Rifles	65
Chicom Rifles	6
Chicom Carbines	14
Mossin Nagart Rifles	4
AK-47 Rifles	3
US M-1 Rifles	7
US M-1 Carbines	18
US M-2 Grease Gun	1
US M-3 SMG	1
US Springfield Rifles	1

CONFIDENTIAL

CONFIDENTIAL

AVBE-SC

25 February 1967

98

SUBJECT: Combat Operations After Action Report (Operation NIAGARA/CEDAR FALLS)

1917 Eddystone Rifle	1
US .45 Caliber Pistols	6
German Mauser Rifles	2
French Mas Rifles	3
British Infield Rifles	1
Bolt Action Rifles	12
Carbines (unk type)	2
Rifles (unk type)	2
Shotguns	3
.38 Caliber Pistols	2
P38 Pistol	1
Browning Automatic Pistol	1
Homemade Pistols	3
Homemade cal .45 Pistol	1
Pistols (Unk Type)	4
<u>Weapons Parts:</u>	
Rifle Barrels	2
Rifle Stock	1
Mortar Aiming Stakes	4
Magazines	5
Grenade Launchers	24
M-60 Barrels	2
AA Gun Mount	1
60mm Bipod & Base Plate	1
Sub-Machinegun Magazines	2
.30 Caliber MG Barrel	1
Bayonet	1

CONFIDENTIAL

94

AVBE-SC
SUBJECT: Combat Operations After Action Report (Operation NIAGARA/CEDAR FALLS) 25 February 1967

Ammunition:

175mm Rounds	2
155mm Rounds	2
105mm Rounds	38
81mm Rounds	8
60mm Rounds	50
40mm Rounds	1
Illuminating Mortar Rounds	1
3.5" Rocket Launcher Rounds	1
B-40 Rounds	1
RP6-2 Rounds	2
57mm Rounds	3
20mm Round	1
10mm Round	1
M-79 Rounds	9
7.92 Rounds	1300
7.62 Rounds	114
5.56mm Rounds	500
Crimped Cartridges	385
Assorted SA Rounds	5030
.50 cal Rounds	100
.45 cal Rounds	700
.30 cal Rounds	6030
Grenades	282
Chicom Grenades	264
Homemade Grenades	127
M-26 Grenades	6
Rifle Grenades	18

CONFIDENTIAL

AVHE-SC
SUBJECT: Combat Operations After Action Report (Operation NIAGARA/CEDAR FALLS)

25 February 1967

100

WP Grenades 2
Grenade Casings 300
Grenade Fuses 240

Mines:

Pressure Type Mines 2
Plastic AP Mines 21
AP Mines 68
AT Mines 45
DH-10 Claymore Mines 1
Other Claymore Mines 10
VC Claymore Mines 4
Homemade Mines 1
Mines (Unk Type) 5

Demolitions:

500 pound Bombs 3
250 pound Bombs 9
USAF Rockets 2
CBU Bombs 76
Plastic Bombs 1
Shaped Charge 1
Blasting Caps 42
C4 27.5 pounds
Detonating Cord 24 feet
TNT 7 pounds
Carbide 55 gallons
Chicom Explosives 300 pounds
Detonator 1

Transportation:

CONFIDENTIAL

101

AVBE-SC

25 February 1967

SUBJECT: Combat Operations After Action Report (Operation NIAGARA/CEDAR FALLS)

Boats 6
Canoe 1
Motor Bikes 2
Bicycles 48
Sampans 78

Installations:

Foxholes 217
Tunnels 193
Bunkers 313
Huts 147
Base Camps 17
Bombshelters 13
Punji Pits 90

Food:

Rice 1,307.5 tons
Salt 3.8 tons

Documents 20,000 estimated

Miscellaneous: 200 pieces of galvanized metal, 25 gauze bandages, 12 bottles of serum, 10 hypodermic needles, assorted medical supplies, medical kit, 1 lighter, 1 carbon lamp, 2 gold rings, 1 fuse, 3 typewriters, 10 pounds of typing paper, 1 French map, assorted clothing, 55 gallons of heavy oil, 85 gallons of gasoline, 5 gallons of tar, 2 trip flares, 32 washpans, 144 eight inch bolts, 2 cameras, 13 rucksacks, 12 pistol belts, 20 pair VN jungle boots, 1 oil skin map, 2 mosquito nets, 1 diary, 1 drafting set, 1 sewing machine, 1 300-gallon fuel tank, 6 rolls of barbed wire, 1 lantern, 1 US bunkbed, 759 - 4.5 volt batteries, 1 flare pistol, 20 flashlights, 1 reloading press, 100 pneumatic pillows, 1 bottle of kerosine, 950 pounds of nitrogen fertilizer, 8,050 feet electrical wire, 7 outboard motors, 1 ammo pouch, 300 pounds of cement, 1 entrenching tool, 4 pack harnesses.

19. Commander's Analysis and Lessons Learned:

a. Commander's Analysis

Operation NIAGARA FALLS:

Although no major contact was made with enemy elements, it was believed that the Viet Cong are using trails throughout the AO and the waterways to infiltrate small numbers of personnel and to transport food. Friendly operations in the AO have also assisted in reducing the effectiveness of the Local VC infrastructure and disclosed areas of operations which can be denied the enemy by a

CONFIDENTIAL

CONFIDENTIAL

AVBE-SC

25 February 1967

102

SUBJECT: Combat Operations After Action Report (Operation NIAGARA/CEDAR FALLS)

program of patrols and artillery harassing and interdiction. It is recommended that throughout the AO from time to time, forces be introduced to harass the VC and to preclude movement of troops and supplies through the area.

Operation CEDAR FALLS:

Judged by all standards, Operation NIAGARA/CEDAR FALLS was a major success. The mission of the 173d Airborne Brigade (Separate) and OPCON units was search and destroy. This was exactly what was done with a degree of thoroughness heretofore not achieved. The keys to this accomplishment were the saturation of the IRON TRIANGLE which US and Vietnamese Forces executed effectively owing to large amount of time made available to these combat units. The presence of highly specialized support troops and equipment provided assistance essential to the combat battalions in accomplishing their mission. This technical assistance included the employment of bulldozers (many of them with Rome plows), CS turbines, demolition teams, tunnel exploration teams, mechanized flame throwers, tank-dozers and acetylene.

Coupled with the river patrols, the Aero Cavalry, the anti-aircraft artillery, the blocking forces, and the air and artillery strikes, the Infantry and Armor on the ground applied tremendous pressure on VC hiding in the IRON TRIANGLE Area. The 185 VC who fell during the days of Operation NIAGARA/CEDAR FALLS give mute testimony to the effectiveness of this pressure. The shock of relentless attack and continuing military defeat resulted in the rapid deterioration of VC morale. Psychological Operations were employed to exploit every tactical and psychological advantage with a highly effective program of speaker missions, leaflet drops, and the delivery of personal messages urging surrender. Both hard core and Local Force VC were persuaded to come out of hiding and either surrender to US Forces or rally to the Government of Viet Nam. Seventy-two (72) POW's and sixty-five (65) Chieu Hoi Ralliers taken is as significant an achievement as the VC body count. A growing trend of dissatisfaction with VC practices and VC life in general was evident in the statements of the Ralliers. A wealth of pertinent intelligence information was derived from the interrogation of these VC and much of it was exploited by units on the ground.

The IRON TRIANGLE had provided the VC with more than a military base area where he could hide, train, store supplies and equipment and stage attacks on Allied Forces and installations. The area was also a VC political entity, independent of any government of Vietnam, where the enemy had complete control of the lives of the civilian populace. The VC grip on this area had to be broken before any further military operation in the area could be considered successful.

To this end, an ambitious program of evacuating all of the Vietnamese people, their livestock and possessions from the area was undertaken in conjunction with the Search and Destroy operations. In coordination with the 1st Infantry Division, 2,740 refugees were moved with all they owned by river assault group boats, helicopters and by road march to a Refugee Village at PHU CONG which the 173d Engineer Company in coordination with the Brigade S5 helped to construct. The refugees were screened by the 172d Military Intelligence Detachment to insure that no VC had infiltrated among the civilians.

The Viet Cong contributed to this program by providing 1,302 tons of captured rice. When the rice was uncovered by the combat units in the field, it was evacuated (polished rice only) for the use of the refugees. Unpolished (Paddy) rice, however, was destroyed in place to prevent its use by the VC. This was a time

CONFIDENTIAL

CONFIDENTIAL

AVBE-SC

25 February 1967

SUBJECT: Combat Operations After Action Report (Operation NIAGARA/CEDAR FALLS)

consuming process but through the use of APC's and helicopters, the refugees were supplied with large quantities of the grain. It is ironic that the rice was probably grown by the refugees in the first place.

The 173d Airborne Brigade (Separate) inflicted a serious defeat on the Viet Cong in the IRON TRIANGLE. Their hold on this political and economic base has been greatly weakened if not broken. They have lost any semblance of security that this former sanctuary may have once offered. Over 300 VC will never fight again. However, the VC are still in the area, and the defeat remains less than total.

The stage has been set for the future. VC "sanctuaries" will continue to be the target of ever increasing detailed seal, search and destroy operations in the CEDAR FALLS mold. Thus, the concept of operations as employed is perhaps the most significant feature in terms of the overall security of VIET NAM. The continued use of this type operation will reduce the power of the Viet Cong to the point where the government of this country can again assume the responsibility for its own security.

b. Lessons Learned:

Item: LZ Assaults

Discussion: During the massive heliborne troop movements of 9 January involving two (2) Battalions of the 503d Infantry (173d Abn Bde (Sep)), and major elements of the 1st Infantry Division, problems were caused by LZ's being in too close proximity. Pilots became disoriented in addition to the artillery preparation mission some LZ's and landing on other LZ's already occupied by US Forces. The assault echelons came in so fast that the first troop on the ground could not maneuver before the next elements were on top of them.

Observation: During massive assaults, LZ's should be no closer than 500 meters apart. All preparation should finish prior to any landing on LZ's, to insure the safety of the Infantry elements and aircraft employed in the assault.

Item: Coordination of Units

Discussion: During all operations, coordination between units is mandatory. This should be accomplished at a predesignated, easily recognizable point. Smoke grenades, flare and aerial directions can aid in the location of the coordination point. Fire must be controlled as well as the movement of troops near the AO boundaries separating units. Rapid link up of units after a heliborne assault is essential and should be made prior to moving out to a final position. When moving into a blocking position, gaps should be covered, especially near coordination points. This may preclude the use of unit perimeters and a "Combat Outpost Line" system can be employed with proper coordination for flank and rear security. The distance covered will be less than "Book" frontages because of terrain limitations and the lack of barriers.

Item: Unit Boundary Coordination

Discussion: In order to completely cover the territory involved in this operation, all units were given smaller than usual AO's. Units were at first unable to maneuver or patrol accustomed sized AO's and would run into adjacent unit's areas. There also arose the problem of "hot pursuit" when VC were discovered in the Brigade AO and attempted to escape into the 25th Division AO along the SAIGON RIVER.

CONFIDENTIAL

CONFIDENTIAL

AVBE-SC

25 February 1967

SUBJECT: Combat Operations After Action Report (Operation NIAGARA/CEDAR FALLS)

104

Observation: To properly sweep an AO clean, it must be a small area. Units must intensively patrol their own area instead of sending patrols on long range but less intensive clearing missions. Units must also take the time to closely coordinate fire and maneuver plans to preclude accidental engagements with friendly troops.

Item: Battalion CP Locations

Discussion: The AO of each Battalion on this operation was small enough so that companies could be effectively controlled from a stationary CP. The Battalion CP could be co-located with another unit thereby freeing all its combat elements of security requirements thus increasing the actual strength of the unit.

Observation: Battalion Command Posts should be located where they will have organic security as long as control is maintained.

Item: Route Reconnaissance

Discussion: A route reconnaissance should be conducted by Military Police and Engineers at least 3 - 5 days in advance of the Brigade Road march, and again 1 day prior, if possible. When routes were properly reconned, no last minute route changes developed, whereas, when a route reconnaissance wasn't made, time and again routes were found to be inadequate for certain vehicles and had to be changed at the last minute.

Observation: A route reconnaissance conducted in advance of deployment tends to cut down on delays which are often encountered along Highways. It also aids in insuring the safety of vehicles, equipment and personnel who are often subjected to sabotage while enroute.

Item: Attached Units

Discussion: When having units attached, it is necessary to have the particular unit attached at least 2 - 3 days in advance of the particular operation. This allows ample time for the unit being attached to familiarize themselves with another unit's method of operation, SOI's and particularities that they may not be familiar with in their own unit. This period of time, when properly used, is well worth it and both units function better together.

Observation: Ideally, attached units should be attached in sufficient time to enable them to go on route reconnaissance with the unit to which they will be attached. This gives them a better picture of what they have in store and ideas of their own may be incorporated so that both units will be able to cope with any problems that may arise.

Item: First Aid

Discussion: Existing Dustoff procedures provide timely medical evacuation allowing combat casualties to receive hospitalization with minimum delay. Once patients were evacuated, their treatment and care was excellent. In many instances, the initial treatment of casualties is performed by Infantrymen who, on more occasions than one, saved the lives of their wounded comrades. During Operation CEDAR FALLS, platoon medics again became swamped with casualties for a short period of time. Also, Medics were themselves wounded or killed. In addition, squad sized elements often operated alone without medics on their patrols.

CONFIDENTIAL

CONFIDENTIAL

105
AVBE-SC

25 February 1967

SUBJECT: Combat Operations After Action Report (Operation NIAGARA/CEDAR FALLS)

Observation: Training in First Aid provided to all individuals proved valuable on at least one occasion when medical aid had to administered to combat casualties without help of a medical corpsman.

Item: VC Boobytraps

Discussion: VC Boobytraps in the AO were designed to impede friendly attacks into enemy bases. They were of the "no-delay" explosive type placed on the periphery of the bases so as to give early warning as well as inflict casualties. The VC did not appear as concerned over boobytrapping foot avenues of approach as they did in impeding vehicular traffic. These approaches were trapped with command detonated mines and boobytrapped artillery shells. The enemy also boobytrapped areas which they did not use with CBU's and grenades. Some of these areas were marked with a skull and crossbone warning sign.

Observation: Personnel are warned to be always on the alert for VC boobytraps and claymore mines when travelling on or off main routes. These demolitions accounted for the major portion of friendly casualties. When moving into an area of suspected mining and boobytraps, maximum use should be made of TAC Air, Artillery and recon by fire. Also, when possible, the roads and trails should be avoided, and new trails cut. Culverts and tunnels beneath a roadway are prime locations for large AT mines, and in this respect, a bunker or foxhole next to a roadway should be investigated as an access to a mined tunnel beneath the road. On one occasion, a sheet of tin foil was found buried at a depth of several inches, probably to confuse the mine sweeping team. At a greater depth in the same location, an AT mine was found.

Item: Interrogation Methods

Discussion: NGUYEN VAN THIET was captured by the 2/503d Infantry on 19 January 1967 at XT 732259. Interrogation was initially aimed at gaining his confidence and realigning his allegiance to the GVN. He was persuaded that he must help to win his country away from communist domination. He was led to reveal information by initially questioning concerning the activities of other POW's and then information concerning Viet Cong Units. Once he started to talk, questions of tactical significance were answered along with information regarding his life and background until he had completely revealed his association and activity with the VC. His information concerning rice caches was proven to be 100% reliable. He stated that the VC were afraid to surrender because of reprisals by the VC and because they were told that the allies would not accept any surrender of VC. He also gave information concerning the OB of the PHU LOI Battalion and activities of the C-61 Company.

Observation: The questioning of VCC and Chieu Hoi Ralliers is perhaps the most effective means of acquiring information directly relating to enemy activity. The willingness of captives to reveal this information can be obtained only when they are confident of the good intentions of Allied Forces.

Item: VC Population Control

Discussion: Prior to Operation CEDAR FALLS the VC had complete control over the people of the IRON TRIANGLE Area. Friendly forces encountered people who were completely indifferent towards the Republic of VIET NAM and they supported the VC as directed.

CONFIDENTIAL

CONFIDENTIAL

AVEE-SC

25 February 1967

SUBJECT: Combat Operations After Action Report (Operation NIAGARA/CEDAR FALLS)

106

Observation: Once the VC were forced to flee the area, the population was left unguarded and was relocated by friendly agencies. However, the people are still under the influence of the VC Infrastructure.

Item: VC Tunnel Clearing Operations - Destruction and Exploration

Discussion: The CEDAR FALLS experience illustrates that patience is a primary weapon against VC hiding in tunnels. It is necessary to remain in a heavily fortified VC Area for an extended period of time to force the enemy to come out of their tunnels as their food is depleted and morale deteriorates. To cover these areas, a series of mechanized patrols should be used to apprehend the enemy when it becomes necessary for him to go in search of food etc.

Observation: Operations in VC tunnel areas should be prolonged over a period of 2 to 4 weeks to increase the likelihood of surrender of a hungry demoralized enemy.

Discussion: There were several instances during Operation CEDAR FALLS when Engineer Company elements were sent to destroy tunnels that had been explored by the Infantry. The Infantry in most cases kept no record or map of the tunnels they had explored. Before the Engineers could destroy the tunnel, the complex had to be re-explored. Much valuable time was lost due to this re-exploration.

Observation: When extensive tunnel systems are found, Engineer "Tunnel Rat" teams should be called to explore, map and destroy the system.

Discussion: One unit was in the process of destroying a tunnel they had explored when a serious incident occurred. Immediately after a charge was set off, a man was sent back into the tunnel to check out the damage. He was immediately overcome by toxic fumes from the explosive and a rescue team had to be sent after him. There was a demolition expert in the area that could have prevented this had he not been sent on another mission.

Observation: No one should be allowed to handle explosives except trained demolition men and they should determine when the tunnel is safe for exploration.

Discussion: On several occasions, tunnel exploration was carried on by units in the Brigade without the use of any type of communication. To state an example, two individuals were found coming out of a tunnel by an element of the Engineer Company. After questioning them, it was discovered that they did not know where they were or where their unit was located. There were other cases where two exploration teams were in a tunnel at the same time with neither team knowing of the others presence. Luckily, there was no one shot by mistake in the tunnels.

Observation: It is recommended that no one be allowed to enter a tunnel more than 50 meters without proper comms, tunnel exploration equipment and knowledge of tunnel exploration techniques.

Item: Disrupting Enemy Use of Base Areas

Discussion: Brigade Operations in the CAU DINH JUNGLE and the IRON TRIANGLE disclosed that friendly activities in enemy base areas can be efficient in disrupting the VC plan of action. This was accomplished by intermittent interdiction by artillery fire and air strikes. The use of LRRP's can measure the

CONFIDENTIAL

CONFIDENTIAL

107

AVHE-SC
SUBJECT: Combat Operations After Action Report (Operation NIAGARA/CEDAR FALLS)

25 February 1967

effectiveness of these fires, direct fire and air strikes, and make US presence felt without necessitating the introduction of a large force.

Observation: LRRP's should be introduced periodically into recently "cleared" areas to survey the effectiveness of H & I fires and to report on VC activities resulting from previous US presence.

Item: Coordination of Ground Troops and Bulldozers

Discussion: On occasion, bulldozers, which can cut through jungle much faster than Infantry elements, found themselves 300 meters to the front of the troops assigned to clear and secure their work area.

Observation: Either the bulldozers need to wait for their Infantry security, or the Infantry should be mounted on APC's to keep up with the Bulldozers.

Item: Night Vision Devices

Discussion: Starlight Scopes and Infra-Red equipment organic to the Armor Company's APC's proved to be extremely effective on perimeter defense during hours of darkness. Infra-red equipment, however, was limited by the need to "crank" APC's to charge the batteries essential to the night vision device.

Item: Additional Training for Scout Dogs

Discussion: Recent Operations have indicated certain weaknesses in the training of Scout Dogs which must be overcome to increase effectiveness.

Observation: The following are several weaknesses that should be overcome:

- a. Dogs must be trained to work in spite of the noises of artillery and airstrikes.
- b. Dogs have to be able to work behind a point man when terrain is such that the SD team cannot maneuver at the point.
- c. Dogs must be trained to further reduce the noises they occasionally make. Noisy dogs hamper operations.
- d. Dogs and handlers must be prepared to be able to work on extended operations with resupply of dog rations and equipment for short periods.
- e. Handlers must have complete control of their animals.

Item: Dustoff Support

Discussion: During Operation CEDAR FALLS the Brigade experienced occasional delays by not having a Dustoff helicopter attached to the Brigade on a standby basis. This also caused some discrepancies in request procedures.

Observation: The Brigade should have its own Dustoff heliambulance during the day while on combat operations.

CONFIDENTIAL

CONFIDENTIAL

AVBE-SC

25 February 1967

SUBJECT: Combat Operations After Action Report (Operation NIAGARA/CEDAR FALLS)

108

Item: Generator Maintenance

Discussion: General maintenance of generators suffered due to two oversights: They were placed too deeply in the ground causing improper ventilation and making access for maintenance difficult. In addition, units were not prepared to perform 1st and 2d Echelon maintenance, owing to a lack of preparation while in base camp.

Observation: Generator positions should allow 2 feet of clearance on all sides for ventilation and servicing. Unit must be prepared to maintain their generators to prevent breakdowns.

Item: Evacuation of Armored Personnel Carriers

Discussion: APC's, in many instances, were disabled by VC mines. This requires evacuation for repair which is, to say the least, a time consuming affair. In one case, the Armor Company was delayed 2 1/2 hours from seizing their objective due to the evacuation of disabled vehicles.

Observation: APC's can be rapidly stripped of equipment and totally destroyed on the spot if the tactical situation prohibits a lengthy evacuation process. This destruction can be executed with thermite grenades, demolitions etc. Therefore it is advisable to dispose of a vehicle that is already destroyed, rather than taking time to evacuate it.

Item: Aero Cavalry Concept

Discussion: E Troop, 17th Cavalry deployed its forces as Infantry mounted in helicopters (see Special Equipment/Techniques and Small Unit Actions, E/17th Cav). When a target was exposed, the Aero Rifle Platoons landed and attacked the VC objective. Certain requirements became apparent and procedures were developed as follows:

Observations:

1. Aircraft must be under the control of the Cavalry Troop Commander for the duration of the operations.
2. The following aircraft must be allocated for effective operations:

Two (2) OH-13 Helicopters (Aero Scouts)
Two (2) UH-1B Helicopters (Light Fire Team Ships)
Six (6) UH-1D Helicopters (Aero Rifle Platoon Ships)
One (1) UH-1B or OH-13 Helicopter (Command and Control Ship)
3. The Aero Rifle Platoon must be on constant Airborne Alert
4. Occasionally remove all aircraft from the AO to dupe the VC into a false sense of safety.
5. Organize ground elements into 6 man helicopter loads.
6. Ground elements must be equipped for fast movement and carry no excess equipment such as helmets or flack jackets.

The following is a list of equipment proven to be essential:

CONFIDENTIAL

CONFIDENTIAL

AVBE-SC

25 February 1967

SUBJECT: Combat Operations After Action Report (Operation NIAGARA/CEDAR FALLS)

109

- a. Ropes for canal and river crossing
- b. Steel Probe Rods
- c. Marking Panels
- d. Smoke Grenades

8. Operations must continue into the hours of darkness employing the Stay Behind Patrols and Ambush Patrols of the Cavalry Troop.

9. Troop helicopter landing should never be accomplished without proper preparation of the LZ by gunships.

Item: Aerial Observers

Discussion: Continuous air observer coverage of maneuver elements requires the alternating use of two aircraft.

Observation: This requirement may be satisfied by either two Ol-E fixed wing aircraft or one Ol-E and one OH-13. The later combination is preferred if the fixed wing aircraft are not able to land near the fire support base. Complete and detailed briefing of observers prior to artillery preparations or major changes in operational plans greatly facilitate accomplishment of the mission and reduce the possibility of errors incurred by incomplete understanding of the mission by the observer.

Item: Operational Control/Artillery

Discussion: Control of more than five firing batteries exceeds the personnel and equipment resources of a direct support artillery battalion. If more than five batteries (Organic, Attached or under OPCON) are placed in support of the Brigade Operations it is also necessary that a suitable headquarters be provided to control the additional firing elements.

Observation: The span of Operational Control which can effectively be exercised by a direct support artillery battalion headquarters is limited to five firing batteries.

FOR THE COMMANDER:



E. B. ROBERSON
CPT, AGC
Asst AG

CONFIDENTIAL

CONFIDENTIAL

///

TAB B

MAPS - AREA OF OPERATION

NIAGARA/CEDAR FALLS

5 January - 25 January 1967

CONFIDENTIAL

OPN NIAGARA/CEDAR FALLS

5 JAN TO 25 JAN 67

IRON TRIANGLE

CONFIDENTIAL

2

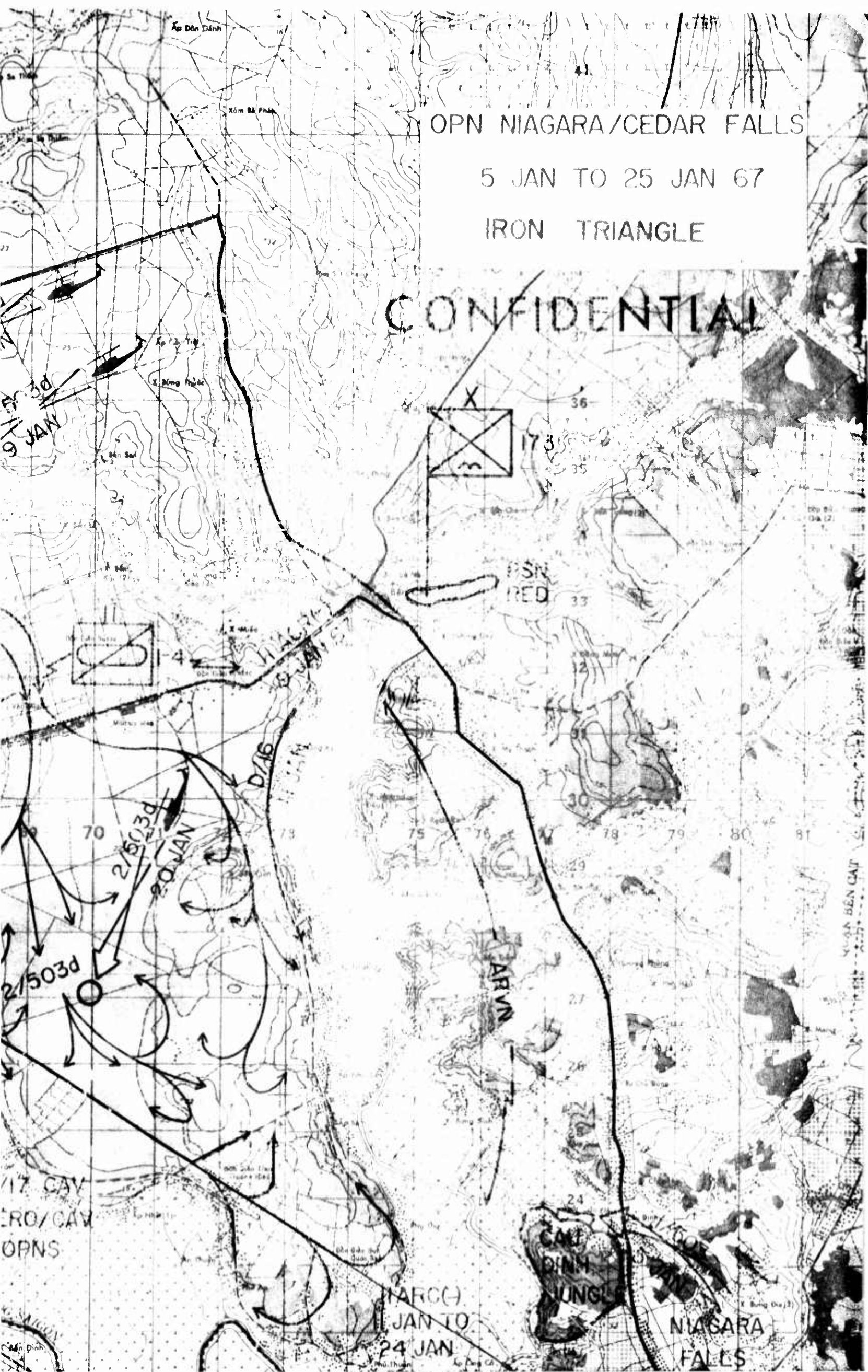

17 CAV
ERO/CAV
OPNS

MARCO
1 JAN TO
24 JAN

NIAGARA
FALLS

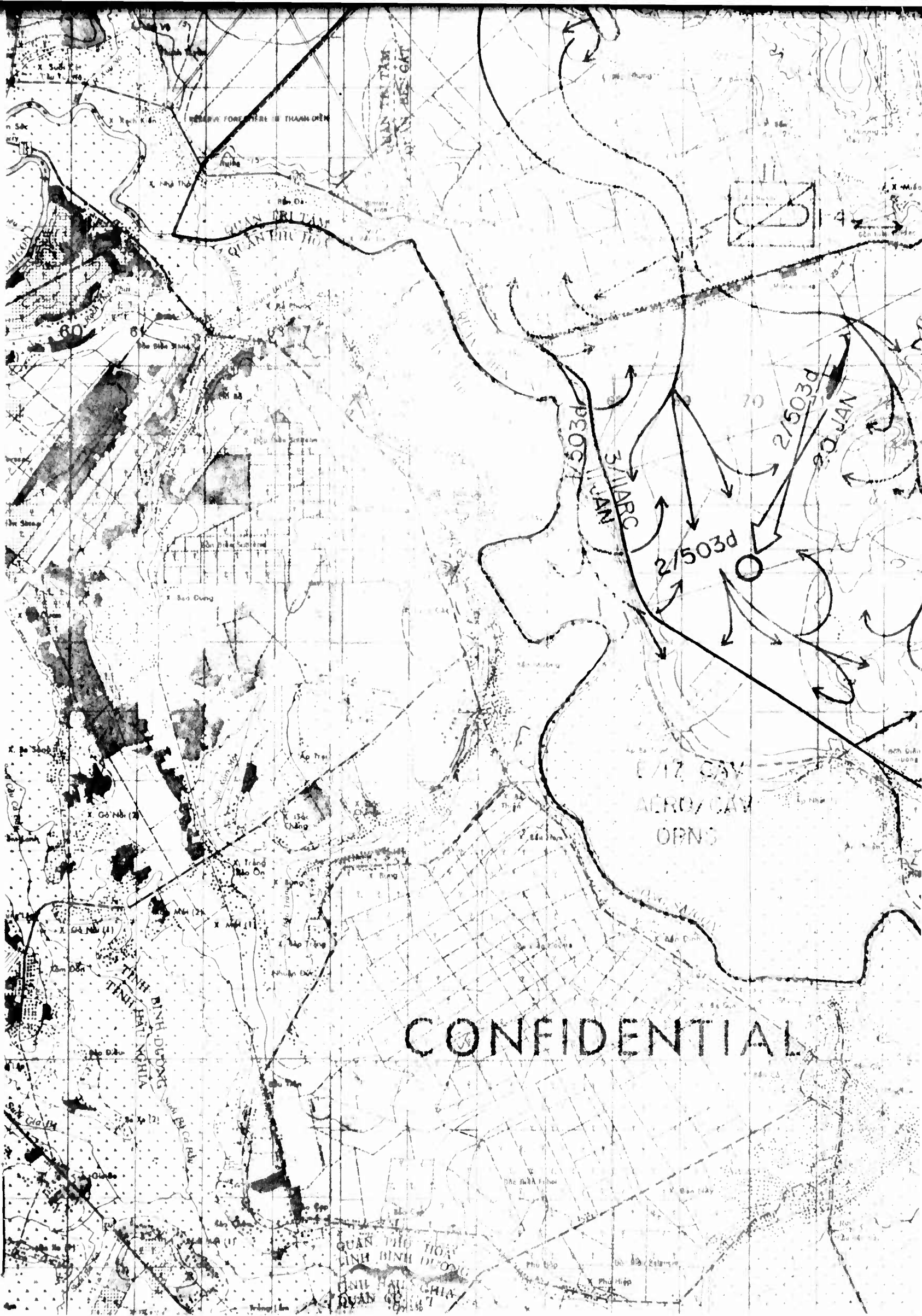

CONFIDENTIAL

3

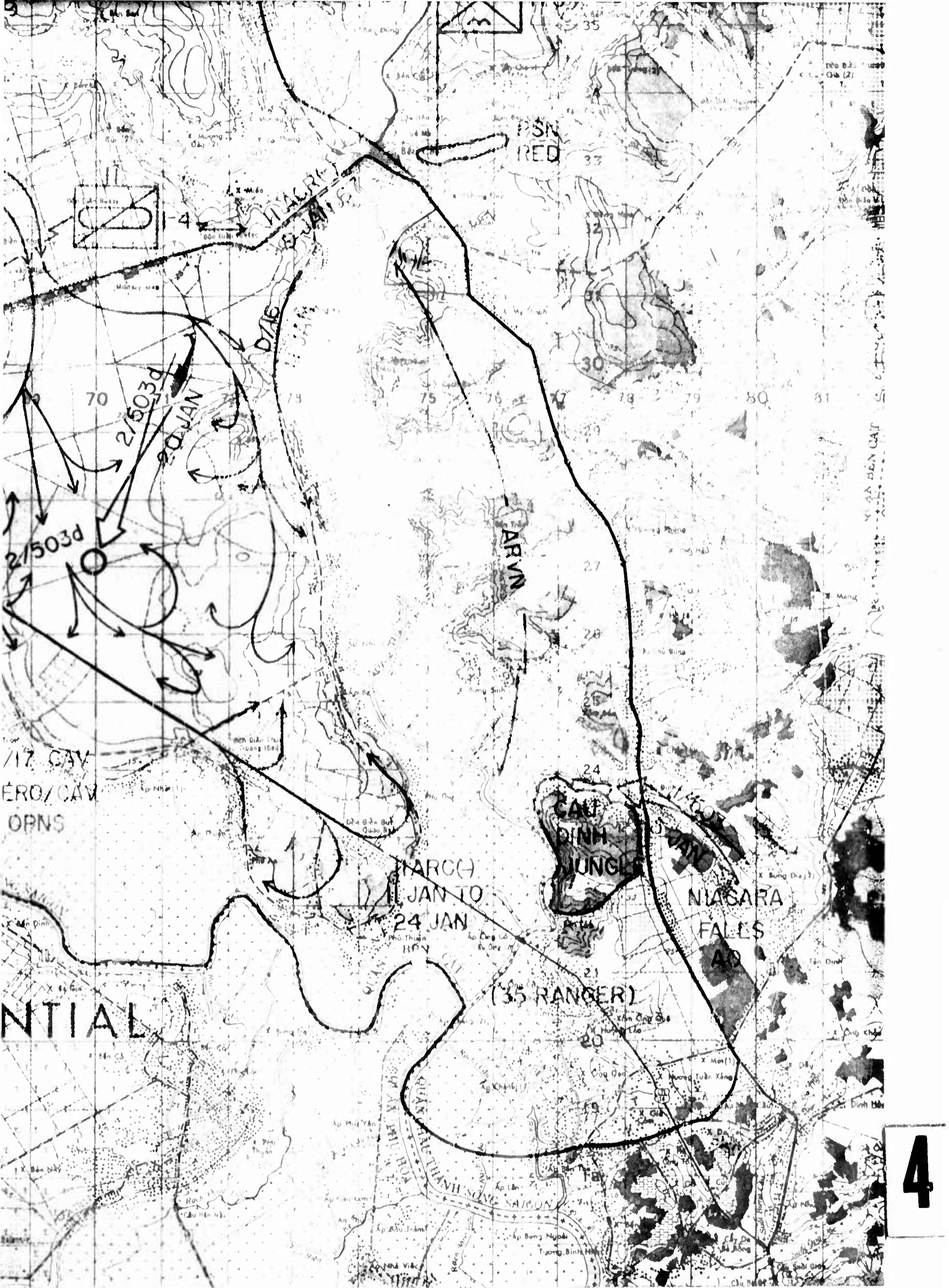

115

CONFIDENTIAL

TAB C

SMALL UNIT ACTIONS

Troop E/17th Cavalry

CONFIDENTIAL

CONFIDENTIAL

116

AVBE-SC

25 February 1967

SUBJECT: Briefing Given by Brigadier General S. L. A. Marshall

From 27 January to 1 February 1967, the 173d Airborne Brigade (Separate) was honored by the visit of Brigadier General S. L. A. Marshall (Retired), one of the world's most highly respected War Historians. The General's international reputation is the product of over twenty-five years of work and experience in compiling, editing and analysing enormous amounts of information directly relating to the role of the individual in war, thereby discovering the practical lessons learned in addition to preserving an accurate account of what actually took place during combat. The General has written numerous books concerning the fighting that took place in the Pacific and European Theaters during World War II, and the Korean Conflict. The purpose of his visit to BIEN HOA was to acquire information directly related to the War of the 60's, the War in VIETNAM.

In conjunction with this task, General Marshall invited selected personnel from the Historical Detachments of the 173d Airborne Brigade (Separate), the 11th Armored Cavalry Regiment, the 9th Infantry Division and the 1st Aviation Brigade to witness his combat interviews at the 173d Airborne Brigade. As a result of this, these personnel gained valuable, first hand knowledge on the procedures and techniques of conducting combat interviews.

The interview commenced on the 29th of January at "E" Troop, 17th United States Cavalry. The General was primarily concerned with the small unit patrolling conducted by the Cavalry troopers during Operation CEDAR FALLS. Before the men were admitted to the interview site, General Marshall gave a briefing/orientation to the Historical personnel gathered, an account of which follows.

The General's first remark was that History is not a dead science, especially during times of war. He related how during the Second World War in the Pacific, information such as "Lessons Learned" was sent forward immediately to the commanders so that necessary changes in SOP could be effected, thereby increasing the efficiency of the unit.

In addition, the General explained that a step by step methodical interview of several participants in an action is the only way to draw a true picture of what actually happened. In many instances, there will be discrepancies during an account. This is why it is necessary that all personnel be placed on the same plane so that the true picture may be brought to light. Often the commander in the rear has little knowledge of what is occurring at the front, and in this respect, the PFC on the line is as qualified to give testimony as his superior. This very important factor is almost always overlooked.

In addition to the Historical value of such an interview, the troops enjoy hashing out the operation, interjecting incidents overlooked into the narrative thread. This also affords the opportunity for them to actually identify with their Nation's History.

Each individual must be treated as such. Therefore he must be completely identified. The information General Marshall requires is as follows:

- a. Full Name of Individual and Rank
- b. Age
- c. Hometown
- d. Amount of Education
- e. Job during specific action, e. g. Team Leader, M-79 grenadier, etc.

CONFIDENTIAL

CONFIDENTIAL

117

AVEE-SC

SUBJECT: Briefing Given by Brigadier General S. L. A. Marshall

25 February 1967

Logistics of the operation must also be included to determine the efficiency of special equipment, the effect of weapons, subscribed and personal ammunition loads etc. This information can seldom be obtained from higher headquarters.

General Marshall also advised having a coffee break. This helps to promote a relaxed atmosphere, conducive to a lively interview. The General has also found that there are invariably two or three individuals who either have a greater degree of awareness of the situation or just a plain old good memory who will provide intelligent, detailed information. These individuals are valuable in clarifying points of conjecture.

General Marshall concluded his briefing by stating that a greater number of Lessons Learned are obtained by taking a cross-section of a unit, in addition to the recommendations provided by the commanders.

For the next three days, General Marshall interviewed nearly 100 officers and enlisted men from the E/17th Cavalry and the 2d Battalion, 503d Infantry. The first combat interview of this Brigade was simultaneously written by the 24th Military History Detachment and appears in this report.

General Marshall departed BIEN HOA on 1 February 1967 and returned to SAIGON, terminating six months of research in VIETNAM. He was highly pleased with the response shown to him by the men interviewed during his stay.

* * *

SMALL UNIT ACTIONS

The information below was obtained through combat interviews conducted at E/17th Cavalry and the 2d Battalion, 503d Infantry. This report was constructed in coordination with the visit of Brigadier General S. L. A. Marshall, 27 January - 1 February 1967. The material relates to isolated small unit patrol activities and ambush techniques used specifically in Operation CEDAR FALLS.

E TROOP, 17TH CAVALRY

Initially, E Troop, 17th Cavalry was given the mission of securing Position WHITE in support of artillery elements in the AO of Operation Cedar Falls. E/17 Cav arrived at Position WHITE on 8 January (approximately 8 kilometers southeast of BEN CAT), and remained there throughout the Operation.

On 11 January 1967, the Troop Commander, Major Dryan Sutton, received a warning order from higher headquarters to conduct air-cavalry activities in the western portion of the AO. This area is primarily rice paddies, crisscrossed with canals and bounded on the west by the SAIGON RIVER.

Major Sutton employed two (2) OH-13 Aero Scout helicopters, code named "Hot Stuff" to conduct visual reconnaissance missions in the northwest portion of the AO. The "Hot Stuff" choppers flew at tree top level, relaying intelligent information to the Troop CP. An augmented rifle squad was kept in the air at all times possible, serving as a quick reaction force to the "Hot Stuff" reconnaissance aircraft.

CONFIDENTIAL

CONFIDENTIAL

AVBE-SC
SUBJECT: Small Unit Actions - E/17th Cavalry

25 February 1967

118

On the ground, two squads were generally employed consisting of 9 and 12 men, two RTO's and a lieutenant. The subscribed ammunition load for riflemen was 11 magazines, however, some men carried as many as 25 full magazines. In addition, riflemen were armed with four (4) fragmentary grenades and one (1) smoke grenade per man. M-60 machine gunners carried 800 rounds of 7.62mm ammunition. Each squad was equipped with either 3 claymore mines or a demolition kit.

Aside from the ammunition loads carried by members of the Troop, several other items were employed. Identification tags and sandbags were utilized in the identification and separation of all enemy documents confiscated during the Operation. The men also carried snap links and ropes to facilitate the crossing of the numerous canals encountered.

During Operation CANARY/DUCK, the Cavalry conducted controlled experiments on the use of camouflaged soft caps in relation to the previously used steel helmet. It was discovered that soft caps enable the men to move much faster and are less fatiguing than steel pots. In addition, hearing capabilities are increased. In the jungle, sound is most often the sole means of detecting enemy movement. Consequently, soft caps have become SOP during the hours of darkness and were utilized during this Operation.

On the morning of 12 January 1967, two Aero Scout helicopters were dispatched to reconnoiter the area around the tributaries and rice paddies adjacent to the SONG SAIGON. The procedure employed by "Hot Stuff" is as follows:

- a. OH-13 helicopters are employed in pairs, designated as Lead and Chase Aircraft.
- b. OH-13's fly at tree-top level at all times at a speed of 20 knots, approximately 200 meters apart.
- c. If the lead ship is fired upon, the chase helicopter has the following three missions:
 - (1) Deliver suppressive fire
 - (2) Issue red smoke grenades for subsequent Infantry elements
 - (3) Plot the coordinates of the fire and relay this information to the Troop Commander or person responsible for initiating air assaults.

At 0757 hours, "Hot Stuff" Aero Scouts received ground fire at XT 687248. Major Sutton issued two squads of the 1st Platoon to 678264. 1LT Horace L. Rektorik, a native of Corpus Christi, Texas was in command of the Platoon (-). After being helilifted to the area, Lieutenant Rektorik placed one squad on each side of the tributary from which fire was previously received. The terrain in this area was extremely difficult and the gnarled roots and vegetation along the tributary bank were such that a sampan could be completely obscured with no difficulty. Huts were constructed directly over the water, being supported by stilts.

Almost immediately after movement was initiated by the two squads, Sergeant Carl McEon, of Manhattan Beach, California, observed two men approximately 30 meters to his front moving out on a tree limb over the water. Before effective fire could be placed, they dove into the tributary. These individuals were assaulted with grenade fire, with negative results. They had apparently heard the movement and made good their escape.

CONFIDENTIAL

CONFIDENTIAL

119

AVBE-SC
SUBJECT: Smf Actions - E/17th Cavalry

25 February 1967

The two [redacted] came from a straw hut with a tin roof adjacent to the water's edge. Search of the dwelling revealed a small quantity of 7.62mm ammunition, black pajamas and assorted rifle slings. LT Rektorik directed the destruction of the hut and continued patrolling along the tributary.

At 0847 hours at XT 678282, a sampan on the opposite side of the tributary was discovered and subsequently destroyed. Further search revealed a 55-gallon drum of CS previously sited by an OH-13 helicopter and another sampan.

Thorough screening of the canal area was continued, with the Cavalry troopers keeping a sharp eye for anything out of the ordinary. The search at this time was directed to a paddy area, then sweeping back to the canal. During the sweep, PVT John A. Fischer noticed what at first appeared to be a bundle wrapped in a poncho. Suddenly, two black heads popped out from behind the bundle. The 20 year old RTO informed LT Rektorik of his sighting of the 2 VC who were now approximately 5 meters from the bundle heading towards the woodline. The Lieutenant directed fire on the VC. The men fired some 20 rounds and threw grenades. When the firing had ceased, they advanced and confirmed the death of one Viet Cong. The bundle previously used for concealment contained a rucksack with miscellaneous documents which were forwarded to the Brigade S2 Section.

Stephen Miller, a Specialist 4th Class from Sonora, California, and a member of E/17th Cavalry's Long Range Reconnaissance Patrol found numerous pot holes in the banks of rice paddies and dikes throughout the AO. In many instances, these pot holes lead to subterranean tunnel complexes. It was believed that the second VC escaped in this manner. These potholes are destroyed by grenades whenever encountered. Later in the operation, SP4 Velmon D. Phillips, another member of the LRRP, heard noises in the same area, however no movement could be detected and no VC were sited. He suspected that the noises were in fact coming from a subterranean labyrinth below the rice paddies. Tunnel entrances were almost invariably found near huts, and in rice paddy dikes throughout the IRON TRIANGLE.

Lieutenant Rektorik's platoon was extracted from their area of operation and flown to Position WHITE shortly after this last contact.

The second Platoon was conducting patrolling operations simultaneously in another AO. The Troop Commander, Major Sutton, decided earlier to place the platoon in an area where Falcon gun ships had previously received fire. The area was prepared by a bombing strike conducted by Air Force F-100 jet fighters.

1LT Juris Jaunitis, a 26 year old graduate of the University of Nebraska was the commander of the 24 man strong 2d Platoon. His unit became airborne at 1028 hours and was dropped approximately 100 - 200 meters southwest of the F-100 strike zone. The terrain in this area was characterized by dense bamboo. All dwellings were built underground and connected to one another and the surface by a vast network of tunnels. Patrolling in this area was difficult since the men were forced to remain within 6 to 8 feet of one another owing to the thickness of the vegetation. If the troopers became separated by more than ten feet, they lost visual contact with one another. The bamboo shoots grew in thick bunches approximately 10" in diameter. Screening of the area revealed numerous underground dwellings or hootches, however, only about half of these showed signs of recent use. There were no hootches whatsoever built above the ground.

Several documents were uncovered, yet only a few had any military or strategic value. A large roll of overlay paper was the only significant find indicative of VC activity.

4
CONFIDENTIAL

CONFIDENTIAL

AVHE-SC
SUBJECT: Small Unit Actions - E/17th Cavalry

25 February 1967 120

Major Sutton, who was then at Position WHITE, was anxious for the 2d Platoon to speed up their movement. LT Jaunitis reported back to the Troop Commander that this was impossible, since the tunnels to be searched were numerous and the bamboo vegetation was so thick that movement was brought to a near standstill.

With this information, Major Sutton became concerned that the 2d Platoon might encounter an enemy force too large to handle effectively. Also, the rear security of this screening operation was inadequate. He therefore directed the men to a clearing, 100 feet to their front and at 1510 hours, the 2d Platoon was extracted.

At 1430 hours, the 1st Platoon, E/17th Cavalry was helilifted to the vicinity of grid coordinates XT 677234. The area of concern was a tributary near the SAIGON RIVER. A "Hot Stuff" OH-13 Observation Helicopter previously spotted a woman and a hut near this area. Upon landing, the two fire teams, "A" and "B" moved approximately 150 - 200 meters conducting patrolling activities on both banks of the tributary. Staff Sergeant Charles E. Park, "B" fire team leader, directed his unit to cross the water. Shortly thereafter, CPL Emanuel Andrews, a native of Cincinnati, Ohio had visual contact with one VC attempting to escape through the waters of the tributary, which was less than 30 meters wide at this point. At this time, SGT Thomas W. Mirick also observed the Viet Cong and followed him to a bunker type shelter. A "Hot Stuff" recon chopper flew over the bunker and pointed to it indicating that there were VC inside. SGT Mirick climbed to the top of the shelter, however he observed nothing. The M-79 man, SP4 Fullhart was soon on the scene, having already drawn his .45 caliber pistol. He observed two arms in the darkness and motioned to SGT Mirick above. The two men called for the Viet Cong to come out ("Lai De") and upon the introduction of the muzzle of a 12 guage shotgun, two men scurried out with their hands up.

The two GI's motioned to the prisoners that they were about to destroy the fortification with grenades. With this, one of the prisoners shouted in the direction of the bunker and almost immediately, a third prisoner jumped from his place of concealment and surrendered.

The first prisoner to come out was apparently suffering from some type of skin disease for his skin was scaly and sickly. The second prisoner was relatively healthy and the third, a boy of about 16 years, had a fresh wound in his hip. Through an interpreter, it was learned that the wound was inflicted by an OH-13 helicopter machinegun. It was further determined that the man, along with approximately 15 others was caught in a B-52 strike, killing half of the estimated party.

SGT Park directed two men to guard the prisoners while he and three other men searched the west side of the tributary. SP4 John Rutchik, one of the men accompanying SGT Park and CPL Andrews spotted a VC with both feet already in the water attempting to escape. Effective M-16 fire was placed before the VC had a chance to escape. As they advanced to confirm the KIA, SP4 Rutchik observed another VC on a bunker located in the middle part of the tributary. Andrews and Rutchik received permission to check out the site from SGT Park. When at close enough range, the men threw fragmentary grenades into the bunker.

One VC was immediately catapulted out into the open. The two men confirmed the KIA and then CPL Andrews entered the bunker alone, thinking perhaps more VC bodies were within. Inside, he could vaguely distinguish the figure of a man on the floor. When he touched the man's arm, he spring to his feet to defend himself. The two men struggled for only a short time before Andrews succeeded in pushing the VC's head out of the door. SP4 Rutchik took aim and fired his weapon and "blew his brains out". After this incident, Andrews and Rutchik discovered a third VC body, resulting from the grenades thrown earlier.

CONFIDENTIAL

CONFIDENTIAL

121
AVVE-SC
SUBJECT: Small Unit Actions - F/17th Cavalry

25 February 1967

Shortly thereafter, another bunker was sighted in a rice paddy. Recon by M-79 fire was employed with negative results. The subsequent extraction of the 1st Platoon marked the end of the day's activities.

On the following day, 13 January, all three platoons were employed in search and destroy operations east of the SAIGON RIVER. At 0842 hours, the 2d Platoon was dropped on a canal from which fire had previously been received. 1LT Jaunitis directed his two reinforced squads to patrol the banks of the canal, utilizing a squad on each bank. At 0850 hours, a camouflaged rice cache was located and destroyed. The platoon moved and estimated 200 meters down stream when a hootch built over the canal was discovered. The point man, PFC William J. Lewis observed movement in the vicinity of the hut. At this time, the order was given to throw grenades at the structure. Inside, unknown to the men of the 2d Platoon, were 2 women and 3 children. Luckily, the grenades only caused minor injuries and LT Jaunitis immediately requested a Dustoff helicopter. Nothing else was found within the hut.

In the meantime, CPL Van Hook, a 22 year old squad leader, observed red smoke on the opposite side of the canal. He and his squad proceeded to ford the stream and discovered the location of another hootch. CPL Van Hook set up a fire support base and prepared to issue an assault. Suddenly, a VC was observed making an attempt to hide within the dwelling, however, he soon realized the futility of this maneuver and willingly surrendered.

The squad with their prisoner recrossed the waist deep stream and continued movement along the bank, resulting in the discovery of two additional crude water-side dwellings and an outboard powered sampan. The river craft contained fire wood and some 500 eggs. Shortly after the destruction of the hootches and sampans, the prisoner was evacuated and the squad continued to patrol the bank of the stream.

At 1103 hours, a UH-1B helicopter reported seeing several VC in black pajamas in the vicinity of XT 698224. LT Rektorik with the 1st squad of his platoon were airborne at this time and were directed by the Troop Commander to initiate search and destroy operations in this area. This platoon landed shortly thereafter. Upon landing, the squad was immediately separated into two fire teams, one on each side of a small tributary of the SONG SAIGON. The Headquarters element, consisting of two RTO's, a Medic and LT Rektorik, spotted a bunker at the junction of the tributary and a small stream. The Lieutenant summoned anyone who might be within to come out. Receiving no response, the four men entered the bunker, finding a wounded VC. He had been wounded in the back and appeared to be totally paralyzed.

At this time, SP4 Selbon of the headquarters element commenced firing at a hootch 75 meters to his front. Selbon had spotted a VC attempting to seek refuge within the hut. Lieutenant Rektorik with the first squad following moved in the direction of the siting. When at close range, the VC bolted from the hootch heading towards the heavily foliated area covering the bank. The subsequent open fire produced negative results however, further search of the area was successful. LT Rektorik found him hiding in the underbrush and then shot him. Search of the VC's personal items revealed several documents and small arms ammunition.

Subsequently, the building was destroyed and the squad continued screening to the south. At this time, an over zealous VC, who had apparently just witnessed the previous incident, stepped into the open gladly surrendering.

CONFIDENTIAL

CONFIDENTIAL

AVHE-SC
SUBJECT: Small Unit Actions - E/17th Cavalry

25 February 1967 122

The 3d Platoon, which had remained at Position WHITE until now, was lifted to XT 706212 on the SONG SAIGON. The Platoon was divided into three elements, two moving north along the canal and a third squad approximately 700 meters north serving as a blocking force.

The platoon had not moved far before noises were heard by the point man, SP4 Harry J. Holmes. The alerted squad proceeded forward with caution since the foliage along the canal was well suited for enemy concealment. A VC then darted out of the underbrush, surrendering. The troopers advanced to check out the VC's place of concealment. From the brush, another VC sped away before contact could be made, however, 1 Chicom P-34 machinegun, miscellaneous documents and equipment were found wrapped in a poncho.

The captured VC commenced to call his comrades into the open and surrender. One did come out, however, another VC chose to run. His choice proved to be fatal as he was killed by SP4 Donald Brown, the RTO for the fire team on the opposite side of the canal.

At this time, a curious incident occurred. Floating nonchalantly down the canal came a rather large clump of matted grass. The men of the 3d Platoon observed this for quite some distance. It passed right between the two fire teams. SP4 Donald Underwood noticed something suspicious and fired M-79's into the mass. As one would expect, a dead Viet Cong floated up from beneath the brush.

SFC Allen, the 3d Platoon leader, suspecting more VC were either hiding or attempting to escape, intensified the saturation of this immediate area. The search revealed a crude bunker containing several maps. Further along the woodline, SP4 Richard Albertson discovered a hootch with a sizeable quantity of rice a few meters away. The rear security element of Albertson's team entered the hootch discovering a .45 caliber pistol, pistol belt and one magazine.

After the hootch and rice were destroyed, the fire team pushed on towards the adjacent rice paddies. They had moved approximately 100 meters when a hut with attached bunker was found very near a dike. Subsequent search of the dwelling revealed nothing, however, a catwalk crossing the canal was spotted. The fire team set up security and three men, SP4 McDonald, PFC Gardner and PFC Chester volunteered to check out the catwalk.

They crossed the canal cautiously and found 3 trails issuing from the water crossing. As SP4 McDonald probed one of the trails, he spotted a sniper's nest 6 feet above the water. The site showed signs of recent use, for a bowl of rice was found which had been prepared approximately 2 days previous to the platoon's entry. Just a few feet further down the trail, an American made 12 guage shotgun was resting in the fork of a tree. SP4 McDonald, fearing the weapon may be boobytrapped, proceeded with extreme caution. After thorough examination, McDonald found that the weapon was placed there only through the negligence of some VC and was not boobytrapped in any way. The three men then regrouped with the rear security element on the other side of the canal. Upon their return, it was discovered that the immediate area just screened was highly boobytrapped indicating that these trails were heavily used by the Viet Cong.

SGT Albert English was at this time in charge of the 2d Squad of the 3d Platoon. He was given the mission of searching the wooded area adjacent to the rice paddies. The two point men of the squad, SP4 James A. Thompson and PFC Gary De Sarno being the first to enter the area, sighted a camouflaged hootch, unobservable

CONFIDENTIAL

133

CONFIDENTIAL

AVBE-SC
SUBJECT: Small Unit Actions - E/17th Cavalry

25 February 1967

from the air. As the point men approached the hootch from the left side, they observed wires running along the length of the roof and terminating a few meters from the bamboo and straw structure. The men pulled back and informed their squad leader. SFC English then threw a hand grenade resulting in an initial and secondary explosion, confirming their suspicion that the hut was boobytrapped. The explosion blew off the roof of the hut completely off and formed a hole five feet in diameter in the floor.

Investigation of the gutted hootch revealed that it was apparently a squad sized CP or supply station. A container, housing several documents and booby-trapped with a fragmentary grenade was found and disarmed. Buried in the mud behind the hut, several claymore mines and assorted hand grenades were also found.

At 1128 hours, two UH-1D helicopters were flying an extraction mission from XT 700226 to 716212. One of the two helicopters noticed a sampan in the canal below. The airship veered sharply to make a pass at the sampan, however the ship flared out too sharply and crashed on its side. Luckily, injuries were restricted to minor cuts and bruises. The crew quickly stripped the ship of its guns and they were soon evacuated.

At 1315 hours, one "Hot Stuff" and one "Falcon" gunship sited 3 VC at XT 710-322. The Falcon ship fired on the VC killing two of the enemy. The third VC waved his hands desparately, indicating his desire to surrender. He was picked up shortly thereafter by a Command and Control helicopter. The two VC KIA were armed with .45 caliber pistols at the time of their death. The prisoner was subsequently escorted to Military Intelligence and shortly after his interrogation was completed, he managed to steal a weapon and shot his ARVN guard. He then bolted from his place of captivity only to be shot and killed by a trooper of the 11th Armored Cavalry Regiment.

In the meantime, elements of the 1st Platoon were given the task of securing the previously wrecked helicopter. This was accomplished successfully and the aircraft was evacuated by CH-47 at 1350 hours. Five minutes later, the 1st Platoon was also picked up and returned to Position WHITE.

A "Hot Stuff" reconnaissance helicopter reported seeing enemy movement at XT 708228. SGT Samuel Haynes of Sanford, North Carolina and SGT McLaurea deployed to this area with a twelve man squad and dropped approximately 100 meters from a canal. The men proceeded south on the east side of the canal. After having gone 150 meters, movement was detected in the grass. A camouflaged VC was crawling through the rice paddy, however, he was out of range of small arms fire. When the squad had finally maneuvered to a position where fire could be effectively placed, the depth of the rice paddy offered the VC adequate cover. The squad's RTO radioed to a nearby gunship which subsequently suppressed the area. The squad advanced finding documents, and the VC's weapon, however, no body was found.

The squad's point man, PFC Ronny D. Wagner then crossed the canal, having observed a hootch on the other side. Two transistor-type radios were found in the hut, but aside from this, nothing of value was discovered, so the search of the canal was continued. The sharp vision of the Point Man paid off again as he spotted a head pop out momentarily from the water of the canal. He fired one round at the submerged man, plunged into the water and dragged out his captive. The squad had an interpreter with them who interrogated the frightened POW. He was asked if there were other VC in the area and replied that his comrades had all fled to the west. A gunship was immediately called into the area in question. The POW's information was quite true as the gunships from the 335th Aviation Company soon spotted and killed 3 VC. The KIA were later verified by a C & C ship.

CONFIDENTIAL

CONFIDENTIAL

AVBE-SC
SUBJECT: Small Unit Actions - E/17th Cavalry

25 February 1967

It was now approximately 1400 hours and the squad departed from the area where the VC was captured. They moved south and then west, once again crossing the woodline searching out any remaining VC. PFC Wagner proved himself once more to be an excellent point man. 75 meters to his front, he observed the movement of three VC approaching a hootch near the woodline. Wagner alerted the squad and fire was directed on the enemy targets. The squad advanced forward to find 3 VC KIA. Subsequent search of the huts revealed several North Vietnamese flags indicating the allegiance of the inhabitants.

The 335th Aviation Company, who provided helicopter support for the E/17th Cavalry, was suffering from a shortage of aircraft and it was imperative that all ships be free by 1600 hours. With this in mind, the Cav made preparations for the extraction of all elements. The squads began to convene on the predetermined points of extraction.

On the opposite side of the canal, Squad Leader SGT Carnes was located on a dike, scanning a rice paddy to see if the area was safe for extraction. He thought he detected movement to his front. The RTO, PFC Warren Archibald, provided security by jumping into the canal so that he could observe activity to the front and cover the advancement of SGT Carnes. The NCO fired in the direction of the movement and then proceeded to check out the results: one dead camouflaged VC. The squad was almost immediately extracted after this incident and returned to Position WHITE.

The final incident of the day occurred when elements led by SGT Welch and SGT Allen encountered several dwellings and sampans along the canal on which their operations were centered. The area was subsequently searched and both sampans and huts were destroyed. SGT Allen's team then crossed the canal since several more hootches were spotted there. One VC was killed when he attempted to escape this area by the fire team crossing the canal.

Shortly after the team arrived on the opposite side, SP4 Holmes, the point man for the team, heard movement as he approached one dwelling. He hesitated outside, then entered emptying one full magazine inside the hootch. As it turned out, two VC were hiding within and were killed by Specialist Holmes' assault.

In another hootch, 20 meters away, noises were again heard. The people inside were summoned to come out by SGT Allen. This they did, all eight of them consisting of an old woman, a ten year old girl and six men. The VC suspects were all evacuated with the fire team shortly thereafter, terminating the days activities.

At 0752 hours, 14 January, OH-13 Aero Scouts once again went airborne to recon an area where a tributary bridge was sited on the previous day's activities (XT 715228). At 0801 hours, the 2d Platoon under the command of 1LT Jaunitis was dropped at XT 719221. The third squad acted as a blocking force northwest of the bridge. The first and second squads were placed on the west and east side of the tributary respectively.

SGT Carnes, squad leader of the 2d Squad, first observed red smoke 15 meters from the point they were dropped. The red smoke was placed by OH-13's denoting that "Charlie" had been sited in the area. The squad was 30 meters from the woodline when they received 4 - 5 rounds of small arms fire. They returned approximately 15 rounds, however, caution in firing was observed since the 1st squad was operating on the west side of the tributary. As the second squad moved towards the woodline, SGT Wright observed one VC hiding in the water holding on to one of

CONFIDENTIAL

AVFE-SC

25 February 1967

SUBJECT: Small Unit Actions - E/17th Cavalry

the gnarled roots along the bank. When at a 5 meter range, Wright fired his M-16 at the enemy. As he and SGT Carnes advanced to confirm the KIA, they found another dead VC hanging in a tree. The VC, who was shot in the face, was armed with a Russian 7.62mm carbine. Also in his possession was a plastic bag containing clothing, ammunition and an inner tube for floating in the water. A crude bunker was found near the scene. Strangely enough, no one could accept credit for the second KIA, since he was apparently struck by a wild round during the landing skirmish.

On the west side of the stream, 1LT Jaunitis and the 1st squad received several rounds of small arms fire resulting in the first casualty of the Cavalry Troop since the beginning of Operation CEDAR FALLS. Twenty year old SP4 Patrick L. Sirmuir was wounded in action while moving along a dike shortly after landing. He observed the fire coming from the woodline and quickly got down into firing position, however, he then noticed a strange sensation in his leg. He looked down to discover that a bullet was lodged below his kneecap. A Dustoff ship was immediately summoned and Sirmuir was evacuated only 10 minutes after sustaining the wound.

The 1st squad continued movement after the Dustoff was accomplished. As they searched along the woodline, the last man in the column, PFC Larry E. Smith of Parsons, Kansas, spotted an arm and a leg wrapped around a tree trunk. The contrast of the light skin against the murky water caught his eye for the undergrowth was thick along the water's edge. He fired 5 rounds at the semi-submerged figure. SGT Carnes, who was on the east side of the tributary, confirmed the KIA.

As the 1st and 2d Squads moved further north towards the bridge and location of the 3d Squad, a corpse was found floating in the stream. PFC Archibald, being a strong swimmer, volunteered to check out the body. He fought his way through the muddy stream and tangled underbrush until he reached the opposite bank where the body was lodged. Archibald determined, as best he could, that this VC had been killed recently, probably by an OH-13 helicopter. The danger involved in this type of mission is great, since the waterways in this region are clogged with treacherous vines and roots, in addition to the strong tidal effect on the tributaries.

The two squads pushed on opposite sides of the tributary, destroying several sampans, huts and uncovering a 10,000 pound, well camouflaged rice cache. The men found that the destruction of such large quantities of rice is highly time consuming.

After several hours of search, the men approached the bridge. It was evident that it was not a temporary structure as is often the case. The bridge was thirty feet long and solidly constructed with logs 12" in diameter. Major Sutton made the decision at this time not to destroy the structure and directed that the bridge remain in tact since it presented an excellent ambush site for future night patrols, (See Night Ambush, 16 - 17 January 1967, page 14 to 15).

The 3d Squad blocking force, which was until now situated 100 meters north of the bridge, rejoined the 1st and 2d squads preparing for subsequent extraction. In order to accomplish this, several of the troopers had to cross the river. Two non-swimmers accidentally dropped their weapons in the process. The M-16's would be a fine prize for the VC, therefore, Sergeants Carnes and Wright dove into the murky water at no small risk to their own safety. A moment or two later, the two men returned to the surface having successfully retrieved the two weapons.

CONFIDENTIAL

CONFIDENTIAL

AVHE-SC
SUBJECT: Small Unit Actions - E/17th Cavalry

25 February 1967

126

The 3d Platoon, E/17th Cavalry was operating not far from the 2d Platoon. The 1st Squad was on the northeast bank of a stream and the 3d squad (led by SFC Allen) served as a blocking force approximately 1,000 meters from the 1st squad. The 2d squad was on the opposite side of the stream, thereby employing the same tactic of two squads moving parallel towards their 3d Squad blocking force.

As the 2d Squad moved north, SGT James Russel broke his unit into two fire teams. SP4 George Carrillo, the pointman on the left side of the canal, moved along the dike and spotted almost directly in front of him, the hand and arm of a VC concealed in a pot hole. Carrillo opened fire, however, his weapon malfunctioned after a few rounds were expended. The wounded VC jumped out and surrendered before the point man could clear his weapon.

Shortly thereafter, Carrillo's weapon redeemed itself. The point man along with PFC Radburn had just completed the search of a nearby hut when Carrillo spotted the head of a VC in a canal some 200 meters away. He fired several rounds at the minute target. SGT Edward Armstrong reported back that the VC was hit several times in the head. The M-16 once again had proven to be a highly effective weapon.

After confirming this KIA, SGT Armstrong checked out another hootch in the same vicinity, discovering 3,000 pounds of bagged paddy rice. The rice was subsequently destroyed by cutting the bags and throwing it into the canal, making later retrieval impossible.

At this time, Major Sutton directed the platoon to back track the area just screened since it is a characteristic of the Viet Cong to return to an area immediately after American troops and helicopters depart.

This proved to be a wise tactic, for as soon as they returned to the area, two VC were spotted with their heads above the water by point man SP4 Holmes. A call was made for the men to surrender, yet they refused and attempted to reach a clump of brush on the bank of the stream. Holmes fired and the VC ducked underneath the water. He then threw a grenade to interrupt their escape. PFC Earl Westmark joined Holmes in the search for the "Charlies". Holmes, who was now a few feet off shore, searched the bank of the stream for the enemy, only to have one of them swim directly between his legs, the VC having apparently lost his sense of direction. The surprised Holmes fired at the figure at point blank range with obvious results. PFC Westmark discovered the second body shortly thereafter.

A search of the immediate area was continued for approximately 30 minutes. Westmark and Holmes found a PK-4 sub-machinegun, pistol belt and various personal items belonging to the two men previously killed. The equipment was located in the hollow of a tree on the water's edge. It was believed that the VC were trying to reach this point at the time fire was placed upon them.

At this time, SGT Welch received an intelligence report from "Hot Stuff" that a sampan was traveling in their direction. The "B" fire team was dispatched to check the movement of the river craft, however, on the way they discovered 2 personnel hiding along the water's edge. SP4 Albertson, the team leader first heard movement in the area. The team immediately set up a rear security and advanced around the bend in the stream. 1SGT Roy Haynes then heard a noise in the brush. He observed a small opening in the undergrowth heading toward the canal which he followed to the water's edge. His vision was still obstructed so he waded approximately 7 - 8 feet into the stream. The vegetation was so thick that SGT Haynes could not see the team leader who was only a few meters away at this time. Suddenly, he spotted a VC in the water nearby. Haynes placed several rounds on the

CONFIDENTIAL

CONFIDENTIAL

AVBE-SC
SUBJECT: Small Unit Actions - E/17th Cavalry

25 February 1967

127
enemy target. Then, as he moved through the water to confirm the KIA, he spotted a second VC, 10 meters away. Again SGT Haynes placed effective fire bringing his total to two VC.

The sampan previously reported was located not far from the scene of the previous action. SP4 Holmes made use of the craft in crossing the stream for although the stream was narrow at this point, the water was still quite deep. Holmes encountered some difficulty in the execution of this maneuver since the sampan was 18' long and the stream was only 15' wide. During the process, he heard the sounds of a man running on the far side of the stream. Holmes did not fire however, since the Cav's Long Range Reconnaissance Patrol was operating on that side of the stream. It was later learned that the LRRP collected the KIA.

The squad regrouped shortly thereafter and the unit was extracted at 1355 hours, owing to the shortage of helicopters.

The 1st Platoon had no actual close contact with the enemy on this day, however, the search and destroy operations were not without significance. Three squads of the platoon were lifted from Position WHITE to a canal (vicinity XT 676234) at 0940 hours. Upon arrival in the AO, 1LT Rektorik directed 2 squads along the canal banks, one on each side moving parallel. A third squad was working nearby and soon discovered a hut containing a sizeable amount of M-1 ammunition. The Platoon encountered several hootches with large quantities of rice, all of which were destroyed.

They had moved approximately 600 meters north when they began to receive sporadic small arms fire. The source, however, could not be determined. Therefore, 1LT Rektorik was anxious to move out of the area since there were friendly troops operating nearby. In fact, he felt that the fire might have come from the friendly forces engaging in a fire fight. The Lieutenant decided to establish a blocking force and continue movement.

At 1008 hours, the elements on the southeast side of the canal discovered a camouflaged storage cache containing 69 - 100 pound bags of rice, M-26 hand grenades and a hootch, all of which was destroyed in place. At 1047 hours, 151-100 pound bags of fertilizer were discovered.

Throughout the day, the 1st Platoon continued to uncover VC storage caches yielding 75 M-1 rounds, 4 sticks of TNT, 800 more pounds of rice, 1 Chicom rifle and 1 Chicom grenade.

Shortly after noon, the 1st Platoon started receiving fire from 600 - 700 meters across a rice paddy. LT Rektorik called in a Falcon gun ship who suppressed the area so that extraction could be initiated. By 1330 hours, the platoon had returned by helicopter to Position WHITE.

LONG RANGE RECONNAISSANCE PATROL - E/17TH CAVALRY

The Long Range Reconnaissance Patrol (LRRP) of E/17th Cavalry consists of 61 crack paratroopers whose mission is to scout 15 to 20 kilometers forward of the CP, thereby obtaining and relaying intelligent information concerning terrain, enemy strength etc. to the commanders. Nearly all LRRPs are made up of graduates of either MACV School, Ranger School or Recondo School and are highly skilled in the techniques of jungle survival and guerrilla warfare.

CONFIDENTIAL

CONFIDENTIAL

AVFE-SC
SUBJECT: Small Unit Actions - E/17th Cavalry

25 February 1967

128

The Patrol is commanded by CPT Allan B. Phillips, a graduate of West Point Military Academy and a native of North Berwick, Maine. The men, while on patrol wear camouflaged fatigues and soft hats. They are armed with M-16's and M-3 grease guns equipped with home-made silencers. They also carry a blood expansion unit as all the men have had 1st Aid experience and training.

The Patrols themselves are made up of 6 man teams consisting of 1 patrol leader, an assistant patrol leader, 1 RTO, 1 senior scout and 2 additional scouts. They rely almost solely on helicopters for deployment since they are usually placed in areas of unknown VC strength. These small well rounded patrolling/reconnaissance units perform an invaluable service to the Cavalry Troop and the Brigade as a whole in supplying information necessary for the introduction of larger infantry elements.

During the first part of Operation CEDAR FALLS, the LRRP remained airborne almost constantly, making bomb strike assessments. On the 12th and 13th they were involved in tunnel search missions. CPT Phillips asked for and was subsequently granted permission to rejoin the Cavalry Troop. They conducted operations with the Cav on the 14th of January, this time, however, their mission was the same as the other platoons.

At 1029 hours, the LRRP was dropped at XT 680321 with the mission of searching along the canal heading northeast. One element of the LRRP moved in from the north-west and commenced patrolling along the canal bank. They soon ran across three elderly men (50 - 60 years of age). The men displayed their ID cards and bowed respectfully. SP4 Edmond D. Smith had them evacuated immediately and movement was continued down the canal. The 11th ACR was working on the opposite side at this time.

Along the way, SP4 Smith's element observed a Vietnamese off to their left working in a rice paddy. They called out to the man just as he dove into the rice paddy. The moment fire was placed on him, a secondary explosion occurred. It appeared as though the VC were about to toss the grenade into the midst of the patrol, however, his attempt was aborted. The scouts entered the rice field to confirm the KIA. The water in the paddy was chest deep in some places and made navigation extremely difficult. The search was then directed to the woodline. Shortly thereafter, the patrol linked up with another LRRP element at XT 693238 which reported negative contact, however, they did discover one VC body, who had apparently been killed a day or two earlier.

At 1041 hours, a twelve man patrol at XT 721222 found an extremely large cache of polished rice while moving north along a canal. After the destruction was completed, they moved 400 meters toward the SONG SAIGON. "Hot Stuff" had reported seeing a 55 gallon drum in this area. The drum was easily found, along with a hootch built on stilts over the canal, a rice cache, a 30' sampan with an inboard diesel engine and 3 smaller sampans. It took 30 minutes to destroy the 225 - 100 pound bags of paddy rice and the 40 - 100 pound bags of polished rice.

At 1256 hours, the patrol became airborne to coordinates XT 745213. A "Hot Stuff" report perpetrated this movement, yet nothing was discovered in the immediate area. The patrol then crossed two canals and at XT 742212 they discovered 15 sampans, an outboard motor and a half dozen hootches, all of which were destroyed. The patrols were all extracted by 1507 hours completing the day's activities.

CONFIDENTIAL

CONFIDENTIAL

129 AVBE-SC
SUBJECT: Small Unit Actions - E/17th Cavalry

25 February 1967

On 15 January, the LRRP worked with the Chemical Detachments in tunnel search and destruction. The following day, Major Sutton received the order to conduct both day time search and destroy operations in addition to night time ambush patrols. On the nights of the 16th and 17th of January, the Cav's LRRP set ambush patrols near the bridge encountered two days previously by the 2d Platoon (XT 715-228).

NIGHT AMBUSH - 16 JANUARY 1967

At 1438 hours, a twelve man patrol led by SGT Michael J. Howard infiltrated the area (XT 715228) where a heavily used footbridge was located. The ambush was set up in such a manner that both the trail and the canal could be covered thoroughly. The patrol was armed with claymore mines, M-60 machineguns, M-16 rifles and hand grenades. The ambush site itself stretched over a one hundred meter area (see Annex 1 for ambush positions).

By 1500 hours, the ambush was ready. The men therefore lay motionless, observing strict silence while waiting for nightfall. At 1919 hours, a VC was seen approaching the bridge from the northwest. All was still until the man walked into the killing zone and the squad opened up, killing the VC instantly.

At 2015 hours, another VC approached the ambush using the same route as his unfortunate predecessor, however, owing to the darkness, he was undetected until he was in the center of the killing zone. Several rounds rang out at the VC but with negative effect. He then brandished a fragmentary grenade, but before he could throw it, another burst of fire rang out. The VC dropped out of sight moaning in pain. His pain ceased when his own grenade exploded beneath him.

Between the first and second encounter, several lights were observed flashing on and off, apparently some sort of signal. This second VC was more than likely a scout sent to check out the situation at the bridge, implying that perhaps a larger force was anxious to use the crossing.

It was not long after the second VC was killed than noises were heard followed by heavy enemy fire, seemingly from all directions. An estimated 15 VC were involved in the fire fight. They had seemingly infiltrated through the same route across the bridge.

At this time, SP4 Collins, on the southern side of the canal, was hit by enemy fire. All patrol members were virtually pinned down to their positions and the brush was too thick to move without being detected. Grenades were thrown to hamper the enemy fire temporarily so that SP4 Phillips and SP4 Moyer could regroup in order to reach the wounded man. As their ammunition was beginning to run seriously low, the fire died down and communication was made to the elements on the north side of the canal informing them of the casualty. SGT Howard crossed the canal to give assistance to the two men as fire ceased altogether on the other side.

When he reached Phillips and Moyer, he gave them a pocket-type flashlight to aid the wounded Collins. He then radiced back to SGT Bolen that two men were needed for security while First Aid was being administered. SP4 Taylor and SP4 Curtis immediately crossed the canal.

Initially, Phillips detected only one small wound in SP4 Collin's cheek, yet he appeared to be in shock. The wounded man was lifted onto the dike where Phillips performed mouth to mouth resuscitation until the Dustoff ship arrived 10 minutes later. A trip flare was employed to guide the evacuation ship into the area. SGT

CONFIDENTIAL

CONFIDENTIAL

AVEE-SC

25 February 1967

SUBJECT: Small Unit Actions - E/17th Cavalry

Howard and Specialists Curtis and Phillips carried the wounded man across the rice paddy to the waiting helicopter. The chest high mud, the darkness and wet made the task near impossible yet they managed to maneuver to the ship and the wounded man was evacuated.

The men then returned to their positions where all was quiet until 2237 hours when 2 VC wandered directly in front of SP4 McDonald's M-60 machinegun. Detecting something wrong, the two VC stopped and exchanged a few words before McDonald fired but the weapon jammed. SGT Howard, a few meters away, immediately fired his M-16 however, it too malfunctioned due to the mud acquired during the evacuation of SP4 Collins. Seeing this, SGT Bolen opened up with his M-16 killing one VC instantly. The second VC was wounded and tried to escape over the dike, down the canal. SGT Bolen left his position and pursued the enemy to the brush at the water's edge and completed the job. The VC were armed with one carbine and one Chicom sub-machinegun. After this, there were no more contacts, however movement was heard until around 0400 hours. Five hours later, the platoon was extracted without incident.

SP4 Collins died in the hospital 7 days later. The bullet he received pierced his cheek and lodged in his brain. The 19 year old native of Houston, Texas had spent the last 19 months in Vietnam.

NIGHT AMBUSH - 17 JANUARY 1967

A 12-man ambush patrol led by SGT Harold Kaiama of Honolulu, Hawaii, infiltrated to XT 717227 at 1848 hours on 17 January. SGT Kaiama positioned his unit north of a bridge on the west side of the canal. This was essentially the same site employed in the previous night's ambush, however, on the night of the sixteenth, the ambush was located south and west of the bridge, with a security element across the canal to the south.

On the ambush of the 17th of January, there was a misunderstanding between SGT Kaiama and assistant team leader SSG Vigo. Sergeant Vigo was under the misconception that he, along with SP4 Smith (M-16) and SP4 Wilkinson (M-16) were to be positioned south of the bridge. Once the ambush was set, no corrective action could be taken since strict silence measures had to be observed. Claymore mines were employed to the southwest and north of their position owing to the lack of rear security (see Annex 2).

All was still until 2030 hours when SP4 Smith on the left flank security spotted 7 VC, 20 to 30 meters from the bridge. When the VC reached the bank, SGT Vigo and SP4 Smith opened fire on the unsuspecting enemy. The VC were unable to determine the direction of fire and in the confusion, one VC was killed and a second was wounded, falling from the dike out of sight.

Later that night, SGT Kaiama, utilizing a starlight scope, spotted 2 VC approximately 10 meters from SP4 Miller's light machinegun position. He radioed the information to the gunner, who immediately opened fire. The results were undetermined at this time due to the darkness, however, two VC MIA were found while searching the area the next morning.

The last incident occurred between 1920 and 2000 hours when SGT Kaiama again spotted an undetermined number of people to his front with the starlight scope. SP4 Rosson and SP4 Dapello fired 6 volleys of M-79's toward the people, the sighting being provided by SGT Kaiama. In the morning, 4 VC dead were found in the area of fire.

CONFIDENTIAL

CONFIDENTIAL

131

AVBE-SC
SUBJECT: Small Unit Actions - E/17th Cavalry

25 February 1967

The ambush patrol met with no opposition throughout the night. One M-79 or possibly a 60mm mortar round was received at one time, however, it produced negative results. The ambush patrol was highly successful, having a total of 5 VC KIA (BC) and an estimated 2 more KIA with friendly forces sustaining no casualties. The patrol was extracted from this position at 1000 hours, 18 January.

RESULTS OF OPERATION JEDAR FALLS - E/17th CAVALRY

12 January 1967

VC Killed by Body Count 6
VC Captured 3
Huts/Bunkers Destroyed 4
Sampan Destroyed 2
Weapons Captured 1
Ammo Captured (sm arms) . . . 53 rnds
Rice Destroyed 1500 lbs

13 January 1967

VC Killed by Body Count 17
VC Captured 33
Huts/Bunkers Destroyed 1
Weapons Captured 5
Ammo Captured (sm arms) . . . 150 rnds
Rice Destroyed 900 lbs
Claymores Captured 3
Grenades Captured 1
Rucksacks Captured 7
Medical Supplies Captured . . . 5 lbs
Weapons Captured 4

14 January 1967

VC Killed by Body Count 12
VC Captured 9
Huts/Bunkers Destroyed 6
Sampan Destroyed 22
Weapons Captured 2
Ammo Captured 150 rnds
Rice Destroyed 41.5 tons
Sampan Outboard motors 4
Rucksacks Captured 8
Grenades Captured 2
TNT Captured 15 lbs
Fertilizer Destroyed . . . 1150 lbs
Documents Many

15 January 1967

VC Killed by Body Count 1
Huts/Bunkers Destroyed 16
Sampan Destroyed 11
Sampan Motors Captured 1
Rice Destroyed 7½ tons
Rucksacks Captured 1
Claymores Captured 8
Gasoline Destroyed 50 gal

16 January 1967

VC Killed by Body Count 9
VC Captured 2
Huts/Bunkers Destroyed 3
Sampan Destroyed 6
Sampan Motors Captured 2
Rucksacks Captured 1
Rice Destroyed 5 tons
Medical Supplies Captured . . . 5 lbs

17 January 1967

VC Killed by Body Count 12
VC Captured 2
Huts/Bunkers Destroyed 5
Sampan Destroyed 3
Weapons Captured 5
Sampan Motors Captured 1
Rice Destroyed 5700 lbs
Medical Supplies Captured . . . 15 lbs
Rucksacks Captured 2
TNT Captured 25 lbs
Base Camp (Sqd Size) 1

CONFIDENTIAL

CONFIDENTIAL

AVBE-SC
SUBJECT: Small Unit Actions - E/17th Cavalry

25 February 1967

132

18 January 1967

VC Killed by Body Count 8
VC KIA by Arty Called by E/17th . . . 5
Huts/Bunkers Destroyed 2
Sampans Destroyed 6
Weapons Captured 2
Ammo Captured (sm arms) 25 rnds

19 January 1967

VC Killed by Body Count 9
VC Captured 4
Huts/Bunkers Destroyed 2
Weapons Captured 2
Rice Destroyed 1200 lbs

20 January 1967

VC Killed by Body Count 9
Sampans Destroyed 1
Weapons Captured 2
Ammo Captured (sm arms) 200 rnds
Grenades Captured 2

21 January 1967

VC Killed by Body Count 1
Huts/Bunkers Destroyed 24
Sampans Destroyed 6
Weapons Captured 1
Claymores Captured 1
TNT Captured 15 lbs
Documents Many

TOTALS

VC KIA: E/17th Cavalry & Supporting Aircraft

Aero Scouts 5
Gun Ships 5
Ground Elements 63
TOTAL 73
Enemy Captured 25
Suspects Detained 13
Weapons Captured 21
Sampans Destroyed 22
Huts Destroyed 38
Rice Destroyed 132 tons (approx)
Documents 40 lbs (approx)
Sampan Engines 9

1

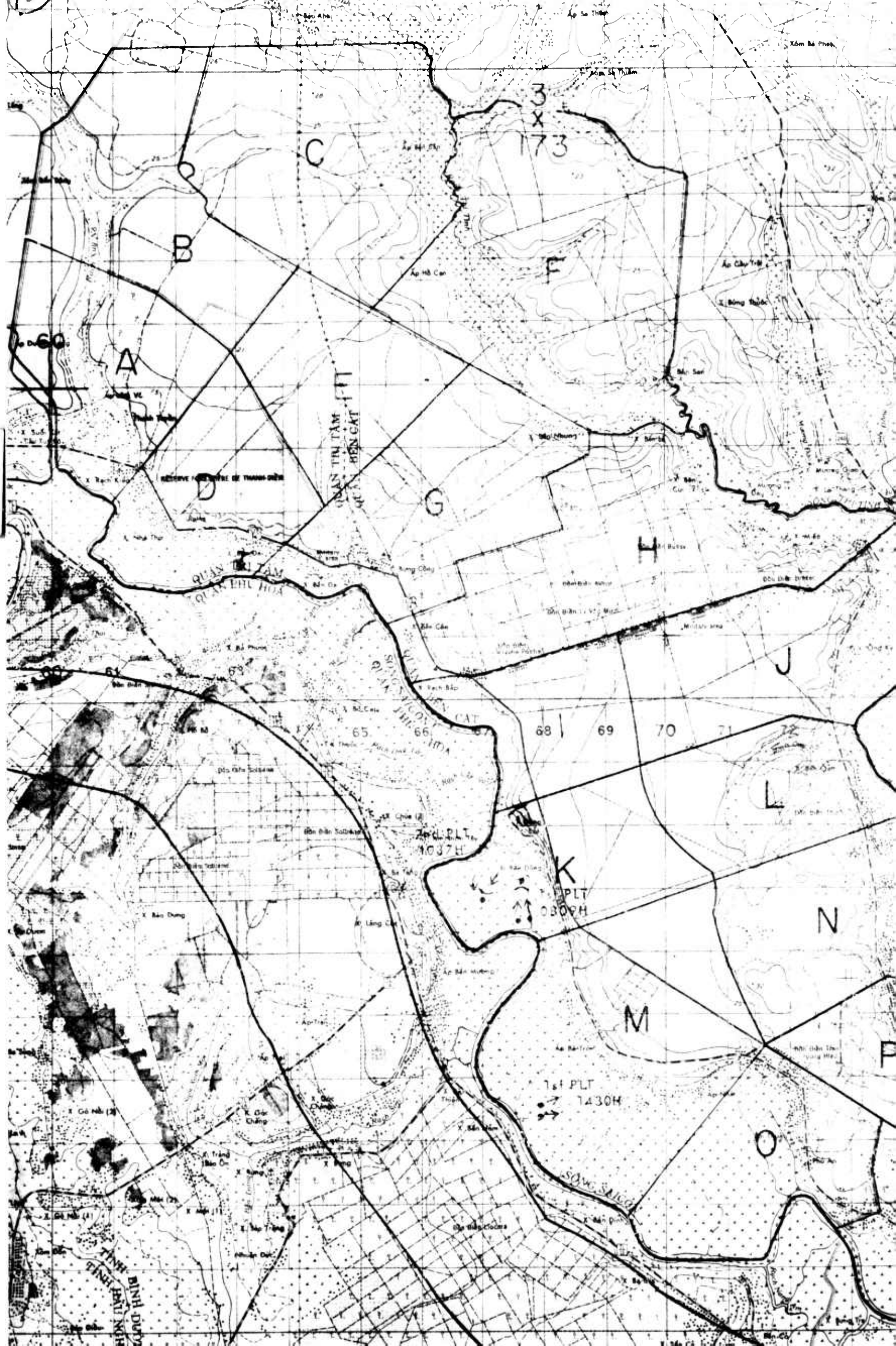

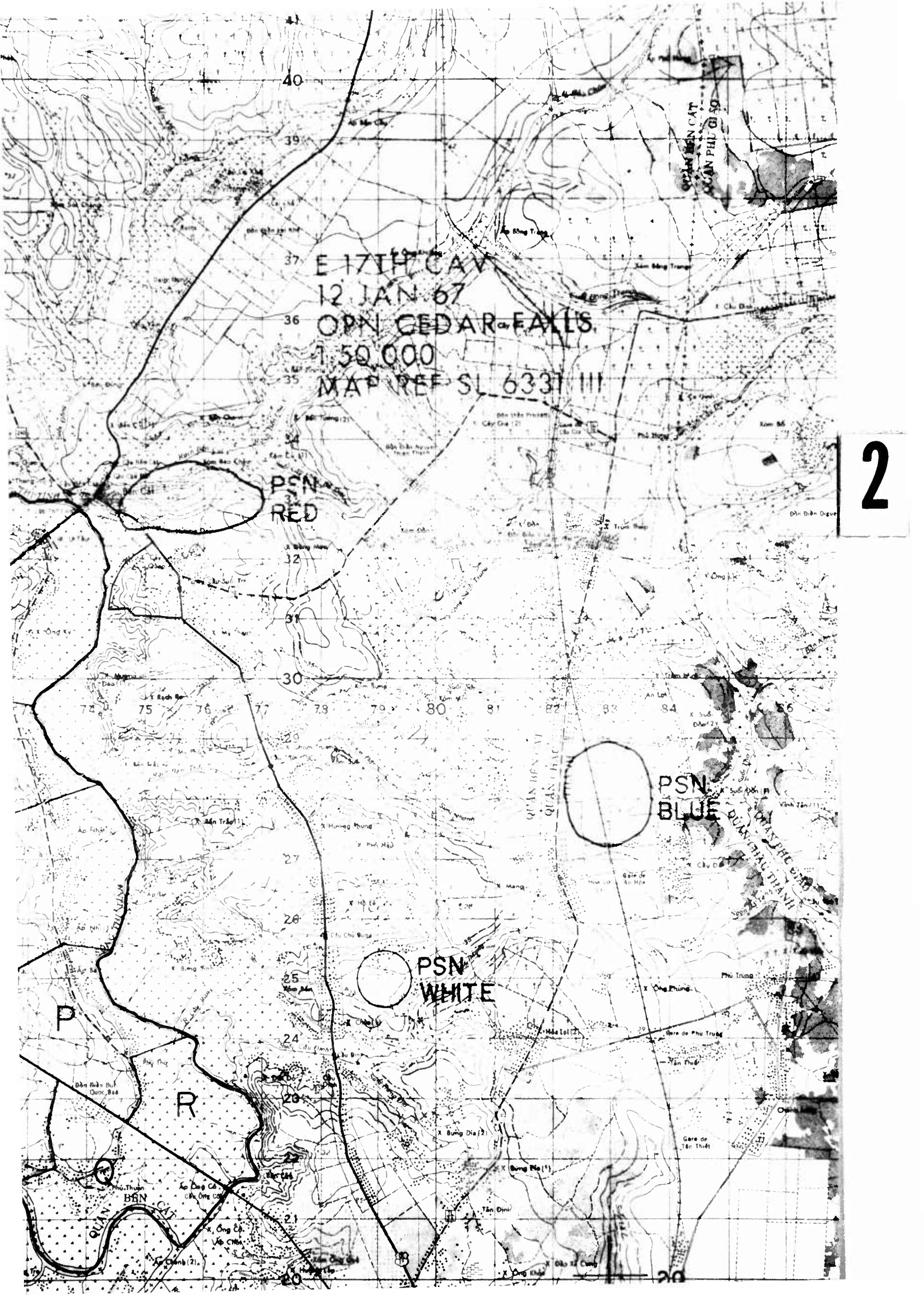

E 17TH CAV
12 JAN 67
OPN CEDAR FALLS
1:50,000
MAP REF SL 6331 III

PSN
RED

PSN
BLUE

PSN
WHITE

2

3

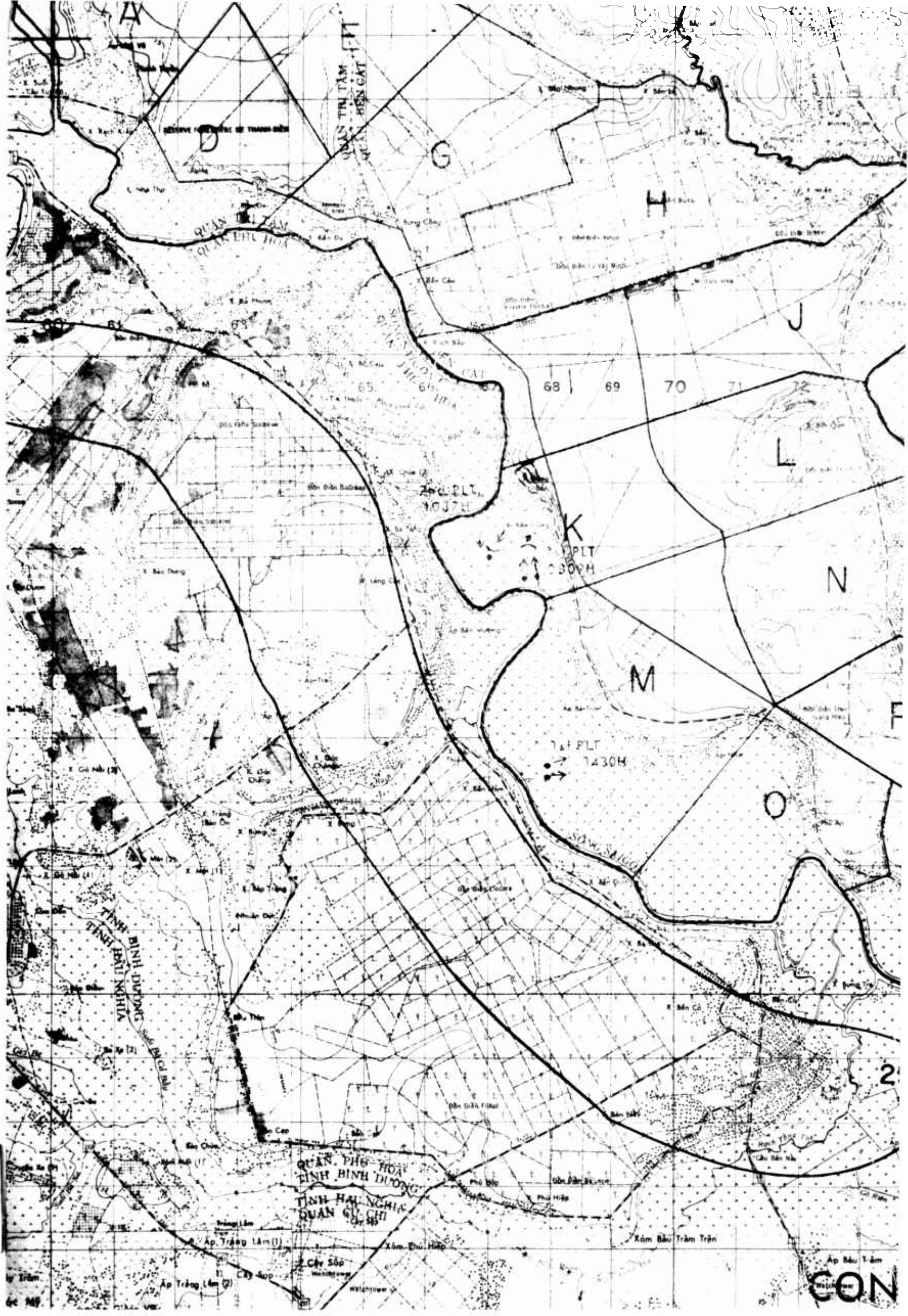

CON

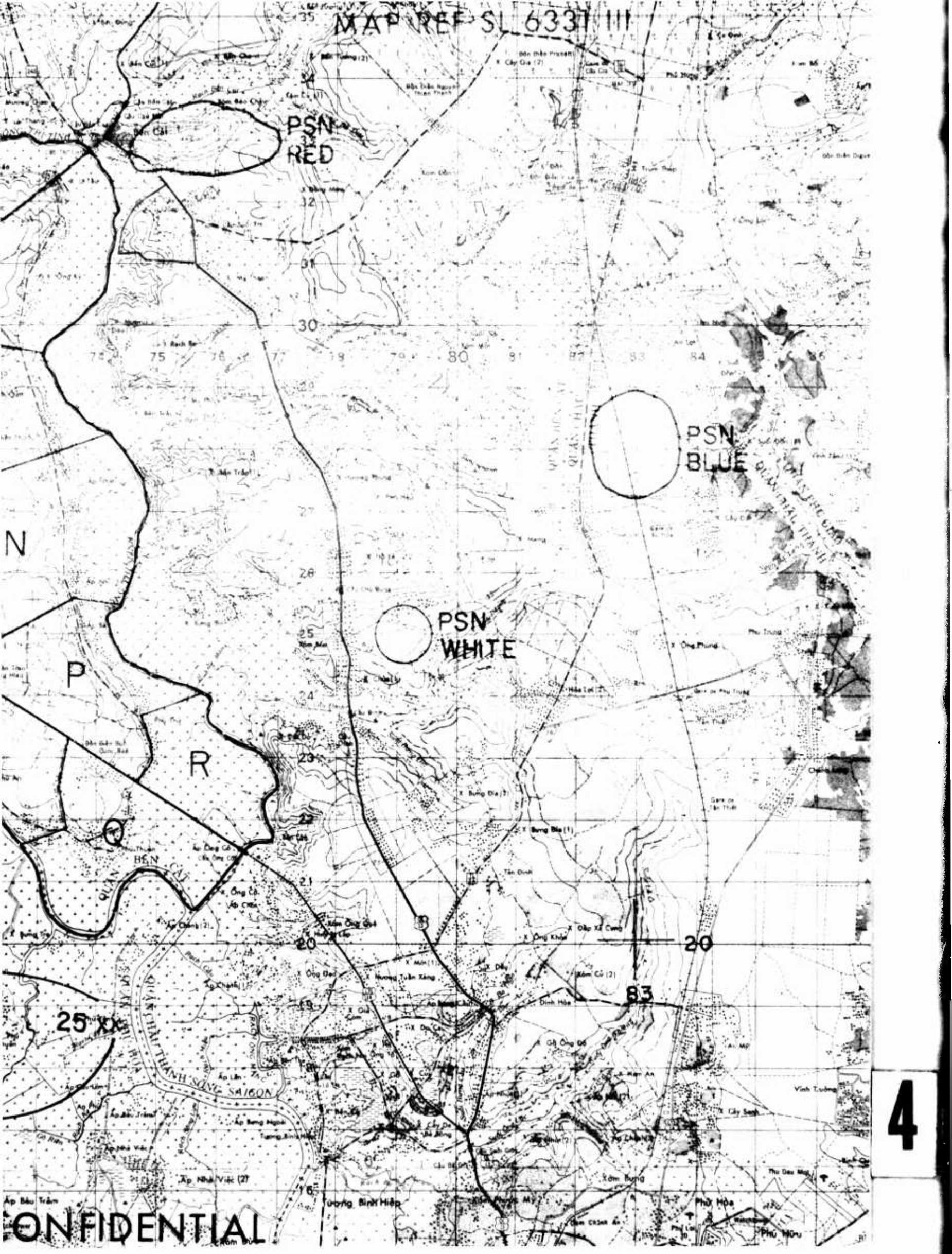

CONFIDENTIAL

4

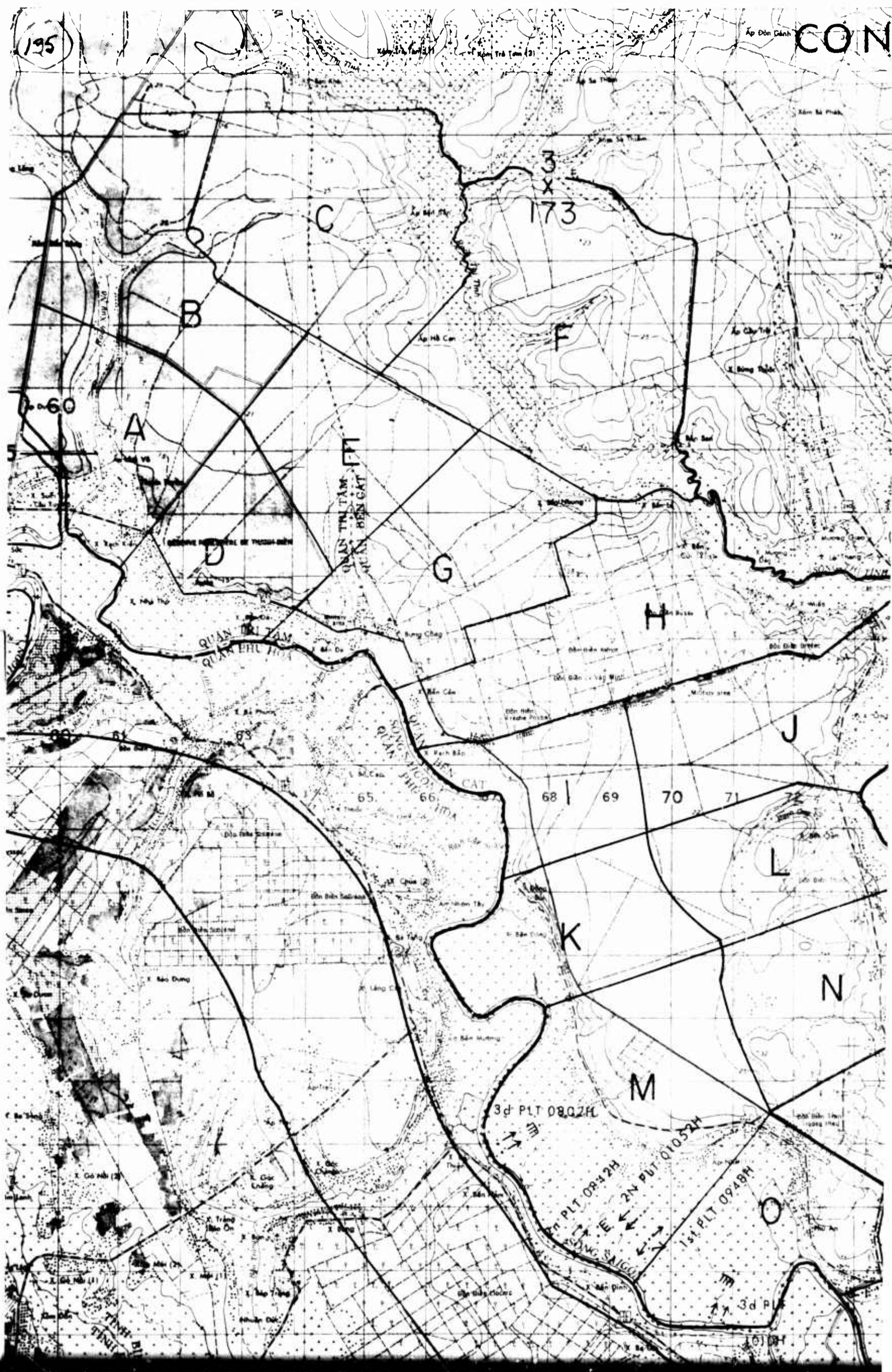

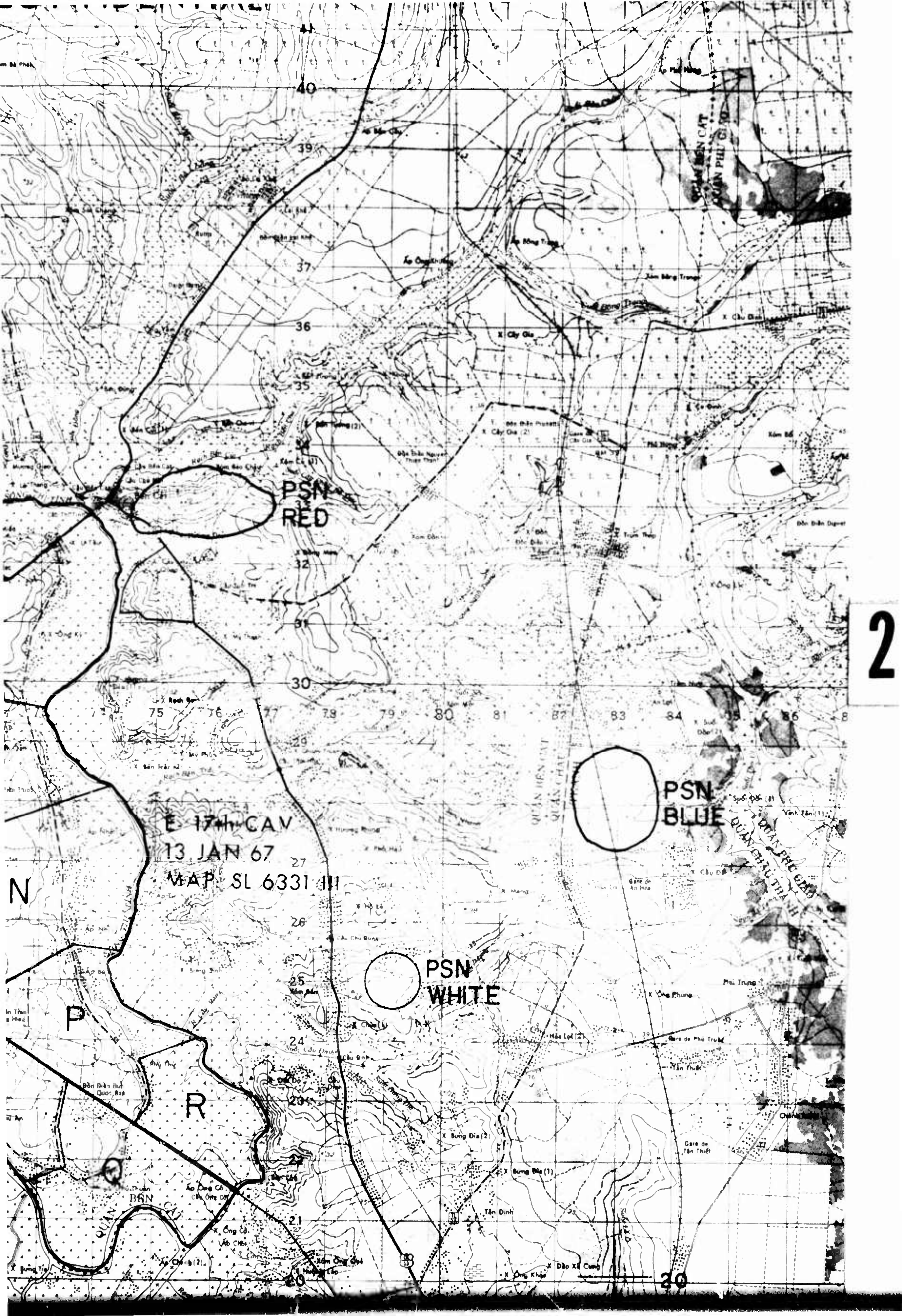

2

PSN
RED

PSN
BLUE

PSN
WHITE

E-17th CAV
13 JAN 67
MAP SL 6331 III

N

P

R

20

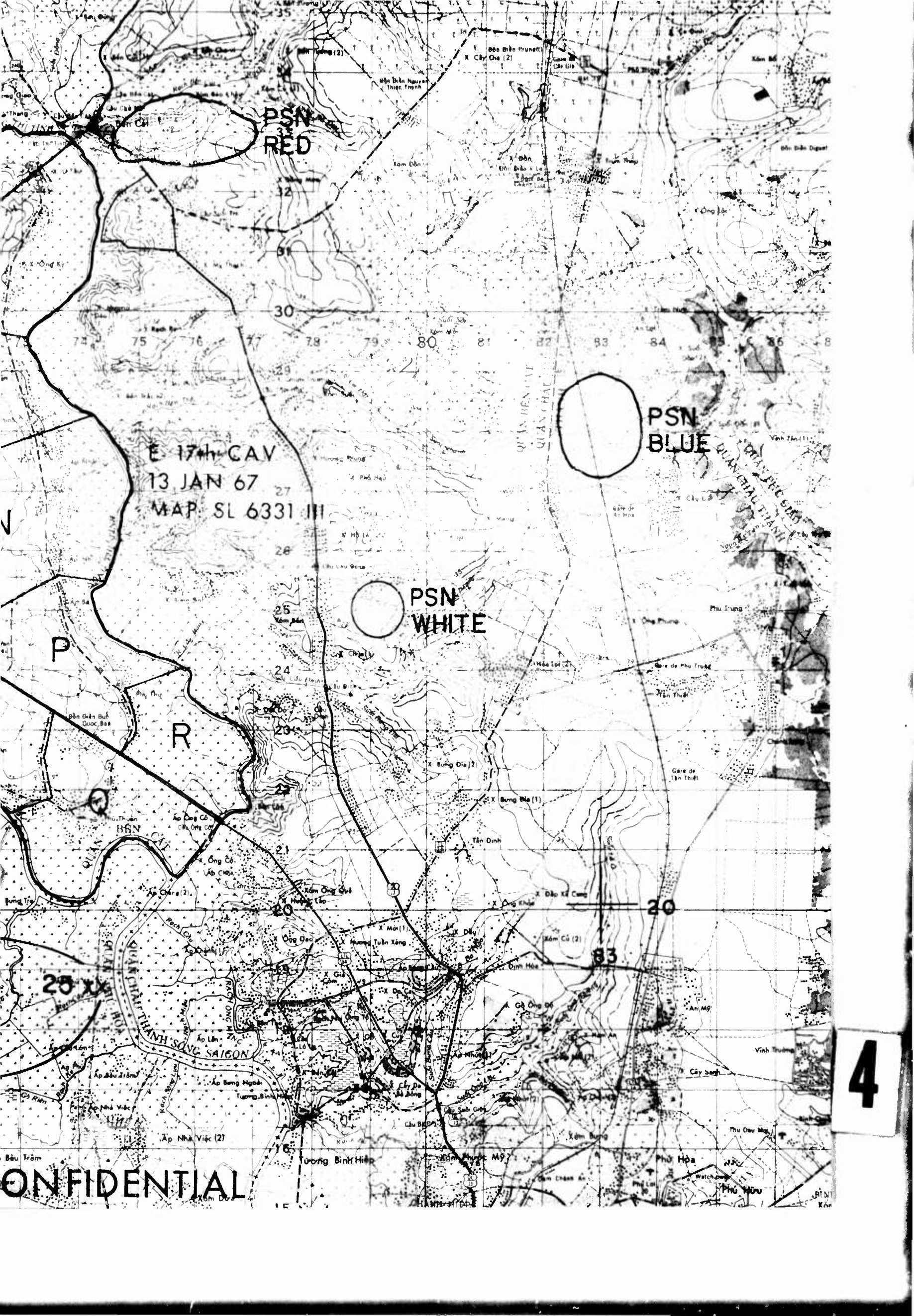

**PSN
RED**

**PSN
BLUE**

**PSN
WHITE**

E-17th CAV
13 JAN 67
MAP SL 6331 III

P
R

4

CONFIDENTIAL

1

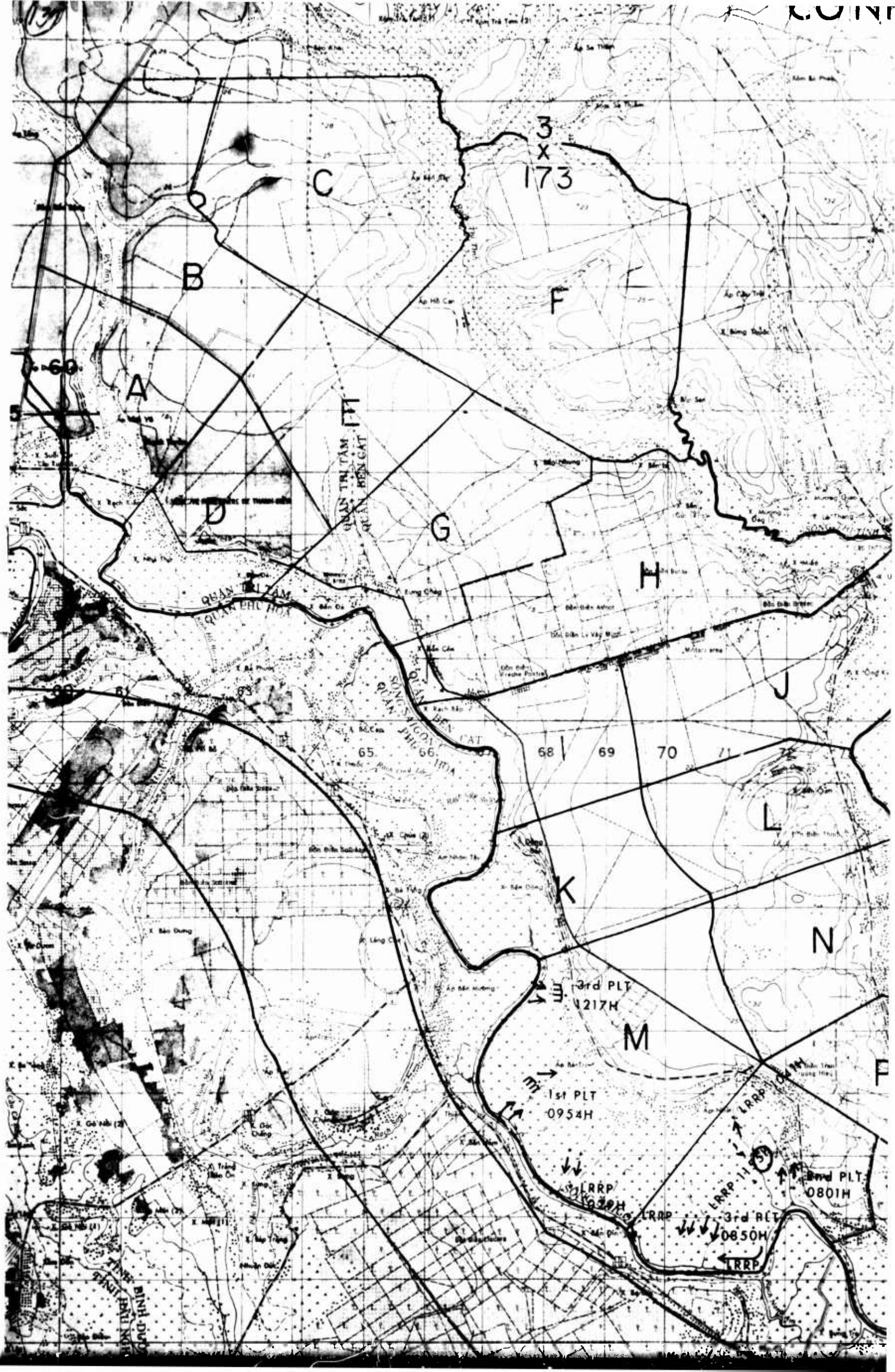

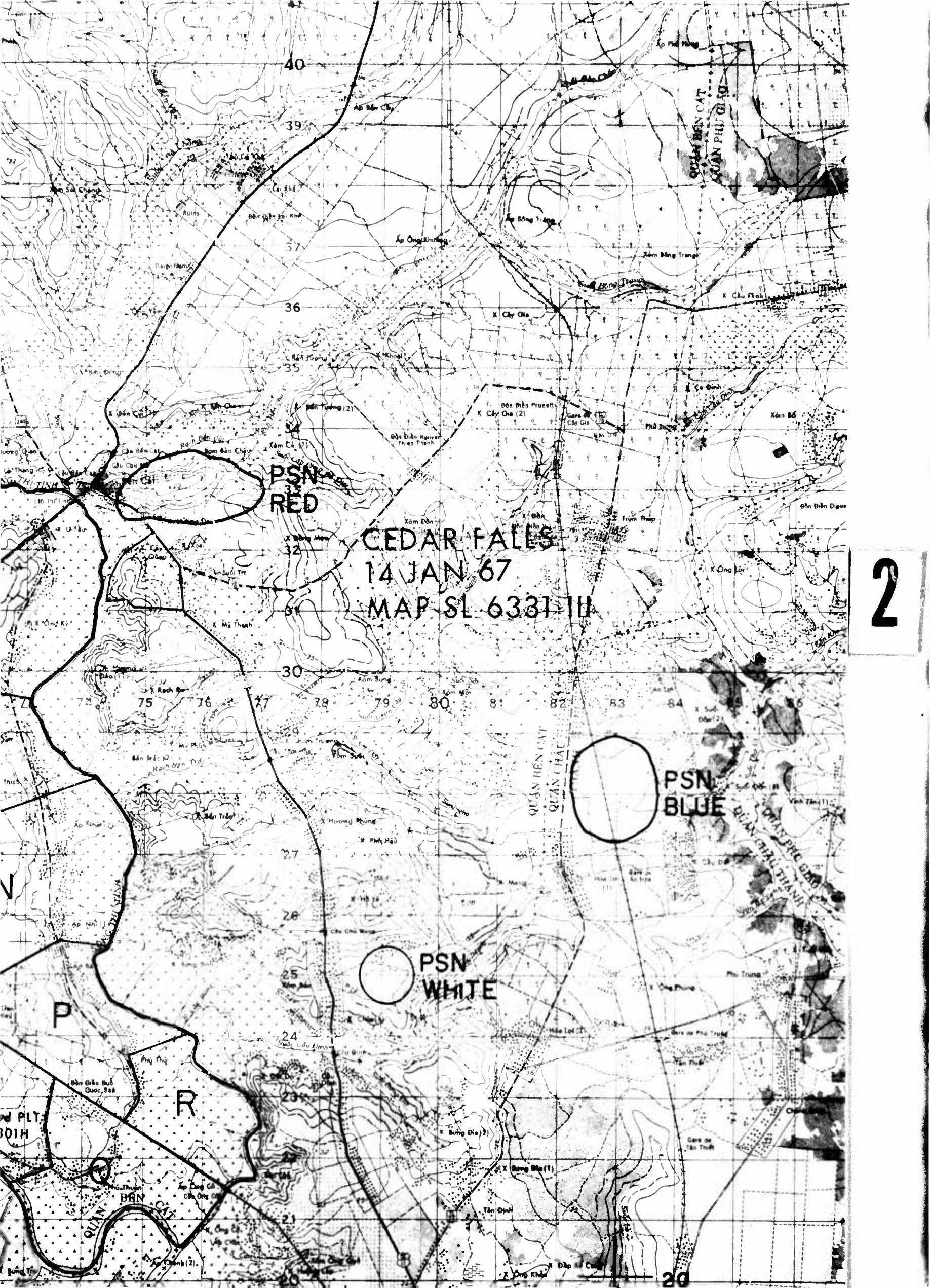

PSN
RED

CEDAR FALLS
14 JAN 67
MAP SL 6331 III

PSN
BLUE

PSN
WHITE

2

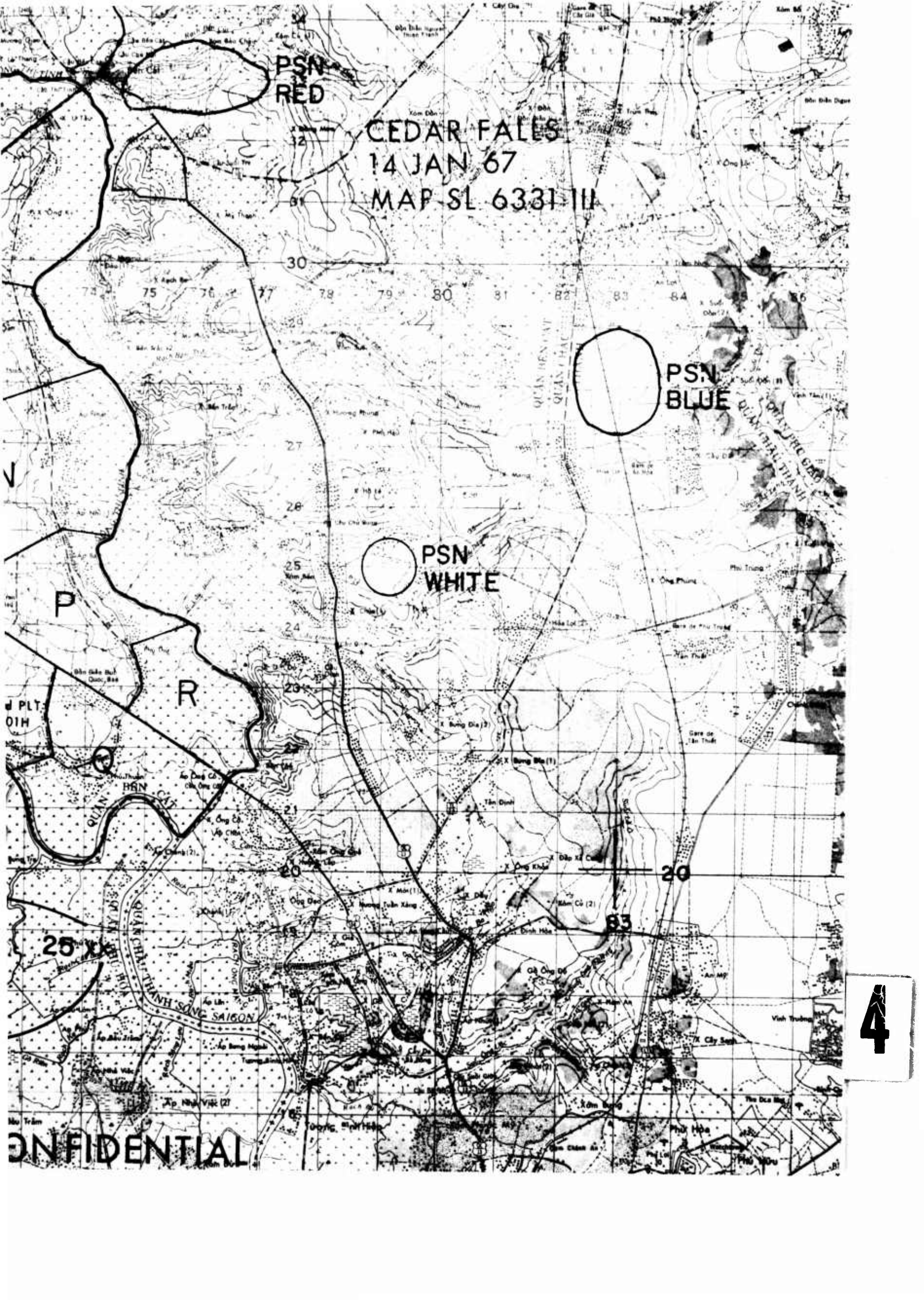

PSN
RED

CEDAR FALLS
14 JAN 67
MAP SL 6331 III

PSN
BLUE

PSN
WHITE

4

CONFIDENTIAL

CONFIDENTIAL

TAB D

SMALL UNIT ACTIONS

2d Battalion/508d Inf

CONFIDENTIAL

CONFIDENTIAL

AVRE-SC

25 February 1967

141
SUBJECT: Small Unit Actions - 2/503d Infantry

"C" COMPANY, 2D BATTALION, 503D INFANTRY

On 8 January 1967, the 2d Battalion, 503d Infantry was deployed from Camp Zinn at the 173d Airborne Brigade (Separate) base camp at BIEN HOA to a staging area at PHU LOI. From this point, the Battalion was lifted to the forward assembly area at Point BLUE (XT 828829) employing 30 helicopters. They remained there until 0930 hours on 9 January 1967. The troops were given a general orientation as to their mission prior to their departing BIEN HOA.

On 9 January, the Battalion landed at two LZ's (XT 6737 & XT 6736) and the separate companies were arranged as shown in Annex 3. The Companies were given the mission of patrolling, forming blocking positions and setting up night ambushes.

Logistically, Company "C" was armed as follows: each rifleman was armed with an M-16 rifle with 400 rounds of ammunition as a basic load, 2 smoke grenades and 2 fragmentary grenades. There were two M-60 machineguns per platoon, each gunner carrying a total of 1,500 rounds of 7.62mm ammunition. In addition, each squad had 2 M-79's with 45 rounds per grenadier and generally 2 claymore mines, depending upon the mission. The company as a whole was equipped with three (3) 81mm mortars with 30 rounds per mortar. Each individual carried three C-Ration meals while on operations.

At 1115 hours, 9 January, Company C landed at the LZ and immediately established a blocking position. Captain Thomas P. Carney, Company Commander, moved to the right flank to make coordination with the CO of B/1/16th Infantry which was operating to the north. After this was completed, the 3 platoons established defense positions along an ox cart road west of the SONG THI TIEN. The AO was primarily jungle with the exception of an area which had been defoliated within the last year. B/1/16th Infantry, located 200 meters to the north of the coordination point, had established a defense perimeter, whereas C/2/503d Infantry was on a line defense. CPT Carney and CPT Wilson (B/1/16th Infantry CO) decided that ambush patrols would be placed on the overgrown trail in the western portion of the 2d Battalion AO. See Annex 3.

Shortly after the 3 platoons had established a defense perimeter, patrols were sent out to search the immediate area for signs of the VC and likely ambush sites. The 3d Platoon soon discovered a hut with a small tunnel/bomb shelter attached. The hootch had been inhabited very recently, for freshly cooked rice was found. Further search of the area revealed a hole containing 12 bicycles and a concrete platform with 200 pounds of polished rice. Everything was destroyed, with the exception of the bicycles which now provide transportation to the men of "Charlie" Company while in base camp.

The weapons platoon, consisting of 33 men, screened the rear of the Company CP finding nothing save one small hootch. After it was destroyed, the platoon moved further east towards the THI TINH River, running into an unfordable stream. They then returned to the company base area.

In addition, each of the 3 platoons sent out squad sized patrols to reconnoiter the front of the perimeter since there was a 100 meter gap between platoons. The Companies also employed three man observation posts during the hours of darkness.

SGT Nathaniel King, of Hartford, Connecticut, was in charge of the patrol from the 1st Platoon. When they returned to the CP, SGT King reported finding 2 fox-holes showing no signs of recent use. He also reported finding a footpath running parallel to the overgrown trail in the western portion of the AO. Although the trail displayed no signs of recent use, the small foot path to the right was heavily traveled, probably because it could not be observed from the air. SGT King's patrol

CONFIDENTIAL

CONFIDENTIAL

AVBE-SC
SUBJECT: Small Unit Actions - 2/503d Infantry

25 February 1967

followed the path back to the CP where he relayed this information.

All patrols returned to the CP by 1630 hours. A-Rations and a .50 caliber machinegun were brought in at this time and the company settled down to warm chow. At 1500 hours, 1LT Phillip Hayden was told to conduct a night ambush 300 meters south of the Company's position. SGT Julius Brown was to be in charge of the patrol.

At approximately 1940 hours, an outpost located between the 2d and 3d platoon positions made enemy contact. SGT Frank Bothwell, SP4 Walter Johnson and PFC Joseph Russo were the three men at the post. They moved into position shortly after night-fall, situating themselves 3 meters from one another in a triangular position, thereby facilitating easy communication in addition to 360° observation. The terrain was flat, consisting of elephant grass and bamboo.

The men lay quietly in the prone position, until they detected movement 50 meters to their front right flank, seemingly approaching the OP. Their vision was obstructed by the elephant grass and being in the prone position, they could not move without being detected. SGT Bothwell could not get to his M-16 since he was in a position that any movement whatsoever could be fatal. He therefore prepared to throw a fragmentary grenade in the direction of the approaching VC.

SP4 Johnson was in such position to observe the VC, however he knew that he must come to a sitting position to fire, thereby exposing himself. The SOP for the outpost was not to fire unless absolutely necessary. As the enemy came closer, Johnson realized that there could be no time more necessary than now.

He darted up into a sitting position and fired approximately 5 rounds before his weapon jammed. As he applied immediate action, a grenade exploded and Johnson took a fragment in the neck. At this time, SGT Bothwell let loose with his grenade, which he had been holding with the pin out for 3 seconds, hoping the grenade would explode upon impact. Unfortunately, the grenade went off while in flight, raining fragments back to the OP. PFC Russo caught a fragment in the hand and was unable to fire his M-79. Bothwell radioed back to the CP informing them of the casualties, then sprayed the area with M-16 fire and made a rapid retreat aiding Johnson and Russo.

Upon returning to the CP, the two wounded men were evacuated at the advise of the Company Medic. The wound in Johnson's neck, although not serious, was very close to the jugular vein. The Dustoff ship arrived and picked up the men 25 minutes later.

By this time, the ambush patrol was in position. CPT Garney had received reports from A/2/503d Infantry and B/1/16th Infantry that movement was detected near their Company CP's. With this in mind, he warned SGT Brown's ambush to keep on the alert for infiltrating Viet Cong.

The ambush patrol had left the CP at 1900 hours and moved south along the foot path. They passed their ambush site and backtracked to it, thereby confusing any enemy elements that might be following their trail. The site was chosen because of the cover available and the indications that the path was frequently traveled at this point. There were nine men on the patrol, 6 armed with M-16's, 2 armed with M-79's and one (1) M-60 machinegun (see Annex 3). The patrol maintained radio silence, however, a predesignated break squelch system was employed as follows: 1 break - negative contact, 2 breaks - involved in action, 3 breaks - enemy casualties, 4 breaks - friendly casualties, 5 breaks - numerous VC in the area.

CONFIDENTIAL

CONFIDENTIAL

143
AVFE-SC
SUBJECT: Small Unit Actions - 2/503d Infantry

25 February 1967

At 1945 hours, the patrol heard fire issuing from SGT Bothwell's Co. previously mentioned. Another warning was issued shortly thereafter. The patrol, on full alert, lay in anticipation of enemy movement.

At 2045 hours, several sounds of movement were heard to the northeast of the ambush site. PFC Gary Gaura became anxious when hearing the movement and crawled to SGT Brown's position a few meters away to ask him what should be done. SGT Brown told him to do nothing and be still. When Gaura crawled back to his position, he coughed, and the enemy movement, which was now only 15 meters away, halted sharply. The VC remained motionless for approximately 10 minutes, and then moved on around the patrol's killing zone. PFC Gaura counted 15 silhouettes. They crossed the trail, avoiding the ambush, yet they still remained in the immediate area.

At 2230 hours, the column of men moved further to the west, out of range and sight. 15 minutes later, machinegun fire was heard; apparently B/1/16th Infantry elements had encountered the VC. At 2300 hours, a straggler wandered directly into the ambush site. Again someone coughed, alerting the VC. This time however, there was no chance for escape. PFC Michael Farmer, an M-16 man on the southeast portion of the ambush observed the silhouette and cut loose with 5 rounds, wounding the VC. He lay on the ground moaning and shrieking in pain.

At this time, another Viet Cong straggler wandered into the ambush. He took one look at his wounded comrade and decided he wanted no part of him. As he turned to leave, the wounded man cried out once again. The other VC decided to be a good samaritan and turned about (almost tripping over an M-60 machinegun) returning to the wounded man. He then sprayed the area with AK-47 fire, having a negative effect on the patrol.

The VC then leaned over his wounded comrade and lit a candle which brilliantly illuminated both men. Immediately after this was done, PFC Michael Hill cut loose with his M-60, however, the machinegun malfunctioned. Simultaneously, PFC Martin C. Norman bore down on the two VC with his M-16. The candle went out and all was quiet.

Silence was maintained until the morning when the two KIA were confirmed. Two AK-47 weapons were found with the bodies, and among their personal items was found a document containing the crypto for the Military Region 4 Headquarters. This document proved to be extremely important and directly led to the capture of a high official in the MR-4. The second VC was obviously a courier whose job was to transport important documents.

At 0630 hours, the ambush patrol moved out of the area and proceeded by foot to the Company CP. The documents captured from the Viet Cong courier turned out to be one of the most significant finds of the Operation.

NIGHT AMBUSH - 1ST PLATOON - B/2/503D INFANTRY - 15 JANUARY 1967

1LT Donald B. Feedham, the 1st Platoon Leader received a mission from the Company Commander, CPT Ken Kaplan, to establish 2 ambush sites along HIGHWAY 14 on the night of 15 January 1967. After due consideration was made to likely ambush sites, Lieutenant Feedham decided to place the two ambushes at XT 706251 and XT 712248. He then divided his 31 man platoon into two groups of 16 and 15 men. The ambushes will be covered separately and will be denoted as SITE I and SITE II.

CONFIDENTIAL

CONFIDENTIAL

AVBE-SC
SUBJECT: Small Unit Actions - 2/503d Infantry

25 February 1967

144

SITE I

Staff Sergeant J. Marlow was the NCO in charge of the first ambush which went into position 500 - 600 meters from the Battalion CP along HIGHWAY 14. There were four fighting positions in the patrol (See Annex 4).

The first position was located furthest north and was equipped with an M-60 machinegun. SGT Mark Peterson was in charge of this team which consisted of himself, PFC Malvin Tomlin (Machinegunner) and PFC Raymond S. Cassidy. There was also a radio at this point.

The second position was located 30 - 40 meters southeast of the first position and consisted of 4 men, 3 of them being armed with M-16's and 1 man armed with an M-79. SP4 Bly was in charge of this position.

The third position consisted of 5 men, located approximately 40 meters southeast of the second position. SGT Marlow was in charge of this group and was armed with an M-16 rifle. The RTO for the patrol, PFC Fred Scerola was also at this point in addition to SGT Clarence Blackshear (M-16), PFC Tommy Amos (M-16 and Starlight Scope) and the M-79 grenadier, SP4 Thomas Hatcher. The 4th Position was located 40 meters southeast of the 3d position, very near the junction of HIGHWAY 14 and a small heavily traveled footpath.

The patrol was in position by 1920 hours, observing strict silence. Each fighting position remained on full alert throughout the night. On several occasions, the men thought they heard voices, however, it was hard to distinguish whether or not it was in fact voices or the wind, which was blowing at 20 to 30 knots. There was no actual contact until early the next morning.

At 0630 hours, SGT Routt, at Position 4, spotted 3 VC at the trail/road junction, beginning to cross the Highway. It was still quite dark at this time and visibility was poor, so rather than fire immediately at the indistinct figures, SGT Routt blew his claymore mine which was located at the base of the trail. Then, the entire patrol fired at the VC employing every weapon available. As it turned out, the VC were not detected earlier since the trip flare placed across the trail failed to function.

As it was now becoming light, the patrol members took up the pursuit of the VC, following the trail on the east side of HIGHWAY 14. The search disclosed one Chicom B-40, 3.5" rocket launcher and 2 hand grenades. The VC were not found, however, a significant blood trail was observed from the point of fire to 150 meters down the path where it vanished in a field of high grass. The patrol had by now ventured into a dense area, therefore it was decided to return to the Battalion CP rather than continue the pursuit.

The patrol met with only this one contact owing to the fact the H & I fires were landing within 200 meters of the site throughout the night, keeping enemy elements out of the area.

SITE II

Ambush Site II was located approximately 1400 meters south of Site I along HIGHWAY 14, directly north of the junction of the Highway and a small road running at a right angle (See Annex 4). Around 1900 hours, while enroute to the ambush site, the patrol noticed several people darting across the highway. Later they

CONFIDENTIAL

CONFIDENTIAL

AVBE-SC
SUBJECT: Small Unit Actions - 2/503d Infantry

25 February 1967

145

found an anti-tank mine which they disarmed on the spot. Shortly thereafter, a hole was discovered off to the side of the Highway where someone had made preparations for another AT mine. All indications were that the hole had been abandoned only minutes earlier, for the earth was freshly dug and an entrenching tool was left behind.

The patrol passed their predetermined ambush site, and then backtracked to the position as is often done to waylay the enemy into an ambush killing zone. They established 4 fighting positions and one Administrative position to the rear where Lieutenant Feedham, the Platoon Sergeant, Harold B. Rowell, a medic, Sp4 Ernest Hoover and PFC John Hayward, the RTO were located. A second radio was located at Position 1.

Between 2115 and 2130 hours, SP4 Leamon Perry and SP4 Joseph Caruso at Position 1 observed 2 VC heading in their direction. When inside the killing zone, Specialist Perry gave the word to open fire. Three minutes after the fire had ceased, a party of three volunteers, consisting of SGT Thompson, SP4 Caruso and PVT Williams advanced to check out the results.

They found no bodies on the Highway where they expected, so they elected to search the clearing on the other side of the road. The three men had covered approximately 50 meters when from out of the brush, one of the VC jumped out to assault. All three troopers opened fire at almost point blank range, killing the enemy instantly.

The VC's body was dragged onto the road where it could serve as a decoy for any others who might happen by. The three men then continued the search of the area where the VC were originally fired upon, discovering 8 bundles of personal items and several documents. They also found a .45 caliber pistol and an M3 type sub-machinegun.

There were no further contacts during the night, however, on one occasion, 3 or 4 hand grenades were received. The fire was returned with apparent negative results and no friendly casualties.

In the morning, the ambush patrols from both SITE I and SITE II linked up and conducted a search of the area. They discovered numerous bundles of personal items indicative that a great number of either Viet Cong or Refugees were moving through this area before the introduction of the 2d Battalion, 503d Infantry.

CONFIDENTIAL

CONFIDENTIAL

TAB E

ANNEXES TO TAB C & D

CONFIDENTIAL

ANNEX 1

NIGHT AMBUSH - 16 JAN 67
E/17th CAV

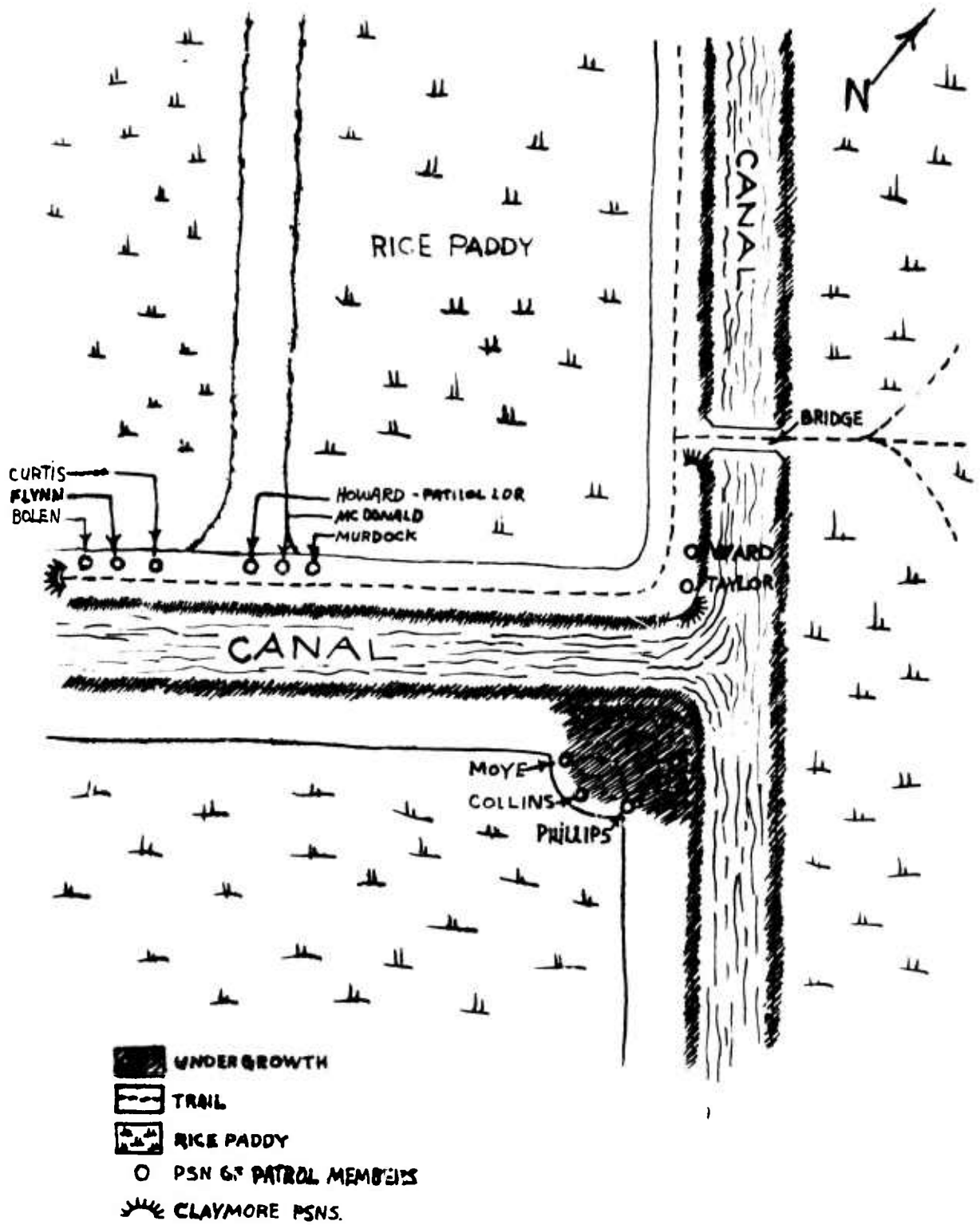





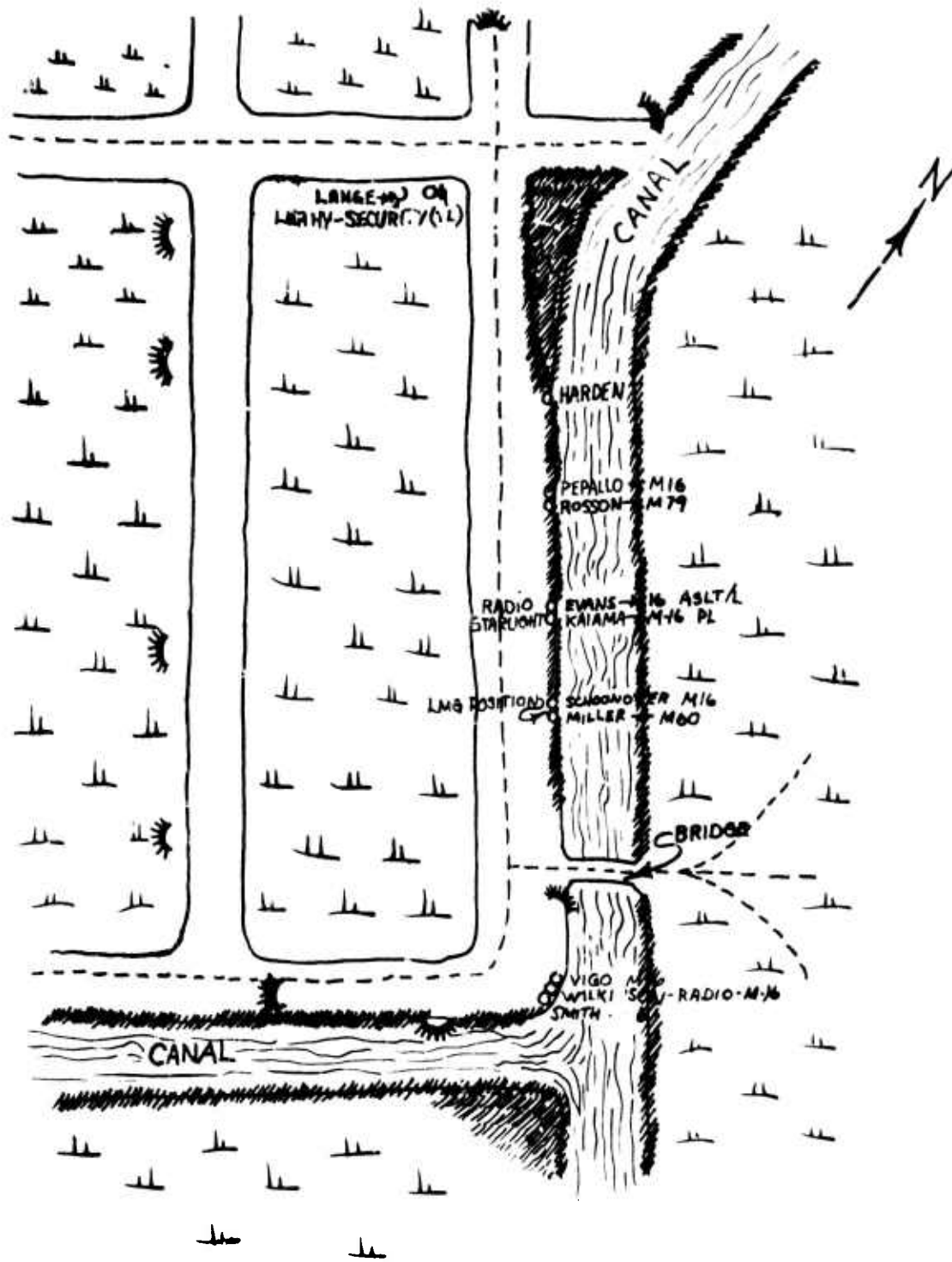

ANNEX 2

NIGHT AMBUSH - 17 JAN 67

E/17th CAV

150



-  - UNDERGROWTH
-  - TRAIL
-  - RICE PADDY
-  - PSN OF PATROL MEMBERS
-  - CLAYMORE PSN

ANNEX 3

POSITIONING OF 2/503 INF.

B/1/16TH INF.

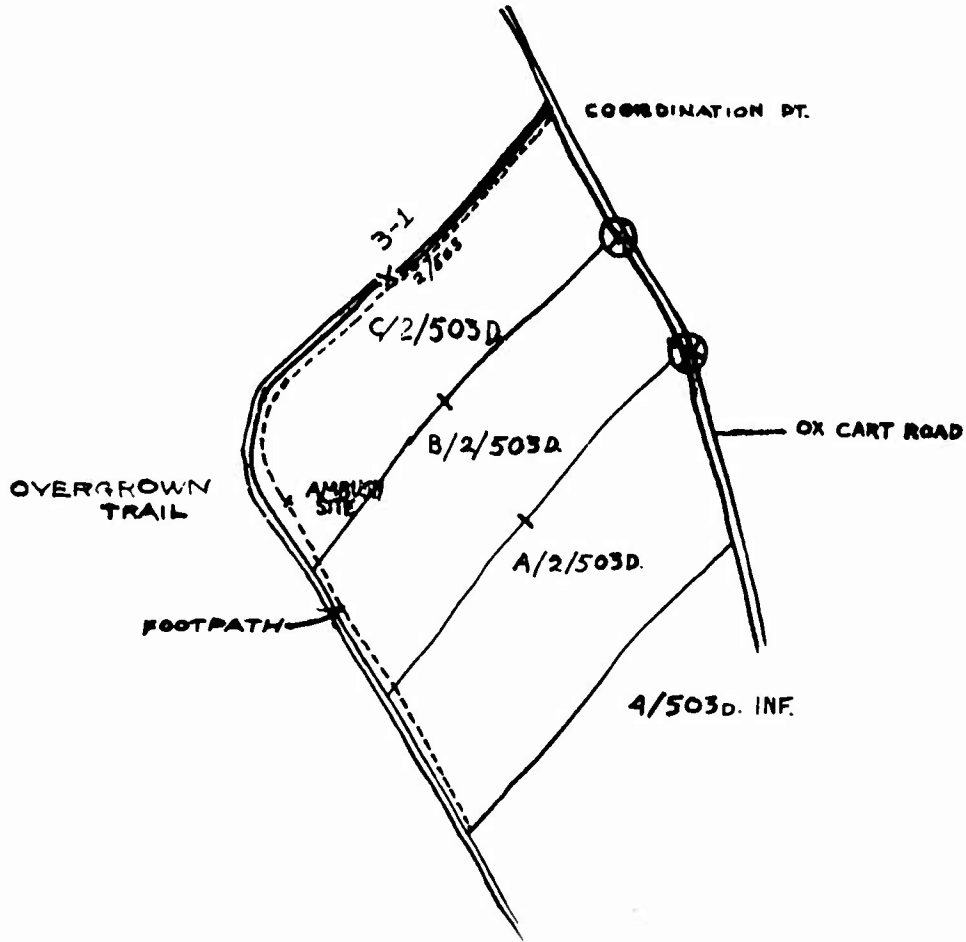

AMBUSH POSITIONS

9 JANUARY 67
C/2/503 INFANTRY

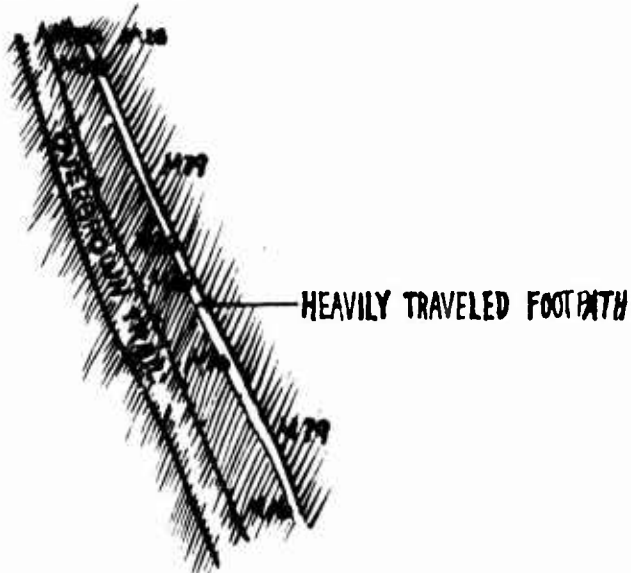

ANNEX 4

AMBUSH JANUARY 1967
SITE 1

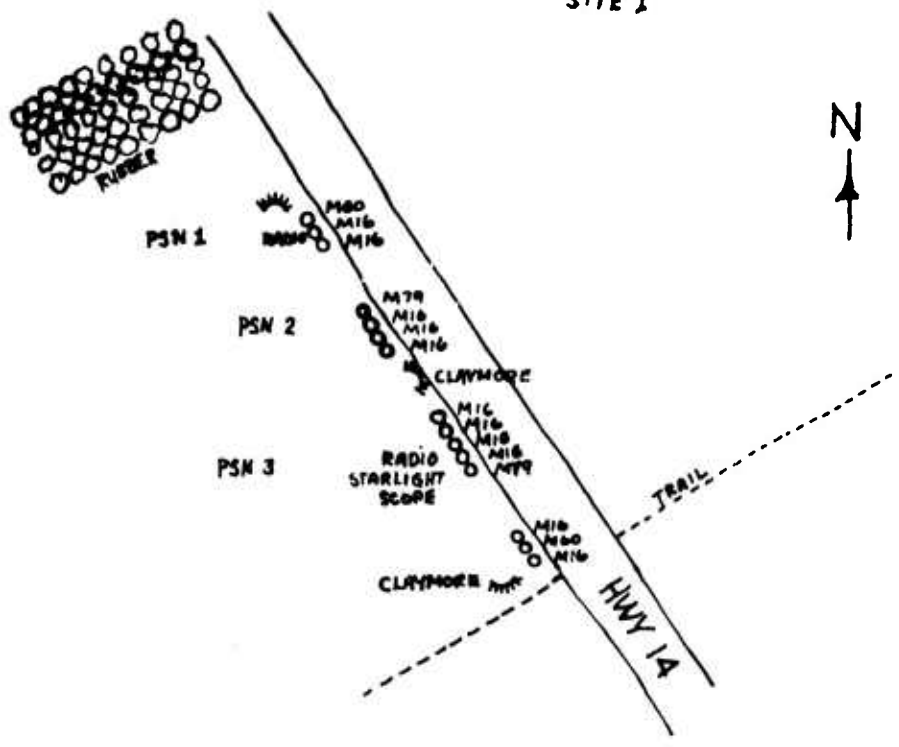

SITE 2

POSITION 1

- SP4 LAMON PERRY - TMLDR - M16
- SM JOSEPH CARUSO - M16
- POB J.B. LINDSEY - M79
- SSA THOMPSON - M16

POSITION 2

- PFC JAMES LONG - M16
- PVT WILLIE L. WILLIAMS - M16
- PVT ERNEST THOMPSON - M79

POSITION 3

- SM JAMES TODD - TMLDR - M16
- PFC JEROME B. ZERFASS - M60
- PFC RAYMOND DAUGHERTY - M16

POSITION 4

- SGT BILLY LATHAM - M16
- PFC TEDDY ROYBAL - M79
- DPC RICHARD CUNNINGHAM - M16

ADMIN PSN

- LT FEEDHAM - PIT LDR
- SSA HAROLD B. ROSWELL - PIT SGT
- PFC JOHN HAYWARD - RTO

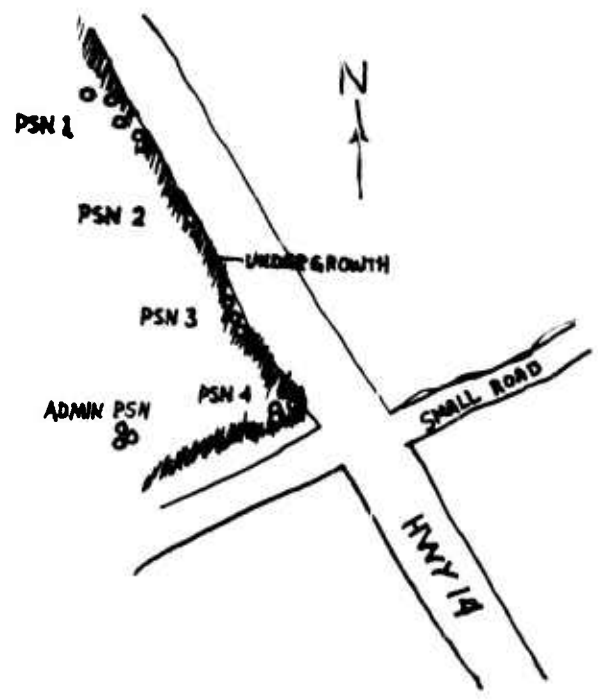

CONFIDENTIAL

TAB F

TUNNEL COMPLEX DRAWINGS

CONFIDENTIAL

TUNNEL COMPLEX

SIDE VIEW

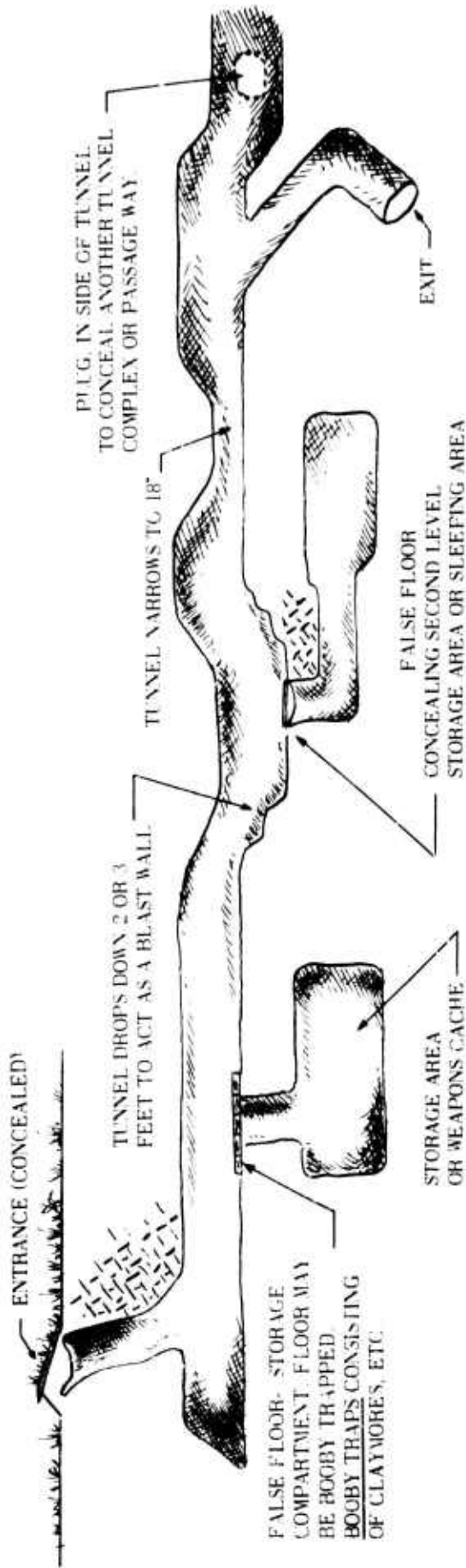

CONFIDENTIAL

CONFIDENTIAL

TUNNEL COMPLEX

TOP VIEW

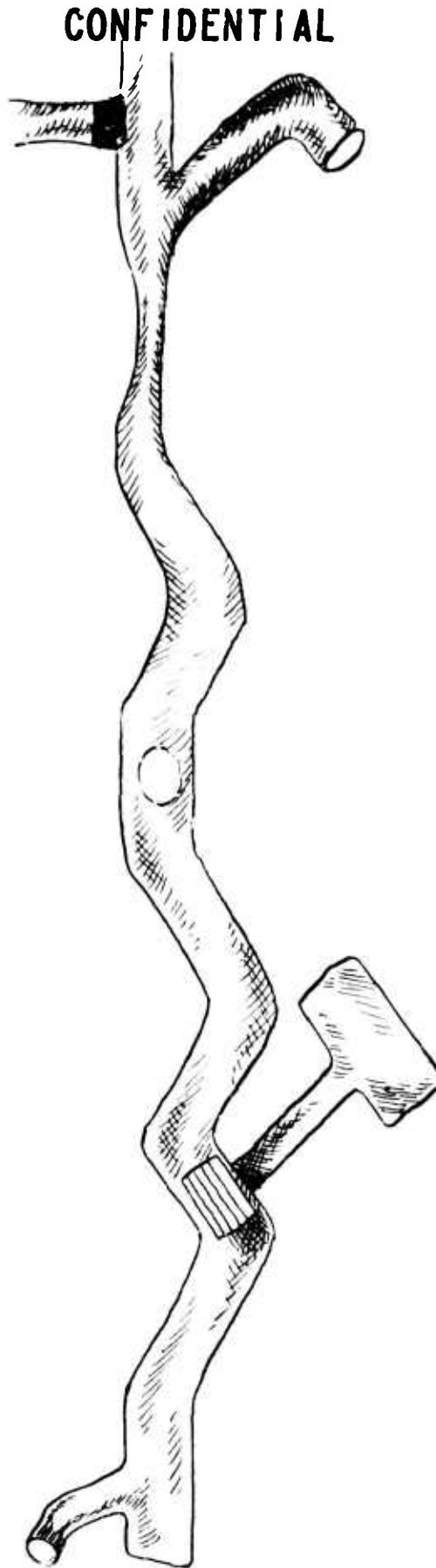

CONFIDENTIAL

156

CONFIDENTIAL

TUNNEL COMPLEX TYPICAL VILLAGE ESCAPE TUNNELS

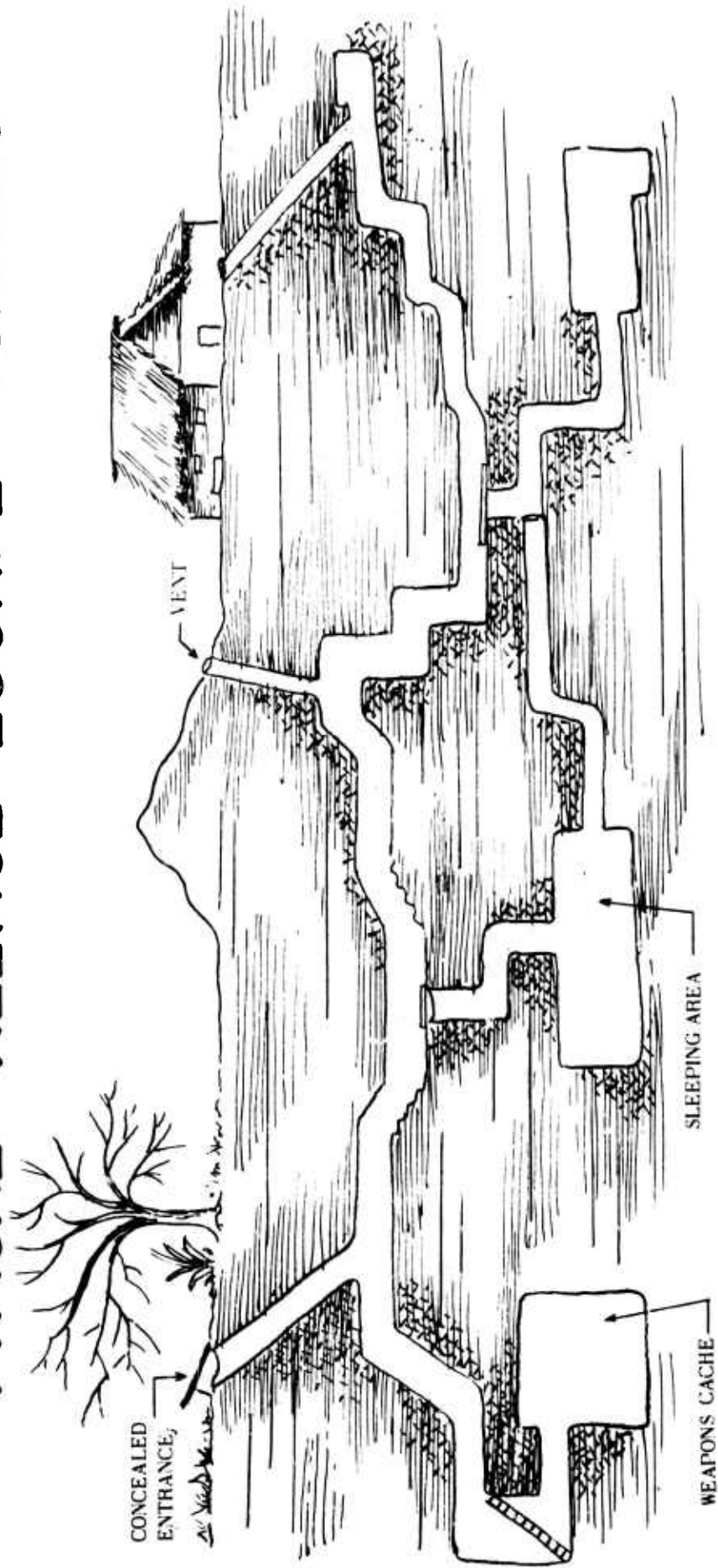

TUNNEL COMPLEX

TYPICAL VILLAGE ESCAPE TUNNELS

CONFIDENTIAL

158

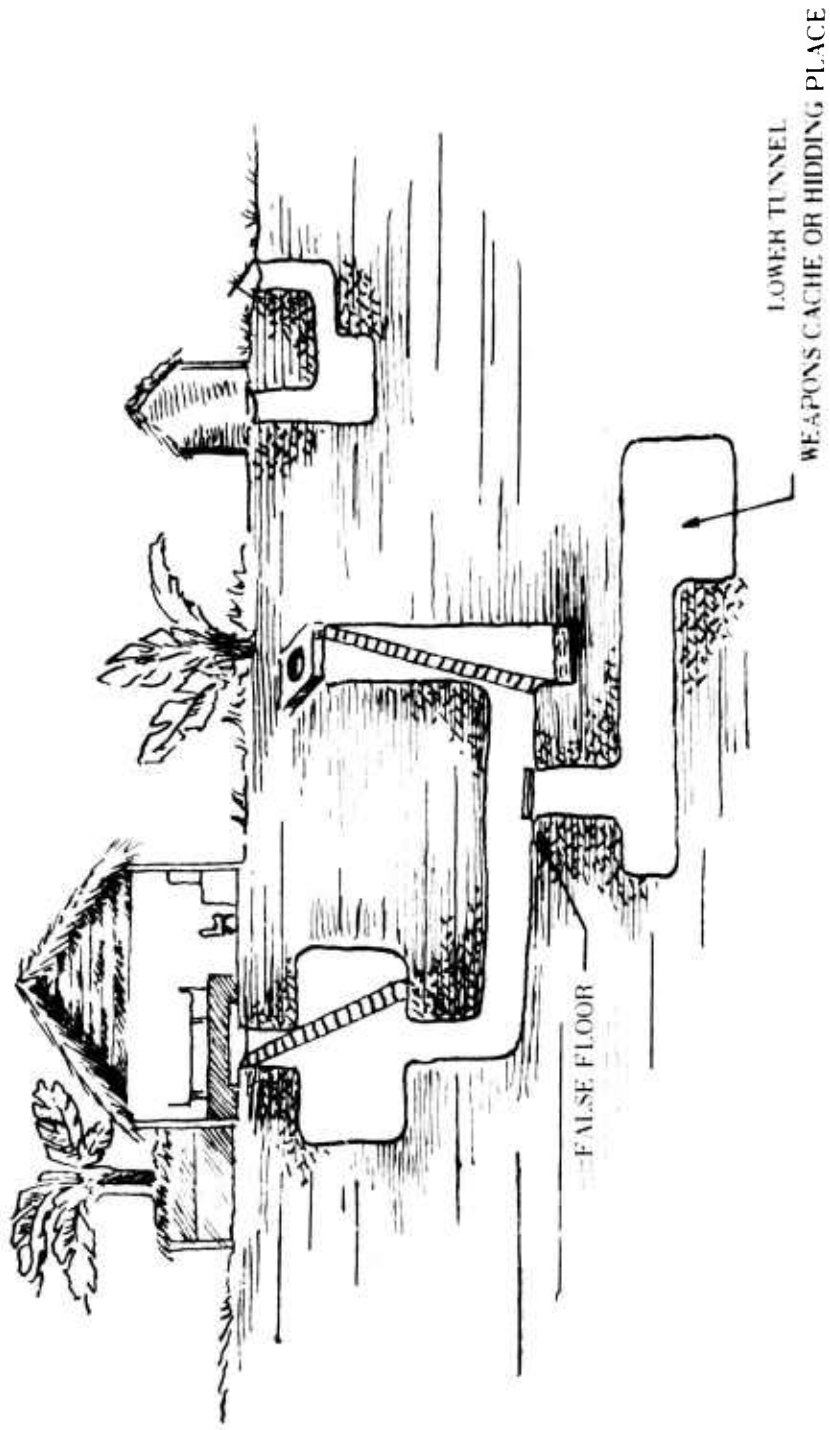

CONFIDENTIAL

CONFIDENTIAL

FALSE FLOOR.
FREQUENTLY BOOBY TRAPPED
WASH PANS FILLED WITH DIRT,
MOSTLY MADE OF WOOD.

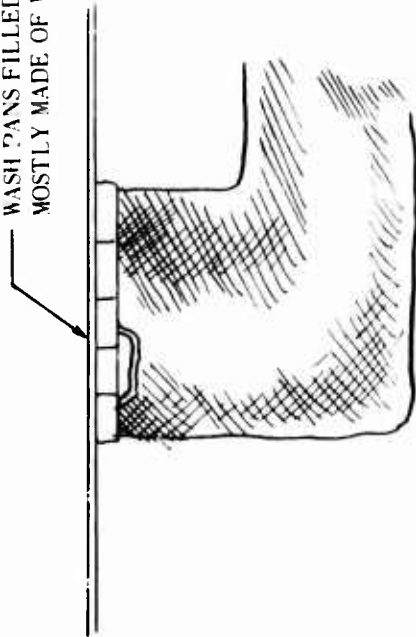

PLUG, MADE FROM
WEED, OR TREE STUMP,
MADE TO FIT TIGHTLY
IN HOLE. ROPE ON END
IS TO PULL IT OUT

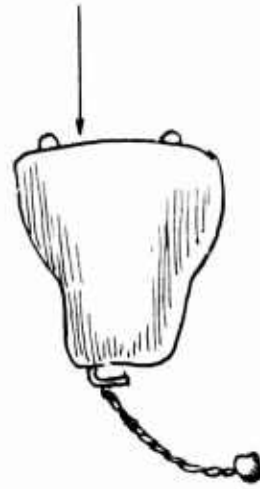

PLUG IN SIDE OF
TUNNEL GENERALLY LEADS
TO ANOTHER TUNNEL OR
STORAGE ROOM

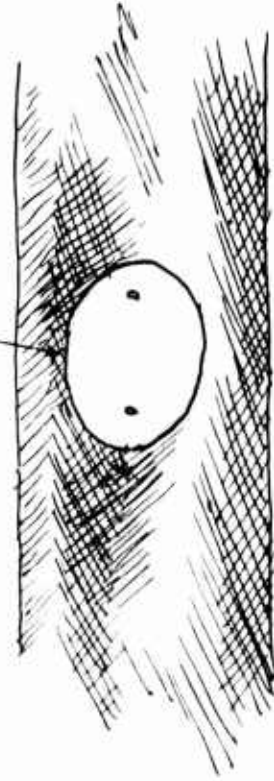

CONFIDENTIAL

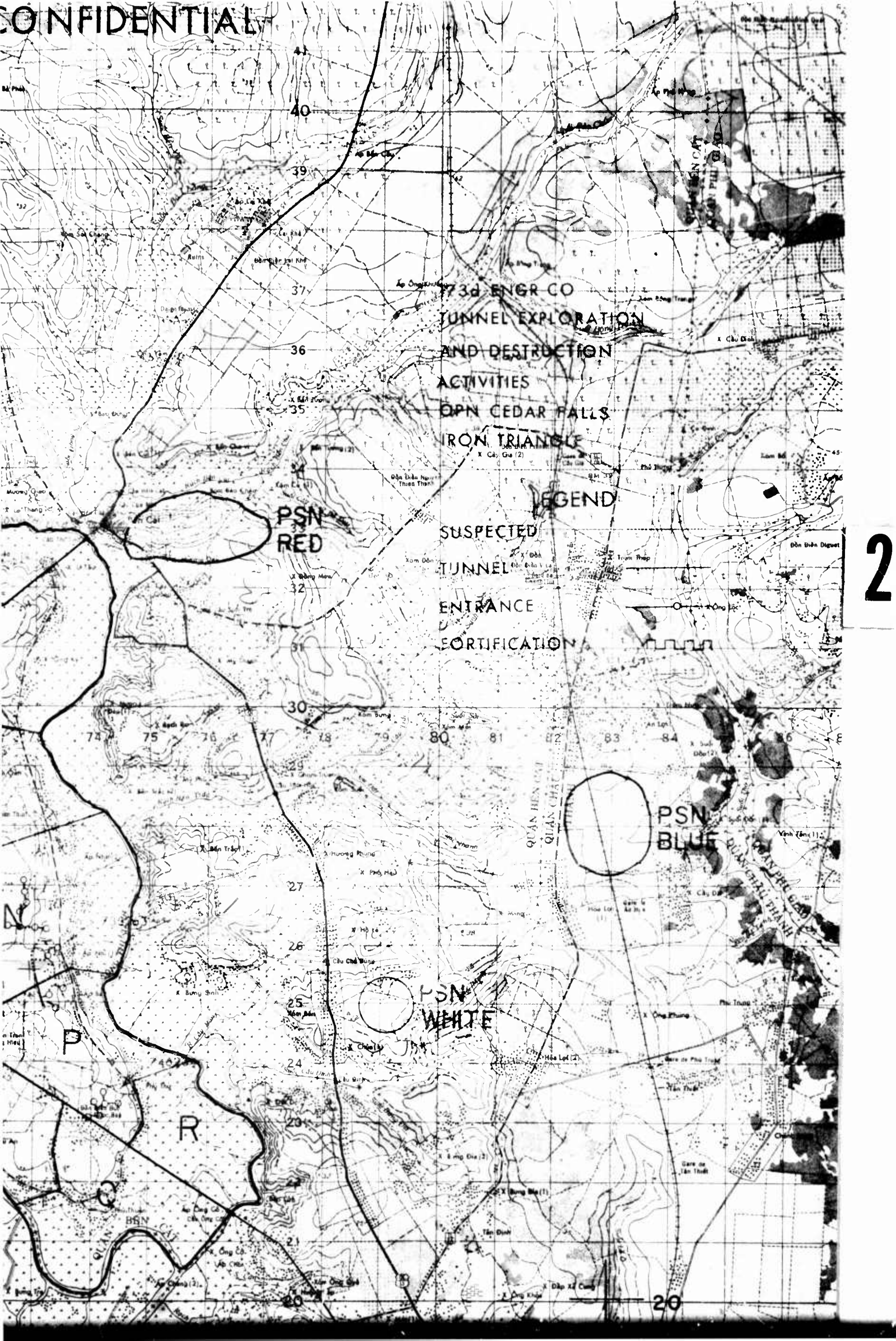

73d ENGR CO
TUNNEL EXPLORATION
AND DESTRUCTION
ACTIVITIES
OPN CEDAR FALLS
IRON TRIANGLE

LEGEND

SUSPECTED
TUNNEL
ENTRANCE
FORTIFICATION

PSN
RED

PSN
BLUE

PSN
WHITE

2

3

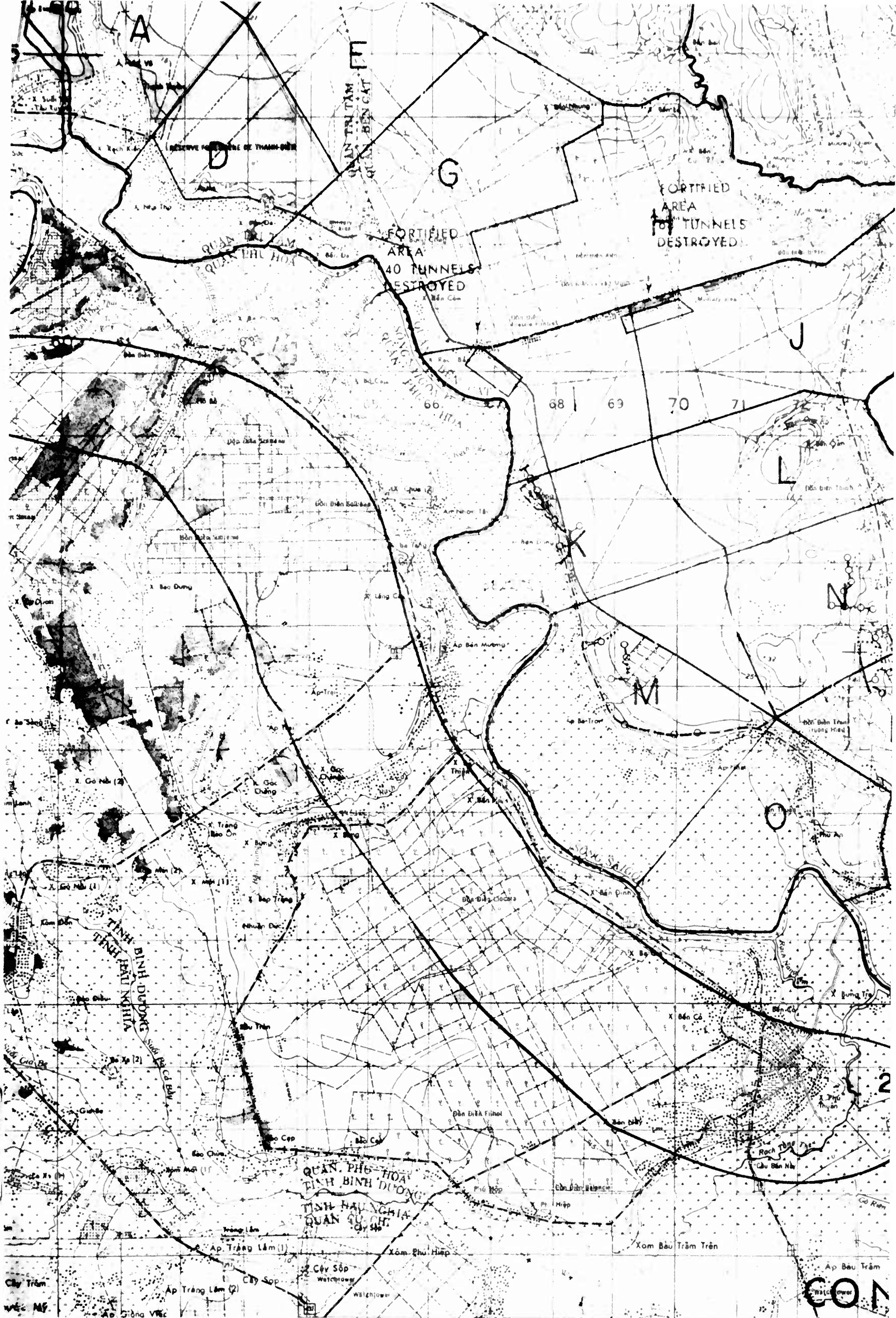

CON

OPEN CEDAR HILLS
IRON TRIANGLE

PSN
RED

LEGEND

SUSPECTED
TUNNEL
ENTRANCE
FORTIFICATION

PSN
BLUE

PSN
WHITE

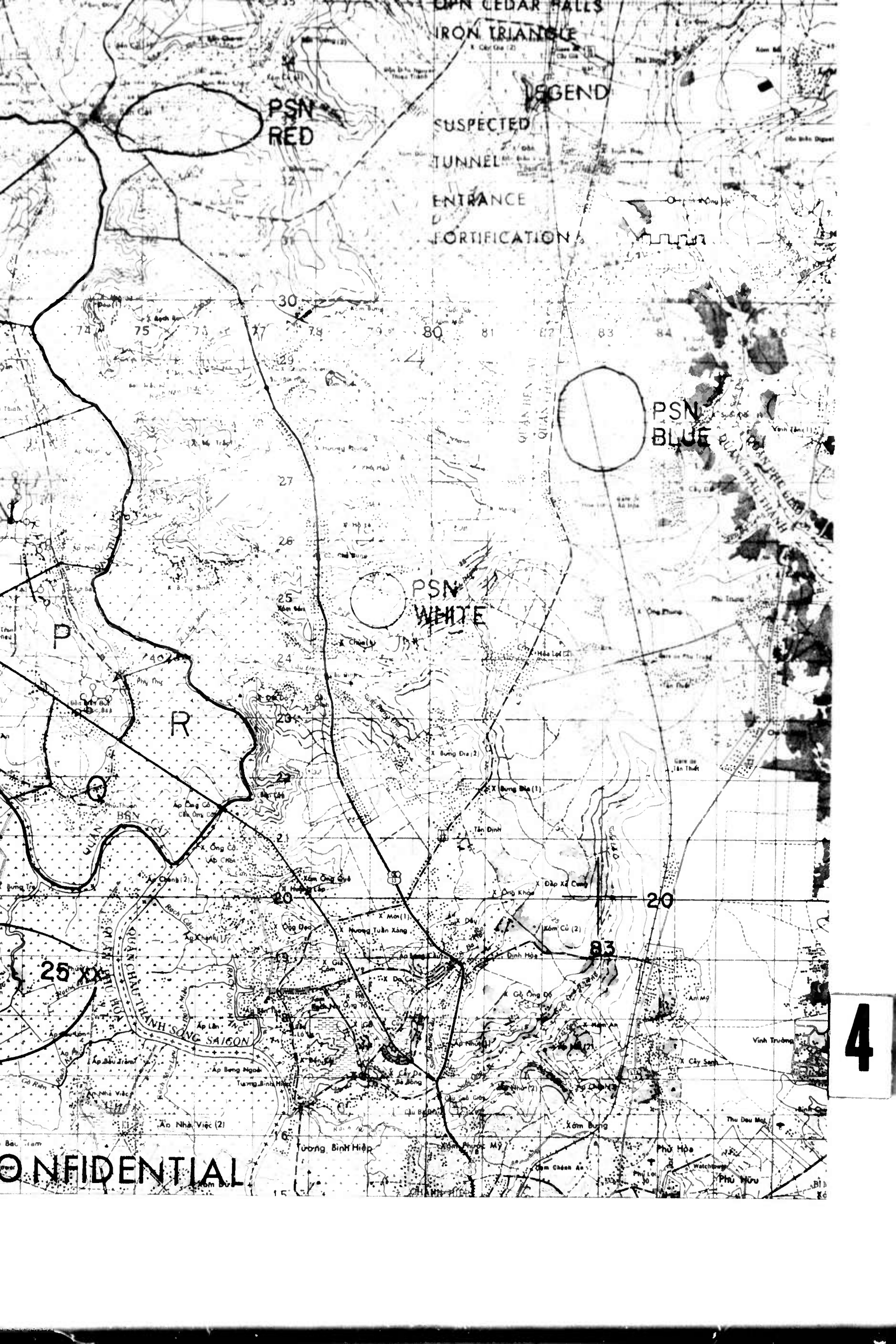

4

CONFIDENTIAL

CONFIDENTIAL

T.B G
PHOTOGRAPHS OF
DI RALLIERS, COMBAT OPERATIONS, ETC.
and
PSY OPS MESSAGES

CONFIDENTIAL

CONFIDENTIALChieu Hoi Aids Paratroopers

A "Chieu Hoi" Returnee who volunteered to help the paratroopers encourage VC to take advantage of the amnesty broadcast his appeal during Operation CEDAR FALLS. He and his brother, both former VC, reunited under the amnest program, voluntarily aided the Americans and were directly or indirectly responsible for the return of 35 Viet Cong to the Government cause during the Operations in the IRON TRIANGLE.

**CONFIDENTIAL**

CONFIDENTIAL

166

The Long Grey Line

Four former Viet Cong walk through the thick jungle just minutes after they emerged from a tunnel and turned themselves over to the American Paratroopers of the 173d Airborne Brigade (Separate). The three women and one man surrendered under the Government of South Vietnam's amnesty program of "Chieu Hoi" or "Open Arms".



CONFIDENTIAL

CONFIDENTIAL

169

"Chieu Hoi"

A former Viet Cong turned "Chieu Hoi" takes advantage of an offer of clean clothes, soap and water from paratroopers of the 173d Airborne Brigade (Separate). The Vietnamese man emerged from a tunnel and turned himself in to the Americans under the South Vietnamese Government's amnesty program of "Open Arms". He then volunteered to lead the paratroopers to a supply cache hidden deep within a tunnel complex in the IRON TRIANGLE during Operation CEDAR FALLS.



CONFIDENTIAL

CONFIDENTIAL

168

"Come Out"

A Chieu Hoi calls for his comrades to come out of their tunnel. The Viet Cong turned himself in to the 173d Airborne Brigade (Separate) under the "Chieu Hoi" policy. The smoke is used to locate air vents and other entrances to the intricate tunnel systems.



CONFIDENTIAL

CONFIDENTIAL

FRONT AND BACK

SAFE CONDUCT PASS WRITTEN IN THEIR LANGUAGES, (VIETNAMESE, ENGLISH, AND KOREAN)

ĐÂY TẤM GIẤY THÔNG HÀNH CÓ GIÁ TRỊ VỚI TẤT CẢ CƠ-QUAN
 QUÂN CHÍNH VIỆT-NAM CỘNG-HÒA VÀ LỰC-LƯỢNG ĐỒNG-MINH.
 SAFE-CONDUCT PASS TO BE HONORED BY ALL VIETNAMESE GOVERNMENT AGENCIES AND ALLIED FORCES
 이 안전보장패스는 월남정부와 모든 연합군에 의해 인정된 것입니다.



SAFE-CONDUCT PASS TO BE HONORED BY ALL VIETNAMESE GOVERNMENT AGENCIES AND ALLIED FORCES



Đây là một tấm Giấy
 Thông Hành có giá trị
 với tất cả cơ quan Quân
 Chính Việt-Nam Cộng-
 Hòa và lực lượng Đồng-
 Minh.

NO 274986 GS

이 안전보장패스는 월남정부와 모든 연합군에 의해 인정된 것입니다.

CONFIDENTIAL

CONFIDENTIAL

FRONT

THE MOTHERS AND WIVES WHO HAVE CHILDREN AND HUSBANDS AT THE VC. KEEPING THESE PASSES ISSUED BY THE GOVERNMENT WITH PICTURES ON THEM LIKE THIS LEAFLET. EACH PASS IS A DOCUMENT OF THE GOVERNMENT, EACH PASS HAD A REFERENCE NUMBER. THESE PASSES ARE GOOD FOR THE VIET CONG WHEN THEY WANT TO RETURN TO THE GVN, KEEP THESE PASSES TO SAVE YOUR CHILDREN AND YOUR HUSBANDS OR YOUR COUSIN'S LIFE. THESE SMALL PASSES ARE BETTER THAN GOLD BECAUSE THEY CAN SAVE YOUR COUSIN'S LIFE.

170

BACK

THESE PASSES ARE BETTER THAN GOLD BECAUSE THEY CAN SAVE YOUR COUSIN'S LIFE.

NHÃN GỠI CÁC BÀ MẸ VÀ VỢ CÓ CHỒNG TRONG HÀNG NGŨ VIỆT-CỘNG

Hãy cất những tờ giấy thông hành do Chính-phủ phân phát có những tấm hình như trong tờ truyền đơn này. Mỗi một tờ thông hành là tài liệu chính thức của Chính-phủ. Mỗi tờ được đánh số và chính-thức ghi vào số. Những tờ giấy thông hành này sẽ có giá trị cho những cán-bộ Việt-Cộng khi muốn dùng để trở về phía Chính-phủ Quốc-gia. Hãy cất giấu thật nhiều giấy thông hành để cứu chồng, con hoặc bạn bè nữa các bà muốn cứu sanh-mạng của họ. Hãy đưa cho họ, khi họ về nhà thăm viếng. Nếu có thể hãy cầm đến cho họ. Những tờ giấy thông hành bé nhỏ này có giá trị hơn vàng vì mỗi tờ có thể cứu được sanh-mạng của những người thân yêu.

SP-95:



CONFIDENTIAL

CONFIDENTIAL**FRONT**

WE COME AS FRIENDS, WE ARE A MEMBER OF THE US FORCES WHO HAVE COME TO VIETNAM TO HELP YOU DEFEAT THE VC AWAY FROM YOUR COUNTRY. WE WANT TO HELP YOU HAVE A BETTER WAY OF LIFE AND THE VC CAN NOT THREATEN YOU. YOU MUST HELP US TO GET INFORMATION ABOUT THE VIET CONG.

BACK

WE ARE THE 173D AIRBORNE BRIGADE SOLDIERS. WE AND THE ARVN FORCES HAVE THE ACTIVITY IN THIS AREA, WITH ALLIED FORCES TO DESTROY THE VC AND THEIR BASE CAMPS. WHEN OUR UNIT IS DESTROYING THE VC FORCES THE OTHER UNITS WILL HELP YOU REBUILD YOUR VILLAGE.



Chúng tôi tới đây là những người bạn. Chúng tôi là một phần của Lực Lượng Hoa Kỳ tới Việt Nam để giúp đỡ các bạn chiến thắng bọn Cộng Sản xâm lăng xứ sở của các bạn. Chúng tôi muốn được giúp đỡ các bạn để có một đời sống tốt đẹp hơn và không bị Việt Cộng khủng bố. Xin các bạn hãy giúp đỡ chúng tôi biết những tin tức về Việt Cộng.



Chúng tôi là binh sĩ thuộc Lữ Đoàn 173 Nhảy Dù Hoa Kỳ. Đơn vị chúng tôi hiện đang hoạt động với các đơn vị thuộc Quân Lực Việt Nam Cộng Hòa và Đồng Minh trong vùng này để tiêu diệt Việt Cộng và các căn cứ của chúng. Trong khi đơn vị chúng tôi tiêu trừ Việt Cộng thì các đơn vị khác lo kiến thiết để giúp đỡ các bạn.

CONFIDENTIAL

CONFIDENTIAL

FRONT

172

THESE ARE THE DIRECTIONS ON HOW TO RETURN TO THE GOVERNMENT.

1. TAKE ONE PASS OF GVN AND KEEP IT WITH YOU UNTIL YOU HAVE A CHANCE TO RETURN TO THE GVN.
2. WHEN YOU ARE WAITING FOR A CHANCE TO RETURN, DO NOT LET THE VC KNOW YOUR IDEA.
3. WHEN YOU HAVE A CHANCE TO ESCAPE AT NIGHT, YOU MUST FIND A PLACE TO HIDE AND REPORT TO A GOVERNMENT SERVICEMAN DURING THE HOURS OF DAYLIGHT. HIDING YOUR WEAPON BEFORE YOU REPORT. AFTER YOU HAVE REPORTED AND HAVE SHOWN THE SERVICEMAN WHERE YOU HAVE HIDDEN YOUR WEAPON YOU GET THE MONEY.
4. WHEN YOU HAVE A CHANCE TO ESCAPE, DO SO RIGHT AWAY AND GO BACK TO YOUR FAMILY.
5. KEEP THE PASS ON YOU AT ALL TIMES WHILE WAITING FOR A CHANCE TO ESCAPE OR WHEN SOMEBODY CAPTURES YOU, YOU COULD SHOW THEM THAT PASS AND EXPLAIN TO THEM YOU WERE GOING TO RETURN TO THE GVN BUT DID NOT HAVE A CHANCE.
6. DAYTIME OR NIGHT TIME BUT YOU HAVE THE PASS, WE WELCOME YOU.

BACK

ATTENTION VC

GVN WILL PAY AND HELP YOU WHEN YOU COME BACK.

24 \$VN for rice per day.

24 \$VN for your wife.

12 \$VN for each child.

and some for the other things and we pay for weapons you bring back.

CÙNG CÁC BẠN TRONG HÀNG NGŨ VIỆT CỘNG

Chính Phủ VNCH sẽ thưởng vũ khí giúp
đồ khi bạn trở về.

- * 24* tiền cơm mỗi ngày
- * 24* mỗi ngày cho vợ bạn
- * 12* cho mỗi đứa con của bạn
- * Sẽ thêm các Khoản Khác

Những KHÍ GIỚI bạn mang về
sẽ được thưởng tùy theo loại.

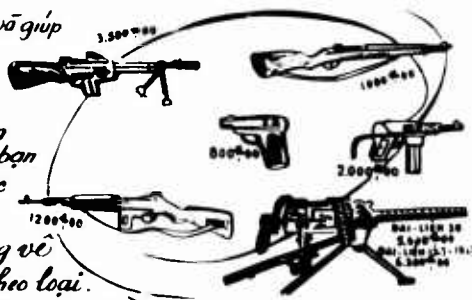

CÙNG CÁC BẠN TRONG HÀNG NGŨ VIỆT CỘNG



Đây là những lời khuyên cần thiết để giúp bạn trở về với Chính Nghĩa Quốc gia

- 1/ Hãy lấy một tờ thông hành của Chính Phủ Quốc Gia và giữ cẩn thận để chờ cơ hội trở về
- 2/ Trong lúc kiên nhẫn chờ một cơ hội tốt, cố tỏ ra trung thành với bạn Việt Cộng để tránh mọi sự nghi ngờ của bạn chúng
- 3/ Khi có dịp là trốn ngay trở về với gia đình
- 4/ Nếu bạn chỉ có thể trốn đi ban đêm, hãy tìm một nơi để ẩn mình. Hãy đến trình diện với Chính quyền vào ban ngày. Đấu vũ khí một chỗ trước khi ra trình diện. Sau khi trình diện bạn có thể chờ cho Chính quyền chế độ bạn đấu khí giới để lãnh thưởng
- 5/ Luôn luôn dấu kỹ tờ thông hành trong người bạn để khi bắt ngờ gặp dịp có thể trở về với Chính Nghĩa hoặc thỉnh linh bị bắt bạn có thể chứng minh là bạn có thiện chí trở về với gia đình và Chính Nghĩa Quốc Gia
- 6/ Bất luận trong trường hợp nào, ngày cũng như đêm nếu có tờ thông hành là có thể được tiếp đón như một người bạn

SP 951A

CONFIDENTIAL

CONFIDENTIAL**FRONT**

WHEN YOU RETURN TO THE GVN, THE GVN GUARANTEES YOU A WARM WELCOM, YOU WILL BE ABLE TO RETURN TO YOUR FAMILY. IF YOU OR YOUR FAMILY NEED MEDICAL CARE OR OTHER HELP THE GVN WILL GIVE YOU A SPECIAL HELP. YOU WILL HAVE MONEY FROM 800 \$VN to 20,000 \$VN DEPENDING UPON THE WEAPONS YOU BRING BACK WITH YOU.

BACK

YOU MUST DO THIS TO RETURN TO THE GOVERNMENT SIDE. YOU CAN REPORT TO ANY GVN SERVICEMAN OR AN ARVN OUTPOST. YOU ALSO CAN REPORT TO AN ARVN SOLDIER OR AN ALLIED FORCES SERVICEMAN, THEY WILL WELCOME YOU.

YOU MUST FOLLOW THE FOLLOWING DIRECTIONS FOR YOUR SAFETY:

1. HIDE YOUR WEAPON BEFORE YOU REPORT, AFTER THAT YOU SHOW ARVN SOLDIERS THE LOCATION OF YOUR WEAPON TO GET YOUR REWARD.
2. YOU ALSO CAN RETURN TO AN ALLIED FORCES SERVICEMAN, IT IS BETTER FOR YOU TO COME DURING THE DAYTIME, PUT YOUR HANDS ON YOUR HEAD, IF YOU HAVE THE PASS OR A LEAFLET THEN SHOW THEM.
3. YOU CAN ALSO RETURN WITHOUT A PASS OR LEAFLET, YOU ONLY NEED TO PUT YOUR HANDS ON YOUR HEAD. LET ARVN SOLDIERS OR THE ALLIED FORCES SERVICEMAN KNOW THAT YOU WANT TO RETURN TO THE GVN.



CÙNG CÁC BẠN TRONG HÀNG NGŨ VIỆT CỘNG

Khi các bạn trở về với Chính Nghĩa Quốc-Gia, Chính Phủ Việt Nam Cộng Hòa cam kết sẽ tiếp đón các bạn một cách nồng hậu, và sẽ đổi xử tử tế. Bạn sẽ được trở về đoàn tụ với gia-đình. Nếu bạn và gia đình cần thuốc men hay một sự trợ giúp nào khác Chính Phủ sẽ đặc biệt giúp đỡ. Các bạn sẽ được lãnh thưởng từ 800 đến 20 ngàn đồng tùy theo loại vũ khí bạn mang về.

SP-1389

Hãy theo những lời chỉ dẫn sau đây để trở về với hàng ngũ Quốc Gia. Bạn có thể đến tiếp xúc với một viên chức hay 1 đơn vị Chính Phủ Việt Nam Cộng Hòa. Bạn cũng có thể liên lạc với binh sĩ Chính Phủ Việt Nam Cộng Hòa hay Đồng Minh. Họ sẽ sẵn sàng đón tiếp bạn.

Trong mọi trường hợp, vì lý do an ninh, bạn nên theo những lời chỉ dẫn sau đây:

1. Giấu vũ khí một chỗ. Ra trình diện, sau sẽ dẫn binh sĩ Chính Phủ Việt Nam Cộng Hòa trở lại chỗ giấu để lãnh thưởng.
2. Khi đến tiếp xúc tại một đơn vị hay với một viên chức có vũ trang, nên đến ban ngày, nên giơ tay lên để tỏ thiện chí của bạn. Nếu có giấy thông hành hay truyền đơn của Chính Phủ Quốc Gia hãy xuất trình.
3. Nếu không có truyền đơn bạn vẫn có thể trở về với Chính Phủ Quốc Gia. Bạn chỉ cần đưa hai tay lên giúp binh sĩ Chính Phủ Việt Nam Cộng Hòa và Đồng Minh hiểu rõ ý muốn trở về của bạn.

CONFIDENTIAL

CONFIDENTIAL

FRONT

THE VC HAS BEEN REDUCED TO FORCEFUL TAXATION IN ORDER TO EXIST . . . DESPARATE
FOR FOOD AND MONEY THEY NOW HAVE TO RESORT TO TAKING FOOD FROM YOUR FAMILIES . . .
YOU AND YOUR CHILDREN MUST SUFFER . . . PROTECT YOUR LOVED ONES . . . NOTIFY A ONCE,
YOUR NEAREST GVN OR ALLIED OFFICIAL OF ANY ATTEMPTED TAXATION BY THE VC.

BACK

ILLUSTRATION OF GIANT VC BEING FED BY PEASANTS, (ROBBERY)

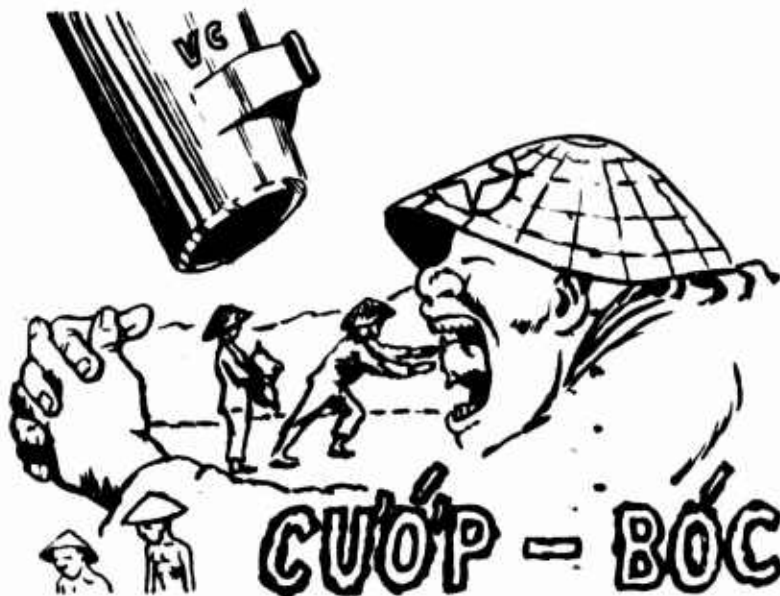

ĐỒNG BÀO CHÚ - Ý ! ĐỒNG BÀO CHÚ - Ý !

Để tồn tại, bọn Việt Cộng đã phải cưỡng bách đồng bào đóng thuế cho chúng. . . . Vì QUÁ CẦN đến lương thực và tiền, chúng đã phải cướp bóc lương thực của đồng bào. . . . ĐỒNG BÀO VÀ GIA ĐÌNH PHẢI CHỊU CỐ CỤC. Để bảo vệ chính quyền lợi của đồng bào, đồng bào hãy thông báo ngay cho các cơ quan chính quyền địa phương hoặc lực lượng Đồng Minh gần nhất biết ngay khi Việt Cộng đến cướp đoạt lúa gạo hay tiền bạc của đồng bào.

246 334

CONFIDENTIAL

CONFIDENTIAL

FRONT

YOUR FAMILIES NEED YOU, THEY WORRY ABOUT YOUR HEALTH. THEY KNOW YOU WILL DIE IF YOU DO NOT BELIEVE THEM. GOVERNMENT IS HOPING FOR YOUR RETURN TOO. REPORTING TO THE NEAREST ARVN OUTPOST OR GOVERNMENT SERVICEMAN. WE WILL WELCOME YOU. WE HELP YOU AND YOUR FAMILIES TOO, WHEN YOU RETURN TO THE GVN. DON'T BE LATE, RETURN RIGHT NOW!

BACK

LETS GO BACK TO YOUR FAMILY.

THEY MISS YOU AND NEED YOU.

CÁC BẠN VIỆT-CÔNG - HÃY TRỞ VỀ !

Gia-đình bạn đang cần bạn. Họ lo cho sức khoẻ và hạnh phúc của bạn. Họ biết rằng các bạn sẽ chết nếu không nghe lời kêu gọi của họ. Chính phủ cũng ước mong bạn trở về. Hãy liên lạc với binh-sĩ Cộng-Hoà và chính-quyền nơi gần nhất. Bạn sẽ được đối xử tử tế. Bạn và cả gia-đình sẽ được giúp đỡ ngay khi bạn trở về với Chính-nghĩa Quốc-Gia. SP-007

ĐỪNG TRÌ HOÃN NỮA . VỀ NGAY ĐI !!

Hãy trở về với gia đình !
Họ đang nhớ thương và cần đến bạn

CONFIDENTIAL

CONFIDENTIAL

FRONT

176

EVERYTIME YOUR FAMILY IS READY FOR DINNER THEY MISS YOU, THEY KNEW YOU HAD A LOT OF HARD TIMES AND DON'T KNOW HOW YOU ARE. MISSION A SON IN THE FAMILY. THEY FEEL VERY LONELY. WE SENT THIS BY BIRTH, BY WAITING AND HOPING IT WILL COME TO YOUR HANDS, AND HOPING YOU WILL RETURN TO THE GOVERNMENT TO LIVE WITH YOUR FAMILY.

BACK

PICTURE

NHÃN GỎI ANH CÁN-BINH TRONG HÀNG NGŨ VIỆT CỘNG

Mỗi lần quây quần quanh chiếc bàn ăn, gia-đình lại bồi hồi thương nhớ. Nhớ đến anh đã từng chịu nhiều khổ cực và hiện giờ không biết anh ra sao. Thiếu người trai cột-trụ, gia-đình cảm thấy hiu-quạnh hơn bao giờ hết.

Nhấn chim, nhấn gió, nhấn mây, mong rằng thư này đến tận tay anh, để anh sớm về đoàn-tụ cùng gia-đình theo Chánh-sách Chiêu-Hồi của Chính-Pủ V. N. C. H.

SP-952



CONFIDENTIAL

CONFIDENTIAL

FRONT

VC YOU WILL DIE!

THE SKY SOLDIERS OF THE 173D AIRBORNE BRIGADE COME FROM THE SKY TO DESTROY YOU. WE WILL KILL HUNDREDS OF VC, YOUR FRIENDS BY BOMBS, BY ARTILLERY, AND BY THE GOOD FIGHTING INFANTRYMAN. IF YOU WANT TO SAVE YOUR LIFE, COME BACK TO THE GVN. IF NOT, YOU WILL DIE A USELESS DEATH, YOUR BODY WILL BE THROWN INTO THE JUNGLE, NOBODY WILL KNOW WHERE YOU ARE. DON'T BE LATE, RALLY RIGHT NOW.

BACK

VC YOU WILL DIE!

THE SKY SOLDIERS OF THE 173D AIRBORNE BRIGADE COME FROM THE SKY TO DESTROY YOU. WE WILL KILL HUNDREDS OF VC, YOUR FRIENDS BY BOMBS, BY ARTILLERY AND BY THE GOOD FIGHTING INFANTRYMAN. IF YOU WANT TO SAVE YOUR LIFE, COME BACK TO THE GOVERNMENT SIDE. YOUR FAMILY AND YOUR COUSINS ARE WAITING FOR YOU. YOU SHOULD RALLY NOW TO HAVE A GOOD LIFE WITH YOUR FAMILY OR DO YOU WANT TO EVER SEE THEM AGAIN?



CÁN BINH V. C. CÁI CHẾT SẼ ĐẾN VỚI CÁC BẠN:
CÁC CHIẾN SĨ THIÊN CHIẾN CỦA LỬ ĐOÀN 173 NHẢY
DÙ HOA KỲ XUẤT HIỆN TỪ TRÊN TRỜI ĐỂ TIÊU DIỆT
CÁC BẠN. CHÚNG TÔI ĐÃ TIÊU DIỆT HÀNG TRĂM
ĐỒNG CHÍ CỦA CÁC BẠN BẰNG BOM, HỎA LỰC PHẠO,
BÍNH, VÀ LỰC LƯỢNG BỘ BINH THIÊN CHIẾN. MUỐN
SỐNG SỐT, CÁC BẠN HÃY RA QUY CHÁNH VỚI CHÁNH
NGHĨA QUỐC GIẢ, NẾU KHÔNG, CÁC BẠN SẼ CHẾT
MỘT CÁCH VÔ ÍCH, THÂN THỂ CÁC BẠN SẼ BỊ Vùi-
LẤP TRONG NÂM MỎ VÔ CHỦ, MỖI ĐỪNG SẦU.
ĐỪNG ĐỂ TRỄ HƠN NỮA, RALLY CHỖ ANH NGAY ĐI
CÁC BẠN !!

P-2

CÁN BINH V. C. CÁI CHẾT SẼ ĐẾN VỚI CÁC BẠN:
CÁC CHIẾN SĨ THIÊN CHIẾN CỦA LỬ ĐOÀN 173 NHẢY
DÙ HOA KỲ XUẤT HIỆN TỪ TRÊN TRỜI ĐỂ TIÊU DIỆT
CÁC BẠN. CHÚNG TÔI ĐÃ TIÊU DIỆT HÀNG TRĂM
ĐỒNG CHÍ CỦA CÁC BẠN BẰNG BOM, HỎA LỰC PHẠO
BÍNH VÀ LỰC LƯỢNG BỘ BINH THIÊN CHIẾN. MUỐN
SỐNG SỐT, CÁC BẠN HÃY RA QUY CHÁNH VỚI CHÁNH
NGHĨA QUỐC GIẢ. NHỮNG NGƯỜI THÂN YẾU ĐANG
THÂN-KHỐC MONG MỎI NGAY VỀ CỦA CÁC BẠN. QUY-
CHÁNH ĐỂ ĐƯỢC GẶP LẠI GIA ĐÌNH HAY CÁC BẠN
SẼ KHÔNG BAO GIỜ GẶP LẠI HỌ NỮA?

CONFIDENTIAL