

UNCLASSIFIED

AD NUMBER	
AD391957	
CLASSIFICATION CHANGES	
TO:	UNCLASSIFIED
FROM:	CONFIDENTIAL
LIMITATION CHANGES	
TO:	Approved for public release; distribution is unlimited.
FROM:	Distribution authorized to U.S. Gov't. agencies and their contractors; Administrative/Operational Use; 25 APR 1968. Other requests shall be referred to Office of the Adjutant General (Army), Washington, DC 20310.
AUTHORITY	
AGO D/A ltr 29 Apr 1980 ; AGO D/A ltr 29 Apr 1980	

THIS PAGE IS UNCLASSIFIED

SECURITY

MARKING

The classified or limited status of this report applies to each page, unless otherwise marked.

Separate page printouts MUST be marked accordingly.

THIS DOCUMENT CONTAINS INFORMATION AFFECTING THE NATIONAL DEFENSE OF THE UNITED STATES WITHIN THE MEANING OF THE ESPIONAGE LAWS, TITLE 18, U.S.C., SECTIONS 793 AND 794. THE TRANSMISSION OR THE REVELATION OF ITS CONTENTS IN ANY MANNER TO AN UNAUTHORIZED PERSON IS PROHIBITED BY LAW.

NOTICE: When government or other drawings, specifications or other data are used for any purpose other than in connection with a definitely related government procurement operation, the U. S. Government thereby incurs no responsibility, nor any obligation whatsoever; and the fact that the Government may have formulated, furnished, or in any way supplied the said drawings, specifications, or other data is not to be regarded by implication or otherwise as in any manner licensing the holder or any other person or corporation, or conveying any rights or permission to manufacture, use or sell any patented invention that may in any way be related thereto.

1473

20

CONFIDENTIAL

DEPARTMENT OF THE ARMY
OFFICE OF THE ADJUTANT GENERAL
WASHINGTON, D.C. 20310



18 OACSFOR

19

IN REPLY REFER TO
AGAM-P (M) (19 Jul 68)

FOR/OT-RD-68X023

5 August 1968

3 @ Lessons Learned

SUBJECT: ~~Combat After Action Report~~ Operation BAN ME THUOT, ~~Headquarters, 3d~~
~~Battalion, 6th Artillery, 22 April 1968~~

SEE DISTRIBUTION

"This document contains information affecting the National Defense of the United States within the meaning of the Espionage Laws, Title, 18, U. S. C., Section 795 and 794. Its transmission or the revelation of its contents in any manner to an unauthorized person is prohibited by law."

1. Subject report is forwarded as inclosure for review and evaluation in accordance with paragraph 5b, AR 525-15.
2. Information contained in this report is provided to insure appropriate benefits in the future from lessons learned during current operations and may be adapted for use in developing training material.

BY ORDER OF THE SECRETARY OF THE ARMY:

9 Combat after action rept. for period ending 22 Apr 68.
Kenneth G. Wickham

KENNETH G. WICKHAM
Major General, USA
The Adjutant General

11 25 Apr 68

1 Incl
as

DISTRIBUTION

- Commanding Generals
US Continental Army Command
US Army Combat Developments Command
- Commandants
US Army War College
US Army Command and General Staff College
US Army Adjutant General School
US Army Air Defense School
US Army Armor School
US Army Artillery and Missile School
US Army Aviation School
US Army Chemical School
US Army Civil Affairs School
US Army Engineer School
US Army Infantry School
US Army Intelligence School

12 51 p.

DDC
RECEIVED
AUG 23 1968

Regraded unclassified when separated
from classified inclosure.

CONFIDENTIAL

mlk(003 650)

AD NO. AD391957
FILE COPY

CONFIDENTIAL

DEPARTMENT OF THE ARMY
HEADQUARTERS 3D BATTALION, 6TH ARTILLERY
APO 96318

AVGG-BA-OP

25 April 1968

SUBJECT: Combat Operations After Action Report

THRU: Commanding Officer
52d Artillery Group
APO 96318

TO: Commanding General
I FFORCEV Artillery
APO 96318

1. Identity: Task Force 1/12 operations near Ban Me Thout.
2. Dates: 03500H March 1968 to 221800H April 1968.
3. Location: AO Wainwright Darlac Sector.
4. Command Headquarters: 1st Battalion, 12th Infantry, 4th Infantry Division.
5. Reporting Officer: Commanding Officer, 3d Battalion, 6th Artillery.
6. Task Organization: 1st Battalion, 12th Infantry, 4th Infantry Division, Headquarters, 3d Battalion, 6th Artillery (-).
Company B, 1st Battalion, 69th Armor (3 Mar-8 Apr 68).
Battery C, 3d Battalion, 6th Artillery, 105mm SP.
Battery B, 5th Battalion, 16th Artillery, 155mm SP.
Battery C, 7th Battalion, 15th Artillery.
Company D, 1st Battalion, 22d Infantry (18 Mar-3 Apr).
1 Platoon, 1st Battalion, 10th Cavalry (8 Apr-22 Apr).
7. Supporting Forces: 6th Battalion, 40th Artillery (one section).
242d Radar Detachment, 8th Target Acquisition Battalion, 26th Artillery.
Met Section, 8th Target Acquisition Battalion, 26th Artillery.
Search light Section, 1st Battalion, 29th Artillery.

a. The radar detachment was very effective. The section performed admirably during the mortar attacks on Ban Me Thuot. The section accurately located hostile mortar positions on two occasions which allowed ARVN units to react to the attack. The section performed several high burst registrations for the Task Force. The section was stationed at Ban Me Thuot City airstrip near the 23d ARVN Division Headquarters and was equipped with a

Incl 3
FOR OI RD
68X023

CONFIDENTIAL

DOWNGRADED AT 3 YEAR INTERVALS;
DECLASSIFIED AFTER 12 YEARS.
DOD DIR 5200.10

CONFIDENTIAL

4

AVGG-BA-OP

SUBJECT: Combat Operations After Action Report

25 April 1968

Radar Set AN/MPQ-4. Nightly the section was assigned a zone to scan by the 23d ARVN Division headquarters.

b. The 6th Battalion, 40th Artillery assigned two M-42 40 mm dusters to the task force. The M-42's were used for convoy and perimeter security throughout the duration of the operation. They were called on to fire during the mortar attack of 8 April 1968. They returned rapid and accurate fire on suspected enemy mortar locations.

c. The Metro detachment operated from Ban Me Thuot East. They gathered and distributed metro data 4 times daily. The section performed effectively and accurately throughout the operation.

d. The searchlight platoon from the 1st Battalion, 29th Artillery functioned effectively throughout the operation. The platoon conducted infrared reconnaissance of the perimeter nightly. Due to the fact that the task force perimeter was never probed, the section's value was never well tested.

8. Intelligence.

a. Enemy Situation Prior to Operations:

- (1) 32d NVA Regiment.
- (2) 33d NVA Regiment.
- (3) 301 LF Battalion.

b. Enemy Disposition Prior to Operations:

- (1) 32d NVA Regiment in and north of the Newal Plantation.
- (2) 33d NVA Regiment approximately 10K northwest of Ban Me Thuot.
- (3) 301 LF Battalion operation southwest of Ban Me Thuot.
- (4) 401 LF Battalion with 33d Regiment.

c. Enemy Situation Prior to the Operation:

- (1) 32d and 33d NVA Regiments were attempting to link up prior to attacking Ban Me Thuot.
- (2) 301 LF Battalion was conducting mortar and harassing attacks southeast of Ban Me Thuot.

d. Enemy Capabilities Prior to the Operation:

- (1) Enemy had capability to conduct multi-regimental sized attacks.
- (2) Enemy had capability to stage mortar, rocket, and recoilless rifle attacks and ground attacks.
- (3) Defend base areas with regimental size forces.
- (4) Employ mines, booby traps and ambushes.
- (5) Withdraw using delay tactics.

e. Resume of Operations:

2

CONFIDENTIAL

CONFIDENTIAL

5
AVGG-BA-OP

SUBJECT: Combat Operations After Action Report

25 April 1968

(1) On 4 March 1968, the 33d NVA Regiment was located west of the Mewal Plantation, Two battalion, believed to be the K101 Battalion and another battalion of the 32d NVA Regiment had occupied the Mewal recently.

(2) On 5 and 6 March the 23d ARVN Division conducted operations in the vicinity of grid AQ7814 to AQ8014 to AQ7818 to AQ8016. Two Battalion of the 45th Regiment (ARVN) had contact on 5 and 6 March. On 6 March an air observer from the 3d Battalion, 6th Artillery received ground fire in the area of contact in the vicinity of grid AQ825135, and in the vicinity of grid AQ812135. The enemy was engaged with rockets by the pilot and one enemy was killed. On 7 March a POW reported the headquarters of the 32d Regiment was located in the Mewal Plantation. Another POW, a private from the 33d Regiment reported that his company strength was from 40-50 men and that the regiment has lost approximately 40 men in the battle for Ban Me Thuot. He stated that the 33d Regiment's mission was the attack of Ban Me Thuot. The POW also reported a base camp area and hospital in the vicinity of grid AQ8440. It was believed that the 32d and 33d NVA Regiments were maneuvering for an attack on Ban Me Thuot.

(3) On 11 March a large number of intelligence targets in the Mewal Plantation were attacked by US artillery. These targets were intended to disrupt lines of communications and movement of the 32d NVA Regiment. An enemy location in the vicinity of grid AQ810210 was taken under fire. Results: 1 NVA KIA.

(4) On 12 March an air observer from the 3d Battalion, 6th Artillery received 800-1000 rounds of automatic weapons fire. He identified the fire as being of heavy caliber. This confirmed the enemy's location in the Mewal. A weapons cache was reportedly located at AQ864363 and it was taken under fire by US Artillery and a secondary explosion was reported. NVA AA guns were reportedly located in the vicinity of grid AP872948.

(5) The period from 13 to 19 March was largely a time of surveillance and reconnaissance. The special agent reports indicated gradual movement of the 32d Regiment to the northwest, while it was believed that two battalions of the 33d Regiment moved northwest to the vicinity of grid ZV2220.

(6) On 20 March the base area of the K-3 Battalion, 33d NVA Regiment was located at ZV2420. This unit is believed to have been hurt badly by the Task Force 1/12 and artillery. A heavy contact materialized which resulted in 7 US KIA, 23 US WIA and 41 NVA KIA, 2 NVA CIA. The POW's stated that they were members of the 33d NVA Regiment. The following day, 21 March, Company A, 1st Battalion, 12th Infantry observed and took under fire 11 NVA resulting in 5 NVA KIA. They also discovered a company base camp and captured ammo, weapons, clothing and medical supplies. A POW from the 3d Battalion, 33d NVA Regiment revealed his base camp area in the vicinity of grid ZV227188. He said another battalion was located 4 kilometers west of the Mewal and that the 32d NVA Regiment had 4 battalions approximately 15 kilometers northwest of the Mewal. Two companies had been sent to Pleiku for an ammunition resupply.

(7) On 23 March the special agent reports indicated that elements of the 33d Regiment were moving west toward Cambodia. Company C, 1st Battalion, 12th Infantry and Company D, 1st Battalion, 12th Infantry captured a regimental hospital at grid ZV225209. It included surgical instruments, anti-biotics, vitamins, anti-malaria medicines, narcotics and antiseptics.

CONFIDENTIAL

CONFIDENTIAL

6

AVGG-BA-OP

SUBJECT: Combat Operations After Action Report

25 April 1968

(8) Further surveillance on 25 March indicated that the 33d Regiment had withdrawn toward Cambodia. The 32d Regiment was working in conjunction with local VC elements to the northwest of the Mewal Plantation.

(9) On 29 March, Ban Me Thuot received approximately 30 rounds of 82mm mortar fire; results were 2 ARVN KIA, 1 civilian KIA, 25 civilians WIA. Reports of 30 March indicated that Ban Me Thuot had been infiltrated by an unknown size enemy and that the 32d NVA Regiment was reported moving to the southwest.

(10) On March 31, Battery C, 7th Battalion, 15th Artillery and Battery B, 5th Battalion, 16th Artillery fired in the area of grid AQ759313. A secondary explosion 50 feet high was reported and the area burned for 45 minutes. It was believed that the target was an enemy weapons cache.

(11) On 2 April a sweep of the area around AP7790 revealed two NVA KIA by Battery C, 7th Battalion, 15th Artillery on 29 March. The elements of the 1st Battalion, 12th Infantry moved to AQ8328, a known enemy multi-battalion staging area. Reliable intelligence located the 32d NVA Regiment in the vicinity of grid AQ765275 with a known mission of attacking Ban Me Thuot. The area was known to contain many bunker/foxhole complexes. A company sized LF VC element appeared to be operating in support of NVA. A POW report indicated that elements of the 34th NVA Regiment were operating north of the Mewal Plantation, however this report was never confirmed. The special agent reports from 8-10 April indicated that the 32d NVA Regiment had moved to the southwest across the Dak Trong River in the direction of Cambodia.

(12) From 10 through 14 April the activity in the AO was very light. It consisted mostly of grave findings and uncovering of bunker and foxhole complexes. The 32d and 33d NVA Regiments appeared to have joined forces in Cambodia. The enemy may have suffered serious losses due to US artillery and air strikes, and possibly disease. By this time it appeared that the enemy was capable of launching no larger than battalion size attacks.

(13) On 17 April a LRRP element made contact with 10-15 enemy. They were extracted and gunships were called. Results: 1 enemy KIA. A subsequent air strike produced 4 large secondary explosions; Two 50 feet high with white smoke, one 100 feet high with black smoke and one 75 feet high with white smoke. Activity through 20 April continued to be of a light nature. The 32d and 33d NVA Regiments appeared to have remained in Cambodia.

(14) On 22 April 1968 Task Force 1/12 returned to the Pleiku area.

f. Enemy Capabilities after the Operation:

(1) Enemy strength after operation in the Ban Me Thuot area.

(a) 301 LF Battalion.

(b) Several LF companies of the 401 LF Battalion

(2) Enemy disposition after the operation:

4

CONFIDENTIAL

CONFIDENTIAL

AVGG-BA-OP

SUBJECT: Combat Operations After Action Report

25 April 1968

- (a) 301 LF Battalion southeast of Ban Me Thuot.
- (b) LF companies north and northeast of Ban Me Thuot.
- (c) 401 LF Battalion in vicinity of grid AP7979.

(3) Enemy situation after the operation:

- Thuot.
- (a) Light local activity by VC LF elements southeast of Ban Me
 - (b) Sporadic VC activity in the vicinity of the Mewal Plantation.

(4) Enemy capabilities after the operation.

- (a) Multi-company attacks.
- (b) Capability to stage limited mortar and rocket attacks.
- (c) Capability to defend base areas in company size strength.
- (d) Employ mines, booby traps and ambushes.
- (e) Withdraw using delay tactics.

g. Summary of Operation:

(1) After initial contacts, the enemy studiously avoided commitment of any large size forces (battalion and upwards). The NVA elements avoided contact of any type with US forces. Aside from the harassment of villages, the enemy was unable to launch any concentrated offensive drive. The NVA elements were unable to sustain or mount any large scale offensives due to reaction capabilities of the 1st Battalion, 12th Infantry and the large scale wide area coverage of the artillery. Combined US-AVN operations denied the enemy the use of his base areas and deprived him of vital ammunition and medical resupply channels.

(2) The enemy constantly used withdrawl by delay tactics. He was forced to continually relocate his elements and could not regroup or link up in the Ban Me Thuot area.

h. Conclusions:

(1) The enemy had support of LF VC elements. He was, however, unable to capitalize on this support due to reaction capability of the US forces.

(2) No record of return of the resupply elements from the Pleiku area lends credence to the conclusion that these elements were severely hampered by artillery and air strikes and were unable to complete their resupply mission.

(3) Actions by elements of the 1st Squadron, 10th Cavalry and the 1st Battalion, 22d Infantry and Battery B, 3d Battalion, 6th Artillery in the Plei Mrong area north of Pleiku in mid-march, in which they destroyed 2 enemy supply companies, may well have diverted an ammunition and medical supply run possibly destined for the Ban Me Thuot area.

(4) NVA/VC pressure exerted on the city of Ban Me Thuot was lifted, thus increasing the morale of the residents in the Ban Me Thuot area as well as increasing the confidence in the Government of Vietnam.

5 CONFIDENTIAL

CONFIDENTIAL

8

AVGG-BA-OP

SUBJECT: Combat Operations After Action Report

25 April 1968

(5) The constant pressure exerted by US artillery, infantry, and air strikes resulted in a severe loss and consequent shortage of ammunition, medical supplies and food among the enemy elements.

(6) The morale of enemy elements appeared to decline sharply in the Ban Me Thuot area. The constant movement forced upon the enemy by US-ARVN forces resulted in an apparent decline in fighting efficiency.

(7) Enemy training was severely curtailed by the operations of Task Force 1/12.

(8) Enemy losses incurred by the artillery supporting Task Force 1/12 were much greater than those confirmed by body count. This is induced by repeated discovery by patrol or other elements in the Ban Me Thuot area of bodies slain by artillery.

9. Missions:

a. Task Force 1/12.

(1) To prevent an expected attack on the city of Ban Me Thuot by the 32d and 33d NVA Regiments.

(2) To conduct search and destroy missions in the Wainwright AO for an indefinite period.

b. Headquarters, 3d Battalion, 6th Artillery with 3 batteries.

(1) Coordinate all fire support in the Task Force 1/12 AO.

(2) Provide direct support to Task Force 1/12.

(3) Provide general support artillery for all friendly forces within range.

(4) Provide reinforcing fires to the 23d ARVN Division Artillery.

10. Concept of Operation, Execution and Results:

a. References.

(1) Operations Order 1-68, 52d Artillery Group.

(2) Frag Order 45-37-67, 4th Infantry Division.

(3) Operations Order 3-68, 3d Battalion, 6th Artillery.

b. The 3d Battalion, 6th Artillery was directed to provide a tactical CP responsible for tactical fire direction of the artillery batteries supporting Task Force 1/12, and to coordinate fire planning and fire support coordination activities through the artillery LO with 1/12 Infantry Battalion.

6 CONFIDENTIAL

CONFIDENTIAL

9
AVGG-Ba-OP

SUBJECT: Combat Operations After Action Report

25 April 1968

c. Initial Preparations.

(1) A staff meeting was conducted at 1900H on 1 Mar by the battalion executive officer. All staff members plus the CO of Battery C, 7th Battalion, 15th Artillery attended this meeting. Ground work was laid for the initial move to the Ban Me Thuot area. All staff sections were directed to coordinate and arrange for the initial move and to prepare to support the artillery units upon arrival in the Ban Me Thuot area.

(2) The S-3 prepared the battalion operations order and arranged for the movement of Battery C, 3d Battalion, 6th Artillery to Camp Enari.

(3) Headquarters element, 3d Battalion, 6th Artillery was organized to control the artillery task force. (See Annex J.)

(4) The S-3, 3d Battalion, 6th Artillery accompanied the Commanding Officer, 1st Battalion, 12th Infantry on a reconnaissance of the Ban Me Thuot area on 1 March 1968. They checked the proposed position areas and determined the feasibility of routes into the area.

(5) Task Force 1/12 was assigned Wainwright AO north of grid line 25.

(6) Headquarters and Service battery commanders, 3d Battalion, 6th Artillery arranged transportation for the HQ element and augmented the transportation capabilities of Battery C, 3d Battalion, 6th Artillery to move all equipment and materials necessary to the Ban Me Thuot area.

(7) The Service Battery commander coordinated the logistics requirements in the Ban Me Thuot area. He visited this area with the S-3 and discussed the anticipated problems with the S-4 from the 1st Battalion, 12th Infantry. The 1st Logistical Command was to establish a forward supply point in Ban Me Thuot East airfield to expedite the flow of materials to the Task Force. The 704th Maintenance Battalion was to establish a team at Ban Me Thuot to adequately maintain all vehicles and equipment in the Task Force and to speed resupply of essential parts.

(8) The S-1 was to arrange for all mail delivery and for the prompt handling of all personnel matters.

(9) The S-2 arranged for the use of the O-1 Bird Dog from 219th RAC to fly convoy coverage for the task force from Pleiku to Ban Me Thuot. The assistant S-2 was assigned as the AO to fly for the task force. He was joined by an FO from Battery C, 3d Battalion, 6th Artillery.

(10) The battalion survey chief was assigned as the survey chief/1st Sergeant for the operation.

(11) Plans were made to provide continuous artillery coverage for the convoy. This fire plan included a target list and a target overlay for each march battery commander and for each march unit commander.

CONFIDENTIAL

AVGG-BA-OP

SUBJECT: Combat Operations after Action Report

25 April 1968

10

d. The Move to Camp Enari:

(1) Battery B, 5th Battalion, 16th Artillery and Battery C, 3d Battalion, 6th Artillery moved to Camp Enari, grid AR7936 on 2 March 1968. There the battery stood down for a day of maintenance.

(2) Battery C, 7th Battalion, 15th Artillery arrived at Artillery Hill on 1 March 1968. The battery commander attended the briefing of all personnel at Headquarters, 3d Battalion, 6th Artillery on 1 March 1968. His unit conducted maintenance on all equipment and vehicles on 2 March 1968. The battery departed Artillery Hill at 030445H 3 March 1968 to link up with the task force convoy at Check point E6, grid AR7736.

(3) Headquarters, 3d Battalion, 6th Artillery departed Arty Hill at 1500H 2 March 1968 for Camp Enari, and arrived at 1630H to remain overnight.

(4) At 022000H March a briefing was held by the task force commander to finalize coordination of the move to Ban Me Thuot. All battery commanders and staff members attended. Final coordination required many changes to the published operation order.

(5) The convoy departed Camp Enari in three serials, commencing at 0530H on 3 March 1968. Battery C, 3d Battalion, 6th Artillery and Headquarters, 3d Battalion, 6th Artillery (-) were in the second serial. They were joined by Battery C, 7th Battalion, 6th Artillery at CP 31 at 0645H. Battery B, 5th Battalion, 16th Artillery was in the third march serial and departed Camp Enari at 0645H. There was a 30 minute interval between convoy elements. There were artillery FO's from 4th Battalion, 42d Artillery with each march unit.

(6) Battery C, 7th Battalion, 15th Artillery had two howitzers break down on the march route. These were both taken forward to the new fire base and closed the same afternoon; in addition the task force had two VTR's break down enroute.

(7) The S-3 of 3d Battalion, 6th Artillery accompanied by the S-3 of the 1st Battalion, 12th Infantry proceeded to the area of the new fire base and designated the areas for each battery.

(8) Battery C, 3d Battalion, 6th Artillery was halted at BQ020327 to provide cover for the fire base while the reconnaissance elements from the Task Force 1/12 reconned the area.

(9) All units closed into the first fire support base in the vicinity of grid AQ933287 by 1600H on 3 March 1968.

(10) All artillery personnel were required to have overhead cover by the completion of the first day's occupation.

e. Operations:

CONFIDENTIAL

AVGG-BA-OP

SUBJECT: Combat Operations After Action Report

25 April 1968

(1) Annex C to this report is a brief summary of all maneuvers by the artillery units while serving with the task force between 2 March and 22 April 1968.

(2) Annex D to this report is a brief summary of significant missions fired by US artillery in support of Task Force 1/12.

(3) Annex E to this report is a brief summary of significant missions fired by US artillery in support of ARVN or GVN forces.

(4) The 3d Battalion, 6th Artillery S-3 was the senior artilleryman with the task force. He controlled the artillery movements and fires.

(5) The battalion established a fire direction center. The mission of the fire direction center was to mass the battery's fires and to check the firing data of all units.

(a) The 3/6 Arty Battalion FDC had the capabilities to provide firing data for the 105mm SP, the 155mm SP and the 8" and 175mm howitzers.

(b) The FDC was established by Headquarters, 3d Battalion, 6th Artillery from personnel in the battalion. To operate the FDC, 2 chart operators and 3 computers were used on each 12 hour shift.

(c) Problems: The battalion FDC did not have the capability of displacing rapidly. Lacking the two authorized M-577's it was necessary to construct from available materials a place in which to operate. The resulting disruptions, before, during, and after moves, negated the FDC's capabilities to maintain control during displacements. Also, the battalion FDC was required to leave its FADAC with the FDC's training course. Each firing battery with its own FADAC was able to produce much more accurate data than the battalion FDC.

(d) Recommendations arising from the functioning of a battalion FDC, controlling 4 calibers of artillery:

(1) That the FDC be manned by individuals pooled from each of the firing batteries and augmented by the battalion FDC.

(2) That the battalion FDC should control all missions in which two or more batteries are massed,

(3) That the battalion FDC's be augmented with FDC equipment for all calibers.

(e) Headquarters, 3d Battalion, 6th Artillery established a forward operations section consisting of 6 individuals. The battalion S-3, the assistant S-3, the assistant operations sergeant and three RTOs. The headquarters maintained communications with battalion headquarters, all firing batteries and operated the air advisory net. In addition communication was maintained at all times with Division artillery and with FSCE, the liaison officer of the 23d ARVN Division and the trains location. The operations

CONFIDENTIAL

CONFIDENTIAL

12

AVGG-BN-OP

SUBJECT: Combat Operations After Action Report

25 April 1968

section had the responsibility of submitting and forwarding all reports, requests and messages to battalion headquarters. The operations section ran the target information center which gathered intelligence information and compiled it into an intelligence report. The sources of the information which were available to the task force were the 23d ARVN Division, Darlac Sector Headquarters, Buon Ho Sub Sector Headquarters, Task Force 1/12, 5th Special Forces, Reconnaissance aircraft, agent reports, aerial observers, radar, prisoner reports and individual combat soldiers.

(f) The operations section submitted a daily situation report which summarized the enemy and friendly situation, stated the mission of the task force, gave the current location of all units, the plans summary for each day, the intelligence gathered during that period, the liaison conducted and the logistical situation.

(g) Operations commenced on 3 March 1968 in the Wainwright AO with the occupation of a fire base. On 4 March A and B companies of the 1st Battalion, 12th Infantry closed into the AO from the Dak To area. All artillery remained at the main fire support base.

f. Operations North of Newal Plantation.

(1) On 4 March 1968 local patrolling was done by Company D and Company C of the 1st Battalion, 12th Infantry.

(2) On 5 March Company C and D, 1st Battalion, 12th Infantry moved to a new patrol base at AQ903265.

(3) On 5 March the 7th Squadron, 17th Cavalry operated in the AO to obtain intelligence information. All artillery remained at the fire support base. Artillery aerial observer was fired on by automatic weapons at AQ825135 and AQ812135. The aerial observer spotted 4 individuals at first location. The area was out of artillery range so the pilot attacked using his rockets. The rockets were on target however no surveillance was obtained. At the second grid, one NVN was spotted and attacked by the pilot: results: 1 NVN KIA, Battery C, 7th Battalion, 15th Artillery fired on an unconfirmed agent report of 750 VC at grid AQ793267.

(4) On 7 March 1968 a large operation was scheduled for the task force to operate with the ARVN forces in the area. A and C companies of 1st Battalion 12th Infantry were scheduled to participate in this attack. Battery C, 3d Battalion, 6th Artillery and Battery B, 5th Battalion, 6th Artillery moved to AQ834110. The attack was aborted when it was determined that the ARVN forces could not be away from the city overnight. Battery C, 7th Battalion, 15th Artillery fired a mission at grid AQ8636 on 3 NVN in a bunker complex. Results: 1 NVN KIA confirmed. The 3d Battalion, 6th Artillery commander conducted extensive liaison with the 23d ARVN Division and Darlac Sector advisor on this date. He coordinated the US artillery role in the area with these officials. His liaison cemented firm relations with the ARVN units.

10

CONFIDENTIAL

CONFIDENTIAL

AVGC-BA-OP

SUBJECT: Combat Operations After Action Report

25 April 1968

13
(5) On 8 March 1968, Battery C, 3d Battalion, 6th Artillery displaced to AQ905255 for an overnight position to support forward infantry units. Battery B, 5th Battalion, 16th Artillery attacked a suspected radio transmitter and destroyed it at AQ825300. Battery C, 7th Battalion, 15th Artillery sank a 20' by 10' raft at AQ801295.

(6) Battery C, 3d Battalion, 6th Artillery returned to the main fire support base at 1030H on 9 March. Company Q, 1st Battalion, 12th Infantry spotted 6 individuals at AQ849250 and Battery C, 3d Battalion, 6th Artillery and Battery B, 5th Battalion, 16th Artillery fired on the area. Result: 1 VC KIA.

(7) Battery C, 7th Battalion, 15th Artillery fired in support of an air strike at AQ855267. Artillery units fired in support of a contact by Company C, 1st Battalion, 12th Infantry at Aq8625. Result: 1 NVA KIA.

(8) Throughout this period, all units fired on targets of opportunity and on reported enemy locations.

(9) Infantry units conducted search and destroy operations northwest of the Mewal Plantation.

(10) On 12 March 1968, a new plan of attack was derived with the ARVN 4th Battalion, 45th Infantry. It was to be a two battalion search and destroy operation to the northwest of Ban Me Thuot. The operation commenced on 13 March with the move of Battery C, 3d Battalion, 6th Artillery and Battery B, 5th Battalion, 16th Artillery to AQ829100. Battery C, 7th Battalion, 15th Artillery followed the next day and set up a new fire base. Companies A, C and D, 1st Battalion, 12th Infantry advanced to the northwest. They searched the area until the 20th of March with no significant findings. Battery C, 3d Battalion, 6th Artillery displaced on 16 March to AQ783108 to provide coverage of company objective areas. Battery B, 5th Battalion, 16th Artillery moved to the same location on the 19th of March. On the morning of 20 March both units again displaced in echelon to AQ766126. They were set up and ready to fire in this position by 1000 hours.

(11) Companies A, C and D, 1st Battalion, 12th Infantry moved from ZV225175 to the north west at 100 hours. Company A in the lead. At 1115 hours company A's point moving north met a column of the 3d Battalion, 33d Regiment, moving west on a trail. Company A's lead platoon took the enemy under fire. The remainder of Company A closed to form a perimeter. While Company A was forming a perimeter, the enemy reacted, took the offensive and attacked from the front and both flanks. Company C and D closed on Company A and formed a perimeter. Coordinated artillery, airstrikes and gunships were used in support of the contact. Results: 7 US KIA, 23 US WIA, 41 NVA KIA, 2 NVA CIA. Sporadic contact continued in the vicinity of ZV2319 for the next two days. Heavy firing was done in the area on the nights of 20 and 21 March to interdict enemy movement out of the battle area.

(12) US Artillery supported ARVN units during this period. On 18 March an ARVN PF unit was attacked at AQ8107. Battery C, 3d Battalion,

CONFIDENTIAL

14

AVGC-BA-OP

SUBJECT: Combat Operations After Action Report

25 April 1968

6th Artillery and Battery B, 5th Battalion, 16th Artillery fired in support of the unit and assisted the defenders in repelling the attack.

(13) The VC had publicly announced that they would attack Boeon Ea Pur (at grid AQ942014) with mortars for 10 straight days and told the people how many rounds they would fire. They attacked for 4 straight nights. On the 5th day the village called for artillery support. Battery C, 7th Battalion 15th Artillery fired in support. The attack ceased almost instantly. Later intelligence reports indicated 2 VC KIA and 4 WIA.

(14) The 4th Battalion, 45th Infantry ARVN Regiment participated fully in operations north of Ban Me Thuot from 13 to 24 March. Their operations were supported by the task force artillery and by ARVN artillery.

g. Operations 23 March to 6 April.

(1) The mission of the task force remained to search and destroy the enemy in assigned AO.

(2) Intelligence reports began to indicate that the 32d Regiment had moved north and that the 33d Regiment seemed to be moving toward Cambodia.

(3) Enemy activity in the Ban Me thuot area dropped off considerably during this period.

(4) On 26 March, Companies B, C and D, 1st Battalion, 12th Infantry worked to the east to vicinity of gridAQ7620. This move allowed the artillery units to displace back to the main fire base at AQ829110.

(5) On 26 March Ban Me Thuot came under mortar attack, Battery C 7th Battalion, 15th Artillery fired counter mortar program. Results unknown.

(6) All infantry units conducted local search and destroy operations northwest of the fire base.

(7) On 28 March Battery C, 7th Battalion, 15th Artillery conducted a hip shoot on request of the ARVN's south of the city. They fired a program of preplanned fires scheduled by the ARVNs. Results of the hip shoot were 2 VC KIA (found during a sweep of the area on 4 April).

(8) On 30 March two 8 inch howitzers for Battery C, 7th Battalion 15th Artillery were taken to Ban Me Thuot East and converted from 8 inch to 175mm. This greatly increased the area influence and ability of the artillery to provide general support for units operating in the task force in the Ban Me Thuot area.

(9) Special agent reports indicated the presence of the 32d NVA Regiment in the vicinity of AQ7829. These reports indicated that this area was a possible base camp of considerable size.

15

CONFIDENTIAL

AVGG-BA-OP

SUBJECT: Combat Operations After Action Report

25 April 1968

(10) On 31 March two 155mm howitzers from Battery B, 5th Battalion, 16th Artillery and one 8 inch howitzer from Battery C, 7th Battalion, 15th Artillery conducted a hip shoot to vicinity AQ7916 to fire into the area of heavy special agent reports AQ7829. They fired a preplanned program based on a detail study of the area using all information collected in that area and achieved one secondary explosion at AQ759313.

(11) Company D, 1st Battalion, 22th Infantry left the task force on 3 April after two weeks of operation with the task force.

(12) Battery C, 7th Battalion, 15th Artillery's 175mm guns fired on numerous targets.

(13) Battery C, 7th Battalion, 15th Artillery moved to a permanent location at Ban Me Thuot East airfield on 5 April 1968. The battery mission became general support of Free World Forces with priority of fires to the 5th Special Forces and the 23d ARVN Division.

(14) On 4 April the infantry companies began to maneuver northward with the mission to find and fight the 32d Regiment. To support the operation against the 32d Regiment, the task force prepared to move to a new fire base in vicinity of grid AQ88328.

h. Operations 6 April to 22 April.

(1) On 061300 April Battery C, 3d Battalion, 6th Artillery element closed at the new fire support base vic grid AQ8328. On 7 April Battery B 5th Battalion, 16th Artillery moved to the new fire support base.

(2) The three companies of the 1st Battalion, 12th Infantry moved north towards the designated objective area. They had very little significant contact in the next few days. The special agent reports indicated that the 32d Regiment was moving towards the Cambodian border.

(3) On 9 April the 7th Squadron, 17th Cavalry operated in the area in search of elements of the 32d Regiment. They found 3 NVA in a bunker and killed them, however, the 7th Squadron, 17th Cavalry was unable to locate any sizeable elements of the 32d Regiment.

(4) On 11 April Battery C, 3d Battalion, 6th Artillery and Headquarters 3d Battalion, 6th Artillery (-) moved to a new fire base vicinity AQ782178. The purpose of this move was to interdict the movement of the 32d Regiment.

(5) On 12 April Battery B, 5th Battalion, 16th Artillery moved to the new fire base.

(6) All batteries fired heavy programs at intelligence targets in the new area of operations.

(7) On 11 April LRRP team 35 killed 1 NVA at grid ZV243222.

CONFIDENTIAL

16

AVGG-BA-OP

SUBJECT: Combat Operations After Action Report

25 April 1968

(8) The companies of the 1st Battalion, 12th Infantry moved southwest to attempt to interdict movement vicinity ZV2422.

(9) By 13 April all indications pointed to the fact that the 32d and 33d Regiments had withdrawn to Cambodia.

(10) On 13 April at AQ807197 Reconnaissance Platoon killed 1 enemy and 2 enemy were captured.

(11) On 16 April Reconnaissance Platoon of the 1st Battalion, 12th Infantry suffered 1 KIA in a brief engagement with local VC.

(12) On 17 April LRRP team at AQ815387 killed 1 VC and captured 1 VC. On 17 April LRRP team at AQ835335 killed on VC. Airstrikes on area produced four secondary explosions.

(13) On 19 April Battery C, 3d Battalion, 6th Artillery moved to the old fire base at grid AQ8328 to support a 2 company sweep to the north in old base area 238.

(14) On 20 April Battery C, 3d Battalion, 6th Artillery fired a preparation for the combat assault of companies C and D, 1st Battalion, 12th Infantry into base area 238. The one day operation produced no significant findings. Companies C and D were extracted on 21 April.

(15) On 21 April Battery C, 3d Battalion, 6th Artillery moved to Buon Ho (BQ033287) to prepare for return to Pleiku area.

(16) Battery B, 5th Battalion, 22d Artillery arrived by convoy on 20 April to replace Battery C, 7th Battalion, 15th Artillery as the heavy battery in the Ban Me Thuot area.

(17) Battery C, 3d Battalion, 6th Artillery, Headquarters, 3d Battalion, 6th Artillery (-), Battery B, 5th Battalion, 16th Artillery and Battery C, 7th Battalion, 15th Artillery departed Ban Me Thuot in convoy on 22 April to return to the Pleiku area. Enroute Battery C, 7th Battalion, 15th Artillery conducted a hip shoot at grid BQ034318 and fired targets directed by I FFORCEV Artillery.

(18) On 23 April Battery C, 7th Battalion, 15th Artillery was relieved from the temporary attachment to 3d Battalion, 6th Artillery.

1. Recommendations:

(1) Stream Crossings - A self propelled artillery task force is severely limited in its stream crossing capabilities. Several times during this operation desirable maneuvers were not initiated because the artillery was unable to ford streams to reach proper firing positions rapidly. The streams in the area have banks which are too steep to ford without building or emplacing bridges. It is recommended that a task force with only self-propelled supporting artillery be augmented with 1 AVLB from supporting engineer units to allow freedom of movement over natural obstacles.

CONFIDENTIAL

14

CONFIDENTIAL

AVGG-BI-OP

SUBJECT: Combat Operations After Action Report

25 April 1968

(2) At no time was ground reconnaissance conducted prior to moves. This led to a great deal of delay when the units occupied the position. When possible an artillery battery should send forward a standard reconnaissance party. This could be done by sending the initial reconnaissance party in with the unit that secures the area. This would allow time to prepare a position and make available more accurate and timely artillery fire when a unit occupies a position. This should be accomplished when possible using one additional sortie for an artillery advance party in a combat assault or by using the standard party designed by the Artillery School augmented by a security element vehicle.

(3) A battalion fire direction center should be set up. This fire direction center is a valuable aid to the Fire support Coordinator because it enables him to determine rapidly if he can attack a target near the limits of the range fans. This enables the S-3 to plan fires knowing that all targets can be attacked by the caliber of weapons designated to attack the target. All calibers of weapons can be massed.

(4) The headquarters element derived an exceptionally rapid and complete way to organize a headquarters element with the task force. This procedure is outlined in Annex J to this report. It is recommended that this or similar procedures be followed whenever a headquarters element occupies a position.

Alonzo S. Kretzer
 ALONZO S. KRETZER
 LTC, Artillery
 Commanding

ANNEXES

- Annex A - References
- Annex B - Communications
- Annex C - Movements
- Annex D - Significant Missions for US Units
- Annex E - Significant Missions for ARVN
- Annex F - Logistics
- Annex G - Aircraft Utilization
- Annex H - Ammunition Expenditures
- Annex I - Casualty Report
- Annex J - Headquarters Detachment, 3d Bn, 6th Arty FWD
- Annex K - Liaison

DISTRIBUTION:

- 2 CG IFFORCEV Arty
- 2 CO 52nd Arty Gp
- 2 CO 1st Bn, 12th Inf
- 6 CO 3d Bn, 6th Arty

CONFIDENTIAL

Annex A: (Reference) to Combat After Action Report for Task Force 1/12

1. Reference used in preparing this report.
 - a. 4th Division Frag Order 47-37-67
 - b. 52nd Group Operations Order 1-6
 - c. 3rd Battalion, 6th Artillery Op Order 3-68
 - d. SITREPS 3rd Battalion, 6th Artillery, 4 March to 22 April 1968
 - e. 3rd Battalion, 6th Artillery Op Order 4-68
2. These references were utilized by the task force in their movements.

CONFIDENTIAL

19

ANNEX B: (Communications) to Combat After Action Report

1. Receipt of Warning Order and Initial Planning: Upon receipt of the Warning Order on 28 Feb 68 from 52 Artillery Group, the communications officer initiated actions to accomplish the following:

- a. Determine the identity, type, initial disposition and missions of all units involved.
- b. Initiate exchange of SOI's with 1/12 Infantry (6 copies), Battery Cm 7th Battalion, 15th Artillery (1 copy)
- c. Determine the communication requirements for internal and external communications for 3rd Battalion, 6th Artillery FWD CP, to include FM and AM radio, telephone/switchboard, and message service.

2. Initial plan: Upon receipt and analysis of the Operations Order the initial communications requirement were determined and plans made to accomplish the missions.

- a. The following tasks were assigned to the Communications Platoon, Headquarters Battery, 3rd Battalion, 6th Artillery.
 - (1) Provide SOP Base Camp Communications
 - (2) To provide SOP for TOC/CP wire system at the FSB.
 - (3) Operate on order RTT station at base camp in 3rd Battalion, 6th Artillery CF Net (AM).
 - (4) Operated FM retransmission station on Dragon Mountail, Pleiku RVN, on the 3rd Battalion, 6th Artillery CF Net, effective 021600H Mar 68.
 - (5) Prepare, package and deliver via courier SOI items to 3rd Battalion, 6th Artillery FWD CP.
 - (6) Provide limited FADAC and radio repair service within the AO.
- b. The operations section, Headquarters Battery, 3rd Battalion, 6th Artillery was to maintain stations in the following nets:
 - (1) 3rd Battalion, 6th Artillery F-1/CF Net - Artillery Command Frequency.
 - (2) 3rd Battalion, 6th Artillery F-4 Net - Artillery Task Force Fire Direction Net.
 - (3) Tollhouse Net - Notice to aircraft broadcasts.
 - (4) FSB perimeter security net.
 - (5) 4th Infantry Division Artillery Command Fire Net.
 - (6) Metro broadcasts net - monitor only.

ANNEX-B

CONFIDENTIAL

CONFIDENTIAL

ANNEX B: (Communications) to Combat After Action Report (cont.)

20

- c. Battery C, 7th Battalion, 15th Artillery was assigned the mission to operate an RPT station in the 52nd Artillery Group Operations Intelligence Net (AM) at the 3rd Battalion, 6th Artillery FWD CP.

3. Personnel and Equipment:

- a. The following communications personnel were assigned to the 3rd Battalion, 6th Artillery FWD CP:

<u>Position</u>	<u>MOS</u>	<u>Grade</u>	<u>No</u>
Comm Officer	0200	O-3	1
Comm Plt Sgt		E-8	1
Senior Wireman	36K40	E-5	1
Wireman	36K20	E-1	3
Radio Repairman	36K20	E-4	1
Radio Teletype Operator	36K20	E-3/E-4	2
Radio Telephone Operator	05040	E-3/E-4	2

- b. The following communications equipment was made available to the 3rd Battalion, 6th Artillery FWD CP.

<u>Quantity</u>	<u>Item</u>	<u>Source</u>
6	Antenna, RC-292	Opns Sect and Comm Plt
1	Radio receiver, AM/GRR 5	Comm Plt HNB
1	Radio Repairman Kit	Comm Plt HNB
1	Radio Set, AM/GRC-46	C/7/15 Artillery
2	Radio Sets, AM/GRC-25	Opns Sect and Comm Plt
8	Remote Sets	Opns Sect and Comm Plt
4	Radio, RT-524	Opns Sect HNB
1	Cipher Device, KY-8	52nd Artillery Group
2	Switchboard, Se-22	Opns Sect and Comm Plt
11 miles	Wire WD-1	Opns Sect and Comm Plt

4. Task Force Planning Conference: At 022000R Mar 68 an initial meeting of all commanders was held at Headquarters Battery, 1st Battalion, 12th Infantry Base Camp for the purpose of coordinating the movement by convoy into Wainwright AO and initial deployment for the Task Force.

- a. At this meeting required frequencies and call signs for all elements were determined and exchanged.
- b. The Task Force operated all convoys on the 1st Battalion, 12th Infantry Administration/Logistic Net (FM) with the convoy Commander, March Unit Commanders, battery FDC'S, security elements, and air observers on this one frequency. Each march unit was assigned a separate frequency for internal control of the individual march units.

5. Movement into AO and initial deployment: The movement by convoy was controlled on FM radio nets as outlined in paragraph 3 above.

- a. An FM retransmission station was established on Artillery Hill, Pleiku, RVN, to operate on the 3rd Battalion, 6th Artillery CF

B2
18
CONFIDENTIAL

21

ANNEX B: (Communications) to Combat After Action Report (cont.)

Net locally aid to transmit on F-1 into the AQ Communications from this location was unsatisfactory and the station was moved to Dragon Mountain, RVN, on the afternoon of 3 Mar 68. Good communications into the FSB was established and maintained throughout the duration of the operation.

b. Initial FSB communication consisted of:

(1) FM Radio Nets:

<u>Net</u>	<u>Frequency</u>	<u>To</u>
3/6 Arty CF	F-1	Base Camp, firing batteries trains INO 23rd ARVN DTOC.
3/6 Arty F-4	F-4	FO's, firing batteries FDC's air observers
1/12 Inf Comm A	SOI	TF HQ and operations
Tollhouse	Per SOI	to all aircraft

(2) AM Radio Nets:

<u>Net</u>	<u>Frequency</u>	<u>To</u>
52nd Gp Arty Opns and Intell	Per SOI	NCS at Arty Hill, Pleiku

(3) Wire and switchboard: Upon arriving in position 2 wireman immediately installed lines from operations in the following order and priority:

- Firing Battery FDC's
- 4.2 in mortar positions
- 81mm mortar positions
- 4 ID Artillery FSCE via VHF
- 4 ID Artillery SWED
- 4/60 Artillery Duster positions
- Searchlight positions
- RTT Station
- En CO/S3 quarters
- Comm Officers quarters
- Resupply pad

6. Second Day Improvements: During the second day, 4 Mar 68, the FSB was 80% completed and improvements made on communications facilities included:

- a. Wirelines laid during the night were policed, overhead or buried. During the first three days in each FSB, heavy vehicle traffic required continuous checks to insure that all lines were operational.**
- b. Additional RC-292 antennas were erected and their installations were improved.**

CONFIDENTIAL

ANNEX B: (Communications) to Combat After Action report (cont.)

22

- c. A trench for the AN-GRC-46 RTT station was dug and the equipment placed below ground level.
7. Messenger Service: Limited messenger service was established between the FSB and the 3rd Battalion, 6th Artillery Base Camp.
- a. At least 4 deliveries per week were made by messenger dispatched from the 3rd Battalion, 6th Artillery Base Camp.
 - b. The Couriers were authorized to handle the following:
 - (1) All distribution
 - (2) Incoming and outgoing US Mail
 - (3) SOI changes and classified distribution
8. FSB/Trains Communication Plan: By the third displacement of the FSB the requirements for the installation of communication facilities had been standardized.
- a. FM radio nets (see Appendix 1 to the Signal Report)
 - b. AM radio nets (see Appendix 2)
 - c. FSB wire system (see Appendix 3)
 - d. Ban Me Thuot/Trains/Base Camp wire system (see Appendix 2)
9. Extensive Administration and Logistic message traffic existed between the Task Force trains and the FSB. Except for several days in early March when the VHF system to Ban Me Thout was operational, all traffic had to be transmitted via FM radio.
10. Recommendations: A VHF multichannel communications system should be installed between the trains and the FSB to provide telephonic means of handling administrative and logistics traffic. In addition a Battalion Administration/Logistics Net (FM) should be established.

20

CONFIDENTIAL

23

CONFIDENTIAL

APPENDIX 1 (FM Radio Nets) to ANNEX B (Communications) to Combat After Action Report (cont.)

FM Radio Nets

1. 3/6 Arty CF Net (FM)

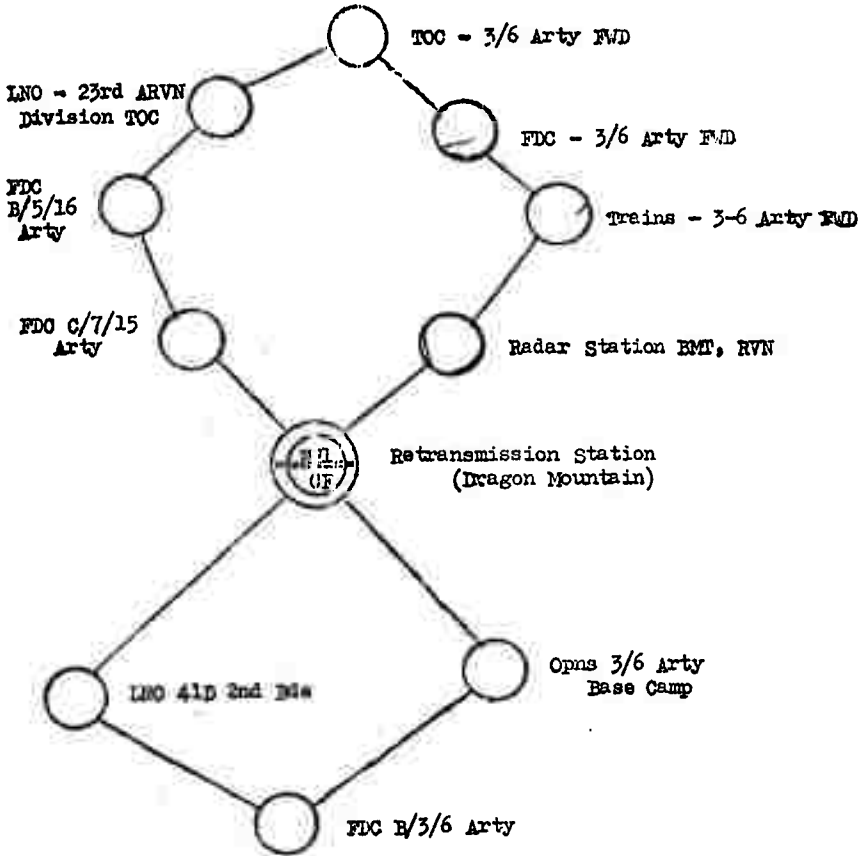

CONFIDENTIAL

APPENDIX I (FM Radio Nets) to Combat After Action Report (cont.)

2. Tollhouse Net (FM)

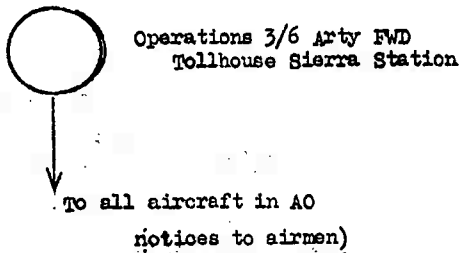

3. 3/6 Arty primary.. Fire Net (F-4)

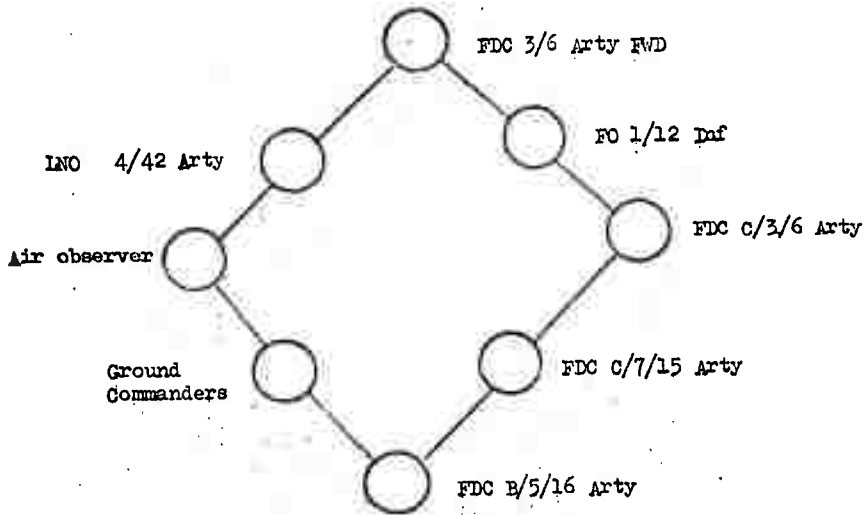

CONFIDENTIAL

75

APPENDIX 1 (FM Radio Nets) to Combat After Action Report

4. 4th Infantry Division Arty CF Net (FM) - was entered when propagation conditions permitted and when telephonic circuits via the VHF system were inoperative.

5. 1/12 Infantry Administrative/Logistics Net (FM)

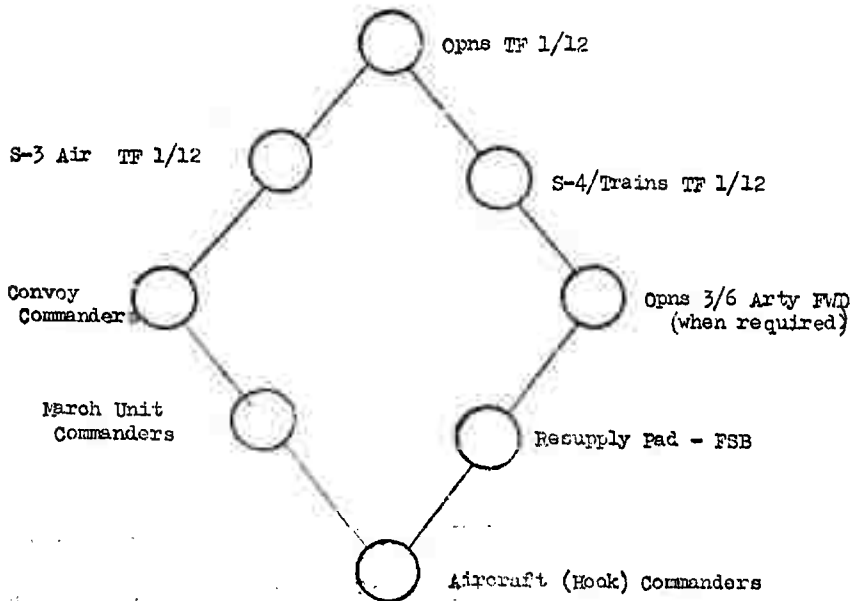

23

CONFIDENTIAL

APPENDIX 1 (FM Radio Nets) to Combat After Action Report (cont.)

6. Convoy Movement Control Systems (FM)

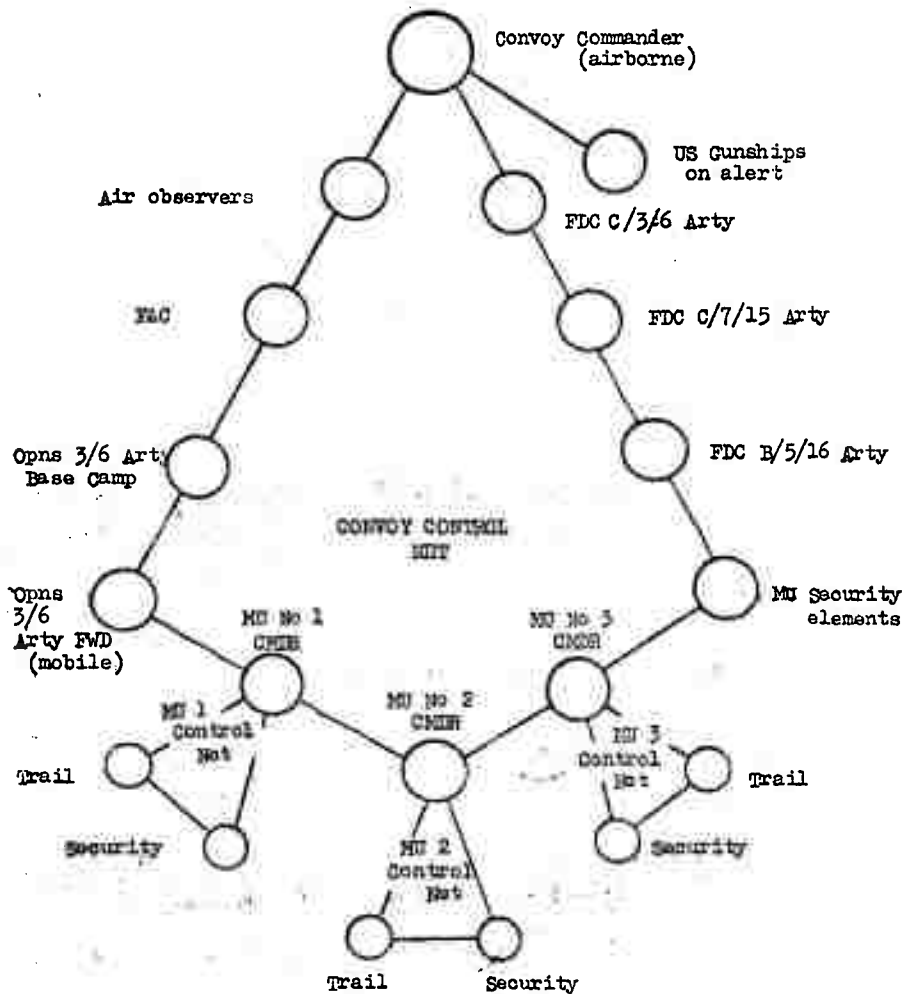

24

CONFIDENTIAL

27

APPENDIX 1 (FM Radio Nets), to Combat After Action Report (cont.)

7. Metro Broadcast Net (FM)

(Nato and Computer Met messages transmitted at 0200, 0800, 1400H and 2000H daily)

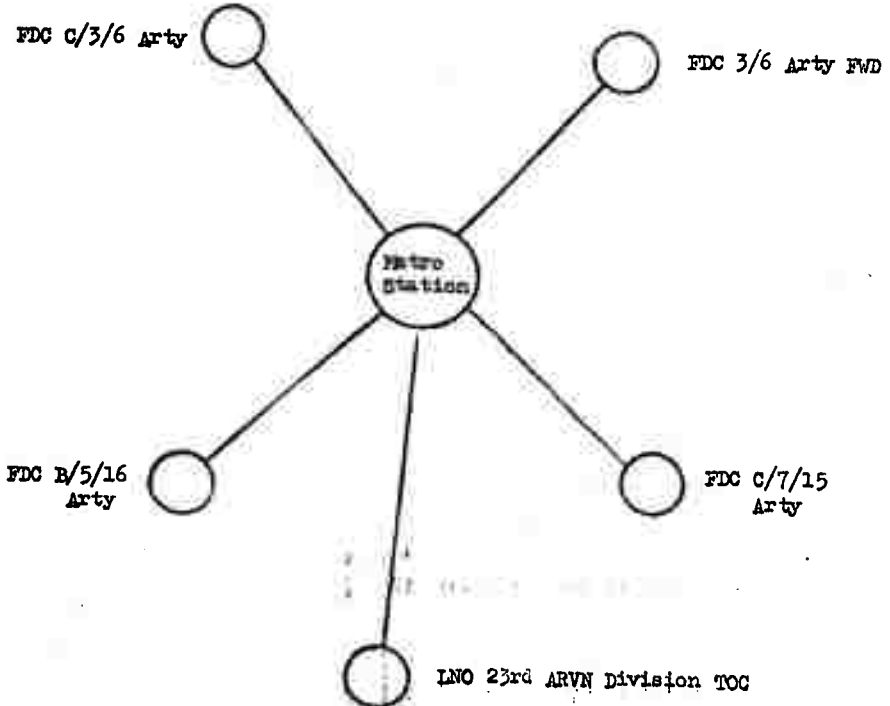

25
1B5

APPENDIX 2 (AM Radio Nets) to ANNEX B (Communications) to Combat After Action Report

AM Radio Nets

1. 52nd Arty Group Opns/Intell Net (AM)

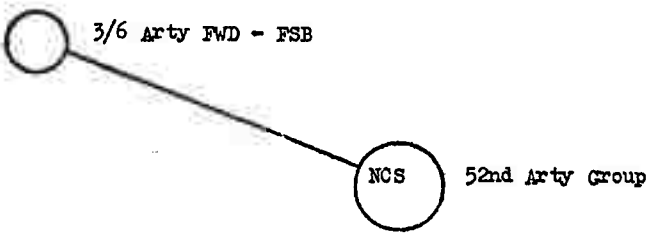

2. 3/6 Arty CF Net (AM)

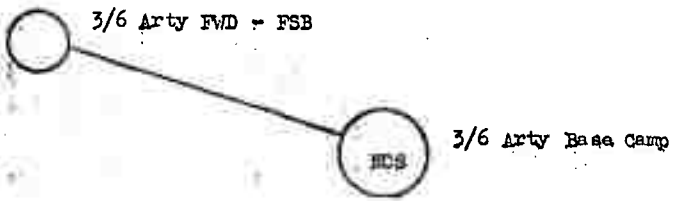

29

CONFIDENTIAL

APPENDIX 3 (FSB Wire System) to ANNEX B (Communications) to Combat After Action Report (cont.)

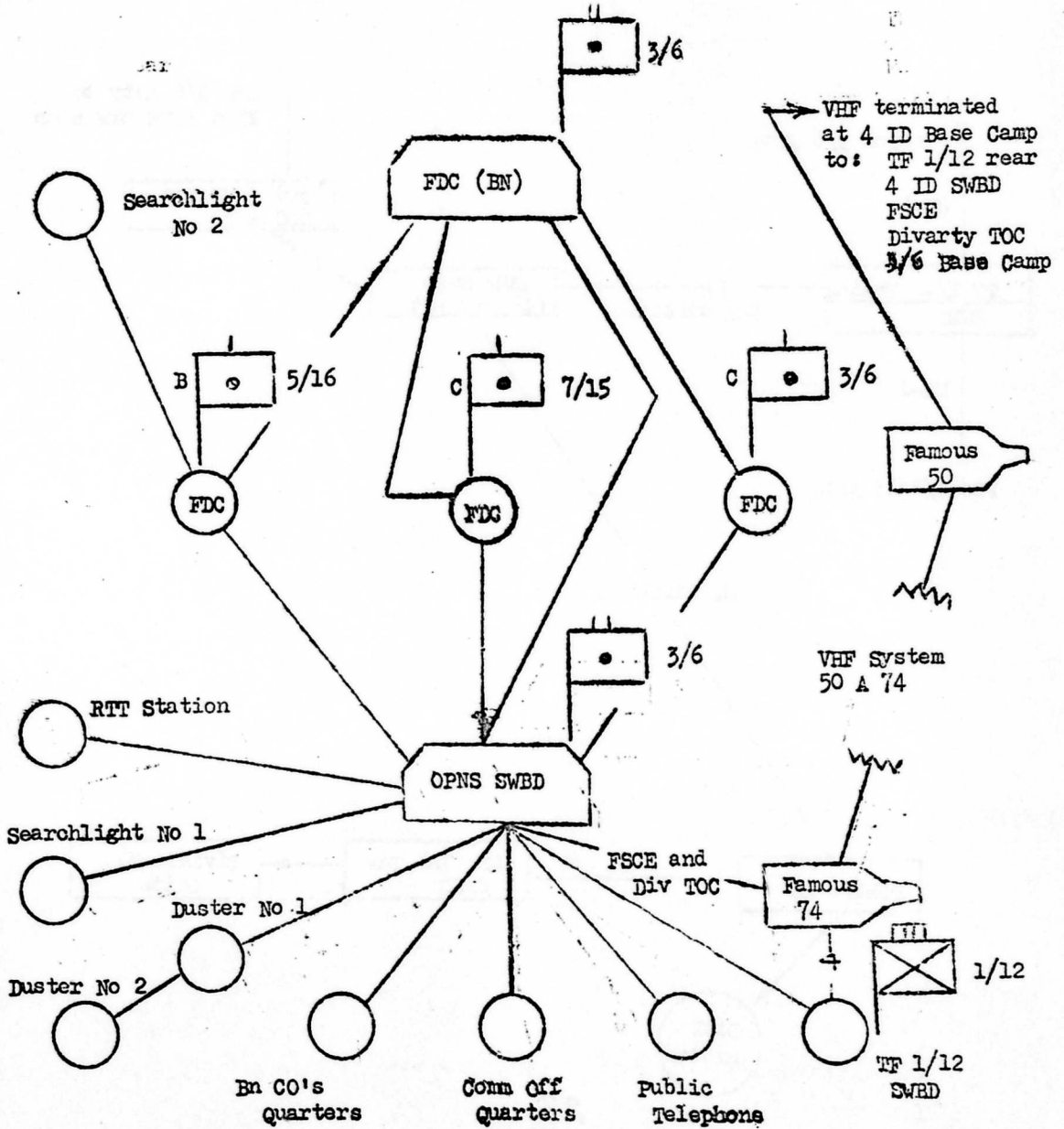

27

CONFIDENTIAL

APPENDIX 4 (BMT/Trains/Base Camp Wire System) to ANNEX B (Communications) to Combat After Action Report (cont.)

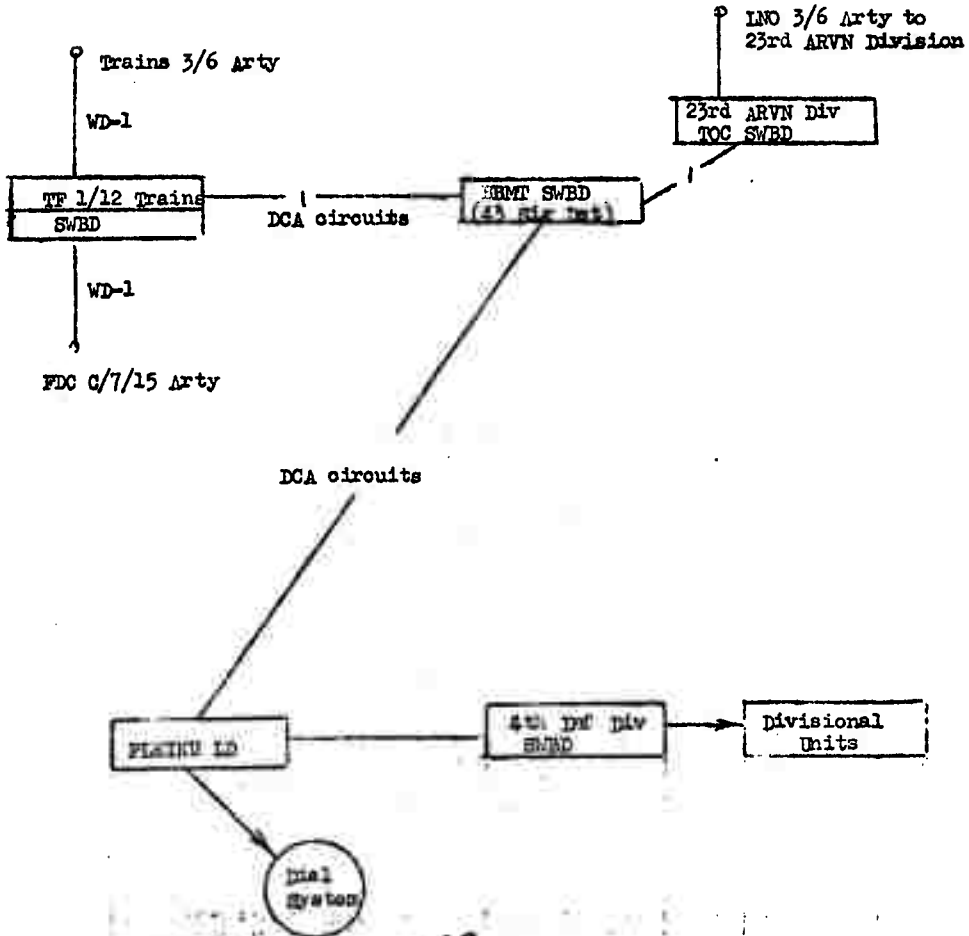

28
4-B-1

CONFIDENTIAL

31

Annex C (Movements) to Combat After Action Report

1. 2 Mar 68 - Btry C, 3d Bn, 6th Arty and Btry B, 5th Bn, 16th Arty moved to Camp Enari. Headquarters and Service Battery 3d Bn, 6th Arty elements moved from Arty Hill to Camp Enari to join with main elements of the column.
2. 3 Mar 68 - Btry C, 7th Bn, 15th Arty moved at 0500H to link up with the other units. Btry C, 3d Bn, 6th Arty, Btry B, 5th Bn, 16th Arty and Hq 3d Bn, 6th Arty moved from Camp Enari; and Btry C, 7th Bn, 15th Arty joined the column just outside of that location. All units moved to the vicinity of grid AQ33287.
3. 7 Mar 68 - Btry B, 5th Bn, 16th Arty and Btry C, 3d Bn, 6th Arty moved to the vicinity of grid AQ829100 to support proposed US/ARVN operation. Returned the same day to grid AQ933287.
4. 10 Mar 68 - Btry C, 3d Bn, 6th Arty moved to the vicinity of grid AQ900270 to provide direct support for Companies B, C and D, 1st Bn, 12th Inf. Returned 11 Mar 68 to grid AQ933287.
5. 13 Mar 68 - Btry C, 3d Bn, 6th Arty, Btry C, 7th Bn, 15th Arty and Btry B, 5th Bn, 16th Arty moved to AQ829100, and set up a new fire support base.
6. 16 Mar 68 - Btry C, 3d Bn, 6th Arty moved to AQ783108 to provide support for Companies A and D, 1st Bn, 12th Inf.
7. 19 Mar 68 - Btry B, 5th Bn, 16th Arty moved to AQ783108 to provide support for Companies A, C and D 1st Bn, 12th Inf.
8. 20 Mar 68 - Btry C, 3d Bn, 6th Arty and Btry B, 5th Bn, 16th Arty moved to AQ776126 to provide support for Companies A, C and D, 1st Bn, 12th Inf.
9. 25 Mar 68 - Btry C, 3d Bn, 6th Arty and Btry B, 5th Bn 16th Arty returned to AQ829100.
10. 28 Mar 68 - 2 tubes of 8" from Btry C, 7th Bn, 15th Arty moved south of Ban Me Thuot vic grid AP764988 on a one day hip shoot to fire on intelligence targets for ARVN.
11. 31 Mar 68 - Two 175's replaced two 8" tubes in Btry C, 7th Bn, 15th Arty.
12. 31 Mar 68 - One 8" from Btry C, 7th Bn, 15th Arty and two 155's from Btry B, 5th Bn, 16th Arty moved to vic AQ790166 for a one day hip shoot to attack the 32nd NVA Regiment.
13. 5 Apr 68 - 8" and 175 guns of Btry C, 7th Bn, 15th Arty moved to Ban Me Thuot East Airfield to take up a permanent position.
14. 6-7 Apr 68 - Btry C, 3d Bn, 6th Arty, Hq 3d Bn, 6th Arty and Btry B, 5th Bn, 16th Arty moved to new FSB at AQ835287.
15. 11 Apr 68 - Btry C, 3d Bn, 6th Arty and Hq 3d Bn, 6th Arty moved to new FSB at AQ781179 to provide fire support for 1st Bn, 12th Inf.
16. 11 Apr 68 - Two 8" from Btry C, 7th Bn, 15th Arty moved to AQ774055 to support new fire base.

29

ANNEX - C

CONFIDENTIAL

CONFIDENTIAL

Annex C (Movements) to Combat After Action Report

32

17. 12 Apr 68 - Btry B, 5th Bn, 16th Arty moved to AQ781179.
18. 13 Apr 68 - Btry C, 7th Bn, 15th Arty moved from AQ774055 back to Ban Me Thuot East.
19. 19 Apr 68 - Btry C, 3d Bn, 6th Arty moved to AQ835287 to provide fire support for Companies C and D, 1st Bn, 12th Inf on their combat assault.
20. 20 Apr 68 - Btry B, 5th Bn, 22nd Arty arrived at Ban Me Thuot East to relieve Btry C, 7th Bn, 15th Arty.
21. 21 Apr 68 - Btry C, 3d Bn, 6th Arty moved to Buon Ho (BQ033287) to prepare for link up with convoy.
22. 22 Apr 68 - Btry C, 7th Bn, 15th Arty departed from Ban Me Thuot at 0600H for hip shoot at Buon Ho and further movement to Pleiku.
23. 22 Apr 68 - Btry B, 5th Bn, 16th Arty and Hq 3d Bn, 6th Arty departed AQ781179 for Pleiku, Btry C, 3d Bn, 6th Arty joined column at Buon Ho.

30

C-2

CONFIDENTIAL

CONFIDENTIAL

ANNEX D: (Significant Missions for U. S. Units) to Combat After Action Report

The following is a list of significant missions fired in support of US Units.

<u>DATE</u>	<u>UNIT</u>	<u>GRID</u>	<u>TARGET</u>	<u>RESULTS</u>
6 March	C/7/15	AQ8636	3NVA in bunkers	1 NVA KIA
8 March	B/5/16	AQ825300	Radio transmitter	Destroyed
8 March	C/7/15	AQ801295	Large Raft	Raft Destroyed
9 March	C/3/6, B/5/16	AQ849250	6 VC	1VC KIA
10 March	C/3/6	AQ8625	Unk. No VC	1VC KIA
20 March	C/3/6, B/5/16 C/7/15	ZV225175	Bn NVA in contact	41 NVA KIA
30 March	C/7/15, B/5/16	AQ7829	32nd NVA Regt.	Unknown
30 March	C/7/15, B/5/16	AQ8028	32nd NVA Regt.	Unknown
30 March	C/7/15	AQ795313	32nd NVA Regt.	1 secondary explosion
8 April	C/3/6, B/5/16	AQ8326	Mortar Fire	Mortars ceased
18 April	B/5/16	ZV2010	Troops in contact	Unknown

ANNEX E: (Significant Missions for US Units) to Combat After Action Report

1. The following is a list of significant missions in support of ARVNS.

<u>DATE</u>	<u>UNIT</u>	<u>GRID</u>	<u>TARGET</u>	<u>RESULTS</u>
17 March	C/7/15	ZV2014	Troops in contact	Unknown
18 March	C/3/6, C/7/15 B/5/16	AQ8107	RFFP under attack	Contact broken
18 March	C/7/15	AQ942014	Village under atk.	2VC KIA, 4 WIA
28 March	C/7/15	AP8889	areaVC concentration	2 VC KIA
15 Mar-6 Apr	C/7/15	Numerous	DEFCONS for vil.	Villages. Defended
1 April	C/3/6, B/5/16	AQ833177	Troops in contact	Contact Broken
8 April	C/3/6, B/5/16	AQ833177	at Quang Nheu	Contact Broken
16 April	C/7/15	AP9496	VC Area	9 VC KIA

2. These fires helped to raise the morale of the local population and hinder operations in the area.

31
CONFIDENTIAL

CONFIDENTIAL

ANNEX D: (Significant Missions for U. S. Units) to Combat After Action Report

The following is a list of significant missions fired in support of US Units.

<u>DATE</u>	<u>UNIT</u>	<u>GRID</u>	<u>TARGET</u>	<u>RESULTS</u>
6 March	C/7/15	AQ8636	3NVA in bunkers	1 NVA KIA
8 March	B/5/16	AQ825300	Radio transmitter	Destroyed
8 March	C/7/15	AQ801295	Large Raft	Raft Destroyed
9 March	C/3/6, B/5/16	AQ849250	6 VC	1VC KIA
10 March	C/3/6	AQ8625	Unk. No VC	1VC KIA
20 March	C/3/6, B/5/16 C/7/15	ZV225175	Bn NVA in contact	41 NVA KIA
30 March	C/7/15, B/5/16	AQ7829	32nd NVA Regt.	Unknown
30 March	C/7/15, B/5/16	AQ8028	32nd NVA Regt.	Unknown
30 March	C/7/15	AQ795313	32nd NVA Regt.	1 secondary explosion
8 April	C/3/6, B/5/16	AQ8326	Mortar Fire	Mortars ceased
18 April	B/5/16	ZV2010	Troops in contact	Unknown

ANNEX E: (Significant Missions for US Units) to Combat After Action Report

1. The following is a list of significant missions in support of ARVNS.

<u>DATE</u>	<u>UNIT</u>	<u>GRID</u>	<u>TARGET</u>	<u>RESULTS</u>
17 March	C/7/15	ZV2014	Troops in contact	Unknown
18 March	C/3/6, C/7/15 B/5/16	AQ8107	RFFP under attack	Contact broken
18 March	C/7/15	AQ942014	Village under atk.	2VC KIA, 4 WIA
28 March	C/7/15	AP8889 area	VC concentration	2 VC KIA
15 Mar-6 Apr	C/7/15	Numerous	DEFCONS for vil.	Villages. Defended
1 April	C/3/6, B/5/16	AQ833177	Troops in contact	Contact Broken
8 April	C/3/6, B/5/16	AQ833177	at Quang Nheu	Contact Broken
16 April	C/7/15	AP9496	VC Area	9 VC KIA

2. These fires helped to raise the morale of the local population and hinder operations in the area.

31
CONFIDENTIAL

Annex F (Logistics) to Combat After-Action Report

1. Logistics support was handled by an FSA located at the Ban Me Thuot East airstrip. Operation of the FSA was handled by a small element from the 1st Logistical Command, elements of the artillery units with the Task Force and personnel from the 1st Battalion, 12th Infantry. The overall supervision of the FSA was given to the S4 from 1st Battalion, 12th Infantry with assistance from the ammunition officer 3d Bn, 6th Arty.

2. Supply Procedure: All supplies were flown to Ban Me Thuot from the Logistical Command Depot at Cam Ranh Bay. Initial stockage of the FSA started approximately 2 days before the task force moved into Ban Me Thuot. At one point there was a shortage of ammunition in the ASP, due to the shortage of aircraft. This problem was solved in approximately 36 hours and ammunition started to arrive in sufficient quantities to stock the ASP and keep the fire base supplied with ammunition.

3. Problem areas:

a. Lack of adequate maintenance support for all the different types of artillery pieces supporting the task force was a continuous problem. The only maintenance support was one track mechanic, one wheeled vehicle mechanic, and one engineer equipment specialist and one signal equipment repairman. There were no artillery or turret mechanics available at Ban Me Thuot and this type of support was needed on many occasions. The artillery mechanic and turret mechanic had to be flown to Ban Me Thuot from Pleiku. The 62nd Maintenance Battalion provided this support when they had personnel available, but due to other commitments in their area of support many times the assistance was not available.

b. Another problem that hindered maintenance was the procurement of parts and getting the parts to Ban Me Thuot. Since no one organization in Pleiku area was responsible, at times all available aircraft were not used because of lack of coordination. Established priorities of scheduled aircraft at times compounded the problem.

4. Recommendations: On further operations of this nature recommend that higher headquarters, i.e. IFFV Artillery or IFFV coordinate with 1st Logistical Command to set up and operate the FSA. Most personnel that worked in the FSA were not familiar with an operation of this type which added to the confusion. Also recommend that elements from 1st Logistical Command provide maintenance support so that parts may be obtained direct from depot stocks, thus eliminating much of the down time while waiting for parts.

5. Organization and planning:

a. The artillery forward rear consisted of one element from each firing battery. They were collocated with 1st Bn, 12th Inf trains at Ban Me Thuot East. The elements consisted of:

HQ & SVC 3d Bn, 6th Arty	- 1 Officer - 2 NCO's - 8 EM - 5 vehicles
Btry C, 3d Bn, 6th Arty	1 NCO - 5 EM - 7 vehicles
Btry B, 5th Bn, 16th Arty	1 NCO - 7 EM - 5 vehicles
Btry C, 7th Bn, 15th Arty	32 1 NCO - 14 EM - 8 vehicles

35

CONFIDENTIAL

Annex F (Logistics) to Combat After Action Report

On arrival at the trains area, minimum equipment was available for the operation of a forward supply area. The artillery elements made use of the infantry equipment to pass messages and contact the fire support base.

b. Rations: One E-5 from Svc Btry, 3d Bn, 6th Arty, was in charge of ration break-down between the batteries.

(1) Initial plans indicated the rations for all artillery units were to be sent together. The E-5 had no experience in ration break-down and there was no one at the trains area that could break down the rations between the batteries. Therefore the rations were sent to the FSB all together based on the number of personnel at the FSB plus 10%. The result was that only one battery got rations and there was no break down at the FSB which caused a small problem soon resolved by the Mess Sergeants.

(2) The problems were solved by the NCOIC breaking the rations down between the batteries at the trains area. This was continued until termination of the task force.

(3) Recommendations:

(a) That a ration breakdown man be included in the rear detachment.

(b) If a ration breakdown man is not available recommend that an NCO with the experience in ration breakdown be available to train someone.

6. POL: POL was available from the 255th QM located at Ban Me Thout, however, a method of transporting POL presented some problems. 3 POL trucks were available. 1 from Btry B, 5th Bn, 16th Arty, 1 from 1st Bn, 12th Inf, and one from 1st Bn, 69th Armor. The one truck from the 5th Bn, 16th Arty element was the only one with force forward and the capacity was limited for 3 SP artillery batteries. Transporting POL in barrels was attempted but this required extra personnel because they are difficult to handle. The use of rubber blivits worked well but the shortage of hoses and nozzles limited their use. Recommendations are that 1 POL truck be available plus blivits and hoses and nozzles for each out lying battery (blivits can be air lifted and POL trucks cannot).

7. Maintenance: Maintenance capabilities posed a major problem.

a. Three self-propelled batteries were at the FSB with only a battalion contact maintenance team.

b. Only 2nd echelon maintenance was available at the trains.

c. Battalion maintenance did not have the capability to properly support the 155mm and the M107 and M110 batteries.

d. No higher maintenance support was clearly designated to the task force.

Annex F (Logistics) to Combat After Action Report

e. The ability to transport parts was severely limited due to the aircraft configuration. (Fixed wing to Ban Me Thuot and rotary wing to the fire support base).

f. Recommendations:

(1) The battery maintenance remain with the battery. That the battalion maintenance provide a team to work out of the trains area. This team would consist of wheel mechanic and track mechanic, as well as turret mechanic and artillery mechanic. The personnel could be supplied from each battalion that has a battery attached therefore having personnel familiar with each weapon concerned available.

(2) That a higher support be designated for the task force so parts and support would be available from one location instead of having to contact a different unit for each different weapon. A radio repairman from battalion should be on the maintenance team with higher support readily available.

8. Class V; Class V posed no significant problems at the battalion level down. Each battery handled their respective Class V resupply both by vehicle and aircraft.

9. Miscellaneous: At least one NCO and vehicle from each battery was located at the trains area to assist in handling small items and POL requests from the batteries. He assisted personnel in-transit and met aircraft carrying parts and personnel. The ammunition NCO in most cases handled this job very satisfactorily.

10. Command and Control in the trains area:

a. Initially the artillery organization in the trains area was unsatisfactory. Three 5 ton trucks with drivers, an ammunition NCO and one supply man were sent to operate the trains area for the artillery. The battalion ammunition officer was soon sent to organize and operate the service element at the trains area. Since this area was somewhat overlooked in the initial planning; the required equipment for his operation had to be made available from equipment meant for other uses.

b. After organization of all battery trains elements the service element operated smoothly.

37

CONFIDENTIAL

ANNEX G: (Aircraft Utilization) Combat After Action Report (cont.)

1. Aircraft: The basic aircraft used by the task force for visual reconnaissance was the OO-1 Bird Dog. The missions of the aircraft were radio relay, Vr, convoy cover, and maneuver element cover, in addition to artillery mission observation. In all roles this aircraft performed well. The majority aircraft support was provided by the 3rd and 4th platoon of the 219th Recon Airplane Company. Each Platoon supplied the Task Force with 1 plane to stay at Ban Me Thuot for 5 days. Each plane would fly 4½ hours per day, giving a total of 9 hours of air coverage per day. In most cases this amount of time proved to be sufficient for the normal operations.
2. Aerial Observers: All AO's were furnished by the Task Forces. In all cases these were qualified personnel with the majority of them coming from artillery.
3. Problems: The main problem came from lack in depth in aircraft. Because of shortage of aircraft in good mechanical condition, the task force was forced to accept aircraft down time.
4. Recommendations: That coordination be made to insure that the maximum of aircraft be available to such an operation, ie., that aircraft be rotated to insure that a minimum of down time is incurred by the supporting units, or that additional aircraft be supplied to enable the support units to absorb the aircraft down time. Basically most of the problems that came up were solved without too much difficulty. However, with the availability of extra aircraft most maintenance problems could be compensated for. In order to have continuous daylight coverage, three aircraft are required.

CONFIDENTIAL

CONFIDENTIAL

39

ANNEX I: (Casualty Report) to Combat After Action Report

1. The entire operation resulted in the following enemy casualties.
 - a. 60 KIA confirmed
 - b. 13 KIA possible
 - c. 5 CIA
2. US Casualties
 - a. 9 KIA
 - b. 32 WIA
3. The artillery casualties: 1 WIA from Battery B, 5th Battalion, 16th Artillery.
4. Artillery accounted for at least 20 enemy KIA.

37

CONFIDENTIAL

ANNEX I

CONFIDENTIAL

40

Annex J (Headquarters Detachment, 3rd Battalion, 6th Artillery) to-Combat After Action Report

1. General: The Headquarters Detachment, 3d Battalion, 6th Artillery Forward was organized from resources of Service and Headquarters Batteries. The unit was specifically tailored to perform the following missions:

- a. Provide tactical and technical fire direction to assigned, attached and supporting units.
- b. Provide supervision and coordination for:
 - (1) Logistics support including:
 - (a) Supplies Class 1 through 5.
 - (b) Maintenance - automotive, signal and crypto.
 - (c) Transportation - ground and air.
 - (2) Personnel activities:
 - (a) US Mail
 - (b) Individual personnel actions
 - (3) Intelligence collection and dissemination.

2. Organization (See Fig. 1)

a. Personnel:

<u>SECTION</u>	<u>ACTUAL JOB TITLE</u>	<u>ACTUAL MOS</u>	<u>GRADE</u>	<u>QUANTITY</u>
HQ	Opns Officer	2162	Maj	1 ea
	Comm Off/Hq Cmdt	0200	Cpt	1 ea
	Survey Ch/1st Sgt	82c40	E-7	1 ea
LNO	LNO	1193	Cpt	1 ea
	LNO Sgt	82C40	E-6	1 ea
TRAINS	RTO	13A10	Sp/4	2 ea
	Ammo Off/Train Co	1193	Lt.	1 ea
	VTR Operators	63C20	E-3	2 ea
	RTO	82C20	E-3	1 ea
MESS	Ammo Sgt	13D40	E-6	1 ea
	Cooks	94B20	Sp/5, Sp/4	2 ea
MAINT.	Mechanic	63C70	Sp/4	1 ea
SURVEY	Surveyor	82C20	Sp/4, PFC	2 ea
OPERATIONS	Asst Opns Officer	1193	Cpt	1 ea
	Air Observer	1193	Lt	1 ea
	Opns Specialist	13E20	Sp5	1 ea
	RTO	13A10	Sp/4, PFC	2 ea
FDC	Chief Computer	13E20	SFC	1 ea
	Chart Operators	13E20	PFC	4 ea
	Computers	13E20	Sp/5, Sp/4	4 ea
INTELIGENCE	Intell Sgt.	13E20	SSG	1 ea

38 J1

ANNEX J

CONFIDENTIAL

CONFIDENTIAL

41
Annex J (Headquarters Detachment, 3d Battalion, 6th Artillery) to Combat After Action Report

INTELLIGENCE	Intell clerk	13A10	PFC	1 ea
COMMUNICATIONS	Wire Chief	36K40	SGT	1 ea
	Wire Man	36K20	Sp4, PFC	3 ea
	PTT operator	05C20	Sp/4	2 ea
	Radio kepairman	36K20	Sp/5	1 ea

b. Equipment & Vehicles:

<u>QUANTITY</u>	<u>ITEM</u>
1 ea	2½ Ton Van with 1½ Ton Trailer
2 ea	2½ ton trucks
3 ea	¾ ton trucks with trailers
1 ea	M113 APC with ¾ ton trailer
1 ea	10Kw generator
1 ea	1.5Kw generator
1 ea	3.0Kw 28 volt generator
1 ea	Fire Direction kits
1 ea	Plotting Chest
1 ea	Field Desk
2 ea	Folding Tables
6 ea	Water Cans
6 ea	RC 292
8 ea	Field Telephones
1 ea	AN-CBR 5
1 ea	Survey Set
1 ea	Light Set
2 ea	AN-PRC 25's
2 ea	SB-22
1 ea	Field Safe
6 ea	Shovels
2 ea	Picks
1 ea	Axe
40 ea	Cases of C-Rations
5000	Sandbags
40 Sheets	SSP
100 ea	Engineer Stakes
4 ea	8' X 8' X 16' Timbers
12 ea	8' X 8' X 16' Timbers
14 ea	Culvert Sections
1 ea	250 Gal Bladder
1 ea	Cross Cut Saw
1 ea	Mechanical Tool Set #1
12 ea	Set of Maps
4 ea	Colman Lanterns
11 miles	WD-1 Wire

Annex J (Headquarters Detachment, 3d Battalion, 6th Artillery) to Combat After Action Report 42

3. Physical Layout

a. The facilities constructed by the detachment were as follows:

- (1) Operations Center
- (2) Fire Direction Center
- (3) Battalion CO and S-3 Quarters
- (4) Enlisted Personnel Bunker
- (5) Communications Bunker
- (6) Perimeter Bunker
- (7) RTT Station

b. Figure 2 depicts the arrangement of these facilities into an area 150' square. The major construction effort was the creation of the FDC/operations personnel bunker within a trench 13' wide and 45' long and dug 7' deep by a bulldozer.

c. Construction of these facilities require 20 men 2 days to complete. The materials required for each bunker are listed in Appendix 1 (Bunker Material). The work was continued during the first day until at least all areas had one layer of sandbags overhead. During the second day, a second layer of sandbags was laid, communications wire and power cables were laid. The third day was spent cleaning up personnel items and areas, rechecking all equipment and weapons.

4. Communications (see Annex B)

5. Security

a. Tactical SOP of the 3rd Battalion, 6th Artillery established the methods by which all elements would move by convoy.

b. Within the FSB, Headquarters personnel were organized into two squads of approximately 8 men each. These teams constituted the reaction force for the headquarters. Each night weapons and ammunition were inspected, and squad leaders were instructed to pass words and predetermined alert and defensive positions in event of attack.

c. In addition, a guard post was manned within the headquarters area. One man shifts were established so each man had a maximum of 2 hours duty per night. The APC, M113 with .50 caliber machine gun was the primary guard.

6. Logistics: The headquarters commandant coordinated all logistic requirements for the artillery headquarters and firing batteries within the FSB.

43

CONFIDENTIAL

Annex J (Headquarters Detachment, 3rd Battalion, 6th Artillery) to Combat After Action Report

- a. Resupply requirements were obtained from each unit by HQOH daily, consolidated and submitted to the trains company, 3rd Battalion, 6th Artillery by FM radio.
- b. Coordination of all resupply requirements were also made with the following personnel:
 - (1) S4 3rd Battalion, 6th Artillery
 - (2) Trains Co., 3rd Battalion, 6th Artillery
 - (3) S4 air, 1/12 Infantry
 - (4) S4 trains 1/12 Infantry
 - (5) Resupply specialist Hq Battery, 3rd Battalion, 6th Artillery
- c. Resupply: An individual with a phone to the operations switchboard was stationed at the resupply pad to coordinate the issue of all items within the FSB. In addition, the headquarters commandant would recheck the receipts daily with each unit Commander.

41

JH

CONFIDENTIAL

Annex J (Headquarters Detachment, 3d Battalion, 6th Artillery) to Combat After Action Report

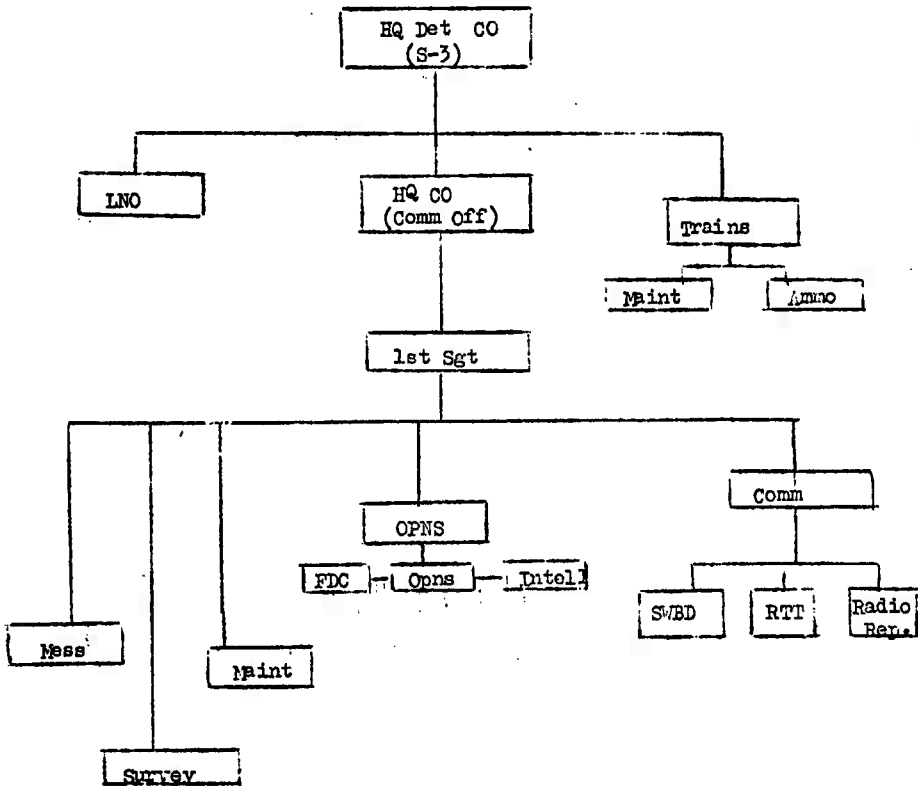

42

Figure 1 - Organizational Chart
HQ Det, 3/6 Arty FWD

45

Annex J (Headquarters Detachment, 3d Battalion, 6th Artillery) to Combat After Action Report

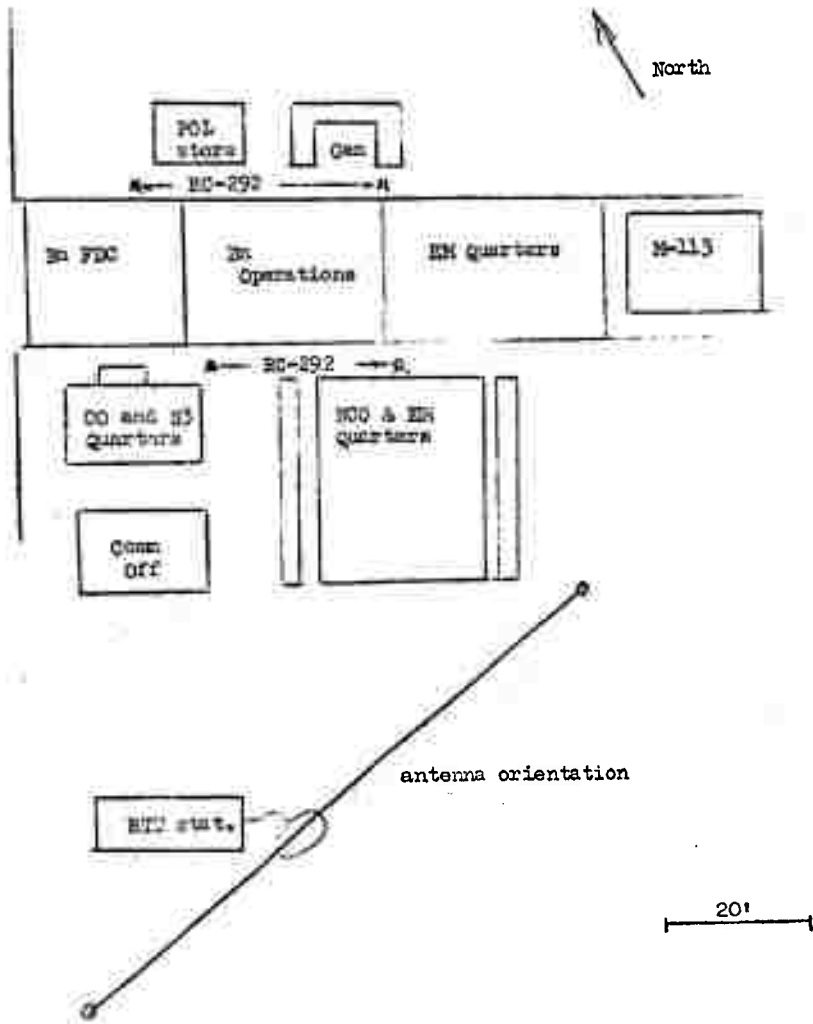

43

Figure 2 - physical layout
HQ Det, 3/6 Arty FWD

CONFIDENTIAL

Annex J (Headquarters Detachment, 3d Battalion, 6th Artillery) to Combat After Action Report 46

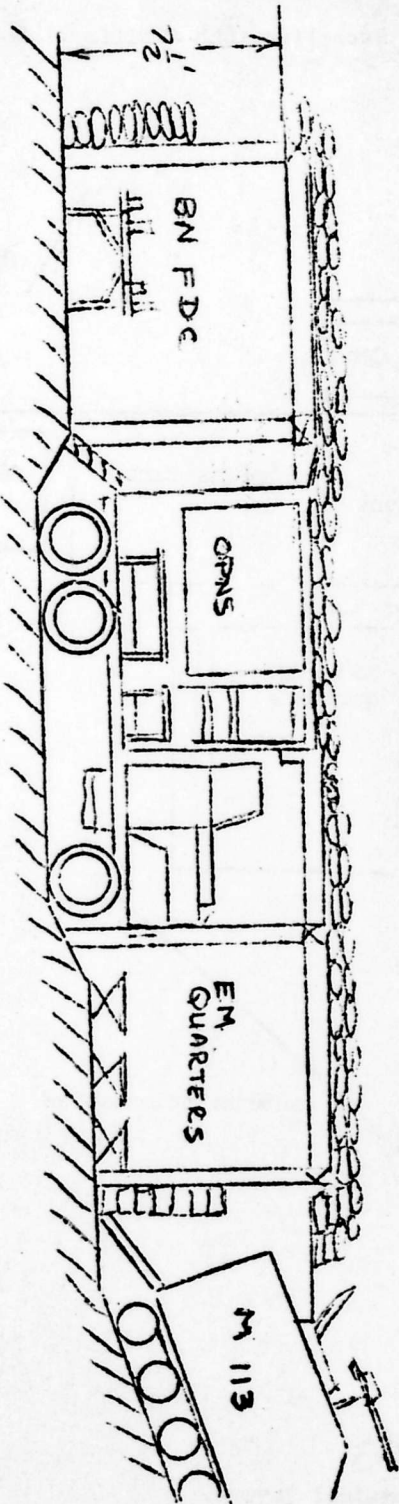
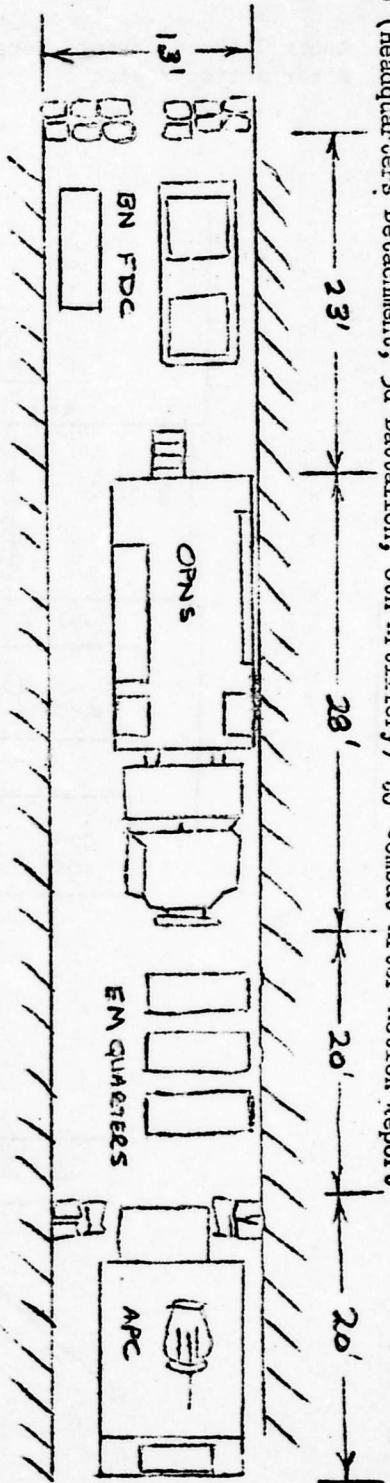

Figure 3 FDC/OPNS/PERSONNEL BUNKER
HQ Det 3/6 Arty

CONFIDENTIAL

44

CONFIDENTIAL

47

APPENDIX 1 (Estimated Bill of Materials) to Annex J (Headquarters Detachment, 3d Battalion, 6th Artillery) to Combat After Action Report

FACILITIES	8' pickets	4' pickets	14' SSP	SAND BAGS	20 penny spikes	8X8X18' timbers	8X8X16' timbers	GP medium tents	16' Logs	10' Log uprights	6' dia culverts
FDC Section			7	1500	12	2		1		2	
OPNS Section	60			2000	12		1				
Quarters Section		10	7	1500	12	2		1		2	
Rn CO and S-3 QTRS	15		6	800			1				
Comm Off Qtr	15		6	800			1				
NCO and EM Qtr				1600							18
Perimeter Bunker #1				500					6		
Perimeter Bunker #2				500					6		
RTT station	25			500					1		
Generator shelter	20			160							
POL shelter	20			160							
Spare Material	10			3000							
Totals	225		40	13000	36	4	3	2	13	4	18

45

CONFIDENTIAL

Annex K (Liaison) to Combat After Action Report

48

1. Goal: The mission of the liaison section at 23d ARVN Division was to integrate US artillery fires with both 23d ARVN division and Sector operations. This integration goes from such immediate requirements as grid clearance, air advisories and massing of US and ARVN artillery to projects such as selling the ARVN on the use of US artillery. Much progress has been made since 5 March 1968; however, much more progress can be made.

2. Problem Areas: The initial problem upon arriving in Ban Me Thuot was in determining whether to establish liaison at sector or division. Sector handles political clearance (concerns villages, shrines, plantations) at all times and also handles military clearance (takes into account troop locations and missions) when the land falls in no ones area of operation. When the land does fall into an AO, the AO commander makes clearances. Clearances could have been obtained by establishing liaison at either headquarters. However, Division headquarters was chosen due to these factors:

a. Coordination of US-ARVN fires would be easier. (Note: In some cases Sector has artillery attached but in the case of Ban Me Thuot all of the artillery was organic to 23d ARVN Division).

b. The FAC center is at 23d ARVN DTOC.

c. Division was responsible for all aspects of the defense of Ban Me Thuot. The choice turned out to be a good one and very few problems were encountered. TOT's and massing of US and ARVN artillery became a common occurrence. Since Division controls the fires near Ban Me Thuot, it gave the liaison officer an opportunity to "sell" US artillery. The 23rd ARVN Division personnel had little experience with US artillery and were unsure of its accuracy. Initially, several promising targets presented themselves south of the city and the liaison officer requested to fire US artillery at them. ARVN refused because they did not want US artillery firing over their city. It took several days to convince them to use the US artillery. Now, ARVN themselves request reinforcing fires over the city. It was soon discovered that ARVN artillerymen are very confident of their capability and take pride in supporting their troops. Therefore they will not request US artillery unless they themselves cannot reach the target or need reinforcing fires. On one occasion a unit made contact and the advisor with the element requested US artillery to fire even though the ARVN artillery could reach the target and he had an ARVN FO. The grid was cleared and US artillery fired it. However, a day later, it was discovered from Cpt Dao, our ARVN assistant, that the ARVNs were very unhappy about it. Since we got the grid cleared through them, there was no problem on the US side but the ARVNs went through channels to insure that the advisor did not repeat his "mistake". This problem also presented itself during the mortar attacks on the city of Ban Me Thuot. The ARVN artillery takes pride in the job that it did during the T&F offensive and felt that they could handle the situation by themselves. They go to great lengths to protect the city from attacks and will only request US artillery when they believe it absolutely necessary for reinforcing fires.

The US was very successful in integrating artillery into the defense plans outside of the city, especially non-divisional units and particularly the Trung Son cadres. The Trung Son cadre is a Montagnard counterpart to the

46

CONFIDENTIAL

49 Annex K (Liaison) to Combat After Action Report

Vietnamese RD new life cadre. The Trung Son cadre has the mission of bringing hamlets and villages back under GVN control. This program has been very successful and the Viet Cong fear it. Just previous to the TET offensive, the program had repatriated many villages outside of Ban Me Thuot. However, after TET, a major portion of the job had to be done over again. This, coupled with the fact that the territory which had long been friendly was now controlled by the VC, greatly lowered the morale of the cadre. Accordingly, US artillery support was offered and accepted by the Trung Son advisor. Since that time US artillery has fired defensive targets around the Trung Son HQ and 4 villages. Additional defensive targets are scheduled around villages in the Ban Me Thuot area.

3. Operations:

a. One village, Boun Sa Pour, had been attacked by mortars for four nights in a row. The VC were so confident of themselves in fact, that they made propaganda leaflets which stated they would attack for 10 nights in a row and even gave the number of rounds that were to be fired. The leaflets also stated that the reason they were attacking was to drive the cadre out of the village. The ARVN had not fired in support of the village. On the fifth night as promised, the attacks started again, this time, the cadre called for fire and US artillery responded. The attack stopped and the next day a sweep of the area revealed blood trails and two bodies. The village was not attacked for more than a month after that, when it was cut short once again by US artillery.

b. The cadre's morale is now high because they know they have artillery support standing behind them. Also the Trung Son advisors say that they can speed up their program considerably because of the support the US has offered them.

c. A continuing objective is the integration of US and ARVN artillery fires. This was initially accomplished during the combined US/ARVN operations north of Ban Me Thuot in March 1968. However, many improvements need to be made by ARVN artillery in areas of computation of met data and registrations. These items are of the utmost importance to improve accuracy and massing fires. We have talked to the US advisor and the ARVN Division Artillery Commander about registration. The advisor is continuously attempting to persuade ARVNs to register but has not been successful to date. They have aircraft and qualified observers but they will not register. The Divarty Commander says that the reason that they do not register is because they cannot afford to fire all of that ammunition every other day or so and that they can get the rounds out with enough accuracy and safety without it.

d. When the radar arrived and the Division Artillery Commander was approached with the proposition of registering with it, thereby saving ammunition and then applying the MET and getting an approximate VE, later using the MET only. He seemed interested. He has reproduced the MET form into Vietnamese and has his people practice computing the MET. Hopefully, he will soon take the next step and register.

47

CONFIDENTIAL

Annex K (Liaison) to Combat After Action Report

e. During our stay in Ban Me Thuot we were assisted by two ARVN LNO's Cpt Pku, and Cpt DAO. Both of these men helped in clearing fires, and in fact they cleared all fires in the AO. They gave us an appreciation of the high caliber of ARVN artillery officers.

f. On one occasion while a RF outpost was in contact with a company sized element, two of the task force artillery units fired in support of the outpost, breaking the attack.

g. IFFV is bringing survey control into the area. Control will be extended to all US and ARVN batteries in the Ban Me Thuot when the survey is completed.

4. Other Points:

a. The liaison officer should understand the advisory effort of MACV. The LO should work almost entirely through the advisor.

b. The air advisory system is adequate.

c. The LO section should have at least two radios. One will monitor the battalion CF and one will monitor sectors frequency, and also be used for air advisories.

d. The Liaison Officer should work very closely with the Intelligence sections of both Division and sector. The exchange of intelligence information was a valuable aid during the Task Force 1/12 operations in Ban Me Thuot.

5. Continuous liaison by Commanding Officer, 3d Bn, 6th Arty was conducted with the advisors at Sector, District, Special Forces, 23rd ARVN Division Artillery. Visits were made to all the 23rd ARVN Division Artillery battalion headquarters and batteries in the Ban Me Thuot area. Through these visits, the commanding officer, 3d Bn, 6th Arty enhanced the relations and spirit of cooperation between all artillery units and clearance agencies in the Ban Me Thuot area.

DOCUMENT CONTROL DATA - R & D

(Security classification of title, body of abstract and indexing annotation must be entered when the overall report is classified)

1. ORIGINATING ACTIVITY (Corporate author) OACSFOR, DA, Washington, D.C. 20310		2a. REPORT SECURITY CLASSIFICATION Confidential	
		2b. GROUP 4	
3. REPORT TITLE Combat After Action - Operation BAN ME THUOT, 3d Bn, 6th Arty			
4. DESCRIPTIVE NOTES (Type of report and inclusive dates) Experiences of unit engaged in counterinsurgency operations, 3 Mar - 22 Apr 1968 (U)			
5. AUTHOR(S) (First name, middle initial, last name) CO, 3d Battalion, 6th Artillery			
6. REPORT DATE 25 April 1968		7a. TOTAL NO. OF PAGES 49	7b. NO. OF REFS
8a. CONTRACT OR GRANT NO.		8b. ORIGINATOR'S REPORT NUMBER(S) 68X023	
9. PROJECT NO. N/A		9d. OTHER REPORT NO(S) (Any other numbers that may be assigned this report)	
10. DISTRIBUTION STATEMENT			
11. SUPPLEMENTARY NOTES N/A		12. SPONSORING MILITARY ACTIVITY OACSFOR, DA, Washington, D.C. 20310	
13. ABSTRACT			

49

THIS REPORT HAS BEEN DELIMITED
AND CLEARED FOR PUBLIC RELEASE
UNDER DOD DIRECTIVE 5200.20 AND
NO RESTRICTIONS ARE IMPOSED UPON
ITS USE AND DISCLOSURE.

DISTRIBUTION STATEMENT A

APPROVED FOR PUBLIC RELEASE;
DISTRIBUTION UNLIMITED.