

UNCLASSIFIED

AD NUMBER

AD423438

LIMITATION CHANGES

TO:

Approved for public release; distribution is unlimited.

FROM:

Distribution authorized to U.S. Gov't. agencies only; Administrative/Operational Use; AUG 1963. Other requests shall be referred to Air Force Cambridge Research Labs., Hanscom AFB, MA.

AUTHORITY

AFCRL per DTIC form 55

THIS PAGE IS UNCLASSIFIED

UNCLASSIFIED

AD 4 2 3 4 3 8

DEFENSE DOCUMENTATION CENTER

FOR

SCIENTIFIC AND TECHNICAL INFORMATION

CAMERON STATION, ALEXANDRIA, VIRGINIA



UNCLASSIFIED

NOTICE: When government or other drawings, specifications or other data are used for any purpose other than in connection with a definitely related government procurement operation, the U. S. Government thereby incurs no responsibility, nor any obligation whatsoever; and the fact that the Government may have formulated, furnished, or in any way supplied the said drawings, specifications, or other data is not to be regarded by implication or otherwise as in any manner licensing the holder or any other person or corporation, or conveying any rights or permission to manufacture, use or sell any patented invention that may in any way be related thereto.

**MEASUREMENTS OF ARTIFICIALLY INJECTED ELECTRONS
FROM SATELLITE 1962 BETA KAPPA**

R. V. Smith
W. L. Imhof
J. C. Bakke
J. B. Reagan
J. H. Rowland

Lockheed Missiles and Space Company
Research Laboratories
Palo Alto, California

Project 8600
Task 860004

Contract AF 19(628)-2421
FINAL REPORT
August 1963

Prepared for
AIR FORCE CAMBRIDGE RESEARCH LABORATORIES
OFFICE OF AEROSPACE RESEARCH
UNITED STATES AIR FORCE
BEDFORD, MASSACHUSETTS

Requests for additional copies by Agencies of the Department of Defense, their contractors, and other Government agencies should be directed to the:

DEFENSE DOCUMENTATION CENTER (DDC)
CAMERON STATION
ALEXANDRIA, VIRGINIA

Department of Defense contractors must be established for DDC services or have their 'need-to-know' certified by the cognizant military agency of their project or contract.

All other persons and organizations should apply to the:

U. S. DEPARTMENT OF COMMERCE
OFFICE OF TECHNICAL SERVICES
WASHINGTON 25, D. C.

MEASUREMENTS OF ARTIFICIALLY INJECTED ELECTRONS
FROM SATELLITE 1962 BETA KAPPA

R. V. Smith
W. L. Imhof
J. C. Bakke
J. B. Reagan
J. H. Rowland

Lockheed Missiles and Space Company
Research Laboratories
Palo Alto, California

Project 8600
Task 860004

Contract AF 19(628)-2421
FINAL REPORT
August 1963

Prepared for
AIR FORCE CAMBRIDGE RESEARCH LABORATORIES
OFFICE OF AEROSPACE RESEARCH
UNITED STATES AIR FORCE
BEDFORD, MASSACHUSETTS

FOREWORD

The work discussed in this report was performed by the Physical Sciences Laboratory of the Lockheed Missiles and Space Company Research Laboratories under Contract AF 19(628)-2421 with the Air Force Cambridge Research Laboratories.

The authors wish to thank V. A. Olivier and A. D. Bacalski for their contributions in instrument development, V. P. Fenton, G. P. Minalga, D. Pefferle, and their associates for cooperation in vehicle integration, and F. E. Washington, D. L. Carr, M. R. Miller, S. J. Norman, and L. R. Seidel for their assistance in data analysis.

We wish to acknowledge the support, understanding, and patience of the Air Force Satellite Systems Division and 6594th Aerospace Test Wing. Without the cooperation of a great number of persons in each organization, these measurements would not have been possible.

ABSTRACT

Omnidirectional flux measurements have been carried out on a special Air Force satellite to establish the intensity, spacial extent, and spectral variations of fission electrons injected into trapped orbits in the earth's magnetic field from various high-altitude nuclear detonations. Data are presented from the period 27 October to 21 November 1962. Omnidirectional electron fluxes above 1.2 Mev are given in the B-L coordinate system for $L = 1.18$ to 1.70 , and as a function of time also for $L = 1.9$ to 3.5 . In addition, ratios of the outputs of two detectors with thresholds at 1 and 2 Mev are given versus L on 27 and 29 October, and versus time for $L = 2.1$, illustrating the spectral variations observed. Data analysis has not been completed; therefore, neither comparisons with other experiments nor conclusions are attempted.

CONTENTS

Section		Page
1	Introduction	1
2	Description of Experiment	4
3	Calibration of Detectors and Associated Electronics	8
4	Geometric Factors	9
5	Data Collection and Processing	12
6	Results	13
7	References	25

ILLUSTRATIONS

Figure		Page
1	Typical Orbits in B-L Space	3
2	Schematic Diagram of Hemispherical Plastic Scintillation Detector	5
3	Photograph of Hemispherical Detector	6
4	Photograph of Detector Package	7
5	Fluxes Observed in the Region of Overlap Between Detectors	11
6	Electron Fluxes Above 1.2 Mev on 1 November for L Shells of 1.7 and Below	14
7	Low-Altitude Isoflux Contours in B-L Space for 1 November, Compared With Those for 3 September	15
8	High-Altitude Flux as a Function of Time and B, for $L = 1.9$	16
9	High-Altitude Flux as a Function of Time and B, for $L = 2.1$	17
10	High-Altitude Flux as a Function of Time and B, for $L = 2.3$	18
11	High-Altitude Flux as a Function of Time and B, for $L = 2.5$	19
12	High-Altitude Flux as a Function of Time and B, for $L = 2.9$	20
13	High-Altitude Flux as a Function of Time and B, for $L = 3.5$	21
14	Ratio of 2- to 1-Mev Detector Output as a Function of Time for $L = 2.1$	22
15	Ratio of 2- to 1-Mev Detector Output as a Function of L on 27 and 29 October	24

Section 1
INTRODUCTION

In order to assess the rather unexpected intensities of trapped electrons resulting from the Starfish high-altitude nuclear detonation of July 9, 1962, several special research payloads were hurriedly assembled during the fall of 1962 and scheduled for flight aboard various satellites. From September to December a great number of separate measurements were carried out by many scientific experimenters in a cooperative NASA-DOD program. First, a series of experiments were carried piggy-back on a number of Air Force satellites, under the direction of the Lockheed Research Laboratories. Second, a special Air Force satellite was launched with an electron-measuring payload, under the direction of the Cambridge Research Laboratories. And third, a special NASA satellite, Explorer XV, was launched for the same purpose, under the direction of the Goddard Space Flight Center. Each of these three programs contained experiments from various scientific groups. Vehicle fortunes were far beyond those expected from statistics, with almost 100% performance. The result was a tremendous volume of data on the spacial distribution, spectrum, angular distribution, and time history of electrons artificially injected and trapped in the earth's field as a result of not only the Starfish detonation, but some Soviet high-altitude detonations as well. All of these inter-related data from many measurements are now being analyzed by the various experimenters. Some preliminary results have been given at two NASA-DASA Symposia (Refs. 1, 2, and 3), but in general the individual experiments have not yet been analyzed in sufficient detail to allow final comparison and evaluation of the overall physical picture.

This report will describe only a small part of the above program, namely the LMSC experiment carried on the special Air Force satellite, 1962 beta kappa. It is intended to document the work carried out under contract AF 19(628)-2421, namely: the development, fabrication, checkout, and vehicle integration of that experiment; and a preliminary analysis of the data. It should be understood that final data analysis has not been completed for either this or other LMSC trapped electron experiments. Only preliminary results have been obtained; therefore, neither comparisons with other experiments nor conclusions will be attempted at this time.

Analysis of data from this and other LMSC trapped electron experiments has also been carried out under separate contracts with the Radiation Division of DASA and with SSD, Air Force Systems Command. Therefore, it is inevitable that some of the results reported here have been obtained under these other contracts.

The data to be discussed were acquired during the period 27 October to 21 November 1962. On 1 November, the vehicle parameters were as follows:

apogee	5580 km at 21° S
perigee	198 km
inclination	71.5 deg
period	148 min

The vehicle tumbled in orbit, with a principal period of 125 sec. Figure 1 shows the orbital coverage in B-L space at approximately 1 November. The particular orbits shown are for those longitudes which give limits on the B-L space traversed by perigee and apogee passes, with the space between being covered by orbits at intermediate longitudes. The excluded region represents that portion of space near the equator which was between apogee and perigee; it was eventually covered by the slow precession of the line of apsides toward the poles at the rate of 0.8 deg/day.

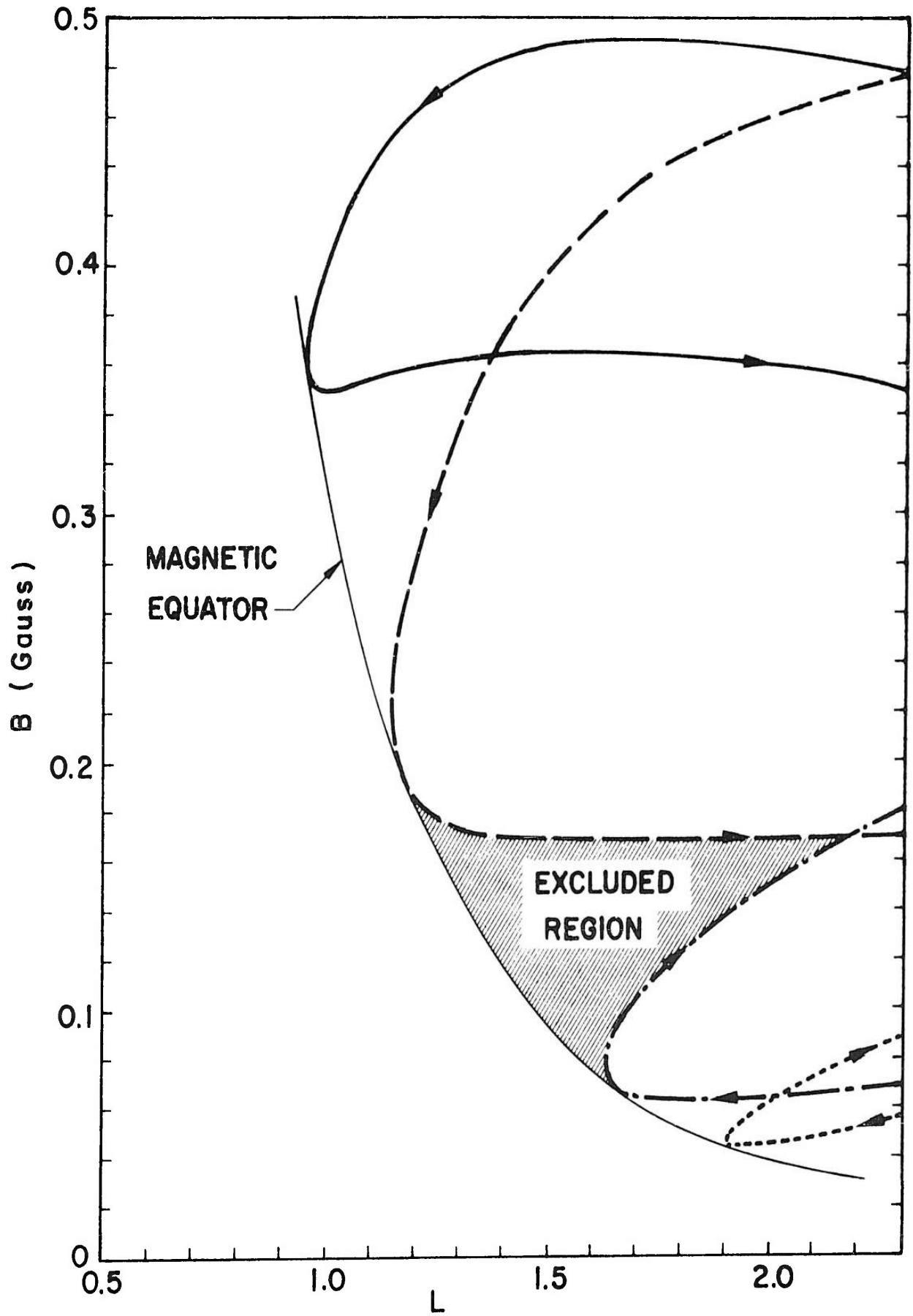

Fig. 1 Typical Orbits in B-L Space

Section 2
DESCRIPTION OF EXPERIMENT

The LMSC experiment was designed to characterize a fission beta spectrum and to measure its omnidirectional intensity over a dynamic range of eight decades, from 10 to 10^9 electrons/cm² sec. Threshold detectors were used, with three counting all electrons with energy above approximately 1 Mev, one counting above 2 Mev, and two above 5 Mev. All were shielded plastic scintillators viewed by photomultiplier tubes in a geometry shown typically in Figs. 2 and 3. These detectors were essentially the same as those described previously (Ref. 4) with certain significant variations. Scintillator sizes were reduced to 3/8 in. by 3/8 in. cylinders on this later flight and the shielding was changed from cylindrical geometry to that of a hemisphere in order to make a 2π solid angle of view which could be calculated in a more straightforward manner. The hemispherical aluminum shields had thicknesses of 0.31, 0.84, and 2.35 gm/cm² for the 1-, 2-, and 5-Mev detectors respectively. Figure 4 is a photograph of an entire detector package.

Two instruments were used to cover the lower portion of the dynamic range at thresholds of 1 and 5 Mev. For these detectors, individual pulses were counted, with an electronic threshold corresponding to an energy deposit in the scintillator of approximately 400 kev. Pulses were recorded on double logarithmic ratemeters in order to cover a wide dynamic range in flux encountered and telemetered to ground as analog voltages.

A series of four total energy detectors was used to cover the upper portions of the dynamic range at all three thresholds. Two of these were devoted to separate intensity ranges at 1 Mev, with shielding and scintillator geometry which was identical to that for the 1-Mev individual particle detector. The third and fourth utilized the 2- and 5-Mev shielding, the latter geometry being identical to the 5-Mev individual particle detector. For these four total energy detectors, light from the plastic scintillator was recorded as a total d. c. intensity on a logarithmic scale, rather than as individual pulses. This scheme produced several interesting comparisons with the individual particle detectors. First, it was possible to extend the dynamic range to somewhat beyond 10^9 electrons/cm² sec, with an overlap region between detectors which provided a useful internal cross calibration in flight. Secondly, these latter detectors measured total energy deposit within the limits of linearity of the scintillator conversion efficiency, including all secondary effects produced in the shielding. It was possible, by careful laboratory calibration of the particular geometries used, to ascertain an experimental average energy deposit per electron in various spectra and thus intercalibrate the geometry used for both types of detectors, in terms of both dose rate and flux.

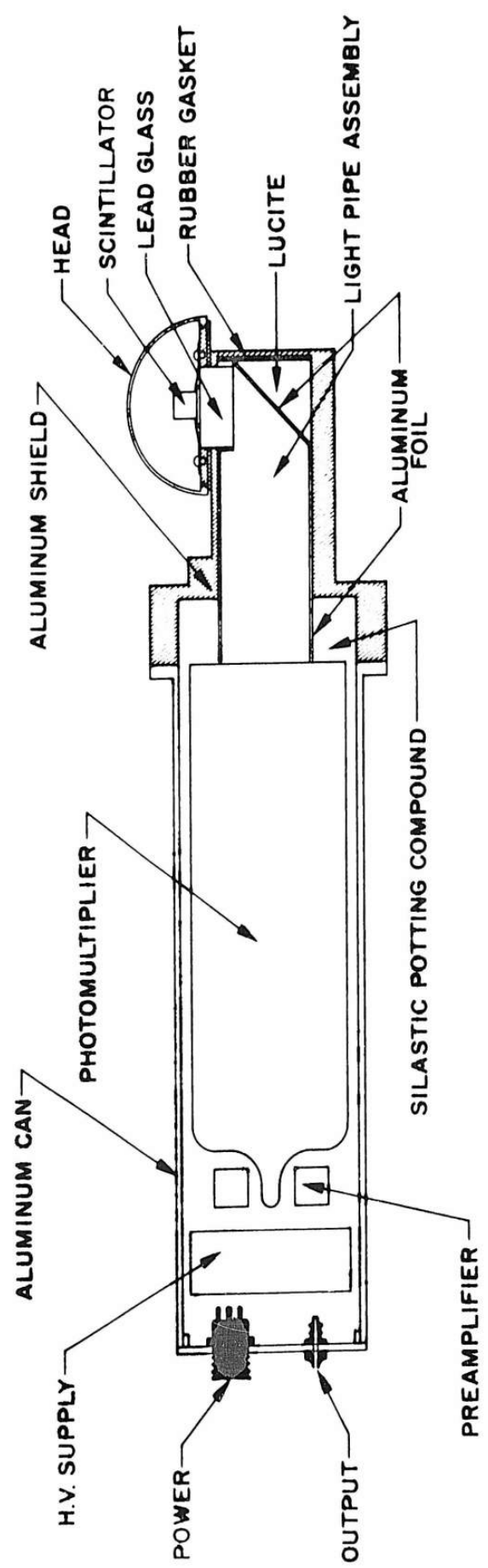

Fig. 2 Schematic Diagram of Hemispherical Plastic Scintillation Detector

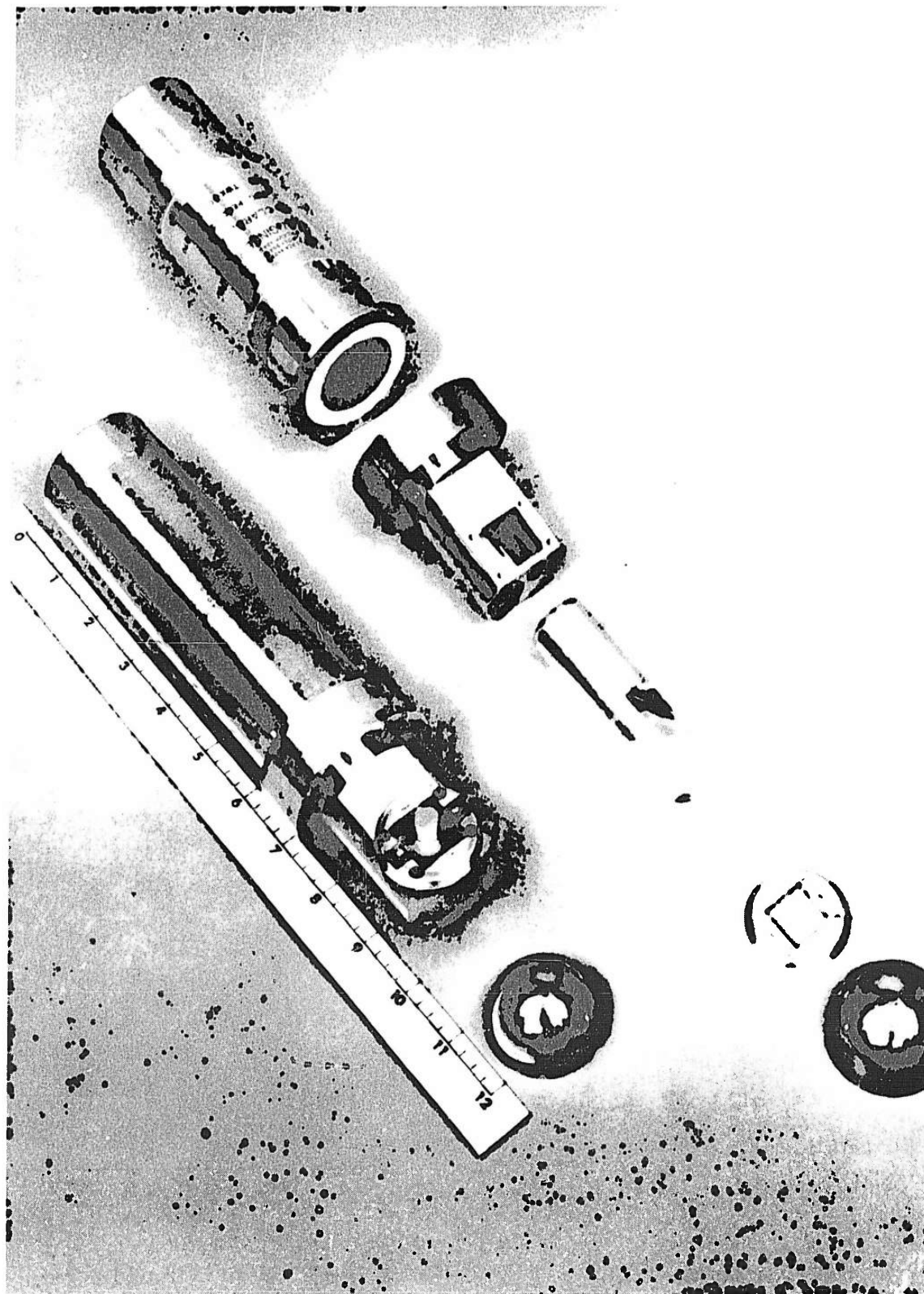

Fig. 3 Photograph of Hemispherical Detector

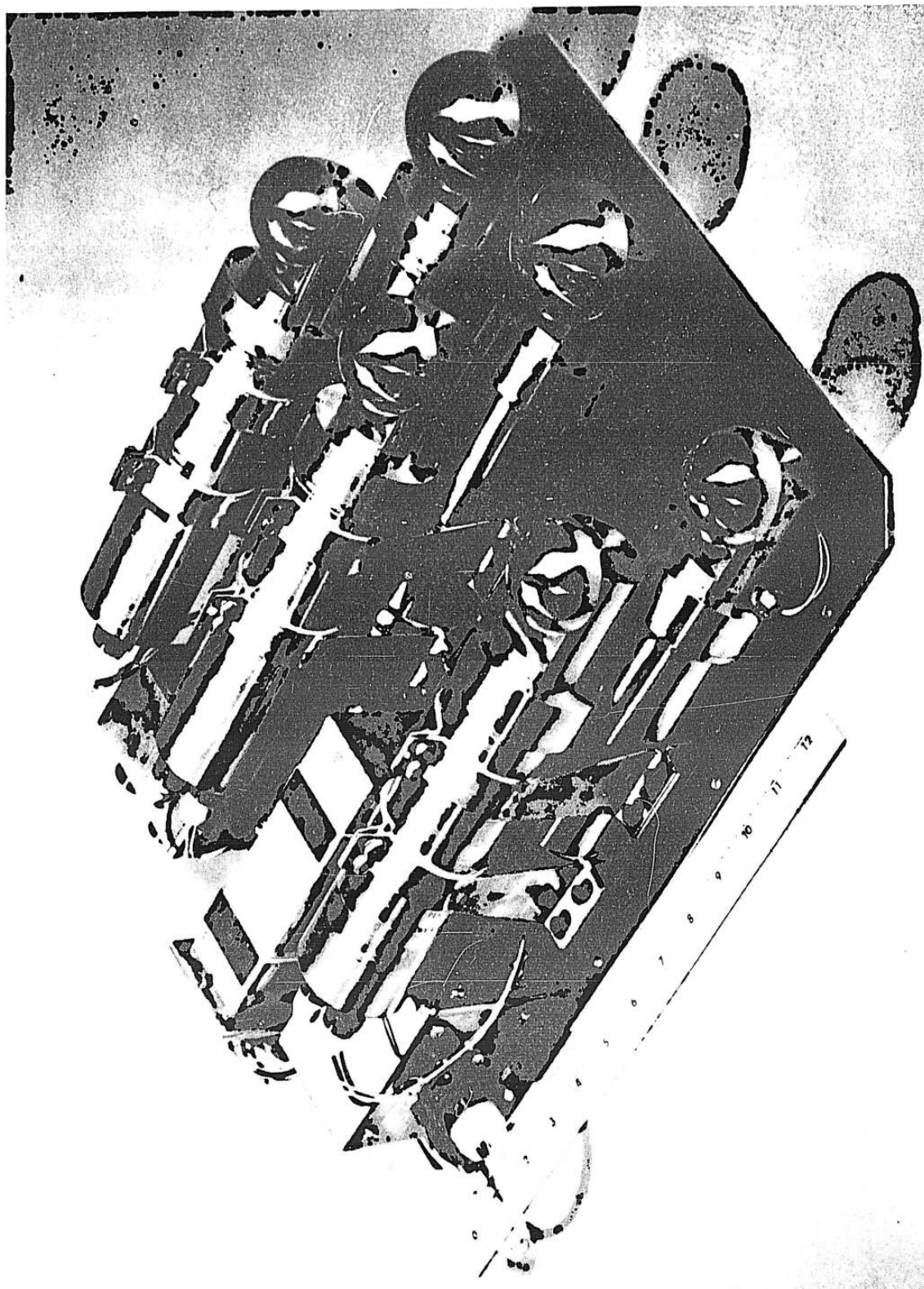

Fig. 4 Photograph of Detector Package

Section 3

CALIBRATION OF DETECTORS AND ASSOCIATED ELECTRONICS

For the individual particle detectors, the biases were set to correspond to an energy deposit in the scintillator of approximately 400 kev. With this threshold energy the detection efficiency was relatively insensitive to the bias and yet the detection of very low energy electrons through bremsstrahlung was avoided. The bias adjustments were accomplished in the laboratory by observing on a 100-channel pulse height analyzer the spectrum obtained from the detector with a Cs^{137} radioactive source ($E_\gamma = 662 \text{ kev}$). With use of the analyzer's coincidence gating circuit, it was arranged that the analyzer would accept only those pulses which also triggered the multivibrator whose output fed the ratemeter in the flight electronics. Thus, one could readily measure the bias energy, and adjust its value through variation of the photomultiplier voltage. Calibration of the electronic ratemeters was accomplished in the laboratory with a simple calibrated pulser since the detector deadtimes, and therefore the flight corrections required, were determined in the instrument by accurately known multivibrator lengths rather than by the characteristics of the detector pulses themselves. In addition, an in-flight calibration scheme was employed, which automatically disconnected each ratemeter from its respective detector for a period of 10 sec out of each 70 sec throughout the flight and instead connected the ratemeter to a stabilized oscillator. This in-flight calibration verified the proper operation of all ratemeters throughout the flight and provided minor corrections to the calibration curves.

In the total energy detectors, the d. c. light intensity from the scintillator was converted to an output voltage by the photomultiplier and associated circuitry. Laboratory calibration of this output voltage in terms of energy deposit in the scintillator was performed with varying amounts of light obtained by placing different gamma ray sources at various distances from a scintillator. Assuming a $1/r^2$ variation in light intensity, it is then possible to obtain a curve of relative light intensity versus output voltage. Deviations from a $1/r^2$ variation were investigated with a considerably weaker source where individual pulses could be observed. An absolute normalization of the photomultiplier response curve was obtained at rather low light intensities from the additional observation of the individual pulse height distributions from which the energy deposit per unit time could be readily calculated. Additional in-flight calibration of the total energy detectors was provided by their overlap with the individual particle detectors and with each other.

Section 4

GEOMETRIC FACTORS

Omnidirectional geometric factors have been obtained for the detectors of lowest energy threshold by a combination of laboratory measurements up to 2 Mev and calculation of shielding to take account of actual vehicle configuration as well as to extend the curve above 2 Mev. Monoenergetic electrons of energy up to 2.2 Mev were obtained from a 180-deg beta ray spectrometer employing $\text{Sr}^{90}\text{Y}^{90}$ as a source. Calibration of the individual particle detectors involved measuring the counting rate of those pulses corresponding to an energy deposit of at least 400 kev. From the known incident fluxes, efficiencies were derived as a function of incident electron energy and angle of incidence. In case of the total energy detectors, the average energy deposit per incident electron was obtained from pulse height distribution measurements. The omnidirectional geometric factors so obtained for the 1-Mev hemispherical detectors differ only slightly from those obtained previously for a 1-Mev cylindrical head, given in Fig. 2 of Ref. 4.

The calibration energy interval is being extended above 2 Mev with use of Li^8 ($E_{\text{max}} = 13 \text{ Mev}$, $T_{1/2} = 0.8 \text{ sec}$) as a source of electrons. The Li^8 is produced on a 3.5-Mev Van de Graaff generator by the $\text{Li}^7(d,p)\text{Li}^8$ reaction, monoenergetic electrons being obtained with a magnetic spectrometer. In view of the short lifetime and the necessity of reducing background, the Van de Graaff beam is pulsed for 2-sec periods spaced at intervals of approximately 20 sec, during which time the calibration is performed. A preliminary run has shown this technique to be quite acceptable with no serious background problems. However, for energies greater than 2 Mev, the geometric factors have not yet been obtained by laboratory measurements.

In order to apply the geometric factors to the measurements performed in space it was necessary to assume an electron energy spectrum, which, for the present purpose, was taken to be a fission spectrum of the form $\exp[-0.575E - 0.055E^2]$. Integration of this spectrum over the geometric factor yields a relationship between counting rate and integral electron flux above a given energy. Since deviations from a fission spectrum are known to exist, this reference energy, although arbitrary, can be chosen to minimize the dependence on spectral shape of the ratio of flux to counting rate. If the threshold of the counter is taken to be 1.2 Mev, it can be shown that the resulting fluxes obtained are not very sensitive to the detailed energy spectrum provided it is reasonably smooth. Thus the integral fluxes quoted have the greatest accuracy when the spectrum is of the form $\exp[-0.575E - 0.055E^2]$, but indeed a negligible error results for reasonable deviations from this spectrum. For the total energy detectors, there are further considerations necessary in the conversion of counting rate to flux. Account must be taken of the effective average energy deposited per incident electron

for an assumed spectrum. This average energy deposit, derived from the pulse height distributions observed during the laboratory calibrations with monoenergetic electrons, coupled with the measured relationship between total energy deposited in the scintillator per unit time and output voltage, provides sufficient information to yield electron fluxes. During flight, the fluxes so obtained from the total energy detectors were found to agree quite well with fluxes derived from the individual particle detectors in the region of overlap. This in-flight calibration between the two types of detectors provides added confidence in the fluxes measured with either. Figure 5 shows the observed flux above 1 Mev as a function of L , from an acquisition which illustrates the agreement in the overlap regions.

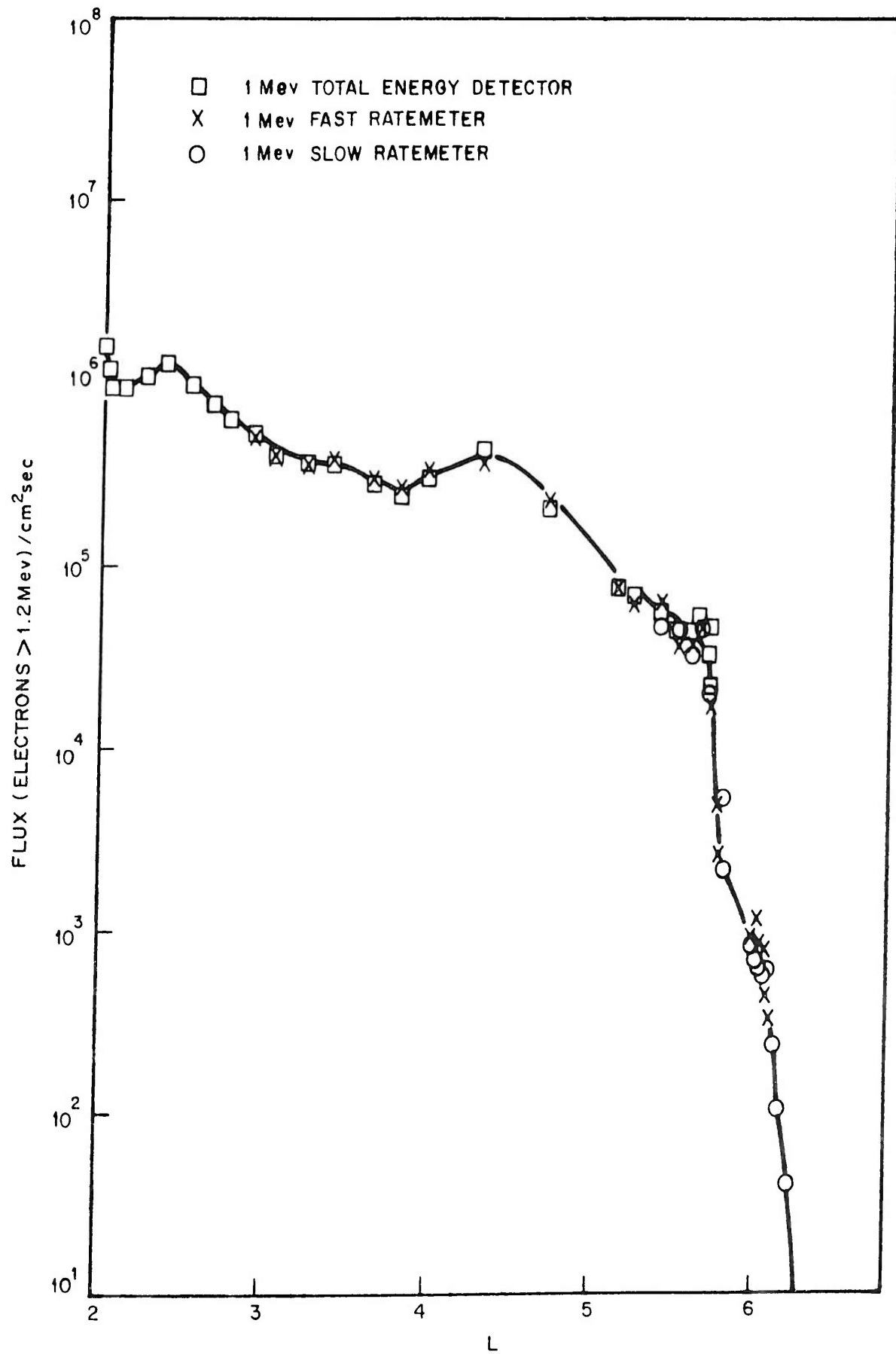

Fig. 5 Fluxes Observed in the Region of Overlap Between Detectors

Section 5

DATA COLLECTION AND PROCESSING

Analog voltages from each detector – together with calibration voltages, temperature measurements, and other diagnostic voltages – were telemetered to ground tracking stations in real time by means of a special narrow-bandwidth, long-range telemetry unit used for the LMSC experiment only. This SAPUT unit consisted of an integral solid-state multiplexer having 32 input channels and a rate of 0.5 frames/sec, and a narrow bandwidth FM/FM transmitter operating at an output power of 1 watt.

In addition to the primary real time data link, partially redundant coverage was provided by processing four outputs only through the on-board tape recorder used by all the other experiments. This tape recorder was capable of recording data from approximately one complete orbit per operation and telemetering the stored information during a single tracking-station pass. Thus, for the total energy detectors at 1 and 2 Mev and for the fast ratemeter output of the 1-Mev individual particle detector, extended geographic coverage was obtained during those orbits when the tape recorder was operating, in addition to that provided by the long-range real time telemetry link. Somewhat surprisingly, there were very few instances of redundant coverage from the two links; in general they provided data from different geographic locations.

Each of the detector outputs was processed to yield voltage versus time of acquisition at the various tracking stations, with proper normalization to in-flight calibration voltages. For the real time data, acquisition times could be immediately associated with appropriate values of B and L (Ref. 5) by means of the vehicle ephemeris and a machine code kindly supplied by McIlwain (private communication). This code converts geographic to magnetic coordinates, using the Jensen and Cain (Ref. 6) 48-term expansion of the magnetic field for 1960.

Tape recorded data required an additional association of read-out time with the read-in corresponding to actual data acquisition, by means of an on-board digital clock. This latter step produced significant timing errors in the processing of early data for all tape recorded experiments; therefore, early analysis of the LMSC experiment was limited to real-time SAPUT data. Later corrections reduced the time uncertainty associated with the tape recorded data so that it could be used without artificial time shifting.

Section 6

RESULTS

The data have been combined by plotting flux versus B for satellite crossings of specifically chosen L shells, to produce plots of omnidirectional flux above 1.2-Mev electron energy on 1 November, as shown in Fig. 6. Note that the upper three curves have been displaced vertically for ease of plotting. These data below $L = 1.7$ represent a rather slowly decaying group of electrons injected by the Starfish detonation of 9 July 1962. In this region, the fluxes were apparently not greatly disturbed by the Soviet detonations at higher L values. Figure 7 shows isoflux contours plotted in B - L space for 1 November, and comparison is made with previous data obtained in early September with an almost-identical detector (Ref. 4). In the region of overlap between the two measurements, there appears to be little change in spacial shape of the lower edge of the artificial belt, but only an overall decay in intensity which appears to be about a factor of four in the two-month period, for electrons with energy greater than 1.2 Mev.

In the region between $L = 1.7$ and $L = 1.9$, the measurements indicate rather violent changes in intensity and spectrum with time, L , and B . Since it was immediately obvious that rather detailed and time-consuming analysis would be required to understand the data in this narrow region populated directly by Soviet detonations, it was decided to concentrate our initial efforts on analysis of the data from those regions of space below $L = 1.7$ and above $L = 1.9$. Therefore, analysis has not been completed for the intermediate region.

For the data above $L = 1.9$, an iterative process has been used to separate the dependence of the flux on time and magnetic field, for specific L shells. As a result of such calculations a self-consistent set of points was obtained for several L shells, giving the time dependence normalized to $B = 0.10$ gauss and the B dependence normalized to day 305 (1 November). Figures 8, 9, 10, 11, 12, and 13 show these separated intensities, for L shells of 1.9, 2.1, 2.3, 2.5, 2.9, and 3.5 respectively. All of the first four shells show a marked flux increase on day 301 (28 October), followed by a rather rapid decay. At $L = 3.5$, however, no increase is seen; the data indicate very little time variation, giving an outer limit to injection from the Soviet detonation of 28 October. Pitch angle distributions can be derived from the plots of omnidirectional flux versus B . For $L = 1.9$, the data suggest a peak in the pitch angle distribution at other than 90 deg. Such a result is consistent with other direct measurements of pitch angle distributions. For higher L values, the satellite did not cover regions as near the magnetic equator, so direct comparison with the result at $L = 1.9$ is difficult.

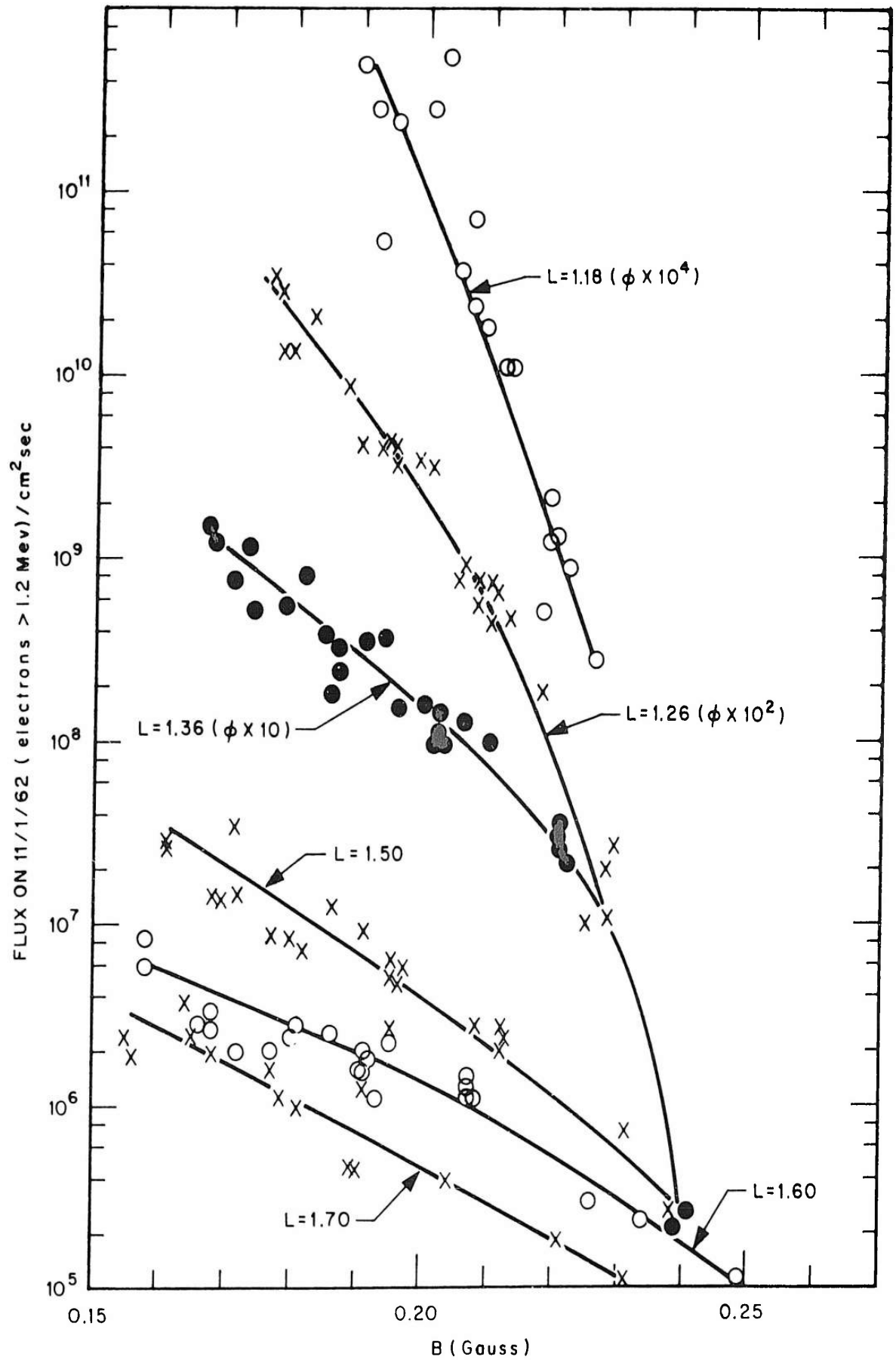

Fig. 6 Electron Fluxes Above 1.2 Mev on 1 November for L Shells of 1.7 and Below

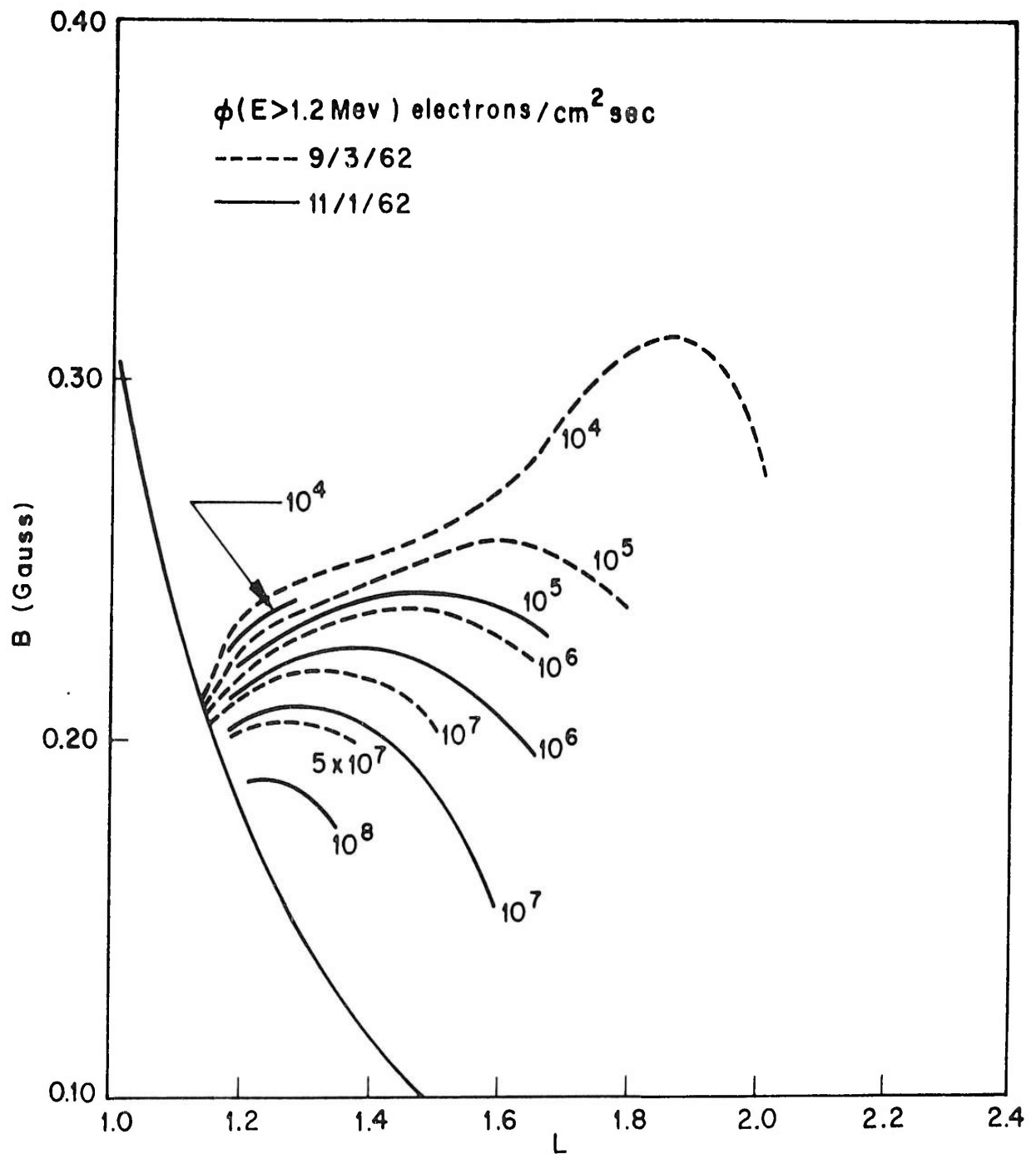

Fig. 7 Low-Altitude Isoflux Contours in B-L Space for 1 November, Compared With Those for 3 September

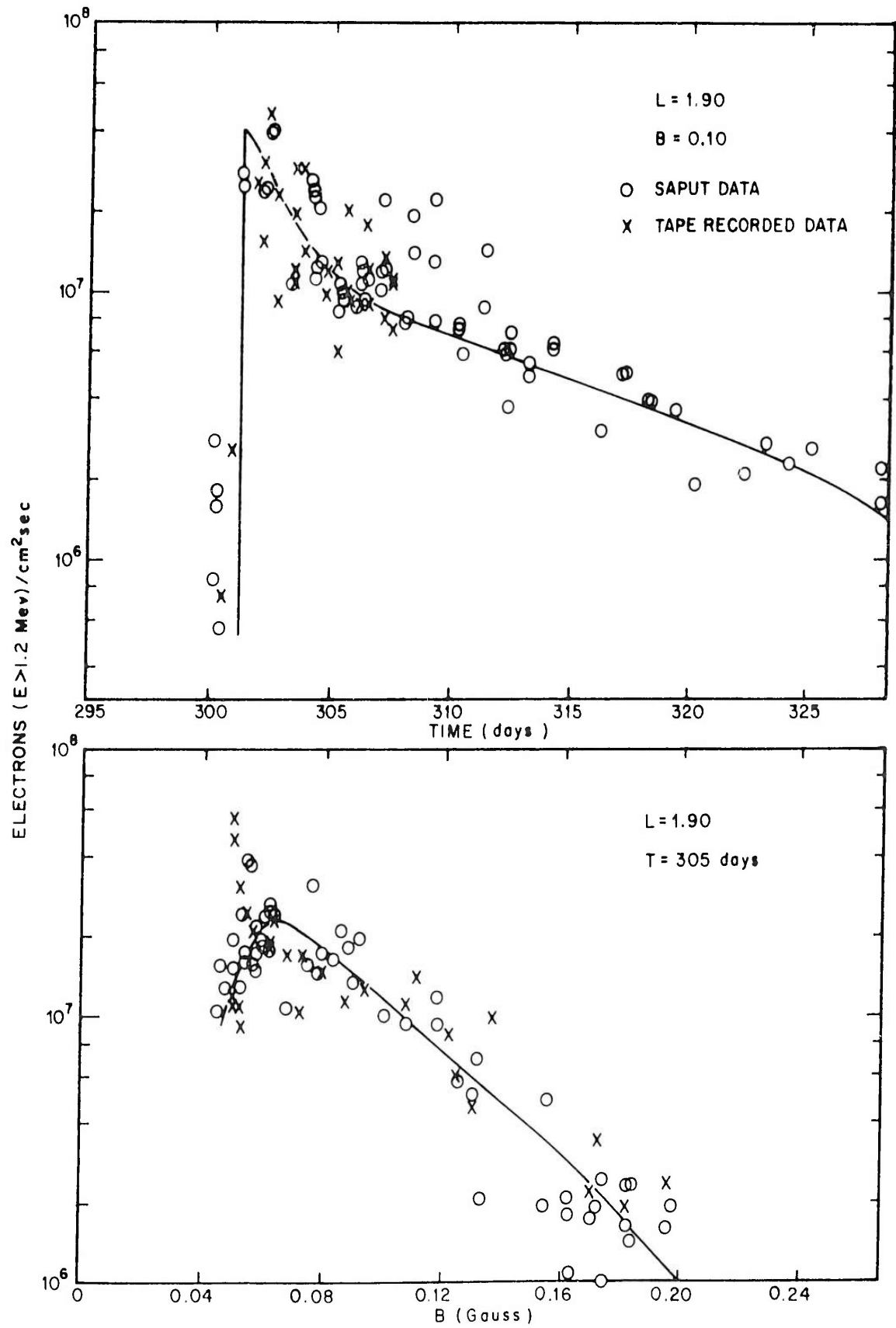

Fig. 8 High-Altitude Flux as a Function of Time and B, for L = 1.9

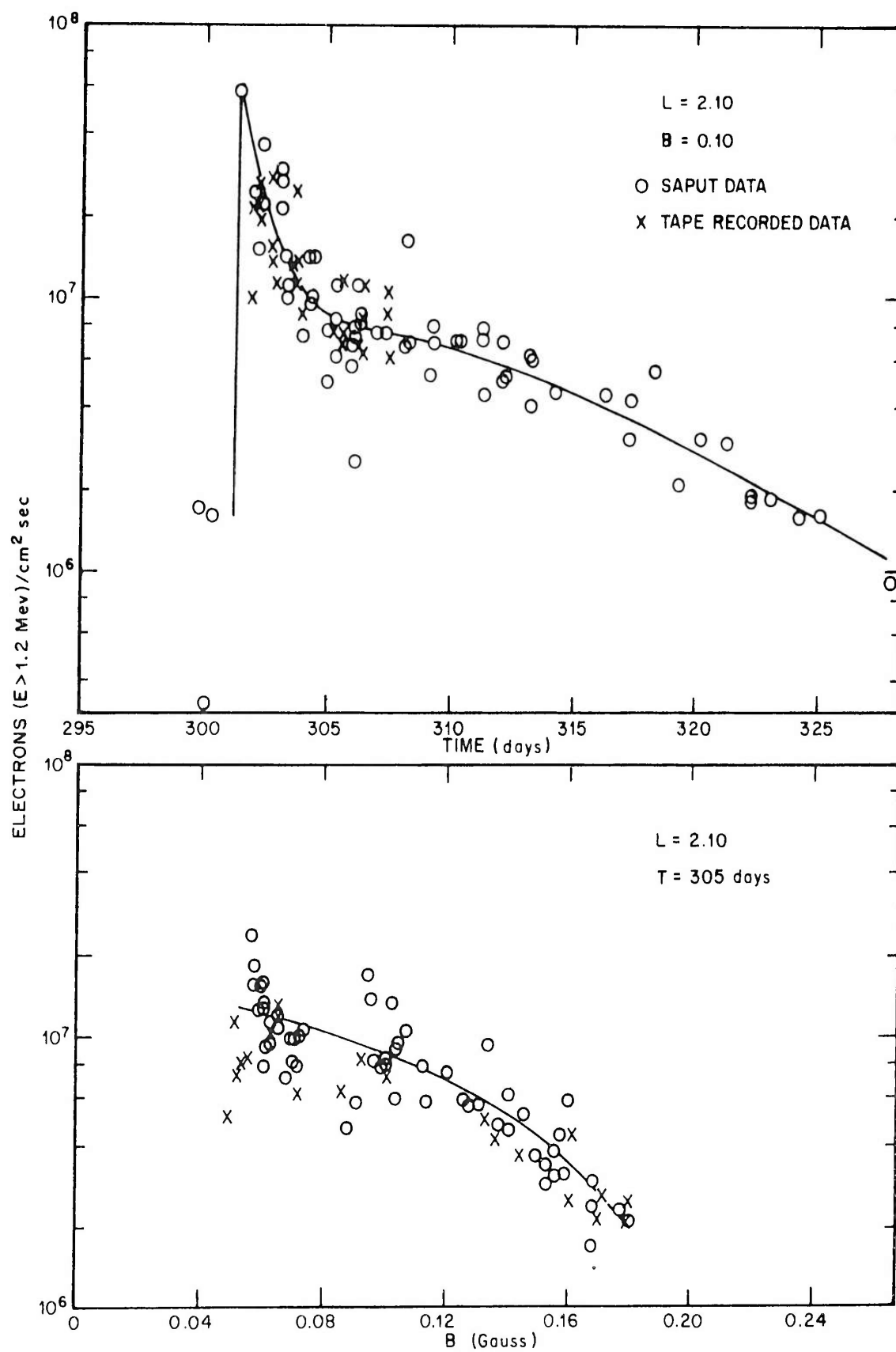

Fig. 9 High-Altitude Flux as a Function of Time and B, for L = 2.1

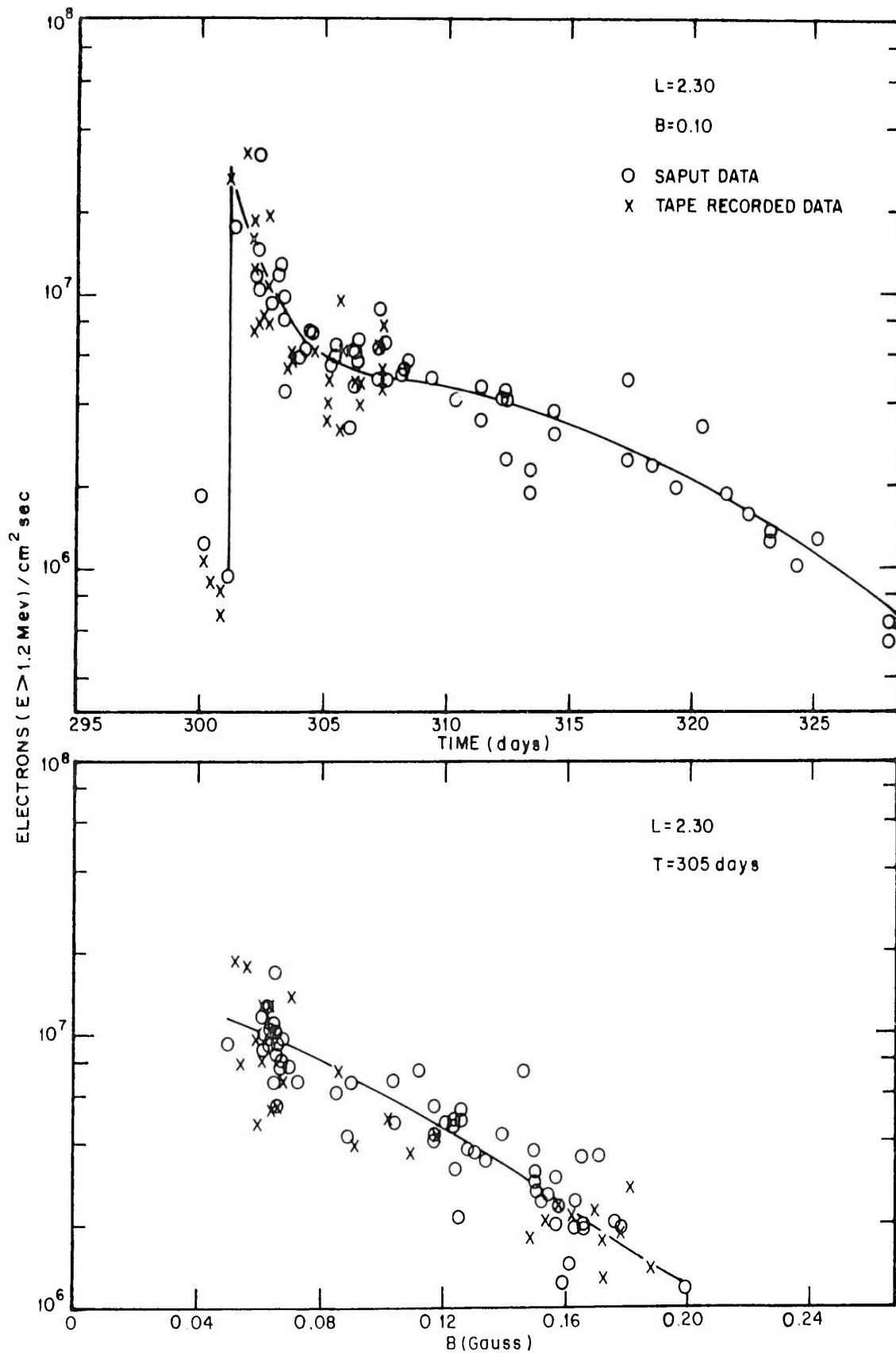

Fig. 10 High-Altitude Flux as a Function of Time and B, for L = 2.3

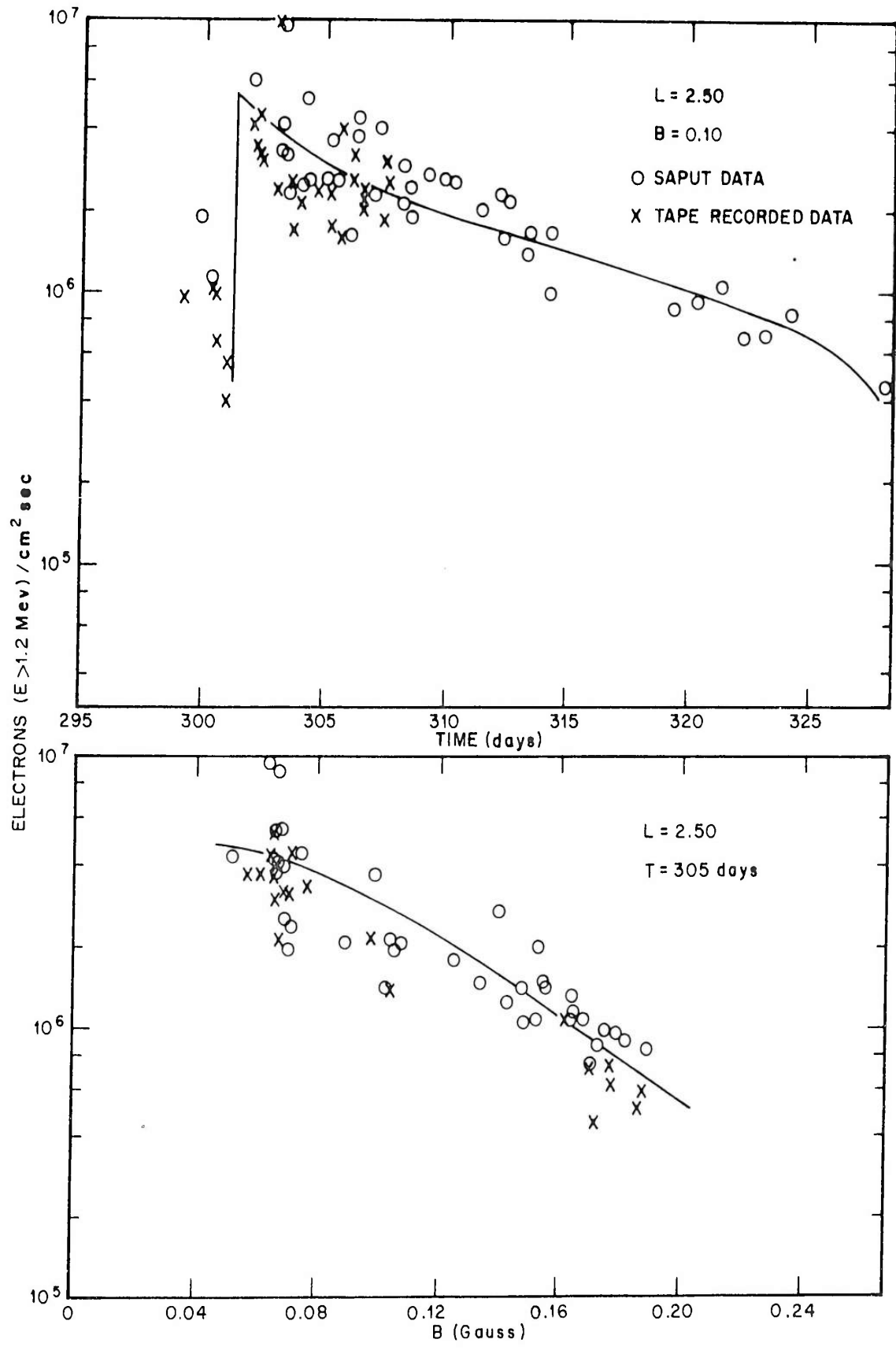

Fig. 11 High-Altitude Flux as a Function of Time and B, for L = 2.5

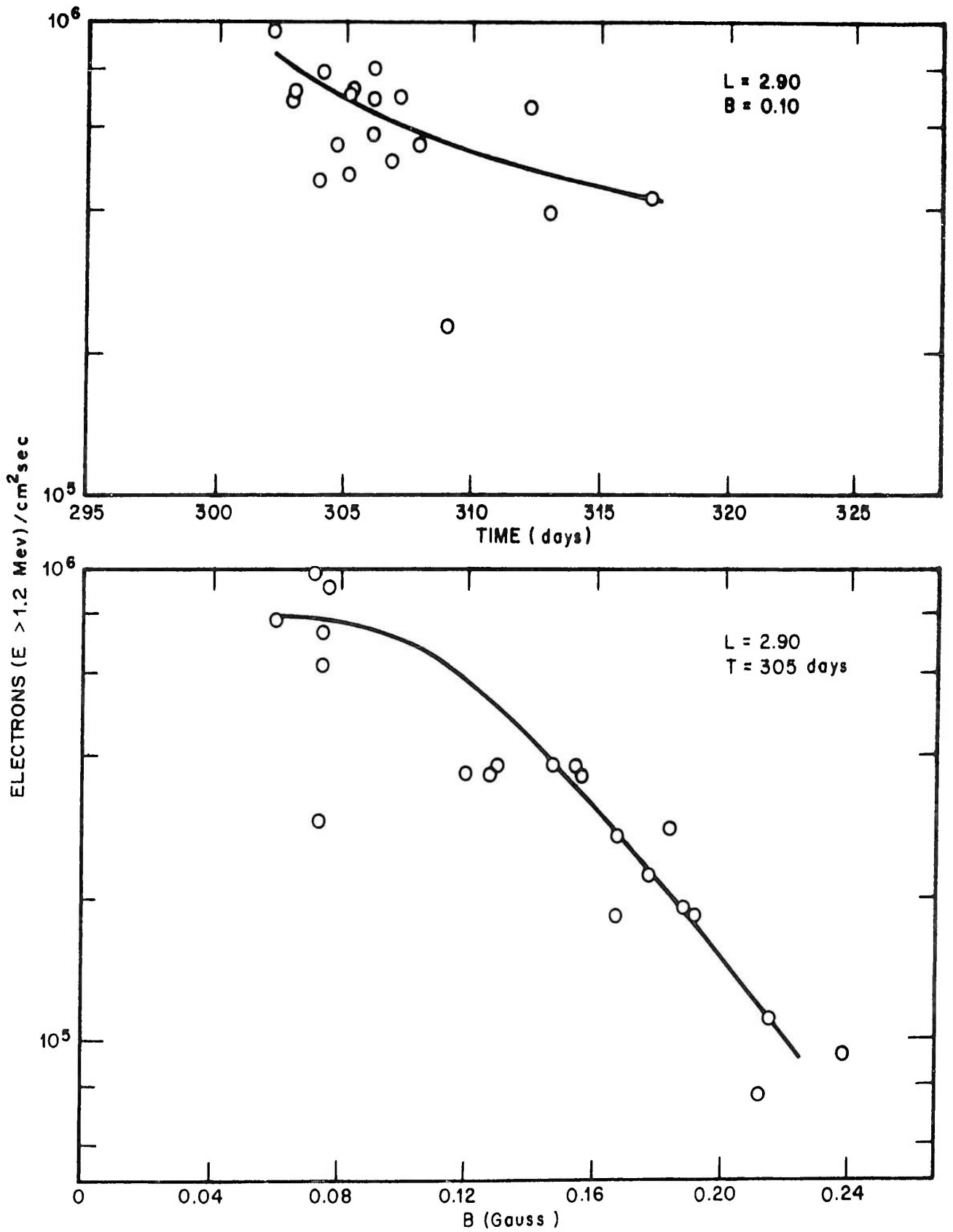

Fig. 12 High-Altitude Flux as a Function of Time and B, for L = 2.9

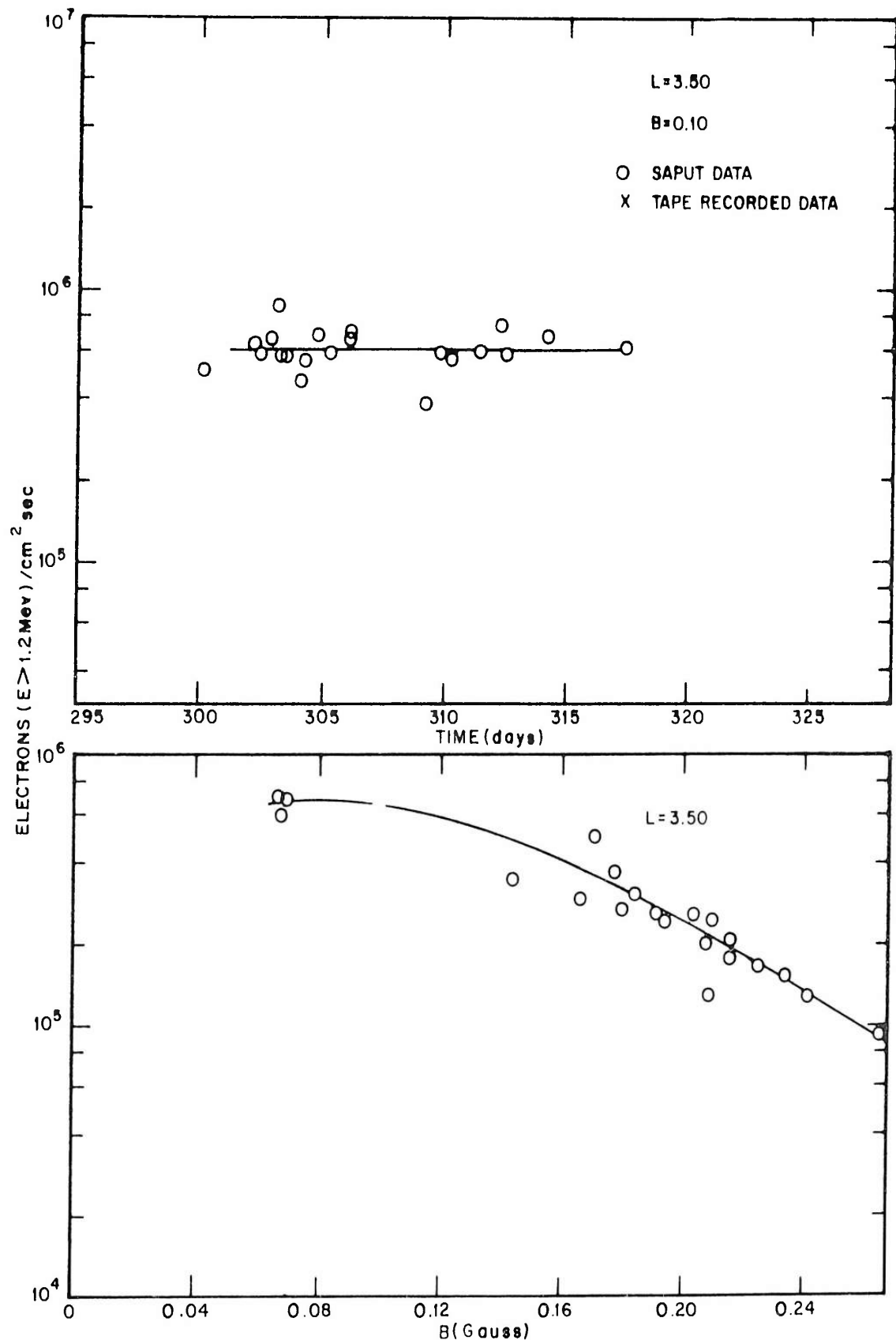

Fig. 13 High-Altitude Flux as a Function of Time and B, for L = 3.5

In order to study the spectral changes associated with both time and L shell during these measurements, we have compared the outputs of the 1- and 2-Mev detectors. Since the detailed geometric factor for the 2-Mev detector has not yet been obtained from laboratory measurements, the comparison must be in terms of arbitrary units for the ratio of 2- to 1-Mev detector outputs, at this time. Nevertheless, the variation of this ratio with time and L gives a measure of spectral hardness, independent of the units used. Figure 14 shows the detector ratio as a function of time for $L = 2.1$, with points toward the top of the figure indicating a harder spectrum. The detonation on 28 October softened the spectrum by a large factor, presumably by injecting large numbers of low-energy electrons. Thereafter, there is evidence for the beginning of a slow return to the "normal" hard spectrum at this L shell. Figure 15 shows the variation of the same spectral parameter with L . On 27 October the spectrum decreased in hardness from $L = 1.18$ to $L = 1.7$, became much harder between $L = 1.7$ and $L = 1.9$, then decreased in hardness again to $L = 3.5$. On 29 October, the spectrum had not been disturbed below $L = 1.7$, but obviously was not nearly so hard as it had been two days before, at $L = 1.9$. This change in spectrum on 28 October becomes less and less with increasing L , until by $L = 3.5$ the spectrum was once again not disturbed by the detonation. This evidence, coupled with the time behavior from Fig. 13, indicates that we were measuring a "normal" flux at $L = 3.5$, which was at least unaffected by the detonation of 28 October.

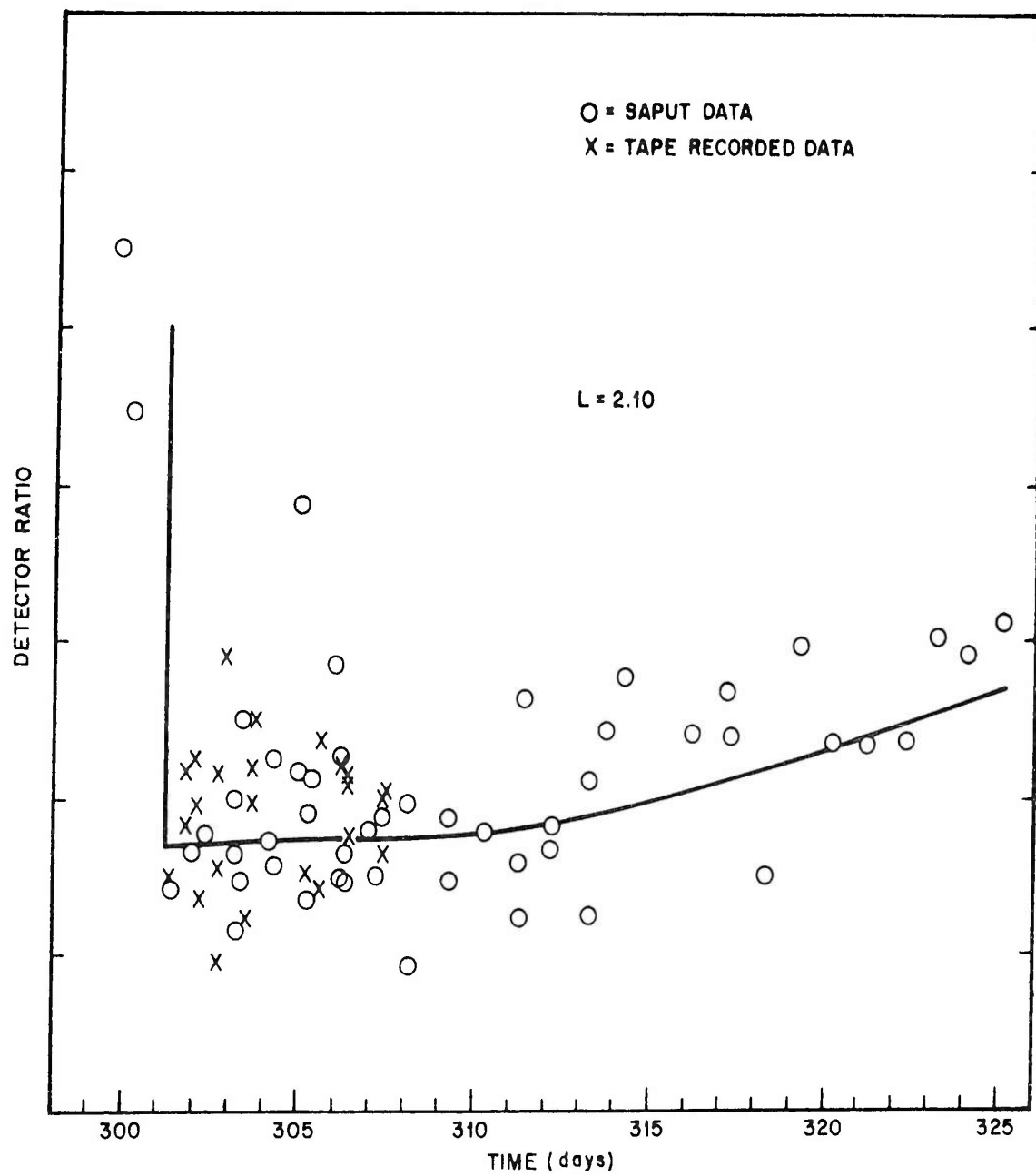

Fig. 14 Ratio of 2- to 1-Mev Detector Output as a Function of Time for $L = 2.1$

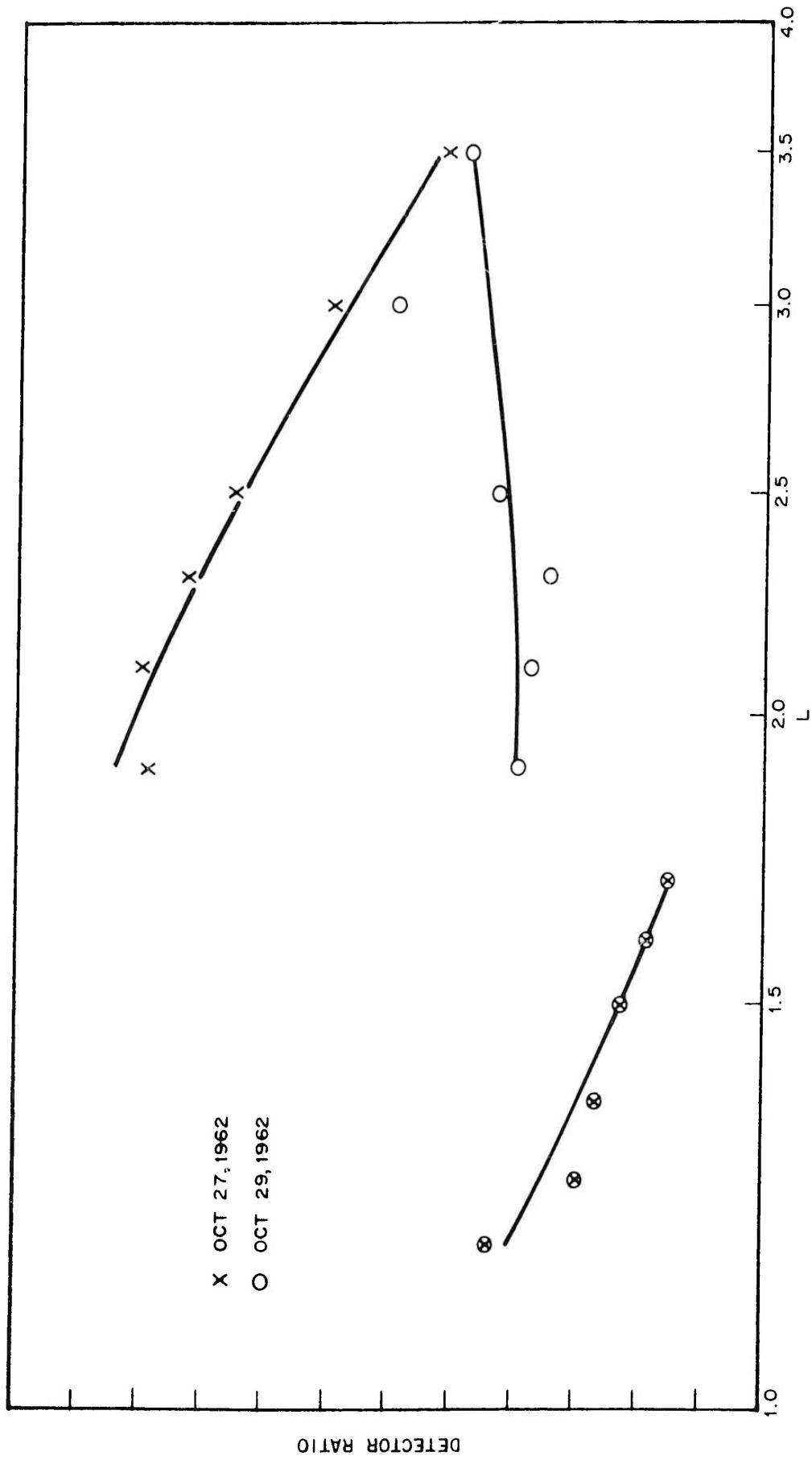

Fig. 15 Ratio of 2- to 1-Mev Detector Output as a Function of L on 27 and 29 October

Section 7

REFERENCES

1. NASA-DASA Symposium on the Artificial Radiation Belt, Greenbelt, Maryland, 10-11 September 1962.
2. Collected papers on the Artificial Radiation Belt from the July 9, 1962, Nuclear Detonation, J. Geophys. Research, 68, 605-758, 1963.
3. NASA-DASA Trapped Radiation Symposium, Greenbelt, Maryland, 15-16 April, 1963.
4. Smith, R. V. and W. L. Imhof, "Satellite Measurements of the Artificial Radiation Belt," J. Geophys. Research, 68, 629-633, 1963.
5. McIlwain, C. E., "Coordinates for Mapping the Distribution of Magnetically Trapped Particles," J. Geophys. Research, 66, 3681-3691, 1961.
6. Jensen, D. C. and J. C. Cain, An Interim Geomagnetic Field (abstract), J. Geophys. Research, 67, 3568-3569, 1962.

AF Cambridge Research Laboratories, Bedford,
Mass.

MEASUREMENTS OF ARTIFICIALLY INJECTED
ELECTRONS FROM SATELLITE 1962 BETA KAPPA,
by R. V. Smith, et al, August 1963. 25 pp.
AFCRL-63-891
Unclassified report

Omnidirectional flux measurements have been carried out on a special Air Force satellite, to establish the intensity, spacial extent, and spectral variations of fission electrons injected into trapped orbits in the earth's magnetic field from various high-altitude nuclear detonations. Data are presented from the period 27 October to 21 November 1962. Omnidirectional electron fluxes above 1.2 Mev are given in the B-L coordinate system for $L = 1.18$ to 1.70 , and as a function of time also for $L = 1.9$ to 3.5 . In addition, ratios of the outputs of two detectors with

(over)

AF Cambridge Research Laboratories, Bedford,
Mass.

MEASUREMENTS OF ARTIFICIALLY INJECTED
ELECTRONS FROM SATELLITE 1962 BETA KAPPA,
by R. V. Smith, et al, August 1963. 25 pp.
AFCRL-63-891
Unclassified report

Omnidirectional flux measurements have been carried out on a special Air Force satellite, to establish the intensity, spacial extent, and spectral variations of fission electrons injected into trapped orbits in the earth's magnetic field from various high-altitude nuclear detonations. Data are presented from the period 27 October to 21 November 1962. Omnidirectional electron fluxes above 1.2 Mev are given in the B-L coordinate system for $L = 1.18$ to 1.70 , and as a function of time also for $L = 1.9$ to 3.5 . In addition, ratios of the outputs of two detectors with

(over)

UNCLASSIFIED

1. Van Allen Radiation
2. Electron, Fluxes
- I. AFCRL Project Nr. 8600
- II. Contract AF 19(628)-2421
- III. Lockheed Missiles & Space Co., Palo Alto, Calif.
- IV. Smith, R. V.
Imhof, W. L.
Bakke, J. C.
Reagan, J. B.
Rowland, J. H.
- V. LMSC 3-05-63-1
- VI. In DDC collection

AF Cambridge Research Laboratories, Bedford,
Mass.
MEASUREMENTS OF ARTIFICIALLY INJECTED
ELECTRONS FROM SATELLITE 1962 BETA KAPPA,
by R. V. Smith, et al, August 1963. 25 pp.
AFCRL-63-891
Unclassified report

Omnidirectional flux measurements have been carried out on a special Air Force satellite, to establish the intensity, spacial extent, and spectral variations of fission electrons injected into trapped orbits in the earth's magnetic field from various high-altitude nuclear detonations. Data are presented from the period 27 October to 21 November 1962. Omnidirectional electron fluxes above 1.2 Mev are given in the B-L coordinate system for $L = 1.18$ to 1.70 , and as a function of time also for $L = 1.9$ to 3.5 . In addition, ratios of the outputs of two detectors with

(over)

UNCLASSIFIED

1. Van Allen Radiation
2. Electron, Fluxes
- I. AFCRL Project Nr. 8600
- II. Contract AF 19(628)-2421
- III. Lockheed Missiles & Space Co., Palo Alto, Calif.
- IV. Smith, R. V.
Imhof, W. L.
Bakke, J. C.
Reagan, J. B.
Rowland, J. H.
- V. LMSC 3-05-63-1
- VI. In DDC collection

AF Cambridge Research Laboratories, Bedford,
Mass.
MEASUREMENTS OF ARTIFICIALLY INJECTED
ELECTRONS FROM SATELLITE 1962 BETA KAPPA,
by R. V. Smith, et al, August 1963. 25 pp.
AFCRL-63-891
Unclassified report

Omnidirectional flux measurements have been carried out on a special Air Force satellite, to establish the intensity, spacial extent, and spectral variations of fission electrons injected into trapped orbits in the earth's magnetic field from various high-altitude nuclear detonations. Data are presented from the period 27 October to 21 November 1962. Omnidirectional electron fluxes above 1.2 Mev are given in the B-L coordinate system for $L = 1.18$ to 1.70 , and as a function of time also for $L = 1.9$ to 3.5 . In addition, ratios of the outputs of two detectors with

(over)

UNCLASSIFIED

1. Van Allen Radiation
2. Electron, Fluxes
- I. AFCRL Project Nr. 8600
- II. Contract AF 19(628)-2421
- III. Lockheed Missiles & Space Co., Palo Alto, Calif.
- IV. Smith, R. V.
Imhof, W. L.
Bakke, J. C.
Reagan, J. B.
Rowland, J. H.
- V. LMSC 3-05-63-1
- VI. In DDC collection

UNCLASSIFIED

1. Van Allen Radiation
2. Electron, Fluxes
- I. AFCRL Project Nr. 8600
- II. Contract AF 19(628)-2421
- III. Lockheed Missiles & Space Co., Palo Alto, Calif.
- IV. Smith, R. V.
Imhof, W. L.
Bakke, J. C.
Reagan, J. B.
Rowland, J. H.
- V. LMSC 3-05-63-1
- VI. In DDC collection

thresholds at 1 and 2 Mev are given versus L on 27 and 29 October, and versus time for L = 2.1, illustrating the spectral variations observed. Data analysis has not been completed; therefore, neither comparisons with other experiments nor conclusions are attempted.



thresholds at 1 and 2 Mev are given versus L on 27 and 29 October, and versus time for L = 2.1, illustrating the spectral variations observed. Data analysis has not been completed; therefore, neither comparisons with other experiments nor conclusions are attempted.



thresholds at 1 and 2 Mev are given versus L on 27 and 29 October, and versus time for L = 2.1, illustrating the spectral variations observed. Data analysis has not been completed; therefore, neither comparisons with other experiments nor conclusions are attempted.



thresholds at 1 and 2 Mev are given versus L on 27 and 29 October, and versus time for L = 2.1, illustrating the spectral variations observed. Data analysis has not been completed; therefore, neither comparisons with other experiments nor conclusions are attempted.



AF Cambridge Research Laboratories, Bedford,
Mass.

MEASUREMENTS OF ARTIFICIALLY INJECTED
ELECTRONS FROM SATELLITE 1962 BETA KAPPA,
by R. V. Smith, et al, August 1963. 25 pp.
AFCRL-63-891
Unclassified report

Omnidirectional flux measurements have been carried
out on a special Air Force satellite, to establish the
intensity, spacial extent, and spectral variations of
fission electrons injected into trapped orbits in the
earth's magnetic field from various high-altitude
nuclear detonations. Data are presented from the
period 27 October to 21 November 1962. Omnidirec-
tional electron fluxes above 1.2 Mev are given in the
B-L coordinate system for $L = 1.18$ to 1.70 , and as
a function of time also for $L = 1.9$ to 3.5 . In addi-
tion, ratios of the outputs of two detectors with

(over)

UNCLASSIFIED

1. Van Allen Radiation
2. Electron, Fluxes
- I. AFCRL Project Nr. 8600
- II. Contract AF 19(62s)-2421
- III. Lockheed Missiles & Space
Co., Palo Alto, Calif.
- IV. Smith, R. V.
Imhof, W. L.
Bakke, J. C.
Reagan, J. B.
Rowland, J. H.
- V. LMSC 3-05-63-1
- VI. In DDC collection

AF Cambridge Research Laboratories, Bedford,
Mass.

MEASUREMENTS OF ARTIFICIALLY INJECTED
ELECTRONS FROM SATELLITE 1962 BETA KAPPA,
by R. V. Smith, et al, August 1963. 25 pp.
AFCRL-63-891
Unclassified report

Omnidirectional flux measurements have been carried
out on a special Air Force satellite, to establish the
intensity, spacial extent, and spectral variations of
fission electrons injected into trapped orbits in the
earth's magnetic field from various high-altitude
nuclear detonations. Data are presented from the
period 27 October to 21 November 1962. Omnidirec-
tional electron fluxes above 1.2 Mev are given in the
B-L coordinate system for $L = 1.18$ to 1.70 , and as
a function of time also for $L = 1.9$ to 3.5 . In addi-
tion, ratios of the outputs of two detectors with

(over)

AF Cambridge Research Laboratories, Bedford,
Mass.

MEASUREMENTS OF ARTIFICIALLY INJECTED
ELECTRONS FROM SATELLITE 1962 BETA KAPPA,
by R. V. Smith, et al, August 1963. 25 pp.
AFCRL-63-891
Unclassified report

Omnidirectional flux measurements have been carried
out on a special Air Force satellite, to establish the
intensity, spacial extent, and spectral variations of
fission electrons injected into trapped orbits in the
earth's magnetic field from various high-altitude
nuclear detonations. Data are presented from the
period 27 October to 21 November 1962. Omnidirec-
tional electron fluxes above 1.2 Mev are given in the
B-L coordinate system for $L = 1.18$ to 1.70 , and as
a function of time also for $L = 1.9$ to 3.5 . In addi-
tion, ratios of the outputs of two detectors with

(over)

UNCLASSIFIED

1. Van Allen Radiation
2. Electron, Fluxes
- I. AFCRL Project Nr. 8600
- II. Contract AF 19(62s)-2421
- III. Lockheed Missiles & Space
Co., Palo Alto, Calif.
- IV. Smith, R. V.
Imhof, W. L.
Bakke, J. C.
Reagan, J. B.
Rowland, J. H.
- V. LMSC 3-05-63-1
- VI. In DDC collection

AF Cambridge Research Laboratories, Bedford,
Mass.

MEASUREMENTS OF ARTIFICIALLY INJECTED
ELECTRONS FROM SATELLITE 1962 BETA KAPPA,
by R. V. Smith, et al, August 1963. 25 pp.
AFCRL-63-891
Unclassified report

Omnidirectional flux measurements have been carried
out on a special Air Force satellite, to establish the
intensity, spacial extent, and spectral variations of
fission electrons injected into trapped orbits in the
earth's magnetic field from various high-altitude
nuclear detonations. Data are presented from the
period 27 October to 21 November 1962. Omnidirec-
tional electron fluxes above 1.2 Mev are given in the
B-L coordinate system for $L = 1.18$ to 1.70 , and as
a function of time also for $L = 1.9$ to 3.5 . In addi-
tion, ratios of the outputs of two detectors with

(over)

UNCLASSIFIED

1. Van Allen Radiation
2. Electron, Fluxes
- I. AFCRL Project Nr. 8600
- II. Contract AF 19(62s)-2421
- III. Lockheed Missiles & Space
Co., Palo Alto, Calif.
- IV. Smith, R. V.
Imhof, W. L.
Bakke, J. C.
Reagan, J. B.
Rowland, J. H.
- V. LMSC 3-05-63-1
- VI. In DDC collection

UNCLASSIFIED

1. Van Allen Radiation
2. Electron, Fluxes
- I. AFCRL Project Nr. 8600
- II. Contract AF 19(62s)-2421
- III. Lockheed Missiles & Space
Co., Palo Alto, Calif.
- IV. Smith, R. V.
Imhof, W. L.
Bakke, J. C.
Reagan, J. B.
Rowland, J. H.
- V. LMSC 3-05-63-1
- VI. In DDC collection

thresholds at 1 and 2 Mev are given versus L on 27 and 29 October, and versus time for $L = 2.1$, illustrating the spectral variations observed. Data analysis has not been completed; therefore, neither comparisons with other experiments nor conclusions are attempted.



thresholds at 1 and 2 Mev are given versus L on 27 and 29 October, and versus time for $L = 2.1$, illustrating the spectral variations observed. Data analysis has not been completed; therefore, neither comparisons with other experiments nor conclusions are attempted.



thresholds at 1 and 2 Mev are given versus L on 27 and 29 October, and versus time for $L = 2.1$, illustrating the spectral variations observed. Data analysis has not been completed; therefore, neither comparisons with other experiments nor conclusions are attempted.



thresholds at 1 and 2 Mev are given versus L on 27 and 29 October, and versus time for $L = 2.1$, illustrating the spectral variations observed. Data analysis has not been completed; therefore, neither comparisons with other experiments nor conclusions are attempted.

