

UNCLASSIFIED

AD **430848**

DEFENSE DOCUMENTATION CENTER

FOR

SCIENTIFIC AND TECHNICAL INFORMATION

CAMERON STATION, ALEXANDRIA, VIRGINIA



UNCLASSIFIED

NOTICE: When government or other drawings, specifications or other data are used for any purpose other than in connection with a definitely related government procurement operation, the U. S. Government thereby incurs no responsibility, nor any obligation whatsoever; and the fact that the Government may have formulated, furnished, or in any way supplied the said drawings, specifications, or other data is not to be regarded by implication or otherwise as in any manner licensing the holder or any other person or corporation, or conveying any rights or permission to manufacture, use or sell any patented invention that may in any way be related thereto.

430848

FILE COPY

430848

~~XXXXXXXXXX~~

Aerospace Corp.

(U) MANNED ORBITING STATION AND ALTERNATIVES

III

REPORT TO THE
PRESIDENT'S SCIENTIFIC ADVISORY COMMITTEE
SPACE VEHICLE PANEL

OCTOBER 10, 1963

(5) 11505

11-10-63

(C)

(B) MANNED ORBITING STATION AND ALTERNATIVES

(S) 11-5



REPORT TO THE
PRESIDENT'S SCIENTIFIC ADVISORY COMMITTEE
SPACE VEHICLE PANEL

VOLUME III *

OCTOBER 10, 1963

(11)

AI

ASSUMPTIONS ABOUT THE MISSION SITUATION

1. Types of missions and vehicles involved.
2. Orbital characteristics of the missions.
3. Stay-times in orbit for crewmen.
4. Requirements for manual control of powered vehicles.
5. Crew functions with on-board equipment.
6. Requirements for a "shirt-sleeve" environment.
7. Emergency environmental back-up equipment.
8. Requirements for extra vehicular operation.

BASIC MISSION PARAMETERS OF GENERAL
SIGNIFICANCE TO THE CREW

	Reconnaissance	Inspection	Command/Control
Crew size (no. of men)	2-6	1-2	2-10 (or more)
Orbital altitude (n.mi.)	70-400	up to 1,500	up to 22,300 (or higher)
Orbital inclination (deg.)	45° - 110°	all	30° - 40°
Orbital stay-times (days)	3-180	3-5	60-180

CREW DUTIES AND REQUIREMENTS ON THE MISSIONS

Crew Parameter	Reconnaissance	Inspection	Command/Control
Manual control required	+	+	+
On-board equipment manipulation	+	+	+
Shirt-sleeve environment	+	?	+
Emergency life support eqpt.	+	+	+
Extra vehicular operation	+	?	+

BIOASTRONAUTICS PRESENTATION

CURRENT PROGRAM		REQUIRED PROGRAM		
Problem	Program	<u>Experiments</u> Ground Facilities or Aircraft	<u>Experiments</u> Space Vehicle Required	Vehicles Not Available
(Summary)	(Summary)	(Specific tasks)	Vehicles Available	(Specific tasks)
				(Specific tasks)

BIOASTRONAUTIC TECHNICAL ANALYSIS OF THE MILITARY
MANNED SPACE FLIGHT MISSIONS

- (1) Biomedical Investigations,
2. Biotechnological Developments and Tests,
3. Radiobiological Research and Testing, *see also*
- (4) Human Performance and Psychophysiology.

Best Available Copy

BIOMEDICAL INVESTIGATIONS

1. Atmospheric requirements
2. Metabolic requirements
3. Thermal tolerance
4. Noise tolerance
5. Acceleration tolerance
6. Weightlessness

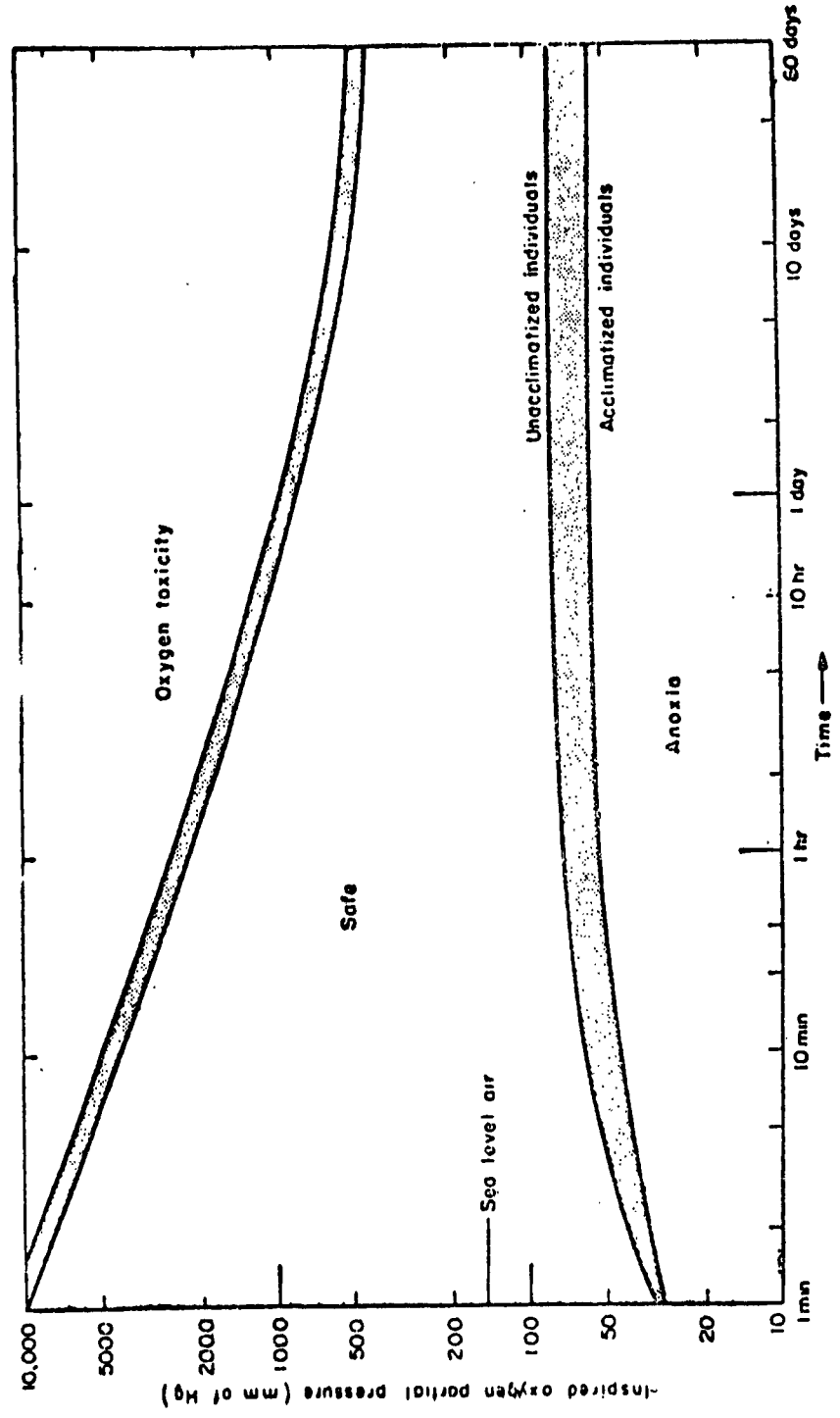

Human time-tolerances - oxygen partial pressure

From Space Handbook: Astronautics and its Applications, Staff Report of the Select Committee on Astronautics and Space Exploration

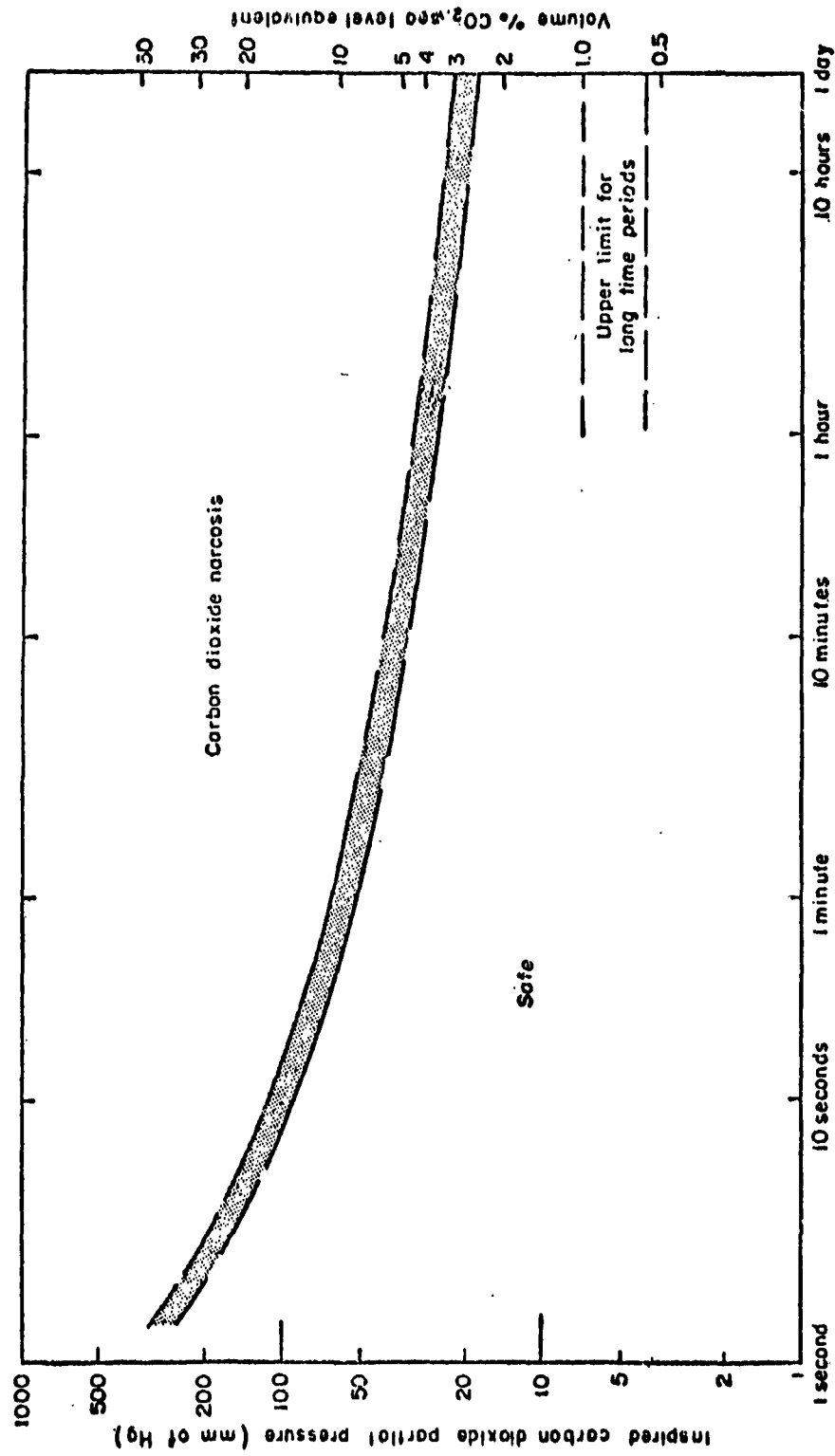

Note: Normal sea level partial pressure of CO₂ (inspired) = 0.21 mm of Hg ≈ 0.03%

Human time-tolerance - carbon dioxide partial pressure

From Space Handbook: Astronautics and its Applications, Staff Report of the Select Committee on Astronautics and Space Exploration

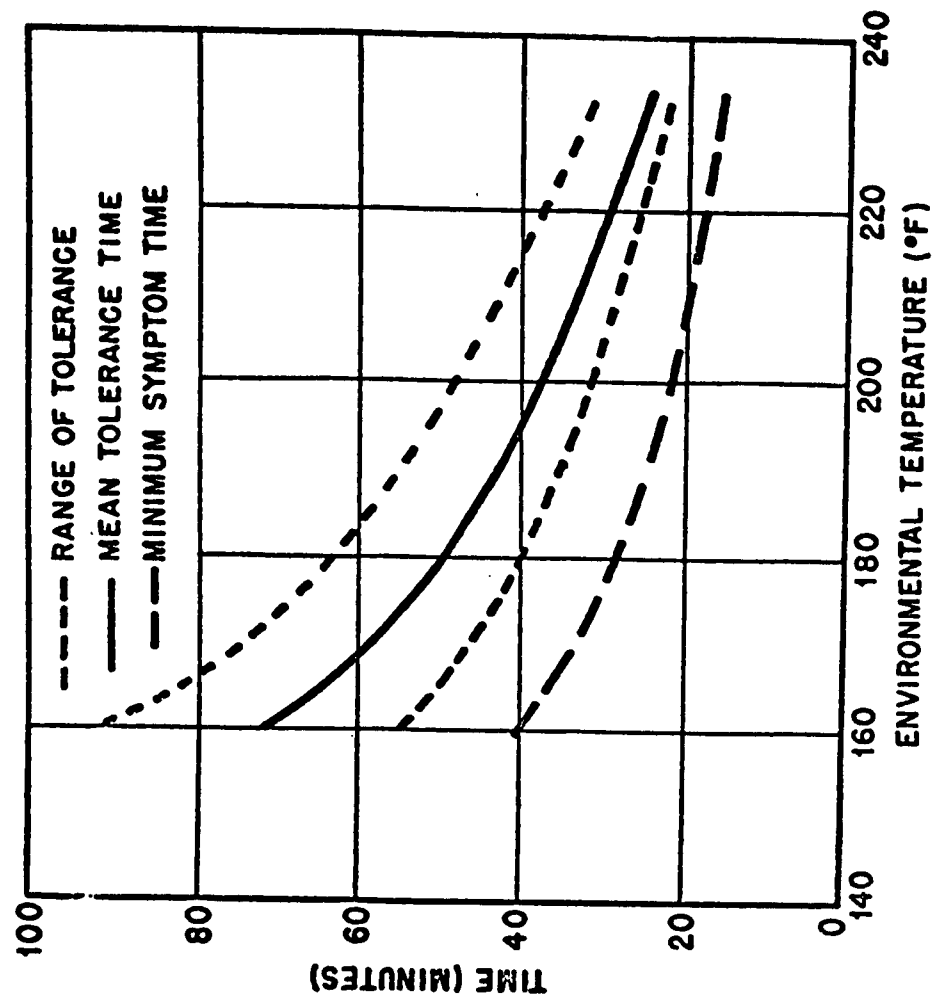

The graph on the opposite page shows time - temperature data for the thermal exposure range from 160°F to 240°F, subjects unclothed. The mean and range of tolerance times limited by serious symptoms, as well as the minimum times for symptoms to begin, are shown.

Limiting symptoms at the lower range (160°F) consist of rapid pulse, exhaustion, and signs of fainting. At the upper end (240°F), the limiting factor is the rapid onset of skin pain (preliminary to burning).

Tolerance data for hotter pulses of shorter duration are lacking; and the physiology of adaptation and prophylaxis for temperatures at the lower range is not well worked out.

ACCELERATION TOLERANCE

FIXED POSITION

Based on Data (0000) from WADC TR 58-156

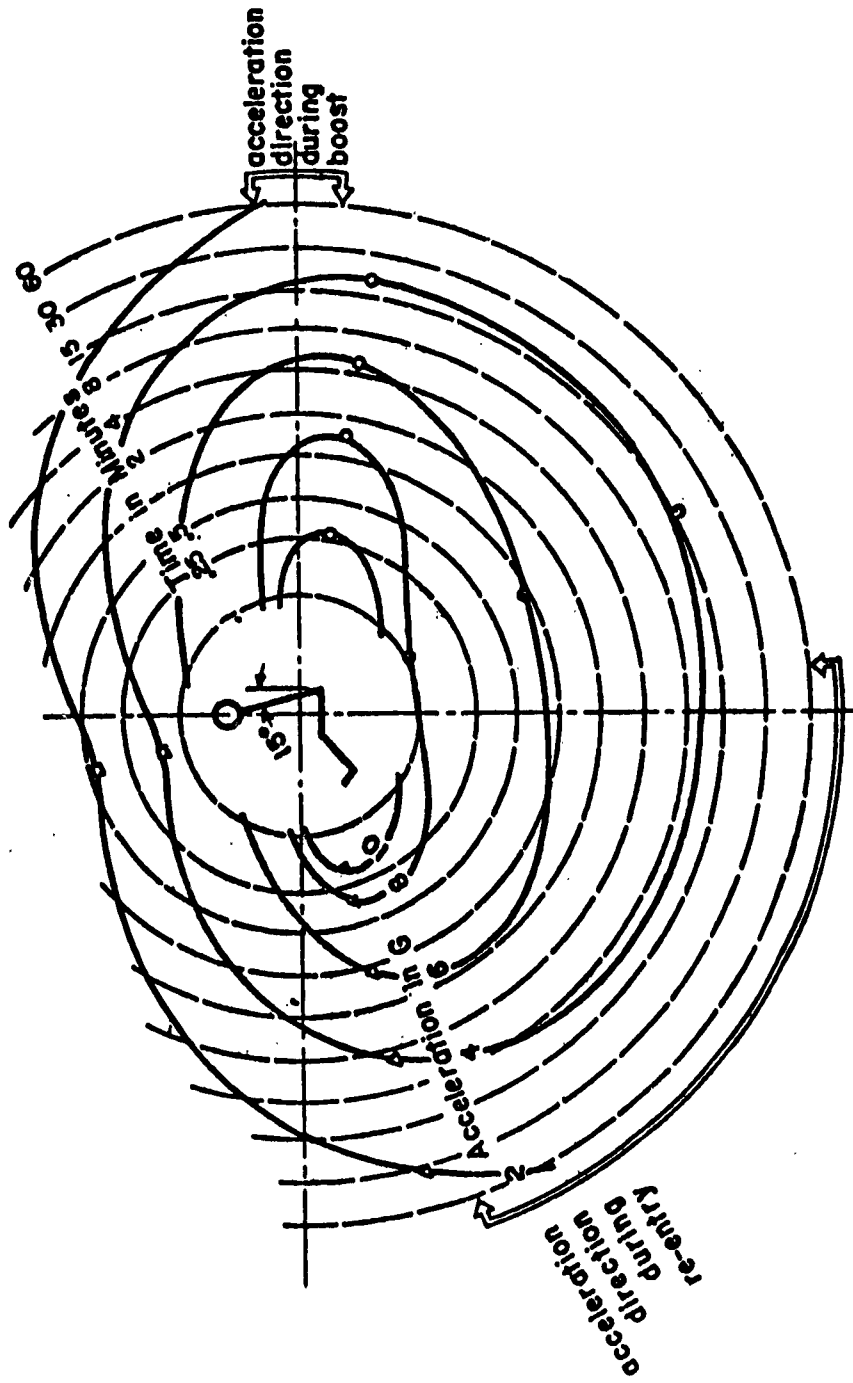

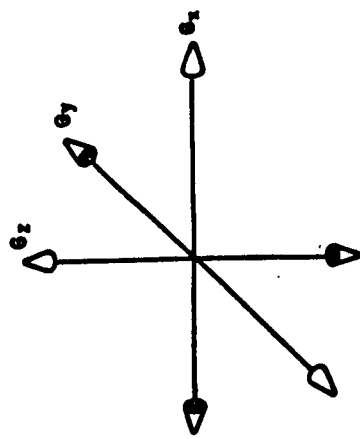
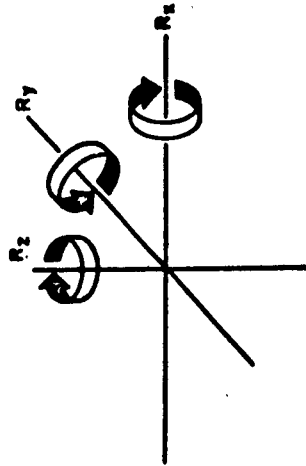

Fig. 1. Translation



Rotation

There are six possible motions which may be induced in a body subjected to accelerative forces. Three of these are translational (Fig. 1: G_x , G_y , and G_z), and three are rotational (Fig. 2: R_x , R_y , and R_z).

In the table on the following page, all motions are described by these terms alone or in combination.

Performance information, in the categories of sensory, motor and "judgment" decrement, should be assayed in all "tolerance" studies, at least in the pre and post exposure periods, and preferably during the run as well.

IMPACT TOLERANCE FIXED POSITION

Based on Data from Lombard in
Physics & Medicine of the Upper Atmosphere

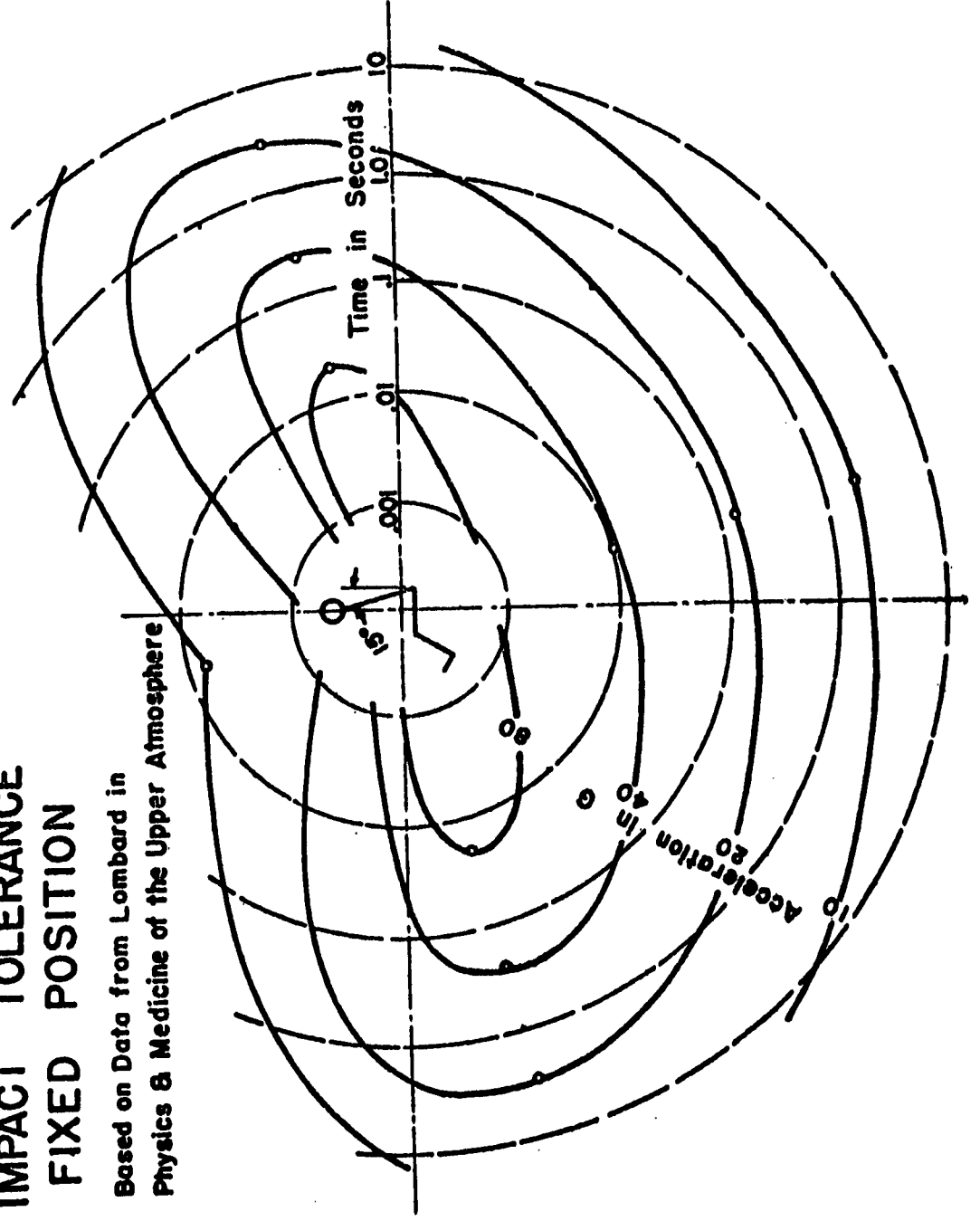

RESPONSE TO VERTICAL VIBRATIONS

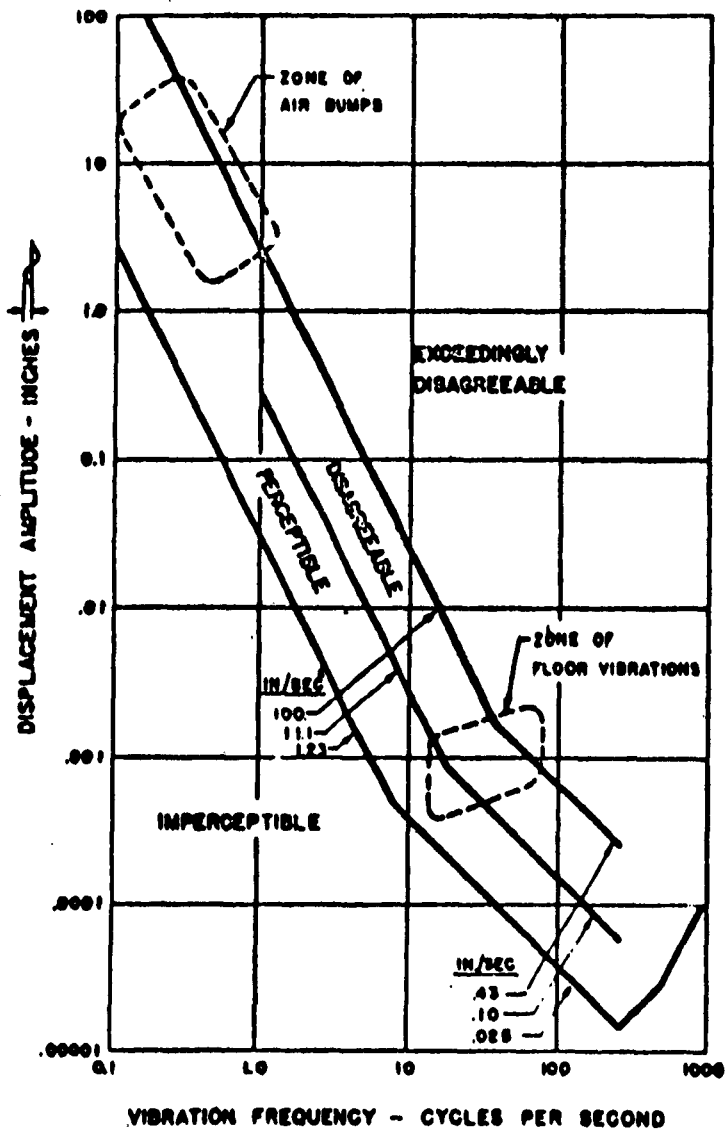

From Ride and Vibration Data, Special Publications
Dept., SP 154, S.A.E., n.d.

HUMAN TOLERANCE TO WHOLE BODY SINUSOIDAL VIBRATION

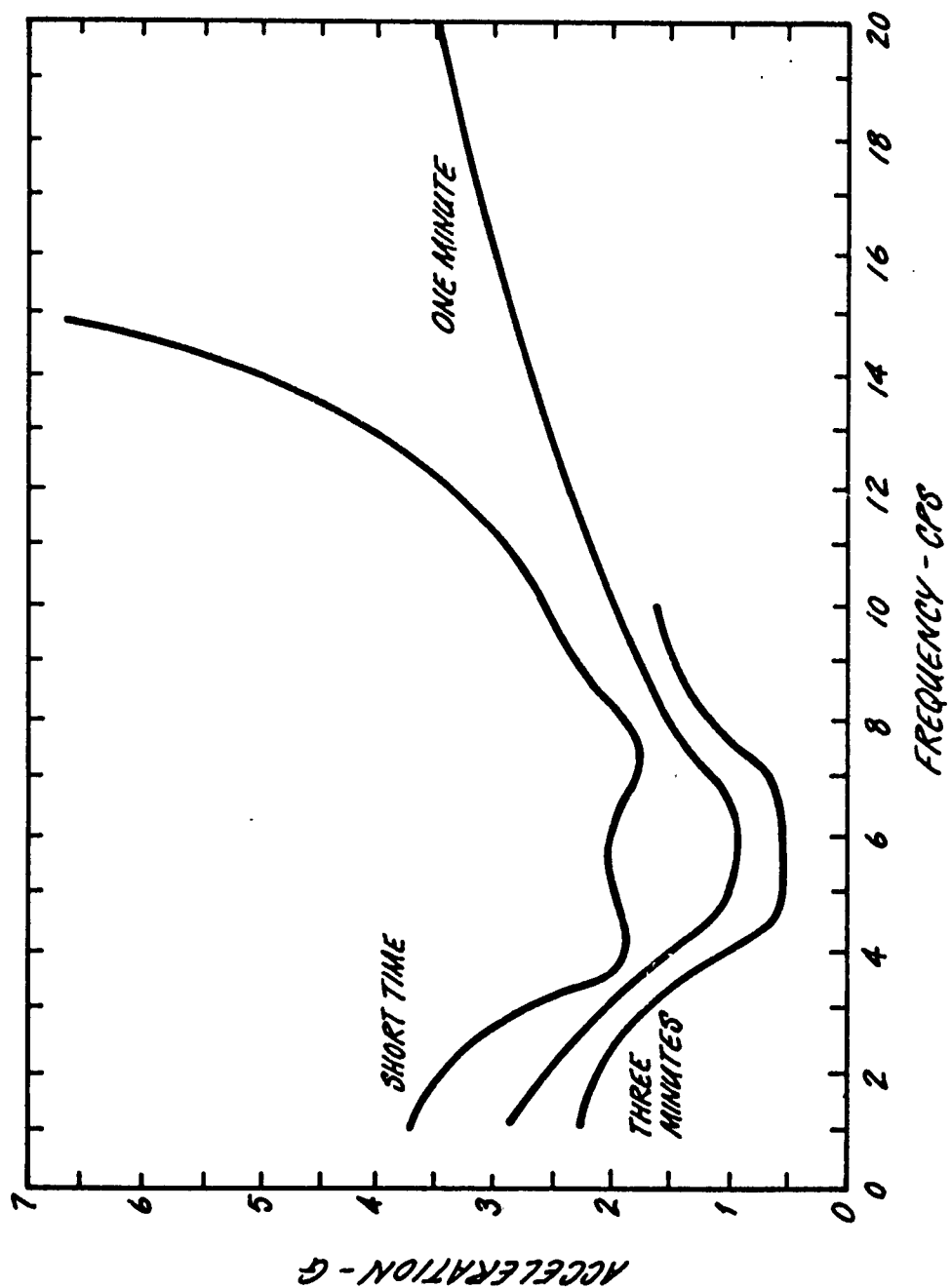

TIME VARIATION OF ACOUSTIC ENVIRONMENT X-20 GLIDER BOOST PHASE

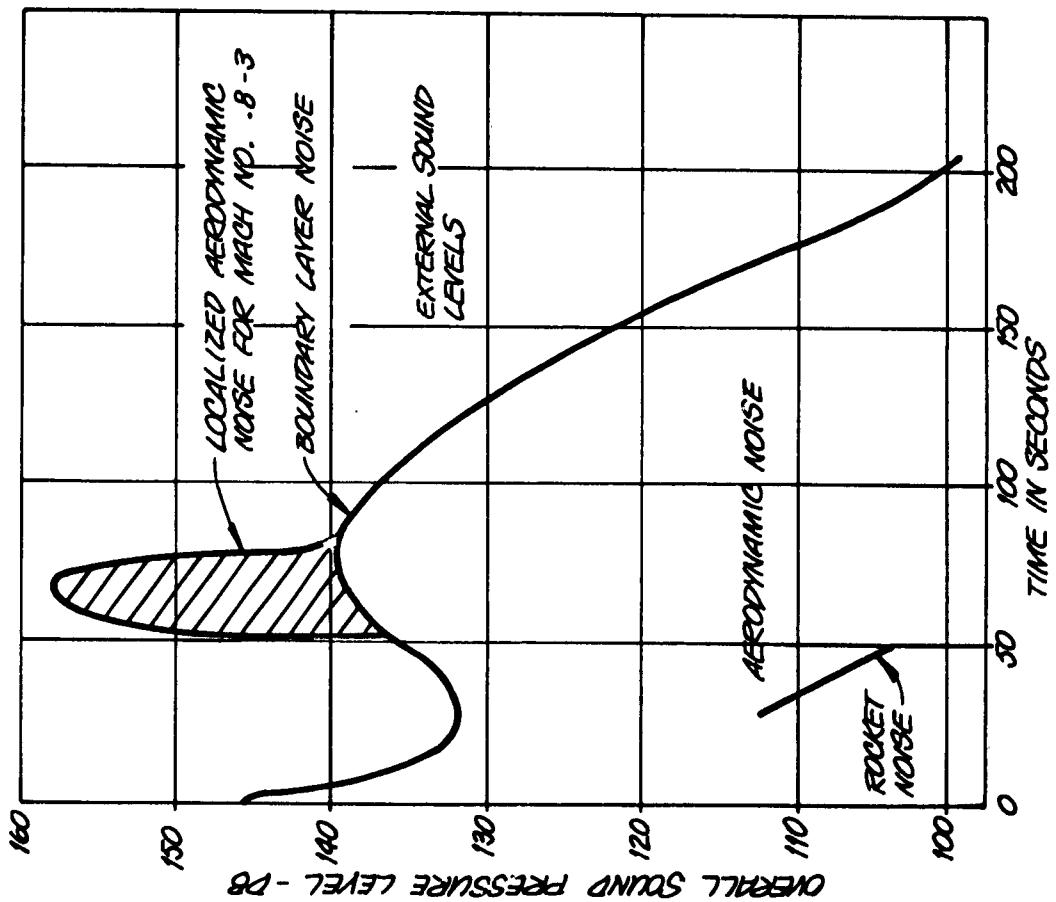

ESTIMATED INTERNAL NOISE LEVELS DURING LAUNCH APOLLO SPACECRAFT

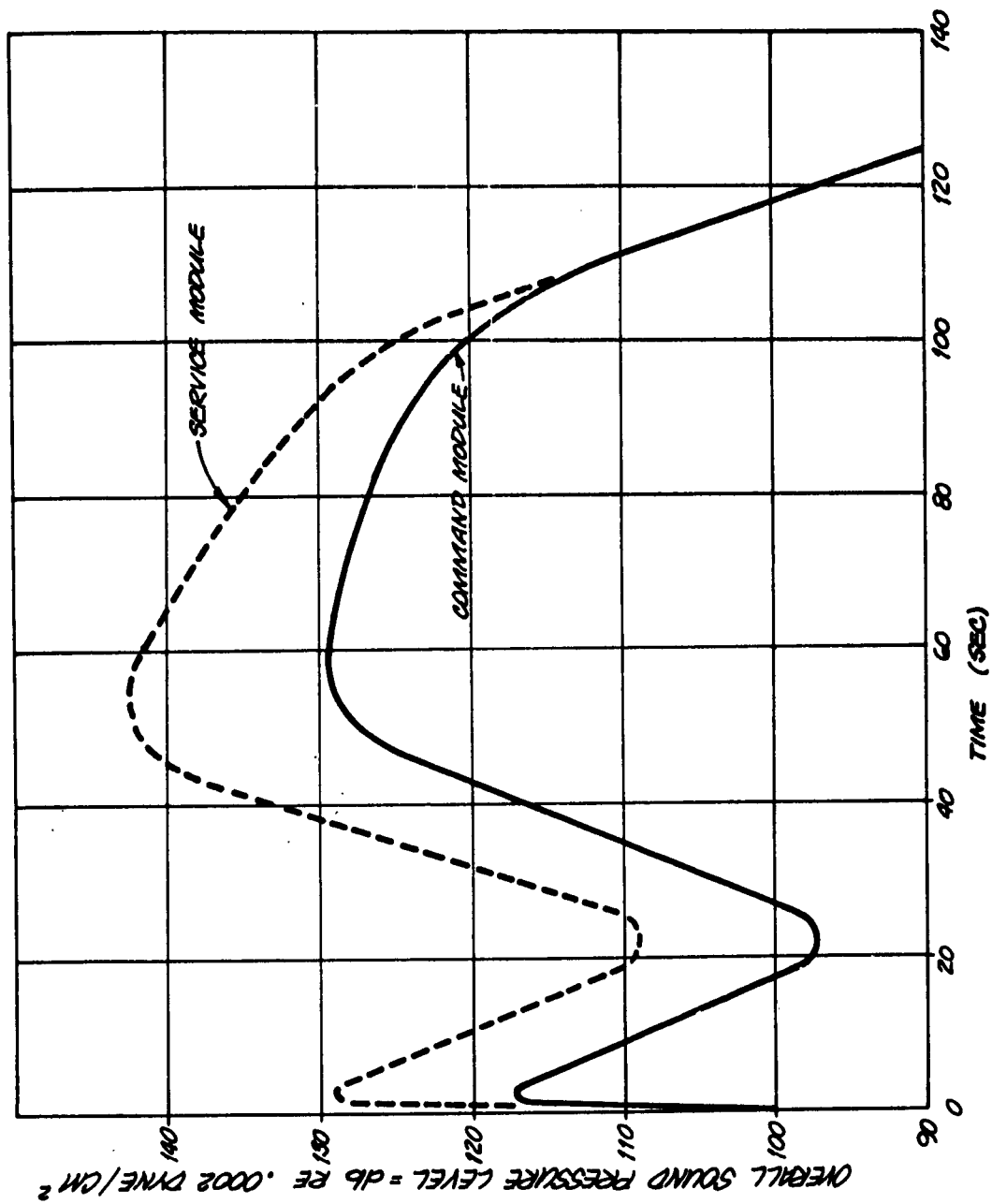

SOUND PRESSURE LEVELS AT LIFT-OFF

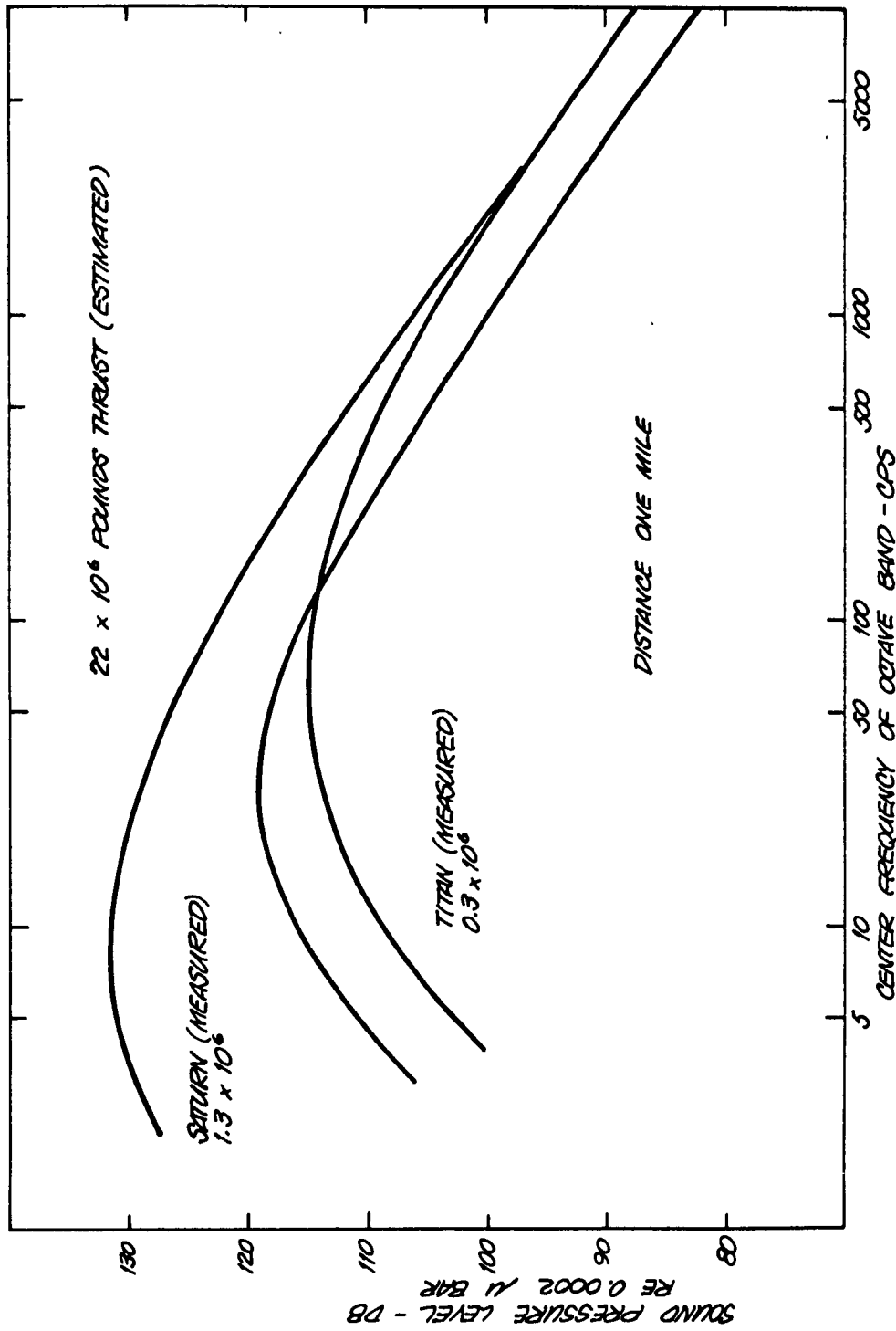

EXPECTED TIME COURSE IF SYMPTOMS DEVELOP IN WEIGHTLESSNESS

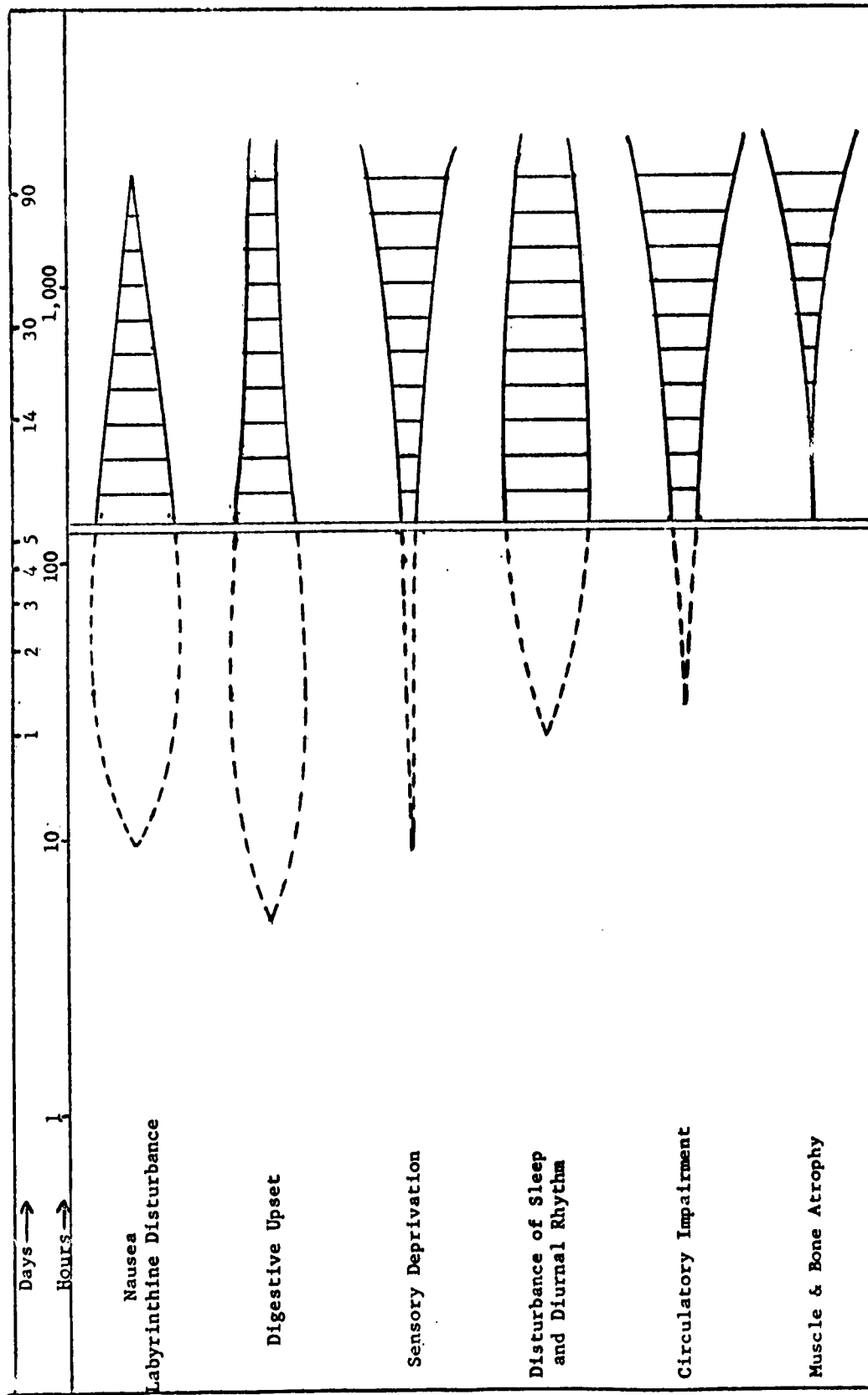
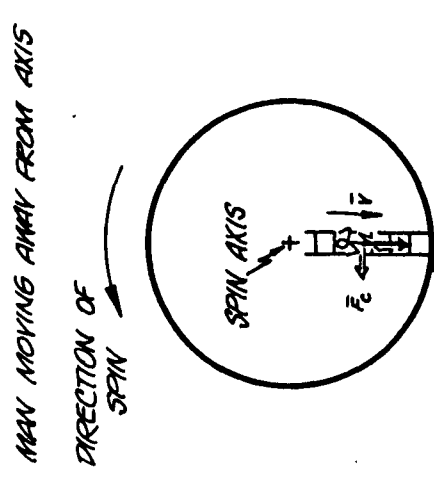
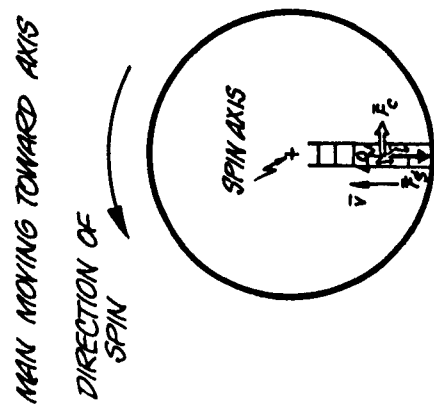
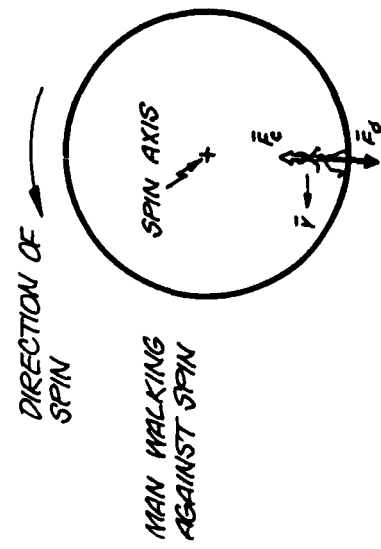
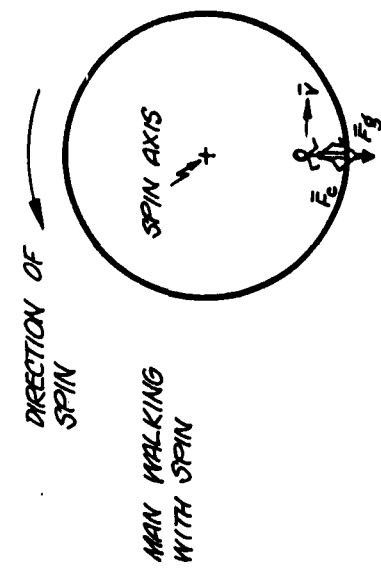

Figure on the opposite page is a hypothetical diagram based upon physiological reasoning which attempts graphic presentation of the time sequence in which symptoms of weightlessness would develop, when and if they occur at all. The six general areas of symptomatology cover all disturbances predicted in the literature. Up to 9 hours of flight time, they are drawn as not occurring because there have been no complaints whatever about weightlessness from the US observers and the Russian Titov experienced no symptoms until the 6th orbit. Where curves taper off with increasing duration, this is to indicate that even if symptoms occur, acclimatization is the rule in the case of similar symptoms induced in the field or in the laboratory. The signs MA-6, 7, 8, 9 refer to the flights of Glenn, Carpenter, Schirra, and Cooper, respectively. V1, 2, 3, 4, 5, and 6 refer to the Vostok flights of Gagarin, Titov, Nikolavayev, Popovich, Bykofsky, and Tereshovka, respectively. The outlines are only drawn with dotted lines up to the point of the double bar at five days to indicate that, so far, no symptoms have been reported (except in the case of Titov) for these various disturbances theoretically anticipated in the weightless state.



INERTIAL REACTION FORCES EXPERIENCED BY MAN MOVING IN RADIAL DIRECTION INSIDE ROTATING VEHICLE.



INERTIAL REACTION FORCES EXPERIENCED BY MAN MOVING IN TANGENTIAL DIRECTION INSIDE ROTATING VEHICLE

HUMAN FACTORS DESIGN ENVELOPE FOR ROTATION TO PRODUCE ARTIFICIAL GRAVITY

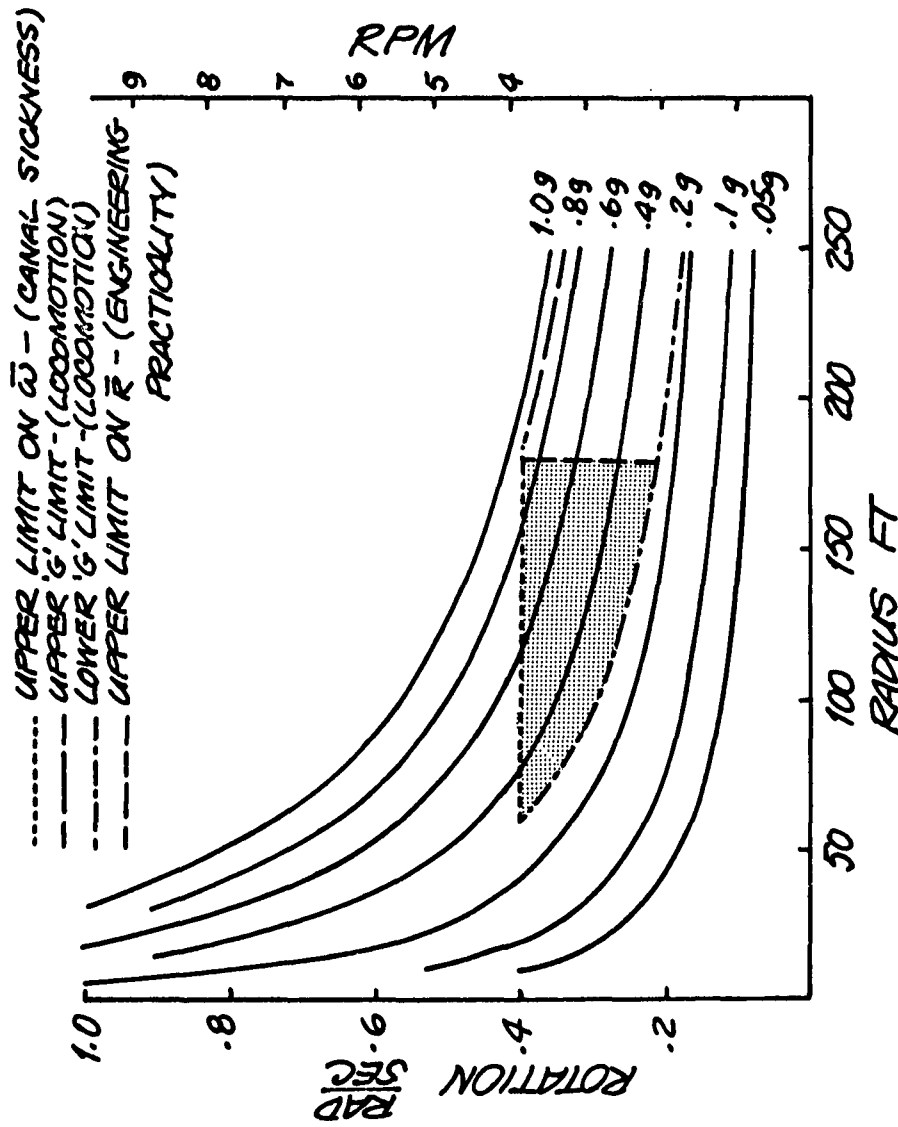

BIOTECHNOLOGY

1. Generation and control of habitable atmospheres
2. Food, water, and waste management
3. Emergency personal protective gear
4. Capabilities for extravehicular operations

BIOTECHNOLOGY

1. Generation and control of habitable atmospheres
2. Food, water, and waste management
3. Emergency personal protective gear
4. Capabilities for extravehicular operations

RESPIRATORY SUPPORT SYSTEM WEIGHT VS. MISSION DURATION

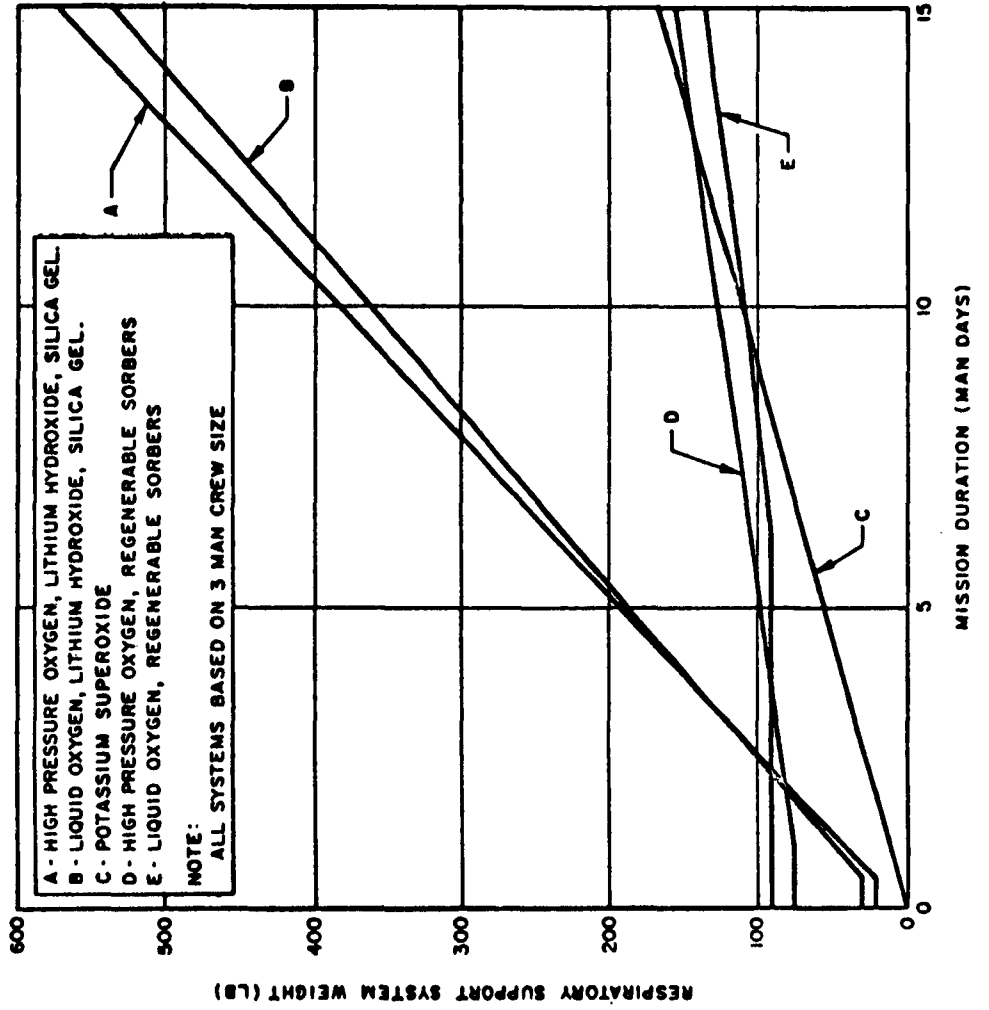

RESPIRATORY SUPPORT SYSTEM WEIGHT VS MISSION DURATION

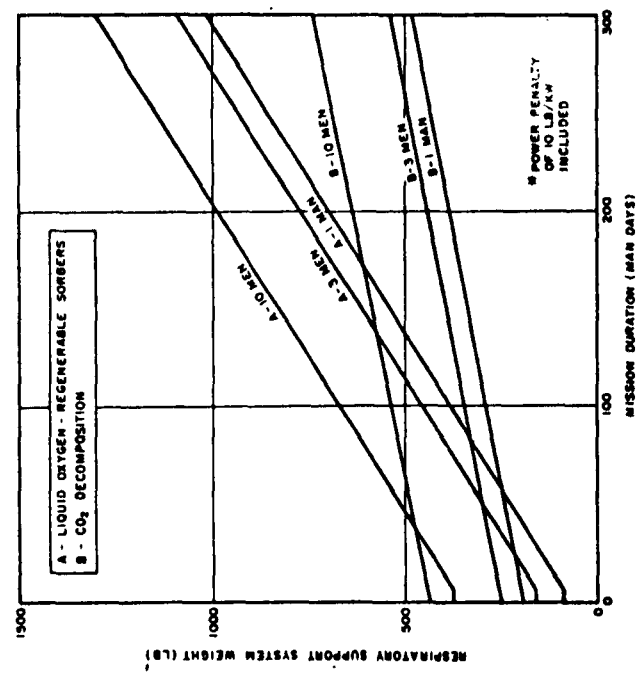
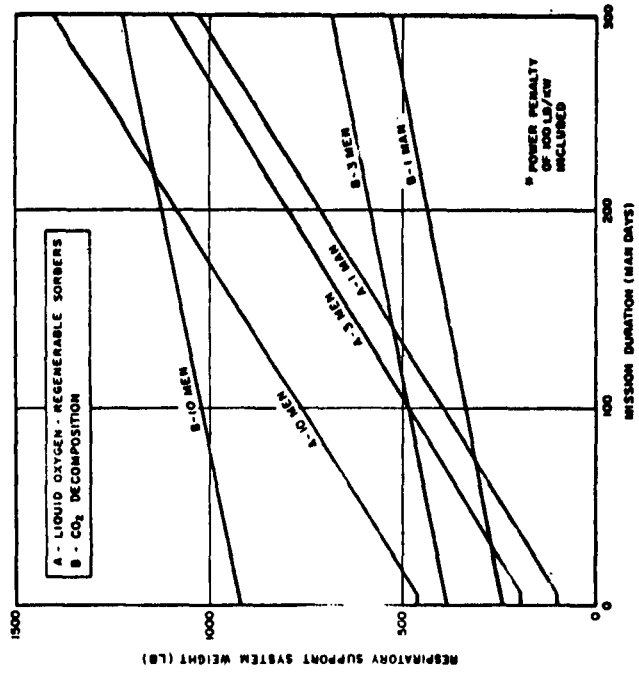

REGENERATED RESPIRATORY SUPPORT SYSTEM WEIGHT
COMPARED TO MISSION DURATION

It can be expected that the weight of power supply systems per kilowatt output will drop substantially in the next decade. Some estimates have placed this drop in a ratio of ten to one, or even better. The graphs on the opposite page show the effect of assuming these two different weight proportions with two basically different atmosphere production and regeneration systems: (1) a low power-consuming, stored oxygen system, employing regenerable sorbers for CO₂ and water; and (2) a high power-consuming oxygen regenerating system dependent on breaking down CO₂ and H₂O.

CHEMICAL AND PHYSICAL STEPS IN GETTING O₂ FROM CO₂

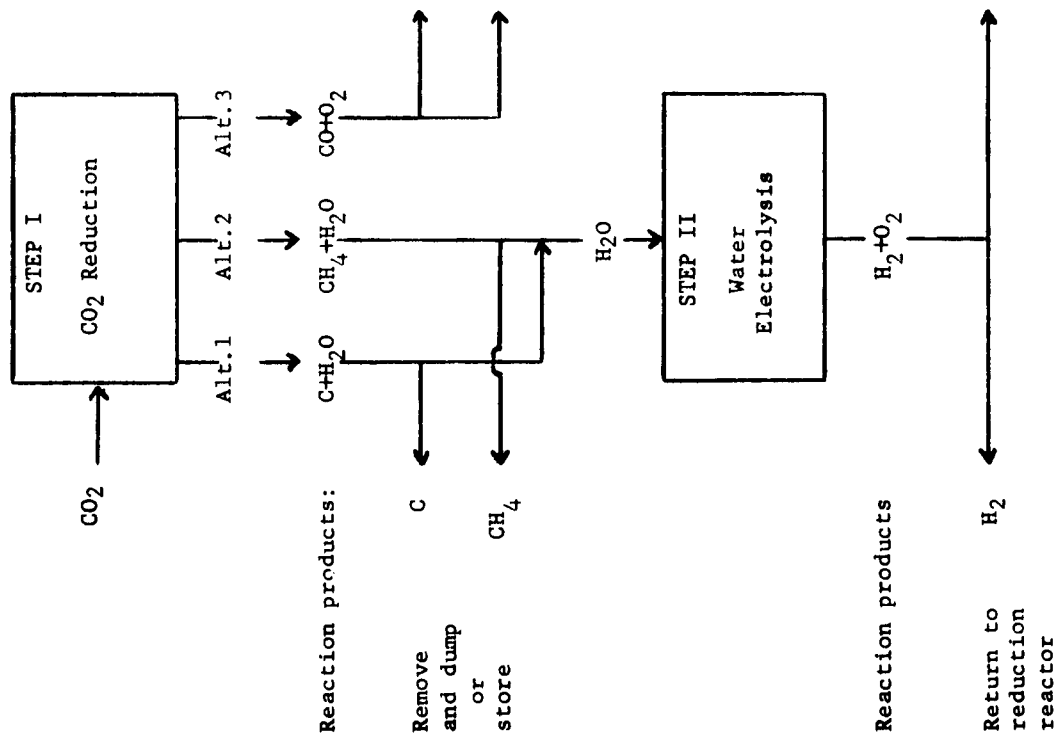
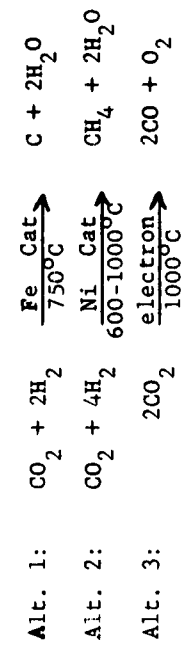

PHYSICAL-CHEMICAL STEPS IN RECOVERY OF OXYGEN FROM CARBON DIOXIDE

(See following chart)

Step 1 - Reduction of Carbon Dioxide: At the present, there are three methods of reduction that deserve strong consideration. There are, however, several other methods that are not now competitive and have not been listed. The alternate methods are:

1. $\text{CO}_2 + 2\text{H}_2 \xrightarrow{\text{Fe-Ca/C}}$ $\text{CH}_4 + 2\text{H}_2\text{O}$ - This method is utilized in the reactor developed at the Battelle Memorial Institute for AMRL and later improved by a program at the Mechanics Research Division of General American Transportation Company. A three-man system weighing approximately 190 lbs requiring 975 watts for operation resulted from this program. The temperature of operation is 750°C over a stainless steel screen catalyst.

2. $\text{CO}_2 + 4\text{H}_2 \xrightarrow{\text{Ni-Ca/C}}$ $\text{CH}_4 + 2\text{H}_2\text{O}$ - This method is known as the methanation reaction and is somewhat simpler than the above reaction. However, the production of methane complicates the over-all system since the penalty for cracking methane would be prohibitive utilizing present techniques. This necessitates dumping or storing methane and also carrying a stored supply of hydrogen.

3. $2\text{CO}_2 \xrightarrow{\text{elect}}$ $2\text{CO} + \text{O}_2$ - This technique employs a $\text{ZrO}_2\text{-Y}_2\text{O}_3$ electrolyte approximately 1/16" in thickness. By applying a potential across the electrolyte oxygen ions dissociated from carbon dioxide on the cathode migrate through the electrolyte where they combine and form molecular oxygen at the anode. The carbon monoxide is catalytically burned to carbon dioxide and carbon over nickel catalyst. The carbon dioxide is returned to the reaction chamber for further treatment. The reaction temperature is approximately 1000°C and the system requires approximately 1 KW. The projected weights of this system are competitive with those resulting from the above described methods.

(See following chart)

Step II - Water Electrolysis: This step is required for both of the first two techniques for reducing carbon dioxide since water results from both reactions. At present, there are three electrolysis systems under consideration.

1. Rotating Cell - This system utilizes a rotating cell to orient the liquid electrolyte. Asbestos membranes are required to prevent mixing of the gases. The oxygen produced is pure and requires no further treatment. The hydrogen is returned to the carbon dioxide reduction reactor.
2. Palladium-Silver Hydrogen Diffusion Cathode - This technique employs a palladium-silver alloy cathode for diffusing the produced hydrogen to a collection chamber and thereby separating it from the electrolyte. A porous matrix containing the electrolyte separates the cathode from the anode and allows the oxygen to be separated from the electrolyte. This system is a static one. Projected weight for a three-man system would be 25 lbs. Power requirement would be 750 watts. Again the oxygen is pure and the hydrogen would be recycled to the carbon dioxide reduction system.
3. Phosphorous Pentoxide Electrolyte Cell - This technique employs a phosphorus pentoxide electrolyte which absorbs water vapor from the atmosphere. The saturated electrolyte forms an impermeable barrier and, therefore, affords separating of the hydrogen and oxygen. Again the oxygen is pure and the hydrogen is recycled to the carbon dioxide reduction system.

GENERATION OF HABITABLE ATMOSPHERES

Current Programs		Future Programs					
Problem Area	Program Summary	Ground Laboratory (or Aircraft) Experiments	Space Vehicle Experiments	Type of Space Vehicle Needed			
High capacity O ₂ storage and supply requirements	Tasks to demonstrate prototypes of cryogenic (supercritical and non-supercritical storage systems) and to develop solid superoxide systems.	After engineering evaluation in environment simulators these units will get brief flight tests in O-g state in Titan missile and in aircraft to validate basic principles	Long duration orbital flight tests of cryogenic storage and supply systems needed to validate operational reliability and crew acceptability	G	A	D/S	Other
CO ₂ removal and reduction for recovery of O ₂	CO ₂ removal from circulating atmospheres by means of such regenerable or non-deteriorating devices as molecular sieves and selectively permeable membrane devices. Solid electrolyte CO ₂ reduction system being fabricated.	Laboratory and suborbital engineering evaluations of operating principles will be desirable, though these are not believed to be sensitive to weightlessness. Ground testing will be completed 1964 and flight test scheduled on Titan missile in 1965.	Items should be flight tested in unmanned flights and as auxiliary systems on manned flights before using as primary systems.	+	+	-	
Water electrolysis for recovery generation	Water electrolysis using chemical and/or chemical means for separation of H ₂ and O ₂ is being studied.	Ground testing, aircraft flights, and suborbital testing is essential.	Orbital flight test in auxiliary status very desirable.	+	+	-	
CO ₂ removal and O ₂ production by algae	Extensive studies of algae culture, plant physiology, CO ₂ consumption and O ₂ production, environmental effects going on.	This program is still at the basic level employing laboratory methodology and environmental simulation to proceed.	Exposure of selected algae strains to various space influenced in orbiting vehicle is desirable to advance research goals.	+	+	-	

CONTROL OF HABITABLE ATMOSPHERES

Current Programs		Future Programs		
Problem Area	Program Summary	Ground Laboratory (or Aircraft) Experiments	Space Vehicle Experiments	Type of Space Vehicle Needed
Gas movement and mixing in the absence of forced convection	Studies of gas movement induced by astronaut respiration and body movement, and by diffusion currents and capsule and/or suit leakage, in the weightless state.	Ground laboratory, aircraft, or piggyback missile tests inadequate, though preliminary tests on transients will be done in KC-135.	Test was scheduled on Mercury MA-10, prior to flight cancellation. Orbital testing of results predicted physical theory and mathematical analysis is required.	G + A + D - S - Other -
Respiratory gas sensing and indicating devices	Various physical principles and sensor instruments are being investigated for applications to two-gas systems. O ₂ , N ₂ CO ₂ , and H ₂ O vapor are primary substances to be sensed, but contaminants are also studied.	Primarily laboratory and environmental simulator tests are required; some suborbital testing would be desirable.	Operational suitability and reliability assurance through orbital flight testing needed.	+ + +
Solid-liquid-gas phase separation problems	In cryogenic supply and distribution systems, and in algae slurries phase separation in the weightless state is being studied, with centrifugal force, capillary devices, surface tension effects, and partially permeable separators receiving most attention.	Ground laboratory tests and theoretical dynamic analyses not conclusive. Aircraft and suborbital tests validate principles for use over brief periods.	Operational suitability and reliability assurance through orbital flight testing needed.	+ + +

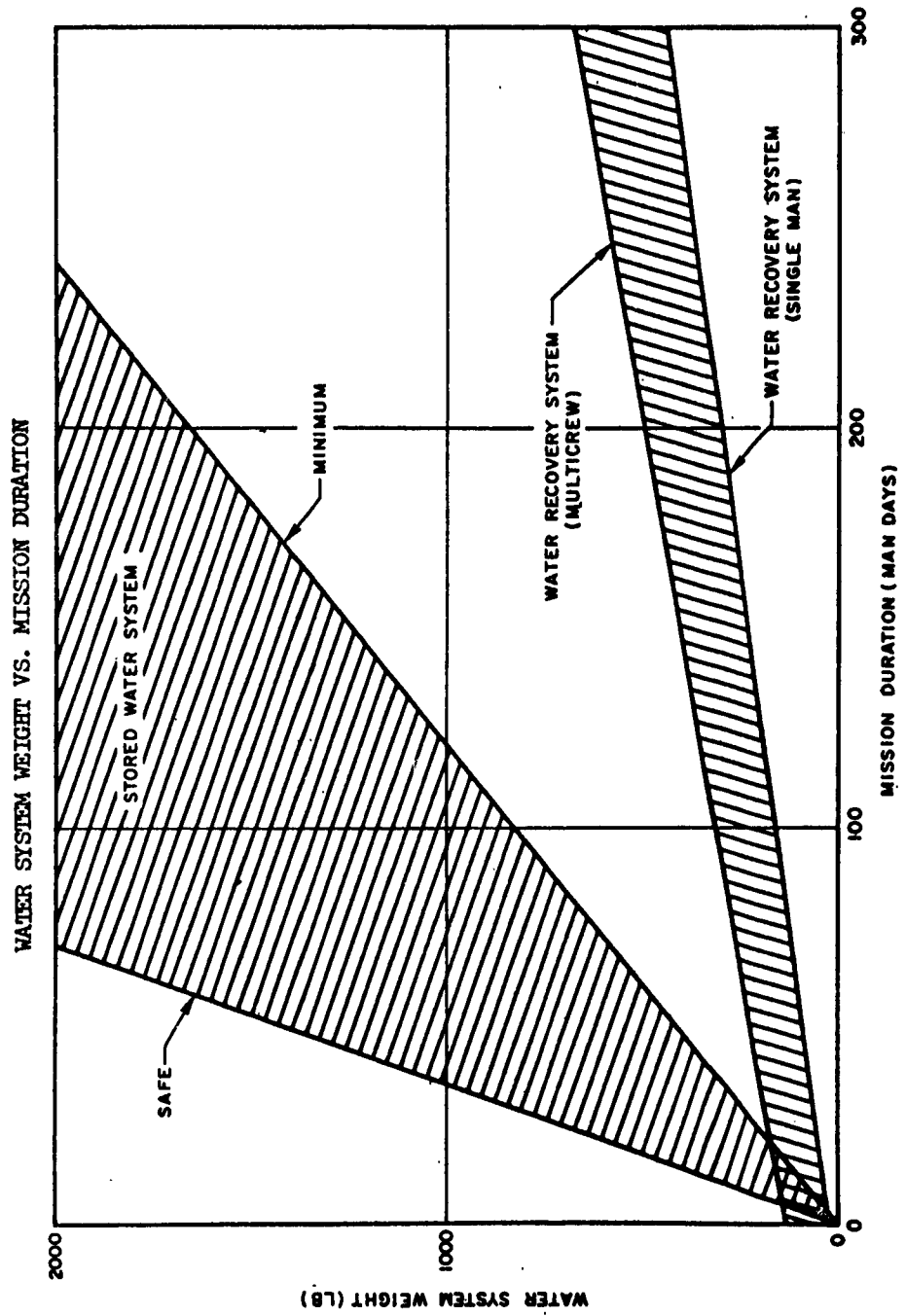

FOOD, WATER, WASTE MANAGEMENT

Current Programs		Future Programs		
Problem Area	Program Summary	Ground Laboratory (or Aircraft) Experiments	Space Vehicle Experiments	Type of Space Vehicle Needed
Food preservation, storage, packaging, dispensing	Tasks on freeze dehydration, flexible packaging films, shelf-life, and palatability of reconstituted foods. Packaging and preparation of a high caloric density, nutritionally optimal space ration is under study.	This work will be conducted almost entirely in ground laboratories and environmental simulators.	Operational suitability and crew acceptability will call for space vehicle testing.	G + A + D/S + Other +
Synthesis and regeneration of food from non-edible materials	Studies on development of synthetic diets, physico-chemical and biological systems for regenerating metabolizable bland products from non-digestible plants or other materials.	This is long range research which will continue to be in laboratory status for some years.	Eventual space vehicle flight testing of equipment and processes used, as well as of crew acceptability will be needed.	- - - +
Water recovery and purification systems	Studies on freeze-drying, fractional distillation, membrane dialysis, and regenerable chemical desalination methods of separating water from liquid wastes are underway.	Several prototype devices have undergone laboratory test, and others will be developed. Basic principles will be developed. Basic principles will be tested in weightless state in aircraft and suborbital flights.	Operational suitability and reliability assurance will require orbital flight tests of considerable duration.	+ - -
Processing and disposal of solid wastes	Mechanical and pneumatic equipment for collection, and processing of solid wastes are under evaluation; and disposal of wastes, including recovery of usable materials (such as water), is being studied.	Research on regeneration of usable materials by chemical and biological means will continue. Flight test of waste-handling devices in aircraft is planned.	Operational suitability, reliability assurance, and crew acceptability will require space flight testing as equipment becomes available.	+ - - +

PERSONAL PROTECTIVE GEAR

Current Programs		Future Programs		
Problem Area	Program Summary	Ground Laboratory (or Aircraft) Experiments	Space Vehicle Experiments	Type of Space Vehicle Needed
				G A D/S Other
Thermal environmental protection	Evaluation of thermal protective qualities of full pressure suits and cold protective and anti-exposure clothing and development of indices and biothermal analog computers for prediction of thermal stress.	Extension of present work to study of space environmental conditions. Emphasis on thermal evaluation of pressure suits, development of IR radiometry and predictive indices, application of biothermal computer to closely simulated space conditions. Improved space environment simulation is required.	Operational suitability and protective effectiveness of crew gear will require space testing under simulated emergency and extravehicular conditions.	- + + +
Crew protection in a vacuum	Development and evaluation of full pressure suits for routine and quick-donning wear inside crew capsules. Oxygen usage rates and ventilation volumes in suits during flight. Integration of suits with seats, restraints, and other protective gear. Extravehicular operational suit incorporating mobility, equipment handling capabilities, thermal protection, self-propulsion, and other characteristics is being initiated.	Continuation of work to more mobile, comfortable, and less bulky suits. Testing of suits in space environment simulators and in aircraft.	Operational suitability, reliability, and crew acceptability in space vehicles will require testing as new models become available.	+ + - +
		Work in this area will be expanded, with more realistic, rigorous testing in environmental facilities simulating space conditions as closely as possible, as such facilities become available.	Operational suitability, reliability, and crew acceptability in space will require continuing tests as a developmental responsibility.	- + - +

ROLE OF RADIOBIOLOGY IN MANNED SPACE FLIGHTS

PREDICTIVE —————> MANNED —————> RESEARCH
MONITORING

USING PROBE
DATA FOR
PREDICTIONS
ON EARLY
FLIGHTS AND
NEW ORBITAL
PROFILES

AS CHECK ON
PREVIOUS
CALCULATED
ESTIMATES FOR
NORMAL AND
UNUSUAL ORBITS
AND FOR EXTRA
CAPSULAR
INSPECTION AND
SAFETY MONITORING

SEE CHART
6

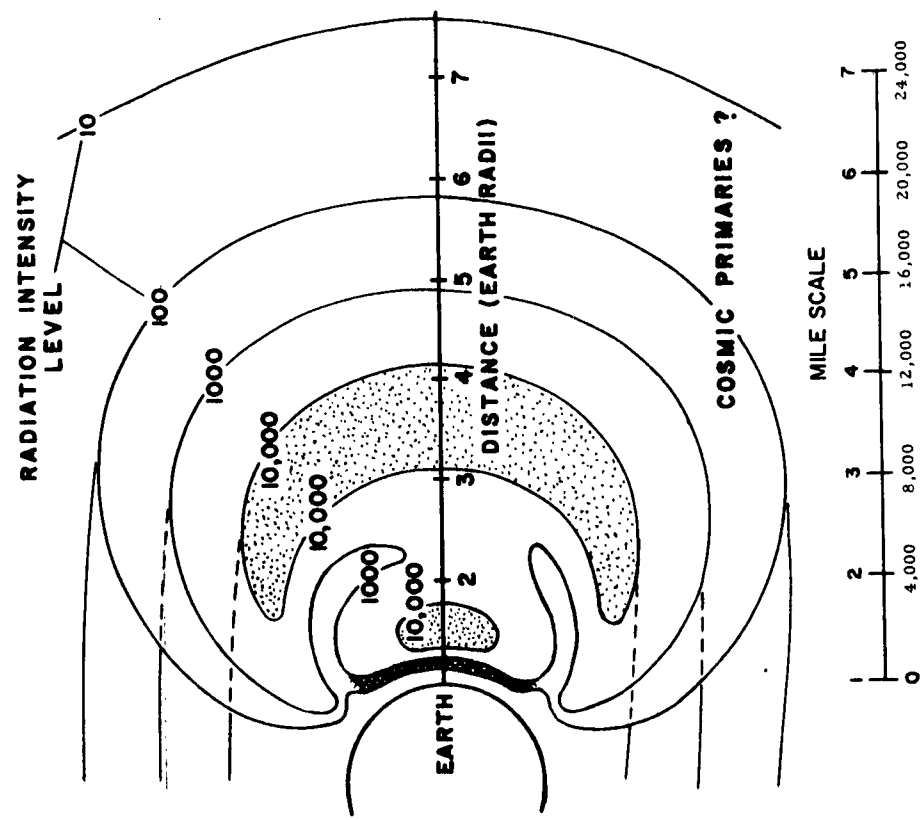

RADIATIONS OF CONCERN

◎ INNER BELT PROTONS AND ELECTRONS

LOCATION < 1 E.R.
EXTENT 5000 km X 6000 km EQUATORIALLY
DOSE 1 R/HOUR

◎ OUTER BELT PROTONS AND ELECTRONS

LOCATION 3 E.R.
EXTENT TAPERS IN TOWARD EARTH AT
50-75° N. OR S. LATITUDE
DOSE 0.1 R/HOUR

◎ SOLAR FLARE PROTONS

LOCATION OUTER SPACE
EXTENT THROUGHOUT — PERIODICALLY
DOSE 30 — 1,300 R TOTAL
10 R/HOUR MAXIMUM
3-7 DAY DURATION

RADIATIONS OF CONCERN

◎ MAN MADE ELECTRONS

LOCATION ARGUS EFFECT

EXTENT _____

DOSE _____

◎ COSMIC PRIMARIES

LOCATION OUTER SPACE

EXTENT THROUGHOUT / DENSITY UNKNOWN

DOSE UNKNOWN

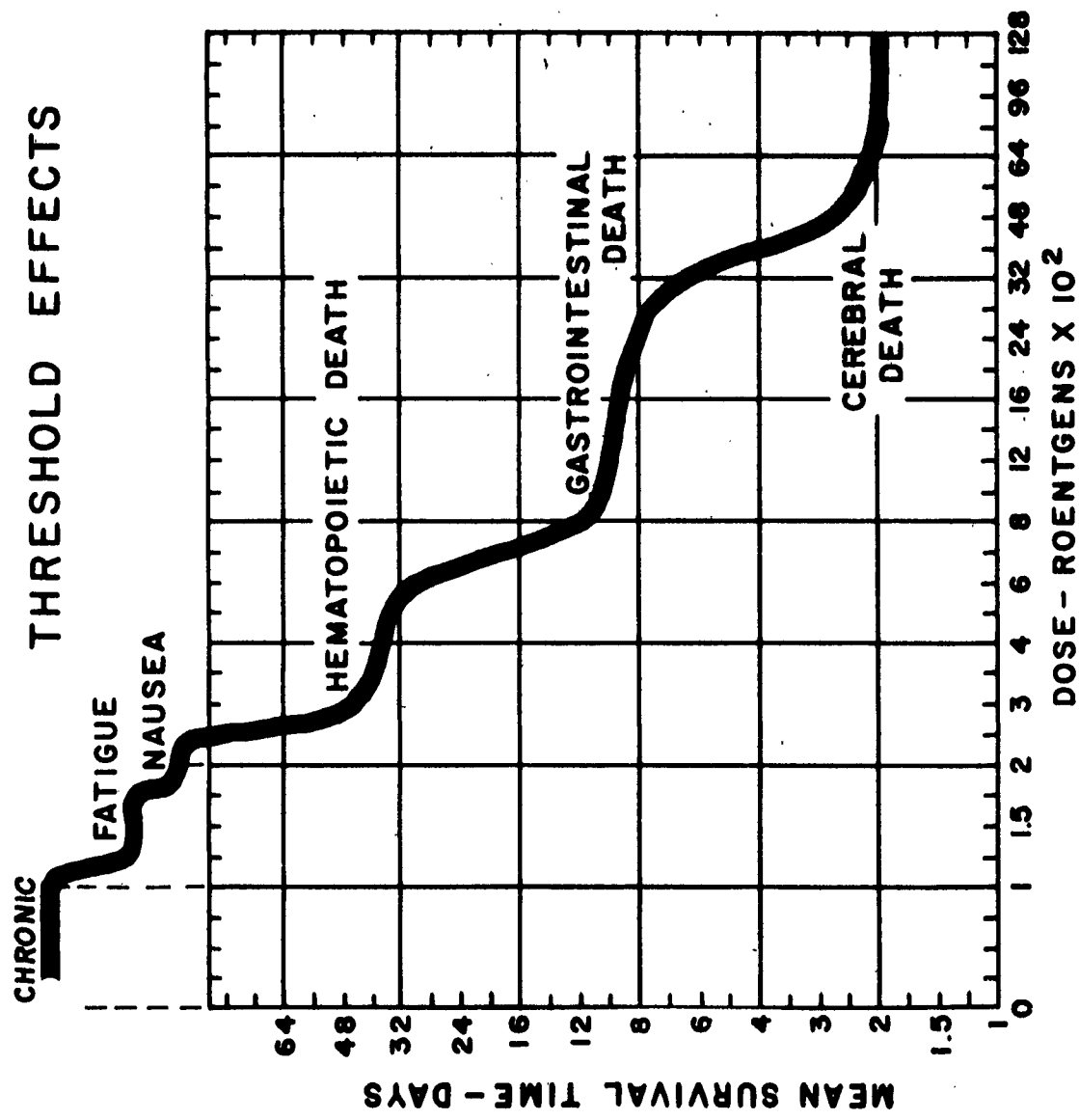

R/ hr R/ day 30 days 60 days 90 days

GALACTIC 0.001 0.025 .750 1.500 2.250

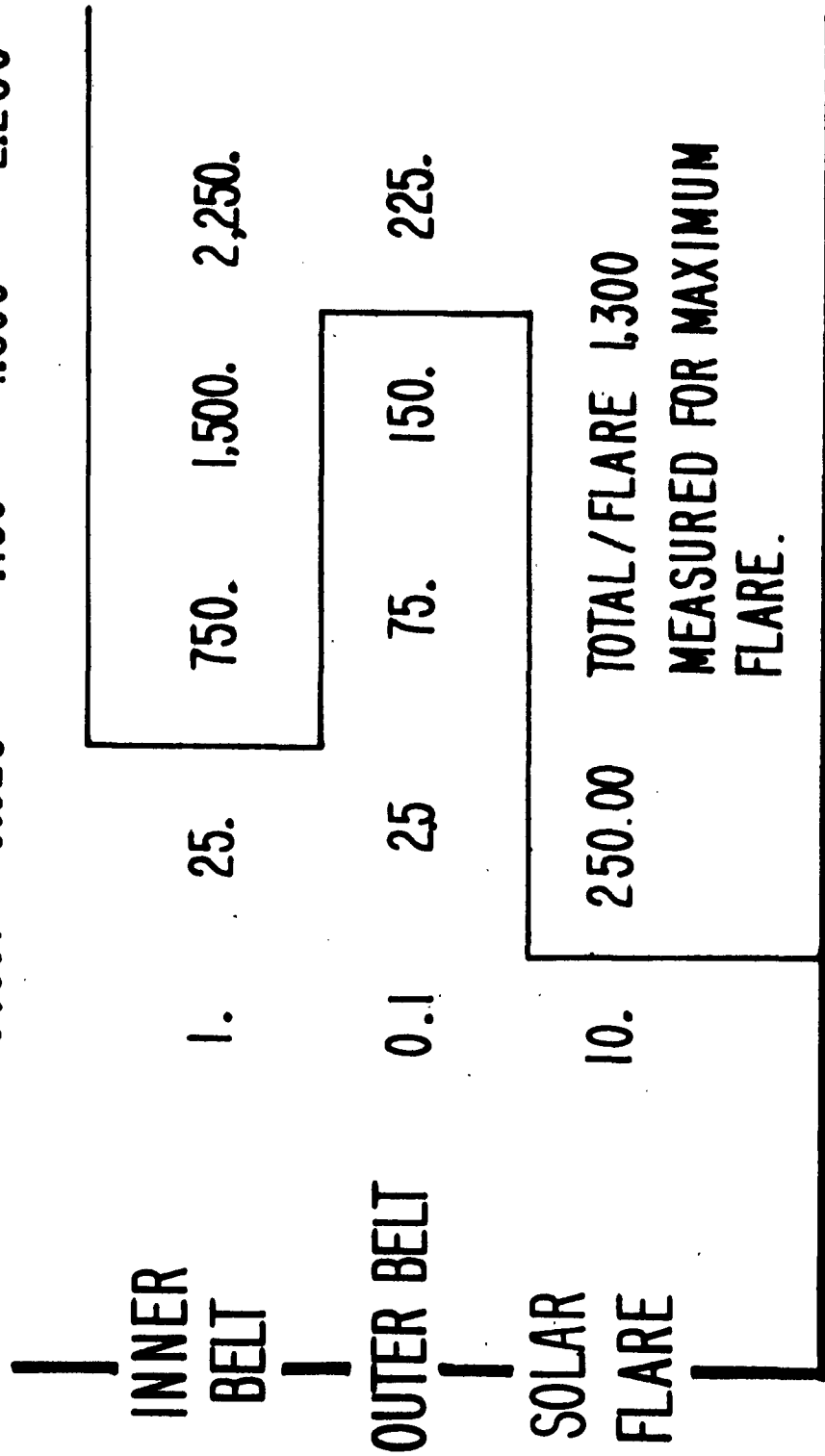

RADIOBIOLOGICAL EXPERIMENTS

◎ SYNERGISTIC STUDIES REQUIRED

MANNED LD 50₃₀ MICE WITH ON BOARD SOURCE.

UNMANNED PRIMATE SOLAR FLARE STUDY WITH TV MONITOR.

BIOLOGICAL EXPERIMENTS

Manned: LD 50/30 mice with on board source. 120-140 mice can be contained and supported in an 18-inch cubic package weighing approximately 70 lbs. While under zero G conditions animals would be exposed to a small gamma source, such to deliver an LD 50/30 dose during the first 30 days of a 60 day flight. Experimental array to be similarly exposed on the ground with all conditions replicated save for zero G. End points will be hematological and time of death.

Unmanned: 1 or 2 primates can be contained and supported in a 3-foot cube and placed in orbit in the inner belt or during a max solar flare. End points will be telemetered performance response, reinforced by electric shock, and time of death by thermo-couple. Dose rate information telemetered to ground stations will permit a similar 1 G experiment. TV monitoring is highly desirable.

RADIOBIOLOGICAL EXPERIMENTS

- ① 2 π PROBES, GAMMA, PROTON, ELECTRON
TO CONFIRM MATRIX OF CABIN DOSE AND
TO IDENTIFY SHADOW SHIELDING AREAS.

- ② REPEAT + HEAVY PRIMARY DETECTOR TO
DETERMINE DENSITY OF HEAVY PARTICU-
LATES AND AS SAFETY MONITOR IN EXTRA
CAPSULAR OPERATIONS.

RADIOBIOLOGICAL EXPERIMENTS

- COLLIMATED OR COINCIDENT GAMMA, PROTON, ELECTRON PROBE TO MEASURE INCIDENT ANGLE OF RADIATION AND TO DEFINE SCATTER HOT SPOTS.
- REPEAT + HEAVY PRIMARY DETECTOR FOR EXTRA CAPSULAR OPERATIONS TO DETERMINE INCIDENT ANGLE OF NATURAL AND MAN MADE RADIATIONS.

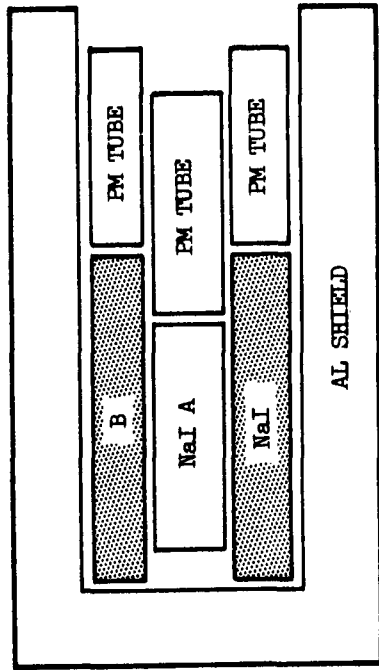

(NOT TO SCALE)

GAMMA RAY DETECTOR

- A. NaI SCINTILLATOR - 1" x 3"
- B. NaI SCINTILLATOR - 1-1/8" x 2-1/8" x 6" LONG

DETECTOR ASSEMBLY AND EXPERIMENT

A simple system to accomplish measurements of primary and secondary geomagnetically trapped particles is shown in Figures 1 and 2. Figure 1 depicts a telescopic proton counter which is capable of measuring proton energies from less than 10 Mev to about 300 Mev, while discriminating against the high incident flux of artificially injected electrons. In Figure 2 is shown a telescopic electron detector capable of measuring electron energies from about 500 Mev to greater than 10 Mev.

Gamma ray measurements are accomplished by an electron shielded sodium iodide crystal placed inside an annular sodium iodide crystal to obtain directional dependence. This arrangement is shown in Figure 3.

With this assembly, time and space variations of electron, proton and gamma ray fluxes inside the space vehicle would be easily obtained, indicating whether there are any points of enhanced or diminished radiation intensity, and if they are directional.

Measurements made outside the capsule, at sufficiently large distances where the primary space flux would not be appreciably perturbed would similarly be made. By placing absorber simulating capsule shielding or tissue, a precise determination of the effectiveness of various materials and the concomitant production of secondaries would also be measured.

Data is accumulated by a suitably gated multichannel pulse height analyzer and count rate meter in a parallel arrangement.

The above systems do not exist in whole and would have to be assembled and packaged to meet requirements of weight, power consumption and versatility for the particular measurement desired.

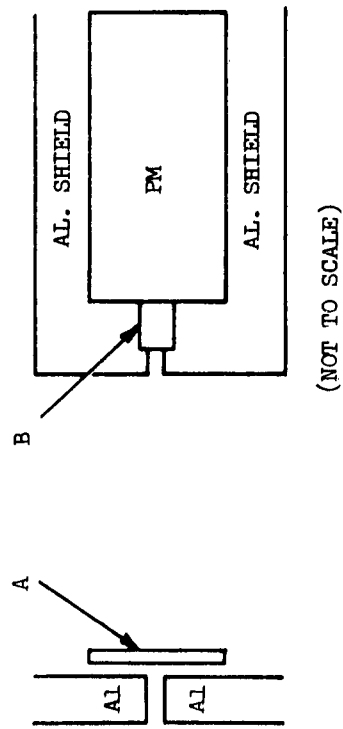

ELECTRON DETECTOR

DETECTOR A - THIN SEMICONDUCTOR

DETECTOR B - THICK PLASTIC OR ANTHRACENE

COINCIDENCE OF A AND B MEASURES ELECTRONS FROM
500 KEV TO GREATER THAN 10 MEV

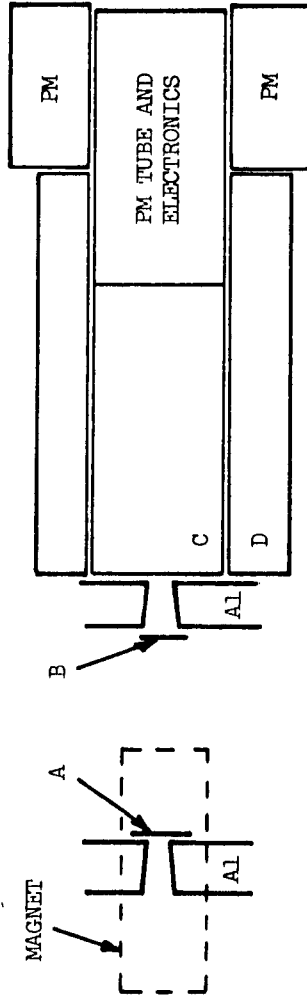

(NOT TO SCALE)

PROTON DETECTOR

- A. DETECTOR - THIN (.004") SEMICONDUCTOR
- B. DETECTOR - THIN (.004") SEMICONDUCTOR
- C. DETECTOR - CsI, 1" x 6"
- D. DETECTOR - PLASTIC SCINTILLATOR 1-1/8" x 2-1/2" x 8" LONG

COINCIDENCE OF A, B & C WITH ANTICOINCIDENCE OF D DEFECTS
 PROTON IN ENERGY RANGE 10 - 300 MEV

CONCLUSIONS

Paucity of reproducible data from unmanned flights requires the extensive and considered measurements made possible with manned flight.

Physical Characteristics

Particle Type)	(orbital coordinates
Particle Energy)	(on repeated passages
Particle Density)	(preferably with radically
Incident Angle)	(elliptical equatorial and polar profiles

Naturally occurring

Environmental Characteristics

- * Cabin matrix dosimetry
- Scatter hot spots
- * Shadow shielding
- Safety monitoring
- Foreign objects

	CURRENT			* NON AVAILABLE VEHICLES
	X-20	Gemini	Apollo	
PHYSICAL CHARACTERISTICS				
Beyond Outer Belt			+ +	+ + + +
Below Inner Belt	+	+ +	+ + + +	+ + + +
ENVIRONMENTAL CHARACTERISTICS				
Beyond Outer Belt			+ + + +	+ + + +
Below Inner Belt	+ +	+ + + +	+ + + +	+ + + +

*Highly elliptical orbit from 10E. R. to 1/10 E. R.

HUMAN PERFORMANCE

Area of Concern	Status of Current Knowledge	Adequacy of Current Investigations	Adequacy of Ground Facilities (Including Simulators and Aircraft)	If Space Test Needed, Adequacy of Gemini, Apollo, and X-20			
				G	A	X-20	None Adeq.
<u>Sensory-Perceptual Capabilities</u>							
• Visual acuity	0	0	0	+	+	+	
• Acuity in depth	0	0	0	+	+	+	
• Brightness discrimination	0	0	0	+	+	+	
• Recognition of ground targets	-	-	-	0	+	+	
• Detection of other space objects	-	-	-	+	+	+	
• Optical aids to vision	-	-	-	+	+	+	
• Displays for space piloting and navigation	0	+	+	+	+	+	
• Display enhancement techniques	-	0	0	+	+	+	
• Display "quickenings"	0	0	0	0	+	+	
• Predictor displays	-	-	-	+	+	+	
• Audio feedback in remote manipulation	-	0	0	+	+	+	
• Labyrinthine effects	0	0	0	+	+	+	

KEY

- "+" indicates adequacy
- "0" indicates marginal adequacy
- "-" indicates inadequacy

NOTES ON SENSORY - PERCEPTUAL CAPABILITIES

"Display enhancement techniques" refers to such things as elimination of noise on radar scopes, sharpening of contours, and similar procedures for enabling the operator better to detect and identify targets.

"Display quickening" refers to the process of adding derivative information to displays. For example, it is frequently found advantageous in terms of accuracy of control to add the first and second derivatives of position (properly weighted) to a dial that originally displayed only position information.

"Predictor displays" refers to those displays that show what will happen some finite period of time in the future if current actions are continued. For example, a display might show the positions (envelope) a vehicle, now at a given point in space, could occupy during the next ten seconds, considering, of course, the limits of maneuverability of the vehicle. It has also been suggested that predictor displays could be used to display the consequences of various alternatives, each of which could involve several variables, variously weighted. (The alternatives are solved in fast time.)

"Audio feedbacks..." refers to the use of auditory cues as an aid in positioning the slave elements of remote manipulators. For example, the approach to the object to be grasped might be signaled by a "beep-beep" of increasing frequency.

"Labyrinthine effects" refers to the orientation and righting reflexes (as well as to disorientation, nystagmus and vertigo) associated with stimulation of the inner ear.

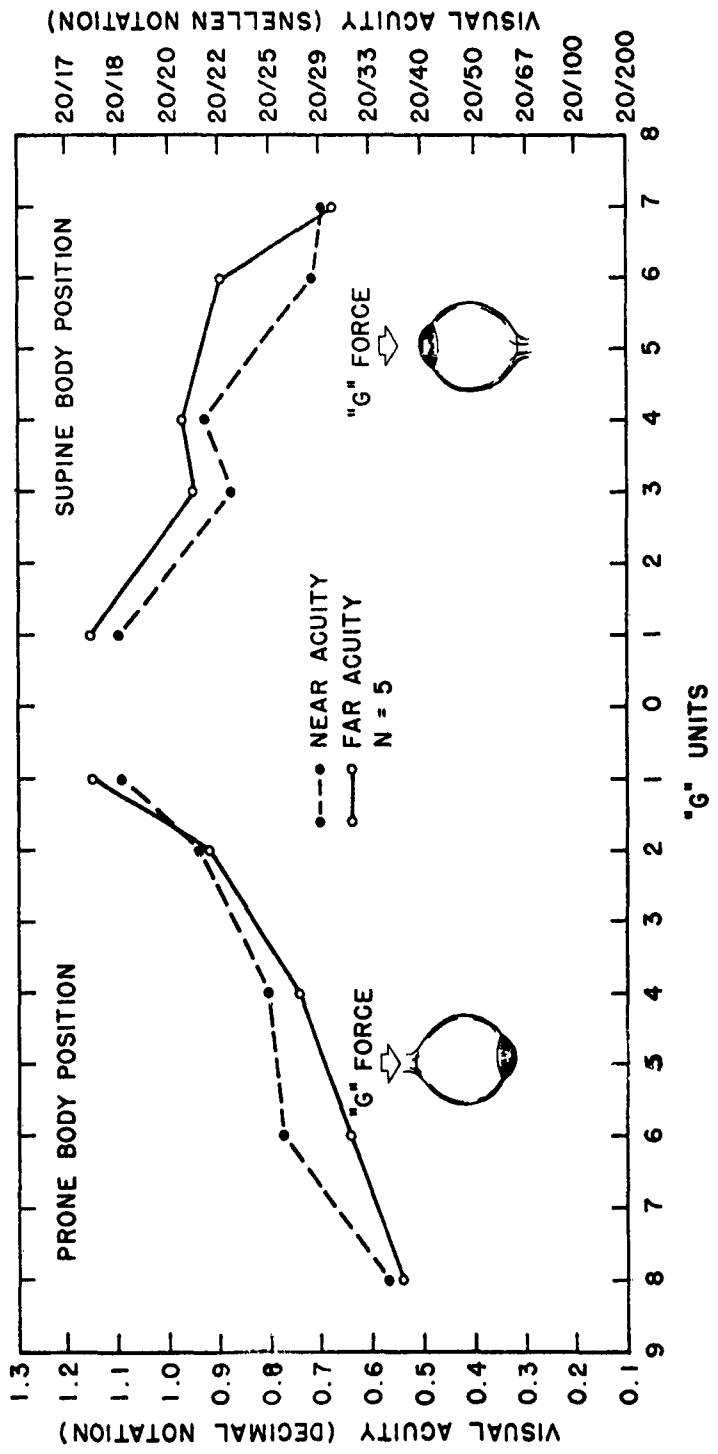

Effect of Acceleration on Visual Acuity

The ability of a pilot to read his instruments is adversely affected by accelerative forces. This is true even when the acceleration is too small to produce any noticeable dimming of peripheral vision.

Preliminary research suggests that a small decrement in visual acuity may also occur under zero G. That is, the attached graph of visual acuity as a function of acceleration (in C units) may dip in the middle.

It has been demonstrated that the loss in visual acuity when the accelerative forces are greater than 1 can be compensated for by simply increasing the illumination. It is quite likely that even if there is a slight loss of visual acuity under zero G, it too can be compensated for by increased illumination.

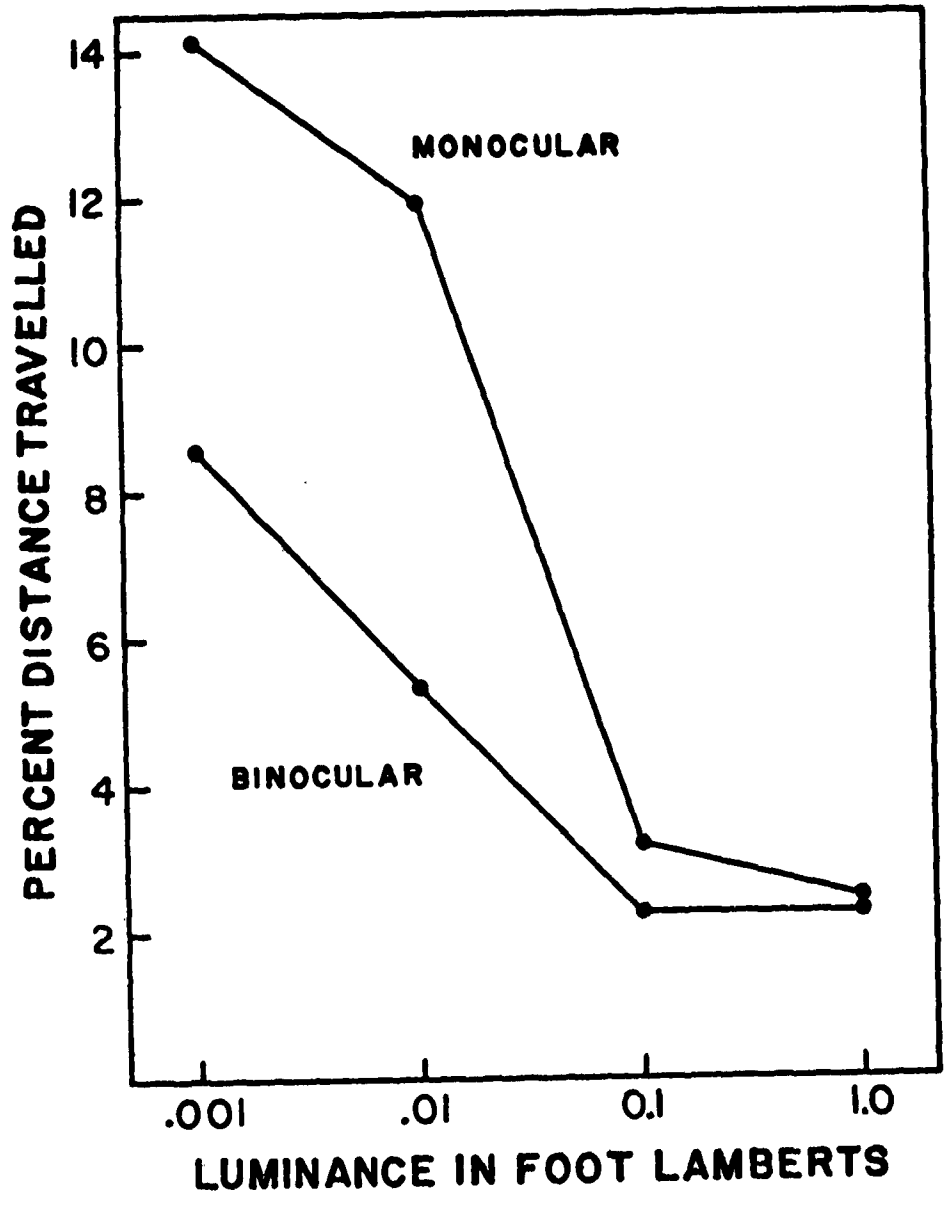

Luminance in Foot Lamberts

The percent distance travelled to obtain 75 percent correct detection of movement in depth as a function of luminance for both monocular and binocular viewing conditions is plotted in Figure 1. For 75 percent correct detection, the percent distance travelled decreases with increasing luminance up to 0.1 foot-Lambert. A further increase in luminance to 1.0 foot-Lambert did not affect binocular performance and lowered thresholds for monocular performance only slightly.

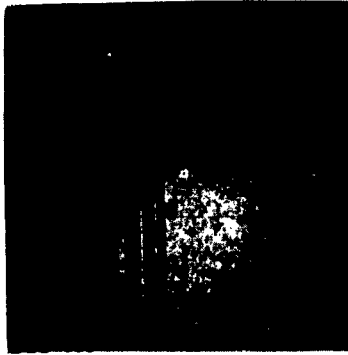

MES No. 3 $\phi + \phi_H$



No. 3 $\phi + \phi_H$

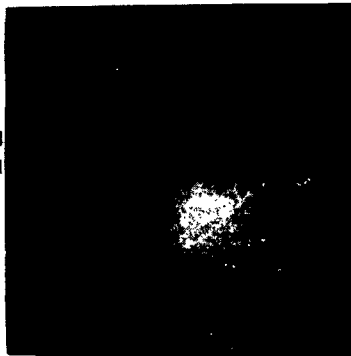

MES No. 1 ϕ

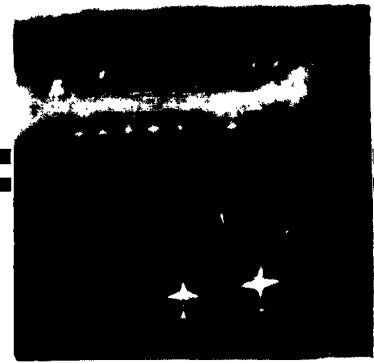

No. 1 ϕ

Enhancement of Optical Images

Targets that naturally, or by design, gradually shade into their background are most difficult to detect by any optical means.

It is possible, however, with electro-optical (TV-like) techniques to accentuate the contrast between a target and its background. This is accomplished by adding to the basic picture various derivatives of the luminance gradient. This has the effect of more sharply defining the contours of the target.

Not all derivative terms are, however, equally effective. For example the second derivative seems to be better than the first or a combination of the first and second.

The effect of adding the second derivative to a photograph of a standard resolution target is shown in the attached picture.

The effect of adding the second derivative to an aerial scene is shown in the figure.

Recent developments suggest that similar effects can be obtained by purely optical means. This possibility and its application to side-looking radar are currently being considered.

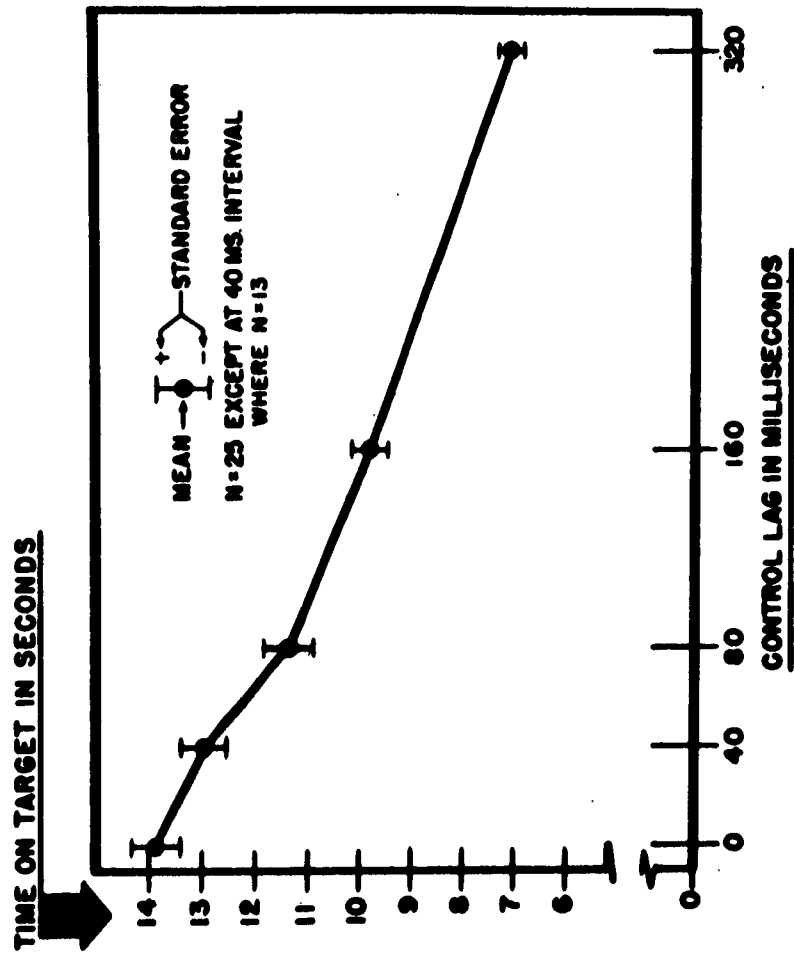

Effect of Control Lags on Tracking Accuracy

Effect of Control Lags on Tracking Accuracy

In almost all mechanical systems there is a delay between the operator's control movement and the response of the system. This is, of course, particularly obvious in the control of remote systems, e. g., space systems.

As shown in this figure even imperceptibly small lags appreciably degrade the system's performance.

However there are ways of getting around this and still allow the man to exercise judgment and control. One technique is referred to as "quickenning". Another technique is the "predictor display".

Quickenning refers to feeding-back to and combining in a single display derivative information. This provides the operator with information as to what he should do as well as information as to what is going on right now.

The predictor display is a somewhat more sophisticated technique. In the predictor display the future status of the system is continuously predicted by high speed simulation of the real system. This allows the operator to determine the probable future status of his system and the path that will be followed in attaining that status if he continues to do what he is doing.

Experimental Area: Effects of extended weightlessness on basic visual functions.

Purpose: Experiments in zero-g aircraft show change in selected basic visual functions and suggest need for examining effects of extended weightlessness (30 days or more) on acuity, depth perception, and brightness discrimination. Assessment of value of optical aids should be included, as well as such things as the use of audio feedback and remote television with remote manipulators in the event unaided depth perception is inadequate.

Technical Approach: Miniaturized units used to make initial assessments in Gemini, Apollo, or X-20. Results might indicate need for more elaborate facilities, such as presence of other vehicles in the vicinity.

Estimated Power, Volume, and Weight Requirements: 1000 watts, 2 ft.³, ten pounds. If audio feedback is installed, remote manipulator would have to be installed; weight and volume unknown.

Experimental Area: Control and display requirements for space operations.

Purpose: To develop principles for the display of information space crews need to control, navigate, interpret sensor information, and predict future courses of action.

Technical Approach: Detailed analysis of mission requirements and vehicle configurations will yield requirements for precision of control and nature of data interpretation tasks. Simulator experiments would be followed by space testing and verification, needed primarily to uncover effects of prolonged weightlessness on psychomotor skills.

Estimated Power, Volume, and Weight Requirements: Experiments would be part of general test of systems. Modest amount of data recording equipment would be needed.

Area of Concern	Status of Current Knowledge	Adequacy of Current Investigations	Adequacy of Ground Facilities (Including Simulators and Aircraft)	If Space Test Needed, Adequacy of Gemini, Apollo, and X-20			
				G	A	X-20	None Adeq.
<u>Psychomotor Capabilities</u>							
• Control coding	0	-	+	-	+	-	
• Remote manipulators (including remote television - 2D & 3D)	0	0	0	+	+	+	
• Transfer function research	0	0	0	+	+	+	
• Pressure suit evaluations	0	0	+	-	+	-	
• Vehicle entry and exit and suit donning	0	0	0	-	+	-	
• Handling of massive materials	-	-	-	-	-	-	X
• Tool design and storage	-	0	+	-	0	-	
• Pulse modulated control systems	-	0	+	-	0	-	
• Personal locomotion under zero and partial gravity	-	0	0	-	0	-	X
• Moments of inertia and centers of gravity in man and his segments	-	0	+	+	+	+	
• Strength and mobility when encumbered	-	0	0	+	+	+	

KEY
 "+" indicates adequacy
 "0" indicates marginal adequacy
 "-" indicates inadequacy

Remote Handling Performance with
Master 8 Slave Manipulator

Photograph shows a subject performing a standard remote handling task using the Argonne National Laboratory Model 8 Master Slave Manipulator. The specific task shown is directed at studying the utility of coding schemes for objects to be manipulated and positioned. Claws are also coded to determine any increase in task performance by providing additional control-effector cues.

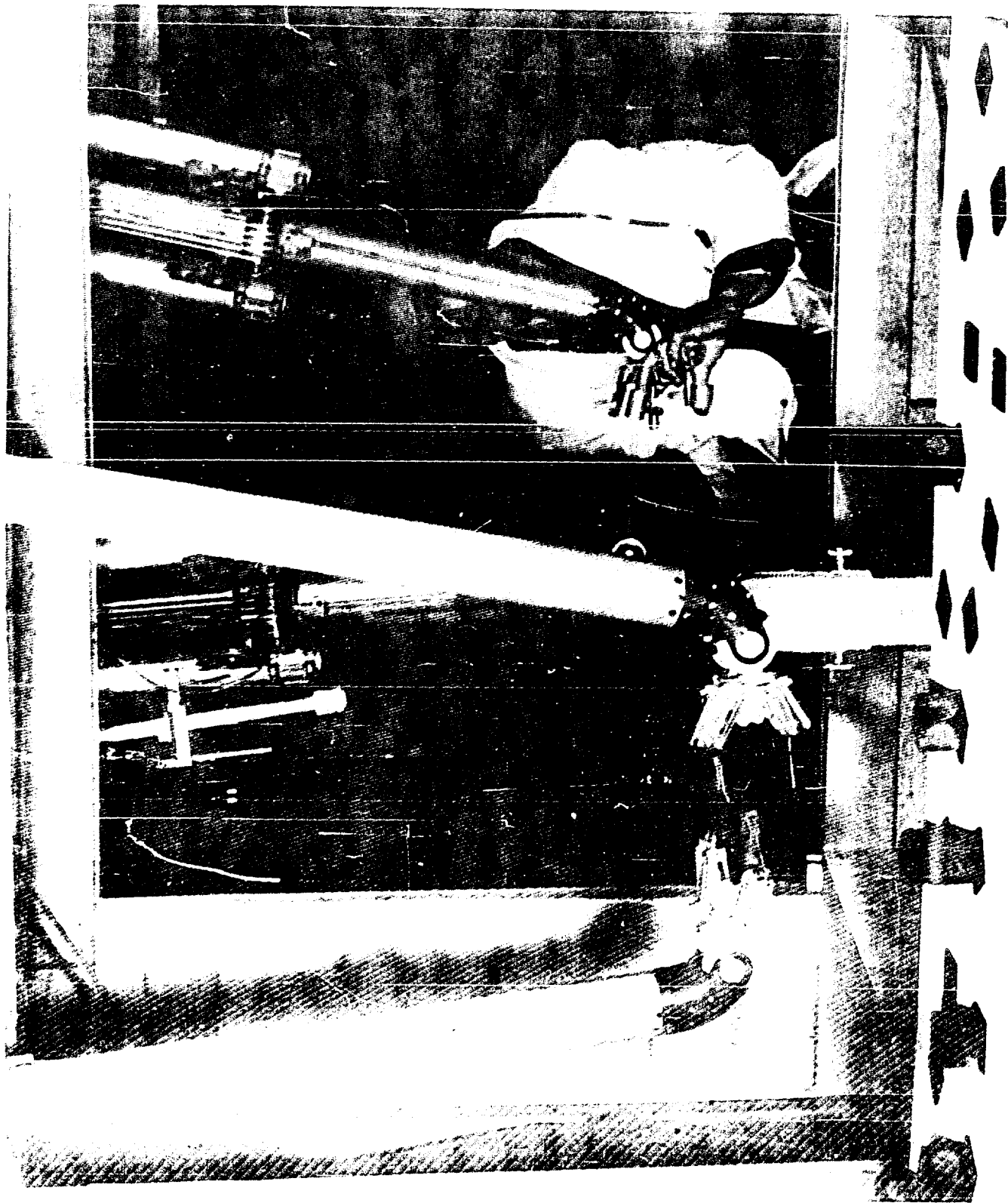

Differential Sensitivity for Mass and
Weight for Direct and Remote Handling

Difference limens were determined by use of the method of Constant Stimulus Differences for remote handling sensitivity using the Argonne National Laboratory Model 8 Master Slave Manipulator and direct handling for both mass (frictionless stimulus weights) and weight. The graph demonstrates that sensitivity is lower (higher difference limens) for mass as opposed to weight discrimination. It also shows direct handling sensitivity is greater than remote handling although direct sensitivity to mass is less than remote handling for weight. Differential sensitivity for all experimental conditions decreases as the judgment standard increases in weight. This confirms classical psychophysical studies.

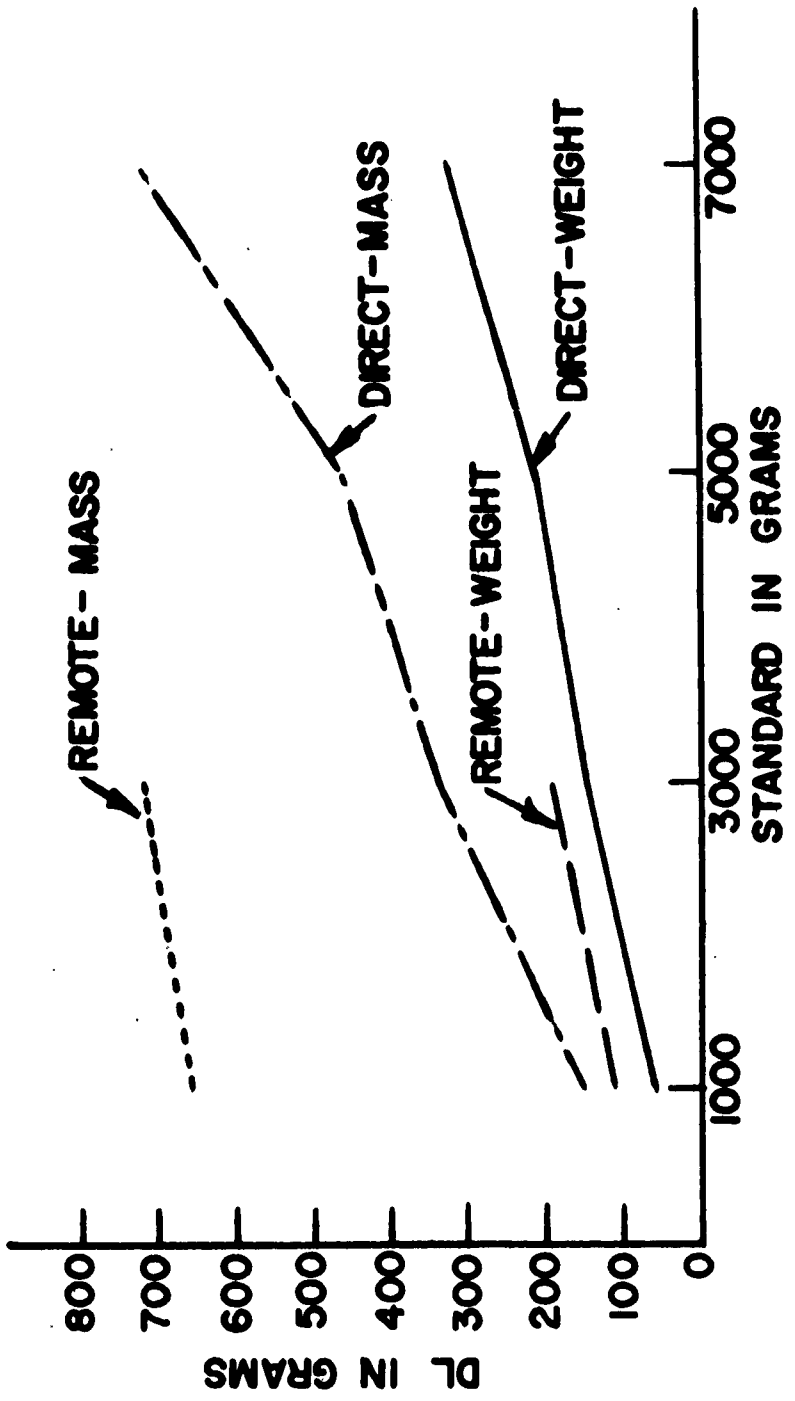

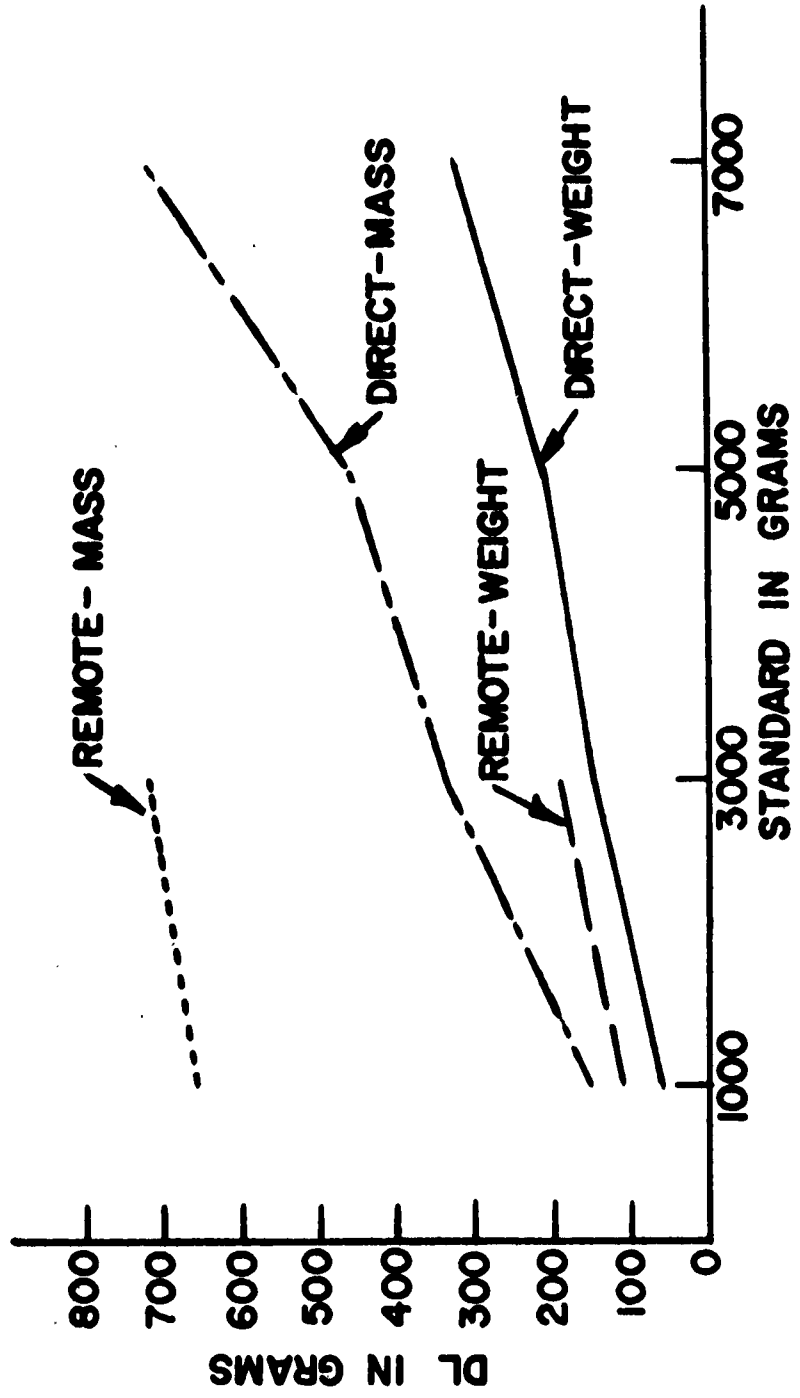

Project Mercury Pressure Suit Evaluation

The workplace apparatus set up for the project mercury full pressure suit evaluation. The subject is in a form fitted couch, fully inflated performing one of the five control operations required.

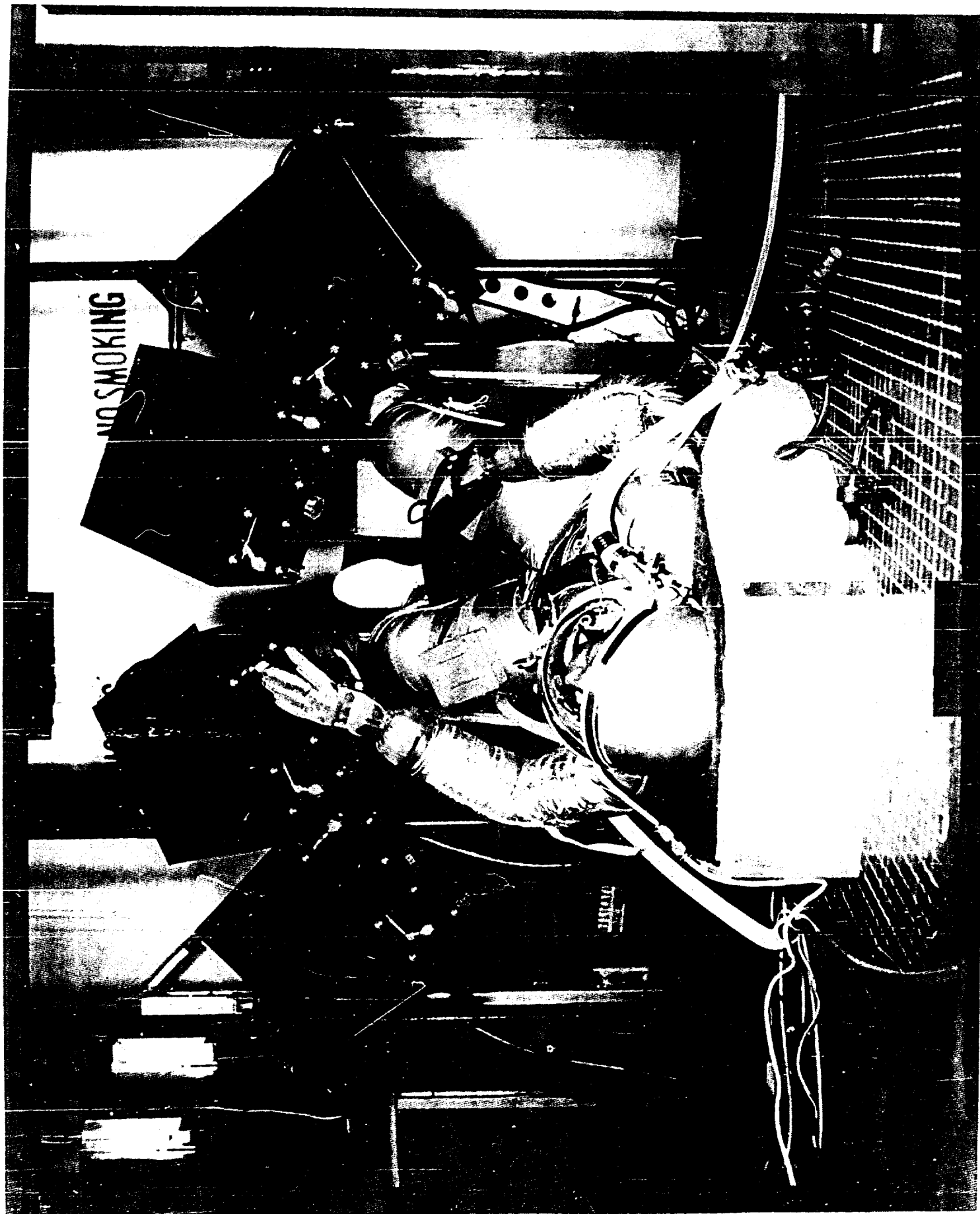

NO SMOKING

TRITE

Reach Measuring Device

With the Anthropology Branch's Reach Measuring Device, grasping-reach capability is ascertained for the subject in shirt-sleeves and in pressure suits, vented and inflated to various pressures. Comparisons between reach capability in shirt-sleeves and reach capability as affected by an encumbering pressure suit offers a means of evaluating mobility in pressure suits and describing the reach envelope within which controls may be situated.

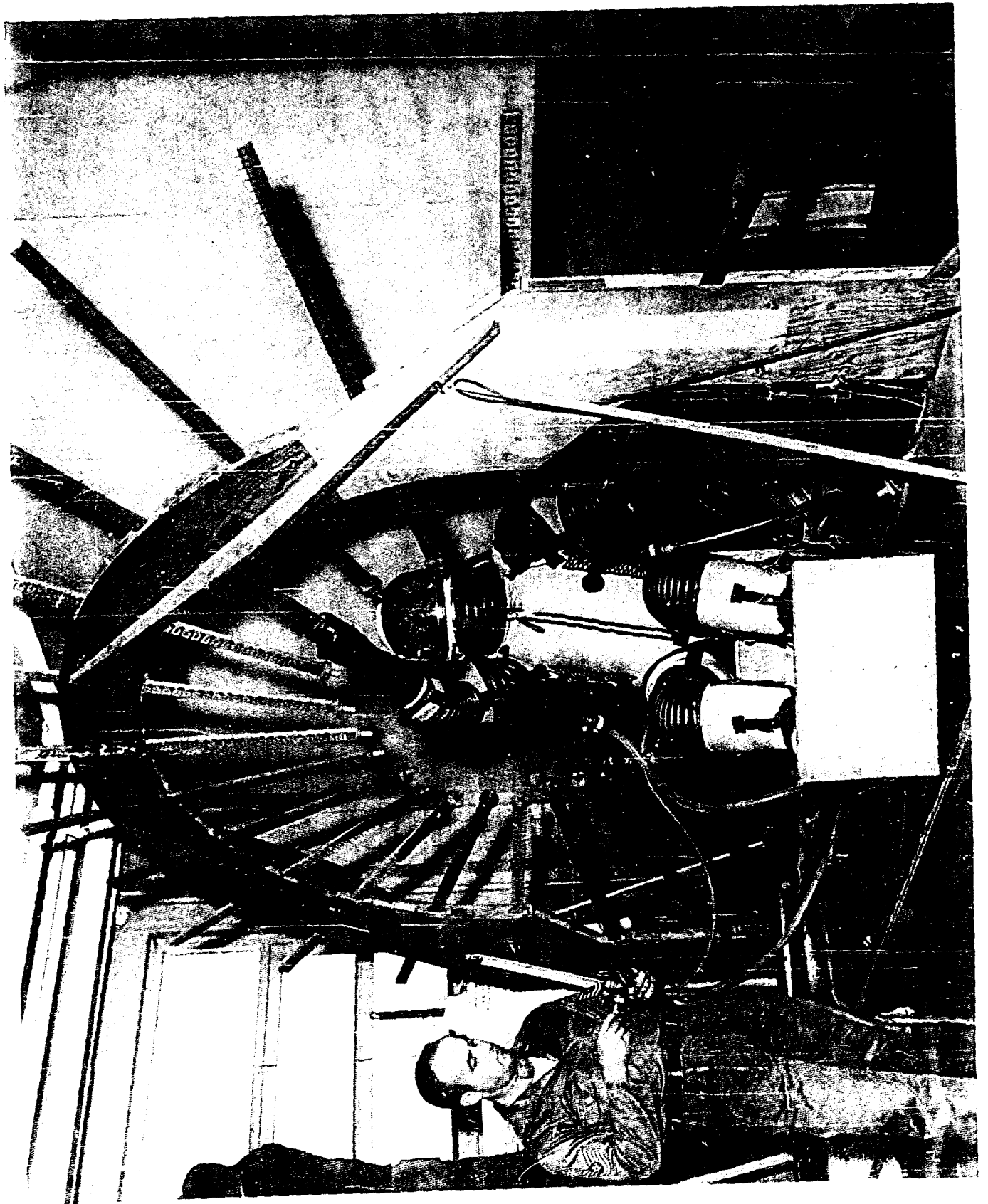

Reach Capability in Pressure Suits

The following figure illustrates the reach capability of one subject in shirt-sleeves and in a pressure suit at different levels of inflation. Data was obtained using the Anthropology Branch's Reach Measuring Device.

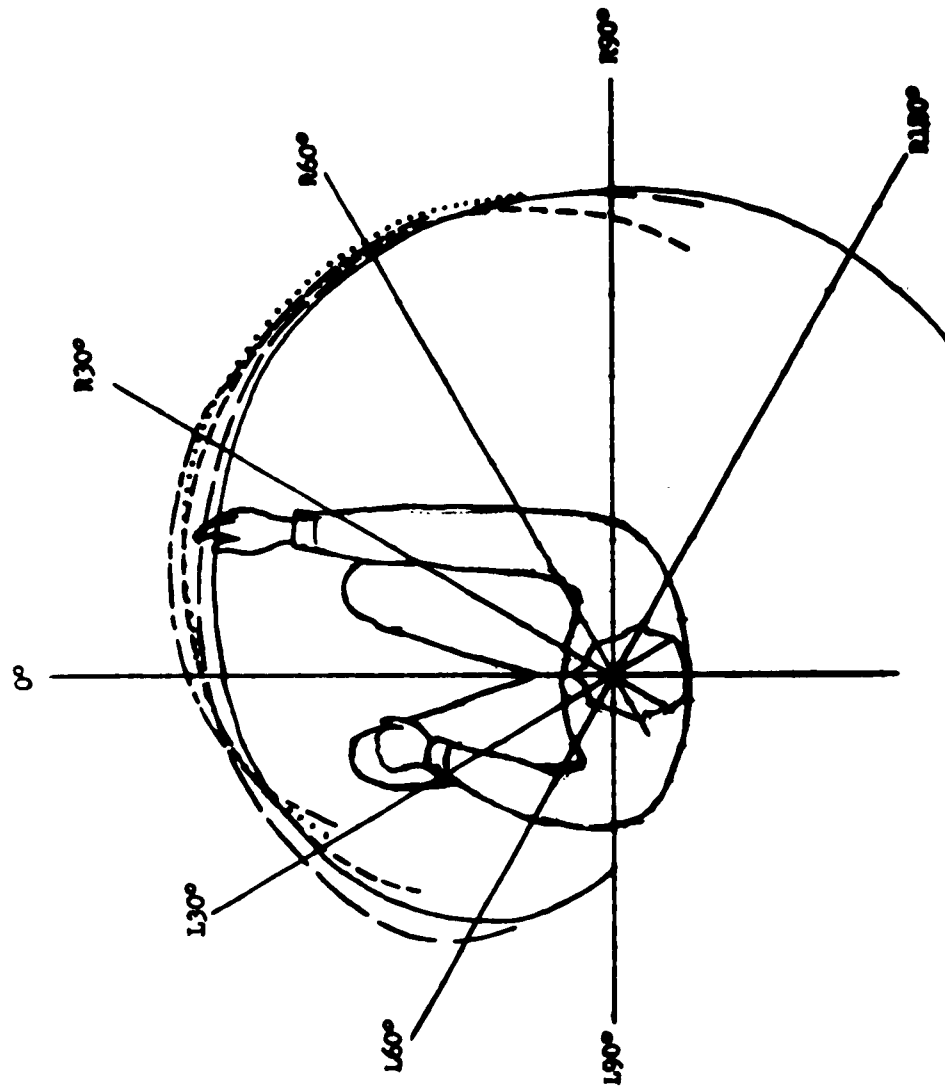

Horizontal section at 25 inches above Seat Reference Point through the
 wrapping-machine envelopes of one subject in shirt-sleeves (—),
 wearing a full pressure suit in the vented condition (---), and
 inflated to 1½ psi (---), 2½ psi (.....), and 3½ psi (---).

Prepared by Anthropology Branch, 6570th AMBL

Pressure suited subjects investigate air lock analysis problems on-board the zero-gravity aircraft. Variables include exit diameters, suit pressure level, subject's posture and G level (zero or lunar G).

57a

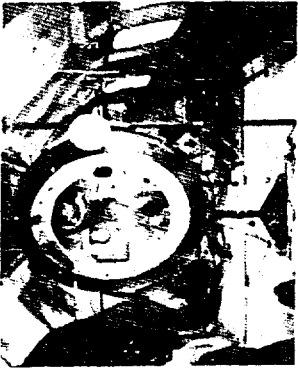
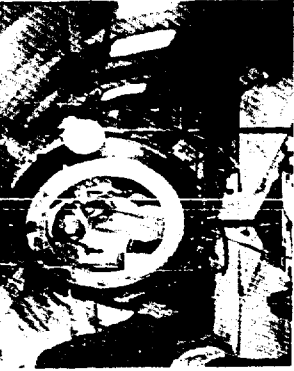
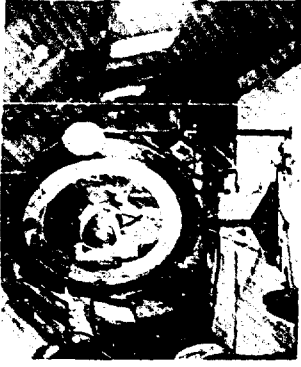

EXIT AREA SEQUENCE
C-131B 53-7806

Sgt Espensen soars at 13.3 miles per hour in the zero-gravity KC-135A.
Accurate soars of up to 60 feet are made repeatedly by experienced subjects.

58a

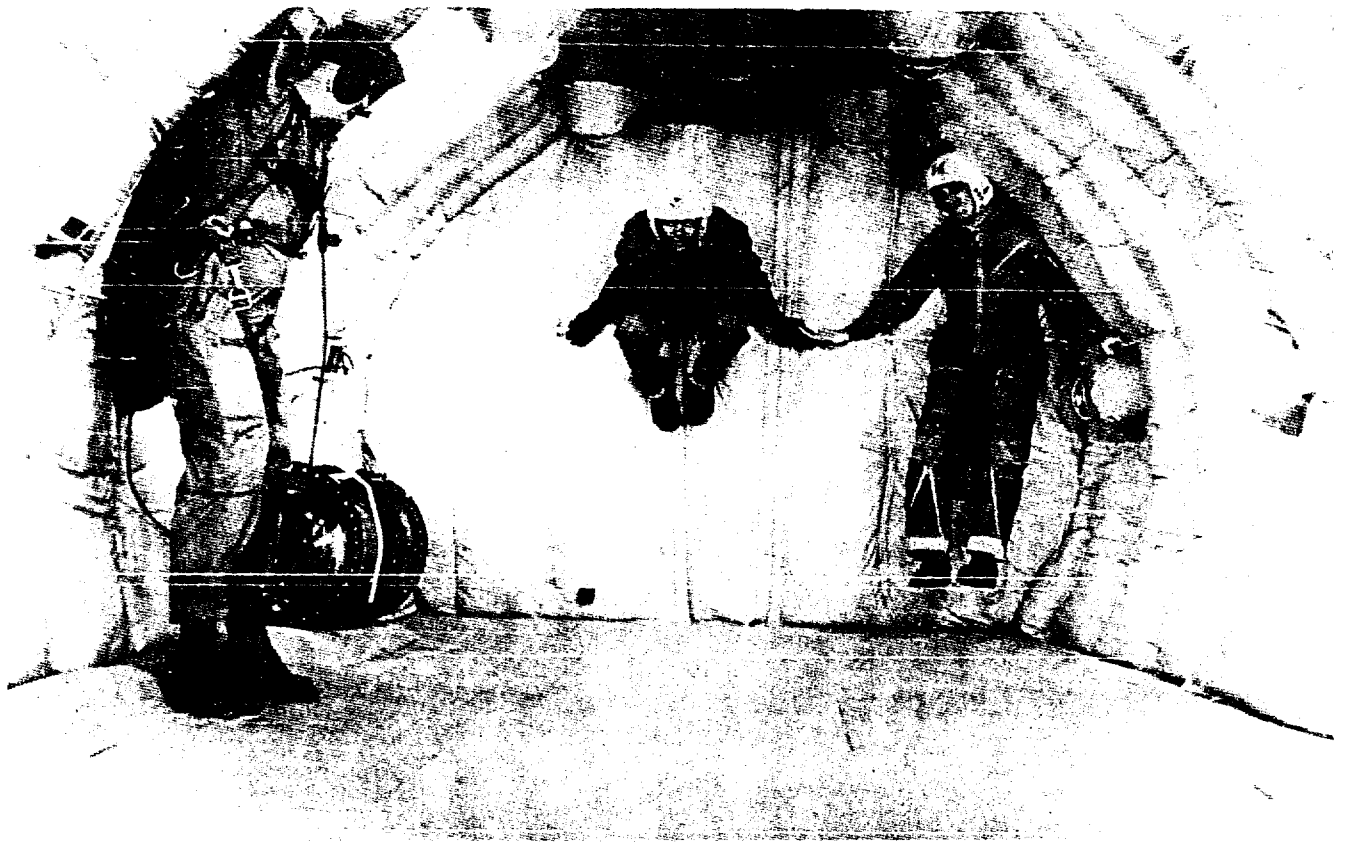

SOARING SEQUENCE ZERO "C"
(SGT ESPENSEN)



PROPULSION GUN MARK IIB
(LT. GARDNER)



Hand Held Momentum Wheel

Hand held gyroscope stabilizes the weightless man about two axes. The current stabilization concept has been included in recent Astronaut Maneuvering Units.

600

Experimental Area: Coding of controls.

Purpose: To develop set of controls that can be discriminated by touch alone, even while wearing a pressure suit.

Technical Approach: Standard psychophysical methods would be used to check adequacy of current coded controls for use with pressurized garments.

Estimated Power, Volume and Weight Requirements: None; no space vehicle required.

Experimental Area: Control dynamics.

Purpose: To develop (1) improved transfer functions describing the behavior of man in a control loop and (2) accuracy of control with pulse-modulated systems so that precision will be increased.

Technical Approach: Available human transfer functions would be improved by resolution of the remnant terms which are composed primarily of non-linearities. Verification in weightless environment required. Efficiency of pulse modulation might be studied entirely in the laboratory.

Estimated Power, Volume and Weight Requirements: Unknown; might involve installation of a complete alternate control system.

Experimental Area: Pressure suit evaluation.

Purpose: To check adequacy of new pressure suits in terms of mobility and comfort.

Technical Approach: Kennedy Reach Apparatus and Dynamic Workspace Evaluation Devices already exist at Aerospace Medical Research Laboratories. These are adequate for foreseeable future.

Experimental Area: Vehicle entry and exit and suit donning.

Purpose: Determine aperture needed to enter and exit space vehicle; check volume needed and time required to don pressure suit while weightless.

Technical Approach: For entry and exit studies, variable iris installed in aircraft capable of weightless flight. Because of time required, suit donning could be marginally checked in aircraft, using successive parabolas. Final check requires space vehicle of at least Apollo size.

Experimental Area: Handling of massive materials under weightlessness.

Purpose: Some missions may require vehicles so large that assembly in space is necessary. Inertia may make movement and control difficult, and should be checked.

Technical Approach: Eventually must resort to handling of large masses in space, perhaps using aids that show acceleration, rate of closure, etc.

Estimated Power, Volume and Weight Requirements: Volume and weight: vehicle specific. Power requirements negligible unless welding or power tools required.

Experimental Area: Personal locomotion under zero and partial gravity.

Purpose: Investigate various means of personal locomotion, such as push-off, walking, and self-maneuvering units (SMU).

Technical Approach: Test above in zero-g aircraft. Adequate test of a self-maneuvering unit requires space vehicle with minimum of two crew members.

Power, Volume and Weight Requirements: Push-off: none; walking: three pounds of Vel-Cro material; SMU: weight of unit (approximately 50 pounds), tether-lines, and fuel.

Experimental Area: Mass moments of inertia and centers of gravity in man and his segments.

Purpose: Knowledge necessary for (1) computation of body rotation under conditions of weightlessness and acceleration; (2) design of space systems where human mass is significant proportion of total, and (3) development of effective restraint devices.

Technical Approach: Dissection and dynamic measurement estimated by shift in center of gravity. No space test required at this time.

Experimental Area: Strength and mobility when encumbered.

Purpose: Knowledge of above in order that tasks may be realistically designed.

Technical Approach: Preliminary ground test followed by essential space test because of durations (minutes and perhaps hours).

Estimated Power, Volume, and Weight Requirements: Power: negligible; volume: 1 ft³ minimum; weight: 100 lbs. (hopefully equipment with other uses).

Area of Concern	Status of Current Knowledge	Adequacy of Current Investigations	Adequacy of Ground Facilities (Including Simulators and Aircraft)	If Space Test Needed, Adequacy of Gemini, Apollo, and X-20			
				G	A	X-20	None Adeq.
<u>Central Capabilities</u> Vigilance (monitoring) Problem solving Man-computer communications	0 0 -	0 0 0	0 0 +	- +	+ +	- +	
Fault isolation and trouble-shooting techniques Integration and interpretation of multi-sensor data	- -	0 0	+ 0				X

KEY

- "+" indicates adequacy
- "0" indicates marginal adequacy
- "-" indicates inadequacy

Experimental Area: Vigilance.

Purpose: Many space tasks (monitoring of scopes, life support systems, etc.) will require extended periods of alertness. Experiments indicate much can be done to increase man's alertness.

Technical Approach: Ground work on variety of tasks employing such techniques as false signals, alertness indicators, drugs, etc.

Estimated Power, Volume, and Weight Requirements: Would attempt to integrate with on-board equipment. Might require small volume for recording of performance (approximately .25 ft.³).

Experimental Area: Problem-solving and man-computer communications.

Purpose: Understand how man acquires, stores, processes and uses information in the performance of decision-making tasks. Improve use of computers by development of simple methods of entering, processing, and withdrawing information from computers.

Technical Approach: Vary number and type of variables.

Experimental Area: Fault isolation and troubleshooting techniques.

Purpose: To expedite isolation of faults in maintenance work.

Technical Approach: Various decision-making models will be examined for application to subject problem. No space verification currently required.

Experimental Area: Integration and interpretation of multi-sensor data.

Purpose: To test ability of interpreters to derive intelligence from reconnaissance imagery based on such sensors as radar, IR, Elint, etc.

Technical Approach: Measurement of performance with all reconnaissance sensors, singly and in combination. Variables considered will be extended periods of viewing, vehicle speed, mode, resolution, type of target, display characteristics, weather, season of year, briefing materials and methods, angle of depression, direction of look, etc. Simulator results will have to be confirmed in space. Program will be closely coordinated with related research in 665A Program.

Estimated Power, Volume, and Weight Requirements: 6500 pounds; 260 ft.³; 17 kilowatts.

Area of Concern	Status of Current Knowledge	Adequacy of Current Investigations	Adequacy of Ground Facilities (Including Simulators and Aircraft)	If Space Test Needed, Adequacy of Gemini, Apollo, and X-20			
				G	A	X-20	None Adseq.
Space Environmental Effects . Individual stressors (heat, acceleration, noise, etc.) . Multiple stressors . Work-site tethering . Work-rest cycles . Extended tether-lines . Extended duration	0 - 0 + 0 -	0 - + + 0 -	+ 0 + + 0 -	- 0 0 + 0	- 0 - -	X X X	

KEY

- "+" indicates adequacy
- "0" indicates marginal adequacy
- "-" indicates inadequacy



TOOL HANDLING
(LT. CARDNER)

Photograph shows that an untethered man applying torques under weightless conditions rotates his body as well as his work. The weightless man can apply only 67% as much torque in a quick twist as can the 1 G operator.

68a



TETHERING TEST
KC-135 55-3129

The use of various tethers or restraint systems permit weightless man to apply as much force with hand tools as he could under 1 G conditions.

692

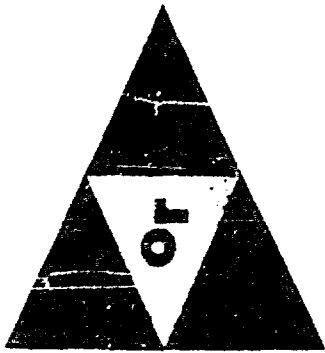

ADVANCED SYSTEM CREW COMPARTMENT MOCKUP

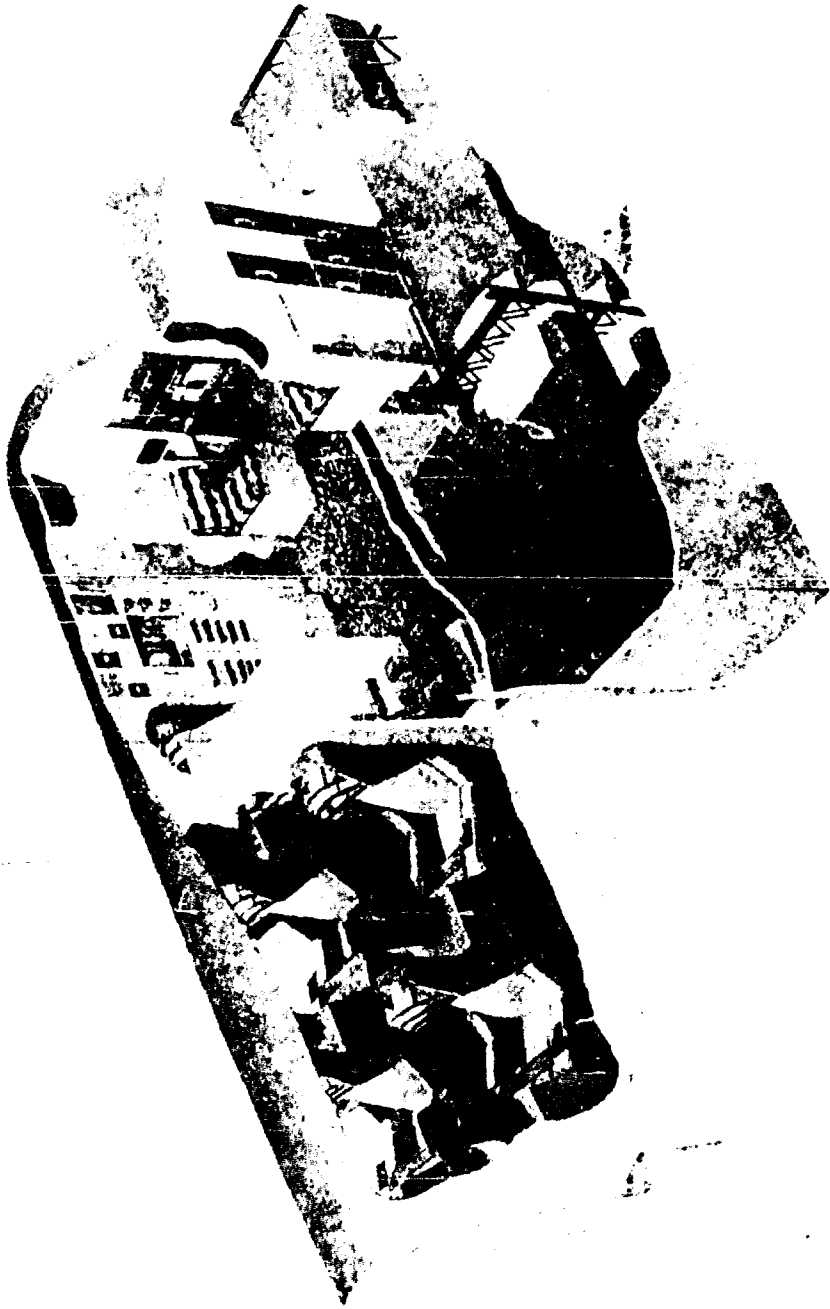

--Experimental crew compartment mock-up.

44

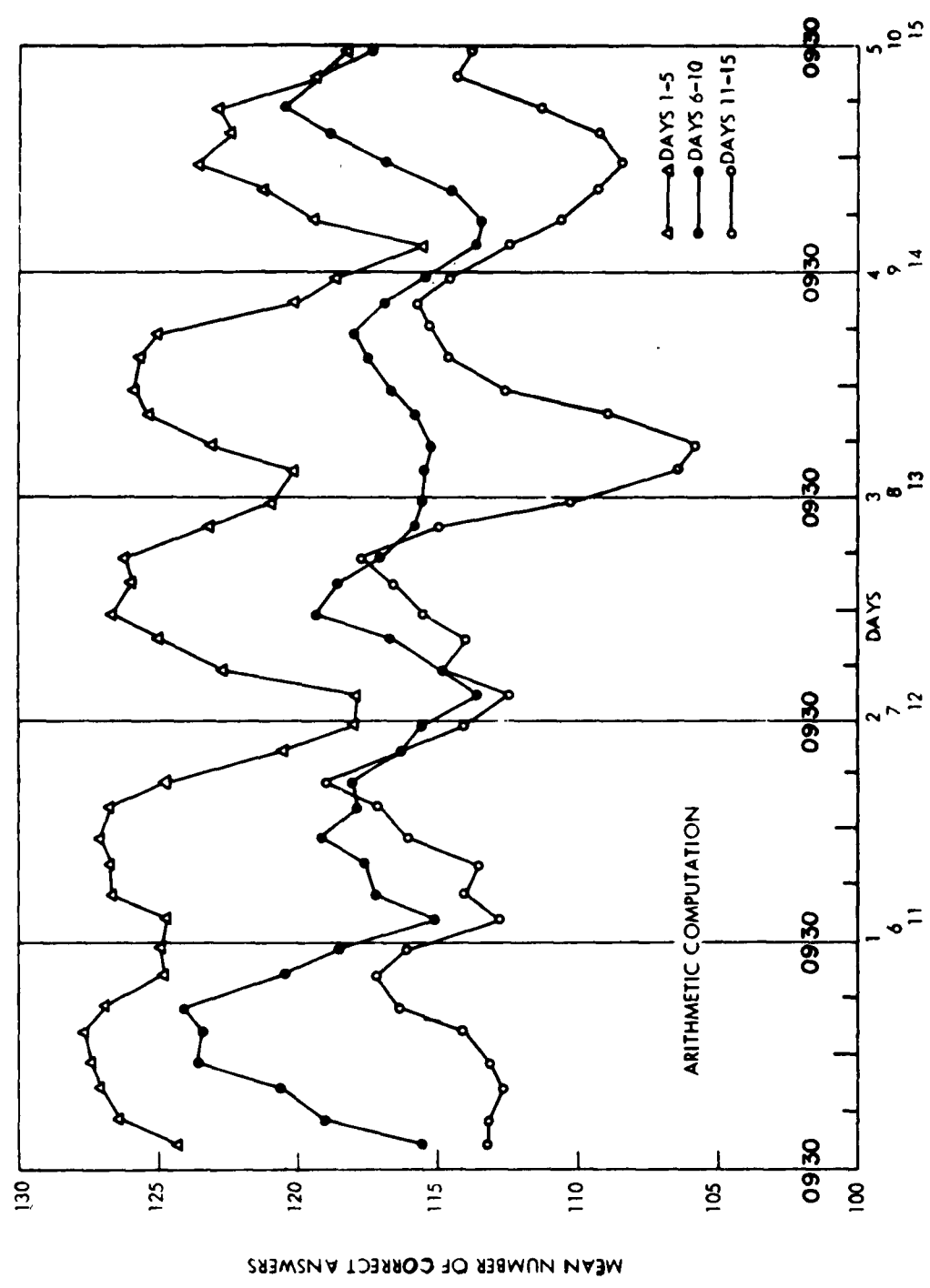

Advanced System Crew Compartment Mockup
for the 15-day Isolation Study

Consisting of work area, leisure area and sleeping area.

70a

Advanced System Crew Compartment Mockup
for the 15-day Isolation Study

Consisting of work area, leisure area and sleeping area.

70a

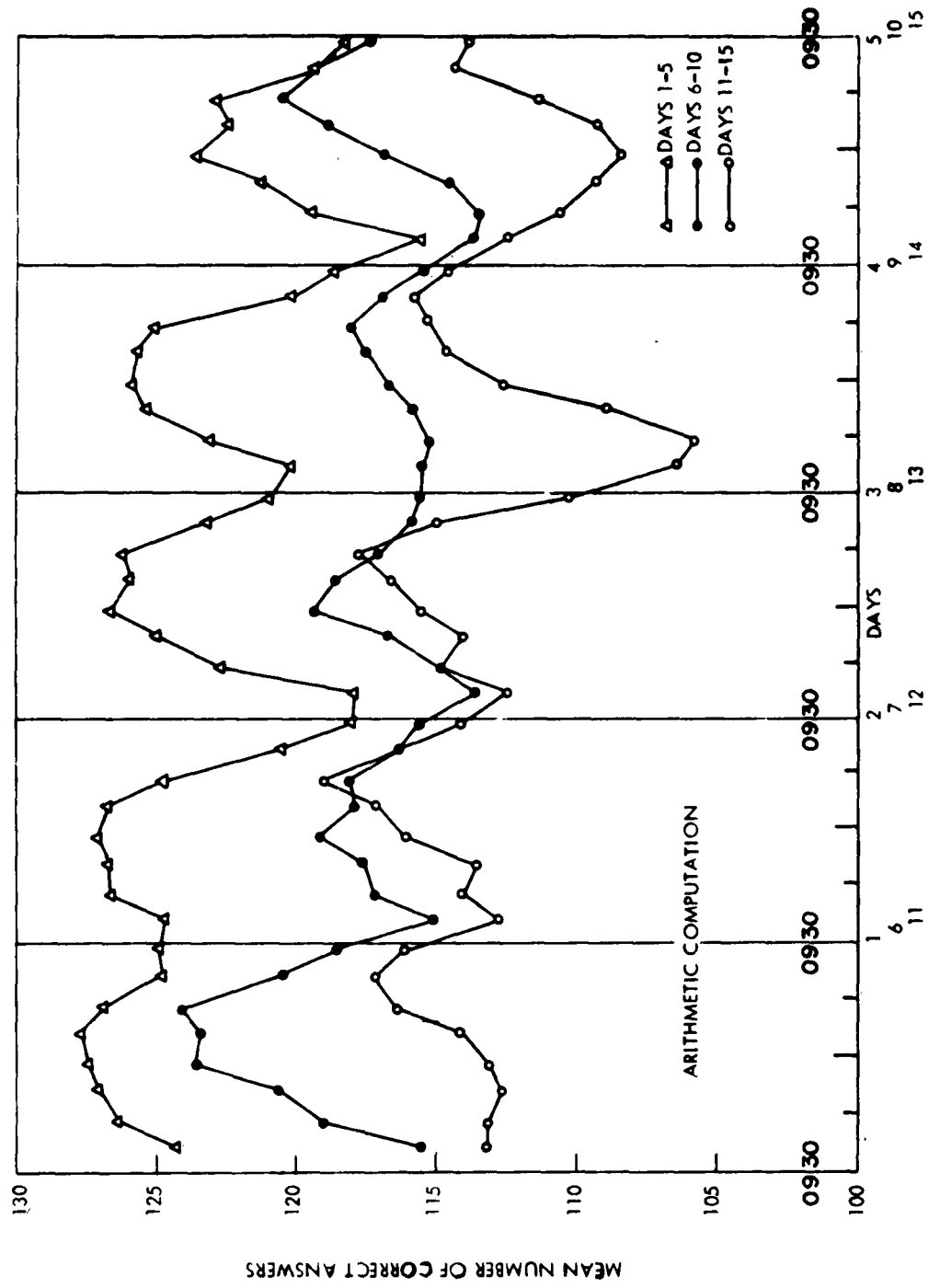

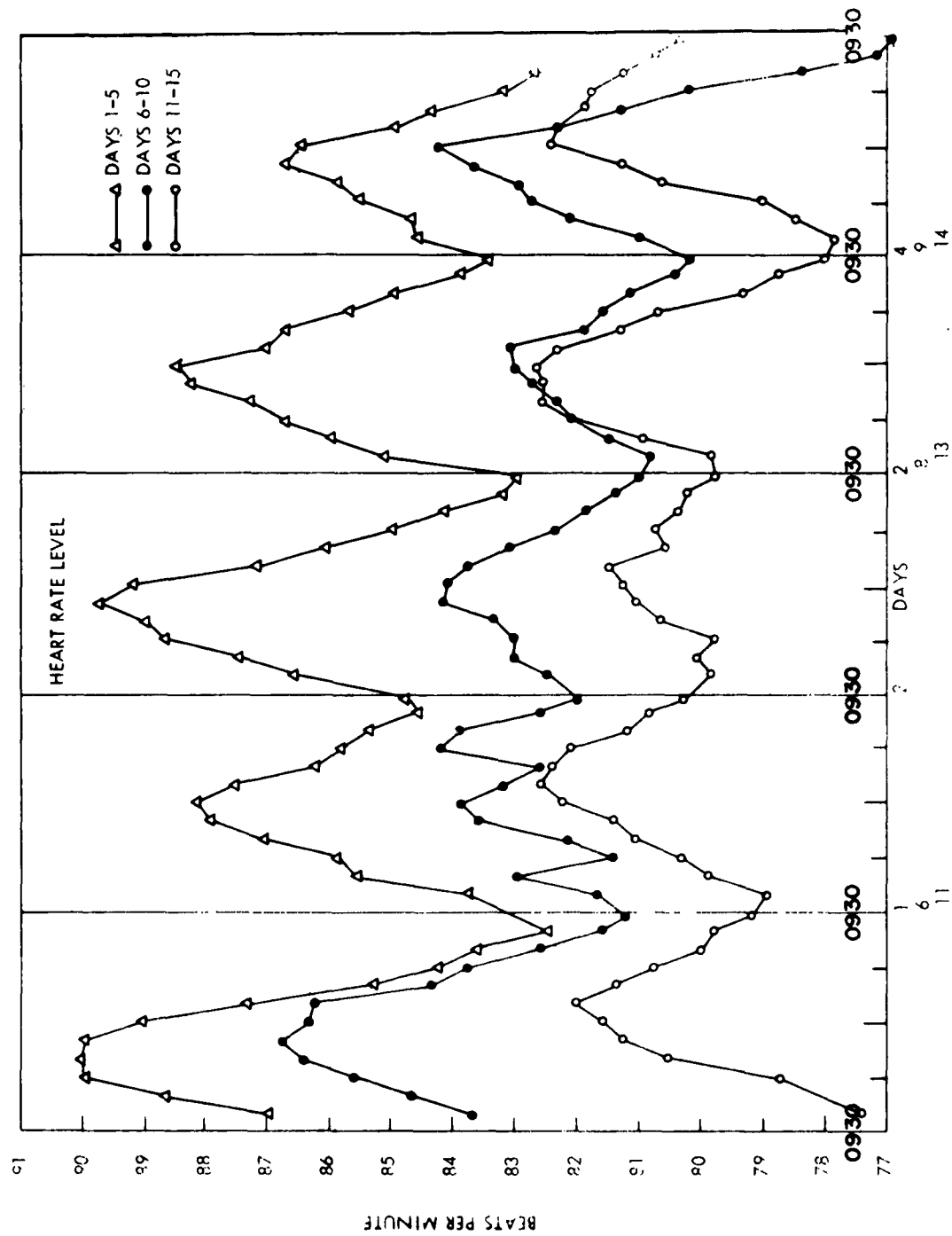

15-day Crew Confinement Study

Note:

- (1) Relatively small changes in arithmetic accuracy over the 15-day period
- (2) Relatively large diurnal changes in arithmetic accuracy over the 15-day period
- (3) Apparent correlation between the physiological and psychological measures (heart rate and arithmetic accuracy).

15-day Crew Confinement Study

Note:

- (1) Relatively small changes in heart rate over the 15-day period
- (2) Relatively large diurnal changes in heart rate over the 15-day period

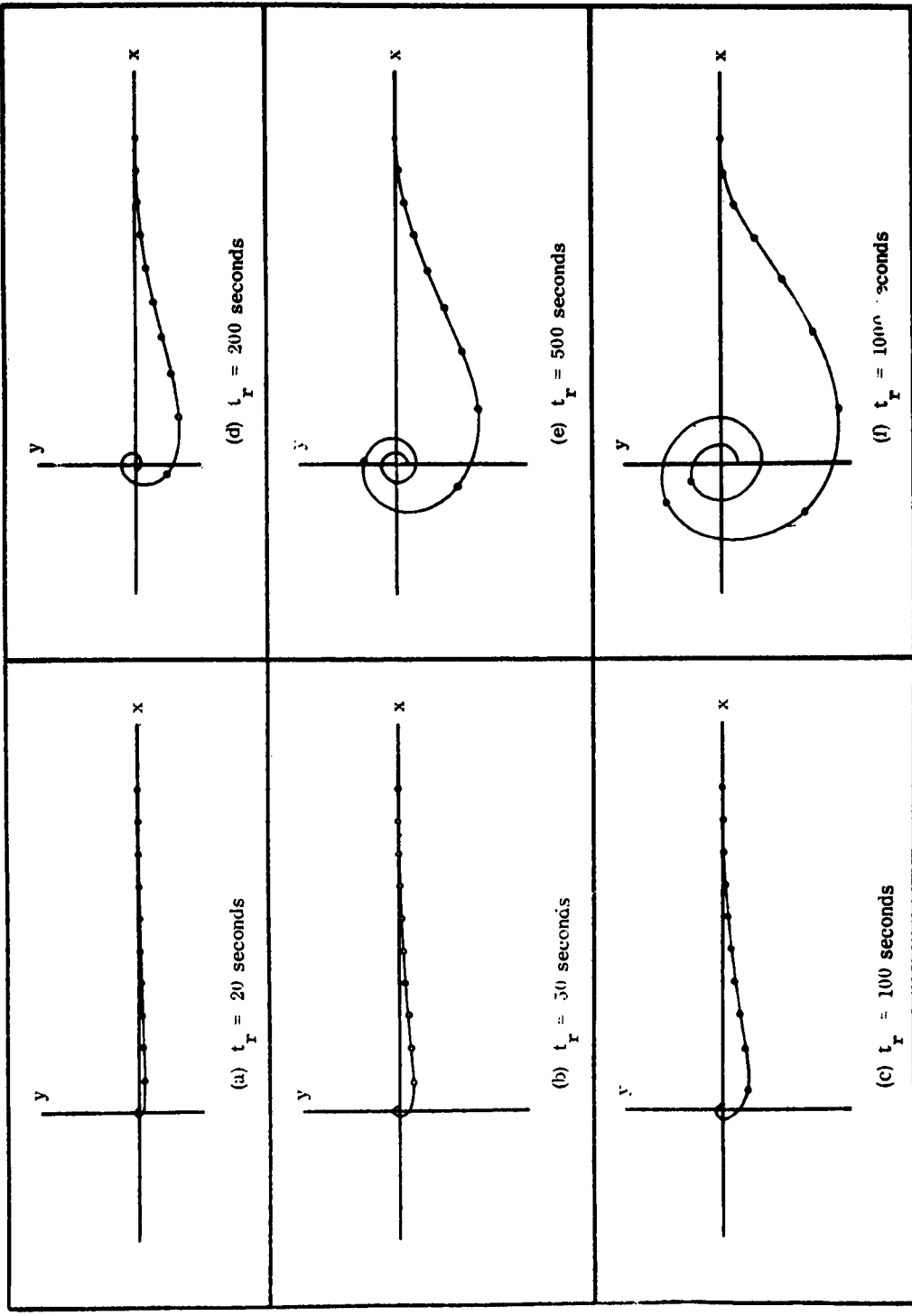

Path of a Mass on the End of a Tetherline
Reeled in at Constant Speed

The figure illustrates the trajectories which result when a mass is reeled at different rates of speed in toward an orbiting vehicle. The mass is initially horizontally ahead of the vehicle and the rest to it. The resulting trajectory depends only on the reel-in time.

Experimental Area: Effects of unusual environmental factors on performance.

Purpose: To determine effects of stressors, individually and in selected combinations, on performance of tasks typical of space operations. A serious lack of knowledge exists in area of multiple stressors.

Technical Approach: Effects on performance will be measured in laboratory experiments, but critical ones at least must be confirmed in space because of unknown interactions with space environment.

Estimated Power, Volume, and Weight Requirements: Unknown; tests for space operations not yet developed.

Experimental Area: Tethering.

Purpose: To determine optimal means of tethering man at work sites inside and outside the aircraft

Technical Approach: Optimal tether points are being fairly well determined by use of zero-g aircraft. However, effects of extended periods cannot be reliably estimated until space laboratory is available.

Estimated Power, Volume, and Weight Requirements: Power: negligible; volume: negligible; weight: 10 pounds (est.).

Experimental Area: Work-rest cycles and extent of time in orbit.

Purpose: To determine optimum and emergency work-rest cycles for space operations and effects of time-in-orbit on work performance.

Technical Approach: Optimum and emergency work-rest cycles for ground operations are quite well-known but should be verified in space. Virtually nothing is known about the effects of extended time-on-the-job on performance in a weightless environment.

Estimated Power, Volume, and Weight Requirements: Power: 2 kilowatts; volume: 2 ft.³; weight: 20 pounds.

Area of Concern	Status of Current Knowledge	Adequacy of Current Investigations	Adequacy of Ground Facilities (Including Simulators and Aircraft)	If Space Test Needed, Adequacy of Gemini, Apollo, and X-20			
				G	A	X-20	None Adeq.
<u>Systems Research</u> • Man-machine system synthesis and simulation	-	0	+				

KEY

- "+" indicates adequacy
- "0" indicates marginal adequacy
- "-" indicates inadequacy

Experimental Area: Systems research.

Purpose: To determine how best to use man in complex space systems operations .

Technical Approach: Determine information requirements and nature of interactions among members of a systems team involved in the accomplishment of a goal requiring highly integrated performance on the part of all. No general space verification needed; specific test of each system obviously needed.

Area of Concern	Status of Current Knowledge	Adequacy of Current Investigations	Adequacy of Ground Facilities (Including Simulators and Aircraft)	If Space Test Needed, Adequacy of Gemini, Apollo, and X-20			
				G	A	X-20	None Adeq.
<u>Workplace Design and Layout</u> • Anthropometrics • Crew activity analyses • Checklists and performance aids • Blind positioning movements under partial and zero gravity	0 C 0 0	+ 0 + 0	+ 0 + 0	+ +	+ 0	X	

KEY

- "+" indicates adequacy
- "0" indicates marginal adequacy
- "-" indicates inadequacy

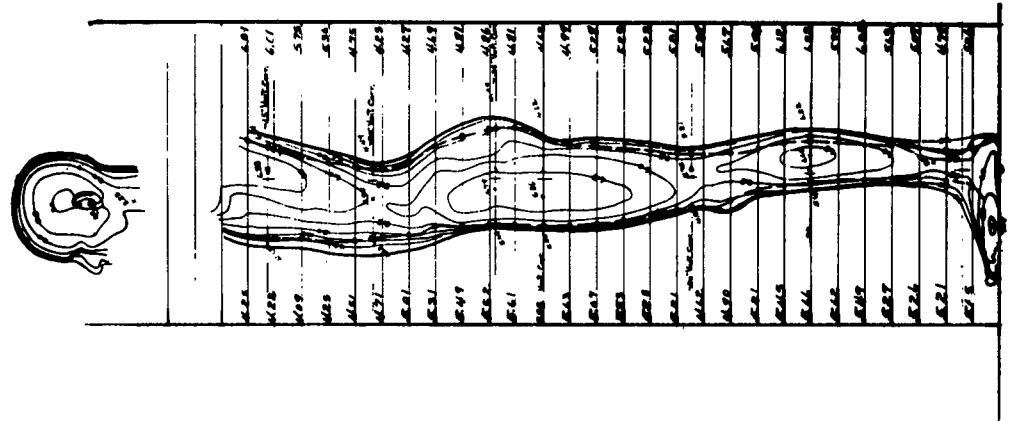

Contour Maps of the Human Body Drawn from Stereophotographs

From such maps extensive anthropometric data can be obtained, e.g., body surface areas, arcs, diameters, and an objective description of body shape.

EYE MOVEMENT LINK VALUES BETWEEN AIRCRAFT INSTRUMENTS SECOND HALF OF CONTACT TAKE-OFF

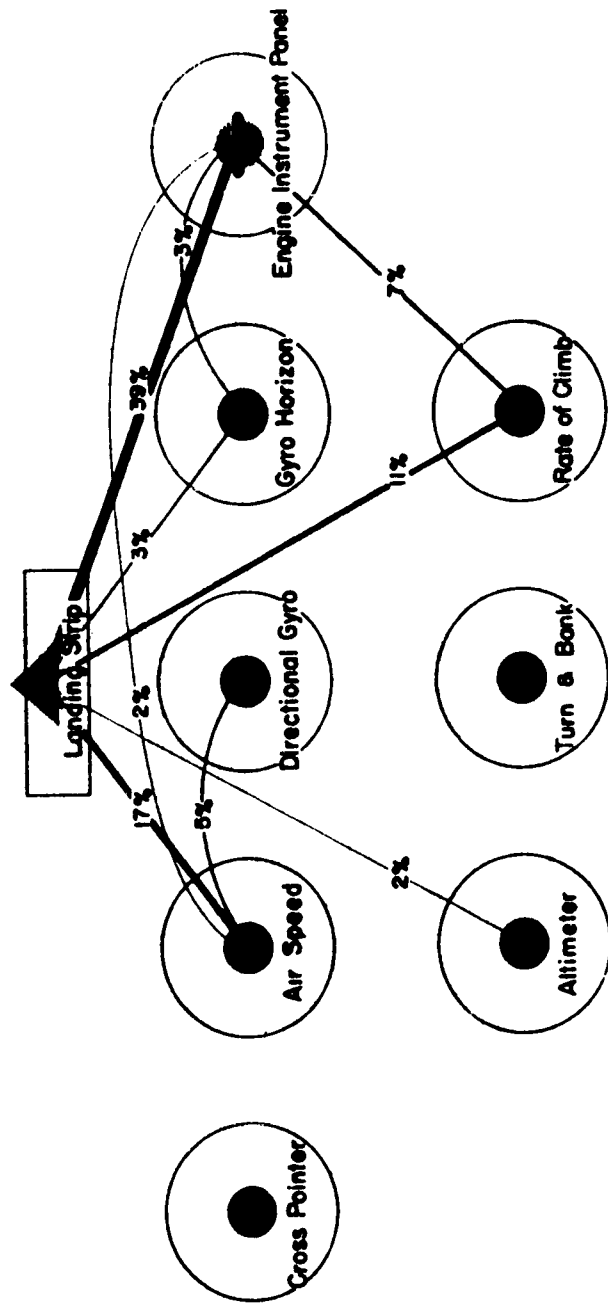

LINK VALUES BASED ON 10 PILOTS

VALUES LESS THAN 2% OMITTED

Eye Movement Link Values between Aircraft Instruments
during Second Half of Contact Take-off

The second half of the contact take-off is considered to be the period after the initial climb when the power controls are being adjusted for climbing RPM and manifold pressure. During this period 39% of all eye movement were between the engine instruments and the outside. 17% were between the outside and the air speed indicator while 11% were between the outside and rate of climb indicator. Frequency of all other eye movements ranged from 2% to 7%.

See

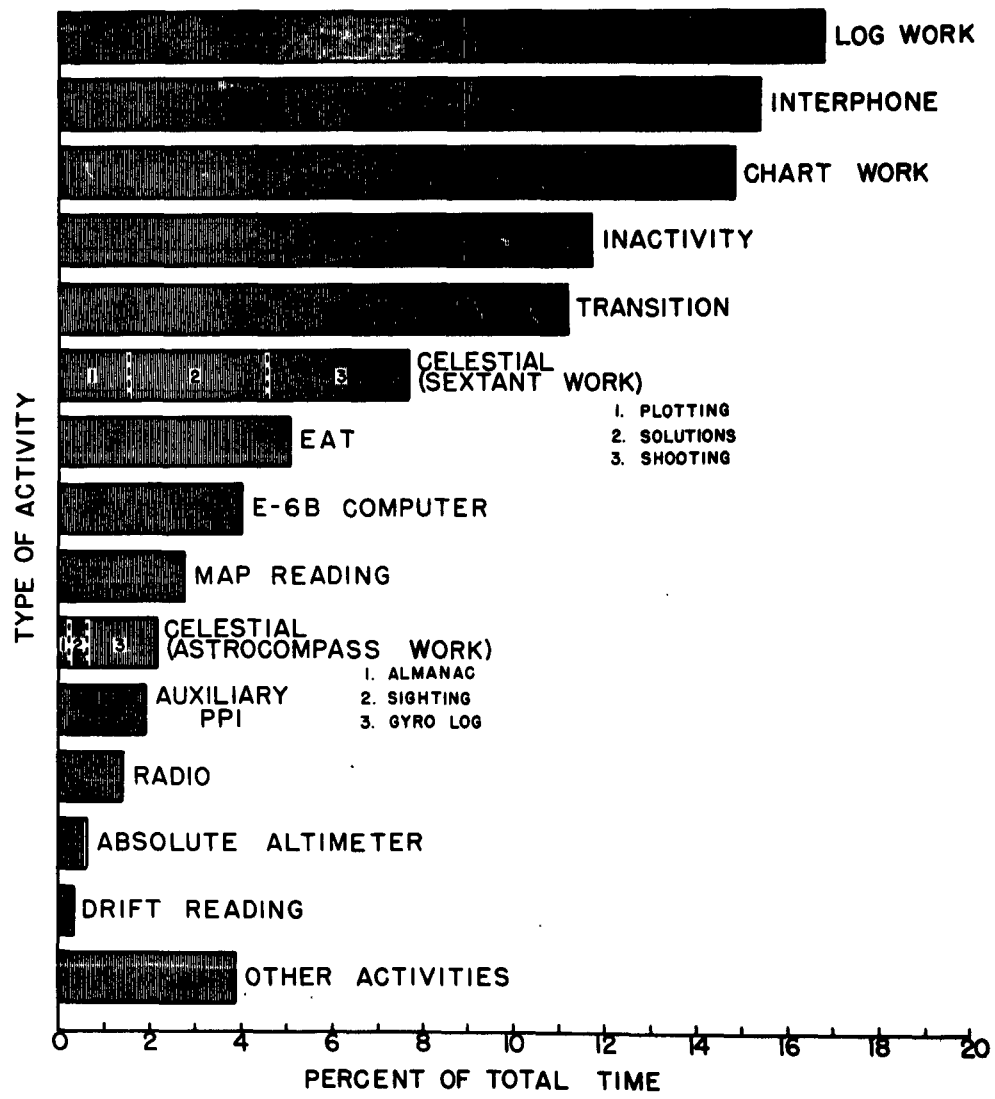

DISTRIBUTION OF FIRST NAVIGATOR'S TIME ON ARCTIC MISSIONS

Experimental Area: Crew activity analysis.

Purpose: To verify validity of predictions regarding activities of members of space crews; to obtain leads as to inefficiencies in work procedures enabling recommendations for improvement.

Technical Approach: Performance of crew members must be measured under actual operational conditions. Ideally, activities would be recorded by an independent observer, although some useful information could be obtained from motion pictures. Crew members might be trained to take performance measurements on each other. If so, no significant increase in weight, power and space requirements.

Experimental Area: Blind positioning movements under partial and zero gravity.

Purpose: To verify accuracy of positioning movements made under partial and zero gravity without benefit of vision.

Technical Approach: Operator would reach to predetermined points while under weightlessness or partial gravity. Results would be compared to similar results obtained on ground to determine any decrements.

Estimated Power, Volume, and Weight Requirements: Negligible; simple paper targets can be used.

Area of Concern	Status of Current Knowledge	Adequacy of Current Investigations	Adequacy of Ground Facilities (Including Simulators and Aircraft)	If Space Test Needed, Adequacy of Gemini, Apollo, and X-20			
				G	A	X-20	None Adeq.
<u>Training</u> • Automated instruction • Maintenance of proficiency • Integrated crew training • Operational Space Training	+ 0 - -	+ 0 0 -	+ 0 0 -	0 + 0 -	0 0 0 0	X X	

KEY

- "+" indicates adequacy
- "0" indicates marginal adequacy
- "-" indicates inadequacy

Area of Concern	Status of Current Knowledge	Adequacy of Current Investigations	Adequacy of Ground Facilities (Including Simulators and Aircraft)	If Space Test Needed, Adequacy of Gemini, Apollo, and X-20			
				G	A	X-20	None Adeq.
<u>Miscellaneous</u>							
. Human variability	-	-	+	0	0	0	X
. Validation of selection	-	0	-				

KEY

- "+" indicates adequacy
- "0" indicates marginal adequacy
- "-" indicates inadequacy

NOTES ON "MISCELLANEOUS" ITEMS

"Human variability" refers to the variability in human responses to stimulus situations which, overtly at least, are constant. This variability is considered by most to be an enormous liability in systems design and operation because it means that at least some aspects of man's behavior must be treated in a statistical manner. A moment's reflection, however, will reveal that this variability in response is necessary for man to learn, to adapt, and to exhibit flexibility -- characteristics that distinguish the outstanding system from the one that is mediocre.

SUMMARY OF SPACE VEHICLE REQUIREMENTS

EXPERIMENT	Adequacy of Current Vehicles		Current Vehicles	
	G	A		X-20
SENSORY-PERCEPTUAL				
Visual acuity	+	+	+	
Acuity in depth	+	+	+	
Brightness discrimination	+	+	+	
Recognition of ground targets	0	+	0	
Detection of other space objects	+	+	+	
Optical aids to vision	+	+	+	
Displays for space piloting and navigation	+	+	+	
Display quickening	0	+	+	
Labyrinthine effects	+	+	+	
PSYCHOMOTOR				
Remote manipulators (including remote TV-2D&3D)	-	+	-	
Transfer functions	+	+	+	
Vehicle entry and exit and suit donning	-	+	-	
Handling of massive materials	-	-	-	X
Personal locomotion under zero and partial gravity	-	0	-	X
Strength and mobility when encumbered	+	+	+	
CENTRAL				
Vigilance	-	+	-	
Problem solving	+	+	+	
Integration and interpretation of multi-sensor data				X

Key
 "+" indicates adequacy
 "0" indicates marginal adequacy
 "-" indicates inadequacy

SUMMARY OF SPACE VEHICLE REQUIREMENTS Continued

EXPERIMENT	Adequacy of Current Vehicles		Current Vehicles Inadequate
	C	A X-20	
SPACE ENVIRONMENTAL EFFECTS			
Multiple stressors	- 0	-	X
Work-rest cycles	0 0	0	X
Extended tether-lines	- +	-	
Extended duration	- -	-	X
WORK PLACE DESIGN AND LAYOUT			
Mission activity analysis	+ +	+	
Blind positioning movements under partial and zero gravity	0 +	0	X (mission specific)
TRAINING			
Maintenance of proficiency	0 +	0	
Operational training	- 0	0	X
MISCELLANEOUS			
Validation of selection	0 0	0	X
TOTALS	11 19	12	
Adequate	6 5	6	
Marginally adequate			8
Inadequate			

Key
 "+" indicates adequacy
 "0" indicates marginal adequacy
 "-" indicates inadequacy