

UNCLASSIFIED

AD NUMBER

AD480031

LIMITATION CHANGES

TO:

Approved for public release; distribution is unlimited.

FROM:

Distribution authorized to U.S. Gov't. agencies and their contractors; Critical Technology; JAN 1966. Other requests shall be referred to Air Force Flight Dynamic Laboratory, Attn: FDTR, Wright-Patterson AFB, OH 45433. This document contains export-controlled technical data.

AUTHORITY

AFFDL ltr, 15 Feb 1973

THIS PAGE IS UNCLASSIFIED

AFFDL-TR-65-213,
PART I

480031

STATICS AND STABILITY OF THIN-WALLED ELASTIC BEAMS
PART I. FORMULATION OF FUNDAMENTAL EQUATIONS

PROF. E. GIANGRECO
ING. M. CAPURSO
ING. M. COMO

INSTITUTE OF STRUCTURAL ENGINEERING
UNIVERSITY OF NAPLES
NAPLES, ITALY

TECHNICAL REPORT AFFDL-TR-65-213, PART I

JANUARY 1966

AIR FORCE FLIGHT DYNAMICS LABORATORY
RESEARCH AND TECHNOLOGY DIVISION
AIR FORCE SYSTEMS COMMAND
WRIGHT-PATTERSON AIR FORCE BASE, OHIO

Distribution of This Document Is Unlimited

DISCLAIMER NOTICE

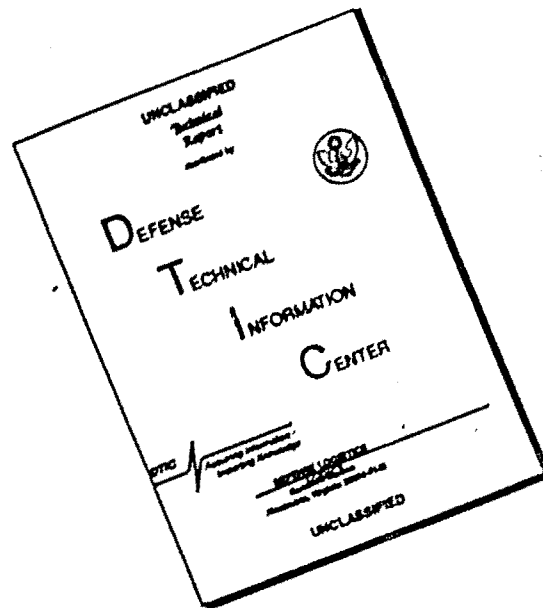

THIS DOCUMENT IS BEST QUALITY AVAILABLE. THE COPY FURNISHED TO DTIC CONTAINED A SIGNIFICANT NUMBER OF PAGES WHICH DO NOT REPRODUCE LEGIBLY.

NOTICES

When Government drawings, specifications, or other data are used for any purpose other than in connection with a definitely related Government procurement operation, the United States Government thereby incurs no responsibility nor any obligation whatsoever; and the fact that the Government may have formulated, furnished, or in any way supplied the said drawings, specifications, or other data, is not to be regarded by implication or otherwise as in any manner licensing the holder or any other person or corporation, or conveying any rights or permission to manufacture, use, or sell any patented invention that may in any way be related thereto.

Copies of this report should not be returned to the Research and Technology Division unless return is required by security considerations, contractual obligations, or notice on a specific document.

STATICS AND STABILITY OF THIN-WALLED ELASTIC BEAMS
PART I. FORMULATION OF FUNDAMENTAL EQUATIONS

PROF. E. GIANGRECO
ING. M. CAPURSO
ING. M. COMO

INSTITUTE OF STRUCTURAL ENGINEERING
UNIVERSITY OF NAPLES
NAPLES, ITALY

Distribution of This Document Is Unlimited

FOREWORD

This report was prepared by the University of Naples, under USAF Contract No. AF 61(052)-813. The contract was initiated under Project No. 1467, Task No. 146703; BPSN 4(6899-61430014-0000-600-FD). The work was administered under the direction of the Air Force Flight Dynamics Laboratory, Research and Technology Division, Mr. Adel Abdessalam and later Mr. Royce G. Forman acting as project engineers.

This report covers work conducted from February 1965 to June 1965.

The work was performed by the Institute of Structural Engineering, University of Naples, Naples, Italy.

This technical report has been reviewed and is approved.

STATICS AND STABILITY OF THIN WALLED ELASTIC BEAMS

ABSTRACT

Formulation of fundamental equations of elastic equilibrium of thin walled beams subject to general loads and dislocations starting only from the hypothesis of non deformed transverse cross sections.

Formulation of the fundamental equations of dynamic stability of thin walled beams subject to general conservative loads and dislocations by use of a systematic geometrical approach.

TABLE OF CONTENTS

1) STATICS	
1,1) Introduction	Page 1
1,2) The basic hypothesis	" 3
1,3) Kinematic relations	" 3
1,4) Elasticity relations	" 7
1,5) Equilibrium equations	" 9
1,6) Basic equations of elastic equilibrium of thin walled beam having continuous directrix and constant thickness	" 15
1,7) Boundary conditions connected with basic equation	" 19
1,8) Basic equation extended to thin walled beams having discontinuous directrix and discontinuous constant thickness	" 22
1,9) Conclusions	" 26
2) STABILITY	
2,1) Introduction	" 27
2,2) General remarks on approach method	" 29
2,3) Effects due to flexural motion	" 31
2,4) Effects due to torsional oscillation	" 40
2,5) Effects due to extensional oscillation	" 48
2,6) General equations of dynamics of thin walled beams	" 50
References	" 52

1) STATICS

1.1) Introduction

The theory of elastic equilibrium of a cylinder subject to loads applied at the bases and represented by a general system of balanced forces, has been accurately and completely developed by St. Venant [1] [2] with the traditional hypotheses of homogeneity, isotropy and linear elasticity.

This study represents the background of the so called "technical theory of the beams" which applies with approximation the results obtained by St. Venant to all the real cases concerning the elastic equilibrium of cylinders subject to any type of loads and constraints.

Such application is founded in a classic postulate carrying St. Venant's name and is synthetically expressed by the following principle: "If a system of balanced forces acts on a limited area S' of the surface S of a body, its effects damp out as they leave S' and actually disappear at distance ρ depending upon the shape and the size of S' ".

Such postulate permits to determine stresses and displacements having knowledge only of six classic stress characteristics connected with the constraints and loads applied to the body, the areas close to constraints or concentrated loads excluded.

However, some conditions are indispensable; of which the most important are:

- 1) the cross section dimensions must be comparable;
- 2) the body's length must be much greater than the above mentioned cross dimensions.

It is the classic case of solid section beams for which the technical theory has a good correspondence with reality.

The same thing does not apply to thin walled beams. In fact, such structures are characterized by three dimensions, anyone of which is negligible if compared to the next one:

- a) thickness of the wall
- b) average dimension of the cross section
- c) length

For this type of structures, which are always more widely used by technical practice, it has been necessary to generalize the results

obtained by St. Venant, specifically as far as torsional stresses are concerned; a new theory has been expressed justifying, with approximation, the discrepancies between technical theory and test controls.

This new theory known as "the theory of sectorial areas", developed by Vlasov [3] [4] and Timoshenko [5] [6] for beams of open cross section, has been later generalized by Karman-Christensen [7] for beams of general cross section.

Vlasov [3] [4], Wagner [8], Kappus [9], Goodier [10], etc. applied this theory to the problem of elastic equilibrium stability and their results have been confirmed by test controls.

Nevertheless, as it has been noticed by Karman-Wei-Zang-Chien [11], the sectorial area theory is only the first term of a repetition procedure the validity of which is in certain cases doubtful.

Such theory, in fact, basically consists in dividing the shear flow produced by the twisting moment into two parts: the primary shear flow typical of St. Venant's theory, and the secondary shear flow associated with the normal stresses caused by the non-uniform warping of cross sections due to the primary flow.

In fact, the sectorial areas theory relapses into the classic solution of St. Venant when warping is constant in the length of the beam. However, this theory neglects the warping caused by the secondary shear flow which sometimes can be more conspicuous than the primary one, and, consequently, fundamentally changes the static condition; furthermore, said theory, even improving considerably the correctness of calculation of stresses and deformations inside the body, cannot be applied in the areas which are close to constraints or concentrated loads.

As a conclusion, we can say that the "sectorial areas theory" is for the thin walled beams what the "technical theory" is for the solid section beams; in other words, the limitations of both can be considered identical.

Therefore, in this Note we want to re-examine from the origin the problem of elastic equilibrium of thin walled beams subject to very general loads and dislocations, making use of a very general method.

In fact, the correct solution of the problems permits to eliminate the limitations related to St. Venant's postulate and to determine exactly some problems of considerable interest for the theory

as well as for the practice, as:

- 1) the calculation of stresses in the areas close to concentrated loads and external constraints;
- 2) the calculation of stresses associated with general loads acting on the surface of the beam;
- 3) the calculation of stresses associated with general dislocation, of general interest for the study of thermic or plastic actions.

In the first part of this study the problem of elastic equilibrium of thin walled beams will be considered from a general viewpoint and basic equations and boundary conditions will be furnished; then, above mentioned problems will be studied and solved.

1,2) The basic hypothesis

The basic hypothesis on which we found our study is the hypothesis of a transversally indeformable cross section. Such hypothesis which appears also in the theory of sectorial areas and in Karman's study, is generally acceptable for the thin walled beams because of shear diaphragms used for structures of this type with the purpose of avoiding the buckling of the wall.

Such diaphragms are usually realized by means of thin plates welded to the wall, in order to avoid deformations of the cross section.

Nevertheless, being such plates very thin, we can imagine them having no resistance to warping outside their plane, and, consequently, leaving the beam cross section free to warp.

Therefore, in this study we will consider the profile as uniformly stiffened along its whole length, that is, we will consider every section as keeping unchanged its shape during the displacement associated with general loads conditions.

1,3) Kinematic relations

With reference to the profile shown in fig. 1, having a constant thickness t and a general cross section, we denote G the centroid and O the shear center of the cross section.

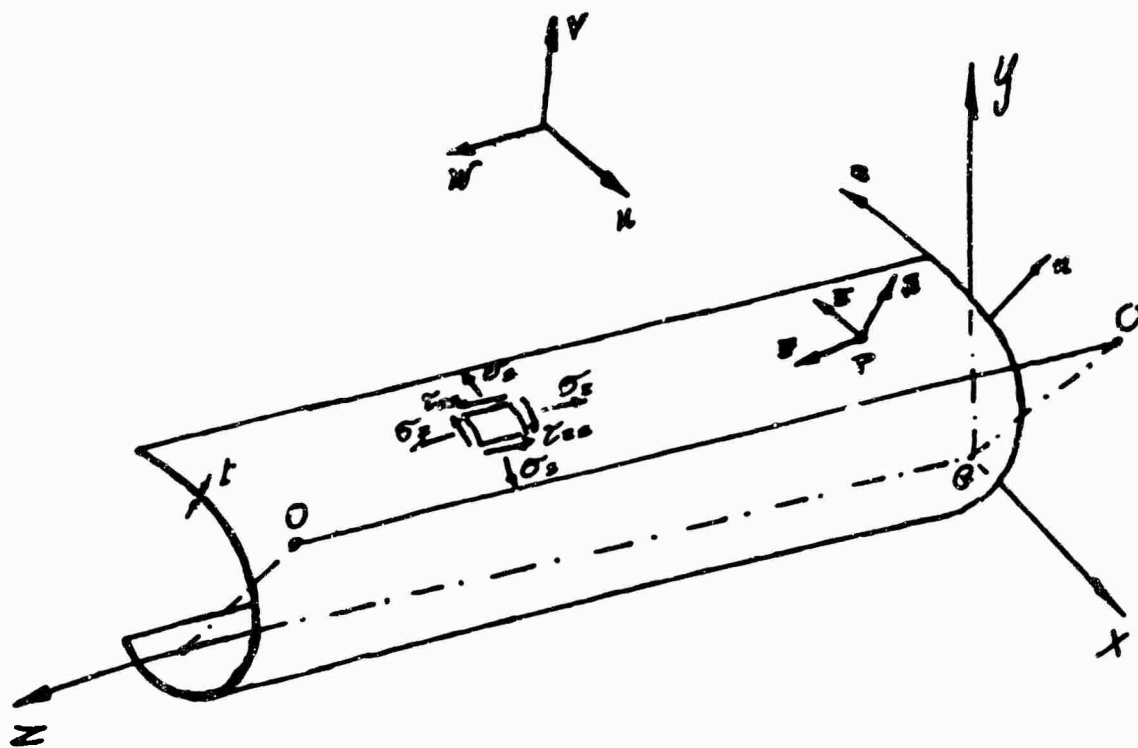

Fig. 1

We refer the points of the surface to the orthogonal right-hand tern $Gxyz$, of which axes x and y coincide with the principal inertia axes of the cross section and axis z is perpendicular and passes through the centroid G . Furthermore, we refer the beam surface to the two groups of orthogonal lines formed by directrices and generatrices of the cylindrical surface, choosing \bar{n} normal to the surface in a point $P(s, z)$, and \bar{s} and \bar{z} such that the directions tern $(\bar{n}, \bar{s}, \bar{z})$ is right and can be superimposed on fixed tern $Gxyz$ with a rigid motion.

Being ϱ the displacement of point P , we denote:

$$\begin{aligned} u &= u(x, y, z), \\ v &= v(x, y, z), \\ w &= w(x, y, z), \end{aligned} \tag{1,1}$$

the components of such displacement on the axes of fixed tern xyz , and we denote:

$$\begin{aligned}
 \xi &= \xi(n, s, z), \\
 \eta &= \eta(n, s, z), \\
 \zeta &= \zeta(n, s, z),
 \end{aligned}
 \tag{1,2}$$

the components of such displacement on \bar{n} \bar{s} \bar{z} . From well known relations we know that:

$$\begin{aligned}
 \xi &= u \alpha_{xn} + v \alpha_{yn} + w \alpha_{zn} \\
 \eta &= u \alpha_{xs} + v \alpha_{ys} + w \alpha_{zs} \\
 \zeta &= u \alpha_{xz} + v \alpha_{yz} + w \alpha_{zz}
 \end{aligned}
 \tag{1,3}$$

being α_{ij} the direction cosine of the straight line i with the axis j , and since in our case:

$$\begin{aligned}
 \alpha_{xn} = \alpha_{ys} = \frac{dy}{ds}, \quad \alpha_{yn} = -\alpha_{xs} = -\frac{dx}{ds}, \quad \alpha_{zz} = 1 \\
 \alpha_{xz} = \alpha_{zx} = \alpha_{yz} = \alpha_{zy} = 0
 \end{aligned}
 \tag{1,4}$$

being:

$$x = x(s) \quad \text{and} \quad y = y(s)
 \tag{1,5}$$

the cartesian coordinates of the points of the surface, the equation (1,3) will become:

$$\begin{aligned}
 \xi &= u \frac{dy}{ds} - v \frac{dx}{ds} \\
 \eta &= u \frac{dx}{ds} + v \frac{dy}{ds} \\
 \zeta &= w
 \end{aligned}
 \tag{1,6}$$

The basic hypothesis permits to determine the displacement in the plane $x y$ of every point of the cross section with only three parameters only depending upon abscissa z . In fact, denoting:

$$\begin{aligned}
 u_0 &= u_0(z) \\
 v_0 &= v_0(z) \\
 \varphi_0 &= \varphi_0(z)
 \end{aligned}
 \tag{1,7}$$

the displacement component on x and y of the shear center O and the section rotation around the shear center, the first two equations (1,1) can be written as follows:

$$u(x, y, z) = u_0(z) - c_0(z)(y - y_0)$$

$$v(x, y, z) = r_0(z) + c_0(z)(x - x_0)$$

(1,8)

where (x_0, y_0) are the coordinates of the shear center O (fig. 2).

Therefore, using equations (1,6), we have:

$$\xi = u_0 \frac{dy}{ds} - r_0 \frac{dx}{ds} - c_0 \left[(y - y_0) \frac{dy}{ds} + (x - x_0) \frac{dx}{ds} \right]$$

$$\eta = u_0 \frac{dx}{ds} + r_0 \frac{dy}{ds} + c_0 \left[(x - x_0) \frac{dy}{ds} - (y - y_0) \frac{dx}{ds} \right]$$

(1,9)

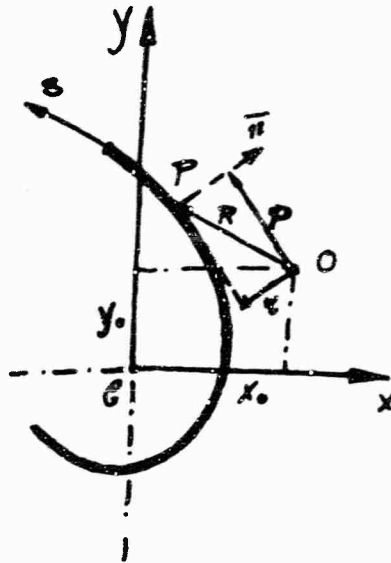

Fig. 2

We observe that the quantities:

$$r = (x - x_0) \frac{dy}{ds} - (y - y_0) \frac{dx}{ds}$$

$$p = (x - x_0) \frac{dx}{ds} + (y - y_0) \frac{dy}{ds}$$

(1,10)

are the components on the axes \bar{s} and \bar{n} of vector $\bar{R} = \overline{OP}$, therefore equations (1,4) can be finally expressed as follows:

$$\xi = u_0 \frac{dy}{ds} - r_0 \frac{dx}{ds} - c_0 p$$

$$\eta = u_0 \frac{dx}{ds} + r_0 \frac{dy}{ds} + c_0 r$$

(1,11)

$$\xi = \eta$$

Consequently, the motion of every point of the beam is expressed by the following four functions:

$$\begin{aligned} u_0 &= u_0(z) \quad , \\ v_0 &= v_0(z) \quad , \\ \varphi_0 &= \varphi_0(z) \quad , \\ w &= w(n, s, z) \quad , \end{aligned} \tag{1,12}$$

and the latter can be considered, with a good approximation, independent of n , in consideration of the smallness of thickness t , and can be written:

$$w = w(s, z) \quad . \tag{1,13}$$

1,4) Elasticity relations

If we neglect the normal stress σ_n , we can express as follows the relations between the stresses components and the unit strains in the thin wall surface:

$$\begin{aligned} \sigma_s &= \frac{E}{1-\nu^2} (\epsilon_s^e + \nu \epsilon_n^e) \\ \sigma_n &= \frac{E}{1-\nu^2} (\epsilon_n^e + \nu \epsilon_s^e) \\ \tau_{sn} &= \frac{E}{2(1+\nu)} \gamma_{sn}^e \end{aligned} \tag{1,14}$$

In a more general case the strain components will be expressed by the following relations:

$$\begin{aligned} \epsilon_n &= \epsilon_n^e + \epsilon_n^p \\ \epsilon_s &= \epsilon_s^e + \epsilon_s^p \\ \gamma_{sn} &= \gamma_{sn}^e + \gamma_{sn}^p \end{aligned} \tag{1,15}$$

where ϵ^e is the elastic strain and ϵ^p the strain due to a general dislocation system, as a thermic, plastic system etc.

So equations (1,14) can be written:

$$\begin{aligned} \sigma_s &= \frac{E}{1-\nu^2} (\epsilon_s^e + \nu \epsilon_n^e) - \frac{E}{1-\nu^2} (\epsilon_s^p + \nu \epsilon_n^p) \\ \sigma_n &= \frac{E}{1-\nu^2} (\epsilon_n^e + \nu \epsilon_s^e) - \frac{E}{1-\nu^2} (\epsilon_n^p + \nu \epsilon_s^p) \\ \tau_{sn} &= \frac{E}{2(1+\nu)} \gamma_{sn}^e - \frac{E}{2(1+\nu)} \gamma_{sn}^p \end{aligned} \tag{1,16}$$

Furthermore, the basic hypothesis permits to reduce the unknowns; in fact, since we must have:

$$\epsilon_s = 0 \quad (1,17)$$

for the cross indeformability of the section, the normal stress σ_s can be expressed:

$$\sigma_s = \nu \sigma_x - E \epsilon_s^p \quad (1,18)$$

while the shearing strain γ_{xs}^p can be expressed as follows:

$$\gamma_{xs}^p = \vartheta_x \frac{dx}{ds} + \vartheta_y \frac{dy}{ds} + \vartheta_z \varrho \quad (1,19)$$

where ϑ_x , ϑ_y , and ϑ_z are general functions of x .

The basic unknowns, expressed as special stress components, can be reduced to the following two functions:

$$\sigma_x = \frac{E}{1-\nu^2} (\epsilon_x - \epsilon_x^p) \quad (1,20)$$

$$\tau_{xs} = \frac{E}{2(1+\nu)} (\gamma_{xs} - \vartheta_x \frac{dx}{ds} - \vartheta_y \frac{dy}{ds} - \vartheta_z \varrho)$$

where:

$$\epsilon_x^p = \epsilon_x^r + \nu \epsilon_s^r \quad (1,21)$$

Taking into account the classic relations:

$$\epsilon_x = \frac{\partial \vartheta_x}{\partial x}, \quad \gamma_{xs} = \frac{\partial \vartheta_x}{\partial s} + \frac{\partial \vartheta}{\partial x} \quad (1,22)$$

equations (1,20) can be written as follows for (1,6):

$$\sigma_x = \frac{E}{1-\nu^2} \left(\frac{\partial W}{\partial x} - \epsilon_x^p \right)$$

$$\tau_{xs} = \frac{E}{2(1+\nu)} \left[\frac{\partial W}{\partial s} + \left(\frac{d\vartheta_x}{dx} - \vartheta_x \right) \frac{dx}{ds} + \left(\frac{d\vartheta_y}{dy} - \vartheta_y \right) \frac{dy}{ds} + \left(\frac{d\vartheta_z}{dz} - \vartheta_z \right) \varrho \right] \quad (1,23)$$

and they express the general elasticity relations of thin walled beams.

Equations (1,23) represent the values of normal stresses σ_x and shear stresses τ_{xs} corresponding to the middle fiber of the wall forming the profile.

In reality such stresses vary along thickness t of the wall, but actually they can be considered constant because of the thickness smallness. However, if the profile has open cross section, it is necessary to consider, together with the stresses (1,23), the shearing stresses linearly variable along the thickness and vanishing in correspondence with the middle fiber associated with the twist of the wall caused by external torque.

Such stresses, classic of St. Venant's study, can be expressed, with good approximation, as follows:

$$\tau_{ns} = G \bar{n} \left(\frac{d\varphi_0}{dz} - \vartheta_0 \right) \quad (1,24)$$

being \bar{n} the distance between the fiber and the middle surface; in fact, said stresses are the only ones which develop for a constant twist of the beam and, consequently, allow the beam to balance the external torque.

In fact, as a result of (1,24) we obtain a twisting moment \bar{M}_z , having the well known expression:

$$\bar{M}_z = JG \left(\frac{d\varphi_0}{dz} - \vartheta_0 \right) \quad (1,25)$$

being J the torsional rigidity which, in case of open sections of constant thickness t , is written:

$$J = m \frac{t^3}{3} \quad (1,26)$$

where m is the length of the middle line, and in the case of cross section consisting of several portions of different thickness t_i , is:

$$J = \sum_{i=1}^n m_i \frac{t_i^3}{3} \quad (1,27)$$

If the profile has a close section (box or multicell beam), stresses (1,24) are no more necessary to give torsional rigidity to the beam. In fact, also in case of constant twist, the external moment is almost completely absorbed by a flow of shear stresses constant along the thickness; and, compared with such stresses, the contribution given by equations (1,24) is quite unimportant.

Therefore, in these cases, stresses (1,23) are sufficient to balance any external action and, consequently, are the only stresses which are considered acting on the wall.

1,5) Equilibrium equations

With reference to the wall element $ds dz$ inside point $P(s,z)$ of the middle surface, the equilibrium equations to be imposed coincide with the three equilibrium conditions relative to the displacement along axes \bar{n} , \bar{s} , \bar{z} . The first two, concerning the equilibrium along normal \bar{n} and tangent \bar{s} , become unessential because of the hypothesis on the inde-

formability of cross section of the beam. In fact, in such directions the equilibrium is guaranteed by the mutual actions of the stiffeners on the wall which can be so calculated.

Therefore, if we denote p_z , \bar{p}_x , \bar{p}_y , \bar{m}_z (fig. 3), respectively, the load acting in the direction of axis z on the wall element $ds dz$; the loads acting in the direction of axes x and y and the twisting moment on an element of the beam having length dz ; the equilibrium equations are written:

$$\frac{\partial \sigma_z}{\partial z} + \frac{\partial \tau_{zs}}{\partial s} + \frac{F_z}{t} = 0$$

$$\frac{dT_x}{dz} + \bar{P}_x = 0$$

$$\frac{dT_y}{dz} + \bar{P}_y = 0$$

(1,28)

$$\frac{dM_z}{dz} + \bar{m}_z = 0$$

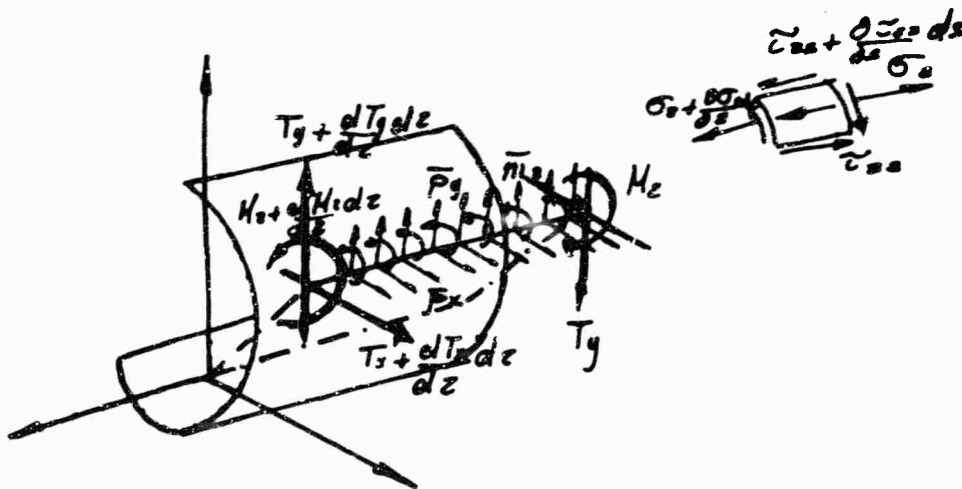

Fig. 3

being T_x , T_y , M_z the resultants of internal stresses τ_{zs} in the direction of axes x and y and the resultant moment in regards of shear centers O .

These letters can, therefore, be expressed as follows:

$$T_x = \int_A \tau_{xs} \frac{ds}{ds} dA$$

$$T_y = \int_A \tau_{ys} \frac{ds}{ds} dA$$

(1,29)

$$M_z = \int_A \tau_{xs} \nu dA + \bar{M}_z$$

being \bar{M}_z the internal moment expressed by equation (1,25) and associated to stresses $\bar{\tau}_{xs}$ which will be taken into account only in the case of open sections.

The last equation (1,29) can have the same form for open sections as well as for box or multicell sections, by introducing a warping function associated with constant twist.

Such function, which we denote ω_s , represents the axial warping function $w(s)$ of the points of the wall middle line when subject to a constant torque having unitary negative gradient $\frac{d\phi_0}{dz}$.

In the case of open section beams, such function is obtained by observing that, since, in accordance with St. Venant's solution,

τ_{xs} equals 0 in correspondence with the middle line, the second equation (1,23), having:

$$w(x, s) = \omega_s(s)$$

$$\frac{d\phi_0}{dz} = -1, \quad u_x = v_x = \partial_x = \partial_y = \partial_z = 0 \quad (1,30)$$

gives:

$$\frac{d\omega_s}{ds} - \nu = 0 \quad (1,31)$$

On the contrary, in the case of close or multicell sections (fig. 4), such function can be obtained by considering that, since τ_{xs} coincides with the flow of stresses resulting from known solution of Bredt-St. Venant:

$$\tau_{xs} = \theta f/t \quad (1,32)$$

being f the flow constant (*), the second equation (1,23), in consideration of (1,30) and (1,32), gives:

$$\frac{d\omega_s}{ds} - \tau + \frac{f}{t} = 0 \quad (1,33)$$



Fig. 4

(*) We must remember that flow constants f , for every element of multicell section, can be obtained with the partial flow f_1 and f_k relative to meshes i and k having such elements in common. The partial flow constants f_1 can finally be obtained from monodromic condition of ω and, consequently, of ω_s which imposes for every circuit the following relation:

$$\oint_i \tau ds = \oint_i \frac{f}{t} ds = 0 \quad (1,33)'$$

from which, denoting Ω_i the area enclosed by circuit i , we obtain:

$$\mathcal{P}\Omega_i - f_i \alpha_i + \sum_{k=1}^s f_k \alpha_{ik} = 0 \quad (1,34)$$

where α_i represents the geometric circulation:

$$\alpha_i = \oint_i \frac{ds}{t}$$

relative to the whole circuit i and α_{ik} represents the partial geometrical circulation of the element in common to meshes i and k . Eqs. (1,34) represent a system which is linear for unknowns f_1 and of simple solution. In view of the above it is easy to obtain constants f .

Therefore, from equations (1,31) and (1,23), with a simple quadrature procedure, we can obtain, neglecting an arbitrary constant, the expression of function w_0 . In general the constant is eliminated with the auxiliary condition:

$$\int_A w_0 dA = 0 \quad (1,35)$$

Thus, equations (1,29) can be written as follows:

$$M_z = \int_A z_{xx} \frac{dw_0}{ds} dA + \frac{QJ}{t} \left(\frac{d\varphi_0}{dz} - \vartheta_0 \right) \quad (1,36)$$

for open sections, and:

$$M_z = \int_A z_{xx} \frac{dw_0}{ds} dA + \int_A z_{xx} \frac{t}{t} dA \quad (1,37)$$

for close or multicell sections.

Denoting m the number of close meshes of cross section, from equations (1,23) we have:

$$\begin{aligned} \int_A z_{xx} \frac{t}{t} dA &= \int_A \frac{Qf}{t} \left[\frac{\partial w}{\partial s} + \left(\frac{du_0}{dz} - \vartheta_x \right) \frac{dx}{ds} + \left(\frac{dv_0}{dz} - \vartheta_y \right) \frac{dy}{ds} + \right. \\ &+ \left. \left(\frac{d\varphi_0}{dz} - \vartheta_0 \right) r \right] dA = \sum_{i=1}^m f_i \oint \left[\frac{\partial w}{\partial s} + \left(\frac{du_0}{dz} - \vartheta_x \right) \frac{dx}{ds} + \right. \\ &+ \left. \left(\frac{dv_0}{dz} - \vartheta_y \right) \frac{dy}{ds} + \left(\frac{d\varphi_0}{dz} - \vartheta_0 \right) r \right] ds \end{aligned} \quad (1,38)$$

taking into account the relations:

$$\begin{aligned} \oint r ds &= 2\Omega_i \\ \oint \frac{\partial w}{\partial s} ds &= \oint \frac{dx}{ds} ds = \oint \frac{dy}{ds} ds = 0, \end{aligned} \quad (1,39)$$

equation (1,38) gives:

$$\int_A z_{xx} \frac{t}{t} dA = 2 \sum_{i=1}^m f_i \Omega_i \left(\frac{d\varphi_0}{dz} - \vartheta_0 \right) \quad (1,40)$$

and, introducing the notation:

$$J = 2 \sum_{i=1}^n f_i \Omega_i \quad (1,41)$$

equation (1,37) can be written as follows:

$$M_z = \int_A \tau_{xz} \frac{dw_z}{ds} dA + \theta J \left(\frac{d\varphi_0}{dz} - \varrho_z \right)$$

and it appears identical to the equation already obtained for open sections and expressed by (1,36).

Therefore, without considering the type of beam cross section, equations (1,29) can be written as follows:

$$T_x = \int_A \tau_{xz} \frac{dx}{ds} dA$$

$$T_y = \int_A \tau_{yz} \frac{dy}{ds} dA$$

(1,42)

$$M_z = \int_A \tau_{xz} \frac{dw_z}{ds} dA + \theta J \left(\frac{d\varphi_0}{dz} - \varrho_z \right)$$

resulting connected to the cross section geometry by the three basic functions:

$$x = x(s) \qquad y = y(s) \qquad w_z = w_z(s)$$

For these functions, we must remember that, since we chose axes x and y as main inertia axes and the center of rotation O as shear center of the section, we will always have the basic relations:

$$\int_A xy dA = \int_A x w_z dA = \int_A y w_z dA = 0 \quad (1,43)$$

In fact, we can obtain the coordinates x_0 and y_0 of center of rotation O by imposing the last two equations (1,43), or by using Jouravsky's procedure for close or cellular sections [12].

1.6) Basic equations of elastic equilibrium of thin walled beam having continuous directrix and constant thickness

We can now obtain the basic equations of elastic equilibrium of thin walled beams, by changing the indefinite equilibrium equations (1,28) into terms of displacement. For the moment, since we consider the body free in the space and subject to a system of balanced forces, we know the three transversal characteristics $T_x(z)$, $T_y(z)$, $M_z(z)$, and we can simplify equations (1,28) as follows:

$$\begin{aligned} \frac{\partial \sigma_x}{\partial z} + \frac{\partial \tau_{xz}}{\partial s} + \frac{P_z}{t} &= 0 \\ \int_A \tau_{xz} \frac{dx}{ds} dA &= T_x \\ \int_A \tau_{yz} \frac{dy}{ds} dA &= T_y \\ \int_A \tau_{xz} \frac{dx}{ds} dA + \rho J \left(\frac{d\varphi_0}{dz} - \vartheta_z \right) &= M_z \end{aligned} \quad (1,44)$$

The first of these equations expresses the equilibrium in the direction z , and the three other ones express the identity between the resultants of internal shear stresses and the corresponding stress characteristics; such equations can be expressed for the displacement parameters (1,12), taking into account the elasticity relations (1,23); in fact, we have:

$$\begin{aligned} \frac{\partial}{\partial z} \left(\frac{\partial u}{\partial z} + \frac{\partial v}{\partial s} + \frac{du}{dz} \frac{dx}{ds} + \frac{dv}{ds} \frac{dy}{ds} + \frac{d\varphi_0}{dz} \frac{dx}{ds} \right) &= \frac{\partial(1+\nu)}{E} \frac{P_z}{t} + \\ + \frac{\partial}{\partial z} \left(\frac{\partial v}{\partial z} + \nu_x \frac{dx}{ds} + \nu_y \frac{dy}{ds} + \nu_z \frac{dz}{ds} \right) & \\ \frac{d\sigma_x}{dz} \frac{dx}{ds} + d\tau_{xz} \frac{dx}{dz} + d\tau_{yz} \frac{dy}{dz} + \int_A \frac{\partial \tau}{\partial s} \frac{dx}{ds} dA &= \frac{\partial(1+\nu)}{E} T_x + \\ + d\tau_{xz} \nu_x + d\tau_{yz} \nu_y + d\tau_{zz} \nu_z & \\ \frac{d\sigma_y}{dz} \frac{dy}{ds} + d\tau_{yz} \frac{dy}{dz} + d\tau_{xz} \frac{dx}{dz} + \int_A \frac{\partial \tau}{\partial s} \frac{dy}{ds} dA &= \frac{\partial(1+\nu)}{E} T_y + \\ + d\tau_{xz} \nu_x + d\tau_{yz} \nu_y + d\tau_{zz} \nu_z & \end{aligned} \quad (1,45)$$

$$d_{21} \frac{du_z}{dz} + d_{22} \frac{dv_z}{dz} + d_{23} \frac{d\omega_z}{dz} + \int \frac{\partial W}{\partial s} \frac{d\omega_z}{ds} dA = \frac{2(1+\nu) M_z}{E} +$$

$$+ d_{21} \tau_x + d_{22} \tau_y + d_{23} \tau_z$$

after introducing the notations:

$$d_{11} = \int \left(\frac{dx}{ds} \right)^2 dA, \quad d_{12} = d_{21} = \int \frac{dx}{ds} \frac{dy}{ds} dA,$$

$$d_{22} = \int \left(\frac{dy}{ds} \right)^2 dA, \quad d_{23} = \int \frac{d\omega_z}{ds} \tau dA + J,$$

$$d_{13} = d_{31} = \int \frac{dx}{ds} \tau dA = \int \frac{dx}{ds} \frac{d\omega_z}{ds} dA, \quad (**) (1,46)$$

$$d_{33} = d_{32} = \int \frac{dy}{ds} \tau dA = \int \frac{dy}{ds} \frac{d\omega_z}{ds} dA.$$

Therefore, equations (1,45) are the requested elastic equilibrium equations of thin walled beams subject to loads and dislocations. Such system can be simplified by drawing from last three equations the functions $\frac{du_z}{dz}$, $\frac{dv_z}{dz}$, $\frac{d\omega_z}{dz}$ in function of the stress characteristics T_x , T_y , M_z and axial displacement u . For this purpose, denoting D the determinant of symmetrical matrix coefficient:

$$\begin{pmatrix} d_{11} & d_{12} & d_{13} \\ d_{12} & d_{22} & d_{23} \\ d_{13} & d_{23} & d_{33} \end{pmatrix} \quad (1,47)$$

and denoting D_{ik} the complementary matrix of element d_{ik} , we obtain from last three equations of system (1,45) the following relations:

$$\frac{du_z}{dz} = -\frac{1}{D} \int \frac{\partial W}{\partial s} \left(D_{11} \frac{dx}{ds} + D_{12} \frac{dy}{ds} + D_{13} \frac{d\omega_z}{ds} \right) dA + \frac{2(1+\nu)}{ED} (D_{11} T_x +$$

$$+ D_{12} T_y + D_{13} M_z)$$

$$\frac{dv_z}{dz} = -\frac{1}{D} \int \frac{\partial W}{\partial s} \left(D_{12} \frac{dx}{ds} + D_{22} \frac{dy}{ds} + D_{23} \frac{d\omega_z}{ds} \right) dA + \frac{2(1+\nu)}{ED} (D_{21} T_x +$$

$$+ D_{22} T_y + D_{23} M_z) \quad (1,48)$$

(**) The last two equations (1,4) are directly verified for open sections with equation (1,32) and for close or cellular sections with equation (1,33) and with the following relations:

$$\int \frac{dx}{ds} dA = \int \frac{dy}{ds} dA = 0 \quad (1,47)'$$

which ensue from the equilibrium condition in the x and y direction.

$$\frac{d\epsilon_s}{ds} = -\frac{1}{D} \int_1^A \frac{d\omega}{ds} (D_{12} \frac{dx}{ds} + D_{22} \frac{dy}{ds} + D_{20} \frac{d\omega_s}{ds}) dA + \frac{g(1+\nu)}{ED} (D_{10} T_x + D_{20} T_y + D_{00} H_0)$$

If we operate in the second part of equations (1,48) the following linear changes:

$$X(s) = \frac{1}{D} \{ D_{11} x(s) + D_{12} y(s) + D_{10} \omega_0(s) \}$$

$$Y(s) = \frac{1}{D} \{ D_{21} x(s) + D_{22} y(s) + D_{20} \omega_0(s) \} \quad (***) (1,49)$$

$$R_0(s) = \frac{1}{D} \{ D_{10} x(s) + D_{20} y(s) + D_{00} \omega_0(s) \}$$

(***) Equations (1,49) require the following inversed relations to be true:

$$x(s) = a_{11} X(s) + a_{12} Y(s) + a_{10} R_0(s)$$

$$y(s) = a_{21} X(s) + a_{22} Y(s) + a_{20} R_0(s)$$

(1,49)'

$$\omega_0(s) = a_{10} X(s) + a_{20} Y(s) + a_{00} R_0(s)$$

furthermore, it is easy to verify that the six functions:

$$\frac{dx}{ds}, \frac{dy}{ds}, \frac{d\omega_s}{ds}, \quad \frac{dX}{ds}, \frac{dY}{ds}, \frac{dR_0}{ds}$$

have the following properties:

$$\int_1^A \frac{dx}{ds} \frac{dY}{ds} dA = 1, \quad \int_1^A \frac{dx}{ds} \frac{dY}{ds} dA = 0, \quad \int_1^A \frac{dx}{ds} \frac{dR_0}{ds} dA = 0$$

$$\int_1^A \frac{dy}{ds} \frac{dX}{ds} dA = 0, \quad \int_1^A \frac{dy}{ds} \frac{dY}{ds} dA = 1, \quad \int_1^A \frac{dy}{ds} \frac{dR_0}{ds} dA = 0 \quad (1,49)''$$

$$\int_1^A \frac{d\omega_s}{ds} \frac{dX}{ds} dA = -\frac{D_2}{D} J, \quad \int_1^A \frac{d\omega_s}{ds} \frac{dY}{ds} dA = -\frac{D_2}{D} J, \quad \int_1^A \frac{d\omega_s}{ds} \frac{dR_0}{ds} dA = 1 - \frac{D_{20} J}{D}$$

which can be controlled taking into account the determinants properties and the relation:

$$\int_1^A \left(\frac{d\omega_s}{ds} \right)^2 dA = \int_1^A \frac{d\omega_s}{ds} x dA = a_{00} - J$$

$$Z_x = \frac{1}{D} \{ D_{11} T_x + D_{12} T_y + D_{13} M_x \}$$

$$Z_y = \frac{1}{D} \{ D_{12} T_x + D_{11} T_y + D_{13} M_x \}$$

(1,50)

$$M_x = \frac{1}{D} \{ D_{13} T_x + D_{23} T_y + D_{33} M_x \}$$

we can simplify as follows:

$$\frac{d u_x}{d z} = - \int_A \frac{\partial w}{\partial s} \frac{d x}{d s} d A + \frac{Z_x}{E} + \alpha_x$$

$$\frac{d v_x}{d z} = - \int_A \frac{\partial w}{\partial s} \frac{d y}{d s} d A + \frac{Z_y}{E} + \alpha_y$$

(1,51)

$$\frac{d \theta_x}{d z} = - \int_A \frac{\partial w}{\partial s} \frac{d R_s}{d s} d A + \frac{M_x}{E} + \alpha_c$$

Therefore, the basic equation of thin walled beams is obtained by substituting (1,51) in first equation (1,45) and observing that for equations (1,31) or (1,33) we always have:

$$\frac{d^2 \omega_x}{d s^2} = \frac{d x}{d s} \quad (1,52)$$

In consideration of the above and taking into account equations (1,49) and (1,50), we obtain the following integral differential linear equation:

$$\begin{aligned} \frac{E}{1-\nu} \frac{\partial^2 w}{\partial z^2} + \frac{\partial^2 w}{\partial s^2} - \frac{d x}{d s} \int_A \frac{\partial w}{\partial s} \frac{d x}{d s} d A - \frac{d y}{d s} \int_A \frac{\partial w}{\partial s} \frac{d y}{d s} d A + \\ - \frac{d R_s}{d s} \int_A \frac{\partial w}{\partial s} \frac{d R_s}{d s} d A = \frac{1}{E} \left(P_x - Z_x \frac{d x}{d s} - Z_y \frac{d y}{d s} - M_x \frac{d R_s}{d s} \right) + \quad (1,53) \\ + \frac{Q}{1-\nu} \frac{\partial \delta^*}{\partial z} \end{aligned}$$

which is of basic importance for the study of thin walled beams of transversally indeformable section subject to general forces and dislocations. In view of future applications, it is therefore advisable to express the elasticity relations (1,23) by the displacement axial component $w(z,s)$. This can be done simply by taking into account equations

(1,51); therefore we have:

$$\begin{aligned} \sigma_z &= \frac{E}{1-\nu^2} \left(\frac{\partial w}{\partial z} - \epsilon_z^* \right) \\ \tau_{xz} &= \frac{E}{2(1+\nu)} \left[\frac{\partial w}{\partial s} - \frac{dx}{ds} \int \frac{\partial w}{\partial s} \frac{dX}{ds} dA - \frac{dy}{ds} \int \frac{\partial w}{\partial s} \frac{dY}{ds} dA + \right. \\ &\quad \left. - \nu \int \frac{\partial w}{\partial s} \frac{dZ}{ds} dA \right] + \tilde{c}_x \frac{dx}{ds} + \tilde{c}_y \frac{dy}{ds} + \eta \tilde{c}_z \frac{dw}{ds} \end{aligned} \quad (1,54)$$

which are the final expressions of elasticity relations for thin walled beams. Equation (1,53) must furnish solutions satisfying the boundary conditions on the bases ($z = 0$ and $z = 1$) and the transversal conditions depending upon the shape of the beam section described in following paragraph.

1,7) Boundary conditions connected with basic equation

We divide the boundary conditions into longitudinal conditions, regarding the external bases $z = 0$ and $z = 1$, and transversal conditions.

In case of longitudinal conditions we notice that, if we consider a body free and subject to a system of balanced forces, said conditions will necessarily impose the equality, in every point, between external actions P_{0z} and P_{1z} acting respectively on bases $z = 0$ and $z = 1$, and corresponding normal stresses $\sigma_z(0, s)$ and $\sigma_z(1, s)$; therefore, they are as follows:

$$\begin{aligned} \sigma_z(0, s) &= - P_{0z} \\ \sigma_z(1, s) &= P_{1z} \end{aligned} \quad (1,55)$$

Equations (1,55), expressed with equations (1,54) for displacement give:

$$\begin{aligned} \left(\frac{\partial w}{\partial z} \right)_{z=0} &= - \frac{1-\nu^2}{E} P_{0z} + \epsilon_z^*(0, s) \\ \left(\frac{\partial w}{\partial z} \right)_{z=1} &= \frac{1-\nu^2}{E} P_{1z} + \epsilon_z^*(1, s) \end{aligned} \quad (1,56)$$

which represent the two necessary longitudinal conditions to be associated with basic equation (1,53). We notice that on bases $z = 0$ and $z = 1$ the identity in every point between external actions and internal stresses

concerns only normal stresses and not shear stresses for which equations (1,44) guarantee global identity referred to resulting actions (forces and moment).

As far as the end bases are concerned, the difference in every point between external actions P_{zs} and internal stresses Z_{zs} is entirely absorbed by two existing stiffeners and, consequently, does not cause any additional deformations or stresses not even in the areas very close to the two bases.

Equations (1,56) are therefore the only longitudinal conditions concerning the extreme bases.

A different procedure is required for transversal conditions, since they depend upon the type of the cross section. Therefore, we will consider them case by case in regards to the shape of the cross section directrix.

a) Open sections having continuous directrix

We consider as continuous directrix a curve having functions $x(s)$, $y(s)$ and $co_2(s)$ continuous up to the second derivatives; such sections (fig. 5) cannot have more than two generatrices and we denote s_1 and s_2 respectively their curvilinear abscissa.

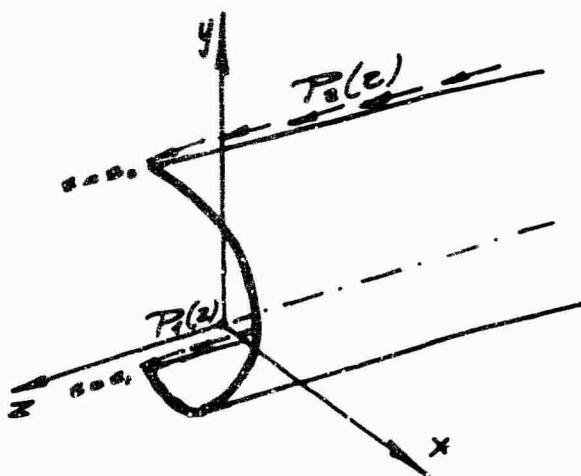

Fig. 5

If we denote $P_1(z)$ and $P_2(z)$ the tangential loads eventually acting on such generatrices, and t the constant thickness of the wall,

we can write the transversal conditions as follows:

$$\begin{aligned} \tau_{zs}(s, z) &= -\frac{P_1(z)}{t} \\ \tau_{zs}(s, z) &= \frac{P_2(z)}{t} \end{aligned} \tag{1,57} a$$

Taking into account equations (1,54) and denoting $L(w)$ the term:

$$\begin{aligned} L(w) &= \frac{\partial w}{\partial s} - \frac{dx}{ds} \int \frac{\partial w}{\partial s} \frac{dY}{ds} dA - \frac{dy}{ds} \int \frac{\partial w}{\partial s} \frac{dV}{ds} dA + \\ &- \nu \int \frac{\partial w}{\partial s} \frac{dZ}{ds} dA \end{aligned} \tag{1,58}$$

equations (1,57) can finally be written as follows:

$$\begin{aligned} L(w)_{s=s_1} &= -\frac{P_1(z)}{t} - \tau_x \left(\frac{dx}{ds} \right)_{s=s_1} - \tau_y \left(\frac{dy}{ds} \right)_{s=s_1} - \nu \tau_z \nu(s_1) \\ L(w)_{s=s_2} &= \frac{P_2(z)}{t} - \tau_x \left(\frac{dx}{ds} \right)_{s=s_2} - \tau_y \left(\frac{dy}{ds} \right)_{s=s_2} - \nu \tau_z \nu(s_2) \end{aligned} \tag{1,59} a$$

b) Close sections having continuous directrix

In addition to what stated in paragraph a) above, concerning the definition of continuous directrix, for these sections (fig. 6) the transversal conditions will be expressed as continuity conditions for functions $w(z, s)$ and $\tau_{zs}(z, s)$ (being t constant) in the limited field of curvilinear abscissa s . Such conditions, reflecting the double aspect of geometrical compatibility and equilibrium, will be expressed as follows:

$$\begin{aligned} \oint \frac{\partial w}{\partial s} ds &= 0 \\ \oint \frac{\partial \tau_{zs}}{\partial s} ds &= 0 \end{aligned} \tag{1,57} b$$

which, because of equations (1,54) and the hypothesis of continuous coordinate functions, become:

$$\oint \frac{\partial w}{\partial s} ds = 0 \quad \oint \frac{\partial w}{\partial s^2} ds = 0 \tag{1,59} b$$

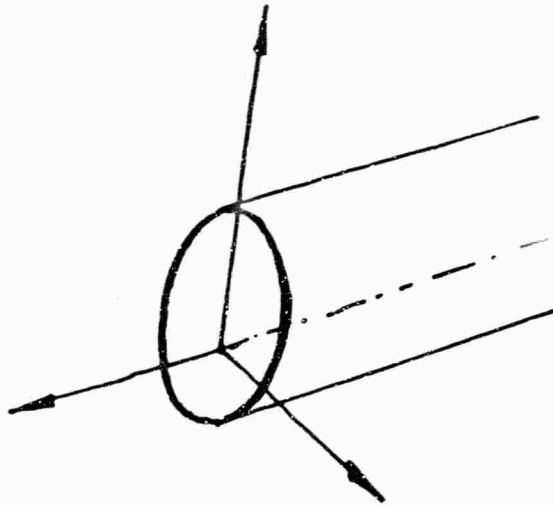

Fig. 6

From equations (1,59) in the form a or b, in accordance with the type of cross section associated with the longitudinal conditions (1,56), we can obtain univocally the solution of basic equation (1,53).

1,8) Basic equation extended to thin walled beams having discontinuous directrix and discontinuous constant thickness

In reality the thin walled beams are nearly always formed by more than one element (fig. 7), everyone of which can be considered as an elementary beam having continuous directrix and constant thickness.

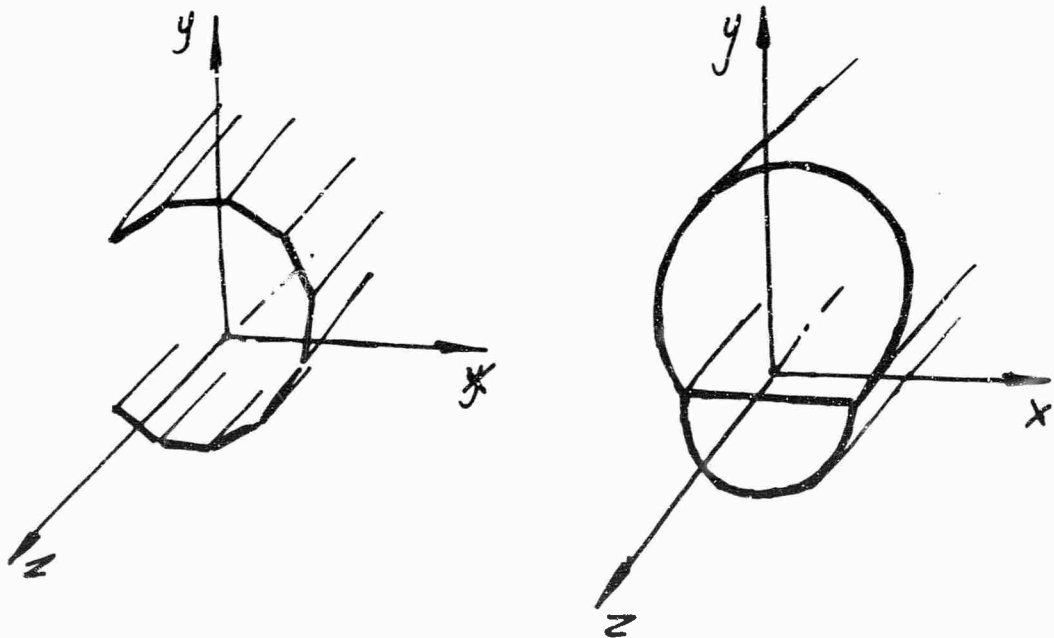

Fig. 7

Denoting n the number of elements forming the beam and i a general element, the displacement parameters indicating the motion of every point of the beam cross section will be the $n + 3$ functions:

$$\begin{aligned} & u_0(z) \\ & r_0(z) \\ & \varphi_0(z) \\ & x_i(z, s_i) \quad (i = 1, 2, \dots, n.) \end{aligned} \tag{1,12}'$$

being $w_i(s_i, z)$ the axial displacement of point $P_i(s_i, z)$ of the element middle surface.

Then, denoting $x_1(s_1), y_1(s_1), \omega_{z1}(s_1), r_1(s_1)$ the functions typical of element i , and $x_1(s_1), y_1(s_1), \Omega_{z1}(s_1)$ the varied expressions:

$$\begin{aligned} X_i(s_i) &= \frac{1}{D} \{ D_{11} x_i(s_i) + D_{12} y_i(s_i) + D_{13} \omega_{zi}(s_i) \} \\ Y_i(s_i) &= \frac{1}{D} \{ D_{12} x_i(s_i) + D_{22} y_i(s_i) + D_{23} \omega_{zi}(s_i) \} \\ \Omega_{zi}(s_i) &= \frac{1}{D} \{ D_{13} x_i(s_i) + D_{23} y_i(s_i) + D_{33} \omega_{zi}(s_i) \} \end{aligned} \tag{1,49}'$$

where D_{1k} are always the complementary matrices of elements d_{1k} of determinant (1,47) which, this time, we express as follows:

$$\begin{aligned} d_{11} &= \sum_{i=1}^n \int_{A_i} \left(\frac{dx_i}{ds_i} \right)^2 dA_i \\ d_{22} &= \sum_{i=1}^n \int_{A_i} \left(\frac{dy_i}{ds_i} \right)^2 dA_i \\ d_{33} &= \sum_{i=1}^n \int_{A_i} \left(\frac{d\omega_{zi}}{ds_i} \right)^2 dA_i + J \\ d_{12} &= \sum_{i=1}^n \int_{A_i} \frac{dx_i}{ds_i} \frac{dy_i}{ds_i} dA_i \\ d_{13} &= \sum_{i=1}^n \int_{A_i} \frac{dx_i}{ds_i} r_i dA_i \\ d_{23} &= \sum_{i=1}^n \int_{A_i} \frac{dy_i}{ds_i} r_i dA_i \end{aligned} \tag{1,46}'$$

the equations determining displacements u_0, v_0, ϕ_0 , with expressions (1,50) of forces $\tilde{c}_x, \tilde{c}_y, M_c$, become:

$$\frac{du_0}{dz} = - \sum_{i=1}^n \int \frac{\partial w_i}{\partial s_i} \frac{dX_i}{ds_i} dA_i + \frac{\tilde{c}_x}{E} + \nu \epsilon_x$$

$$\frac{dv_0}{dz} = - \sum_{i=1}^n \int \frac{\partial w_i}{\partial s_i} \frac{dY_i}{ds_i} dA_i + \frac{\tilde{c}_y}{E} + \nu \epsilon_y$$

$$\frac{d\phi_0}{dz} = - \sum_{i=1}^n \int \frac{\partial w_i}{\partial s_i} \frac{dR_i}{ds_i} dA_i + \frac{M_c}{E} + \nu \epsilon_c$$

(1,51)'

Therefore, n equations determining displacements w_i will be written as follows:

$$\frac{\partial}{\partial z} \left(\frac{\partial w_i}{\partial z} + \frac{\partial \epsilon_i^*}{\partial s_i} \right) - \frac{dX_i}{ds_i} \sum_{i=1}^n \int \frac{\partial w_i}{\partial s_i} \frac{dX_i}{ds_i} dA_i - \frac{dY_i}{ds_i} \sum_{i=1}^n \int \frac{\partial w_i}{\partial s_i} \frac{dY_i}{ds_i} dA_i +$$

$$- \frac{dR_i}{ds_i} \sum_{i=1}^n \int \frac{\partial w_i}{\partial s_i} \frac{dR_i}{ds_i} dA_i = \frac{1}{E} \left(\frac{p_{zi}}{t_i} - \tilde{c}_x \frac{dX_i}{ds_i} +$$

(1,53)'

$$- \tilde{c}_y \frac{dY_i}{ds_i} - M_c \frac{dR_i}{ds_i} \right) + \frac{\partial}{\partial z} \left(\frac{\partial \epsilon_i^*}{\partial z} \right)$$

where t_i represents the constant thickness of element i ; $p_{zi}(s_i)$ represents the axial load acting on said element for unit of surface; and ϵ_i^* represents the anelastic strain component acting on the same element.

Therefore $n + 3$ equations formed by (1,51)' and (1,53)' generally solve the problem of elastic equilibrium of thin walled beams, provided that its section has constant discontinuous thickness.

In order to solve said equations we must find the longitudinal and transversal boundary conditions.

The first ones express, as usual, the equilibrium condition:

$$\begin{aligned} \sigma_{xi}(s_i, 0) &= -p_{xi} \\ \sigma_{xi}(s_i, l) &= p_{xi} \end{aligned} \quad (1,55)'$$

and, reduced in terms of displacement, give:

$$\begin{aligned} \left(\frac{\partial w_i}{\partial z}\right)_{z=0} &= -\frac{1-\nu^2}{E} p_{xi} + \epsilon_{xi}^*(s_i, 0) \\ \left(\frac{\partial w_i}{\partial z}\right)_{z=l} &= \frac{1-\nu^2}{E} p_{xi} + \epsilon_{xi}^*(s_i, l) \end{aligned} \quad (1,56)'$$

while the transversal conditions will concern geometrical compatibility and equilibrium conditions corresponding to every junction point of several consecutive elements.

Denoting k the number of elements present in the junction (fig. 8), these letters will be written as follows:

$$\begin{aligned} N_i(\bar{s}_i, z) &= N_{i+1}(\bar{s}_{i+1}, z) \\ \sum_{i=1}^k \left\{ \pm t_i \tau_{xi}(\bar{s}_i, z) \right\} &= P_i(z) \end{aligned} \quad (1,57)'$$

where \bar{s}_i is the curvilinear abscissa of the junction in relation with element i , and $P_i(z)$ is the eventual external tangential action acting on the junction point itself.

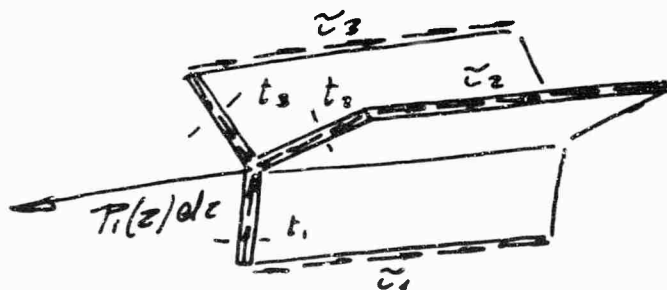

Fig. 8

In the summation, the positive signs concern the elements having curvilinear abscissa converging in the junction point, and the

negative ones concern the remaining elements. Therefore, equations (1,57)', written in terms of displacement, give:

$$w_i(\bar{s}_i, z) = w_{i+1}(\bar{s}_{i+1}, z)$$

$$\sum_{i=1}^n \left\{ \pm b_i \left[L_i(w_i) + \tau_x \frac{d^2 w_i}{ds_i^2} + \tau_y \frac{d^2 w_i}{ds_i^2} + M_z \frac{d^2 w_i}{ds_i^2} \right] \right\} = F_i \quad (1,59)'$$

and is obvious the change, if the end of element i is free rather than connected to other elements.

1,9) Conclusions

From the study performed it appears clear that the problem of elastic equilibrium of thin walled beams, considered as cylinders having transversally indeformable profile, is more complicated than what could be expected following the beams technical theory or the more recent Vlasov's theory of sectorial area.

In fact, the problem can strictly be expressed by an integro-differential equation linear to the partial derivatives in unknown function $w(z, s)$, which physically coincides with the axial component of points displacement of middle fiber of the wall.

Such equation is not of difficult solution; a general solution will be furnished in the following part of this report, showing how our solutions are similar to those obtained by above mentioned approximate theories and pointing out the unavoidable approximation of same theories.

2) STABILITY

2.1) Introduction

The different static behaviour of a thin walled beam in regards of St. Venant's cylinder appears conspicuous when we study its equilibrium stability; unlike the classic behaviour of the beam subject to combined bending and compressive stress, which bends in a main inertia plane of the section, in case of instability due to axial stress, the thin walled beam of open section bends and twists at the same time under loads such smaller than those corresponding to Euler's formula.

The possibility of having a flexio-torsional buckling under axial stress was discovered when thin walled members of open section were used for the first time in designing aeronautic structures: many Authors [3], Ostenfeld [13], F. and H. Bleich [14], and Kappus [9] investigated the laws governing the phenomenon. Only with F. and H. Bleich up to the more recent studies of Timoshenko [6] and Goodier [10] together with the works of Vlasov [15] and Goldenweiser [16], the following principles have been established: in order to determine the presence of bending in the beam, the center of gravity had to be substituted with the center of torsion; only when the axis of the center of torsion was rectilinear no flexural energy was present in the thin walled members; and, furthermore, the warping rigidity C_1 was exactly formulated.

Of great importance are the studies performed by Vlasov [15] for the formulation of a theory concerning the instability of the thin walled beam of open section subject to normal, bending and shearing stresses, and the studies performed by Krall [17], who obtains the stability equations by using the variational approach with the introduction of the twisting moment and considering various cases of combined instability.

The constant progress of technics led to an always wider application of the thin walled beams; this structural element is now present in most civil and industrial, naval, aeronautic and space constructions

Therefore, the study of equilibrium stability of a thin walled beam of open section is always of great interest and new problems arise: as, for instance, the basic one concerning the influence of the dislocation on the stability, its effect and the effect of external conservative and

nonconservative forces on the dynamics, etc.

Thus, we want to examine again the whole system of elastic equilibrium stability of the thin walled beam subject to general loading and dislocation and we try to set up a new general theory.

The study of such beams, as conducted in the first part of this report and connected with researches underway, the results of which will be furnished in a later report, confirm the validity of sectorial areas theory without consideration of local effects connected to the presence of concentrated forces, holes, etc.

Thus, making use of Vlasov's static theory, simple and sufficiently correct for an investigation on such phenomena, we obtain, in accordance with dynamic method, and using a geometric systematic procedure, the basic differential equations governing the stability problem of the beam motion under generally distributed conservative forces and dislocations. Such equations are expressed by the loads directly applied and the stress components corresponding to the basic configuration and includes four functions characterizing the flexural, torsional and extensional oscillations respectively. The extensional oscillation is often neglected, but is interesting because of its stabilizing effects.

The system of forces $F^0(x, y, z)$ acting on the thin walled beam is formed by distributed forces $Q_x^0(z, s)$; $Q_y^0(z, s)$; $Q_z^0(z, s)$, which have the same direction of axes x, y, z , and are functions of curvilinear abscissa s formed by the center line of the cross section. Such forces are conservative and keep their direction during the displacement of the points at which they are applied and generally originate a distribution of transversal forces $p_x^0(z)$ and $p_y^0(z)$, axial forces $p_z^0(z)$, bending couples $m_x^0(z)$ and $m_y^0(z)$, twisting couples $m_z^0(z)$, and bimoments $B^0(z)$.

The dislocations system $\Delta^0(x, y, z)$ causes a stress condition which can be annulled, generally, only by dividing the body into its elementary particles or, more simply, by cutting it into a finite number of planes. The introduction of the dislocations system $\Delta^0(x, y, z)$ will be useful later for the study of the unstabilizing effects caused by residual stresses, non uniform thermic field or prestressing systems.

2,2) General remarks on approach method

Fig. 9 shows the axes system where C is the centroid; x and y are the main inertia axes of cross section; z is the centroid axis. The coordinates of shear center O in the section plane are x_0 and y_0 .

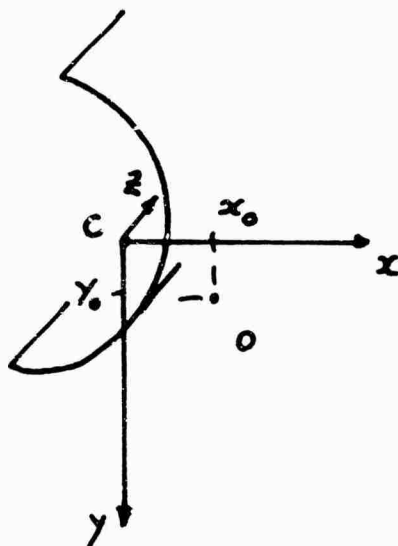

Fig. 9

The external forces are generally represented by components $Q_x^0(z, s)$, $Q_y^0(z, s)$, and $Q_z^0(z, s)$ having the same direction of axes x, y, z of fixed coordinates system Cxyz; and are general functions of curvilinear abscissa s formed by the center line of thin cross section and by abscissa z. Such forces will be considered as conservative forces and, specifically, as keeping unchanged their directions determined by fixed axes x, y, z respectively. The loads at the end sections are formed by a distribution of general forces but still conservative corresponding to normal, shearing, bending, twisting and warping actions. The coaction state due to dislocations is represented by normal and shearing stresses in every cross section self-balanced if the external constraints do not react.

Therefore, with reference to a general cross section of the body, the stress state will be represented by seven stress characteristics; bending moments $M_x(z)$ and $M_y(z)$; twisting moment $M_z(z)$; shearing stresses $T_x(z)$ and $T_y(z)$; bimoment $B(z)$, as shown in fig. 10.

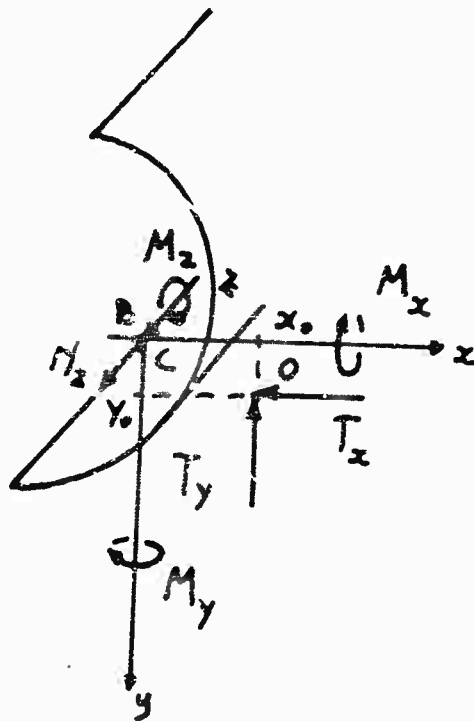

Fig. 10

The thin beam motion will be formed by:

a) a system of displacements, typical of a flexural oscillation, by which the axis of shear centers O bends in the planes xz and yz , and the cross sections of the beam transfer along their planes and rotate around axes x and y ;

b) a system of displacements, typical of a torsional oscillation, by which the cross sections transfer along their planes, rotating around the shear centers axis (which remains rectilinear) and warp because of the sectorial areas;

c) a system of displacements, typical of an extensional oscillation, by which the cross sections transfer in parallel with themselves along the direction z of fixed system $Cxyz$.

The new actions developing along the direction z on the element $dA dz$ will be calculated by determining:

1) the transversal and axial elementary forces due to the change of

direction of stresses $\tau_{zx} dA$, $\tau_{zy} dA$, $\sigma_z dA$, following the fibers buckling;

2) the elementary couples, which we call "turnover" couples, causing the rotation of element $dA dz$ around fixed axes x and y and z and due to the components along axes x , y , z of fixed system of elementary forces $\tau_{zx} dA$, $\tau_{zy} dA$, $\sigma_z dA$, acting on the buckled body;

3) the elementary couples, which we call "displacement" couples, due to the fact that forces $\tau_{zx} dA$, $\tau_{zy} dA$, $\sigma_z dA$, acting on the two sides dA of element $dA dz$ and the surface forces $Q_x^o(z,s) ds$, $Q_y^c(z,s) ds$, $Q_z^o(z,s) ds$, during the buckling, assume a different position in regards of fixed referenced system.

Further, we calculate the actions which, because of the degree of freedom of cross section, are consequent on the previous ones; in this manner torques distributed on z will be associated to a transversal elementary load, and bending couples and bimoments will be associated to axial actions. The determination of inertia forces will complete the calculation of the actions caused by imposed displacements.

Such procedure is systematically used for the flexural, torsional and extensional oscillations and permits to formulate the general equations expressing the motion of the thin walled beam in general as well as taking into account the unstabilizing effects of stresses (corresponding to the basic position of the beam) and of the surface loads.

2,3) Effects due to flexural motion

Let us consider the flexural deformation. It is characterized (fig. 11) by displacement components:

$$u(z, t) ; v(z, t) \quad (2,1)$$

of the line of shear centers O ; and, for the rotation of sections around axes x and y , by the displacement component along axis z :

$$w(x, y, z, t) = - \left(\frac{\partial u}{\partial x} x + \frac{\partial v}{\partial z} y \right) \quad (2,2)$$

We consider, above all, the unstabilizing effects due to stresses and we calculate, along axis x of fixed system $Cxyz$, the components df_x of the elementary forces acting on the elementary buckled stripe $dA dz$ of the beam pertaining to two cross sections at the distance dz . With reference to fig. 12, representing the projection of $dA dz$ on the plane

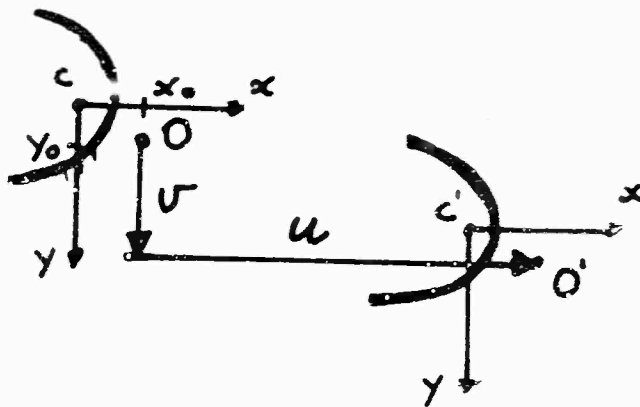

Fig. 11

x z, we have:

$$d f_x = -\sigma_z dA \frac{\partial u}{\partial z} + \left(\sigma_z + \frac{\partial \sigma_z}{\partial z} dz \right) dA \frac{\partial}{\partial z} \left(u + \frac{\partial u}{\partial z} dz \right) \quad (2,3)$$

since the load $Q_z^0(z, s) ds dz$ applied on the element does not give any component along x and keeps the direction of axis x.

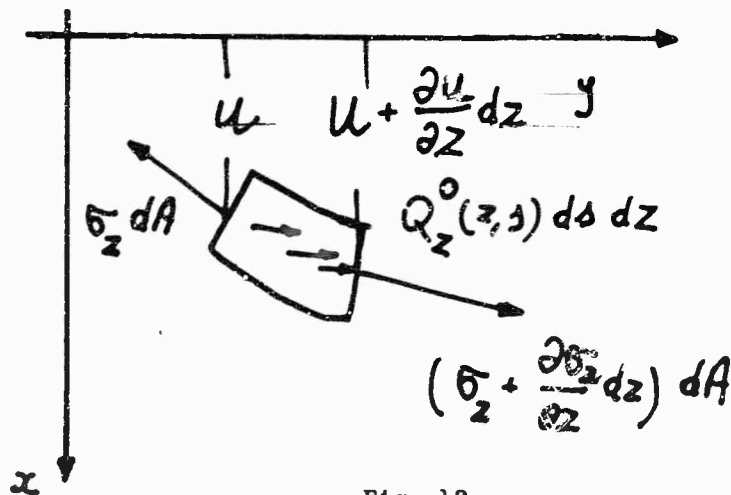

Fig. 12

Developing equations (2,3) we obtain, neglecting quantities of higher order than the first:

$$dP_x = \frac{\partial}{\partial z} (\sigma_z \frac{\partial u}{\partial z} dA) \quad (2,4)$$

In this manner, for unit of length, we have the cross elementary load:

$$dP_x = \frac{\partial}{\partial z} (\sigma_z \frac{\partial u}{\partial z} dA) \quad (2,5)$$

Correspondingly, we have the elementary moment dM_y , due to the components of $\sigma_z dA$ along x which tends to turn over the element $dA dz$ around axis y ; it is:

$$dM_y = - \sigma_z dA \frac{\partial u}{\partial z} dz \quad (2,6)$$

in this manner, for unit of length, we have the elementary distributed moment:

$$dM_y = - \sigma_z dA \frac{\partial u}{\partial z} \quad (2,6')$$

and, for the whole section:

$$M_y = - \int_A \sigma_z \frac{\partial u}{\partial z} dA \quad (2,7)$$

Projecting the buckled element on plane yz , we have (fig. 13):

$$dP_y = - \sigma_z dA \frac{\partial v}{\partial z} + (\sigma_z + \frac{\partial \sigma_z}{\partial z} dz) dA \frac{\partial}{\partial z} (v + \frac{\partial v}{\partial z} dz) \quad (2,8)$$

because, also in this case, the loads $Q_z^0(z,s)$ have no effect along y .

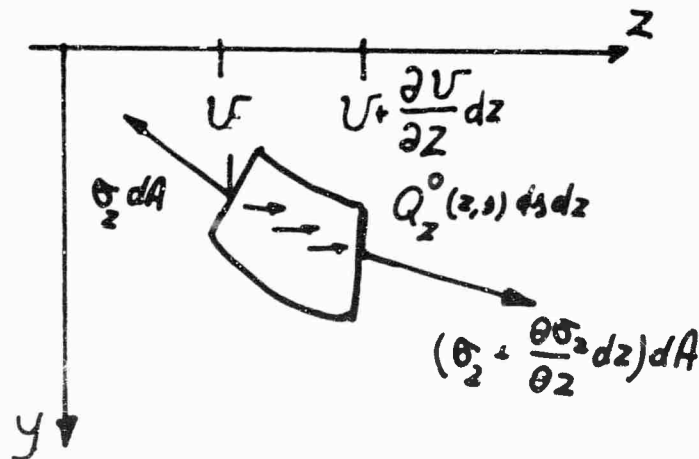

Fig. 13

Developing equation (2,6) we obtain, for unit of length:

$$dP_y = \frac{\partial}{\partial z} (\sigma_z \frac{\partial v}{\partial z} dA) \quad (2,9)$$

In the same manner as for equation (2,6), we have the moment:

$$dM_x = -\sigma_z dA \frac{\partial v}{\partial z} dz \quad (2,10)$$

tending to turn over the element $dA dz$ around axis x ; for unit of length, we have the elementary distribution moment:

$$dm_x = -\sigma_z dA \frac{\partial v}{\partial z} \quad (2,10')$$

and, for the whole section:

$$M_x = -\int_A \sigma_z \frac{\partial v}{\partial z} dA \quad (2,11)$$

Integrating equations (2,5) and (2,9) on the transversal area, we have the new distributed actions due to the fact that, in buckled condition, normal stresses σ_z lean forward forming variable angles in regards to the original direction of z axis.

Thus we have:

$$P_x = \int_A \frac{\partial}{\partial z} (\sigma_z \frac{\partial u}{\partial z} dA) \quad P_y = \int_A \frac{\partial}{\partial z} (\sigma_z \frac{\partial v}{\partial z} dA) \quad (2,12)$$

Equations (2,5) and (2,9) give the transversal load due to the flexural buckling of the elementary stripe $dA dz$; consequently, we have the following twisting elementary moment distributed along z :

$$dm_z = \frac{\partial}{\partial z} \left[\sigma_z \frac{\partial u}{\partial z} (y_0 - y) dA \right] - \frac{\partial}{\partial z} \left[\sigma_z \frac{\partial v}{\partial z} (x_0 - x) dA \right] \quad (2,13)$$

using the symbols of fig. 13 which shows as positive the twisting moment (or the angle ϕ) if its direction of rotation is the same bringing axis x on axis y .

Integrating on the whole cross section A we obtain:

$$M_z = \int_A \frac{\partial}{\partial z} \left[\sigma_z \frac{\partial u}{\partial z} (y_0 - y) - \sigma_z \frac{\partial v}{\partial z} (x_0 - x) \right] dA \quad (2,14)$$

Equations (2,8) and (2,10) are always valid if the loads $Q_z^0(z,s)$ keep the same direction of axis z of fixed system $Cxyz$. Let us consider now the effects of shearing stresses τ_{zx} and τ_{zy} acting on the transversal sides dA of the elementary buckled stripe.

With reference to fig. 14, showing the projection of element $dA dz$ on plane x, z , we calculate the components along z of elementary forces

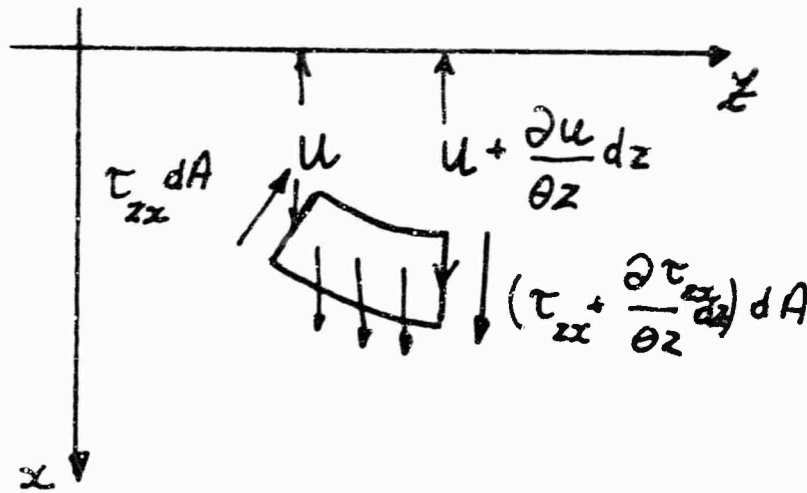

Fig. 14

acting on the buckled stripe.

Therefore we have:

$$dP_z = - \frac{\partial}{\partial z} \left(\tau_{zx} \frac{\partial u}{\partial z} dA \right) dz \quad (2,15)$$

where the effect of surface loads $Q_x^0(z, s)$ is not present, since such loads remain parallel to the axis x of fixed system $Cxyz$.

In conclusion, for unit of length, along z we have the following elementary axial load:

$$dP_z = - \frac{\partial}{\partial z} \left(\tau_{zx} \frac{\partial u}{\partial z} dA \right) \quad (2,16)$$

In the same manner, considering the projection of buckled stripe $dA dz$ on the plane zy to calculate the effect of τ_{zy} oblique in regards of fixed axis y , we have (fig. 15):

$$dP_y = \tau_{zy} \frac{\partial v}{\partial z} dA - \left(\tau_{zy} + \frac{\partial \tau_{zy}}{\partial z} dz \right) dA \frac{\partial}{\partial z} \left(v + \frac{\partial v}{\partial z} dz \right) \quad (2,17)$$

where is not present the effect of conservative loads $Q_y^0(z, s)$ which keep their direction along y .

Developing equation (2,17), we have:

$$dP_y = - \frac{\partial}{\partial z} \left(\tau_{zy} \frac{\partial v}{\partial z} dA \right) dz \quad (2,18)$$

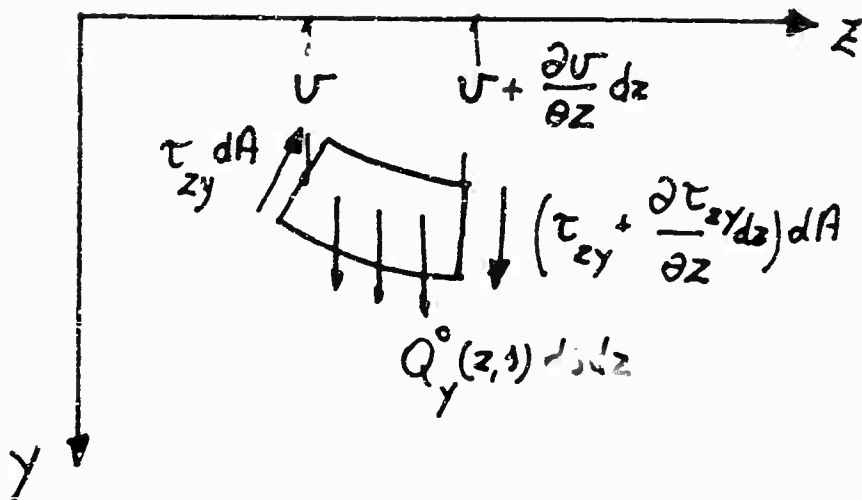

Fig. 15

representing the new action along z due to the different slopes of stresses in the buckled state of element $dA dz$; for unit of length, from equation (2,18) we have:

$$dP_z = - \frac{\partial}{\partial z} (\tau_{zy} \frac{\partial v}{\partial z} dA) \quad (2,19)$$

Equations (2,16) and (2,19) refer to the elementary area dA ; for the whole area A of the beam cross section, we have the following new axial action:

$$P_z = - \int_A \frac{\partial}{\partial z} (\tau_{zx} \frac{\partial u}{\partial z} + \tau_{zy} \frac{\partial v}{\partial z}) dA \quad (2,20)$$

To equations (2,16) and (2,19) are associated some distributed bending moments, since they act at distance x and y from the axis of the centroid; therefore, we have for τ_{zx} the elementary distributed moments dm_x and dm_y

$$dm_x = - \frac{\partial}{\partial z} (\tau_{zx} \frac{\partial u}{\partial z} y dA) \quad dm_y = - \frac{\partial}{\partial z} (\tau_{zx} \frac{\partial u}{\partial z} x dA) \quad (2,21)$$

and for τ_{zy}

$$dm_x = - \frac{\partial}{\partial z} (\tau_{zy} \frac{\partial v}{\partial z} y dA) \quad dm_y = - \frac{\partial}{\partial z} (\tau_{zy} \frac{\partial v}{\partial z} x dA) \quad (2,22)$$

Integrating on area A we finally have:

$$M_x = - \int_A \frac{\partial}{\partial z} (\tau_{zx} \frac{\partial u}{\partial z} y + \tau_{zy} \frac{\partial v}{\partial z} y) dA \quad (2,23)$$

$$M_y = - \int_A \frac{\partial}{\partial z} (\tau_{zx} \frac{\partial u}{\partial z} x + \tau_{zy} \frac{\partial v}{\partial z} x) dA \quad (2,24)$$

Furthermore, equation (2,16) gives the bimoment variation:

$$\frac{\partial B}{\partial z} = - \int_A \frac{\partial}{\partial z} (\tau_{zx} \frac{\partial u}{\partial z} w + \tau_{zy} \frac{\partial v}{\partial z} w) dA \quad (2,25)$$

Equations (2,7), (2,11), (2,12), (2,14), (2,20), (2,23), (2,24), and (2,25) represent the new actions due to the variable slopes of normal and shearing stresses in the buckled state, but it is essential to notice that in such condition the forces acting on the element have a different position if compared to the fixed axis Cxyz. Obviously, this changes the stresses field in the body; in order to calculate this effect it will be sufficient to refer to the elementary stripe $dA dz$ and consider the moments, relative to the forces acting on two sides dA as well as those acting on lateral surface of $dA dz$, due to the displacement of such forces from basic position to the displaced one.

We begin by considering the effects of the displacement of elementary shearing forces $\tau_{zx} dA$ and $\tau_{zy} dA$, distributed on A, and of surface forces $Q_x^0(z, s)$ and $Q_y^0(z, s)$.

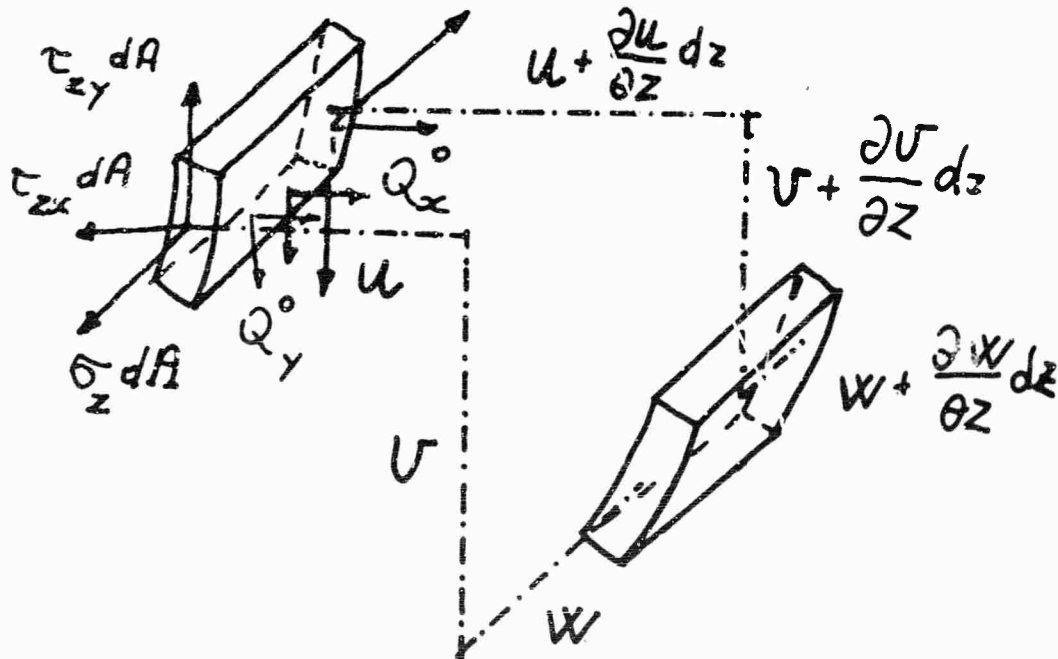

Fig. 16

With reference to fig. 16 we have for the elementary stripe

$dA dz$ the following change of twisting moment:

$$\begin{aligned}
 dM_z = & -\left(\tau_{zx} + \frac{\partial \tau_{zx}}{\partial z} dz\right) \left(v + \frac{\partial v}{\partial z} dz\right) dA + \\
 & + \left(\tau_{zy} + \frac{\partial \tau_{zy}}{\partial z} dz\right) \left(u + \frac{\partial u}{\partial z} dz\right) dA + \tau_{zx} v dA - \tau_{zy} u dA + \\
 & - Q_x^0(z, s) ds dz v + Q_y^0(z, s) ds dz u = -\frac{\partial}{\partial z} (\tau_{zx} v dA) + \\
 & + \frac{\partial}{\partial z} (\tau_{zy} u dA) - Q_x^0(z, s) ds dz v + Q_y^0(z, s) ds dz u
 \end{aligned} \tag{2,26}$$

Integrating on area A and on center line s of the cross section, we obtain for unit of length:

$$m_z = -\int_A \frac{\partial}{\partial z} (\tau_{zx} v dA) + \int_A \frac{\partial}{\partial z} (\tau_{zy} u dA) - \int_s Q_x^0(z, s) v ds + \int_s Q_y^0(z, s) u ds \tag{2,27}$$

Also because of the rotation of cross sections around axes x and y , the elementary internal forces $\tau_{zx} dA$, $\tau_{zy} dA$ and the external surface loads $Q_x^0(z, s)$ and $Q_y^0(z, s)$ move their points of application of quantity:

$$w = -\left(\frac{\partial u}{\partial z} x + \frac{\partial v}{\partial z} y\right) \tag{2,28}$$

With the same procedure previously used, we obtain the following distributed elementary bending couples:

$$dm_x = \frac{\partial}{\partial z} \left[\tau_{zy} \left(\frac{\partial u}{\partial z} x + \frac{\partial v}{\partial z} y \right) dA \right] + Q_y^0(z, s) \left(\frac{\partial u}{\partial z} x + \frac{\partial v}{\partial z} y \right) ds \tag{2,29}$$

$$dm_y = \frac{\partial}{\partial z} \left[\tau_{zx} \left(\frac{\partial u}{\partial z} x + \frac{\partial v}{\partial z} y \right) dA \right] + Q_x^0(z, s) \left(\frac{\partial u}{\partial z} x + \frac{\partial v}{\partial z} y \right) ds \tag{2,30}$$

integrating on A and s we finally have:

$$m_x = \int_A \frac{\partial}{\partial z} \left[\tau_{zy} \left(\frac{\partial u}{\partial z} x + \frac{\partial v}{\partial z} y \right) dA \right] + \int_s Q_y^0(z, s) \left(\frac{\partial u}{\partial z} x + \frac{\partial v}{\partial z} y \right) ds \tag{2,31}$$

$$m_y = \int_A \frac{\partial}{\partial z} \left[\tau_{zx} \left(\frac{\partial u}{\partial z} x + \frac{\partial v}{\partial z} y \right) dA \right] + \int_s Q_x^0(z, s) \left(\frac{\partial u}{\partial z} x + \frac{\partial v}{\partial z} y \right) ds \tag{2,32}$$

The calculation of effects due to the displacement of forces directed along axes x and y is now complete: now we want to consider the effects of displacements of normal forces $\sigma_z dA$, distributed on A , and of surface forces $Q_z^0(z, s)$.

With reference to fig. 16, we have the following elementary displacement couples:

$$dM_x = \sigma_z dA \frac{\partial v}{\partial z} dz + \frac{\partial \sigma_z}{\partial z} v dA dz + Q_z^0(z, s) v ds dz \quad (2,33)$$

$$dM_y = \sigma_z dA \frac{\partial u}{\partial z} dz + \frac{\partial \sigma_z}{\partial z} u dA dz + Q_z^0(z, s) u ds dz \quad (2,34)$$

integrating on area A and on line s , we obtain for unit of length:

$$m_x = \int_A \sigma_z \frac{\partial v}{\partial z} dA + \int_A \frac{\partial \sigma_z}{\partial z} v dA + \int_s Q_z^0(z, s) v ds \quad (2,35)$$

$$m_y = \int_A \sigma_z \frac{\partial u}{\partial z} dA + \int_A \frac{\partial \sigma_z}{\partial z} u dA + \int_s Q_z^0(z, s) u ds \quad (2,36)$$

Now we calculate the corresponding inertia reactions.

Being μ the mass for unit of volume of the thin beam, for the elementary mass $dA dz$ the following forces correspond to the displacements (2,1) and (2,2):

$$d f_x = -\mu dA dz \frac{\partial^2 u}{\partial t^2}$$

$$d f_y = -\mu dA dz \frac{\partial^2 v}{\partial t^2}$$

(2,37)

$$d f_z = -\mu dA dz \left(\frac{\partial^3 u}{\partial z \partial t^2} x + \frac{\partial^3 v}{\partial z \partial t^2} y \right)$$

obviously, to (2,37) correspond the distributed couples:

$$d m_x = -\mu dA \left(\frac{\partial^3 u}{\partial z \partial t^2} x + \frac{\partial^3 v}{\partial z \partial t^2} y \right) y; \quad d m_y = -\mu dA \left(\frac{\partial^3 u}{\partial z \partial t^2} x + \frac{\partial^3 v}{\partial z \partial t^2} y \right) x \quad (2,38)$$

$$d m_z = -\mu dA \left[\frac{\partial^3 u}{\partial t^2} (y_0 - y) - \frac{\partial^3 v}{\partial t^2} (x_0 - x) \right]$$

Integrating on the whole section we obtain the following actions

for unit of length:

$$P_x = -\mu A \frac{\partial^2 u}{\partial t^2} \quad P_y = -\mu A \frac{\partial^2 v}{\partial t^2} \quad P_z = 0 \quad (2,39)$$

$$M_x = -\mu I_x \frac{\partial^3 v}{\partial z \partial t^2} \quad M_y = -\mu I_y \frac{\partial^3 u}{\partial z \partial t^2} \quad M_z = -\mu A \left(\frac{\partial^2 u}{\partial t^2} y_0 - \frac{\partial^2 v}{\partial t^2} x_0 \right) \quad (2,40)$$

On the contrary, the bimoment which seems to develop from (2,37) equals zero; in fact, we have:

$$\frac{\partial B}{\partial z} = \mu \int_A \left(\frac{\partial^3 u}{\partial z \partial t^2} x + \frac{\partial^3 v}{\partial z \partial t^2} y \right) \omega dA = 0 \quad (2,41)$$

because the sectorial coordinate ω is orthogonal to the coordinates x and y .

2,4) Effects due to torsional oscillation

Let us consider the torsional buckling shown in fig. 17.

Since the cross sections rotate around the shear center axis, every element of the area dA moves along x and y as follows:

$$u(z, t) = (y_0 - y) \phi \quad ; \quad v(z, t) = - (x_0 - x) \phi \quad (2,42)$$

and moves along z , because of the warping

$$w(z, t) = - \omega \frac{\partial \phi}{\partial z} \quad (2,43)$$

as it results from the sectorial areas theory.

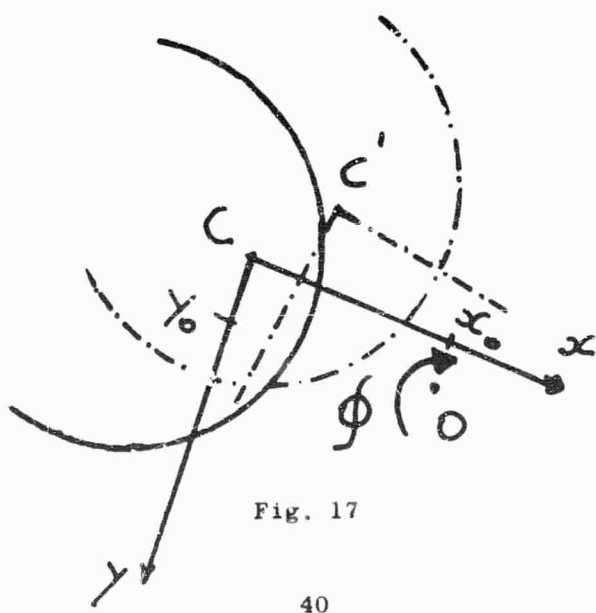

Fig. 17

The angle ϕ , together with the twisting moment M_z , is therefore considered positive if it brings x on y , being z downward.

Considering above all the effect of stresses σ_z we calculate the components along x of elementary forces acting on the buckled form of the elementary stripe $dA dz$ (fig. 18).

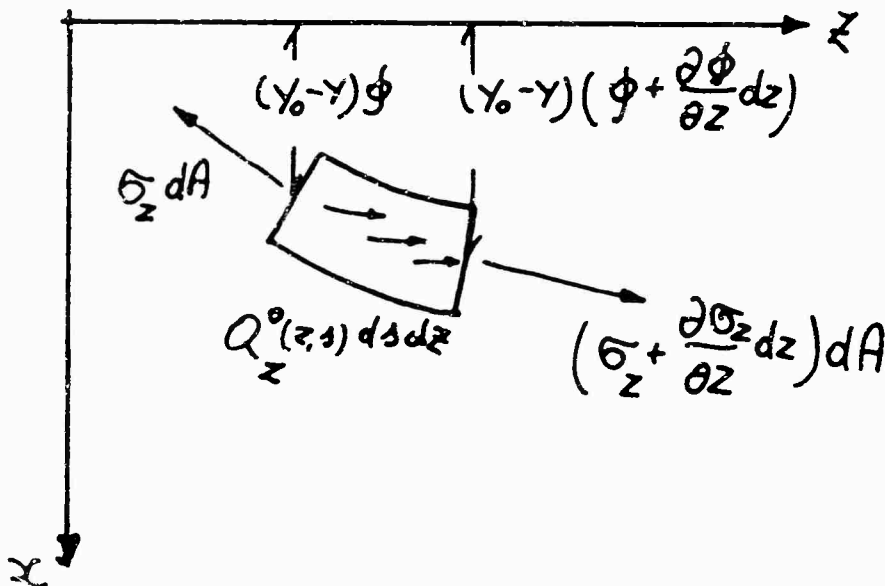

Fig. 18

As in the case of flexural motion, we obtain the transversal action relative to the buckled element $dA dz$:

$$df_x = -\sigma_z dA (y_0 - y) \frac{\partial \phi}{\partial z} + \left(\sigma_z + \frac{\partial \sigma_z}{\partial z} dz \right) dA (y_0 - y) \frac{\partial}{\partial z} \left(\phi + \frac{\partial \phi}{\partial z} dz \right) \quad (2,44)$$

since, also in this case, the load $Q_z^0(z, s)$ keeps its direction. From equation (2,44) we obtain, with reference to the unit of length, the following elementary transversal forces:

$$dP_x = \frac{\partial}{\partial z} \left[\sigma_z (y_0 - y) \frac{\partial \phi}{\partial z} dA \right] \quad (2,45)$$

In the same manner, considering the projection of $dA dz$ on plane $y z$ we obtain (fig. 19):

$$dP_y = -\frac{\partial}{\partial z} \left[\sigma_z (x_0 - x) \frac{\partial \phi}{\partial z} dA \right] \quad (2,46)$$

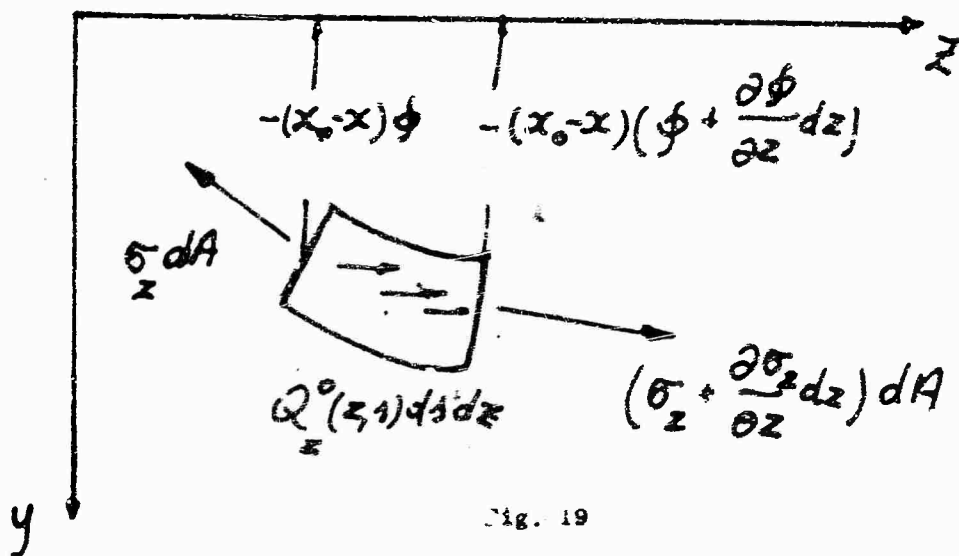

Fig. 19

Integrating on A, we obtain:

$$P_x = \int_A \frac{\partial}{\partial z} \left[\sigma_z (y_0 - y) \frac{\partial \phi}{\partial z} \right] dA \quad (2,47)$$

$$P_y = \int_A \frac{\partial}{\partial z} \left[\sigma_z (x_0 - x) \frac{\partial \phi}{\partial z} \right] dA \quad (2,48)$$

which represent the transversal loads developing on the thin beam slightly twisted due to the different slope of stresses σ_z acting along the fibers. The loads $Q_z^0(z, s)$ also in this case remain parallel to axis z of fixed system Cxyz.

Furthermore, as in section 2,2), for equations (2,45) and (2,46) we have elementary turnover moments dM_x and dM_y due to the components along y and x of elementary forces $\sigma_z dA$; they are:

$$dM_x = \sigma_z (x_0 - x) \frac{\partial \phi}{\partial z} dA dz \quad (2,49)$$

$$dM_y = -\sigma_z (y_0 - y) \frac{\partial \phi}{\partial z} dA dz \quad (2,50)$$

integrating equations (2,49) and (2,50) on A we obtain, for unit of length:

$$m_x = \int_A \sigma_z (x_0 - x) \frac{\partial \phi}{\partial z} dA \quad (2,51)$$

$$m_y = -\int_A \sigma_z (y_0 - y) \frac{\partial \phi}{\partial z} dA \quad (2,52)$$

As a result of equations (2,45) and (2,46) we obtain the elementary twisting moment distributed as follows:

$$d\pi_z = \frac{\partial}{\partial z} \left[\sigma_z (y_0 - y) \frac{\partial \phi}{\partial z} dA \right] (y_0 - y) + \frac{\partial}{\partial z} \left[\sigma_z (x_0 - x) \frac{\partial \phi}{\partial z} dA \right] (x_0 - x) \quad (2,53)$$

due to the fact that dp_x and dp_y act at distances $(y_0 - y)$ and $(x_0 - x)$

from the axis of shear center; integrating we obtain:

$$P_z = \int_A \frac{\partial}{\partial z} \left\{ \sigma_z \frac{\partial \phi}{\partial z} [(x_0 - x)^2 + (y_0 - y)^2] dA \right\} \quad (2,54)$$

Let us consider now the unstabilizing effects due to shearing stresses τ_{zx} and τ_{zy} which, because of torsional buckling, produce components along the directions of axes x , y and z of fixed system $Cxyz$. Since the fibers of the thin beam bend because of $\phi(z)$, as we did for the flexural motion, we calculate the components along z of elementary forces $\tau_{zx} dA$ and $\tau_{zy} dA$, distributed on A and variable along the buckled fiber.

From the projection of element $dA dz$ on planes zx and zy , we obtain, in accordance with figs. 14 and 15:

$$\begin{aligned} dP_z &= \tau_{zx} dA \frac{\partial}{\partial z} [\phi(y_0 - y)] - \left(\tau_{zx} + \frac{\partial \tau_{zx}}{\partial z} dz \right) dA \frac{\partial}{\partial z} \left[\left(\phi + \frac{\partial \phi}{\partial z} dz \right) (y_0 - y) \right] \\ &- \tau_{zy} dA \frac{\partial}{\partial z} [\phi(x_0 - x)] + \left(\tau_{zy} + \frac{\partial \tau_{zy}}{\partial z} dz \right) dA \frac{\partial}{\partial z} \left[\left(\phi + \frac{\partial \phi}{\partial z} dz \right) (x_0 - x) \right] \quad (2,55) \\ &= - \frac{\partial}{\partial z} \left\{ \frac{\partial \phi}{\partial z} [(y_0 - y) \tau_{zx} - (x_0 - x) \tau_{zy}] \right\} \end{aligned}$$

Integrating on A , for unit of length, we obtain the axial distributed load

$$P_z = - \int_A \frac{\partial}{\partial z} \left\{ \frac{\partial \phi}{\partial z} [\tau_{zx} (y_0 - y) - \tau_{zy} (x_0 - x)] dA \right\} \quad (2,56)$$

Equation (2,56) furnishes the distributed bending moments:

$$M_x = - \int_A \frac{\partial}{\partial z} \left\{ \frac{\partial \phi}{\partial z} [\tau_{zx} (y_0 - y) - \tau_{zy} (x_0 - x)] y dA \right\} \quad (2,57)$$

$$M_y = - \int_A \frac{\partial}{\partial z} \left\{ \frac{\partial \phi}{\partial z} [\tau_{zx} (y_0 - y) - \tau_{zy} (x_0 - x)] x dA \right\} \quad (2,58)$$

and the bimoment variation:

$$\frac{\partial B}{\partial z} = - \int_A \frac{\partial}{\partial z} \left\{ \frac{\partial \phi}{\partial z} [\tau_{zx} (y_0 - y) - \tau_{zy} (x_0 - x)] w dA \right\} \quad (2,59)$$

Let us calculate now the unstabilizing actions corresponding to components of $\tau_{zx} dA$ and $\tau_{zy} dA$, distributed on A , on axes x and y .

We consider the elementary stripe $dA dz$ of fig. 20; it will be stressed on two sides dA , of abscissa $z + dz$ and z respectively, by

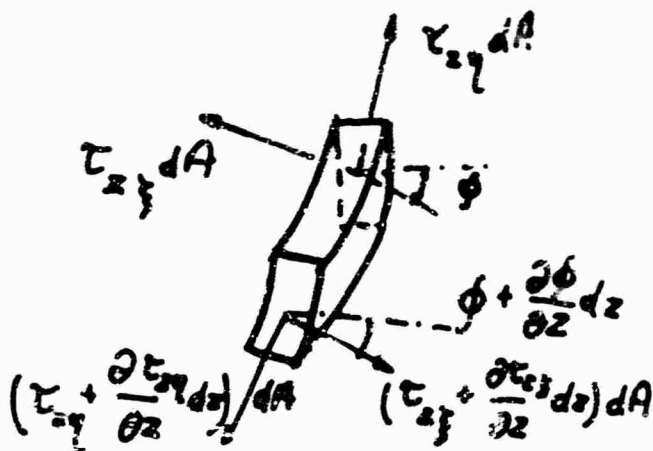

Fig. 20

elementary forces

$(\tau_{zy} + \frac{\partial \tau_{zy}}{\partial z} dz) dA$; $(\tau_{zy} + \frac{\partial \tau_{zy}}{\partial z} dz) dA$; $\tau_{zy} dA$; $\tau_{zy} dA$
 bent in regards of fixed axes x and y of angles $(\phi + \frac{\partial \phi}{\partial z} dz)$ and ϕ , being ξ and η the directions of movable axes x and y.

The loads $Q_x^0(z, s) ds dz$ and $Q_y^0(z, s) ds dz$ will act on the side surface $ds dz$ of the stripe and will keep the directions of fixed axes x and y.

By calculating the components on x and y of all forces acting on $dA dz$, we obtain the transversal loads. Thus we have:

$$d f_x = (\tau_{zy} + \frac{\partial \tau_{zy}}{\partial z} dz) dA \cos(\phi + \frac{\partial \phi}{\partial z} dz) - (\tau_{zy} + \frac{\partial \tau_{zy}}{\partial z} dz) dA \sin(\phi + \frac{\partial \phi}{\partial z} dz) + Q_x^0(z, s) ds dz - \tau_{zy} dA \cos \phi + \tau_{zy} dA \sin \phi =$$

$$= \frac{\partial \tau_{zy}}{\partial z} dz dA - \frac{\partial \tau_{zy}}{\partial z} \phi dA dz - \tau_{zy} dA \frac{\partial \phi}{\partial z} dz + Q_x^0(z, s) ds dz \quad (2,60)$$

For the equilibrium in the basic position, we have:

$$\frac{\partial \tau_{zx}}{\partial z} dz dA + Q_x^0(z, s) ds dz = 0$$

and equation (2,60) is simplified as follows:

$$d f_x = - \frac{\partial}{\partial z} (\tau_{zy} \phi dA) dz \quad (2,61)$$

representing the new transversal forces, distributed on dz and directed along x , due to the new slope of shearing stresses after buckling; for unit of length, we have:

$$dP_x = -\frac{\partial}{\partial z} (\tau_{xy} \phi dA) \quad (2,62)$$

being $\tau_{xy} = \tau_{zy}$.

In the same manner, performing a projection along y , we obtain the elementary transversal forces directed along y and relative to the length dz of element $dA dz$:

$$\begin{aligned} dP_y &= (\tau_{zy} + \frac{\partial \tau_{zy}}{\partial z} dz) dA \cos(\phi + \frac{\partial \phi}{\partial z} dz) + (\tau_{xy} + \frac{\partial \tau_{xy}}{\partial z} dz) dA \sin(\phi + \frac{\partial \phi}{\partial z} dz) \\ &+ Q_y^0(z, s) ds dz - \tau_{zy} dA \cos \phi - \tau_{xy} dA \sin \phi = \\ &= (\tau_{zy} + \frac{\partial \tau_{zy}}{\partial z} dz) dA + (\tau_{xy} + \frac{\partial \tau_{xy}}{\partial z} dz) dA (\phi + \frac{\partial \phi}{\partial z} dz) \quad (2,63) \\ &+ Q_y^0(z, s) ds dz - \tau_{zy} dA - \tau_{xy} dA \phi = \\ &= \frac{\partial}{\partial z} (\tau_{xy} \phi dA) dz \end{aligned}$$

being, for the equilibrium along the direction y in the basic condition

$$\frac{\partial \tau_{xy}}{\partial z} dA + Q_y^0(z, s) ds = 0 \quad (2,64)$$

For unit of length, we have:

$$dP_y = \frac{\partial}{\partial z} (\tau_{xy} \phi dA) \quad (2,65)$$

Integrating equations (2,62) and (2,65) on the area A of cross section, we obtain the transversal loads:

$$P_x = -\int_A \frac{\partial}{\partial z} (\tau_{xy} \phi dA) \quad (2,66)$$

$$P_y = \int_A \frac{\partial}{\partial z} (\tau_{xy} \phi dA) \quad (2,67)$$

Furthermore, the components along x and y of σ_{zz} and produce the following turnover couples around axes x and y .

$$dM_x = -\tau_{xy} \phi dA dz \quad (2,68)$$

$$dM_y = \tau_{xy} \phi dA dz \quad (2,69)$$

Integrating on A, we obtain, for unit of length:

$$m_x = -\int_A \tau_{xy} \phi dA \quad (2,70)$$

$$m_y = \int_A \tau_{xy} \phi dA \quad (2,71)$$

From equations (2,62) and (2,65) we obtain the distributed elementary twisting moments:

$$\begin{aligned} d\omega_z &= dP_x (y_0 - y) - dP_y (x_0 - x) = \\ &= -\frac{\partial}{\partial z} (\tau_{xy} \phi dA) (y_0 - y) - \frac{\partial}{\partial z} (\tau_{xy} \phi dA) (x_0 - x) \end{aligned} \quad (2,72)$$

from which, by integration on area A, we have:

$$m_z = -\int_A \frac{\partial}{\partial z} [\tau_{xy} \phi (y_0 - y) dA] - \int_A \frac{\partial}{\partial z} [\tau_{xy} \phi (x_0 - x) dA] \quad (2,73)$$

In this manner we have calculated the new actions developing along abscissa z of the thin walled beam in a slightly buckled form due to the variable slopes of the stresses. For the calculation of such actions we did not consider the warping of the cross section, because it causes only a variation of generatrices length and not their bending; on the contrary, as shown later, it will affect the calculation of displacement moments.

For the calculation of such displacement moments, we consider that, because of displacements

$$u = (y_0 - y) \phi \quad ; \quad v = - (x_0 - x) \phi$$

the shearing stresses τ_{xz} and τ_{xy} and the surface loads Q_x^0 and Q_y^0 moved along y and x respectively; thus we have, as in equation

(2,27) the elementary distributed twisting moments:

$$\begin{aligned} d\omega_z &= \frac{\partial}{\partial z} [\tau_{xz} (x_0 - x) \phi dA] + \frac{\partial}{\partial z} [\tau_{xy} (y_0 - y) \phi dA] \\ &+ Q_x^0 (z, y) (x_0 - x) \phi dA + Q_y^0 (z, x) (y_0 - y) \phi dA \end{aligned} \quad (2,74)$$

from which, integrating on A, we obtain:

$$m_z = \int_A \frac{\partial}{\partial z} \left\{ \phi [\tau_{xz} (x_0 - x) + \tau_{xy} (y_0 - y)] dA \right\} + \quad (2,75)$$

$$+ \int_S [Q_x^0(z, s)(x_0 - x) + Q_y^0(z, s)(y_0 - y)] \phi ds.$$

Let us consider now the warping of cross section of positive sectorial coordinate; because of this warping, which varies along z with ϕ , the shearing stresses τ_{zx} and τ_{zy} and the surface loads $Q_x^0(z, s)$ and $Q_y^0(z, s)$ move in parallel with themselves; in the same manner as for equations (2,31) and (2,32), we have the distributed bending couples:

$$m_x = \int_A \frac{\partial}{\partial z} (\tau_{zy} \frac{\partial \phi}{\partial z} \omega) dA + \int_S Q_y^0(z, s) \frac{\partial \phi}{\partial z} \omega ds \quad (2,76)$$

$$m_y = \int_A \frac{\partial}{\partial z} (\tau_{zx} \frac{\partial \phi}{\partial z} \omega) dA + \int_S Q_x^0(z, s) \frac{\partial \phi}{\partial z} \omega ds \quad (2,77)$$

Now we calculate the effect of displacement of normal stresses σ_z and of surface loads $Q_z^0(z, s)$.

As for equations (2,33) and (2,34) we have the displacement elementary couples:

$$dM_x = -\sigma_z dA (x_0 - x) \frac{\partial \phi}{\partial z} dz - \frac{\partial \sigma_z}{\partial z} (x_0 - x) \phi dA dz - Q_z^0(z, s) (x_0 - x) \phi ds dz \quad (2,78)$$

$$dM_y = \sigma_z dA (y_0 - y) \frac{\partial \phi}{\partial z} dz + \frac{\partial \sigma_z}{\partial z} (y_0 - y) \phi dA dz + Q_z^0(z, s) (y_0 - y) \phi ds dz \quad (2,79)$$

from which, by integrating on A , we obtain:

$$m_x = - \int_A \sigma_z (x_0 - x) \frac{\partial \phi}{\partial z} dA - \int_A \frac{\partial \sigma_z}{\partial z} (x_0 - x) \phi dA - \int_S Q_z^0(z, s) (x_0 - x) \phi ds \quad (2,80)$$

$$m_y = \int_A \sigma_z (y_0 - y) \frac{\partial \phi}{\partial z} dA + \int_A \frac{\partial \sigma_z}{\partial z} (y_0 - y) \phi dA + \int_S Q_z^0(z, s) (y_0 - y) \phi ds \quad (2,81)$$

Now we calculate the inertia forces appearing during the torsional motion.

With reference to elementary mass $dA dz$, we have the elementary forces:

$$\begin{aligned}
 df_x &= -\mu dA dz (y_0 - y) \frac{\partial^2 \phi}{\partial t^2} \\
 df_y &= \mu dA dz (x_0 - x) \frac{\partial^2 \phi}{\partial t^2} \\
 df_z &= \mu dA dz \omega \frac{\partial^3 \phi}{\partial z \partial t^2}
 \end{aligned}
 \tag{2,82}$$

correspondingly, we have the elementary couples:

$$\begin{aligned}
 dm_x &= -\mu dA dz \omega y \frac{\partial^3 \phi}{\partial z \partial t^2} \\
 dm_y &= -\mu dA dz \omega x \frac{\partial^3 \phi}{\partial z \partial t^2} \\
 dm_z &= -\mu dA dz [(x_0 - x)^2 + (y_0 - y)^2] \frac{\partial^2 \phi}{\partial t^2}
 \end{aligned}
 \tag{2,83}$$

Equations (2,82) and (2,83) give the cross and axial distributed forces:

$$P_x = -\mu A y_0 \frac{\partial^2 \phi}{\partial t^2} \quad P_y = \mu A x_0 \frac{\partial^2 \phi}{\partial t^2} \quad P_z = 0
 \tag{2,84}$$

and the couples:

$$m_x = 0 \quad m_y = 0 \quad m_z = -\mu I_0 \frac{\partial^2 \phi}{\partial t^2}
 \tag{2,85}$$

while the components df_z give the bimoment variation:

$$\frac{\partial B}{\partial z} = \mu I_\omega \frac{\partial^3 \phi}{\partial z \partial t^2}
 \tag{2,86}$$

being I_0 and I_ω the quantities:

$$I_0 = \int_A [(x_0 - x)^2 + (y_0 - y)^2] dA = I_x + I_y + A(x_0^2 + y_0^2); \quad I_\omega = \int_A \omega^2 dA
 \tag{2,87}$$

polar moment of the cross section in regards of the shear center O and sectorial moment, respectively.

2,5) Effects due to extensional oscillation

Let us consider the extensional oscillation.

Since the sections have only displacements $w(z)$ along (fig. 21), in the extensional buckling we do not have variable slopes of stresses, in regards of axes x , y and z , and corresponding unstabilizing effects do not appear. On the contrary, we notice some unstabilizing effects because, due to the extensional displacement w , variable

with z , the shearing stresses τ_{zx} and τ_{zy} and the loads $Q_x^0(z, s)$ and $Q_y^0(z, s)$ move in parallel with themselves, So we have the bending distributed couples:

$$m_x = -\int_A \frac{\partial}{\partial z} (\tau_{zy} w dA) - \int_S Q_y^0(z, s) w ds \quad (2,88)$$

$$m_y = -\int_A \frac{\partial}{\partial z} (\tau_{zx} w dA) - \int_S Q_x^0(z, s) w ds \quad (2,89)$$

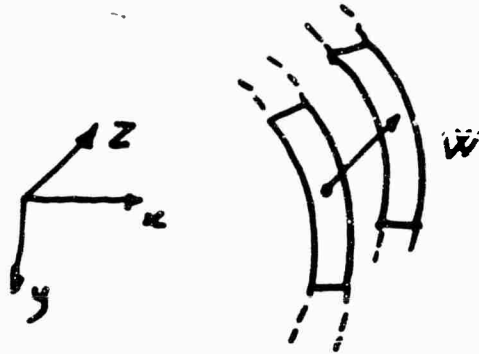

Fig. 21

The inertia forces are given by:

$$p_x = 0 \quad p_y = 0 \quad p_z = -\rho A \frac{\partial^2 w}{\partial t^2} \quad (2,90),$$

$$m_x = m_y = m_z = B = 0 \quad (2,91)$$

2.6) General equations of dynamics of thin walled beams

In paragraphs 2.2), 2.3) and 2.4) above we calculated the actions developing on the thin walled beam during its displacement caused by flexural, torsional and extensional buckling. They are always balanced with the elastic reactions and the loads directly applied; if we approximate the curvatures in the planes xz and yz to the curvatures in $\xi\xi$ and $\eta\eta$, we will obtain the following differential equations system:

$$EI_x \frac{\partial^4 u}{\partial z^4} = \int_A \frac{\partial}{\partial z} (\sigma_x \frac{\partial u}{\partial z} dA) + \int_A \frac{\partial^2}{\partial z^2} \left[\frac{\partial v}{\partial z} (\tau_{xy} x - \tau_{yx} y) dA \right] - \int_S \frac{\partial}{\partial z} [Q_x^0 (\frac{\partial u}{\partial z} x + \frac{\partial v}{\partial z} y) ds] \\ + \int_A \frac{\partial}{\partial z} [\sigma_x (y_0 - y) \frac{\partial \phi}{\partial z} dA] - \int_A \frac{\partial}{\partial z} (\tau_{xy} \phi dA) + \int_A \frac{\partial^3}{\partial z^3} \left\{ \frac{\partial \phi}{\partial z} [\tau_{xx} (y_0 - y) x - \tau_{xy} (x_0 - x) x] dA \right\} \\ - \int_A \frac{\partial^2}{\partial z^2} (\frac{\partial \phi}{\partial z} \tau_{xx} \omega dA) - \int_S \frac{\partial}{\partial z} (Q_x^0 \frac{\partial \phi}{\partial z} \omega ds) + \int_A \frac{\partial^2}{\partial z^2} (\tau_{xx} w dA) + \int_S \frac{\partial}{\partial z} (Q_x^0 \omega ds) \\ - \mu A \frac{\partial^4 u}{\partial t^4} + \mu I_y \frac{\partial^4 u}{\partial z^2 \partial t^2} - \mu A y_0 \frac{\partial^3 \phi}{\partial t^3} + \int_S Q_x^0 ds - \int_S \frac{\partial Q_x^0}{\partial z} x ds$$

$$EI_x \frac{\partial^4 v}{\partial z^4} = \int_A \frac{\partial}{\partial z} (\sigma_y \frac{\partial v}{\partial z} dA) - \int_A \frac{\partial^2}{\partial z^2} \left[\frac{\partial u}{\partial z} (\tau_{xy} x - \tau_{yx} y) dA \right] - \int_S \frac{\partial}{\partial z} [Q_y^0 (\frac{\partial u}{\partial z} x + \frac{\partial v}{\partial z} y) ds] \\ - \int_A \frac{\partial}{\partial z} [\sigma_y (x_0 - x) \frac{\partial \phi}{\partial z} dA] + \int_A \frac{\partial}{\partial z} (\tau_{yx} \phi dA) + \int_A \frac{\partial^3}{\partial z^3} \left\{ \frac{\partial \phi}{\partial z} [\tau_{xx} (y_0 - y) y - \tau_{xy} (x_0 - x) y] dA \right\} \\ - \int_A \frac{\partial^2}{\partial z^2} (\frac{\partial \phi}{\partial z} \tau_{yx} \omega dA) - \int_S \frac{\partial}{\partial z} (Q_y^0 \frac{\partial \phi}{\partial z} \omega ds) + \int_A \frac{\partial^2}{\partial z^2} (\tau_{yx} w dA) + \int_S \frac{\partial}{\partial z} (Q_y^0 \omega ds) \\ - \mu A \frac{\partial^4 v}{\partial t^4} + \mu I_x \frac{\partial^4 v}{\partial z^2 \partial t^2} + \mu x_0 \frac{\partial^3 \phi}{\partial t^3} + \int_S Q_y^0 ds - \int_S \frac{\partial Q_y^0}{\partial z} y ds \quad (2.92)$$

$$EA \frac{\partial^2 w}{\partial z^2} = - \int_A (\tau_{xx} \frac{\partial u}{\partial z} + \tau_{xy} \frac{\partial v}{\partial z}) dA - \int_A \frac{\partial}{\partial z} \left\{ \frac{\partial \phi}{\partial z} [\tau_{xx} (y_0 - y) - \tau_{xy} (x_0 - x)] dA \right\} - \mu A \frac{\partial^2 w}{\partial t^2} + \int_S Q_z^0 ds$$

$$C_1 \frac{\partial^4 \phi}{\partial z^4} - C_2 \frac{\partial^3 \phi}{\partial z^3} = \int_A \frac{\partial}{\partial z} \left\{ \sigma_x \left[\frac{\partial u}{\partial z} (y_0 - y) - \frac{\partial v}{\partial z} (x_0 - x) \right] dA \right\} - \int_A \frac{\partial}{\partial z} (\tau_{xx} u - \tau_{xy} v) dA - \int_S (Q_x^0 u - Q_y^0 v) ds \\ + \int_A \frac{\partial}{\partial z} \left\{ \sigma_x \frac{\partial \phi}{\partial z} [(x_0 - x)^2 (y_0 - y)^2] dA \right\} + \int_S [Q_x^0 (x_0 - x) + Q_y^0 (y_0 - y)] \phi ds \\ - \int_A \frac{\partial^2}{\partial z^2} \left[(\tau_{xx} \frac{\partial u}{\partial z} + \tau_{xy} \frac{\partial v}{\partial z}) \omega dA \right] - \int_S \frac{\partial^2}{\partial z^2} \left\{ \frac{\partial \phi}{\partial z} [\tau_{xx} (y_0 - y) - \tau_{xy} (x_0 - x)] \omega dA \right\} \\ - \mu I_0 \frac{\partial^4 \phi}{\partial t^4} + \mu I_w \frac{\partial^4 \phi}{\partial z^2 \partial t^2} - \mu A (y_0 \frac{\partial^4 u}{\partial z^2 \partial t^2} - x_0 \frac{\partial^4 v}{\partial z^2 \partial t^2}) +$$

$$+ \int_S [Q_x^0 (y_0 - y) - Q_y^0 (x_0 - x)] ds + \int_S \frac{\partial Q_z^0}{\partial z} \omega ds$$

Above system, together with the boundary and initial conditions, furnishes the motion of the beam under (F^0) and (Δ^0) ; these letters are represented directly by distributed loads $Q_x^0(z, s)$, $Q_y^0(z, s)$ and $Q_z^0(z, s)$ and indirectly by stresses components σ_z , τ_{xz} , τ_{zy} , corresponding to the basic equilibrium condition.

As far as stability is concerned, it is interesting to determine the value of the multiplier λ of (F^0) and (Δ^0) for which the motion is no more limited; in such case of conservative forces and dislocations the change from stability to instability will be expressed by the value zero of the motion frequency.

Above system (2.93) also includes all the problems of stability and dynamics of thin walled beam of close section and of the solid section beam and can be easily applied to the various particular cases, expressing from time to time the applied loads and the stresses components σ_z , τ_{xz} , τ_{zy} .

References

- [1] B. De St. Venant "Memoire sur la flexion des prismes, ecc." Journal de Math. de Liouville - 2^e serie - T.1, 1856
- [2] B. De St. Venant "Memoire sur la torsion des prismes" Paris Memoires des Savants Etrangers Vol. 14, 1856
- [3] B. Z. Vlasov "Torsion et stabilité des tiges à parois minces et à profil ouvert" Industrie de la Construction, 1937
- [4] B. Z. Vlasov "Thin walled elastic beams" National Science Foundation, Jerusalem 1961
- [5] S. Timoshenko "Einige Stabilitätsprobleme der Elastizitätstheorie" Zeitschrift für Mathematik und Physik Vol. 58, 1910
- [6] S. Timoshenko "Theory of bending, torsion and buckling of thin walled members of open section" Journal Franklin Institute 1945
- [7] Von Karman-Christensen "Methods of analysis for torsion with variable twist" Journal of Applied Mechanics, Vol. 19, n. 3
- [8] H. Wagner "Verdrehung und Knickung von offenen profilen" 25th Anniversary Publication T. Hochschule Dsuring 1929
- [9] R. Kappus "Brillnicken zentrisch gedruckter stabe mit offenen profil un elastischen bereich" Luftfahrt Porschung 1937
- [10] J. H. Goodier "The buckling of compressed bars by torsion and flexure" Cornell University Eng. Expt. Sta. Bull. December 1944
- [11] Von Karman-Wei-Zang-Chien "Torsion with variable twist" Journal of Aeronautical Sciences Vol. 13, 1946
- [12] M. Caspurso "La trattazione di Jouravski per le sezioni pluriconnesse" Rend. Acc. di Scienze Fisiche e Matematiche di Napoli - Serie IV Vol. XXVIII, 1961
- [13] A. Ostenfeld "Politeknisk Laereanstalts Laboratorium for Byningsstatik" Meddelelse n.5, Kopenhagen 1931
- [14] F. & H. Bleich "Bending torsion and buckling of bars composed of thin walls" Prelim. Pub. 2nd Cong. Int. A. Bridge and Structural Eng. pag. 861, Berlin 1936
- [15] B. Z. Vlasov "Theorie approchée des structures prismatiques flexibles en voiles minces et des plaques; calcul de stabilité, calcul des vibrations" Etudes sur la dynamique des constructions, Recueil d'articles sous la direction de Rabinowitch, Stroudsdat 1947
- [16] A. L. Goldenweyser "Stabilité des pieces longues en voiles minces sous l'action d'une force longitudinale pour différentes conditions de condition aux limites" Etude du Labor. de la Statique des Constructions, Z.N.I.P.S., 1941
- [17] G. Krall "Sulla stabilità dell'equilibrio di barre in profilato sottile" Nota I e II Rend. Acc. Naz. Lincei 1-2 1962

UNCLASSIFIED

Security Classification

DOCUMENT CONTROL DATA - R&D		
<i>(Security classification of title, body of abstract and indexing annotation must be entered when the overall report is classified)</i>		
1. ORIGINATING ACTIVITY (Corporate author) Institute of Structural Engineering University of Naples, Naples, Italy		2a. REPORT SECURITY CLASSIFICATION UNCLASSIFIED
		2b. GROUP
3. REPORT TITLE (U) STATICS AND STABILITY OF THIN WALLED ELASTIC BEAMS, PART I - FORMULATION OF FUNDAMENTAL EQUATIONS		
4. DESCRIPTIVE NOTES (Type of report and inclusive dates) Final Report on work conducted from February 1965 to June 1965		
5. AUTHOR(S) (Last name, first name, initial) Giangreco, Prof. E, Capurso, Ing. M., Como, Ing. M.		
6. REPORT DATE January 1966	7a. TOTAL NO. OF PAGES 52	7b. NO. OF REFS 17
8a. CONTRACT OR GRANT NO. AF 61(052)-813	8b. ORIGINATOR'S REPORT NUMBER(S)	
b. PROJECT NO. 1467		
c. Task No. 146703	8c. OTHER REPORT NO(S) (Any other numbers that may be assigned file report) AFFDL-TR-65-213, Part I	
d. BPSN 4(6899)-614 30014-0000-600-FD)		
10. AVAILABILITY/LIMITATION NOTICES This document is subject to special export controls and each transmittal to foreign governments or foreign nationals may be made only with prior approval of AFFDL (FDTR) WPAFB, Ohio 45433		
11. SUPPLEMENTARY NOTES		12. SPONSORING MILITARY ACTIVITY Air Force Flight Dynamics Laboratory Research and Technology Division Air Force Systems Command - USAF Wright-Patterson Air Force Base, Ohio
13. ABSTRACT Formulation of fundamental equations of elastic equilibrium of thin walled beams subject to general loads and dislocations starting only from the hypothesis of non-deformed transverse cross sections. Formulation of the fundamental equations of dynamic stability of thin walled beams subject to general conservative loads and dislocations by use of a systematic geometrical approach.		

DD FORM 1473
1 JAN 64UNCLASSIFIED
Security Classification

UNCLASSIFIED

Security Classification

KEY WORDS	LINK A		LINK B		LINK C	
	ROLE	WT	ROLE	WT	ROLE	WT
Thin Walled Elastic Beams Statics and Stability Theoretical Results						

INSTRUCTIONS

1. **ORIGINATING ACTIVITY:** Enter the name and address of the contractor, subcontractor, grantee, Department of Defense activity or other organization (corporate author) issuing the report.
- 2a. **REPORT SECURITY CLASSIFICATION:** Enter the overall security classification of the report. Indicate whether "Restricted Data" is included. Marking is to be in accordance with appropriate security regulations.
- 2b. **GROUP:** Automatic downgrading is specified in DoD Directive 5200.10 and Armed Forces Industrial Manual. Enter the group number. Also, when applicable, show that optional markings have been used for Group 3 and Group 4 as authorized.
3. **REPORT TITLE:** Enter the complete report title in all capital letters. Titles in all cases should be unclassified. If a meaningful title cannot be selected without classification, show the classification in all capitals in parentheses immediately following the title.
4. **DESCRIPTIVE NOTES:** If appropriate, enter the type of report, e.g., interim, progress, summary, annual, or final. Give the inclusive dates when a specific reporting period is covered.
5. **AUTHOR(S):** Enter the name(s) of author(s) as shown on or in the report. Enter last name, first name, middle initial. If military, show rank and branch of service. The name of the principal author is an absolute minimum requirement.
6. **REPORT DATE:** Enter the date of the report as day, month, year, or month, year. If more than one date appears on the report, use date of publication.
- 7a. **TOTAL NUMBER OF PAGES:** The total page count should follow normal pagination procedures, i.e., enter the number of pages containing information.
- 7b. **NUMBER OF REFERENCES:** Enter the total number of references cited in the report.
- 8a. **CONTRACT OR GRANT NUMBER:** If appropriate, enter the applicable number of the contract or grant under which the report was written.
- 8b, 8c, & 8d. **PROJECT NUMBER:** Enter the appropriate military department identification, such as project number, subproject number, system numbers, task number, etc.
- 9a. **ORIGINATOR'S REPORT NUMBER(S):** Enter the official report number by which the document will be identified and controlled by the originating activity. This number must be unique to this report.
- 9b. **OTHER REPORT NUMBER(S):** If the report has been assigned any other report numbers (either by the originator or by the sponsor), also enter this number(s).
10. **AVAILABILITY/LIMITATION NOTICES:** Enter any limitations on further dissemination of the report, other than those

imposed by security classification, using standard statements such as:

- (1) "Qualified requesters may obtain copies of this report from DDC."
- (2) "Foreign announcement and dissemination of this report by DDC is not authorized."
- (3) "U. S. Government agencies may obtain copies of this report directly from DDC. Other qualified DDC users shall request through _____."
- (4) "U. S. military agencies may obtain copies of this report directly from DDC. Other qualified users shall request through _____."
- (5) "All distribution of this report is controlled. Qualified DDC users shall request through _____."

If the report has been furnished to the Office of Technical Services, Department of Commerce, for sale to the public, indicate this fact and enter the price, if known.

11. **SUPPLEMENTARY NOTES:** Use for additional explanatory notes.

12. **SPONSORING MILITARY ACTIVITY:** Enter the name of the departmental project office or laboratory sponsoring (paying for) the research and development. Include address.

13. **ABSTRACT:** Enter an abstract giving a brief and factual summary of the document indicative of the report, even though it may also appear elsewhere in the body of the technical report. If additional space is required, a continuation sheet shall be attached.

It is highly desirable that the abstract of classified reports be unclassified. Each paragraph of the abstract shall end with an indication of the military security classification of the information in the paragraph represented as (TS), (S), (C), or (U).

There is no limitation on the length of the abstract. However, the suggested length is from 150 to 225 words.

14. **KEY WORDS:** Key words are technically meaningful terms or short phrases that characterize a report and may be used as index entries for cataloging the report. Key words must be selected so that no security classification is required. Identifiers, such as equipment model designation, trade name, military project code name, geographic location, may be used as key words but will be followed by an indication of technical context. The assignment of links, rules, and weights is optional.

SUPPLEMENTARY

INFORMATION

AD 480031

Errata

ERRATA PAGE
TO
AFFDL-TR-65-213, Part I

Statics and Stability of Thin-Walled Elastic Beams
Part I. Formulation of Fundamental Equations

AF Flight Dynamics Laboratory
Research and Technology Division
Air Force Systems Command
Wright-Patterson Air Force Base, Ohio

Cover Page and Title Page. Strike out the statement "Distribution of this Document is Unlimited".

Notices Page. Add the statement "This document is subject to special export controls and each transmittal to foreign governments or foreign nationals may be made only with prior approval of AFFDL(FDR), WPAFB, Ohio 45433".

Foreword. This technical report has been reviewed and is approved.

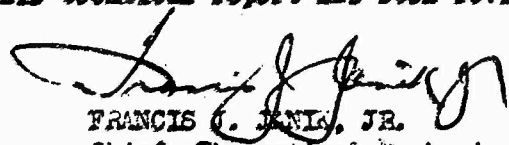

FRANCIS J. JENKS, JR.
Chief, Theoretical Mechanics Branch
Structures Division

D D C
RECEIVED
JUN 21 1966
REGULATED
B

atc