

Author(s)	Gonzalez, John C.
Title	A 10kc Kerr cell modulator for the production of repetitive giant laser pulse.
Publisher	Monterey, California: U.S. Naval Postgraduate School
Issue Date	1963
URL	http://hdl.handle.net/10945/11540

This document was downloaded on May 22, 2015 at 08:04:56



<http://www.nps.edu/library>

Calhoun is a project of the Dudley Knox Library at NPS, furthering the precepts and goals of open government and government transparency. All information contained herein has been approved for release by the NPS Public Affairs Officer.

**Dudley Knox Library / Naval Postgraduate School
411 Dyer Road / 1 University Circle
Monterey, California USA 93943**



<http://www.nps.edu/>

NPS ARCHIVE
1963
GONZALEZ, J.

A 10 KC KERR CELL MODULATOR FOR
THE PRODUCTION OF REPETITIVE
GIANT LASER PULSES

JOHN C. GONZALEZ

LIBRARY
U.S. NAVAL POSTGRADUATE SCHOOL
MONTEREY, CALIFORNIA

A 10 KC KERR CELL MODULATOR FOR THE
PRODUCTION OF REPETITIVE GIANT LASER PULSES

John C. Gonzalez

A 10 KC KERR CELL MODULATOR FOR THE
PRODUCTION OF REPETITIVE GIANT LASER PULSES

BY

JOHN C. GONZALEZ
Captain, United States Marine Corps

Submitted in partial fulfillment of
the requirements for the degree of

MASTER OF SCIENCE
IN
ENGINEERING ELECTRONICS

United States Naval Postgraduate School

1963

A 10 KC KERR CELL MODULATOR FOR THE
PRODUCTION OF REPETITIVE GIANT LASER PULSES

BY

JOHN C. GONZALEZ

This work is accepted as fulfilling
the thesis requirements for the degree of

MASTER OF SCIENCE
IN
ENGINEERING ELECTRONICS

from the

United States Naval Postgraduate School

ABSTRACT

The output from a conventional laser is a spontaneous burst of radiation which lasts about one microsecond. If now the reflectivity of one of the two "mirrors" in the system is controllable, it is possible to develop laser system conditions which permit the generation of high peak-power pulses with a pulse width of about 30 nanoseconds. Such a system utilizes the principle of regeneration modulation and has been successfully applied to the production of single high peak-power pulses. A natural step then is to utilize this method to generate a series of repetitive "giant" pulses.

This report describes the electronics equipment developed to assist in producing such pulses at a 10 kc pulse repetition frequency. The approach used represents a first attempt towards an effective means of obtaining controlled high-powered laser pulses.

The author extends appreciation to all the members of the Hughes Aircraft Company Laser Research group who offered their advice and knowledge.

The final successful days of the experiment were under the guidance of Dr. E. Woodbury. The author was also directly and ably assisted during the final stages of the experiment by engineer-physicist Mr. B. E. Dobratz. Also, gratitude and appreciation is offered to Mr. E. D. Stephans for his special kind of guidance and good humor.

TABLE OF CONTENTS

	Page
CERTIFICATE OF APPROVAL	i
ABSTRACT	ii
TABLE OF CONTENTS	iii
LIST OF ILLUSTRATIONS	iv
TABLE OF SYMBOLS AND ABBREVIATIONS	v i
SECTION	
1 INTRODUCTION	1
2 DESIGN OF THE KERR CELL MODULATOR	9
3 TESTS AND RESULTS	28
4 CONCLUSIONS	49
Appendicies	
A Characteristic Impedance Calculations	52
B Pertinent Data About Equipment Used	53
Bibliography	57

LIST OF ILLUSTRATIONS

Figure		Page
1.	Conventional vs Giant Pulse Laser Output	2
2.	Giant Pulse Laser Configuration	4
3.	Ruby Energy Levels	5
4.	Complete Optical System of Giant Pulse Laser	7
5.	Output Waveforms of First Modulator Circuit	15
6.	Static Transfer Characteristics	17
7.	Schematic of 10 kc Kerr Cell Modulator	19
8.	Kerr Cell Modulator Driver Stage	22
9.	Pulses Appearing Within Circuitry of Modulator	24
10.	Kerr Cell Modulator Output Stage	26
11.	Kerr Cell and Holder	29
12.	Ruby and Flashlamp	30
13.	Schematic of Planned Circuit Arrangement	35
14.	Equipment Arrangement to Measure Laser Output	36
15.	Actual System	37
16.	Integrated Output of Giant Pulse Laser (Modulated at 10 kc Rate)	40
17.	Integrated Output of Giant Pulse Laser (Modulated at 4 kc Rate)	41

Figure		Page
18.	Output Pulse; 10 kc vs 25 kc Modulator Operation	43
19.	Multiple-Pulsing of Modulator and Laser	45
20.	Integrated Laser Output; Maximum Input Energy to Flashlamp	48
21.	Actual Giant Pulse (Kerr Cell Pulsed at 10 kc Rate)	48
B-1.	Cavity and Flashlamp	55
B-2.	Flashlamp	56

TABLE OF SYMBOLS AND ABBREVIATIONS

<u>SYMBOL</u>	<u>DEFINITION</u>
kc	kilocycles
kv	kilovolts
nsec	nanoseconds
"Q"	cavity quality factor
Cr ⁺³	chromium ions
Å	angstrom units (1Å = 10 ⁻⁴ microns)
τ	pulse width in seconds
Z _o	characteristic impedance
sw	switch
I _b	D.C. plate current in milliamperes
E _b	D.C. plate voltage in volts
E _g	D.C. grid bias in volts
E _{bb}	D.C. plate supply voltage in volts
mh	millihenries
L	inductance
C	capacitance
λ	wavelength in a medium
ν	frequency
O.D.	outside diameter
r.f.	radio frequency
cm	centimeter

1. Introduction

Since the first operating laser was introduced by T. H. Maiman in 1960 /5,6/ a great deal of effort has been directed by physicists and engineers toward understanding and improving the characteristics of this device. In the past few years it has become readily apparent that the harnessing of the tremendous potential that the laser unquestionably possesses will prove to be a great asset to both science and industry. Already the laser has made an impact comparable to that made by electron tubes and semiconductor devices, even with its true versatility not yet fully exploited, and perhaps not completely known. However, in the strides that have been made, a technique for improving the utility of the laser beam output has resulted. Less than two years ago an optical switching technique was proposed by McClung and Hellwarth /1/ of Hughes Aircraft Company, which "compressed" a great deal of the total energy inherent in a conventional laser pulse into one "giant" pulse. In this fashion, the characteristic low-energy sporadic output of uncontrolled "spikes" of the conventional laser, as shown in Figure 1-a, was modified so that intense and very narrow pulses of radiation were emitted by the same material. (See Figure 1-b) To date these giant pulses have been generated by the sudden change of the regeneration characteristics of a laser cavity whose active medium is chromium-doped sapphire (ruby). The system which gen-

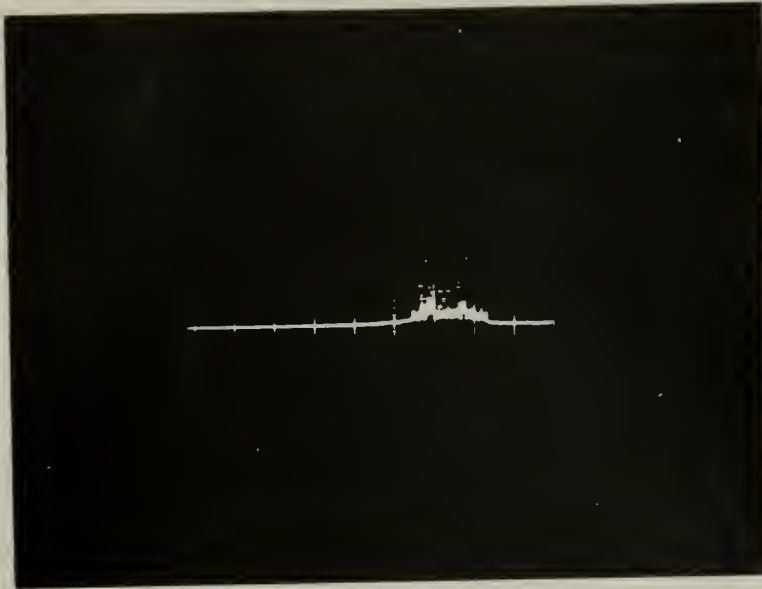

FIGURE 1a
CONVENTIONAL LASER ACTION
HORIZ.: 200 microseconds/cm

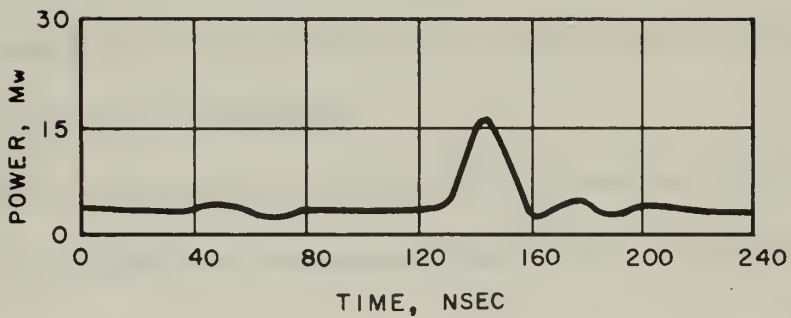
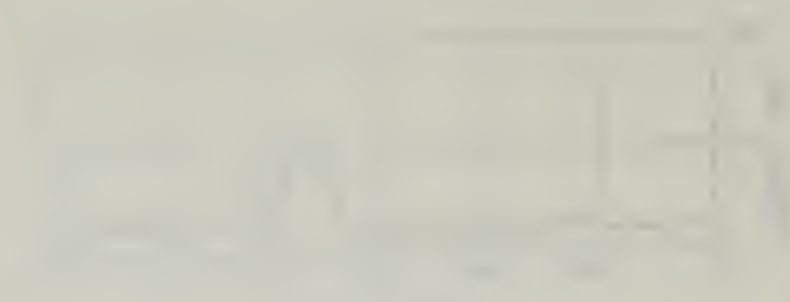

FIGURE 1b
GIANT PULSE LASER OUTPUT; ACHIEVED
BY REGENERATION MODULATION OF
RUBY LASER /7/

FIGURE 1



Very faint, illegible text centered below the dark area.



Very faint, illegible text located below the diagram.

erates these high peak-power pulses has been called the Giant Pulse Laser or Pulsed Reflector Laser¹ and the principle of operation is based on the fact that materials which laser in the conventional configuration can be caused to emit fast, intense pulses. Figure 2 shows the arrangement used by McClung and Hellwarth in their first experiments. It was similar to the usual laser configuration except that a voltage-controlled Kerr cell /15/ was physically introduced between one end reflector and the ruby. The flash lamp was first fired in order to bathe the ruby in white light. Inversion commenced to a higher energy level (see Figure 3) and when the voltage applied to the Kerr cell was quickly pulsed off, the back reflector was effectively introduced into the optical path thereby permitting the "Q" of the laser cavity to be enhanced and allowing regeneration of the red light beam. Instantly, a single high peak-power pulse was emitted. Characteristically this pulse was about 30 nanoseconds wide and had a peak of about 14 megawatts.

The optical configuration of Giant Pulse Lasers has since been improved by the addition of a Wollaston prism² /15/. Figure 4 dis-

¹There exists another technique for generation of high peak-power pulses. It is called the Hair Trigger Mode. See References /2,7/.

²The Wollaston prism is not essential but improves the system operation in that regeneration can be achieved on all passes through the ruby and not on just alternate passes as when no prism is in the system.

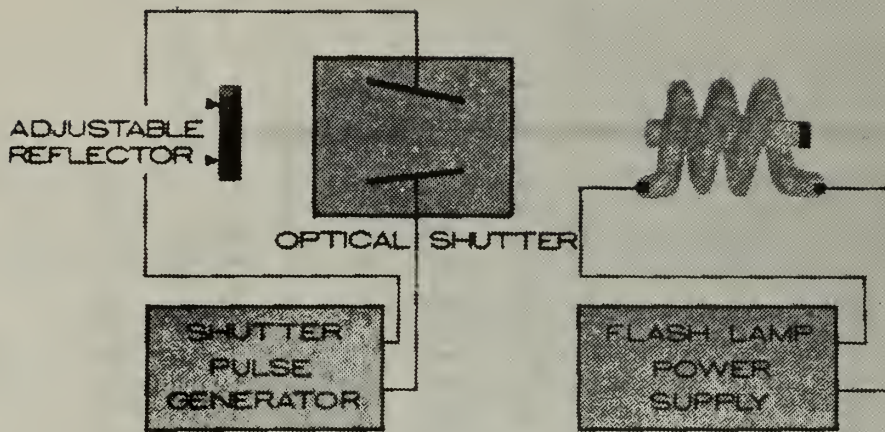
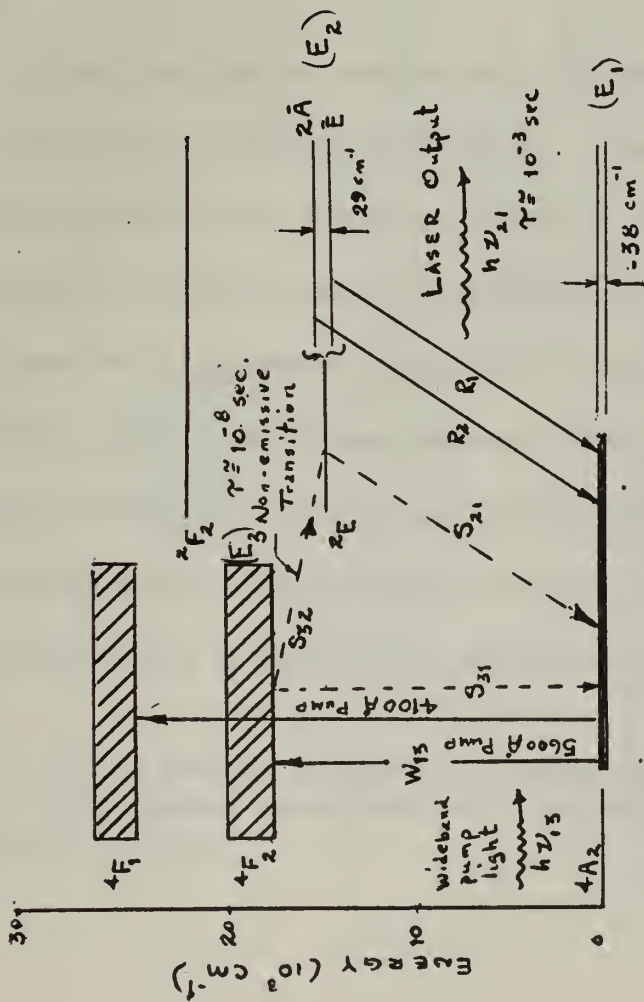

FIGURE 2

GIANT PULSE LASER CONFIGURATION;
FOR OBTAINING HIGH-POWER PULSE
FROM A RUBY LASER /1/

FIGURE 3



$\nu_{12} = \frac{E_2 - E_1}{h} = 4.5(10^{14}) \text{ s}^{-1}$ $\nu_{12} \approx 14.4(10^3) \text{ cm}^{-1}$ $\therefore \lambda_{12} \approx 6943 \text{ \AA} \quad (R_1 \text{ LINE})$ $\quad \quad \quad \quad \quad \quad \quad \quad \quad (6929 \text{ \AA}) \quad (R_2 \text{ LINE})$
$\nu_{13} = \frac{E_3 - E_1}{h} = 5.4(10^{14}) \text{ s}^{-1}$ $\nu_{13} \approx 18(10^3) \text{ cm}^{-1}$ $\therefore \lambda_{13} \approx 5600 \text{ \AA} \text{ (Green)}$

RUBY ENERGY LEVELS /5,6/

4A₂ CR³⁺ ION GROUND STATE (SPLIT UNDER MAGNETIC FIELD INFLUENCE)

4F CR³⁺ ION UPPER ABSORPTION BANDS

2E METASTABLE INTERMEDIATE ENERGY LEVEL (TWO SUBLEVELS)

S₃₂ DECAY RATE --- PHONON PRODUCTION ONLY; LATTICE HEATING

W₁₃ INDUCED TRANSITION PROBABILITY PER UNIT TIME

plays the arrangement of all the essential optical pieces. Each is supported firmly in its specially built holder and mounted on a firm base. After the flash lamp is fired, the Kerr cell is held "on"³ to permit the ground-level ions to be "pumped" until a high inversion ratio is first achieved. Thus, stimulated emission is restrained until the Kerr cell voltage is removed electronically permitting the Cr⁺³ ions to be then triggered to "fall" together to the ground state. The released energy is emitted as a single narrow pulse of intense radiation of very short duration. The result is known as a "giant" pulse.

A simple calculation can be made of power out which is indicative of the future utility of this system. Assume an output pulse containing one joule of energy--a realistic choice. If this amount of energy is emitted in about 33 nanoseconds, as usually occurs, the power out is 30 megawatts. The state of the art as of the period of the writing of this paper, has exceeded this output. It then becomes apparent that the high peak-power feature offered by the Giant Pulse Laser has a realistic and practical application. The technique described--which is also called regeneration modulation--has an

³"On" implies that the quarter-wave voltage is applied to the plates and the polarization characteristics of the entire system is such as to prevent lasering.

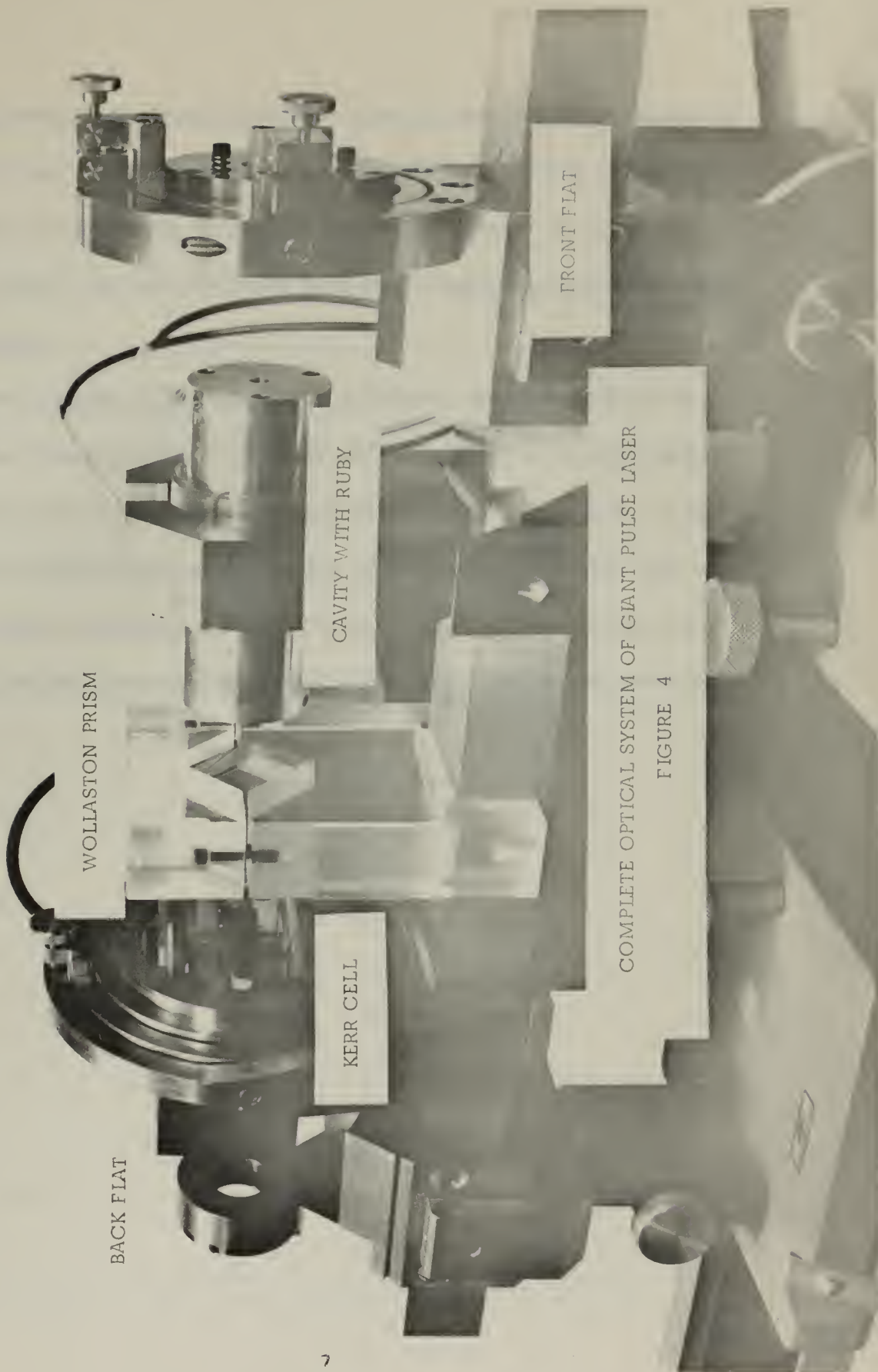

WOLLASTON PRISM

KERR CELL

CAVITY WITH RUBY

FRONT FLAT

BACK FLAT

COMPLETE OPTICAL SYSTEM OF GIANT PULSE LASER

FIGURE 4

obvious extension. With proper electronics circuitry so designed to pulse the Kerr cell off repetitively it should be possible to develop a series of such pulses at equally spaced intervals--contingent, of course, upon how long the flash lamp can continue to bathe the ruby in white light.

It was proposed that the author attempt to design a pulser (or modulator) that could force the Kerr cell on and off at a controllable repetition frequency. The objective of this paper, therefore, is to present an explanation of the design of the modulator which was finally used to generate repetitive giant pulses and to disclose the overall results obtained from both the designed pulser and the ruby output.

♦

2. Design Of The Kerr Cell Modulator /8,9,11,12,13,14/

As described previously, generation of giant pulses is based upon an important factor, that of suitably switching the Kerr cell from a condition of high voltage to one of essentially less than 1/10 of this level--or, equivalently, a condition of incomplete transmission to one of complete transmission. A 10 kilovolt Kerr cell was used as the criterion in the design of the high voltage modulator. Thus the circuitry required, had to reduce the Kerr cell voltage instantaneously from 10,000 volts to less than 1,000 volts.⁴

The following criteria were used as a basis for the design. They were somewhat arbitrary in that the full requirements and the effect such a design would have on a Giant Pulse Laser had not previously been ascertained.

- (1) 10 kc or higher repetition rate
- (2) \approx 10 kilovolt pulse height
- (3) Less than 50 nanosecond rise time
- (4) Fall time not critical
- (5) Pulse width from 200- to 400- nanoseconds
- (6) Variable pulse width, if possible

The following pulser waveshape was offered as a suggested goal:

⁴It was found experimentally that the Kerr cell was completely "on" when anything less than 5,000 volts was applied to its plates.

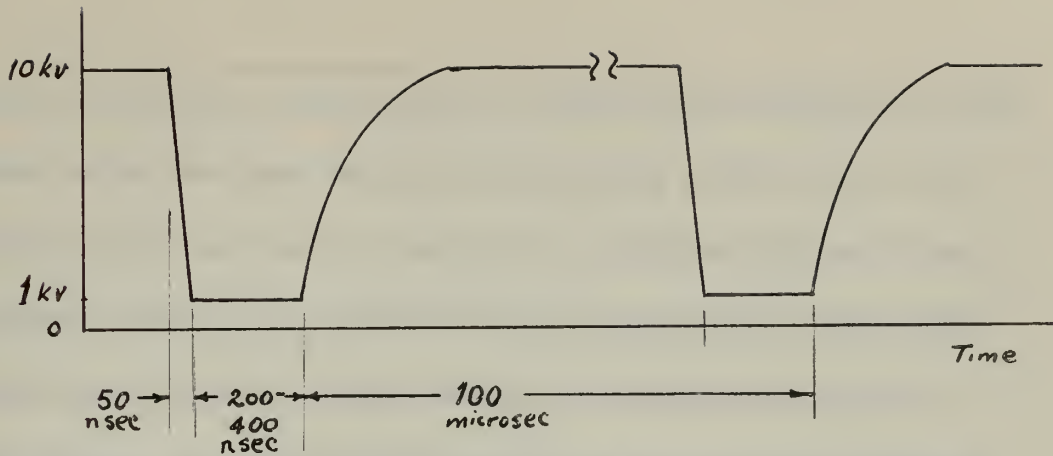

The charge-time back to 10 kilovolts was not critical as long as the 10 kilovolt level was reached within the stated 100 microseconds.

When the initial specifications were proposed one important feature was brought to the attention of the author. It was known that an initial pumping-time interval of about 200- to 500- microseconds was required during which the chromium ion population was raised to a high energy level. /3/ It would be necessary to restrain the pulser from pulsing the Kerr cell during this period. After satisfactory inversion resulted, lasering could occur. If the Kerr cell was then triggered "off" the first single giant pulse should result. Preparation to repeat the cycle would then be a matter of turning the Kerr cell back "on" while the flash lamp was still emitting light. As long as the flash lamp was on, any controlled repetitive pulsing of the Kerr cell should permit well-spaced laser emissions. It became apparent that, to be really effective in controlling the giant pulse laser output, the modulator had to commence pulsing only after this relatively long initial inversion time had passed. This and one other important

feature was kept in mind during the design of the modulator. Other experiments disclosed that immediately after a giant pulse was emitted much less time was required to pump the ruby back above threshold since only a portion of all the excited ions (about 25%) gave up their energy as laser radiation during each successive giant pulse. It was necessary then to excite only this portion of the ions again. (Along with any that gave up their energy in normal fluorescence.) The process is depicted below.

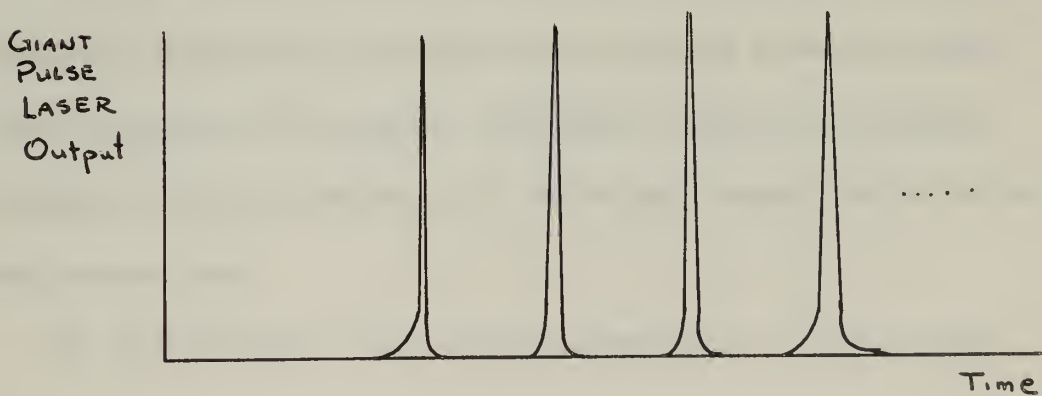
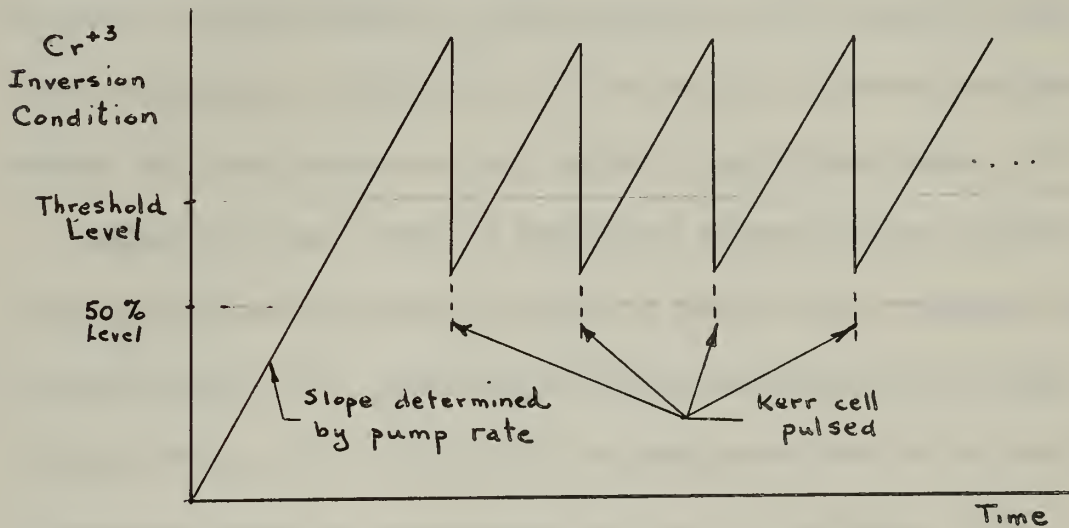

A power supply was available which was able to keep the flash lamp "on" a maximum of 1344 microseconds. Therefore, it was hoped that after allowing \cong 350 microseconds initial inversion time, about 1000 microseconds of additional flash lamp on-time would remain. Thereafter, if the modulator could pulse the Kerr cell every 100 microseconds, a maximum of 10 giant pulses might be obtained when proper synchronization was used.

The basic problem faced, then, involved the development of a modulator or pulser similar in characteristics to that utilized to pulse a radar magnetron. Consequently, it was natural to investigate radar circuits that could produce a fast, narrow, high-voltage pulse. /16/

Normally two main types of modulators categorize most all electronic circuits that are used to develop or generate high voltage pulses as used in radar. /10/ These are the line-type pulser and the hard-tube type pulser. /17/ Generally such modulators involve the storage of electrical energy by some means and then the discharge of this energy through some load (all or a fraction of it) during a pulse. Usually, the line-type discharges a pulse forming network's stored energy into the load through a "soft-tube" (mercury or hydrogen thyatron) switch. However, in a "hard-tube" pulser the switch is a high-vacuum tube.

Up until the time of the author's experiment, all giant pulse

work involved the production of only single pulses. The modulators used to develop these pulses are composed of a charged line whose characteristic impedance almost match the "on" impedance of the flash-lamp. The line's stored energy is then discharged through a soft-tube switch with the flash lamp as a load. The hydrogen thyatron soft-tube permits developing pulses with exceedingly short rise times--on the order of 30 nanoseconds. Such rise times make it ideal for fast switching use. However, the greatest problem faced in its use results from the very same effect that permits the fast rise time--the ionized hydrogen. After the gas is ionized and the tube fired, it is very difficult to extinguish the discharge. Only after the plate voltage is reduced and the gas is deionized is the tube extinguished. The deionization time is of the order of 10 microseconds or more, and is dependent upon the tube used, the degree of ionization and the plate voltage. The hard-tube pulser was therefore, considered as more appropriate for the use intended since it offered better control features, though the rise-time might not equal that of a soft-tube pulser.

A simplified schematic of the approach considered to solve the modulator problem using hard tube switches follows:

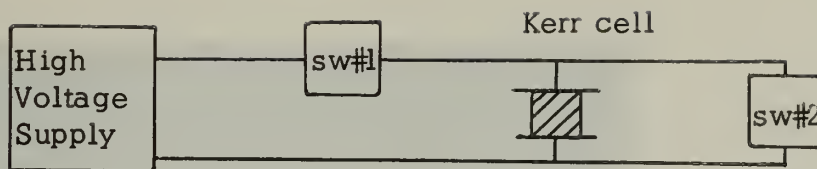

Ideally one switch is instantaneously opened as the other is closed. Thus, when sw#1 is closed and sw#2 is opened, the Kerr cell can be charged to the full value of the supply voltage. After a fixed increment of time, sw#1 is opened and sw#2 is closed, thereby discharging the Kerr cell. (At first it was hoped to use high-vacuum tubes for both switches. A simpler arrangement was finally evolved by replacing sw#1 with a suitable resistor.)

Many circuits were tried on paper incorporating the above approach and three were actually breadboarded. The first circuit attempted, used an interstage coupling pulse transformer. It gave a satisfactory output pulse (see Figure 5) but the output stage had to be operated beyond the rated values of the tubes. It was therefore abandoned. The second circuit contained a bootstrap driver but was also unsatisfactory because of input isolation problems. The third and last breadboarded circuit was the most suitable, and although the rise time of the final output pulse was not that originally

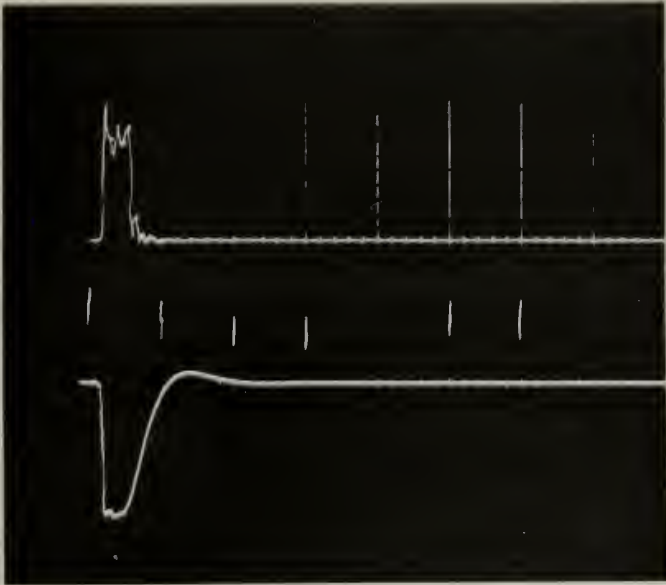

HORIZ.: 200 nsec/cm

UPPER: Input pulse;
50 volts/cm

LOWER: Modulator
output pulse;
5 kilovolts/cm

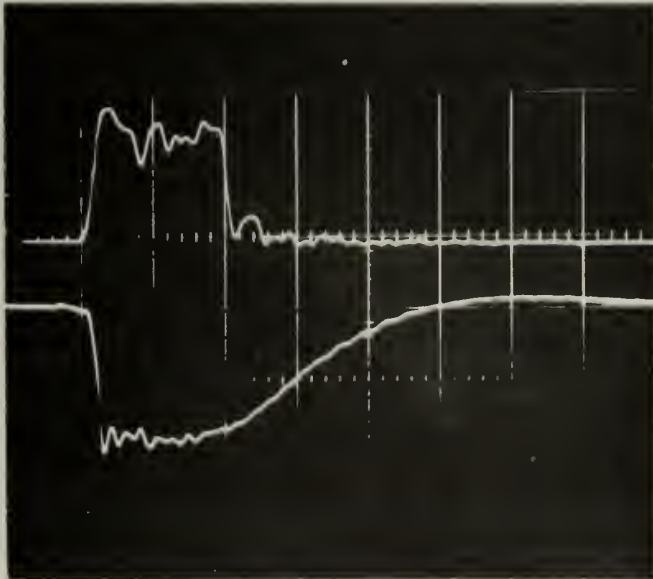

HORIZ.: 100 nsec/cm

Upper: Input pulse;
50 volts/cm

LOWER: Modulator
output pulse;
5 kilovolts/cm

FIGURE 5

OUTPUT WAVEFORMS OF
FIRST MODULATOR CIRCUIT

arbitrarily stipulated, the results obtained proved useful. It was stated previously that the specifications originally offered required a pulse rise time of 30- to 50-nanoseconds. The pulser that was finally assembled developed a pulse with a 90 nanosecond rise time (10% to 90%). While actual testing was being performed on each circuit, it was determined that the final pulse rise time was a function of two principle factors: the pulse transformer used (with its inherent stray capacitance and leakage inductance), and the grid characteristics of the power tetrodes (4PR60B) which were used in the final stage. The last factor proved to be the most difficult to contend with in that the tubes, though listed as possessing sharp cutoff features did not actually function in this fashion. A plot of the change in plate current (ΔI_p) versus change in grid voltage (ΔE_g) was made to verify this point. From Figure 6, which was drawn for a plate voltage of 1,000 volts, it can be seen that unless the grids of these power tubes were driven into the positive region, the operation was essentially in the non-linear region of the curve. Consequently, the g_m was a changing number and relatively low. Thus, the tubes turned on too slowly to obtain the rise time desired, which, perhaps in part, accounts for the slower rise time pulse finally obtained. In the first breadboarded circuit, the last stage tubes were biased off at -500 volts. They were then raised to

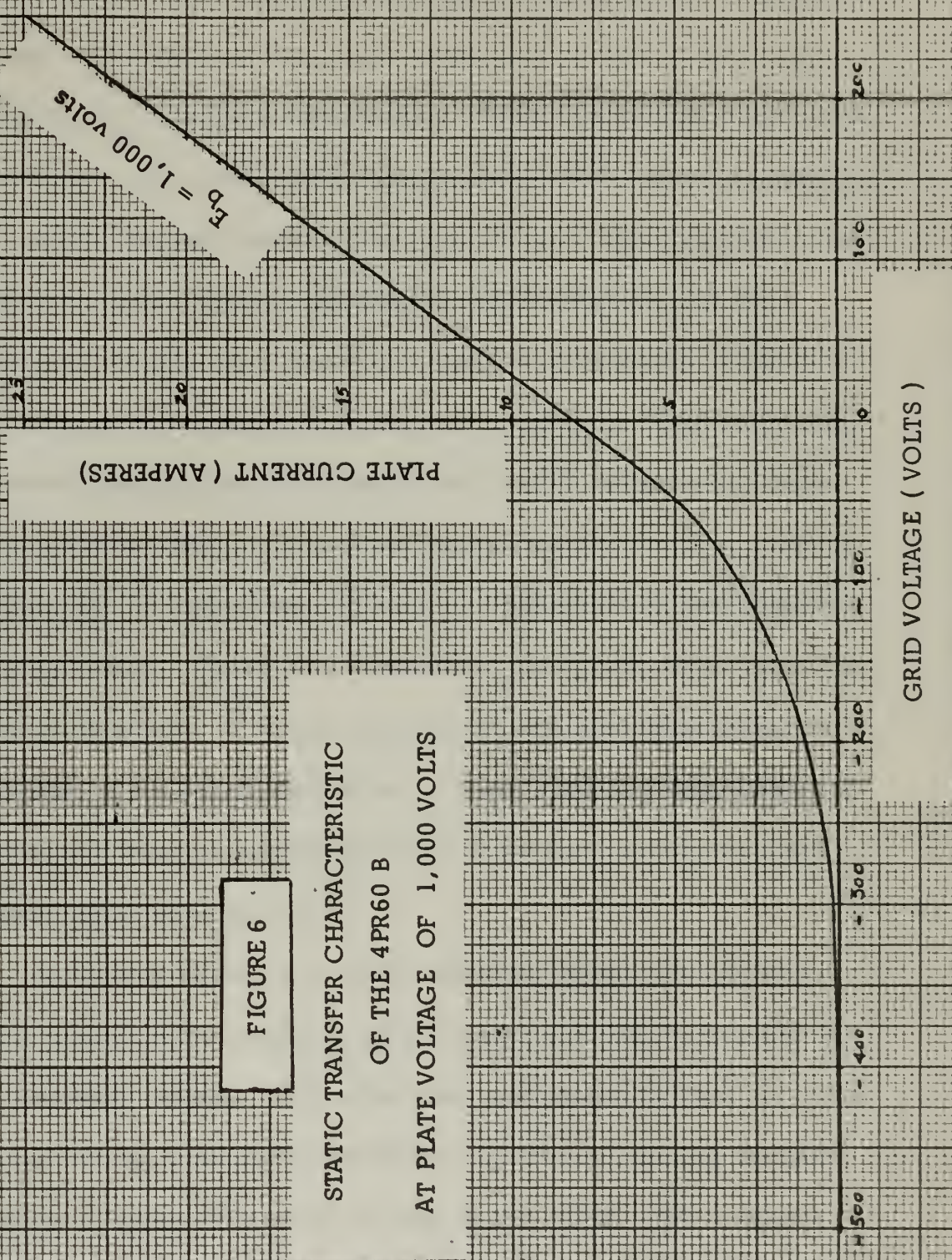

FIGURE 6

STATIC TRANSFER CHARACTERISTIC
 OF THE 4PR60 B
 AT PLATE VOLTAGE OF 1,000 VOLTS

0 volts with a +500 volt pulse from the preceding stage. A glance at Figure 6 will disclose that in the range of from -500 volts to zero volts the g_m is varying continuously. Thus, the driving pulse never drove the output power tubes into the truly linear region of operation.

In the approach used for the final design it was considered that one of the better ways of pulsing the output stage was to use a circuit in the preceding stage that was not appreciably loaded when the large output tubes were in the "on" condition. This would then pre-empt loading that might be caused by grid current being drawn. It was decided that either of two alternatives was in order, a pulse transformer for impedance matching or a different and more suitable driving circuit. The second alternative was chosen since parts were readily available. A regenerative driver was assembled to act as the heart of the entire modulator. A pulse amplifier stage preceded a triggered blocking oscillator which drove the final high-voltage output stage (see Figure 7).

An Electro-Pulse, Inc. pulse generator (Model 190215) was used to provide the negative input trigger pulse which initiated the entire pulser action. This pulse when more negative than -10 volts turned-off the normally-on first tube, the 6S4-A, causing its plate voltage to swing from about 40 volts to 300 volts. The resultant positive going pulse was coupled into the next stage, the blocking

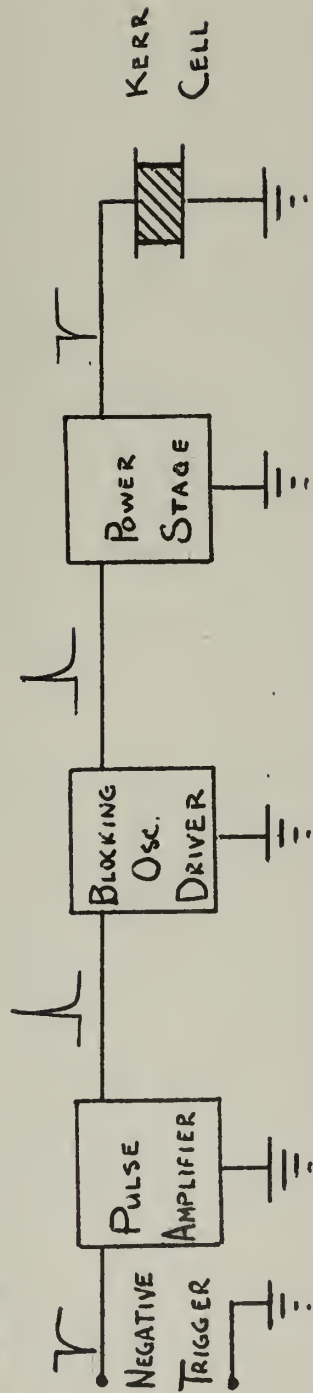

SCHEMATIC OF 10 KC KERR CELL MODULATOR

FIGURE 7

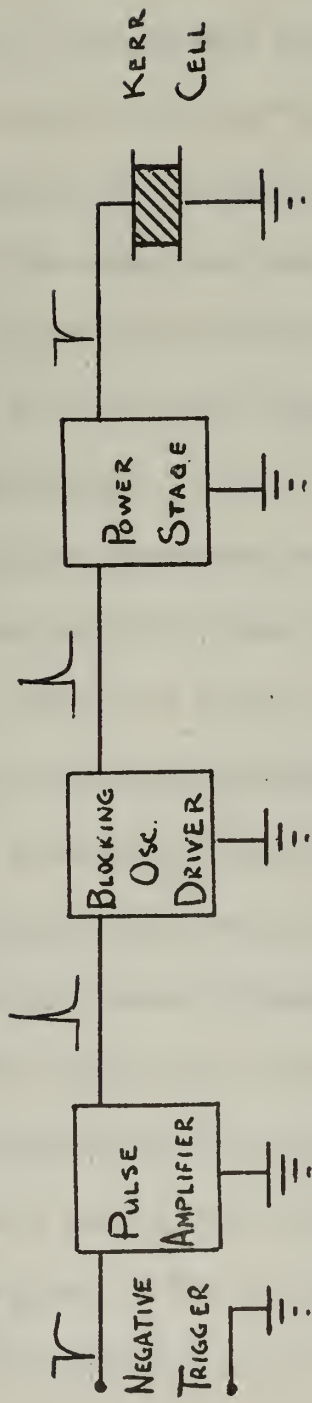

SCHEMATIC OF 10 KC KERR CELL MODULATOR

FIGURE 7

oscillator. The 260-volt pulse out of the first stage triggered the blocking oscillator and started the usual blocking oscillator regenerative action. The resulting plate current developed a positive voltage of 500 volts across an unbypassed 330-ohm cathode resistor. This voltage was then used to pulse "on" two parallel-connected 4PR60B's which made up the last stage. The output of this stage was fed directly to the capacitive energy storage device, the Kerr cell. The 6S4-A (triode) was chosen for the first stage since it could be operated up to 500 volts thereby permitting a large amplitude pulse to be developed in order to trigger the blocking oscillator. It was later determined experimentally that good blocking oscillator action occurred with the 6S4-A plate supply voltage reduced to as low as 300 volts. Below 300 volts, however, the rise time of the pulse triggering the blocking oscillator was increased causing irregular triggering to result and pulse-to-pulse jitter to appear in the output. When triggered hard, the blocking oscillator went into and out of conduction more strongly thereby reducing jitter appreciably, and allowing better control of the last stage output.

The blocking oscillator circuit used was of a standard configuration built around a power triode (the 811-A) capable of developing a large amplitude pulse. A 2:1 (2-winding) pulse transformer (PCA 102-1) was used in the plate and grid circuits. The plate voltage

was 1,000 volts and the tube was biased off at -22 volts. Depending on the amplitude of the trigger pulse into this stage, any variation of the bias from -20 volts to -30 volts caused a change in the slope of the leading edge of the output pulse. A bias more positive than -20 volts caused free-running operation of the blocking oscillator. A diagram of the first two stages is shown in Figure 8.

The final-stage positive driving-pulse was obtained from the unbypassed 330-ohm resistor in the cathode of the 811-A. The output impedance of this cathode follower was determined to be about 90 ohms. Thus, a 93-ohm line (RG62A/U) was used to couple this pulse to the two 4PR60B tubes used in the last stage. The plate supply voltage of these tubes was 10 kilovolts and the screen supply was 1250 volts. The grids were biased in the off-condition at -500 volts. A clamping circuit was also used to assure that the bottom of the input pulse was held at -500 volts. The chokes used in the grids of the second and last stages aided in blocking out of the bias circuits the r.f. components in the pulse. The choice of the particular tube, the 4PR60B, was based on the following features: it had (1) low interelectrode capacitance, (2) a plate voltage capability of 10 kv or greater, (3) the ability to withstand large current pulses for short lengths of time (a plate dissipation of 60 watts) and (4) a high emission capability. Since relatively large

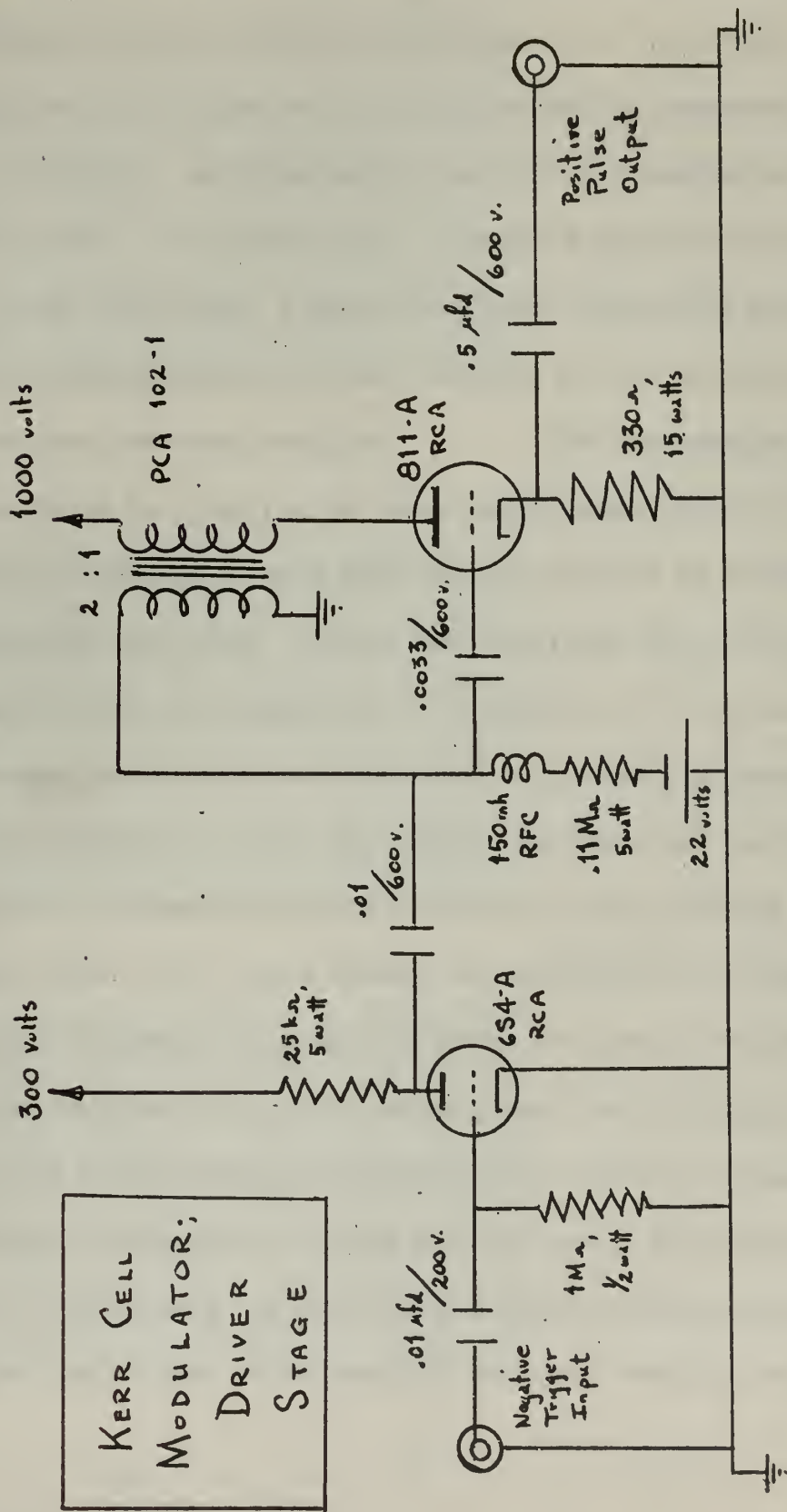

FIGURE 8

pulses of current of short duration were handled in the last stage, it was decided to use two of these tubes in parallel. In addition, small resistors were used in the screen and plate leads to suppress parasitic oscillations. An added feature was also incorporated to assure a fast fall time on the output pulse; inductors were tried in the plate circuit of the last stage. First attempts were unsuccessful since at the high voltage involved, corona and arcing occurred in the "pancake"-type inductors that were available. The most satisfactory solution during the course of the experiment resulted from the use of inductive wire-wound Sprague high-wattage resistors for the load resistor of the last stage. Though this gave little control over the inductance value, the output pulse was improved. A 2000-ohm wire-wound resistor was used which had a characteristic inductance of 110 mh (bridged at 1 kc). The improved waveform can be seen in Figure 9b, as compared to that of Figure 9c which displays the resulting pulse of the circuit without any inductance in the plate. Care was exercised in the amount of series inductance used since excessive overshoot could have turned the Kerr cell off again at 14 kv. (This is the 140%-of-maximum-voltage point in the sine-squared transmission characteristics of the Kerr cell used. See References /11,12/.) Note that a low value of load resistor was necessary to assure that the Kerr cell charge path (when the 4PR60B's were off)

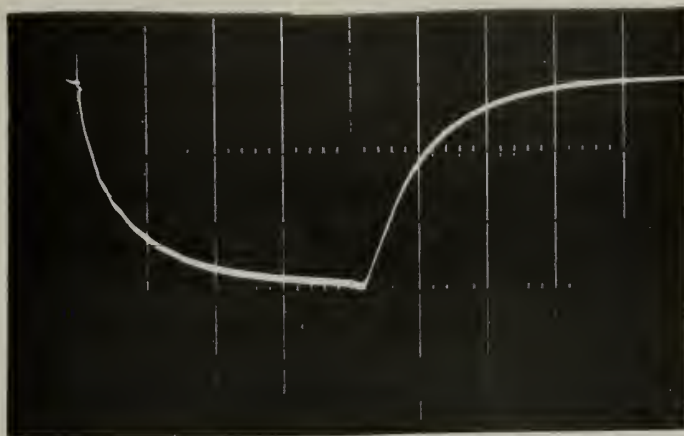

FIGURE 9 a
 Negative-trigger input
 pulse to first stage.
 Time Scale: 100 nanosec./cm
 Vertical Scale: 10 volts / cm

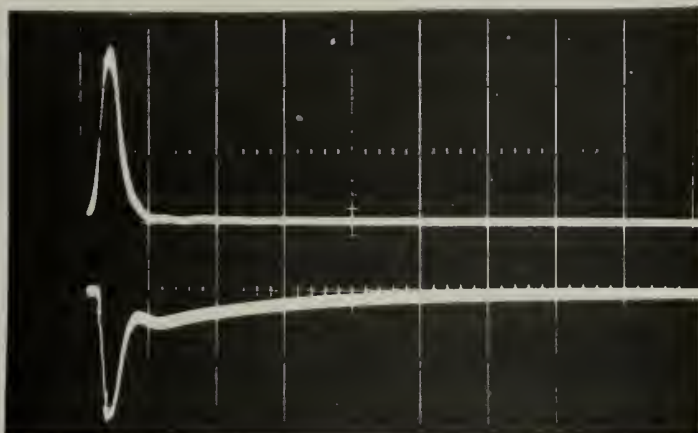

FIGURE 9 b
 Output pulse from cathode
 resistor of blocking oscillator
 circuitry.
 Vertical Scale: 200 volts/cm
 Output pulse to Kerr cell
 (series inductance in output
 stage plate circuit).
 Vertical Scale: 5,000 volts/cm
 Time Scale: 1 microsecond/cm

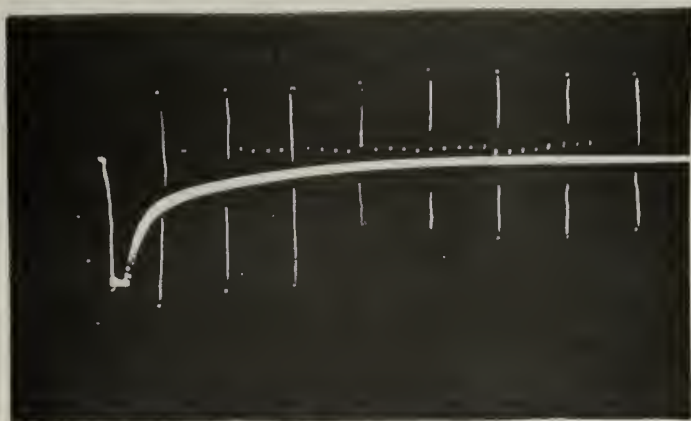

FIGURE 9 c
 Output pulse to Kerr cell
 (no series inductance in output
 stage plate circuit).
 Vertical Scale: 5,000 volts/cm
 Time Scale: 1 microsecond/cm

PULSES APPEARING WITHIN CIRCUITRY OF MODULATOR

had as low an RC time constant as was practicable in order to give a fast pulse fall time (the time involved in charging the Kerr cell back to 10 kv). A diagram of the output stage is shown in Figure 10.

With no applied pulse and the output tubes "off" the Kerr cell capacitance and stray capacitance (≈ 50 picofarads) was charged by the last stage plate supply through the 2000--ohm load. This gave an R-C charge time constant of 100 nanoseconds which seemed satisfactory for the conditions under which the Kerr cell was to be operated. When the last stage was then turned on the total output capacitance expended its stored energy through the low resistance of the two tubes.

Because of the high cost of Kerr cells it was necessary during the breadboard stage to use a substitute which simulated as closely as possible the Kerr cell's actual characteristics. This required that the author construct a capacitor which presented a capacitive load of about 50 picofarads (includes output, stray, and Kerr cell capacitance) and did not break down with 10,000 volts across its plates. Two plates cut from thin sheet copper were separated by several thin layers of Teflon insulator. Plexiglass outer plates were cut to hold the "sandwich" compactly. It was found that the capacitance was variable from 17 picofarads to 50 picofarads by simply tightening down on the four corner support nuts. The

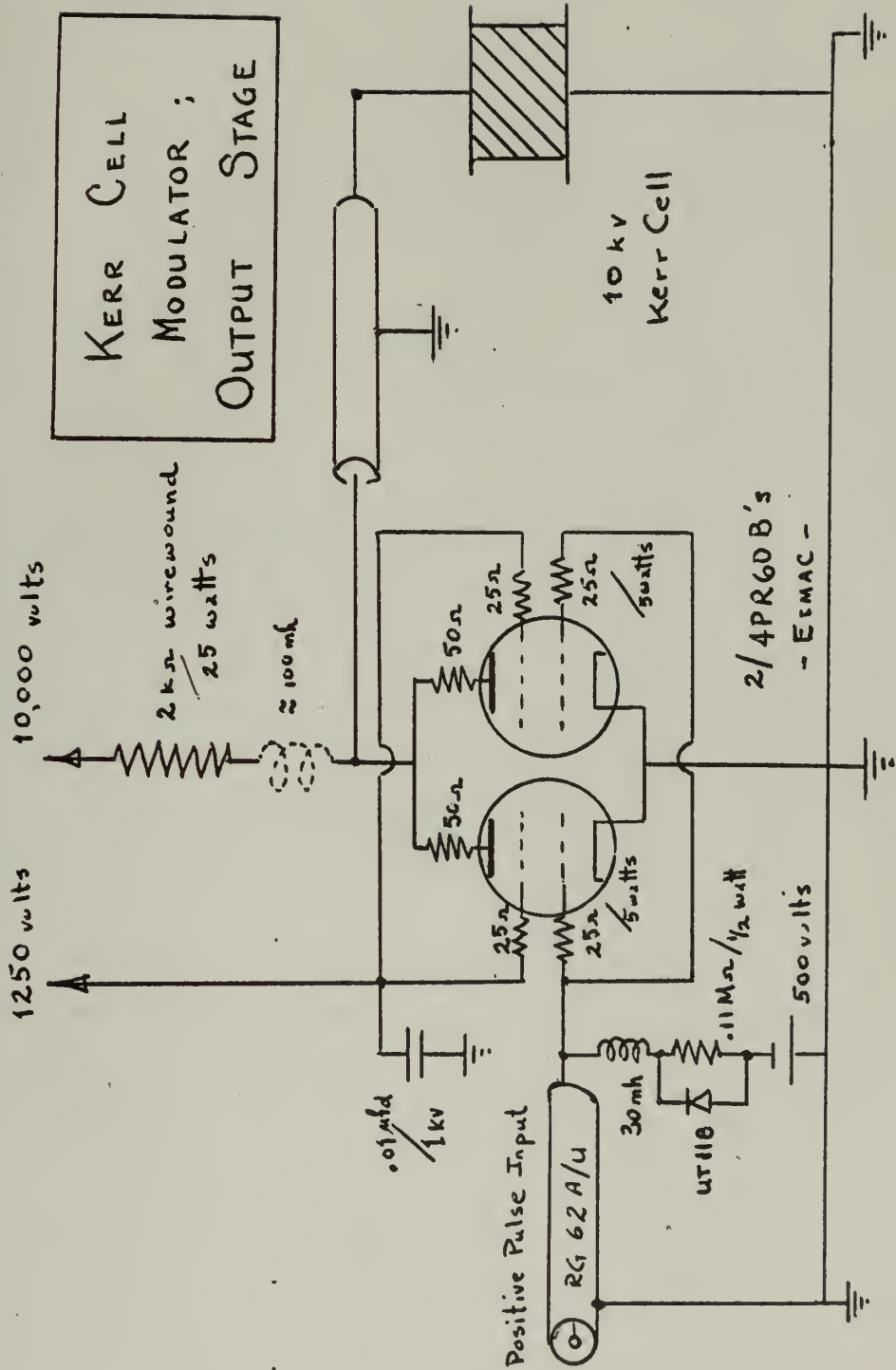

FIGURE 10

arrangement proved quite satisfactory, since results obtained on the breadboard were not too different from those obtained when the actual Kerr cell was used.

116

3. Tests And Results

After it was determined that the circuitry would be capable of pulsing the Kerr cell, a complete laser system was assembled. An optical bench 160 cm long was selected as the foundation piece. A heavy metal base mounting bar was then erected on the optical bench. Upon this accurately machined bar was mounted the entire laser cavity with associated optical pieces in their respective special precision-made holders (see Figure 11). At each end of the bar (about 15 1/2 " apart) was placed a dielectrically coated "flat" of high grade glass. The back flat had a 98% reflection characteristic while the front flat had 53%. Adjacent to the back flat and mounted on the bar was the 10 kv Kerr cell. Next in line toward the front flat was the Wollaston prism. Between the prism and the front flat was mounted the ruby's metallic cylindrical cavity containing the special spiral flash lamp, the trigger lead and the 3" ruby. (See Figure 12)

In addition to the optical pieces two magnesium oxide diffuse reflectors were placed on the optical bench--one immediately behind the back flat as protection from back scatter and the other about 4 feet forward of the front flat.

The power supply used to operate the flash lamp was specially designed for Laser operation. It consisted essentially of two

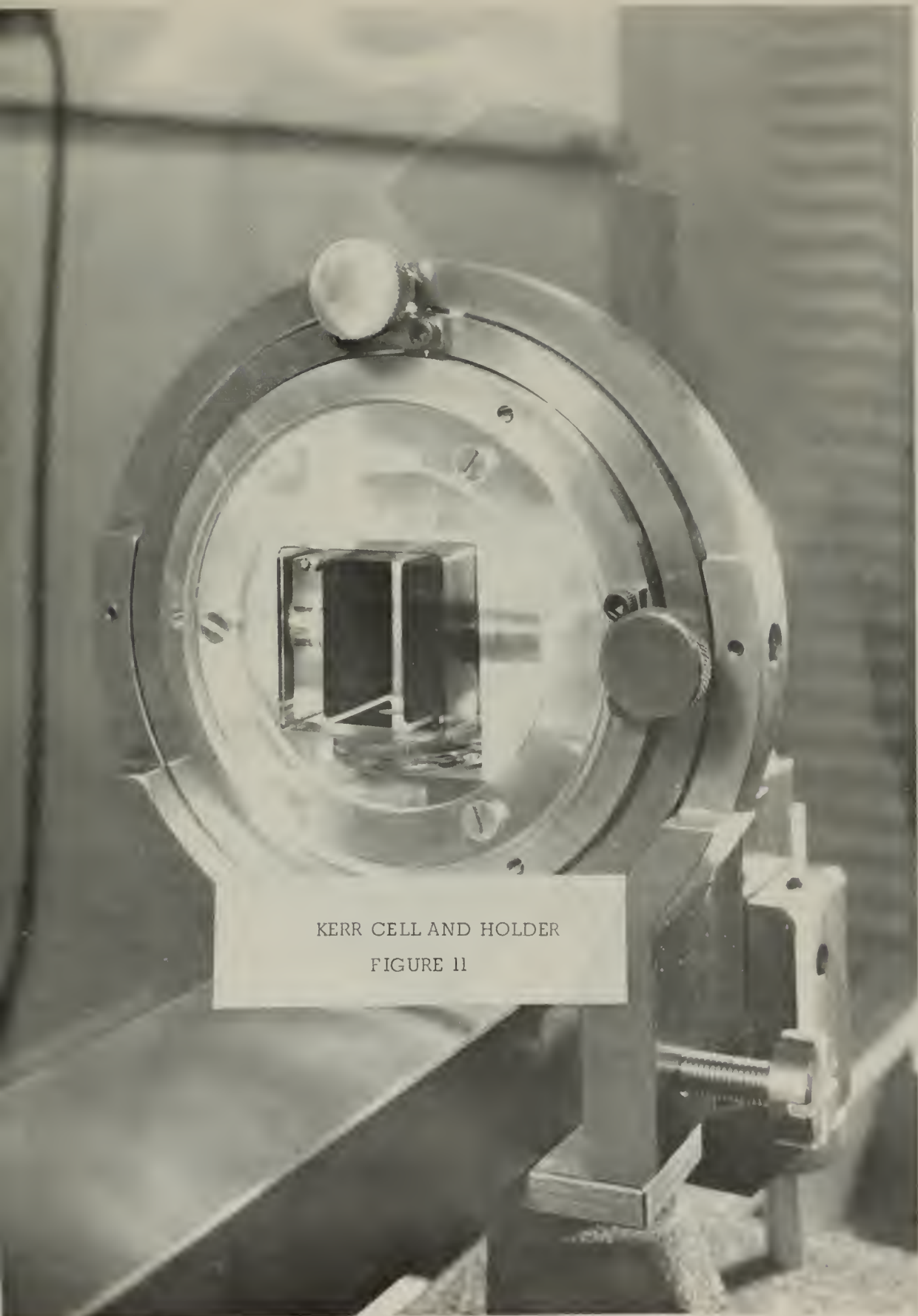

KERR CELL AND HOLDER
FIGURE 11



THE UNIVERSITY OF CHICAGO
LIBRARY

separate circuits. One was used to charge a pulse-forming network, the other was used to develop triggers to fire the ignitron switch and to ionize the xenon gas in the spiral flash lamp.

To the output of the charged pulse forming network was attached, in series, the flash lamp and the open ignitron switch. After the line was charged, the main switch was depressed. This introduced one trigger to ionize the flash lamp xenon gas and another to ionize the ignitron pool. Upon this action the energy stored on the pulse forming network was released into the series load represented by the "on"-condition low impedances offered by the flash lamp and ignitron.

The light pulse width, (or the "on"-time of the flash lamp) and the rate at which energy could be injected into the flash lamp were controllable. By suitable choice of up to eight independent "L" sections, light pulse widths of from 168 microseconds to 1344 microseconds in eight equal increments could be chosen by inserting capacitance (13.2 microfarad/section) and inductance (530 microhenries/section) to make up the line.⁵ The energy stored on the line was also controllable by varying the charging voltage. Except for the distinct upper limit of the light-pulse width resulting from the

⁵ Z_0 of this line was 6.3 ohms (see Appendix A).

physical limitation of the power supply, all other parameters could be readily controlled.

The first arrangement used for monitoring the ruby light output utilized an RCA 6217 phototube as a photodiode.⁶ This tube was housed in a flat-back coated oblong container. A 270-volt battery was used as its power supply and the tube output was fed through a 50-ohm cable (RG 58 C/U) to a capacitive load which totaled .0014 microfarads (20 picofarad, scope; 187 picofarad, line; and .00120 microfarad, fixed) and shunted the input of the Tektronix-555 oscilloscope. The purpose of this capacitive load was to produce integration of the output pulses. During the test the pulse periods used were in the hundreds of microseconds, and since the output giant laser pulse was on the order of 30 nanoseconds, integration would assure that if a pulse existed its amplitude could be detected by the polaroid ASA 3000 film used when the oscilloscope was set on the 100 microsecond/cm time scale.

During this portion of the experiment no major synchronization circuitry was used. The pulser was started and kept on. The flash lamp was then fired while the polaroid camera shutter was kept open. For the initial period of time from about 200 microseconds to

⁶A later arrangement used a more sensitive photomultiplier with Kodak Wratten (gelatin) neutral density filters.

600 microseconds (depending on the pump rate in joules/sec) the ruby was pumped. When the inversion level went above threshold the ruby was ready to laser. If after this point any pulse from the designed modulator opened the Kerr cell optical shutter, the back reflector was switched instantaneously into the optical path thereby increasing the "Q" of the laser cavity to a point which permitted regeneration. A giant pulse resulted as the energy was released. This was accompanied by a reduction in the upper level inverted Cr^{+3} ion population. The Kerr cell was then quickly turned "off" but the flash lamp remained on. Consequently, there was sufficient time for the ruby to be re-pumped. A situation prevailed which was similar to that described on page 11. It appeared possible to continue this process of pumping the ruby, switching the Kerr cell and obtaining a single laser pulse as long as the flash lamp was on and the ruby temperature was not raised excessively. Any rise in temperature was accompanied by an upward shift of the threshold level /4/ and made it more difficult to obtain lasering. As was hoped, when the modulator was operated at 10 kc, about 6 to 8 giant pulses were obtained. (Pictures of the resulting integrated output of laser pulses are shown later in this section.) Since synchronization was not at first attempted only pure chance permitted a large number of laser giant pulses to be emitted. When this occurred,

the pulse sequence of the modulator was such as to allow sufficient time for a large initial inversion above the threshold level to be reached before the Kerr cell was triggered. It was hoped to eventually implement a method of synchronizing all the circuitry in order to assure that the largest number of pulses were emitted during a firing. A schematic of the planned synchronization system is shown in Figure 13. The complete system used to obtain the described experimental results is schematically depicted (without power supplies) in Figure 14, and photographs of the actual equipment are shown in Figure 15. Appendix B also provides pertinent data describing each piece that was used in the system.

During the actual tests of the system the pulser was first started, and the polaroid camera shutter was then held open until the flash lamp was fired. A train of giant pulses, at a controlled repetition rate, was emitted from the air-cooled ruby. The output was monitored by the photodiode whose output was fed to the integrating circuit which paralleled the input of the Tektronix dual-beam (555) oscilloscope. When the flash lamp extinguished, lasering ceased. The camera shutter was then closed. From the photograph taken it was then possible to make a calculation of the energy output in each of the integrated pulses. The energy in these pulses was determined without too much difficulty, since

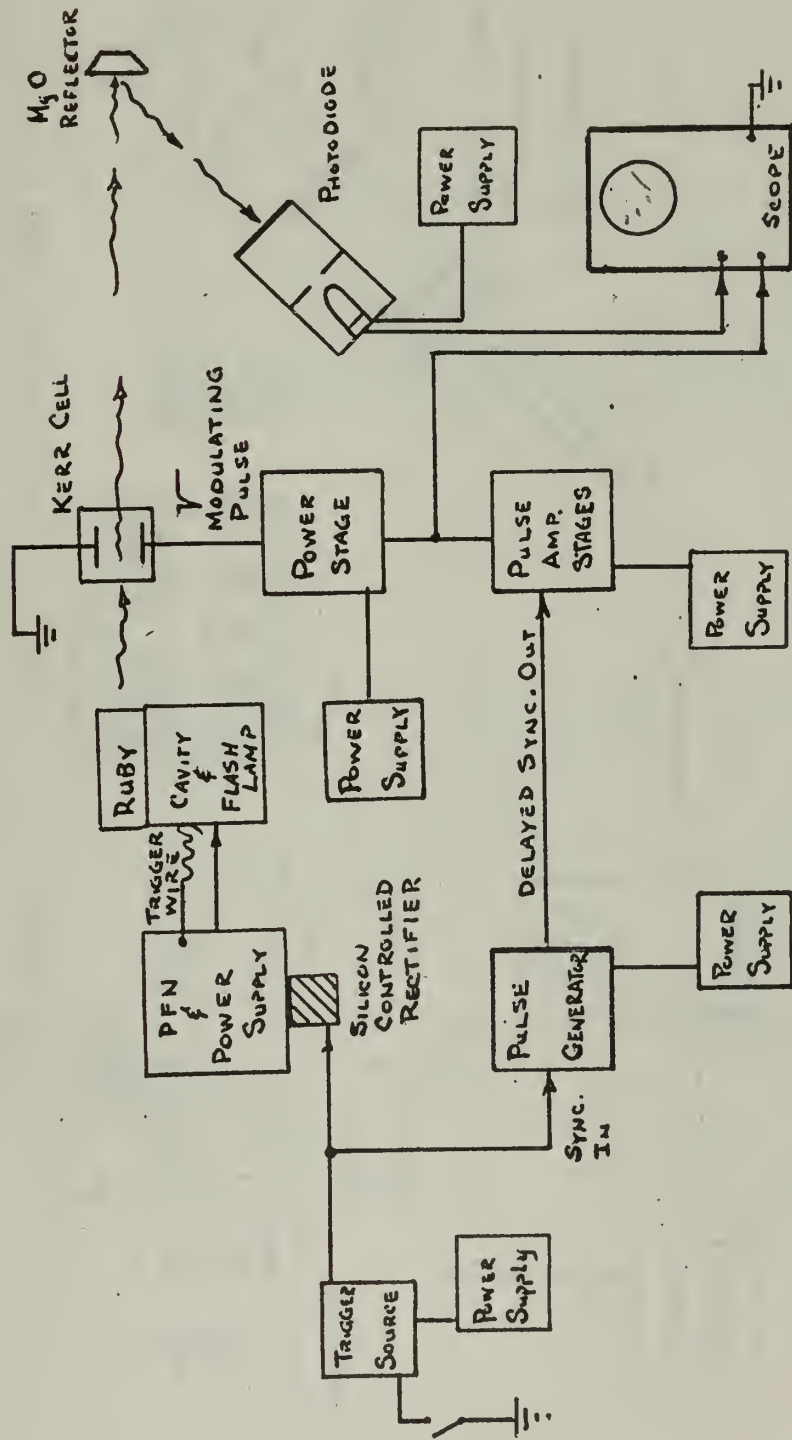

Schematic Of Planned Circuit Arrangement

FIGURE 13

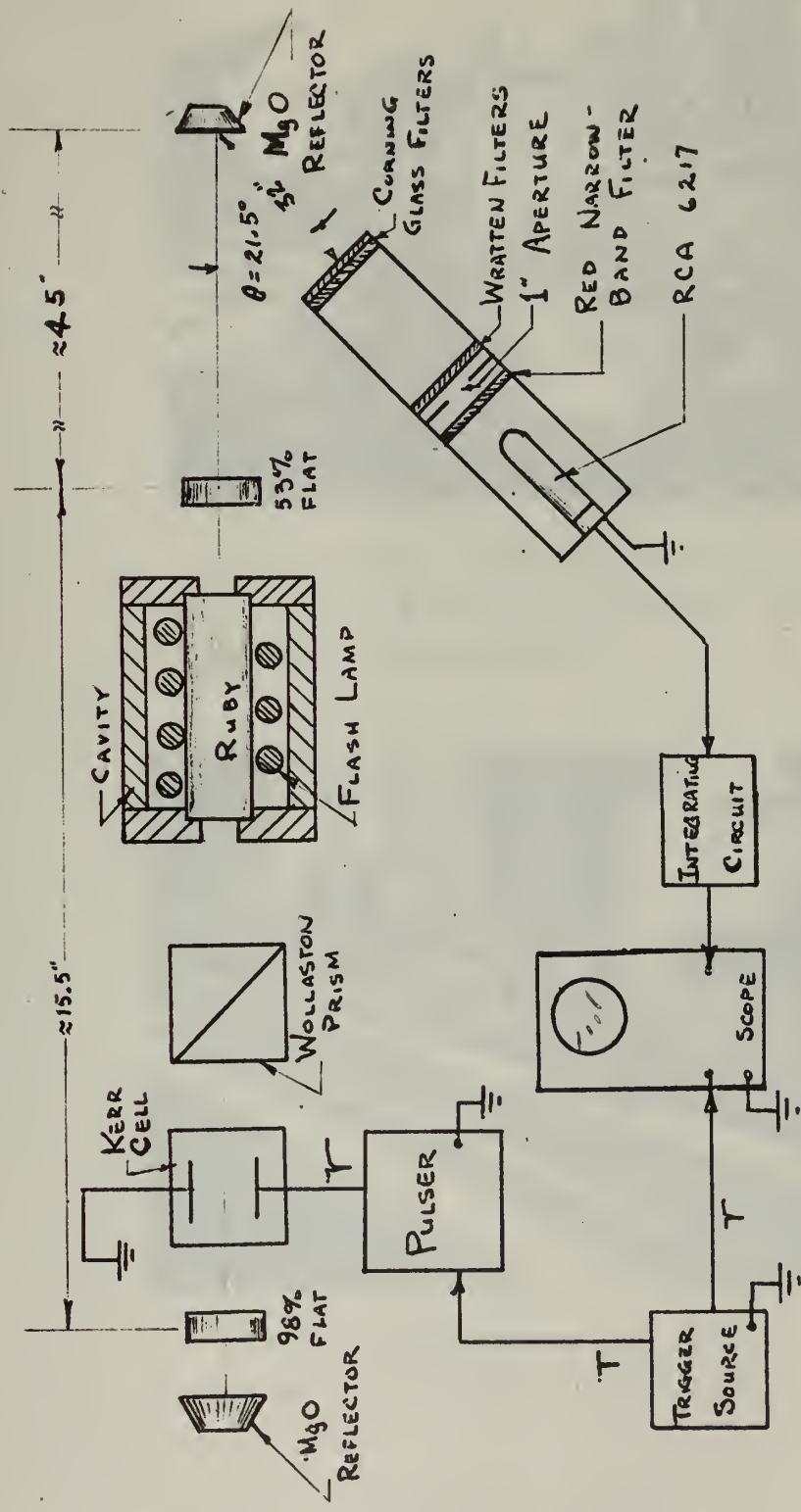

EQUIPMENT ARRANGEMENT TO MEASURE LASER OUTPUT
 FIGURE 14



LEFT: Output stage supplying pulse
to Kerr cell in background.
RIGHT: Driver stage.

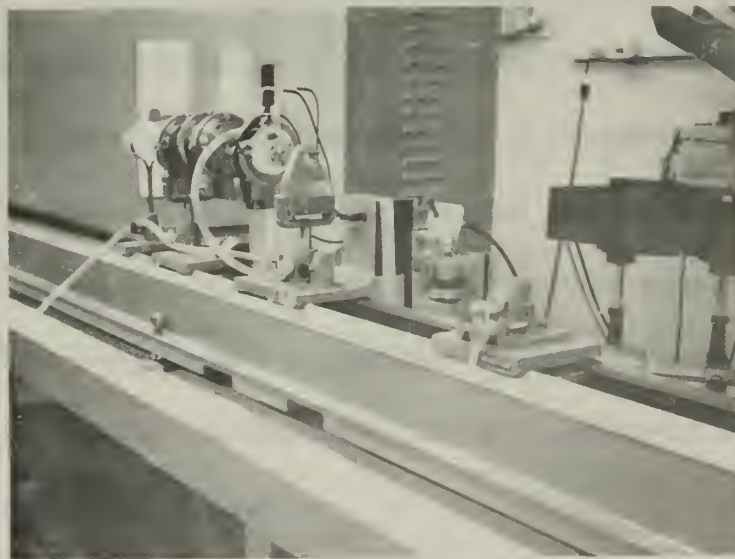

Optical arrangement including
cavity with forced air cooling.

ACTUAL SYSTEM

FIGURE 15

it was a function of the photodiode sensitivity, the total integration capacitance in the output of the photodiode and into the oscilloscope, the voltage amplitude appearing across the integration capacitance, as read from the photograph, the filters and attenuators used in the optical path, and the general geometry of the readout system. The energy input to the flash lamp was simply a function of the total capacitance in the number of sections of line used and the amount of voltage to which this capacitance was charged. Figure 16 is a group of photographs of the integrated laser output. Time increases from left to right and the leading edge of each step represents a giant laser pulse which resulted when the Kerr cell was pulsed. The giant pulses were so fast that the film responded only to the interpulse decay of the stored energy on the integration capacitance. However, the magnitude of the step-change was a direct representation of the energy that was emitted in each giant pulse. In the following chart, the energy in each pulse is compared as a function of the number of sections used in the pulse forming network that fired the flash lamp. The modulator was operated at a 10 kc rate for these results.

Sections	Energy (mj) in Pulse Number							Total Energy (Joules)	
	1	2	3	4	5	6	7	Output	Input
5	153	204	150	201	153			.86	1200
6	223	121	93	197	147	≈15*		.80	1200
7	115	248	93	188	102	80		.83	1200
8	178	71	233	≈15*	≈16*	259	80	.85	1200

*See photo of Figure 19.

Energy per pulse at a 10 kc pulse repetition frequency.

Similar results were obtained when the modulator was adjusted to pulse at other repetition frequencies. Photographs taken when the modulator pulsed the Kerr cell at a 4 kc rate are shown in Figure 17. All these photographs disclose that for any fixed input energy, an increase in the number of pulse-forming-network sections used (i.e. an increase in the width of the flash lamp light pulse) generally gave an increased number of output pulses emitted from the laser. Also, an increase in the energy input resulted in laser pulses of larger magnitude. It is felt that the pump rate was a significant factor in determining how large the individual pulses were. Time did not permit a thorough investigation of this aspect

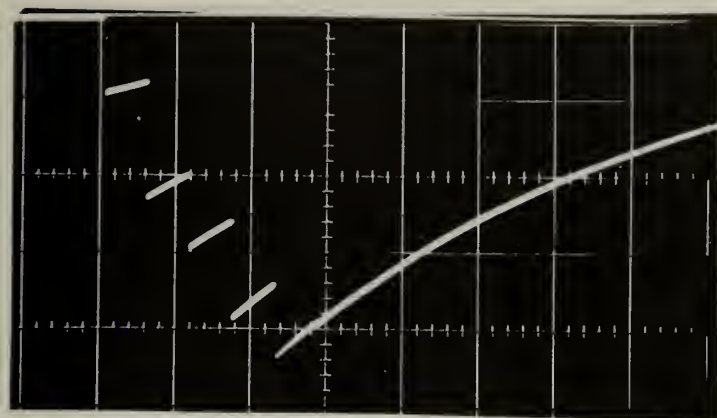

FIVE sections of line
Total output: 0.86 joules

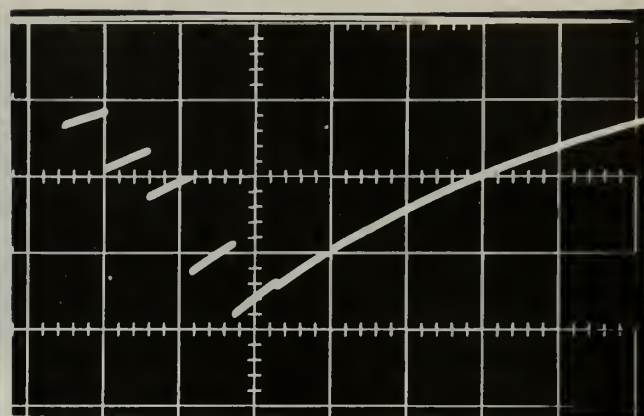

SIX sections of line
Total output: 0.80 joules

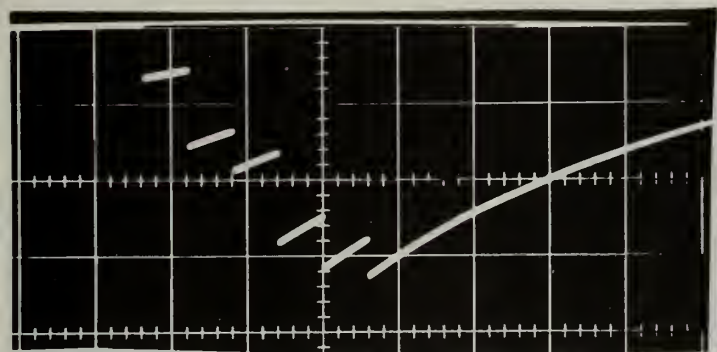

SEVEN sections of line
Total output: 0.83 joules

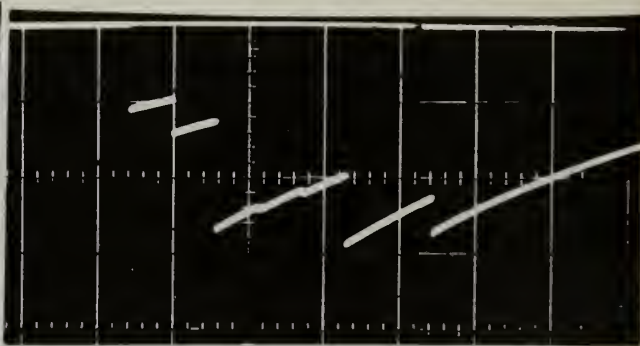

EIGHT sections of line
Total output: 0.85 joules

Time Scale: 200 microseconds/cm
Pulse Repetition Frequency: 10 kc
Input Energy: 1200 joules

INTEGRATED OUTPUT OF GIANT PULSE LASER (10 kc RATE)

FIGURE 16

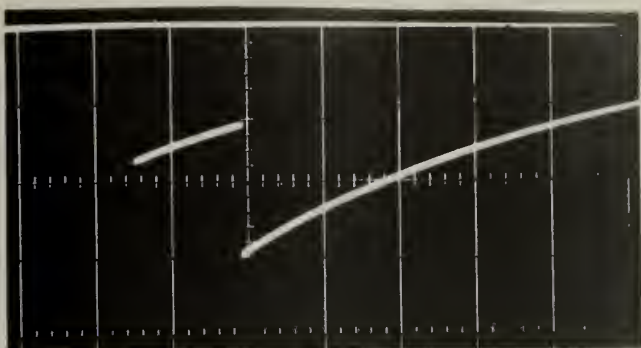

SIX sections of line
 Total input: 1010 joules
 Total output: ≈ 0.54 joules

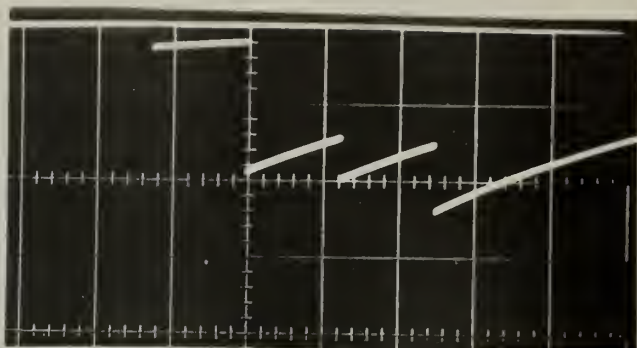

EIGHT sections of line
 Total input: 1013 joules
 Total output: ≈ 0.53 joules

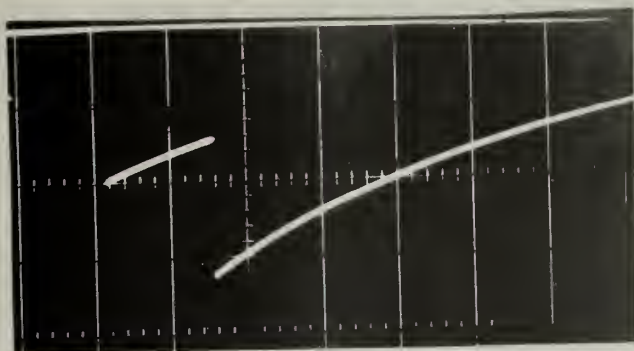

SIX sections of line
 Total input: 1200 joules
 Total output: ≈ 0.60 joules



EIGHT sections of line
 Total input: 1200 joules
 Total output: ≈ 0.77 joules

Time Scale: 200 microseconds/cm
 Pulse Repetition Frequency: 4 kc

INTEGRATED OUTPUT OF GIANT PULSE LASER (4 kc RATE)

FIGURE 17

of the system. Though not conclusive, it is noticed that the photographs disclose a trend toward larger giant pulses when the pump rate is higher. Eight sections gave a flash lamp light pulse of about 1340 microseconds whereas five sections gave a light pulse of 840 microseconds. Thus, when a fixed energy of 1200 joules was stored on the pulse forming network the pump rates were respectively $\approx .9$ joules per microsecond and ≈ 1.4 joules per microsecond for the light pulses described above. The shorter light pulse injected more joules per microsecond permitting a large inversion condition to result more quickly. This should give larger amplitude laser pulses. It is noted, however, that the wider pulse of white light obtained from the 8-section line gave the ruby a greater opportunity to have its Cr^{+3} ion population inverted more often; consequently, a greater number of pulses resulted even though they were of lower magnitude.

Though the pulser was designed to be operated at a 10 kc rate it was decided to determine if it could be operated at a higher pulse repetition frequency. Figure 18 is a photograph of the pulser output when being operated at a 25 kc rate in comparison with the output when operating at a 10 kc rate. Beyond 25 kc the output tubes began to draw excessive currents to a point where they were operating beyond their ratings. Typical values of voltages and

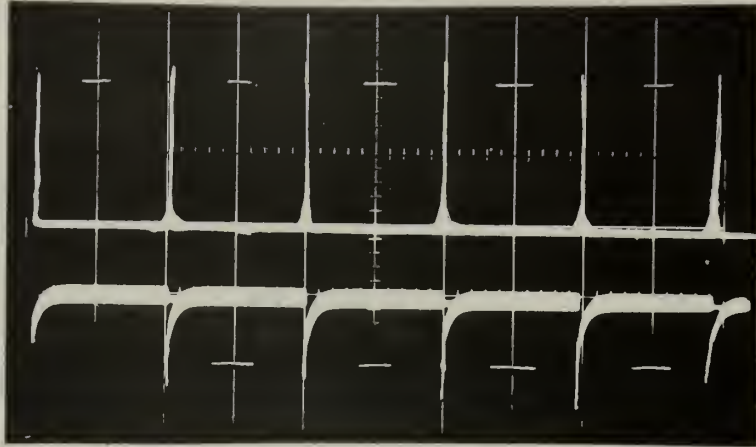

PULSE REPETITION FREQUENCY: 25 kc

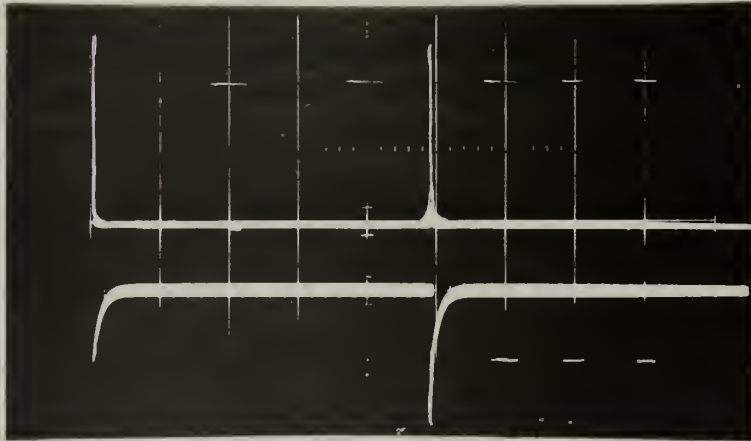

PULSE REPETITION FREQUENCY: 10 kc

Time Scale: 20 microseconds/cm

OUTPUT PULSE; 10 kc vs. 25 kc
MODULATOR OPERATION

FIGURE 18

currents resulting during operation of the final modulator constructed are shown below for two arbitrary pulse repetition frequencies:

	PULSE REPETITION RATE	
	3.3 kc	10 kc
FIRST STAGE		
E_{bb} (volts)	350	350
I_b (ma)	13.5	13.5
SECOND STAGE		
E_{bb}	1200	1200
I_b	2.5	6
LAST STAGE		
E_{bb}	10,000	10,000
I_b	5	15
E_{sc}	1200	1200
I_{sc}	4	7

Toward the end of the experimental period interesting results were obtained by increasing the width of the input trigger emanating from the laboratory pulse generator. It seems that when the trigger pulse was made much greater than 500 nanoseconds wide the blocking oscillator was able to recycle itself two and even three times (depending on the width of the input trigger pulse). This resulted in double- and triple-pulsing of the Kerr cell with subsequent emission of double and triple giant laser pulses spaced approximately 2.2 microseconds apart. (See Figure 19). The first laser pulse

currents resulting during operation of the final modulator constructed are shown below for two arbitrary pulse repetition frequencies:

	PULSE REPETITION RATE	
	3.3 kc	10 kc
FIRST STAGE		
E_{bb} (volts)	350	350
I_b (ma)	13.5	13.5
SECOND STAGE		
E_{bb}	1200	1200
I_b	2.5	6
LAST STAGE		
E_{bb}	10,000	10,000
I_b	5	15
E_{sc}	1200	1200
I_{sc}	4	7

Toward the end of the experimental period interesting results were obtained by increasing the width of the input trigger emanating from the laboratory pulse generator. It seems that when the trigger pulse was made much greater than 500 nanoseconds wide the blocking oscillator was able to recycle itself two and even three times (depending on the width of the input trigger pulse). This resulted in double- and triple-pulsing of the Kerr cell with subsequent emission of double and triple giant laser pulses spaced approximately 2.2 microseconds apart. (See Figure 19). The first laser pulse

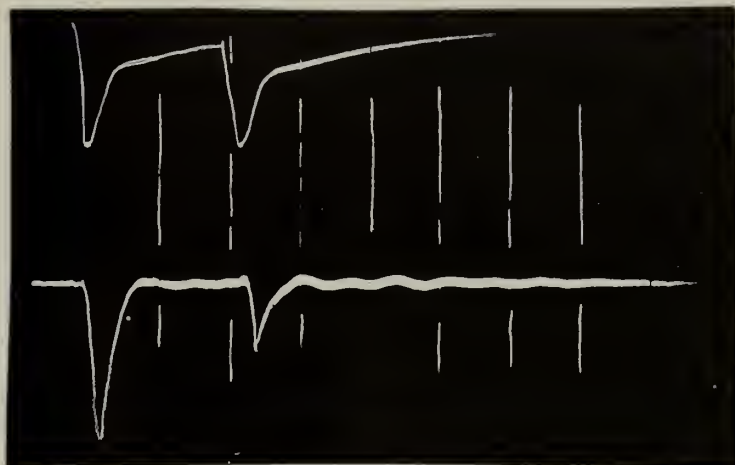

Double-pulsing of
Kerr cell

Double-pulsing of
laser output

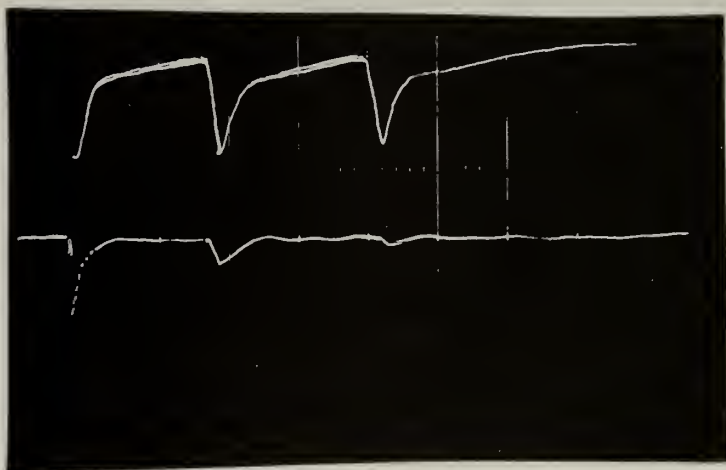

Triple-pulsing of
Kerr cell

Triple-pulsing of
laser output

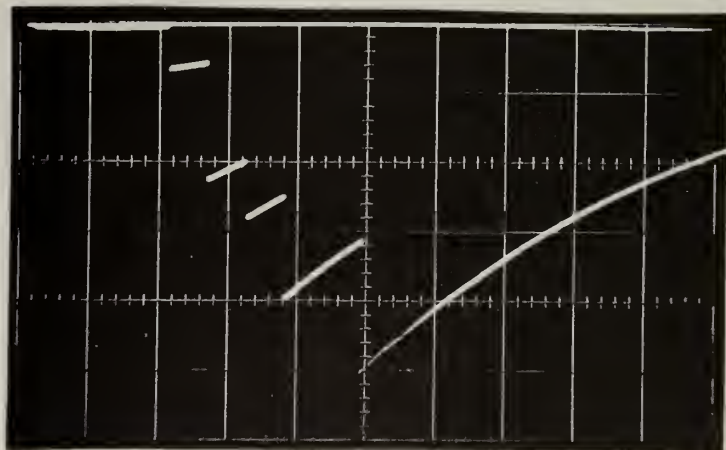

Multiple-pulsing
of integrated
output

Time Scale: 200
microseconds/cm

MULTIPLE - PULSING OF MODULATOR AND LASER

FIGURE 19

was usually quite large; the second and third were much smaller. The short 2.2 microsecond interpulse period did not permit the ruby chromium ions to be inverted sufficiently to provide a significant laser output from the additional pulses. From these results it became apparent then, that a closer investigation was in order, of the integrated output photographs taken during the series of tests where the input trigger pulse had been widened. In the integrated output photograph of Figure 19 what was overlooked before was now obvious. Though barely discernible double-pulsing is apparent in the region of the third and fourth distinct giant pulse step.

A test was carried out to determine what the result would be if the flash lamp was fired with an input energy near its rated maximum of 1500 joules. All 8 sections of the pulse forming network were used in this test in order to obtain the longest light pulse possible with the available equipment. The resulting output is shown in the photograph of Figure 20. This represented the largest total energy output that was obtained in any of the tests performed at a 10 kc repetition frequency.

In order to be sure that each of the laser pulses emitted was truly a giant pulse, a separate test was performed. It was decided to attempt to isolate, at random, one of the pulses that appeared in the train. A slight modification of trigger circuitry was used

and the oscilloscope time scale was set to 100 nanoseconds per centimeter. The first pulse out of the laser was used to trigger the Tektronix. By varying the delay time in the oscilloscope any pulse after the first could then be selected for photographing. Figure 21 shows a photograph of a typical giant pulse. Note the very fast rise time (much less than 10 nanoseconds). Another interesting aspect is the pulse width, which is no more than 40 nanoseconds even at the widest portion of the base. For an idea of the power available in such a pulse an average pulse magnitude of 120 millijoules can be selected from the chart shown previously and divided by the pulse width of 40 nanoseconds. The result is 3 megawatts of average power. (From the pulse shape the peak power can be estimated at about 12 megawatts.) Even with the relatively low energy involved, the pulse power is significant and quite comparable to that in some present-day radar pulses. Yet at the time of this writing no radar can give the narrow beam width, spatial directivity, and coherence which is characteristic of the laser output.

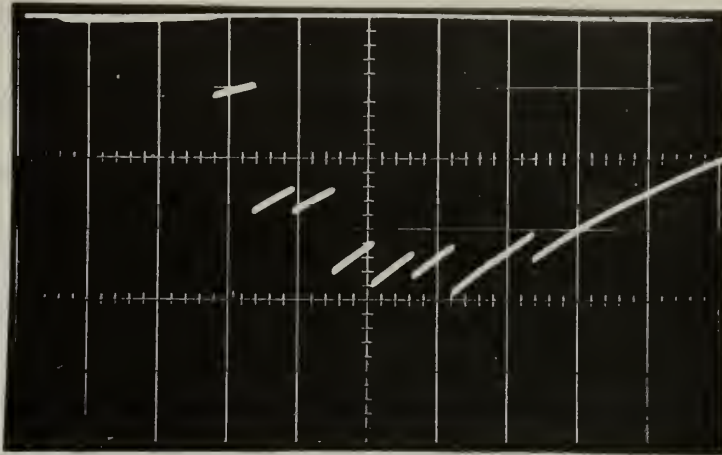

FIGURE 20

INTEGRATED OUTPUT; MAXIMUM INPUT ENERGY
TO FLASHLAMP

Eight sections of line

Total input: 1513 joules

Total output: 0.98 joules

Pulse Repetition Frequency: 10 kc

Time Scale: 200 microseconds/cm

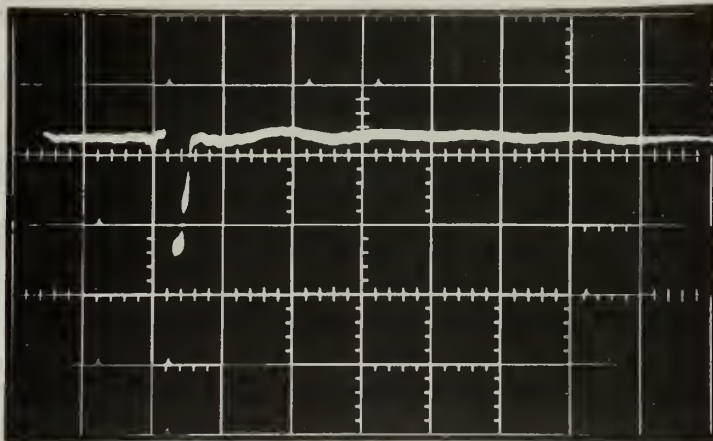

FIGURE 21

ACTUAL GIANT PULSE

Time Scale: 100 nanoseconds/cm

4. Conclusions

The major problem faced in attempting to generate a series of repetitive giant laser pulses was that of electronically modulating the Kerr cell. The circuitry used was successful in that it was capable of producing as many as eight successive laser pulses. Except for the rise time of the pulse driving the Kerr cell the more important specifications of those originally stipulated were met satisfactorily. Those specifications that were not actually met in the final circuitry were mainly refinements necessary to assist in controlling the output more effectively. Their omission did not detract from proving the feasibility of the concept. The experimental results proved the possibility of controlling the Giant Pulse Laser output in applications requiring high peak-power pulses.

The following suggestions are offered to assist in improving the entire modulator system that was used in this experiment:

(a) Remove the coupling capacitor that exists between the first stage and the blocking oscillator. In its place insert a variable, or tapped delay line. This will add a means of controlling the output pulse width.

(b) Select an optimum inductance for insertion into the plate circuit of the last stage to improve the pulse fall time.

(c) Introduce external synchronization circuitry so that the modulator pulse can be forced to commence at a desired time after the ruby has had its ion population pumped high above the threshold level.

(d) Use different tubes in the last stage with sharper cutoff features; or drive the tubes used, into the linear region of operation.

(e) Parallel more than two tubes in the last stage so that the Kerr cell discharges through a lower impedance switch, thereby, improving the pulse rise time. More tubes in parallel will also provide the added capability of operating at higher repetition frequencies than 25 kc without the danger of exceeding the individual tube ratings.

(f) Consider using a different modulator design one which takes advantage of the sine-squared transmission characteristic of the Kerr cell. Normally the Kerr cell is operated in a condition of full voltage or zero voltage; however, the sine-squared feature provides another zero of transmission at the 140% full-voltage point. In the Kerr cell used in this experiment it would mean designing the modulator to instantaneously modify the voltage from 10,000 volts to 14,000 volts. This obviously represents a voltage swing of only 4,000 volts in comparison to the $\approx 9,000$ volt swing used in this experiment.

(g) If it is desired to use higher pulse repetition rates without revising the circuit entirely, the last stage plate resistance can be increased in order to reduce the average plate current inherent when using larger duty factors. An increase in plate load resistance, however, will necessarily also increase the Kerr cell charge time.

(h) Finally, a more comprehensive testing program should be carried out in which one system parameter at a time is varied through a wide range of values. Such a program would result in a better understanding of the ultimate capabilities of the modulator.

APPENDIX A

Calculation of the pulse width from, and the characteristic impedance of, the pulse forming network used in the large power supply to pulse the flash lamp.

$$\tau/\text{section} = 2\sqrt{LC} = 2\sqrt{(530 \text{ microhenries})(132 \text{ microfarads})}$$

$$\cong 168 \text{ microseconds/section}$$

Maximum light pulse width:

$$8 \text{ sections } (168) \cong 1344 \text{ microseconds}$$

$$Z_o = \sqrt{\frac{L}{C}} = \sqrt{\frac{530}{13.2}} = 6.32 \text{ ohms}$$

APPENDIX B

Pertinent data for some of the other equipment and optical pieces used in the 10 kc modulator system:

- (1) Reflecting Flats: Perkin and Elmer. They were dielectrically coated having a 53% and 98% reflectivity at 6943\AA .
- (2) Laser Cavity: (see Figure B-1) 9.5 cm long by 4.3 cm O.D.
- (3) Flash Lamp: Kemlite (specially made) (see Figure B-2).
- (4) Ruby: Linde and Company
.05% doping of Cr^{+3} ; $1/4'' \times 2.5''$.
 90° optic axis unpolished; end faces flat to $1/15$ of a wavelength and parallel to within 2.5 seconds.
- (5) Oscilloscope: Tektronix dual-beam (with power supply and associated fast rise time pre-amplifiers); 20 picofarad, 1 megohm input. Photographs of repetitive pulses were taken with a sensitivity setting of 10 millivolts/cm.

- (6) Phototube: RCA 6217 in a photodiode configuration
Sensitivity $.75 (10^{-3})$ microamps/
microwatt (calibrated against an Eppley
thermopile).
- (7) Filters: (a) Corning glass plate neutral density
filters placed on front of photodiode
housing. Attenuation factor of 4 each.
(b) Interference filter (red)
48.8% transmission (measured at 6943\AA
on Cary photo spectrometer)
 100\AA bandwidth; attenuation factor of 2.
(c) Wratten filters (Kodak)
Various N.D. numbers used.
- (8) Kerr Cell: Electro-Optic Company. Rated at 10
kilovolts. Plates were 4.0 cm x 1.2 cm
with a .6 cm spacing between. Plates
immersed in Nitrobenzene and packaged
in a pyrex container.

- (6) Phototube: RCA 6217 in a photodiode configuration
Sensitivity $.75 (10^{-3})$ microamps/
microwatt (calibrated against an Eppley
thermopile).
- (7) Filters: (a) Corning glass plate neutral density
filters placed on front of photodiode
housing. Attenuation factor of 4 each.
(b) Interference filter (red)
48.8% transmission (measured at 6943\AA
on Cary photo spectrometer)
 100\AA bandwidth; attenuation factor of 2.
(c) Wratten filters (Kodak)
Various N.D. numbers used.
- (8) Kerr Cell: Electro-Optic Company. Rated at 10
kilovolts. Plates were 4.0 cm x 1.2 cm
with a .6 cm spacing between. Plates
immersed in Nitrobenzene and packaged
in a pyrex container.

- (6) Phototube: RCA 6217 in a photodiode configuration
Sensitivity $.75 (10^{-3})$ microamps/
microwatt (calibrated against an Eppley
thermopile).
- (7) Filters:
- (a) Corning glass plate neutral density
filters placed on front of photodiode
housing. Attenuation factor of 4 each.
 - (b) Interference filter (red)
48.8% transmission (measured at 6943\AA
on Cary photo spectrometer)
 100\AA bandwidth; attenuation factor of 2.
 - (c) Wratten filters (Kodak)
Various N. D. numbers used.
- (8) Kerr Cell: Electro-Optic Company. Rated at 10
kilovolts. Plates were $4.0\text{ cm} \times 1.2\text{ cm}$
with a $.6\text{ cm}$ spacing between. Plates
immersed in Nitrobenzene and packaged
in a pyrex container.

- (6) Phototube: RCA 6217 in a photodiode configuration
Sensitivity $.75 (10^{-3})$ microamps/
microwatt (calibrated against an Eppley
thermopile).
- (7) Filters:
- (a) Corning glass plate neutral density
filters placed on front of photodiode
housing. Attenuation factor of 4 each.
 - (b) Interference filter (red)
48.8% transmission (measured at 6943\AA
on Cary photo spectrometer)
 100\AA bandwidth; attenuation factor of 2.
 - (c) Wratten filters (Kodak)
Various N.D. numbers used.
- (8) Kerr Cell: Electro-Optic Company. Rated at 10
kilovolts. Plates were 4.0 cm x 1.2 cm
with a .6 cm spacing between. Plates
immersed in Nitrobenzene and packaged
in a pyrex container.

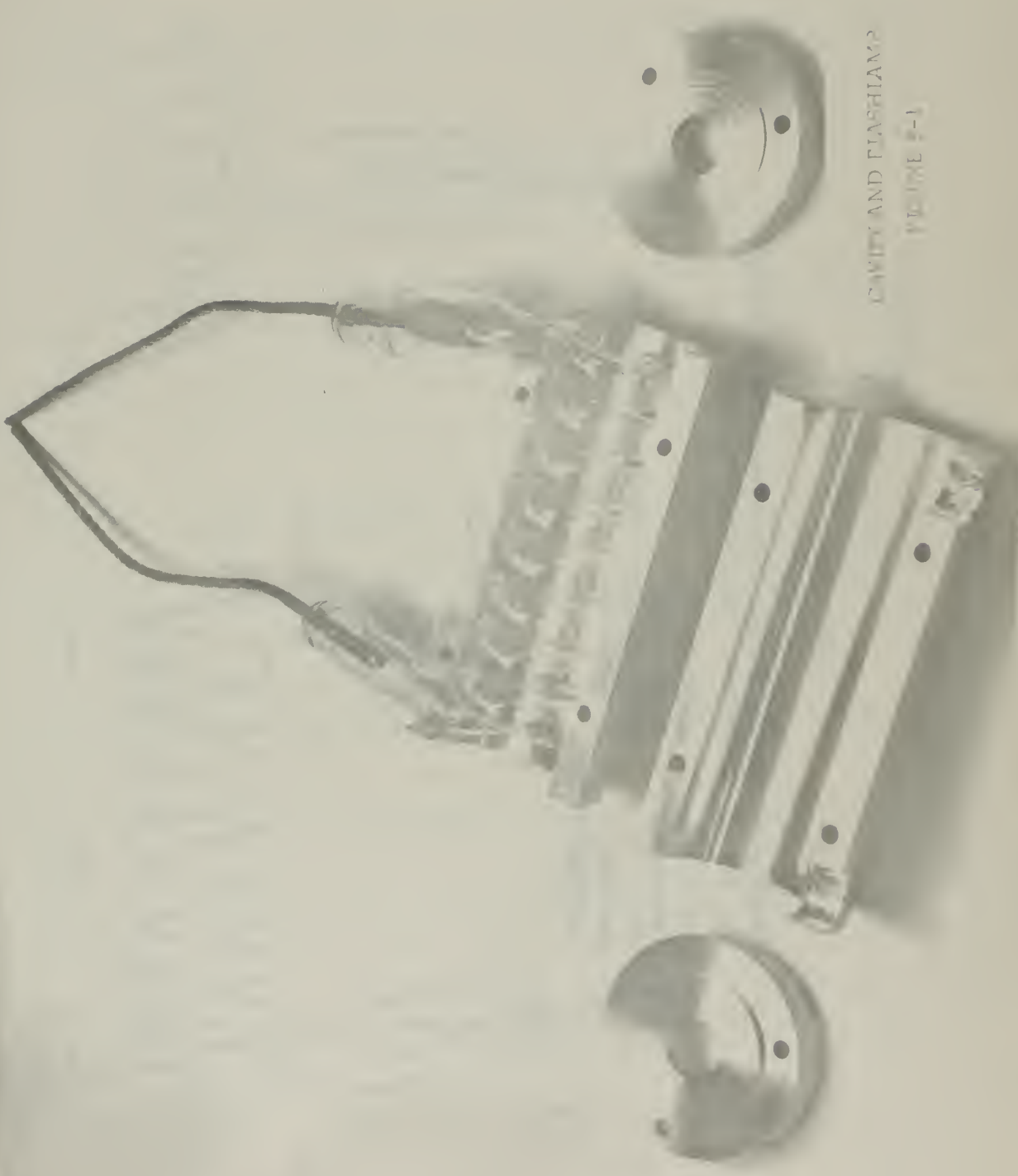

CAVITY AND FLASHLAMP
FIGURE 8-1

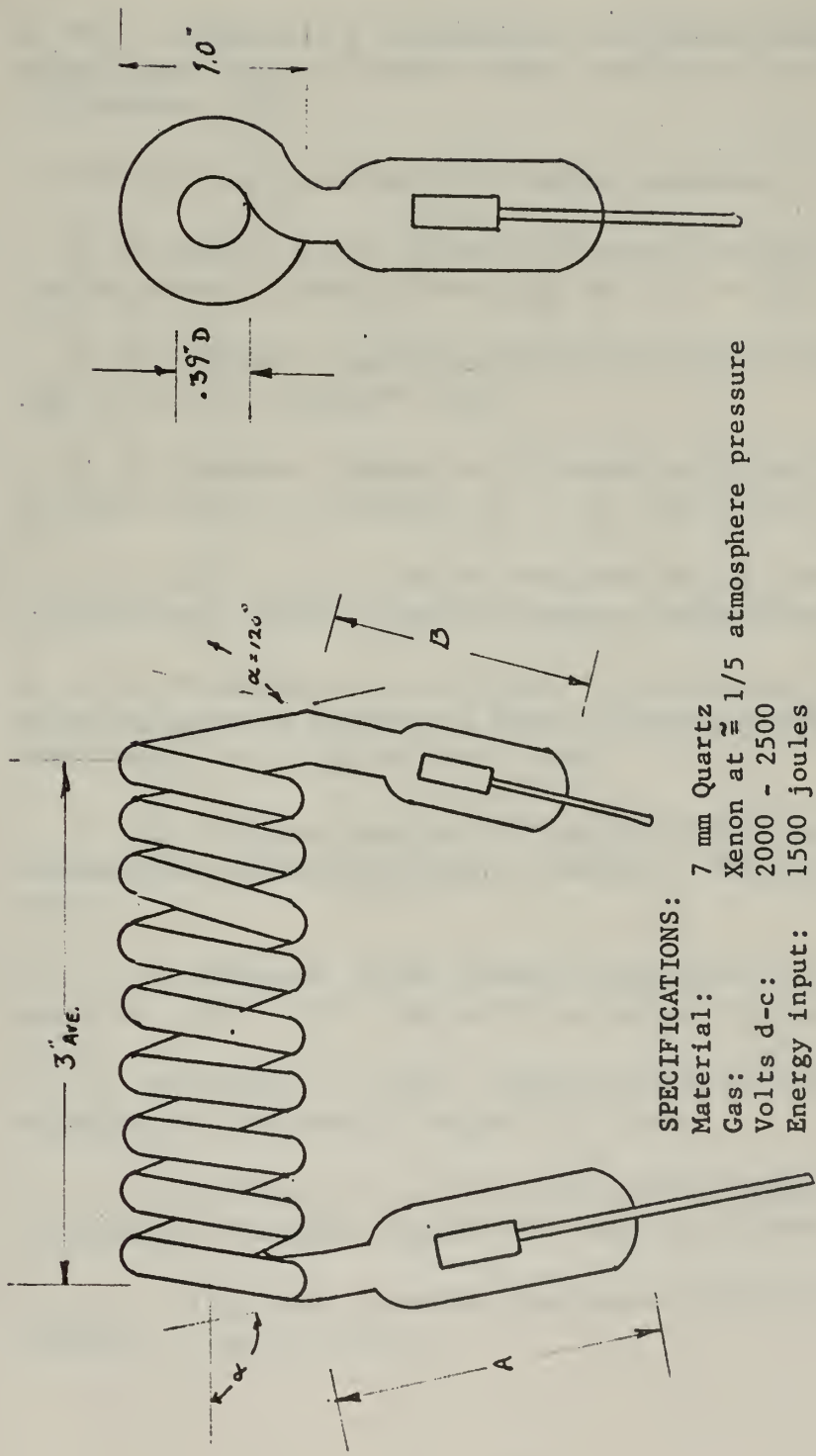

SPECIFICATIONS:

- Material: 7 mm Quartz
- Gas: Xenon at $\approx 1/5$ atmosphere pressure
- Volts d-c: 2000 - 2500
- Energy input: 1500 joules

"A" and "B" dimensions: $1\frac{1}{2}$ " to 2" nominal.
 Cylindrical tube 3" X $3/8$ " fits inside helical winding.

FLASH LAMP

FIGURE B-2

BIBLIOGRAPHY

1. F. J. McClung, R. W. Hellwarth, Giant Optical Pulsations from Ruby, *J. Appl. Phys.*, 33, pp. 828-829, March, 1962.
2. M. L. Stitch, E. J. Woodbury, J. H. Morse, Repetitive Hair-Trigger Mode of Optical Maser Radiation, *Proc. IRE*, 49, 10, October, 1961.
3. Private communication with Hughes personnel.
4. I. D. Abella, H. Z. Cummins, Thermal Tuning of Ruby Optical Maser, *J. Appl. Phys.*, 32, pp. 1177-1178, June, 1961.
5. T. H. Maiman, Stimulated Optical Radiation in Ruby, *Nature*, 187, 6, p. 493, August 6, 1960.
6. T. H. Maiman, Optical and Microwave-Optical Experiments In Ruby, *Phys. Rev. Letters*, 4, 11, p. 564, June 1, 1960.
7. C. V. Smith, M. L. Stitch, Applications of Lasers to Ranging and Tracking, Hughes Aircraft Company Memorandum, March, 1962.
8. A. E. J. Holtham, H. A. Prime, The Operation and Photographic Characteristics of a Kerr-cell Type of Electro-optical Shutter, *Proc. Phys. Soc.*, 63, Pt. 8-B, 1950.
9. J. Kerr, On a New Relation Between Electricity and Light, *Philosophical Magazine (London, England)*, 4th Series, 1, p. 337, 1875.
10. L. N. Ridenour, *Radar Systems Engineering*, 1, McGraw-Hill Book Co., Inc., 1947, (Radiation Laboratory Series).
11. S. M Hauser, H. Quan, Applying the Kerr Cell to Nanosecond Photography, *Electronics*, August 25, 1961.
12. A. M Marshall, F. L. Poole, An Electro-Optical Shutter for Photographic Purposes, *Trans. Am. Inst. Elect. Engr.*, 68, 1, 1949.
13. E. F. Kingsbury, The Kerr Electrostatic Effect, *Rev. Sci. Instrum.*, 1, p. 22, 1930.

14. F. G. Dunnington, The Electro-optical Shutter - Its Theory and Technique, Phys. Rev., 38, pp. 1506-1534, October 15, 1931.
15. B. Rossi, Optics, Addison-Wesley Publishing Co., Inc., 1959.
16. J. F. Reintjes, G. T. Coate, Principles of Radar, 3rd edition, McGraw-Hill Book Co., Inc., 1952.
17. G. N. Glasoe, J. V. Lebacqz, Pulse Generators, 5, McGraw-Hill Book Co., Inc., 1959, (Radiation Laboratory Series).

thesG548

A 10kc Kerr cell modulator for the produ



3 2768 002 13095 7

DUDLEY KNOX LIBRARY