

NPS ARCHIVE  
1962  
SANCHES, M.

PRELIMINARY EXPERIMENTAL ANALYSIS OF  
16.2 Bev/c INTERACTIONS IN EMULSION

MANUEL L. SANCHES  
and  
THOMAS R. TYLER

LIBRARY  
U.S. NAVAL POSTGRADUATE SCHOOL  
MONTEREY, CALIFORNIA

PRELIMINARY EXPERIMENTAL  
ANALYSIS OF 16.2 Bev/c  $\pi^-$  INTERACTIONS  
IN EMULSION

\* \* \* \* \*

Manuel L. Sanches

and

Thomas R. Tyler

PRELIMINARY EXPERIMENTAL  
ANALYSIS OF 16.2 Bev/c  $\pi^+$  INTERACTIONS  
IN EMULSION

By

Manuel L. Sanches  
//

Captain, United States Army

and

Thomas R. Tyler

Lieutenant, United States Coast Guard

Submitted in partial fulfillment of  
the requirements for the degree of

MASTER OF SCIENCE  
IN  
PHYSICS

United States Naval Postgraduate School  
Monterey, California

1962

NPS Archive  
1962  
Sanchez, M.

~~Thesis~~  
S1078

LIBRARY  
U.S. NAVAL POSTGRADUATE SCHOOL  
MONTEREY, CALIFORNIA

PRELIMINARY EXPERIMENTAL  
ANALYSIS OF 16.2 Bev/c  $\pi^-$  INTERACTIONS  
IN EMULSION

by

Manuel L. Sanches

and

Thomas R. Tyler

This work is accepted as fulfilling  
the thesis requirements for the degree of

MASTER OF SCIENCE

IN

PHYSICS

from the

United States Naval Postgraduate School

## ABSTRACT

The interactions of  $16.2 \pm 0.6$  Bev/c  $\pi^-$  mesons in Ilford K-5 emulsion were studied. In  $1.11 \text{ cm}^3$  of emulsion (0.1% of the stack), 139 events were found. The largest event had 33 prongs, while the smallest had 3 prongs. The median was 12 prongs. A total of 1926 prongs were produced for an average of 14 prongs per event.

A total of 841 cm of prong track was followed, yielding 1115 prong terminations. Of these terminations, 1063 were protons or light fragments, 28 were pions, and 15 were interactions in flight. Two stars in flight were produced by energetic pions, three by heavy particles of mass two or three, and the others by baryons, probably protons. The mean free path for stars in flight was 56 cm.

One definite and ten possible strange particles were found. A definite  $\Sigma$  decay in flight was seen. Ten events were seen which might have been  $\Sigma$  interactions at rest or large angle scatters of protons nearly at rest. No other strange particles were found, nor were any anti-particles found.

Several hundred stars not produced by beam pions were found in the scanned volume. None of these represented capture stars of anti-particles or hyperons which could have been produced by energetic pion interactions elsewhere in the emulsion.

Three hyperfragments were found. Two of these were produced by 16.2 Bev  $\pi^-$  interactions and the other by the interaction of an unidentified neutral particle.

## TABLE OF CONTENTS

Section	Title	Page
1.	Introduction	1
2.	Theory	2
3.	Experimental Procedures	
	a. Emulsion Exposure	5
	b. Scanning Techniques	5
	c. Data Recording	7
4.	Experimental Results	
	a. Distribution of Prongs	11
	b. Identification of Prongs	13
	1) Protons and other stable particles	13
	2) Pions	14
	3) Other particles	14
	4) Stars in flight	15
	5) Hyperfragments	16
5.	Neutral Stars	19
6.	Conclusion	19
Appendix		
I.	Track Ionization	21
II.	Ionization Measurements	27
III.	Production of Hyperons in Relativistic Interactions	31
Acknowledgments		33
Bibliography		34

## LIST OF ILLUSTRATIONS

Figure		Page
1.	Diagram of Position of Emulsion in Beam	9
2.	Diagram of Position of Area Scanned in Pellicle	9
3.	Reproduction of McBee Keysort Card	10
4.	Prong Frequency Distribution	11
5.	Energy Distribution of Stopping Pions	17
6.	Lacunarity Dip Correction	23
7.	L vs $\beta$	24
8.	B vs $\beta$	25
9.	g vs $\beta$	26
10.	Schematic of Motor and Microscope	29
Table		
I.	Terminal Behavior of Particles	4
II.	Parameters of Particles with $\beta = 0.48$	8
III.	Table of Prong Analysis	12
IV.	Characteristics of Stars in Flight	18
V.	Stage Speed vs Voltage	30

## 1. Introduction

Yukawa's prediction of the meson in 1935 marked the beginning of the search for elementary particles. For many years cosmic rays were studied in an attempt to discover and identify new particles, and several members of the present list  $\overline{\Lambda}^0$  were first detected in cosmic ray experiments. The difficulties inherent to cosmic ray research led to the development and construction of particle accelerators which could produce high energy reactions under controlled conditions.

As the energy of the accelerators was increased, new and unexpected particles were discovered. The Bevatron and Cosmotron opened new fields of research, and, for most of the past decade, effort in high energy physics has been directed toward the problem of understanding the behavior and nature of the "new" particles. With the completion of the CERN 28 Bev proton accelerator in Switzerland, in 1959, experiments to study particle behavior and production at previously unattainable energies began.

A stack of Ilford K-5 emulsion was exposed at CERN to a 16.2 Bev/c  $\pi^-$  meson beam in November 1960. The present experiment is the first of a planned series of experiments designed to study the nature of high-energy pion interactions with emulsion nuclei. This paper is a preliminary analysis of the particles produced by the  $\pi^-$  interactions.

Part 2 of this report is a review of the theoretical basis for the experiment. Part 3 describes the experimental procedures used.

Part 4 describes the results of the analysis. Part 5 is a discussion of those interactions located in the scanning which were not caused by incident beam pions. Part 6 contains the conclusions derived from the analysis and compares them with those from other experiments.

## 2. Theory

Very little information is available concerning the nature of pion interactions with emulsion nuclei at energies in excess of a few Bev. This paper presents the results obtained in a sample scanning of a limited region of the emulsion exposed to 16.2 Bev/c negative pions and a partial analysis of the "stars" found in this region. A study of this emulsion stack within a selected region was made for the following reasons.

a. The pion energy of 16 Bev is well above the threshold energy for production of any known hyperon or anti-hyperon. For example, the threshold energy for producing a  $\Xi^-$ , which is the heaviest known hyperon, by the reaction

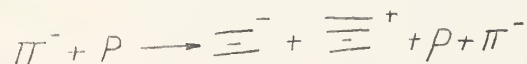

is 6.75 Bev. This calculation is based upon the formula

$$T_{TH} = \frac{(\sum M_i)^2 - (M_\pi + M_p)^2}{2M_p}$$

where  $\sum M_i$  = total rest energy of the products ( $c = 1$ )

$M_\pi$  = rest energy of the  $\pi$  meson

$M_p$  = rest energy of the proton

and gives threshold energies for pion interactions with protons at rest in the emulsion. The interactions in emulsion are usually with complex

nuclei rather than free protons therefore, these threshold values are approximations and the true values are somewhat lower  $\sqrt{2}$ . By solving the above equation for  $M_f^2$  it is seen that there is sufficient energy available to produce particles in the final state whose total rest energy is about 5.5 Bev.

In order to detect the production of any rare particles it is necessary that the particles produced be identified by their interactions or decays. If the particles come to rest, their terminal behavior serves to identify them. Terminal behaviors are listed in Table 1.

b. All particles produced in the forward direction in the center-of-mass (CM) system will appear as near-minimum tracks in the emulsion. This follows from the fact that the velocity of the CM for a pion-proton interaction is  $\beta \approx 0.94$ . Thus a particle produced at rest in the CM would appear to have  $\beta \approx 0.94$  in the lab and be near minimum ionization.

Particles produced backwards in the CM may have much smaller velocities in the lab system than they do in the CM system. It is these particles which one can hope to identify in the emulsion. In the case of the hyperons, it is reasonable to suppose that such backward emission in the CM is common; the baryon tends to maintain its momentum in the CM. Data from bubble chamber experiments confirms this  $\sqrt{3}$ .

To calculate the expected momentum of a particle in the lab system, if the particle is produced in a relativistic collision, it is convenient to use the geometrical method of Blaton  $\sqrt{4}$ . Sample

calculations carried out in Appendix III indicate that hyperons with ranges in emulsion of a few millimeters can be produced. It is, therefore, plausible to search the emulsion for the terminations of these particles and to investigate the heavy-particle tracks from the  $\pi^-$  stars.

TABLE I.

Terminal Behavior of Particles in Nuclear Emulsion

Particle	Behavior
$K^\pm$ in flight	Decay. Can produce three charged mesons or a single charge meson or lepton.
$K^-$ at rest	Capture star.
$K^+$ at rest	Decay. Usually emits a charged meson or lepton with a track at near minimum of ionization.
$\Sigma^\pm$ in flight	Decay. Produces a single charged pion or proton.
$\Sigma^-$ at rest	Capture star. Frequently not possible to distinguish from a proton.
$\Sigma^+$ at rest	Decay. May either emit a proton of $\approx 1.68$ mm range or a pion near the minimum of ionization.
$\Xi^-$ in flight	Decay. Produces a charged pion.
$\Xi^-$ at rest	Capture star. Probably not very different from $\Sigma^-$ capture.
$\Xi^\pm \rightarrow \bar{n} + \pi^\pm$	Not possible to separate from $\Sigma^\pm \rightarrow \pi^\pm + n$ unless $\pi^\pm$ energy can be determined.
$\Xi^+ \rightarrow \bar{p} + \pi^0$	Anti-proton star, large energy release.
$\Xi^+ \rightarrow \bar{\Lambda} + \pi^+$	Range and charge of pion separates from $\bar{\Sigma}^+ \rightarrow \bar{n} + \pi^+$ $\Sigma^+ \rightarrow n + \pi^+$

### 3. Experimental Procedures

#### a. Emulsion Exposure

A stack of Ilford K-5 emulsion was exposed to a  $16.2 \pm 0.6$  Bev/c  $\pi^-$  meson beam at CERN from 26 to 28 November 1960. The stack consisted of 180 pellicles, each measuring 75 X 150 X 0.62 mm ( $1255 \text{ cm}^3$  of emulsion). The beam was 25 cm by 25 cm with less than 10% contamination, due to  $\mu^-$ ,  $K^-$ , and  $\bar{P}$  [5]. The physical positioning of the emulsion in the beam is shown schematically in Fig. 1. The stack was carefully leveled so that the pion trajectories would be parallel to the pellicle surfaces.

At the Lawrence Radiation Laboratory, Berkeley, Calif., a rectangular coordinate grid of 1 mm squares was printed on the bottom of each pellicle. The pellicles were processed and mounted on glass plates on 2 December 1960. Pellicles number 1 through 120 are at LRL. Pellicles 121 through 180 are at the U. S. Naval Postgraduate School, Monterey, California. The data reported herein is taken entirely from this portion of the stack.

#### b. Scanning Techniques

Because of the large size of the beam and the high pion energy, the pion interactions are fairly uniformly distributed throughout the volume of the stack. <sup>1</sup>Those pions that do not interact lose  $\approx 100$  Mev ( $< 1\%$ ) in passing through the stack; the mean free path for interactions is several times the length of the stack. <sup>1</sup> Since biases

<sup>1</sup>The geometric MFP for strongly interacting particles in emulsion is about 25 cm.

which tend to reduce the efficiency for locating events in which only fast particles are produced were not important in this study, area scanning techniques were used. The area to be scanned was chosen as 10 mm long and 30 mm wide perpendicular to the beam and centered 50 mm downstream from the entering edge, as diagrammed in Fig. 2. The location of the area is a compromise between the desire to bring to rest energetic evaporation particles and also energetic hyperons produced directly in the interaction in the available volume of emulsion. The reactions which produce hyperons cannot produce them backwards in the lab system, so as much emulsion as possible was wanted "downstream" from the interactions. On the other hand, evaporation particles would be produced approximately isotropically in the lab, and it was desired to provide enough emulsion to bring them to rest. The following considerations governed our choice of an area near the entrance edge of the stack.

A proton whose track has a blob density twice that of the incoming negative pion has a kinetic energy of  $\approx 132$  Mev ( $\beta = 0.48$ ), a residual range of 50 mm, and a moderation time of  $4.3 \times 10^{-10}$  sec. The corresponding values for other particles of interest are shown in Table II. It can be seen that the moderation time is several times the lifetime of the charged hyperons. Therefore, a hyperon emitted forward with a track of this blob density would probably decay before coming to rest in the emulsion. A  $\Sigma$  hyperon with a flight time equal to  $1 \times 10^{-10}$  sec would have a residual range of only 6.0 mm, and an initial kinetic energy of 43 Mev, and be 3.0 times minimum ionization. The downstream

distance of over 90 mm is adequate to stop any baryons with a track of initial ionization greater than twice minimum. The  $\approx 50$ mm of emulsion available to stop particles emitted in the backward direction is sufficient to bring to rest protons of energy less than  $\approx 130$  Mev.

The scanners, to whom much credit is due for these data, completely scanned the designated areas of plates 131, 132, 133 and 140. The authors partially scanned plates 134 and 135. The total volume of the emulsion scanned was  $1.11 \text{ cm}^3$  or 0.1% of the stack. Available scanning time was not sufficient to permit complete scanning of the indicated plates.

In order to minimize scanning bias and increase scanning efficiency, each square millimeter was examined at four different positions, which provided approximately 25% overlap in the fields of view. At each position the depth of the pellicle was traversed twice, up and then down. The efficiency for locating events was checked by re-scanning a selected region and comparing the data obtained by two observers. We estimate that more than 90% of the events with at least one particle emitted above minimum ionization, in the scanned volume of emulsion, were located; although some bias (failure to observe interactions which produce only particles near the minimum of ionization) is expected.

c. Data Recording

All data are recorded on  $8 \frac{1}{2}$  by 11 inch McBee Keysort cards  $\overline{\overline{6}}$  of the type shown in Fig. 3. The holes across the top are used to describe the event. Holes along the bottom give the date the event is found. When an event is located, a card is made for it and a

sketch of the event is drawn on the back of the card. After marking its location in the emulsion on the front side, the appropriate holes are punched to describe the interaction and the date found. As the prongs are analyzed, the data are recorded on the front. Where necessary, additional comments are added on the back.

TABLE II.

Track Parameters of Various Particles in Emulsion with  $\beta = 0.48$

	P	$\Sigma^-$	$\Xi^-$	$K^-$	$\pi^-$
Kinetic Energy (Mev)	132	167	185	70	20
Residual Range (mm)	50	63	70	26	7.5
Moderation Time ( $10^{-10}$ sec)	4.3	5.5	6.1	2.3	6.6
Mean Lifetime ( $10^{-10}$ sec)	stable	1.6	1.3	100	200

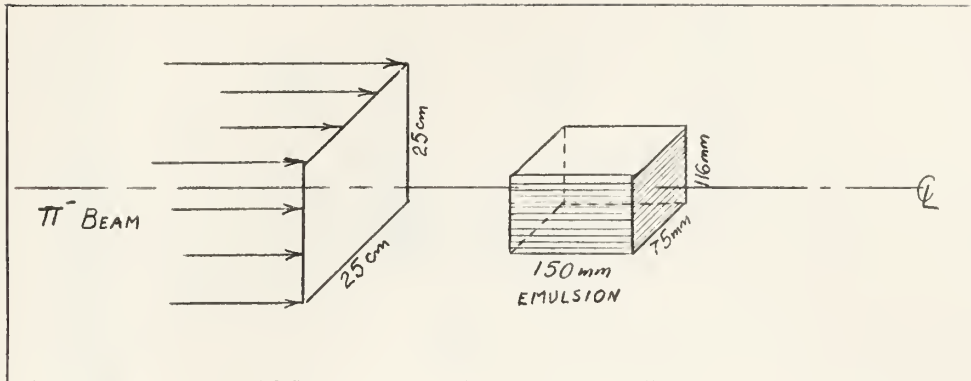

Fig. 1. Diagram of Position of Emulsion in Beam

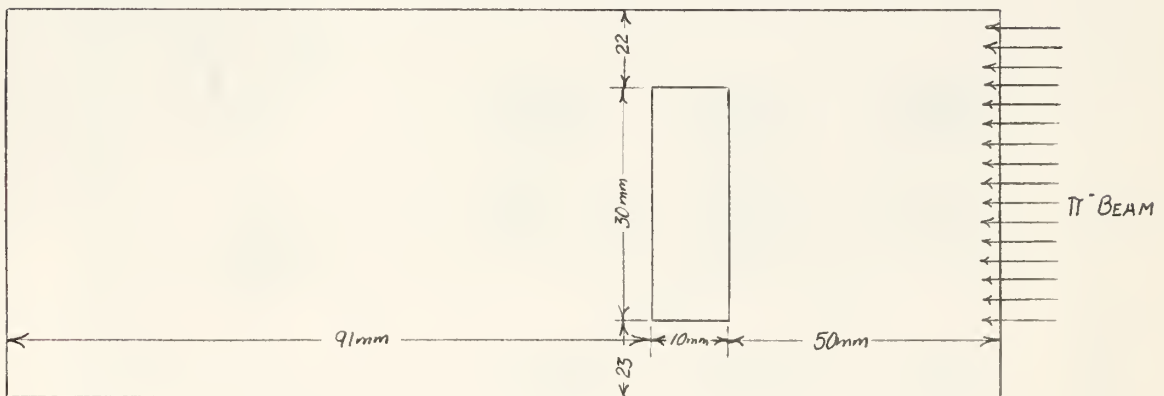

Fig. 2. Diagram of Position of Area Scanned in Pellicle

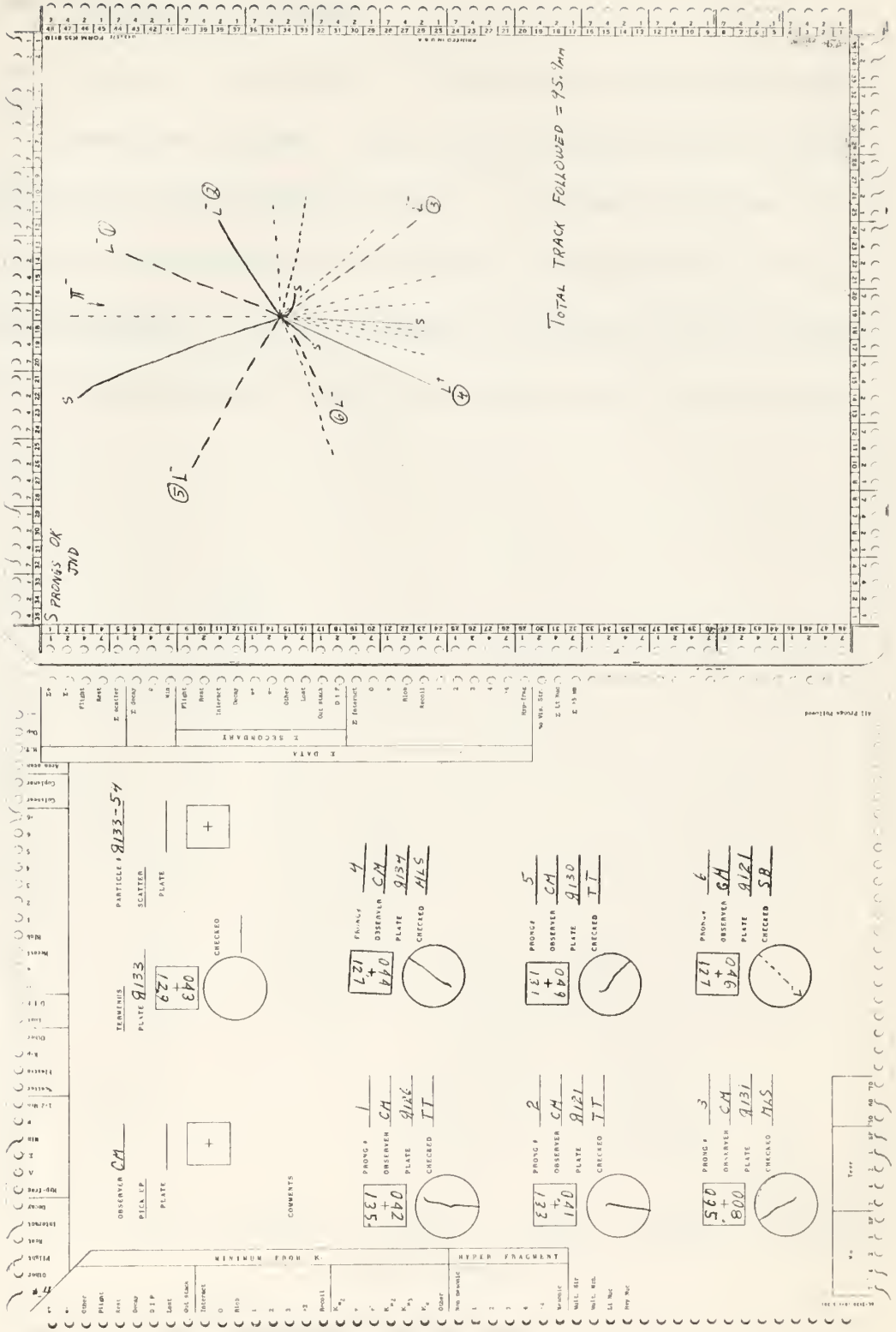

Fig. 3. McBee Keysort Card

#### 4. Experimental Results

##### a. Distribution of Prongs

A total of 139 incident  $\pi^-$  interactions were found in the 1.11<sup>3</sup> cm of emulsion scanned. These stars produced a total of 1926 recordable prongs as tabulated in Table 3. In several of the stars there were so many minimum tracks in the jet that no accurate count of the tracks was attempted. The least number of prongs was 3 and the maximum was 33. As is shown in Fig. 4, the median was 12, and the mean was 14.

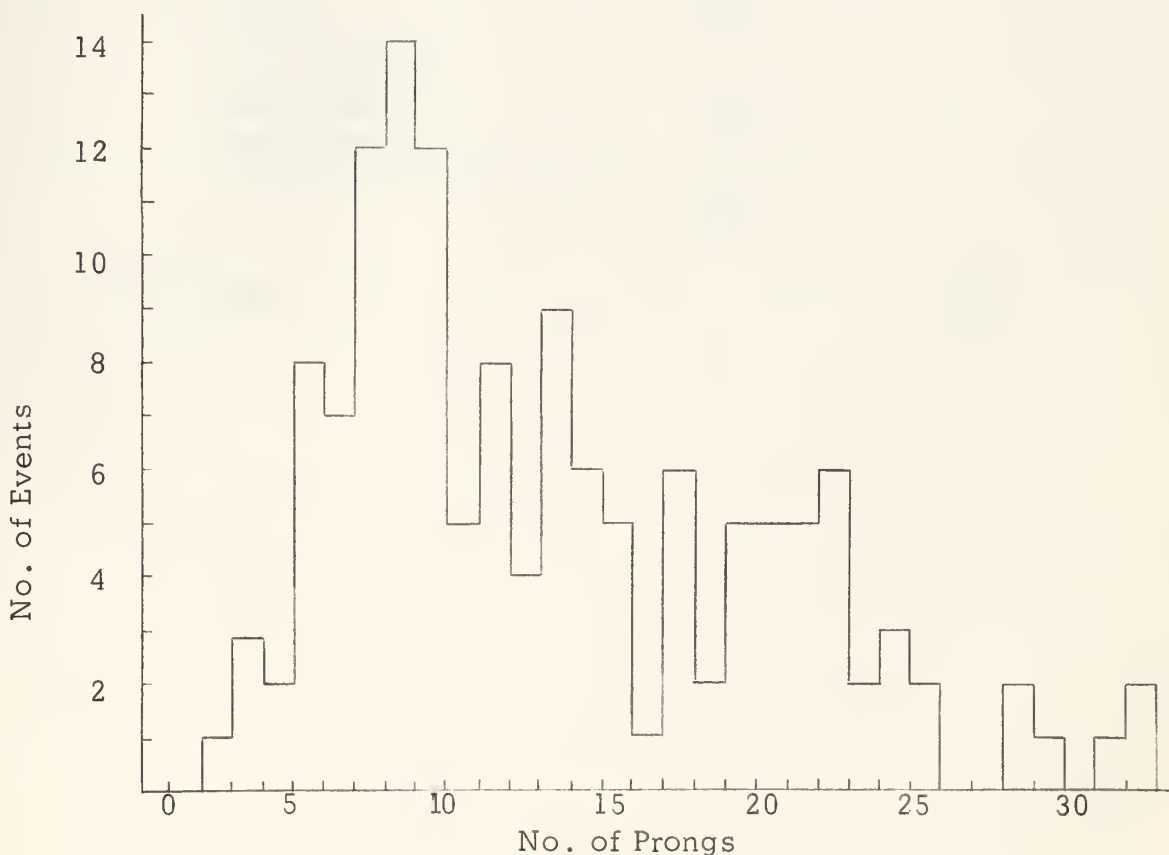

Fig. 4. Prong Frequency Distribution

TABLE III.

Prong Observations and Identifications  
of Those Followed to Termination

Number of prongs unfollowed		604
Number of prongs partially followed		207
left emulsion	27	
passed through 121	154	
quit following	<u>26</u>	
	207	
Number of prongs followed to completion		1115
Protons	1063	
Stars in flight	15	
Decay in flight	1	
Stars at Rest	21	
Decays at Rest	11	
Energetic Particle Scatters	<u>4</u>	
	1115	
Total Prongs		1926

All prongs whose blob density was at least twice that of the incoming pion track were followed. Other prongs were followed if they were (1) not near-minimum tracks emitted in the forward jet and (2) had dip angles less than  $30^\circ$ . Scanning along steep tracks was stopped if, after following them through ten plates, no change in lacunarity was observed. This occurred with only 26 prongs. In addition, 154 prongs were not followed to their termination because they passed through plate 121. Another 27 prongs were not followed to termination because they left the stack.

b. Identification of Prongs

1) Protons and other stable particles. Of the 1115 prongs which were followed to their termination, decay, or interaction, 1063 were found to have proton-like endings. A particle was classified as a proton if the scattering and rate of change of lacunarity of its track were consistent with a proton and the prong ending was clean. No attempt was made to separate deuterons, tritons,  $\alpha$ -particles, or other low Z fragments from this group. We use "proton" as a general classification for all particles whose behavior is similar to protons.

Care was taken to insure that none of the proton endings actually were hyperon decays at rest. To insure that decays that produce only a minimum ionization track were not being overlooked, nearly every prong ending was inspected by at least two observers. No minimum tracks were found originating at the proton-like endings. Minimum blob density in this emulsion is 22 blobs/100  $\mu$ , which is sufficiently high to make recognition of fast particle tracks relatively certain. Energetic electrons from muon decays in the emulsion were readily seen.

Although it is possible that our identification of these prongs as tracks of stable particles conceals some  $\Sigma^-$  interactions at rest, and some  $\Sigma^+ \rightarrow P + \pi^0$  decays in flight, the lack of other indications for the presence of these particles leads us to believe that the number of such events is negligible.

Anti-particles generally produce easily recognized stars  $\overline{\langle 7 \rangle}$  and we assume none were overlooked among these prongs.

2) Pions. There were 28 pions identified among the 1115 tracks which were followed to termination. Of the 28, three were  $\pi^+$ , 22 were  $\pi^-$ , and three interacted in flight and were of unknown charge. The energy distribution of the 25 stopping pions is shown in Fig. 5. Owing to our criteria for selecting tracks to follow, this distribution is complete only for energies below about 20 Mev. The tracks of pions of higher energy (blob density less than twice that of the incident beam pions) were followed only when they were not in the forward jet. It is reasonable to assume that the jet of the pion-nucleon interactions contained many energetic pions.

Three other pions were found. One had a kinetic energy of 283 Mev and a second had 30 Mev, each produced a five prong star in flight. The third had a kinetic energy of 104 Mev, suffered a collision, and left the stack. The charges of these three pions could not be determined.

3) Other particles. Only one definite strange particle was identified. It appeared to be a  $\Sigma^+$  decaying in flight. Ten possible interactions were found. Six of these appeared as short black tracks

approximately at rest with one short (few microns) black track originating at the end. In each of these six events, the prong ending is also commensurate with a large angle proton scatter. No detailed analysis of the events was possible because of the short length of track.

The four remaining possible sigmas each seemed to produce a slow electron when it came to rest. These could be  $\Sigma^-$  interactions. As was true with the six other possible sigmas, the tracks were too short to allow a detailed analysis. We believe these electrons are not the result of  $\Sigma^-$  captures on nuclei, but are background electron tracks in the emulsion whose appearance at the terminations of these proton-like tracks is coincidental.

In summary, only one decay in flight was detected and, except for pions, no clear case of a decay or interaction at rest was noted. The lack of other evidence for strange particle or anti-particle production leads us to believe that the possible interactions noted above are not cases of  $\Sigma$  or  $\Xi$  interactions.

4) Stars in flight. There were 15 stars in flight. Table IV is a table indicating the incident particle velocity at the point of interaction, determined from ionization measurements; the corresponding energy; the number of prongs; and the visible energy release for each star, assuming the particles emitted are protons. None of the stars were found to be exothermic with the exception of one pion star in flight. Since they were not exothermic, it appears that they were not

caused by anti-particles or strange particles. Examination of the incident prong indicates that in addition to the two pion stars in flight there were 10 baryon (probably proton) stars in flight. Most of the tracks from the stars in flight came to rest in the emulsion and were found to have been produced by protons. The three remaining stars in flight (included in Table IV) were produced by particles heavier than a baryon. Measurements of the tracks indicate the particles were deuterons or tritons.

A total of 841 cm of track (prong lengths) was followed. The mean free path is thus 56 cm, not inconsistent with that expected for protons.

5) Hyperfragments. Three hyperfragments (HF) were found with the characteristics listed below.

<u>Event</u>	<u>No. of Protons Emitted by Parent Star</u>	<u>Prongs of HF</u>	<u>Range of HF</u>	<u>Angle with Beam</u>
140-93	19	2	9.8 $\mu$	102 <sup>o</sup>
129-1	17	2	842 "	94 <sup>o</sup>
131-23	11	3	594 "	----

The number of evaporation protons indicates that the nuclei were of high  $Z$ , probably Ag or Br in the emulsion. Two of the HFs were fairly energetic with a minimum of 25 Mev. One HF was not produced by a beam pion star, therefore, there is no angle associated with its emission. The HF appear to be light fragments produced by interactions with heavy nuclei. All were non-mesonic decays.

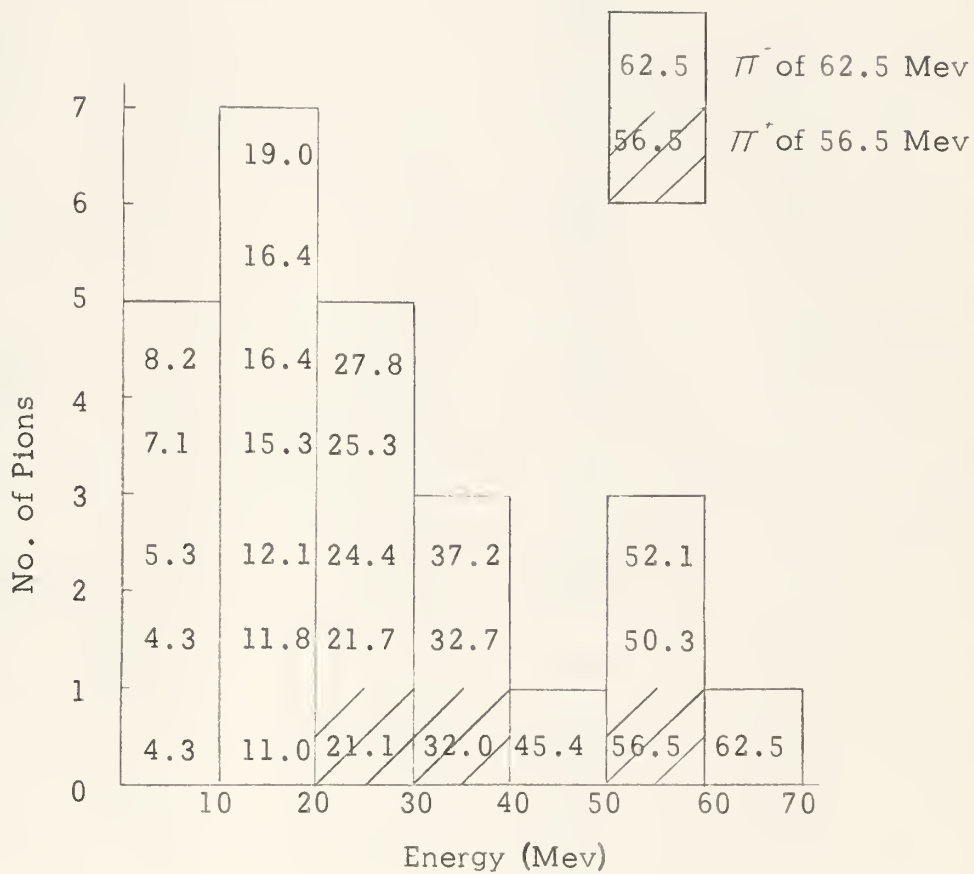

Fig. 5. The energy distribution of stopping pions.  
 Twice minimum is  $\approx 14$  Mev.

TABLE IV

## Characteristics of Stars in Flight

Event Number	Incident Particle	$\beta^1$	$T^2$ (Mev)	No. of Prongs	$T^3$ (Mev)
131-19(10)	Baryon	.35	63	1	1
131-77(6)	"	.35	63	3	36
131-64a(3)	"	.35	63	2	32
132-30(7)	"	.35	63	1	4
132-31(7)	"	.56	195	4	109
132-78(1)	"	.35	63	1	18
132-100(4)	"	.35	63	2	19
133-18(3)	"	.39	81	2	29
135-23a(9)	"	.37	72	2	7
135-23a(10)	"	.50	160	1	3
133-83(14)	Pion	.57	30	5	24
140-1(4)	"	.94	283	5	352
131-28(2)	Heavy	.37	140	1	10
133-83(4)	"	.35	126	2	12
135-23a(3)	"	.41	180	3	26

1. Velocity of incident particle.

2. Kinetic energy of the incident particle if the baryon is a proton and the heavy particle is a deuteron.

3. Total kinetic energy of the emitted particles.

## 5. Neutral Stars

Of primary interest for this thesis were the stars produced by incoming pions. Of secondary interest were stars produced by the contaminating particles in the pion beam or by particles produced in the pion interactions. The prongs of all the non-pion stars were examined to determine which, if any, produced the event. A few of the stars were produced by particles originating in beam pion stars. These were discussed in Section 4, as part of the stars in flight or stars at rest.

The majority of the stars did not have a charged incoming prong. These 333 stars were probably produced by neutrons or neutral mesons which were emitted from the pion stars. No interesting particles were produced by these neutral stars, other than the HF already discussed.

## 6. Conclusion

In the 139  $\pi^-$  stars, one definite  $\Sigma^+$  decay was found. No other positive identification of strange particles was possible. This lack of strange particle production indicates very low cross-sections for the associated production reactions needed to conserve strangeness in pion collisions. Recent data from bubble chamber groups indicate  $\sqrt{s}$  that hyperon production cross-sections are only a few millibarns for charged  $\Sigma$  and the order of microbarns for  $\Xi^-$ .

Three important results follow from this thesis.

(a) This stack does not provide a useable source of charged strange particles for further study of their characteristics.

(b) The production of heavy fragments (d, t, and etc.) by the stars has been detected and warrants further study.

(c) Hyperfragment production has been detected and is frequent enough to make possible a future study of HF production in these interactions.

## APPENDIX I

### Track Ionization

The grain density of a track is directly related to the particle velocity. The number of grains per unit length is not directly observable, however, because adjacent grains may coalesce into a "blob." The number of blobs and the distance between blobs are the observable characteristics of the track which can be related to particle velocity  $\sqrt{g}$ .

The blob density (B) is related to the grain density (g) by

$$(1) \quad B = g e^{-\alpha g}$$

where  $\alpha$  is the mean distance between centers of "just resolvable" grains. The value of  $\alpha$  can be calculated by noting that B is maximum when  $g = \frac{1}{\alpha}$  and  $B_{MAX} = \frac{1}{e\alpha}$ . Lacunarity (L) is defined as the linear fraction of the track occupied by gaps. It is related to the grain density by

$$(2) \quad L = e^{-\alpha g}$$

It can be noted that g is equal to B/L.

It was found useful to measure B, L, and g as functions of particle velocity. Since all tracks are inclined to some degree with respect to the emulsion surface, it was necessary to correct the observed values of B and L, which are measured along the projected horizontal distance, to the actual values of the dipping track. If  $\delta$  is the dip angle in unprocessed emulsion, then the previous equations become

$$(3) B_{\delta} = g \sec \delta e^{-\alpha g \sec \delta}; \quad B = B_{\delta} \cos \delta e^{\alpha g (\sec \delta - 1)}$$

$$(4) L_{\delta} = e^{-\alpha g \sec \delta}; \quad L = L_{\delta} e^{\alpha g (\sec \delta - 1)}$$

To simplify the conversion of  $L_{\delta}$  to  $L$ , a plot of  $L/L_{\delta}$  versus  $g$  was made for different dip angles as shown in Fig. 6. The actual value of  $L/L_{\delta}$  for a given angle was found by interpolating from the curves. The correction of  $B$  for the dip was performed by using the equation (3) above.

Using the equipment described in Appendix II,  $B$  and  $L$  were measured as a function of residual range for tracks known to be caused by protons which have small inclinations ( $< 20^{\circ}$ ) with respect to the emulsion surface. The velocity of the protons at the measured residual ranges was taken from tables developed by Barkas [9, 10] of velocity as a function of range. Curves were then made of  $L$  and  $B$  as a function of velocity as shown in Figs. 7 and 8. A curve of  $g$  vs  $\beta$  as shown in Fig. 9 was plotted by taking the values of  $B$  and  $L$  for a given  $\beta$  from Figs. 7 and 8 and calculating  $g$ .

To determine the velocity at a given point of an unknown particle,  $B$  and  $L$  were measured and  $g$  then calculated. A value of  $\beta$  was then determined from each of the appropriate curves. An average value of  $\beta$  was then calculated.

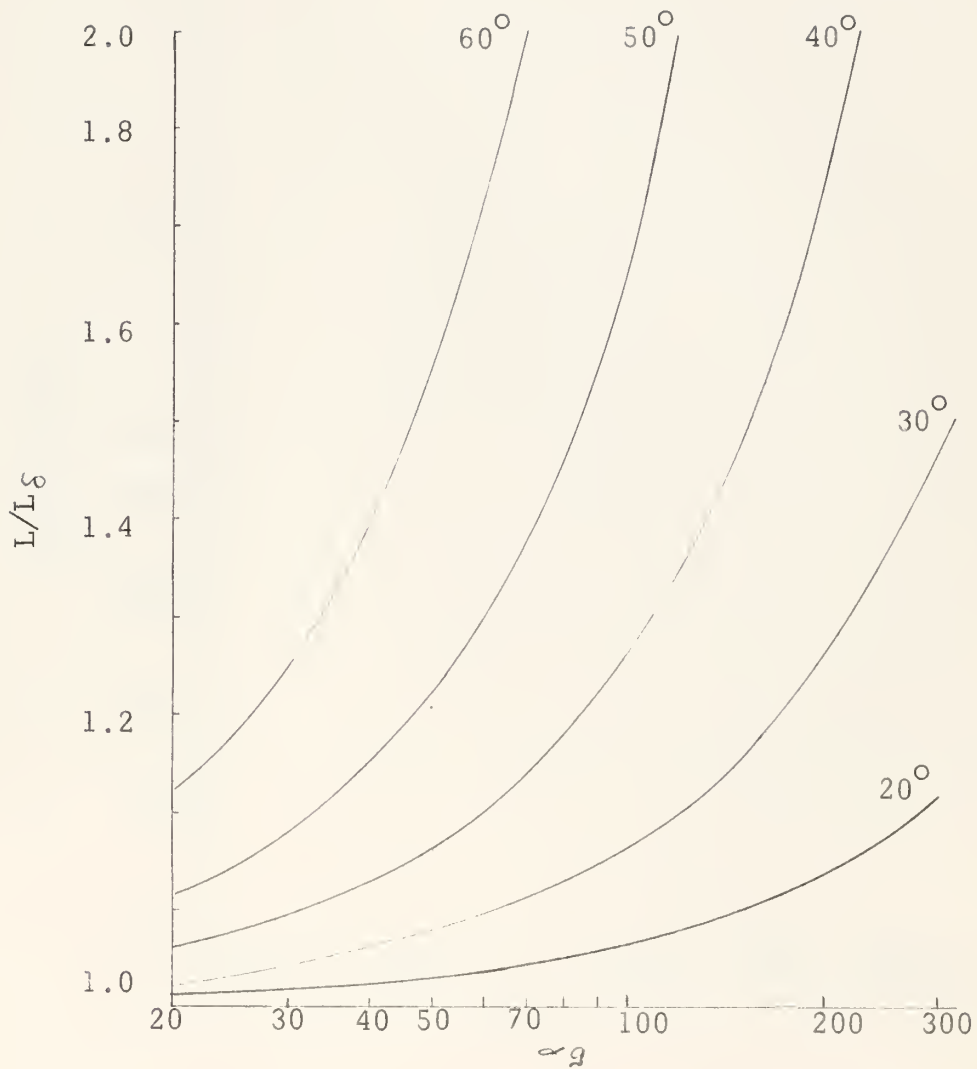

Fig. 6. The lacunarity dip correction plotted for various dip angles.



Fig. 7. The experimental curve of lacunarity vs velocity.

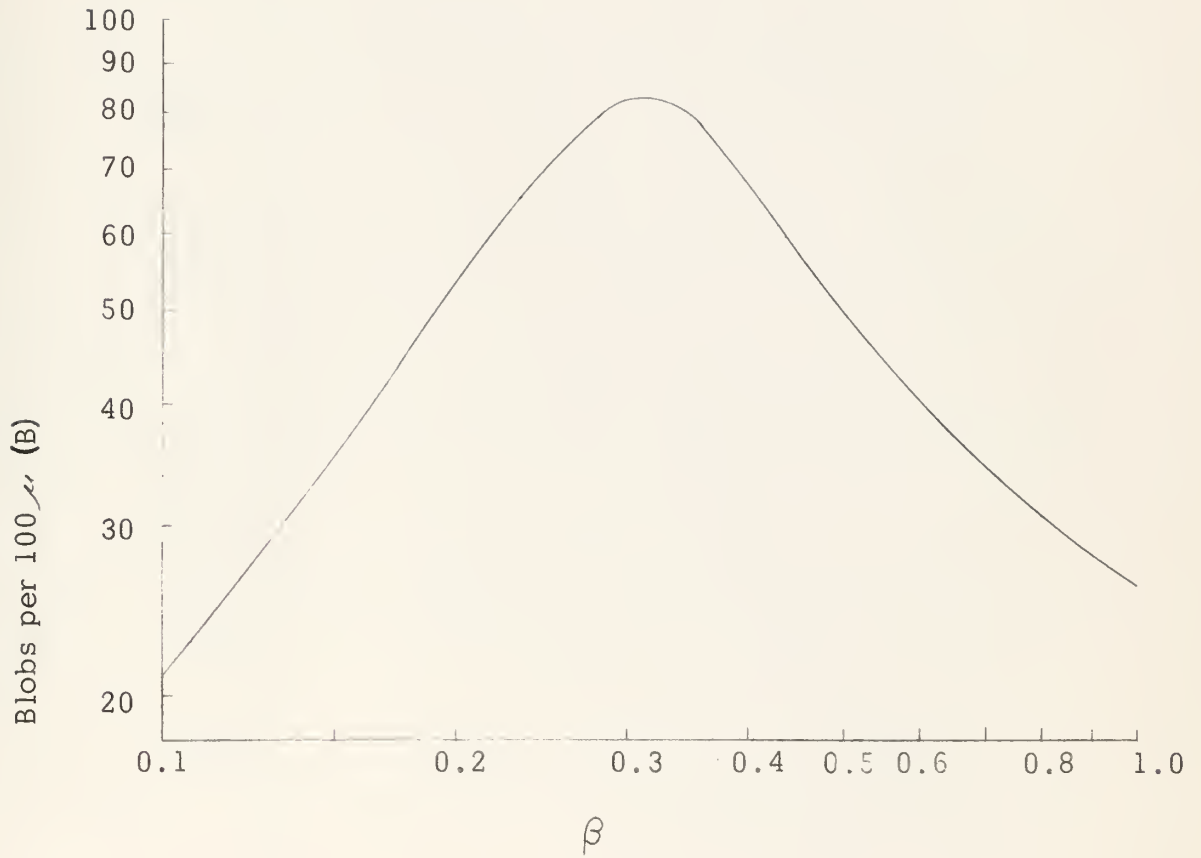

Fig. 8. Experimental curve of blob density vs velocity.

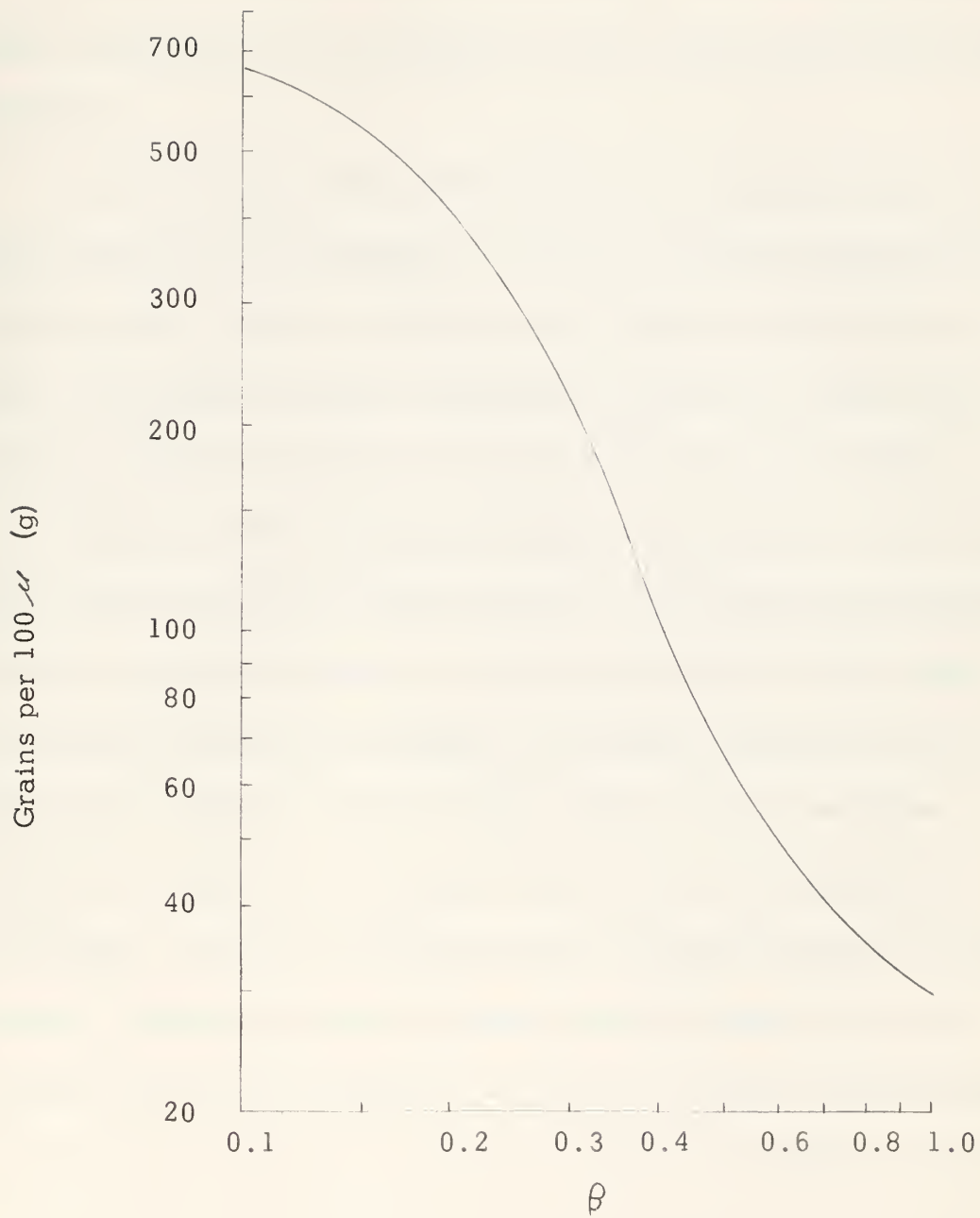

Fig. 9. Experimental curve of true grain density vs velocity where  $g=B/L$ .

## APPENDIX II

### Ionization Measurements

Blob counts and lacunarity measurements were made with an automated microscope stage and recording device, which consisted of the following:

a) A microscope with a motor driven motion along the X-axis and speed controlled by the observer. The drive mechanism consisted of a variable speed, 115v DC, 1/125 HP, 4000 RPM motor with 200:1 and 100:1 oil bath gear reduction assemblies, (connected in series with flexible couplings) to provide a total speed reduction of 20,000:1. Two 2-inch gears were used (one mounted concentrically on the X-axis of the stage screw and the other mounted on the second gear reduction assembly), by direct meshing, to couple the motor unit to the stage. The complete motor driving assembly was mounted separately from the microscope. The microscope and motor drive assembly were then mounted on a common base equipped with a guide bar and clamping arrangement to permit rapid alignment when engaging the motor driving assembly. Speed control and regulation (constant speed being most important, since track differentials are used in lacunarity measurements) was provided by the use of a constant voltage AC transformer and two DC rectifiers providing independent power supplies for the field and armature coils. The use of two rectifiers in this manner was found necessary in order to minimize speed variations resulting from varying loads (caused by eccentricity and other irregularities of the X-axis drive screw).

Using a constant field of 110v while varying the armature voltage from 15v to 75v gave advance rates from 21 to 150  $\mu$  /min. with little or no loss in resolution caused by vibration, even under 1500X magnification. The majority of measurements were made at the slowest speed with the higher speeds used for measuring track length.

b) A telegraph key switch which was held down while a blob (or gap) passed beneath a hairline situated in one of the microscope eyepieces.

c) A recording device consisting of two clocks and a counter.<sup>1</sup> One clock measured the total time in which the track was studied (proportional to track length). The other recorded the total time required for blob (or gap) traversal (proportional to blob length). The counter, actuated by the closing of the telegraph key, registered the number of blobs (or gaps). The complete recording device was controlled by a foot switch which turned the equipment on whenever the observer desired to make measurements. With a single traversal the blob count and opacity (or lacunarity) of a track segment may be determined.

Table 5 lists the advance rates for various voltages, and Fig. 10 is a schematic drawing of the complete arrangement.

<sup>1</sup>

We are indebted to Dr. W. H. Barkas of the Lawrence Radiation Laboratory for lending us this equipment.

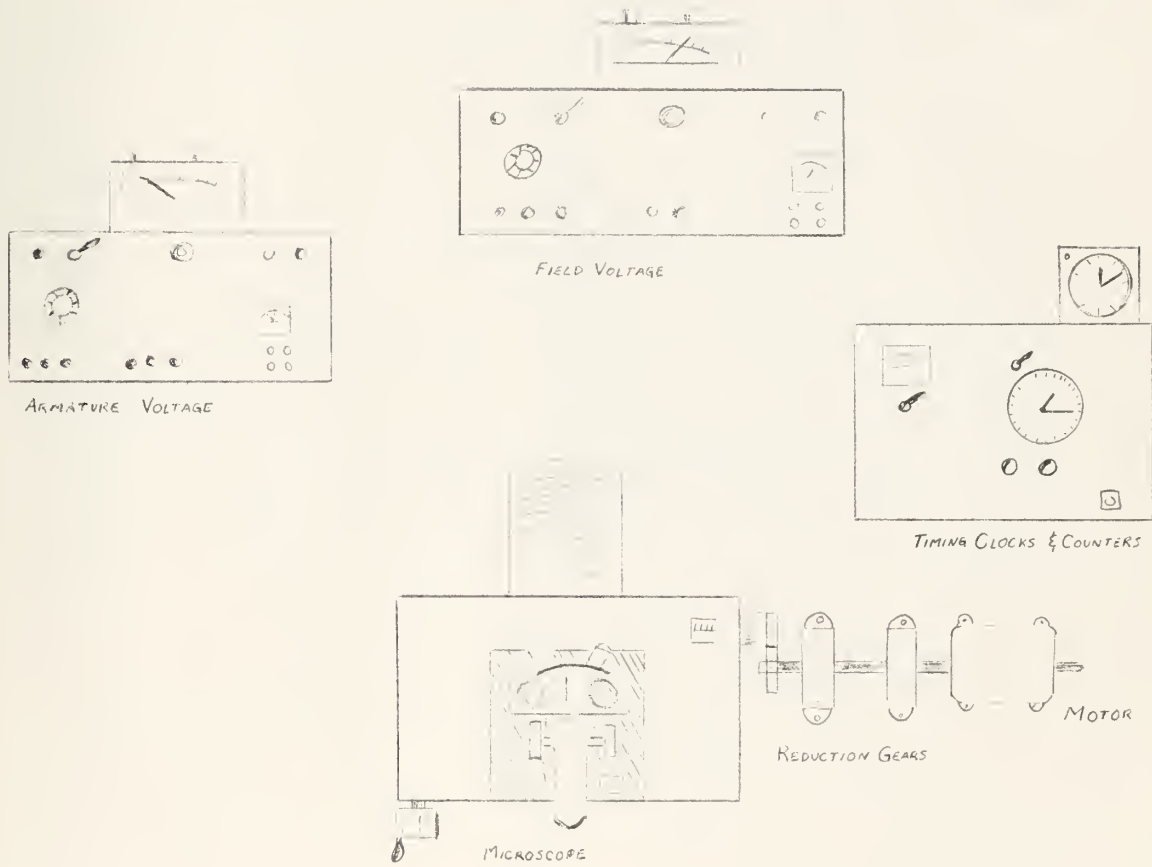

Fig. 10. Schematic of Motor and Microscope

TABLE V

## Stage Speed versus Voltage

Field Voltage (Volts)	Armature Voltage (Volts)	Stage Speed ( $\mu$ /min)
110	15	21
110	25	45
110	35	65
110	45	86
110	55	105
110	65	136
110	75	150

### APPENDIX III

#### Production of Hyperons in Relativistic $\pi^-$ Interactions

We illustrate the calculation of the momentum of a hyperon in the lab by a specific example, the reaction



The relations needed are shown in the diagram below.

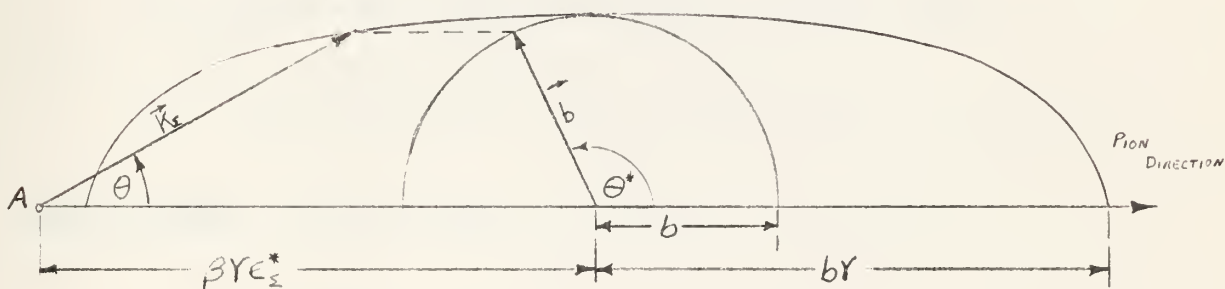

$\beta$  and  $\gamma$  refer to the velocity of the CM

$E_{\Sigma}^*$  = total energy of  $\Sigma$  in CM

$b$  = momentum of  $\Sigma$  in CM

$\vec{K}_{\Sigma}$  = momentum of  $\Sigma$  in lab

$\theta$  and  $\theta^*$  = angle of emission in lab and CM respectively

The vector  $\vec{K}_{\Sigma}$  originates at A and may terminate anywhere on the momentum ellipse. Using standard relativistic formulas, and letting  $M_{\Sigma} = 1.19$  Bev and  $M_{\pi} = 0.14$  Bev, the following are easily derived:

( $c = 1$ )

$$\beta = \frac{K_{\pi}}{\epsilon_{\pi} + m_p} = \frac{16.2}{16.2 + 0.94} = 0.945$$

$$\gamma = \frac{1}{\sqrt{1 - \beta^2}} = 3.057$$

$$\beta\gamma = 2.889$$

The CM momentum,  $b$ , can be calculated from the relativistically invariant quantity  $N = \sqrt{E^2 - K^2}$  where  $E$  = total energy of system and  $\vec{K}$  = total momentum of system. The result of the calculation is

$$b = \frac{1}{2N} \sqrt{[N^2 - (M_{\Sigma} + M_{\pi})^2][N^2 - (M_{\Sigma} - M_{\pi})^2]} = 2.647 \text{ Bev}$$

$$N = \sqrt{[\epsilon_{\pi} + m_p]^2 - K_{\pi}^2} = 5.596 \text{ Bev}$$

Thus we have  $b = 2.647 \text{ Bev}$

$$b\gamma = 8.09 \text{ Bev}$$

$$\beta\gamma\epsilon_{\Sigma}^* = 8.38 \text{ Bev}$$

and  $\vec{K}_{\Sigma}^*(min) = \beta\gamma\epsilon_{\Sigma}^* - b\gamma = 0.29 \text{ Bev}$

At this momentum a  $\Sigma$  hyperon has a range in emulsion of only about 4 mm. A similar calculation for the reaction  $\pi^- + p \rightarrow \Xi^- + K^+ + K^0$  shows that the minimum  $\Xi^-$  range in emulsion is about 10 mm.

The production of additional pions in the final state will increase the range of the hyperon in the lab systems. The hyperon momentum in the CM will be reduced. The pions moving forward in the CM will produce tracks near minimum ionization.

## ACKNOWLEDGMENTS

We are grateful to Dr. John N. Dyer for suggesting and guiding this research, and to Dr. Fred R. Buskirk and Dr. Harry E. Handler for their interest and encouragement.

Our sincerest thanks go to the scanners, Mrs. Gail Henderson and Mrs. Carol Magers, and to the technicians who assisted us in maintaining the equipment, particularly to Mr. Manuel Lago.

We are also indebted to our wives, without whose assistance it would have been difficult to have completed this work.

This research was done under the auspices of the Office of Naval Research and the United States Atomic Energy Commission.

## BIBLIOGRAPHY

1. W. H. Barkas and A. H. Rosenfeld, *Data for Elementary Particle Physics*, UCRL - 0830 (rev) Oct. 1, 1961
2. W. G. McMillan and E. Teller, *Phys. Rev.* 72, 1 (1947) also W. H. Barkas, *Phys. Rev.* 75, 1109 (1949)
3. CERN HEP and IEP Groups. Reported in Aix-en-Provence International Conference on Elementary Particles, 1961
4. J. Blaton, *Kgl. Danske Videnskab. Selskab, Mat.-Fys. Medd.* 1950
5. Private communication from Dr. O. Lock, CERN
6. W. H. Barkas, *Equipment and Methods for Automatic Track Analysis*, UCRL - 8482, Aug 14, 1958
7. Dyer, Heckman, Smith, Esenberg, Nikols, Schneeberger and Winzeler, *Helv. Phys. Acta*, 32, Fasc 6-7, 1959
8. J. N. Dyer, *Charged Hyperon Production and Decay: Energetics, Lifetimes, and Branching Ratios (Thesis)*, UCRL - 9450, Nov 1, 1960
9. W. H. Barkas and D. M. Young, *Emulsion Tables, I. Heavy-Particle Functions*, UCRL-2579 (Rev), Sept 1954
10. W. H. Barkas, *The Range-Energy Relation in Emulsion Part 2 The Theoretical Range*, UCRL-3769, April 9, 1957





thesS1578

Preliminary experimental analysis of 16

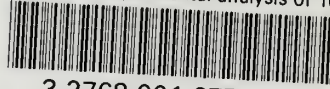

3 2768 001 97716 8

DUDLEY KNOX LIBRARY