

UNCLASSIFIED

AD NUMBER

AD506484

CLASSIFICATION CHANGES

TO: UNCLASSIFIED

FROM: CONFIDENTIAL

LIMITATION CHANGES

TO:
Approved for public release; distribution is unlimited.

FROM:
Distribution authorized to U.S. Gov't. agencies and their contractors;
Administrative/Operational Use; 14 AUG 1969.
Other requests shall be referred to Office of the Adjutant General (Army), Washington, DC 20310.

AUTHORITY

AGO ltr 29 Apr 1980 ; AGO ltr 29 Apr 1980

THIS PAGE IS UNCLASSIFIED

GENERAL DECLASSIFICATION SCHEDULE

**IN ACCORDANCE WITH
EO 13526.1-3 & EXECUTIVE ORDER 11652**

SECURITY

MARKING

The classified or limited status of this report applies to each page, unless otherwise marked.

Separate page printouts MUST be marked accordingly.

THIS DOCUMENT CONTAINS INFORMATION AFFECTING THE NATIONAL DEFENSE OF THE UNITED STATES WITHIN THE MEANING OF THE ESPIONAGE LAWS, TITLE 18, U.S.C., SECTIONS 793 AND 794. THE TRANSMISSION OR THE REVELATION OF ITS CONTENTS IN ANY MANNER TO AN UNAUTHORIZED PERSON IS PROHIBITED BY LAW.

NOTICE: When government or other drawings, specifications or other data are used for any purpose other than in connection with a definitely related government procurement operation, the U.S. Government thereby incurs no responsibility, nor any obligation whatsoever; and the fact that the Government may have formulated, furnished, or in any way supplied the said drawings, specifications, or other data is not to be regarded by implication or otherwise as in any manner licensing the holder or any other person or corporation, or conveying any rights or permission to manufacture, use or sell any patented invention that may in any way be related thereto.



CONFIDENTIAL

DEPARTMENT OF THE ARMY
OFFICE OF THE ADJUTANT GENERAL
WASHINGTON, D.C. 20310

IN REPLY REFER TO

AGDA (M) (8 Dec 69) FOR OT UT 693083

16 December 1969

AD506484

**SUBJECT: Operational Report - Lessons Learned, Headquarters, Americal
Division Artillery, Period Ending 31 July 1969 (U)**

SEE DISTRIBUTION

1. Subject report is forwarded for review and evaluation in accordance with paragraph 4b, AR 525-15. Evaluations and corrective actions should be reported to ACSFOR OT UT, Operational Reports Branch, within 90 days of receipt of covering letter.
2. Information contained in this report is provided to insure appropriate benefits in the future from lessons learned during current operations and may be adapted for use in developing training material.

BY ORDER OF THE SECRETARY OF THE ARMY:

KENNETH G. WICKHAM
Major General, USA
The Adjutant General

1 Incl
as

DISTRIBUTION:

Commanding Generals

- US Continental Army Command
- US Army Combat Developments Command
- US Army Materiel Command

Commandants

- US Army War College
- US Army Command and General Staff College
- US Army Air Defense School
- US Army Armor School
- US Army Aviation School
- US Army Chemical School
- US Army Combat Surveillance School
- US Army Electronic Warfare School
- US Army Engineer School
- US Army Field Artillery School
- US Army Infantry School
- US Army Missile and Munitions School
- US Army Ordnance School
- US Army Special Warfare School

"THIS DOCUMENT CONTAINS INFORMATION AFFECTING THE NATIONAL DEFENSE OF THE UNITED STATES WITHIN THE MEANING OF THE ESPIONAGE LAWS, TITLE 18, U. S. C., SECTION 793 AND 794. ITS TRANSMISSION OR THE REVELATION OF ITS CONTENTS IN ANY MANNER TO AN UNAUTHORIZED PERSON IS PROHIBITED BY LAW."

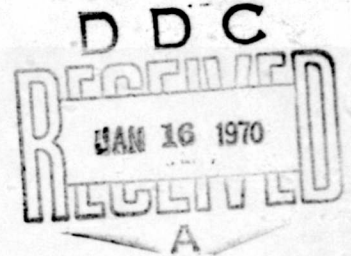

**Regraded unclassified when separated
from classified inclosure.**

CONFIDENTIAL

CONFIDENTIAL

DISTRIBUTION (Cont'd)
US Army Transportation School

Copies furnished:
Office, Chief of Staff, US Army
Deputy Chiefs of Staff
Chief of Research and Development
Assistant Chiefs of Staff
Chief of Engineers
OSD(SA) Assistant for Southeast Asia Forces
Director, Defense Research & Engineering
Office, Joint Chiefs of Staff
Commanding Generals
 US Army Electronics Command
 US Army Weapons Command
 III Corps
Deputy Chief of Staff, Air Force, Plans & Operations
Commandant of the Marine Corps
Senior Army Representative, Marine Corps Development & Education Command
USAF Air Ground Operations School
The Air University Library
Defense Documentation Center
Security Officer, Hudson Institute
USAF Project RAND
Commanding Officers
 US Army Limited War Laboratory
 US Army Logistics, Doctrine Systems & Readiness Agency
 US Army Mobility Equipment Research & Development Center
 Americal Division Artillery

CONFIDENTIAL

CONFIDENTIAL

DEPARTMENT OF THE ARMY
Headquarters Americal Division Artillery
APO San Francisco 96374

AVDF-ATCO

14 August 1969

SUBJECT: Operational Report of Americal Division Artillery
for the Period Ending 31 July 1969, FCS CSFOR (RI) (U)

SEE DISTRIBUTION

1. (C) Section I: Operations

a. (U) Command

(1) Colonel Leslie B. Hardy commanded Americal Division Artillery during the period of this report.

b. (U) The following units were assigned, attached or CPCON to Americal Division Artillery:

(1) 6th Battalion, 11th Artillery (105mm towed) remained assigned. LTC James H. Sloan, Jr. commanded during this report.

(2) 1st Battalion, 14th Artillery (105mm towed) remained assigned. LTC James J. Durbin commanded during the period of this report.

(3) 3d Battalion, 16th Artillery (155mm towed) remained attached. LTC Andrew E. Foster Jr. assumed command 1 June 1969, replacing LTC Jack R. Pilk who commanded through 31 May 1969.

(4) 2d Battalion, 18th Artillery (8"how/175mm gun) remained attached. LTC William F. Sifford Jr. assumed command on 19 July 1969 replacing LTC James E. Pruitt who commanded until 17 July 1969.

(5) 6th Battalion, 56th Artillery (HAWK) remained assigned to the Americal Division Artillery and CPCON 7th Air Force until 1 July 1969. The unit departed for CCNUS on 2 August 1969 and will be inactivated. LTC J.A. Richard Guertin commanded during the period of this report.

(6) 1st Battalion, 82d Artillery (155mm towed/2"SP)

PAGE 1 OF 21 PAGES

1

CONFIDENTIAL

FOR OT UT
693083
Inclosure

DOWNGRADED AT 3 YEAR INTERVALS;
DECLASSIFIED AFTER 12 YEARS.
DOD DMR 5200.10

AVDF-ATCC

CONFIDENTIAL

14 August 1969

SUBJECT: Operational Report of Americal Division Artillery
for the Period Ending 31 July 1969, RCS CSFOR (RI) (U)

remained assigned. LTC James M. Compton assumed command on 3 July 1969, replacing LTC John J. Luxemburger, who assumed the duties of the Assistant Fire Support Coordinator.

(7) 3d Battalion, 82d Artillery (105mm towed) remained assigned. LTC Herbert E. Knight assumed command on 22 June 1969, replacing LTC Edouard A. Peloquin, who departed the command on 28 June 1969.

(8) 2d Battalion, 320th Artillery (105mm towed) arrived in the Americal Division TACR with the 1st Brigade, 101st Airborne Division (Airmobile) on 18 May 1969. On the same date the 2-320 was made CPOCN to the Americal Division Artillery. LTC John C. Walton assumed command on 21 June 1969 replacing LTC Richard D. Boyle who commanded until 20 June 1969.

(9) Battery G, 55th Artillery (MG) remained attached. CPT T.J. Stevens commanded during the period of this report.

(10) 3d Platoon, Battery G, 29th Artillery (SLT) was assigned to 100th FA Group, CPOCN to Americal Division Artillery until 1 June 1969 at which time the unit became attached to the Americal Division. On the same date the unit was further attached to Battery B, 55th Artillery (MG).

(11) 251st Field Artillery Detachment (Counter Mortar Radar) remained attached. SFC Joe E. Boyett commanded the unit until 18 May when 1LT Michael J. Flannigan assumed command.

(12) 252d Field Artillery Detachment (Counter Mortar Radar) remained attached. CW2 Thomas M. Roper commanded during the period of the report.

(13) 271st Field Artillery Detachment (Surveillance Radar) was attached to Division Artillery on 4 May 1969. 2LT Garold M. Johnson commanded during the reporting period.

c. (C) Operations: At the beginning of the period four major operations were being conducted within the Americal Division TACR. These were RUSSELL BEACH, FREDERICK HILL, GENEVA PARK and IRON MOUNTAIN. Activities consisted primarily of preemptive operations against enemy base camps and staging areas. Arc light strikes were conducted followed by multi-battalion sized exploitation of the bombed area. Whenever feasible, joint operations were conducted between AEFVN regiments and US Brigades with US battalions operating in conjunction with

CONFIDENTIAL

AVDF-ATCO

CONFIDENTIAL

14 August 1969

SUBJECT: Operational Report of Americal Division Artillery for the Period Ending 31 July 1969, RCS CSPOK-65 (LI) (U)

ARVN battalions. Artillery moves were made consistent with the above operations.

Special operations in the Americal TAOI were as follows:

Two operations were conducted in the Northern Barrier Island area. The first was a Marine Special Landing Force Operation, DARING REBEL, that terminated on 20 May 1969. The 196th Infantry Brigade conducted a joint operation with an LF Company in the same area beginning on 7 July 1969.

On 13 May 1969, the 1st Brigade, 101st Airborne Division (Airmobile) was airlifted to Tam Ky airfield to support operations against the 2d NVA Division in the Tam Ky area. Upon arrival, the brigade was CPCOM to the Americal Division and assumed control of the southern portion of the FREDERICK HILL OZ. This operational zone was designated LAMAR PLAIN. The 1st Bde then conducted several preemptive operations southeast and southwest of Tien Phuoc. Most of these battalion sized operations were preceded by Arc Light strikes.

On 20 July 1969, a combined ARVN and 1st Marine Division operation, DURHAM PEAK, was initiated in the mountainous area west of FSB Ross.

On 24 July, Operation NANTUCKET BEACH was initiated in the Batangan Peninsula area. In this joint operation, the 190th Infantry Brigade and the 6th ARVN Regiment were utilized. A Marine Special Landing Force Operation, BRAVE ARMADA, was initiated with BLT 2-26 north of the Batangan Peninsula in conjunction with NANTUCKET BEACH. The primary purpose of these operations was to secure the Batangan Peninsula in preparation for the 1969 Accelerated Pacification Program.

During the period, the 196th, 190th and 11th Infantry Brigades and the 1st Squadron, 1st Cavalry, employed naval gunfire for preparations, interdiction fires, and observed fires against confirmed targets.

(1) Artillery Support

(a) The 6th Battalion, 11th Artillery (105mm towed) remained in direct support of the 11th Infantry Brigade and supported operations in the Iron Mountain Operational Zone. On 1 June, 6-11 Artillery was authorized a fourth battery of six

CONFIDENTIAL

CONFIDENTIAL

AVDF-ATCO

14 August 1969

SUBJECT: Operational Report of Americal Division Artillery
for the Period Ending 31 July 1969, RCS CSFOR (RI) (U)

105mm howitzers. By 1 July the battalion had attained full strength of four batteries of six (M101) howitzers each.

1 A/6-11 remained on FSB Debbie (BS869319) during the entire period and fired in support of the 3-1 and 4-21 Infantry in the southern portion of the operational zone.

2 B/6-11 remained on LZ San Juan (BS634380) during the entire period and fired in support of the 4-3 Infantry. Also the battery had the mission of interdicting high speed approaches into the Song Ve Valley.

3 C/6-11 provided support for 1-20, 3-1 and 4-21 Infantry during the period. At the beginning of the period C/6-11 had two platoons on LZ Jeff (BS689323) supporting operations in the Song Ve Valley and one platoon on FSB Bronco (BS812390). On 4 May, the two platoons on LZ Jeff moved to FSB Bronco, where the battery was located for the remainder of the period. At FSB Bronco the battery was employed in support of 1-20 Infantry and in countering the enemy rocket and mortar threat.

4 At the beginning of the period, D/6-11 was on FSB Amy in support of the 4-21 Infantry (BS474525). On 4 May, D/6-11 moved to LZ Jeff to assume the mission of C/6-11 as described above. On LZ Jeff the battery remained in support of 4-21 Infantry. On 19 May, D/6-11 was moved to a new fire base, FSB John (BS542384), to support 4-3 Infantry in an Arc Light exploitation. In order to support 4-3 and 4-21 Infantry operations in the southern tip of the TAOR, the battery was moved on 2 June to FSB Don (BS764277). After completion of this operation on 16 June, the battery moved to LZ Max (BS760471) to support the 1-20 Infantry in operations along the coast. On 27 July, the battery moved to the "Horseshoe" area to support the 3-1 Infantry at a new fire base, FSB 411 (BS547730). From this position the battery fired south of the Tra Khuc River on personnel targets which were acquired by the Div Arty TPS-25 Ground Surveillance Radar located on CP 1 (BS516778).

(b) 1st Battalion, 14th Artillery (105mm towed) provided direct support for the 198th Inf Bde in the Geneva Park OZ during the entire period. On 1 June the battalion was authorized four batteries of six M102 howitzers each.

1 During the entire period A/1-14 supported the 5-46 Infantry. Initially located on FSB Gator (BS578961),

CONFIDENTIAL

AVDF-ATCO

CONFIDENTIAL

14 August 1969

SUBJECT: Operational Report of Americal Division Artillery for the Period Ending 31 July 1969, RCS CSFOR-65 (RI) (U)

A/1-14 moved a platoon to Hill 26 (BS771817) on 4 May to provide artillery coverage of the Batangan Peninsula. Because of an Arc Light exploitation south of Tra Bong the battery moved two platoons to FSB Clemson (BS480828) on 27 June to provide artillery support for the operation. On 5 July, the two platoons moved back to FSB Gator. In order to support operation NANTUCKET BEACH in the Batangan Peninsula area on 21 July, the battery moved a platoon from FSB Gator to FSB Dottie (BS630855). On 23 July, the platoon from Hill 26 also moved to FSB Dottie.

2 On 13 May, B/1-14 moved from FSB Fat City (BT 435079) to Tam Ky Airfield (BT302188) to support the 3-21 Infantry and 1-1 Cavalry in an operation to retake Nui Yon outpost (BT248169). Upon completion of the operation on 30 May, the battery (minus two howitzer sections) moved to FSB Professional (BT173078). The battery was given the mission of providing support for the 1-46 Inf. In this role, the battery minus was OPCON 2-320 Artillery and supported operations in the Lamar Plain Operational Zone. The remaining platoon of the battery moved to FSB Gator on 30 May and was attached to A/1-14 in order to assist that battery in firing the counter mortar program in the Chu Lai "Rocket Pocket".

3 On 1 May, C/1-14 was on FSB Professional; OPCON to the 3d Bn, 82d Arty and firing in support of the 1-46 Infantry. During the period 1-30 May, the battery was very active in providing fire for the defense of FSB Professional. On 30 May the battery moved to FSB Fat City where it assumed support of the 1-6 Infantry for the remainder of the period. C/1-14 (minus two howitzer sections) moved on 6 July to Hill 410 (BT389034) to support a 1-6 Infantry operation. During this operation, C/1-14 was also able to provide artillery coverage for FSB Hustler (BT296031) and the area east of FSB Hustler where the 1-501 Infantry was conducting a concurrent operation. On 19 July, the battery minus moved back to FSB Fat City where it continued to support the 1-6 Infantry. From this position the battery provided scheduled interdiction fires for the Chu Lai "Rocket Pocket".

4 During the entire period, D/1-14 was in support of the 1-52 Infantry. At the beginning of the period, D/1-14 was on FSB Buff (BS538824). On 2 May, the battery moved to FSB Cindy (BS343883) to support operations exploiting Arc Light strikes south of Tra Bong. On 6 May, another Arc Light exploitation was conducted west of Ha Thanh (BS383700). The battery was moved to Ha Thanh on that date to support the operation. On 9 May, one platoon was moved back to FSB Buff.

CONFIDENTIAL

CONFIDENTIAL

AVDF-ATCO

14 August 1969

SUBJECT: Operational Report of Americal Division Artillery For
the Period Ending 31 July 1969, RCS CSFOR-65 (R1) (U)

On 13 May, the other platoon was returned in order that the entire battery could support an operation west of FSB Buff. On 21 May, FSB Buff was renamed FSB Stinson. To again provide support for an Arc Light exploitation south of Tra Bong, three howitzers were moved on 26 June from FSB Stinson to FSB Cindy. After completion of the operation on 1 July, the three howitzers moved back to FSB Stinson. While at FSB Stinson, the battery fired many HE and ICM missions in the "Horseshoe" area against targets acquired by the Div Arty TPS-25 Ground Surveillance Radar on OP 1 (BS516778).

(c) 3d Battalion, 16th Artillery (155mm towed) supported operations in the Frederick Hill and Lamar Plain Operational Zones with a general support-reinforcing mission.

1 A/3-16 remained at HAWK Hill (BT224311) in direct support of the 1st Sqdn, 1st Cavalry. On 4 May, the battery moved three howitzer sections to FSB Baldy (BT140445) to support a multi-national, multi-battalion operation on Barrier Island. On 16 May, the three howitzers returned to FSB HAWK Hill.

2 On 1 May, B/3-16 had three howitzers at Tien Phuoc Special Forces/CIDG Camp (BT105142) and three howitzers at New Hau Duc (BT070062). On 13 May the three howitzers were returned to Tien Phuoc, and the battery was given the mission of general support-reinforcing of 2-320 Arty. Three howitzers were again moved on 31 May to New Hau Duc to support operations of the 1st Brigade, 101st Airborne Division (Airmobile) vicinity of BT 1800. The sections returned to Tien Phuoc on 4 June. In order to reinforce C/2-320 Arty in its support of exploitation west of Old Hau Duc by the 1-502 Infantry three howitzers from the battery were again moved from New Hau Duc on 27 June. On 10 July these weapons were moved to New Hau Duc to FSB Professional (BT177077) to support operations in the vicinity of FSB Hustler (BT296031).

3 As of 1 May C/3-16 had three howitzers on FSB Ross (BT028341) and three howitzers on FSB West (AT988249) firing in support of US and ARVN Battalions in the Que Son and Hiep Duc Valleys. On 6 July a platoon of C/3-16 (three 155mm howitzers) moved from FSB Ross to FSB Baldy (BT140445) to fire for 2-1 Inf, RF/PF joint operation on northern Barrier Island.

(d) During the period, the 3d Battalion, 18th Artillery (8" how/175mm gun) provided general support for the Americal Division.

1 A/3-18 supported operations in the Lamar Plain and Geneva Park Operational Zone from FSB Cindy (BS342883). The battery also provided fire for US Special Forces and CIDG

6
CONFIDENTIAL

CONFIDENTIAL

AVDF-ATCO

14 August 1969

SUBJECT: Operational Report of Americal Division Artillery for the Period Ending 31 July 1969, RCS CSFOR-65 (RI) (U)

Operations around Tra Bong and gave defensive support to Ha Thanh Special Forces Camp.

2 B/3-18 on FSB Ross moved an eight inch howitzer by road to Tam Ky Airfield (BT303128) on 30 May. It was joined by an eight inch replacement howitzer on 31 May. On 16 May, the platoon moved from Tam Ky Airfield to LZ Young (BT187155) to support 1st Brigade, 101st Airborne Division (Airmobile) operations in the vicinity of Tien Phuoc and FSB Professional. On 23 July, the platoon moved from LZ Young to Tam Ky Airfield in preparation for a 1st Brigade operation west of Ky Tra. The platoon remained at Tam Ky airfield for the remainder of the period.

3 C/3-18 remained on FSB Crunch (BS534515) and provided fires for the Iron Mountain Operational Zone during the period. In addition, the battery established a quick fire channel to the US Special Forces at Minh Long and supported Special Forces operations in the area.

(e) The 6th Battalion, 56th Artillery (HAWK) continued to provide defense for southern I Corps against the hostile air threat.

1 Battery C was inactivated at Tan Son Nhut Air Force Base on 1 June.

2 The battalion detachment located in the 4th Division TAOR continued surveillance during project Western Pistol. On the night of 10-11 May, LZ Oasis, the location of the Western Pistol element, was subjected to an intense enemy ground attack by an estimated battalion size force. The continuous wave acquisition radar and pulse acquisition radar were destroyed during hostile shelling. On 1 July 1969, project Western Pistol was terminated.

3 The battalion ceased all operations on 1 July 1969 and began preparations for redeployment to CONUS. On 2 August, the battalion departed.

(f) The 1st Battalion, 82d Artillery (155mm towed/ 8"SP) provided general support-reinforcing fires for RUSSELL BEACH, GENEVA PARK, NANTUCKET BEACH and IRON MOUNTAIN Operational Zones.

1 At the beginning of the period, A/1-82 (-) was located at FSB Fat City (BT438073) and the remaining platoon

CONFIDENTIAL

4

CONFIDENTIAL

AVDF-ATCO

14 August 1969

SUBJECT: Operational Report of Americal Division Artillery for the Period Ending 31 July 1969, RCS CSFOR-65 (RI) (U)

was located at FSB Gator (BS572962). To support an Arc Light exploitation south of Tra Dong a platoon from Fat City was moved on 2 May to FSB Cindy (BS343883). On 6 May, the platoon moved from FSB Cindy to Ha Thanh Special Forces Camp (LZ Shirley, BS382700) in support of the same operation. After completion on 13 May, the platoon returned to FSB Fat City.

2 B/1-82 (-) remained on FSB Snoopy (BS707609) during the entire period while the remaining platoon supported operations in the southern area of Geneva Park and the Batangan Peninsula area from FSB Dottie (BS630853). On 12 May at FSB Snoopy, the battery minus, plus one platoon of engineers defended the firebase against a combined sapper, ground and mortar attack. The results were 37 VC KIA, 10 rifles, 2 pistols and 150 Chi Com grenades captured. From 20 July until the end of the period, B/1-82 platoon on FSB Dottie supported Operation NANTUCKET BEACH.

3 C/1-82 was attached to 6-11 Arty during the period of the report. C/1-82 (-) remained at FSB Liz (BS757432) during the entire period. On 8 June the battery assisted the 1-20 Inf in blunting a combined ground and mortar attack against FSB Liz. The results were 14 NVA KIA, 3 rifles, 1 RPG and 30 grenades captured. On 11 June, FSB Liz was again hit by a combined mortar and ground attack. The results were 2 VC KIA. During the period, the battery provided general support-reinforcing fires for the southern Iron Mountain Operational Zone and was at times given the mission of supporting the 1-20 Infantry.

4 On 13 May, D/1-82 located at FSB Dottie (BS630853) moved one platoon (two eight inch howitzers) to Tam Ky Airfield (BT303188) to fire in general support of the operation to recapture Nui Yon outpost. The platoon moved back to FSB Dottie on 30 May and was replaced by an 8 inch platoon, from B/3-18 Arty.

(g) During the period, the 3d Battalion, 82d Artillery (105mm towed) remained in direct support of the 196th Infantry Brigade in the Frederick Hill Operational Zone.

1 A/3-82 remained on FSB Baldy (BT140445) during the entire period and was the battery supporting the 2-1 Infantry. The battery also supported RF/PF operations in the Mac Bai Area. The battery fired for operations on Northern Barrier Island and to the north and west of FSB Baldy. In addition, the battery supported infantry security operations along Highway 535 in the Que Son Valley. This fire support added materially to the security for the pacification program especially around Phu

CONFIDENTIAL

CONFIDENTIAL

14 August 1969

AVDF-ATCC

SUBJECT: Operational Report of Americal Division Artillery for
the Period Ending 31 July 1969, RCE CSFOR-65 (RI) (U)

Thai Village (BT0940).

2 On 5 May B/3-82 moved from FSB Center (BT052253) to a new fire support base, FSB Prep (BT008148), to support A/3-21 Infantry operation in the Phuoc Chau Valley. After completion of the operation on 11 May, the battery returned to FSB Center. Because of 2d NVA Division activity south of FSB East (BT129202), the battery moved to FSB East on 2 June to support 3-21 Infantry operations. In the early morning hours of 11 June, FSB East was attacked by an estimated 50 to 70 sappers. Two howitzers were damaged beyond repair. One howitzer section was moved from A/3-82 (FSB Baldy) and another howitzer section was moved from C/3-82 (FSB West) to replace losses incurred. At this point, the battalion consisted of four batteries, each with four howitzers. On 14 June, the battery returned to FSB Center and continued to support 3-21 Infantry for the remainder of the period.

3 During the entire period, C/3-82 remained on FSB West (AT990250) in support of 4-21 Infantry. Along with D/3-82, the battery assisted in the pacification program by providing security to the Hiep Duc Valley Resettlement Camp (AT9124).

4 D/3-82 remained on FSB Siberia (AT901232) during the entire period and fired in support of security operations of 4-31 Infantry in the Hiep Duc Valley.

(h) On 13 May, the 2d Battalion, 320th Artillery (105mm towed) minus batteries B and D, arrived by air at Tam Ky Airfield and became OPCON to the Americal Division Artillery. The battalion was augmented by a platoon of aerial rocket artillery from Btry B, 4th Bn, 77th Arty. The battalion provided direct support for the 1st Brigade, 101st Airborne Division (Airmobile) during the remainder of the period. The 2-320 assumed OPCON of C/1-14 until 30 May and B/1-14 thereafter.

1 On 17 May A/2-320 moved to Tien Phuoc (BT105141) to support the 1-501 Infantry in operations south and east of that location. As activity of the 2d NVA Division increased in the area south and west of FSB Professional the battery was moved to that fire support base on 31 May. In order to support the 1-501 in an Arc Light exploitation, a new fire support base, FSB Hustler (BT296031) was established. On 6 July, the battery moved to FSB Hustler and supported the 1-501 Infantry until the end of the period.

2 After arrival at Tam Ky Airfield on 13 May, C/2-320

CONFIDENTIAL

CONFIDENTIAL

AVDF-ATCO

14 August 1969

SUBJECT: Operational Report of Americal Division Artillery for the Period Ending 31 July 1969, RCS CSFOR-65 (RI) (U)

moved to LZ Young (BT188157) to support operations south of the location. The battery moved to New Hau Duc (BT071063) on 16 June to support the 1-501 Infantry in operations against the 2d NVA Division west and south of New Hau Duc. As intelligence was received, an Arc Light exploitation was conducted by the 1-502 Infantry in the area west of Old Hau Duc (BT024979). To support this exploitation three howitzers were moved from New Hau Duc to Old Hau Duc on 26 June. On 27 June, the remainder of the battery displaced to that location to support a 1-502 Infantry operation east of Old Hau Duc. The entire battery moved to LZ Young on 23 July, where it remained in support of 1-502 Infantry until the close of the period.

(i) Battery G, 55th Artillery (MG) with twenty-four quad .50 machine gun squads has been deployed throughout the Americal Division TAOR with the primary mission of supporting the ground defensive plans of the division fire bases. The unit assisted in fire base, convoy and road security.

During the period, the 3d Platoon, Battery G, 29th Artillery (SLT) was deployed throughout the Division TAOR. The platoon was attached to Battery G, 55th Artillery (MG) on 1 June. This unit consists of twelve searchlights, mounted on 1/2-ton vehicles. The platoon enhanced the security of isolated fire bases by providing battlefield illumination and assisting in target acquisition. The platoon was also used to provide navigational assistance to the supported units. When possible, the searchlights were co-located with quad .50 machine guns to assist in target acquisition and immediate engagement of the targets during periods of reduced illumination. The searchlights can be used in either the visible light or infrared mode.

(j) Countermortar Radar Detachment

1 The 251st FA Detachment (CM Radar) remained at ORI (BS518778) where it covered FSB Stinson and FSB 411 (BS540730). The detachment also conducted registrations for artillery units within range.

2 The 252d FA Detachment (CM Radar) was located at Artillery Hill (BT535039) with primary sector of scan to the west into the northern Chu Lai "Rocket Pocket". This unit assisted artillery units located at FSB Fat City and FSB Gator to fire radar registrations.

(k) Ground Surveillance Radars

CONFIDENTIAL

CONFIDENTIAL

AVDF-ATCO

14 August 1969

SUBJECT: Operational Report of Americal Division Artillery for the Period Ending 31 July 1969, RCS CSFOR-65 (RI) (U)

1 The AN/TPS-25 radar organic to Headquarters and Headquarters Battery, Division Artillery, remained at CPL (BS516778). The center of sector was west over the Tra Khuc River. Large groups of enemy were consistently detected, even when activity was at a low level in the division TAOR.

2 The 271st FA Detachment (Surveillance Radar) was attached to the Division Artillery and deployed on 14 May to OP 3 (BS754421). During the first thirty days, the detachment detected 211 targets. The radar has detected targets in all directions. Artillery, firing on these targets has interdicted night operations in the area. The ground surveillance radar was also effectively used during daylight operations. During one daylight engagement in a lightly wooded area, the radar was directed to screen the enemy's flanks and rear to report any attempted disengagement by the enemy. During this screening process, the radar detected enemy reinforcements moving to join the unit in contact. Artillery fires and an airstrike were placed on the unit which neutralized the attempted reinforcements.

(1) Ammunition expenditure by caliber for the period 1 May to 31 July 1969:

105mm.	233,630
155mm.	84,512
8 IN	18,642
175mm	7,882
TOTAL	<u>344,666</u>

2. Section 2: Lessons Learned: Commanders Observation, Evaluation and Recommendation

- a. (U) Personnel. Omitted
- b. (C) Operations

(1) -Subject: Naval Gunfire

(a) Observation. Naval gunfire is a highly effective source of firepower which can be used in support of ground troops provided there is close coordination with the naval representative.

(b) Evaluation. When planning use of naval gunfire, the artillery liaison officer should insure the naval representative

CONFIDENTIAL

//

CONFIDENTIAL

AVDF-ATCO

14 August 1969

SUBJECT: Operational Report of Americal Division Artillery for the Period Ending 31 July 1969, RCS CSFOR-65 (RI) (U)

receives the proposed targets and friendly locations as early as possible. This facilitates positioning of the ship target line. Having the naval observer aboard the C&C helicopter greatly simplifies coordination and control of fires. The rapid rate of fire and area coverage makes rocket ships ideal for preparations. Large areas can be adequately covered in a minimum amount of time. The low trajectory of the rockets allows lift helicopters to orbit the landing zone until the firing of preparations and area type targets is completed. They can be effectively used to support ground troops provided there is a ground observer with the troops and the troops are kept well off the gun target line. Through experience it has been found that rounds will ricochet great distances when the guns are firing short ranges with flat trajectories. This can be prevented by having the ship increase the angle of fall. The cruiser's 8 inch guns are the most accurate and can be effectively used to destroy point targets deep in enemy terrain. They are very effective against bunkers and enemy in trench or tunnel complexes. The 8 inch round will penetrate triple canopy producing desirable results on the ground. Numerous secondary explosions have been observed when firing on targets under triple canopy. The 81mm mortar aboard the swift boats can be used to harass enemy positions or interdict supply trails along the coast. They can also provide illumination for troops on the beach when necessary.

(c) Recommendation. The artillery liaison officer should plan for and use naval gunfire whenever possible. Not only is it an effective source of firepower, but it also reduces the drain on the artillery ASR, leaving the artillery available for engagement of targets of opportunity.

(2) Subject; Minimum Quadrant Elevation Reference Chart

(a) Observation. The use of a minimum quadrant elevation chart, which is constructed from data computed by the battery executive officer, allows the fire direction officer to easily preclude fires from impacting on visible crests.

(b) Evaluation. The Battery Executive Officer computes minimum QE's immediately upon occupation of a new position for each charge and each piece to crests visible from the gun position. This data is relayed to the battery FDC for their reference. A four to six gun battery with a 6400 mil capability will generate more minimum QE data than an FDC can keep readily available, if the data is not properly organized. A method was devised that displayed the data for each artillery piece in a ready reference

CONFIDENTIAL

CONFIDENTIAL

14 August 1969

AVDF-ATCO

SUBJECT: Operational Report of Americal Division Artillery for the Period Ending 31 July 1969, LCS CSFOR-65 (RI) (U)

format for the FDC to check before firing. A large poster was constructed (Inclosure 1) containing a 6400 mil fan for each gun. The FDC simply compares the direction of fire and the quadrant with the chart and the applicable minimum QE for the charge to be fired.

(c) Recommendation. That minimum Quadrant Elevation Reference Charts be preprinted and stocked for issue to units in the same manner as other standard fire direction forms and charts.

(3) Subject; FM Communications.

(a) Observation: Shortly after an artillery battalion became OPCON to this Division Artillery many of the assigned frequencies were found to be identical with those assigned to Americal Division units.

(b) Evaluation: The above problem was solved by monitoring all frequencies and recording those that seemed clear or had little traffic. After this was accomplished, permission was requested from the Americal Division Signal Officer to use some of the clear frequencies.

(c) Recommendation: To avoid similar problems in the future, direct coordination should be made between unit signal officers in advance of a move.

(4) Subject: Cartridge, Tactical, CS, XM 629.

(a) Observation. On 26 July 1969, the 6th Battalion, 11th Artillery employed cartridge, tactical, CS, XM 629 for the first time. The missions were fired by Battery C in support of Company B, 1st Battalion, 20th Infantry. Two missions were fired using two different methods of fire to determine types of effect.

(b) Evaluation. The first mission was fired on grid BS 813452 at 260735H July 1969. Nature of target was a preparation for an infantry company size sweep. The mission was adjusted using one gun. The first round resulted in a target hit; fire for effect was requested and battery six rounds was fired (36 rounds). All rounds were on target with 100% immediate concentration build up in the target area. The initial area covered was 200 x 300 meters; in five minutes the area covered 200 x 600 meters. Observations made by the supported infantry battalion commander, his S3 and the artillery liaison officer were that

CONFIDENTIAL

CONFIDENTIAL

AVDF-ATCO

14 August 1969

SUBJECT: Operational Report of American Division Artillery for the Period Ending 31 July 1969, LCS CSFOR-65 (RI) (U)

the XM 629 CS round produces a rapid concentration over a large area. Individuals observing the mission were requested to evaluate this round in comparison to the 4.2" mortar CS round. All concurred that the XM 629 round is more effective. The second mission was fired on grid BS802473 at 260800 H July 1969. The nature of target was the same, but could not be exploited. This mission required two adjustments to place the round on target. The method of fire was battery, one round, 3 quadrants and 3 deflections, zone sweep (36 rounds). All rounds hit in expected areas except one. Initial coverage was estimated at 80% of the target area saturated with eventual build up to 100% of the area of initial coverage (600 x 800 meter), but the gas lifted rapidly.

(c) Recommendation. Tactical CS round XM 629 can be employed in support of ground operations in this area of operations with at least equal effect as mortar fired CS. Different methods of fire will produce a variety of effects in the target area. When the method of fire is battery fire for effect, immediate build up in the target area is 100% effective, but confined to a smaller area than a zone sweep. In comparison, when a zone sweep method of fire is selected a larger area is covered, but concentration build up is slow and results in approximately 80% coverage. With either method of fire, all persistency and presence of gas in target area will dissipate.

(5) Subject: Emplacing Collimator in Hard or Rocky Ground.

(a) Observations: Many fire bases are built in laterite and rock. Emplacement of the collimator is difficult, time consuming and lacks the required stability.

(b) Evaluation: Sand boxes, 2 ft by 2 ft and 4 inches deep, used in pairs, 3200 mils apart, allow for 6400 mil capability and provides an excellent surface for accurate emplacement and is sufficiently stable for firing operations.

(c) Recommendations: That this method for collimator emplacement be considered for those units situated in hard or rocky ground.

(6) Subject: M102 Firing Platform

(a) Observation. M102 Howitzer firing platform assembly becomes unstable during heavy rains.

CONFIDENTIAL

CONFIDENTIAL

AVDF-ATCO

14 August 1969

SUBJECT: Operational Report of Americal Division Artillery for
the Period Ending 31 July 1969, RCS CSFOR-65 (RI) (U)

(b) Evaluation. It has been noted that when the ground becomes heavily saturated by rain, the firing platform assembly begins to "mush" and firing becomes hazardous. An attempt was made to use 8" x 8" timbers anchored by 8 foot engineer stakes, but this technique was unsatisfactory. The timbers and pickets could not withstand the shock. Three 4½ ft sections of landing mat, M&A1 were locked together, and then anchored by driving five to eight 8 ft engineer stakes to a depth of 7½ feet on each side. The remaining 6 inches of stake was bent over the matting. The firing platform was then emplaced over the anchored matting, and the stakes driven through the platform and matting. This technique has been successful to date, but thorough evaluation cannot be made until the rainy season arrives.

(c) Recommendations. That use of the landing mat be continued until thorough experience is gained.

(7) Subject; Howitzer Parapet

(a) Observation: Artillery pieces on any fire base are a primary target. On numerous occasions, rockets, grenades, satchel charges and small arms have been directed into gun pits causing extensive injuries and damage. The gun pit in effect "collects" enemy grenades and satchel charges.

(b) Evaluation:

(1) Guards are mandatory at key locations on the gun parapet wall during night firing, especially during sapper attacks. The battery may be required to answer calls for fire even though sappers are within the perimeter. Guards carefully positioned on the gun parapet can provide the required close-in protection for the gun and the crew.

(2) The construction of a double parapet wall provides good protection for the gun crew in case of attack, by having the second wall behind the primary wall with a space of two feet or so between them, the entire section is provided with a circular trench from which they can fight, while protected from the fragments of rounds that land within the howitzer pit. Over-head protection is provided by culverts.

(c) Recommendation: That this means of protection be considered and employed as appropriate.

CONFIDENTIAL

CONFIDENTIAL

AVDF-ATCO

14 August 1969

SUBJECT: Operational Report of Americal Division Artillery for the Period Ending 31 July 1969, RCS CSFOR-65 (RI) (U)

(8) Subject: Shifting Howitzers Trails and Re-Laying

(a) Observation: The requirement to maintain a 6400 mil firing capability and to deliver accurate and responsive fires is largely dependent on the speed with which howitzer trails can be shifted, and the accuracy and rapidity of relaying the howitzer for new direction.

(b) Evaluation: Means devised to reduce the time required to re-lay the howitzer on new direction are as follows:

a. Azimuth markers are placed at 400 mil intervals around the periphery of the pit, at the muzzle end of the howitzer to aid the section in shifting to the required azimuth. In addition, for the 155mm howitzer, secondary azimuth markers (105mm cannisters) are embedded in the ground at the approximate periphery of the howitzer lunette each 200 mils. When the muzzle is pointed at azimuth marker 4000 mils, the lunette will be over the cannister marked 4000 mils. This secondary marker aids the crewman on the trails in finding the direction and provides a secondary check for the chief of section who is observing the primary azimuth marker.

b. A deflection reference sheet is prepared for each howitzer. On this sheet are listed referred deflections to the aiming circle for each azimuth of fire. By reference to this sheet, the gunner will know the deflection to set on the panoramic telescope for any azimuth, enabling him first to "find" the aiming circle and secondly, facilitating his rough lay of the howitzers. Frequently, a howitzer can be zero mils on the first reading from the aiming circle. The gunner can also detect errors in direction of lay from the aiming circle.

c. Recommendation: That these techniques be considered for use by all units.

(9) Subject: Shorthaul Movement Techniques for 175mm Gun Tubes

(a) Observation. The 175mm gun tube is a 12,000 lb component that can be easily damaged in movement over rough terrain where fire support bases are often located. A movement technique has been developed to lessen the possibilities of equipment damage and/or increased downtime.

(b) Evaluation. While on its shipping skid the 175mm gun tube is susceptible to tipping over while being moved to the

CONFIDENTIAL

CONFIDENTIAL

AVDF-ATCO

14 August 1969

SUBJECT: Operational Report of Americal Division Artillery for the Period Ending 31 July 1969, RCS CSFOR-65 (RI) (U)

location where the tube will be changed. Rough terrain will greatly add to this possibility. If the tube does tip over, damage is possible to components of the breech. Also valuable time is lost attempting to right the tube. For short hauls, insert a stout timber (inclosure 2) between the skid and the tube. If the tube begins to tip over the beam will stop it, and 5-6 men can use their weight on the beam as a lever to right it again.

(c) Recommendation. That TM 9-1000-218-35 describe these or other acceptable methods of shorthaul movement techniques of the 175mm gun tube over rough terrain.

(10) Subject: Gunner's seat for Howitzer, 105mm, M102

(a) Observations. Due to the low silhouette of the M102 howitzer, the gunner is required to crouch or squat constantly to take up the proper sight picture through the panoramic telescope.

(b) Evaluation. The British 25-pounder provides an integral gunner's seat. The 3d Battalion, 82d Artillery set out to design and build a comparable item. The end product is shown as inclosures 3 and 4. The seat is a salvaged jump seat from an M113 APC. This is the only standard item, the rest being scrap metal available in a local salvage yard. A mounting bracket made from three pieces of steel plate cut to conform to the shape of the box trail, attaches the device to the howitzer. It slips over the trail member and is secured by means of slip-on straps crossing underneath the trail. The unit, weighing about 25 lbs, mounts or dismounts in a few seconds. The four fiberglass "feet" on the salvaged seat are bolted to another piece of steel plate which is in turn affixed to smaller plate by two bolts. The smaller plate contains a six inch slot in which the bolts travel making the seat adjustable backward and forward for about four inches. Three lengths of ordinary lightweight steel pipe form the connection between the seat mounting and the trail bracket. Arc welds are used throughout. This description, diagrams and recommendation have been forwarded through channels to the Weapons Mobility Command and the Field Artillery School for possible inclusion in the Field Artilleryman.

(c) Recommendations. That a modification to the M102, 105mm Howitzer be authorized to include a gunner's seat. The work could be performed locally at field maintenance level, and incorporated on all new 105mm howitzers, M102, prior to being issued to units.

CONFIDENTIAL

CONFIDENTIAL

AVDF-ATCO

14 August 1969

SUBJECT: Operational Report of Americal Division Artillery for the Period Ending 31 July 1969, RCS CSFOR-65 (RI) (U)

(11) Subject: Danger Zone for Artillery Illumination Debris.

(a) Observation. The debris from artillery illuminating rounds present a hazard to friendlies who happen to be on or near the gun-target line. Little helpful guidance is available which recognizes the dangers inherent, and which provides a solution for the commander.

(b) Evaluation. The predicted range to projectile impact of illumination rounds, as depicted in Tabular Firing Tables considers only the case of total mechanical time fuse failure. The impact point of the empty carrier and debris resulting from the base ejection of the illuminating element is no less important because of danger to friendlies. Since these danger zones are arbitrary and cannot be accurately predicted, these procedural rules were announced for units of the Americal Division Artillery:

1 The danger zone is the area 400 meters on each side of the gun-target line, extending from the range to fuze function to the predicted point of projectile impact. In addition, the danger zone includes the area within a 600 meter radius of the predicted point of projectile impact.

2 For 155mm fires, the range to fuze function is stated in the illumination tables of TFT 155-Q-4. For 105mm fires, the range to fuze function is defined as a point 400 meters short of the illumination point, on the gun-target line.

3 Under no circumstances will illumination missions be fired where the empty carrier or debris will impact into densely populated areas.

(c) Recommendations. That other artillery adopt similar considerations for illumination round danger zones.

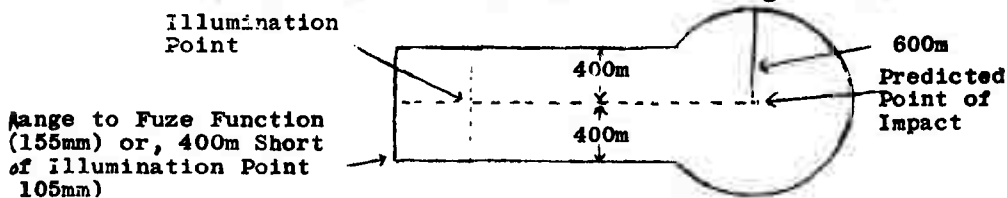

CONFIDENTIAL

14 August 1969

SUBJECT: Operational Report of Americal Division Artillery for
the Period Ending 31 July 1969, RCS CSFOR-65, (RI) (U)

c. (U) Training

(1) Subject: Directional Device for 81mm Mortar

(a) Observations. Heavy Artillery Batteries with 81mm mortars added to the MTO&E to provide emergency illumination generally do not have trained mortar personnel to fire the weapons.

(b) Evaluation. A large circular piece of 3/4" or 1" plywood was obtained (Inclosure 5). A hole was cut in the center for the base plate, and true grid azimuths were marked off every 50 mils around the outer edge of the board. A piece of 2" x 4" was cut and notched to fit between the supporting bipodal legs. Directly beneath the tube on the 2X4 an arrow indicator was constructed. Then desired defensive illumination targets were adjusted around the fire base perimeter. The adjusted data, (charge, time and elevation) was recorded on the board behind the approximate azimuth. Thus, training time was greatly reduced for inexperienced mortar crews who had other primary jobs. With limited instruction, practically anyone can master this defensive mortar directional device.

(c) Recommendation. That other field artillery units consider this alternative to an extensive, time consuming training program for contingency mortarmen.

d. (U) Intelligence.

(1) Subject: Use of an Artillery Air Observer on APD Missions

(a) Observation. The Airborne Personnel Detector (APD) intelligence gathering system is lacking only in the rapidity with which target data can be relayed to artillery battalions.

(b) Evaluation. Rapid dissemination of intelligence gathered by APD missions is essential, if effective use is to be made of the data collected. Artillery air observers may be used to translate the data quickly into fire requests to artillery battalions.

(c) Recommendation. Intelligence acquired by APD

AVDF-ATCO

14 August 1969

SUBJECT: Operational Report of Americal Division Artillery for
the Period Ending 31 July 1969, RCS CSFOR-65 (RI) (U)

missions must be passed to the firing battalion immediately to be effective. Artillery air observers flying on APD missions are able to give accurate data concerning location of otherwise unseen enemy forces while still in flight. At the conclusion of the mission the air observer can return to the area of maximum readings and continue to direct artillery fire into the suspect location, thus reducing artillery reaction time from hours to a matter of minutes.

e. Logistics

(1) Subject: Portable, Emergency Lighting for FDC

(a) Observation. A requirement exists for a portable emergency lighting set with dry battery power source to be used in each battery and battalion FDC.

(b) Evaluation. When a FDC displaces to a forward fire base, the primary source of power for lighting is a 1.5 KW DC generator. Should enemy action or maintenance problems result in an inoperable generator, alternate power for lighting must be available immediately. Flashlights, Coleman lanterns etc, are inadequate, and the lanterns are dangerous. A portable sealed-beam light source with dry-cell battery would eliminate the hazard of gasoline lanterns, and would provide a more reliable system than flashlights or battery powered lanterns.

(c) Recommendation. That a portable light source as described above be procured on the basis of one per artillery FDC.

f. (U) Organization. Omitted

g. (U) Other

(1) Subject: Preparation for Redeployment to CONUS

(a) Observation. The redeployment of units to CONUS creates several problems.

(b) Evaluation. The experience of the 6th Battalion, 56th Artillery (HAWK) in their redeployment sheds light on problems and solutions that would be common to most units in the Division under similar circumstances.

(c) Recommendation. That the lessons learned by this

AVDF-ATCO

14 August 1969

SUBJECT: Operational Report of Americal Division Artillery for
the Period Ending 31 July 1969, RCS CSFOR-65 (RI) (U)

redeploying unit be widely disseminated and that specific guidance
be provided (Americal Division POM-SOP) to all units. (Lessons
Learned attached as Annex A)

5 Incl
as
Annex A

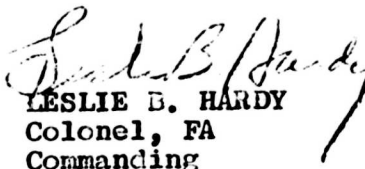
LESLIE B. HARDY
Colonel, FA
Commanding

DISTRIBUTION: SP

COPY

1 Dept of the Army (ACSFOR-DA) ACoS For Force
Development, Washington, D.C. 20310

2 - 3 Dept of the Army (ACSFOR-DA) ACoS For Force
Development, Washington, D.C. 20310, THEU:
Commanding General, Americal Division, APO 96374

4 - 5 Commander-in- Chief, US Army Pacific, ATTN:
GPOP-DT, APO 96558

6 - 7 - 8 Commanding General, US Army Vietnam, ATTN:
AVEGC-D3T APO 96375

9 - 10 Commanding General, Americal Division, ATTN:
AVDF-GC, APO 96374

11 Commanding General, Americal Division, ATTN:
AVDF-HL, APO 96374

COPY

12 6th Battalion, 11th Artillery
13 1st Battalion, 14th Artillery
14 3d Battalion, 16th Artillery
15 3d Battalion, 18th Artillery
16 1st Battalion, 82d Artillery
17 3d Battalion, 82d Artillery
18 3d Platoon, Battery G, 29th Artillery
19 Battery G, 55th Artillery
20 - 25 File, Div Arty S3

CONFIDENTIAL

AVDF-GCDO (14 Aug 69) 1st Ind
SUBJECT: Operational Report Lessons Learned (Americal Division Artillery)(U)

DA, Headquarters Americal Division, APO 96374 5 SEP 69

TO: Commanding General, United States Army Vietnam, ATTN: AVHGC-DST,
APO 96375

1. (U) Forwarded herewith is the subject report of the Americal Division Artillery for the period 1 May 69 - 31 Jul 69.
2. (U) This Headquarters concurs with the observations and recommendations contained in the basic communication.

FOR THE COMMANDER:



E. R. GREEN
CPT, AGC
Asst AG

CONFIDENTIAL

CONFIDENTIAL

AVHGC-DST (14 Aug 69) 2d Ind

SUBJECT: Operational Report of Americal Division Artillery for the Period
Ending 31 July 1969, RCS CSFOR-65 (R1) (U)

HEADQUARTERS, UNITED STATES ARMY, VIETNAM, APO San Francisco 96375 20 OCT 1969

TO: Commander in Chief, United States Army, Pacific, ATTN: GPOP-DT,
APO 96558

1. (U) This headquarters has reviewed the Operational Report-Lessons Learned for the quarterly period ending 31 July 1969 from Headquarters, Americal Division Artillery.

2. (C) Comments follow:

a. (U) Reference item concerning "Minimum Quadrant Elevation Reference Chart," section II, page 12, paragraph 2b(2); concur. Recommend the US Army Field Artillery School, Ft Sill, Oklahoma take action to provide the charts.

b. (C) Reference item concerning "Use of an Artillery Air Observer on APD Missions," section II, page 19, paragraph 2d(1); concur. This item will be discussed during the USARV, G2 Air Orientation Course which is conducted monthly by the 1st Military Intelligence Battalion (ARS). This course is designed to orient newly assigned G2/S2 Air personnel on the capabilities, planning and employment of the in-country aerial reconnaissance and target acquisition systems. No action by USARPAC or DA is recommended.

c. (U) Reference item concerning "Portable, Emergency Lighting for FDC," section II, page 20, paragraph 2e(1); concur. A portable light with characteristics generally meeting the requirements described is available for testing under the ENSURE program. The Americal Division will be contacted to determine whether or not the lights should be provided the Division for operational use.

d. (U) Reference item concerning "Preparation for Redeployment to CONUS," section II, page 20, paragraph 2g(1) and ANNEX A; concur. These recommendations had been previously forwarded to this headquarters. They have been evaluated and many appear in either the previous quarters ORLL from this headquarters or in redeployment guides to units in the field.

FOR THE COMMANDER:

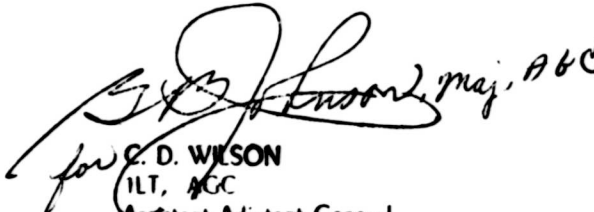
for C. D. WILSON
1LT, AGC
Assistant Adjutant General

Cy furn:
Americal Div Arty
HQ Americal Div

CONFIDENTIAL

GPOP-DT (14 Aug 69) 3d Ind
SUBJECT: Operational Report of HQ, Americal Division Artillery
for Period Ending 31 July 1969, RCS CSFOR-65 (R1)

HQ, US Army, Pacific, APO San Francisco 96558 19 NOV 69

TO: Assistant Chief of Staff for Force Development, Department
of the Army, Washington, D. C. 20310

This headquarters concurs in subject report as indorsed.

FOR THE COMMANDER IN CHIEF:

C. L. SHORTT
CPT, AGC
Asst AG

CONFIDENTIAL

MINIMUM QUADRANT ELEVATION REFERENCE CHART

175-mm Gun (SP)

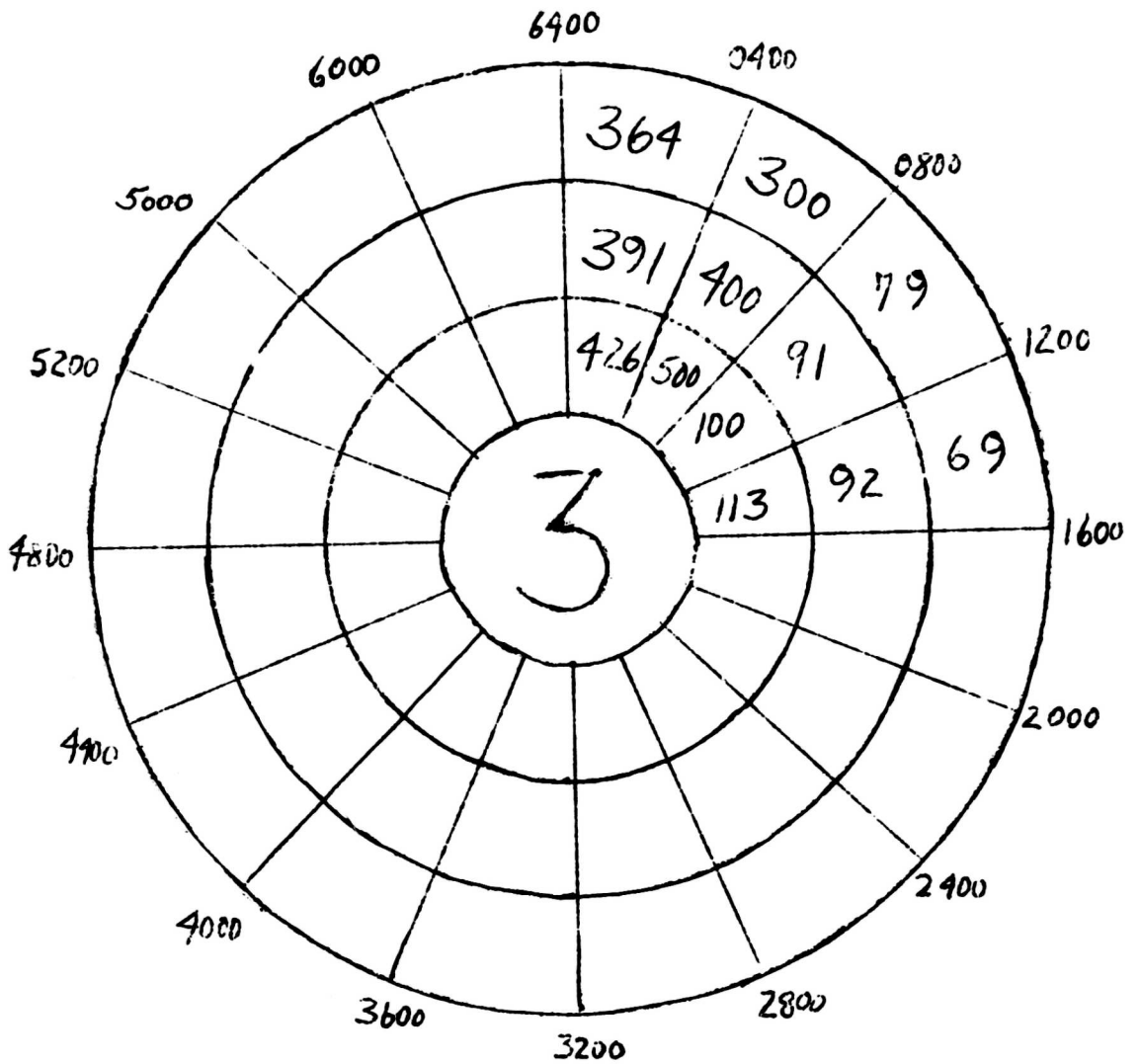

Note: Inner Circle - Zone 1
 Middle Circle - Zone 2
 Outer Circle - Zone 3

Short-haul Technique for 175-mm Gun Tubes

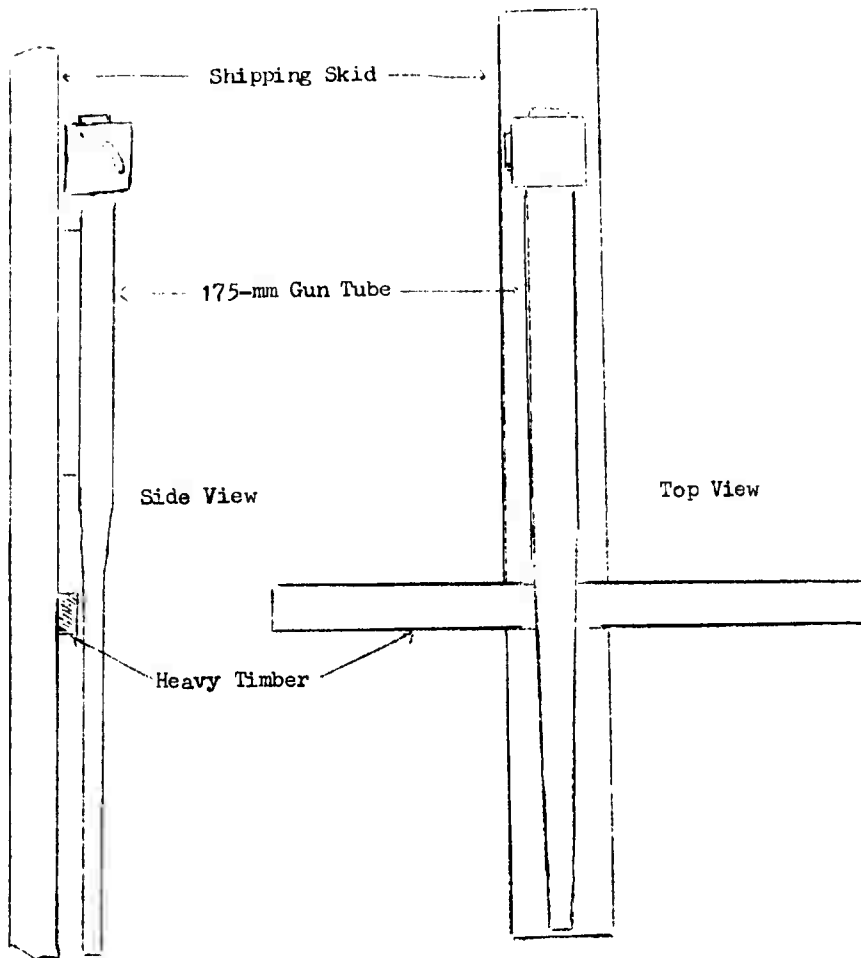

Inclosure 2

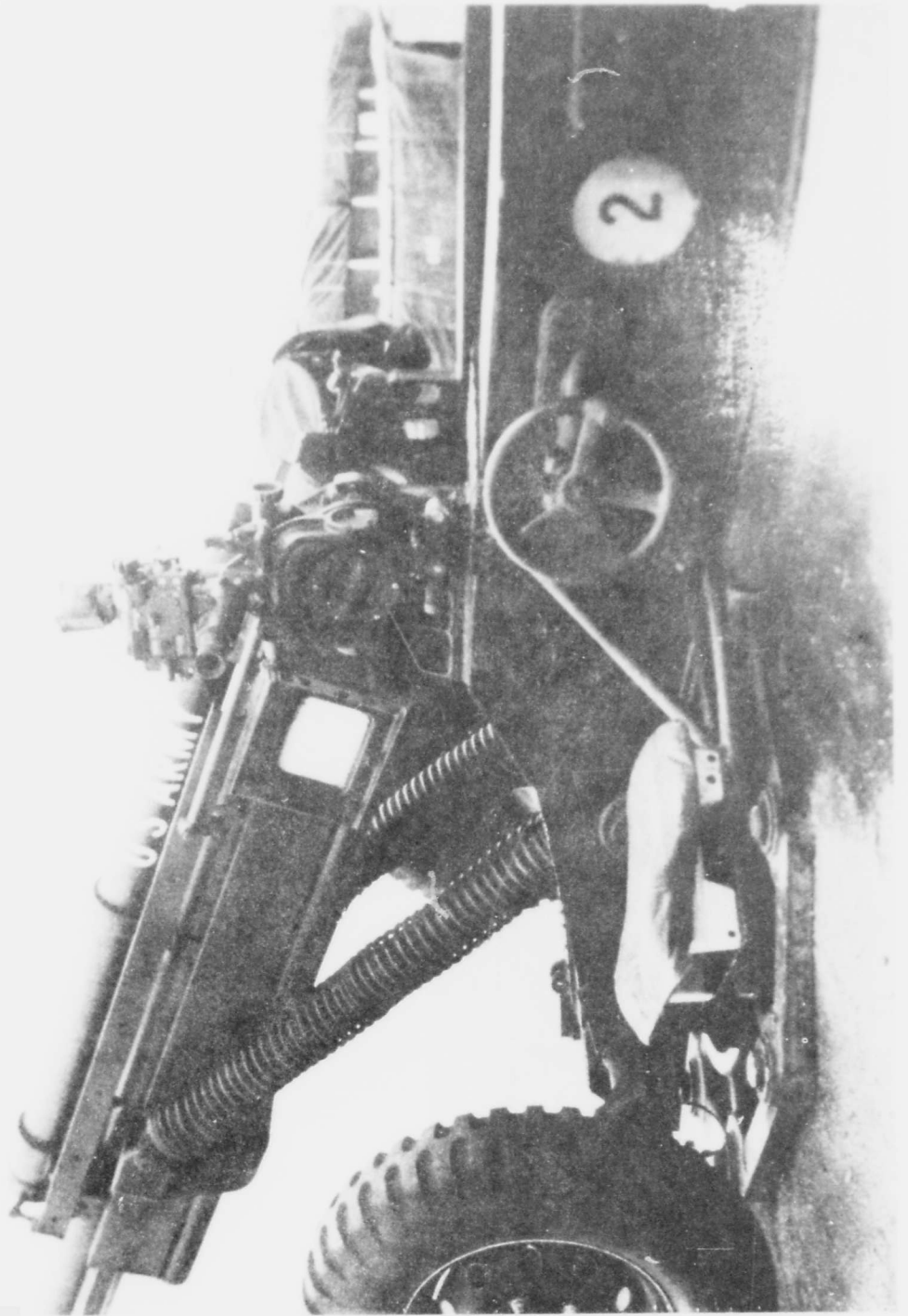

INCLOSURE 1

Inclosure 1

GUNNER'S SEAT, 105-mm HOWITZER, M-102

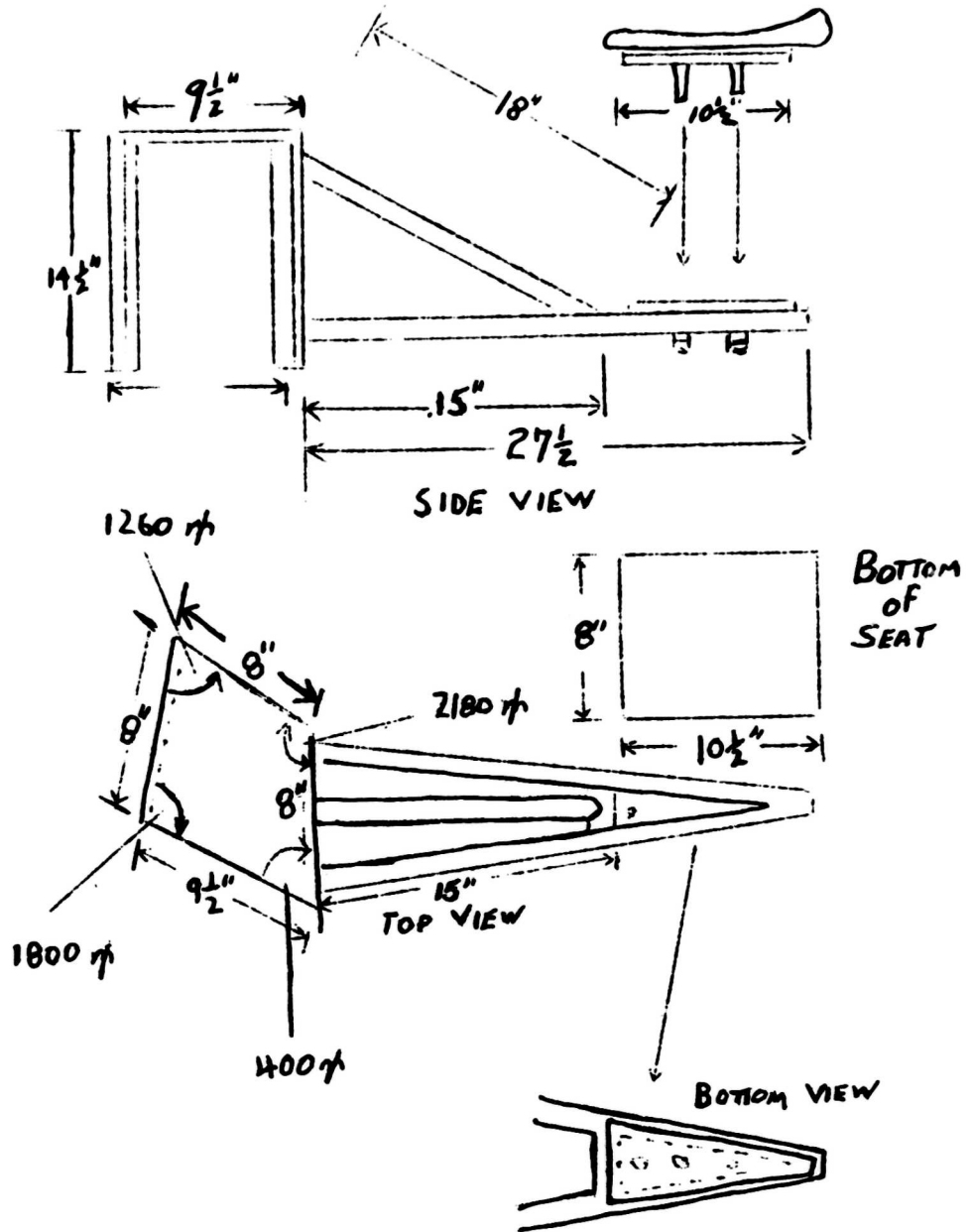

Inclosure 4

81-mm MORTAR DIRECTIONAL DEVICE

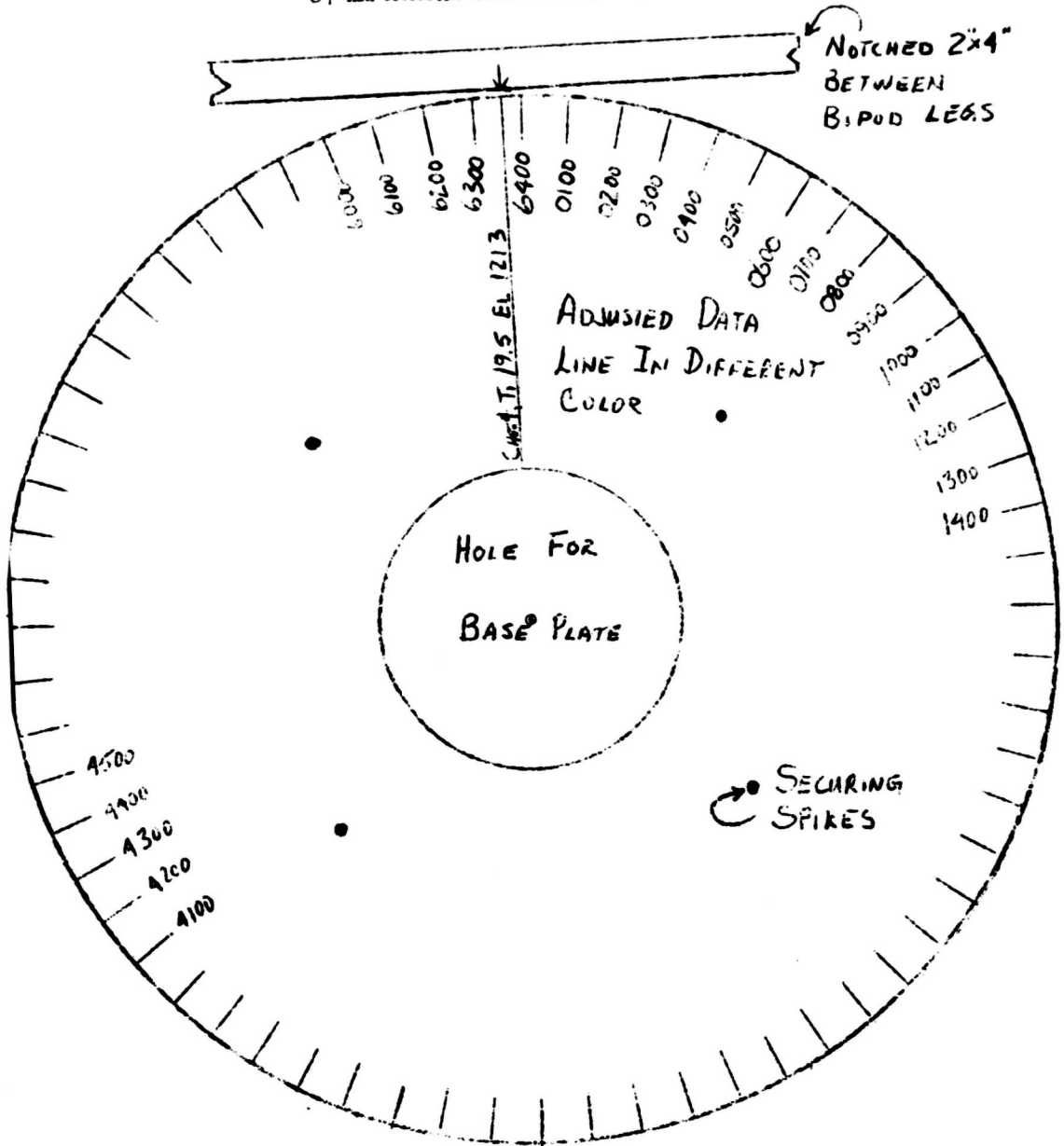

Inclosure 5

Annex A to Operational Report of Americal Division Artillery
for the Period Ending 31 July 1969, RCS CSFOR-65 (R1) (U)

A. (U) Personnel:

1. Personnel rosters:

a. Observation. An immediate decision must be made by higher headquarters concerning criteria for personnel redeployment and disseminated to redeploying units early.

b. Evaluation. Valuable time was lost in processing personnel actions because an accurate and detailed criterion for redeployment was not furnished on a timely basis. Consideration of MOS's, extensions, early outs and other individual problems must be accomplished early.

c. Recommendation. Contingency plans must include detailed criteria for redeployment of personnel, with a consideration for unique units in RVN.

2. Personnel rosters:

a. Observation. Personnel rosters should be compiled by the redeploying unit.

b. Evaluation. Initially, a records check was performed and a deployable and non-deployable roster was developed on this information. The roster proved inaccurate.

c. Recommendation. Upon notification, the deploying unit should distribute a questionnaire to each individual. The signed questionnaire then commits the individual to a specific course of action and provides the personnel section with the data required for compilation of accurate rosters. (See Appendix 1, to Annex A, Information Sheet.)

3. Personnel Assignment:

a. Observation. Personnel continued to be assigned to this unit after stand down.

b. Evaluation. Personnel with missile peculiar MOS's continued to be assigned. Numerous messages were dispatched in an attempt to curtail these inputs.

c. Recommendation. When specialized units are redeployed and immediate termination of incoming personnel in each specific MOS must be effected.

Annex A (Continued)

4. Finance

a. Observation. Each individual is authorized payment of accrued pay and allowances prior to relocation.

b. Evaluation. There were many different individual desires where pay was concerned. A finance questionnaire was developed by the Americal Division Finance Center to determine if a partial pay, no pay, check or cash was desired.

c. Recommendation. A questionnaire should be published in coordination with the finance center and distributed to all personnel.

5. Processing Center:

a. Observation. The deploying unit should conduct out processing of personnel at their level.

b. Evaluation. A central location for out processing should be established in order to maintain control.

c. Recommendation. A central location should be designated as the out processing center. All clearing functions must be accomplished in the center. Each individual carries a check list through the processing center and is not allowed to leave until each item is initialed. (See Appendix 2 to Annex A, Out Processing Check List)

6. Mail:

a. Observation. When more than 50% of a unit deploys, mail is diverted to the unit destination and a scheme of change must be submitted.

b. Evaluation. Loss of mail could present a significant morale problem. Individuals remaining in country, if not immediately reassigned, will not receive mail for an extended period of time.

c. Recommendation. Detail mail clerks to destination headquarters and make arrangements to have all unit mail delivered to that headquarters until all personnel are reassigned.

7. Rest and Recuperation (R&R):

a. Observation. Initial instructions directed cancellation of all R&R's within the deploying unit.

Annex A (Continued)

b. Evaluation. Personnel losses to R&R during this period are not significant. Cancellations could cause morale problems.

c. Recommendation. All eligibilities for R&R should be evaluated as separate cases by the commander.

8. Hold Baggage:

a. Observation. The large number of personnel deploying in a short time creates a definite problem.

b. Evaluation. When a unit redeploys, personnel assignment orders are published as a unit. These orders are not immediately available. Hold Baggage may not be shipped without PCS orders. A certificate in lieu of orders developed by the Americal Division greatly assisted expeditious handling of hold baggage.

c. Recommendation. The major subordinate command should authorize shipment of hold baggage when accompanied by a certificate signed by the adjutant. Additionally, it should appoint customs inspectors at company/battery level to speed shipment. (See Appendix 3 to Annex A - Certificate in lieu of orders)

9. Unit Funds:

a. Observation. Immediate action is required to conduct a terminal audit and close unit fund accounts.

b. Evaluation. Final spending must be limited to allow for accurate accounting of the unit fund. Units must consider that with the excessive free time in the last days prior to redeployment, recreation activities need to be established to occupy the time.

c. Recommendation. Planning must be accomplished and trophies and awards purchased to support this program prior to closing the unit fund.

B. (U) Operations. Movement Operations Center

1. Observation: The need for centralized control and coordination of effort, planning and periodic evaluation of attained progress dictated the establishment of an operations center.

2. Evaluation. Through the planning process, problem areas surfaced and the need for a centralized control center to record

Annex A (Continued)

progress and facilitate coordination between staff sections became apparent. Significant areas were material procurement, time scheduling, site disposition, liaison requirements, processing facilities and personnel reassignments.

3. Recommendation. A movement operations center should be established which provides for visual presentation of schedules versus accomplishments, as a tool for keeping the commander informed of progress and problems. It also provides up to date information to all staff sections and disseminates changes in policy or schedules. Status of materiel and personnel should also be displayed.

C. (U) TRAINING: Redeployment

1. Observation. A majority of personnel within this battalion were not familiar with retrograde or redeployment operations.

2. Evaluation. As items were readied for shipment, personnel became well educated in preservation and packing procedures. Inexperience at early stages created problems and caused lost time.

3. Recommendation. Include classes on all aspects of retrograde and redeployment as part of periodic training requirements.

D. (U) Intelligence: Omitted

E. (U) Logistics:

1. Fabrication and material

a. Observation. Excessive time was lost assembling the necessary preservation and packaging materials.

b. Evaluation. This unit was required to construct many pallets and shipping crates. The battalion did not have the materials, the tools nor the necessary skills for this type of work.

c. Recommendation. Unit redeployment contingency plans should delegate construction support units having the required equipment and skills.

2. Logistical information:

Annex A (Continued)

a. Observation. Inadequate detailed information was relayed to this unit in the early stages of redeployment. Timely guidance was needed for the preparation of TCMD's and turn-in documentation, planning for equipment preparation to meet Department of Agriculture standards, determination of the mode of transportation to be utilized and accomplishment of various personnel items.

b. Evaluation. As a result of the lack of early instructions, this battalion initiated many actions based on past experience. Some of these actions were later countermanded by higher headquarters' directives.

c. Recommendation. Initially the unit should be informed as to which areas of the operation will be command directed. A schedule indicating sequential accomplishment of tasks and level of responsibility is needed as soon after stand down as possible.

3. Preservation, Packaging and Packing Material (PP&P):

a. Observation. 1st Logistical Command listings for preservation and packaging materials for TOE 44-235D and 44-236D were inaccurate.

b. Evaluation. Only a portion of HAWK equipment was listed on supply requirement listings. Significant research was required by unit personnel to correct the listings.

c. Recommendation. Supporting units should verify all listings of requirements on a regularly scheduled basis with the supported unit.

4. PP&P Material:

a. Observation. PP&P material was difficult to obtain in the type and quantity required.

b. Evaluation. Non-Availability of PP&P materials delayed the operation at the Preparation for Overseas Movement (POM) line for approximately three days.

c. Recommendation. Supporting units should stock, or have readily available, PP&P material for units according to contingency schedules for redeployment.

5. Turn-in procedures:

a. Observation. Normal procedures utilized for day to day

Annex A (Continued)

supply actions cannot be utilized in a total TOE reduction.

b. Evaluation. The normal method of transporting item for turn-in to the support unit, so that an inspection can be performed, is time consuming, exceeds transportation availability and is difficult to control. Support units provided contact teams on all battery sites. These teams classified each item subsequent to conducting their inspection.

c. Recommendation. Supporting units should be required to provide on-site technical inspections teams for each commodity type material. These teams must have authority to determine the logistical disposition of each item.

6. Unit Transportation:

a. Observation. Sufficient transportation was not organically available to the unit during the latter stages of redeployment.

b. Evaluation. Upon receipt of redeployment orders, transportation requirements increase significantly. Preparation of organic vehicles for turn-in or transfer decreases their availability.

c. Recommendation. Support units must be tasked to provide vehicles to the deploying unit. Vehicle requirements should be determined for extended periods of time, rather than requested on a daily basis.

7. Vehicle availability:

a. Observation. In the final weeks of the redeployment operation, transportation became critical.

b. Evaluation. Vehicle maintenance became critical due to increased transportation requirements. In order to counter this, all vehicles not being utilized by sections were assigned to a battalion transportation pool.

c. Recommendation. Establish a centralized unit transportation pool. All serviceable vehicles, no longer needed by sections and not scheduled for immediate turn-in, should be placed in this pool. Each vehicle is assigned a driver and supervised scheduled maintenance is performed. Dispatch is strictly controlled through a central office.

8. Sea-Land trailers:

a. Observation. Sea-land trailers were found to be an

Annex A (Continued)

economical and efficient method of shipment containerization.

b. Evaluation. Use of Sea-Land vans reduced greatly the preparation and preservation process of high dollar items for shipment. A reduction in handling, especially at intermediate ports, results from the use of these vans.

c. Recommendation. Sea-Land vans should be utilized for shipment of selected items in redeployment operations.

9. Wooden components:

a. Observation. Insect infested wooden components of equipment will not meet U.S. Department of Agriculture standards.

b. Evaluation. An entomologist inspected the wooden runners of all missile containers and found them infested with termites and wood borers. These runners had to be replaced.

c. Recommendation. As early in the preparation as possible a qualified representative from the Department of Agriculture should be contacted and required to inspect all wooden components.

Appendix 2 to Annex A to Operational Report of Americal
 Division Artillery for the Period Ending 31 July 1969, RCS
 CSFOR-65 (KI) (U)

O U T P R O C E S S I N G

<u>STATIONS</u>	<u>INITIALS</u>
1. RA-50 Turn-in	_____
2. ID Card, ration card, MACV card, dog tags, personal appearance check.	_____
3. Finance	
a. Records check and processing	_____
b. Cashier	_____
4. Personnel	
a. Records issue	_____
b. Records check	_____
c. Dog tags made	_____
d. ID cards made	_____
e. Turn-in of personnel and finance records	_____
5. Medical Team	
a. Shot record check	_____
b. Issue of malaria pills w/instructions	_____
c. Dental and health record check	_____
d. Issue handouts	_____
6. Security out-briefing form	_____
7. Customs information and legal assistance	_____
8. Provost Marshall	_____
9. Postal team (Locator cards)	_____
10. Ration card and MACV card turn-in	_____
11. Turn-in of out-processing checklist	_____

NOTE: Station locations indicated on attached map.

NAME: _____ INITIALS _____
 RANK: _____

SAMPLE/SAMPLE/SAMPLE/SAMPLE/SAMPLE/SAMPLE/SAMPLE/SAMPLE/SAMPLE
DEPARTMENT OF THE ARMY
HEADQUARTERS, 6TH BATTALION, 56TH ARTILLERY
APO San Francisco 96325

17 July 1969

SUBJECT: Certificate in Lieu of Orders

TC WHOM IT MAY CONCERN

1. Reference: Force Order 4050.1B, dtd 25 Feb 67
2. In accordance with referenced force order, this letter certificate indicates the following named individual, who departed CONUS on this current tour of duty in the Republic of Vietnam on the date indicated, is scheduled to return to the United States in conjunction with the unit movement of the 6th Battalion, 56th Artillery (HAWK). The appropriate fund citation for this movement is: for officers, CIC 201 A01; for enlisted personnel, CIC 201A03.

<u>NAME</u>	<u>RANK</u>	<u>SSAN</u>	<u>DDUS</u>
SAMPLE	SAMPLE	SAMPLE	SAMPLE

3. Request this certificate in lieu of orders be honored by the NSAD Household Effects Section for the purpose of the above named individual shipping baggage.

FOR THE COMMANDER:

ARNOLD J. ECKELMAN
Captain, ADA
Adjutant

UNCLASSIFIED

Security Classification

DOCUMENT CONTROL DATA - R & D

(Security classification of title, body of abstract and indexing annotation must be entered when the overall report is classified)

1. ORIGINATING ACTIVITY (Corporate author) HQ, OACSFOR, DA, Washington, D.C. 20310		2a. REPORT SECURITY CLASSIFICATION CONFIDENTIAL	
		2b. GROUP 4	
3. REPORT TITLE Operational Report - Lessons Learned, HQ, Americal Division Artillery			
4. DESCRIPTIVE NOTES (Type of report and inclusive dates) Experiences of unit engaged in counterinsurgency operations, 1 May 69 to 31 July 69.			
5. AUTHOR(S) (First name, middle initial, last name) CO, Americal Division Artillery			
6. REPORT DATE 14 August 1969	7a. TOTAL NO. OF PAGES 42	7b. NO. OF REFS	
8a. CONTRACT OR GRANT NO.	8b. ORIGINATOR'S REPORT NUMBER(S) 693083		
b. PROJECT NO.	8c. OTHER REPORT NO(S) (Any other numbers that may be assigned this report)		
c. N/A			
d.			
10. DISTRIBUTION STATEMENT			
11. SUPPLEMENTARY NOTES N/A		12. SPONSORING MILITARY ACTIVITY OACSFOR, DA, Washington, D.C. 20310	
13. ABSTRACT			

THIS REPORT HAS BEEN DELIMITED
AND CLEARED FOR PUBLIC RELEASE
UNDER DOD DIRECTIVE 5200.20 AND
NO RESTRICTIONS ARE IMPOSED UPON
ITS USE AND DISCLOSURE.

DISTRIBUTION STATEMENT A

APPROVED FOR PUBLIC RELEASE;
DISTRIBUTION UNLIMITED.