

UNCLASSIFIED

AD NUMBER

AD521801

CLASSIFICATION CHANGES

TO: unclassified

FROM: confidential

LIMITATION CHANGES

TO:
Approved for public release, distribution unlimited

FROM:
Distribution authorized to U.S. Gov't. agencies only; Test and Evaluation; JUL 1972. Other requests shall be referred to Director, Naval Research Laboratory, Washington, DC 20390.

AUTHORITY

NRL Code/5309 memo dtd 20 Feb 1997; NRL Code/5309 memo dtd 20 Feb 1997

THIS PAGE IS UNCLASSIFIED

UNCLASSIFIED

AD NUMBER
AD521801
CLASSIFICATION CHANGES
TO
confidential
FROM
secret
AUTHORITY
31 Jul 1984, per doc marking, DoDD 5200.10

THIS PAGE IS UNCLASSIFIED

AD- 521801

SECURITY REMARKING REQUIREMENTS

DOD 5200.1-R, DEC 78

REVIEW ON 12 JUL 92

SECURITY

MARKING

The classified or limited status of this report applies to each page, unless otherwise marked.

Separate page printouts MUST be marked accordingly.

THIS DOCUMENT CONTAINS INFORMATION AFFECTING THE NATIONAL DEFENSE OF THE UNITED STATES WITHIN THE MEANING OF THE ESPIONAGE LAWS, TITLE 18, U.S.C., SECTIONS 793 AND 794. THE TRANSMISSION OR THE REVELATION OF ITS CONTENTS IN ANY MANNER TO AN UNAUTHORIZED PERSON IS PROHIBITED BY LAW.

NOTICE: When government or other drawings, specifications or other data are used for any purpose other than in connection with a definitely related government procurement operation, the U. S. Government thereby incurs no responsibility, nor any obligation whatsoever; and the fact that the Government may have formulated, furnished, or in any way supplied the said drawings, specifications, or other data is not to be regarded by implication or otherwise as in any manner licensing the holder or any other person or corporation, or conveying any rights or permission to manufacture, use or sell any patented invention that may in any way be related thereto.

SECRET

NRL Report 7428
Copy No. 3

Acceleration-Velocity-Range Signal Processor Capabilities Demonstrated with Three-Coordinate Real-Time Data Formats

[Unclassified Title]

GAROLD K. JENSEN

*Radar Techniques Branch
Radar Division*

July 12, 1972

AD 521801



NAVAL RESEARCH LABORATORY
Washington, D.C.

DDC CONTROL
NO. 21770

SECRET

Downgraded at 12 year intervals;
Not automatically declassified.

SECRET

SECURITY

This document contains information affecting the national defense of the United States within the meaning of the Espionage Laws, Title 18, U.S.C., Sections 793 and 794. The transmission or revelation of its contents in any manner to an unauthorized person is prohibited by law.

SECRET

SECRET

CONTENTS

Abstract ii
Authorization ii

INTRODUCTION 1

MEASUREMENTS OF THE AVR SIGNAL PROCESSOR. 2

 Three-Coordinate Waveforms 2
 Resolution Capabilities. 4
 Large Signal—Small Signal Performance and Spurious Levels 25
 Other Data and Display Formats. 33
 Dynamic Range 33

DESCRIPTION OF THE REAL-TIME AVR PROCESSOR 33

DESIGN PHILOSOPHY. 36

SUMMARY 38

REFERENCES 39

APPENDIX A—Description of Past and Current NRL Literature . . 40

REFERENCES. 42

"NATIONAL SECURITY INFORMATION"
"Unauthorized Disclosure Subject to Criminal
Sanctions"

21730

SECRET

ABSTRACT
(Secret)

Measurements have been made on the NRL second-generation acceleration-velocity-range signal processor. Acceleration and velocity resolutions and coverage, signal dynamic range, target-handling capabilities, large and small signal performance and spurious levels have been considered, and then performance is illustrated with three-coordinate and two-coordinate data formats. The three coordinate real-time data formats aid the observer to grasp more quickly the significance of the combinations of acceleration, velocity, range, amplitude, and time data being presented. They also quickly reveal the serious consequences of mismatched signal processing.

The effectiveness and potential of the acceleration-velocity-range signal processor may more easily be judged with the aid of the three-coordinate data formats.

AUTHORIZATION

NRL Problem R02-23
Project RF12-151-402-4007

Manuscript submitted April 14, 1972.

**ACCELERATION-VELOCITY-RANGE SIGNAL PROCESSOR CAPABILITIES
DEMONSTRATED WITH THREE-COORDINATE REAL-TIME DATA FORMATS
(Unclassified Title)**

INTRODUCTION

(U) The Naval Research Laboratory has been working to improve signal processing capabilities, as much as possible, for all types of targets of interest to over-the-horizon (OTH) radar applications. This particular work has been directed toward obtaining as much information as possible from missile and aircraft targets even though they often exist in a very unfavorable environment.

(S) Two generations of acceleration-velocity-range (AVR) signal processors have been developed using phase-coherence, integration, and signal-matching (matching of both acceleration and velocity parameters) processes. In the case of the second-generation processor, added emphasis was placed on obtaining wide signal dynamic range, on obtaining real-time processing capabilities including the additional parameter of acceleration, and on obtaining output data capabilities and formats of most benefit to the user. Further emphasis was placed on obtaining the simplest, most cost-effective solution consistent with the technical design goals. Also system flexibility was stressed; that is, the ability to adapt the processor readily to different needs.

(S) It is the purpose of this report to

1. Demonstrate the effectiveness and potential of AVR signal processing.
2. Demonstrate the effectiveness of real-time three-coordinate formats in aiding the observer to grasp quickly the significance of the combinations of acceleration, velocity, range, amplitude, and time data being presented. It also will quickly reveal the serious consequences of mismatched signal processing.
3. Demonstrate the following capabilities of the second-generation AVR processor:
 - a. Signal dynamic range
 - b. The ability to detect a small target in the presence of a large target
 - c. The capability of resolving two or more targets even with very low g separation and when one may be a constant velocity target
 - d. The ability to discriminate between or exclude either constant velocity or accelerating targets from a display.
4. Discuss certain design considerations and philosophies.

(S) Many stages of development preceded the work presently described. Each provided the foundation for the next step. The reasons for desiring certain processor capabilities, the philosophy involved in system designs, investigations into basic phenomena that were necessary before processor systems could be defined, and system development work have been described in a series of NRL reports. A brief description of each report along with a listing of these reports is given in Appendix A.

MEASUREMENTS OF THE AVR SIGNAL PROCESSOR

(S) The performance of the second-generation processor has been measured, and many of its most important capabilities have been recorded on three- and two-coordinate photographs taken from certain of the data formats in real time. Simulated signals were used in the measurements and were applied at the input of the signal analyzer which was set up for an integration time of 10 sec with commensurate signal processing gain and velocity and acceleration resolutions.

Three-Coordinate Waveforms

(S) Figure 1 shows the AVR signal processor output when a simulated accelerating target signal is applied at the input. The output is a waveform which depicts the three-dimensional ambiguity surface of the signal-matching process. Three coordinates are used in this figure. The acceleration and velocity parameters are assigned to the two coordinates forming the base of the three-dimensional figure. Amplitude is shown as the coordinate which appears to be vertical in the figure. Acceleration, velocity, and amplitude data are presented here, but other selections of parameters could have been made. For example, range could have been substituted for one of the other three parameters, the unused parameter being suppressed. The acceleration extent is 3 g with zero acceleration appearing on the left edge. The target was simulated at about 1.5 g and was matched in both acceleration and velocity, as will be evident in the figure with the explanation given below.

(S) A velocity-only signal processor is capable of examining only the zero acceleration cell for targets. As a consequence, it ignores all of the remainder of the three-dimensional space. As Fig. 1 shows the only evidence of the accelerating target that such a processor will produce will be greatly reduced in amplitude and spread over many velocity cells, denying even a velocity determination. This is true even for low-g targets, as shown, and becomes more severe at the high g's exhibited by missiles.

(S) Conversely, the display will also show that if the acceleration processor does not process zero acceleration and a few succeeding cells, constant-velocity targets will be suppressed. When necessary this capability permits the separation of the two types of targets and the display of either one or both.

(S) The cross section of the signal response is very thin and is only one cell thick under the peak response. When many targets are to be resolved a much more advantageous viewing angle is available. A 4 o'clock viewing position allows an edge view of the waveform.

(S) It is possible to rotate the point from which the three-dimensional waveform is viewed to any other point desired. This will be demonstrated in succeeding figures. In

ACCELERATION AND VELOCITY SIGNAL
PROCESSOR OUTPUT

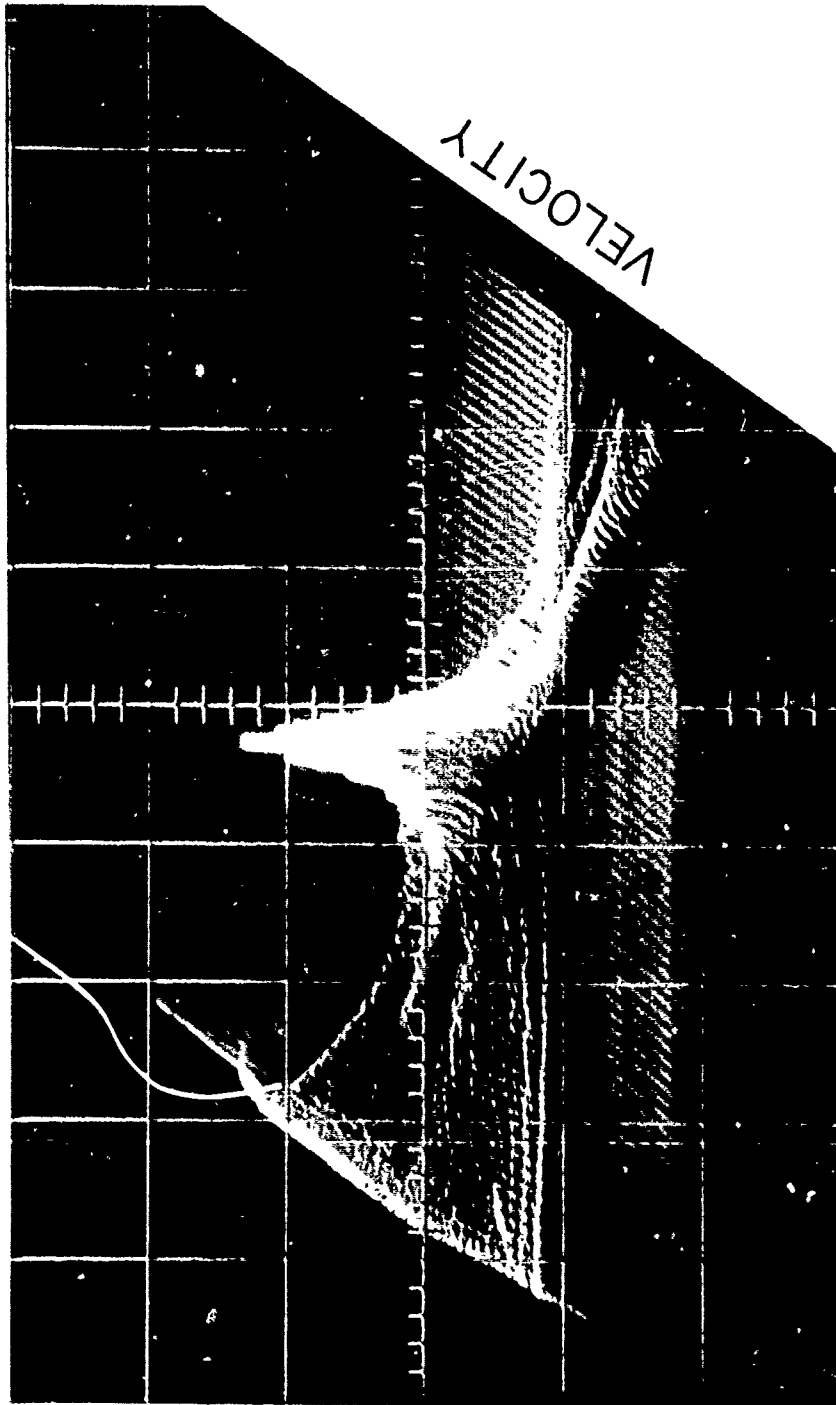

ACCELERATION

SIMULATED ACCELERATING TARGET-SIGNAL INPUT

Fig. 1 - (S) Acceleration-velocity-range (AVR) signal processor output with a 1.5-g simulated accelerating target input and a 0- to 3-G Acceleration axis extent

these figures the system gain has been increased until noise is shown and the signal level has been dropped to 80 dB below the maximum signal level. Also the acceleration extent has been increased to 10 g from 3 g. In Figs. 2 and 3 the observation point is to the left of that of Fig. 1. In Figs. 4, 5, 6, and 7 the observation point is to the right with Fig. 7 being edge-on where the thin profile is evident.

(S) All of the preceding figures have shown targets with positive acceleration. A negative acceleration target with about a 7-g acceleration and a high velocity is illustrated in Fig. 8. An edge view of this same target is shown in Fig. 9 in two dimensions where the velocity parameter has been collapsed to zero. And again a broadside view of the target with the acceleration parameter collapsed to zero is given in Fig. 10.

(S) In addition to looking at the sides of three-dimensional objects where only two dimensions are visible it is also possible to look down at the top, leaving only the acceleration and velocity parameters in view. Figure 11 shows the top view of the same target displayed in the preceding three figures.

Resolution Capabilities

(S) In order to demonstrate the processor's (a) capability to detect a small signal in the presence of a very large signal, (b) dynamic range, (c) resolution, and (d) spurious levels, a second signal will be introduced. A constant-velocity target has been added, shown by Fig. 12, which lies in the zero acceleration cell at about 25% of the full velocity extent. Figure 13 shows both the constant-velocity signal and an accelerating target signal having about 4 g acceleration. Both targets are 80 dB below maximum signal level.

(S) In Fig. 14 the accelerating target has been moved-down to about 1.3 g. It can be seen that targets with even a fractional g separation can easily be resolved even if one is at constant velocity. It is also evident that additional targets in the display could be distinguished.

(S) If the lowest 5% of the 210 acceleration cells in the acceleration extent are not processed the result will be as revealed in Fig. 15. The constant-velocity target has suffered a large loss in amplitude because of the mismatched signal processing. In Fig. 16 the lowest 10% of the acceleration cells were not processed. This results in a still larger loss in amplitude response.

(S) Conversely, if the processor is programmed to process only zero acceleration it will properly match constant-velocity targets and will mismatch accelerating targets. The results are shown in Fig. 17. Here the constant-velocity target appears at full amplitude; the accelerating target (at 1.3 g) is spread and reduced in amplitude.

(S) The accelerating target has been moved to 3 g in Fig. 18. The lowest 5% of the acceleration cells are not processed in Fig. 19 and the lowest 10% in Fig. 20. Again the constant-velocity target has been suppressed. If necessary aircraft targets could essentially be removed from a missile display. Velocity-only processing reveals even less of the 3-g target than it did of the 1.3-g target as illustrated in Fig. 21. Under certain combinations of radar operating frequency, prf, and integration time, a 20-g target can produce a doppler return that will fold at $\text{prf}/2$ and 0 frequency up to 20 times within an integration period.

ACCELERATION AND VELOCITY SIGNAL
PROCESSOR OUTPUT

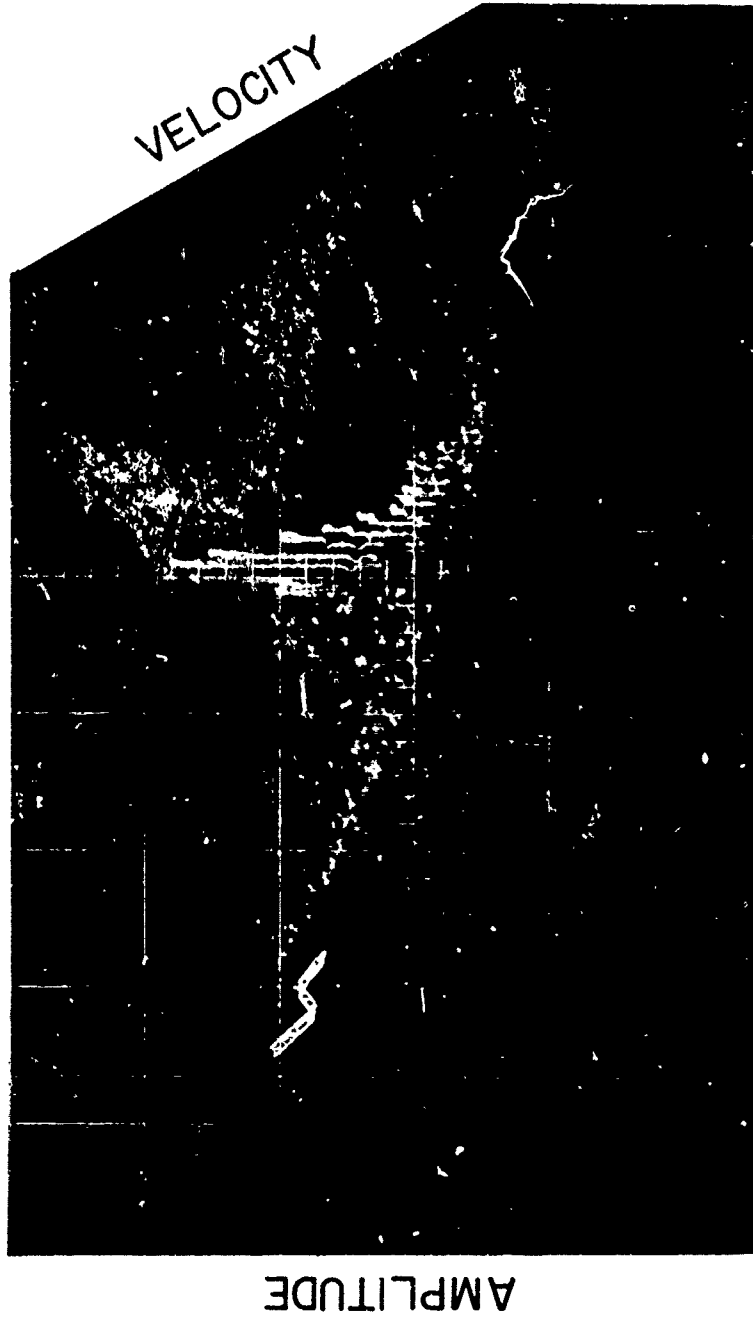

ACCELERATION
SIMULATED ACCELERATING TARGET
SIGNAL INPUT

Fig. 2 -- (S) AVR signal processor output with a simulated accelerating target input and 0- to 10-g acceleration axis extent.
The observation point is to the left.

ACCELERATION AND VELOCITY SIGNAL
PROCESSOR OUTPUT

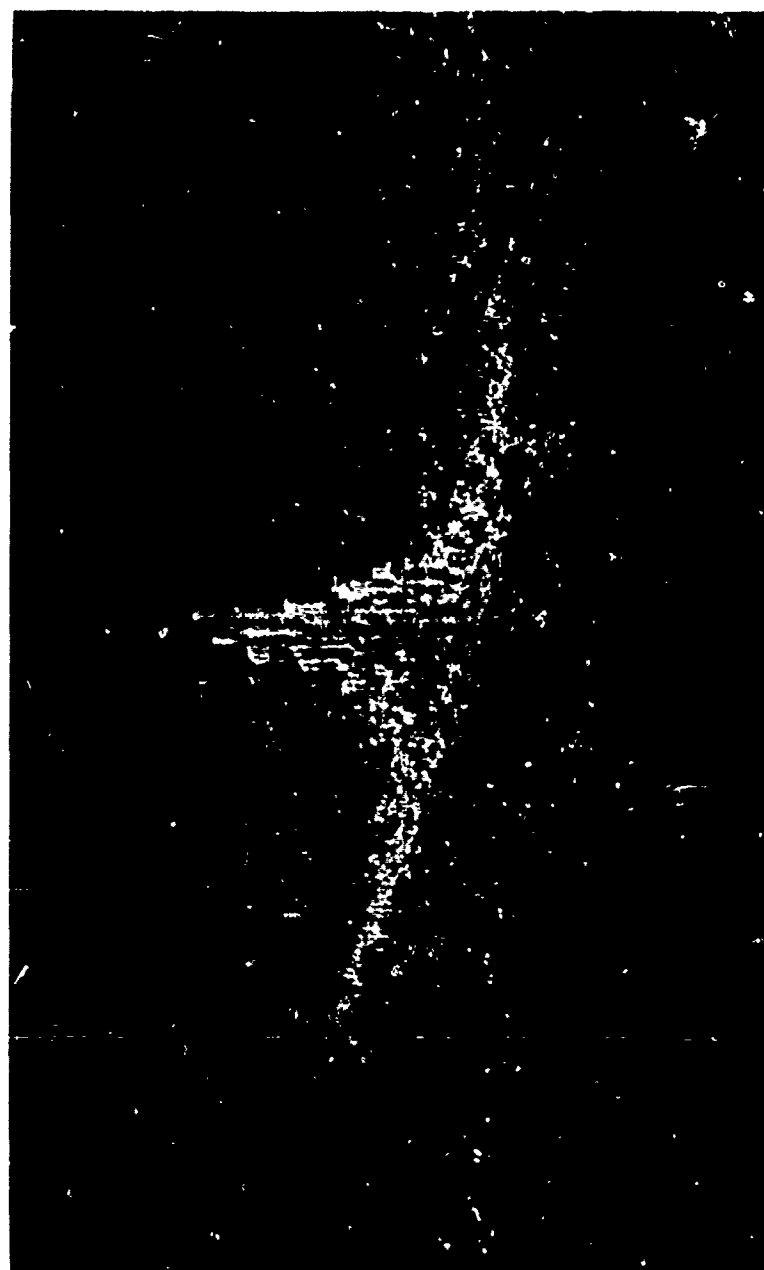

AMPLITUDE

VELOCITY

ACCELERATION

SIMULATED ACCELERATING TARGET
SIGNAL INPUT

Fig. 3 - (S) AVR signal processor output with a simulated accelerating target input and a 0- to 10-g acceleration axis extent. The observation point has been rotated to the right.

ACCELERATION AND VELOCITY SIGNAL
PROCESSOR OUTPUT



AMPLITUDE

ACCELERATION
SIMULATED ACCELERATING TARGET
SIGNAL INPUT

Fig. 4 - (S) AVR signal processor output with a simulated accelerating target input and a 0- to 10-g acceleration axis extent. Further rotation of the observation point to the right has taken place.

ACCELERATION AND VELOCITY SIGNAL
PROCESSOR OUTPUT

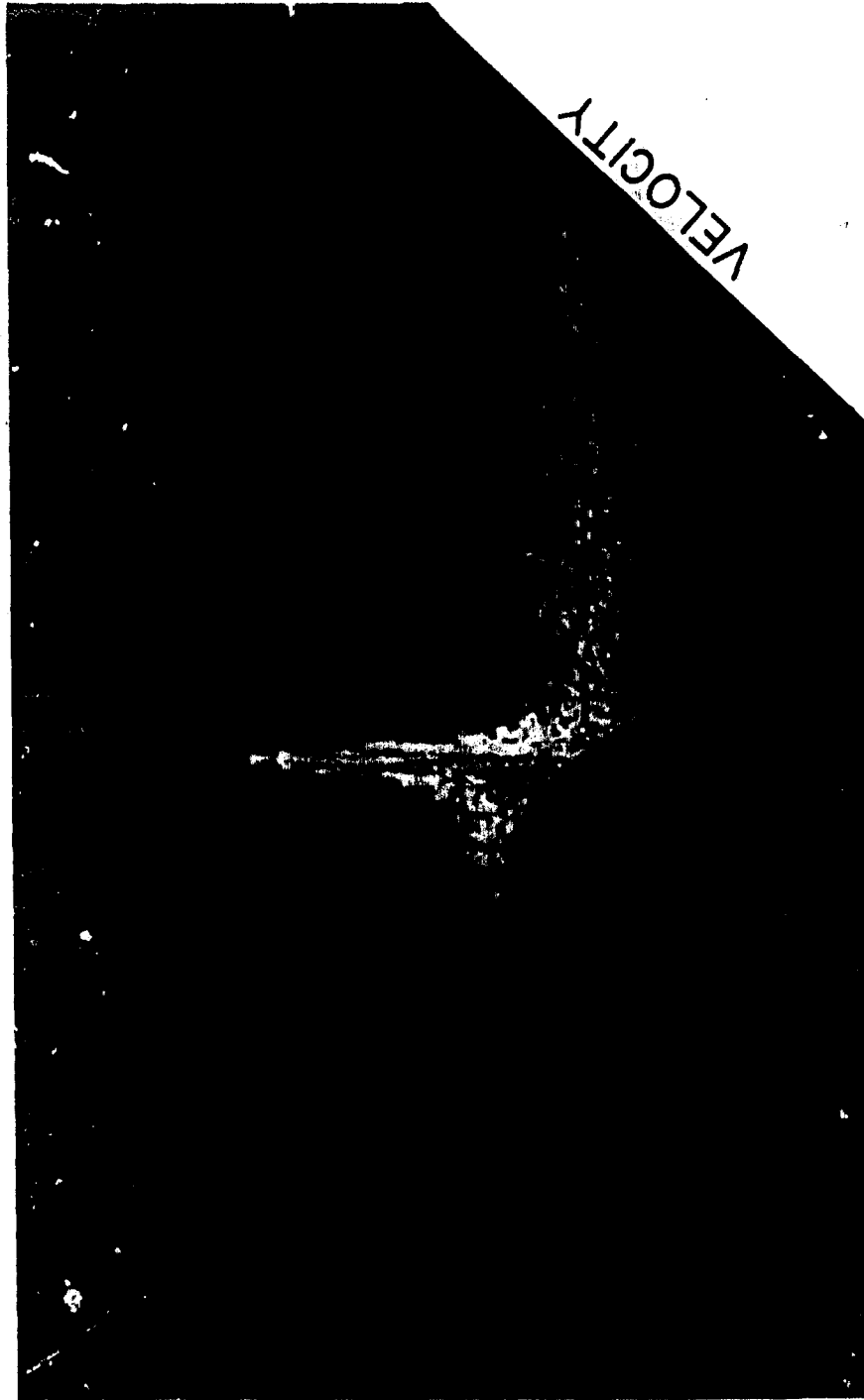

AMPLITUDE

ACCELERATION
SIMULATED ACCELERATING TARGET
SIGNAL INPUT

Fig. 5 - (S) AVR signal processor output with a simulated accelerating target input and a 0- to 10-g acceleration axis extent. The observation point has been rotated further right.

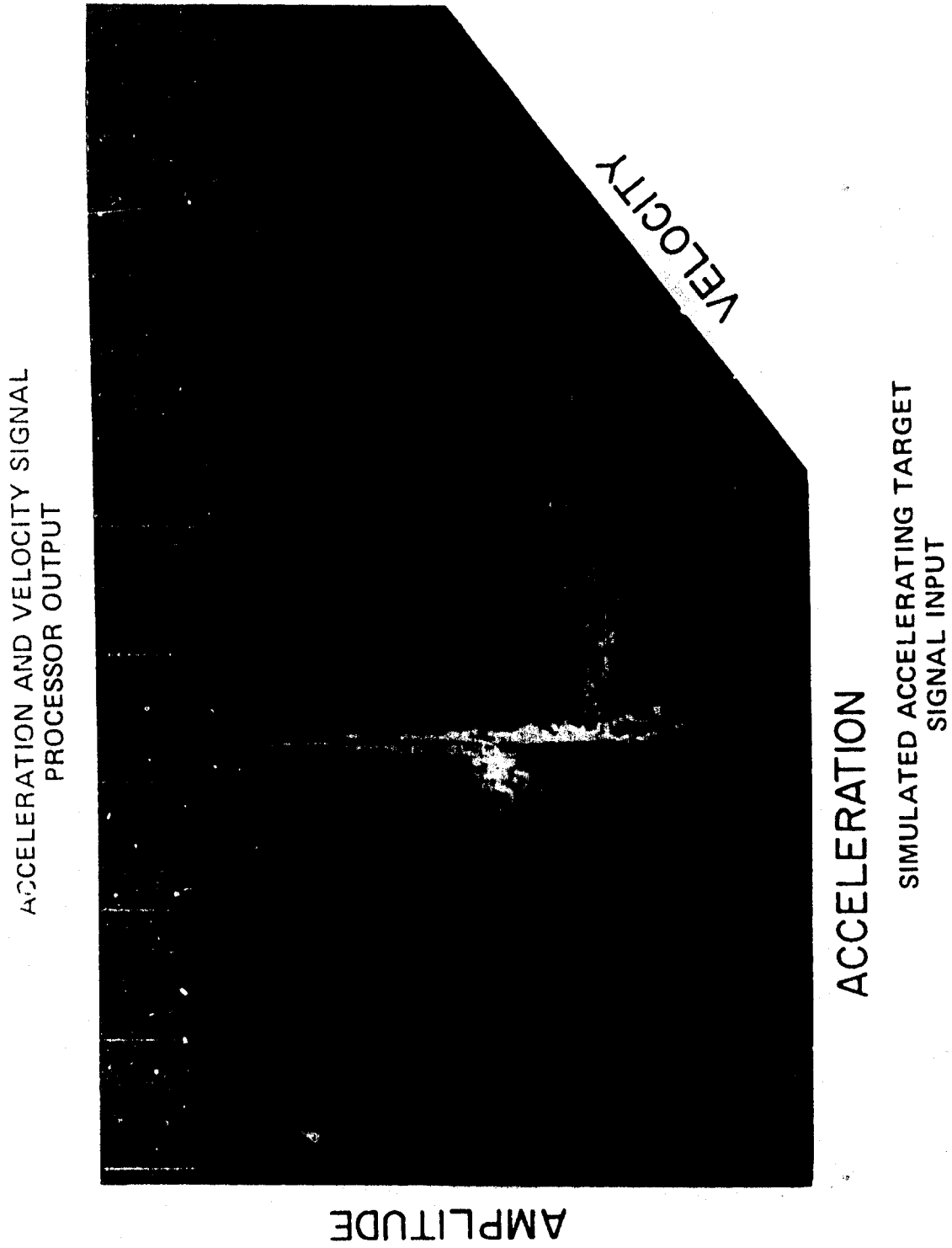
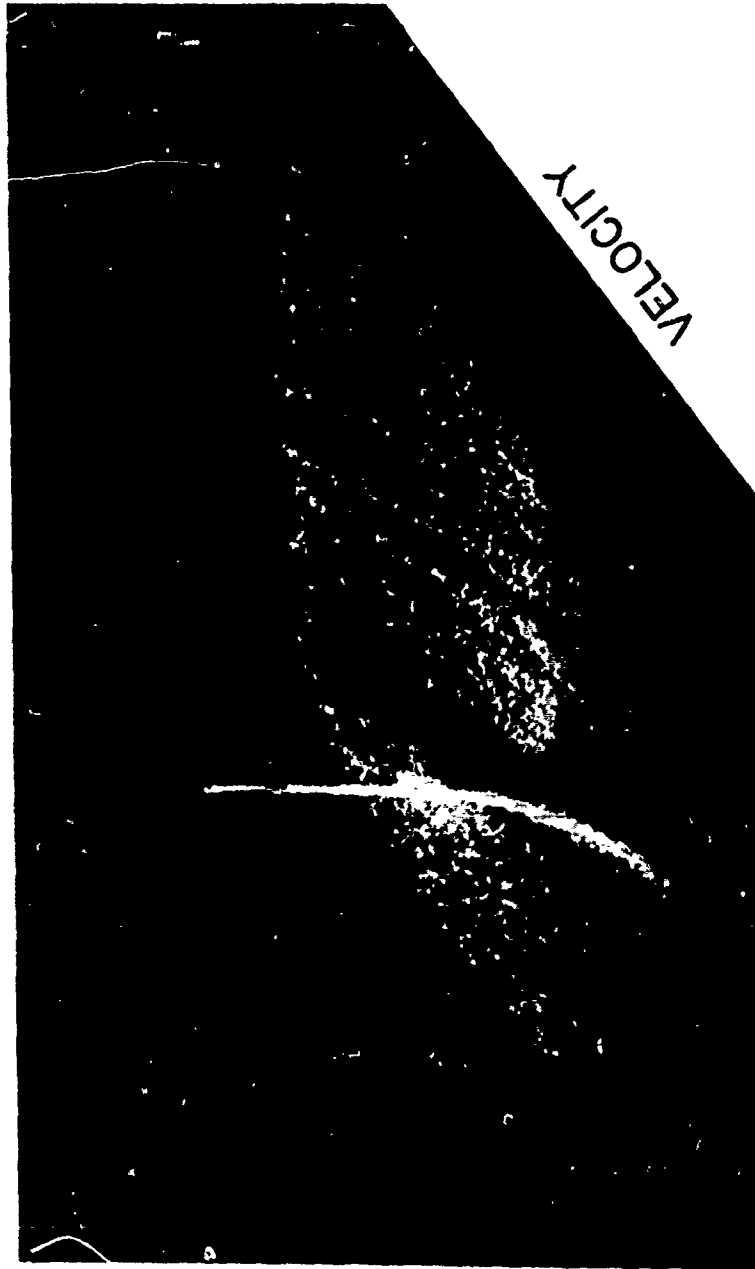

Fig. 6 - (S) AVR signal processor output with a simulated accelerating target input and a 0- to 10-g acceleration axis extent. More rotation has placed the observation point near an edge-on view.

ACCELERATION AND VELOCITY SIGNAL
PROCESSOR OUTPUT



ACCELERATION

SIMULATED ACCELERATING TARGET
SIGNAL INPUT

Fig. 7 — (S) AVR signal processor output with a simulated accelerating target input and a 0- to 10-g acceleration axis extent. The observation point has now been rotated to a full edge-on view (4 o'clock position).

ACCELERATION AND VELOCITY SIGNAL
PROCESSOR OUTPUT



ACCELERATION
SIMULATED ACCELERATING TARGET
SIGNAL INPUT

Fig. 8 — (S) AVR signal processor output with a simulated negative 7-g target input and a 0- to 10-g acceleration axis input

ACCELERATION AND VELOCITY SIGNAL
PROCESSOR OUTPUT



AMPLITUDE

ACCELERATION

SIMULATED ACCELERATING TARGET
SIGNAL INPUT

Fig 9 -- (S) AVR signal processor output and the target of Fig. 8 shown with the velocity axis collapsed

ACCELERATION AND VELOCITY SIGNAL
PROCESSOR OUTPUT

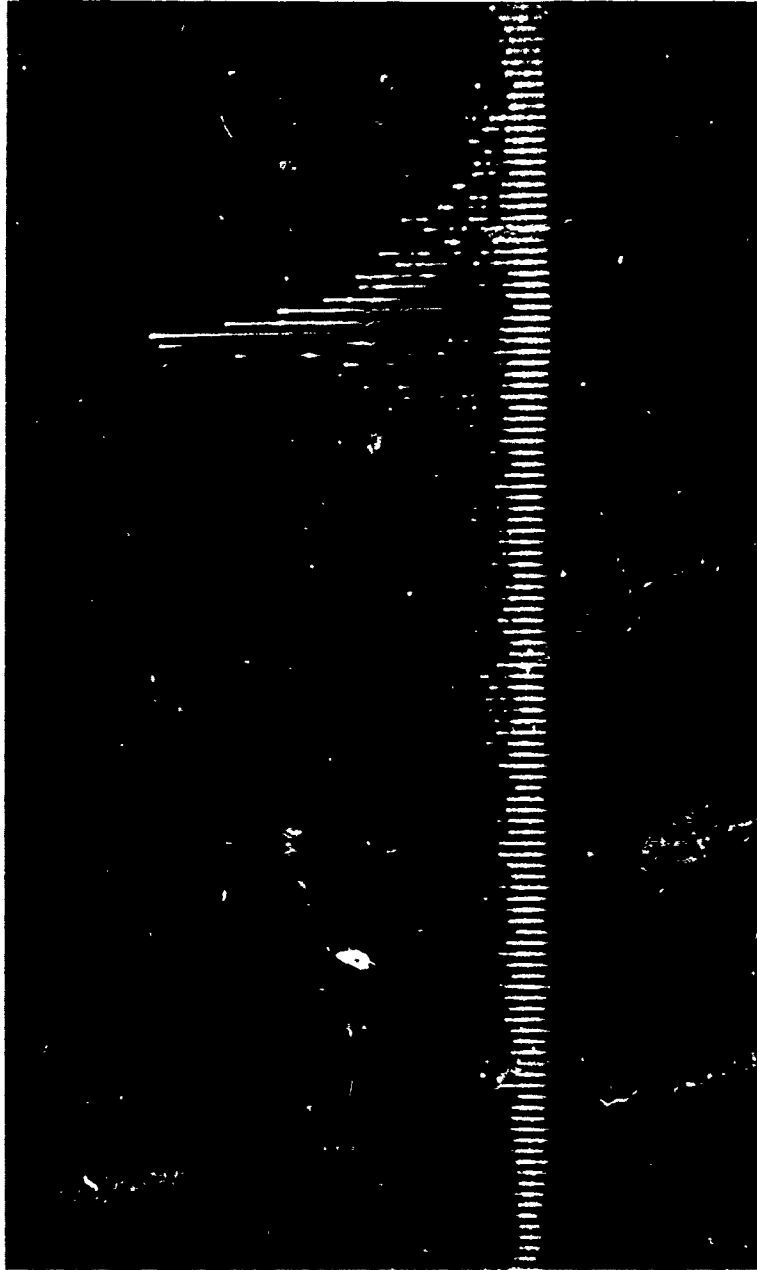

AMPLITUDE

VELOCITY

SIMULATED ACCELERATING TARGET
SIGNAL INPUT

Fig. 10 — (S) AVR signal processor output and the target of Fig. 8 shown with the acceleration axis collapsed

ACCELERATION AND VELOCITY SIGNAL
PROCESSOR OUTPUT

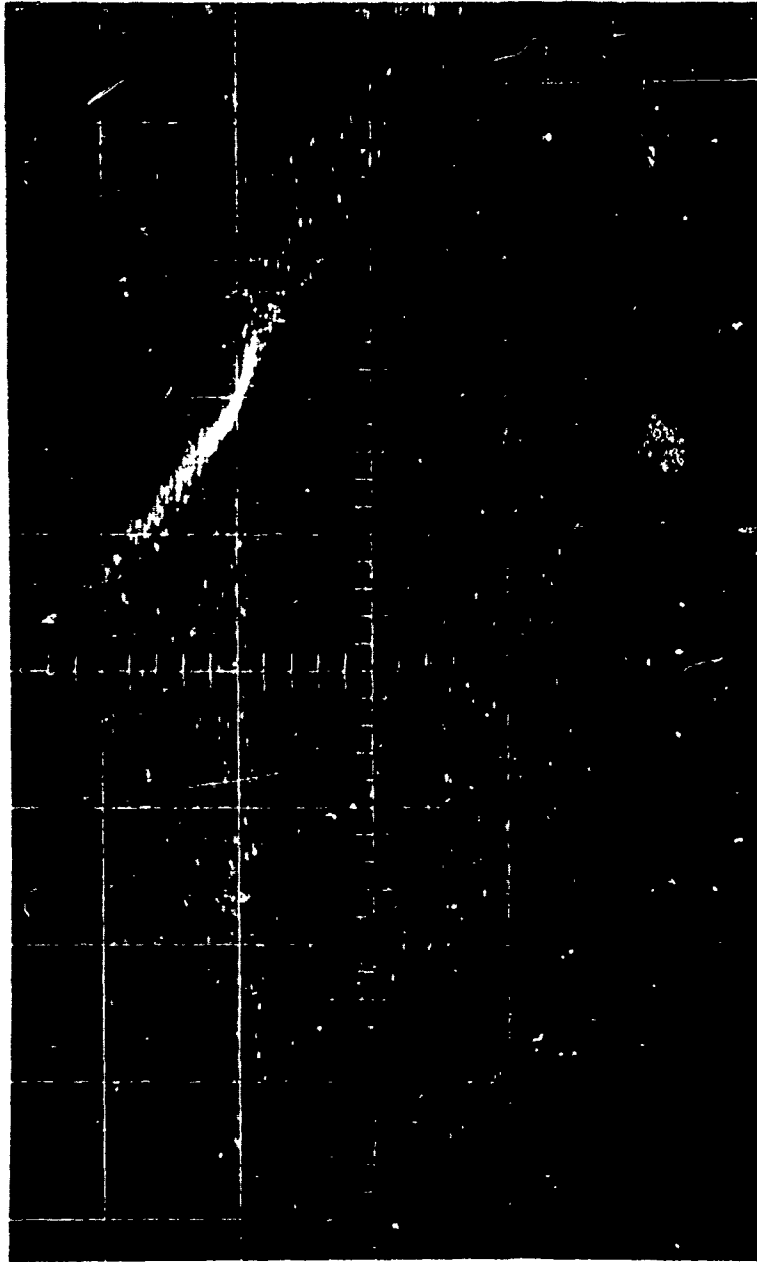

VELOCITY

ACCELERATION

SIMULATED ACCELERATING TARGET
SIGNAL INPUT

Fig. 11 — (S) AVR signal processor output and the target of Fig. 8 shown with the amplitude axis collapsed

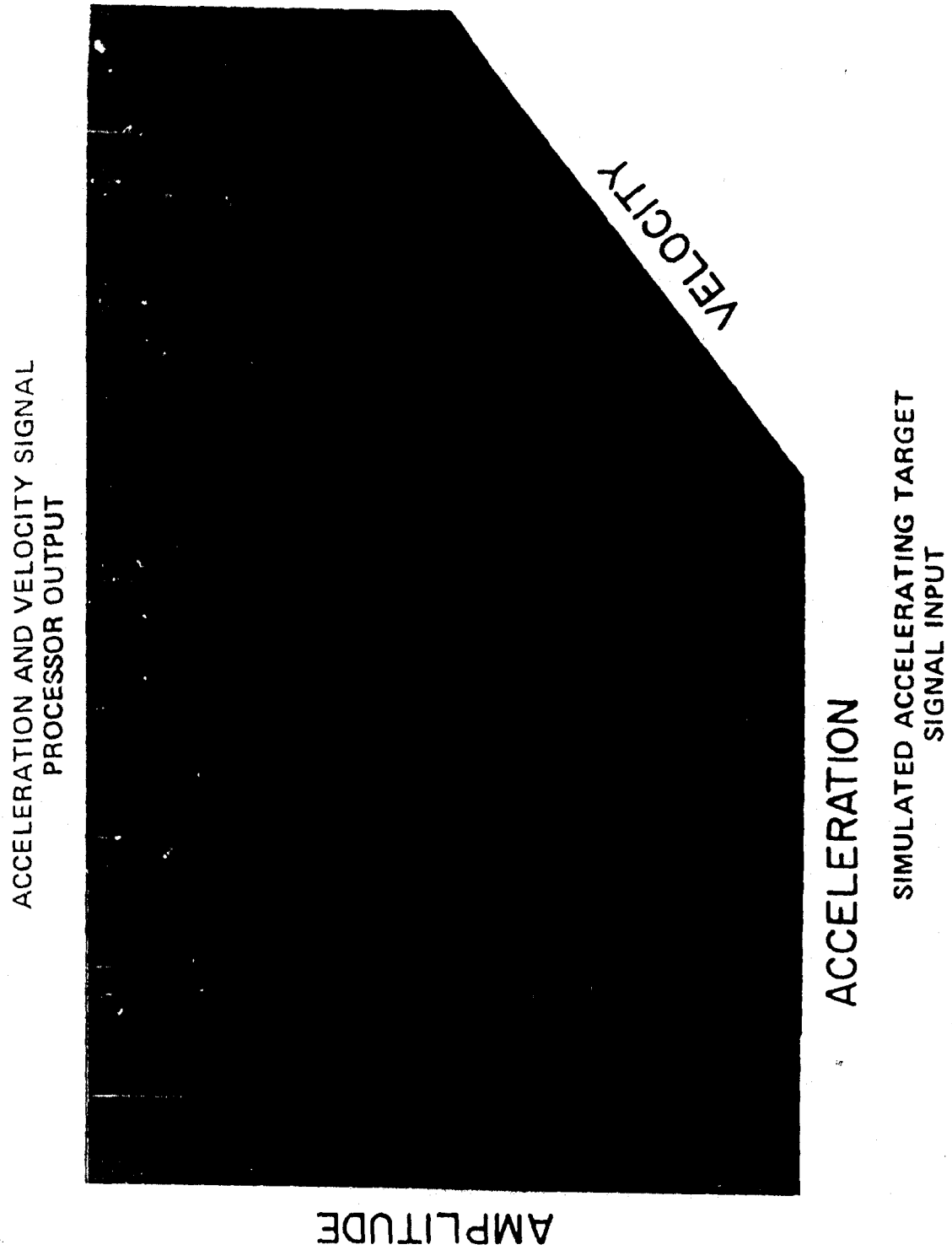
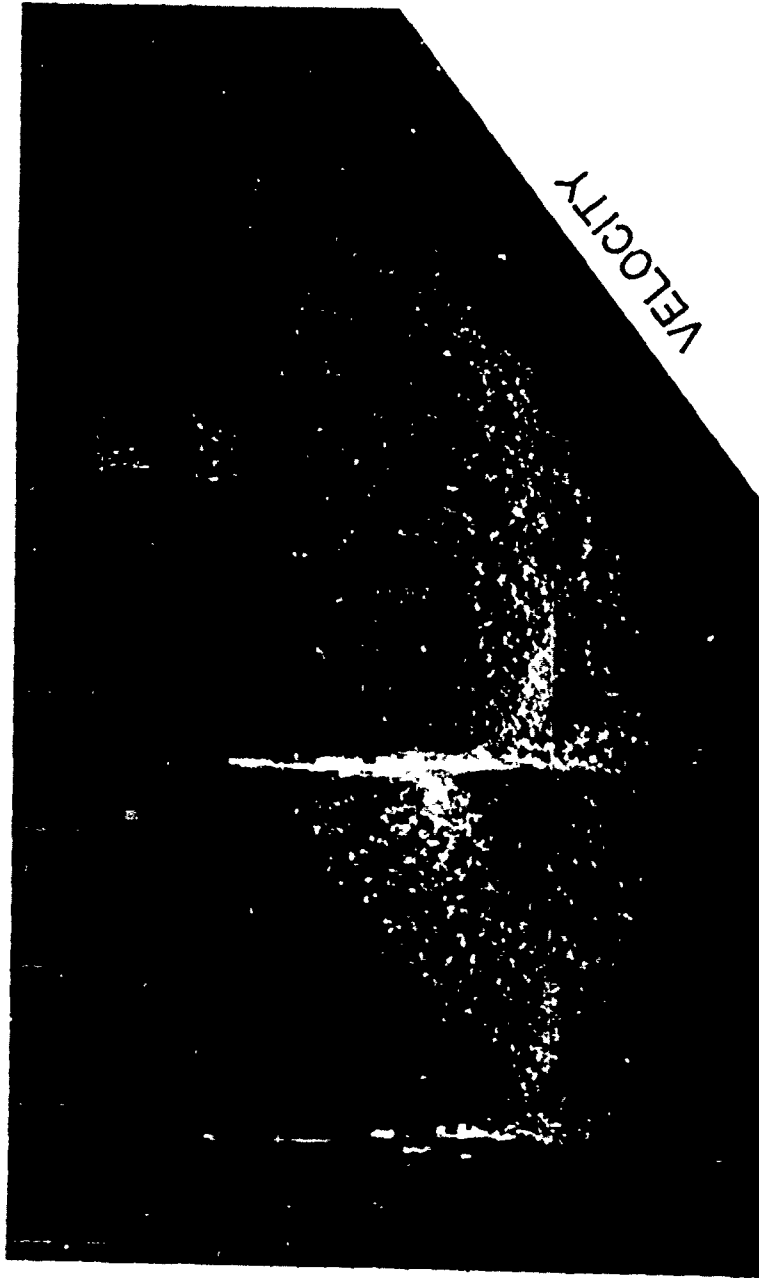

Fig. 12 - (S) AVR signal processor output showing a simulated constant-velocity target in the zero acceleration cell

ACCELERATION AND VELOCITY SIGNAL
PROCESSOR OUTPUT



AMPLITUDE

ACCELERATION

SIMULATED ACCELERATING TARGET
SIGNAL INPUT

Fig. 13 — (S) AVR signal processor output showing a simulated constant-velocity target as well as a 5-g accelerating target

ACCELERATION AND VELOCITY SIGNAL
PROCESSOR OUTPUT

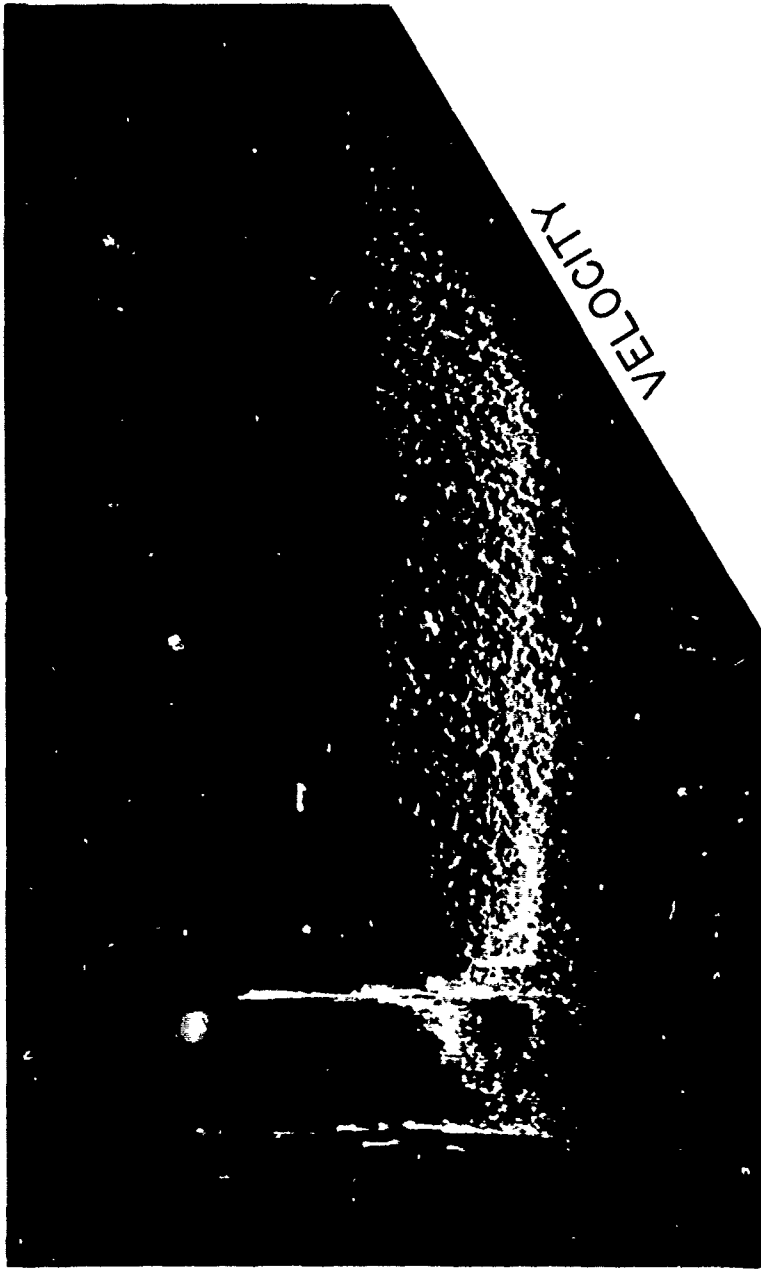

AMPLITUDE

ACCELERATION

SIMULATED ACCELERATING TARGET
SIGNAL INPUT

Fig. 14 — (S) AVR signal processor output showing a simulated constant-velocity target and a 1.3-g accelerating target. The acceleration axis extent is 0 to 10 g. Both signals are 80 dB below maximum signal amplitude.

ACCELERATION AND VELOCITY SIGNAL
PROCESSOR OUTPUT

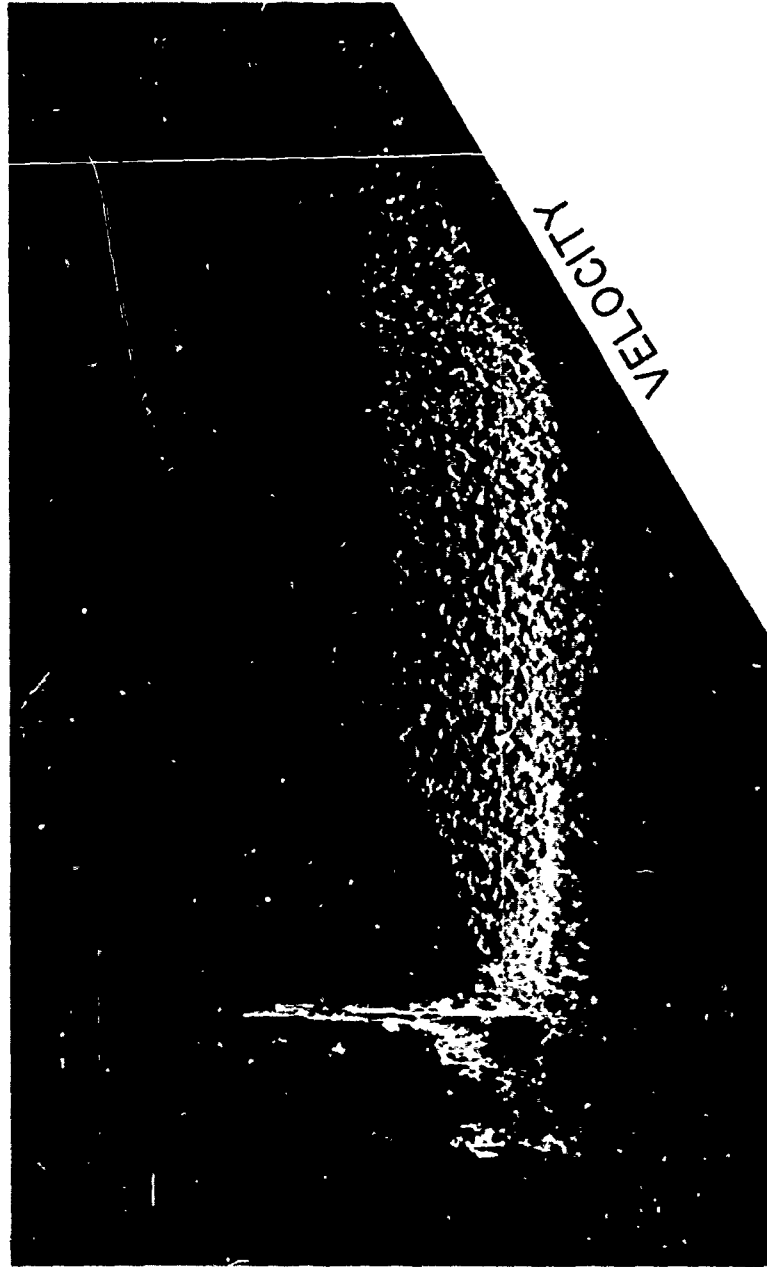

AMPLITUDE

ACCELERATION

SIMULATED ACCELERATING TARGET
SIGNAL INPUT

Fig. 16 -- (S) AVR signal processor output with the target signals of Fig. 14. The lowest 5% of the acceleration cells were not processed, thus mismatching the constant-velocity target and suppressing it.

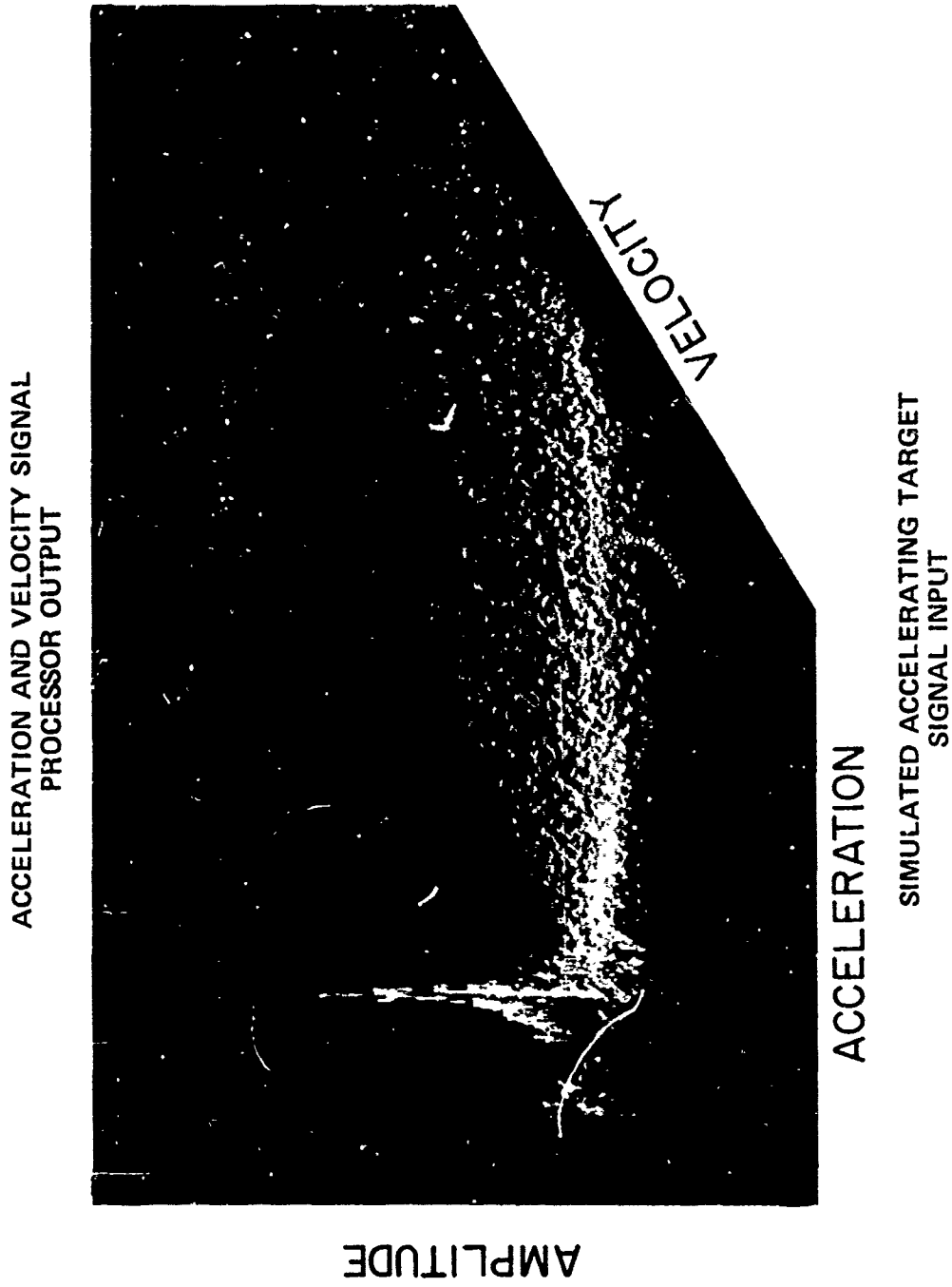
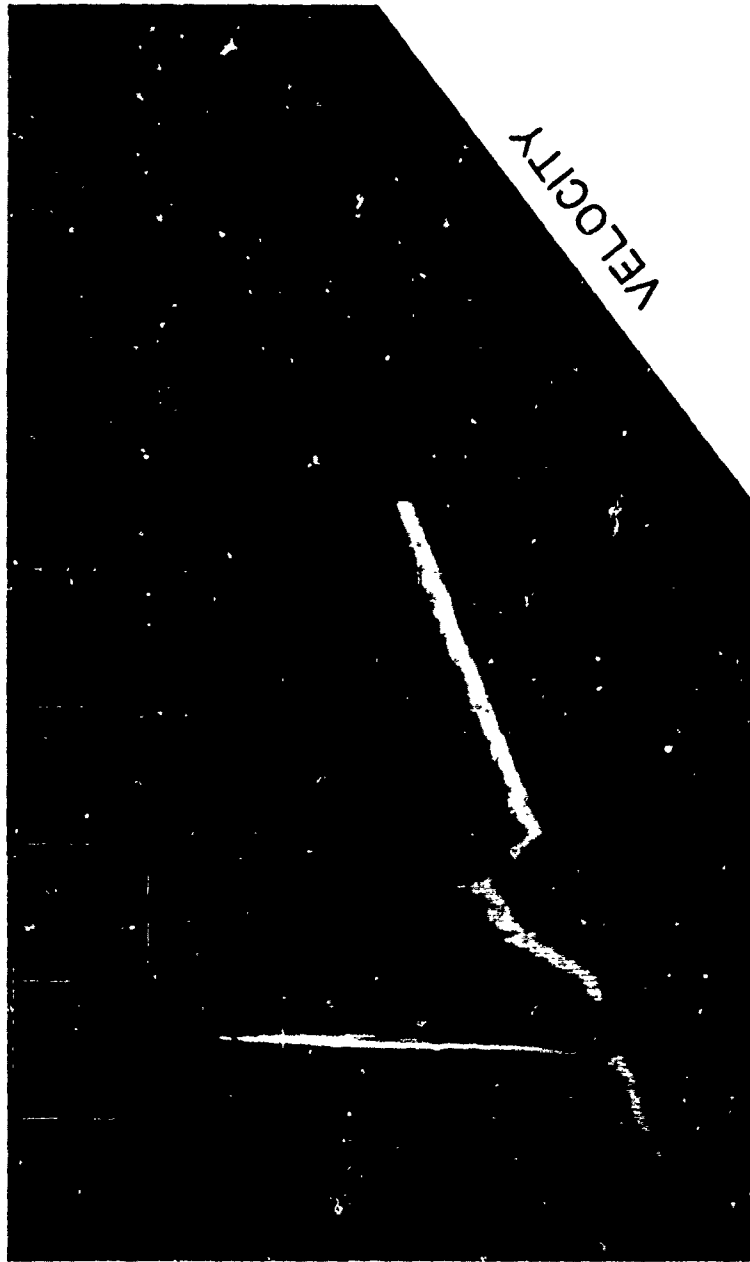

Fig. 16--(S) AVR signal processor output with the target signals of Fig. 14. The lowest 1.0% of the acceleration cells were not processed, thus increasing the mismatch and further suppressing the constant-velocity target.

ACCELERATION AND VELOCITY SIGNAL
PROCESSOR OUTPUT



SIMULATED ACCELERATING TARGET
SIGNAL INPUT

Fig. 17 -- (S) AVR signal processor output with the target signals of Fig. 14. Only the zero acceleration cell was processed, mismatching and suppressing the accelerating target.

ACCELERATION AND VELOCITY SIGNAL
PROCESSOR OUTPUT

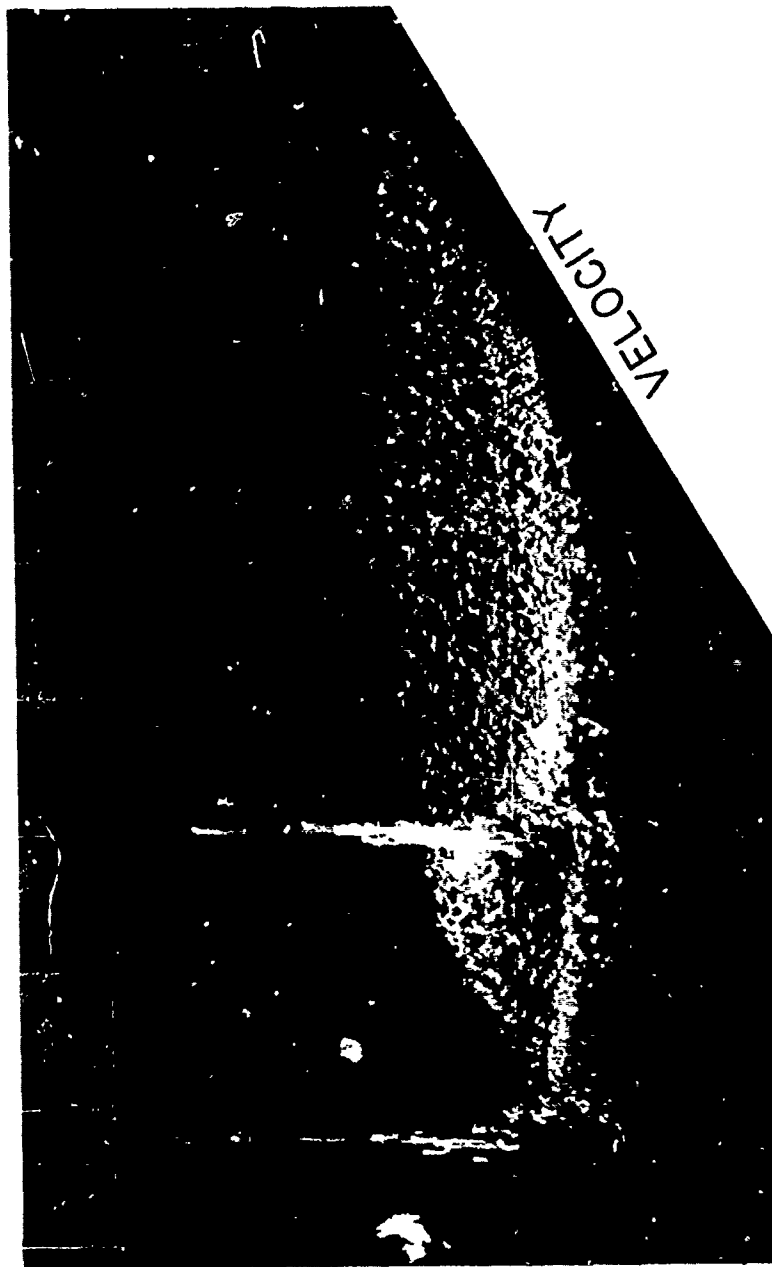

AMPLITUDE

ACCELERATION

SIMULATED ACCELERATING TARGET
SIGNAL INPUT

Fig. 18 - (S) AVR signal processor output showing a simulated constant-velocity target and a 3-g accelerating target. Both signals are 80 dB below maximum signal amplitude and the acceleration axis extent is 0 to 10 g.

ACCELERATION AND VELOCITY SIGNAL
PROCESSOR OUTPUT

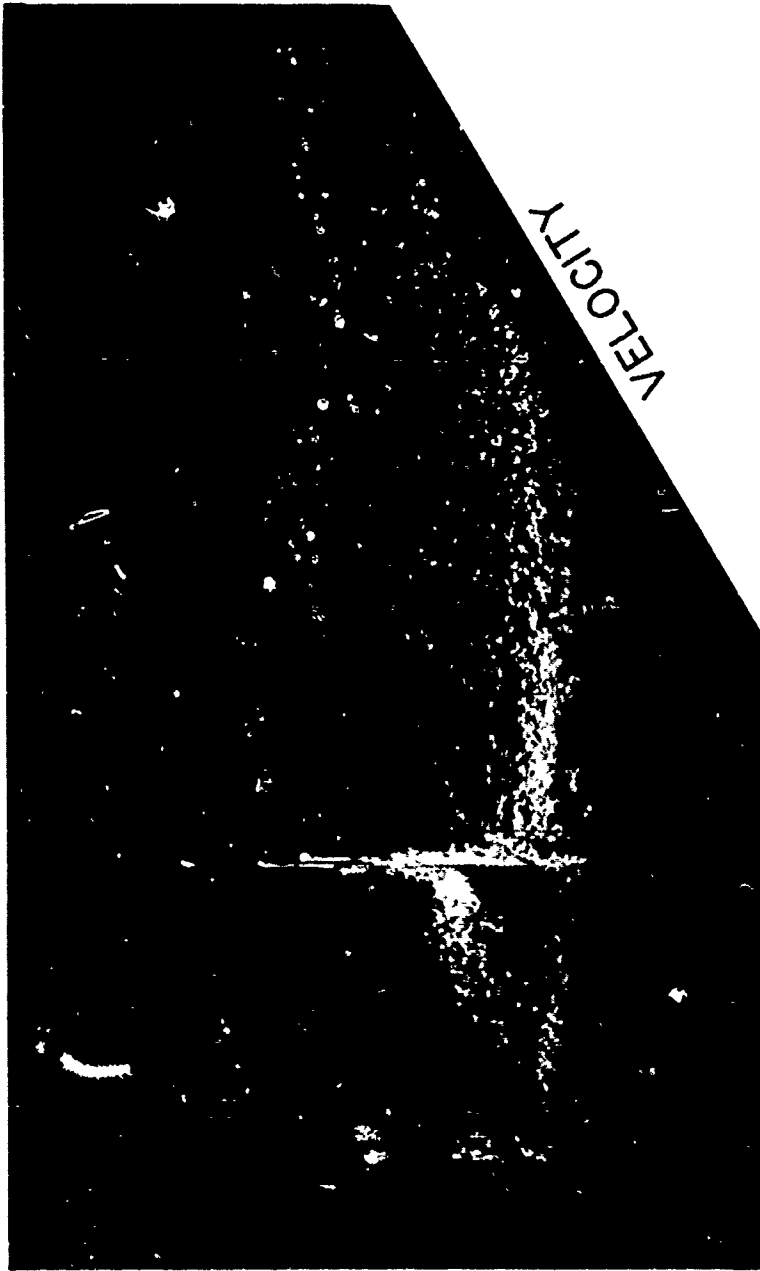

AMPLITUDE

ACCELERATION

SIMULATED ACCELERATING TARGET
SIGNAL INPUT

Fig. 19 — (S) AVR signal processor output with the target signals of Fig. 18. The lowest 5% of the acceleration cells were not processed, mismatching and suppressing the constant-velocity target.

ACCELERATION AND VELOCITY SIGNAL
PROCESSOR OUTPUT

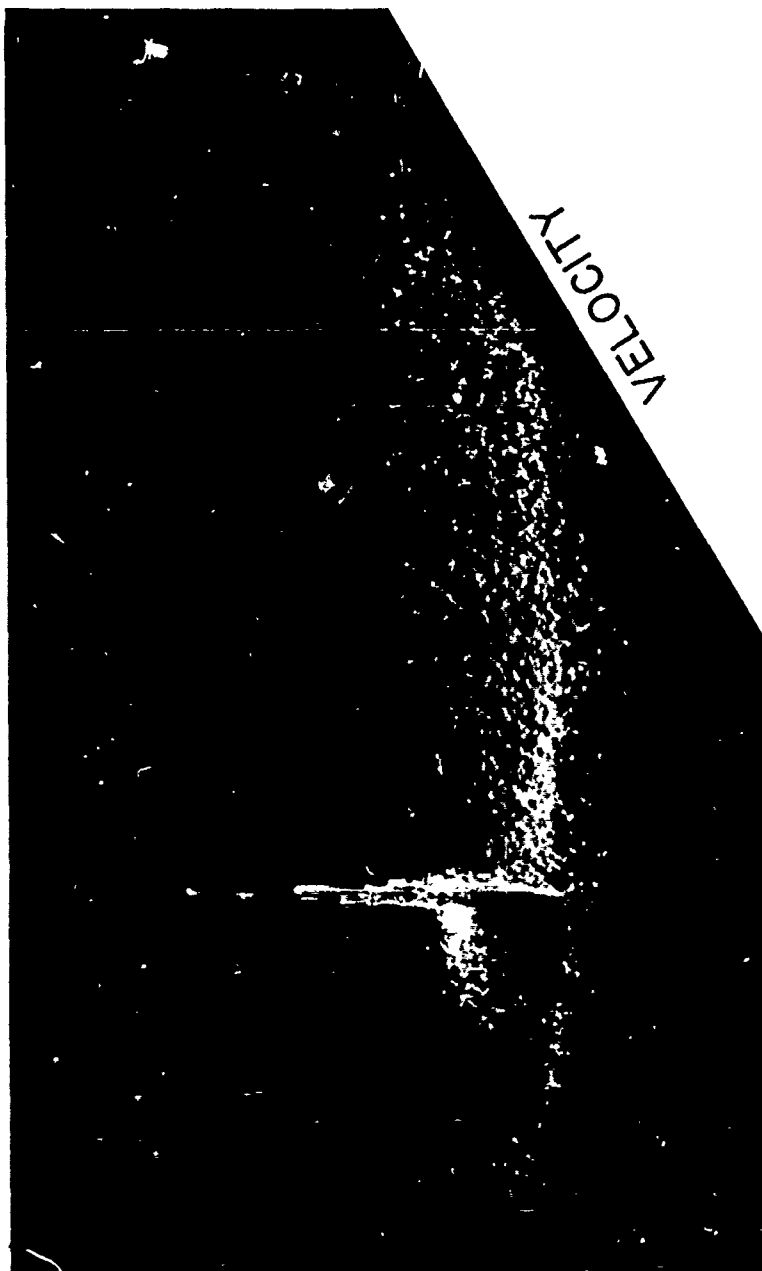

AMPLITUDE

ACCELERATION

SIMULATED ACCELERATING TARGET
SIGNAL INPUT

Fig. 20 -- (S) AVR signal processor output with the target signals of Fig. 18. The lowest 10% of the acceleration cells were not processed, thus increasing the mismatch and suppression of the constant-velocity target as before.

ACCELERATION AND VELOCITY SIGNAL
PROCESSOR OUTPUT

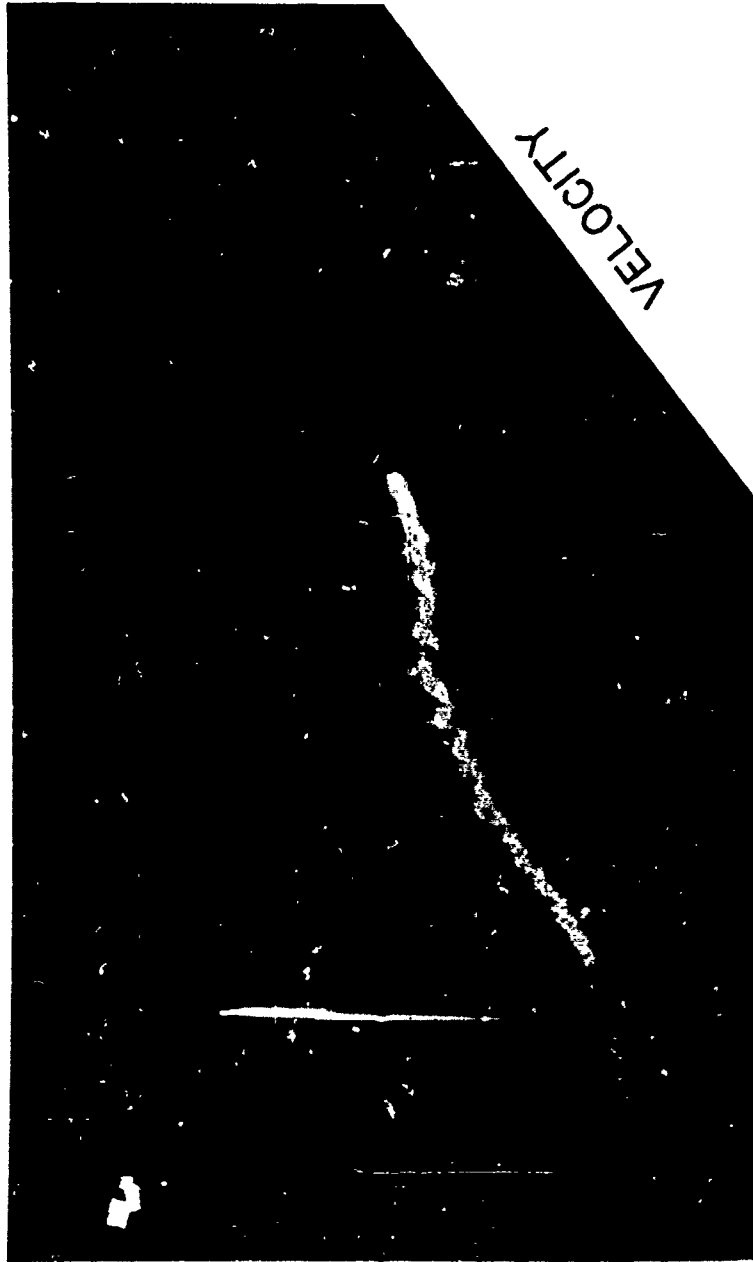

AMPLITUDE

VELOCITY

SIMULATED ACCELERATING TARGET
SIGNAL INPUT

Fig. 21 - (S) AVR signal processor output with the target signals of Fig. 18. Only the zero acceleration cell was processed, mismatching and suppressing the acceleration target considerably more than in Fig. 17. At the higher g's exhibited by missiles the suppression is still greater. It is also obvious that, with velocity-only processing, determining even the velocity of the accelerating target is impossible.

Needless to say, when the doppler return has swept only one prf/s extent in an integration period, velocity-only processing will indicate only an increase in noise level over the full doppler frequency extent and the target will be completely lost.

(S) Velocity-only processors have sometimes been used to show doppler time histories of targets, with slowly changing doppler responses, over a multiminute period (many integration periods). In some cases the target doppler may sweep over several prf/2 extents in a multiminute period. It should be realized that the change in doppler frequency in one integration period was very small, representing a very low g acceleration. Even though a target was detected it was mismatched with a loss of amplitude response and a loss of resolution as indicated by a more broadly displayed pip or track.

(S) Figure 22 shows a top view of the two target signals when the accelerating target was set to about 3 g, and in Fig. 23 it has been moved to about 4 g. The results of skewing the velocity axis, as seen from the top view, are shown in Figs. 24 and 25.

Large Signal—Small Signal Performance and Spurious Levels

(S) One of the most important characteristics of a radar system is the ability to detect small signals in the presence of large signals with little or no suppression of the small (minimum detectable) signals. In the case of acceleration-matched signal processing the resulting output waveform is poorly shaped for the best selectivity of one signal from another when the amplitude of one is much larger than the other. Figure 1 illustrates this problem. Consequently, it is necessary to normalize the level of signals above a selected amplitude before they are completely processed. Signals below the normalizing level are processed linearly and with full processing signal-to-noise (S/N) ratio gain. Signals above the normalizing level must be handled in a manner to maintain harmonics and intermodulation products below the minimum detectable output signal level.

(S) Either of two normalizing techniques may be used with an analog signal processor: One is frequency-selective limiting which employs parallel contiguous filter channels to divide the multiplied doppler band into about eight subbands, the other is a swept-filter approach which requires only a single filter and a limiter following the multiplication of LO and multiplied doppler signals in the signal analyzer. In the latter case it is possible to effectively divide the doppler band into a large number of subbands because it is not necessary to maintain phase linearity across a set of contiguous filters. Contiguous filtering was used in the system when the data presented herein were obtained.

(S) Figure 26 shows a constant-velocity target and an accelerating target at about 1.3 g and a low velocity. Both signals are 80 dB below maximum signal level. The constant-velocity signal has been raised 20 dB in Fig. 27 and has exceeded the normalizing level. In Fig. 28 the constant-velocity signal has been raised 60 dB above the accelerating target signal. Very little suppression of the small signal occurred and no spurious responses appeared except for an increase in noise at maximum acceleration extent, which was connected with processor cycling from high to low doppler analysis and should be correctable.

ACCELERATION AND VELOCITY SIGNAL
PROCESSOR OUTPUT

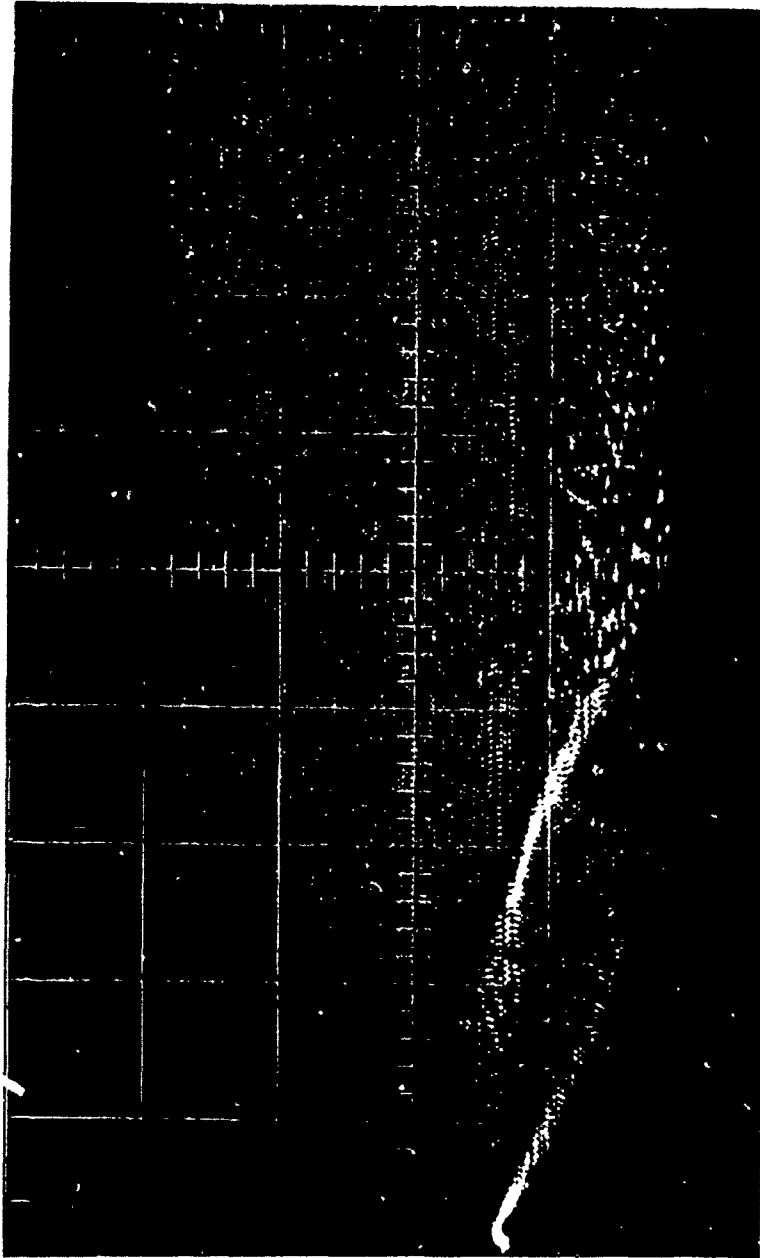

VELOCITY

ACCELERATION
SIMULATED ACCELERATING TARGET
SIGNAL INPUT

Fig. 22 - (S) AVR signal processor output and the signals of Fig. 18 shown with the amplitude axis collapsed

ACCELERATION AND VELOCITY SIGNAL
PROCESSOR OUTPUT

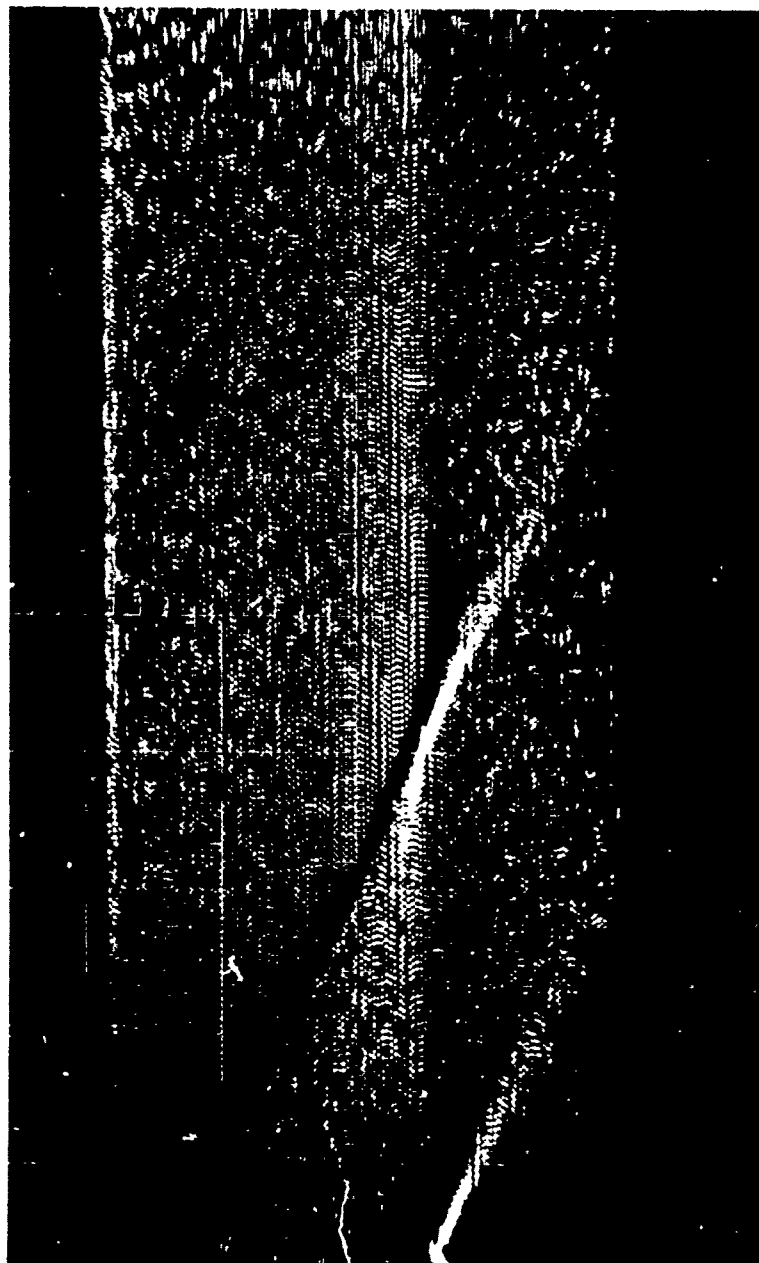

ACCELERATION
SIMULATED ACCELERATING TARGET
SIGNAL INPUT

Fig. 23 -- (S) AVR signal processor output with the signals of Fig. 22 except that the g of the accelerating target is higher

ACCELERATION AND VELOCITY SIGNAL
PROCESSOR OUTPUT

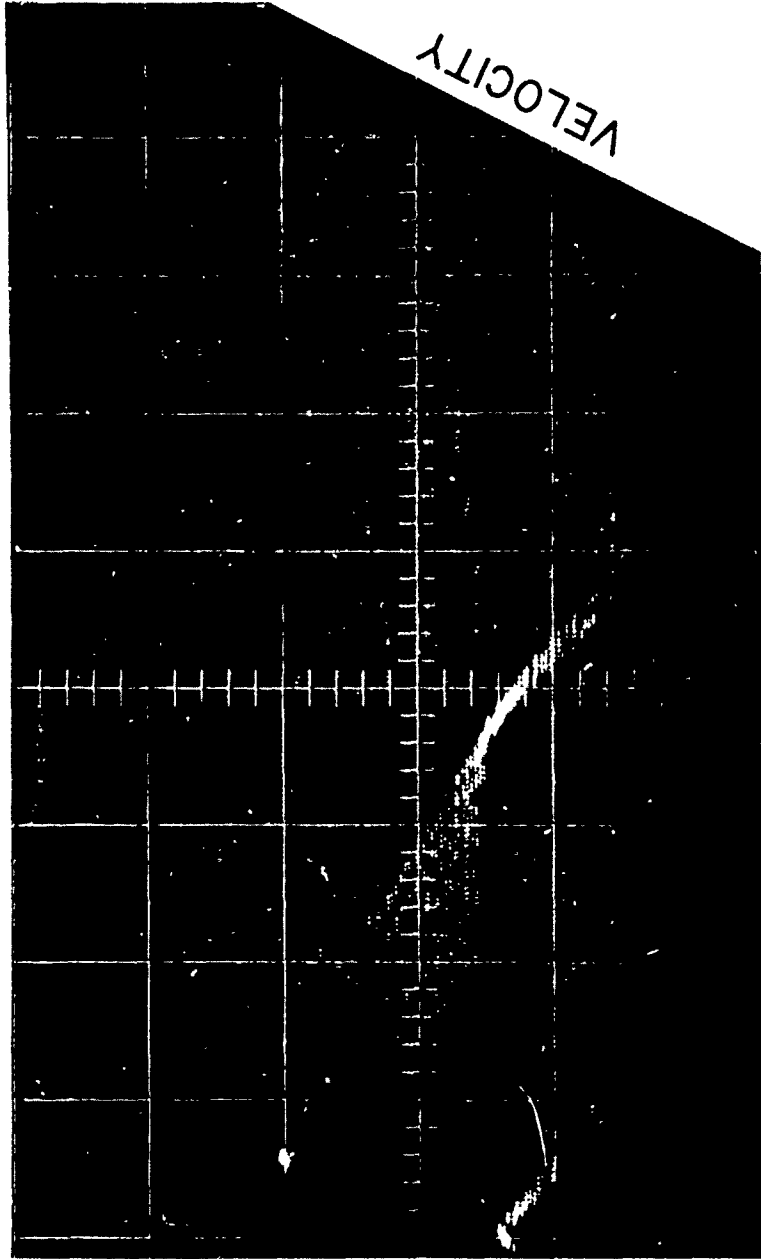

ACCELERATION
SIMULATED ACCELERATING TARGET
SIGNAL INPUT

Fig. 24 - (S) AVR signal processor output with the signals of Fig. 22. The observation point has been rotated to the right.

ACCELERATION AND VELOCITY SIGNAL
PROCESSOR OUTPUT

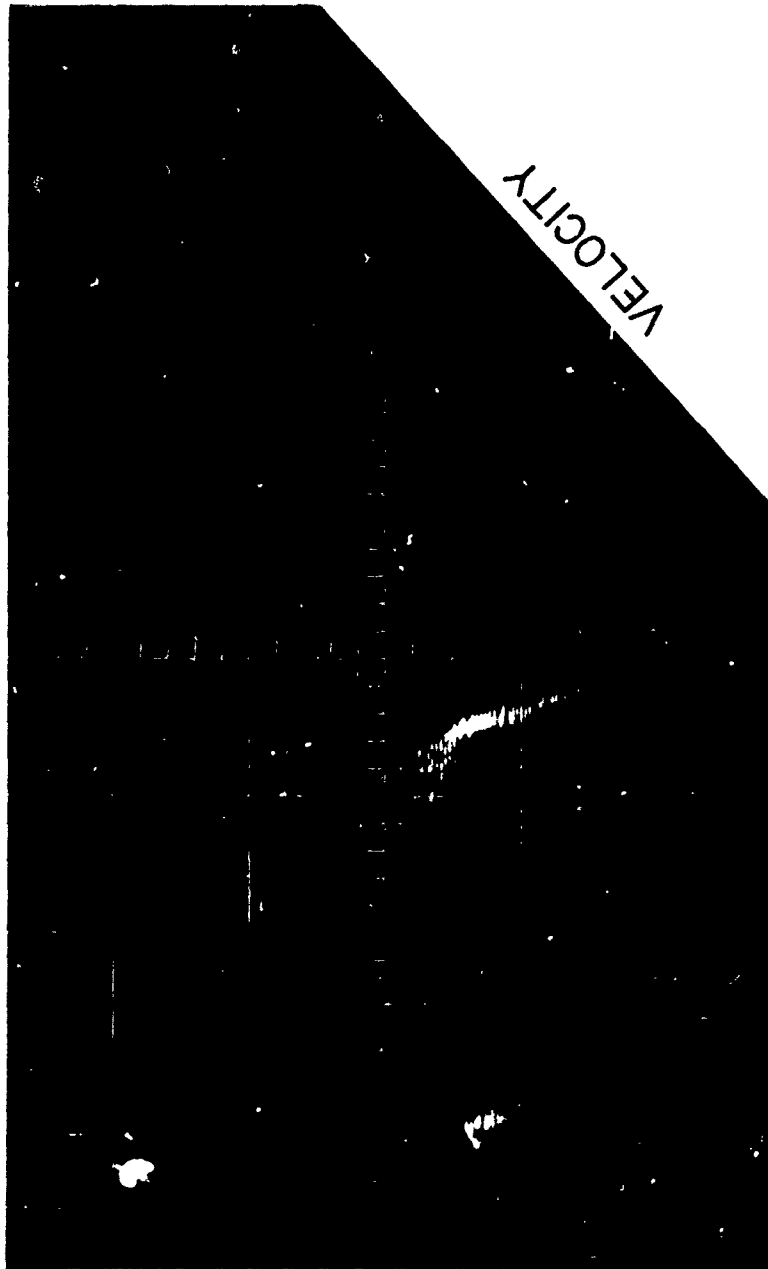

ACCELERATION

SIMULATED ACCELERATING TARGET
SIGNAL INPUT

Fig. 25 - (S) AVR signal processor output with the signals of Fig. 22. An edge-on view is shown in two coordinates

ACCELERATION AND VELOCITY SIGNAL
PROCESSOR OUTPUT

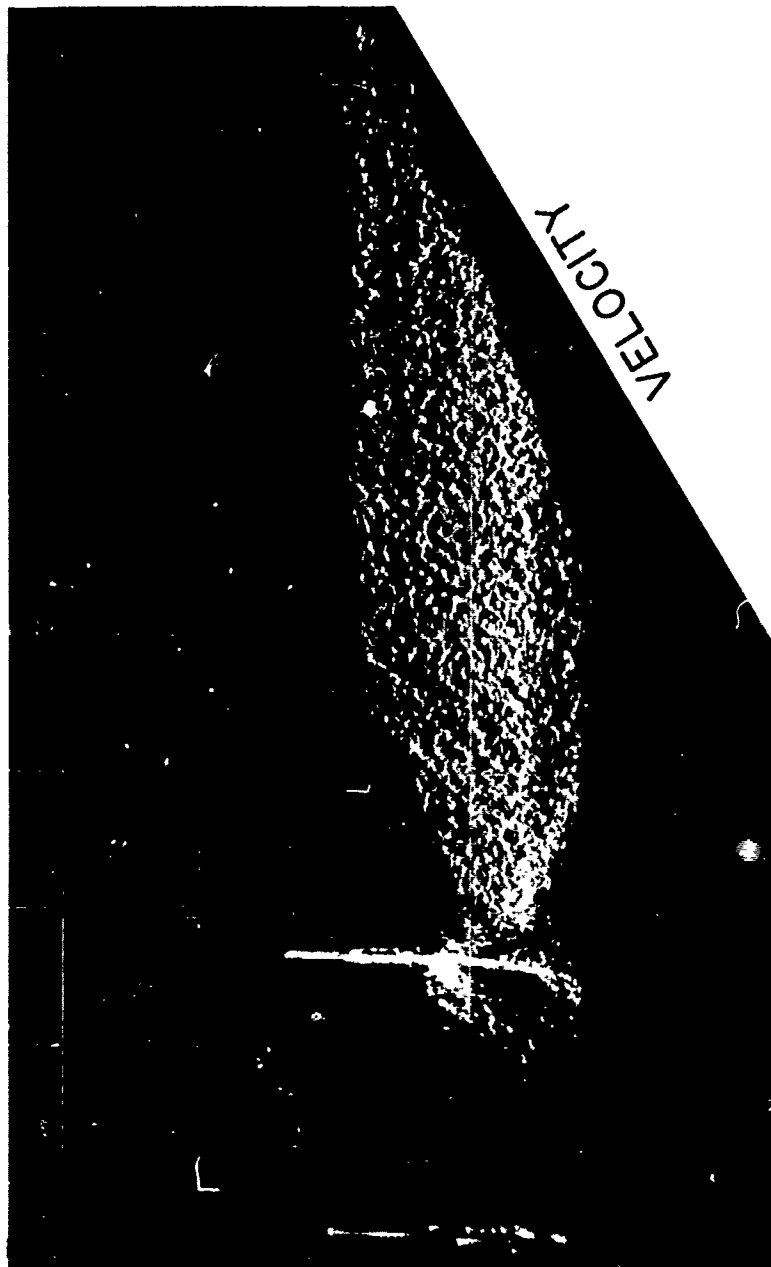

AMPLITUDE

ACCELERATION

SIMULATED ACCELERATING TARGET
SIGNAL INPUT

Fig. 26 -- (S) AVR signal processor output showing a simulated constant-velocity target and an accelerating target. Both signals are 80 dB below maximum signal amplitude and the acceleration axis extent is 0 to 10 g.

ACCELERATION AND VELOCITY SIGNAL
PROCESSOR OUTPUT

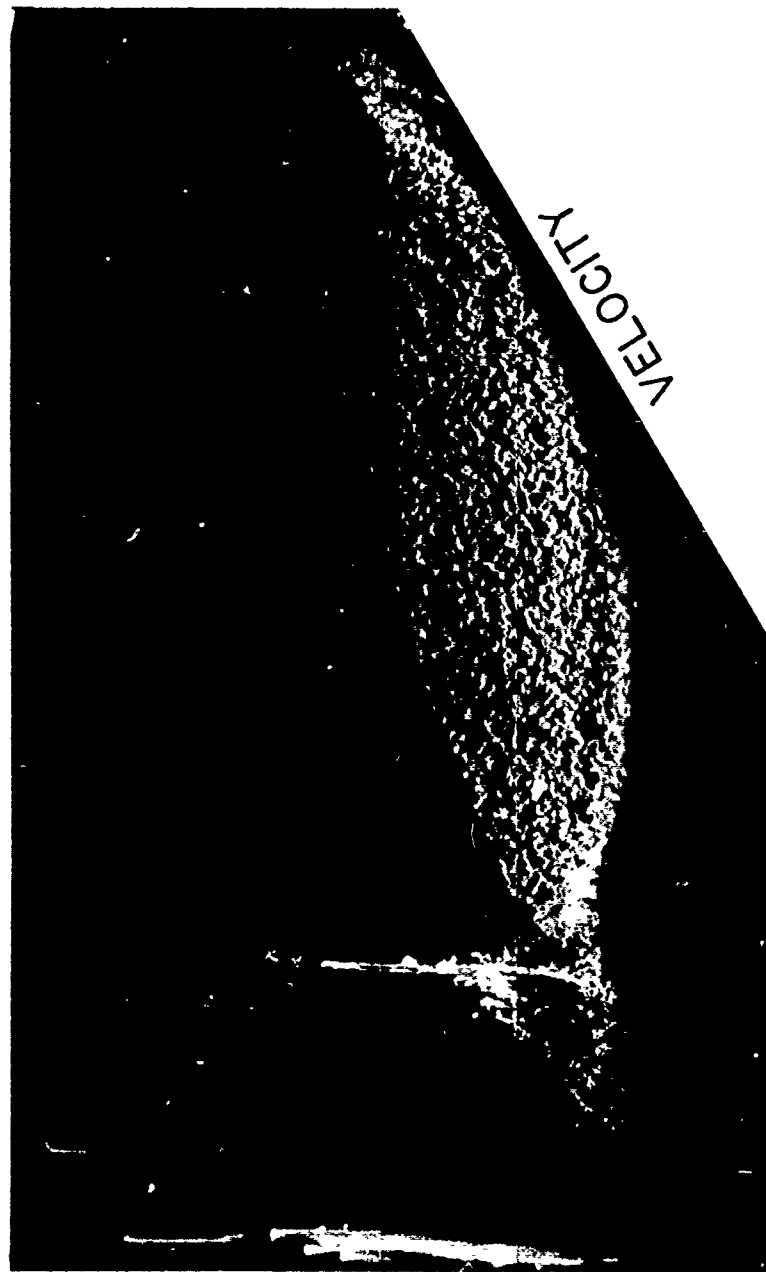

ACCELERATION
SIMULATED ACCELERATING TARGET
SIGNAL INPUT

Fig. 27 — (S) AVR signal processor output with the signals of Fig. 26 except that the amplitude of the constant-velocity target has been raised 20 dB. It now exceeds the normalizing level.

ACCELERATION AND VELOCITY SIGNAL
PROCESSOR OUTPUT

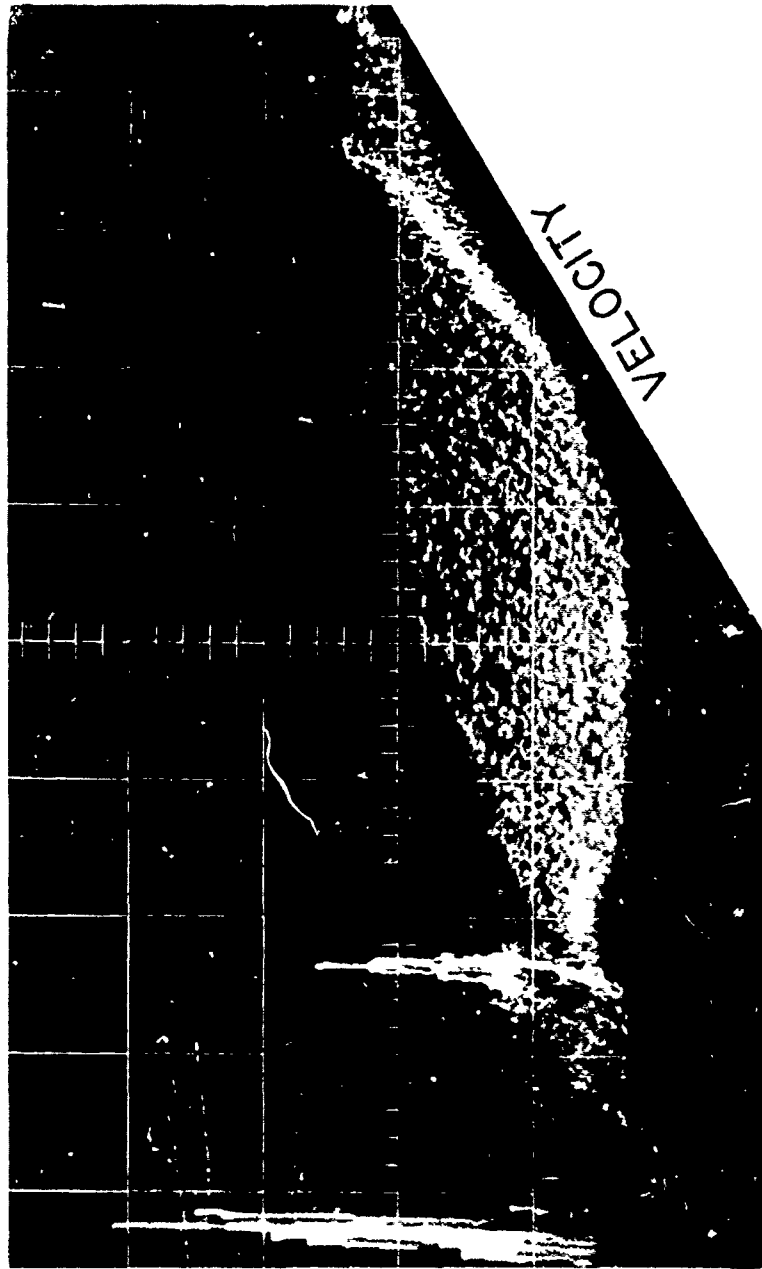

ACCELERATION

SIMULATED ACCELERATING TARGET
SIGNAL INPUT

Fig. 28 - (S) AVR signal processor output with the signals of Fig. 26 except that the amplitude of the constant-velocity target has now been raised to 60 dB above the level of the small accelerating target. Little suppression of the small signal has occurred and the only spurious signal to appear is the increase of noise at maximum acceleration which is believed to be a correctable processor flyback problem.

Other Data and Display Formats

(S) Range data can also be included in a three- or two-coordinate format. Other very useful formats are the separate time histories of each of the three parameters. These may be two- or three-coordinate with amplitude as the third axis. The spectra (amplitude vs expanded doppler frequency) of any target signal may also be displayed for study. Various two-coordinate and spectra formats have been used to display actual target returns in previous work that has been reported (1-3).

(S) In the two-coordinate display formats, z-axis intensification may be derived from either signal amplitude or threshold output. It should be emphasized that, with acceleration processing, amplitude information is not lost with threshold intensification. Because of the particular waveform involved, an increase of signal level in the range from minimum detectable to the normalization level will cause a lengthening of the display pip or vice versa. This is true for the velocity and range parameters as well as for the acceleration parameter. An example of a thresholded display is shown in Fig. 29. Both of the previously mentioned targets are shown here.

Dynamic Range

(S) The processor's response to large signals has been previously shown. The minimum detectable signal level was found by setting the threshold detector just above the peak noise. Then the level of the two signals (a constant-velocity and an accelerating target) was reduced to a point just above the threshold where a consistent detection was obtained. The results are shown on Fig. 30. Both signals were reduced 92 dB below the maximum signal level.

DESCRIPTION OF THE REAL-TIME AVR PROCESSOR

(S) The NRL second-generation AVR processor employs phase-coherence, sampled-signal, and integration techniques to achieve a signal processing gain up to 30 dB (depending upon choice of operating parameters), doppler resolution up to 0.1 Hz, and a doppler rate resolution up to 0.04 Hz/sec. An acceleration extent of up to 20 g can be processed with a choice of resolutions. Any part or the complete extent from 0 to 20 g may be processed with any number up to 399 positive acceleration cells and a like number of negative acceleration cells. Similarly, the number and coverage of velocity cells may be freely selected.

(S) Detailed information has previously been given on resolvable target speeds, acceleration, etc. for various radar operating conditions (4,5).

(S) Real-time processing of acceleration, velocity, and range data is provided. Because three parameters must be processed a much higher data rate must be realized. This is done by paralleling signal analyzer channels (providing a separate analyzer channel for each range cell) and by increasing the data rate of each analyzer. Since an all-analog processor design has been used, each analyzer fills only a modest-sized rack drawer.

ACCELERATION AND VELOCITY SIGNAL
PROCESSOR OUTPUT

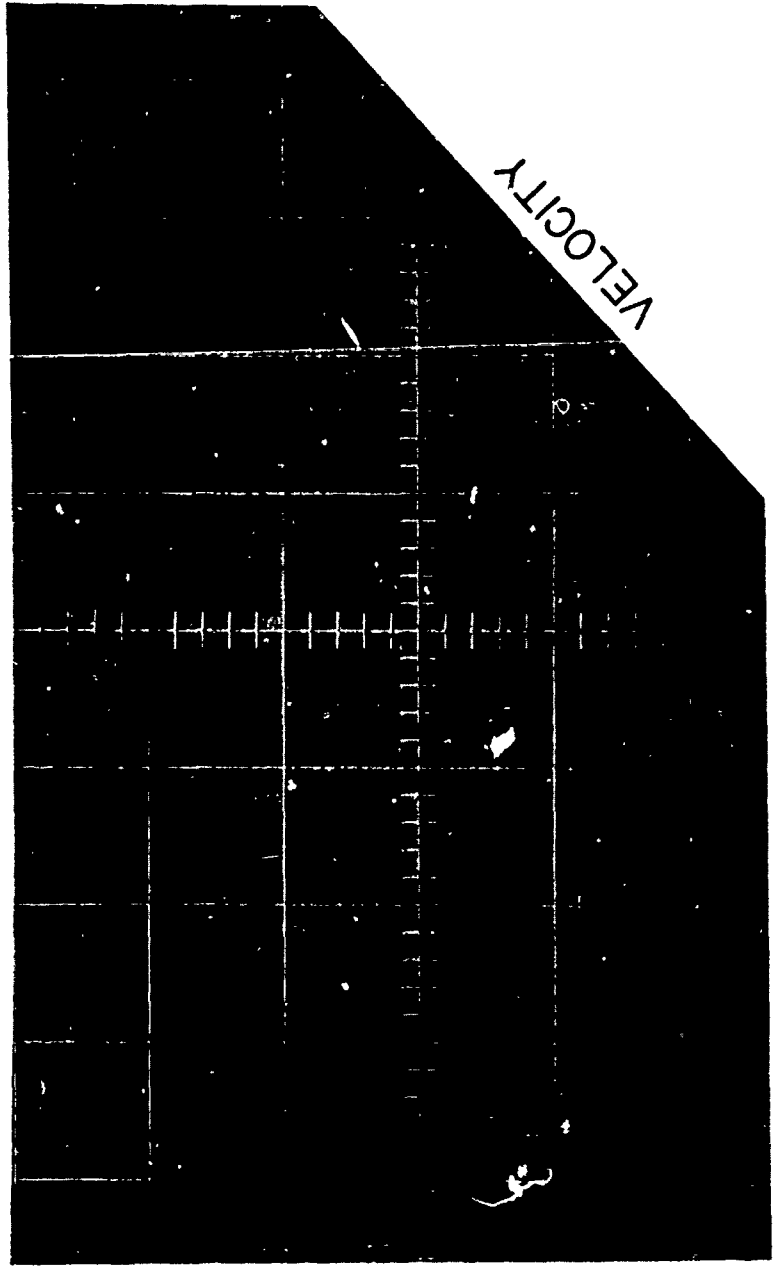

ACCELERATION

SIMULATED ACCELERATING TARGET
SIGNAL INPUT

Fig. 29 — (S) AVR signal processor output with the signals of Fig. 26 except for a higher accelerating target g. A target threshold is used here and the amplitude dimension has been collapsed.

ACCELERATION AND VELOCITY SIGNAL
PROCESSOR OUTPUT

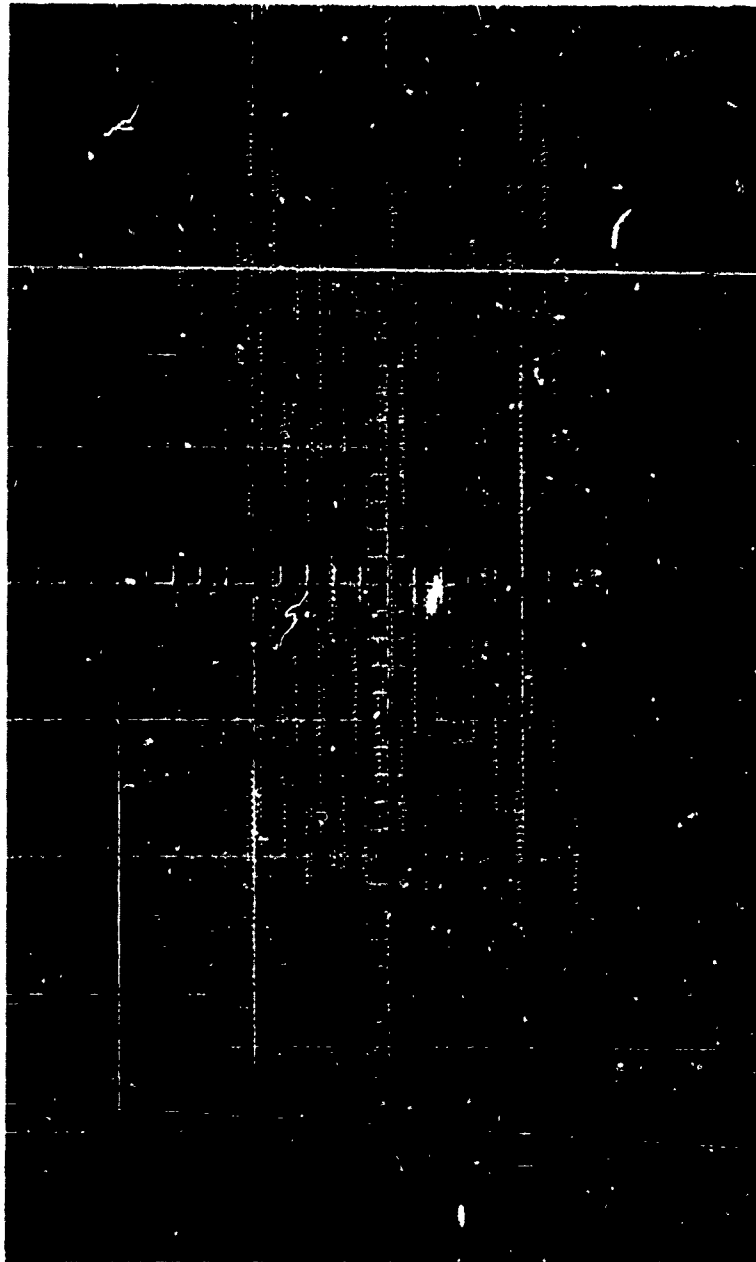

VELOCITY

ACCELERATION

SIMULATED ACCELERATING TARGET
SIGNAL INPUT

Fig. 30 — (S) AVR signal processor output with the target signals of Fig. 29. The exception is that the threshold detection level has been lowered to just above peak noise and both signal levels have also been lowered to 92 dB below maximum signal level, which just trips the threshold.

(S) A very wide linear signal dynamic range was desired for this processor; a goal of 120 dB had been set.

(S) It should be noted here that for reasons of funding and because this work has been directed to proving principles and to obtaining a research tool the equipment to process the full complement of range cells was not obtained. Since the processing equipment of all range cells is identical the lack of a full complement of range cells has not compromised the research effort. Equipment was procured for 10 range cells except for the necessary memory where memory for five range cells was acquired. For target observation at NRL this is a passable system. Within the five range cells all acceleration and velocity cells may be processed in real time.

(S) The solid blocks of Fig. 31 show the AVR signal processor and data output displays.

(S) Each range cell of the receiver output is sampled. These samples may either be clutter filtered or fed directly to the signal memory. The analog clutter filter accepts the signal samples and performs a filtering operation to reject low doppler frequencies. A frequency of 5 Hz is down 3 dB and 1.0 Hz is down 80 dB. Other filter characteristics may be realized by changing the values of the components in the feedback networks.

(S) Signal samples are stored in the signal memory for the duration of the integration period. Up to 900 analog samples may be stored for each range cell, there being a separate section of memory for each one. The storage medium of the memory consists of a capacitor for each sample stored. A sample-and-hold technique accomplishes write-in while a buffered output allows nondistinctive multiple readouts with time-compression ratios as large as 165,000 to 1. High time-compression ratios permit high analyzer speeds. Each separate section of the memory consists of a matrix of 30 rows and 30 columns. All sections of the memory are controlled by a single set of logic. Also all sections of the memory are read out simultaneously and fed to parallel \cos^2 time-weighting circuits. Next the signals of each range cell are normalized by a frequency-selective limiter (contiguous filters) and then are analyzed for target acceleration and velocity. Signal analysis is accomplished by multiplying the target signal with a series of acceleration frequency ramps and velocity frequency steps. Only one function generator is required for all parallel analyzers. The analyzers have been designed to match successfully the target signal even though high target acceleration has caused the signal doppler frequency sweep to greatly exceed $\text{prf}/2$.

(S) Output of the signal analyzers is coupled either to data storage or directly to the displays which do not contain a time axis. The data storage permits displaying the time histories of acceleration, velocity, and range.

(S) There are many ways to present acceleration, velocity, range, amplitude, and time data to an observer. Many have been demonstrated or suggested in this or previous reports. The specific requirements of each radar application will determine the most suitable formats. Also additional data processing, not indicated here, might be required.

DESIGN PHILOSOPHY

(S) The purpose of this work has been to develop and demonstrate the capabilities and potential of real-time AVR signal processing. The implementation of this type of

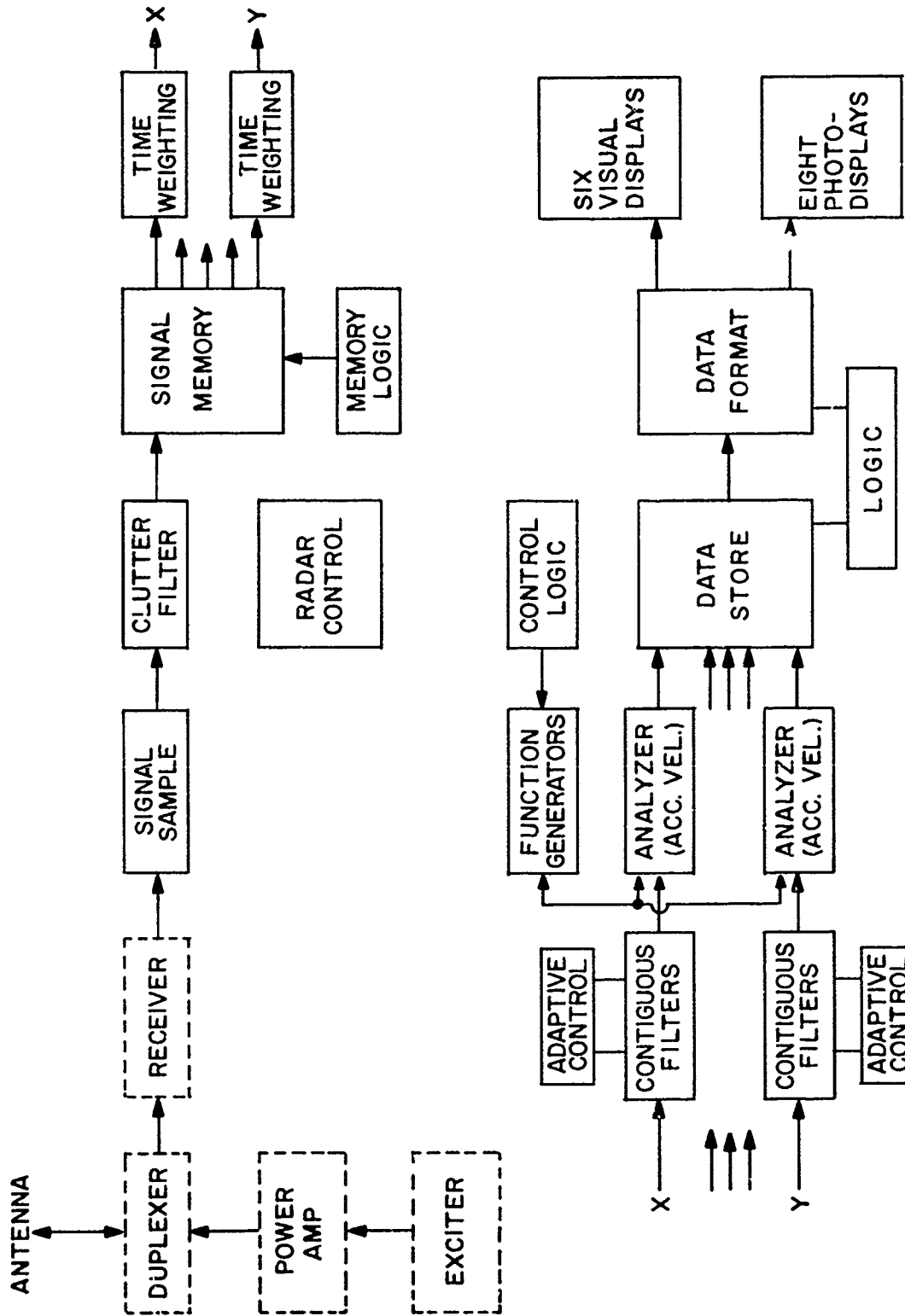

Fig. 31 - (S) The NRL second-generation AVR signal processing system

processing capability in any operational radar should use whatever means is most cost effective without sacrificing necessary processing capability. For example, processing only 30 or so acceleration cells in real time instead of 200 or more would be unacceptable.

(S) An all-analog approach was selected in this work because at the beginning digital techniques were not sufficiently advanced in dynamic range or speed to justify their use. An analog approach involves a minimum of hardware and basically straightforward uncomplicated electronics, of course, pushed to the widest possible dynamic range, speed, etc. to insure real-time processing of reasonable numbers of cells of all three parameters.

(S) All-digital signal processing of acceleration, velocity, and range data with good dynamic range is now theoretically possible with pipeline FFT techniques. The main remaining problem is signal processing speed. With the most recently available hardware, digital signal processing is still about eight times slower than real-time processing and eight times slower than the hybrid AVR signal processor used in the AN/FPS-95 OTH radar. Thus all-digital signal processing will require parallel equipment for full processing or a sacrifice in the number of cells processed when paralleling is not used. The second solution is not desirable except perhaps in certain special situations.

SUMMARY

(S) The capability of the NRL second-generation AVR signal processor to properly match accelerating and constant-velocity targets in real time and to provide acceleration and velocity resolutions and signal-processing gain commensurate with a 10-sec coherent integration time was demonstrated. Two targets with a fractional g separation are resolvable, and one may be at zero acceleration if desired. Also many targets may occupy the display and still be completely resolvable.

(S) Acceleration extents of up to 20 g may be covered either in full or in part with up to 399 positive or 399 negative acceleration cells with a choice of resolutions up to 0.04 Hz/sec.

(S) The capability of the processor to process small signals in the presence of large ones without loss or appreciable suppression of the small signal was demonstrated. A signal 60 dB larger than a nearby small signal did not appreciably reduce the level of the small signal.

(S) The dynamic range of the signal analyzers was indicated with a photograph showing two signals 92 dB below maximum signal level.

(S) Many three- and two-coordinate display formats were shown and others have been implemented but were not shown. The three-coordinate displays, since they provide additional information, aid the observer to grasp more quickly the significance of the combinations of acceleration, velocity, range, amplitude, and time data being presented. It also quickly reveals the serious consequences of mismatched signal processing. For example, a velocity-only signal processor when used to look at accelerating targets will provide only a very reduced amplitude response which will be spread over a large number of velocity cells denying even a definite velocity determination. Conversely, if the lowest 5 or 10% of the acceleration cells are not processed, constant-velocity targets will be mismatched and

SECRET

suppressed. Thus, the AVR processor may be programmed to match either constant-velocity targets, accelerating targets, or both, providing good identification and separation of these targets if necessary.

The NRL Second-generation acceleration-velocity-range signal processor capabilities that have been demonstrated together with many of the three- and two-coordinate data formats provide an effective and powerful system for use with operational radars or use as a research tool.

REFERENCES

1. "Results of Applying the Information Gathering Capabilities of Acceleration and Velocity Signal Processing to H.F. Radar," G.K. Jensen and J.E. McGeogh, NRL Memorandum Report 1789 (Secret Report, Unclassified Title), July 21, 1967.
2. "Acceleration and Velocity Processing of H.F. Radar Signals," J.E. McGeogh and G. K. Jensen, NRL Report 6611 (Secret Report, Unclassified Title), Oct. 16, 1967.
3. "Analog System Configuration for the Performance of Real Time Acceleration and Velocity Analysis of Missile or Aircraft Type Targets," J.E. McGeogh and G.K. Jensen, NRL Memorandum Report 1790 (Secret Report, Unclassified Title), July 14, 1967.
4. "Development of an Advanced Signal Processor for the NRL H.F. Research Radar," J.E. McGeogh and G.K. Jensen, NRL Memorandum Report 2014 (Secret Report, Unclassified Title), June 1969.
5. "Sampled-Signal Advanced Signal Processor for H.F. Radar," G.K. Jensen and J.E. McGeogh, NRL Report 6992 (Secret Report, Unclassified Title), Jan. 28, 1970.

SECRET

Appendix A

DESCRIPTION OF PAST AND CURRENT NRL LITERATURE (Unclassified Title)

(U) The literature covered herein gives descriptions of past NRL reports on signal processing developments, studies of OTH signal returns, and studies of missile detection.

(S) One of the first efforts toward developing phase-coherent, integrating signal processors for OTH radar began in 1949 with an investigation of the Graphecon storage tube (A1). A signal storage means was needed and the most feasible storage device available at the time was the Graphecon. Another approach to the problem of obtaining large signal-processing S/N ratio gains which would allow the detection of small target signals buried in noise was the development of an active filter (A2). An active filter was developed which provided more than 30 dB processing gain.

(S) In 1955 the spectral bandwidth and amplitude of HF backscatter clutter signals were unknown. If OTH radar were ever to become a reality it was necessary to determine whether or not the large-amplitude backscatter, which usually masked all desirable targets, could be removed from the doppler band by filtering. A compact backscatter spectrum would be required for this type of process, not one spread over much of the doppler band. Measurements of the spectral bandwidth of backscatter signals were successfully made (A3). They showed that the backscatter spectra were almost always confined to the lowest 4 Hz of the doppler band which if removed by filtering would not be too serious a portion of the doppler band to lose for target detection.

(S) About 1953 a simulated radar was developed (A4) which incorporated all the elements of a radar such as the transmitter, receiver, signal sampling, signal storage, and coherent signal integration. The purpose was to demonstrate that large, nearly theoretical signal processing gains could be achieved and that adequate signal storage and processing means could be developed. Success of this effort led to the development of the first NRL on-the-air OTH radar system (A4). Average radiated power was low but line-of-sight detection of aircraft was possible which showed that the target returns were of such quality that good velocity resolution and processing gains were possible.

(S) Backscatter rejection filters were developed (A5) for this radar system which successfully rejected backscatter and permitted detection of small targets buried below the noise level. Also signal storage systems, based on the Radechon storage tube, were developed (A6-A9) and built for this radar.

(S) The performance characteristics of the radar were measured (A10). Signal processing gains of over 30 dB were found with simulated signals, and essentially the same processing gains were realizable with live aircraft targets.

SECRET

(S) When considering over-the-horizon (one-hop) detection of targets it is necessary to know as much as possible about the amount of spectral spreading exhibited by the return echo, the characteristics of the ionospheric path, and the range accuracies achievable. A study was initiated in 1958 to find answers to some of these questions (A11).

(S) A magnetic drum storage radar was proposed (A12) by Dr. R.M. Page in 1957. It was capable of velocity-only signal processing with about a 30-dB linear signal dynamic range.

(S) The NRL HF radar was used not only to study coherent detection of line-of-sight aircraft and one-hop ionospheric propagation path characteristics, but beginning in 1957 was also employed to study OTH missile detection (A13-A16) and OTH detection of nuclear events (A17).

(S) In 1959-1960 a high-quality, quartz crystal, comb backscatter rejection filter was proposed and developed (A18) for the Madre magnetic drum signal processor.

(S) Being a velocity-only signal processor, the magnetic drum processor mismatched accelerating targets (missiles) with serious loss of targets and velocity data. Therefore, in 1959 an acceleration-velocity-range (AVR) signal processing system was proposed (A19) which used phase coherence, integration, and signal matching of both acceleration and velocity. Funding was received in 1960 and a system was developed at NRL (A20-A23).

(S) When complete, the first-generation AVR signal processor was moved to the NRL Chesapeake Bay Division (CBD) for use with the high-power transmitting equipment. Missile launches were observed (A24) and matched-signal processing of both the acceleration and velocity parameters was successful and provided heretofore unattainable data.

(S) Because the first-generation AVR processor made use of the magnetic drum storage its dynamic range was limited to only 30 dB. A much greater dynamic range was desirable, 120 dB if achievable. In 1964 a 60-dB dynamic range, analog capacitor, signal storage system was proposed (A25).

(S) A complete, real-time, wide-dynamic-range AVR processing system was proposed in 1965 (A26). A 120-dB dynamic range was proposed for both the signal memory and the AVR signal analyzer. Also the signal processing speed was to be increased to insure real-time signal processing even with three parameters instead of the usual two parameters. A relatively simple, cost-effective analog design was to be used. Funding was received for this system and it became NRL's second-generation AVR signal processor.

(S) In the meantime the first-generation AVR signal-processor system was being used to observe and study more missile launches (A27). Additional output data formats were added to the system such as a target signal spectrum display and time histories of acceleration, velocity, range, and amplitude. These formats increased the effectiveness and usefulness of the displays as far as the observer was concerned. Together with the signal spectrum display they aided studies such as the determination of the compactness of the spectra of the return echoes from accelerating targets, the useful length of integration time for various missile targets, and the performance characteristics of the acceleration and velocity matching signal processor.

(S) Observation and study of missile launches continued. More results were published (A28,A29) that were obtained with a velocity-time format added to the previously available output data formats.

(S) The spectra of missile target signals after matched acceleration and velocity processing with a 20-sec integration time along with the time histories of velocity, range, and signal amplitude were next reported (A30). One of the missiles observed was the Athena launched from Green River to White Sands Missile Range (WSMR) at a range of 1600 naut. mi. This is not a large missile; however, hard echoes were obtained from 45 to 220 sec after launch.

(S) These studies showed that (a) many missile targets have matched bandwidths equal to or less than 1/3 Hz, (b) acceleration and velocity matching of targets with spectral bandwidths equal to or less than 1/3 Hz has been successfully accomplished, (c) this results in good velocity and acceleration resolution for missile and aircraft targets and realizable signal processing gains up to 30 dB, and (d) in the case of many of the missile targets integration times of up to 20 sec were found to be productive.

(S) A study and discussion of the many problems involved in the design of OTH radar and signal processing systems has been published (A31,A32). Solutions to many of the problems were proposed.

(S) One method used to normalize signals for AVR processing has been described (A33) along with the results obtained.

(S) Development and construction of the second-generation AVR signal processor was obtained by contract with the Boeing Company. The status of this work and a detailed description of the performance expected of this system was reported in 1969 (A34) and 1970 (A35).

(S) The AN/FPS-95 radar has an AVR signal and data processor. When the radar was nearing completion and shipment to its overseas site, a plan for a one year's research effort to add to the fund of knowledge in the OTH radar field was initiated. A large number of experiments were to be conducted with the radar, and the design of the experiments was also initiated. As a result three missile experiments were designed, making full use of the AVR signal and data processing capabilities of the radar (A36-A38). Also many of the aircraft experiments made use of these capabilities.

REFERENCES

- A1. "Investigation of the Graphechon Storage Tube," G.K. Jensen and C.L. Uniacke, NRL Report 4134, May 1953.
- A2. "An Active Filter," G.K. Jensen and J.E. McGeogh, NRL Report 4630, Nov. 1955.
- A3. "Spectral Bandwidth of Backscatter Signals," G.K. Jensen and F.M. Gager, NRL Report 4976, Aug. 1957.
- A4. "Cross Correlation Electronic Storage Radar," G.K. Jensen and F.M. Gager, NRL Report 5016, Oct. 1957.

- A5. "Backscatter and Doppler Filters for the Project Music Radar," C.L. Uniacke and G.K. Jensen, NRL Report 5441 (Confidential Report, Unclassified Title), Feb. 1960.
- A6. "An Investigation of the Radechon Storage Tube," C.L. Uniacke and G.K. Jensen, NRL Report 5201 (Confidential Report, Unclassified Title), Sept. 1958.
- A7. "A Frequency-Translation and Storage System Utilizing the Radechon Storage Tube," C.L. Uniacke and G.K. Jensen, NRL Report 5238 (Confidential Report, Unclassified Title), Dec. 1958.
- A8. "Circuits for the Operation of the Project Music Storage System," C.L. Uniacke and G.K. Jensen, NRL Report 5399 (Confidential Report, Unclassified Title), Nov. 16, 1959.
- A9. "The Storage System for Project Music," C.L. Uniacke and G.K. Jensen, NRL Report 5338 (Confidential Report, Unclassified Title), Aug. 1959.
- A10. "Performance Characteristics of the Music Radar System," G.K. Jensen and C.L. Uniacke, NRL Report 5247 (Secret Report, Unclassified Title), Dec. 1958.
- A11. "Quality of Radar Information as Influenced by an Ionospheric Propagation Path," G.K. Jensen, C.L. Uniacke, and E.N. Zettle, NRL Report 5540 (Confidential Report, Unclassified Title), Oct. 12, 1960.
- A12. "Magnetic Drum Storage Applied to Surveillance Radar," R.M. Page and S.F. George, NRL Report 4878 (Confidential Report, Unclassified Title), Jan. 1957.
- A13. "A Study of Ionospheric Disturbances (Detection of Missiles) with the Project Music Radar from September 1957 to May 31, 1959," C.L. Uniacke, G.K. Jensen, C.B. Tesauro, and J.H. Veeder, NRL Report 5508 (Secret Report, Unclassified Title), Aug. 8, 1960.
- A14. "A Study of Ionospheric Disturbances (Missile Detection) with the Project Music Radar from June 1, 1959, to October 31, 1959," G.L. Uniacke, G.K. Jensen, J.H. Veeder, NRL Report 5511 (Secret Report, Unclassified Title), Aug. 19, 1960.
- A15. "A Study of Ionospheric Disturbances (Missile Detection) with the Project Music Radar from November 1, 1959, to January 31, 1960," C.L. Uniacke, G.K. Jensen, and J.H. Veeder, NRL Report 5564 (Secret Report, Unclassified Title), Dec. 6, 1960.
- A16. "A study of Ionospheric Disturbances (Missile Detection) with the Project Music Radar from February 1, 1960 to June 30, 1960," C.L. Uniacke, G.K. Jensen, and J.H. Veeder, NRL Report 5584 (Secret Report, Unclassified Title), Feb. 1961.
- A17. "An Investigation of Ionospheric Disturbances (Detection of Nuclear Events) with the Project Music Radar in 1957 and 1958," C.L. Uniacke, G.K. Jensen, F.M. Gager, E.N. Zettle, and J.H. Veeder, NRL Report 5585 (Secret Report, Unclassified Title), Mar. 24, 1961.
- A18. "A 100-kc Quartz Crystal Comb Rejection Filter," J.E. McGeogh, G.K. Jensen, and C.L. Uniacke, NRL Report 5589 (Confidential Report, Unclassified Title), Feb. 16, 1961.
- A19. "An Improved Gate System for the Madre Radar," G.K. Jensen, NRL Report 5570 (Secret Report, Unclassified Title), Dec. 1960.

- A20. "Development of a Gate System for the Improvement of the Madre Radar. Part 1—System Theory, Calculations, and Planning," G.K. Jensen and J.E. McGeogh, NRL Report 5876 (Secret Report, Unclassified Title), Jan. 11, 1963.
- A21. "Development of a Gate System for the Improvement of the Madre Radar. Part 2—Development of Key Circuits and a Signal Simulator," G.K. Jensen and J.E. McGeogh, NRL Report 5899 (Secret Report, Unclassified Title), Feb. 1963.
- A22. "Development of a Gate System for the Improvement of the Madre Radar. Part 3—Experimental Verification of System Theory by Means of the Signal Simulator and Key System Components," G.K. Jensen and J.E. McGeogh, NRL Report 5900 (Secret Report, Unclassified Title), Feb. 1963.
- A23. "Development of a Gate System for the Improvement of the Madre Radar. Part 4—Laboratory Evaluation of the Complete System and Report of Recent Circuit Developments," G.K. Jensen and J.E. McGeogh, NRL 5926 (Secret Report, Unclassified Title), Apr. 19, 1963.
- A24. "Development of a Gate System for the Improvement of the Madre Radar. Part 5—Observations of Tests 0169 and 2084," J.E. McGeogh, G.K. Jensen, and J.H. Veeder, NRL Report 6328 (Secret Report, Unclassified Title), Feb. 24, 1965.
- A25. "A Proposed All-Electronic Signal-Sampling, Storage and Time-Compression System for the Improvement of the Madre Radar," G.K. Jensen, NRL Report 6154 (Secret Report, Unclassified Title), Sept. 28, 1964.
- A26. "A Proposed Simplified Signal Processor for the Improvement of the Madre Radar," G.K. Jensen, NRL Report 6237 (Secret Report, Unclassified Title), Mar. 11, 1965.
- A27. "Development of a Gate System for the Improvement of the Madre Radar. Part 6—Observations of Tests 0351 and 0050," J.E. McGeogh, G.K. Jensen, and J.H. Veeder, NRL Report 6289 (Secret Report, Unclassified Title), May 24, 1965.
- A28. "Results of Acceleration and Velocity Processing of H.F. Radar Signals from Missile Launches. Part 1—Observations of ETR Tests 2949, 6075, and 3635," G.K. Jensen, J.E. McGeogh, and J.H. Veeder, NRL Report 6476 (Secret Report, Unclassified Title), Oct. 10, 1966.
- A29. "Results of Acceleration and Velocity Processing of H.F. Radar Signals from Missile Launches. Part 2—Observations of ETR Tests 0169 and 3760," G.K. Jensen, J.E. McGeogh, and J.H. Veeder, NRL Report 6485 (Secret Report, Unclassified Title), Oct. 10, 1966.
- A30. "Results of Applying the Information Gathering Capabilities of Acceleration and Velocity Signal Processing to H.F. Radar," G.K. Jensen, and J.E. McGeogh, NRL Memorandum Report 1789 (Secret Report, Unclassified Title), July 21, 1967.
- A31. "Acceleration and Velocity Processing of H.F. Radar Signals," J.E. McGeogh and G.K. Jensen, NRL Report 6611 (Secret Report, Unclassified Title), Oct. 16, 1967.
- A32. "Analog System Configuration for the Performance of Real Time Acceleration and Velocity Analysis of Missile or Aircraft Type Targets," J.E. McGeogh and G.K. Jensen, NRL Memorandum Report 1790 (Secret Report, Unclassified Title), July 14, 1967.

- A33. "Contiguous Filtering for H.F. Radar Acceleration and Velocity Signal Processing," J.E. McGeogh, G.K. Jensen, and J.H. Veeder, NRL Report 6479 (Secret Report, Unclassified Title), Oct. 18, 1966.
- A34. "Development of an Advanced Signal Processor for the NRL H.F. Research Radar," J.E. McGeogh and G.K. Jensen, NRL Memorandum Report 2014 (Secret Report, Unclassified Title), June 1969.
- A35. "Sampled-Signal Advanced Signal Processor for H.F. Radar," G.K. Jensen and J.E. McGeogh, NRL Report 6992 (Secret Report, Unclassified Title), Jan. 28, 1970.
- A36. "Special Information on High Frequency Radar. Part I—Missile Launch Identification and Analysis DVST Experiment 303," G.K. Jensen and J.F. Thomason, NRL Memorandum Report 2237 (Secret Report, Unclassified Title), Apr. 1971.
- A37. "Special Information on High Frequency Radar. Part VIII—Vertical Velocity Estimate with Missiles DVST Experiment 307," G.K. Jensen and J.F. Thomason, NRL Memorandum Report 2243 (Secret Report, Unclassified Title), May 1971.
- A38. "Special Information on High Frequency Radar. Part VII—Missile R and D. Test Intelligence DVST Experiment 315M," G.K. Jensen and J.F. Thomason, NRL Memorandum Report (Secret Report, Unclassified Title), Apr. 1971.

SECRET

Security Classification

DOCUMENT CONTROL DATA - R & D		
<i>(Security classification of title, body of abstract and indexing annotation must be entered when the overall report is classified)</i>		
1. ORIGINATING ACTIVITY (Corporate author) Naval Research Laboratory Washington, D.C. 20390		2a. REPORT SECURITY CLASSIFICATION SECRET
		2b. GROUP 3
3. REPORT TITLE ACCELERATION-VELOCITY-RANGE SIGNAL PROCESSOR CAPABILITIES DEMONSTRATED WITH THREE-COORDINATE REAL-TIME DATA FORMATS (U)		
4. DESCRIPTIVE NOTES (Type of report and inclusive dates) An interim report on one phase of a continuing NRL Problem.		
5. AUTHOR(S) (First name, middle initial, last name) Garold K. Jensen		
6. REPORT DATE July 12, 1972	7a. TOTAL NO. OF PAGES 50	7b. NO. OF REFS 43
8a. CONTRACT OR GRANT NO. NRL Problem R02-23	8b. ORIGINATOR'S REPORT NUMBER(S) NRL Report 7428	
b. PROJECT NO. RF12-151-402-4007	9b. OTHER REPORT NO(S) (Any other numbers that may be assigned this report)	
c.		
d.		
10. DISTRIBUTION STATEMENT Distribution limited to U.S. Government Agencies only; test and evaluation; July, 1972. Other requests for this document must be referred to the Director, Naval Research Laboratory, Washington, D.C. 20390.		
11. SUPPLEMENTARY NOTES	12. SPONSORING MILITARY ACTIVITY Department of the Navy (Office of Naval Research) Arlington, Virginia 2221.	
13. ABSTRACT <p>Measurements have been made on the NRL second-generation acceleration-velocity-range signal processor. Acceleration and velocity resolutions and coverage, signal dynamic range, target-handling capabilities, large and small signal performance and spurious levels have been considered, and then performance is illustrated with three-coordinate and two-coordinate data formats. The three coordinate real-time data formats aid the observer to grasp more quickly the significance of the combinations of acceleration, velocity, range, amplitude, and time data being presented. They also quickly reveal the serious consequences of mismatched signal processing.</p> <p>The effectiveness and potential of the acceleration-velocity-range signal processor may more easily be judged with the aid of the three-coordinate data formats.</p>		

SECRET

Security Classification

14 KEY WORDS	LINK A		LINK B		LINK C	
	ROLE	WT	ROLE	WT	ROLE	WT
Radar Signal processing Acceleration processing Velocity processing range processing Three-dimensional displays						

SECRET

Security Classification

MEMORANDUM

20 February 1997

Subj: Document Declassification

Ref: (1) Code 5309 Memorandum of 29 Jan. 1997
(2) Distribution Statements for Technical Publications
NRL/PU/5230-95-293

Encl: (a) Code 5309 Memorandum of 29 Jan. 1997
(b) List of old Code 5320 Reports
(c) List of old Code 5320 Memorandum Reports

1. In Enclosure (a) it was recommended that the following reports be declassified, four reports have been added to the original list:

Formal: 5589, 5811, 5824, 5825, 5849, 5862, 5875, 5881, 5903, 5962, 6015, 6079, 6148, 6198, 6272, 6371, 6476, 6479, 6485, 6507, 6508, 6568, 6590, 6611, 6731, 6866, 7044, 7051, 7059, 7350, 7428, 7500, 7638, 7655. Add 7684, 7692.

Memo: 1251, 1287, 1316, 1422, [redacted], 1500, 1527, 1537, 1540, 1567, 1637, 1647, 1727, 1758, 1787, 1789, 1790, 1811, 1817, 1823, 1885, 1939, 1981, 2135, 2624, 2701, 2645, 2721, 2722, 2723, 2766. Add 2265, 2715.

The recommended distribution statement for the these reports is: **Approved for public release; distribution is unlimited.**

2. The above reports are included in the listings of enclosures (b) and (c) and were selected because of familiarity with the contents. The rest of these documents very likely should receive the same treatment.

J. M. Headrick
J. M. Headrick
Code 5309

Copy:

Code 1221
Code 5300
Code 5320
Code 5324

— *CR OK 7/2/97* —