

AD615792

NOTS TP 3565, REV. 1 • JUNE 1965

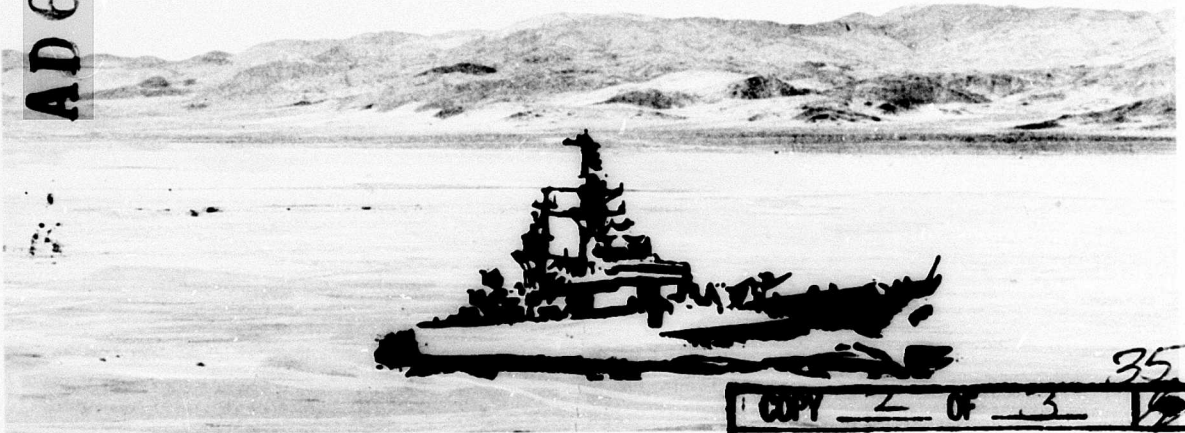

COPY	2	OF	3	1/2
HARD COPY	\$ . 2.00			
MICROFICHE	\$ . 0.50			

35-1

**USER'S GUIDE**

---

**TO THE EXPERIMENTAL**

---

**SURFACE • LAUNCHED WEAPON • CONTROL**

---

**TEST FACILITY**

DDC  
**RECEIVED**  
 JUN 9 1965  
 DDC-IRA E

U. S. NAVAL ORDNANCE TEST STATION • CHINA LAKE, CALIFORNIA

**ARCHIVE COPY**

# U. S. NAVAL ORDNANCE TEST STATION

AN ACTIVITY OF THE BUREAU OF NAVAL WEAPONS

**J. I. HARDY, CAPT., USN**  
*Commander*

**WM. B. MCLEAN, PH.D.**  
*Technical Director*

## FOREWORD

The U. S. Naval Ordnance Test Station (NOTS), China Lake, California, is conducting an exploratory development program in surface launched weapon control systems under the direction of the Bureau of Naval Weapons, Code RMWC-24.

To carry on this program effectively, NOTS has established a special in-house equipment test facility on the G-1 Guided Missile Range. The facility, designed for experimental test and pre-prototype evaluation of new concepts and equipments relating to shipboard fire control (both digital and analog), is available for use by activities operating under Navy auspices.

This handbook describes the equipment and instrumentation available at G-1 Range as they pertain to surface launched weapon control exploratory development.

Released by  
**F. M. ASHBROOK, Head**  
Instrument Development Division  
5 May 1965

Under authority of  
**IVAR E. HIGHBERG**  
Head, Test Department

This report, published by the Test Department, is the approved version of 30/MS-714; it is a revision of NOTS TP 3565, published in June 1964. First printing, 600 copies.

**BLANK PAGE**

## CONTENTS

### Surface-Launched Weapon-Control Test Equipment

Experimental Test Facility . . . . .	1
Digital Fire Control Radar . . . . .	2
Digital Fire Control, Computer, Digital Data CP-789/UYK (UNIVAC 1218B) . . . . .	4
Digital-Analog Servo System . . . . .	6
Guided Missile Launcher Mk 5 Mod 1 . . . . .	8
Automatic Tracking Optical System . . . . .	10
Digital-to-Analog Deck Angle Converter . . . . .	12
Ship's Motion Simulator . . . . .	14
Adaptive Research Computer (Modular Type) . . . . .	16
Digital Shaft-Angle Encoder Evaluation Facility . . . . .	19

### Associated Range Equipment

Radar Equipment Mk 25 Mod 3 . . . . .	21
Radar Set AN/SPQ-5 . . . . .	22
Computer EX-13 Mod 0 . . . . .	24
Missile Launcher Type X-7 . . . . .	25
Missile Launcher Type X-8 . . . . .	26
Range Control System . . . . .	28

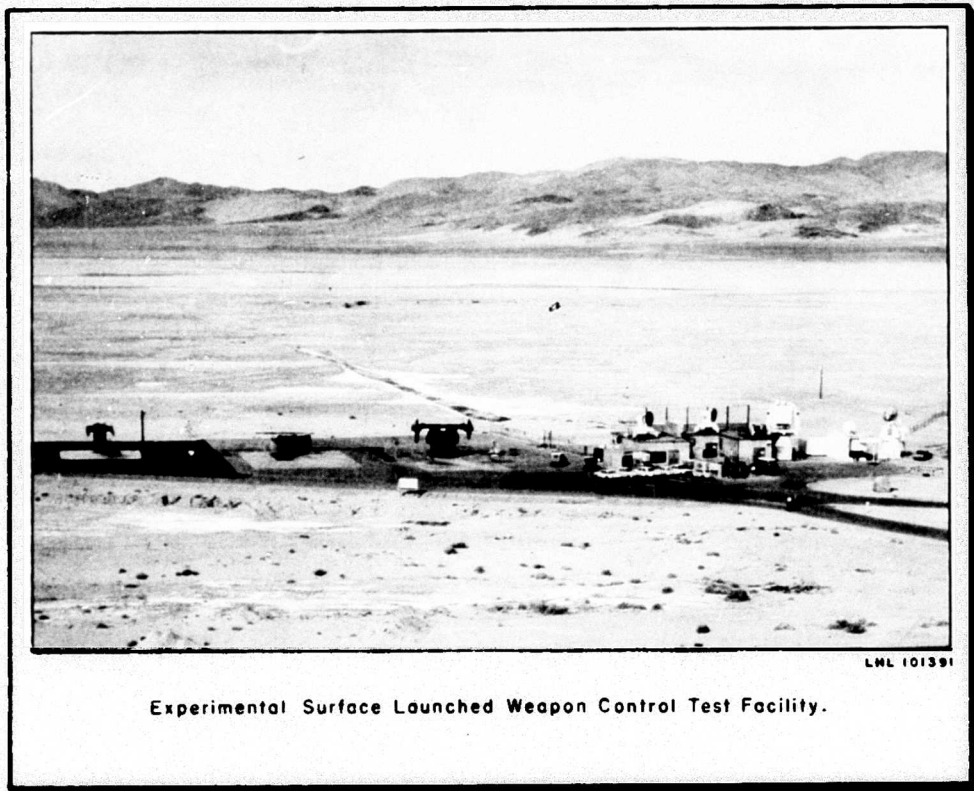

LML 101391

Experimental Surface Launched Weapon Control Test Facility.



---

**EXPERIMENTAL  
SURFACE-LAUNCHED WEAPON-  
CONTROL TEST FACILITY EQUIPMENT**

---

**SURFACE-LAUNCHED WEAPON-CONTROL TEST EQUIPMENT**

**SURFACE WEAPON CONTROL SYSTEMS BRANCH • TEST DEPARTMENT**

**BLANK PAGE**



## DIGITAL FIRE CONTROL RADAR

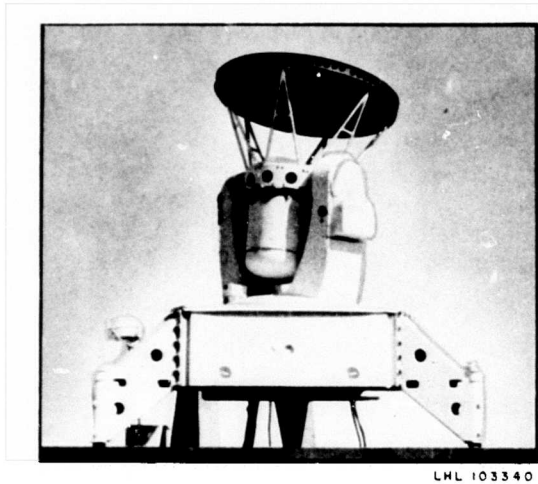

FIG. 2. Digital Fire Control Radar.

The digital fire control (DFC) radar system (Fig. 2) is basically a monopulse type Nike/Ajax target-tracking radar system operating in the X-band range. The transmitter is a tunable magnetron with a peak power

of 250 kilowatts. Pulse repetition frequency is 1,000 pulses per second. Operation is continuous in azimuth. Tracking modes are manual, aided, and automatic.

### Analog Values

Tracking rates:	Range . . . . .	1,000 yd/sec
	Azimuth . . . . .	750 mils/sec
	Elevation . . . . .	750 mils/sec
Slewing rates:	Range . . . . .	12,000 yd/sec
	Azimuth . . . . .	750 mils/sec
	Elevation . . . . .	750 mils/sec
Maximum range:	. . . . .	100,000 yd

### Digital Values

The digital range unit, designed at NOTS for use with this radar, modifies the range capabilities as follows:

Maximum range . . . . .	130,000 yd
Range rate . . . . .	3,000 yd/sec
Slewing rates in range . . . . .	20,000 yd/sec
Acceleration limits (selectable)	
Low gain . . . . .	10g
Low gain 'out' . . . . .	90g

The digital range unit least significant bit is equal to one yard in range and one yard per second in velocity.

The DFC radar with the digital range unit (Fig. 3) has a real-time readout of azimuth, elevation, and range to the Computer, Digital Data CP-789/UYK (UNIVAC 1218B), from which an IBM 7094 compatible tape record can be made for data reduction. Visual (decimal) readout presentation is available at the radar console on NIXIE tubes. In the visual readout, velocity is presented in yards per second, range is given in yards, and azimuth and elevation are given in artillery mils or degrees, selectable by a switch.

This radar system can receive digital target designation in azimuth, elevation, and range from the digital-to-analog servo system (DASS), and synchro designation from a designation bus.

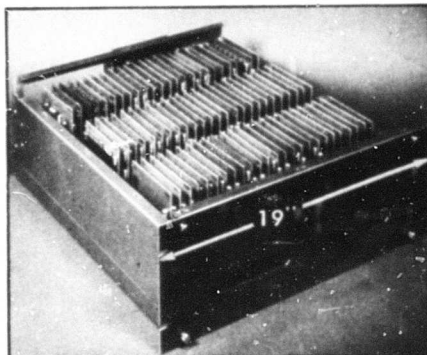

LNL 086363

FIG. 3. Digital Range Unit.

---

REFERENCES:

Headquarters, Department of the Army. Nike/Ajax Anti-Aircraft Guided Missile System--Target/Missile Antenna Rec/Trans (U). August 1959. TM-9-5020 Series. (CONFIDENTIAL).

U. S. Naval Ordnance Test Station. Digital Range Unit Theory of Operation and Circuit Description, by Kenneth O. Bryant and Sara G. Valdivia. China Lake, Calif., NOTS, January 1965. (NOTS TP 3730).

**DIGITAL FIRE CONTROL COMPUTER,  
DIGITAL DATA CP-789/UYK (UNIVAC 1218B)**

The Computer CP-789/UYK (UNIVAC 1218B) is a general-purpose, stored-program, real-time digital computer. It has a magnetic-core memory with a 16,384-word capacity. Word length is 18 bits. Eight input and eight output channels are available. Each channel provides 18 parallel data lines plus necessary control lines. Channels can be paired to form 36-bit dual channels. The computer has a repertoire of 98 flexible instructions and 32 nondestruct memory locations for initial load and automatic-recovery routine.

FIG. 4.

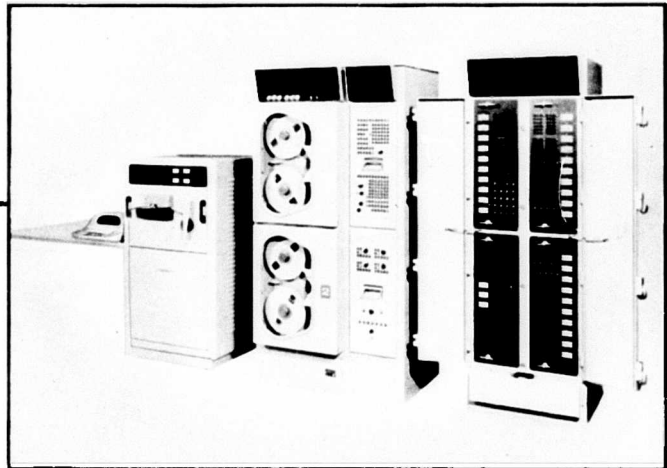

LHL  
103341

Computer, Digital Data CP-789/UYK (UNIVAC 1218B)  
With Peripheral Equipment.

The DFC computer system (Fig. 4) consists of a Computer, Digital Data CP-789/UYK (UNIVAC 1218B) and the following peripheral gear:

An input/output (I/O) console with alpha/numeric typewriter. This console allows paper tape or typewriter input/output communication with the computer.

A magnetic tape system with two tape transports used to load programs or record raw data input. The two tapes have independent control and are IBM-709<sup>4</sup> compatible.

Program inputs to the computer can be made by manual entry on the face of the computer, by typewriter or punched paper tape through the I/O console, and by magnetic tape.

There are two CP-789/UYK (UNIVAC 1218B) computers on the G-1 Guided Missile Range. One is in the DFC system; the other is part of the range control system (RCS). Separate cabling (45 twisted-pair per cable) is installed for direct computer-to-computer communication. This gives the DFC computer additional computing (or memory) capabilities when required.

---

REFERENCES:

UNIVAC. Technical Manual for Digital Data Computer Type 1218, Sections 1-4, Vol. 1. PX 2526.

----- . Technical Manual for Input/Output Console Type 1232. PX 2527.

## DIGITAL-ANALOG SERVO SYSTEM

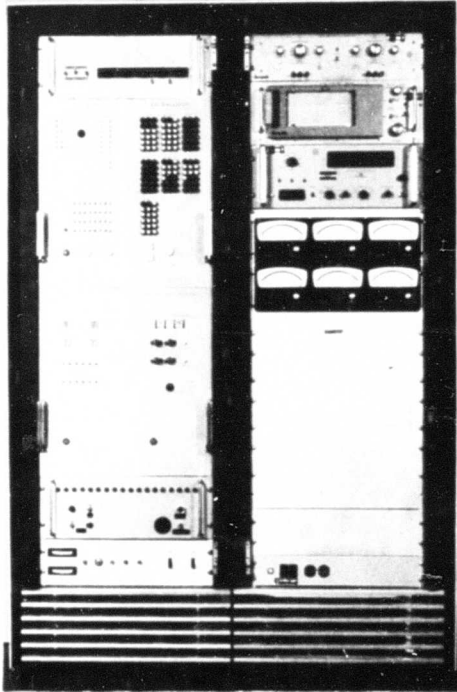

The digital-analog servo system (DASS), designed and developed at NOTS as part of the surface launched weapon control systems exploratory development program, accepts digital position data from shaft-angle encoders on responders such as the Guided Missile Launcher Mk 5 Mod 1 or the DFC radar director. Digital target position and velocity orders are also received by DASS from the DFC Computer, Digital Data CP-789/UYK (UNIVAC 1218B). The DASS console is shown in Fig. 5.

FIG. 5. Digital-Analog Servo System (DASS) XN-2 Console.

The target position information from the computer is updated by integrating the velocity and is then compared with encoder position readout to obtain an error value. Errors in train and elevation and the rate of change of errors are scaled and combined digitally, then transformed to analog signals (DC voltages proportional to the compensated error) and sent to the launcher or director power-drive elements to correct the responder's aimpoint.

Figure 6 is a block diagram of the digital-analog servo system with the Guided Missile Launcher Mk 5 Mod 1 as the responder.

The primary function of the DASS loop is to translate digital computer outputs into the analog form required by the responder. In addition, the updating elements of DASS provide intermediate outputs to keep the launcher from being driven in large step increments, which would cause it to hunt.

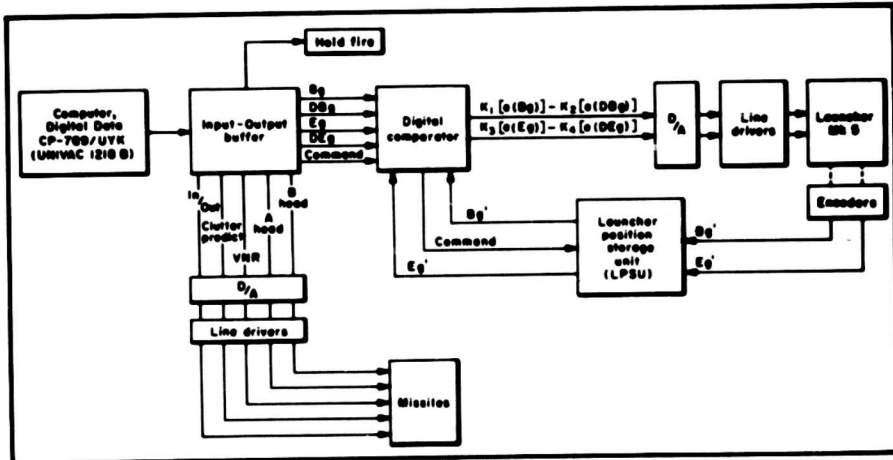

FIG. 6. Block Diagram of Digital-Analog Servo System (DASS).

Parameters:

- Order input rate . . . . . 10 cps to 2 kc
- Updating rate . . . . . 1 or 2 kc
- Position error transfer . . . . . 1 or 2 kc
- Rate of change of position error
  - Output transfer rate in train . . . . . 400 cps
  - Output transfer rate in elevation . . . . . 250 cps

DASS also acts as a buffer for certain functions. It buffers digital designation information from the DFC computer to the DFC radar and buffers missile head orders from the computer to the missile G&C section.

REFERENCE:

U. S. Naval Ordnance Test Station. Functional Description of the Digital-Analog Servo System, by Claude W. Brown and Sara G. Valdivia. China Lake, Calif., NOTS, March 1964. (NOTS TP 3478).

## GUIDED MISSILE LAUNCHER MK 5 MOD 1

The Guided Missile Launcher Mk 5 Mod 1 is a twin-rail launcher designed for firing Terrier missiles. It is hydraulically powered and synchro controlled. When fitted with adapter rails, the launcher can be used for firing other missiles, such as ASROC (Fig. 7).

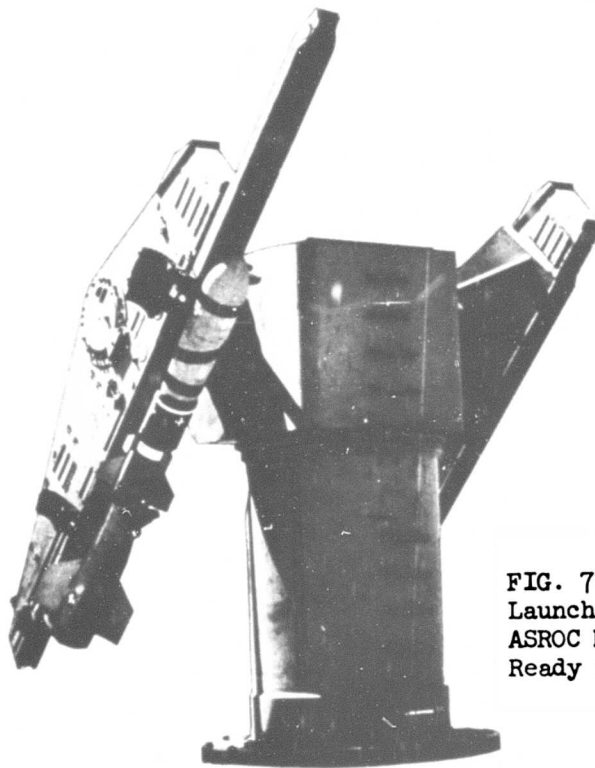

FIG. 7. Guided Missile Launcher Mk 5 Mod 1 With ASROC Missile Mounted Ready for Firing.

LHL 103342

Under normal operation, the launcher receives position commands from 60-cps synchros and rate commands from a DC tachometer; both commands are necessary for proper operation of the launcher power drive. A synchro signal amplifier is available to convert from a 400-cps source to the required 60 cps. Conversion of the power drive to 400-cps synchro control is expected to be accomplished in FY 1966.

Under digital control, the position and rate orders are generated in a digital computer (or other digital device). A digital order is derived within the digital-analog servo system (DASS), converted to DC voltage, and applied to the launcher power drive, bypassing much of the existing analog circuitry. Datex Model CG-708-1 digital shaft-angle encoders have been mounted on the train and elevation power-drive shafts to monitor launcher position for the position feedback needed for DASS control. The resolution of these encoders is  $2^{16}$  bits, or 19.78 seconds of arc.

The launcher control panel is located adjacent to the DASS console in the digital fire control room. This panel contains switches for activating the launcher power drive, selecting mode of operation, manually positioning the launcher by synchros, and monitoring launcher position.

**Launcher Characteristics:**

Train rate . . . . .	30°/sec maximum
Acceleration . . . . .	60°/sec <sup>2</sup> maximum
Rotation . . . . .	no restraints
Elevation rate . . . . .	20°/sec maximum
Acceleration . . . . .	40°/sec <sup>2</sup> maximum
Rotation . . . . .	-10° to +90°

---

**REFERENCE:**

Bureau of Naval Weapons. Guided Missile Launcher Mk 5 and Mods (U), Vol. 1: Stand, Carriage, Guide, and Miscellaneous Systems; Vol. 2: Train and Elevation Systems; Vol. 3: Care and Maintenance and Launcher Tests. Washington, D.C., 1 December 1958. (NAVWEPS OP 2350), CONFIDENTIAL.

## **AUTOMATIC TRACKING OPTICAL SYSTEM**

In the presence of severe electronic countermeasures or in the event of radar failure, shipboard surface launched weapon control systems use optical techniques for a secondary mode of operation. Currently, the optical systems are hand-controlled, which produces an attendant roughness of data that limits their usefulness in solving the fire control problem. NOTS has developed an automatic tracking optical system that is capable of supplying target-angle information with an accuracy comparable to radar information. Tracking system operation is described below.

The circuitry which derives tracking error data from the video signal of the radar boresight closed-circuit optical system is used as an alternate source of signal for the azimuth and elevation drive motors of the digitized fire control radar.

The tracking error circuitry is entirely solid state and is matched to a high resolution (945-line scan) closed-circuit system. The output of the tracking error circuitry is a step-wise analog presentation of the digital information from the video circuits. The output voltage ( $\pm 8$  volts), which is derived from a low impedance source (less than 1,000 $\Omega$ ), is proportional to the tracking error and can be used to drive the mount servos, thus achieving passive automatic tracking. The digital output is also available for combination with the shaft-angle encoder data.

Using a 24-inch focal length lens, the field of view is approximately one degree, with digital output steps corresponding to 7 arc seconds in elevation and 10 arc seconds in azimuth.

---

### **REFERENCE:**

Thompson, Julian L. "The U. S. Naval Ordnance Test Station's Experimental Tracking Error Detector," Proceedings from the 8th SPIE Technical Symposium, 7 August 1963, Los Angeles, Calif. SPIE J, Vol. 2, June-July 1964.

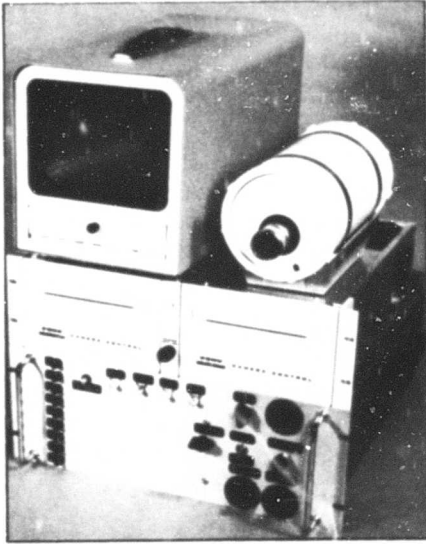

LHL 091701

FIG. 8a. Automatic Tracking  
Optical System Equipment.

FIG. 8b. Optical Tracking  
System Camera Mounted on  
Radar Antenna.

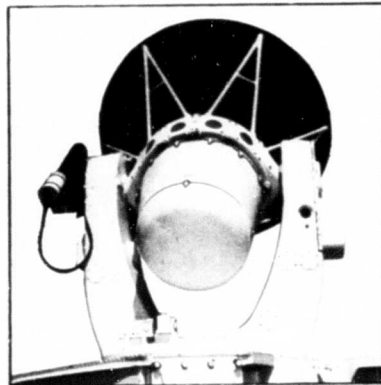

LHL 104598

## DIGITAL-TO-ANALOG DECK ANGLE CONVERTER

Exploratory development funds were used to develop the digital-to-analog deck angle converter (DADAC) as a means of smoothing the intermittent output of a digital computer for control of an analog responder. The DADAC is a gyro-stabilized dummy responder with two axes--a deck train axis and a deck elevation axis. By predicting a desired line-of-sight, then torquing the gyros at a constant rate to attain that predicted line-of-sight, a smooth continuous responder motion results, even with intermittent computer outputs. In addition, any ship's motion occurring between samples is compensated for by the platform's gyro-controlled servo. The DADAC control loop is shown in Fig. 9; the sensing platform is on the left in Fig. 10, and the associated electronics are on the right.

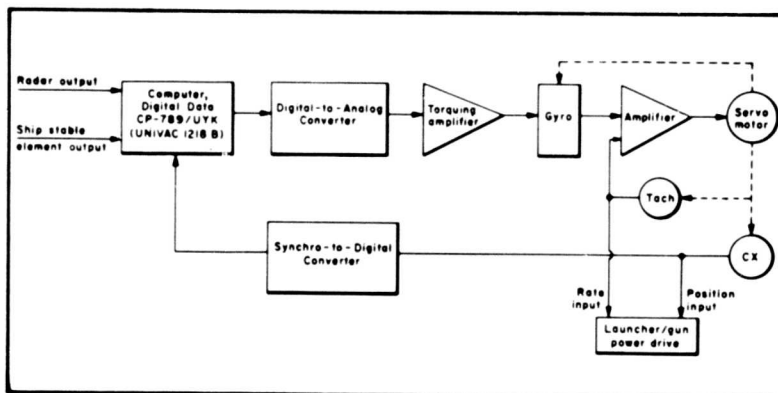
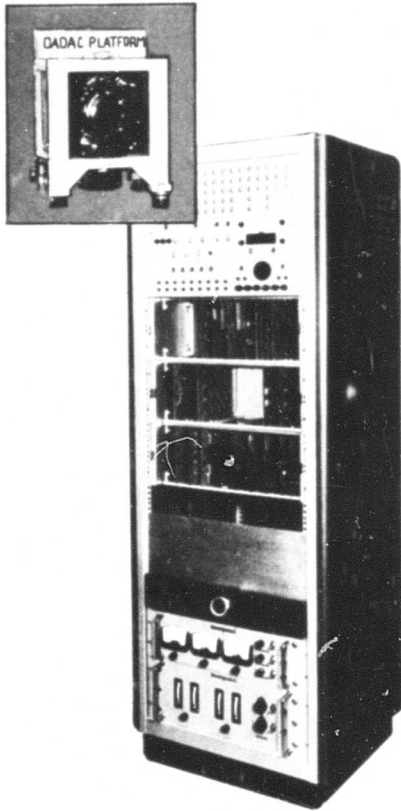

FIG. 9. Digital-to-Analog Deck Angle Converter.



The sensing platform, which has gearless 1 and 36 speed 400-cps synchro outputs and a 1 volt/degree/second velocity feed-forward as required by the tactical Guided Missile Launcher Mk 5 Mod 1, can be used to control the launcher from a digital computer. The equipment is portable and can be used at other locations where an appropriate computer is available.

FIG. 10. Digital-to-Analog Deck Angle Converter Console; (Inset) DADAC Platform. LHL 103344

**DADAC Characteristics:**

Train rate . . . . .	90°/sec maximum
Rotation . . . . .	unlimited
Elevation rate . . . . .	90°/sec maximum
Rotation . . . . .	+85° to -30°

**REFERENCES:**

General Electric Company. DADAC (Digital-to-Analog Deck Angle Converter) Phase A Final Report, by Ordnance Department. Pittsfield, Mass., 21 Oct. 1963. (Contract N123(60530)33851A).

----- DADAC (Digital-to-Analog Deck Angle Converter) Phase B Final Report, by Ordnance Department. 26 January 1965. (Contract N123(60530)33851A).

## SHIP'S MOTION SIMULATOR

A ship's motion simulator (SMS) has been constructed at NOTS for use in evaluation of experimental weapon control equipment. When coupled with appropriate electronic monitoring equipment, the SMS (Fig. 11) will be a part of the experimental surface launched weapon control test facility.

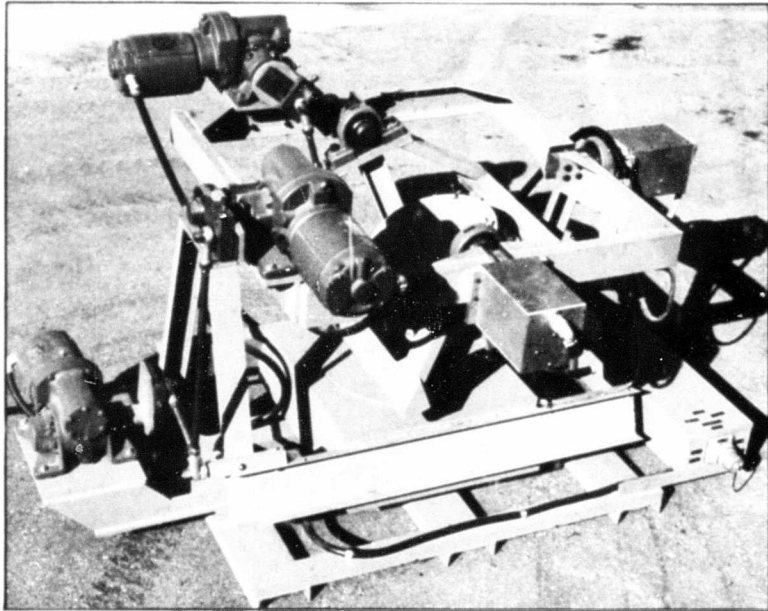

LHL 103256

FIG. 11. Ship's Motion Simulator.

The SMS is a transportable, 3-axis gimballed structure providing a roughly sinusoidal oscillatory motion for each axis. The three orthogonal axes intersect at a point about 12 inches above the mounting surface of the cradle. Each axis is driven and controlled individually and is equipped with 16-bit digital encoders to read out axis orientation. Resolution is approximately 20 arc seconds.

The simulator is 81 inches long, 64 inches wide, 50 inches high, and weighs 2,100 pounds. It consists of structural steel weldments in four main components: base platform, yoke, outer gimbal, and cradle (or inner gimbal). The yaw drive system and yoke are mounted on the base platform. The outer gimbal is mounted on the yoke and carries the pitch and roll axes drive systems; the cradle is mounted on the outer gimbal at a right angle to the yoke. Three 3x3-inch coplanar pads, each having three 11/16-inch diameter holes 120° apart on a bolt circle 24.687 inches in diameter are used to mount test items or adapters for test items.

Ship's Motion Simulator Characteristics:

Axis motion

- Yaw . . . . . infinitely adjustable displacement from  $\pm 7\frac{1}{2}^{\circ}$  to  $0^{\circ}$
- Pitch . . . . . infinitely adjustable displacement from  $\pm 12\frac{1}{2}^{\circ}$  to  $0^{\circ}$
- Roll . . . . . infinitely adjustable displacement from  $\pm 25^{\circ}$  to  $0^{\circ}$
- Speed ranges . . . . . infinitely variable periods from 4 to 60 sec on all three axes
- Capacity . . . . . the cradle has an effective 24x27-inch mounting space--24 inches along the roll axis; 27 inches along the pitch axis. Maximum payload is limited by an inertia of 10 slug-ft<sup>2</sup>
- Drive motors . . . . . each axis is driven by a 1/2 horse-power gearmotor with an electronic speed control. Power requirement for each motor is 115 VAC, 15-ampere

## ADAPTIVE RESEARCH COMPUTER (MODULAR TYPE)

The Adaptive Research Computer (ARC) is a stored-program, real-time digital computer built from large subunit modules. It is designed for easy modification and expansion. The present ARC at NOTS (Fig. 12) contains a 4,096-word, 36-bit magnetic core memory. Access time for the memory is 3  $\mu$ sec; cycle time is 6  $\mu$ sec. At present, the ARC has two 36-bit input and three 36-bit output channels. A third 36-bit input channel is to be added soon. In addition, the computer has six 12-bit input and six 12-bit output channels. Control sets for four more channels are available for immediate expansion to an 18-channel capacity; program provision is made for up to 64 channels.

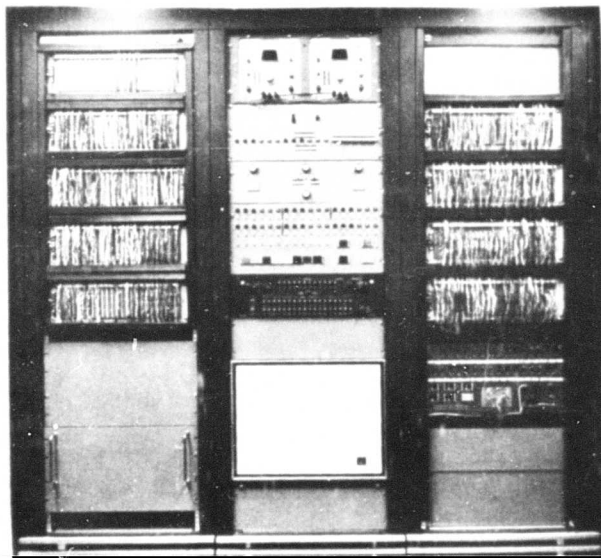

FIG. 12. Adaptive Research Computer.

LHL 103255

The input and output of the modules comprising the current ARC are defined from the viewpoint of the multiplex unit. The presently available 36-bit modules are:

1. A control, multiplex, and memory unit
2. An IBM 7094 digital computer input
3. An IBM 7094 digital computer output
4. A Flexowriter typewriter and/or paper tape punch output
5. An Ampex FR-300 digital magnetic tape unit input
6. An Ampex FR-300 digital magnetic tape unit output
7. A Monroe high-speed 12-decimal digit printer output

The presently available 12-bit modules are:

1. A serial 8-megacycle arithmetic unit input
2. A serial 8-megacycle arithmetic unit output
3. Four analog-to-digital (A-D) inputs
4. Four digital-to-analog (D-A) outputs

The eight A-D and D-A inputs and outputs are currently connected to a Pace TR-48 analog computer, which has 48 operational amplifiers and a few function generators, including multipliers.

With these modules, the ARC can simulate a wide variety of digital, analog, and hybrid fire control problems and devices.

All input interfaces are standardized and identical, and all output interfaces are standardized and identical. Interface requirements for additional modules are relatively simple. They are general enough to permit almost any digital or digitized-analog device to be used as an ARC module. Module additions planned for the near future include:

1. 6 each additional A-D inputs and D-A outputs
2. A Flexowriter typewriter and/or paper tape reader input
3. A Midwestern M-3100 digital magnetic tape unit input and output

Continued

Other proposed additions include:

1. A high-speed photoelectric paper tape reader input
2. A high-speed, variable-format page printer output
3. Special-purpose arithmetic units
4. Memory input and output modules, both ferrite-core and magnetic drum
5. Other digital computer inputs and outputs
6. Unspecialized A-D and D-A modules to connect to analog fire control devices

---

REFERENCES:

U. S. Naval Ordnance Test Station. Revised ARC Channel Definitions, by Gary Babcock and Robert D. Coleman. China Lake, California, NOTS, June 1964. (Tech Note 3031-71).

----- ARC Module, Cable, and Plug Wiring, by Robert D. Coleman. September 1963. (Tech Note 3031-42).

----- Console Manual Controls for ARC, by Robert D. Coleman. January 1963. (Tech Note 3031-27).

----- Modular Computer Exploratory Development, by Robert D. Coleman. June 1964. (Tech Note 3031-69).

## DIGITAL SHAFT-ANGLE ENCODER EVALUATION FACILITY

The tracking radar director from a Guided Missile Fire Control System AN/MSG-3A has been selected as the basic mount for the encoder evaluation facility. The MSG-3A has a large-diameter data gear attached to the azimuth turntable. The gear is easily accessible from inside the radar van and there is ample space at the gear to allow a normal installation of the encoder being evaluated and a reference (or monitor) encoder.

The encoder facility also includes portable interface digital logic and tape recording units (Figs. 13 and 14) that can be used to evaluate any type of encoder in comparison with the monitor encoder. Simultaneous recording of the two (or three) outputs is made on magnetic tape up to the maximum velocity and acceleration rates of  $40 \text{ deg/sec}$  and  $40 \text{ deg/sec}^2$  on this particular mount. Higher rates can be attained by using breadboard servos in the laboratory. Near-automatic data reduction is accomplished by using the IBM 7094 to compute listings and data plots from a maximum of three encoder data sources simultaneously. These sources each have a maximum 18-bit word capacity. Continuous sampling is accomplished by using a selectable rate of 5 or 10 samples per second; long-term evaluation can be made by using the hourly burst-of-8 samples, which are recorded in relative time.

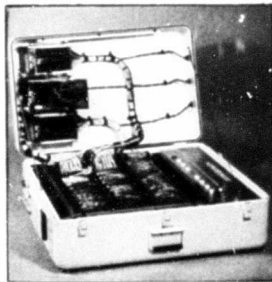

LHL 100943

FIG. 13. Interface  
Digital Logic Unit.

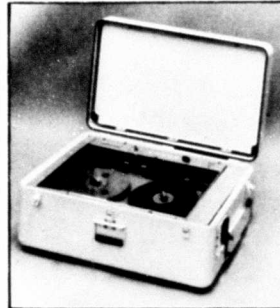

LHL 100942

FIG. 14. Digital  
Tape Recorder.



**ASSOCIATED RANGE EQUIPMENT  
AVAILABLE FOR USE WITH THE  
WEAPON-CONTROL  
TEST FACILITY EQUIPMENT**

## RADAR EQUIPMENT MK 25 MOD 3

The Radar Equipment Mk 25 Mod 3, a pulse-echo type radar that operates in the X-band, is normally a part of the Gun Fire Control System (GFCS) Mk 37. The unit at G-1 Range (Fig. 15) carries a special 8-foot reflector (antenna) instead of the standard Mk 9 Mod 0.

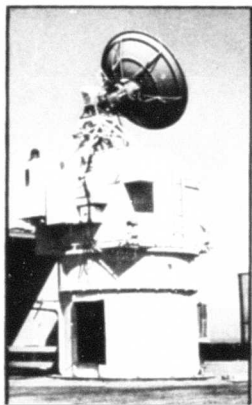

LHL 093677

FIG. 15. Radar Equipment Mk 25 Mod 3.

The radar has standard circuitry for automatic tracking and ranging. Although it cannot be slaved to the other radars, it has a follow-the-pointer capability for accepting designation. Through a switching arrangement, the Varian Illuminator can be slaved to the Radar Equipment Mk 25 Mod 3. Parametric amplifiers have been installed to provide a 50% increase in acquisition range.

This radar has been modified by ORDALT 4308, giving it the capability of the Radar Set AN/SPG-53 in the Gun Fire Control System Mk 68.

---

### REFERENCES:

Bureau of Naval Weapons. Radar Equipment Mk 25 Mod 3. Description, Theory, Installation, and Adjustment, Vol. 1. Washington, D.C., 22 August 1950. (NAWWEPS OP 1845).

General Dynamics. CW Illuminator Set Mod 1 Ser 1, Description, Operation, and Maintenance. Pomona, Calif., March 1961. (Contract #16840).

Varian Associates. Varian Illuminator Model V-4673, Instruction Manual. April 1959. (TM-45).

## RADAR SET AN/SPQ-5

The Radar Set AN/SPQ-5 XN-2 (Fig. 16) is an automatic tracking, Terrier missile guidance control, C-band radar set with a missile beacon tracking capability. Its operational modes include track and capture, and guidance (the acquisition capability was removed to make way for installation of special gear). The supporting components permit three-dimensional movement of both the main antenna (track and guidance) and the capture antenna. Range, traverse, train, and elevation data are transmitted by a 400-cps synchro system.

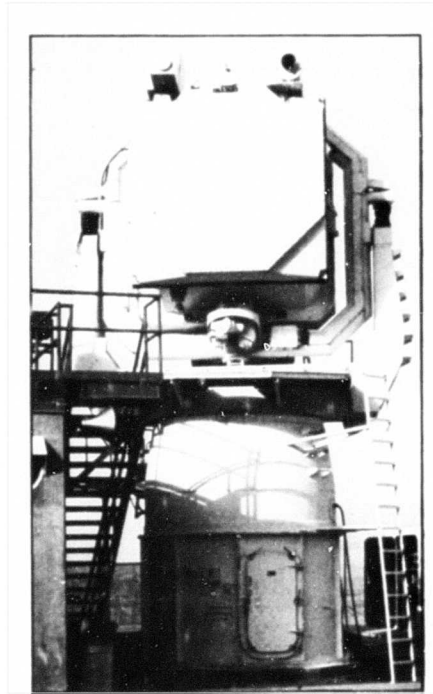

FIG. 16. Radar Set AN/SPQ-5.

LHL 101932

The Radar Set SPQ-5 can receive designation information from any one of three tracking (instrumentation) radars: the AN/MPS 26, the Model 7298, or the M-33.

**Special purpose equipment includes:**

Closed-circuit television display, aligned with the tracking line-of-sight of the radar, gives resolution of a normal aircraft target to approximately 30,000 yards.

70mm Photo Sonics radar boresight camera with a 12-inch lens for early flight and a 150-inch lens for later flight coverage; sampling rate is normally 10 frames per second.

Director programmer that can: program the Radar Set AN/SPQ-5 in elevation; slave the SPQ-5 to another 400-cycle radar for a controlled elevation program, and convert from 3-axis to 2-axis synchro data for slaving the Varian Illuminator to the SPQ-5.

Located 1,000 feet south of the radar, there is a permanent installation test tower that can be used for testing standard angle sensitivity and radar collimation.

---

**REFERENCES:**

Bureau of Naval Weapons. Radar Set AN/SPQ-5. Vol. 1: Description, Operation, and Maintenance. Washington, D.C., April 1956. (NAVWEPS OP 2138).

----- Radar Set AN/SPQ-5 (XN-1). Vol. 1: General Description and Theory of Operation. Washington., D. C. (NAVWEPS OD 9178).

General Dynamics. Radar Guidance Monitor, Operation and Maintenance. Pomona, Calif. November 1956.

Sperry Gyroscope Company. Beacon Tracking Equipment OA-1732/SPQ-5A. Great Neck, New York. (Engineering Bulletin 1895122, Adjustment Procedure).

U. S. Naval Ordnance Test Station. Program Director-- A Computer for Special Missile Trajectories, by L. F. Van Buskirk. China Lake, Calif., NOTS, July 12, 1962. (Tech Note 304-74).

## COMPUTER EX-13 MOD 0

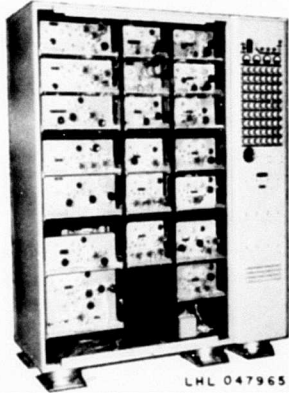

FIG. 17. Computer EX 13 Mod 0.

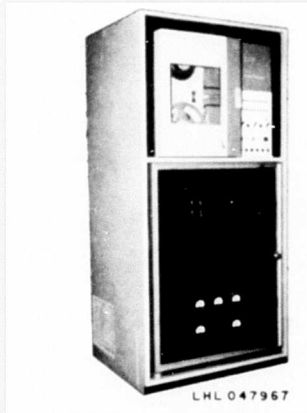

FIG. 18. Beckman Recorder.

The NOTS Computer EX-13 Mod 0 (Fig. 17) is an electromechanical analog fire control computer designed and built by the Ford Instrument Company. It has both a Terrier and a Tartar capability.

The computer receives target information from either the Radar Set AN/SPQ-5 or the Radar Equipment Mk 25 Mod 3, and wind direction from an anemometer. The computer generates launcher positioning information and missile orders for Terrier, Tartar, and Standard Missile Type 1. It does not have a deck tilt corrector group section.

The output of the Computer EX-13 Mod 0 is monitored and recorded by the Beckman Recorder System (Fig. 18).

---

### REFERENCE:

Ford Instrument Company. Computer EX-13 Mod 0, Engineering Report.

## MISSILE LAUNCHER TYPE X-7

The Missile Launcher Type X-7 is a converted 40mm gun mount used primarily for the launching of Tartar guided missiles (Fig. 19). The mount is synchro-controlled and hydraulically-powered; underground wiring leads to the switchboards and launcher controls in the Radar Building.



LHL 671314

FIG. 19. Tartar Missile Mounted on Guided Missile Launcher Type X-7.

The X-7 receives Tartar and Standard Missile Type 1 MR (medium range) fire control commands from the analog Computer EX-13 Mod 0 via a synchro signal amplifier for conversion of the synchro signals from 400 cps to 60 cps as required by the launcher. A dummy director is available to exercise and test the Missile Launcher Type X-7.

Train and elevation rates of the mount are 15°/second, constant velocity (without acceleration control)

Elevation limits are 54°10'

Train mechanical limits are 118°24', right, and 134°11', left, of the guided missile line of fire

Camera and television mounting pads are available for monitoring the launcher line of sight. Normally, synchro torque transmitters installed on the launcher transmit launcher position to data readout dials in the Radar Building. Recently installed encoders give launcher position readout on the Beckman tape.

---

### REFERENCE:

Missile Launcher Type X-7. Puget Sound N.S.Y. (Navy Ord OD 7340-10), CONFIDENTIAL

## MISSILE LAUNCHER TYPE X-8

The Missile Launcher Type X-8, which is a modified twin 5"/38 gun mount used primarily for launching Terrier guided missiles, can be adapted to fire other types of missiles. It is synchro-controlled and hydraulically-powered. Underground wiring leads to the switchboards and launcher controls in the Radar Building.

The X-8 receives Terrier and Standard Missile Type 1 ER (extended range) commands from the Computer EX-13 Mod 0 via a synchro signal amplifier for conversion of the synchro signals from 400 cps to 60 cps as required by the launcher. A dummy director is available to exercise and test the Missile Launcher Type X-8.

Train and elevation rates are below 8°/sec

The mount elevates to 70°23'

Train limits are 131°40' to the right and 131°02' to the left of the guided missile line of fire.

Camera and television mounting pads are available for monitoring launcher line of sight. The synchro generators on the launcher transmit launcher position to synchro motors that drive data dials in the Radar Building. Currently, the only way to record launcher position as a function of time is to photograph the data dials; however, plans are completed for the installation of encoders similar to those used with the launcher type X-7.

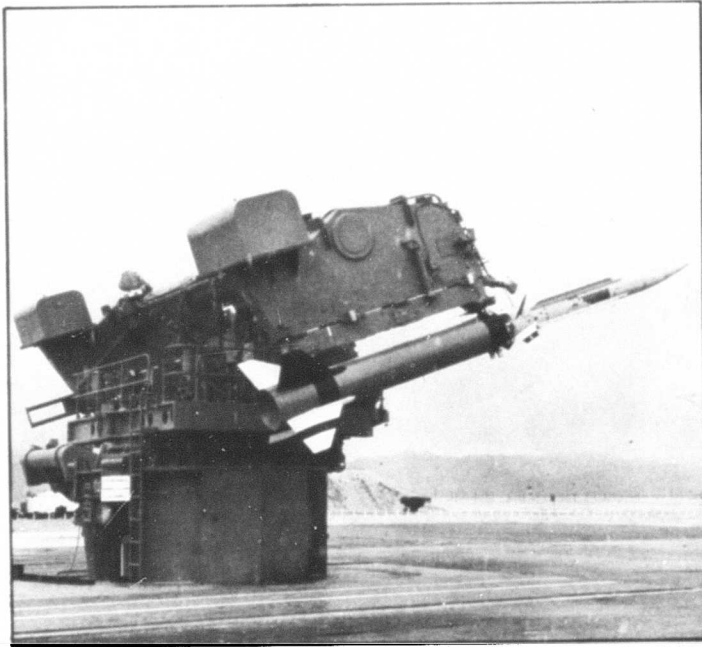

LML 671303

FIG. 20. Terrier Missile Mounted on  
Guided Missile Launcher Type X-8.

---

REFERENCE:

Bureau of Naval Weapons. Missile Launcher Type X-8--  
General Description of Mount and Adapter Arms. Assembly and  
Operating Instructions. Washington, D.C., September 1955.  
(OD 7911 Rev. C), CONFIDENTIAL.

## RANGE CONTROL SYSTEM

FIG. 21. Range Control System.

The range control system (RCS) located in the G-1 Range Test Control Building (Fig. 21) processes and displays information originating from three tracking instrumentation radars and MIDAS.\* The RCS consists of a Computer, Digital Data CP-789/UYK (UNIVAC 1218B), a magnetic tape system, an input/output console, an interface rack, a numerical display, and four plotting boards.

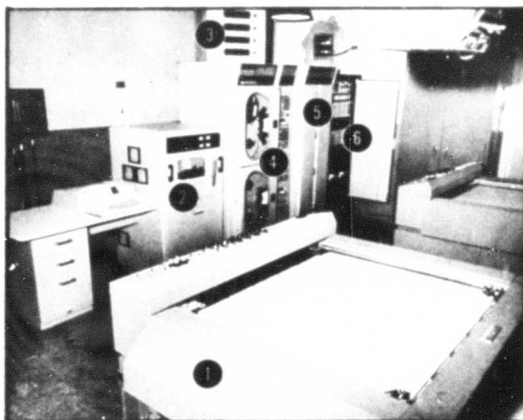

LHL 103735

- |                         |                      |
|-------------------------|----------------------|
| 1. Plotting board       | 4. Dual tape handler |
| 2. Input/Output console | 5. Computer          |
| 3. Numerical display    | 6. Interface rack    |

Target acquisition data are also computed by the RCS computer and sent to downrange optical instrumentation sites (cinetheodolites\*\*) by microwave/RF link. The look angles are compared with the cinetheodolite line of sight. If a difference is detected, an indicator light in the operator's telescope is illuminated; this designates to the operator the direction he must move his mount, up or down, right or left, in order to point at the target.

---

\*MIDAS is a passive interferometer-type system using two widely separated complexes to derive three-dimensional target position.

\*\*The Askania type cinetheodolites have pulse-operated shutters and movements able to operate in synchronism at 1, 2, 4, or 5 pulses/second. When used in arrays, they provide accurate three-dimensional target position data.

In addition to the necessary input/output connections to the peripheral equipment (as shown in the RCS block diagram, Fig. 22), one output channel is used to transfer data from the computer to the four plotting boards; one output channel is used to send digital data to the four numerical NIXIE tube displays; the target acquisition system output occupies one channel; and the DFC computer is connected to the RCS computer through an input and output channel. Radar and MIDAS data are transferred into the computer on separate input channels.

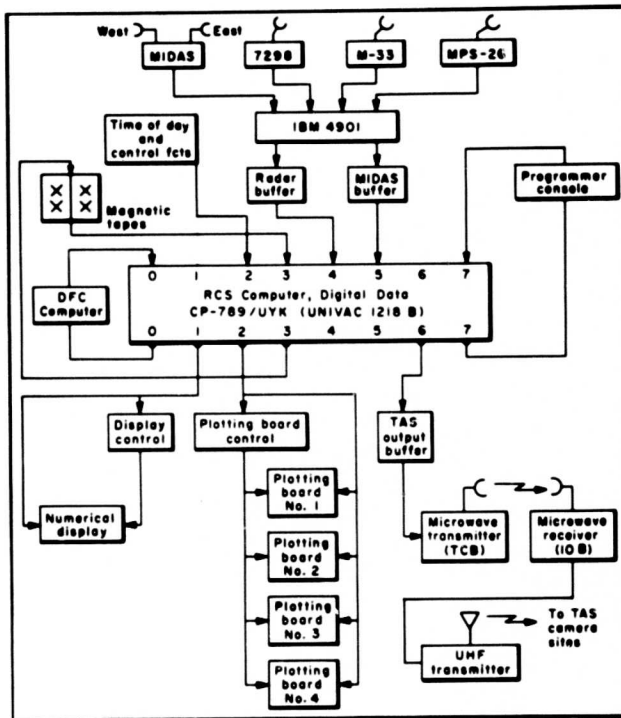

FIG. 22. Block Diagram of Range Control System.

Continued

Two devices are connected to the computer as peripheral equipment--the magnetic tape unit and the I/O console. The magnetic tape unit (designated the Recorder-Reproducer, Digital Data RD-270(V)/UYK) has two tape handlers and can write IBM-compatible tapes at 200 or 556 bpi at a maximum rate of 62.5 characters per second. The I/O console (designated the Recorder-Reproducer, Digital Data RD-271/UYK) contains a 300-character per second paper tape reader, a 110-character per second paper tape punch, and an alpha/numeric keyboard with page printer.

A microwave link, connecting G-1 Range with the IBM 7094 computer in Michelson Laboratory, can be used to increase the data handling capacity of the DFC and RCS computers.

---

REFERENCE:

U. S. Naval Ordnance Test Station. Range Control System, by Neil R. Krenzel. China Lake, Calif., NOTS, December 1964. (Tech Note 3031-85).