

AD629607

AFWL-TR-65-224

AFWL-TR
65-224

SIMULATION DEVICES FOR USE IN STUDIES OF PROTECTIVE CONSTRUCTION

James A. Mahoney



CLEARINGHOUSE FOR FEDERAL SCIENTIFIC AND TECHNICAL INFORMATION		
Hardcopy	Microfiche	
\$6.00	\$1.25	225 pp. 03
ARCHIVE COPY		

Coel

TECHNICAL REPORT NO. AFWL-TR-65-224

February 1966

AIR FORCE WEAPONS LABORATORY
Research and Technology Division
Air Force Systems Command
Kirtland Air Force Base
New Mexico

AFWL-TR-65-224

SIMULATION DEVICES FOR USE IN STUDIES
OF PROTECTIVE CONSTRUCTION

James A. Mahoney

TECHNICAL REPORT NO. AFWL-TR-65-224

Distribution of this document
is unlimited.

Research and Technology Division
AIR FORCE WEAPONS LABORATORY
Air Force Systems Command
Kirtland Air Force Base
New Mexico

When U. S. Government drawings, specifications, or other data are used for any purpose other than a definitely related Government procurement operation, the Government thereby incurs no responsibility nor any obligation whatsoever, and the fact that the Government may have formulated, furnished, or in any way supplied the said drawings, specifications, or other data, is not to be regarded by implication or otherwise, as in any manner licensing the holder or any other person or corporation, or conveying any rights or permission to manufacture, use, or sell any patented invention that may in any way be related thereto.

This report is made available for study with the understanding that proprietary interests in and relating thereto will not be impaired. In case of apparent conflict or any other questions between the Government's rights and those of others, notify the Judge Advocate, Air Force Systems Command, Andrews Air Force Base, Washington, D. C. 20331.

Distribution of this document is unlimited.

FOREWORD

This report was prepared under Program Element 7.60.06.01.D, Project 5710, Subtask 13.162, and was funded by the Defense Atomic Support Agency (DASA). Inclusive dates of research were 1 January 1965 to 31 December 1965. The report was submitted 5 January 1966 by the AFWL Project Engineer, Mr. James A. Mahoney (WLDC).

The assistance of the following personnel and organizations is gratefully acknowledged: Professor Marvin C. May, Chairman, Civil Engineering Department, University of New Mexico, Thomas F. Lowry, Jr., Colonel, USAF, former Chief, Civil Engineering Branch, Air Force Weapons Laboratory (AFWL), Robert E. Crawford, Major, USAF, Deputy Chief, Civil Engineering Branch, AFWL, Major Thomas F. Dean, Chief, Special Projects, AFWL (WLDC) Merril E. Barnes, Major, USAF, Defense Atomic Support Agency, and G. Stanton Mason, Jimmy D. Ross, Don Mackel and Hans Neubert, University of New Mexico engineering students who accomplished the drafting.

This technical report has been reviewed and is approved.

JAMES A. MAHONEY
Project Engineer

FREDERICK W. KORBETZ, JR.
Lt Colonel, USAF
Chief, Civil Engineering Branch

JOHN W. KODIS
Colonel, USAF
Chief, Development Division

ABSTRACT

This report contains information on dynamic loading simulation devices that were either designed or could be modified for use in studies of protective construction. The information includes the following items: 1) the type of device, 2) the owner and location, 3) the loading characteristics, 4) the physical description, 5) the driver used, and 6) a short discussion concerning the device and its present use. Pictures and diagrams are also furnished for the majority of the devices.

CONTENTS

<u>Section</u>		<u>Page</u>
I	INTRODUCTION	1
II	RAM LOADERS	9
	A-2. Air Force - MDI 50-Kip Dynamic Ram Loader	10
	B-2. Dynamic Triaxial Test Apparatus	14
	C-2. Dynamic Loading Apparatus (Small Ram)	17
	D-2. Dynapak Loading Machine	20
	E-2. Earth Shock Tube/Hyge Shock Tester	25
	F-2. MDI Model DM 4-50 Dynamic Material Evaluation Machine	28
	G-2. 60-Kip Capacity Ram Loader (1, 2, & 3)	32
	H-2. University of Illinois 7-Kip Pneumatic-Hydraulic Loading Machine	37
	I-2. 20-Kip Pulse Loading Device	44
	J-2. WES - MIT Impact Loader	48
	K-2. WES - 200-Kip Loader	50
	L-2. WES - 500-Kip Loader	54
III	SHOCK TUBES	59
	A-3. Air Force 2-Foot-Diameter Shock Tube	60
	B-3. The Boeing 24 - 36-Inch Shock Tube Facility	63
	C-3. Detonation-Driven Shock Tube	69
	D-3. BRL 24-Inch O.D. Shock Tube	74
	E-3. Conical Shock Tube	78
	F-3. Detonation-Driven Shock Tube	80
	G-3. Double-Driver Shock Tube (Shock Tunnel)	81
	H-3. 4-Inch-Diameter Shock Tube	85
	I-3. 4-Inch Square Shock Tube	87
	J-3. 40-72-Inch Diameter Shock Tube	88
	K-3. High-Capacity Pressure Tube	91
	L-3. High-Pressure Driven Shock Tube	93
	M-3. General Electric Shock Tubes & Tunnels	95
	N-3. Low-Pressure Loader (2)	106
	O-3. MRD-Detonation-Driven Shock Tube	109

<u>Section</u>	<u>Page</u>
P-3. NCEL Shock Tube (Combination)	111
Q-3. 6-Foot-Diameter Shock Tube	114
R-3. 6-Inch Loader	120
S-3. Shock Tube Loading Facility for Soils	121
T-3. The 4 x 15-Inch-Diameter Shock Tube	127
U-3. 13-Inch-Diameter High-Pressure Shock Tube	129
V-3. 3-Inch-Diameter High-Pressure Loader	132
W-3. 12-Inch-Diameter Shock Tube	133
X-3. 24-40-Inch-Diameter Shock Tube	136
Y-3. 24-Inch-Diameter Shock Tube	140
IV PLANE WAVE LOADERS	145
A-4. Boynton Dynamic Load Generator (URS)	146
B-4. Boynton Dynamic Load Generator (MIT)	148
C-4. Boynton Dynamic Load Generator (Stanford)	150
D-4. Dynamic Slab Loader	152
E-4. Soil Tank	155
F-4. Seven-Cell 4-Foot-Diameter Gas Dynamic Loader	157
G-4. 2-Foot-Diameter Vertical Shock Tube	161
H-4. The Sinnamon Dynamic Loader	163
I-4. 12-Inch-Diameter Vertical X-Ray Shock Tube	167
J-4. University of Arizona Plane Wave Generator	170
K-4. WES - 4-Foot-Diameter Blast Load Generator (SBLG)	173
L-4. WES - Large Blast Load Generator (LBLG)	177
M-4. USAF 2-Foot-Diameter Vertical Shock Tube	182
V MISCELLANEOUS LOADERS	187
A-5. AFWL Gas Bag Program	188
B-5. Atomic Blast Simulator	191
C-5. Drop Tower (WES)	194
D-5. High-Explosive Test Site (Concrete Pad)	196
E-5. IIT Research Institute Dynamic Soil Facility	199
F-5. Lockheed Shock Tunnel	205
G-5. Long-Duration Dynamic Loader (URS)	209
H-5. Dynamic Pressure Tank	212
Distribution	216

ILLUSTRATIONS

<u>Figure</u>		<u>Page</u>
1	Blast Load Generator Facility at the Waterways Experiment Station, Vicksburg, Miss.	3
2	The Eric H. Wang Civil Engineering Research Facility	4
3	Civil Engineering High-Intensity Dynamics Test Laboratory, University of Illinois, Urbana, Illinois	5
4	IIT Research Institute Dynamic Soil Facility	6
5	Air Force - MDI 50-Kip Dynamic Ram Loader	11
6	Schematic, Air Force - MDI 50-Kip Dynamic Ram Loader	12
7	Dynamic Triaxial Testing Machine	15
8	Schematic Dynamic Loading Apparatus (Small Ram)	18
9	Schematic Drawing of Load Actuator	21
10	WES Dynapak Loading Machine	22
11	WES Dynamic Triaxial Test Apparatus	23
12	Earth Shock Tube	26
13	Close-up Showing the Hyge Shock Tester	27
14	System Schematic MDI Model DM4-50 Dynamic Material Evaluation Machine	29
15	MDI Model DM4-50 Dynamic Material Evaluation Machine	30
16	60-Kip Pulse Loading Machine	33
17	Two-Position Close-up of 60-Kip Pulse Loader Trigger Assembly	34
18	60-Kip Pulse Loading Machine #1 Close-up	35
19	Close-up of 7-Kip Pneumatic-Hydraulic Loading Machine	39
20	Overall View of 7-Kip Loader	40
21	Schematic Frame and Machine Assembly 7-Kip Loader	41
22	Schematic 7-Kip Loader Hydraulic System	42
23	20-Kip Pulse Loading Device	45
24	Schematic Diagram of Testing Machine	46
25	WES-MIT Impact Loader	49
26	WES 200-Kip Loader	51
27	WES 500-Kip Loader	55
28	Load-Velocity Capability for 500-Kip Loader	56
29	Load Application to Rigid Specimen for 500-Kip Loader	57
30	2-Ft-Diameter Shock Tube	61

<u>Figure</u>		<u>Page</u>
31	Boeing Tulalip 24-Inch Shock Tube Facility	64
32	Detonation Driven Shock Tube	70
33	Photograph of the Drive Section	71
34	Photograph of the First Driven Section	72
35	The 24-Inch Shock Tube	75
36	BRL 24-Inch Shock Tube	76
37	Proposed Conical Shock Tube Facility	79
38	Double-Driver Shock Tube	82
39	Sketch of Shock Tube Used in Experiments	83
40	Details of 40-72-Inch-Diameter Lovelace Shock Tube	89
41	Lovelace 40-72-Inch-Diameter Shock Tube	90
42	NCEL-High Capacity Pressure Tube	92
43	MRD High-Pressure Driven Shock Tube	94
44	Summary Description of Operating Shock Tubes and Shock Tunnels	97
45	Electrically Driven Shock Tube	98
46	6-Inch-Diameter Electric Arc Discharge Shock	99
47	Electrically Driven Shock Tunnel with 30-Inch-Diameter Test Section	100
48	Sketch of Large Shock Tunnel with Contoured Nozzle Installed	101
49	2-30-Inch-Diameter Shock Tunnel with Electron Beam Assembly	102
50	2-10-Inch-Diameter Combustion Shock Tunnel	103
51	GE Shock Tunnel	104
52	Shock Tube Performance	105
53	Fluid Boundary Wave Propagation Device with Low-Pressure Loader	107
54	Photograph Shows 12-Inch I.D. Shock Tube Right & 2 1/8-Inch I.D. Detonation Driven Shock Tube-Left	110
55	1-Ft Square NCEL Shock Tube	112
56	Shock Tubes Shown are Left to Right: 2-Foot-Diameter Horizontal Tube, 2-Foot-Diameter Vertical Tube, 6-Foot- Diameter Tube, 2-Foot Vertical Tube and 12-inch X-Ray Tube	115
57	The 350-PSI Compression Section Door of the 6-Ft-Diameter Shock Tube	116
58	Layout and Elevation of Six-Foot Shock Tube	117
59	III Shock Tube Showing Supported Soil Sample	122
60	Shock Wave Test Apparatus	123

<u>Figure</u>		<u>Page</u>
61	IIT 8 Inch x 8-Inch Square Shock Tube	124
62	Schematic Shock Tube With Attached Soil Box and Generated Air Shock Pulse	125
63	The 4 x 15-Inch Shock Tube	128
64	Driver End of 13-Inch-Diameter High-Pressure Shock Tube	130
65	12-Inch-Diameter Shock Tube	134
66	Layout and Elevation of 24-40-Inch-Diameter Shock Tube	137
67	Lovelace 24-40-Inch-Diameter Shock Tube	138
68	Shock Tube Diagram and Cross Section of the Test Section	141
69	Schematic of 24-Inch-Diameter Shock Tube	142
70	Laboratory Model 500 PSI Dynamic Load Generator	147
71	Sketch of Dynamic Slab Loader	153
72	Typical Section of Dynamic Slab Loader	154
73	NCEL Soil Tank	156
74	Section Through a Loading Cell	158
75	Seven-Cell 4-Foot-Diameter Gas Dynamic Loader Sketch Showing Retention Frame and Massive Concrete Foundation	159
76	On the Right is the 2-Ft-Diameter Vertical Shock Tube and Left is the 12-Inch-Diameter Vertical X-Ray Shock Tube	162
77	Sketch Showing the Sinnamon Dynamic Loader Before Firing	164
78	Loader After Firing with the Decay and Main Orifices Open	165
79	Schematic of 12-Inch X-Ray Shock Tube	168
80	University of Arizona Plane Wave Generator Open Position	171
81	WES 4-Ft Generator Ring Assembly	174
82	Foundation for 4-Foot Generator	175
83	WES Large Blast Load Generator Facility	178
84	Sketch of Large Blast Load Generator	179
85	USAF 2-Ft-Diameter Vertical Shock Tube	183
86	Sketch of a 2-Foot-Diameter Vertical Shock Tube	184
88	NCEL Atomic Blast Simulator	192
89	WES Drop Tower	195
90	Schematic of Lovelace High-Explosive Test Site	197
91	High Explosive Test Site (Concrete Pad)	198
92	IIT Research Institute Dynamic Soil Loader	200
93	Close-up Showing Steel Diaphragm in Place	201
94	Steel Diaphragm Before and After	202

<u>Figure</u>		<u>Page</u>
95	Schematic of Soil Bin	203
96	Artists Conception of Lockheed-Georgia Company, 3-Ft-Diameter Shock Tunnel	206
97	Shock Tunnel System Diagram	207
98	URS Long-Duration Dynamic Loader Disassembled	210
99	Dynamic Loader Prepared for Firing	211
100	Details of Test Vessel	213
101	Diagram Illustrating the Principal Features of the UED Dynamic Pressure Tank	214

SECTION I
INTRODUCTION

1. Objectives

The objective of this document is to catalog, in terms of their usefulness as nuclear blast simulators, the known dynamic-loading devices located in military and civilian scientific laboratories throughout the United States. The majority of these devices are designed to simulate the dynamic characteristics of a nuclear burst. The remainder are adaptable, with but minor modifications, to simulate most of the loading characteristics of a nuclear detonation.

2. Background

A genuine need exists for thoroughly documenting the major dynamic-loading devices used in protective construction research. In conjunction with this need a brief look at prior efforts and published reports is presented.

In November 1961, Mr. E. B. Ahlers, IIT Research Foundation, authored a final report, "Experimental Methods of Determining the Behavior of Underground Structures Under Dynamic Loads," (Ref. a) for the Office of Civil and Defense Mobilization (OCDM). Subsequently, Dr. Richard D. Woods wrote his master's thesis during 1962 and later published it as an Air Force Weapons Laboratory Technical Report (Ref. b). Both of these authors limited the material in their publications to devices that were in current use as nuclear blast simulators. In April 1965, the Defense Atomic Support Agency Data Center published a report, DASA 1627, entitled "Blast and Shock Simulation Facilities in the United Kingdom, Canada, and the United States," (Ref. c) which included blast simulation facilities discussed at the Tripartite Technical Cooperation Program (TTCP) meeting on 16 March 1964.

The Ahlers report discusses the problems encountered in designing experiments, scaling relationships, limitation of soil chamber dimensions, and the shock and soil properties. It investigates the theory of various types of dynamic loading devices, the reproductibility of the shock strengths for a series of firings, the versatility of different loaders, and the different media used as drivers.

Dr. Woods, while working on a Masters Degree in Civil Engineering at the University of Notre Dame, was assigned to work on an Air Force contract for

protective construction research. This project required that Notre Dame develop a direct shear apparatus for testing soils under both static and dynamic loads. A by-product effort included a thorough literature search, and it was during this search that a review of existing testing equipment was made. This review is reported in Chapter 3 of reference b.

DASA 1627 (Ref. 2) reports on military laboratories both stateside and abroad. It relates the investigational philosophy used at various laboratories, the description and specifications of the devices, test parameters used principally for their investigations, limitations of available facilities, the instrumentation used, and future plans.

Since the publication of these documents, numerous new devices have been designed and installed; other existing devices have been modified. The complexity of a facility or laboratory and its philosophy is not discussed in this document since it is assumed that such items will be included elsewhere.

3. Discussion

Now that the Test Ban Treaty is in effect, simulated nuclear testing must suffice. Research efforts are accomplished through in-house laboratories such as those shown in figures 1 and 2 and through contracts with research organizations as illustrated in figures 3 and 4. Government and private funds continue to be used for the construction of simulation devices and laboratories to produce the varied phenomena analogous to those produced by the detonation of a nuclear device.

Not all the simulators listed in this report are used for the investigation of basic phenomena associated with the response of soils and structures under dynamic loads. Some are used simply to study shock waves, others are used to study the effects of shock waves on animals, while yet others are used to study the effects of a shock wave on re-entry shapes. All could be utilized, some with minor modifications, as an aid to conducting research in the areas of protective construction and protective structures.

In the modern generic sense, protective construction or protective structures mean buried or partially buried structures in soil. The offices of Civil and Defense Mobilization (OCDM) and the Department of Defense (DOD) have for many years been performing research in the field of protective construction. Therefore, this report should be valuable as an aid in avoiding duplication of devices at various laboratories.

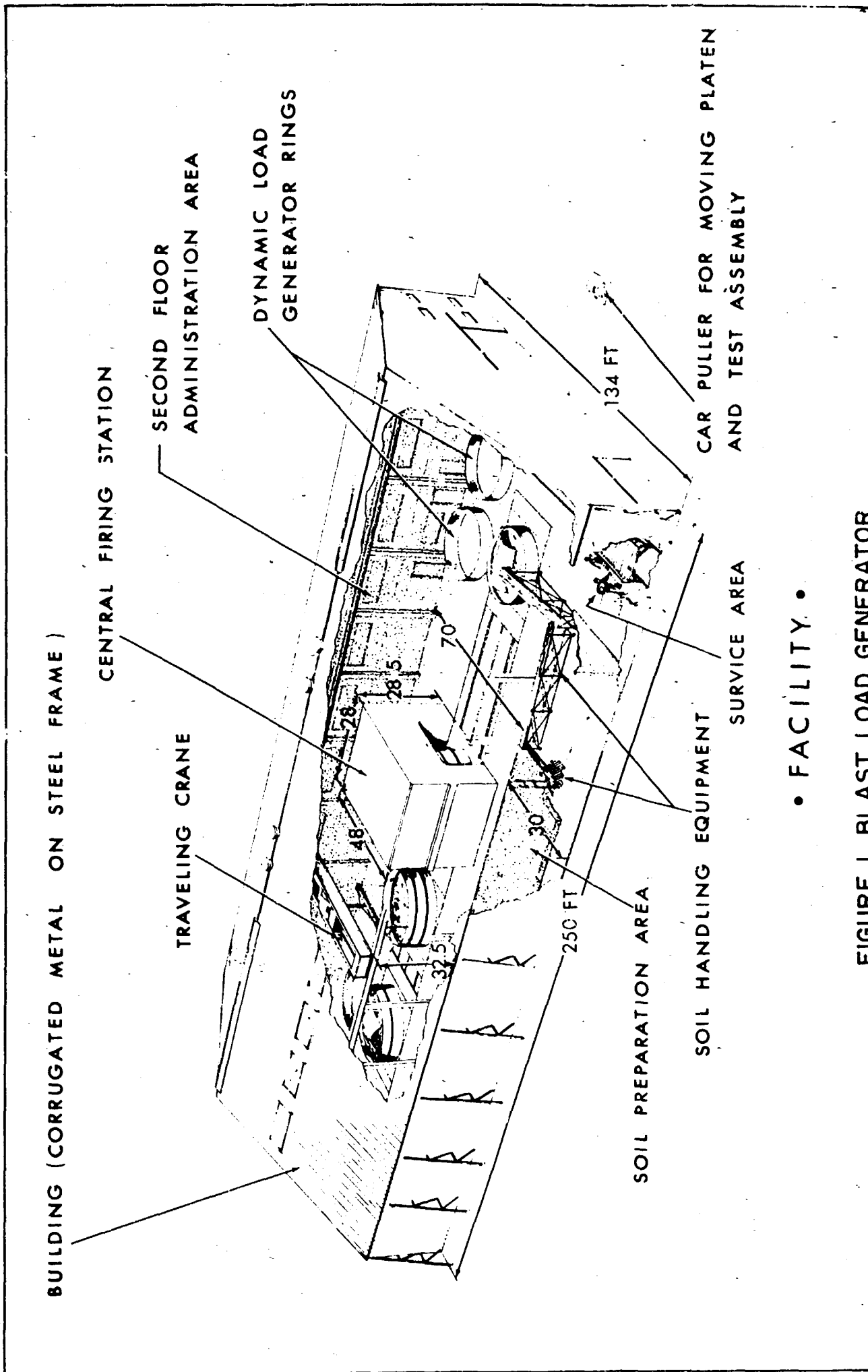
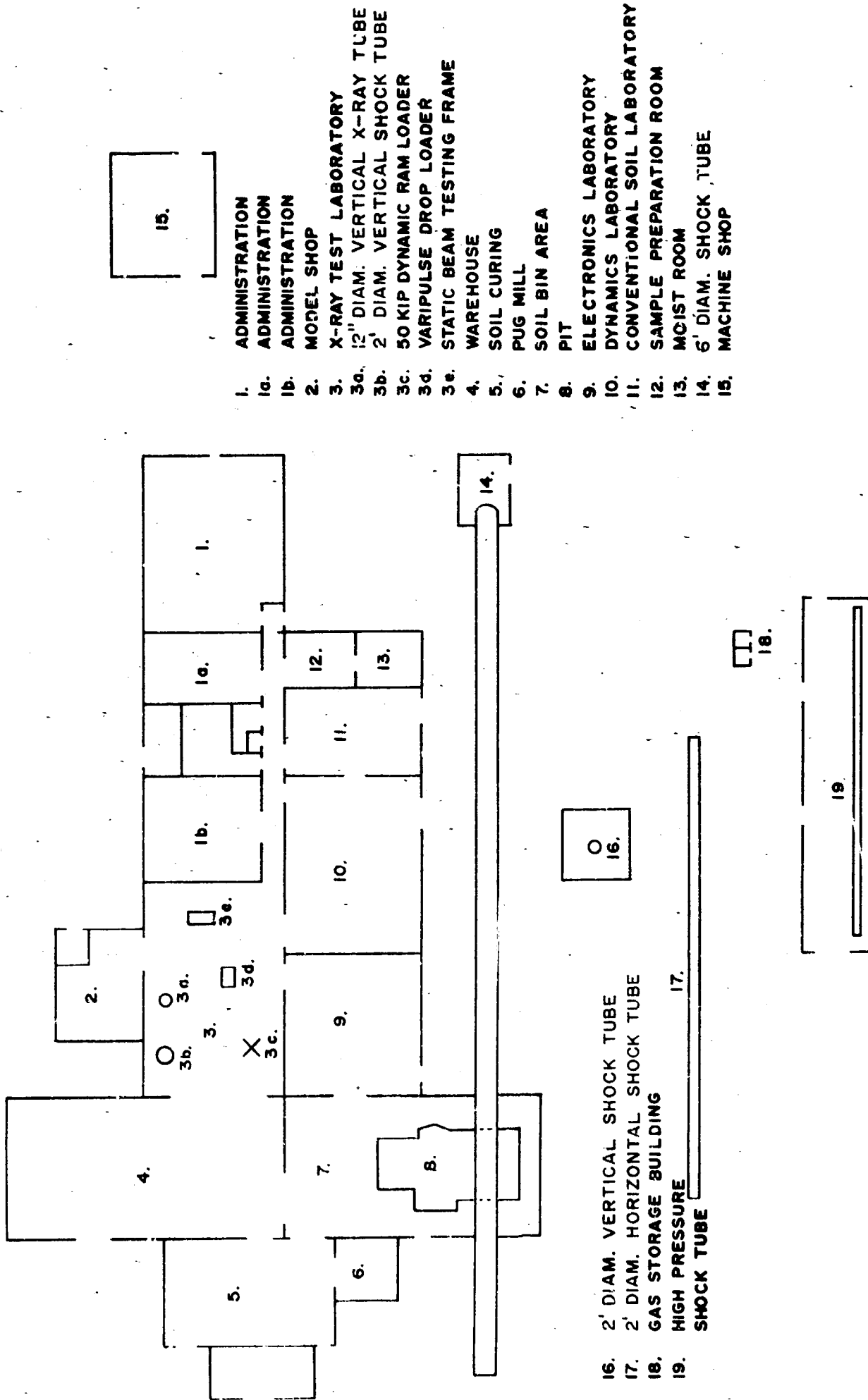

FIGURE 1. BLAST LOAD GENERATOR FACILITY AT THE WATERWAYS EXPERIMENT STATION, VICKSBURG, MISSISSIPPI

AUG 1960



- 1. ADMINISTRATION
- 1a. ADMINISTRATION
- 1b. ADMINISTRATION
- 2. MODEL SHOP
- 3. X-RAY TEST LABORATORY
- 3a. 12" DIAM. VERTICAL X-RAY TUBE
- 3b. 2' DIAM. VERTICAL SHOCK TUBE
- 3c. 50 KIP DYNAMIC RAM LOADER
- 3d. VARIPULSE DROP LOADER
- 3e. STATIC BEAM TESTING FRAME
- 4. WAREHOUSE
- 5. SOIL CURING
- 6. PUG MILL
- 7. SOIL BIN AREA
- 8. PIT
- 9. ELECTRONICS LABORATORY
- 10. DYNAMICS LABORATORY
- 11. CONVENTIONAL SOIL LABORATORY
- 12. SAMPLE PREPARATION ROOM
- 13. MOIST ROOM
- 14. 6' DIAM. SHOCK TUBE
- 15. MACHINE SHOP

- 16. 2' DIAM. VERTICAL SHOCK TUBE
- 17. 2' DIAM. HORIZONTAL SHOCK TUBE
- 18. GAS STORAGE BUILDING
- 19. HIGH PRESSURE SHOCK TUBE

FIGURE 2.
THE ERIC H. WANG CIVIL ENGINEERING RESEARCH FACILITY

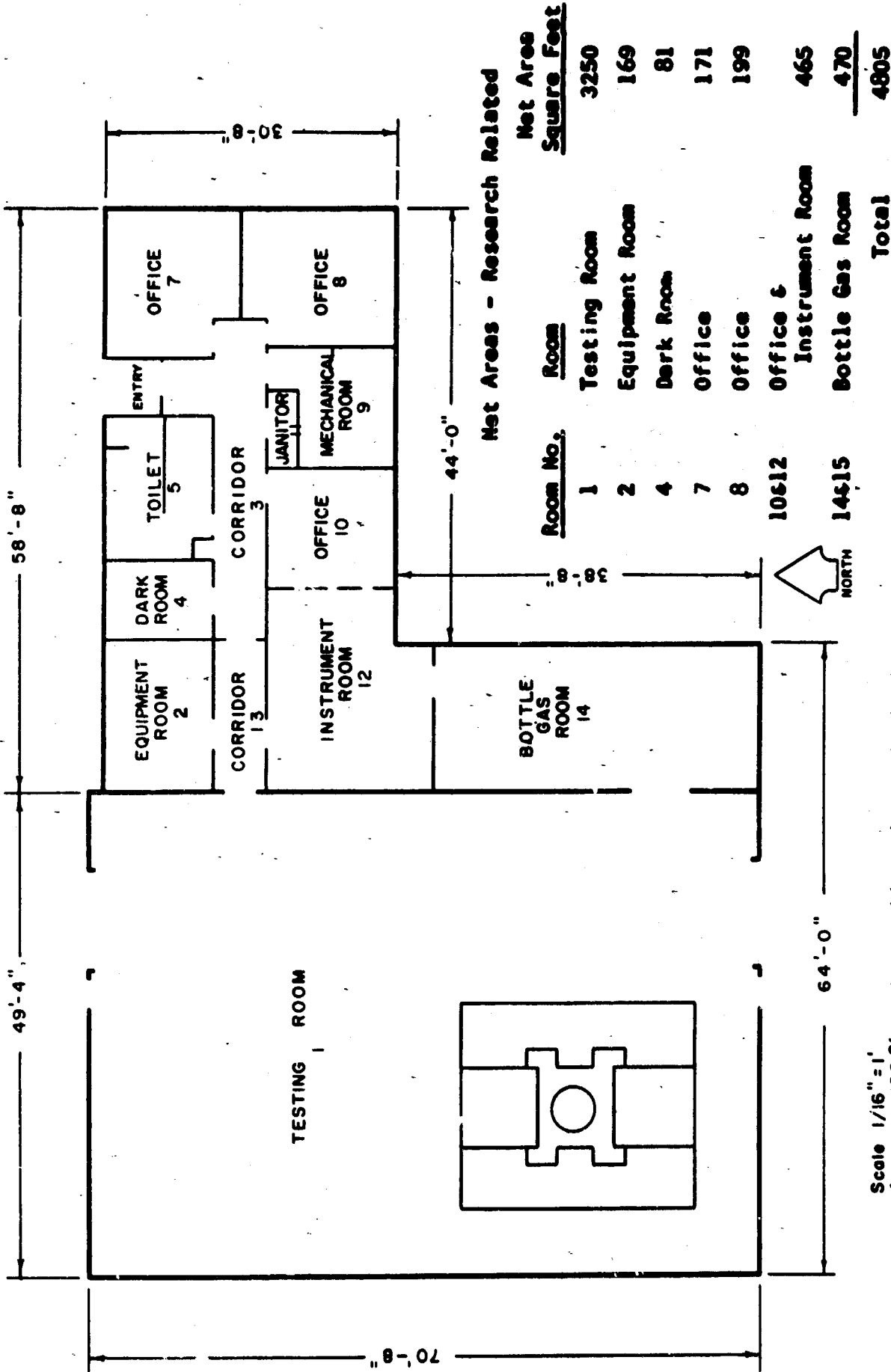
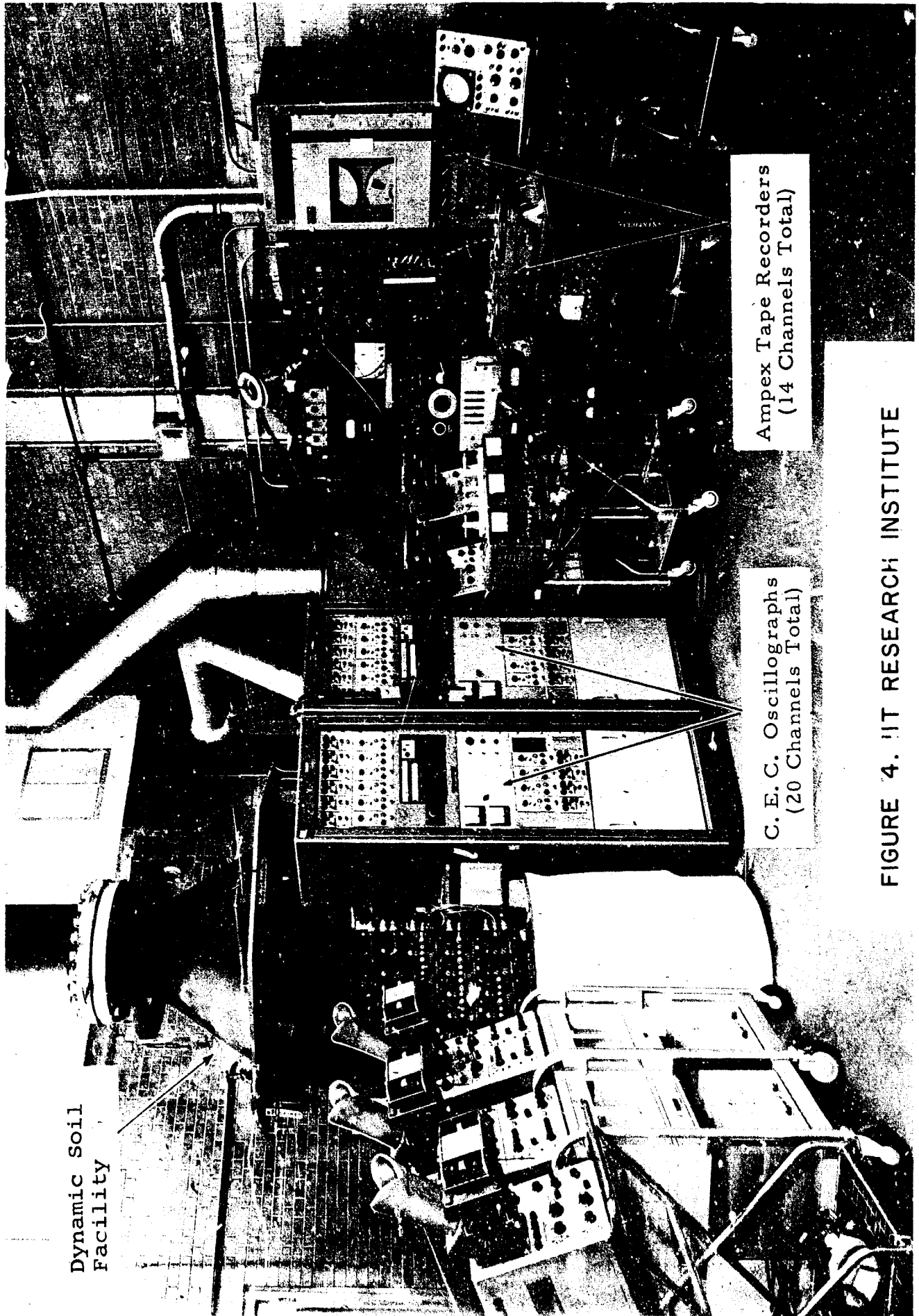

FIGURE 3.
CIVIL ENGINEERING HIGH INTENSITY DYNAMICS TEST LABORATORY
 UNIVERSITY OF ILLINOIS
 URBANA, ILLINOIS
 Revised 5/25/64



Dynamic Soil
Facility

Ampex Tape Recorders
(14 Channels Total)

C. E. C. Oscillographs
(20 Channels Total)

FIGURE 4. IIT RESEARCH INSTITUTE
DYNAMIC SOIL FACILITY

4. Conclusion

The loading devices reported herein are placed in four categories: (a) Ram Loaders, (b) Shock Tubes, (c) Plane Wave Loaders and (d) Miscellaneous

To standardize the presentation of information on the various loading devices, the following format is used: (a) title, location and owner, (b) the loading characteristics and physical description, (c) the driver and controls, (d) availability, (e) a short discussion and (f) the references citing the source of the material.

5. References

- a. Ahlers, E. B., "Experimental Methods of Determining Behavior of Underground Structures under Dynamic Loads," IIT Research Foundation report, November 1961.
- b. Woods, R. D., "Preliminary Design of Dynamic/Static Direct Shear Apparatus for Soils, and Annotated Bibliographies of Soil Dynamics and Cratering," RTD-IDR-63-3050.
- c. DASA Report 1627, "Blast and Shock Simulation Facilities in the United Kingdom, Canada, and the United States," April 1965.

SECTION II

RAM LOADERS

1. TITLE AND/OR TYPE: Air Force-MDI 50-Kip Dynamic Ram Loader
2. LOCATION: Eric H. Wang Civil Engineering Research Facility
Area Y
Sandia Base, New Mexico
3. OWNER: U. S. Air Force
4. LOADING CHARACTERISTICS:
 - a. Force: Minimum (lbs) 100 Maximum (lbs) 50,000
 - b. Rise Time: Adjustable from 1.5 to 50 milliseconds
 - c. Dwell Time: Adjustable from 0 to 1 minute
 - d. Decay Time: Adjustable from 20 milliseconds to 30 seconds
 - e. Constant Velocity: Adjustable from 4 to 750 inch/minute
5. PHYSICAL DESCRIPTION (Figures 5 & 6)
 - a. Height: 139.75 to 144.75 inches
 - b. Width: 88 inches
 - c. Depth: 48 inches
 - d. Weight: 8600 pounds
 - e. Maximum Stroke: 5 inches
 - f. Main Piston Area: 31.25 sq. inches
 - g. Clearance between specimen grips:
14 to 74 inches
 - h. Operating Pressure: 2000 psi
6. DRIVER: Pneumatic-Hydraulic system
7. CONTROLS: A control console which will allow the operator to pre-program the tests within the limitations of the loading characteristics given above.

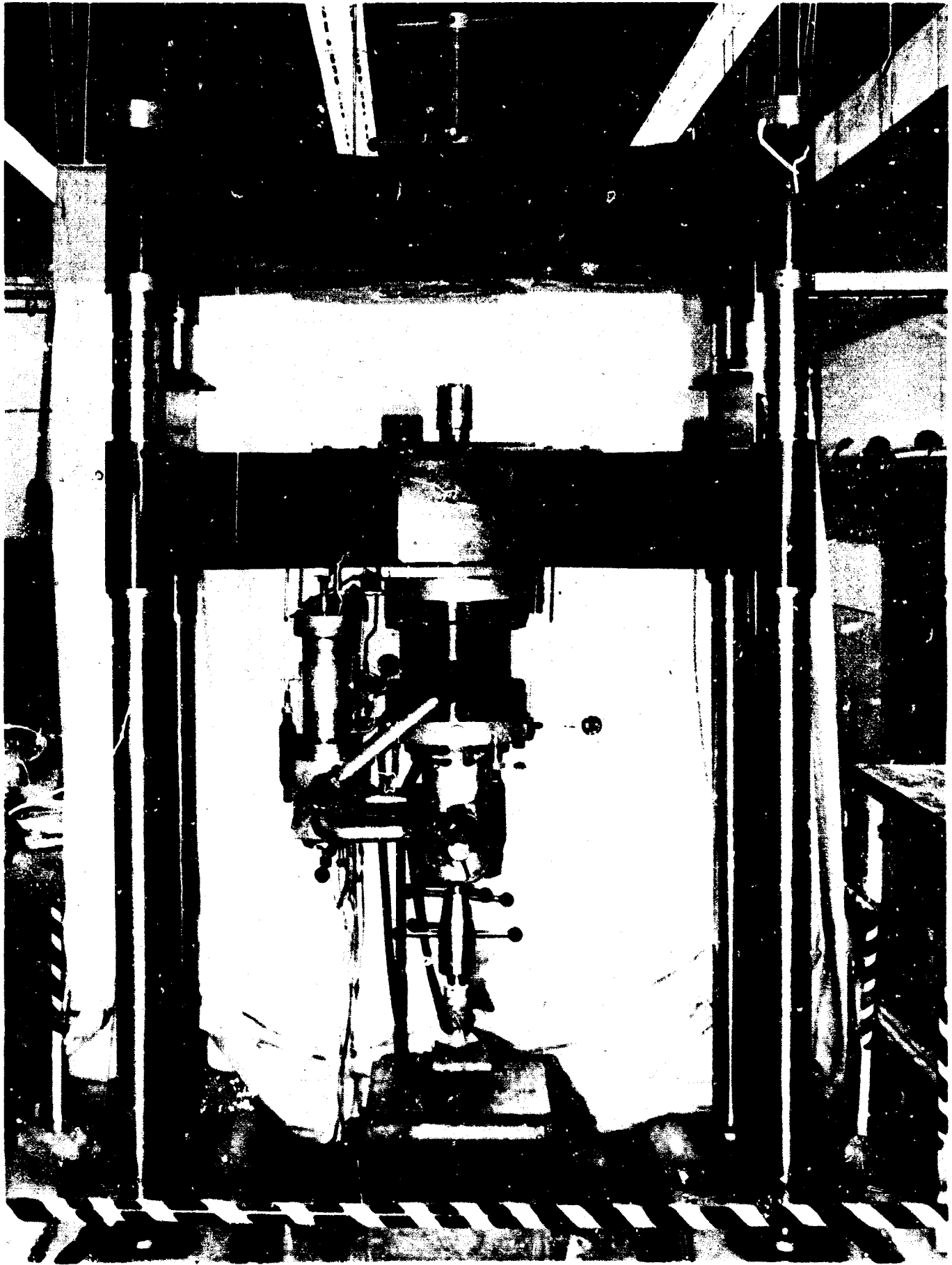
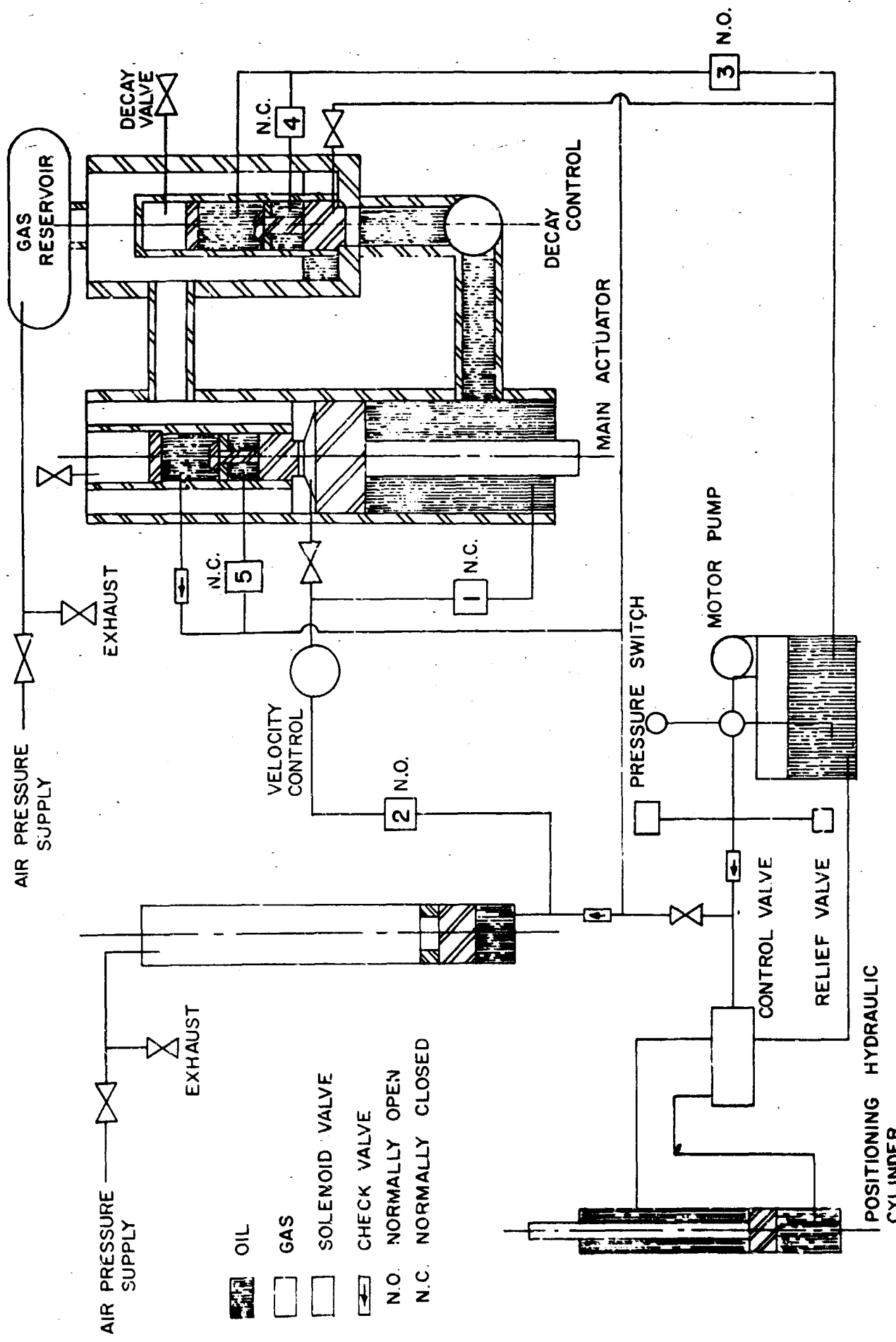

FIGURE 5. AIR FORCE - MDI 50-KIP DYNAMIC RAM LOADER









-  OIL
-  GAS
-  SOLENOID VALVE
-  CHECK VALVE
-  N.O. NORMALLY OPEN
-  N.C. NORMALLY CLOSED

FIG. 6 SCHEMATIC - AIR FORCE MDI 50-KIP DYNAMIC RAM LOADER

8. AVAILABILITY: Available to other government agencies and to contractors of the United States Government on contracts requiring testing within the ram loader limitations. Scheduling is controlled by the Air Force Project Officer and the Director of the Facility.

9. OTHER CONSIDERATIONS: The reaction frame is designed to contain the loader with a maximum column stretch and/or horizontal head deflection of 0.10 inch. Vertical adjustment of the horizontal head is provided in increments of 3/4 of the total ram stroke from 1 foot minimum to a maximum of 6 feet level above the floor. The foundation is so designed that the portion of the foundation supporting a soil bin will be completely isolated from that part of the foundation supporting the reaction frame. The complete foundation is designed that a 3 millisecond minimum delay shall exist between the signal produced upon impact of the ram (to sample) and a return signal traveling through the reaction frame into the foundation and up into the soil bin.

10. DISCUSSION:

This machine is designed for two separate operating modes:

- a. Force-time, tension or compression.
- b. Constant velocity, tension or compression.

Mobile carts, 4 feet wide, 4 feet long and 3 feet deep were designed and manufactured to be used with this machine. This device will be used in the study of dynamic properties of materials. Between the ram loader for dynamic testing and the 300-Kip Riehle Universal Testing Machine for static testing, the laboratory can test all types of materials.

11. REFERENCE:

a. "Design and Construction of a Gas Powered Dynamic Ram Loader Device and Accessories," Project Engineers Contract Folder, Contract AF 29(601)-5805, James A. Mahoney, Project Engineer, Air Force Weapons Laboratory, Kirtland Air Force Base, New Mexico, February 1963.

b. Stewart, William and Yang, Robert, "Instruction Manual-Dynamic Loading Machine," Machine Dynamics Incorporated, 660 So. Arroyo Parkway, Pasadena, California for AFWL-KAFB, New Mexico, Contract AF 29(601)-5805, pages 1, 2, & 3, December 1963.

1. TITLE AND/OR TYPE: Dynamic Triaxial Test Apparatus
2. LOCATION: U. S. Army Engineer Waterways Experiment Station,
Vicksburg, Mississippi
3. OWNER: U. S. Army
4. LOADING CHARACTERISTICS: A rigid yoke moving at constant velocity impacts upon the triaxial cell piston and drives it to axially deform cylindrical soil specimens at constant rates. Particular loading characteristics are as follows:
 - a. Force: Minimum (lb) 1 Maximum (lbs) 1200
 - b. Rise-time: Time to failure of soil specimens variable from 10 msec to 1 sec
5. PHYSICAL DESCRIPTION (Figure 7):
 - a. Height: 6 feet
 - b. Width: 2-1/2 feet
 - c. Depth: 1-1/2 feet
 - d. Operating pressure: 800 psi
 - e. Ram stroke: 4 inches
6. DRIVER: Controlled hydraulic flow under 800-psi gas pressure with yoke velocities ranging from 0.14 to 13.0 inches per sec
7. CONTROLS: Electrically controlled solenoid valves and series of manual valves
8. AVAILABILITY: Testing that is considered within the capabilities of the apparatus may be conducted for other interested agencies on a priority basis. Inquiries should be sent to: Director, U. S. Army Engineer Waterways Experiment Station, P. O. Box 631, Vicksburg, Mississippi 39181.
9. OTHER CONSIDERATIONS: Maximum size of specimen which can be tested is 1.5 inches in diameter by 3.0 inches long. Maximum acceptable sample deformation at a constant deformation rate (between 0.14 and 13 inches per sec) is about 1.5 inches. Confining pressures up to 100 psi can be supplied.

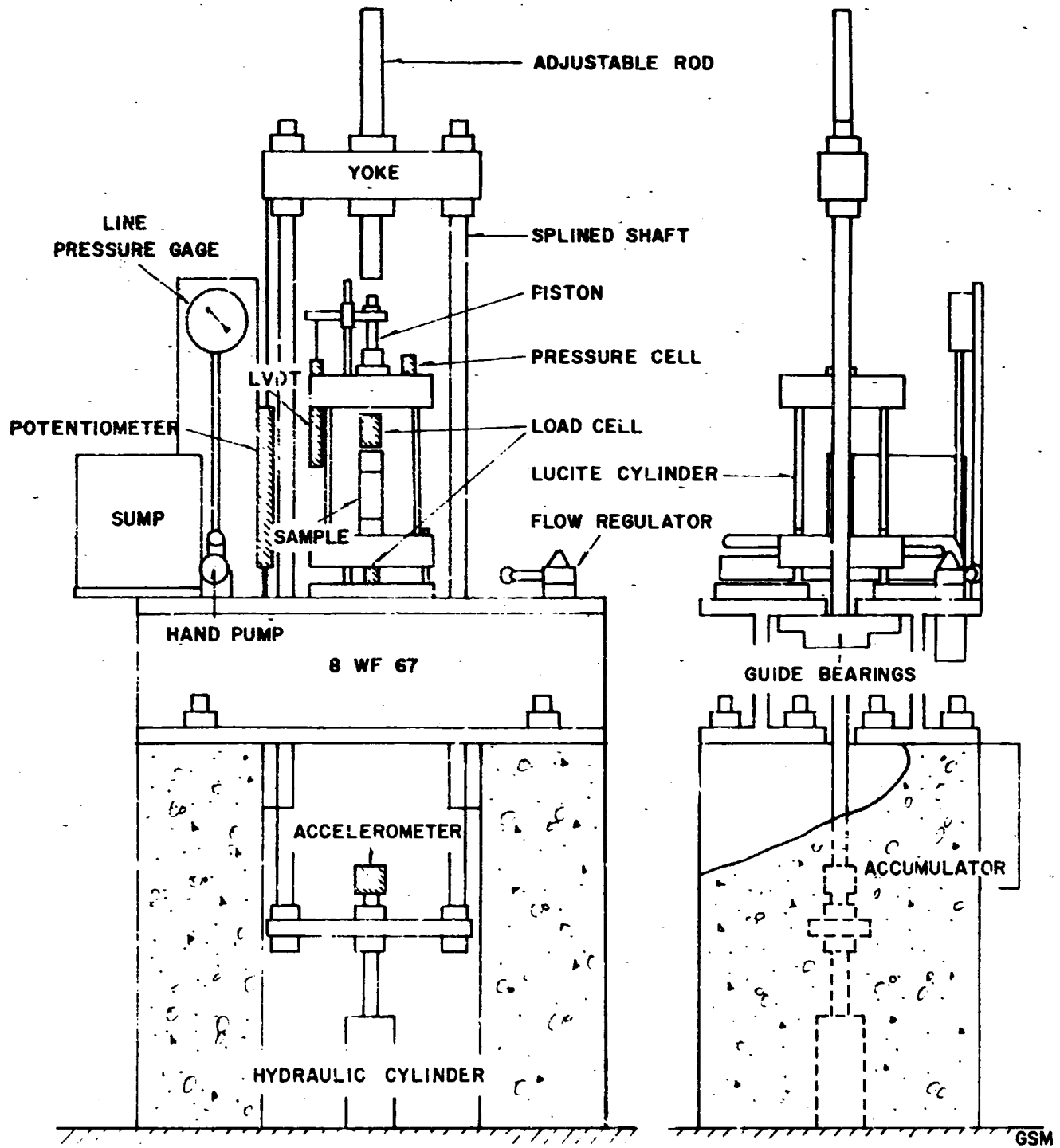

FIGURE 7. DYNAMIC TRIAXIAL TESTING MACHINE
 (SCALE 1" = 10")

10. DISCUSSION: The dynamic triaxial test apparatus provides a means for studying soil properties under loadings much faster than the conventional triaxial test. The test is a strain-controlled-type test. The loads developed and the motion of the piston are measured continuously as a function of time.

11. REFERENCE:

U. S. Army Engineer Waterways Experiment Station, Technical Report No. 3-599, "Dynamic Bearing Capacity of Soils; Report 5, Vertical Displacements of Spread Footings on Clay: Static and Impulsive Loadings," September 1963, Appendix A.

1. TITLE AND/OR TYPE: Dynamic Loading Apparatus (Small Ram)
2. LOCATION: IIT Research Institute
Technology Center
10 W. 35th Street
Chicago, Illinois 60616
3. OWNER: IIT Research Institute
4. LOADING CHARACTERISTICS:
 - a. Force: From 0 to 520 pounds with a 13-msec valve opening
 - b. Rise Time: 2 to 5 milliseconds
 - c. Dwell Time: Variable
 - d. Decay Time: Determined by the length of time the solenoid is actuated; and a sudden decay to zero force (approx. 5 msec) after the hydraulic valve is closed.
5. PHYSICAL DESCRIPTION (Figure 8): The apparatus consists of a nitrogen bottle, capable of delivering 2400 psi; an air pressure regulator; and an air accumulator; a hydraulic accumulator; a solenoid operated hydraulic valve; and a hydraulic cylinder.
6. DRIVER: Nitrogen and hydraulic system
7. CONTROLS: A Barksdale a-c. solenoid, 3-way valve
8. AVAILABILITY: Contact address above for inquiry
9. OTHER CONSIDERATIONS: Test frame allows the ram to be used both in an inclined position as well as vertical. This apparatus might well be considered a portable loading device. The Armour Glass Box and 4-foot-square soil bin are just two of the many accessories that can be utilized with this ram loader.
10. DISCUSSION: This device has been used in the study of soil-structure interaction for buried structures. The apparatus has been used in conjunction with a large circular soil bin for footing tests and an analytical and experimental investigation of the axial loadings of silo linings generated by skin friction effects at the structure-soil interface. One study for the Structures Branch of the Air Force Weapons Laboratory gave the initial impetus for the development of this device. The study was called "Design and Analysis of Foundations for Protective Structures." It is planned to use this device in a future study of the soil-related dynamic problems of fluidization.

DYNAMIC APPARATUS

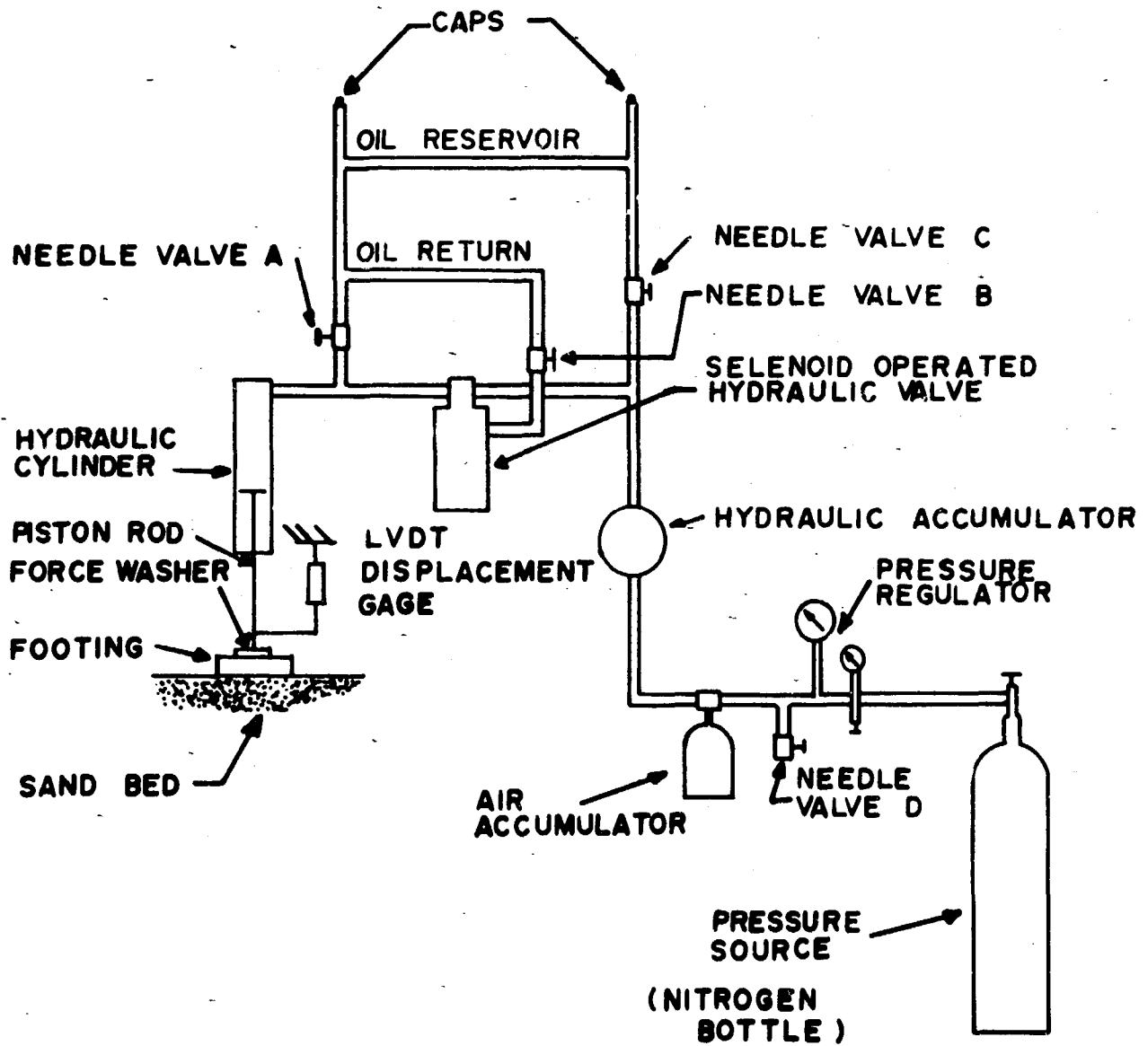

FIGURE 8. SCHEMATIC DYNAMIC LOADING APPARATUS (SMALL RAM)

L.H.H.

11. REFERENCES:

a. Shenkman, S., and McKee, K. E., "The Armour Research Foundation Dynamic Soil Facility," Armour Research Foundation Pamphlet, pages A-6, A-7, A-12 and A-13, 7 December 1961.

b. McKee, K. E., "Design and Analysis of Foundations for Protective Structures," Appendix A., AFSWC-TN-61-14, Armour Research Foundation, Chicago, May 1961.

1. TITLE AND/OR TYPE: Dynapak Loading Machine
2. LOCATION: U. S. Army Engineer Waterways Experiment Station,
Vicksburg, Mississippi
3. OWNER: U. S. Army
4. LOADING CHARACTERISTICS: Machine applies controlled static and impulsive driving forces to a vertical load column. Specimen loadings are the combined result of the driving force and the inertia force generated by the load-column assembly (minimum weight approximately 160 lbs) as the specimen deforms. Characteristics of the impulsive driving forces are as follows:
 - a. Force: Minimum (lbs) 500 Maximum (lbs) 50,000*
 - b. Rise Time: Variable between 3 and 150 msec
 - c. Dwell Time: Variable between 0 and several hours
 - d. Decay Time: Variable between 20 msec and 10 sec
5. PHYSICAL DESCRIPTION (Figures 9, 10, & 11): Specimen clearances are governed by height between bottom of load column and floor (variable between 4-1/2' and 51 inches) and width between support columns (8 feet).
6. DRIVER: Gas pressure applied to either side of load collar surrounding a 4-inch-diam load column. Ram stroke limited to 6 inches, but it must be stopped by specimen resistance.
7. CONTROLS: Prepressurization of various chambers with electrically sequenced gas flow to control magnitude and shape of axial driving force.
8. AVAILABILITY: The Dynapak loading machine is normally scheduled for fulltime use on Waterways Experiment Station testing programs; however, testing that is considered to be within the capabilities of the loader may be conducted for other interested agencies on a priority basis. Inquiries should be sent to: Director, U. S. Army Engineer Waterways Experiment Station, P. O. Box 631, Vicksburg, Mississippi 39181.

* Loads up to 42,000 lbs have been applied to a large 3-ft-square footing. Normally, the machine is not used to apply loads over 25,000 to 30,000 lbs. Test specimens which rupture cannot be tested unless provisions can be made to provide sufficient resistance to arrest the load-column movement before the end of its 6 inch stroke.

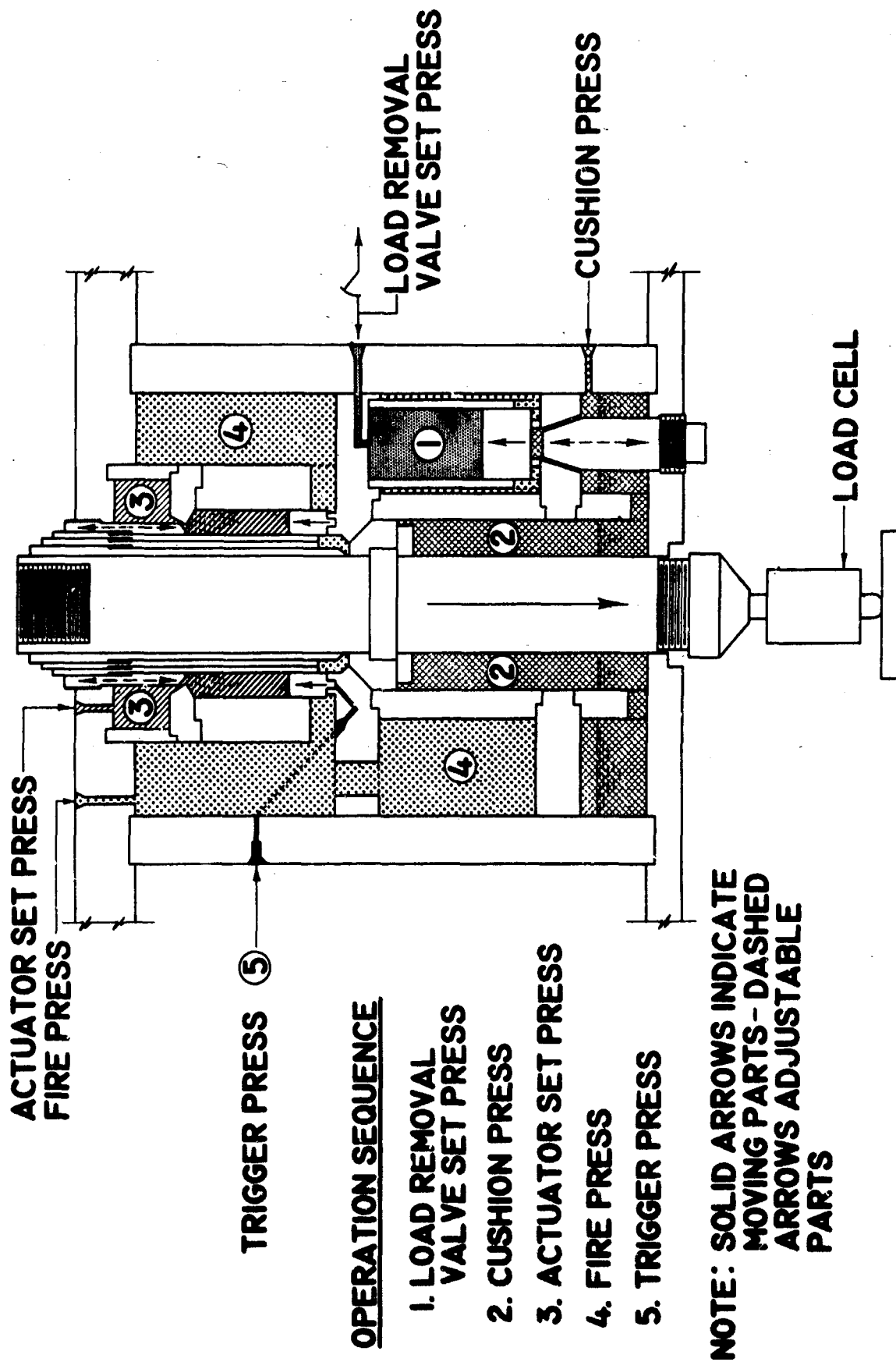

FIGURE 9. SCHEMATIC DRAWING OF LOAD ACTUATOR

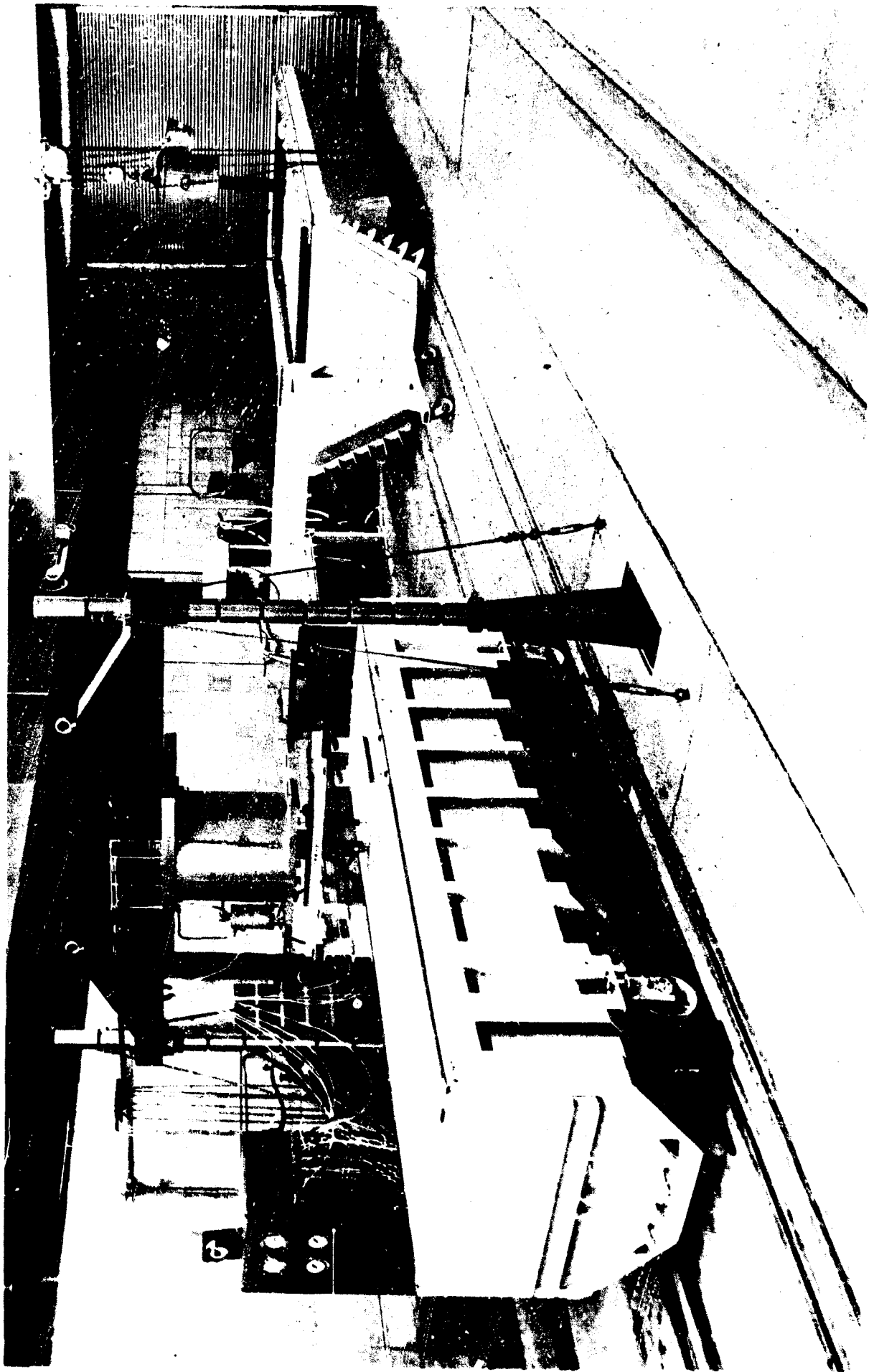

FIGURE 10. WES DYNAPAK LOADING MACHINE

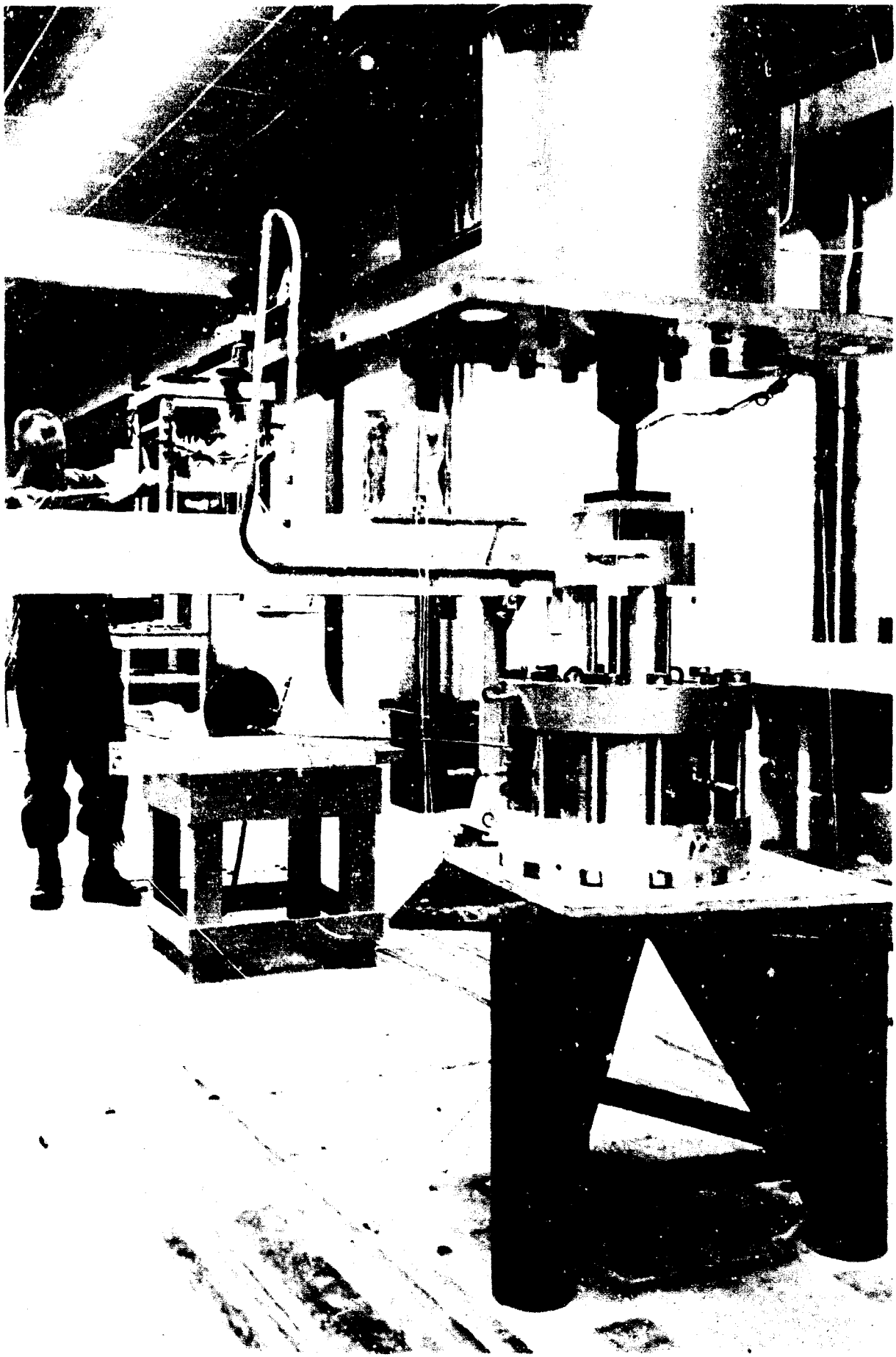

FIGURE II. WES DYNAMIC TRIAXIAL TEST APPARATUS

9. OTHER CONSIDERATIONS: Mobile soil carts are available to contain prepared soil specimens (fig. 10). The carts are mounted on tracks running beneath the loading machine. The inside dimensions of the carts are as follows: First-type cart: 3 feet 4 inches wide at the top, 3 feet deep, 11 feet 10 inches long, with a volume of 108 cubic feet. Second-type cart: 7 feet 2 inches wide at the top, 3 feet deep, 21 feet 6 inches long, with a volume of 340 cubic feet.

A thick-walled one-dimensional compression testing device (fig. 11) has been designed and fabricated which can be used with the Dynapak loader to produce uniformly distributed, controlled pressure pulses of up to about 3000 and 500 lbs psi on specimens 4 and 10 inches in diameter, respectively.

10. DISCUSSION: The Dynapak has been used to conduct model tests on small-scale footings resting on carefully prepared clay specimens. This was the first of a series of tests to be conducted using the principles of similitude to gain the capability of predicting the dynamic displacement response of prototype foundations subjected to nuclear blast loadings. These same principles are presently being applied to a series of small-scale footings buried in carefully prepared sand specimens.

11. REFERENCES:

a. U. S. Army Engineer Waterways Experiment Station, Vicksburg, Miss., Technical Report No. 3-599, "Dynamic Bearing Capacity of Soils; Report 1, Dynamic Loading Machine and Preliminary Small-Scale Footing Tests," June 1962, pp vii, 2, 6-8.

b. U. S. Army Engineer Waterways Experiment Station, Vicksburg, Miss., Technical Report No. 3-599, "Dynamic Bearing Capacity of Soils; Report 2, Dynamically loaded Small-Scale Footing Tests on Dense Sand," in publication.

c. U. S. Army Engineer Waterways Experiment Station, Vicksburg, Miss., Technical Report No. 3-599, "Dynamic Bearing Capacity of Soils; Report 3, The Application of Similitude to Small-Scale Footing Tests," December 1964, Appendix B.

d. U. S. Army Engineer Waterways Experiment Station, Vicksburg, Miss., Technical Report No. 3-599, "Dynamic Bearing Capacity of Soils; Report 4, Investigation of a Dimensionless Load Displacement Relation for Footings on Clay," in publication.

1. TITLE AND/OR TYPE: Earth Shock Tube/Hyge Shock Tester
2. LOCATION: Atlantic Research Corporation
Alexandria, Virginia
3. OWNER: U. S. Army
4. LOADING CHARACTERISTICS:
 - a. Type Wave: Step input can be varied with choice of various metering pins
 - b. Pressure: Minimum(psi) 0 Maximum(psi) approximately 500 psi
 - c. Force: Minimum (lbs) 0 Maximum (lbs) 40,000 static
 - d. Rise Time: 2 - 3 milliseconds
 - e. Dwell Time: With Step input usable dwell time of about 40 milliseconds
 - f. Decay Time: Depends on soil relaxation. Essentially soil remains loaded until the Hyge Shock Tester is reversed.
5. PHYSICAL DESCRIPTION (Figures 12 & 13): The device consists of a Hyge Shock Tester as manufactured by Consolidated Electrodynamics Corp. supported by structural members and a hydraulic jacking system which raises and lowers the shock tester. This rests on a massive foundation consisting of approximately 800 cubic feet of reinforced concrete. A three foot diameter formed hole, ten feet deep is located at the middle of the ten feet squared foundation. A ten foot long, ten inch I. D. shock tube is securely fastened and centered in this hole. When the tube is filled with some type soil medium a circular steel plate called a "Piston" is placed on the soil. Between the ram of the Hyge Shock Tester and the piston is a BLH load cell. The shock tube is triggered and the stroke of the ram pushes the load cell and piston into the upper portion of the soil creating a shock.
6. DRIVER: Pneumatic-Hydraulic System
7. AVAILABILITY: Contact Mr. Bernard P. Polanin at Atlantic Research Corporation, Alexandria, Virginia.
8. REFERENCE:

Polanin, B.P., and Bryant, R. C., "Design and Instrumentation of an Earth Shock Tube - Progress Report No. 7" Atlantic Research Corporation, Alexandria, Virginia, pages 1, 2, 3, and Figure 1, 9 February 1961.

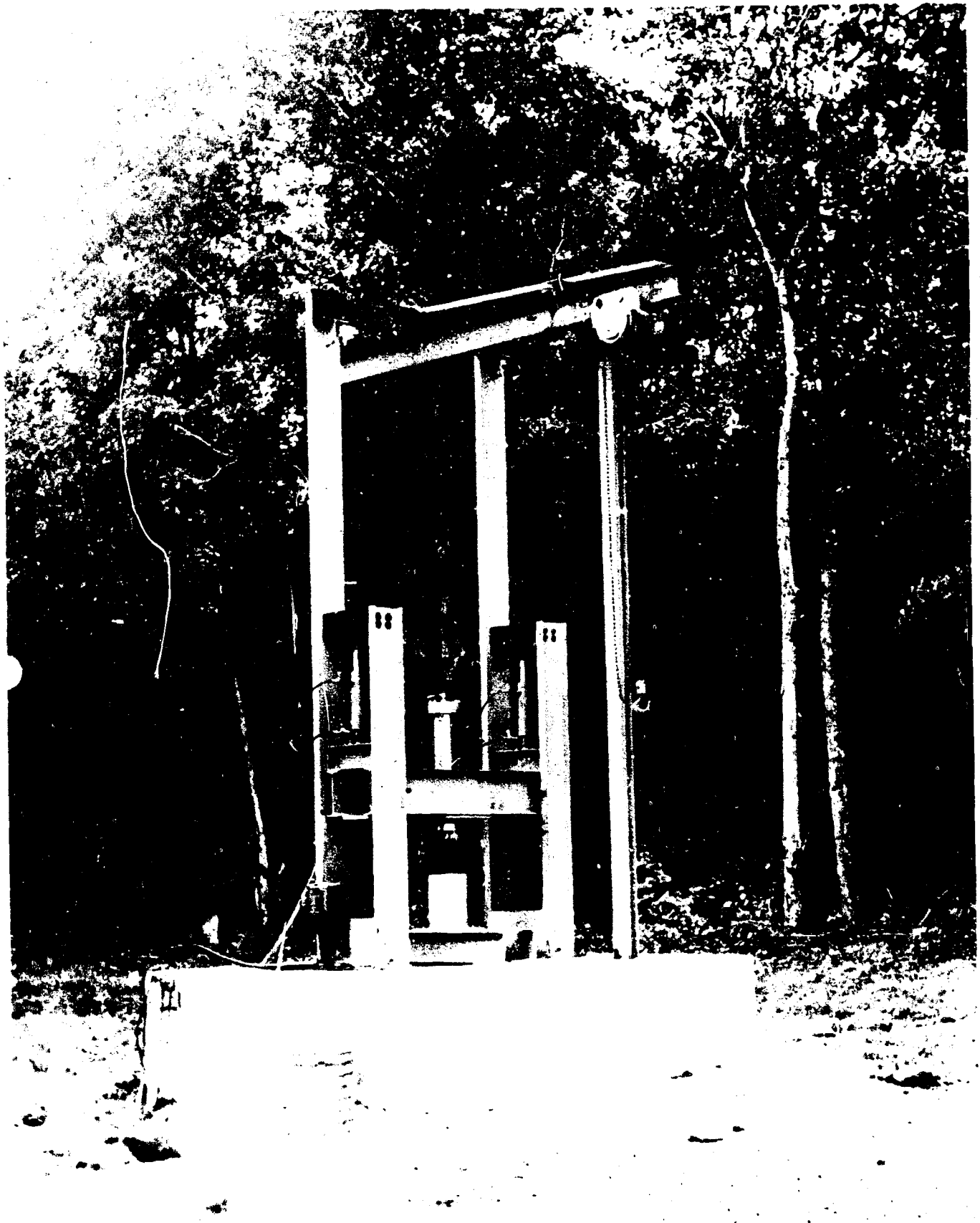

FIGURE 12. EARTH SHOCK TUBE

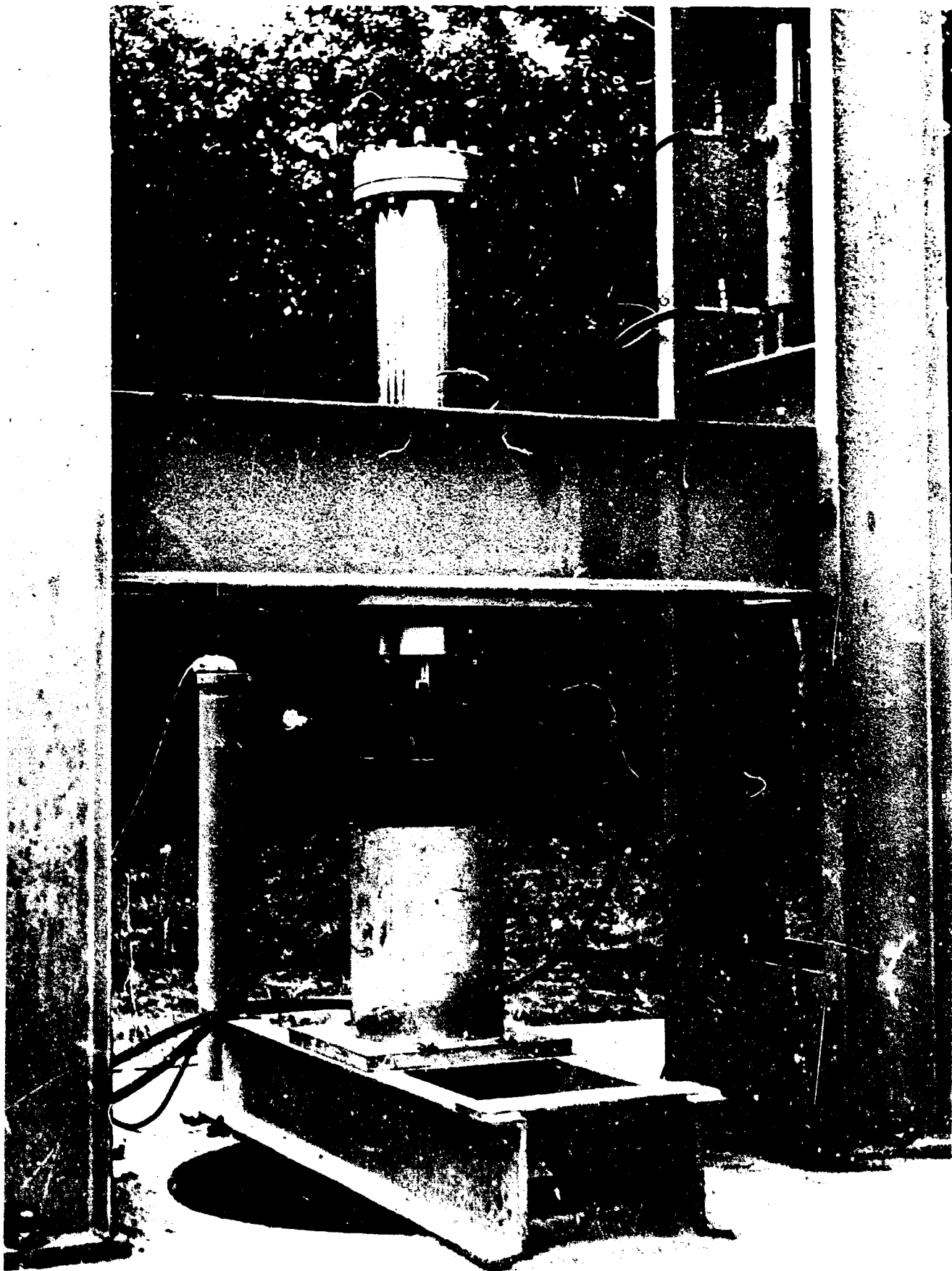

FIGURE 13. CLOSE UP SHOWING THE HYGE SHOCK TESTER

1. TITLE AND/OR TYPE: MDI Model DM 4-50 Dynamic Material Evaluation Machine
2. LOCATION: U. S. Naval Civil Engineering Laboratory
Port Hueneme, California 93041
3. OWNER: U. S. Navy
4. LOADING CHARACTERISTICS:
 - a. Force: Minimum (lbs) 0 Maximum (lbs) 50,000
 - b. Rise Time: Adjustable from 2 to 200 milliseconds
 - c. Dwell Time: Adjustable from 0 to 2 seconds
Constant Head Velocity Range: 3 to 1800 inches/minute
 - d. Constant Strain Rate: 0.02 to 1.5 inches/inch/second on a
2 inch gauge length specimen
5. PHYSICAL DESCRIPTION (Figures 14 & 15):
 - a. Height: 126 inches
 - b. Width: 52 inches
 - c. Depth: 21 inches
 - d. Weight: 2,500 pounds
 - e. Clearance between Specimen Grips: 2X2X2 feet
 - f. Grip Adjustable Distance: 18 inches
 - g. Total Stroke: 4 inches
 - h. Operating Pressure: 300 to 2600 psi
6. DRIVER: Hydraulic and compressed air system
7. CONTROLS: Control console
8. AVAILABILITY: Available by scheduled arrangement
9. OTHER CONSIDERATIONS: The machine is capable of either tension or compression testing. An environmental chamber capable of maintaining temperature at $\pm 2F$ from room temperature to $-100F$ is provided.

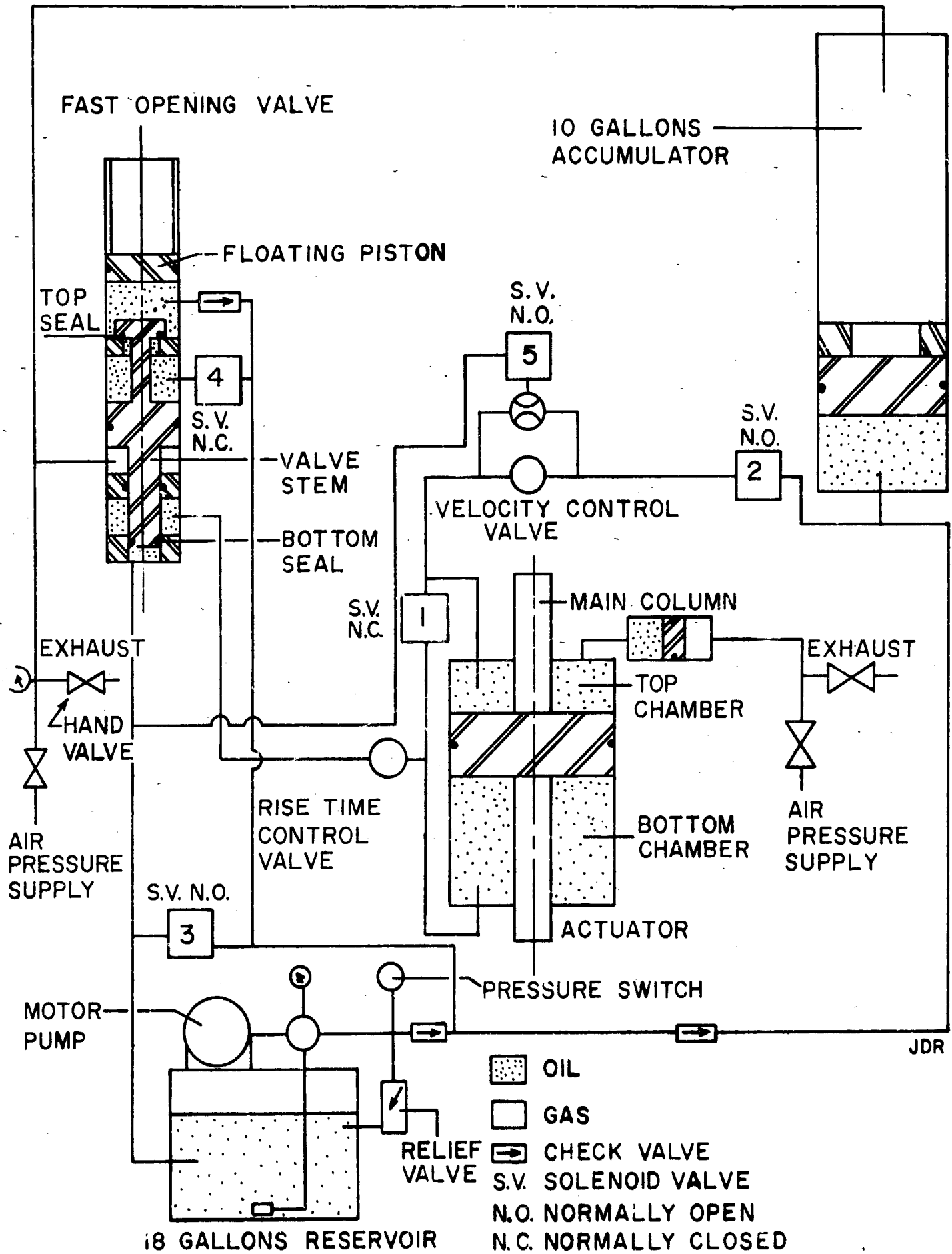

FIGURE. 14 SYSTEM SCHEMATIC MDI MODEL DM 4-50 DYNAMIC MATERIAL EVALUATION MACHINE

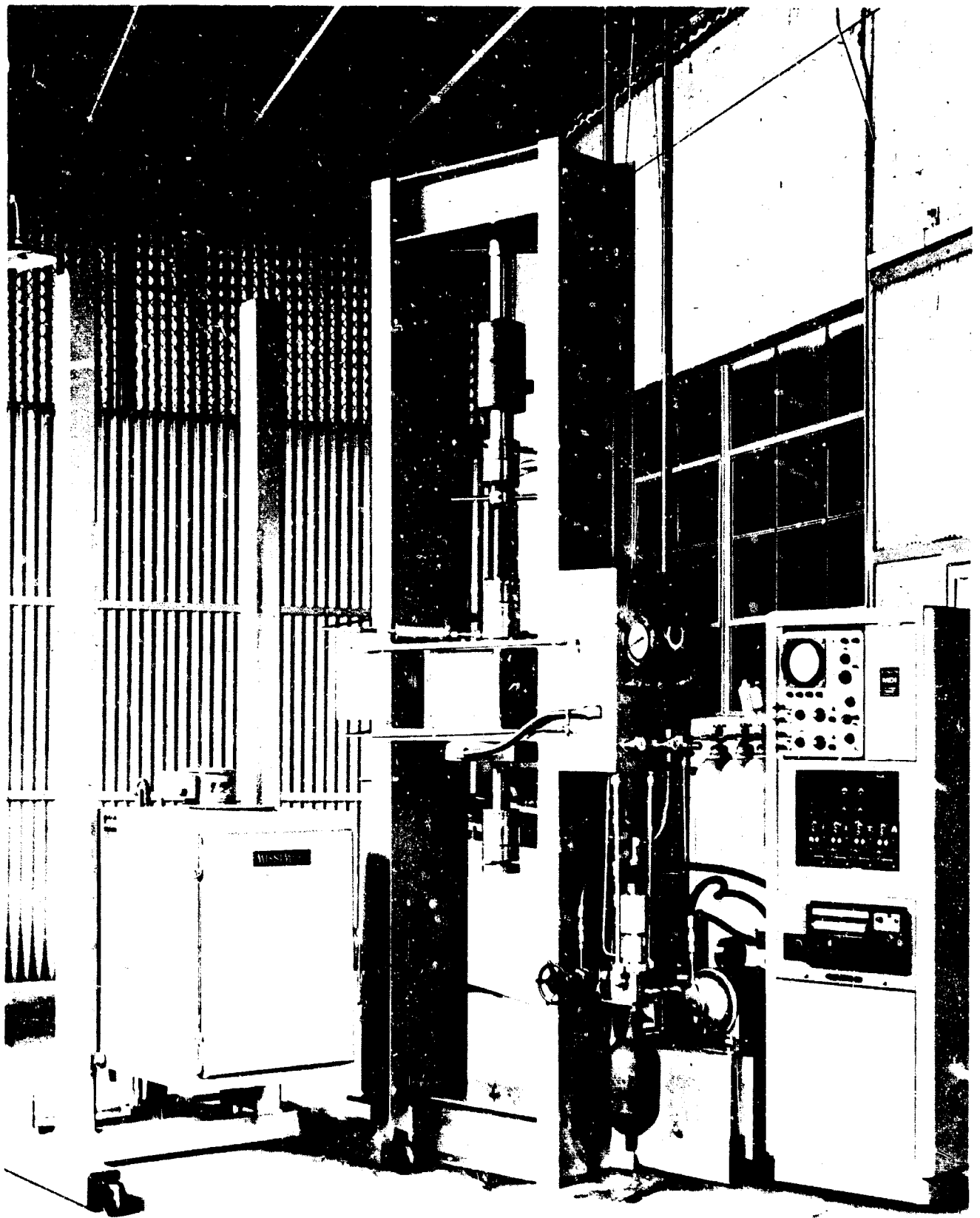

FIGURE 15 MDI MODEL DM4-50 DYNAMIC MATERIAL EVALUATION MACHINE

10. DISCUSSION: The machine is used to determine the dynamic properties of basic materials, such as, determination of the variation in certain parameters such as the increase in yield stress when certain materials are subject to blast-type loads.

11. REFERENCES:

a. "Progress Report for FY 1963 on Tasks Pertaining to Protective Structures," U. S. Naval Civil Engineering Laboratory, page 20, July 1963.

b. "Schedule NBY-32212," Specifications for purchase of the Dynamic Material Evaluation Machine, Page 3, undated.

c. "Machine Dynamics Incorporated Instruction Manual; Model No. DM 4-50 Dynamic Material Evaluation Machine, pages 1, 2, and 9, undated.

d. "NCEL Dynamic Testing Machine:, Technical Report R-331 by W. L. Cowell, U. S. Naval Civil Engineering Laboratory, 30 October 1964.

1. TITLE AND/OR TYPE: 60-Kip Capacity Ram Loader (1, 2, & 3)
2. LOCATION: University of Illinois
Attn: Prof. George K. Sinnamon
Talbot Laboratory
Urbana, Illinois
3. OWNER: No. 1 and No. 2 U. S. Air Force (Contract AF 33(616)-170, Supplemental Agreement S9(55-102), No. 3 University of Illinois
4. LOADING CHARACTERISTICS:
 - a. Pulseload: A load having any selected value up to 62,800 pounds can be applied, either slowly or rapidly. For a compressive loading, approximately 70 percent of the load acts at the end of an 18 inch stroke or approximately 80 percent at the end of a 12 inch stroke.
 - b. Rise Time: For a compressive loading using nitrogen as the pressure source the rise time will range between 5 & 18 milliseconds depending upon the pressure and piston position. For helium the compressive load rise time will range between 3 and 8 milliseconds.
 - c. Dwell Time: Adjustable from a true peak with zero dwell to many hours
 - d. Decay Time: The time varies with the gas used as a driver from approximately 5 to 43 milliseconds and is controllable between this range.
5. PHYSICAL DESCRIPTION (Figures 16, 17, & 18): This machine consists of a main piston assembly, slide valve chamber assemblies, and trigger assemblies. In addition, large 36 inch O.D. cylinders are clamped and sealed around each of the slide valve chambers to act as storage chambers into which the gas discharges when the machine is used in the explosion mode or as high pressure storage chambers when the implosion mode of operation is utilized.
6. DRIVER: Nitrogen and/or helium
7. CONTROLS: Controls are in a room isolated from the firing area. This room controls the distribution valves for gas loading the devices, firing switch, gas storage, and instrument recording apparatus.
8. AVAILABILITY: Arrangements for use may be made by contacting Professor George K. Sinnamon, Civil Engineering Department, Talbot Laboratory, University of Illinois, Urbana, Illinois.

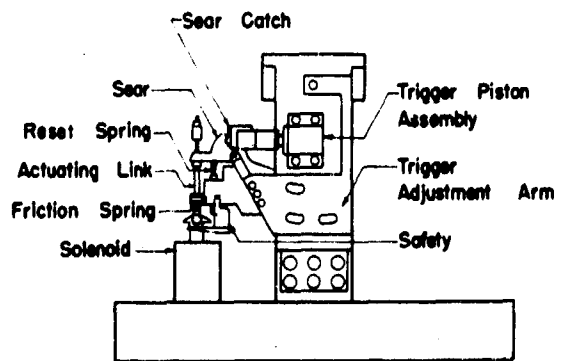
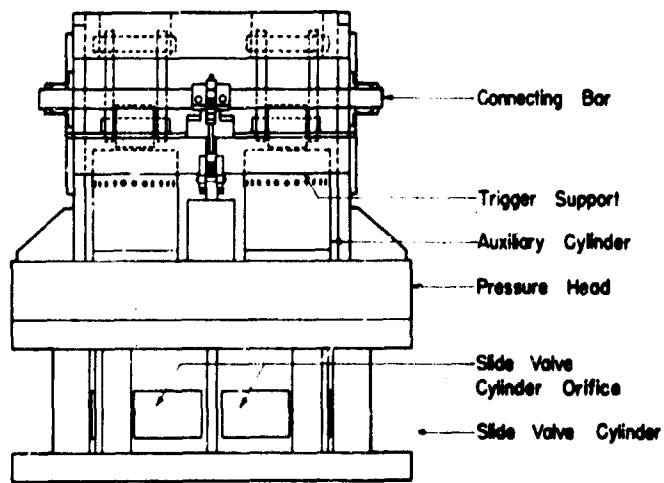

SIDE VIEW OF TRIGGER MECHANISM

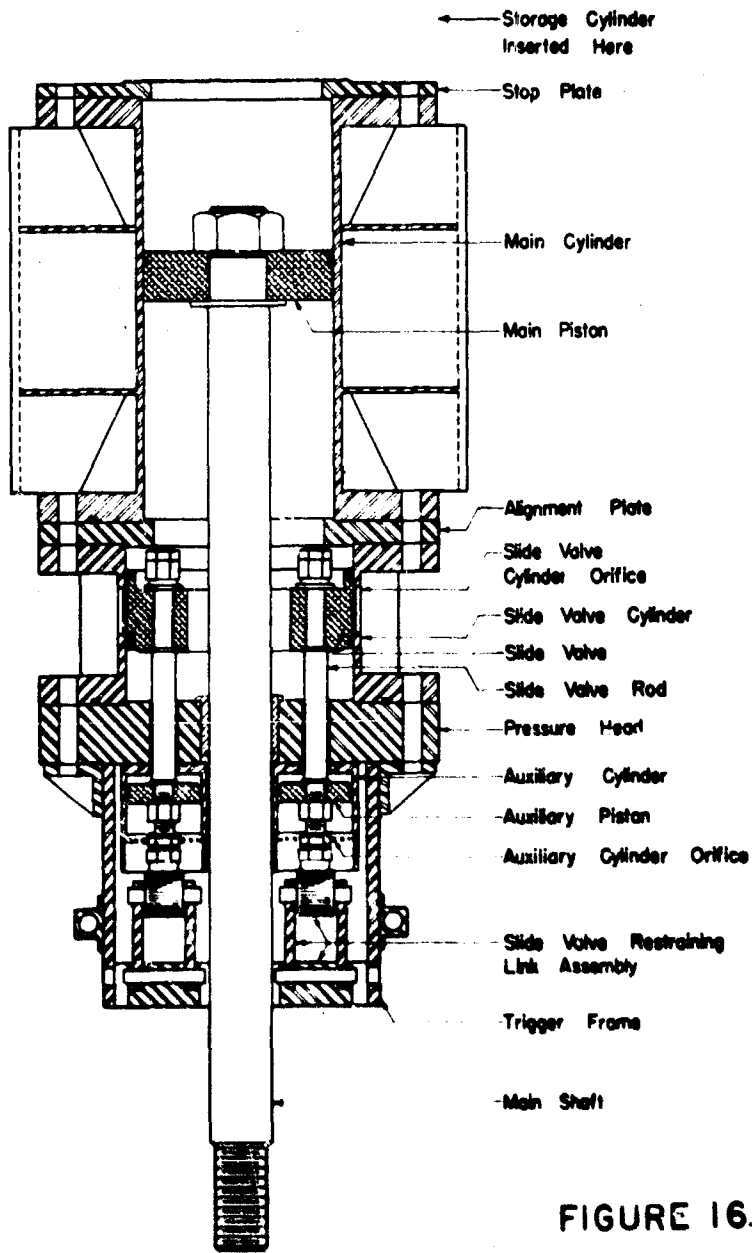

SECTION A-A

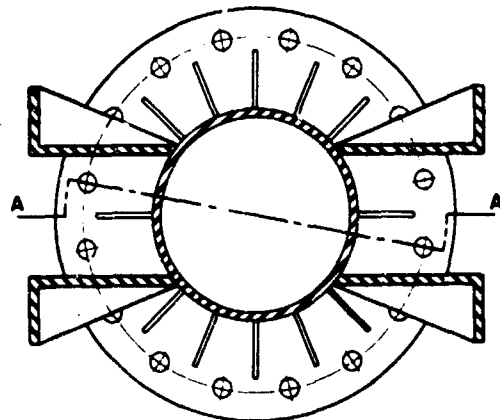

SECTION THROUGH MAIN CYLINDER



FIGURE 16.
60 KIP PULSE LOADING MACHINE

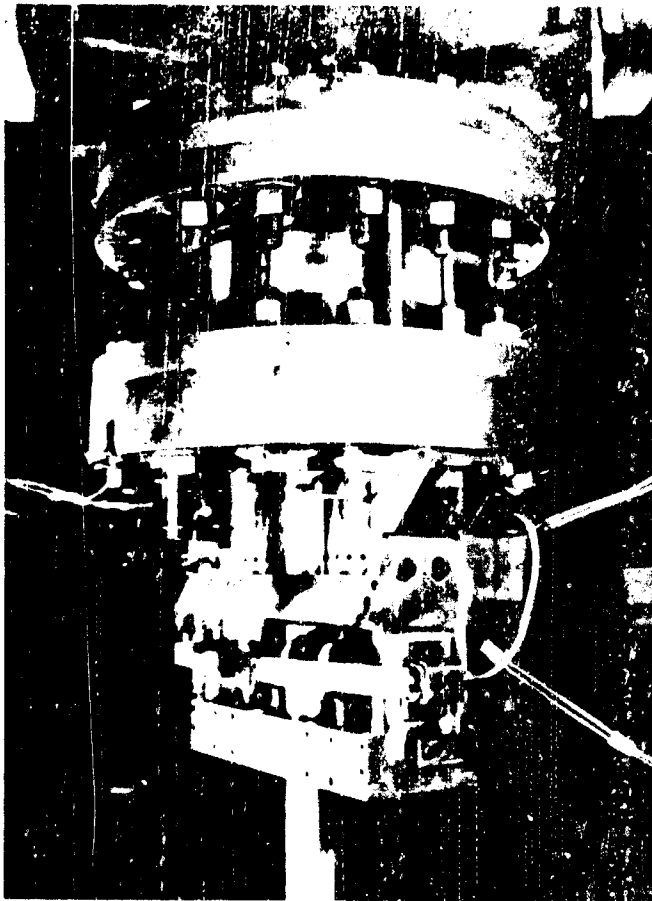

Trigger Assembly in
Ready Position

Trigger Assembly in
Fired Position



FIGURE 17. TWO POSITION CLOSE UP
OF 60-KIP PULSE LODER
TRIGGER ASSEMBLY

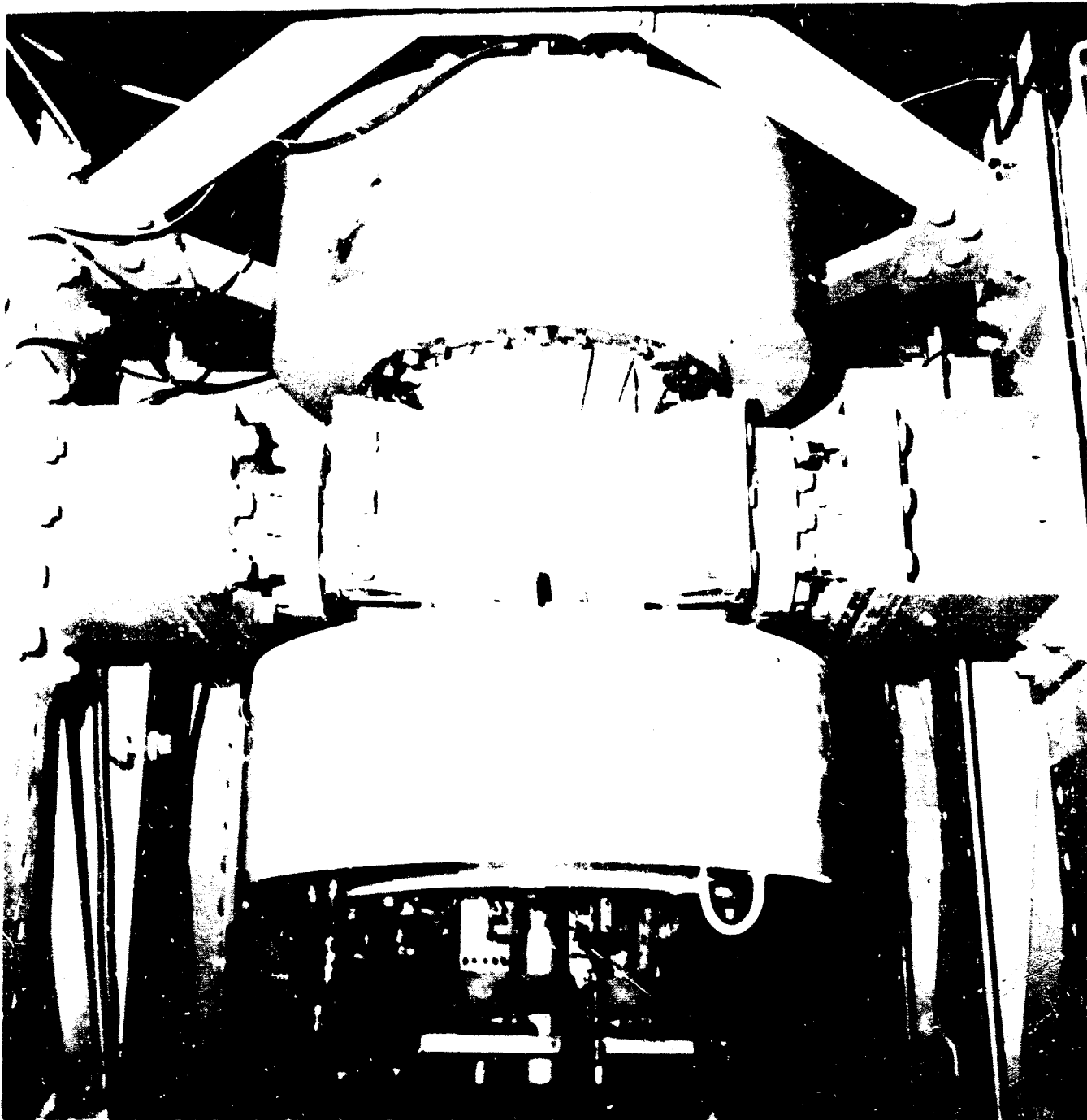

FIGURE 18 60-KIP PULSE LOADING MACHINE
■ 1 CLOSE UP

9. OTHER CONSIDERATIONS: Machines 1 and 2 have recently been modified to have operational characteristics and physical appearance of machine No. 3. These modifications have been accomplished after Professor Egger wrote his report listed as reference one. However, 1 and 2 can be still operated as described in the referenced report.

10. DISCUSSION: The design of these machines was based upon a 20 Kip Pulse loading device designed by J. M. Massard for the University of Illinois. Larger machines were needed to obtain dynamic tests of structures and structural components.

11. REFERENCES:

a. Ahlers, E. B., "Experimental Methods of Determining the Behavior of Underground Structures Under Dynamic Loads," for Office of Civil & Defense Mobilization (OCDM) Battle Creed, Michigan, Armour Research Foundation, Technology Center Chicago 16, Illinois.

b. Sinnamon, George K., & Newmark N. M., "Facilities for Dynamic Testing of Soils," Reprint from Symposium on Soil Dynamics Special Technical Publication No. 305, American Society for Testing and Materials, 1961, Civil Engineering Studies, Structural Research Series No. 244, University of Illinois, Urbana, Illinois, pages 39, 40 and 41, June 1961.

c. Egger, W., "60 Kip Capacity Slow or Rapid Loading Apparatus," Structural Research Series No. 158, University of Illinois, Urbana, Illinois for Research Directorate, A. F. Special Weapons Center, ARDC, Contract AF 33(616)-170, pages 1, 2, 6, 7, 8 and 9.

1. TITLE AND/OR TYPE: University of Illinois 7-Kip Pneumatic-Hydraulic Loading Machine
2. LOCATION: University of Illinois
Attn: Prof. George K. Sinnamon
Talbot Laboratory
Urbana, Illinois
3. OWNER: Defense Atomic Support Agency Contract AF 29(601)-5535
4. LOADING CHARACTERISTICS:
 - a. Type: Loader Combination, Hydraulic-Pneumatic Ram Loader
 - b. Force:
 - (1) Loading Machine, Pneumatic
 - (a) Valve chamber pressures - 400 psi
 - (b) Main chamber
 - 1 3/4" thick piston, 1" travel, maximum pressure 700 psi, maximum load approximately 6.7 kips
 - 2 1" thick piston, 0.8" travel, maximum pressure 1000 psi, maximum load approximately 9.6 kips
 - (2) Loading Machine, Hydraulic
 - (a) Valve chamber pressures - 400 psi
 - (b) Main chamber maximum pressure - 640 psi, maximum load approximately 6.1 kips, 1" travel
 - (c) Rate of movement approximately 330 inches/sec to .3 inches/min
 - (3) Triaxial Cell
 - (a) Sample size - 1-1/2 inches in diameter by 3 or 3-1/4 inches long
 - (b) Maximum cell pressure - 1500 psi. (The triaxial cell itself will withstand pressures as high as 3000 psi; however, the O-ring seals should be carefully inspected after each test at pressures above 1500 psi).

(c) Load cell capacity is sufficient for triaxial tests run at confining pressures up to 1000 psi and axial pressures of 4000 psi.

(d) Maximum piston travel - 1-1/2 inches

5. PHYSICAL DESCRIPTION (Figures 19, 20, 21, & 22):

a. Height: Overall, including triaxial cell apparatus 5'-6"

b. Width: 1'-6" approximately

c. Depth: 1'-6" approximately

d. See 4b above.

6. DRIVER: Gas with or without hydraulic speed control.

7. CONTROLS: The operation of the loading machine is dependent on three fast opening valves, the main valve, oil valve, and decay valve (see the drawing of the hydraulic circuit and the assembly drawing of the machine.) Although opening each of these valves produces a different net machine output, they all operate in exactly the same manner.

The valves are designed so that pressure on the upstream side of the port cannot produce a net force in the direction of the longitudinal axis of the valve. The motivating force is provided by charging a small chamber under the piston at the top of the valve. The valve is held down by a mechanical restraint (the release mechanism) which is removed by a solenoid at the desired time.

8. AVAILABILITY: Arrangement for use may be made by contacting Professor George K. Sinnamon, Civil Engineering Department, University of Illinois, Urbana, Illinois.

9. OTHER CONSIDERATIONS: When operated hydraulically, the system allows slower rates of application of the load and in many instances, a nearly constant strain rate.

The triaxial cell is of more or less conventional design with modifications for rapid loading. The axial load is measured by strain gauge dynamometer mounted in the base of the cell. The piston is guided by Thompson ball bushings and sealed by a quad-ring. An LVDT is used to measure the sample deformation.

10. DISCUSSION: The pneumatic portion of the 7 Kip loading machine is essentially miniaturized version of existing pneumatic loading machines in the Dynamics Laboratory at the University of Illinois. It deviates in operation from the larger machines in that it operates in only one direction and its normal mode will apply

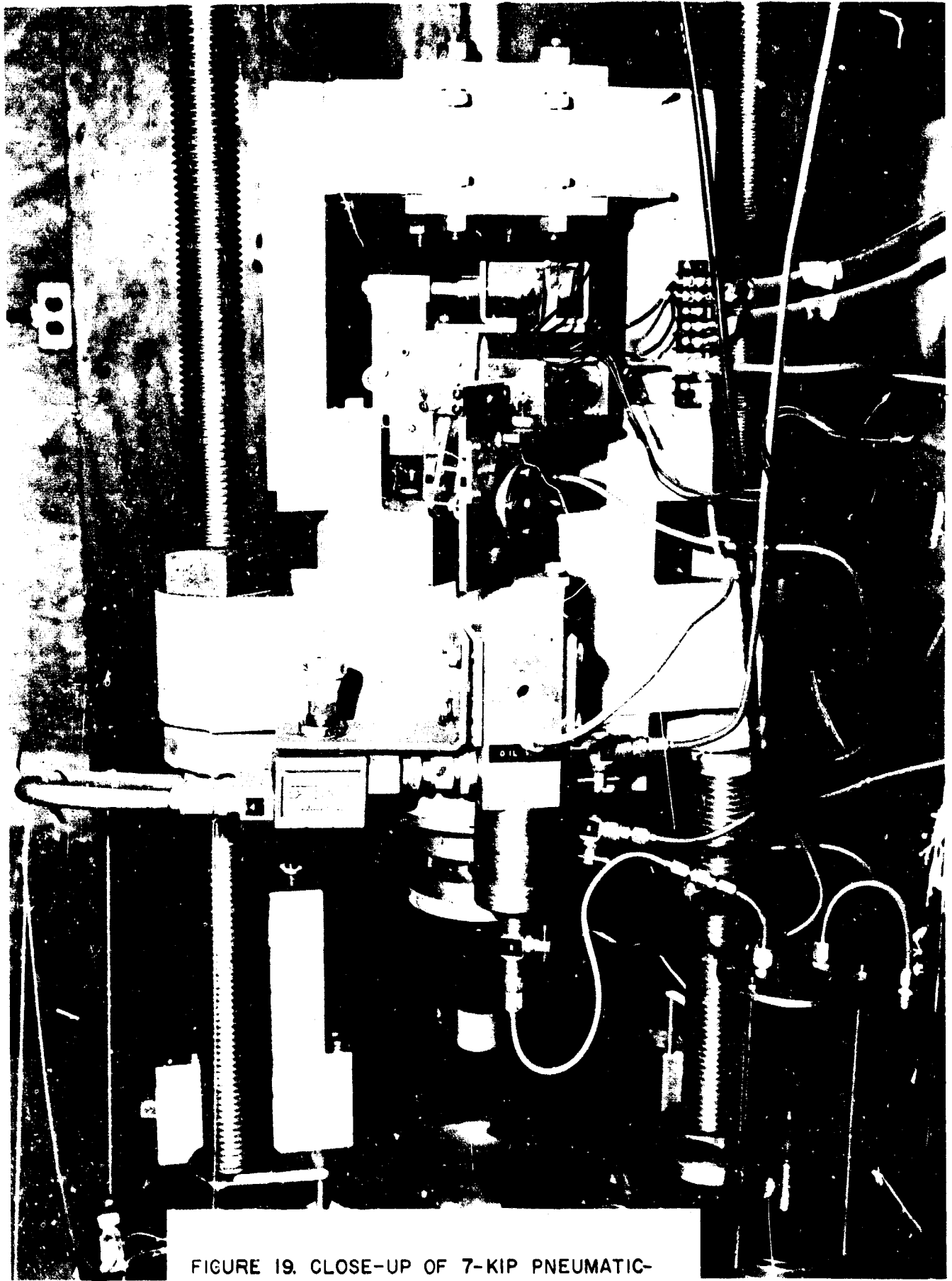

FIGURE 19. CLOSE-UP OF 7-KIP PNEUMATIC-HYDRAULIC LOADING MACHINE

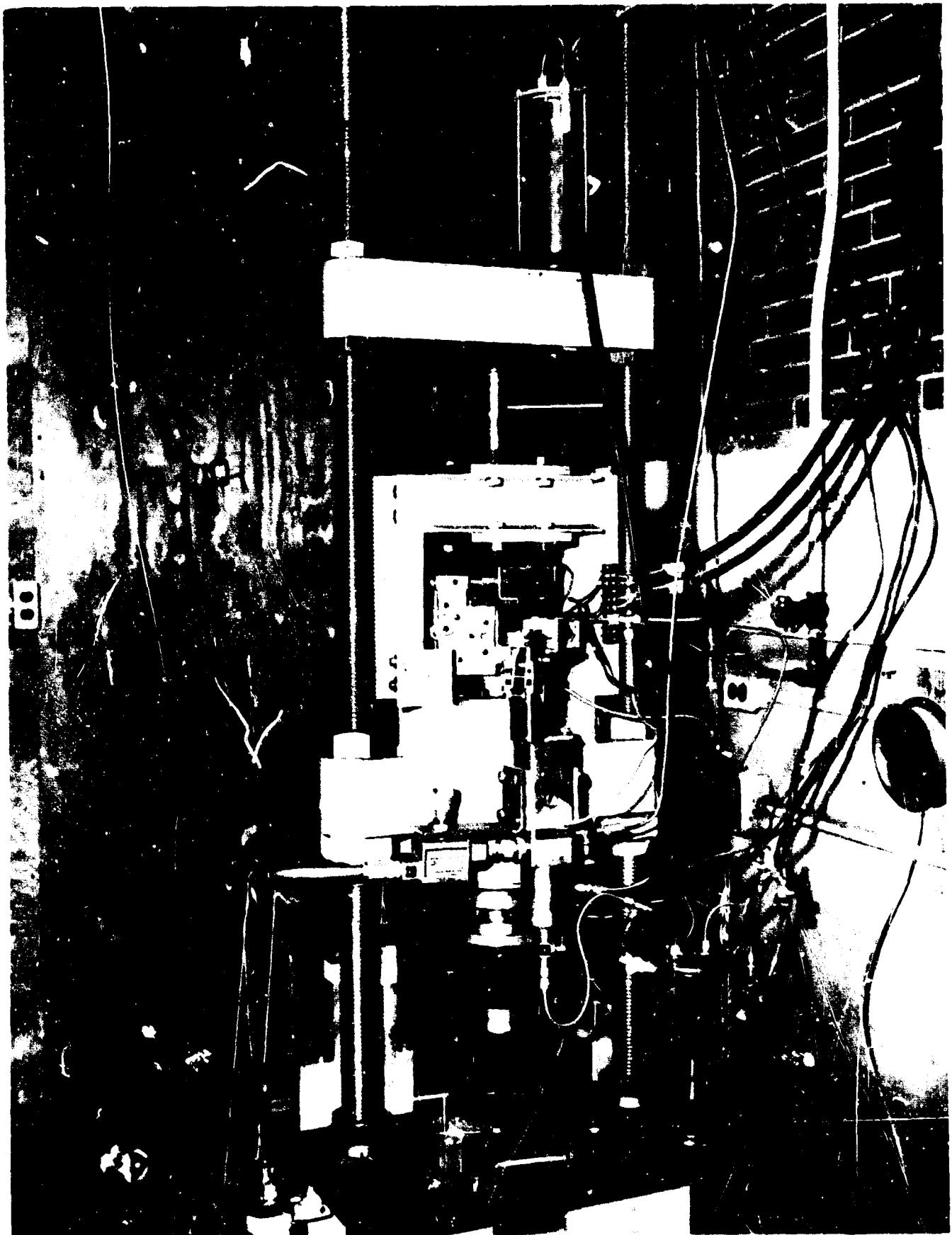

FIGURE 20. OVERALL VIEW OF 7-KIP LOADER

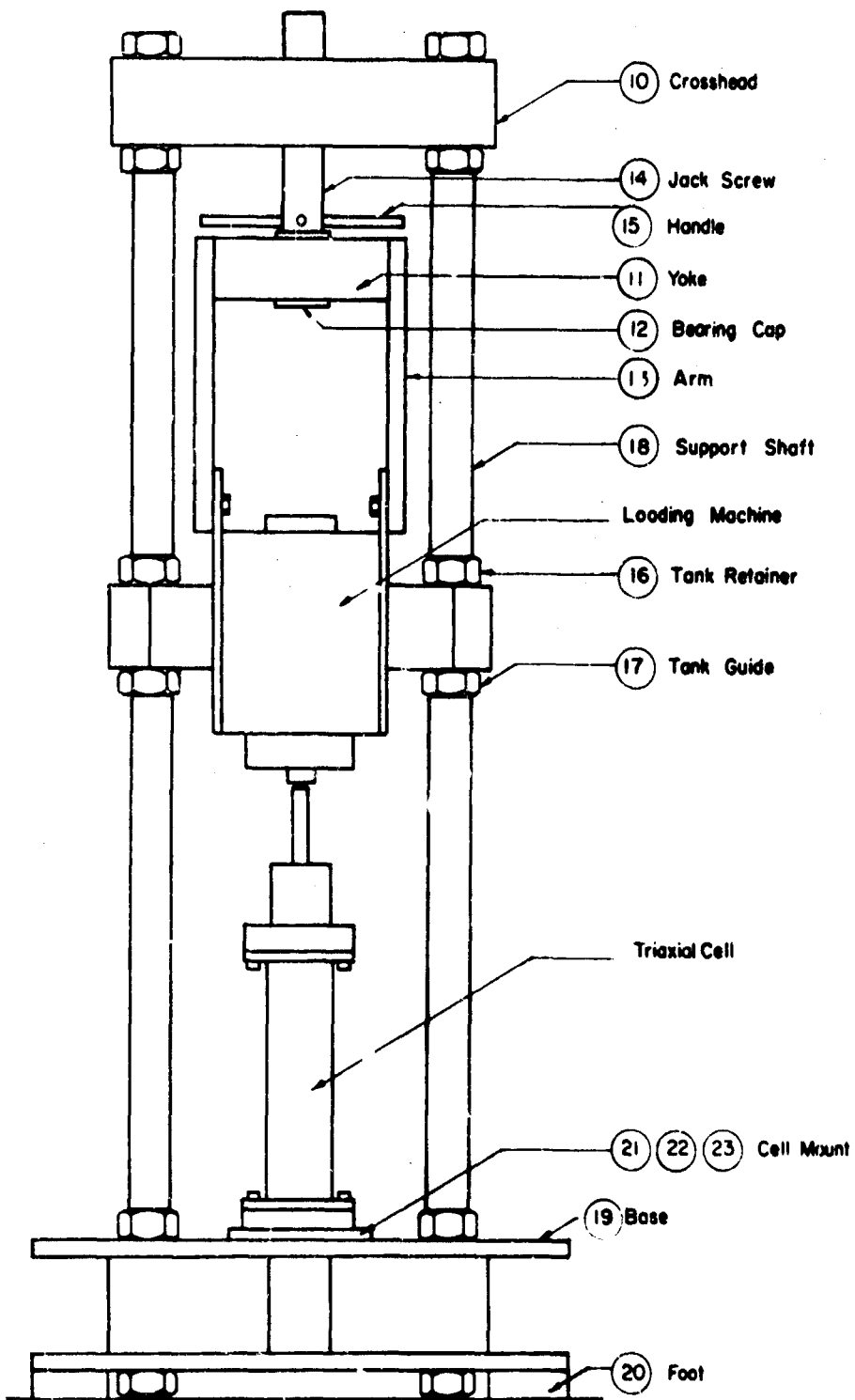
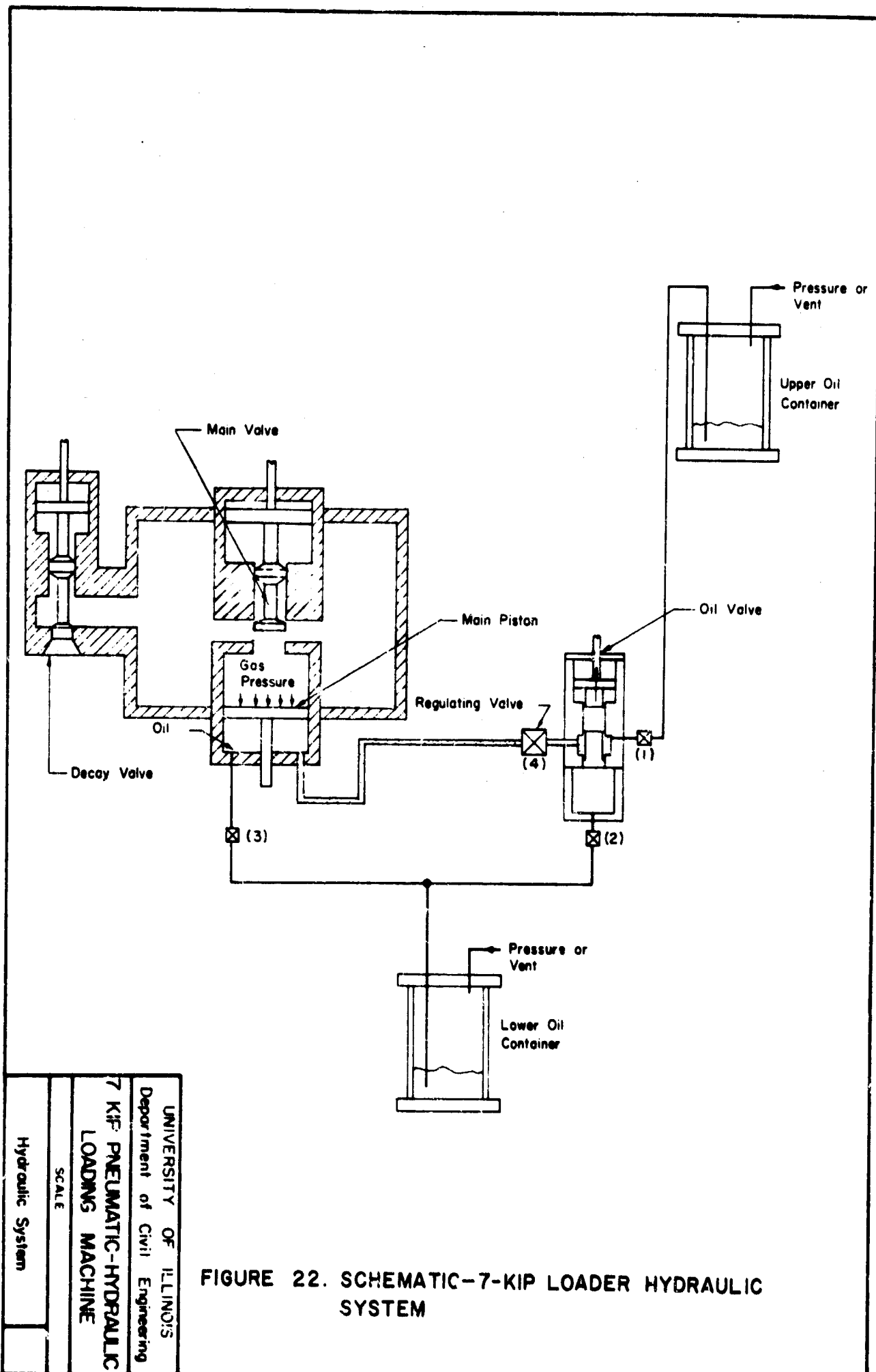

FIGURE 21. SCHEMATIC FRAME & MACHINE ASSEMBLY
7-KIP LOADER

UNIVERSITY OF ILLINOIS
 Department of Civil Engineering
 7 KIP PNEUMATIC-HYDRAULIC
 LOADING MACHINE
 SCALE 1" = 6"
 Frame and Machine Assembly



UNIVERSITY OF ILLINOIS
 Department of Civil Engineering
 7 KIP PNEUMATIC-HYDRAULIC
 LOADING MACHINE
 SCALE
 Hydraulic System

FIGURE 22. SCHEMATIC-7-KIP LOADER HYDRAULIC SYSTEM

compressive loads. In addition to the pneumatic portion, the 7 kip loading machine also incorporates a hydraulic system with which it is possible to apply a constant load over a wide range of strain rates. Operated in this manner, the loading machine essentially acts as a gas over oil piston-type accumulator. The oil is allowed to flow out of the accumulator through a micro-regulating valve, thereby controlling the quantity of flow with respect to time and the movement of the piston with respect to time.

11. REFERENCE:

Smith, J. L., "Operation Instructions - 7 kip Pneumatic-Hydraulic Loading Machine and Triaxial Apparatus." University of Illinois Urbana, Illinois, Pages 1, 2, 3, 4, 5 and Dwg. Sheet Nos. 2, 3, and 38: 1 August 1963.

1. TITLE AND/OR TYPE: 20-Kip Pulse Loading Device
2. LOCATION: University of Illinois
Attn: Prof. George K. Sinnamon
Talbot Laboratory
Urbana, Illinois
3. OWNER: University of Illinois
4. LOADING CHARACTERISTICS:
 - a. Force: Minimum (lbs) variable Maximum (lbs) 19,000
 - b. Rise Time: 2 milliseconds
 - c. Dwell Time: Variable
 - d. Decay Time: 90% removal of the loading in about 0.25 seconds
 - e. Stroke: 5.25 inches in either tension or compression
5. PHYSICAL DESCRIPTION (Figures 23 & 24): The major elements of the loading device are shown in figure 24. The external chambers, each 1870 cubic inches in volume, act as accumulators for the pressurized gas. The internal chambers (one on either side of the piston) each have a volume of 120 cubic inches when the piston is in its central position. The main piston is 5.145 inches in diameter. The machine is designed to operate at a peak pressure of 1000 psi. Aluminum slide valves, covering orifices of 18 square inches area, control the passage of gas between the external and internal chambers. The walls of one external chamber contain a poppet valve system of 39 square inches orifice area.
6. DRIVER: Nitrogen and/or helium
7. CONTROLS: Controls are in a room isolated from the firing area. This room controls the distribution valves for gas loading the devices, firing switch, gas storage, and instrument recording apparatus.
8. AVAILABILITY: Arrangements for use, may be made by contacting Professor George F. Sinnamon, Civil Engineering Department, Talbot Laboratory, University of Illinois, Urbana, Illinois.
9. DISCUSSION: The 20,000 pound capacity slow or rapid loading device was developed over a period of several years in the structural Research Laboratory, Department of Civil Engineering, University of Illinois. The original machine was developed by F. M. Massard but

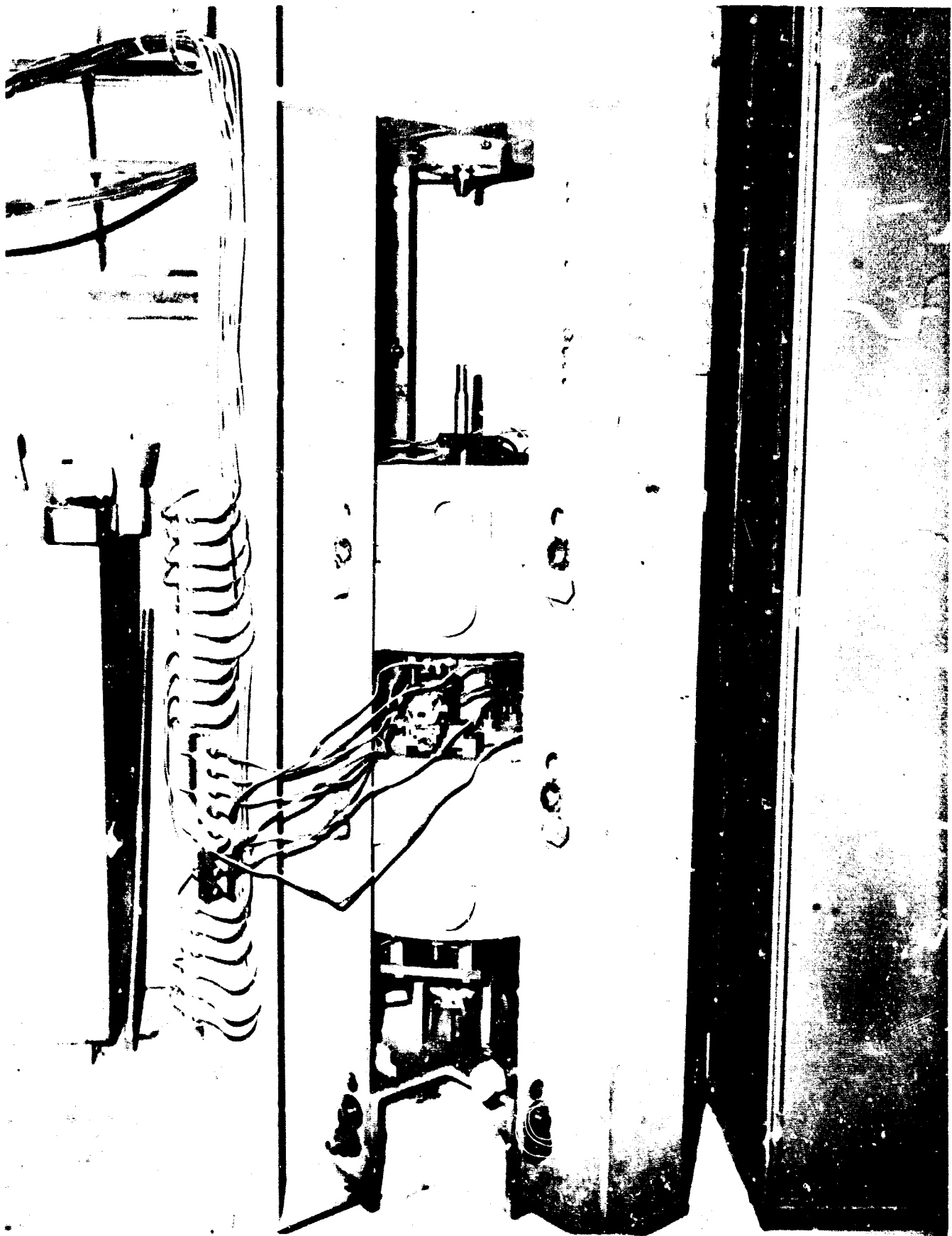

FIGURE 23. 20-KIP PULSE LOADING DEVICE

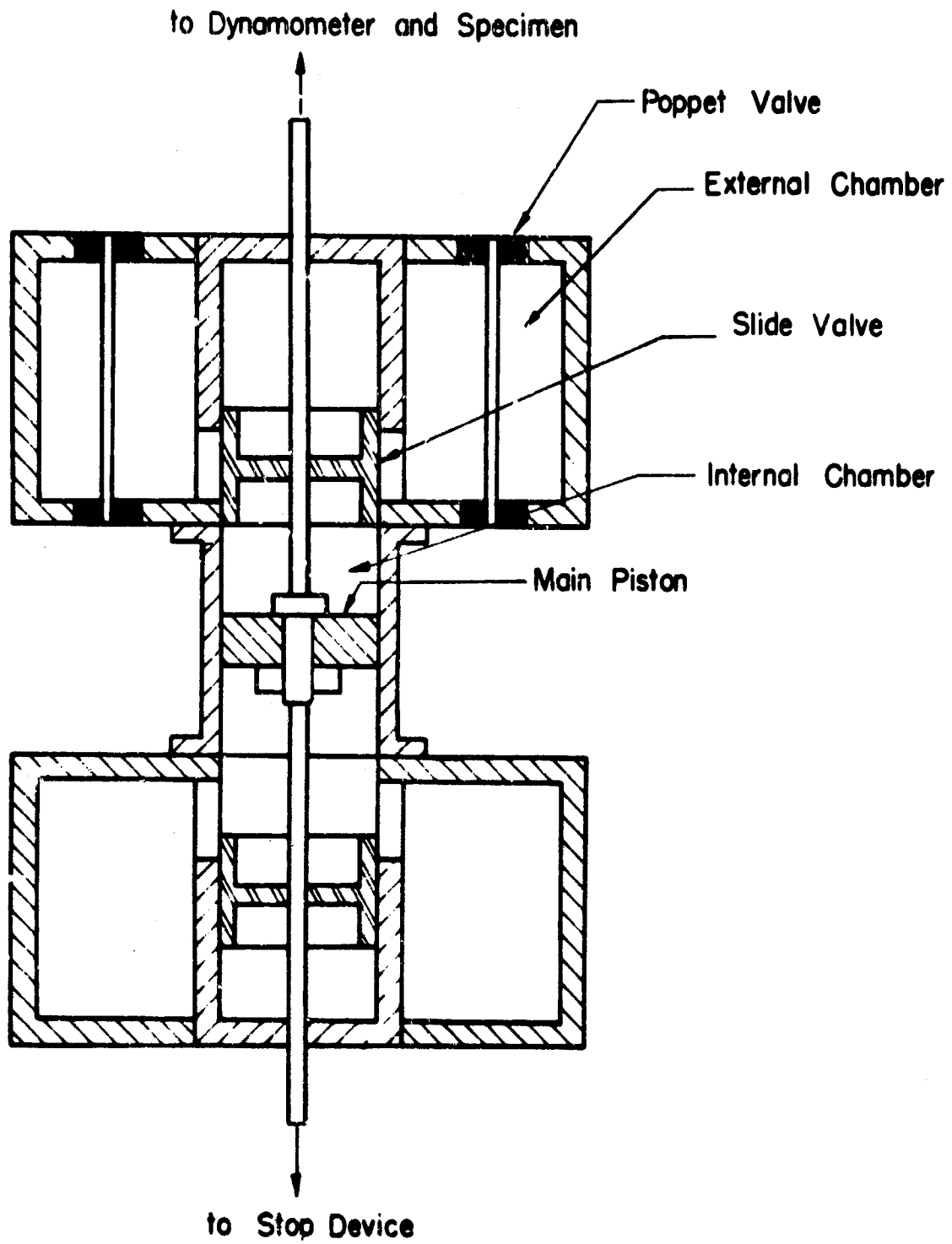

FIGURE 24. SCHEMATIC DIAGRAM OF TESTING MACHINE

over the years it has had many modifications.

The device is a loading type machine; the force applied to the test specimen results from gas pressure acting on a piston. The flow of gas onto and off of the loading piston is controlled by two types of rapidly operable, balanced valves; the valves are balanced in the sense that the forces required to restrain and activate these valves are not markedly affected by the orifice area and gas pressure level.

10, REFERENCE:

Wright, R. N., Hall, W. F., and Hamada, H. S., "The Behavior of Structural Steel Under Slow and Rapid Reversal of Loading" Sixty-seventh Annual Meeting of the American Society for Testing Materials, Reprint. pages 21 and 22, 21-26 June 1964.

1. TITLE AND/OR TYPE: WES - MIT Impact Loader
2. LOCATION: U. S. Army Engineer Waterways Experiment Station
Corps of Engineers
Vicksburg, Mississippi
3. OWNER: U. S. Army
4. LOADING CHARACTERISTICS:
 - a. Pressure: (Tank) Minimum (psi) 0 Maximum (psi) 800
 - b. Force: Minimum (lbs) 0 Maximum (lbs) 30,000
 - c. Rise Time: 1 to 5 milliseconds (varies according to type of material being tested)
 - d. Dwell Time: No load release
5. PHYSICAL DESCRIPTION: (Figure 25)
 - a. Diameter: 4 inch diameter head
 - b. Length: 4 inch maximum stroke of piston.
6. DRIVER: Pressurized nitrogen
7. CONTROLS: Electromagnetic valve opens and nitrogen is released. The nitrogen in turn drives the piston. Load cells are on the piston shaft and under the specimen. Deformations are measured with a linear potentiometer. Strain is measured with strain gages. Stress, strain, and deformations are recorded with an oscilloscope.
8. AVAILABILITY: The WES MIT impact loader is normally scheduled for full-time use on Waterways Experiment Station testing programs; however, testing that is considered to be within the capabilities of the loader may be conducted for other interested agencies on a priority basis. Inquiries should be sent to: Director, U. S. Army Engineer Waterways Experiment Station, P. O. Box 631, Vicksburg, Mississippi 39181.
9. OTHER CONSIDERATIONS: A control valve is on an auxiliary nitrogen tank. This valve insures constant pressure on an electromagnetic valve. When this valve is energized, the nitrogen releases a trigger piston which releases the pressurized N₂ that drives the piston. Specimen heights can be varied to a maximum of 3 feet.
10. DISCUSSION: The WES - MIT impact loader is located within the Concrete Division building at WES's Jackson Installation.

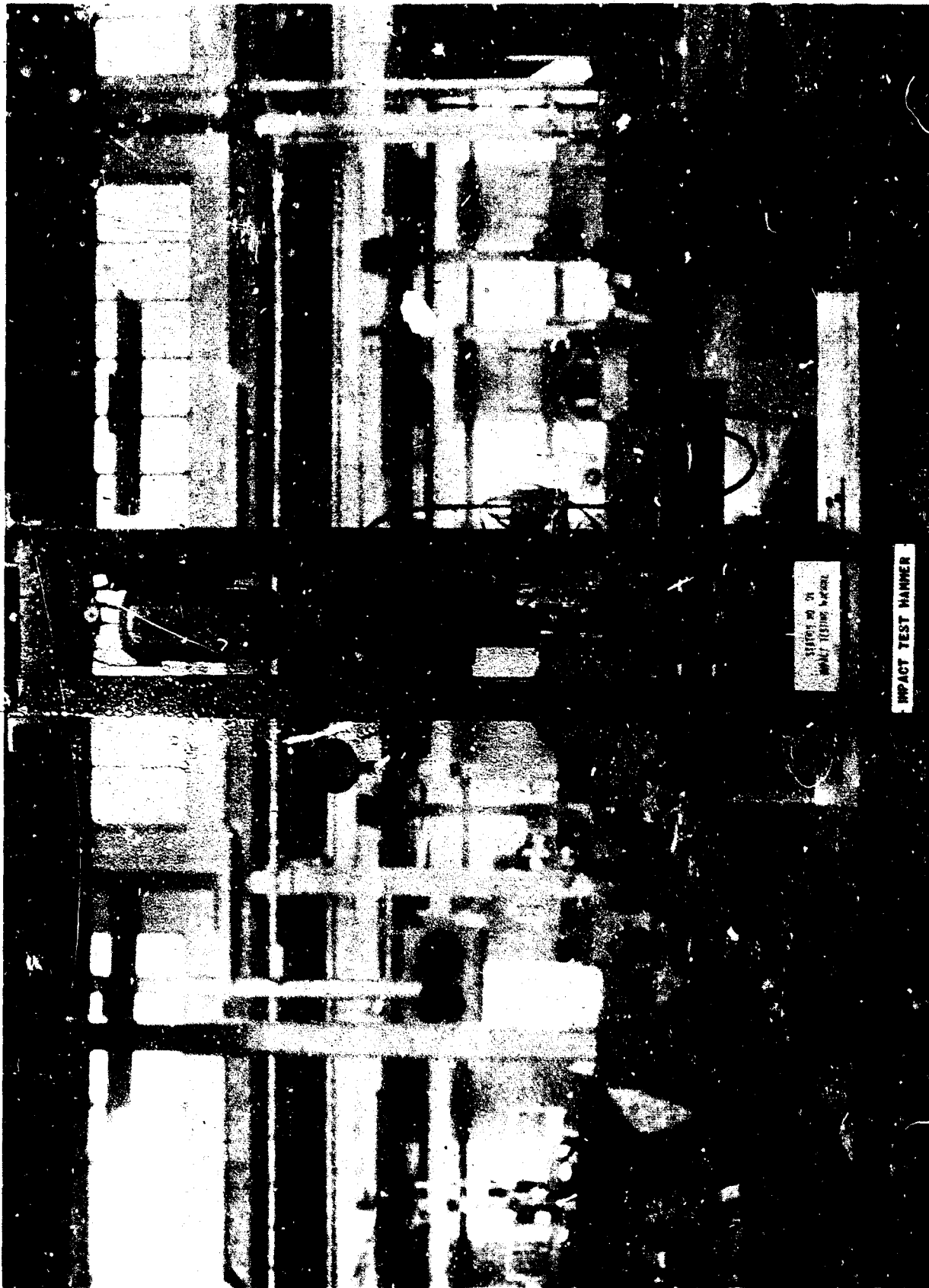

FIGURE 25. WES-MIT IMPACT LOADER

1. TITLE AND/OR TYPE: WES - 200-Kip Loader
2. LOCATION: U. S. Army Engineer Waterways Experiment Station
Corps of Engineers
Vicksburg, Mississippi
3. OWNER: Defense Atomic Support Agency (DASA)
4. LOADING CHARACTERISTICS: (see discussion)
 - a. Force: Minimum (lbs) 0 for both static and dynamic with considerably reduced accuracies in the lower ranges. Maximum (lbs) 200,000 lbs with possibly higher capabilities.
 - b. Rise Time: Variable from 1.5 msec up (uncontrolled) depending upon specimen being tested.
 - c. Dwell Time: Obtainable but uncontrollable in msec range.
 - d. Decay Time: Variable from a few msec and up (uncontrolled) depending upon piston velocity at time of initiation of decay load.
5. PHYSICAL DESCRIPTION (Figure 26):
 - a. Diameter: Piston - 9.5 inches Piston Shafts - 4 inches
 - b. Length: Over-all height of device - 14 feet, 4 inches
 - c. Other: Maximum stroke - 4 inches. Maximum area available for specimen placement is 8 feet high by 5 feet wide by 25 feet long.
6. DRIVER: Open-looped hydraulic pressure applied to piston.
7. CONTROLS: Dynamic loads are obtained by rupturing a metal disc for rise and decay of load. Static loads are obtained by manual control of a hand valve.
8. AVAILABILITY: The 200-kip loader is normally scheduled for full time use on Waterways Experiment Station testing programs; however, testing that is considered to be within the capabilities of the loader may be conducted for other interested agencies on a priority basis. Inquiries should be sent to: Director, U. S. Army Engineer Waterways Experiment Station, P. O. Box 631, Vicksburg, Mississippi 39181.

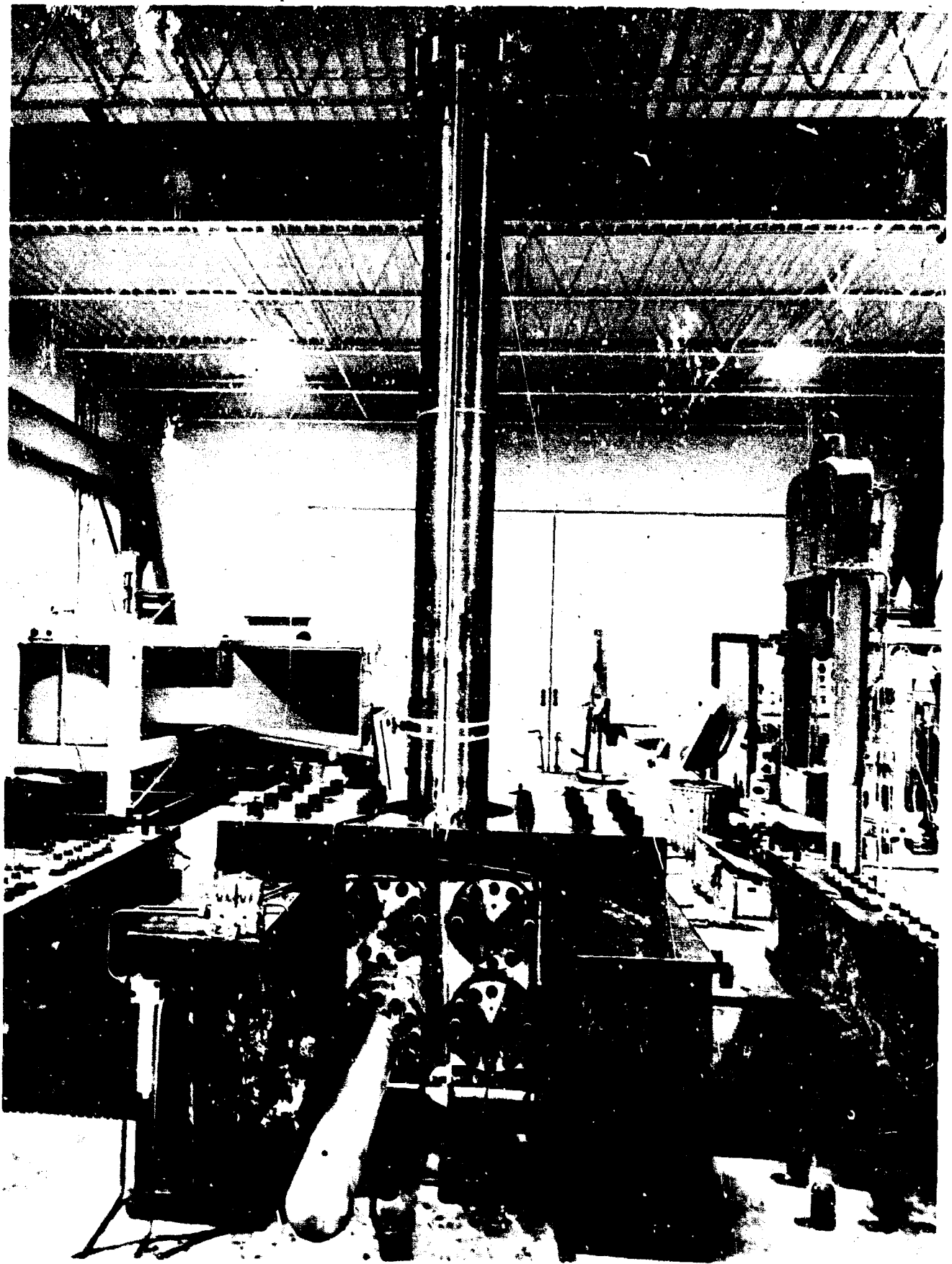

FIGURE 26. WES 200-KIP LOADER

9. **OTHER CONSIDERATIONS:** This loader is a companion item of equipment with the WES 500-kip loader which together provide a capability for testing of structural shapes with loading rates varying from a true static load to rates where the maximum load is reached in a very few msec. This loader provides the capability for the very fast rise type of load.

10. **DISCUSSION:** The 200-kip loader is a hydraulic, open-looped, testing device capable of applying a concentrated load in short times over a maximum of 4 inches of stroke. The loader is scheduled to be operational in the fall 1965 with loading characteristics defined in Section 4. Efforts to design valves capable of controlling the rise and decay of the load will be continued after installation of the device.

Load: The device is designed to apply loads varying from 10,000 to 200,000 lbs in either tension or compression and has applied loads in compression in excess of 200,000 lbs to specimens. The design of the device is such that loads as high as 400,000 lbs may be possible with the device; however, definition of the maximum load capability of the device is subjected to further evaluation.

Load-Time History: The minimum time required to develop a specific load is subject to many variables which include piston location, magnitude of load, response of resisting member, and characteristics of the control valves, etc.; therefore, the rise-time characteristics of the loader are a function of the test conditions. A minimum rise-time of 1.3 msec for a load in excess of 200,000 lbs with approximately 1/4 inch movement of the piston has been obtained with the device, indicating that rise-times approaching 1 msec might be obtained for stiff specimens.

Accuracy and ability to obtain hold-times in the msec range cannot be defined at this time. Considerable experience is needed in operating with rupture discs that control the porting of the oil in the loader before the capability of rupture discs to control pressure-time histories can be defined.

Times required to decay a load have not been determined; however, they also will be a function of many variables. Times approaching 1 msec should be obtained under certain conditions.

Specimen Limitations: The type and size of specimen that can be tested include:

- a. Beams up to 24 inches deep, 18 inches wide, and 144 inches long.
- b. Columns with a maximum height of 6 feet and cross-sectional diameter of 18 inches.

c. Circular specimens having a maximum diameter at the grips of 2-1/2 inches and approximately 36 inches long under tensile loading.

d. Tests where 2-point loading is required up to a maximum of 4 feet between points of load application.

1. TITLE AND/OR TYPE: WES 500-717 Loader
2. LOCATION: U. S. Army Engineer Waterways Experiment Station
Corps of Engineers
Vicksburg, Mississippi
3. OWNER: Defense Atomic Support Agency (DASA)
4. LOADING CHARACTERISTICS: (see discussion)
 - a. Force: Minimum (lbs) 0 for all loading rates with considerably reduced accuracies in the lower ranges. Maximum (lbs) Variable with 700,000 lbs for true static load.
 - b. Rise Time: Controllable variable depending upon specimen being tested. Minimum time will be available in late summer 1965.
 - c. Dwell Time: Controllable and variable from seconds to hours.
 - d. Decay Time: Controllable and variable depending upon specimen tested. Minimum time will be available in late summer 1965.
5. PHYSICAL DESCRIPTION (Figure 27, 28, 29)
 - a. Diameter: Piston - 18 inches Piston Shaft - 8 inches
 - b. Length: Over-all height of device - 5 feet, 1 inch
 - c. Other: Maximum stroke - 18 inches. Maximum area available for specimen placement is 8 feet high by 5 feet wide by 25 feet long.
6. DRIVER: Hydraulic pressure applied to top and bottom of piston.
7. CONTROLS: Closed-looped, servo-controlled hydraulic system. Maximum travel of the piston is 18 inches in tension or compression with provisions to limit travel to 4 or 8 inches for compression loading.

The maximum ramping capability of the device is defined by two conditions, position ramping, or load ramping. Figure 28 is a plot of the maximum position ramping rate of the device vs. resistance to the piston. Figure 29 is a plot of the position of the piston from the end of the chamber vs. load ramping rate for three values of resistance to the piston. This plot assumes no movement of the piston. The curves shown in Figure 29 should be recognized as limiting values of a maximum theoretical capability. The curves must be considered together for evaluation of a particular desired test, i.e., if a coupon

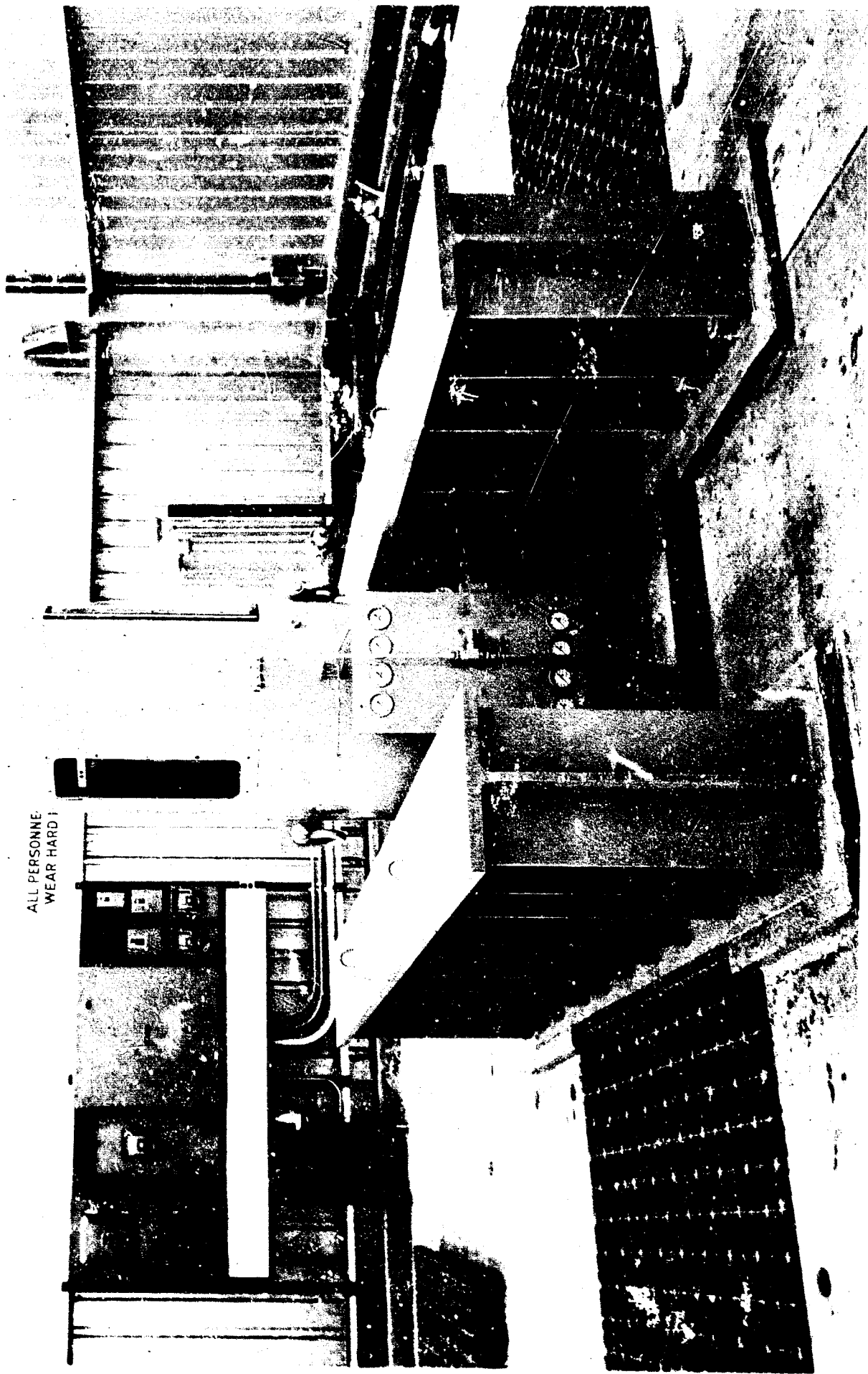

ALL PERSONNE
WEAR HARD I

FIGURE 27. WES 500-KIP LOADER

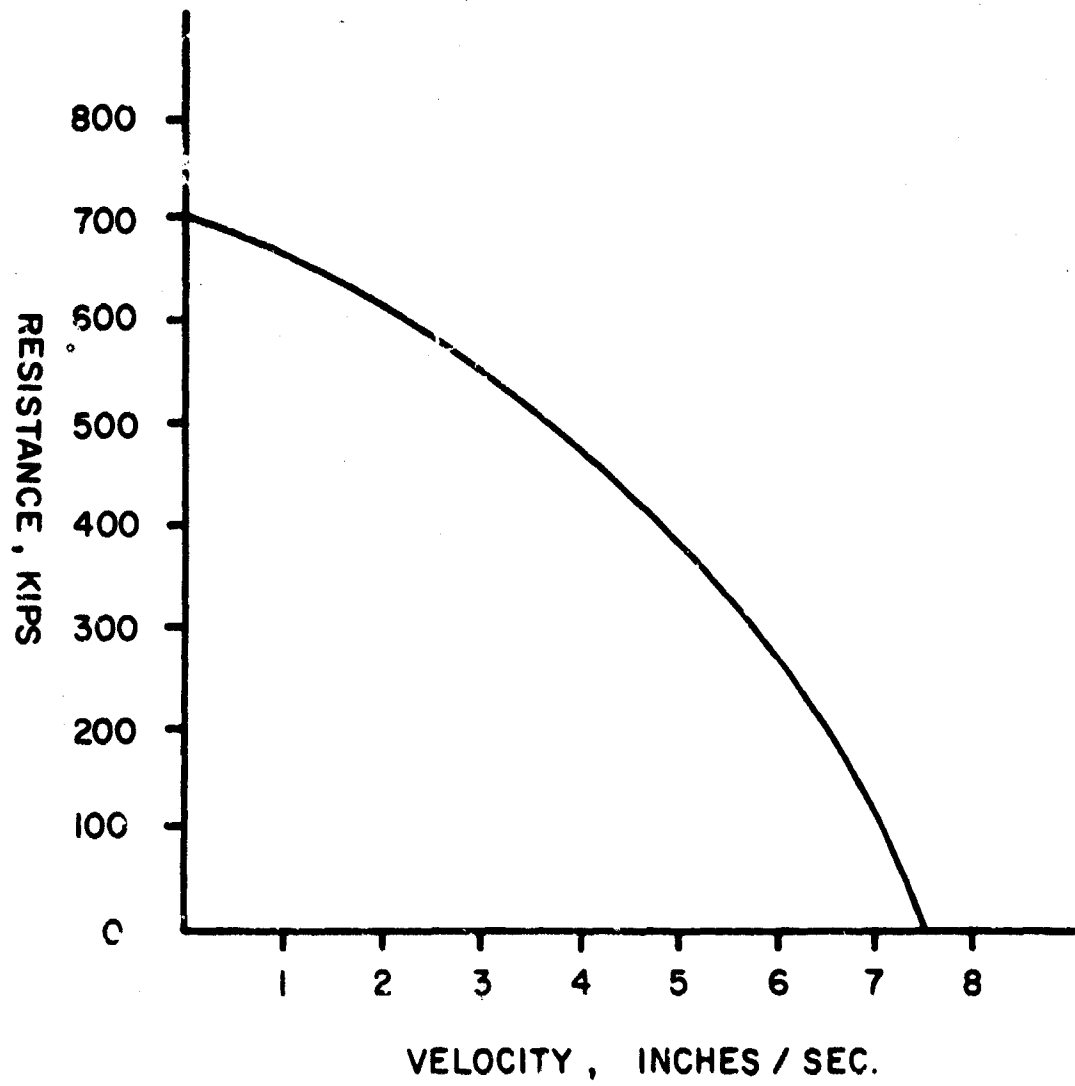

FIGURE 28 LOAD-VELOCITY CAPABILITY FOR 500-KIP LOADER

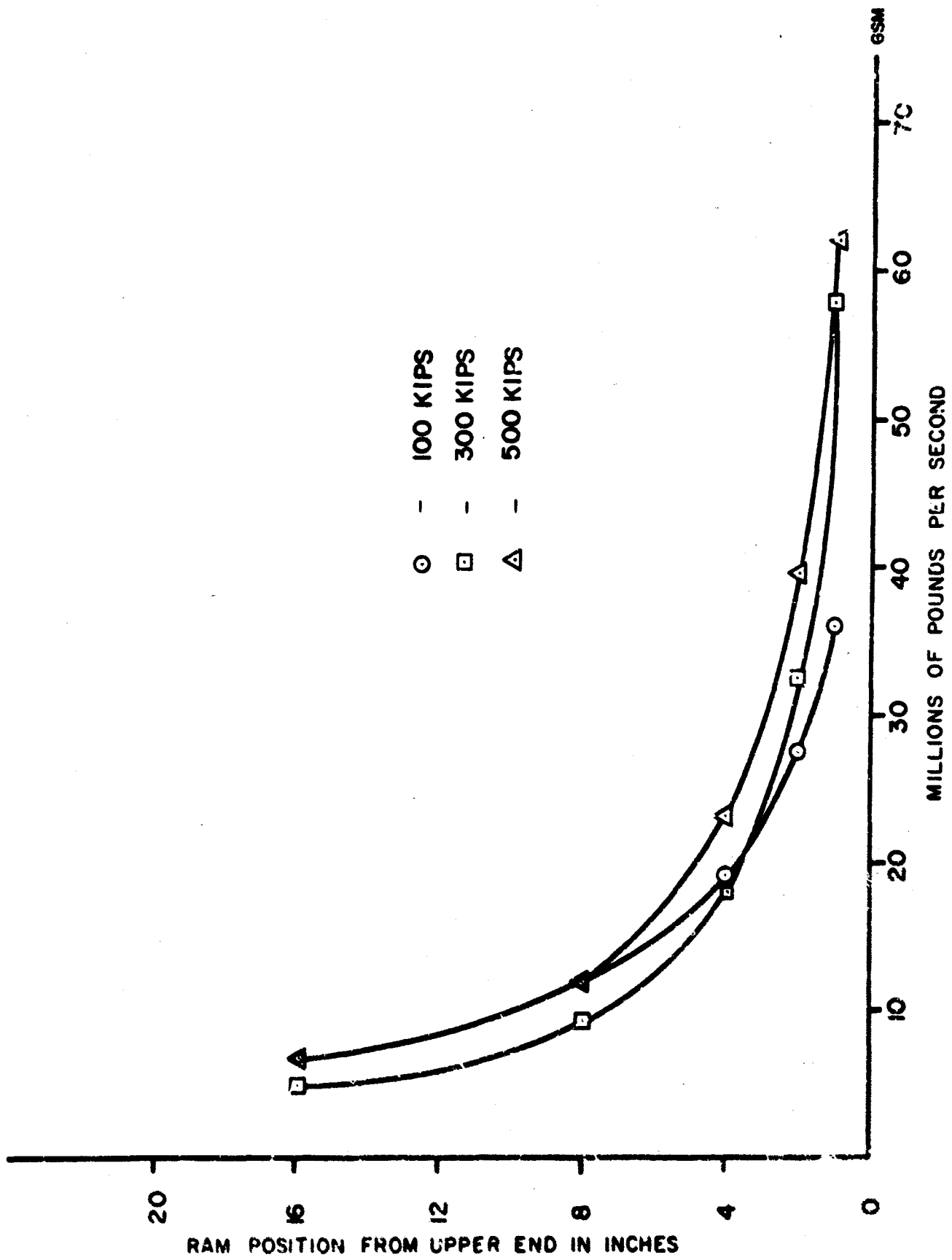

FIGURE 29 LOAD APPLICATION TO RIGID SPECIMEN FOR 500-KIP RAM LOADER

were tested at a specific load rate, this rate would be maintained only if the position rate as defined in Figure 28 is not exceeded. Position ramp ranges of .001 to .01, .01 to .1, .1 to 1.0, and 1.0 to 10.0 inches per second and load ramp ranges of 0 to 100, 0 to 1000, 0 to 10,000, and 0 to 100,000 kips per second are available. In addition, the device can be operated at a specific position or load rate, a specific load rate then position control, or by an arbitrary function generator for any particular test.

8. AVAILABILITY: The WES 500-kip loader is normally scheduled for fulltime use on Waterways Experiment Station testing programs: however, testing that is considered to be within the capabilities of the loader may be conducted for other interested agencies on a priority basis. Inquiries should be sent to: Director, U. S. Army Engineer Waterways Experiment Station, P. O. Box 631, Vicksburg, Mississippi 39181.

9. OTHER CONSIDERATIONS: This loader is a companion item of equipment with the WES 200-kip loader which together provide a capability for testing structural shapes with loading rates varying from a true static load to rates where the maximum load is reached in a very few msec. This loader provides the capability for rates of loading varying from times to maximum load in the high msec range to a true static load.

10. DISCUSSION: The device shall be used primarily to determine the effect of strain rate on the strength characteristics of various structural materials as well as to determine the various strength parameters of various engineering materials in both tension and compression under either transient or static loads. The device will be operational in the summer of 1965.

SECTION III

SHOCK TUBES

1. **TITLE AND/OR TYPE:** Air Force 2-Foot-Diameter Shock Tube
2. **LOCATION:** Eric H. Wang Civil Engineering Research Facility
Area Y
Sandia Base, New Mexico
3. **OWNER:** U. S. Air Force
4. **LOADING CHARACTERISTICS:**
 - a. **Type Wave:** Exponential Decay
 - b. **Pressure:** Minimum (psi) Up to 200 Maximum (psi)
 - c. **Rise Time:** Instantaneous
 - d. **Time:** Positive Duration
 - e. **Decay Time:** All values to 160 milliseconds for entire range of overpressures up to 100 psi
5. **PHYSICAL DESCRIPTION (Figure 30):**

The over-all length is 132 feet, 6 inches and is made up of six sections 20 feet long and one section 12 feet, 6 inches long. These sections are steel pipe 24 inches O.D., 5/8 inch wall thickness with heavy flanges at each end that permit various sections to be bolted together.
6. **DRIVER:** Primacord
7. **CONTROLS:** U.E.D. - Ampex Control Counsel
8. **AVAILABILITY:** Available to other government agencies and to contractors of the United States Government on contracts requiring the use of and within the limitations of the tube. Scheduling is controlled by the Air Force Project Officer and the Facility Director.
9. **OTHER CONSIDERATIONS:** The two foot tube is fired with a closed-end compression chamber and an open-end expander chamber. A hinged-blind flange is used for the compression chamber door and is bolted in place, for each firing. The tube is held in place by a trunnion placed 50 feet downstream from the compression chamber.
10. **DISCUSSION:** This tube has been used for tests of several types of blast valves, filters, air intakes and exhaust ducts. A portion of this tube was used to erect the first vertical tube.

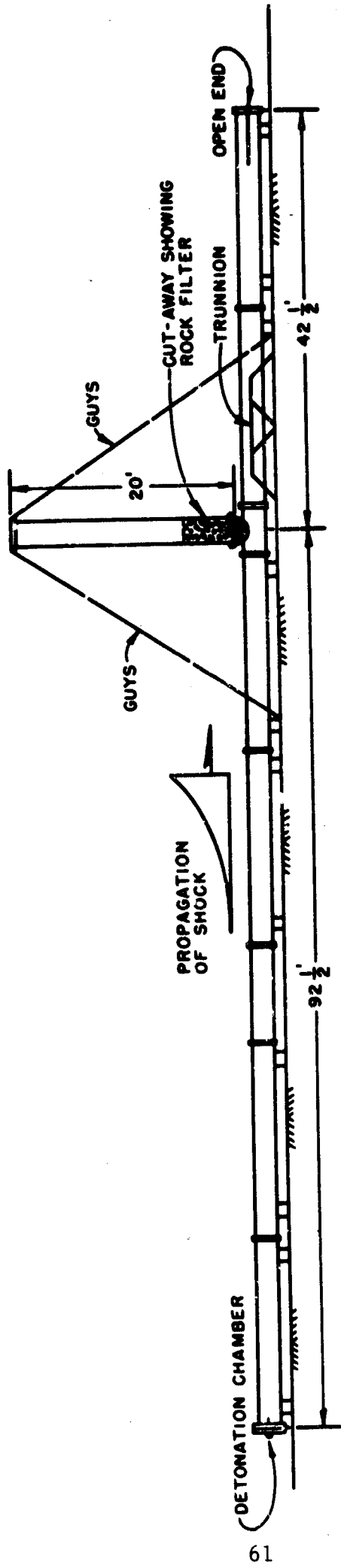

FIGURE 30. 2 ft. DIAMETER SHOCK TUBE
 (As used in the Rock Filter Study)

NOT TO SCALE

11. REFERENCE:

a. Crist, Robert A., "The Use of Rock Filters to Attenuate Air Shocks," AFSWC TDR-63-27, March 1961.

b. Holt, R. E., and Crist, R. A., "Calibration of a Six-Foot and a Two-Foot Diameter Shock Tube, AFSWC TDR-63-5, April 1963.

1. TITLE AND/OR TYPE: The Boeing 24 - 36-Inch Shock Tube Facility
2. LOCATION: The Boeing Company
Tulalip Test Site
Marysville, Washington
3. OWNER: The United States Air Force
4. LOADING CHARACTERISTICS:
 - a. Type Wave
 - (1) Peaked Wave - Simulated nuclear blast waves
 - (2) Flat Wave - Simulated blast waves in underground duct facilities
 - (3) Reflected Waves - Simulated reflected blast wave loading on underground duct facility components (Blast Valves).
 - b. Pressure (Figure 31):

(1) 24-Inch Shock Tube

	Primacord Driver	Air Driver
Maximum		
Incident	150 psig	10 psig
Reflected	600 psig	21 psig
Minimum		
Incident	15 psig	0
Reflected	35 psig	0

(2) 36-Inch Shock Tube (24 Inch Driver)

	Primacord Driver	Air Driver
Maximum		
Incident	60 psig	5 psig
Reflected	230 psig	10 psig
Minimum		
Incident	10 psig	0
Reflected	21 psig	0

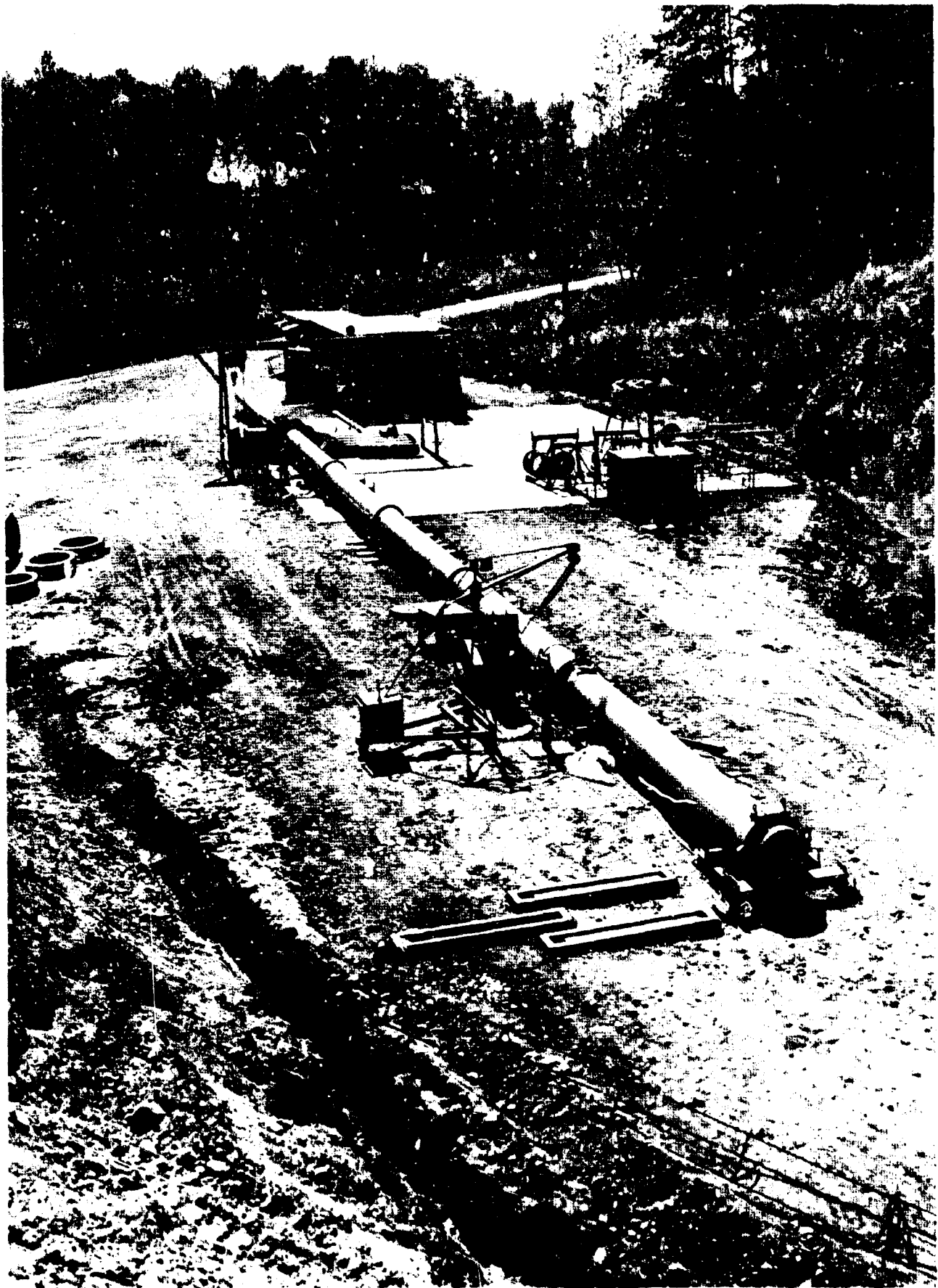

FIGURE 31. BOEING (TULALIP) 24" SHOCK TUBE FACILITY

(3) 2'-6" X 4'-4" Cross Section Driven Section (24 Inch Driver)

	Primacord Driver	Air Driver
Maximum		
Incident	27 psig	4 psig
Reflected	75 psig	8 psig
Minimum		
Incident	4 psig	0
Reflected	8 psig	0

c. Force - Force is defined as reflected pressure times the area of application.

(1) 24 Inch Shock Tube (i.d. of 22 inches)

Maximum	200 kips
Minimum	0

(2) 36 Inch Shock Tube (i.d. of 35 1/4 inches)

Maximum	200 kips
Minimum	0

(3) 2'-6" X 4'-4" Cross Section Driven Section

Maximum	100 kips
Minimum	0

d. Rise Time - The pressure rise time across the shock waves is usually much less than one millisecond. The rise time can be increased to several milliseconds for low pressure waves.

e. Dwell Time - Incident and Reflected Waves

Flat Time - Zero to greater than 50 milliseconds

f. Decay Time - Defined as the time from overpressure level of interest to no overpressure. This time varies from a few milliseconds to approximately 40 milliseconds depending upon the shock tube configuration.

5. PHYSICAL DESCRIPTION

a. Shock Tube:

24 Inch Shock Tube:

Maximum tube length is approximately 118 feet. Inside diameter is 22 inches throughout. The tube consists of 4 sections each of 25 foot length, 1 section of 12 foot length, and 3 chambers (designed as high pressure driver section for use with high explosive loadings) of 22, 22 and 33 inch length.

36 Inch Shock Tube:

The maximum tube length is approximately 89 feet. It has an inside diameter of 35-1/4 inches throughout. The tube consists of 5 sections each of 15 foot length and 2 sections each of 6 foot length. An additional thick wall chamber of 30 inch length can be used as a detonation chamber for use with the 36 inch tube, or modified to be used as a transition section between the 24 inch and 36 inch tubes. The 36 inch tube can be used by itself or in conjunction with the 24 inch tube as a driver.

2'-6" x 4'-4" Rectangular Driven Section:

The maximum tube length is approximately 20 feet. It is rectangular in cross section with inside dimensions of 2'-6" x 4'-4" throughout. This tube is attached to the 24 inch shock tube by a 7 foot long transition section.

A breakdown of the shock tubes is presented below:

	24 Inch Shock Tube	36 Inch* Shock Tube	2'6"x4'4"* Driven Section
Section Lengths			
(Number of)	(4) 25 feet (1) 12 feet (1) 35 inches (2) 22 inches	(5) 15 feet (2) 6 feet (1) 30 inches**	(1) 20 feet (1) 7 feet**
Length (total)	118 feet	89 feet	20 feet
Internal Diameter	22 inches	35 1/4 inches	2'6"x4'4" rectangular cross-section

b. Mounting System:

The shock tube (or tubes) is supported above the ground on steel racks. The downstream end of the tube (opposite the driver end) is attached to a rigid steel structure which is in turn bolted to a concrete pad.

*A transition section is used to connect this tube with the 24 inch shock tube. The 36 inch tube can be used alone.

**Transition section between this tube and 24 inch shock tube.

6. DRIVER - The shock tube facility has only been used with the 24 inch shock tube as the driver.
 - a. Low Pressure (0-10 psig) - Compressed gas with mechanically ruptured mylar diaphragm.
 - b. Medium - High Pressure - Primacord fuse detonated in ambient (15-150 psig) air or compressed gas generates the high pressure in the driver.
 - c. Pressure Ratios (10-100) - The driver is prepared as in (b), and the driven section of the tube is evacuated to as low as 0.1 psia.

Recent tests have been conducted using various combinations of pressurized gas with Primacord in the driver (The driven section was at ambient pressure). By using this technique, the driver sound speed was controlled resulting in high pressure shocks with over 50 milliseconds of flat time. This increased "flat time" has greatly improved the usefulness of the facility which was originally designed for a "flat time" of approximately 15 milliseconds.

7. CONTROLS - Remote in hardened control house.

The shock tube facility and associated control equipment are located in a remote area with sufficient A.C./D.C. power to support the operation in a hardened control house. All test runs are conducted remotely from within the control house.

Safety procedures and controls have been established for handling the explosives. No accidents involving explosives have occurred.

8. AVAILABILITY - Subject to negotiation.

The shock tube and associated facilities were purchased with Air Force funds for qualification tests on Minuteman blast valves and blast dampers. If no conflict exists with Minuteman tests, the facility is available for use subject to negotiations with the Boeing Company.

Inquiries concerning the availability of the shock tube should be addressed to:

Raymond G. Day
Orgn: 2-5742, Mail Stop 31-01
The Boeing Company
P. O. Box 3707
Seattle, Washington 98124

Phone: Area Code 206, OL 9-1291

9. OTHER CONSIDERATIONS - Fifty-five channels of instrumentation with frequency response up to 20,000 cps are available.

The recording instrumentation is located in a hardened control house. Typical instrumentation includes: piezoelectric pressure transducers, Kistler Charge Amplifiers, two Ampex CP 100 tape recorders (14 channels each), and either a Honeywell 1012 Visicorder Oscillograph or a CEC 5-119 Oscillograph. Frequency responses of up to 20,000 cps may be obtained.

The instrumentation can be readily expanded to four Ampex CP 100 tape recorders.

10. DISCUSSION - The facility has been used for generating blast loads on blast valves and blast dampers, blowby damage evaluation on facilities and subscale tests on air entrainment duct systems.

The following systems have been successfully tested with this shock tube facility:

a. Blast Valves and Blast Dampers:

Full scale blast valves and blast dampers were located at the downstream end of the tube and subjected to pressures of prescribed magnitudes and decay rates. Incident pressures ranged from 1 psig to approximately 100 psig. Both air and Primacord drivers were used. In all cases, the driven chamber contained air at ambient pressure. Tube configurations used for these include: The 24 inch shock tube, the 24 inch and 36 inch shock tubes, and the 24 inch tube and 2'6" X 4'4" driven section.

b. Facilities Downstream of Blast Dampers:

Full scale environmental control equipment has been located downstream of a blast damper to evaluate the effects of "blowby". "Blowby" is the air pressure pulse which is transmitted downstream of a blast valve or blast damper. During these tests, the facility equipment operated as it would in the field. The tube configuration used for these tests were the 24 inch tube and the 2'6" X 4'4" driven section.

c. Sub-Scale Air Duct Models:

Sub-scale models of underground air entrainment systems were mounted normal to the shock tube wall. The pulse generated in the tube simulated the pressure - time history of a scaled nuclear blast pulse. For most tests, the driven section and the model were evacuated and pressure ratios were simulated. The 24 inch shock tube was used for these tests.

1. TITLE AND/OR TYPE: Detonation-Driven Shock Tube
2. LOCATION: U. S. Army Research Laboratories
Aberdeen Proving Ground Maryland 21005
3. OWNER: U. S. Army
4. LOADING CHARACTERISTICS:
 - a. Type Wave: Flat top to peaked with exponential decay.
 - b. Pressure: Up to 180 psi obtained at main test section expect to be able to obtain 250 psi at test section.
 - c. Duration: Positive Phase - 40 milliseconds, 6 msec of which are flat-topped.
5. PHYSICAL DESCRIPTION (Figure 32, 33, & 34):
 - a. Diameter: Variable from 8 inch I. D. through a transition section to 22 1/8 inch I. D.
 - b. Length: Variable from 113 feet to 213 feet.
 - c. Other: First driven section: 8.25 inch diameter, 27 feet 2 inches long, 4140 steel, with 2 inch diameter test ports located (two each opposing each other) at 9 feet, 16 feet and 21 feet from the diaphragm, 28° conical nozzle machined into the end of this section. Second driven section: 22 1/8 inch nominal inside diameter, variable in length from 58 feet to about 155 feet: outside diameter 24 inches, commercial seamless wrought steel. Two 2.5 inch diameter test ports opposing each other at 18 inches and two at 56 inches from the nozzle end. Two test ports 4 inches by 18 inches opposing each other normally at 55 feet from the nozzle. Section lengths are random from 19 feet to 24 feet.
6. DRIVER: Mixture of hydrogen and oxygen.
7. CONTROLS: Detonating of the mixture is initiated by a blank 38 caliber cartridge at the back end. The resulting detonation wave travels through the ambient mixture until it reaches the diaphragm. The diaphragms consist of either mylar or aluminum materials.

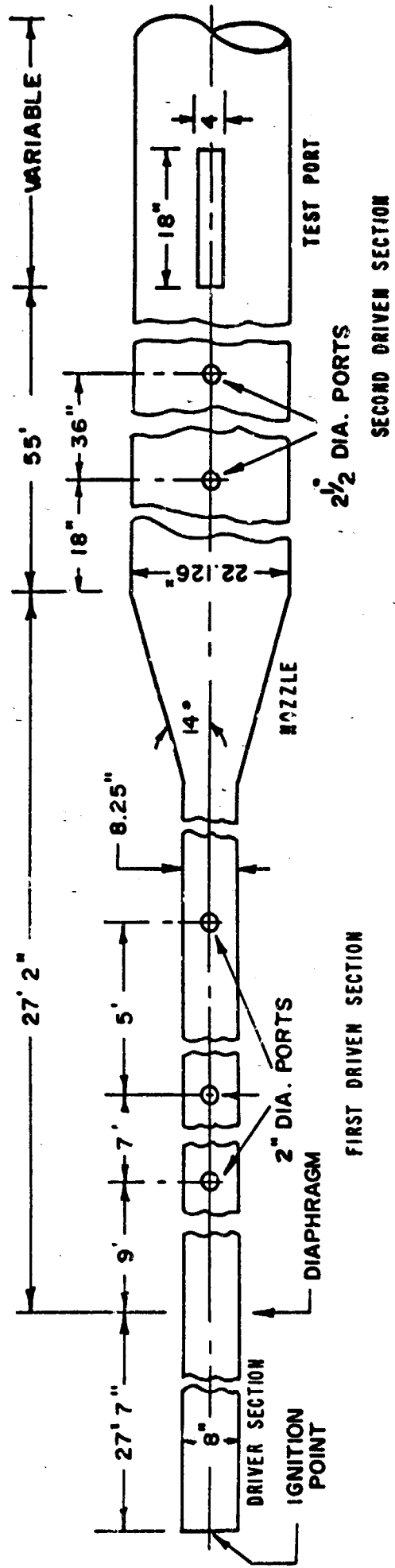

FIGURE 32. DETONATION DRIVEN SHOCK TUBE

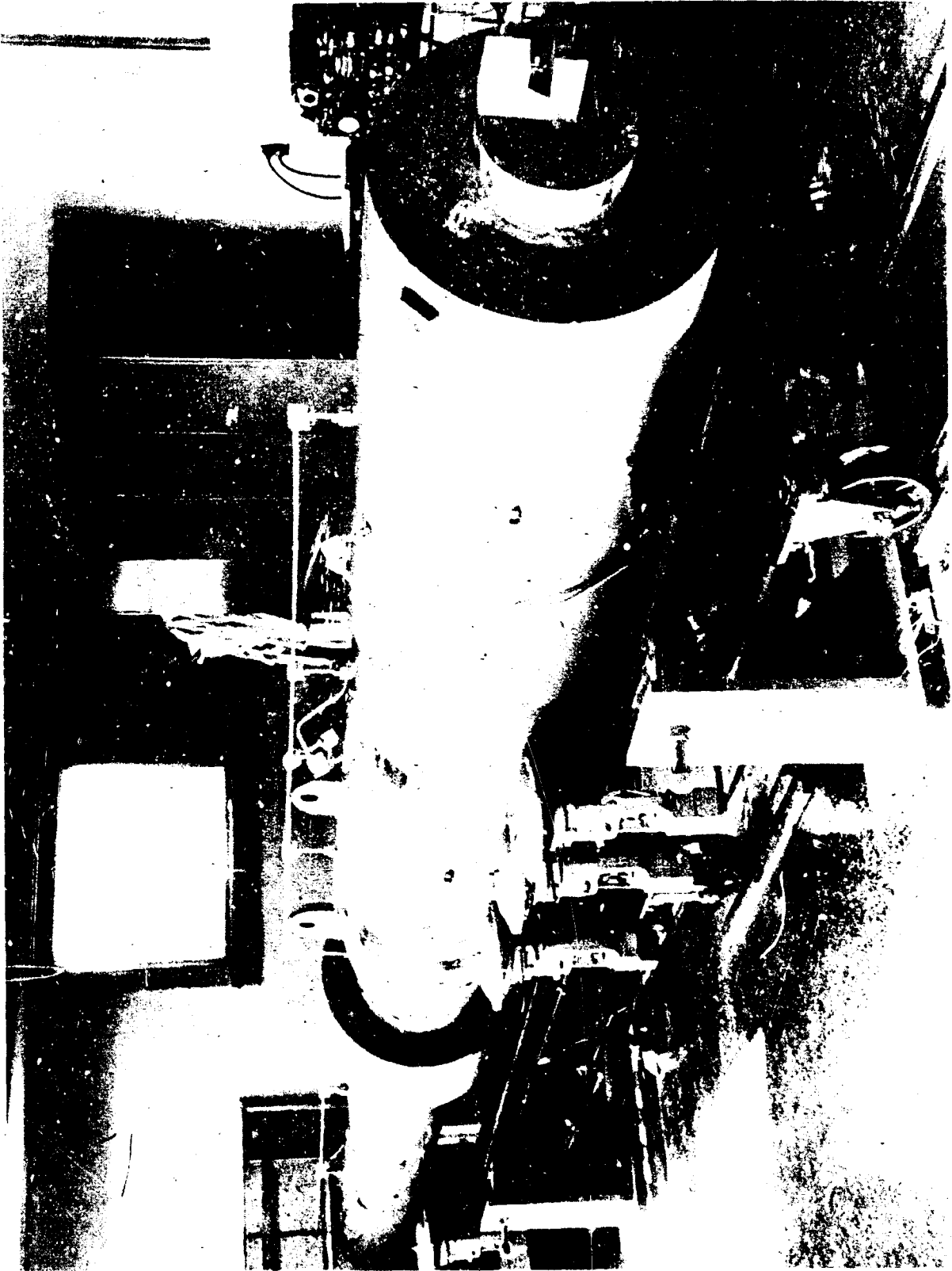

FIGURE 33. PHOTOGRAPH OF THE DRIVER SECTION

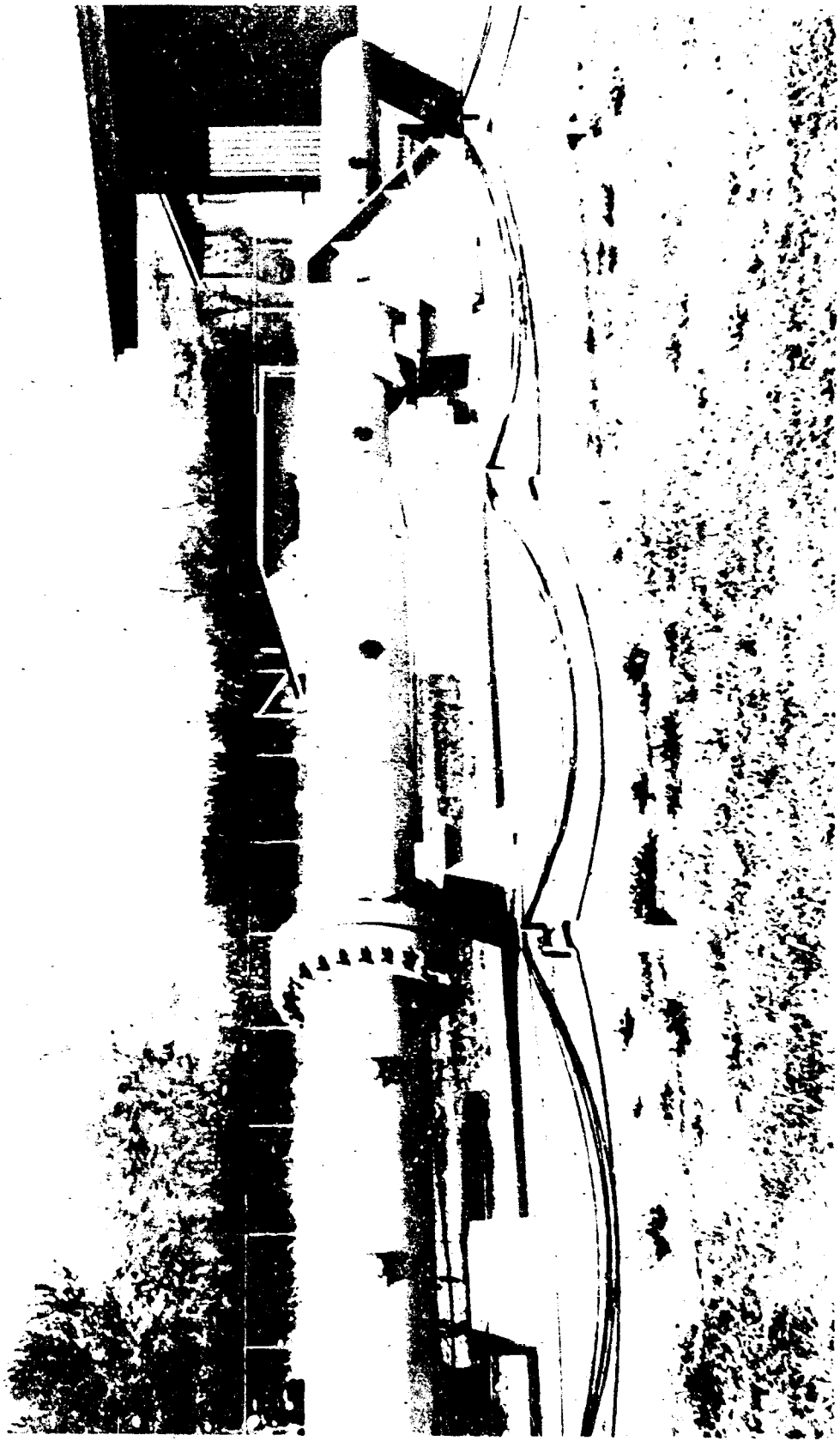

FIGURE 34. PHOTOGRAPH OF FIRST DRIVEN SECTION.

8. AVAILABILITY: U. S. Government and Government Contractor.
9. OTHER CONSIDERATIONS: The driver section is mounted on a carriage that is moved hydraulically along tracks to allow insertion and clamping of the diaphragm.
10. DISCUSSION: The driver section is completely housed. The diaphragm section is under roof but partially screened in, since this is the area most likely to have hydrogen accumulation in the event of breakage around the diaphragm, or power failure. A 20 foot by 20 foot, building partially covers the second driven section at the test section area and also serves as housing for the recording equipment. Gas bottles are stored in separate sheds; one for oxygen and one for hydrogen.

The tube has been used to develop piezoelectric gauges for shock tube instrumentation as well as various other pressure transducers for field operation. Shock propagation in scaled tunnel systems has been partially investigated and further work in this field is anticipated.

A program to perfect a stagnation probe using a piezo gauge has been conducted in which the problem of shielding the gauge from damage in field operations was solved.

Shock diffractions studies of scaled field models will be done in the near future. It is also expected to put a large test section at the end of the tube to allow testing of full scale models.

11. REFERENCE: Bertrand, Brian P., "High Pressure Shock Tube Progress Report," Ballistic Research Laboratories, Aberdeen Proving Ground, Maryland, pages 33, 34, 35, 39, 42, and 44.

1. TITLE AND/OR TYPE: BRL 4-Inch O.D. Shock Tube
2. LOCATION: U. S. Army
Ballistic Research Laboratories
Aberdeen Proving Ground, Maryland
3. OWNER: U. S. Army
4. LOADING CHARACTERISTICS:
 - a. Type Wave: Peaked for 1, 3, and 6 foot driver sections.
Step shock for driver sections 10 feet and longer.
 - b. Pressure: Minimum (psi) Peak Overpressure Maximum (psi)
 $1 < P_{21} < 7$ Air $0 < P_s < 32$ PSIG: $P_1 = .2$ PSIA
 - c. Positive Duration: Minimum of 10 msec and a maximum of
350 milliseconds at the 20 X 20 inch
test section.
5. PHYSICAL DESCRIPTION (Figures 35 & 36):

Test Sections

- a. 20 X 20 inch Section: Square 20 X 20 inch I. D., 24 ST aluminum, mill finish, 16 feet long with 2 inch thick walls. Center of this section may be 100 feet from diaphragm. It has 4 access parts: 1) Two each 12" X 12", 2) One 9" diameter, and 3) Four each 1 7/8" diameter.
- b. 24 inch O. D. Section: 22 5/8" I. D., seamless steel pipe, Bitumastic lining, 10' 8" long with 0.69" wall. Center of test section 111 feet from diaphragm. This section has 12 access parts: 1) Three 2" X 8", 2) Three 2" X 12", 3) Three 4" X 18" and 4) Three 3 1/4" diameter.
- c. 4 X 4 foot Section: 4 X 4 feet square inside dimensions, steel plate, 1/2 inch thick walls. Total length of this section is 58 feet with a 6 foot transition section from 24 inch shock tube. This section has eight access parts: 1) Four 2 X 2 feet in each 4 foot length and 2) Four one inch thick 17 1/2 inch square Herculite windows.

The shock tube is composed of random lengths of nominal 24 inch O. D. schedule 40, ASTM A 106-55 Grade B seamless steel tubing. The lengths are joined by Dresser couplings with the exception of the high pressure driver sections and end plates which are bolted. The overall length utilizing all test sections in place is approximately 300 feet.

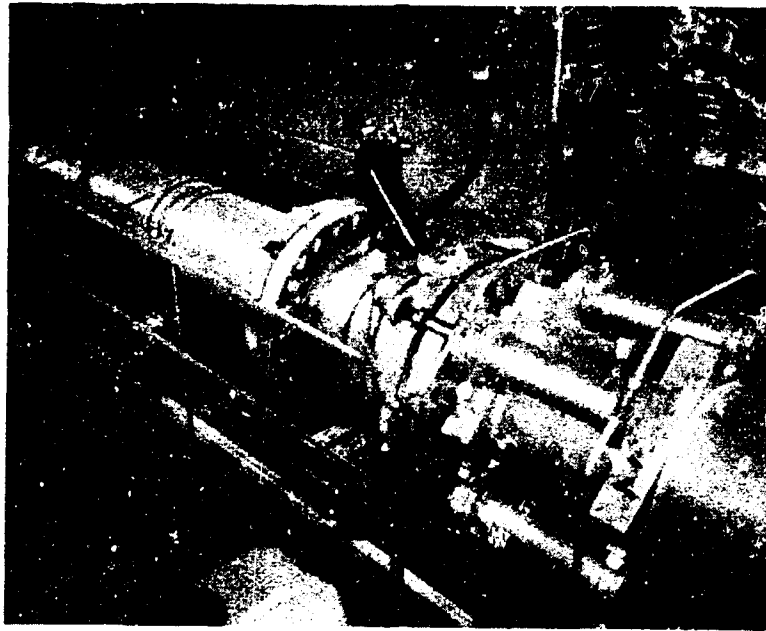

FIGURE 35-A COMPRESSION CHAMBER



FIGURE 35-B EXPANSION SECTION

FIGURE 35. THE 24-INCH SHOCK TUBE

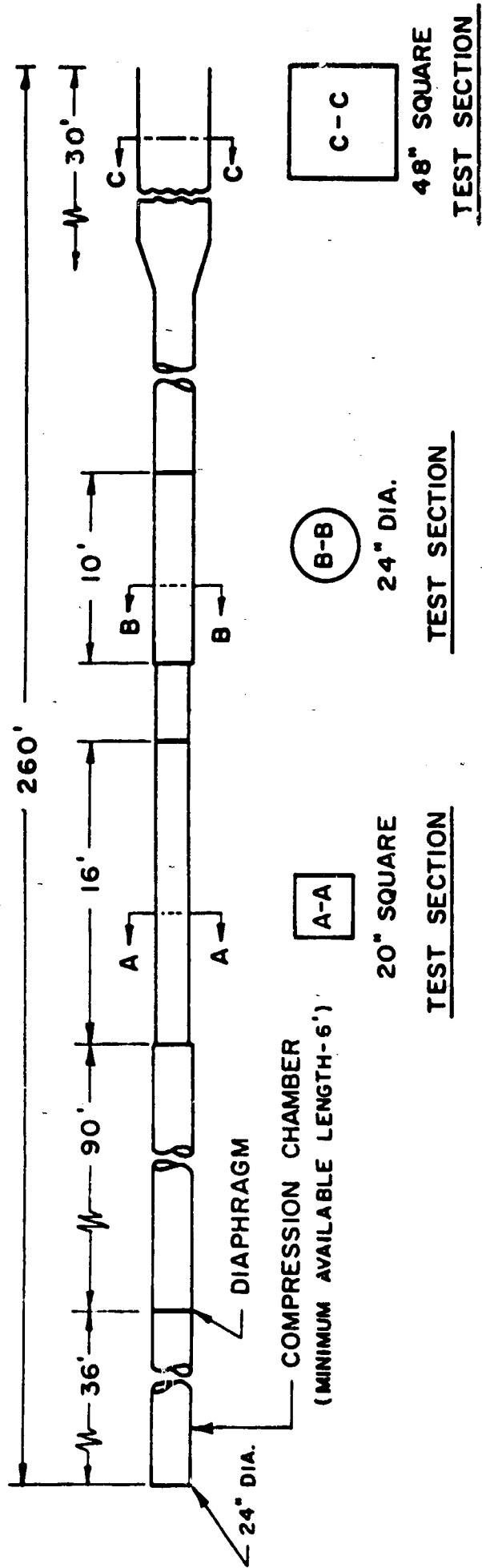

FIGURE 36. BRL 24" SHOCK TUBE

6. DRIVER: Compressed air in a driver section which may vary from 1 foot to a maximum of 55 feet. The air is supplied by two 125 psi compressors delivering 105 CFM and 223 CFM, respectively. These compressors may be coupled as first stages for two 550 psi booster compressors with 100 CFM and 230 CFM, respectively.

7. AVAILABILITY: U. S. Government and Government Contractor.

8. OTHER CONSIDERATIONS: A separate air supply drives the air piston for the diaphragm breaker. Cellophane, Mylar, lumerith, and aluminum diaphragms are used to separate the driver gas from the low pressure or expansion section of the shock tube. The 28 inch square sheets of diaphragm material are held by a 3000 psi hydraulic system. By a proper choice of driver length and air pressure many pressure-time profiles are available at the down stream test section.

9. DISCUSSION: The parts of the first test section may be used for test equipment or models. The second test section has about seven feet clearance between the outer wall of the device and a building. Models should be designed to fit within this space if they are to be attached to the outside of either of these two test sections.

10. REFERENCE: Draft Report furnished by Mr. E. E. Minor, Chief, Terminal Ballistics Laboratory, BRL, Aberdeen Proving Ground, Maryland, Letter dated 16 July 1964; Ahlers, E. B., "Experimental Methods of Determining the Behaviour of Underground Structures Under Dynamic Loads," IIT Research Foundation, Chicago, Illinois, for OCDM, Battle Creek, Michigan, page 145, November 1961.

1. TITLE AND/OR TYPE: Conical Shock Tube
2. LOCATION: U. S. Naval Weapons Laboratory
Dahlgren, Virginia
3. OWNER: Defense Atomic Support Agency
4. LOADING CHARACTERISTICS:

- a. Type Wave: Spherical
- b. Pressure: (Maximum Estimated)

Test Station 1 - 138 psi

Test Station 2 - 41 psi

Test Station 3 - 17 psi

- c. Duration: (Maximum Estimated)

Test Station 1 - 200 ms

Test Station 2 - 300 ms

Test Station 3 - 450 ms

5. PHYSICAL DESCRIPTION (Figure 37):

The shock tube is a frustum of a right circular cone, increasing in diameter from 16 inches to 24 feet, connected to four 16 inch diameter naval guns coupled in tandem. The shock tube is 2460 feet long and has 10', 15' and 22' diameter test stations located 1000, 1500 and 2200 feet respectively from the small end. Test station number one can be evacuated to simulate an altitude of approximately 100,000 feet.

6. DRIVER: Up to 1000 pound charge of TNT.
7. AVAILABILITY: 2nd Qtr FY67.
8. DISCUSSION: Information furnished is based on final A&E design submitted by MRD of American Transportation Co. in December 1964.

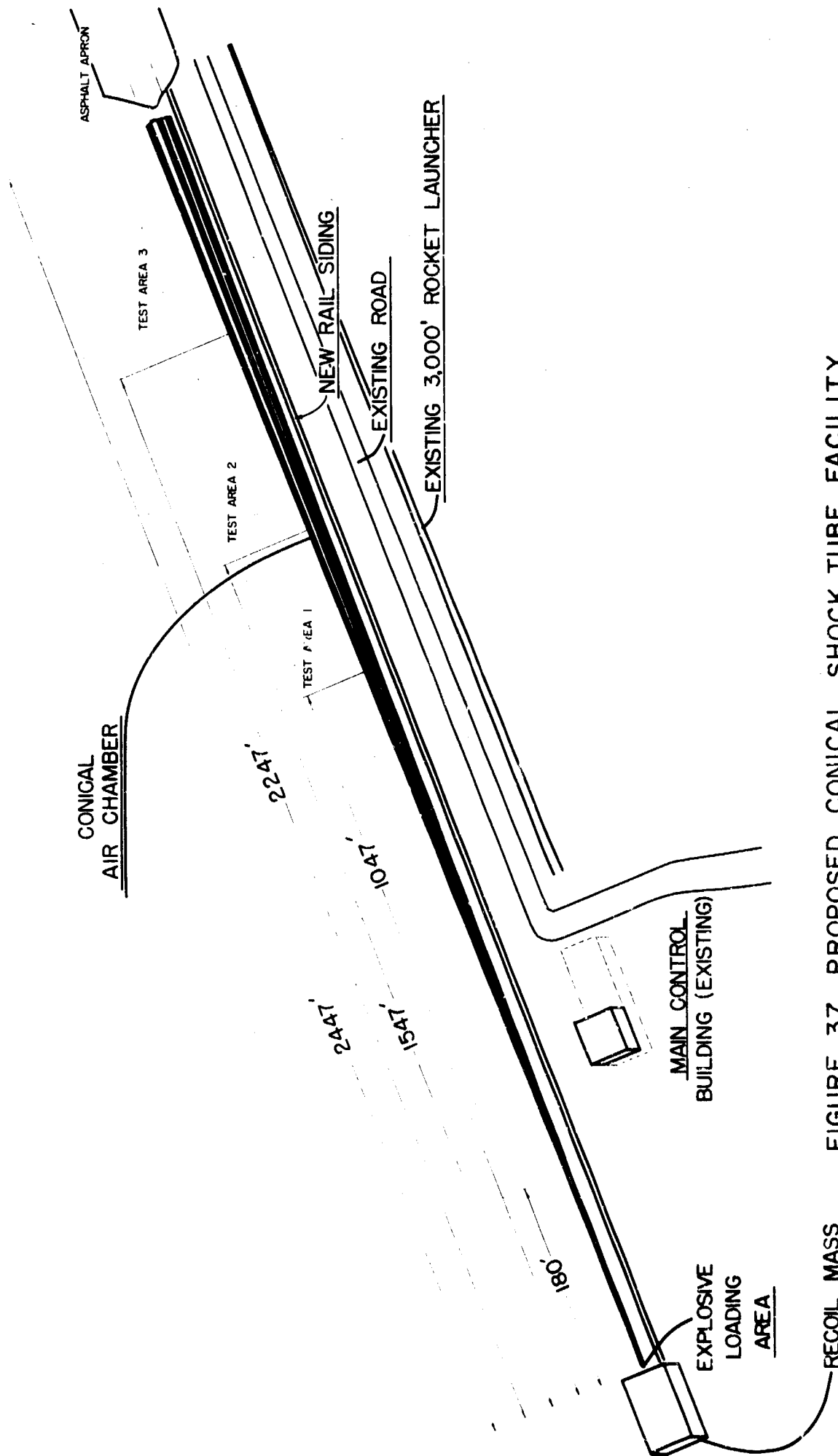

FIGURE 37. PROPOSED CONICAL SHOCK TUBE FACILITY

RECOIL MASS

1. TITLE AND/OR TYPE: Detonation-Driven Shock Tube
2. LOCATION: MRD Division (General American Transportation Corp)
7501 North Natchez Avenue
Niles, Illinois
3. OWNER: MRD Division
4. LOADING CHARACTERISTICS:
 - a. Type Wave: Exponential Decay
 - b. Pressure: Minimum (psi) 0 Maximum (psi) Incident 5000
Reflected 12,500
 - c. Force: Minimum (lbs) 0 Maximum (lbs) Reflected 48,000
 - d. Rise Time: 0
 - e. Dwell Time: 0
 - f. Duration: To 1/2 peak pressure up to 1.5 milliseconds
5. PHYSICAL DESCRIPTION (see figure 54 on page 110):
 - a. Diameter: 2 1/8 inches inside diameter
 - b. Length: 26 feet, 6 inches
6. DRIVER: Detonable gas such as propane-oxygen, methane-oxygen, and hydrogen-oxygen.
7. AVAILABILITY: Yes, by service or research contract with MRD.
8. DISCUSSION: Pressure and shock velocity measured with Kistler piezoelectric crystal pressure transducers.

The shock tube has been used to study the gas dynamics of the interaction that takes place when detonation waves are used to generate high overpressure shock waves.

1. TITLE AND/OR TYPE: Double-Driver Shock Tube (or Shock Tunnel)
2. LOCATION: Cornell Aeronautical Laboratory (CAL)
Buffalo, New York
3. OWNER: Cornell Aeronautical Laboratory
4. LOADING CHARACTERISTICS:
 - a. Type Wave: Shock Wave
 - b. Pressure: Pressure change across second shock
Minimum (psi) 0 Maximum (psi) 400
 - c. Force: Depends upon model size and Mach number of the flow.
Minimum (lbs) 0 Maximum (lbs) 18,000
 - d. Rise Time: $< 10^{-1}$ millisecond (risetime for pressure change in the gas).
 - e. Dwell Time: > 100 milliseconds
 - f. Decay Time: No pressure decay under normal test conditions.
If desired a pressure decay can be produced.
5. PHYSICAL DESCRIPTION (Figures 38 & 39):
 - a. Diameter: 4 inches, test section diameter, 96" for double-driver shock tunnel operation.
 - b. Length: 100 feet, test section 10 inches, test section (Shock Tunnel): 8 feet.
6. DRIVER: Hydrogen at 30,000 psi, 1260 R
7. CONTROLS: Standard controls for shock tube operation.
8. AVAILABILITY: Reference Cornell Aeronautical Laboratory, Applied Hypersonic Research Department, Buffalo, New York.
9. OTHER CONSIDERATIONS: This tube is being used in tests in conjunction with tests performed in a 4' diameter, 170 foot tube with a maximum pressure of 50 psi belonging to the Research Institute of the National Swedish Defense (FOA) under an Aeronautical Research Institute of Sweden (FFA) contract. Dr. Bo Lemcke has been

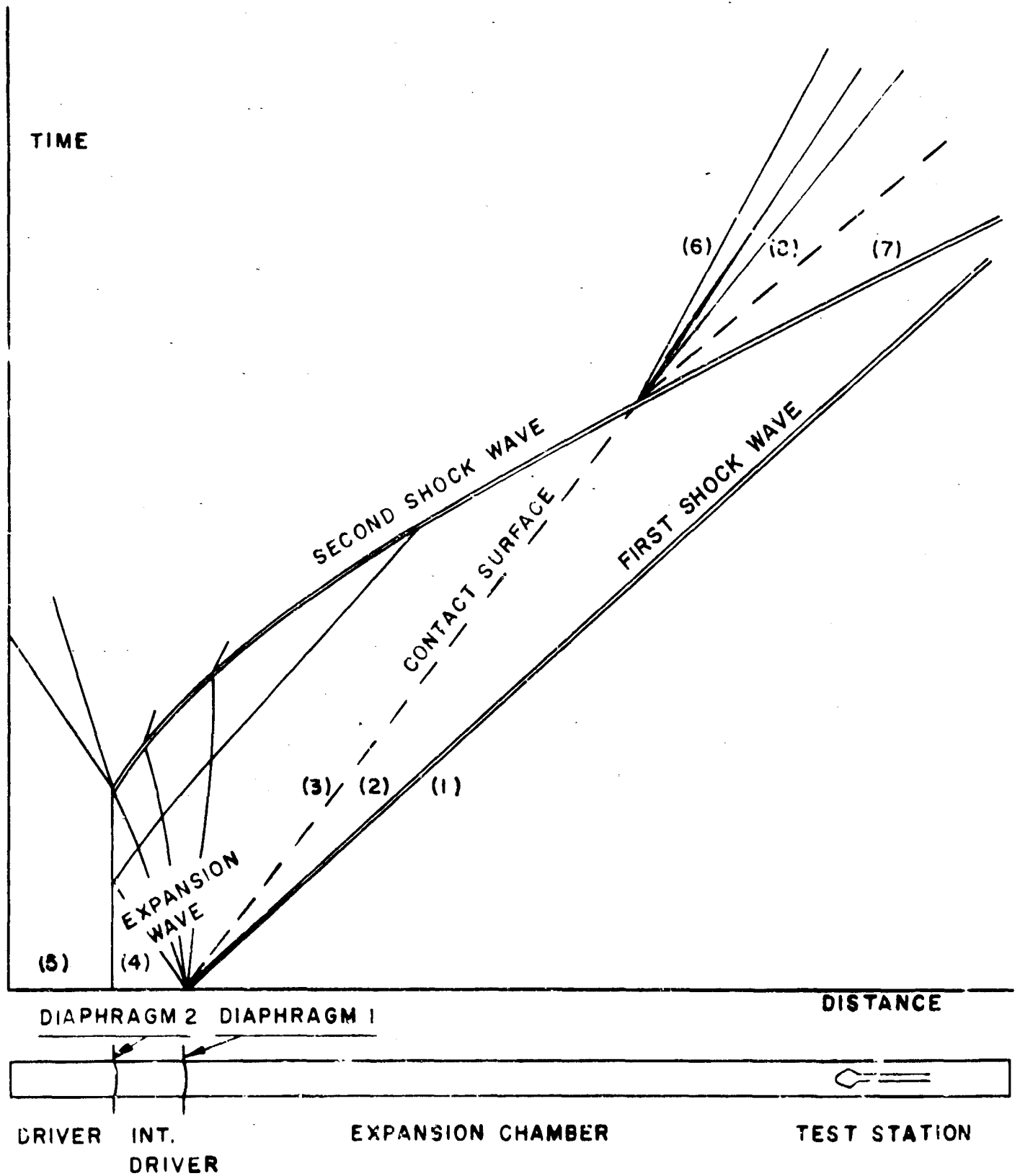
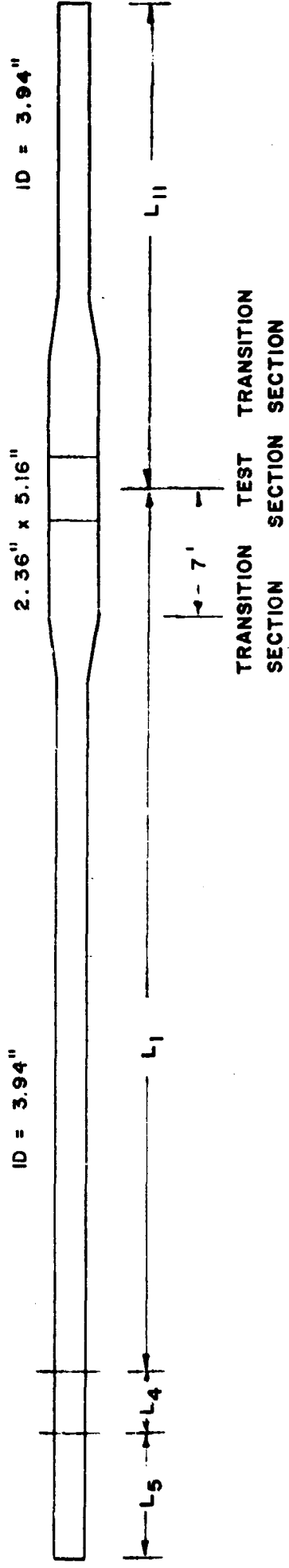

FIGURE 38. DOUBLE-DRIVER SHOCK TUBE.

JDR



- L5 = 3.3' - 13.1' : 2 SECTIONS 3.3' LONG, 2 SECTION 6.55' LONG.
- L4 = 1.3' - 7.9' : 2 SECTIONS 1.3' LONG, 1 SECTION 2.0' LONG, SECTION 3.3' LONG
- L1 = - 96' : 1 SECTION 3.5' LONG, 1 SECTION 6.55' LONG, SECTIONS 9.85' LONG, TRANSITION PLUS SQUARE SECTION UP TO TEST STATION 8'.
- L11 = - 50' : SQUARE SECTION PLUS 9.85' SECTIONS.

* 2 OF THESE SECTIONS HAVE 5 HOLES, 9.85" APART, FOR INSTRUMENTATION. ALL CIRCULAR SECTIONS ARE INTERCHANGEABLE. GSM

FIGURE 39 SKETCH OF SHOCK TUBE USED IN EXPERIMENTS

conducting the experiments.

10. DISCUSSION: The goal of the two test programs is to study the effects of shock wave impact on models that are already subjected to an ambient air flow. This is accomplished by employing a double-driver shock tube (DDST) as described in the referenced report. Thus two consecutive shock waves are formed; behind the first shock the steady flow around the model is established, at the arrival of the second shock the steady flow around the model is established, at the arrival of the second shock the transient can be studied.

11. REFERENCE: Lemcke, Bo, "Performance of Double-Driver Shock Tube," Consultant, Aerolastic & Structures Research Laboratory, Massachusetts Institute of Technology, present address, The Aeronautical Research Institute of Sweden (FFA), Bromma II, Sweden. FFA Contract No. AE-513:1. Report not dated.

b. Pantall, Jack T. Jr., Capt, USAF, Civil Engineering Branch, Air Force Weapons Laboratory, Kirtland Air Force Base, New Mexico, unpublished report, page 22, January 1962.

c. Hampton, Delon, "A Study of Pore Air Pressure Generated in Soil Subjected to Air Shock Waves," WL-TDR-64-3, Contract AF 29(601)-6002, Air Force Weapons Laboratory, Kirtland Air Force Base, New Mexico, October 1964.

1. TITLE AND/OR TYPE: 4-Inch Square Shock Tube
2. LOCATION: United Research Services
formerly Broadview Research Corporation
1181 Trousdale Drive
Burlingame, California
3. OWNER: United Research Services
4. LOADING CHARACTERISTICS:
 - a. Type Wave: Typical square wave
 - b. Pressure: Minimum (psi) Maximum (psi)
 Incident 2 Peak Reflected 70
 - c. Rise Time: About 3 milliseconds
 - d. Dwell Time: 0-10 milliseconds
 - e. Decay Time: 8-4 milliseconds
5. PHYSICAL DESCRIPTION (Figure not available)
 - a. Shape: 4 inches square
 - b. Length: 44" compression chamber and 60" expansion chamber
 - c. Other: Soil bin 4 inches square by 2 feet long.
6. DRIVER: Compresses air
7. CONTROLS: Electro-mechanical rupturing of bursting diaphragm
8. AVAILABILITY: Presently operational
9. REFERENCE: Mason, H. G., Griner, O. H., Waissar, R., Wallace, N. R.,
"A Study of Dynamic Soil Structure Interaction Characteristics of Real
Soil Media," United Research Services, Burlingame, California, RTD-TDR-
63-3075, page 20, December 1963.

1. TITLE AND/OR TYPE: 40-72-Inch Diameter Shock Tube
2. LOCATION: Lovelace Foundation for Medical Education & Research
Sandia Base Laboratory
Albuquerque, New Mexico
3. OWNER: Defense Atomic Support Agency
4. LOADING CHARACTERISTICS: Data not available
5. PHYSICAL DESCRIPTION (Figures 40 and 41): Its overall length is 179 feet. The 15 foot long compression chamber is 40 inches in diameter as is the first 125 feet of the expansion chamber, after which this diameter increases to 72 inches over a 9 foot conical section. The 72 inch diameter test section is 30 feet long and is closed with a blind flange.
6. DRIVER: Compressed air
7. AVAILABILITY; Available to a government agency with the consent of the Director of the Defense Atomic Support Agency and Dr. C. S. White of Lovelace Foundation.
8. OTHER CONSIDERATIONS: The entire shock tube is mounted on a system of wheels and rails so the various components can be easily interchanged.
9. DISCUSSION: The construction of this shock tube has recently been completed and has not yet been calibrated.
10. REFERENCE: "DASA-AEC-Lovelace Foundation Blast-Simulator Facilities," Sandia Base, Albuquerque, New Mexico. Report transmitted by letter dated 7 April 1965 from Dr. D. Richmond, page 3, author and date not available.

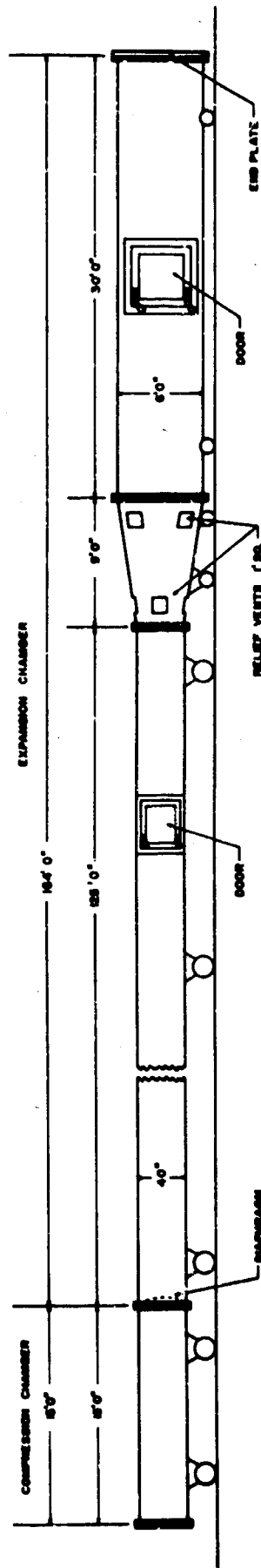

FIGURE 40. DETAILS OF 40-72 INCH DIAM. LOVELACE SHOCK TUBE

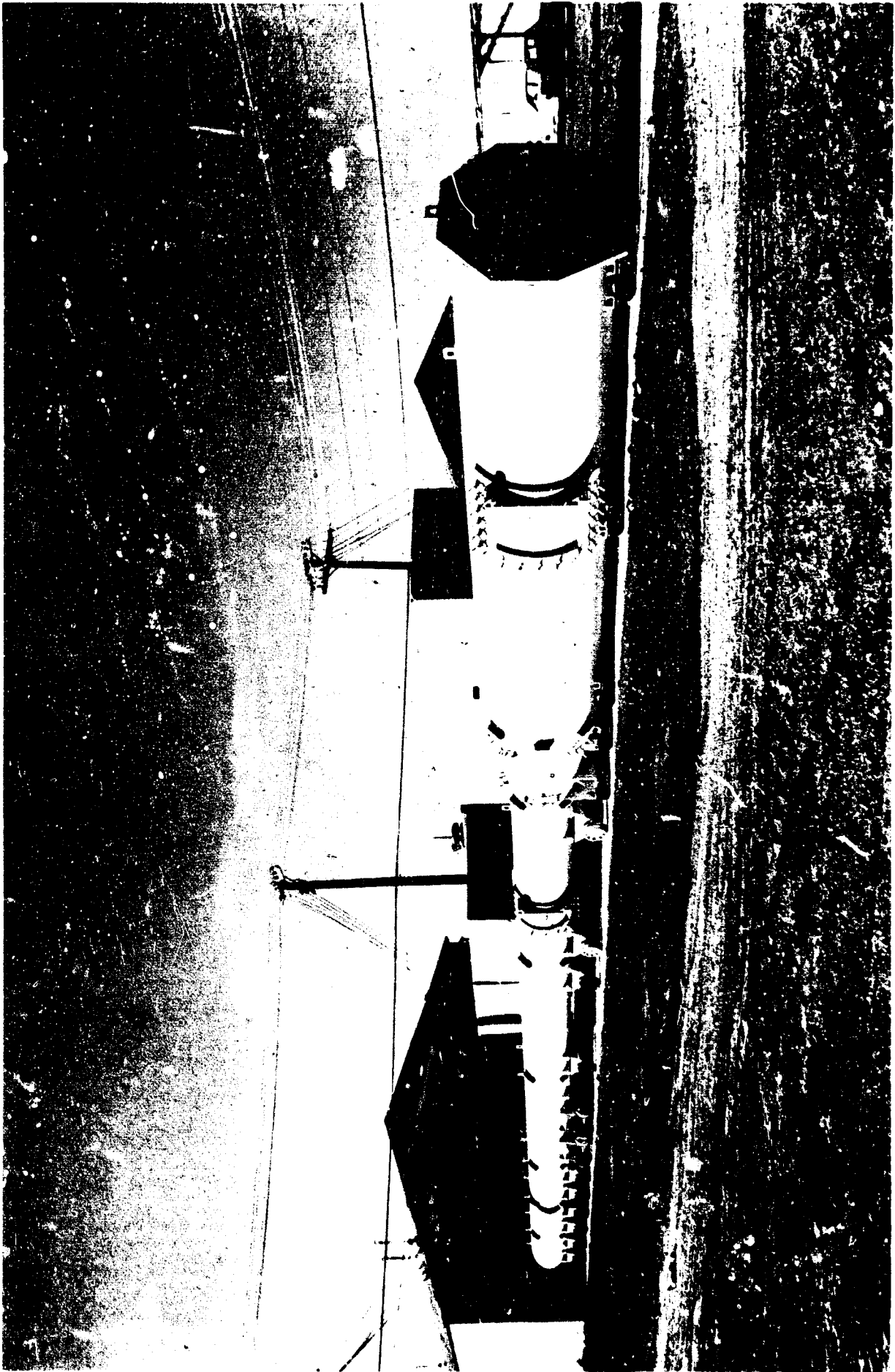

FIGURE 4.1. LOVELACE 40-72-INCH-DIAMETER
SHOCK TUBE

1. TITLE AND/OR TYPE: High-Capacity Pressure Tube
2. LOCATION: U. S. Naval Civil Engineering Laboratory
Port Hueneme, California
3. OWNER: U. S. Navy
4. LOADING CHARACTERISTICS:
 - a. Type Wave: Typical blast exponential
 - b. Pressure: Minimum (psi) 0 Maximum (psi) 1000
 - c. Rise Time: Instantaneous Shock
 - d. Dwell Time: Variable
 - e. Decay Time: Variable
 - f. Duration: Equivalent to 10 MT weapon @ 1000 psi.
5. PHYSICAL DESCRIPTION (Figure 42):
 - a. Diameter: 16 inches
 - b. Length: 30 feet
6. DRIVER: Special low-detonation pressure AN-SN-FO-TNT explosive.
7. CONTROLS: None
8. AVAILABILITY: Proof of principle, model only.
9. DISCUSSION: Preliminary proof tests have been completed. A suitable method was devised for achieving a concentric line charge without the use of carbon producing combustibles. Good pressure-time records have been achieved at overpressures less than 500 psi; no high pressure tests have been performed as yet.
10. REFERENCE: "First Semi-Annual Progress Report for FY-1965 on Tasks Supported by the Defense Atomic Support Agency-" U. S. Naval Civil Engineering Laboratory, Port Hueneme, California, pages 4, 5, 6, and 7, January 1965.

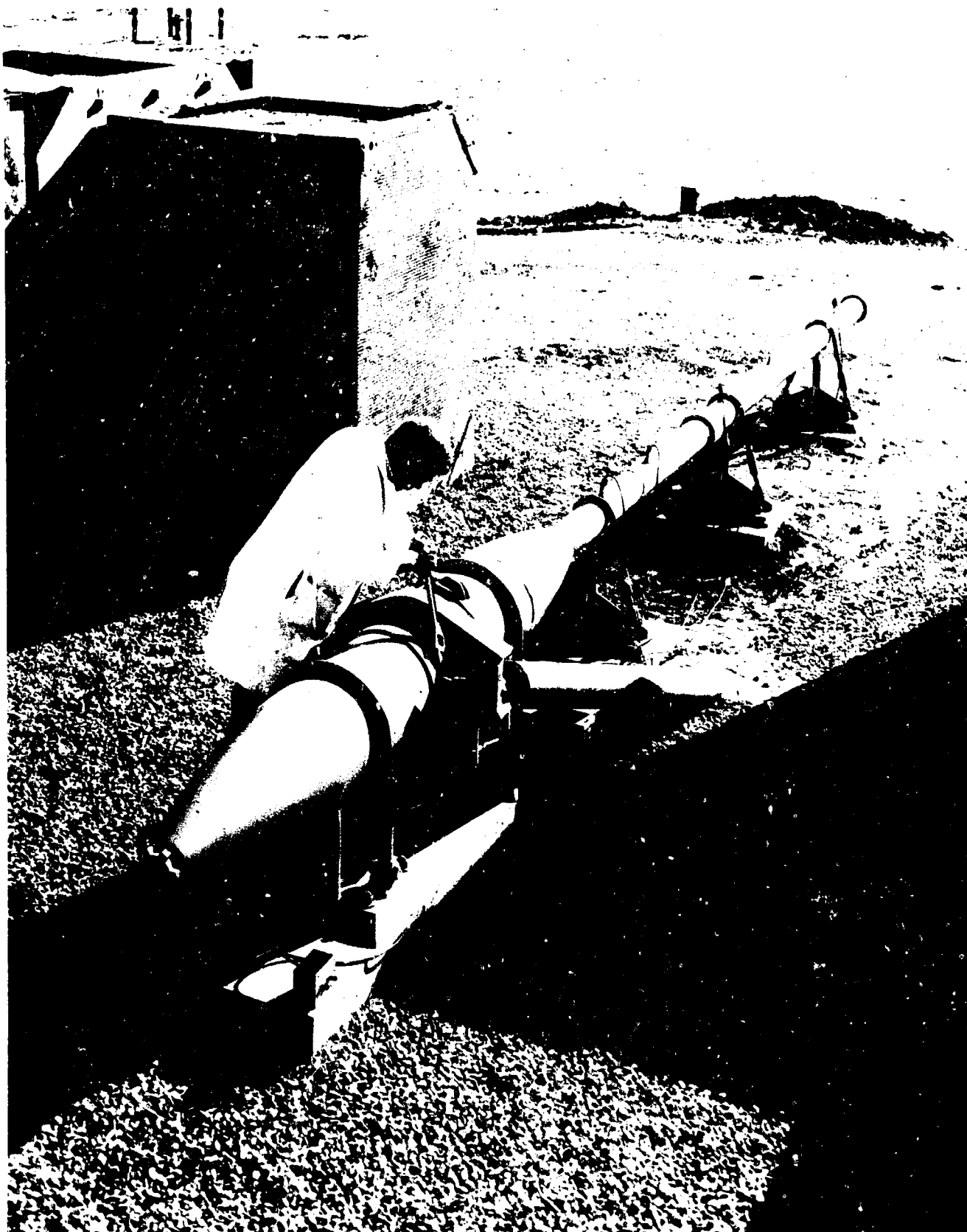

FIGURE 42. NCEL-HIGH CAPACITY PRESSURE
TUBE

1. TITLE AND/OR TYPE: High-Pressure Driven Shock Tube
2. LOCATION: MRD Division (General American Transportation Corp.)
7501 North Natchez Avenue
Niles, Illinois
3. OWNER: MRD Division
4. LOADING CHARACTERISTICS:
 - a. Type Wave: Square
 - b. Pressure: Minimum (psi) 0 Maximum (psi) 50
 - c. Rise Time: 0
 - d. Dwell Time: 5 ms
 - e. Decay Time: 10 ms
5. PHYSICAL DESCRIPTION (Figure 43):
 - a. Diameter: 10" I.D.
 - b. Length: 33 feet
 - c. Other: The test section is 6" X 8" and isolated by splitter plates.
6. DRIVER: Helium Gas Or Compressed Air
7. AVAILABILITY: Yes, by service or research contract with MRD.
8. DISCUSSION: A high capacity vacuum pump is available for evacuating the expansion chamber. Shock strengths of 34 can be obtained. The tube is equipped with a Mach-Aehnder interferometer and necessary apparatus to permit observation of flow characteristics by schlieren methods. The interferometer yield is eight inches in diameter and has a resolution better than one-quarter of one inch.

The tube has been used to determine shock loadings and response, including a study of an X-ray technique to monitor shock loaded soil response and a study of diffraction loads on aircraft shelters.

Piezoelectric crystal gauges are used for the measurement of diffraction and drag loads on shock-loaded models.

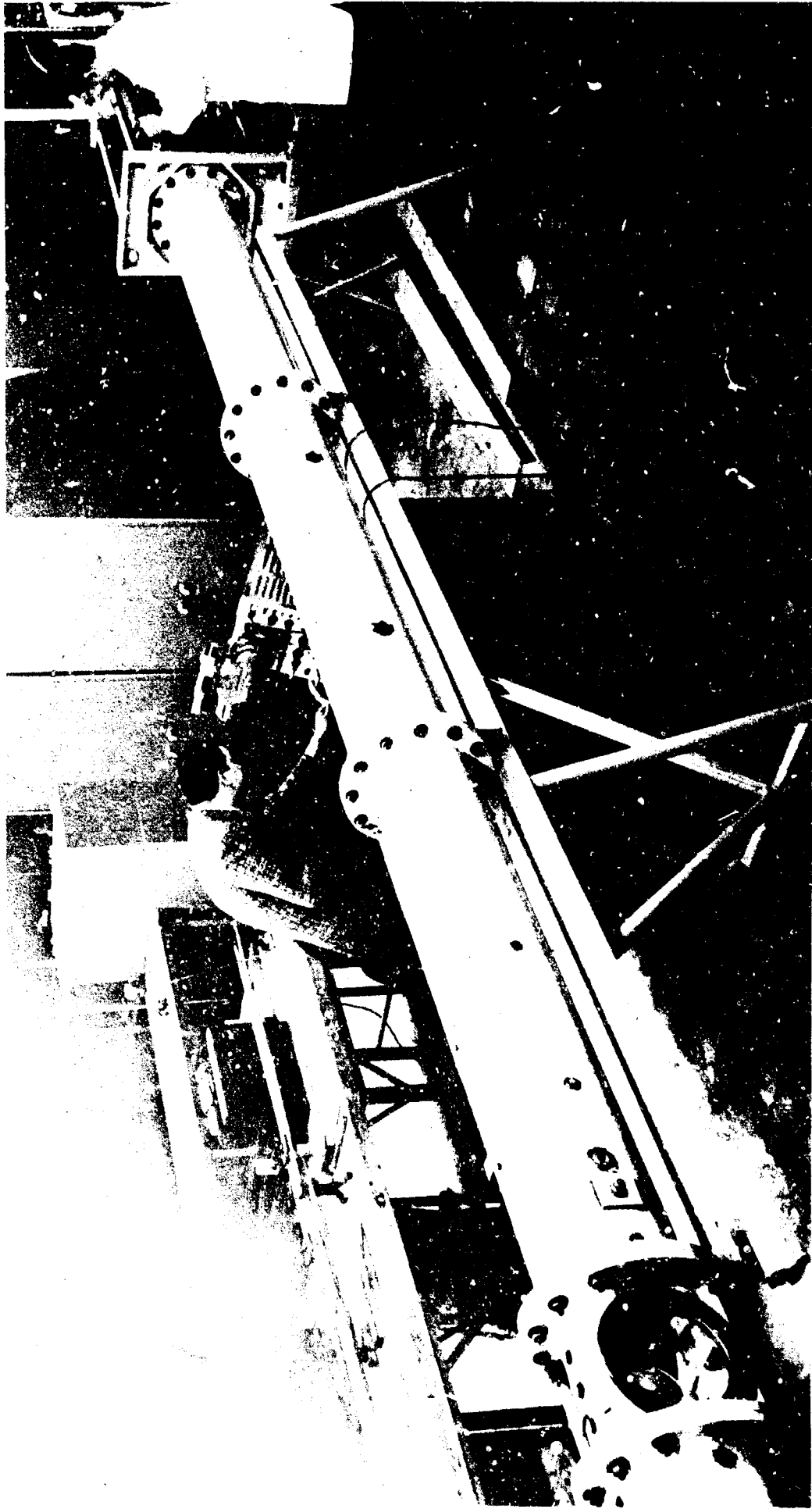

FIGURE 43. MRD HIGH-PRESSURE DRIVEN SHOCK TUBE

1. TITLE AND/OR TYPE: General Electric Shock Tubes & Tunnels
 - a. Electrically heated helium driver - 6" shock tube
 - b. Electrically heated helium driver - 30" shock tunnel
 - c. Combustion driver - 54" shock tunnel
 - d. Combustion driver - 30" shock tunnel
 - e. Combustion driver - 10" shock tunnel
2. LOCATION: General Electric Co. - Space Sciences Lab.
Valley Forge Space Technology Center
King of Prussia, Pa.
3. OWNER: G. E.: a & b
U.S.A.F.: c, d & e
4. LOADING CHARACTERISTICS:
 - a. Type Wave - Normal Aerodynamic Shock Wave
 - b. Pressure
 - (1) Static - Figure 51
 - (2) Dynamic - Figure 52
 - c. Force
 - (1) Function of model shape & size
 - d. Rise Time - < 1 microsecond
 - e. Dwell Time
 - (1) Air - 10 microseconds to 5 msec
 - (2) Air & Driver Gas - 100 microseconds to 20 msec
 - f. Decay Time - zero to 500 microseconds to $1/2 P_{max}$.
5. PHYSICAL DESCRIPTION:
Figures 45 & 46 - 6" Dia., electric arc discharge shock tube (a)
Figure 47 - 2"-30" Dia., electric arc discharge shock tunnel (b)

Figure 48 - 6"-54" Dia., combustion shock tunnel (c)

Figure 49 - 2"-30" Dia., combustion shock tunnel (d)

Figure 50 - 2"-10" Dia., combustion shock tunnel (e)
(also shock-on-shock modification using
heated driven tube gas as blow-down
reservoir to establish Mach 7 flow over
test model prior to shock tube operation)

Figure 44 - Summary Description of Tubes & Tunnels

6. AVAILABILITY: (a) 1966, (b) 1966, (c) 1966, (d) Oct. 1965,
(e) Nov. 1965

I. LARGE SHOCK TUNNEL

A. AERODYNAMICS - FLUID MECH
B. HIGH ENERGY FLOWS

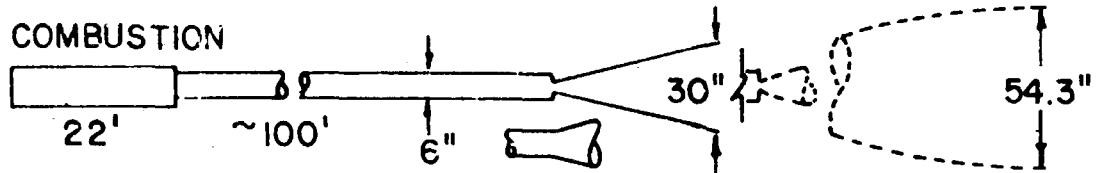

2. SMALL SHOCK TUNNEL

A. AERODYNAMICS - FLUID MECH.

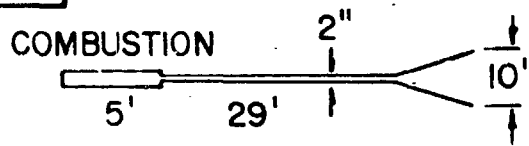

3. CLEAN SHOCK TUNNEL

A. HIGH ENERGY FLOWS
B. AERO-FLUID MECH

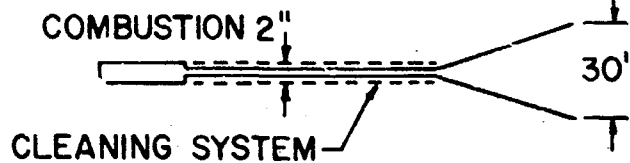

4. HYPERVELOCITY SHOCK TUBE

A. HIGH ENERGY FLOWS
B. FLUID MECHANICS

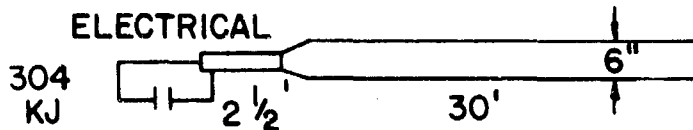

5. HYPERVELOCITY SHOCK TUNNEL

A. HIGH ENERGY FLOWS

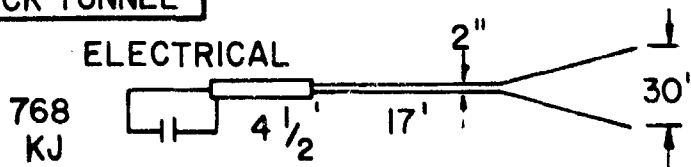

FIGURE 44. SUMMARY DESCRIPTION OF OPERATING SHOCK TUBE AND SHOCK TUNNELS.

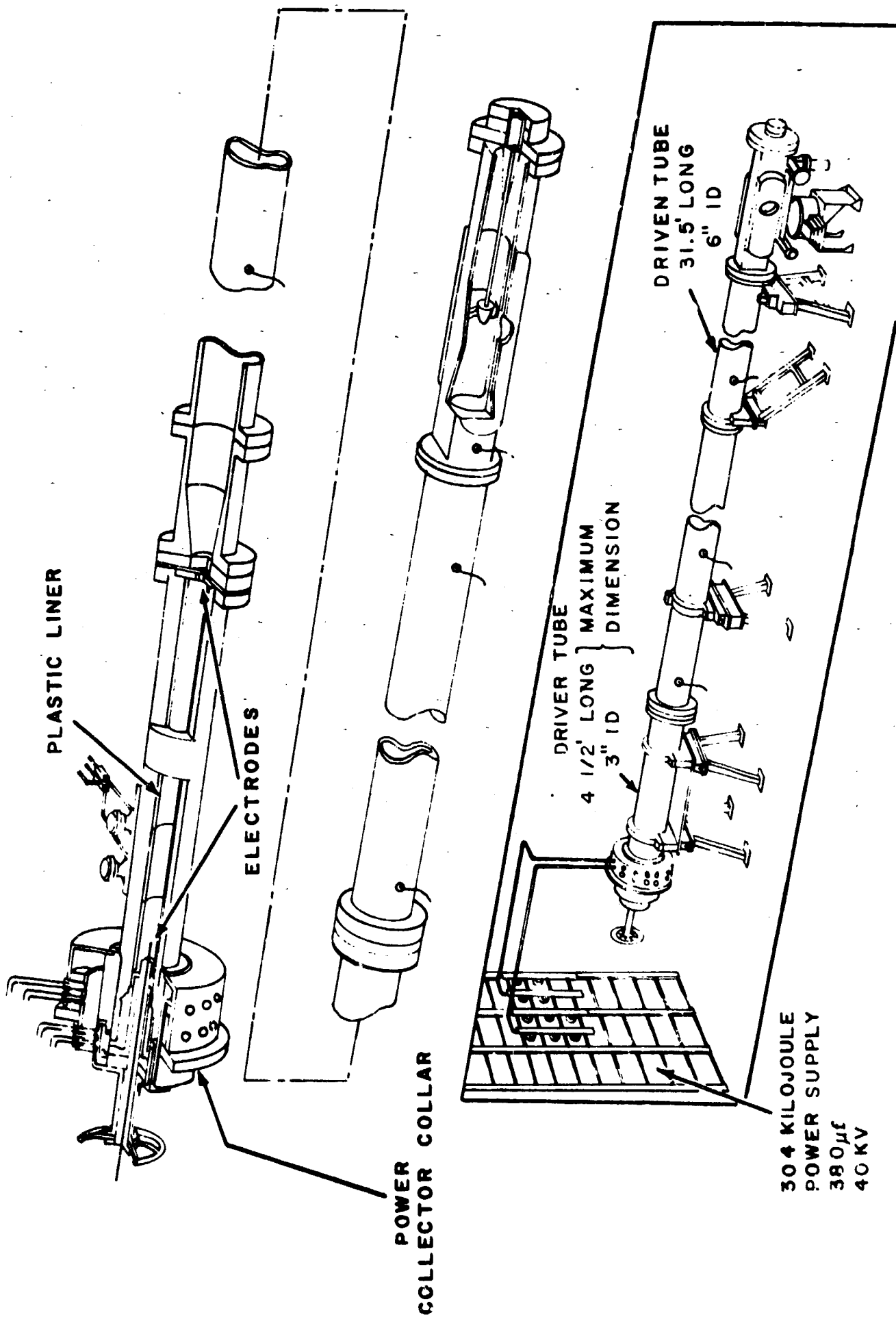

FIGURE 45. ELECTRICALLY DRIVEN SHOCK TUBE

JDR

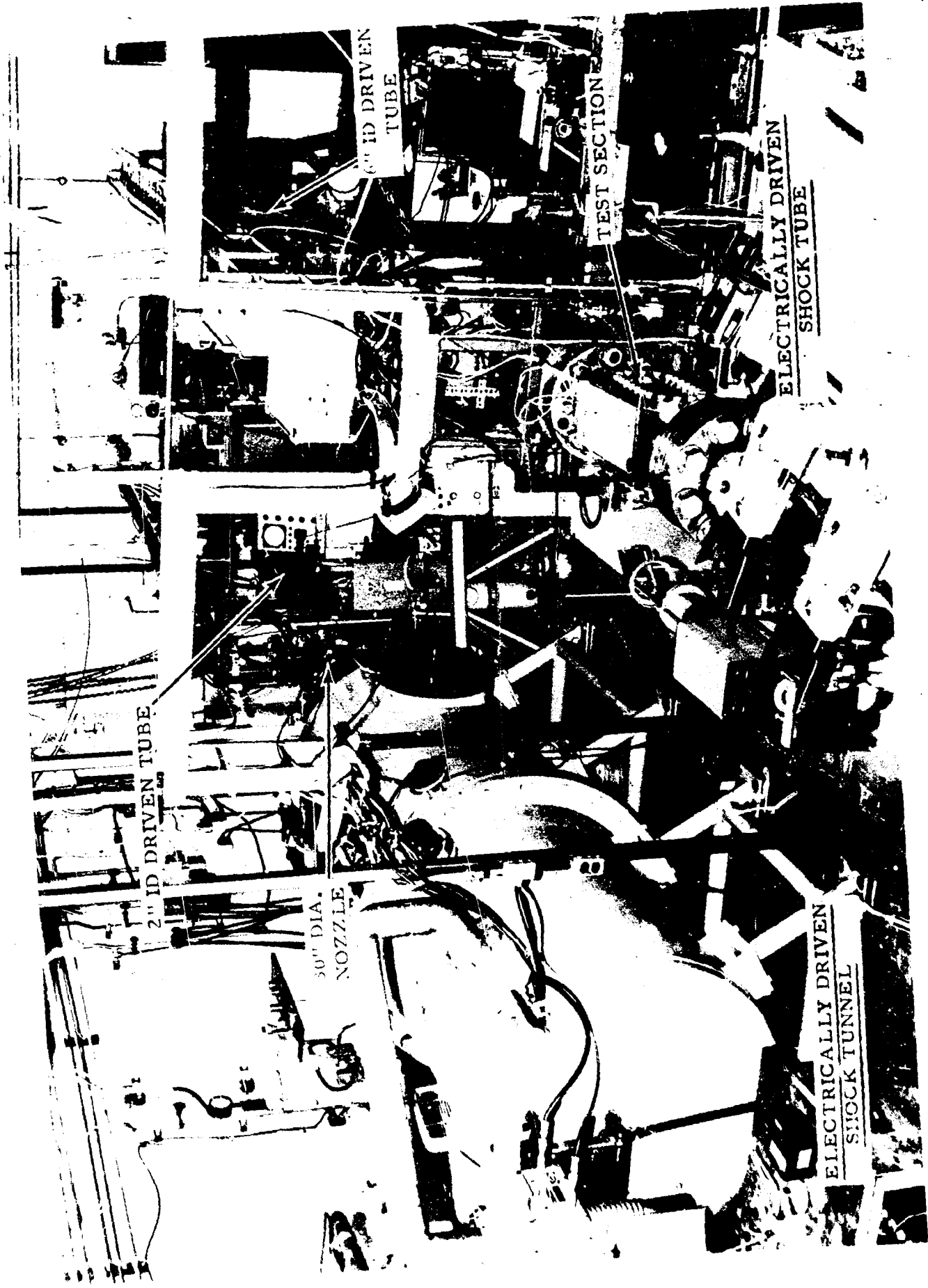

Figure 46. 6" Dia., electric arc discharge shock tube

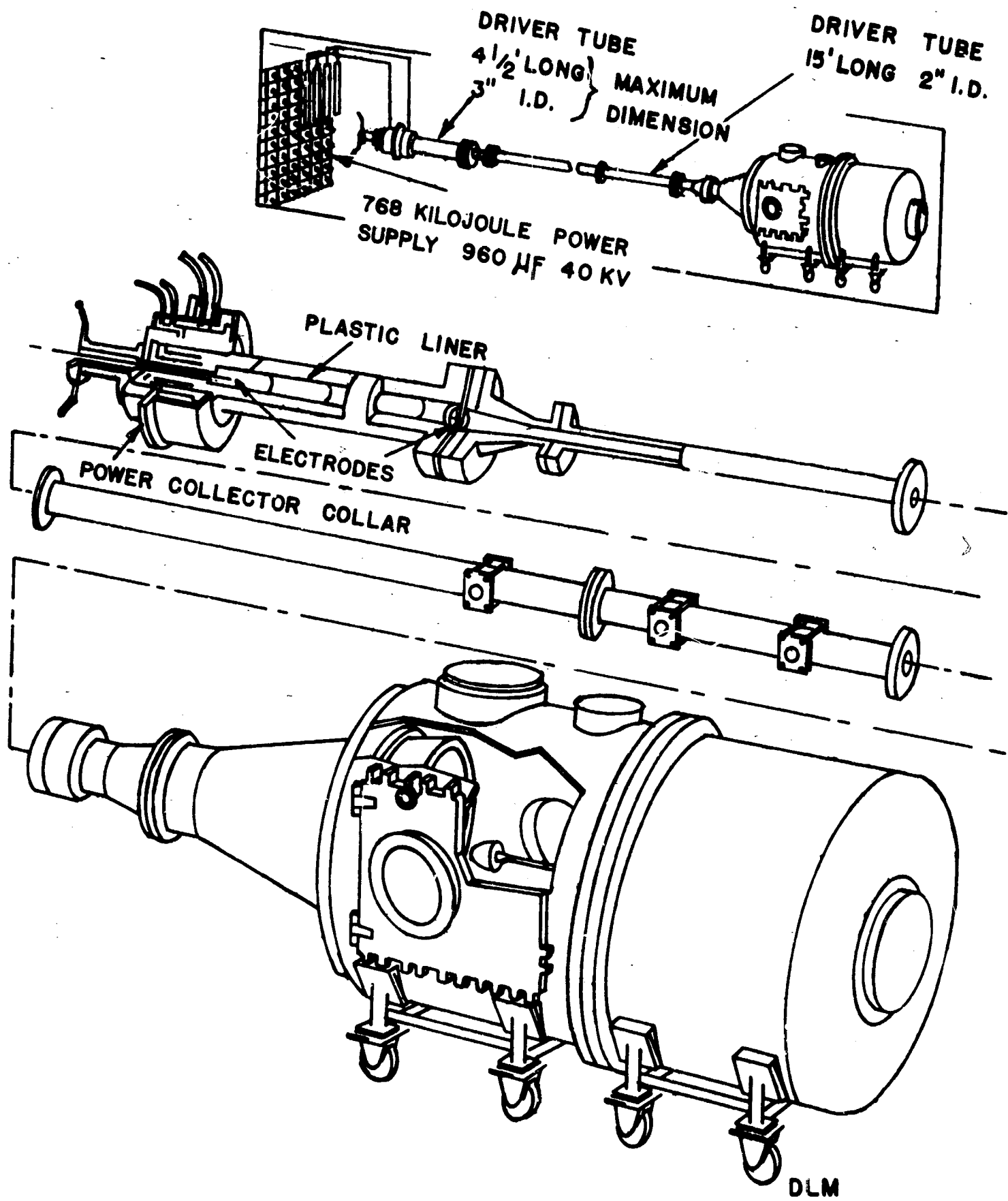

FIGURE 47. ELECTRICALLY DRIVEN SHOCK TUNNEL
WITH 30" DIAMETER TEST SECTION.

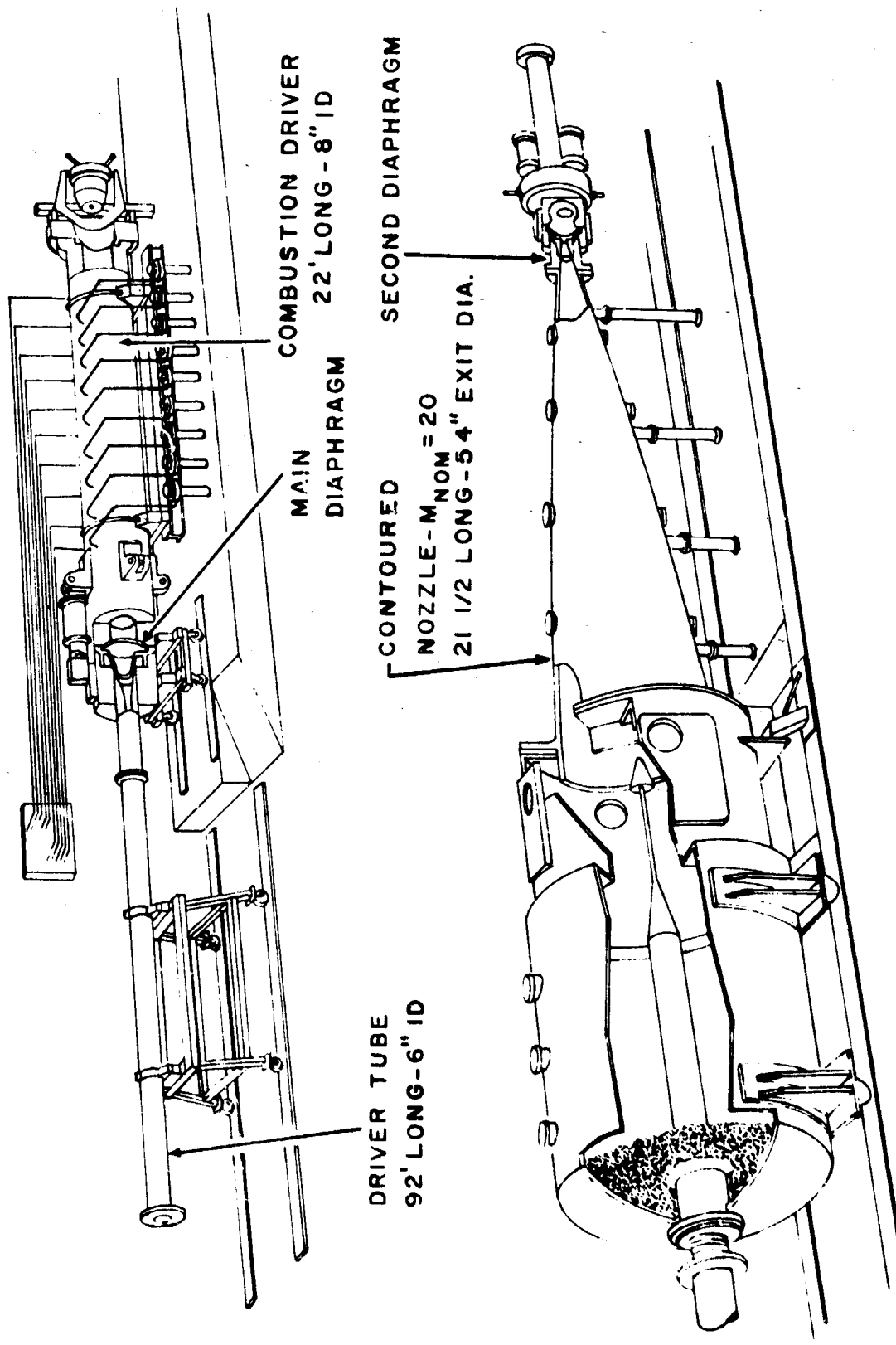

FIGURE 48. SKETCH OF LARGE SHOCK TUNNEL WITH CONTOURED NOZZLE INSTALLED

JDR

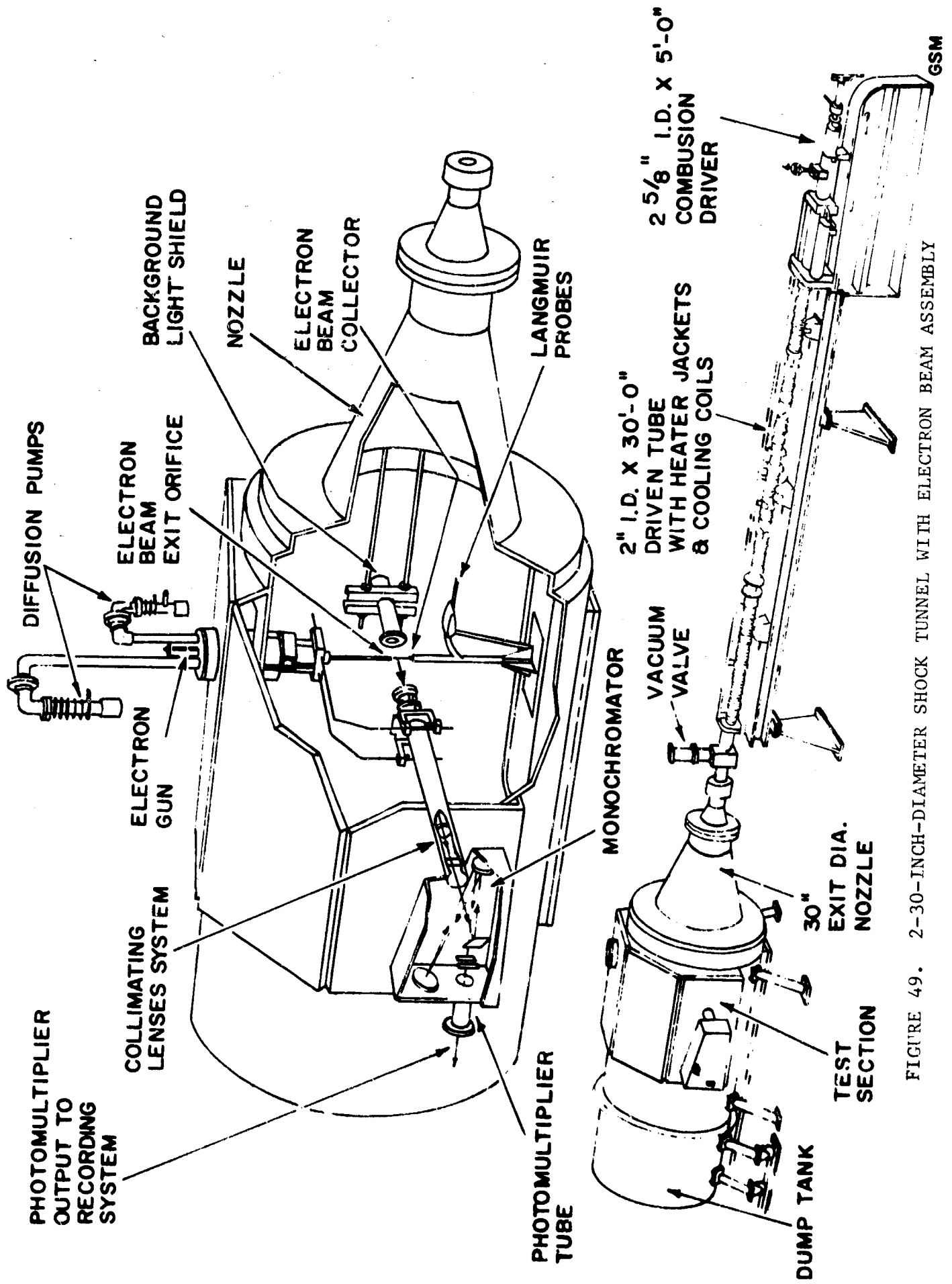

FIGURE 49. 2-30-INCH-DIAMETER SHOCK TUNNEL WITH ELECTRON BEAM ASSEMBLY

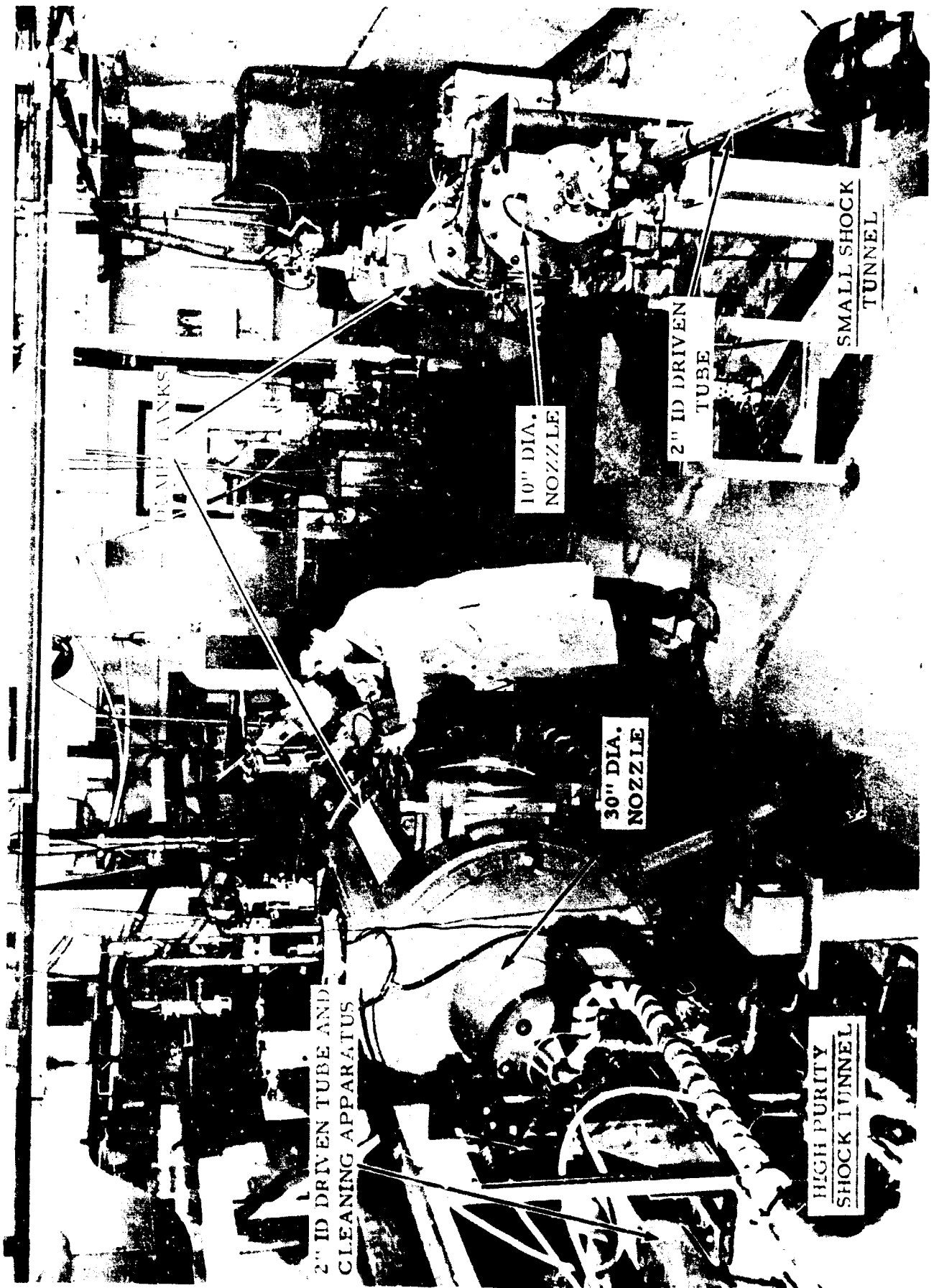

FIGURE 50. 2-10-INCH-DIAMETER COMBUSTION SHOCK TUNNEL

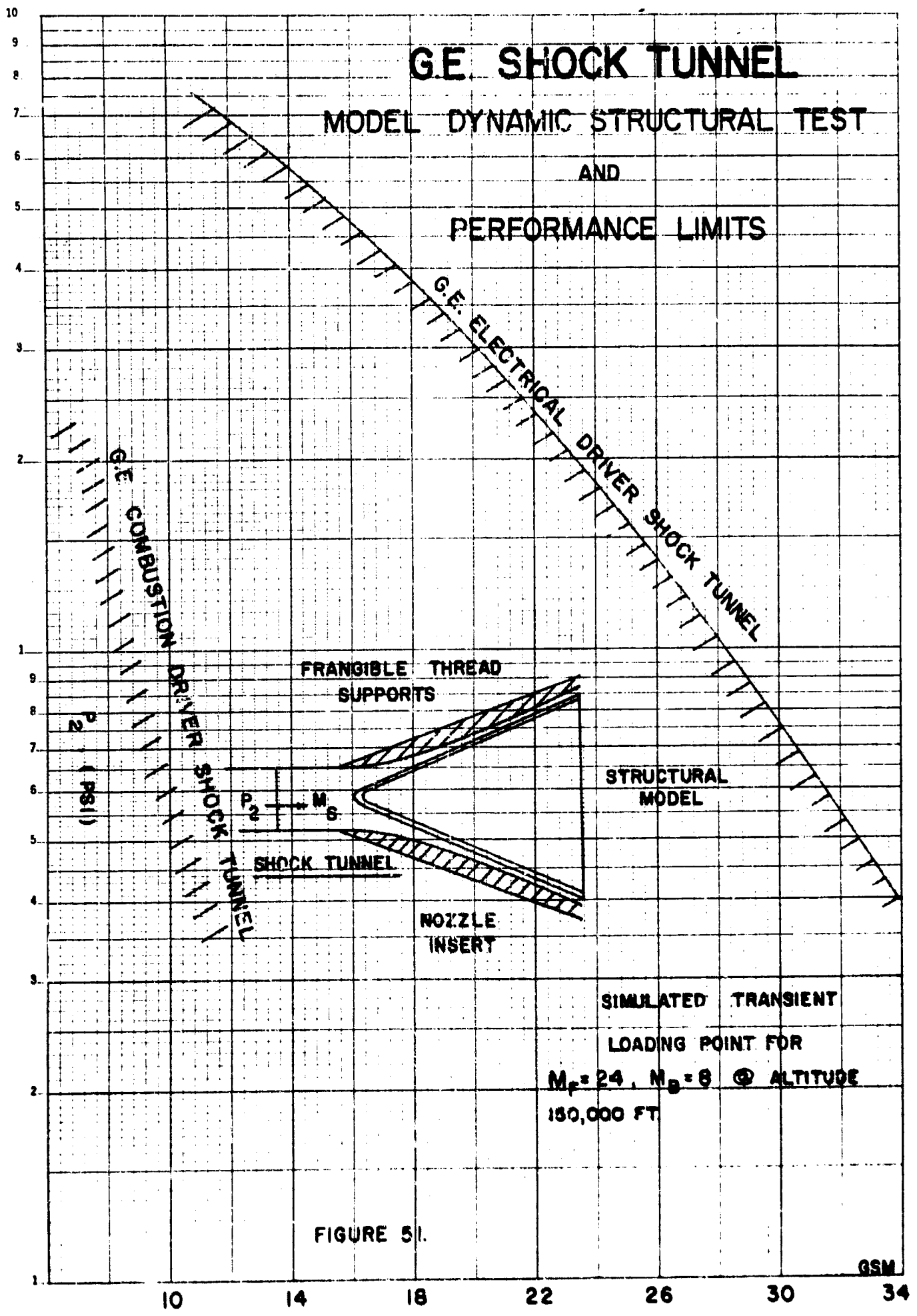

FIGURE 51.

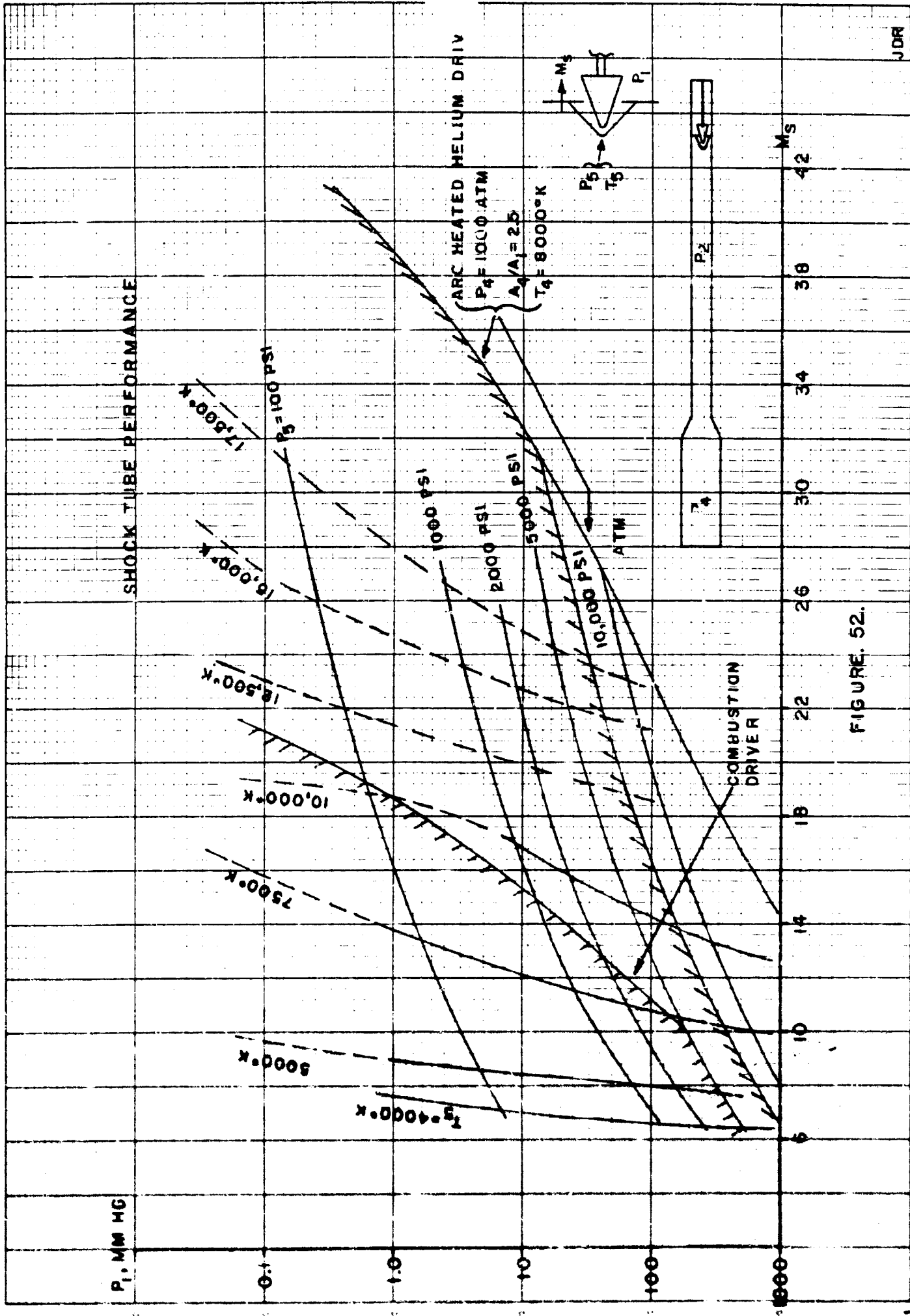

FIGURE 52.

JDR

1. TITLE AND/OR TYPE: Low-Pressure Loader (2)
2. LOCATION: URS Corporation
1811 Trousdale Drive
Burlingame, California
3. OWNER: DASA
4. LOADING CHARACTERISTICS:
 - a. Type Wave: Step Wave, (a square wave can be applied to the sample by means of a limiting piston)
 - b. Pressure: Minimum (psi) 10 Maximum (psi) 500 in chamber
 - c. Force: Minimum (lbs) Maximum (lbs) 20,000 w/multiplier
 - d. Rise Time: Variable from about 200 microseconds to quasi-static
 - e. Dwell Time: Continuous as desired
 - f. Decay Time: About 200 microseconds at the input end of the sample by arresting loading piston
5. PHYSICAL DESCRIPTION (Figure 53):
 - a. Diameter: 4 in. I. D.
 - b. Length: 8 in. (Compression Chamber only)
 - c. Other: Length of expansion chamber is variable. The maximum stress applied to a sample can be increased substantially above the chamber pressure by means of a multiplier piston. Stresses in excess of 3500 psi have been developed in 1 1/2 in. diameter samples.
6. DRIVER: Compressed air-piston
7. CONTROLS: Electromechanical rupturing of bursting diaphragm
8. AVAILABILITY: Currently operational, contact above address
9. OTHER CONSIDERATIONS: Loaders can be used for calibrating pressure transducers and free-field stress gauges, as well as, generating stresses in soil samples.

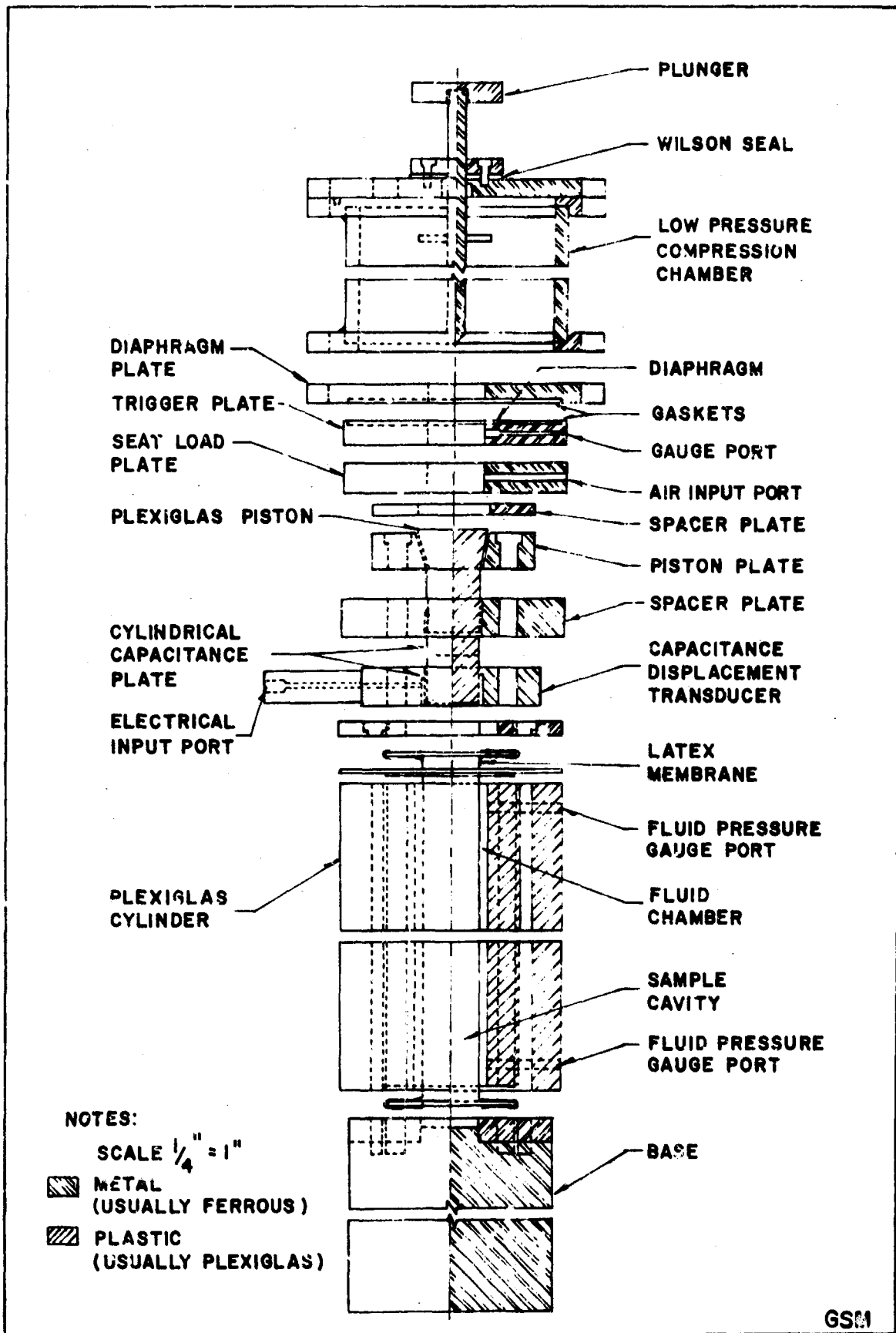

FIGURE 53. FLUID BOUNDARY WAVE PROPAGATION DEVICE WITH LOW-PRESSURE LOADER.

10. REFERENCE: Zaccor, J. V., "Techniques and Equipment for determining Dynamic Properties of Soils", United Research Services, Incorporated, Burlingame, Calif., URS B155-24. pp 9-11, July, 1962.

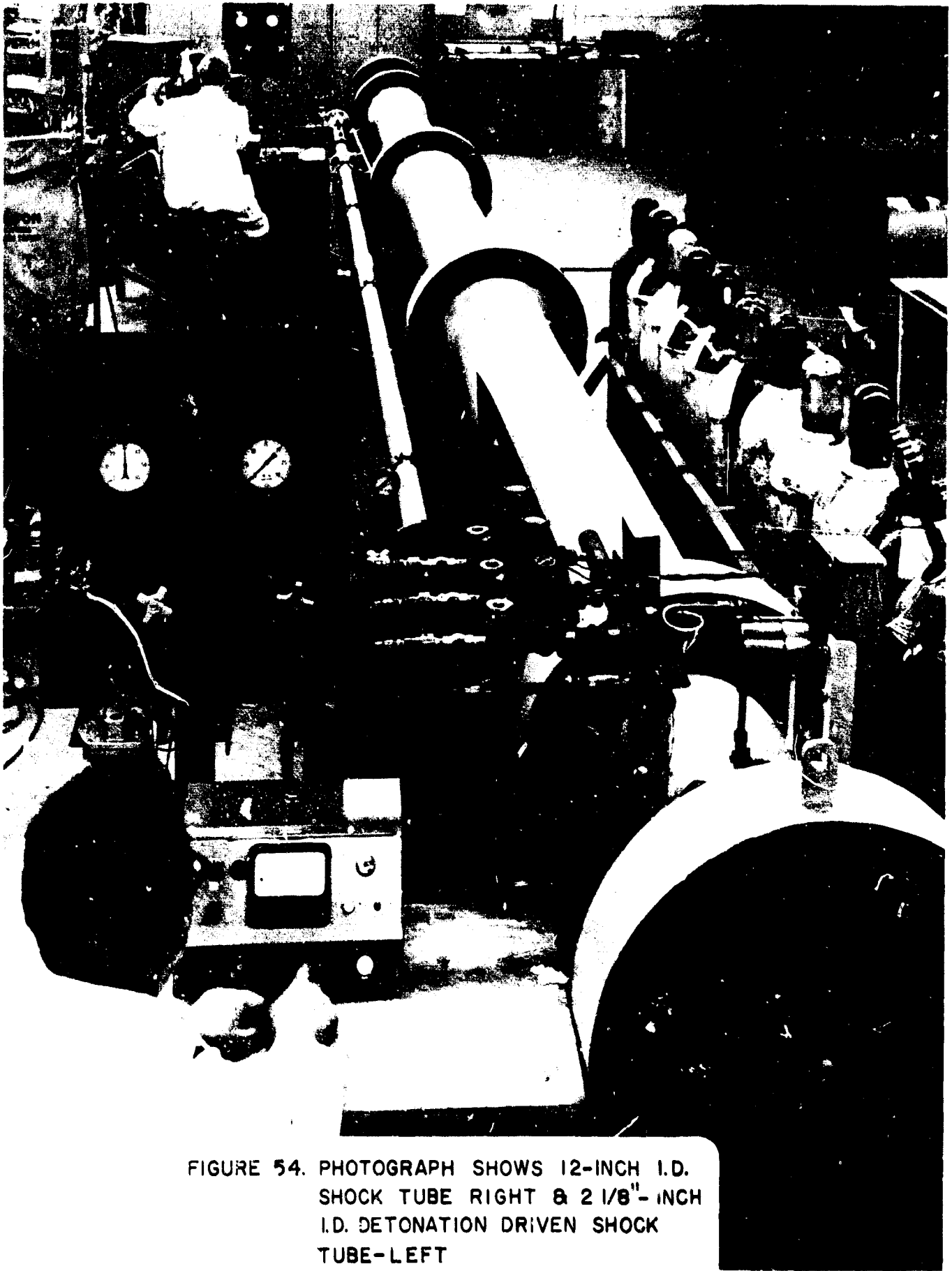

FIGURE 54. PHOTOGRAPH SHOWS 12-INCH I.D. SHOCK TUBE RIGHT & 2 1/8"- INCH I.D. DETONATION DRIVEN SHOCK TUBE-LEFT

1. TITLE AND/OR TYPE: NCEL Shock Tube (Combination)
2. LOCATION: U. S. Naval Civil Engineering Laboratory
Port Hueneme, California 93041
3. OWNER: U. S. Navy
4. LOADING CHARACTERISTICS:
 - a. Pressure: Minimum (psi) 0 Maximum (psi) 12
 - b. Force: Minimum (lbs) 0 Maximum (lbs) 1728
 - c. Rise Time: 1 msec
 - d. Decay Time: See duration
 - e. Duration: Positive phase is 40 milliseconds open tube; 400 milliseconds modified closed end.
5. PHYSICAL DESCRIPTION (Figure 55):
 - a. Size: 1 foot squared
 - b. Length: 38 feet
6. DRIVER: Compressed air using a mylar diaphragm broken by a wax projectile shot from a modified 22-caliber rifle.
7. CONTROLS: Manual
8. AVAILABILITY: Scheduled for use as a pressure loading device until July 65. Usually available on arrangement for several months each year.
9. OTHER CONSIDERATIONS: When used as a pressure loading device the square tube is blanked off and the cylindrical tank is connected to an 8-inch-diameter tube made of extra heavy steel. The positive phase duration can be varied from about 0.5 seconds to 5 seconds. Maximum overpressure is 150 psi.
10. DISCUSSION: Items to be tested, such as blast closure valves, are connected to the 8-inch tube but separated from the tank by a mylar diaphragm. The diaphragm is broken as above (Driver) and at the same instant solenoid valves on the tank are opened to release the air pressure.



FIGURE 55. 1-ft. SQUARE NCEL SHOCK TUBE

The shock tube is being used to test fragile items such as air filters, which would be located downstream from a blast closure valve and subject to small shock waves due to leakage (5 to 10 psi). The pressure loading device is being used to test a blast closure valve designed by BUSHIPS. This equipment will be continued to be used for similar purposes in the future. There are no immediate plans for increasing the capacities of the equipment.

11. REFERENCE: Christensen, W. J., Captain, CEC, USN, "Summary on NCEL Shock Tube and Valve Loading Device," Ltr dtd 31 March 1964.

1. **TITLE AND/OR TYPE:** 6-Foot-Diameter Shock Tube
2. **LOCATION:** Eric H. Wang Civil Engineering Research Facility
Area Y
Sandia Base, New Mexico
3. **OWNER:** U. S. Air Force
4. **LOADING CHARACTERISTICS:**
 - a. **Type Wave:** Traveling
 - b. **Over-Pressure:** Minimum (psig) 2 Maximum (psig) 100
 - c. **Rise Time:** Instantaneous
 - d. **Positive Phase Duration:** 190 milliseconds at 100 psig overpressure
5. **PHYSICAL DESCRIPTION (Figures 56, 57, & 58):**
 - a. **Diameter:** 6 Foot outside diameter
 - b. **Length:** 246 feet overall
 - c. **Other:** 22 pieces of 72 inch O.D. steel pipe make up the tube utilizing 5, 6, 7, 10, 15 and 20 foot long sections.
6. **DRIVER:** Primacord is used. A volume-detonation technique similar to that applied in explosive-gas shock tubes, is employed in using the primacord. The primacord is distributed over a finite length of compression chamber on expendable cross wires that are attached to the walls of the chamber.
7. **CONTROLS:** The UED-Ampex Control Console with 65 channels of recording ability and 5 channels of time-mark.
8. **AVAILABILITY:** Available to contractors of the United States Government on contracts requiring testing within the tubes limitation. Scheduling is controlled by the Air Force Project Officer and the Director of the Facility.
9. **OTHER CONSIDERATIONS:** Air blast testing is done on a limited basis. Radar domes and structural shapes have been tested and taken to destruction by small increments of overpressure.

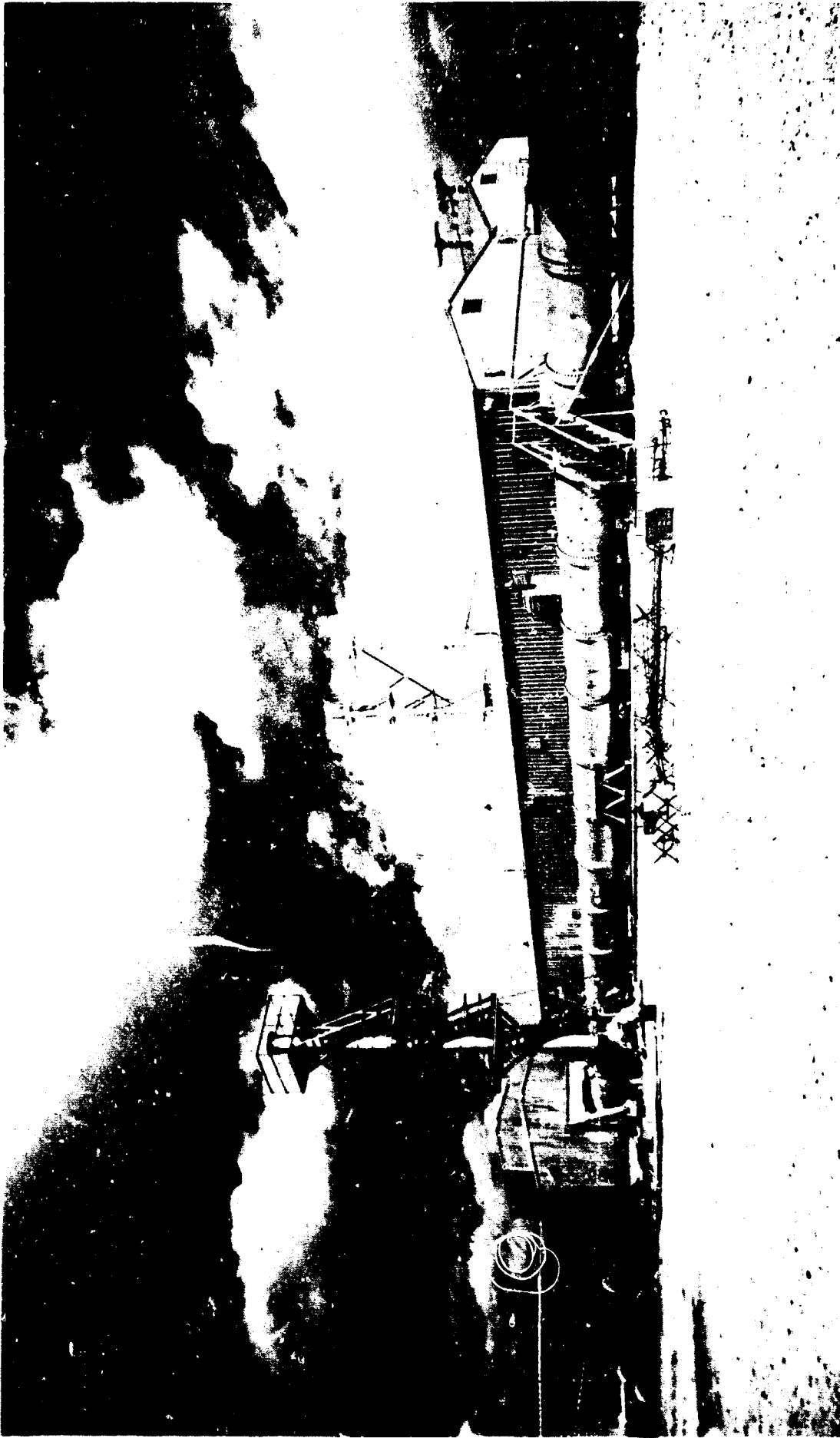

FIGURE 56. SHOCK TUBES SHOWN ARE L. TO
R.: 2-FOOT-DIA. HORIZONTAL
TUBE, 2-FOOT-DIA. VERTICAL
TUBE, 6-FOOT-DIA. TUBE, 2-FOOT
VERTICAL TUBE & 12-INCH X-RAY
TUBE



FIGURE 57. THE 350-PSI COMPRESSION SECTION DOOR OF THE 6-FT.-DIAMETER SHOCK TUBE

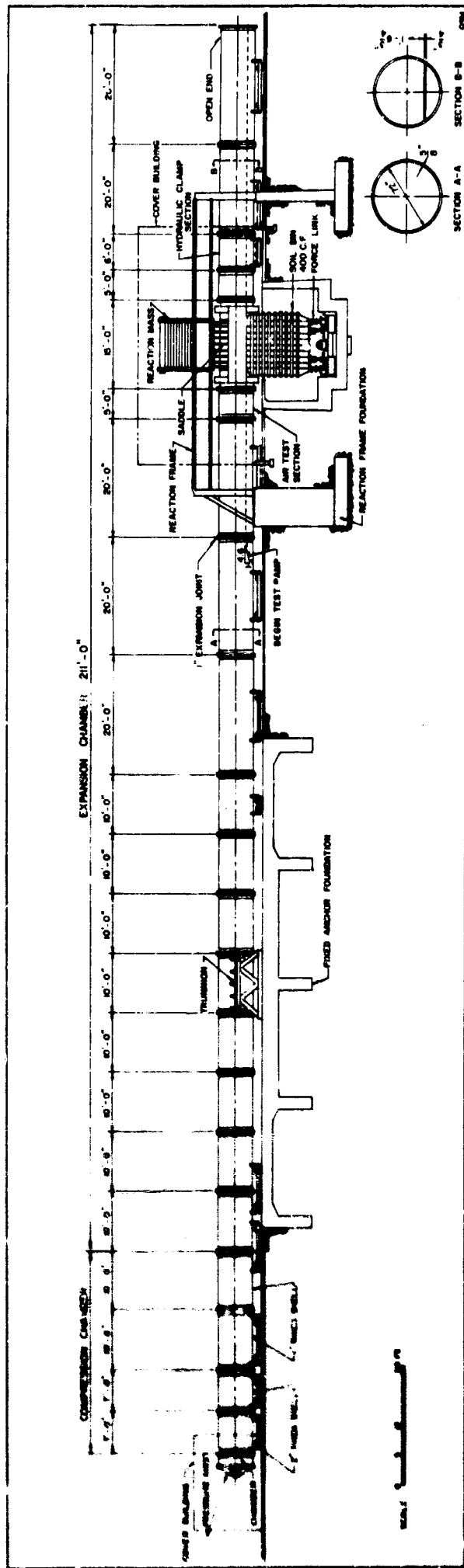

FIGURE 58. LAYOUT AND ELEVATION OF SIX-FOOT SHOCK TUBE

10. DISCUSSION:

This 6 foot diameter shock tube was formerly located at Gary, Indiana and was operated for the Air Force by the Armour Research Foundation. In Albuquerque, at Sandia Base, the WCERF is operated under a service contract by the University of New Mexico. The 6 foot shock tube was redesigned to test soil and buried structures in a 400 cubic foot bin. At Gary, it was used for air blast tests primarily until Mr. Harold R. J. Walsh, AFWL, designed a small soil bin and ran a few experiments. The testing of soil seemed promising and led to the design of the present configuration and testing program.

At this soil test section, there is a 5 foot by 8 foot opening in the floor of the shock tube. The soil bin or the closure device (used for air blast tests) is placed under this opening and jacked into place. A reaction frame on the upper side of this test opening and completely divorced from the tube resists the upward force. Based on a maximum overpressure of 100 psig the upward force is approximately a 576,000 pound thrust.

The tube, at the test section, crosses a pit which contains two 400 cubic foot bins and the closure device. A Linkbelt car spotter, through a pulley system and a turntable, pulls the bin on rails to a position over four synchronized jacks. The jacks when energized raises the bin into place. The soil bins are 5 feet wide, 8 feet long and 10 feet deep, and are constructed of one inch steel plate that is reinforced with vertical and horizontal stiffeners.

At the air test section four view ports for Fastax camera recording are available. The viewing windows are 3/4 inch thick and 7 1/2 inches in diameter and are made of "Plex II," an optically pure Lucite material. A similar view port is installed at the soil test section.

Ottawa sand has been used as the soil media in tests to date but clay and coarse soils are to be used as testing continues. The sand is placed in the bin using a raining technique. This method of placing the Ottawa sand affords controlled densities of the soil by raising or lowering the containers to a measured fall.

The 6 foot diameter tube will be used in gathering information for the following studies:

- a. Measurement of shock strength in the step-shock region.
- b. Pressure profile to determine location of complete shock formation.

- c. Complete time-duration data in step-shock region to plot time and distance parameter curves.
- d. Compile more data to allow a statistical method of averaging.

11. REFERENCES:

a. Holt, R. E., and Crist, R. A., "Calibration of a Six-Foot and a Two-Foot Diameter Shock Tube," by the University of New Mexico Contract AF 29(601)-4520 for AFWL, Kirtland AFB, New Mexico, SWC-TDR-63-5, pages iii, 1, 2, 7, 8, 9, 10, 11 and 14, April 1963.

b. Pantall, Jack P., Capt, USAF, "AF Shock Tube Facility Operations," Hq Air Force Special Weapons Center, AFSC, Kirtland AFB, New Mexico, page 7, 9, 17, A-2, A-7 and A-13, January 1962.

R-3

1. TITLE AND/OR TYPE: 6-Inch Loader
2. LOCATION: URS Corporation
1811 Trousdale Avenue
Burlingame, California
3. OWNER: DASA
4. LOADING CHARACTERISTICS:
 - a. Type Wave: Step Wave
 - b. Pressure: Minimum (psi) 25 Maximum (psi) 2000 in chamber
 - c. Force: Minimum (lbs) Maximum (lbs) 80,000
 - d. Rise Time: Variable
 - e. Dwell Time: Continuous
5. PHYSICAL DESCRIPTION
 - a. Diameter: 6 inch I. D.
 - b. Length: 16 inch (Compression Chamber only)
 - c. Other: This is a modified cold gas shock tube similar to the other URS devices.
6. DRIVER: Compressed Air-piston
7. CONTROLS: Electro-mechanical rupturing of bursting diaphragm.
8. AVAILABILITY: Under development, essentially completed but not yet tested.
9. OTHER CONSIDERATIONS: This loader was designed for application of shock type loadings to soil samples 6 inches in diameter.
10. REFERENCE: None

1. TITLE AND/OR TYPE: Shock Tube Loading Facility for Soils
2. LOCATION: IIT Research Institute of Illinois Institute of Technology
Technology Center
Chicago 16, Illinois
3. OWNER: IIT Research Institute
4. LOADING CHARACTERISTICS:
 - a. Pressure: Minimum (psi) 0 Maximum (psi) 30
 - b. Rise Time: Less than 1 millisecond, essentially zero
 - c. Peak Pressure Duration: 5 milliseconds
 - d. Duration: Greater than 14 milliseconds
5. PHYSICAL DESCRIPTION (Figures 59, 60, 61 & 62):
 - a. Cross Section: 8 inches x 8 inches
 - b. Length: 21.29 feet
 - c. Other: Seven flanged sections of 36 1/2 inches/section.
6. DRIVER: Compressed Air
7. AVAILABILITY: Contact above address
8. OTHER CONSIDERATIONS: One end section is used as the driver section and is separated from the rest of the tube by a plastic membrane. This section is pressurized to a predetermined level and the membrane punctured suddenly causing an air shock wave to travel down the tube. By using different lengths of driver section, the pressurized volume can be altered thereby changing the decay time of the air pulse loading. The shock tube may be fitted with a 6 foot long thin wall 3 inch diameter cylindrical tube. The latter extended up into the shock tube and is attached to a flat end plate having a 3 inch diameter hole centrally located and in line with the cylindrical tube. This plate then is bolted to the far end of the shock tube. A sand column is mounted horizontally outside the tube with one end extending into the 3 inch diameter hole. Normally a 32 inch long specimen is used.

The tube also is supplied with a test chamber which consists of a steel framed box with a height of 24 inches, a length of 24 inches and a width of 4 inches. The front face of the box consists of a panel of plate glass and a plate glass liner against the rear face.

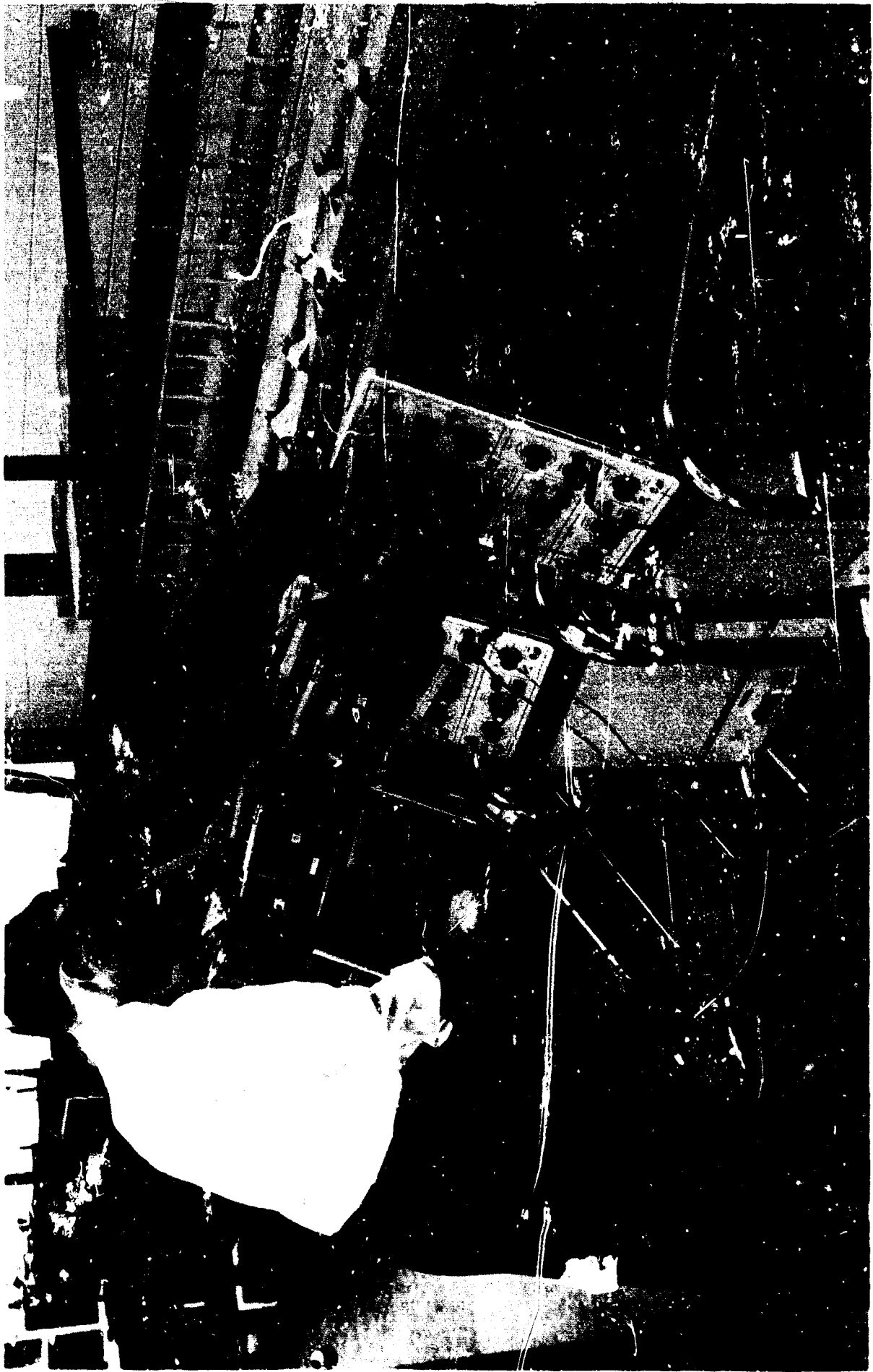

FIGURE 59. IIT SHOCK TUBE SHOWING
SUPPORTED SOIL SAMPLE

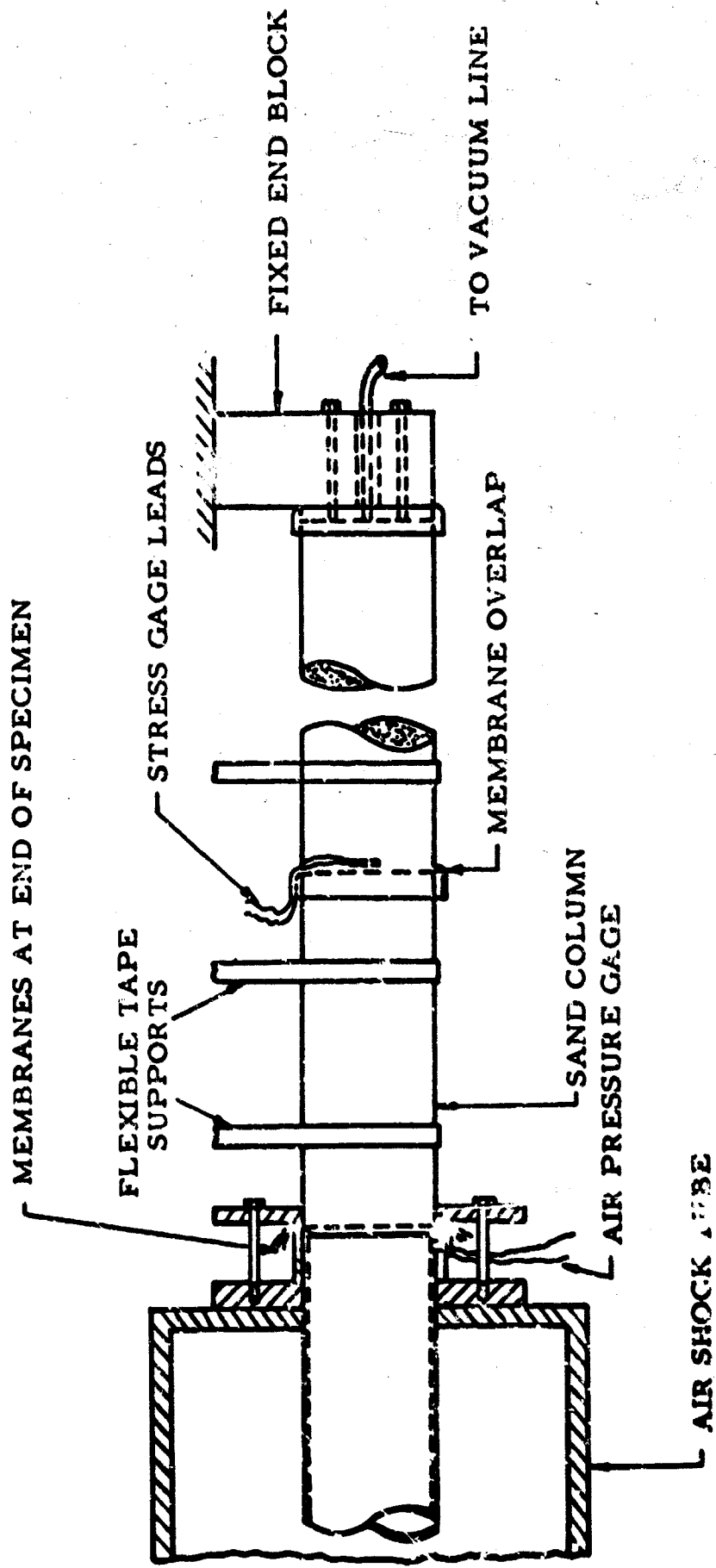
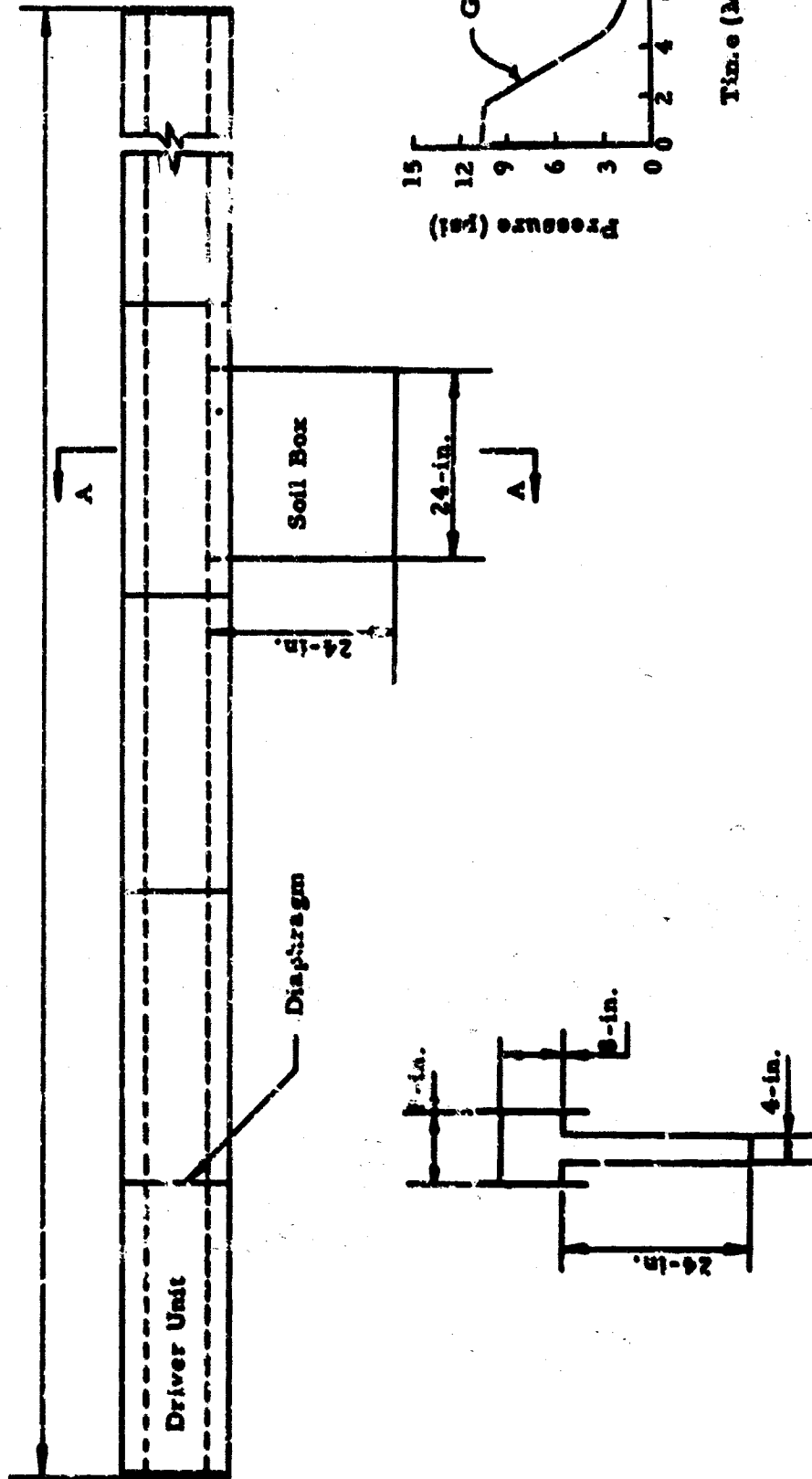

FIGURE 60. - SHOCK WAVE TEST APPARATUS



FIGURE 61. 11T 8" x 8" SQUARE SHOCK TUBE

7 Sections @ 36-1/2 in. Per Section



SECTION A-A

FIGURE 62. SCHEMATIC SHOCK TUBE WITH ATTACHED SOIL BOX AND GENERATED AIR SHOCK PULSE

9. DISCUSSION: This device has been used for soil loading in studies of (1) one-dimensional stress wave propagation (2) roof loads on underground structures, and (3) air shock induced accelerations in soil.

10. REFERENCE: "Shock Tube Loading Facility For Soils," Soil Mechanics Laboratory, IIT Research Institute, pages 1, 4, 7, 8 and 10, August 1963.

1. **TITLE AND/OR TYPE:** The 4 x 15-Inch-Diameter Shock Tube
2. **LOCATION:** U. S. Army Ballistic Research Laboratory
Aberdeen Proving Ground, Maryland 21005
3. **OWNER:** U. S. Army
4. **LOADING CHARACTERISTICS:**
 - a. **Type Wave:** Variable shaped peak wave or step shock with the duration dependent upon the driver length.
 - b. **Pressure:** Minimum (psi) 0.32 PSIA Maximum (psi) 15 PSIG
 - c. **Duration:** Minimum of 7 msec. for peak shock and max. 35 msec for step shock.
5. **PHYSICAL DESCRIPTION (Figure 63):**
 - a. **Size:** 4" X 15" I.D. 1/2" thick wall
 - b. **Length:** 45.5 feet approximately
 - c. **Other:** Driver section 24 inch minimum length with arrangements to add additional sections of 34 inches per section. The tube utilizes a cellophane or mylar diaphragm of varying thicknesses. An electric solenoid operated knife edge or hot wires are used to rupture diaphragm.
6. **DRIVER:** Cold gas driven with air, helium, or nitrogen.
7. **AVAILABILITY:** U. S. Government and Government Contractor
8. **OTHER CONSIDERATIONS:** The tube has three test sections which consist of: 1) 34" sections which have 2-2" opposed parts. 2) 34" optical sections with 9.75 inch parts utilizing either matched optical windows or 1" thick plate glass, and 3) a 48" photographic section with 15 inch X 15 inch - 1 inch thick plate glass windows. The window parts have an opening of 15 inches X 17 inches.
9. **DISCUSSION:** The rectangular shock tube is ideally suited to measurements of shock wave interaction with, and flows about, two dimensional models of full scale targets. The optical sections are used with the schlieren system and/or the Mach-Zehnder interferometer.
10. **REFERENCES:** This material was extracted from a draft report being prepared for publication. It was transmitted from the U. S. Army Ballistic Research Laboratories, by Mr. E. E. Minor, letter dtd 16 July, 1964.

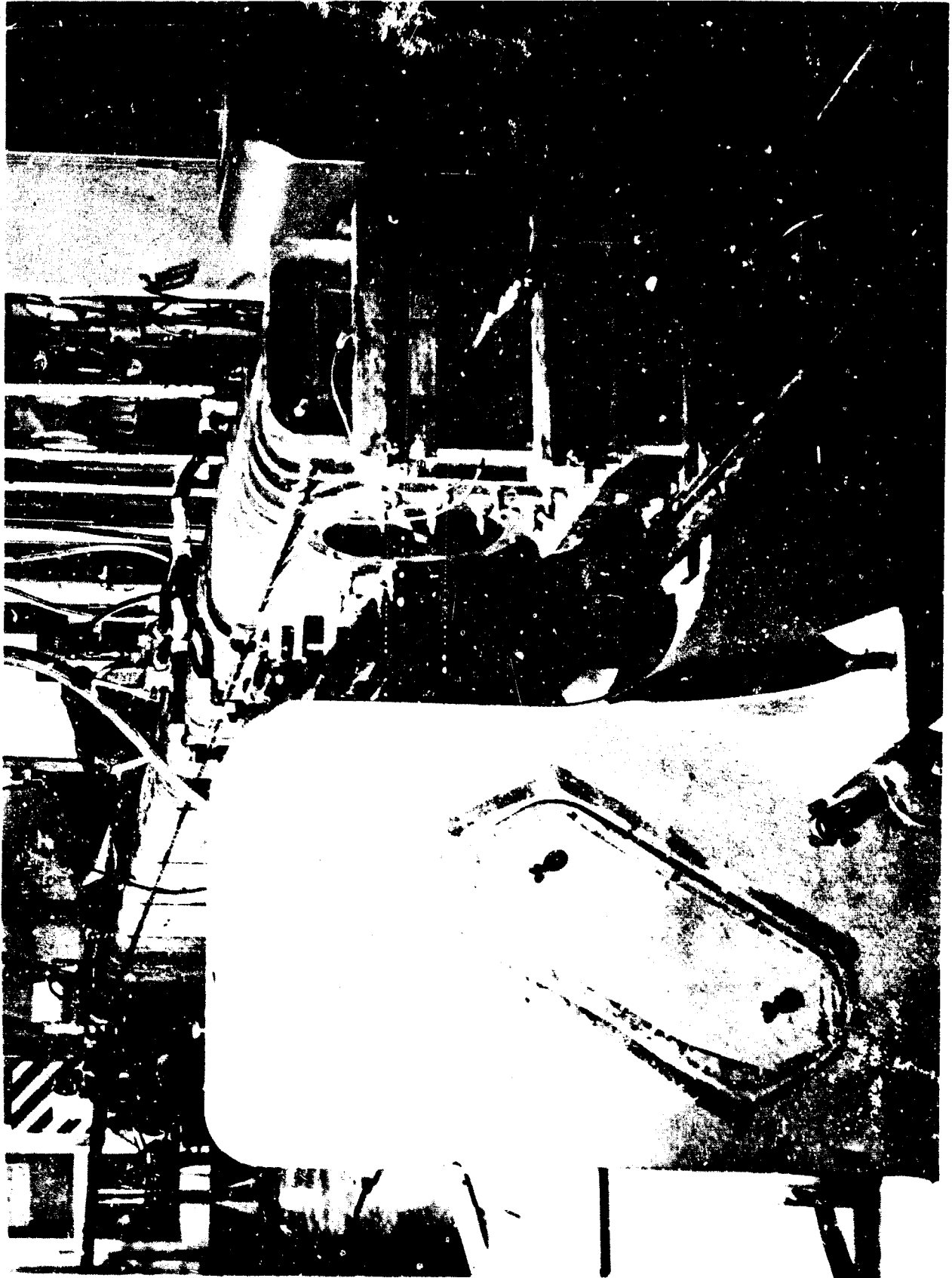

FIGURE 63. THE 4 x 15 - INCH SHOCK TUBE

1. TITLE AND/OR TYPE: 13-Inch-Diameter High-Pressure Shock Tube
2. LOCATION: Eric H. Wang Civil Engineering Research Facility
Area Y
Sandia Base, New Mexico
3. OWNER: U. S. Air Force
4. LOADING CHARACTERISTICS:
 - a. Type Wave: Shock pulse
 - b. Pressure: Minimum (psi) Maximum (psi) 1000
 - c. Rise Time: Instantaneous
 - d. Duration Time: Up to 20 milliseconds, longer under some conditions
5. PHYSICAL DESCRIPTION (Figure 64): This 13 inch inside diameter tube consists of the following components: a 9.5 foot compression chamber, seven 10 foot sections, blind flange closed ends, recoil expansion section, a 2 foot diameter 40 feet long exhaust section and four 100 ton pistons to clamp one or two diaphragms separating the up and down stream expansion tubes. The wall thickness of the tube is 1-1/2 inches.
6. DRIVER: Exploding gas (hydrogen and oxygen mixture)
7. CONTROLS: The tube is operated from a small "shock proof" control room. These operations include control and regulation of the vacuum system, and the purge system. The control of all gas is accomplished by the hand valves extended into the control room. On both sides of the control room are the gas supply rooms containing hydrogen in one and oxygen in the other, the valves and lines which convey the gases to the controls.
8. AVAILABILITY: Available to other government agencies and to contractors of the United States Government on contracts requiring the use of and within the limitations of the loader. Scheduling is controlled by the Air Force Project Officer and the Director of the Facility.
9. OTHER CONSIDERATIONS: The ignition of the gas mixture in the driver section is accomplished by 14 spark plugs distributed on each side of the driver chamber. The plugs can be fired individually or simultaneously. The tube can also be driven by non-explosive gas pressure. There are vacuum pumps connected to the expansion test section which allows the tube to be evacuated to obtain simulated shock strengths up to 15,000 psi.

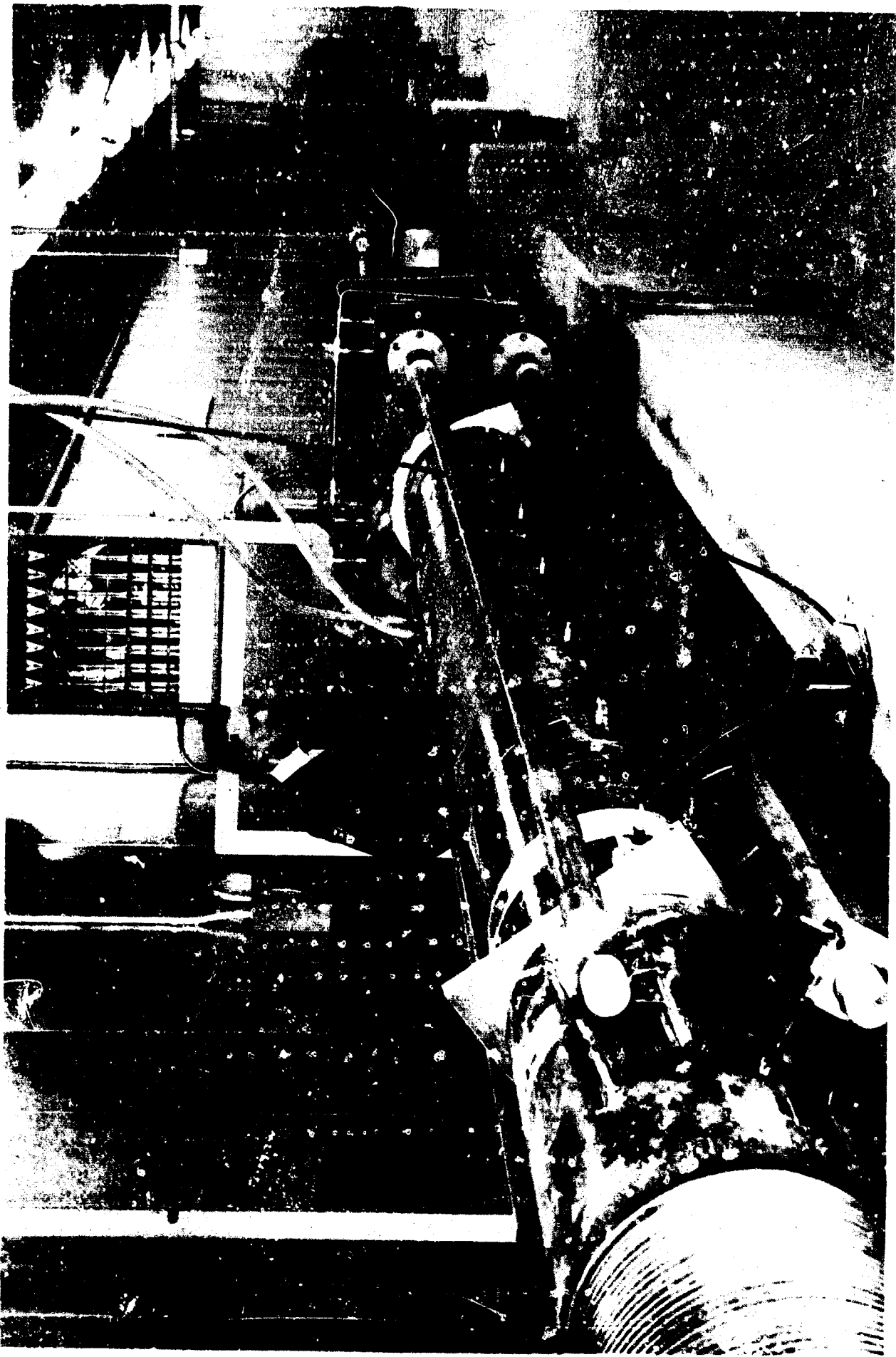

FIGURE 64. DRIVER END OF 13" DIAMETER
HIGH-PRESSURE SHOCK TUBE

10. DISCUSSION: This tube will be used to extend the pressure results of lesser pressured tube experiments which is an area void of information. The tube will also be used in blast pressure attenuation studies in tunnels and other underground configurations.

11. REFERENCE: Mahoney, James A., "The Air Force Shock Tube Facility," Civil Engineering Branch, Air Force Weapons Laboratory, Kirtland Air Force Base, New Mexico, Unpublished report.

1. TITLE AND/OR TYPE: 3-Inch-Diameter High-Pressure Loader
(Modified cold gas shock tube)
2. LOCATION: URS Corporation
1811 Trousdale Drive
Burlingame, California
3. OWNER: DASA
4. LOADING CHARACTERISTICS:
 - a. Type Wave: Step Wave (A square wave can be applied to the sample by means of a limiting piston)
 - b. Pressure: Minimum (psi) 10 Maximum (psi) 2000 in chamber
 - c. Force: Minimum (lbs) Maximum (lbs) 80,000 w/multiplier
 - d. Rise Time: Variable from about 300 microseconds to quasi-static
 - e. Dwell Time: Continuous as desired
 - f. Decay Time: About 200 microseconds at the input end of the sample by arresting the loading piston
5. PHYSICAL DESCRIPTION (Figure not available)
 - a. Diameter: 3 in. I.D.
 - b. Length: 9 in. (Compression Chamber only)
 - c. Other: The maximum stress applied to a sample can be increased substantially by means of a multiplier piston in accordance with 4c above and the sample area.
6. DRIVER: Compressed air-piston
7. CONTROLS: Electro-mechanical rupturing of bursting diaphragm.
8. AVAILABILITY: Presently operational
9. OTHER CONSIDERATIONS: Apparatus has been used for studying shocks propagating in 1 1/2 inch diameter samples to examine momentum and energy distribution with time and distances. To date stresses as high as 7000 psi have been generated in samples of this size.
10. REFERENCE: J. V. Zaccor, and N. R. Wallace, "Techniques and Equipment for Determining Dynamic Properties of Soils", United Research Services, Burlingame, Calif., DASA 1421, P. 14, November 1963.

1. TITLE AND/OR TYPE: 12-Inch-Diameter Shock Tube
2. LOCATION: Lovelace Foundation for Medical Education and Research
Sandia Base Laboratory
Albuquerque, New Mexico
3. OWNER: Defense Atomic Support Agency
4. LOADING CHARACTERISTICS:
 - a. Pressure: Minimum (psi) Incident 0 Maximum (psi) Incident 42
Reflected 136
 - b. Duration: Positive phase of 16-20 milliseconds
5. PHYSICAL DESCRIPTION (Figure 65):
 - a. Diameter: 12 inches inside diameter
 - b. Length: 32 feet, 6 inches (variable)
 - c. Other: 3/8" thick wall with a 2 foot, 6 inch compression chamber utilizing a fragile diaphragm and a 30 foot expansion chamber. Closed end with animal cage mounted on end-plate.
6. DRIVER: Compressed air
7. AVAILABILITY: Available to a government agency with the consent of the Director of the Defense Atomic Support Agency and Dr. C. S. White of Lovelace Foundation.
8. DISCUSSION: This tube has been used to develop a shock tube and related techniques for exposing animals to air blast at different ambient pressures and to explore the tolerance of mice to "sharp" rising overpressures of "long" duration as related to pre-shot ambient pressures ranging from a fraction of an atmosphere to several atmospheres. Shock pressures are measured with piezoelectric gauges mounted side on in the wall of the tube 6 inches upstream from the end plate. Gauges were also located on the end-plate to record the pressure time wave form at the position of the animals. The transducers contain sensors of lead metaniobate (model ST-2, Susquehanna Instruments, Bel Air, Maryland). Overpressures in the expansion chamber before and after blasts are measured by a Bourdon-type dial pressure gauge. (Heise Bourdon Tube Co., Newton, Conn.).

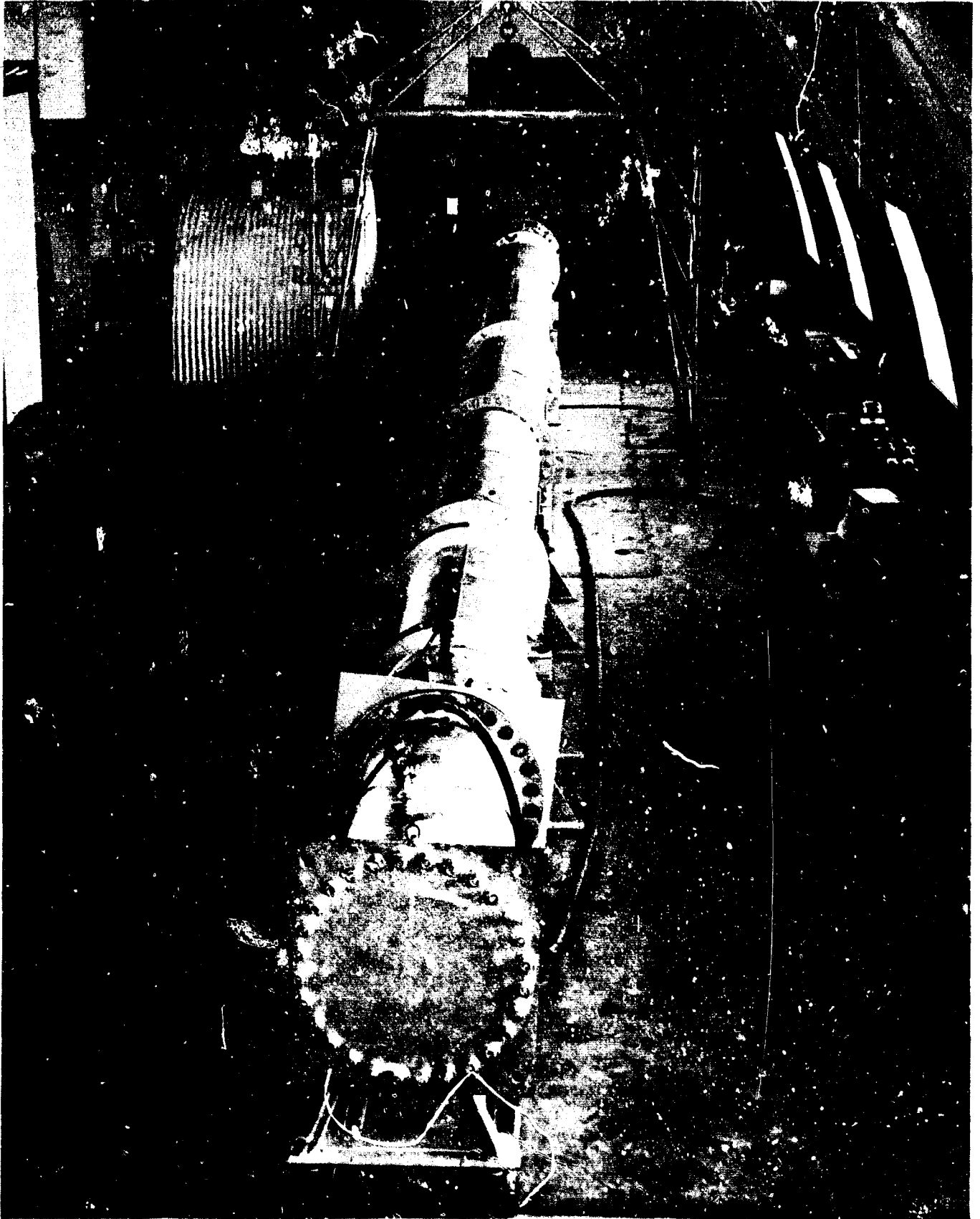

FIGURE 65. 12" DIAM. SHOCK TUBE

9. REFERENCES:

Edward G. Damon, Donald R. Richmond, and Clayton S. White,
"The Effects of Ambient Pressure on the Tolerance of Mice to Air
Blast," Technical Progress Report on Contract No. DA-49-146-XZ-
055, pages 1, 3, 5, and 7, March 1964.

"DASA-AEC-Lovelace Foundation Blast-Simulation Facilities,"
Sandia Base, Albuquerque, New Mexico. Report transmitted by letter
dtd 7 April 1965 from Dr. D. Richmond, page 2, author and date not
available.

1. **TITLE AND/OR TYPE:** 24-40-Inch-Diameter Shock Tube
2. **LOCATION:** Lovelace Foundation for Medical Education & Research
Sandia Base Laboratory
Albuquerque, New Mexico
3. **OWNER:** Defense Atomic Support Agency
4. **LOADING CHARACTERISTICS:**
 - a. **Pressure:** Minimum (psi) 0 Maximum (psi) Reflected 60
 - b. **Rise Time:** Instantaneously with freedom of driver.
 - c. **Duration:** Approximately 400 milliseconds
5. **PHYSICAL DESCRIPTION (Figures 66 and 67):**
 - a. **Diameter:** Compression chamber 40.5 inches, 3 foot transition section to 23.5 inches
 - b. **Length:** Overall 70 feet - Compression chamber 17.5 feet including 3-foot transition and an expansion chamber of 53.4 feet.
 - c. **Other:** It is closed distally by a steel end-plate to generate high pressures from the reflected shock. Three vents in the expansion side of the system serve to control the duration of the overpressure and to eliminate multiple reflections by bleeding off the reflected shock as it travels upstream.
6. **DRIVER:** Compressed air
7. **AVAILABILITY:** Available to a government agency with the consent of the Director of the Defense Atomic Support Agency & Dr. C. S. White of Lovelace Foundation.
8. **OTHER CONSIDERATIONS:** A diaphragm of mylar sheets of 0.010 and 0.0075 thick are used. A predetermined number being used to hold a given pressure in the driver section is used. Diaphragms are ruptured by lead pellets from a sawed-off 12-gauge shotgun mounted on the tube.
9. **DISCUSSION:** This tube has been used on mice, rats, guinea pigs, rabbits, dogs and cats to determine the mortality as related to the magnitude of incident and reflected shock fronts of a simulated nuclear blast.

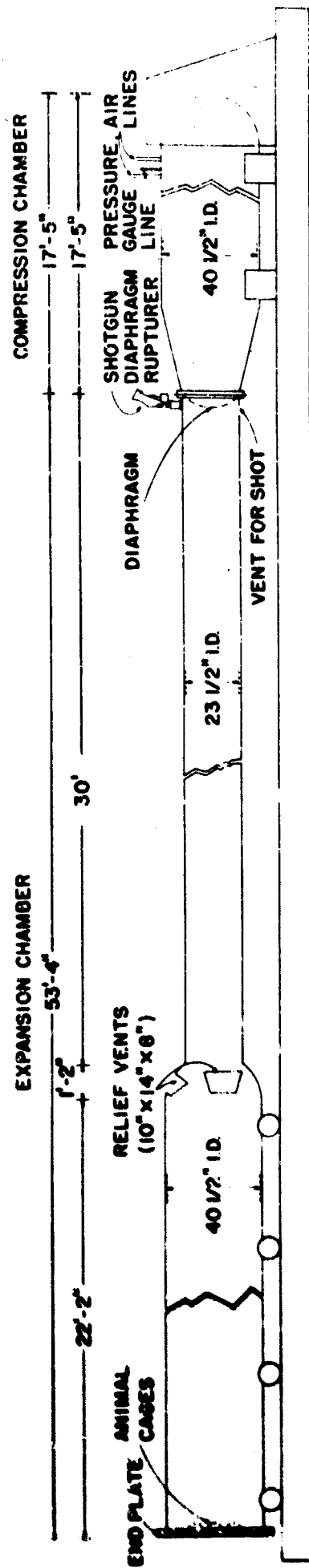

FIGURE 66. LAYOUT AND ELEVATION OF 24--40--INCH-DIAMETER SHOCK TUBE

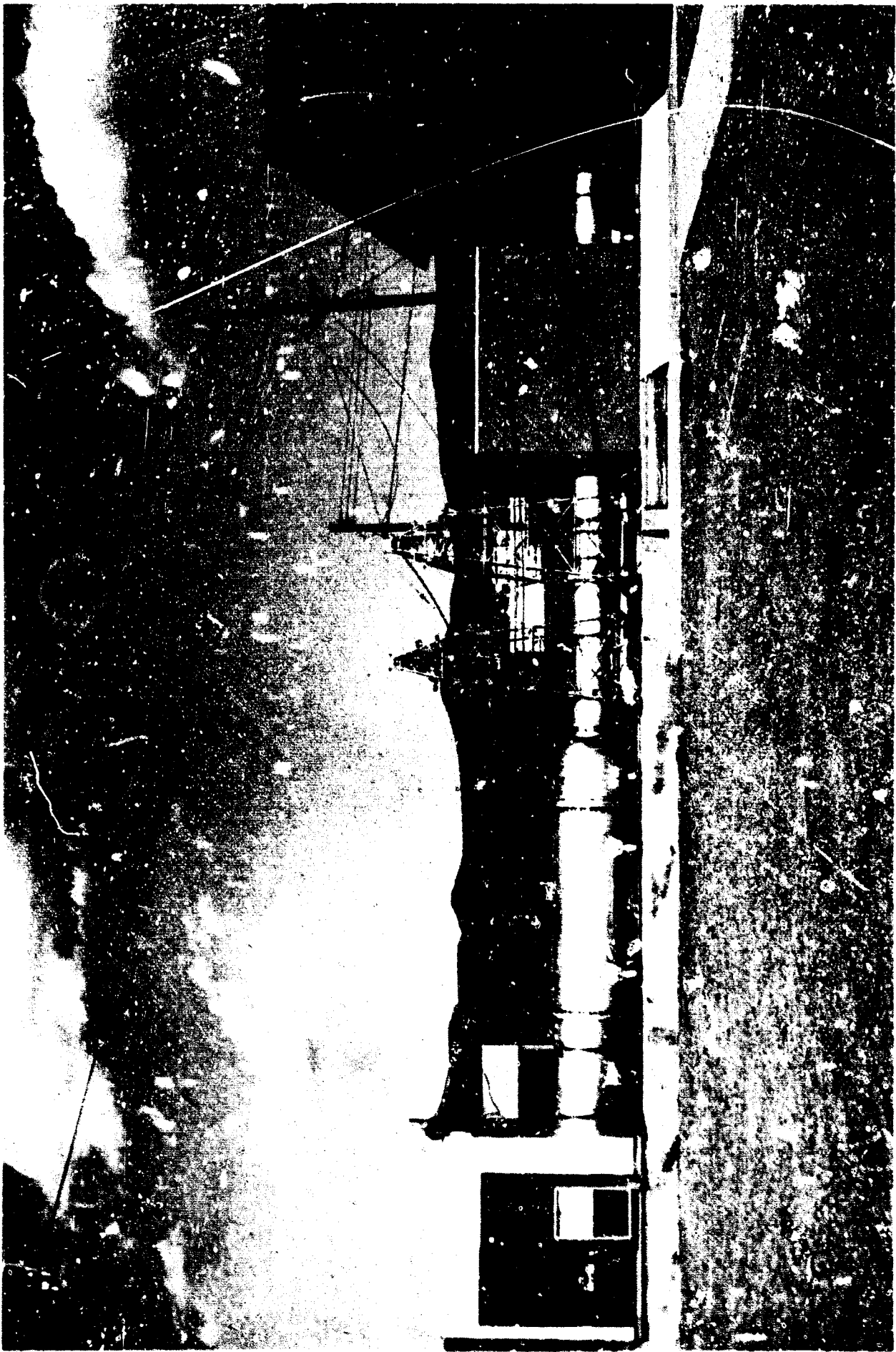

FIGURE 67. LOVELACE 24-40-INCH-DIAMETER
SHOCK TUBE

10. REFERENCES:

Richmond, Clare, Goldizen, Pratt, Sanchez & White, DASA 1246, Technical Progress Report on Contract No. DA-49-146-XZ-055, Lovelace Foundation, Pages 1, 5, 6, & 16, April 7, 1961.

"DASA-AEC-Lovelace Foundation Blast-Simulator Facilities," Sandia Base, Albuquerque, New Mexico. Report transmitted by letter dtd 7 April 1965, from Dr. D. Richmond, pages 1 & 2, author and date not available.

1. TITLE AND/OR TYPE: 24-Inch-Diameter Shock Tube
2. LOCATION: Lovelace Foundation for Medical Education and Research
Sandia Base Laboratory
Albuquerque, New Mexico
3. OWNER: Defense Atomic Support Agency
4. LOADING CHARACTERISTICS:
 - a. Pressure: Minimum (psi) 0 Maximum (psi) Incident 35
 - b. Rise Time: Instantaneously
 - c. Duration: 40 to 60 milliseconds
5. PHYSICAL DESCRIPTION (Figures 68 & 69):
 - a. Diameter: 23 1/2 inches I.D.
 - b. Length: 76 feet, 2 inches (variable)
 - c. Other: Side wall 1/2 inch thick, a 5 foot compression section utilizing Du Pont Mylar Diaphragms, 71 feet, 2 inch expansion section. 3 feet, 6 inch test section is located 47 feet, 8 inches downstream from the diaphragm. Fired open ended. Two different test sections may be used with this tube.
6. DRIVER: Compressed air
7. AVAILABILITY: Available to a government agency with the consent of the Director of the Defense Atomic Support Agency & Dr. C. S. White of Lovelace Foundation.
8. OTHER CONSIDERATIONS: The test section has four chamber-mounts. The chambers are so arranged as to utilize three different geometries by using extensions and wooden blocks. Each chamber is always placed end-on with respect to the incident shock front. The 20 X 20 inch square test section contains glass ports for high-speed camera viewing.
9. DISCUSSION: Animals (guinea pigs) are exposed to air blast while mounted in the four chambers in the test section. Piezo-electric gauges (Model ST-2) containing lead metaniobate sensing elements are used to measure pressure-time variation. Permanent pressure-time records are taken by photographing the sweep on the face of the cathode tube of an oscilloscope with a Polaroid Land Camera.

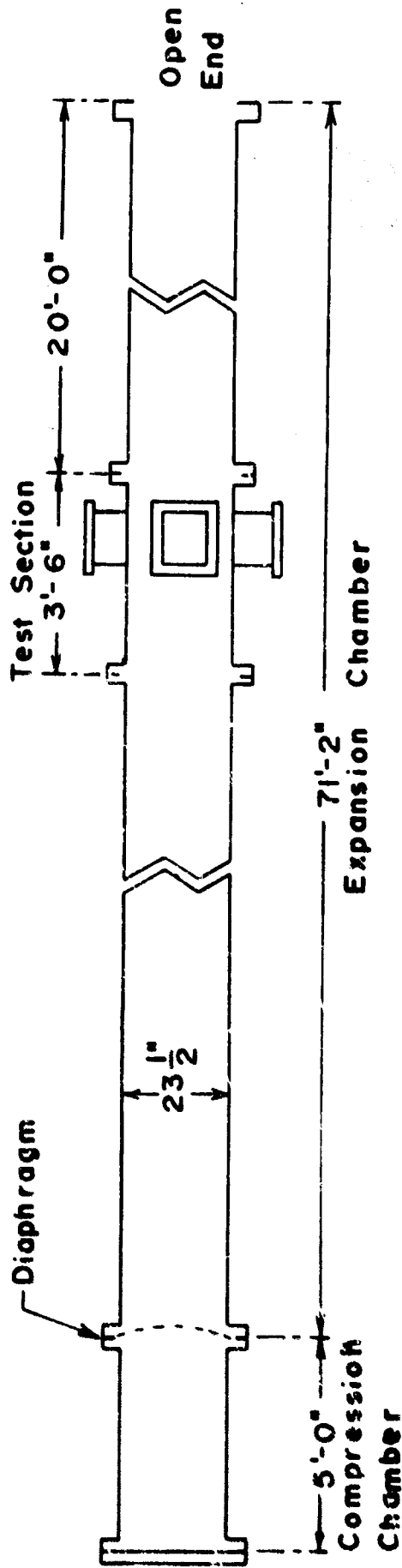

SHOCK TUBE DIAGRAM

CROSS SECTION OF THE TEST SECTION AT THE CHAMBERS

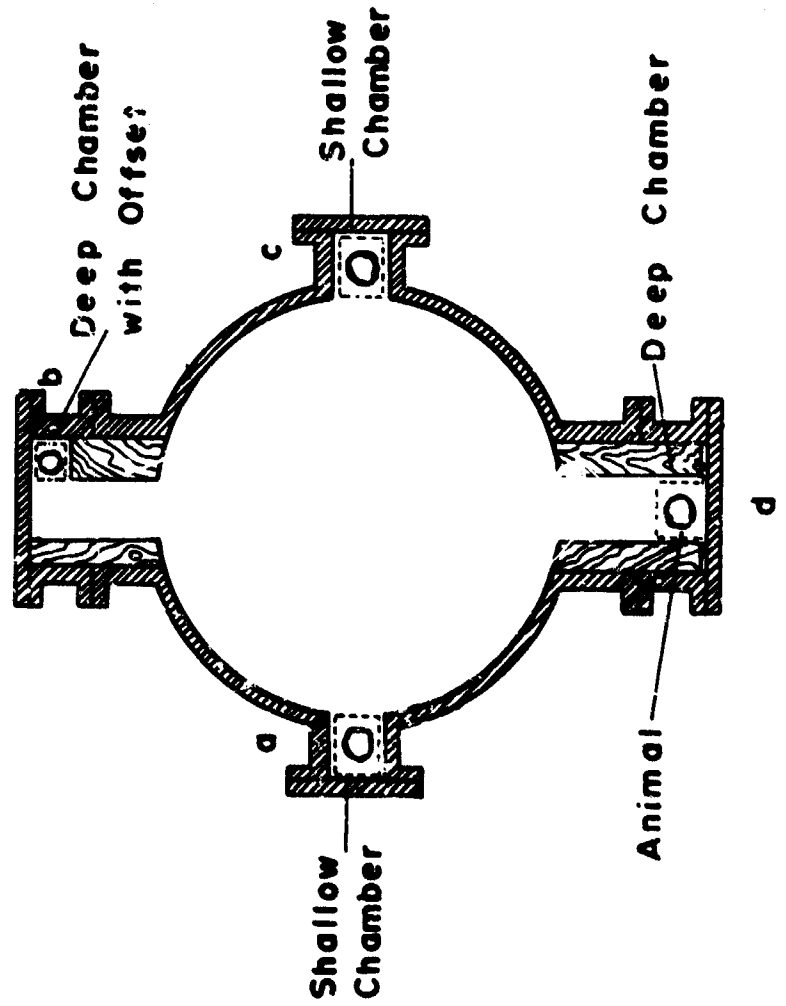

FIGURE 68.

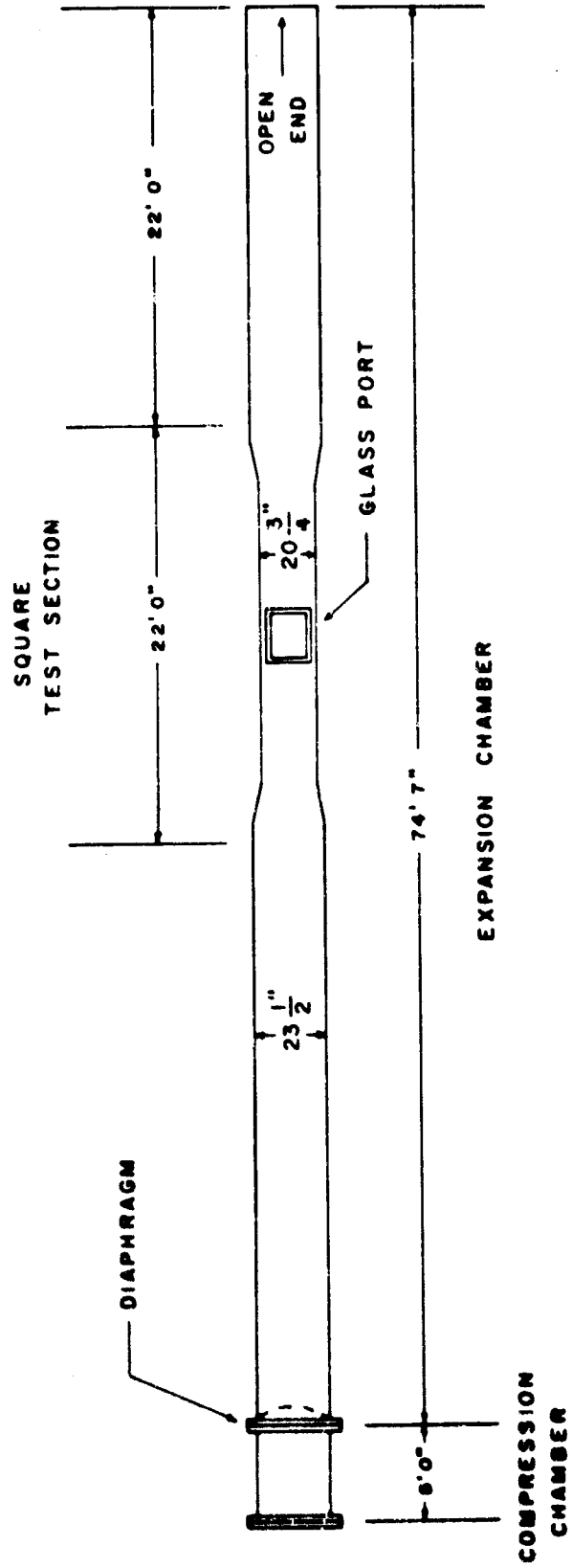

FIGURE 69. SCHEMATIC OF 24-INCH-DIAMETER SHOCK TUBE

10. REFERENCES:

Richmond, Donald R., Clare, Victor R., and White, Clayton S.,
DASA-1334, Technical Progress Report, Lovelace Foundation, pages
1, 2, 3, 4, 6, 12, and 17, October 27, 1962.

"DASA-AEC- Lovelace Foundation Blast-Simulator Facilities,"
Sandia Base, Albuquerque, New Mexico. Report transmitted by ltr
dtd 7 April 1965 from Dr. D. Richmond, page 2, author and date
not available.

SECTION IV
PLANE WAVE LOADERS

1. **TITLE AND/OR TYPE:** Boynton Dynamic Load Generator
2. **LOCATION:** United Research Services formerly
Broadview Research Corporation
1181 Trousdale Drive
Burlingame, California
3. **OWNER:** DASA
4. **LOADING CHARACTERISTICS:**
 - a. **Type Wave:** Plane Wave
 - b. **Pressure:** Minimum (psi) 20 Maximum (psi) 500
 - c. **Rise Time:** 0.5 to 2.0 milliseconds
 - d. **Duration:** 1 second or can be prolonged indefinitely.
5. **PHYSICAL DESCRIPTION (Figure 70):**
 - a. **Diameter:** Sample opening 12 inches
 - b. **Shape:** Dome, which consists of cartridge retainer, firing chamber, a baffle assembly, dome retainer ring, sample holder and stand.
6. **DRIVER:** Detonation of a cartridge containing PETN
7. **CONTROLS:** A "Controller" console which provides a complete firing cycle, such as; timing sequence of events, power to trigger oscilloscope cameras, excites pressure transducers and fire.
8. **OTHER CONSIDERATIONS:** The Dynisco Model PT 76U-7.5C pressure transducer was decided upon because of reliability of performance in this specific application.
9. **DISCUSSION:** The generator is designed to test small samples, such as soil, under a dynamic load of predetermined characteristics.
10. **REFERENCE:** Boynton, Wm. V., Final Report, "Research Concerning Investigations and Development of a Laboratory Model 500 PSI Dynamic Load Generator for Soil Testing, and Its Operational Instrumentation System," Defense Atomic Support Agency Contract No. DA-29-146-XZ-017, pages 1, 3, 4, 7, and 8, December 1960 and Appendix I, Same Author, "Operational Manual of 500 PSI Laboratory Model Dynamic Load Generator," Defense Atomic Support Agency, Contract No. DA-49-146-XZ-017, pages 1, 2, 7, 8, and Drawing BA-D3-10, July 1960.

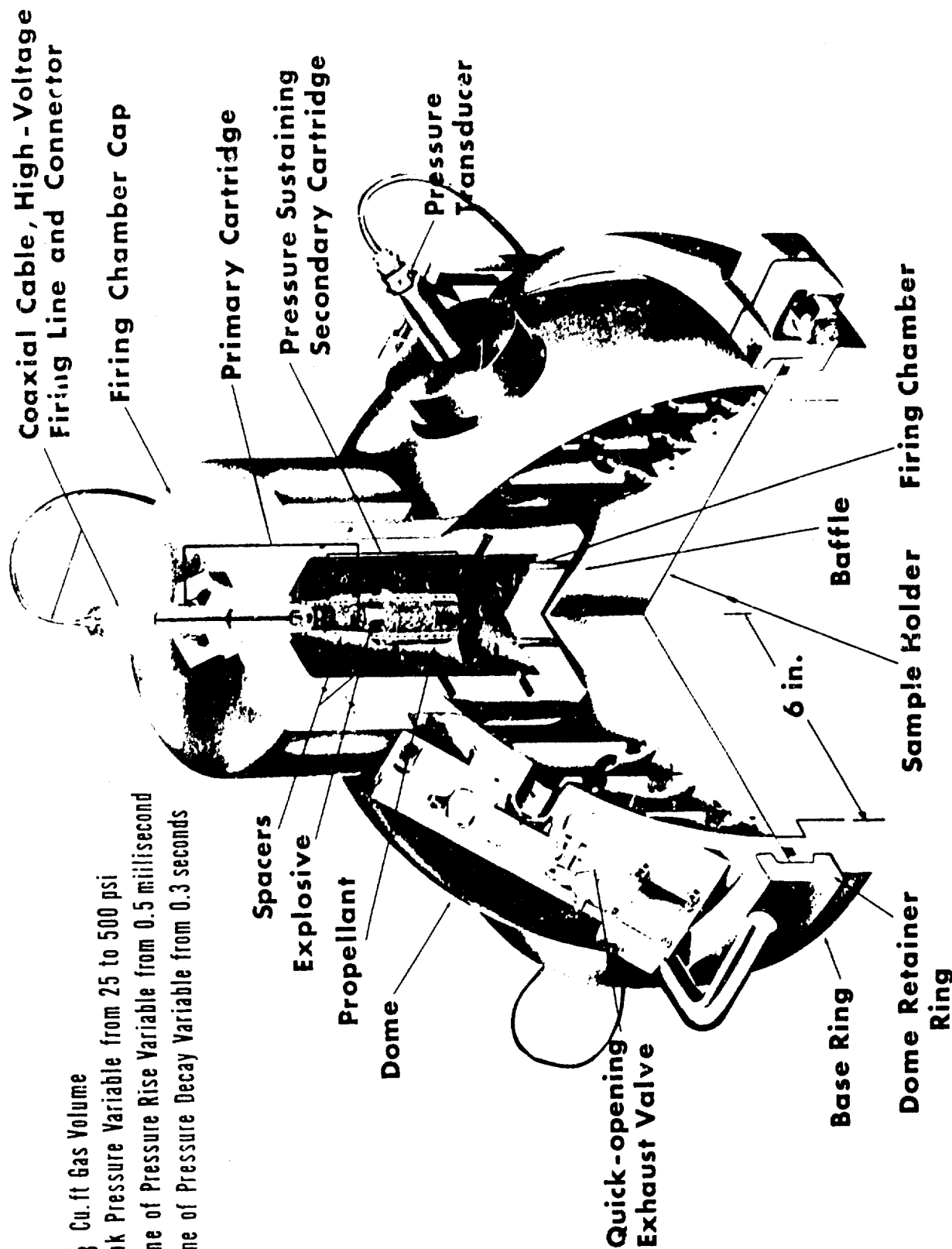

1. $\frac{1}{3}$ Cu. ft Gas Volume
2. Peak Pressure Variable from 25 to 500 psi
3. Time of Pressure Rise Variable from 0.5 millisecond
4. Time of Pressure Decay Variable from 0.3 seconds

FIGURE 70. LABORATORY MODEL 500 psi DYNAMIC LOAD GENERATOR

1. **TITLE AND/OR TYPE:** Boynton Dynamic Load Generator
2. **LOCATION:** Massachusetts Institute of Technology
Soils Group
77 Massachusetts Avenue
Cambridge 39, Mass.
3. **OWNER:** DASA
4. **LOADING CHARACTERISTICS:**
 - a. **Type Wave:** Plane Wave
 - b. **Pressure:** Minimum (psi) 25 Maximum (psi) 500
 - c. **Rise Time:** 0.5 to 2.0 milliseconds
 - d. **Decay Time:** Variable from 0.3 seconds
 - e. **Duration:** 1 second or can be prolonged indefinitely
5. **PHYSICAL DESCRIPTION (Figure 70):**
 - a. **Diameter:** Sample opening 12 inches
 - b. **Shape:** Dome, which consists of cartridge retainer, firing chamber, a baffle assembly, dome retainer ring, sample holder and stand.
6. **DRIVER:** Detonation of a cartridge containing PETN
7. **CONTROLS:** A "Controller" console which provides a complete firing cycle, such as; timing sequence of events, power to trigger oscilloscope cameras, excites pressure transducers and fire.
8. **AVAILABILITY:** Not known
9. **OTHER CONSIDERATIONS:** The Dynisco Model PT 76U-7.5C pressure transducer was decided upon because of reliability of performance in this specific application.
10. **DISCUSSION:** The generator is designed to test small samples, such as soil, under a dynamic load of predetermined characteristics.

11. REFERENCE: Boynton, Wm. V., Final Report, "Research Concerning Investigations and Development of a Laboratory Model 500 PSI Dynamic Load Generator for Soil Testing and Its Operational Instrumentation System," Defense Atomic Support Agency Contract No. DA-49-146-XZ-017, pages 1,3,4,7, and 8, December 1960 and Appendix I, Same Author, "Operational Manual of 500 PSI Laboratory Model Dynamic Load Generator," Defense Atomic Support Agency, Contract No. DA-49-146-XZ-017, pages 1, 2, 7, 8, and Drawing BA-D3-10, July 1960.

1. **TITLE AND/OR TYPE:** Boynton Dynamic Load Generator
2. **LOCATION:** Stanford Research Institute
Physics Department
Menlo Park, California
3. **OWNER:** DASA
4. **LOADING CHARACTERISTICS:**
 - a. **Type Wave:** Plane Wave
 - b. **Pressure:** Minimum (psi) 25 Maximum (psi) 500
 - c. **RiseTime:** 0.5 to 2.0 milliseconds
 - d. **Decay Time:** Variable from 0.3 seconds
 - e. **Duration:** 1 second or can be prolonged indefinitely
5. **PHYSICAL DESCRIPTION (Figure 70):**
 - a. **Diameter:** Sample opening 12 inches
 - b. **Shape:** Dome, which consists of cartridge retainer, firing chamber, a baffle assembly, dome retainer ring, sample holder and stand.
6. **DRIVER:** Detonation of a cartridge containing PETN
7. **CONTROLS:** A "Controller" console which provides a complete firing cycle, such as; timing sequence of events, power to trigger oscilloscope cameras, excites pressure transducers and fire.
8. **AVAILABILITY:** Not known
9. **OTHER CONSIDERATIONS:** The Dynisco Model PT 76U-7.5C pressure transducer was decided upon because of reliability of performance in this specific application.
10. **DISCUSSION:** The generator is designed to test small samples, such as soil, under a dynamic load of predetermined characteristics.

11. REFERENCE: Boynton, Wm. V., Final Report, "Research Concerning Investigations and Development of a Laboratory Model 500 PSI Dynamic Load Generator for Soil Testing and Its Operational Instrumentation System," Defense Atomic Support Agency Contract No. DA-49-146-XZ-017, pages 1, 3, 4, 7, and 8, December 1960 and Appendix I, Same Author, "Operational Manual of 500 PSI Laboratory Model Dynamic Load Generator," Defense Atomic Support Agency, Contract No. DA-49-146-XZ-017, pages 1, 2, 7, 8, and Drawing BA-D3-10, July 1960.

1. TITLE AND/OR TYPE: Dynamic Slab Loader
2. LOCATION: U. S. Naval Civil Engineering Laboratory
Port Hueneme, California
3. OWNER: U. S. Navy
4. LOADING CHARACTERISTICS:
 - a. Type Wave: Plane
 - b. Pressure: Minimum (psi) 0 Maximum (psi) 300
 - c. Force: Minimum (lbs) 0 Maximum (lbs) 1,560,000
 - d. Rise Time: 1 to 3 milliseconds
 - e. Decay Time: Several seconds
5. PHYSICAL DESCRIPTION (Figures 71 & 72):
 - a. Dimensions: Outside 10 ft X 10 ft X 4 ft; Inside 6 ft X 6 ft X 1 1/2 ft; Topless reinforced concrete box with a plate steel liner.
6. DRIVER: Detonation of primacord in each of four tubes.
7. CONTROLS: Peak dynamic pressure, lateral restraint of slab, clamped vs simply supported edges.
8. AVAILABILITY: After July 1966 by arrangement
9. OTHER CONSIDERATIONS: Static pressures will be developed by pumping fluid under pressure into the chamber beneath the slabs.
10. DISCUSSION: Slab specimens are placed on top of the slab loader and are fastened to the loader with anchor bolts located around perimeter of the specimen. Edges of the slab may be either clamped or simply supported; the edges can also be restrained against lateral displacement by means of stiffened angles located around the top periphery of the slab loader.
11. REFERENCE: "First Semi-Annual Progress Report for FY-1965 on Tasks Supported by the Defense Atomic Support Agency," U. S. Civil Engineering Laboratory, Port Hueneme, California, pages 13, 14, 15 and 16, January 1965.

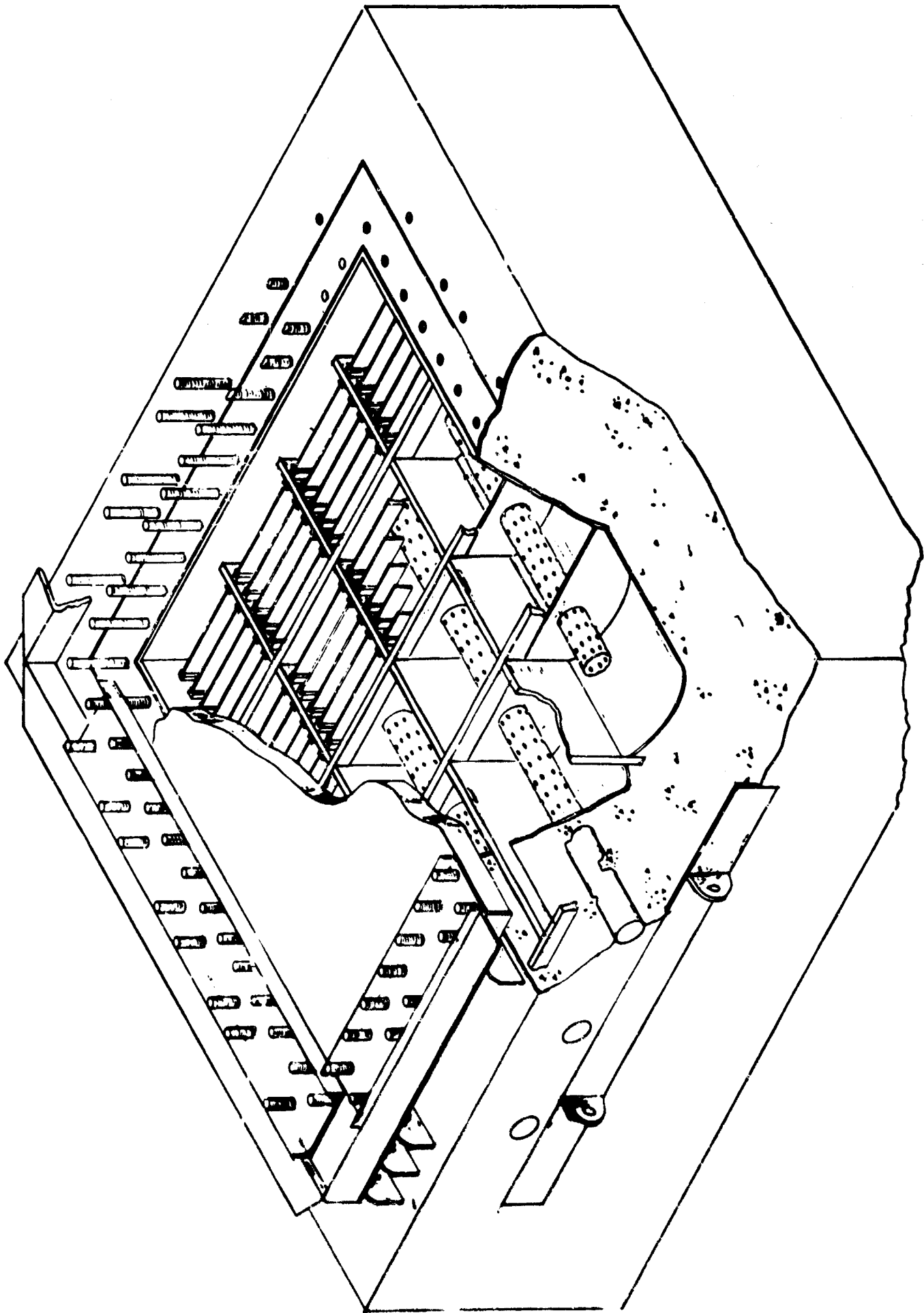

FIGURE 71. SKETCH OF DYNAMIC SLAB LOADER

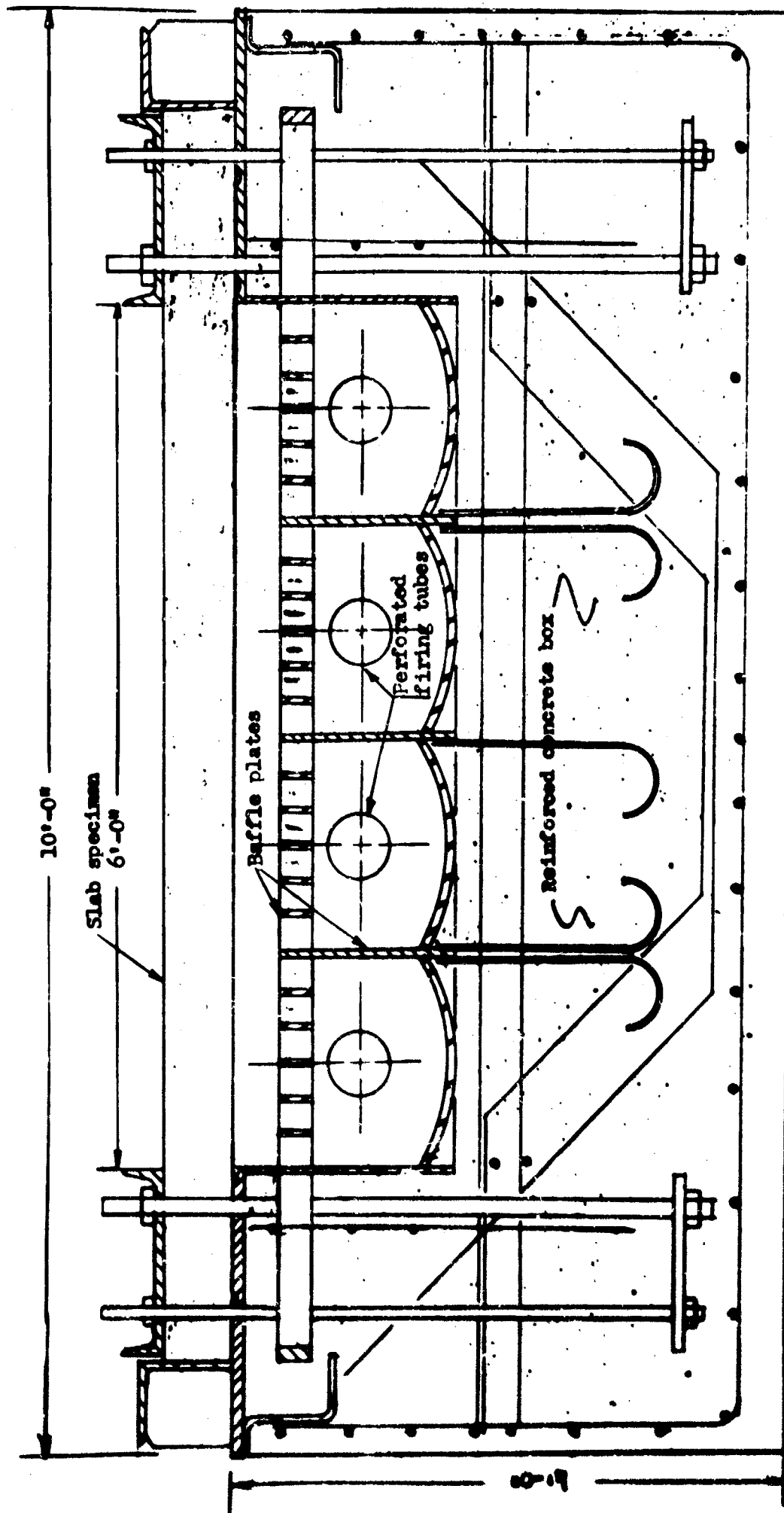

FIGURE 72. TYPICAL SECTION OF DYNAMIC SLAB LOADER

1. TITLE AND/OR TYPE: Soil Tank
2. LOCATION: U. S. Naval Civil Engineering Laboratory
Port Hueneme, California
3. OWNER: U. S. Navy
4. LOADING CHARACTERISTICS:
 - a. Type Wave: Static, plane
 - b. Pressure: Minimum (psi) 0 Maximum (psi) 300
5. PHYSICAL DESCRIPTION (Figure 73):
 - a. Diameter: 60 inches
 - b. Length: Variable from 42 to 66 inches
 - c. Other: Segmented construction with 5-inch-high rings and 1/4-inch neoprene spacers.
6. DRIVER: Bottled nitrogen gas
7. CONTROLS: Precision pressure calibration unit.
8. AVAILABILITY: It is anticipated that there will be intermittent periods of availability subsequent to FY 65.
9. OTHER CONSIDERATIONS: Earlier plans for a system to apply dynamic loads to the contained soil have been shelved.
10. DISCUSSION: Work has been accomplished to develop a method of determining the soil properties associated with the buried cylinder that are required in response and buckling relations. A series of small structure tests is currently underway in the facility to study soil arching.
11. REFERENCE: "First Semi-Annual Progress Report for FY-1965 on Tasks Supported by the Defense Atomic Support Agency," U. S. Naval Civil Engineering Laboratory, Port Hueneme, California, pages 4, 5, 6, and 7, January 1965.

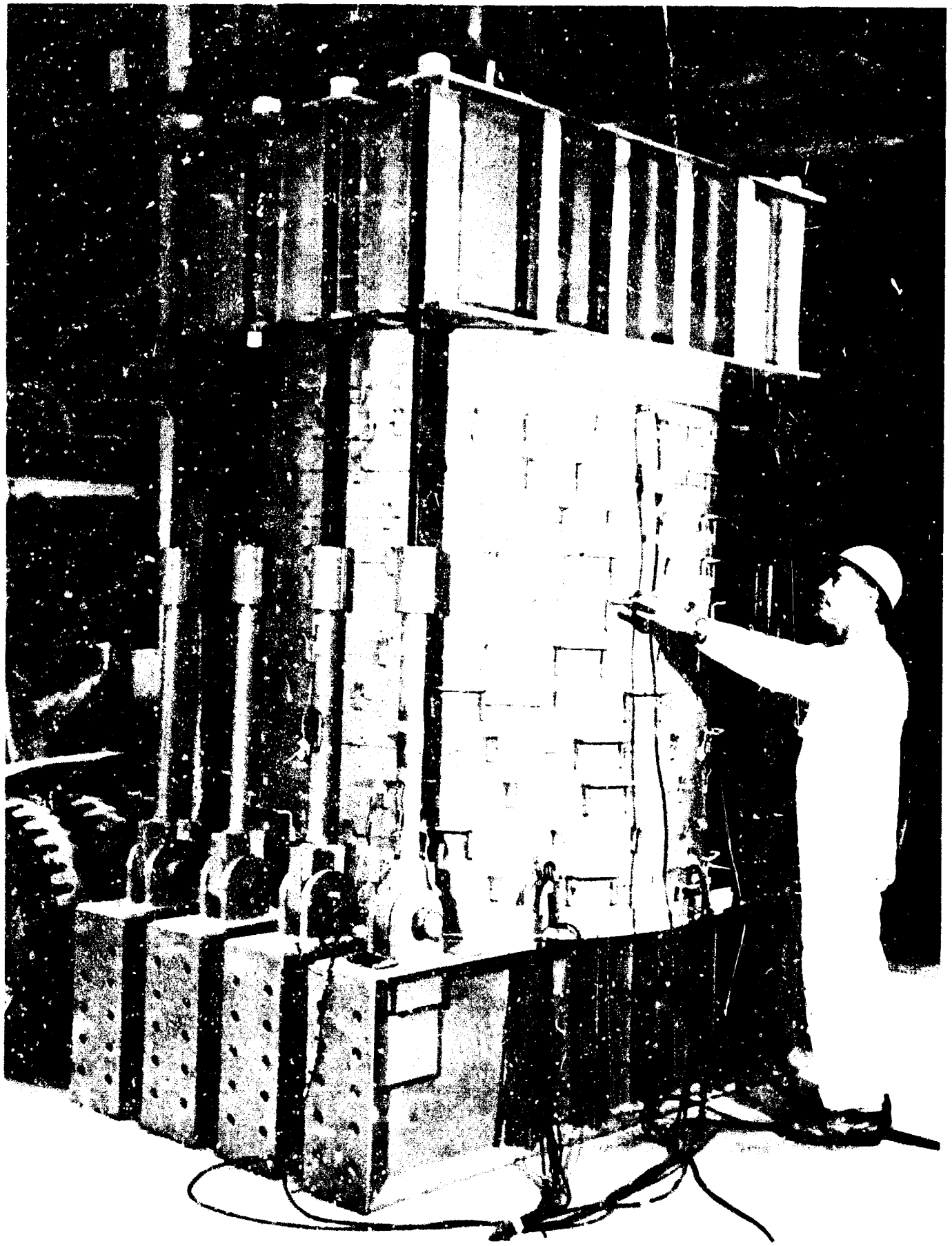

FIGURE 73. NCEL SOIL TANK

1. **TITLE AND/OR TYPE:** Seven-Cell 4-Foot-Diameter Gas Dynamic Loader
2. **LOCATION:** University of Illinois
Dynamic Testing Laboratory
Department of Civil Engineering
Urbana, Illinois
3. **OWNER:** Defense Atomic Support Agency (Contract AF29(601)-6101)
4. **LOADING CHARACTERISTICS:**
 - a. **Type Wave:** Plane Wave
 - b. **Pressure:** Minimum (psi) 50 Maximum (psi) 750
 - c. **Rise Time:** Nitrogen - 6 milliseconds or less
Helium - 3 milliseconds or less
 - d. **Dwell Time:** A few milliseconds to several hours
 - e. **Decay Time:** Variable from 30 milliseconds to one hour or longer
5. **PHYSICAL DESCRIPTION (Figures 74 & 75):** The device consists of seven cells, six placed in a hexagonal configuration and one cell in the center which will load a 4 foot diameter surface. The loading unit is supported by a heavy steel frame on a massive concrete foundation.
6. **DRIVER:** Nitrogen and/or helium - the trigger mechanism is so designed as to allow all seven cells to fire simultaneously.
7. **CONTROLS:** The new Civil Engineering High Intensity Dynamics Test Laboratory is equipped with an instrumentation room which will have firing controls and a separate storage for bottle gas.
8. **AVAILABILITY:** Arrangements for use may be made by contacting Professor George K. Sinnamon, Civil Engineering Department, 111 Talbot Laboratory, University of Illinois, Urbana, Illinois.
9. **OTHER CONSIDERATIONS:** The loading device is affixed to massive concrete walls forming a bridge over a large deep pit. In the pit a soil bin carriage on rails supports the bin sections. The carriage is equipped with a hydraulic jacking system, which when in the proper place is energized and the soil bin is raised into place.

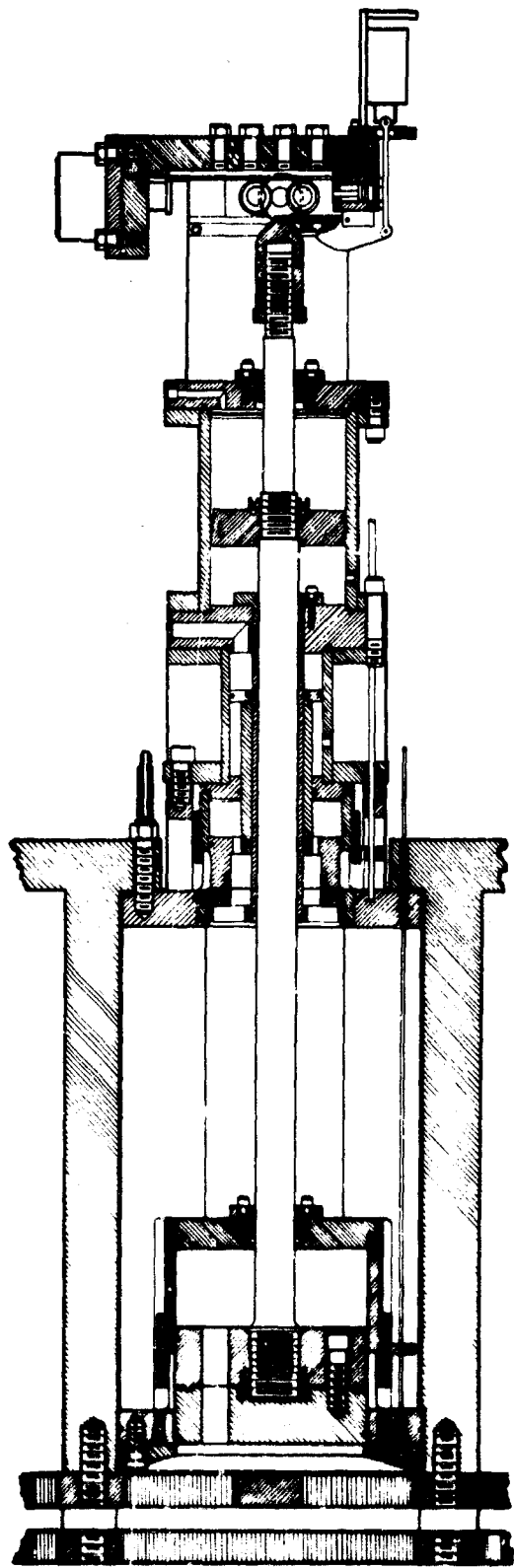

FIGURE 74. SECTION THROUGH A LOADING CELL

SEVEN CELL - 4-FOOT-DIAMETER
GAS DYNAMIC LOADER SKETCH
SHOWING RETENTION FRAME &
MASSIVE CONCRETE FOUNDATION

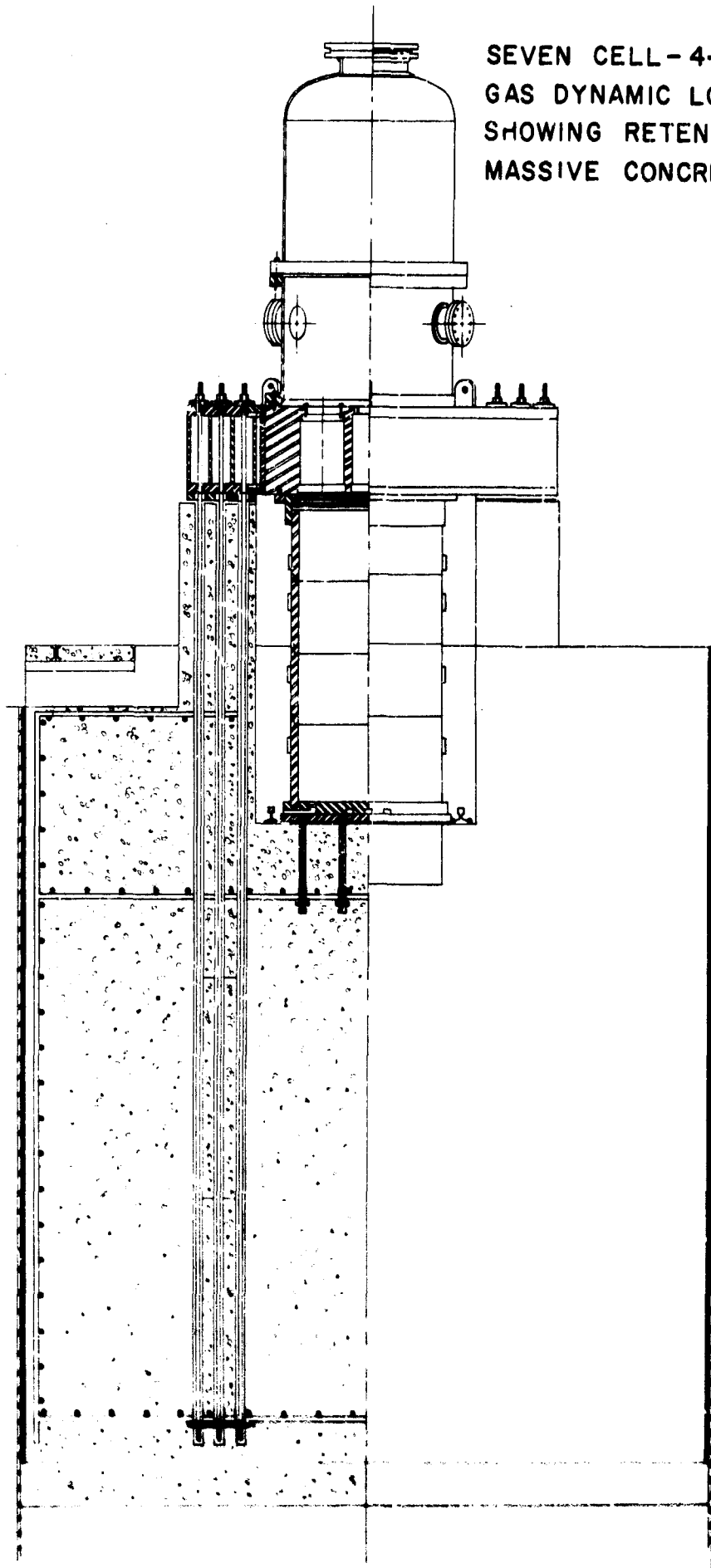

FIGURE 75.

The soil bins will be 4 feet in diameter by 4 feet to 8 feet deep. The bins will be isolated in an attempt to eliminate shock vibrations transferred from the foundation to the contents of the bin.

10. DISCUSSION: The State of Illinois entered into a joint venture with DASA by appropriating \$286,000.00 for the laboratory building to house this loader. Both are in the construction and fabrication stage at the time of this writing. Information was obtained from the Air Force contract file. The Air Force has been the technical monitors of this work since 1960. The initial firing of this device is anticipated early in the summer 1965.

1. **TITLE AND/OR TYPE:** 2-Foot Diameter Vertical Shock Tube
2. **LOCATION:** Eric H. Wang Civil Engineering Research Facility
U. S. Air Force
Area Y
Sandia Base, New Mexico
3. **OWNER:** U. S. Air Force
4. **LOADING CHARACTERISTICS:**
 - a. **Type Wave:** Plane wave exponentially decays in 30 to 40 milliseconds
 - b. **Pressure:**

	Maximum (psi)
Incident	250
Reflected	500
 - c. **Decay Time:** 40 milliseconds
5. **PHYSICAL DESCRIPTION (Figure 76):** The tube consists of one 2 foot pipe section and three 20 foot sections with flanges bolted together for a total of 60 feet in height. The diameter is 24 inches outside diameter. It has a stairway with five landings for loading access.
6. **DRIVER:** Primacord is used and is placed at the open end at the top of the tube. The tube is fired both ends open.
7. **CONTROLS:** UED-Ampex Control Center
8. **AVAILABILITY:** Available to other government agencies and to contractors of the US Government on contracts requiring the use of and within the limitations of the tube. Scheduling is controlled by the Air Force Project Officer and the Facility Director.
9. **OTHER CONSIDERATIONS:** The testing area is inside the main building, with the tube supported by a steel frame work on a massive concrete foundation. Access is provided for placing and removal of a 4 foot deep soil bin.
10. **DISCUSSION:** The tube has been used principally for instrumentation proofing and development.

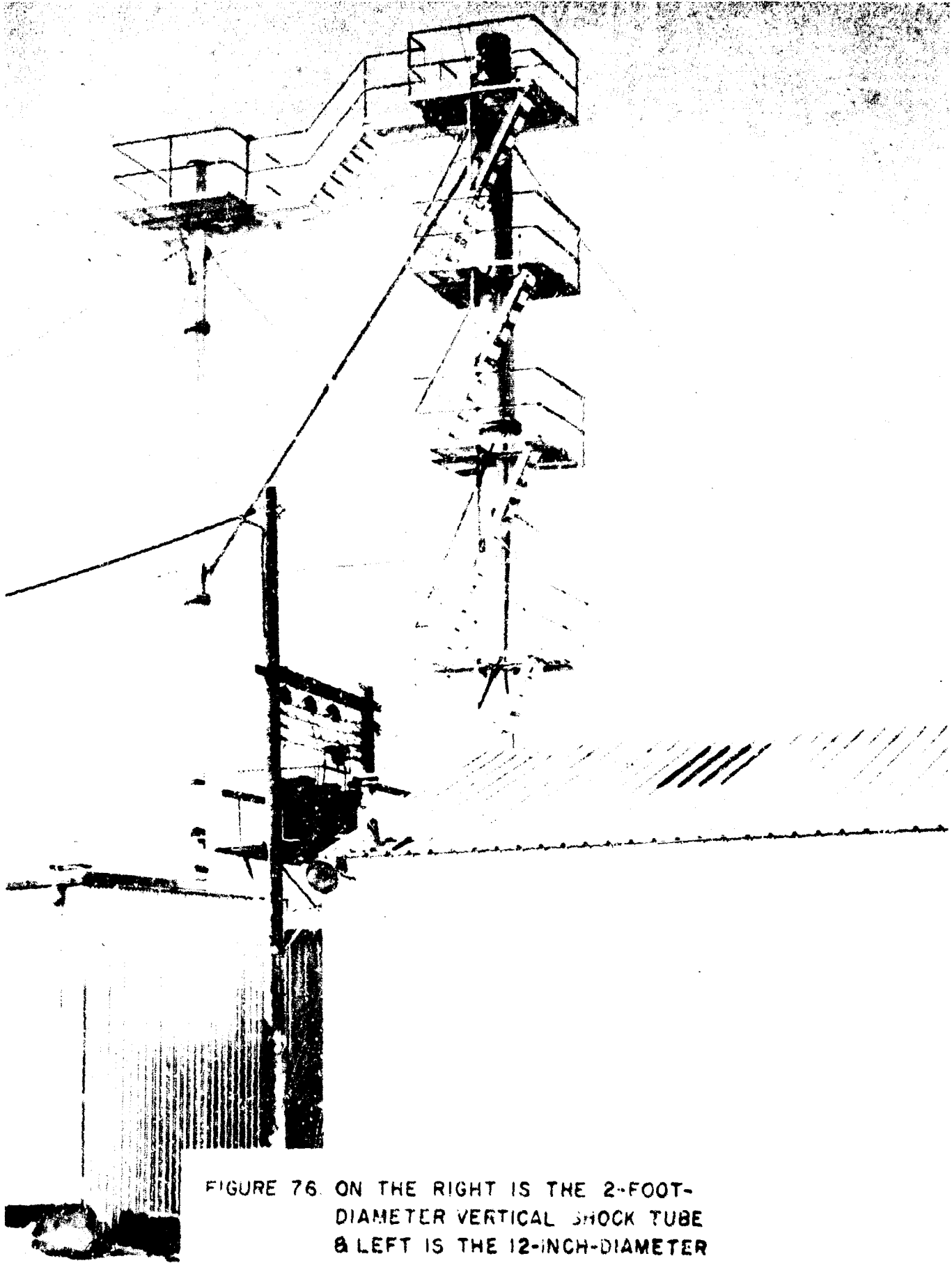

FIGURE 76. ON THE RIGHT IS THE 2-FOOT-DIAMETER VERTICAL SHOCK TUBE & LEFT IS THE 12-INCH-DIAMETER VERTICAL X-RAY SHOCK TUBE

1. TITLE AND/OR TYPE: The Sinnamon Dynamic Loader
2. LOCATION: University of Illinois
Attn: Prof. George K. Sinnamon
Talbot Laboratory
Civil Engineering Department
Urbana, Illinois
3. OWNER: Defense Atomic Support Agency (Contract AF29(601)-2876)
4. LOADING CHARACTERISTICS:
 - a. Type Wave: Plane Wave
 - b. Pressure: Minimum (psi) 50 Maximum (psi) 780
 - c. Force: Minimum (lbs) Maximum (lbs)
 - d. Rise Time: Helium - 2.8 milliseconds
Nitrogen - 5.6 milliseconds
 - e. Dwell Time: Adjustable from approximately 0 time to several hours
 - f. Decay Time: Variable from a minimum of 30 milliseconds to several hours
5. PHYSICAL DESCRIPTION (Figure 77 & 78): The loader stands approximately 6' 0" high and is attached to a heavy structural steel frame.
6. DRIVER: Helium or Nitrogen
7. CONTROLS: Machine is operated from an isolated control center which contains a valved distribution system for the gas, gas storage, firing controls and recording apparatus for instrumentation.
8. AVAILABILITY: Arrangements for use may be made by contacting Professor George K. Sinnamon, Civil Engineering Department, 111 Talbot Laboratory, University of Illinois, Urbana, Illinois.
9. OTHER CONSIDERATIONS: Ram attachment which is rated at 300 kips. The gas pressure is directed to a spring loaded piston producing a ram effect.
10. DISCUSSION: This loader was built as a pilot cell to test the feasibility of the design prior to the construction of the 7 cell 4 foot diameter loader. The pilot cell when operated for the "shake-down" tests produced loading pressures in excess of 20 percent

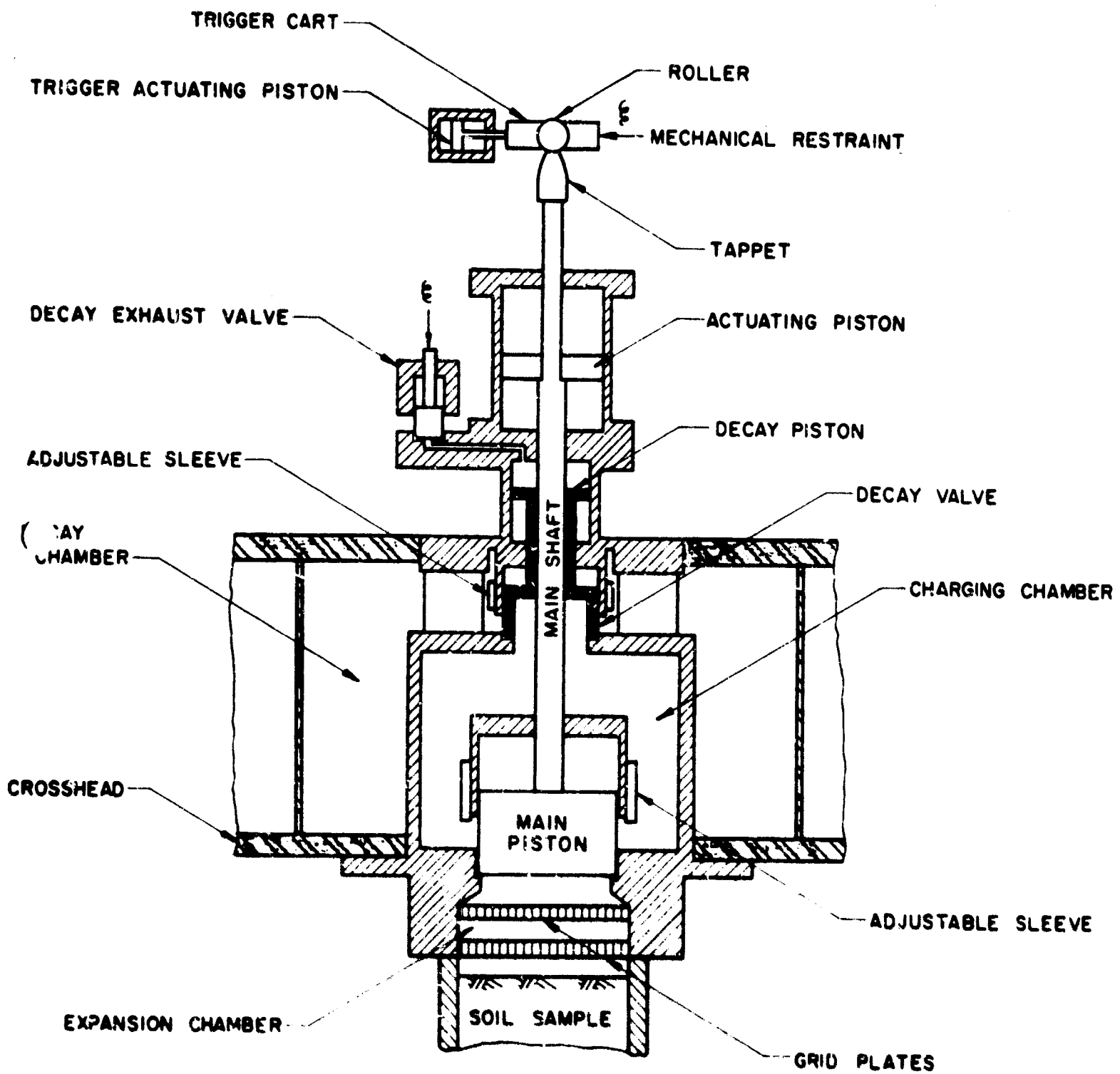

FIGURE 77. SKETCH SHOWING THE SINNAMON DYNAMIC LOADER BEFORE FIRING

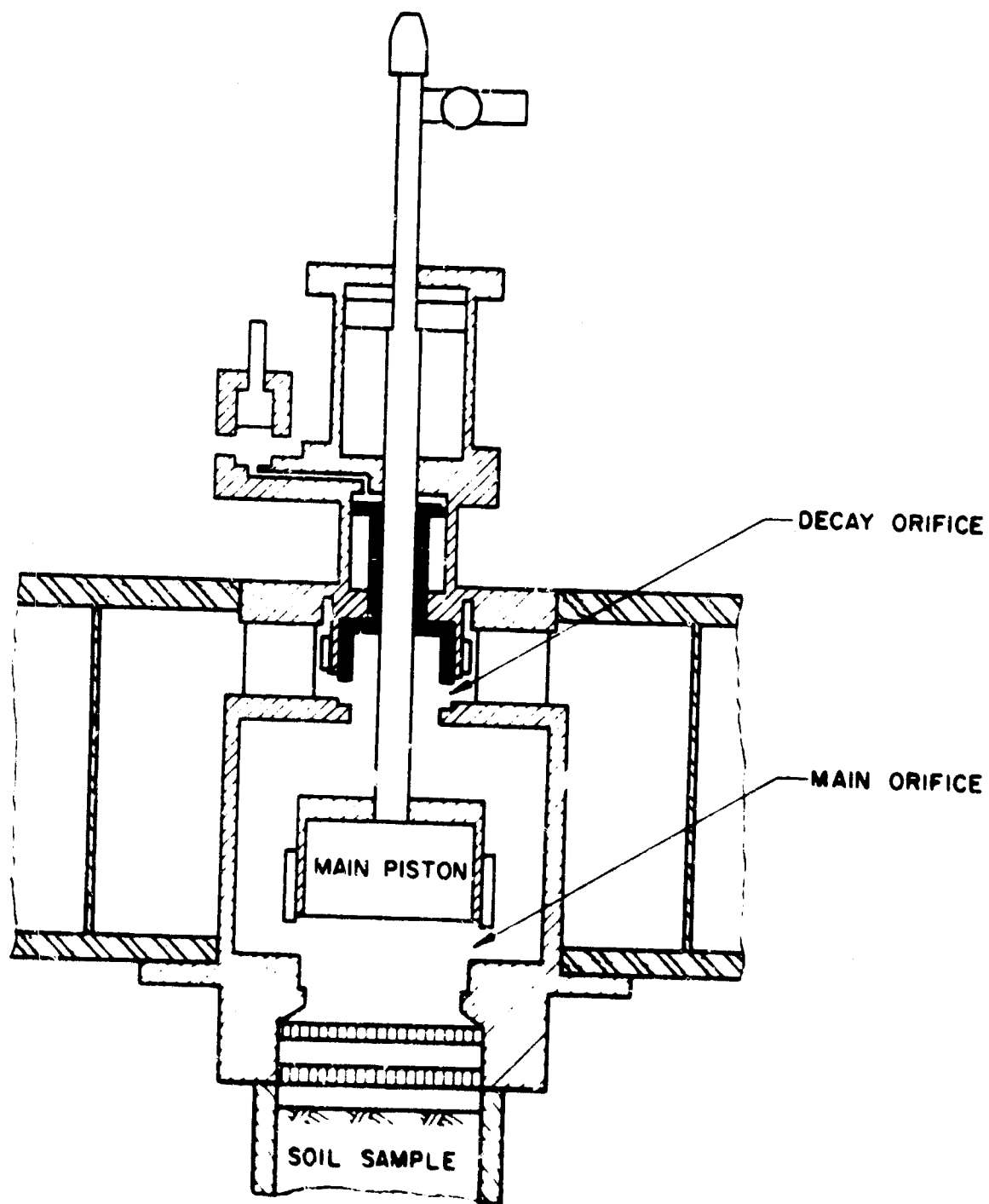

FIGURE 78. LOADER AFTER FIRING WITH THE
DECAY & MAIN ORIFICES OPEN

higher than originally required, it was decided to operate the cell as a separate loading device. The rise time using helium as a driver was slightly faster than anticipated.

The device has been in operation for approximately 1.5 years with very little maintenance necessary. The University has used it in their soil study program. By utilizing a 14 inch diameter collector plate, the machine has been used to conduct dynamic consolidation tests of soil. In these tests, pressures as high as 20,000 psi were obtained on four inch diameter specimens.

11. REFERENCE: The Project Report on this device will be incorporated with the final report on Contract AF29(601)-6101. This report will also cover the 7 cell loading device being constructed at the University.

1. TITLE AND/OR TYPE: 12-Inch-Diameter Vertical X-Ray Shock Tube
2. LOCATION: Eric H. Wang Civil Engineering Research Facility
Area Y
Sandia Base, New Mexico
3. OWNER: U. S. Air Force
4. LOADING CHARACTERISTICS:
 - a. Type Wave: Plane Wave
 - b. Pressure: Minimum (psi) 0 Maximum (psi) 200
 - c. Rise Time: A few microseconds, variable
 - d. Decay Time: Exponential decay with durations up to 50 milliseconds
5. PHYSICAL DESCRIPTION (Figure 79):
 - a. Diameter: 12 in I.D.
 - b. Height: 65 feet
 - c. Other: Utilizes a four foot transition section to a rectangular dimension 7 inch by 18 inch. This is supported by a steel structure so designed to accommodate a 7 inch by 18 inch by 36 inch deep soil bin. A specially designed concrete massive foundation is incorporated which allows an Elfdyne shock absorber system to support the soil bin.
6. DRIVER: Primacord
7. CONTROLS: The UED-Ampex Control Center.
8. AVAILABILITY: Available to other government agencies and their contractors. Contact Air Force Project Officer or the Facility Director.
9. OTHER CONSIDERATIONS: This tube and soil bin was designed to be used with the Zenith Flash X-ray system to determine the feasibility of using X-rays or gamma rays for the study of soil dynamics.
10. DISCUSSION: Pilot tests were performed to assess the utility of the Zenith Multiple Flash X-ray system (one picture frame per pulse) in tracking the motions of buried lead pellets and objects in soil, and in detecting density changes in soil. The first tests determined

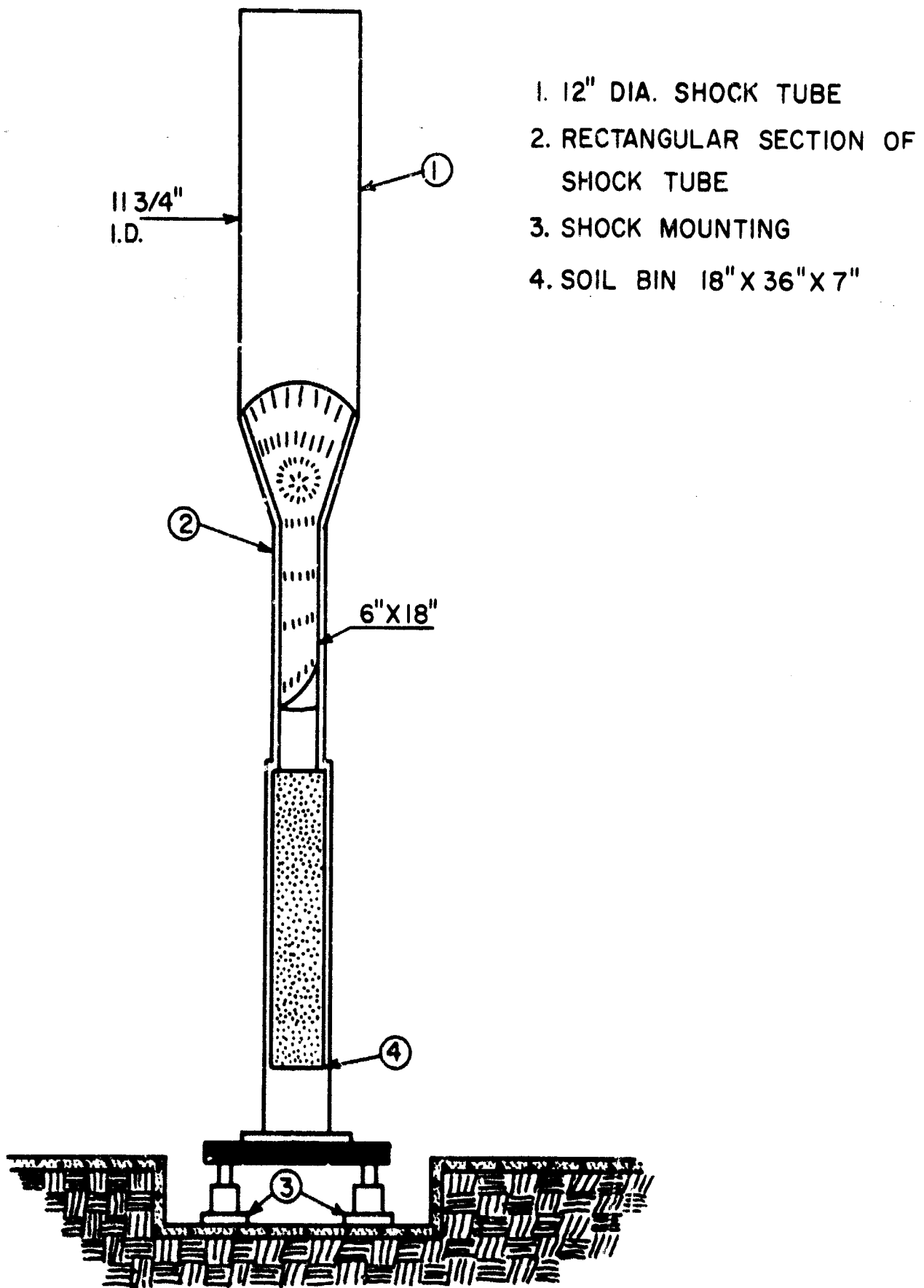

FIGURE 79. SCHEMATIC OF 12" X-RAY SHOCK TUBE

the quality of pictures (radiographic sensitivity) that could be obtained through various thicknesses of soil. A 6- inch sample of dense Ottawa sand attenuated the X-rays so that no usable radiograph was obtained; however, in 6 inches of loose Ottawa sand radiographs were obtained -- three frames for each sample. Although readable radiographs were available from these tests, it is evident that the contrast and edge sharpness were insufficient to show the fine detail desired.

A very limited amount of quantitative radiographic information was obtainable using the multiple flash X-ray system because of inadequate X-ray intensity and resolution.

A considerable amount of qualitative information was obtained which indicated that there are areas where the multiple flash X-ray system can produce good results in its present form. Tests resulting in large displacements or changes are easily radiographed and show the desired gross details.

The pilot tests provided valuable information indicating how scattering could be suppressed and showing the sample thickness and density required for particular soil tests.

Investigation of other equipment indicates that an X-ray system of the Field Emission type has the necessary characteristics for making dynamic measurements in soils; namely, higher X-ray intensity, shorter pulse widths, and a programmable pulse-repetition rate which allows radiographing the interaction of the leading edge of a shock front with a buried object.

A final report to assess the utility of X-ray techniques in soil dynamics studies is being reviewed; it contains the various technical objectives listed previously.

This device will be used to study the dynamic behaviour and interaction of buried structures in a soil media which will include (1) Strain, displacement and particle velocity, (2) Cratering Phenomenon, (3) Wave Propagation and (4) Soil-Structure Interaction.

11. REFERENCE:

a. "Nuclear Weapons Effects Research Program in Protective Structures Under Technical Direction of the Air Force Weapons Laboratory", Air Force Weapons Laboratory, Pages 145, 146, and 147 dated February 1966.

b. Baker, Warren J., Research Assistant Engineer, University of New Mexico, "AFWL, Air Force Shock Tube Facility - High Speed X-ray System," pages 4,5, and 6, Non-dated Unpublished Report.

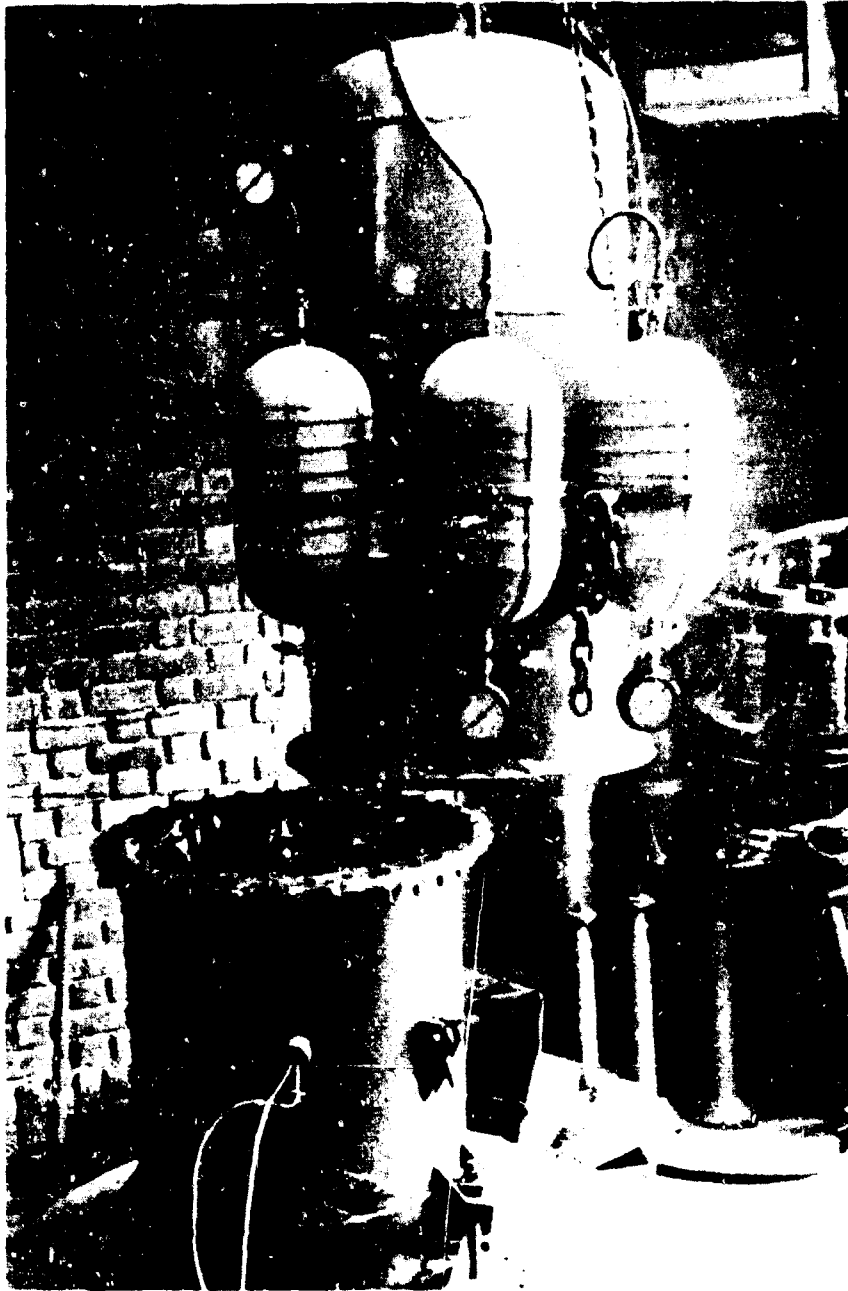

THE SIMULATOR OPENED

FIGURE 80. UNIVERSITY OF ARIZONA PLANE WAVE GENERATOR,
OPEN POSITION

8. AVAILABILITY: Yes, by a service or research contract.

9. OTHER CONSIDERATIONS: The instrumentation and recording consists of two statham pressure transducers (0 to 50 psi), two Tektronix dual beam oscilloscopes with cameras, one six-channel Brush recorder and two dual-channel Sanborn recorders. The mechanical driver has approximately the same range of rise times, peak overpressures, and decay times as the hydrogen-oxygen driver. Both drivers give very good reproducibility, with the explosive gas replication being within 10% from test to test.

10. DISCUSSION: The University of Arizona Plane Wave Generator has been used to test yielding membrane structures above and below ground. The investigations being made to determine the effect of depth of burial and relative structure flexibility on the percentage of load carried by the structural elements. This simulator has also been used for studies on soil pressure redistribution on flexible roof panels and soil arching studies of the "Terzaghi Trap Door" type. The simulator will be used for general parameter studies.

11. REFERENCE: Linger, Don A., "University of Arizona Plane Wave Generator," Tucson, Arizona, pages 1 and 2, 6 August 1964.

1. TITLE AND/OR TYPE: WES - 4-Foot-Diameter Blast Load Generator (SBLG)
2. LOCATION: U. S. Army Engineer Waterways Experiment Station
Corps of Engineers
Vicksburg, Mississippi
3. OWNER: U. S. Army
4. LOADING CHARACTERISTICS: (see discussion)
 - a. Type Wave: Plane (\pm 10%)
 - b. Pressure: Minimum (psi) 10 Maximum (psi) 250
Static pressure - 0 to 500 psi
 - c. Rise Time: 4 to 5 msec
 - d. Dwell Time: None
 - e. Decay Time: In excess of 2 seconds (uncontrollable)
5. PHYSICAL DESCRIPTION (Figures 81 & 82): (see discussion)
 - a. Diameter: 46-3/4 in. (I. D.)
 - b. Other: Over-all height of specimen is variable from 6 in to 20 ft.
6. DRIVER: Hot gases from the electric detonation of PETN in the form of primacord for dynamic pressures. Water or nitrogen gas is compressed to the desired pressure for static pressures.
7. CONTROLS: Rise-time of the pressure is obtained by the detonation of the explosive charge. No provisions are available to control decay of the pressure.
8. AVAILABILITY: The WES 4-foot diameter blast load generator (SBLG) is normally scheduled for full-time use on Waterways Experiment Station testing programs; however, testing that is considered to be within the capabilities of the generator may be conducted for other interested agencies on a priority basis. Inquiries should be sent to: Director, U. S. Army Engineer Waterways Experiment Station, P. O. Box 631, Vicksburg, Mississippi 39181.

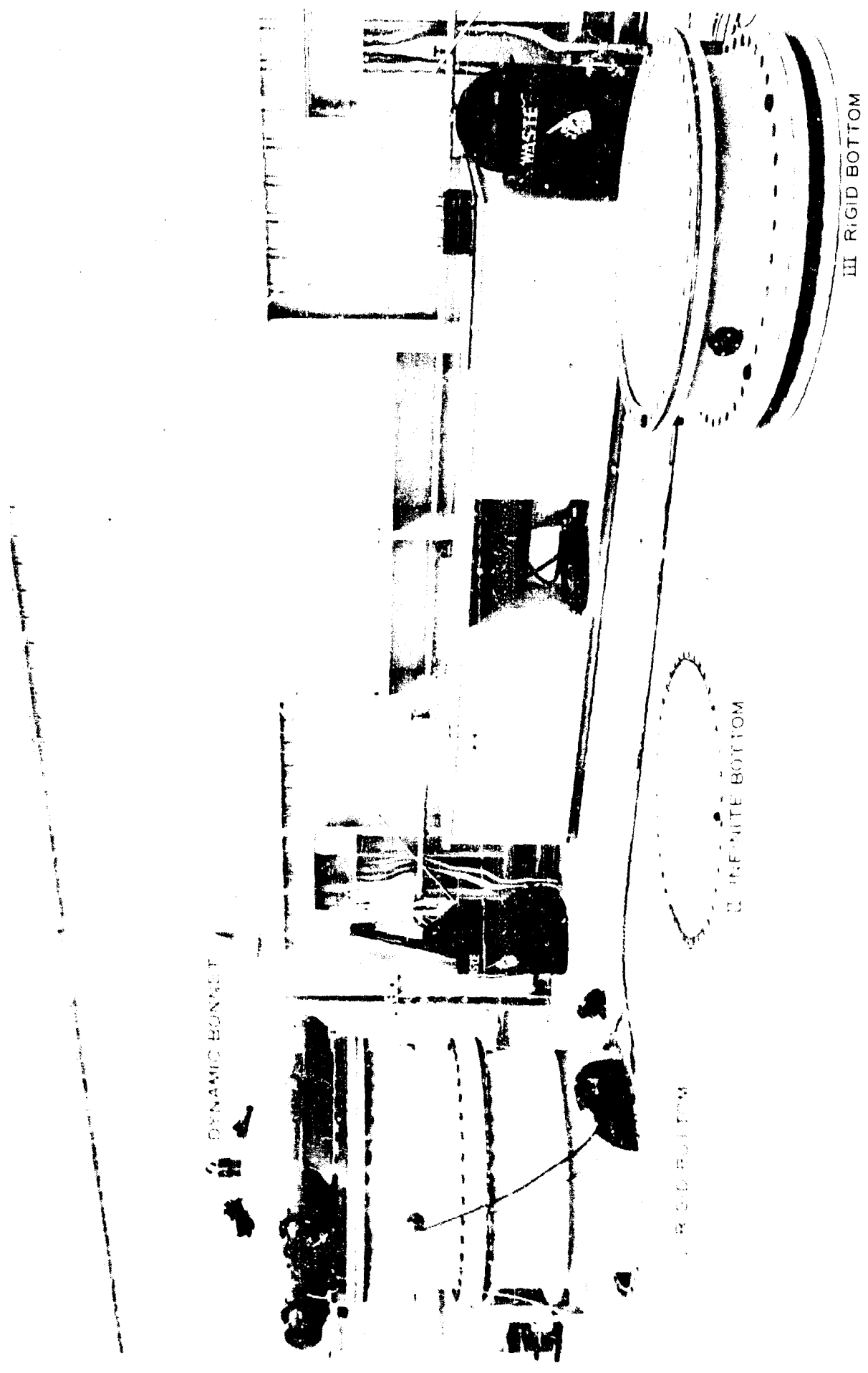

FIGURE 81. VES 4-FOOT GENERATOR RING ASSEMBLY

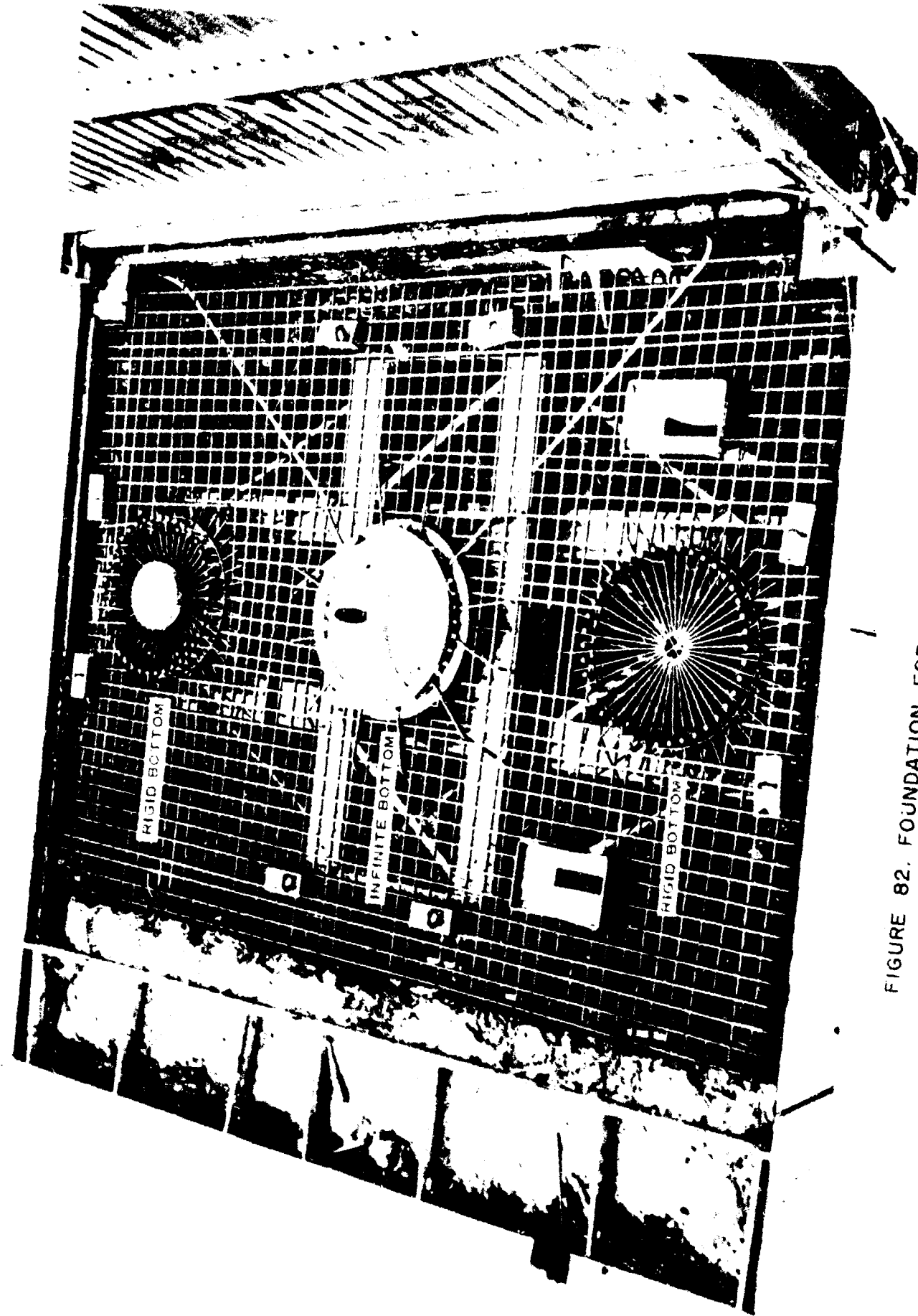

FIGURE 82. FOUNDATION FOR 4-FOOT GENERATOR

9. OTHER CONSIDERATIONS: The SBLG is a companion item of equipment with the WES large Blast Load Generator and is used to evaluate designs and to verify design procedures for underground protective structures.

10. DISCUSSION: The SBLG is located within the Blast Load Generator building at WES. The SBLG consists of a 9/16 inch thick steel cylindrical shell with an elliptical dome top, or bonnet. The dynamic bonnet is shown atop the rigid bottom (Figure 81). The shell or test chamber is composed of a series of rings which are bolted together to allow the depth of the soil sample to be varied. The rings and the bonnet are fastened together by forty 1-1/8 inch threaded studs and nuts per ring. Sealing is provided by O-rings in the separating flanges.

The concrete foundation to support the generator is 9 1/2 feet thick and has three anchorage locations, i.e., two rigid bottoms and one infinite bottom, see Figure 82. One of the rigid bases has a flat concrete interface at the base and the other provides an anchorage for a cylindrical ring having a flat steel bottom plate one inch thick and heavily stiffened. In the center of the steel bottom a trap-door can be mounted (maximum diameter 6 in.) and at various locations on the plate pressure transducers can be mounted. The infinite bottom is a steel lined hole in the base, 9.5 feet deep. The interface between soil specimen and base is the sub-soil which is clay. With this base, a specimen up to 20 feet long, 46-3/4 inches in diameter, and with essentially no horizontal reflecting interface can be tested.

The dynamic bonnet (Figure 81) houses two firing tubes surrounded by a baffling grid. The detonation of explosives in the two firing tubes generates pressure which loads the soil surface. The baffling grid breaks up the shock fronts and helps to form an essentially plane wave over the sample surface.

The SBLG is equipped with two quick-opening valves which can be timed to open automatically at 0.3, 0.6, 0.9, 1.2, 1.5 or 1.8 seconds after firing, or they can be operated manually. The body of the generator contains about (depending on the type base used) 10 ports for the insertion or mounting of pressure transducers, accelerometers, and other instrumentation.

1. TITLE AND/OR TYPE: WES - Large Blast Load Generator (LBLG)
2. LOCATION: U. S. Army Engineer Waterways Experiment Station
Corps of Engineers
Vicksburg, Mississippi
3. OWNER: Defense Atomic Support Agency (DASA)
4. LOADING CHARACTERISTICS: (see discussion)
 - a. Type Wave: Plane (\pm 50% at peak pressure)
 - b. Pressure: Minimum (psi) 30 Maximum (psi) 450
Static loads up to 1000 psi could be sustained by
modifications of the facility.
 - c. Rise Time: 2 to 4 msec
 - d. Dwell Time: None
 - e. Decay Time: Approaches 2 seconds (uncontrollable)
5. PHYSICAL DESCRIPTION: (Figures 83 & 84): (see discussion)
 - a. Diameter: 23 ft (O.D.)
22 ft, 10 in. (I.D.)
 - b. Other: Available surface area - 410 sq. ft. Available
depth for soil and test specimen - 10 ft.
6. DRIVER: Hot gases from the electric detonation of PETN in the
form of primacord for pressure up to 250 psi. Combination of prima-
cord and smokeless piston powder for higher pressures.
7. CONTROLS: Rise-time of the pressure is obtained by the detonation
of the explosive charge. No provisions are available to control decay
of the pressure.
8. AVAILABILITY: The WES large Blast Load Generator (LBLG) is
normally scheduled for full-time use on Waterways Experiment Station
testing programs; however, testing that is considered to be within
the capabilities of the generator may be conducted for other interested
agencies on a priority basis. Inquiries should be sent to: Director,
U. S. Army Engineer Waterways Experiment Station, P. O. Box 631, Vicke-
burg, Mississippi 39181.

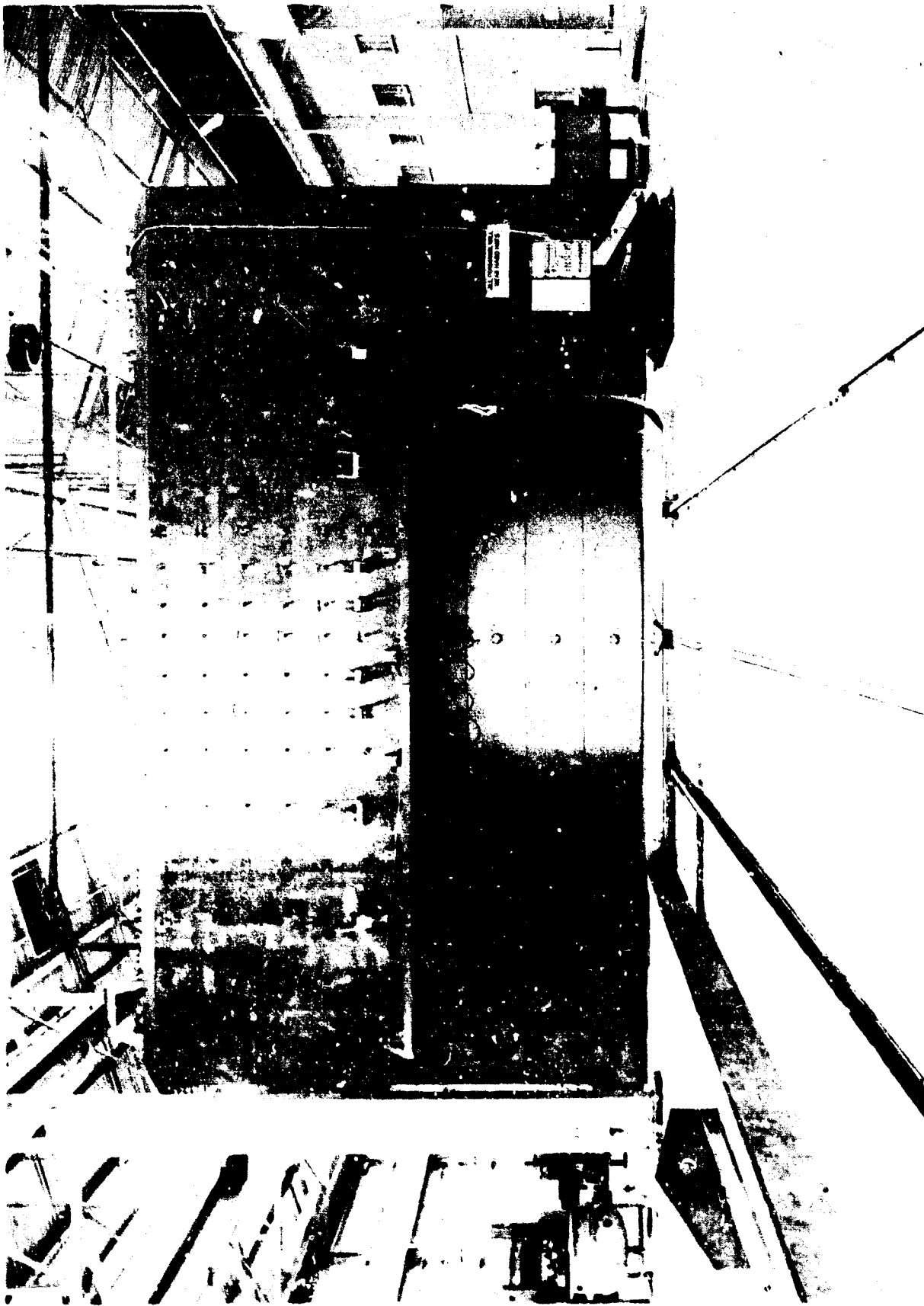

FIGURE 83. WES LARGE BLAST LOAD
GENERATOR FACILITY

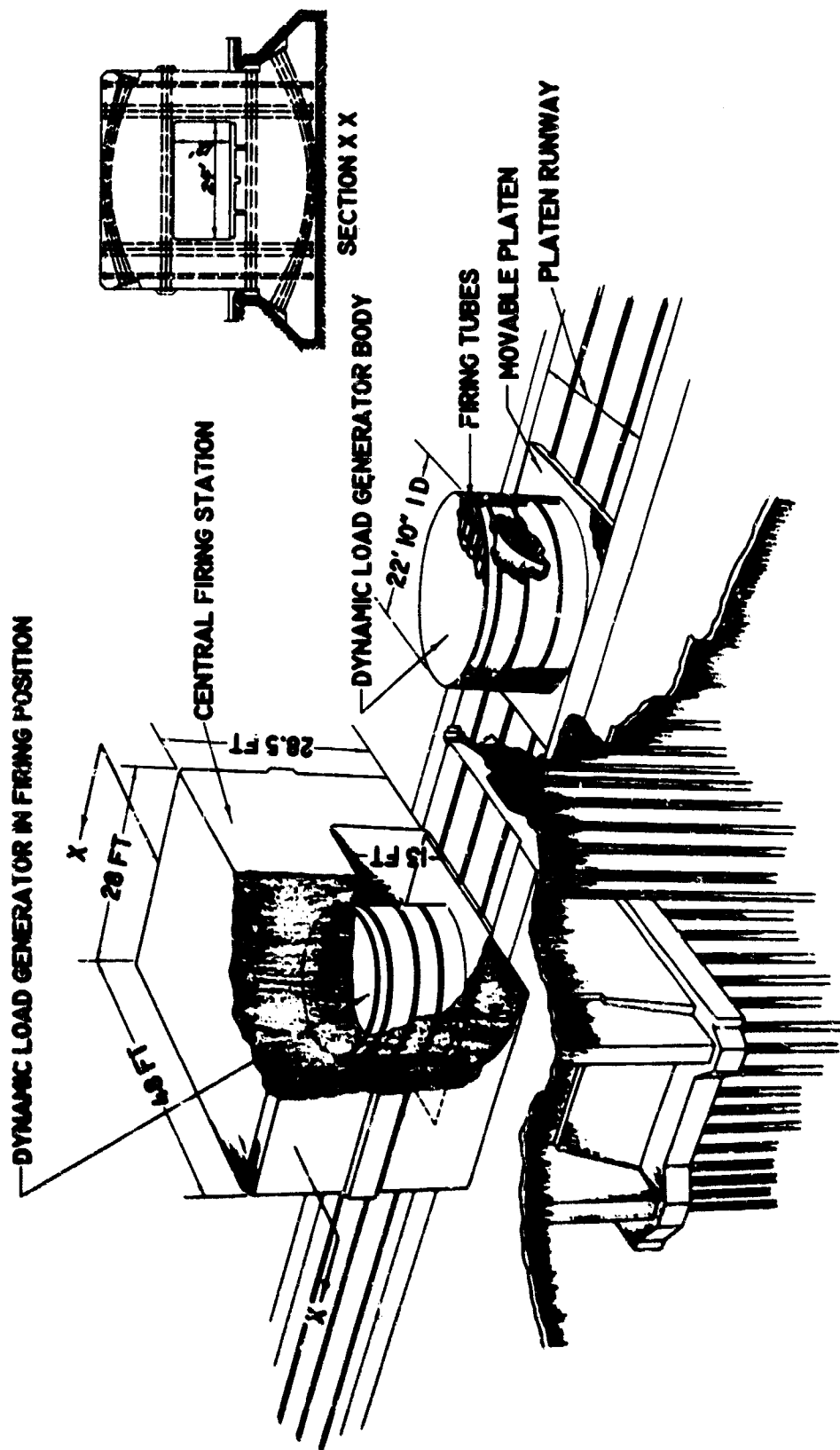

FIGURE 84. SKETCH OF LARGE BLAST LOAD GENERATOR

9. OTHER CONSIDERATIONS: The LBLG is a companion item of equipment with the WES 4-foot generator and is used to evaluate designs and to verify design procedures for underground protective structures.

10. DISCUSSION: The Blast Load Generator consists of two basic components; the central firing station and the test chambers. The central firing station is a massive, post-tensioned, prestressed concrete reaction structure designed to resist the large dynamic or static loads generated in the test chamber. The test chambers are cylindrical, steel bins 23 feet O.D., 22 feet 10 inches I.D., that contain the test media and test structures. A test chamber consists of three "C" rings that stack to a height of 10 feet, one "B" ring that contains the firing tubes and one "A" ring that is a telescoping type lid. The "A" and central firing station and test chamber are housed in a large laboratory building equipped with overhead cranes, special handling equipment, instrumentation and offices.

The platen which supports the test chamber is drawn into the tunnel of the central firing station. The rails supporting the platen are lowered so that the bottom of the platen can rest in intimate contact with the floor of the firing station. Nitrogen gas under pressure is allowed to flow into a circumferential slot in the "B" ring. The pressure thus forcing the "A" ring upward in a telescope fashion and insures that the flat top of the "A" ring is in intimate contact with the roof of the central firing station.

Heavy blasting mats are hung at both ends of the tunnel as a safety precaution against such flying objects as exhaust valves that could be ejected from the test chamber during tests.

The explosives in the firing tubes are fired electrically by a standard engineer cap connected to a leader strand of primacord. The leader strand is connected to individual strands of primacord that lead to each tube.

Upon completing a test, the "A" ring is lowered and the entire test chamber is raised by the rail lift system and moved from the central firing station. The "A" ring is removed and the tubes are examined to determine if all the explosives have been burned. If no further tests are to be conducted the soil and test specimens are removed and the chamber readied for future use.

The device is used in investigation of the following:

a. Studies in the design and analysis of the response of underground structures to dynamic loads:

1. Effect of the shape of the structure.

2. Effect of the ratio of span length to depth of burial.
 3. Effect of the ratio of span length to the over-all length of the structure.
 4. Effect of structural flexibility.
 5. Effect of the ratio of the duration of the loading to the period of the structure.
- b. Studies in the response of various types of soils to dynamic loads.
 - c. Studies of shock isolation methods.
 - d. Studies of stress wave propagation in soils.
 - e. Studies of blast-closure devices.
 - f. Studies in the design of entrance ways and entrance closure methods.

1. **TITLE AND/OR TYPE:** USAF 2-Foot-Diameter Vertical Shock Tube
2. **LOCATION:** Eric H. Wang Civil Engineering Research Facility
U. S. Air Force
Area Y
Sandia Base, New Mexico
3. **OWNER:** U. S. Air Force
4. **LOADING CHARACTERISTICS:**
 - a. **Type Wave:** Plane Wave
 - b. **Pressure:**

Minimum (psi)	Maximum (psi)
Reflected	500
Incident	250
 - c. **Force:** Minimum (lbs) Maximum (lbs)
 - d. **Rise and Decay Time:** The wave is peaked and decays exponentially with a duration of 20 milliseconds.
5. **PHYSICAL DESCRIPTION (Figures 85 & 86):**
 - a. **Diameter:** 2 foot O.D.
 - b. **Height:** 40 feet
 - c. **Other:** The tube is supported by a steel frame which is bolted to a massive concrete foundation. It is guyed with steel cable with dead men anchors. A stairway to the top is provided with three landings.
6. **DRIVER:** Primacord is used on a cardboard form and affixed to the tube top opening. At times the primacord is suspended by a cable for a variance in shot configurations and durations. The tube is fired with both ends open.
7. **CONTROLS:** UED-Apex Control Console
8. **AVAILABILITY:** Available to other government agencies and to contractors of the United States Government on contracts requiring the use of and within the limitations of the tube. Scheduling is controlled by the Air Force Project Officer, and the Director of the Facility.

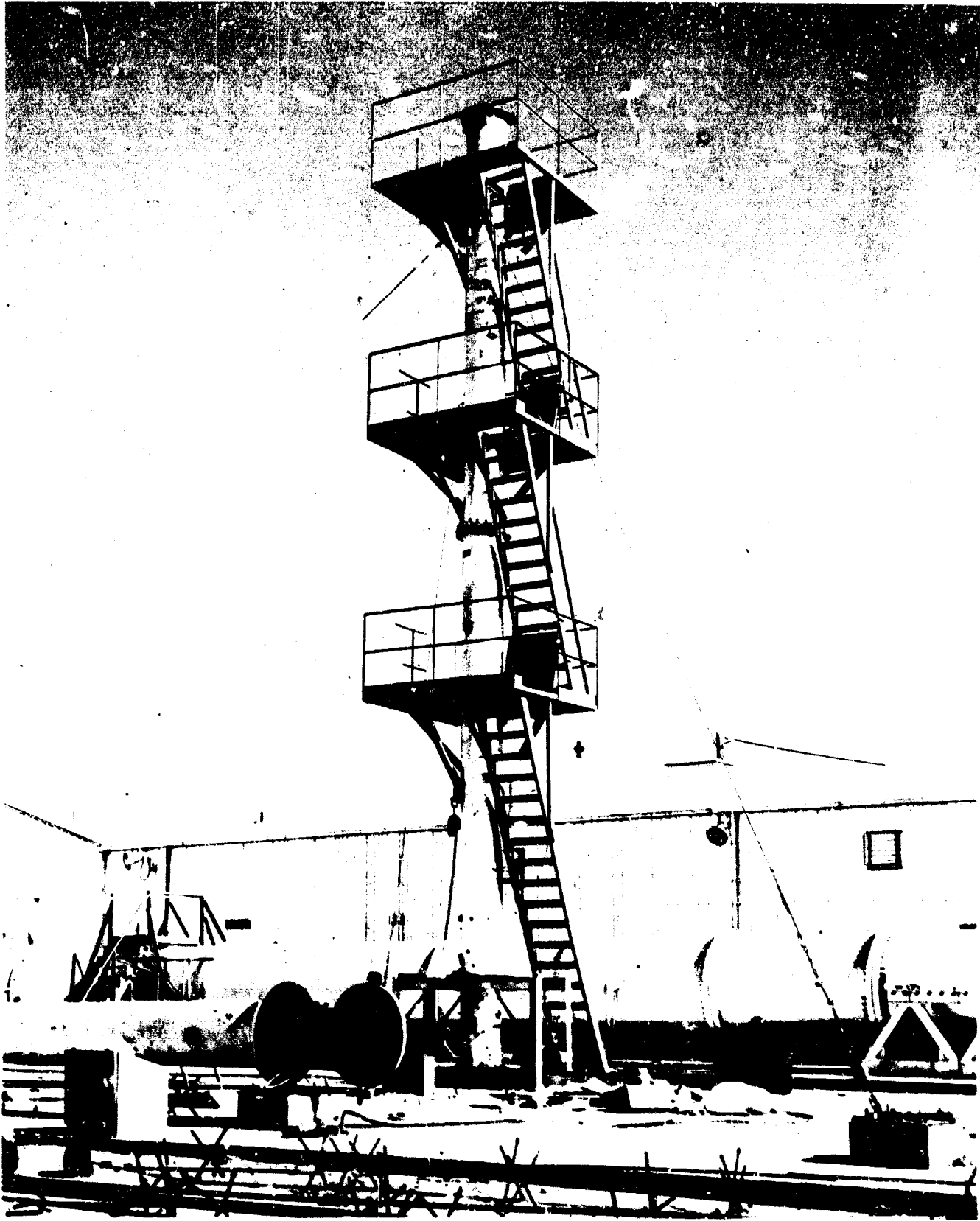

FIGURE 85. USAF 2-FOOT-DIAMETER VERTICAL SHOCK TUBE

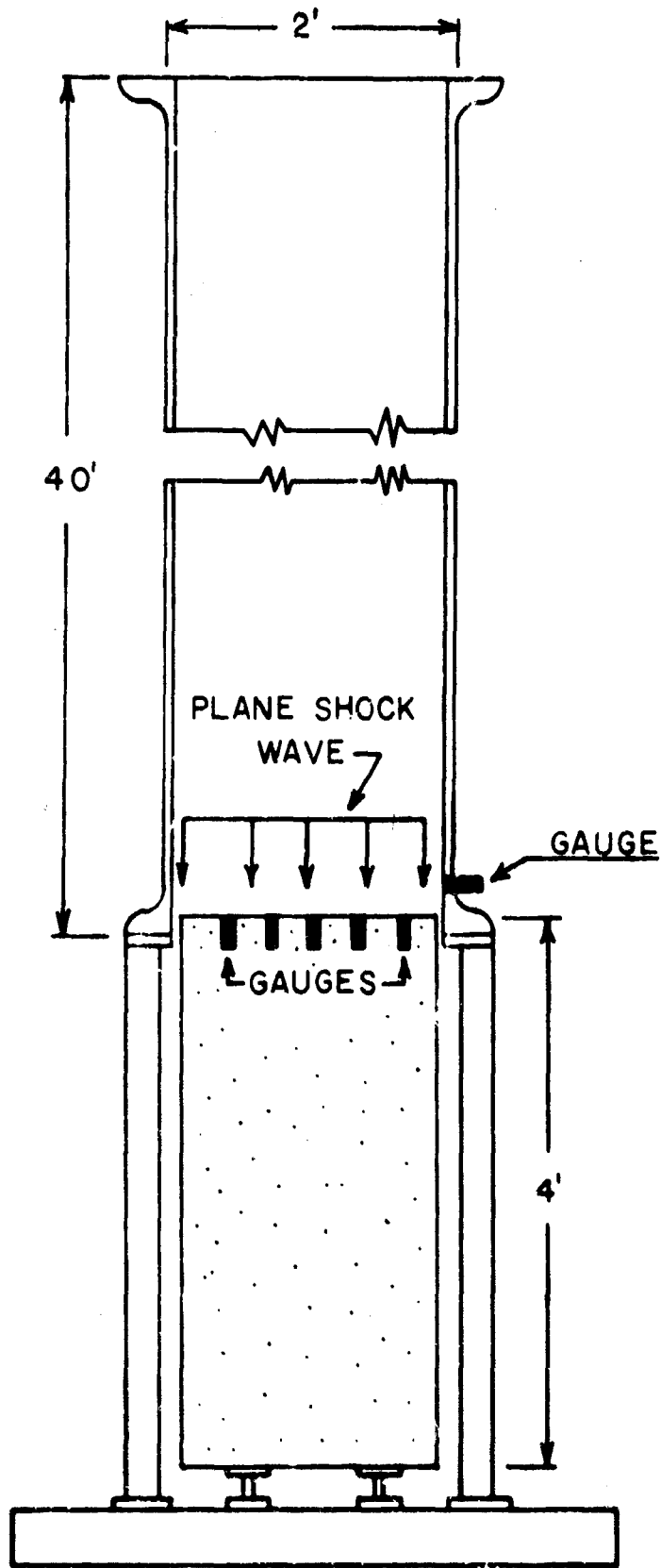

FIGURE 86. SKETCH OF 2-FOOT-DIAMETER
VERTICAL SHOCK TUBE

JDR

9. OTHER CONSIDERATIONS: The tube has a 2 foot diameter by 4 feet deep soil bin mounted on a shock resistant device.

10. DISCUSSION: The tube was used in a study involving the locking medium concept and the gross behavior of a plane incident shock wave was required. Shock wave amplitude and shape prior to reflection from a soil surface and immediately after reflection were also required. Of interest too, was the motion of the soil surface. Gauge development and tests on small buried structures has utilized the tube.

11. REFERENCES:

a. Hampton, Delon, "A Study of Pore Air Pressure Generated in Soil Subjected to Air Shock Waves," WL TDR 64-3, Contract AF 29(601)-6002, Air Force Weapons Laboratory, Kirtland AFB, New Mexico, October 1964.

b. Mahoney, James A., "The Air Force Shock Tube Facility," Civil Engineering Branch, Air Force Weapons Laboratory, Unpublished Report, June 1964.

c. Pantall, Jack T., Capt, USAF, "AF Shock Tube Facility Operations," Civil Engineering Branch, Air Force Weapons Laboratory, Unpublished Report, Pages 12 and 13, January 1962.

SECTION V
MISCELLANEOUS LOADERS

1. TITLE AND/OR TYPE: AFWL Gas Bag Program
2. LOCATION: Eric H. Wang Civil Engineering Research Facility
Area Y
Sandia Base, New Mexico
3. OWNER: U. S. Air Force through DASA Funding
4. LOADING CHARACTERISTICS:
 - a. Type Wave: Traveling wave
 - b. Pressure: Minimum (psi) Maximum (psi) in excess of 1000
 - c. Rise Time: Instantaneous
 - d. Duration: Variable to simulate up to one magaton.

5. PHYSICAL DESCRIPTION (Figure 87):

a. Phase I. This consisted of a concrete walled 20 foot by 40 foot by 10 foot tank and having an earth bottom. A plastic bag was inflated with an explosive gaseous mixture of hydrogen and oxygen to a depth of two feet from the bottom. Steel plate panels were layed across haunches provided at the concrete walls. A layer of sheets of sterof foam was used for a chafe proof surface for a plastic liner to contain the water surcharge. Later shots used wooden box panels in place of the steel panels.

b. Phase II. This consisted of an area of 97 feet by 151 feet. A pit was dug and around the perimeter 10 gauge steel interlocking sheet piling was driven 5 feet into the ground leaving 11 feet extended above the ground surface. A surcharge retention structure was erected within the steel pile perimeter. This structure consisted of 3 in. X 6 in. footing, 5-2" X 12" pieces bolted together formed the girders. The girders ran longitudinally and were spaced at 8 feet centers except that the two outer spans were at 4 feet spacings. Primacord matrixes on wooden frame panels were placed on haunches formed by the short columns. Then spanning the girders in the transverse direction were the retention panels which consisted of 1/2" plywood sheet bottom, 2 in. by 8 in. joists, and 3/4 in. plywood sheet top. Between the panel joists sand was placed at a density of 105 pounds/cubic foot. The distance from ground level to the bottom of the panel was approximately 3 feet and the primacord was placed at the 2/3 point from ground level. The panels were made in 6 different size dimensions, the largest panel being 4 feet by 16 feet, joints staggered. Upon the panels was placed a 5 foot surcharge of selected sand at a density of 105 pounds/

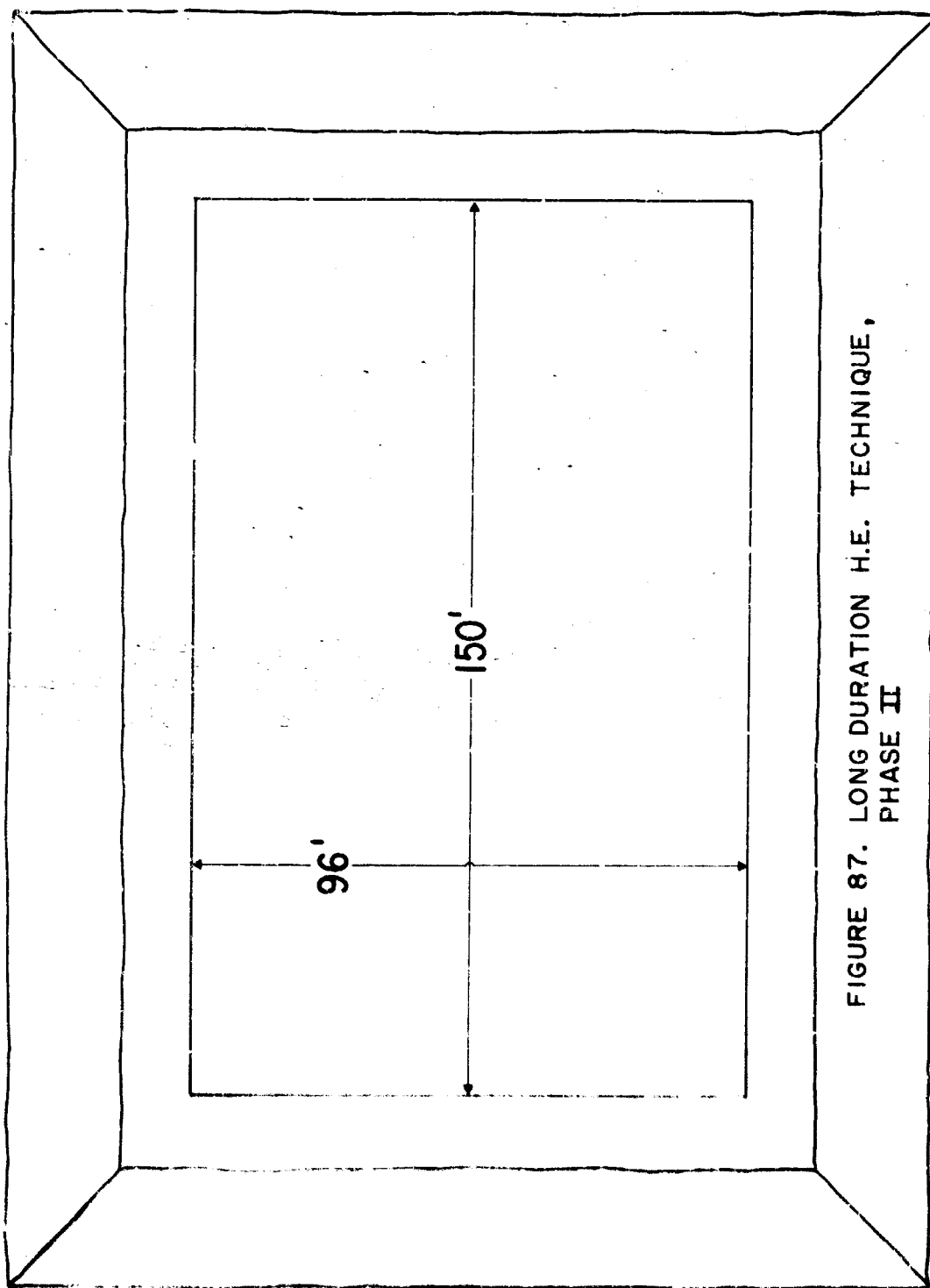
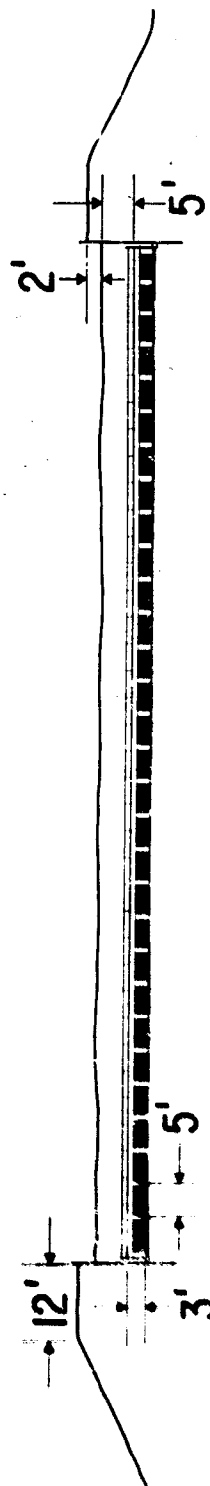

FIGURE 87. LONG DURATION H.E. TECHNIQUE,
PHASE II



cubic foot. 100 feet down stream from the ignition end a scaled reinforced concrete model structure was constructed. Instrumentation was included but can be found in other reports to be published in the near future by AFWL-Civil Engineering Branch.

6. DRIVER: A gaseous mixture of hydrogen and oxygen and primacord matrix.

7. CONTROLS: AF Weapons Laboratory Instrumentation Trailer

8. DISCUSSION: The Term "GAS Bag" is used in the title because it is well known by everybody connected to the simulation field. Actually only a few tests were run in the Phase I series using the gas bag principle. Primacord has been used both in the Phase I and II series. The University of New Mexico operating contractor of the Wang Civil Engineering Research Facility is carrying on with the Phase I and II series of tests. A Phase IIa is currently being planned and will incorporate other underground shaped structures.

A Phase III series of tests is contemplated which will be "full scale tests" funded completely by the Air Force. BSD has programmed tests on a constructed missile complex. Phase I and II were funded by Hq DASA.

9. REFERENCES:

a. D'Arcy, G. P. Capt, USAF and Auld, H. E., Capt, USAF, "Interim Progress Report on the Study of Simulation of Air-Blast Induced Ground Motions," Air Force Weapons Laboratory, Research & Technology Division, Air Force Systems Command, Kirtland Air Force Base, New Mexico, pages 1, 5, 6, 7, and 8, 15 June 1964.

b. Project AFWL-1 Plans & Specifications for Construction of Phase II, Prepare & Designed by the Civil Engineering Branch of the Air Force Weapons Laboratory, Kirtland Air Force Base, New Mexico, October 1964.

c. D'Arcy, G. P., Capt, USAF & Clark, R. O., University of New Mexico, "Simulation of Air Shocks with Detonation Waves, AFWL-TR-65-9 Kirtland AF Base, New Mexico" (to be published).

d. D'Arcy, G. P., Capt, USAF, Auld, H. F., Capt, USAF, and Leigh, G. G., Capt, USAF "Simulation of Air-Blast Induced Ground Motion (Phase I) AFWL TR 65-11, Kirtland AF Base, New Mexico (being published).

B-5

1. TITLE AND/OR TYPE: Atomic Blast Simulator
2. LOCATION: U.S. Naval Civil Engineering Laboratory
Port Hueneme, California
3. OWNER: U. S. Navy
4. LOADING CHARACTERISTICS:
 - a. Pressure: Minimum (psi) 30 Maximum (psi) 185
 - b. Rise Time: Adjustable from 0.75 to 3 milliseconds, longer if desired.
 - c. Dwell Time: Variable
 - d. Decay Time: Approximates equation $p = p_0 \left(1 - \frac{t}{t_0}\right) e^{-\frac{t}{t_0}}$
 - e. Durations: 0.4 to 7.0 seconds
5. PHYSICAL DESCRIPTION (Figure 88)
 - a. Height: 7 ft
 - b. Length: 19 feet
 - c. Other: The main pressure chamber has a diameter of approximately 2 feet. The slotted plates is 2 1/2 inches thick; welded to each side of this plate and extending downward are 1 1/4 inch thick plates referred to as skirts. Stiffer ribs resembling horse collars are placed at intervals of 17 inches along the length of the simulator. These ribs reinforce the pressure chamber and the skirts.

Inside the pressure chamber is a baffle assembly dividing the main chamber into smaller chambers for the purpose of preventing reverberations.
6. DRIVER: Primacord detonated within a firing tube.
7. CONTROLS: On the exterior of the simulator, spaced at equal intervals along both sides of the pressure chamber are 22 quick-opening pressure relief valves which are actuated by solenoids.
8. AVAILABILITY: Available by arrangement, see address above.



FIGURE 88. NCEL ATOMIC BLAST SIMULATOR

9. OTHER CONSIDERATIONS: The blast simulator is positioned over a pit 9 feet wide, 10 feet long and 12 feet deep. The pit is necessary for the testing of structural frames. Further, the pit accommodates extensions (6 feet by 10 feet) to the skirts which permits the testing of structural arches and model structures buried in soil. The pit is covered when beams are tested.
10. DISCUSSION: A track below the skirts of the simulator extends 26.5 feet beyond one end of the simulator and is embedded in the concrete. Two carts, which serve as reactions for the test beams, move on the track and provide a means of moving the test beam into position between skirts. Various structural configurations and systems can be tested in the simulator including beams, frames, arch sections, structural connections, and model structures buried in soil. Because of the physical dimensions of the simulator, test elements cannot exceed a width of 8 inches. Beams may vary in depth from 8 inches to 14 inches and can be reinforced concrete or steel. Rigid frames can have a maximum column length of 8 feet and a span of 12 feet. Arch shaped structures may be tested in either its normal position or rotated 90 degrees in a vertical plane. The maximum spans of the arches that can be tested in the two positions are 9 feet 6 inches and 13 feet 10 inches respectively. The simulator is capable of testing structural models buried in a soil medium. These models can be either reinforced concrete or steel. They may have spans of 3 feet to 4 feet and a rise of 1 foot to 2 feet.
11. REFERENCE: Allgood, J.R., Shaw, W.A., "An Atomic Blast Simulator," U.S. Naval Civil Engineering Laboratory, Port Hueneme, California, pages 2, 3, 4, and 5. No date.

1. TITLE AND/OR TYPE: Drop Tower (WES)
2. LOCATION: U. S. Army Engineer Waterways Experiment Station
Corps of Engineers
Vicksburg, Mississippi
3. OWNER: U. S. Army
4. LOADING CHARACTERISTICS:
 - a. Pressure: (Energy Available) Maximum (ft-lb) 40,000
 - b. Force: Minimum (lb) 450 Maximum (lb) 2,300
 - c. Rise Time: Varies, depending upon material being tested.
5. PHYSICAL DESCRIPTION: (Figure 89): Drops the variable weight between 0 and 17 ft.
6. DRIVE: Gravity
7. CONTROLS: A helicopter release hook operated off a 22-volt battery releases the mass. The load and strain are measured with an oscilloscope. An electric eye triggers the scope. Load can either be measured with an accelerometer or load cell. Strain gages measure strain.
8. AVAILABILITY: The drop tower is normally scheduled for full-time use on Waterways Experiment Station testing programs; however, testing that is considered to be within the capabilities of the tower may be conducted for other interested agencies on a priority basis. Inquiries should be sent to: Director, U. S. Army Engineer Waterways Experiment Station, P. O. Box 631, Vicksburg, Mississippi 39181.
9. OTHER CONSIDERATIONS: The rise time may be varied, depending upon height of drop and weight of the mass and mitigating material between mass and specimen. For instance, the rise time of concrete may be varied from 1 to 8 milliseconds.
10. DISCUSSION: The drop tower is located within the Concrete Division building at WES's Jackson Installation. The device is used primarily to obtain dynamic stress-strain relationships of concrete in compression.

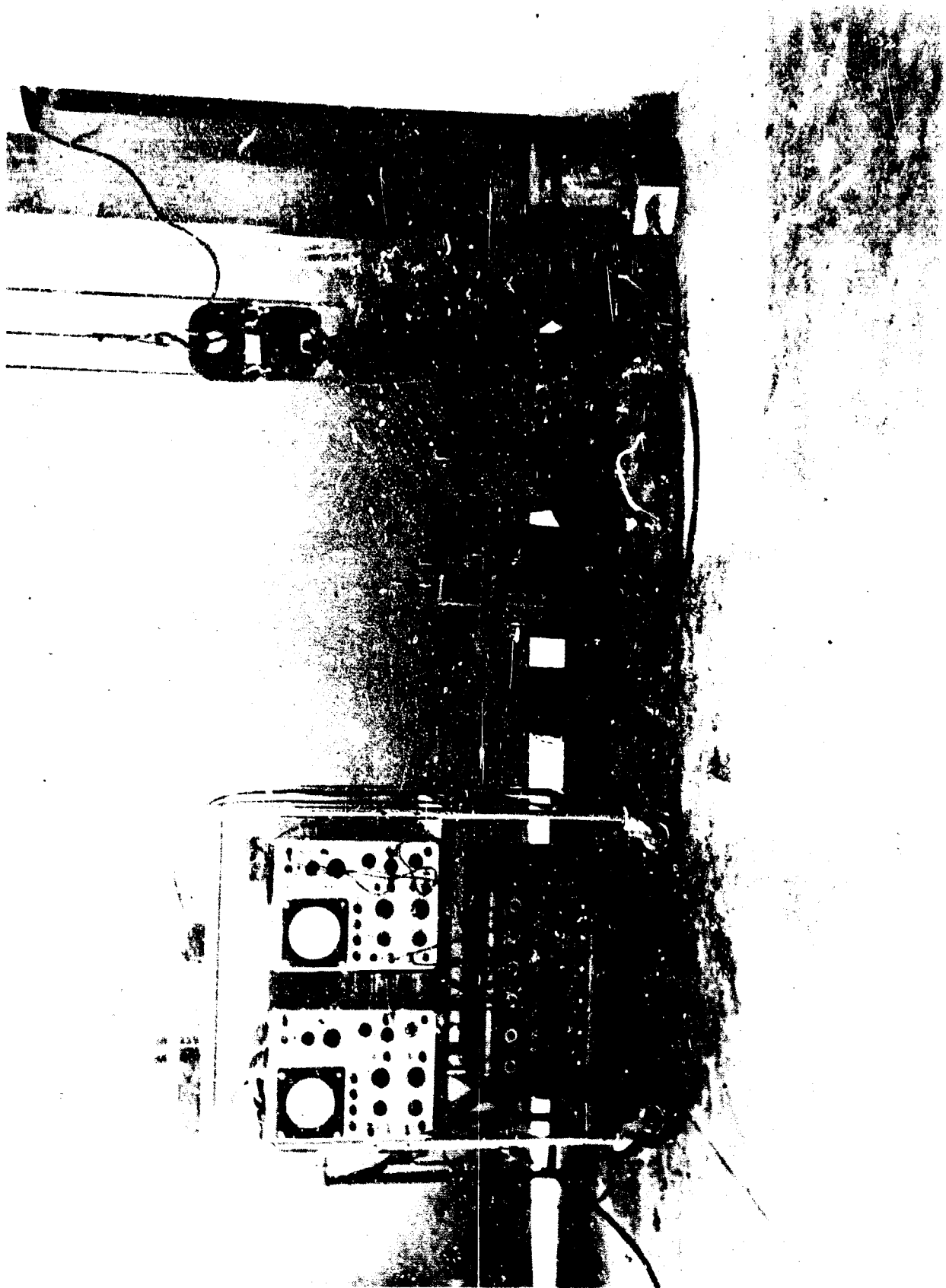

FIGURE 89. WES DROP TOWER

1. **TITLE AND/OR TYPE:** High-Explosive Test Site (Concrete Pad)
2. **LOCATION:** Lovelace Foundation for Medical Education & Research
Sandia Base Laboratory
Albuquerque, New Mexico
3. **OWNER:** Lovelace Foundation
4. **LOADING CHARACTERISTICS:** Data not available.
5. **PHYSICAL DESCRIPTION (Figures 90 & 91):**
 - a. **Diameter:** 60 feet - 6 inches thick
6. **DRIVER:** H-E with charges ranging from 0.5 oz. to 64 pounds
7. **CONTROLS:** 7 X 12 foot underground bunker for recording instruments located 84 feet from the center of the pad.
8. **AVAILABILITY:** Available to a government agency with the consent of the Director of the Defense Atomic Support Agency and Dr. C. S. White of the Lovelace Foundation.
9. **OTHER CONSIDERATIONS:** Included at this site are camera towers and an above ground control bunker. Pressure-gauge mounts are located in the lids of steel boxes flush with the surface of the pad along several radii. Conduits embedded in the concrete carry the gauge-leads from these boxes to the recorders in the underground bunker. A similar system of conduits extend from the underground bunker to the area adjacent to the concrete pad for tests conducted on or over soil.
10. **REFERENCE:** "DASA-AEC-Lovelace Foundation Blast-Simulator Facilities," Sandia Base, Albuquerque, New Mexico, Report transmitted by ltr dated 7 April 1965 from Dr. D. Richmond, page 3, author and date not available.

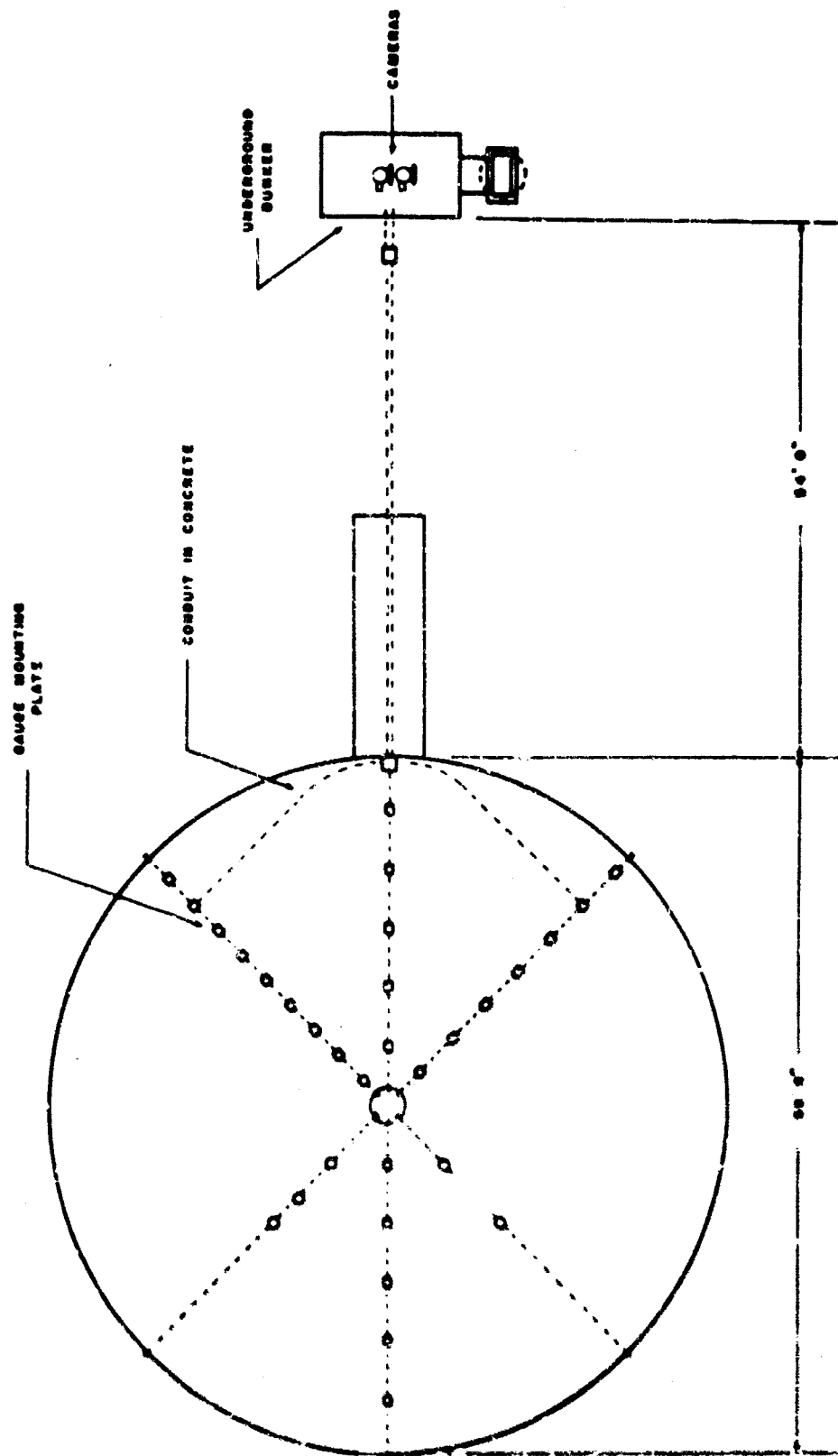

FIGURE 80. SCHEMATIC OF LOVELACE HIGH—
EXPLOSIVE TEST SITE

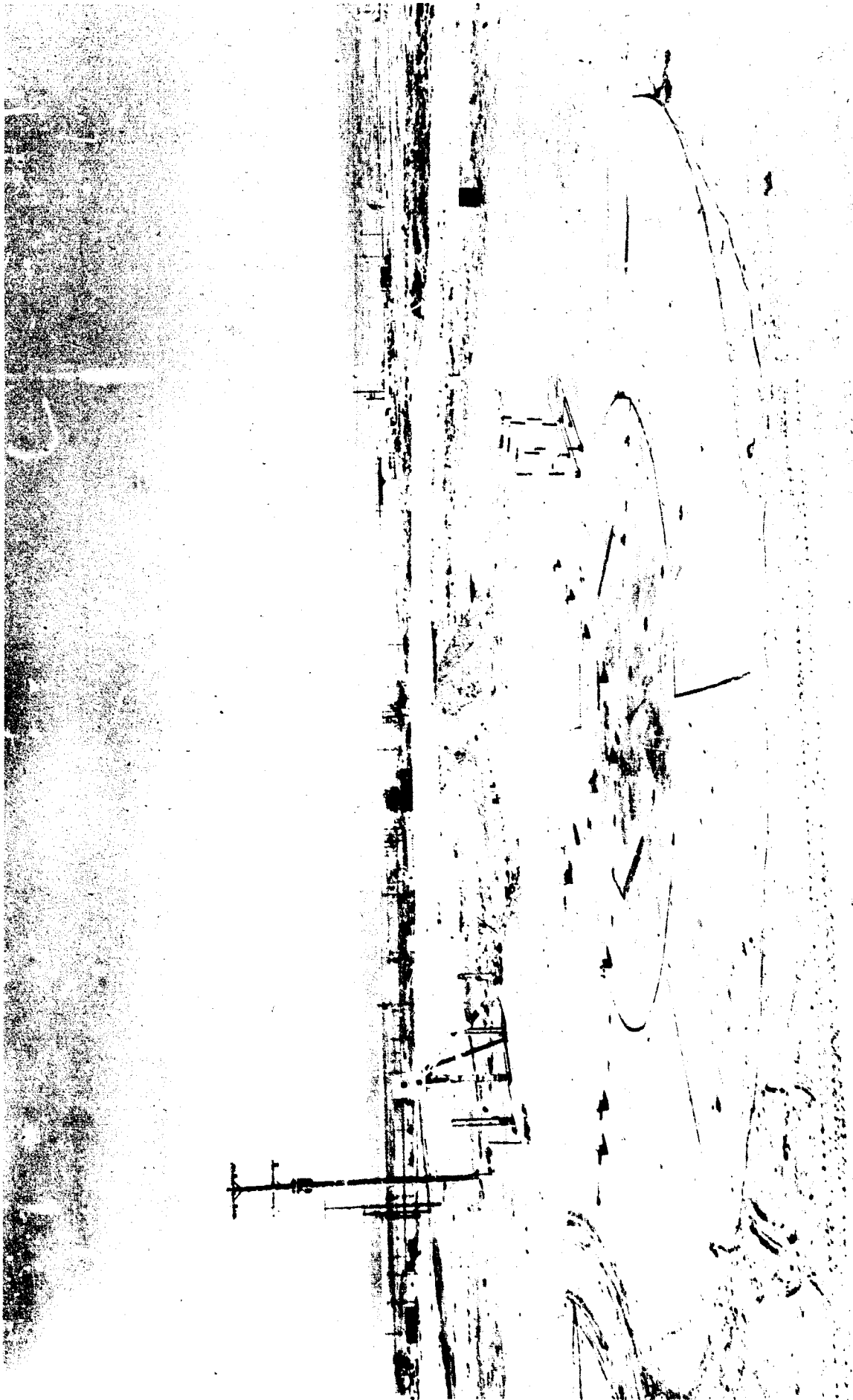

FIGURE 91. HIGH-EXPLOSIVE TEST SITE
(CONCRETE PAD)

1. **TITLE AND/OR TYPE:** IIT Research Institute Dynamic Soil Facility
2. **LOCATION:** IIT Research Institute
Technology Center
Chicago, Illinois
3. **OWNER:** IIT Research Institute
4. **LOADING CHARACTERISTICS:**
 - a. **Pressure:** Minimum (psi) 0 Maximum (psi) 530 peak
 - b. **Rise Time:** 6 milliseconds
 - c. **Dwell Time:** An overpressure of approximately 240 psi is maintained steady after 100 milliseconds.
5. **PHYSICAL DESCRIPTION (Figures 92, 93, 94 & 95):** The facility is built around a 48 inch diameter cylindrical tank approximately 6 feet deep. The loading system for applying the dynamic overpressure to the surface of the soil consists of a cylindrical pressure chamber (18 inches in diameter by 36 inches long with 1 1/8 inch thick walls) for providing the driving pressure and a conical shaped transition section (18 inch upper diameter, 48 inch lower diameter, 38 inches long, with 1 1/8 inch wall thickness) connecting the pressure chamber to the vessel containing the soil. This conical shaped section can be filled with water to any desired level. The water acts to distribute the dynamic pressure pulse uniformly across the soil surface. A flexible rubber diaphragm is employed between the conical section and the soil tank to prevent the water from entering the soil pores. A thin (0.030 to 0.040 inches thick) steel diaphragm is used between the cylindrical chamber and the conical section to retain pressurized gas in the upper chamber.
6. **DRIVER:** The conical shaped transition section is first filled with water to a level approximately 6 inches below the steel diaphragm. This 6 inch air space allows the diaphragm to deform freely without contacting the water as the upper chamber is pressurized with nitrogen gas to the valve necessary to produce the desired magnitude of soil overpressure. In order to rapidly release the pressure in the upper chamber and transfer it to the surface of the soil, the steel diaphragm is ruptured by detonating four 6 inch lengths of 25 grain primacord.
7. **AVAILABILITY:** Contact Dr. E. T. Selig at the above address.

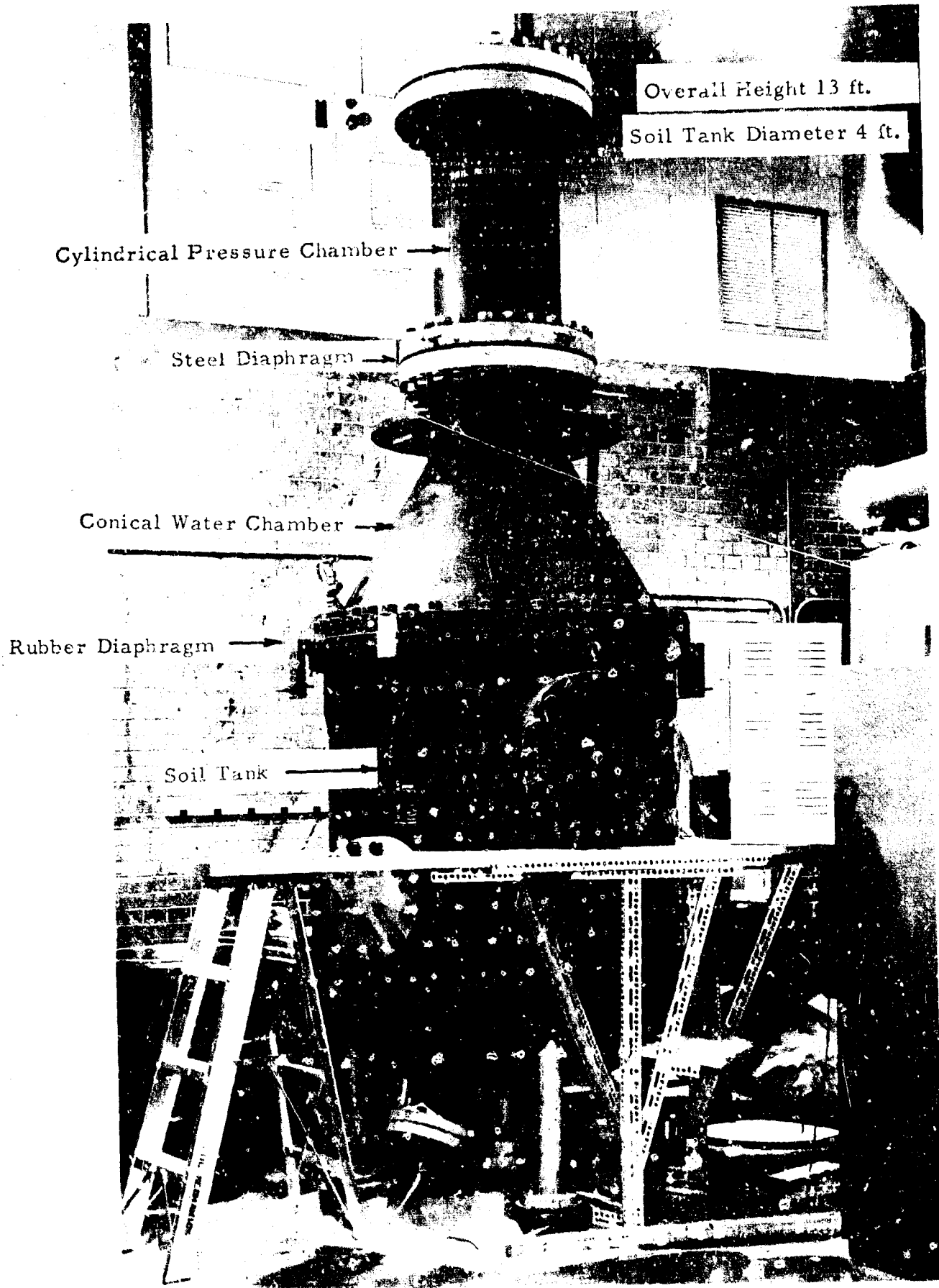

FIGURE 92. IIT RESEARCH INSTITUTE DYNAMIC SOIL LOADER

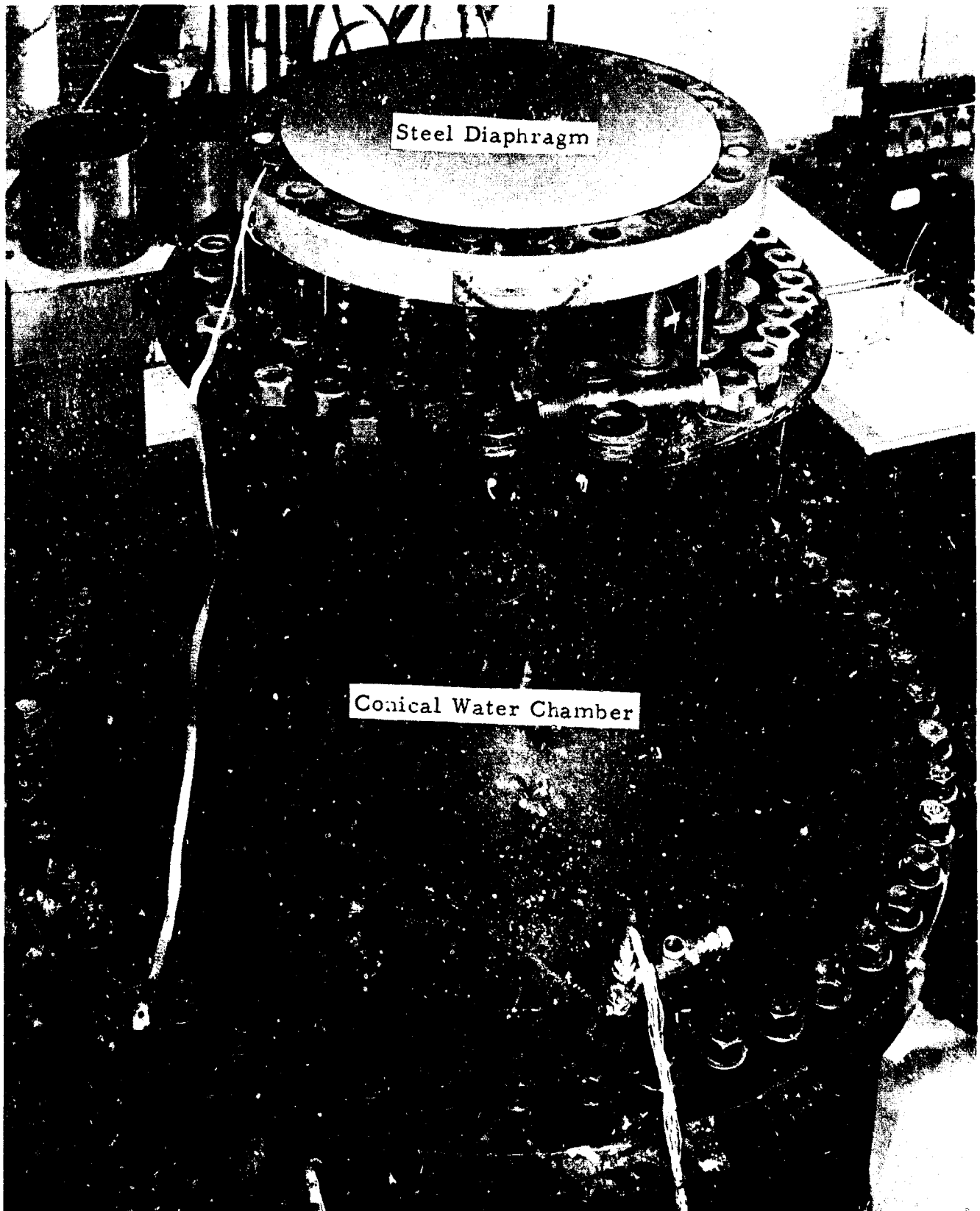

FIGURE 93. CLOSE-UP SHOWING STEEL
DIAPHRAGM IN PLACE

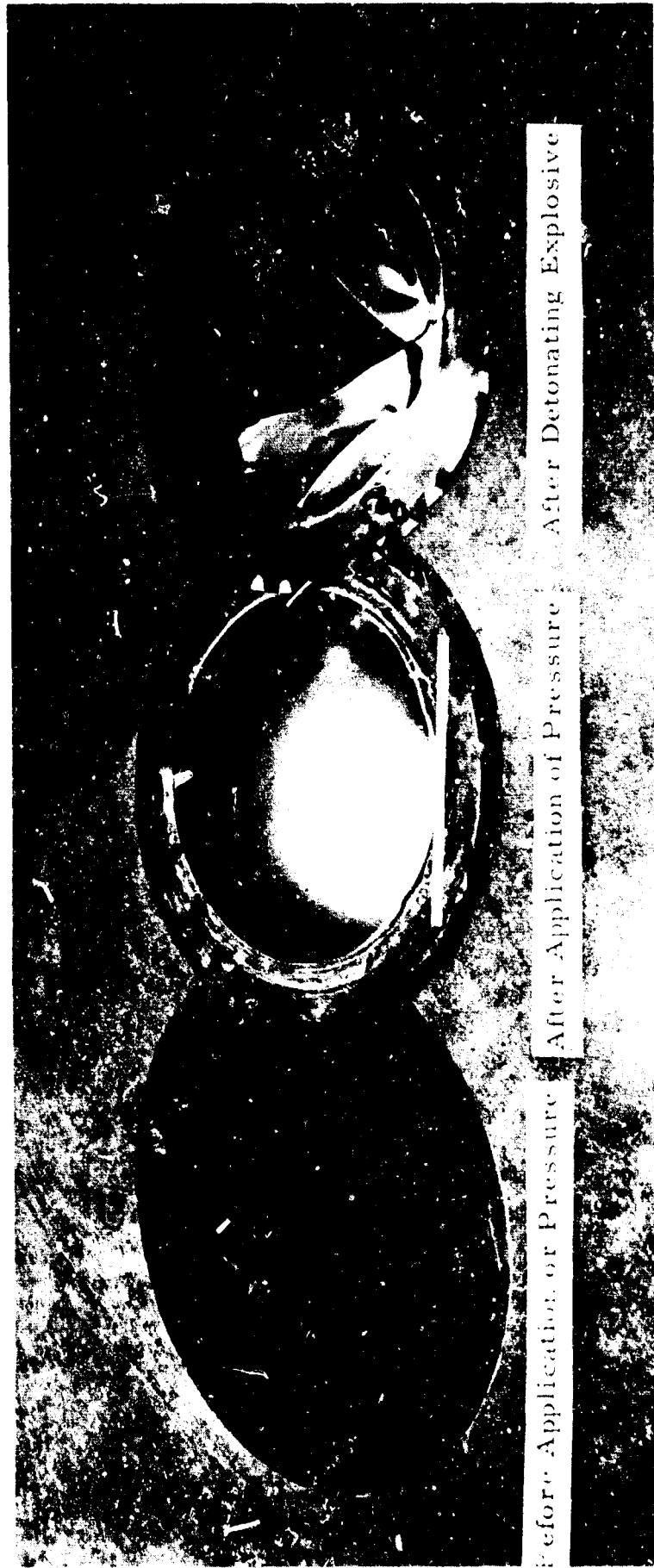

FIGURE 94. STEEL DIAPHRAGM BEFORE & AFTER

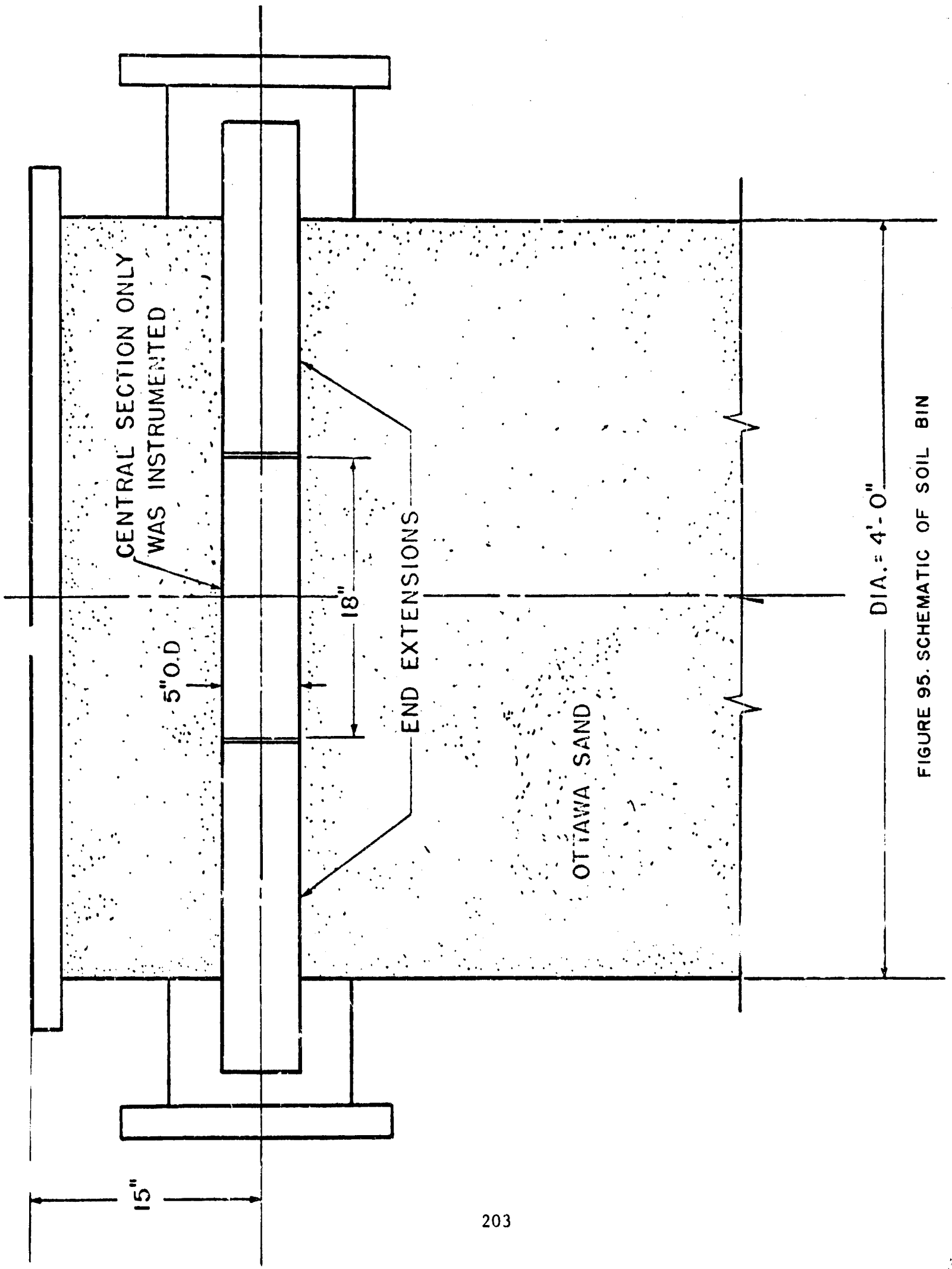

FIGURE 95. SCHEMATIC OF SOIL BIN

8. OTHER CONSIDERATIONS: FM record amplifiers having a frequency response of 0-10 Kcps are used in conjunction with quartz piezo-electric Kistler pressure gauges and soil transducers and recorded on an Ampex Model ER-200 and on Ampex Model FR-11000 tape recorders. Also available are three Tektronix type 502 dual beam oscilloscopes with C-12 Polaroid cameras and two Consolidated Electroynamics Corp. type 5-124 oscillographs.

9. DISCUSSION: The dynamic soil facility has been employed in an investigation to determine the influence of an encompassing layer of energy absorbing isolation material on the response characteristics of tunnel models buried in soil.

10. REFERENCE: Marino, Jr., Robert L., "IIT Research Institute, Description of Facility for Generating Dynamic Soil Overpressures," Unpublished Report, pages 1, 6 & 9, 1964.

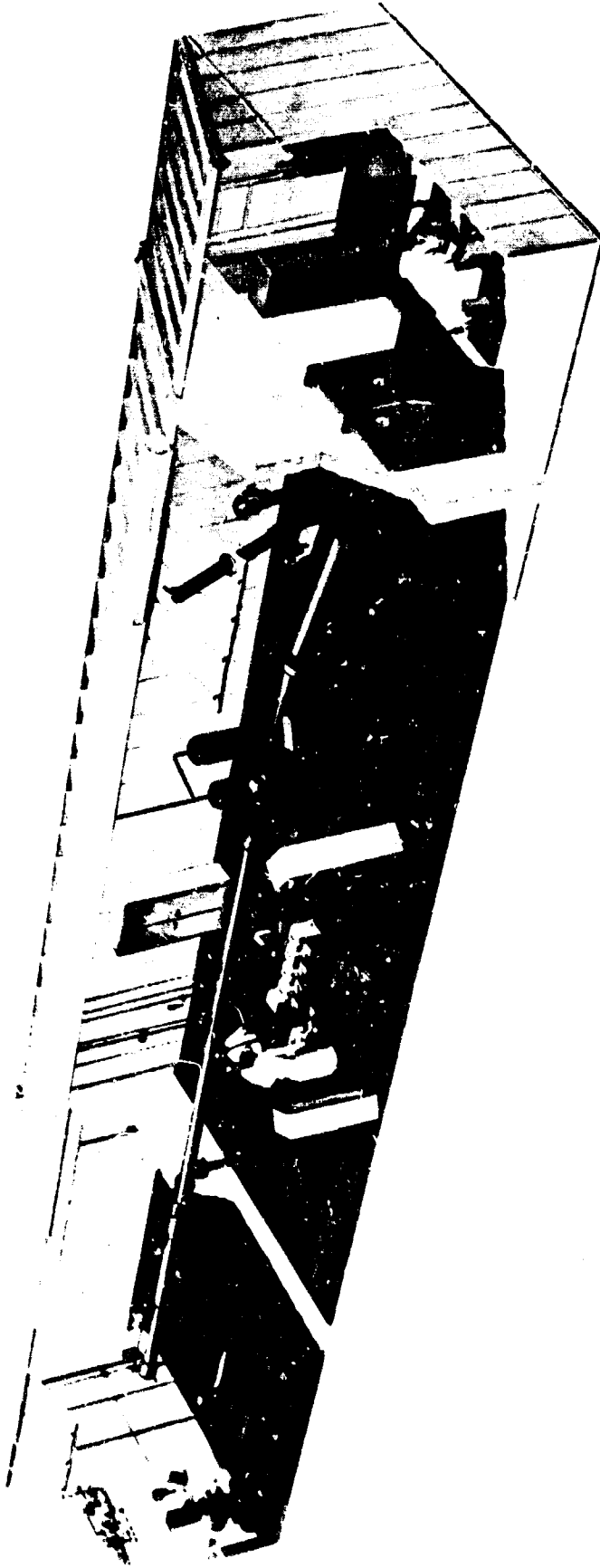

FIGURE 96. ARTIST'S CONCEPTION OF LOCKHEED-GEORGIA COMPANY
3-FOOT-DIAMETER SHOCK TUNNEL

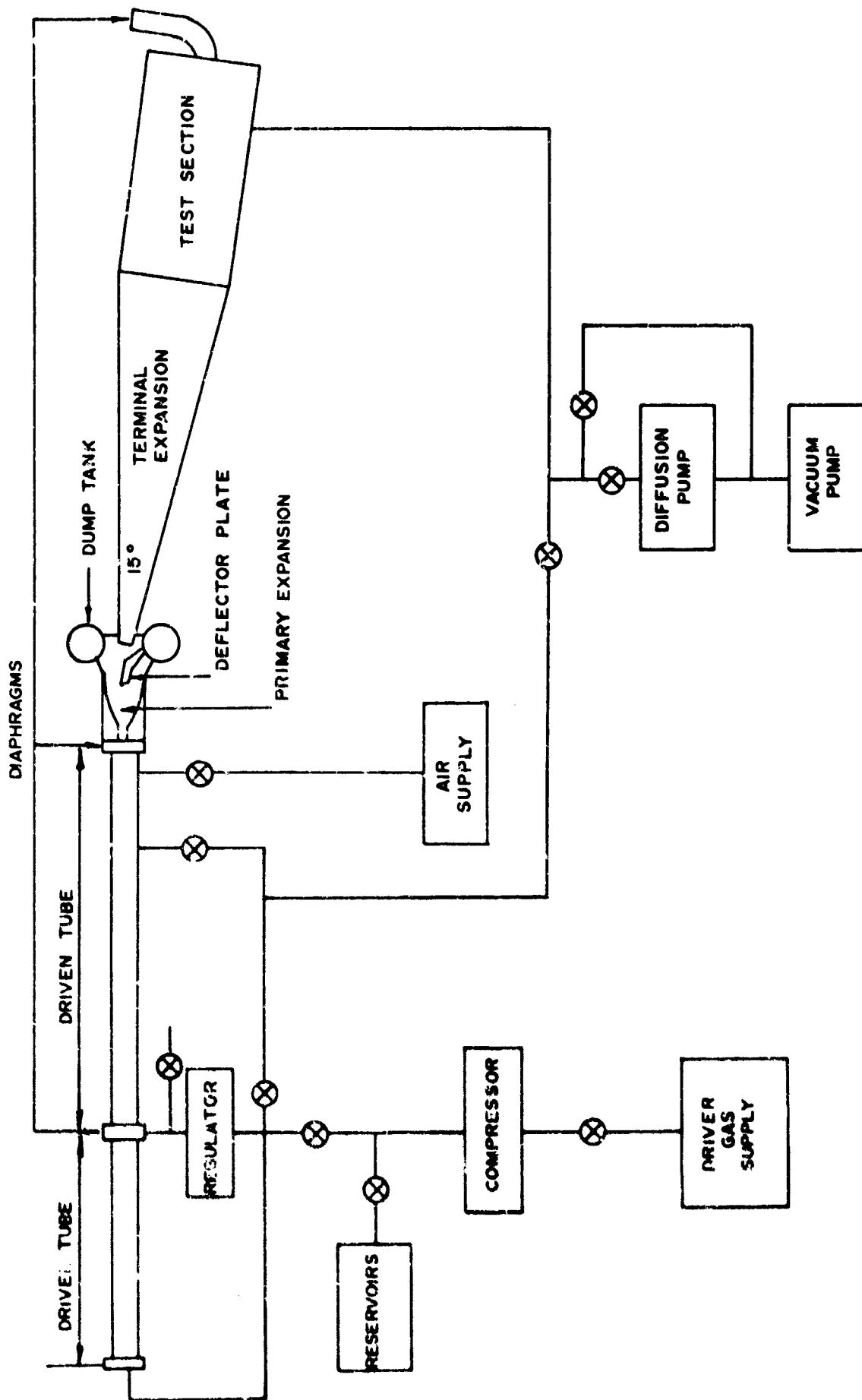

FIGURE 97. SHOCK TUNNEL SYSTEM DIAGRAM

9. DISCUSSION: The purpose of the shock tunnel is to simulate, in a ground facility, the flight environment for the aircraft and spacecraft of the future. The success of these advanced vehicles will depend in a large measure on how well their aerodynamic problems are anticipated and solved in such facilities as the shock tunnel.

10. REFERENCE: Little, Jr., B. H., "Tunnel to Space," printed in the Lockheed Georgia Quarterly, Marietta, Georgia, Vol I, No. 2, Spring, 1964 Issue, pages 16, 17, 18, 19, 20 and 21.

1. TITLE AND/OR TYPE: Long-Duration Dynamic Loader
2. LOCATION: United Research Services
formerly Broadview Research Corporation
1811 Trousdale Drive
Burlingame, California
3. OWNER: United Research Services
4. LOADING CHARACTERISTICS:
 - a. Type Wave: Step pulse
 - b. Pressure: Minimum (psi) Maximum (psi) 200 in chamber
 - c. Force: Minimum (lbs) Maximum (lbs) 57,000
 - d. Rise Time: Approximately 1 millisecond
 - e. Dwell Time: Continuous as desired
5. PHYSICAL DESCRIPTION (Figures 98 & 99): This is a vertical laboratory type shock device with a dome shaped compression head which is detachable and moveable from the soil container. The device will load a 19 inch diameter, 7 foot long soil sample. An acetate diaphragm is placed between the compression and expansion chambers and the loader is then clamped to the soil bin.
6. DRIVER: Compressed air
7. CONTROLS: Electro-mechanical rupturing of bursting diaphragm.
8. AVAILABILITY: Presently in use, contact Mr. William L. Durbin at above location.
9. DISCUSSION: This device was designed and built at URS and was based on a design developed under Contract DA 49-146-XZ-019 with the Defense Atomic Support Agency.
10. REFERENCE: Mason, H. G., Criner, O. H., Waisner, R., Wallace, N. R., "A Study of the Dynamic Soil-Structure Interaction Characteristics of Real Soil Media," United Research Services, Burlingame, California RTD-TDR 63-3057, pages 20 and 21, December 1963.

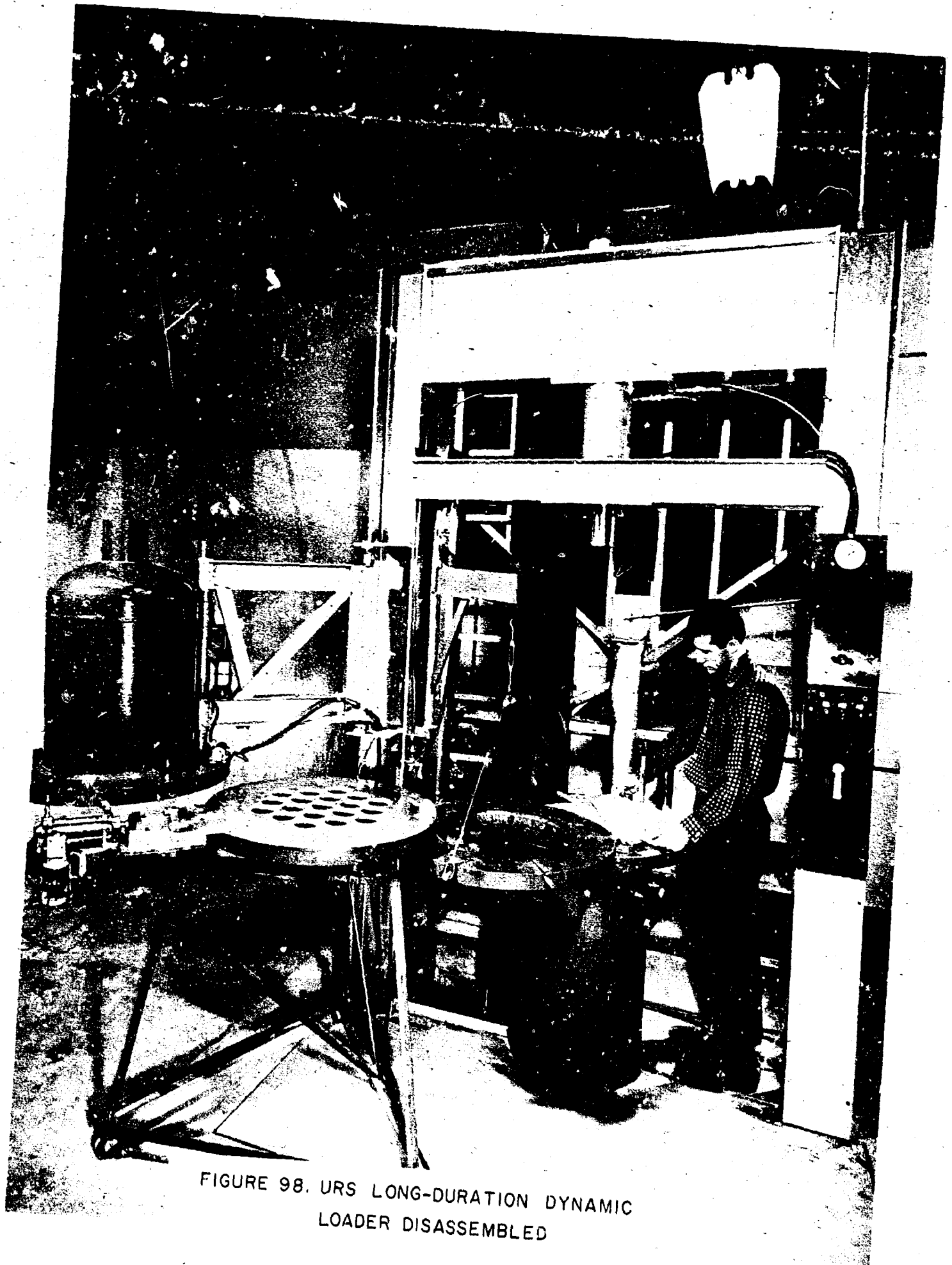

FIGURE 98. URS LONG-DURATION DYNAMIC
LOADER DISASSEMBLED

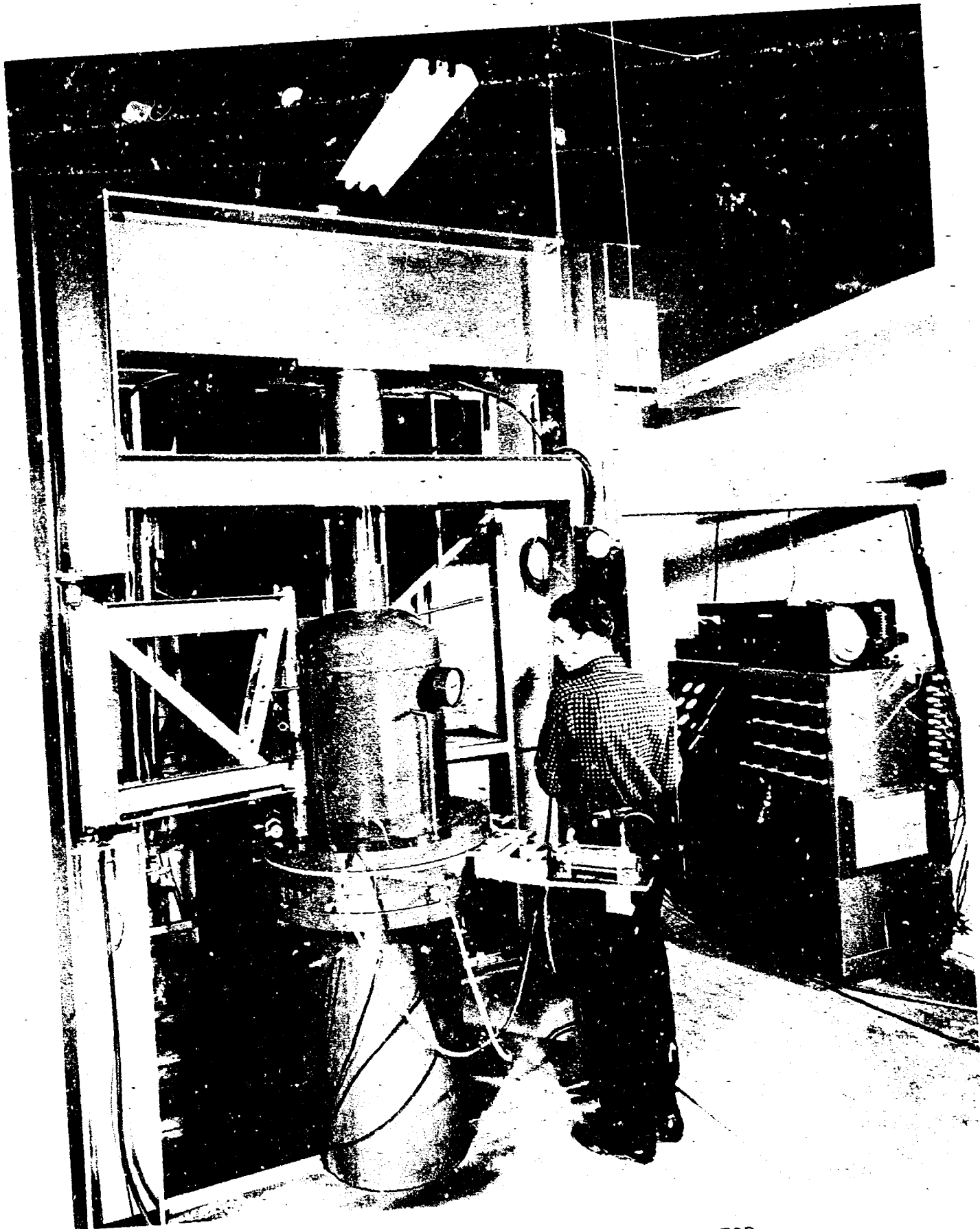

FIGURE 99. DYNAMIC LOADER PREPARED FOR FIRING

1. TITLE AND/OR TYPE: UED Dynamic Pressure Tank
2. LOCATION: United Electro Dynamics, Inc.
200 Allendale Road
Pasadena, California
3. OWNER: U. S. Air Force
4. LOADING CHARACTERISTICS:
 - a. Type Wave: Spherical in nature
 - b. Pressure: Minimum (psi) Maximum (psi) 1000
 - c. Rise Time: 15 to 50 milliseconds
 - d. Dwell Time: Variable
5. PHYSICAL DESCRIPTION (Figures 100 & 101): The tank is composed of three basic elements: The high pressure tank, water chamber and the soil chamber. It is 3 feet in diameter and the soil chamber is 3 feet deep.
6. DRIVER: Compressed air
7. CONTROLS: Falling weight punctures carbon diaphragm allowing compressed air to fill void above water line.
8. AVAILABILITY: This device is being transferred back to the Air Force and will be located at the Air Force Shock Tube Facility sometime in the fall of 1965. It will be available to other government agencies and to contractors of the United States Government on contracts requiring the use of and within the limitations of the vessel. Scheduling is controlled by the Air Force Project Officer and the Director of the Facility.
9. OTHER CONSIDERATIONS: The tank is operated by filling the high-pressure tank with compressed air to some selected pressure and activating a bursting mechanism which ruptures the burst diaphragm. This process rapidly applies a high pressure over the small area at the top of the water chamber which is transmitted hydraulically over the surface of the soil. The pressure wave, originating at the neck of the test vessel, thus becomes an input to the soil where instrumentation is located to measure its effect.

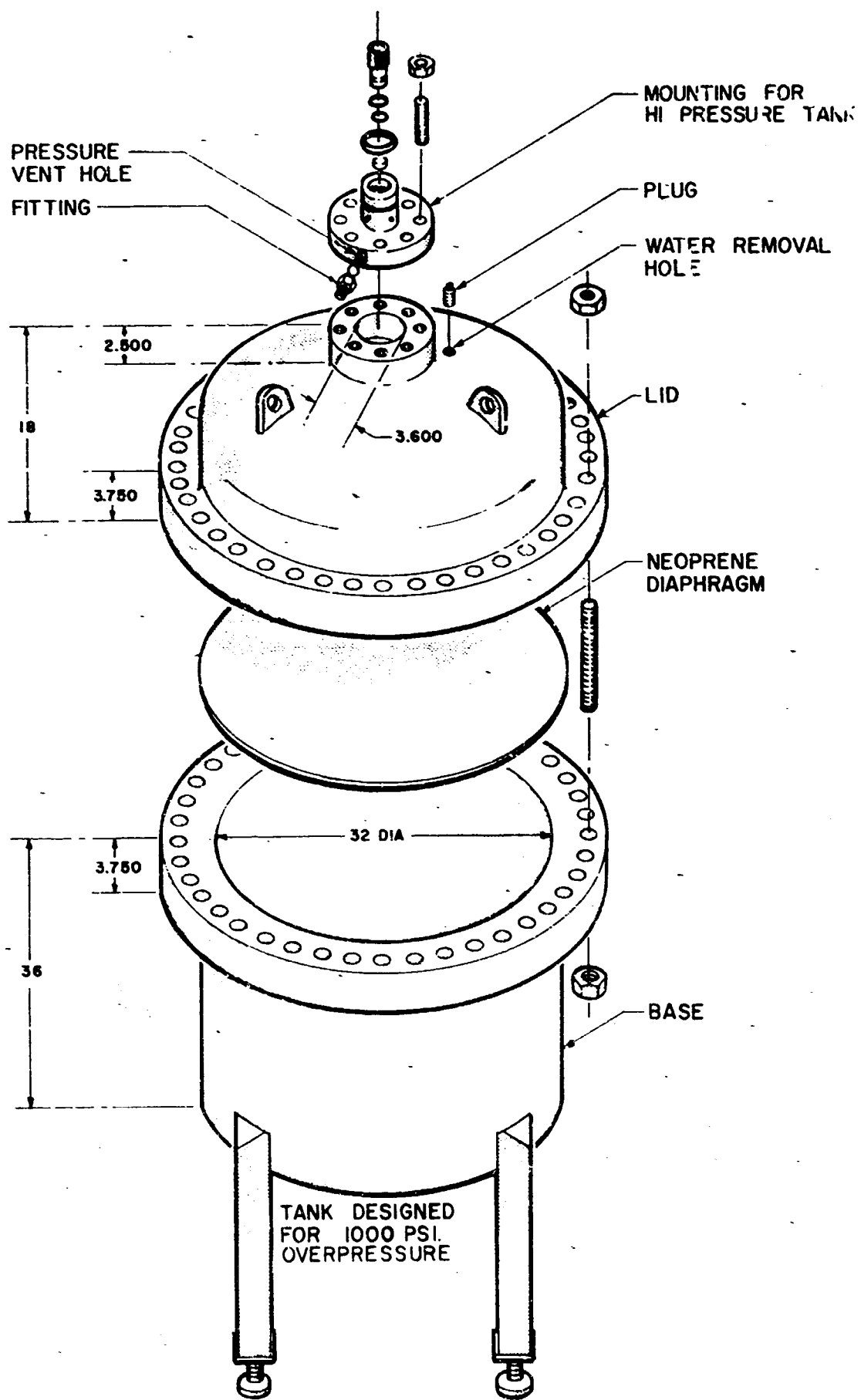

FIGURE 100. DETAILS OF TEST VESSEL

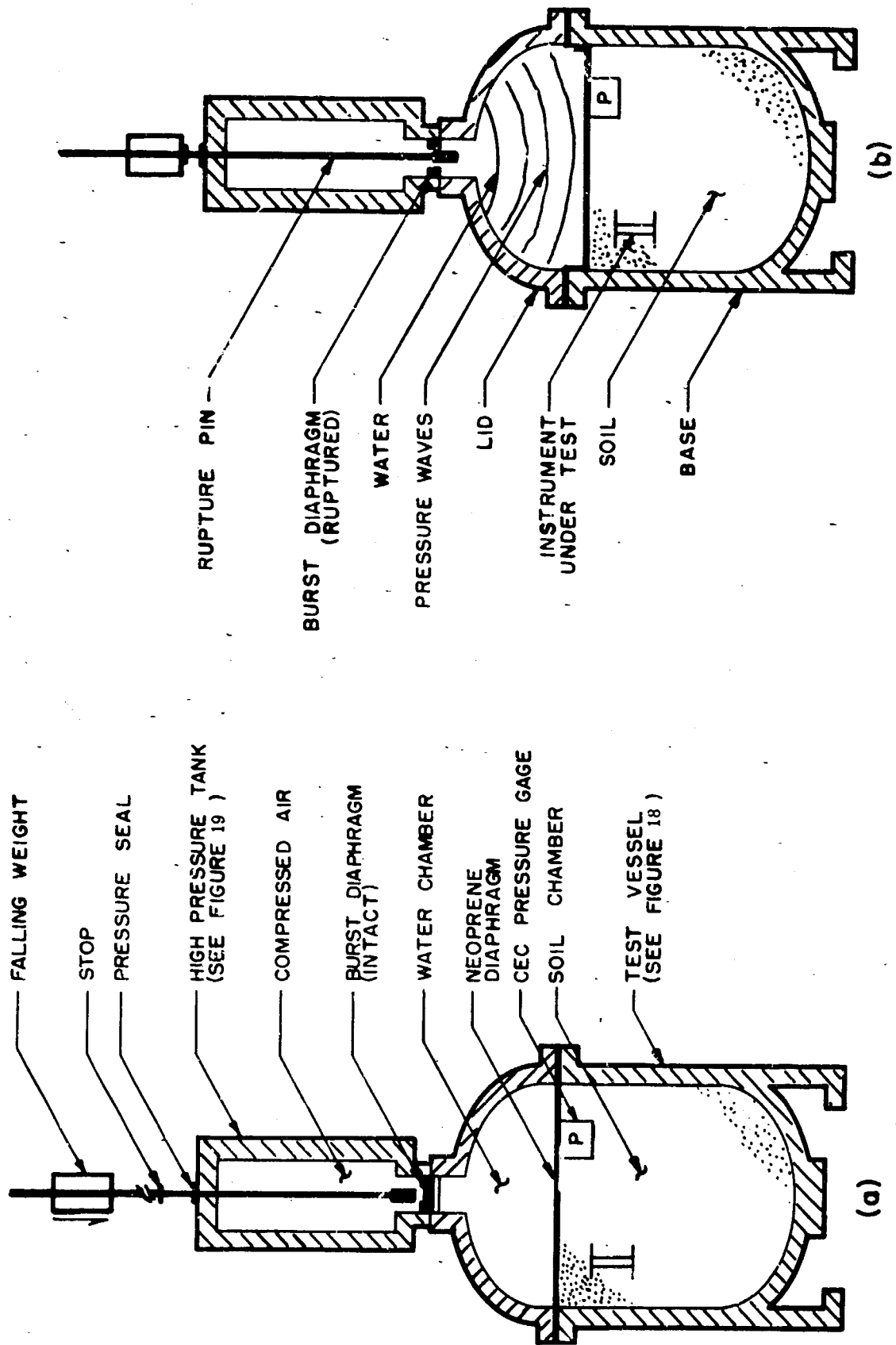

DIAGRAM ILLUSTRATING THE PRINCIPAL FEATURES OF THE UED DYNAMIC PRESSURE TANK

FIGURE 101.

Unclassified

Security Classification

DOCUMENT CONTROL DATA - R&D		
<i>Security classification of title, body of abstract and indexing annotation must be entered when the overall report is classified</i>		
1. ORIGINATING ACTIVITY (Corporate author) Air Force Weapons Laboratory Kirtland Air Force Base, New Mexico		2a. REPORT SECURITY CLASSIFICATION Unclassified
		2b. GROUP
3. REPORT TITLE SIMULATION DEVICES FOR USE IN STUDIES OF PROTECTIVE CONSTRUCTION		
4. DESCRIPTIVE NOTES (Type of report and inclusive dates) 1 January 1965 to 31 December 1965.		
5. AUTHOR(S) (Last name, first name, initial) Mahoney, James A.		
6. REPORT DATE February 1966	7a. TOTAL NO. OF PAGES 230	7b. NO. OF REFS
8a. CONTRACT OR GRANT NO.	9a. ORIGINATOR'S REPORT NUMBER(S) AFWL-TR-65-224	
b. PROJECT NO. 5710	9b. OTHER REPORT NO(S) (Any other numbers that may be assigned this report)	
c. Subtask 13.162		
d.		
10. AVAILABILITY/LIMITATION NOTICES Distribution of this document is unlimited.		
11. SUPPLEMENTARY NOTES	12. SPONSORING MILITARY ACTIVITY AFWL (WLDC) Kirtland AFB, NM	
13. ABSTRACT This report contains information on dynamic loading simulation devices that were either designed or could be modified for use in studies of protective construction. The information includes the following items: 1) the type of device, 2) the owner and location, 3) the loading characteristics, 4) the physical description, 5) the driver used, and 6) a short discussion concerning the device and its present use. Pictures and diagrams are also furnished for the majority of the devices.		

14. KEY WORDS	LINK A		LINK B		LINK C	
	ROLE	WT	ROLE	WT	ROLE	WT
Nuclear simulation						
Test loading device						
Laboratory shock simulator						
Shock tube						
Plane wave loader						
Ram loader						
Soil testing device						
Dynamic loading device						

INSTRUCTIONS

1. **ORIGINATING ACTIVITY:** Enter the name and address of the contractor, subcontractor, grantee, Department of Defense activity or other organization (*corporate author*) issuing the report.
- 2a. **REPORT SECURITY CLASSIFICATION:** Enter the overall security classification of the report. Indicate whether "Restricted Data" is included. Marking is to be in accordance with appropriate security regulations.
- 2b. **GROUP:** Automatic downgrading is specified in DoD Directive 5200.10 and Armed Forces Industrial Manual. Enter the group number. Also, when applicable, show that optional markings have been used for Group 3 and Group 4 as authorized.
3. **REPORT TITLE:** Enter the complete report title in all capital letters. Titles in all cases should be unclassified. If a meaningful title cannot be selected without classification, show title classification in all capitals in parenthesis immediately following the title.
4. **DESCRIPTIVE NOTES:** If appropriate, enter the type of report, e.g., interim, progress, summary, annual, or final. Give the inclusive dates when a specific reporting period is covered.
5. **AUTHOR(S):** Enter the name(s) of author(s) as shown on or in the report. Enter last name, first name, middle initial. If military, show rank and branch of service. The name of the principal author is an absolute minimum requirement.
6. **REPORT DATE:** Enter the date of the report as day, month, year; or month, year. If more than one date appears on the report, use date of publication.
- 7a. **TOTAL NUMBER OF PAGES:** The total page count should follow normal pagination procedures, i.e., enter the number of pages containing information.
- 7b. **NUMBER OF REFERENCES:** Enter the total number of references cited in the report.
- 8a. **CONTRACT OR GRANT NUMBER:** If appropriate, enter the applicable number of the contract or grant under which the report was written.
- 8b, 8c, & 8d. **PROJECT NUMBER:** Enter the appropriate military department identification, such as project number, subproject number, system numbers, task number, etc.
- 9a. **ORIGINATOR'S REPORT NUMBER(S):** Enter the official report number by which the document will be identified and controlled by the originating activity. This number must be unique to this report.
- 9b. **OTHER REPORT NUMBER(S):** If the report has been assigned any other report numbers (*either by the originator or by the sponsor*), also enter this number(s).
10. **AVAILABILITY/LIMITATION NOTICES:** Enter any limitations on further dissemination of the report, other than those

imposed by security classification, using standard statements such as:

- (1) "Qualified requesters may obtain copies of this report from DDC."
- (2) "Foreign announcement and dissemination of this report by DDC is not authorized."
- (3) "U. S. Government agencies may obtain copies of this report directly from DDC. Other qualified DDC users shall request through _____."
- (4) "U. S. military agencies may obtain copies of this report directly from DDC. Other qualified users shall request through _____."
- (5) "All distribution of this report is controlled. Qualified DDC users shall request through _____."

If the report has been furnished to the Office of Technical Services, Department of Commerce, for sale to the public, indicate this fact and enter the price, if known.

11. **SUPPLEMENTARY NOTES:** Use for additional explanatory notes.
12. **SPONSORING MILITARY ACTIVITY:** Enter the name of the departmental project office or laboratory sponsoring (*paying for*) the research and development. Include address.
13. **ABSTRACT:** Enter an abstract giving a brief and factual summary of the document indicative of the report, even though it may also appear elsewhere in the body of the technical report. If additional space is required, a continuation sheet shall be attached.

It is highly desirable that the abstract of classified reports be unclassified. Each paragraph of the abstract shall end with an indication of the military security classification of the information in the paragraph, represented as (TS), (S), (C), or (U).

There is no limitation on the length of the abstract. However, the suggested length is from 150 to 225 words.

14. **KEY WORDS:** Key words are technically meaningful terms or short phrases that characterize a report and may be used as index entries for cataloging the report. Key words must be selected so that no security classification is required. Identifiers, such as equipment model designation, trade name, military project code name, geographic location, may be used as key words but will be followed by an indication of technical context. The assignment of links, rules, and weights is optional.

10. DISCUSSION: Ottawa Sand (20-30) has been used as the soil medium. The vessel has been used for free field gauge development and evaluation.

11. REFERENCES:

a. Winston, T. and Stagner, J. R., "A Free-Field Stress Gage and Test Results in a New 1,000 PSI Dynamic Pressure Tank," United Electro Dynamic, Inc., Pasadena, California, pages 4, 5, and 6, 17 November 1960.

b. Winston, T., "Research Studies on Free-Field Instrumentation - Final Report," AFSWC-TR-60-55, Kirtland Air Force Base, New Mexico, 19 December 1960.