

AD 701 928

SECOND GENERATION CARTRIDGE CASE FOR 152 MM WEAPON  
FRANGIBLE GLASS AND CERAMIC CONCEPT

IIT Research Institute  
Chicago, Illinois

24 July 1969

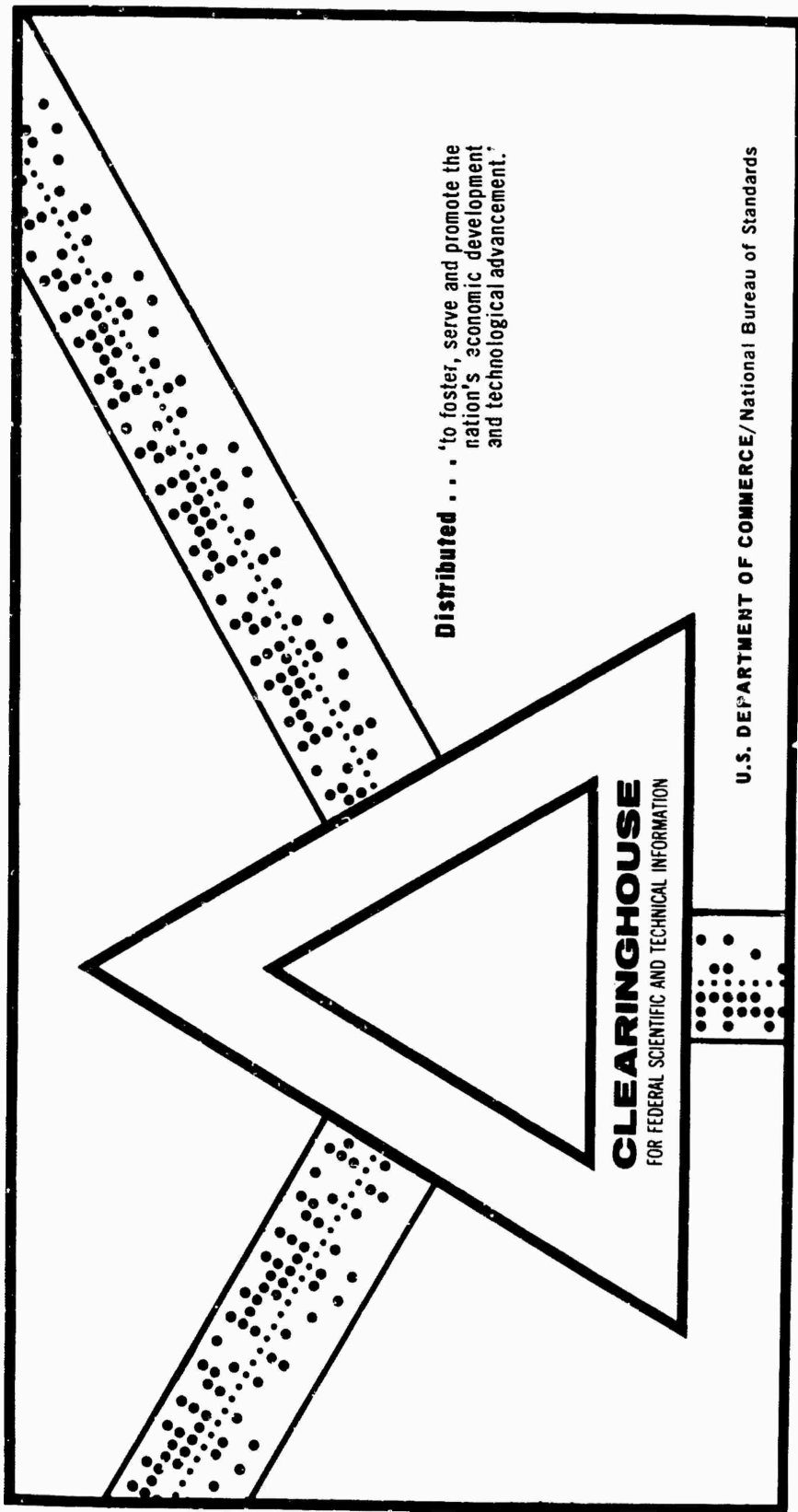

This document has been approved for public release and sale.

Final Report  
IITRI Project No. G6023-12

SECOND GENERATION CARTRIDGE CASE FOR  
152 mm WEAPON, FRANGIBLE GLASS AND  
CERAMIC CONCEPT

Prepared for:  
Picatinny Arsenal  
Dover, New Jersey 07801  
July 24, 1969

Reproduced by the  
**CLEARINGHOUSE**  
for Federal Scientific & Technical  
Information Springfield Va. 22151

IIT RESEARCH INSTITUTE  
10 West 35th Street  
Chicago, Illinois 60616

Final Report  
Project No. G6023-12  
Contract No. DAAA 20-68-C-1105

SECOND GENERATION CARTRIDGE CASE FOR 152 mm WEAPON  
FRANGIBLE GLASS AND CERAMIC CONCEPT

Prepared for:  
Picatinny Arsenal  
Dover, New Jersey 07801

July 24, 1969

The findings in this report are not to be construed  
as an official Department of the Army position.

Distribution of this document is unlimited.

IIT RESEARCH INSTITUTE

## TABLE OF CONTENTS

	Page
Abstract	i
1.0 Introduction	1
2.0 Objective, Procedures and Goals (Contractural)	3
3.0 Program Plan	7
4.0 Materials Sources and Screening Tests	8
5.0 Cartridge Case Design	10
6.0 Ballistic Testing	13
6.1 Test Series I and II	13
6.2 Test Series III	16
6.3 Test Series IV	19
6.4 Test Series V	21
6.5 Analysis of the Results of Ballistic Testing on Tempered Glass Cartridge Case Variables	24
7.0 Testing of XM-81 Scavenger System	27
8.0 Laboratory Studies	29
8.1 Analytical Study of the Motion of Glass Particles and Their Influence on Round Performance	29
8.2 Vented Bomb Experiments	32
8.2.1 Time-Pressure Results	34
8.2.2 Particle Size Data	36
8.3 Mechanical Testing of Cartridge Cases	37
8.3.1 Materials Evaluation	37
8.3.1.1 Testing Procedures	37
8.3.1.2 Screening Tests	40

	<u>Page</u>
8.3.1.3 Wall Thickness and Tempering Variables	41
8.3.2 Impact Studies	44
8.3.2.1 Test Procedures	44
8.3.2.2 Results	45
8.3.2.3 Analysis of Stresses	49
8.3.3 Impact Testing of Tempered Cartridge Cases	53
8.3.3.1 Cartridge Cases with Simulated Propellant	53
8.3.3.2 Cartridge Cases with Simulated Propellant and Projectile Specimens O-I 202-8 and O-I 202-11	54
8.3.3.3 Analysis of Stresses in Cartridge Cases	55
8.3.4 Interpretation of Test Results	56
8.3.4.5 Analysis of Glass Cartridge Case	57
8.4 Stress Levels in Chemically Tempered Glass Cartridge Cases	60
9.0 Tempered Glass Cartridge Cases for Army Evaluation	63
10.0 Conclusions	65
11.0 Recommendations for Future Work	66
Tables I-XV	67-90
Figures 1-53	91-140

## 1.0 INTRODUCTION

A major problem in fixed ammunition is the disposability of cartridge cases. In close quarters, disposal after firing is awkward and time consuming, while noxious gases are difficult to remove. The cost of conventional brass cases is high, materials are sometimes critical, and salvage is expensive. For these reasons, the development of a consumable cartridge case is of interest to the Army.

Glass, as a casing material for ammunition, has a number of significant advantages. It is chemically and mechanically durable and should protect the propellant against heat, flame, and mechanical effects. It is structurally stable and compatible with existing projectiles, guns, and vehicles. The required raw materials are readily available, low in cost, and domestic in origin. Glass should not produce noxious gases or odors nor should it produce corrosion products which could damage the gun.

Glass, in reality, is very strong, its theoretical strength being in the order of millions of pounds per square inch. Experimentally, strengths have been measured to as high as two million psi. The reason for the breakage in normal glass is the occurrence of surface flaws; such glass having strengths of approximately 10,000 psi.

The best known technique for strengthening glass is by tempering. The mechanism is based on establishing a highly stressed gradient within the glass that counteracts the influence of surface flaws. The surface of the glass is placed in compression and the interior in tension.

There are three types of highly stressed or tempered glasses that can be considered for cartridge cases. Thermally stressed glasses are produced by heating to a high temperature and rapidly cooling the outer surface. The maximum strength that is generally achieved for a glass of this type is approximately 20,000 psi.

IIT RESEARCH INSTITUTE

With chemically stressed glasses, the outer surfaces are placed in a state of compression by ion packing. Either lithium ions are replaced by larger sodium ions or sodium ions are replaced by larger potassium ions. The process is performed in molten salt baths. Greater stress differences can be achieved in chemically stressed glasses and the uniformity of treatment is not restricted to shape considerations as in thermal stressing. These glasses usually have thinner surface compressive layers and the stress gradient is much greater than in thermally stressed glass.

Chemically stressed glass-ceramics are similar to the chemically stressed glasses. The main difference is that the base material is a ceramic that has been made from a glass. This type of material is much stronger than the chemically stressed glass and therefore, has potential for better handling characteristics. The maximum strength that has been achieved in chemically stressed glass-ceramics is approximately 300,000 psi. A present practical limit is in the order of 130,000 psi.

The nature of highly stressed glass or glass-ceramics is to be fragmentable on its destruction and as a cartridge case material the vast majority of resulting particles should be transported from the gun by the propellant gases. In this program, design, fabrication, test and evaluation studies were conducted to determine if the frangible glass or glass-ceramic approach was feasible and practical for Second Generation 152 mm Cartridge Cases.

## 2.0 OBJECTIVE, PROCEDURES AND GOALS (CONTRACTURAL)

The objective of the program has been to conduct an exploratory development program, to determine the feasibility and practicability of developing a second generation cartridge case for the subject weapon systems, that has as its prime characteristics, self-disposability, i.e. the case or its fragments are not to be deposited in the vehicle after firing. Detail performance goals are listed in this scope, as is relevant background information.

The procedures have been to initiate and conduct a series of design, fabrication, test and evaluation cycles to determine at the end of the contract period if the approaches will lead to a feasible, practical Second Generation Cartridge Case that would at least meet the essential requirements.

At the conclusion of the contract period an evaluation will be made by the government with the cooperation of the contractor to determine whether continuation of the approach into the advanced development phase is warranted or desirable.

The goals are such that the developed item shall have the following characteristics:

a. Current STD "A" conventional tank gun ammunition shall provide standards of cartridge case performance and safety.

b. The Second Generation Cartridge Case (SGCC) shall be usable in the M81, XM162, and XM150, 152 mm Gun-Launchers with only minor modifications and shall not degrade the performance (interior, exterior and terminal ballistics) of any of the items.

c. Although weapon modification is not desired, some modification of breech, chamber, firing mechanism and tube may be necessary. The modified weapon must be capable of firing an unmodified current Shillelagh GM without degradation of its performance.

d. The Second Generation Cartridge Case and the components of the propulsion system shall leave no residue in the tube or chamber that would be hazardous or would interfere with the loading and firing of subsequent rounds. The effects of the Second Generation Cartridge Case et al on weapon life shall be equal to or less than that currently experienced with the present C.C.C. Weapon life shall not be less than 200 rounds on tube and 600 on breech.

e. It is desirable that the Second Generation Cartridge Case and its components be as invulnerable as present STD "A" metal cased tank ammo; i.e., the Second Generation Cartridge Case shall be no more vulnerable than 105 mm M60 Tank ammo under similar vehicle stowage and protection conditions when exposed to the following hazards:

1. Fragment spray or flash resulting from penetration or attack of the vehicle.

2. Initiation of charge due to a fire in adjacent ammo.

f. It is essential that the Second Generation Cartridge Case and components not be ignited by, and protect the propellant from, lighted cigarettes, sparks or electrical shorts, short duration flash flames, and friction caused by vibration of the vehicle.

g. The complete round shall be resistant to long duration open exposure at high humidity levels, moisture, and rain while being in either the horizontal or vertical ammunition storage racks and during unpacking, loading or off-loading during combat conditions. The essential standards of protection are provided by current Standard "A" tank ammunition.

h. 152 mm conventional ammunition employing a Second Generation Cartridge Case shall not use any cover or protective barrier that must be stripped from the round prior to loading after the complete round has been unpacked from its shipping container and stowed within the combat vehicle stowage racks.

i. The complete 152 mm conventional ammunition round shall be of the fixed type. The Second Generation Cartridge Case shall support the projectile to the extent that sealing and complete round alignment is maintained during extended transportation in the combat vehicle stowage racks and/or gun tube.

j. Rate of fire with the Second Generation Cartridge Case shall not be less than that achieved with the combustible cartridge case (3.7 rounds/min initial round in chamber).

k. It is desired that the seating of the complete round in the weapon be accomplished by stopping the round on a surface of the Second Generation Cartridge Case rather than the leading edge of the rotating band. It is also desirable that an extractor lip be provided on the Second Generation Cartridge Case compatible with the extractors on the weapons.

l. The Second Generation Cartridge Case shall be no more susceptible to in-chamber pre-ignition (cock-off) than present STD "A" metal cased ammo under similar rates of fire.

m. 152 mm conventional ammunition complete rounds utilizing the SGCC shall be capable of withstanding the effects of rough handling, including the five foot and twelve foot unpackaged drop tests, transportation and vibration in combat vehicle ammunition stowage racks for at least 2000 miles (4000 miles desired) or one year (two years desired) with frequent loading and off-loading during maintenance periods under adverse environmental and tactical conditions such as prevail in Southeast Asia, without degradation of performance.

n. 152 mm conventional ammunition complete rounds, utilizing the Second Generation Cartridge Case, shall be capable of withstanding the effects of rough handling in loading, extraction, transportation and vibration in the gun tube for at least 500 miles (1000 miles desired) with frequent extraction, stowage and reloading under adverse environmental conditions specified

in AR 705-15, with Change 1, adjusted where necessary to include the hot, wet, and humid environment prevailing in Southeast Asia and South America.

o. 152 mm conventional ammunition complete rounds utilizing the SGCC shall be capable of meeting world-wide environmental, operational, storage, and transportation requirements outlined in AR 705-15, with Change 1, adjusted where necessary to include the hot, wet, and humid environment prevailing in Southeast Asia and South America.

p. Second Generation Cartridge Case ammo shall require no maintenance at the organizational level.

q. The Second Generation Cartridge Case when fired shall not disperse lethal fragments outside a 10° conical volume, with apex at the muzzle and a cone length of 100 feet.

### 3.0 PROGRAM PLAN

The program conducted is presented in Figure 1. Due to long delivery times for glass cases and test samples, and because of the urgency of the program, laboratory studies and tests on full size prototype cases were conducted concurrently. During the program, six materials were evaluated in screening tests and three selected for more intensive study. A total of 13 case designs of these three materials were evaluated. Cases of three designs and two materials are being submitted to the Army for further evaluation.

#### 4.0 MATERIALS SOURCES AND SCREENING TESTS

All possible sources of materials for this program were contacted. These included seventeen companies of whom seven responded as follows:

1. Ball Brothers Company
2. Brockway Glass Company
3. Corning Glass Works, Inc.
4. General Electric Company, Lamp Division
5. Ford Motor Company, Glass Division
6. Glass Container Industry Research Corp.
7. Owens-Illinois Company

Of these, Owens-Illinois (O-I), Corning Glass Works (Corning), and the Glass Container Industry Research Corp. (GCIRC) submitted materials for initial screening tests. Test samples were either tubular, approximately 3-in. long x 1-in. O.D. x 0.1-in. wall thickness, or tabular, 4-in. long x 1-in. wide x 0.1-in. thickness. Table I presents a tabulation of all candidate materials. Screening tests included: static strength, impact strength and particle size distribution. Availability and cost of test specimens and cost of sample cartridge cases also entered into the choice of materials.

Table II presents a summary of the properties of candidate materials as determined by experimental testing described in Section 7.0 - Laboratory Studies. Of the three Corning materials, the Chemcor 0313 was the least variable in properties, the most versatile in forming, and the least expensive. These aspects reflect the fact that this material has been in production for several years. Its one disadvantage was that it was also the lowest in strength. The other two Corning materials, Pyrocerams, were stronger but more expensive, and delivery was a problem. The 9611 material displayed considerable variability in strength as compared to both the 9608 and Chemcor 0313. The O-I materials, Glass 202 and CERVIT 206, possessed good strength

and availability. There was a considerable spread in strength values for these materials but it was not unexpected because of their developmental status.

The tempered materials destructed as desired with the Corning 9608 and 0326 yielding the coarsest particles. The other materials yielded particles of smaller sizes without any appreciable spread in particle size distribution. All of the particles had rounded edges and were safe to handle without fear of skin cuts.

On the basis of the above technical data, formability, availability, and cost, it was decided to procure cases made of Chemcor 0313, O-I Glass 202 and O-I CERVIT 206 for ballistic testing. O-I 202 glass was used for cases made for impact studies. Chemcor 0313 was the material that was used to make laboratory samples.

## 5.0 CARTRIDGE CASE DESIGN

The initial cartridge case design is shown in Figure 2. The design consisted of a simple tubular shape with a 15° taper in the wall to match the contour of the tube and breech of the 152 mm gun/launcher. This design was selected in order to provide a case that was easily fabricated, capable of modification, and able to yield representative data on the performance of a frangible glass case during ballistic testing. The techniques of manufacture consisted of casting a tubular blank, machining to size, acid-etching to remove surface flaws, chemical tempering in a salt bath and inspection.

The base, a supporting flange, and the ignitor components were portions of standard combustible cases machined to size (Figures 3 and 4). These components were bonded to each other with cellulose nitrate adhesive as shown in the assembly view in Figure 5. The projectile was machined to the rear of the rotating band (Figure 6) in order to mate it to the case. The case was bonded to the projectile with epoxy resin. Silicone rubber seals (Figures 7 and 8) were located at the tapered section of the case and at the rear in order to assure sufficient pressure across the case to fracture it. The fully assembled case ready for firing in the 152 mm gun/launcher breech and tube is shown in Figure 9.

After the results of the first series of tests, design modifications were introduced in order to further the percentage of case expulsion, provide a rear tempered glass base, and improve the case design with better impact resisting features.

Figures 10 and 11 are straight-wall cylindrical designs which provide added space between the case and chamber wall. This extra space produced increased turbulence, and allowed more glass particles to enter the main flow of gases, thereby, expelling a larger portion of the particles. The case in Figure 10 has a 0.080-in. wall in order to reduce the amount

of glass to be expelled while the one in Figure 11 has a 0.125-in. wall. The first design required full machining from either a cast or blown blank. The case in Figure 11 is a design with wider tolerances than those in Figure 10 and may be made either by full machining or by partially machining a blown blank. No machining is required on the outer diameter. Figure 12 shows a single piece, straight-wall case with an integral base. This case can also be made by using a blowing process and requires no machining of the outer diameter. Wider tolerances are also provided in this design.

Figures 13, 14 and 15 show case designs that also have modifications to provide added space between the body of the case and the chamber wall. The case in Figure 13 has a double tapered wall with a decrease in diameter toward the rear in moving from the front tapered section. With this design, added space is provided between the case and the chamber wall toward the rear of the breech. However, this design was not made due to difficulties in chucking the case during machining.

The design in Figure 14 provides added space between the chamber wall and the case by the addition of longitudinal flats machined on the outer surface. These run from the taper to the rear. Radial grooves machined on the outer surface between the taper and the rear of the case provide added space between the case and chamber wall for the design in Figure 15. In all designs, increased turbulence between the case and chamber wall was anticipated which would aid particle entrainment in exhausting gases.

A glass base was provided for the designs in Figures 10 and 11 by the tempered glass bulkhead shown in Figure 16. For the designs in Figures 2, 14 and 15, bulkheads of a larger outer diameter of 6.02-in. were used. These plates were assembled to combustible ignitor adopting components as shown in Figure 17. These were then assembled to cases using flanges as shown in Figure 4 for support. The cases with integral bases

IIT RESEARCH INSTITUTE

needed only a combustible ignitor adapter and a combustible ignitor tube.

In Figure 18 may be seen a picture of four shells utilizing different designed cases. From left to right:

(1) a tapered sidewall case with longitudinal flats and a combustible base, (2) a tapered sidewall case with circumferential grooves and a combustible base, (3) a straight sidewall case with a separate glass base and (4) a straight sidewall case with an integral base. The cases were painted for color coding in order to identify particles from different portions of the case.

The final case design used in the program was an integral base design without an ignitor assembly hole in the base. This case was used for impact testing only and the hole was omitted to eliminate stress concentrating corners. A drawing is shown in Figure 19 and the specifications for its manufacture are shown in Table III.

## 6.0 BALLISTIC TESTING

The ultimate utility of a consumable cartridge case can best be determined in ballistic testing using full-sized cases. A series of such tests were conducted at Picatinny Arsenal and Aberdeen Proving Grounds using different case designs and ignition systems.

### 6.1 Test Series I and II

The first series of ballistic test firings were conducted using two Corning 0313 tempered glass cartridge cases. Firing No. 1 used the front and rear seal arrangement as shown in Figure 9. A charge of 6 lb of propellant was used plus eight extra ounces to provide energy usually contributed by the combustible 152 mm case. The first projectile travelled at 2200 ft/sec while the second one was timed at 2220 ft/sec. The peak pressure in the first firing was 35,000 psi and 35,100 psi in the second. These values are comparable to those achieved with combustible cartridge cases, and indicate no loss of performance. A description of cases, variables examined and results are given in Table IV.

In the first firing the burning propellant shattered the case, and the front half of the case was exhausted out of the muzzle. The portion of the case to the rear of the breech seal was also shattered but had expanded to the inner surface of the chamber and the particles were locked in place. A behavior of this type was previously observed in vented bomb tests on one inch diameter test cylinders (Section 8.2). At that time the problem was believed to be caused by the gaskets holding the particles in place or a lack of space for the particles to disperse. A test cylinder of tempered CERVIT 206 that was slightly non-uniform in thickness and O.D. concentricity was observed to separate from the wall and largely exhaust from the firing chamber. The improved exhausting of the particles

was believed due to turbulence caused by non-uniform fracturing and subsequent dispersion of the particles.

For the second firing, the rear gasket was removed to provide increased volume for turbulence in the rear of the breech. In order to insure fracture of the cylinder, a gasket of the same type as the front gasket was placed on the outer diameter 4-1/2-in. from the rear of the case. With this arrangement of seals, a bursting pressure was assured between the interior and the outer surface of the case between the gaskets. The second shot shattered the case, and, as in the first shots the front portion of the case was vented out the muzzle. In this test, the particles did not lock in place and those that were not blown out the muzzle, settled down along the length; particles consisting of approximately one-half the case weight were deposited in the front portion of the chamber just behind the point where the rifling began. Particles from all sections of the case were found in the pile deposited before the rifling. These could be identified by the color-coding of the cylindrical portion of the case to the rear of the tapered section.

Apparently, the particles originally to the rear of the tapered section, were moving toward the muzzle along the chamber wall when they were impeded by the rifling; their velocities dropped below that necessary to support them in the gas stream and they fell to the bottom of the chamber behind the rifling.

The second series of tests (Firing Nos. 3 and 4) were with O-I CERVIT 206 and Corning 0313 using the standard ignition systems for 152 mm ammunition. Besides using different materials, the arrangement of seals was varied in order to determine if they greatly influenced the expelling of particles. In the next two firings (Firing Nos. X-1 and 5), an ignition system was tried in which a mild detonation fuse (MDF) was stranded along the inside of the case wall.

In Firings 3 and 4, the peak pressure and velocity were of acceptable level, 35,000 psi and 2110 fps respectively. The cases shattered as designed and all particles were broken away from the walls of the chamber. In the firing of the O-I case, 74.5% of the particles were expelled while 78.3% of the particles from the Corning case were expelled. Both of these firings were successful in that the cases shattered and a large portion of particles were exhausted.

Firings 1 through 4 showed that the seal arrangement is important in expelling particles. The removal of the rear seal in Program Firing 2 enabled the dispersal of the particles from the chamber wall. A large portion of these were deposited at the origin of the rifling. By removing the rear seal and eliminating the front seal (Program Firing No. 4), more of the particles were allowed to enter the main gas stream and be expelled.

For Firings X-1 and 5, a standard combustible case and a prototype glass case were loaded with a MDF ignition system.

The objective of the MDF system of ignition was to:

- (1) fracture the glass case early in the ballistic cycle and
- (2) create a turbulent gas flow that could be beneficial in expelling the glass fragments from the chamber and gun tube.

The standard black powder igniter was eliminated and replaced with the MDF as shown in Figure 20. A length of 2 grain PETN/FT MDF 14 inches long had one end flared out. The flared end was loaded with a small charge of lead azide and the combustible case base was fitted with the MDF. Two of these lengths were used. To provide confinement, epoxy was cast around the leads and on top of the initiation base as shown. The MDF was taped to the base in a spiral pattern on the sidewall. The combustible case was loaded with a 6 lb charge of propellant and the glass case with a 6.5 lb of propellant. The 0.5 lb of extra propellant was added to compensate for the energy of the combustible case. The epoxy was completely set at the time of

IIT RESEARCH INSTITUTE

the final loading and firing. However, it was still in a slightly plastic state and it possibly did not provide the desired amount of confinement.

The firing of both rounds (Firings X01 and 5) showed longer than normal ignition delays, which would indicate that the MDF did not function. Poor ignition is also indicated by the low velocity for both rounds, 2133 FPS for the combustible case and 2179 FPS for the glass case. Normal expected velocity is about 2210 FPS. Examination of the chamber after firing the glass case, showed a large amount of glass particles pressed in place onto the chamber wall in the forward area of the chamber.

From the results it appears that the MDF failed to ignite and, since black powder was omitted from these rounds, the charge then had to be ignited by the initiator at the base of the chamber. A base-type of ignition of slow initial pressure buildup probably resulted. A second possibility is that the MDF did ignite the propellant but did not ignite it rapidly enough. Either type of ignition, obviously, was not desirable, since this firing condition left more glass in the gun in an unfavorable geometry than other test firings.

## 6.2 Test Series III

In the third series of firings, one glass-ceramic and three glass cases were loaded and tested in a series of ballistic firings (Table V). All, with the exception of the warmer round, were loaded with loose powder. The first firing of the day (No. X-2) was with a warmer round using a combustible case and a mild detonating fuse (MDF) ignition system. In the second firing (No. 6), the MDF ignition system was used, with an O-I glass-ceramic case of the same design as previously tested cases. In the third firing (No. 7), a case of Corning 0313 glass of reduced outer diameter and wall thickness was used with the MDF ignition system. The last two firings (Nos. 8 and 9) utilized normal ignition with two Corning 0313 cases of reduced outer

diameter and wall thickness. The former had a wall thickness of 0.100-in. while the latter had a wall thickness of 0.080-in.

The warmer round (No. X-2) showed that the MDF ignition system functioned properly, as the round displayed acceptable velocity and pressure. A sketch of the MDF ignition system is shown in Figure 21. The ignition end of MDF was held in place by an aluminum bushing, which was bonded to the ignitor housing. The MDF was positioned inside and up the combustible ignitor tube a distance of about two inches; it was then passed through the tube and back along the outside of the tube toward the base. The MDF was passed across the inside surface of the base and up the interior wall of the case sidewall in a spiral pattern. Two MDF strands were used and they were located only along the rear half of the case. A normal electrical ignitor was used which set off the lead azite in the ignition end of the MDF. The MDF set off the black powder which in turn set off the propellant. The primary function of the MDF was to provide turbulence along its path which, hopefully, would enable dispersion of glass particles into the exhausting gas stream.

In the firing of the O-I CERVIT 206 case in Firing No. 6, the case was completely shattered and none remained on the chamber walls. As in Firing No. 3, fragments of this material were about  $1/2 \times 1/2 \times 0.125$ -in. in size and the majority were exhausted. However, 87.8% of the particles were exhausted using the MDF, while only 74.5% were exhausted with the normal ignition system. Observation of the breech wall revealed white areas along the path of the MDF strands, indicating that the MDF functioned as desired along the chamber wall.

In Firing No. 7, the case shattered completely and no particles remained on the chamber walls. The case used in the firing was of a reduced thickness (0.100-in.) and reduced outer diameter (6.020-in.) in comparison to previous firings. With this type of design, smaller, lighter particles were formed and greater turbulence was believed to occur, due to

more space between the case and chamber wall. Both factors should tend to enable a higher percentage of particles to be entrained in the gas stream. In addition, MDF strands were used for ignition. This case design exhausted 95.0% of its particles during the firing cycle with the majority of the retained particles being deposited at the origin of the rifling.

The case used in Firing No. 8 was identical to that used in the previous firing but normal ignition was used instead of the MDF system. In the firing 94.3% of the particles were exhausted, but about two square inches of particles adhered to the rear of the breech sidewall in four areas. The case had shattered completely although the adhering particles were still locked together in their original juxtaposition after the case shattered.

The case used in Firing No. 9 was similar in design to those in Firing Nos. 7 and 8, except it was only 0.080-in. in wall thickness. As with the previous cases, the case was completely broken. However, as with Firing No. 8, about two square inches of particles adhered to the rear portion of the breech sidewall, although this time in two areas. It was thought possible that the silicone grease which was used to protect the piezoelectric pressure gauge may have caused the sticking of particles to the chamber wall in Firings 8 and 9.

The cylinders which were used in the firings described above were color coded into three equal-sized areas. With respect to the muzzle, these were: the front-, center- and rear-portions. Only rear-particles from Firing Nos. 7, 8, and 9 were retained in the gun. For Firing No. 5, approximately two-thirds were rear-particles while one-third were center-particles. This information verified the supposition and the analysis which is presented in Section 8.1, Analytical Study of the Motion of Glass Particles and Their Influence on Round Performance.

The tests indicated that the smaller sized case and the thinner wall helped in exhausting a larger portion of the particles than in previous designs. The MDF ignition system was possibly useful in dispersing particles from the sidewalls with the CERVIT 206 case. (87.8% vs 74.5% for comparable CERVIT 206 cases). However, these also had a different seal arrangement that may have contributed to this result.

### 6.3 Test Series IV

In the fourth series of ballistic tests, eight glass cases were loaded and tested (Table VI). All, with the exception of the standard combustible warmer round, were loaded with 6.5 lb of loose powder. The first firing (No. X-2) employed a warmer round using a combustible case and a mild detonating fuse (MDF) ignition system. Two strands of MDF in this round were spiraled inside the case and along the base with only the last 2-in. extending along the walls of the case. Otherwise, the mounting of the MDF was similar to that employed when spiraled along the sidewalls in Firings X-2 and 6. The velocity and peak pressure for this round were of an acceptable level although the velocity was slightly low.

Firing Nos. 10, 11 and 12 were with similar types of cases: O-I 202 blown glass with integral glass bases and high sidewall clearances. Only the propellant ignition systems varied: normal in Firing No. 10, MDF along the sidewalls in Firing No. 11, and MDF along the base in Firing No. 12. For all firings, the pressure and velocity were of acceptable levels although on the low side. The cases were completely broken and did not cling to the chamber walls. Very few particles were left in the breech section. The highest percentage of particle expulsion achieved, 94.9%, was with the normal ignition. With the case having MDF along the sidewalls, 92.4% of the particles were expelled, and 90.6% with the case having MDF along the base.

Firing No. 13 evaluated the influence of eight longitudinal flat portions along the outer surface of the case. The influence of three circumferential grooves on the periphery of a case was evaluated in Firing No. 14. Both cases were made of Corning 0313 glass and had combustible bases. In both firings, the cases were completely frangible and were off the chamber walls. However, the RTV silicone rubber seal used on the tapered section of the case in Firing No. 13 was incompletely cured and adhered to its mating surface in the tube. The rubber interfered with the flow of particles and only 62.0% were expelled. A similar seal was removed from the case tested in Firing No. 14 and 78.5% of the particles were expelled.

Firing Nos. 15, 16 and 17 were with similar types of cases: O-I 202 blown glass of straight wall cylindrical design, separate Corning 0313 tempered glass bases and high sidewall clearance. As with Firings Nos. 10, 11 and 12 only the propellant ignition systems varied: normal in Firing No. 15, MDF along the sidewalls in Firing No. 16 and MDF along the base in Firing No. 17. For all, the peak pressures and velocities were also acceptable although on the low side. The cases were all broken completely and off the sidewalls with very few particles being left in the breech section. The highest percentage of particles expelled were with the normal ignition and the MDF ignition along the sidewalls, 95.2 and 95.6%, respectively. With the MDF ignition along the base, 90.6% of the particles were expelled.

The firing tests of the fourth series were the first ones in which glass bases were utilized. The results were extremely encouraging since it was possible to exhaust almost all particles for these cases. Approximately 95% were expelled in Firing Nos. 11, 15 and 16. These included cases with integral glass bases, separate glass bases and an MDF ignition system with a concentration along the sidewall. The tests indicated that the

clearance between the case and breech walls was instrumental in obtaining maximum particle expulsion.

For the cases with high sidewall clearance, the use of MDF along the sides was detrimental in Firing No. 11 and not of help in Firing No. 16. The use of MDF along the base was detrimental in Firing Nos. 12 and 17. The circumferential grooves did not offer a great improvement (78.5% particle expulsion vs 74.5 or 78.3% for comparable cases). The influence of flats was obscured by the sticking of RTV silicon rubber to the taper on the wall of the tube.

#### 6.4 Test Series V

The fifth series of ballistic tests were performed at Aberdeen Proving Grounds. Tests involved the use of a scavenger system, and various types of cases and ignition systems. The tests were hampered prior to any firings by problems in the electrically controlled valves that determined the action of the scavenger system. Replacement of two valves was necessary in order to get the system operating properly.

In all of the firings (Table VII) acceptable ballistic pressures and velocities were recorded. As previously, the cases with greater sidewall clearances gave slightly reduced pressures and velocities as opposed to standard cases. One interesting aspect was the high target accuracies achieved in Firings X-5 and 18 during the first day of firing and then Firings 21 through 28 on the second day. The operation of the scavenger system was erratic and no measurements were made of its operation during the ballistic cycle.

The first two firings (Firings X-4 and X-5) were with combustible cases using normal and MDF ignition respectively. The rounds, the gun and the scavenger system functioned adequately. In Firing No. 18, a Corning 0313 straight wall design case with 0.080-in. wall and a separate glass base was used. An inspection of the gun after firing revealed only two glass particles.

IIT RESEARCH INSTITUTE

These were about 0.050-in. in diameter. One of these was 12-in. from the muzzle. The other was in the breech. A number of smaller particles were also noticed in the breech.

After the firing, a slight ridge of metal (approximately 0.030-in. high) was noted in the gun tube just prior to the origin of the rifling and the taper. The locations were at the 6, 8 and 10 o'clock positions. It was surmised that the galling was due to a scraping of metal by the leading edge of the glass cartridge case. Particles of glass would be adhered to the rear portion of the case by the epoxy which was used in bonding the case to the projectile. If the case did not fit exactly on center, a scraping action could have occurred as the projectile moved into the gun tube. An inspection of the gun tube removed the possibility that the striations could have been deep-seated cracks. Firings tests were resumed the next day.

In Firing No. 19, a similar case as used in Firing No. 18 was bonded to the projectile with cellulose nitrate adhesive instead of epoxy resin. Cellulose nitrate is much weaker than epoxy and adhering glass particles would have been expected to shear from the projectile instead of causing galling. During the firing the scavenger system functioned but small particles about 0.030-in. in diameter were observed in the breech and barrel. A cycling of the scavenger system revealed that it was operating at 520 psi instead of the required 620 psi. Readjustment was made of the pressure regulator to increase the pressure. No galling was observed in the gun tube.

The case used in Firing No. 20 was similar to that used in Firing No. 19. During the firing, the scavenger system did not function at all. The case was broken satisfactorily and off the chamber walls, and eighty-eight per cent of the case was expelled out the muzzle. A third defective switch was replaced in the scavenger system.

In Firing No. 21 an O-I Glass No. 202 case with an integral glass base was used with a normal ignition system. After the firing, the barrel and breech were observed to be completely clear of all glass particles. A scratching was observed at the 15° taper by the origin of the rifling.

The case in Firing No. 22 was identical to that in Firing No. 21, except an MDF ignition system was used in which the MDF was spiraled along the rear one-half portion of the sidewall. After the firing no particles were observed in the breech or tube and a lightening of the color of the interior of the barrel seemed to be occurring. It was judged that a carbonized layer in the gun tube was being removed.

In Firing No. 23, a case similar to that used in Firing No. 18 except for an MDF ignition system, was used. All of the particles were expelled except for one particle about 0.050-in. in the breech, and particles were observed in the detent hole.

In Firing No. 24, an O-I case of Glass No. 202 with a separate glass base and a normal ignition system was used. A few small particles about 0.010-0.020-in. in diameter were left at the origin of the rifling.

The case and ignition system in Firing No. 25 was identical to that of Firing No. 18. A few small particles approximately 0.010-0.020-in. in diameter were observed in the gun tube and breech. It was noted that the pressure in the scavenger system air storage tank was down to 1000 psi from a previously normal setting of approximately 1750. A pressure greater than 1050 psi is considered adequate for the system, according to the gun crew.

In Firing No. 26, a case similar to that in Firing No. 18 was used except it had a sidewall thickness of 0.100-in. The results were similar to that of the previous firing and

the scavenger system was recycled to clear the gun tube and breech. The tank pressure was also adjusted upward to 1750 psi.

In Firing No. 27, a Corning 0313 glass case with a tapered sidewall and eight flats machined onto the outer sidewall was tested with a normal ignition system. The case was largely exhausted by the scavenger although about 2.9% of the particles were left in the gun tube. The scavenger system was recycled to clear the gun.

In Firing No. 28, a case of Corning 0313 glass of tapered wall design with circumferential grooves machined on to the outer sidewall was tested with a normal ignition system. All of the particles except for a few around a pressure gauge that did not exhaust from the gun tube were expelled.

#### 6.5 Analysis of the Results of Ballistic Testing on Tempered Glass Cartridge Case Variables

The variables considered for different case designs included: various seal arrangements, three types of materials, three wall thicknesses, three types of bases, two case-chamber wall clearances, five shapes, and four types of ignition systems. An analysis of the results of the firing tests in relation to these variables is given below.

The first series of tests (Firings 1-5) established that the case could be shattered completely and up to 78.3% of the particles could be expelled out the muzzle during a ballistic cycle without a scavenger system. The rear seal was found to be unnecessary to effect breakage of the case and actually was detrimental to particle movement. This seal apparently limited turbulence in the rear of the breech and caused the rear portion of the case to join in place about the breech wall. The front seal was believed to be inconsequential and was eliminated in later firings with no adverse effects.

Of the three materials, the O-I CERVIT 206 performed the best, with 87.8% of the case exhausted vs 78.3% for a

IIT RESEARCH INSTITUTE

comparably shaped Corning case. Only two CERVIT 206 cases were made due to problems in manufacturing this type of material. The O-I 202 glass was not made in a shape comparable to the CERVIT 206 but in shapes similar to the Corning 0313; it behaved similarly to the Corning material.

Corning 0313 cases were made in three wall thicknesses: 0.125, 0.100 and 0.080-in. The particles expelled for straight cylindrically shaped cases (Figure 9) were: 88.7, 94.3 and 95.2%, respectively. From these data, it appears that the cases allow a larger percentage of particle expulsion than the thinner ones. The reason for this apparent anomaly is not understood.

Three types of bases were used on the cases: combustible (Figure 2), separate glass (Figure 15) and integral glass bases (Figure 11). Particle expulsion for similarly shaped cases were: 94.3, 94.9 and 95.2%. The differences are considered insignificant.

Two case-chamber wall clearances were used: 0.062 and 0.237-in. In using the former wall clearance, a case with a tapered section (Figure 1) was used while a straight-wall design (Figure 2) gave the larger clearance. The best performance for the low clearance wall design was 78.3% of the particles expelled; while 95% was achieved for the larger wall clearances, even when using glass bases.

Five different types of shapes were examined: a tapered wall (Figure 2), a straight walled cylinder (Figure 10) a tapered shape with longitudinal flats machined on the outer diameter (Figure 14), a tapered shape with circumferential grooves machined on the outer diameter (Figure 15), and a straight walled cylinder with an integral base (Figure 12). Comparison of these cases with respect to sidewall clearance and types of bases have already been made above. The flats machined on the sides did not aid the expulsion of particles and the test using circumferential grooves was indeterminate

IIT RESEARCH INSTITUTE

due to an incompletely cured RTV silicone rubber gasket that interfered with the expulsion of particles.

Four types of ignition systems were tried: normal for combustible cases (example in Figure 3), MDF along the interior of the case wall without the use of black powder (Figure 20), MDF along the interior of the case wall with the use of black powder (Figure 21) and MDF along the interior of the base with black powder (not shown in a figure). The MDF with no black powder gave improper ignition, as indicated by low velocity and pressure while the other techniques gave acceptable velocity and pressure. For cases with high sidewall clearance (0.237-in.), the normal ignition gave a high degree of particle expulsion (95%) while the ignition with MDF along the base with the use of black powder gave poor particle expulsion (90.6%). The ignition with MDF along the sidewall with the use of black powder gave 92.4 and 95.6% expulsion of particles in two trials.

Unless otherwise mentioned, all of the designs above yielded acceptable velocity and pressures during the ballistic cycle. The cases with high sidewall clearances and, by necessity, smaller case volumes were, however, on the low side in both velocity and pressure. None of the designs interfere with the missile launching groove and none require modification of the gun/launcher.

During the fifth series of ballistic firing tests at Aberdeen Proving Grounds, a type of "nicking" or "pitting" of the gun tube bore was observed. At the time of the writing of this report, all test results were not available. Therefore, no definite analysis is possible at this time.

## 7.0 TESTING OF XM-81 SCAVENGER SYSTEM

The effectiveness of the XM-81 scavenger system in removing particles of the type encountered in tempered glass cases was evaluated at Aberdeen Proving Grounds in a series of non-ballistic tests. The testing was designed to examine variations in particle sizes, shapes, amounts and distribution in the barrel. A summary of the types of experiments and results are shown in Table VIII. The first five tests were designed to determine if problems existed in expelling the various particle sizes encountered from shattered tempered glass cases during early firing finals. No problems were observed, as the scavenger system expelled all of the particles. The arrangement of the particles in the barrel for Test No. 1 is shown in Figure 22, and the cleared barrel after Test No. 1 in Figure 23.

Test Nos. 6, 7 and 8 were performed with larger weights of particles and different distributions in the barrel and breech. All of the particles were expelled by the scavenger in these tests. The distribution of the particles for Test No. 3 are shown in Figure Nos. 24 and 25. The cleared barrel after these tests appeared just as it did in Figure 23. Tests Nos. 10 and 11 involved larger amounts of glass particles and the distribution of them along the entire length of the barrel. Test No. 11 was made using the residual fragments of the G-I CERVET No. 206 case left in the barrel after Program Firing No. 3. The particles were distributed as they had been observed in the gun after firing. In these tests all of the particles were expelled by the scavenger system.

A possible problem area was identified after Test No. 7. An eroded area at the origin of the rifling was observed. If one uses a clock as the method of orientation, the erosion was at the 3 o'clock position (Figure 26). Prior to Test No. 10, the tapered section including the eroded area was colored with

a yellow marking pencil. The system was cycled without any glass particles in the gun and no abrasion of the barrel or coloring was observed. After Test No. 10 it was indeterminate if abrasion of the coloring had occurred. After Test No. 11 it appeared that portions of the coloring had been removed in the area of the erosion. The eroded area after Test No. 11 is shown in Figure 12.

The results of this series of tests show that the XM-91 scavenger system is remarkably effective in clearing the gun of particles of the type encountered in glass cartridge cases. All of the sizes, shapes, amounts and distribution anticipated in actual glass cartridge cases were expelled. As the tests progressed, a slight white coating seemed to be deposited throughout the barrel. The origin of this was not determined but it was surmised that it may have been very fine particles of glass. Erosion of the barrel was not definitely established but could have been due to the impacting of the glass particles against the wall by the inlet jets of air. The scavenger inlet orifices could be repositioned or realigned to lessen this effect. Other alternatives would be hardening of the eroded area or plating with an abrasive resistant coating.

## 8.0 LABORATORY STUDIES

Laboratory studies were performed to establish the technical bases for experimental work on full sized cases. These included: (1) an analytical study of the motion of glass particles and their influence on round performance, (2) vented bomb tests, (3) strength and particle size determinations on one-inch diameter tubes and (4) impact studies on six-inch diameter jars, beakers and cases.

### 8.1 Analytical Study of the Motion of Glass Particles and Their Influence on Round Performance

The introduction of glass particles into a gas stream to form a two phase system will influence gas dynamics to some degree. How such particles influence round performance and their motion in the barrel has been analyzed for 152 mm ammunition.

Interior Ballistics - For the purpose of this study, the interior ballistics of the 152 mm firing have been assumed to be as shown in Figures 27 and 28. The breech pressure and projectile velocity as a function of projectile motion and time provide an adequate history of the firing cycle.

Local Gas Environment - Initially, the gases within the chamber are turbulent due to the burning of the propellant. The gas tends to flow down the bore with a linear velocity gradient as the projectile is accelerated. The velocity is zero at the breech face and equal to the projectile velocity at the base of the projectile as shown in Figure 29. In addition to the gradient down the barrel there is a radial gradient in which the velocity near the chamber walls is decreased. The density of the gas behind the projectile although varying in time as the projectile moves down the bore, can be considered constant throughout the chamber at any instant in time.

Fragment Acceleration - Once the glass case is broken into fragments, the local gas environment determines the force to

which the fragments are subjected. This environment is transient and dependent upon the location in the chamber relative to both the projectile and the breech chamber. An acceleration of the fragments is developed by the flow of the chamber gases past the fragments and a drag force is developed by the relative motion. The magnitude of this force is dependent upon the local environment (gas velocity and density) as well as the physical characteristics of the fragment (size, shape, and weight).

Fragment Motion - The initial motion of the case wall fragments is radial, out towards the breech wall. A combination of gas turbulence and rebounding tends to keep these particles away from the wall. As the gas flows down the bore, the case wall fragments are accelerated in the direction of the gas stream. This is not true for the particles from the rear of the case. The local gas velocity tends to remain zero in the vicinity of the breech face and the fragments are not effectively accelerated down the bore. They have a tendency to remain in their original positions.

Results of Calculations - In analyzing the motion of the fragments, it was assumed that the case fragments started at rest and were in the main gas stream at all times. In other words, the particles were located along the center line of the bore, and at no time digressed to the side walls. This assumption simplified the calculations. While the effect of the drag along the wall has not been analyzed, it is felt that these computations give a reasonable indication of the problem of evacuating the bore and the influence of such important parameters as fragment size and weight.

The computations were made utilizing an existing computer code that was modified specifically for this problem. The result of the calculations are shown in Figure 30, where both the velocity of the fragment at muzzle exit and the time

it took the fragment to exit is plotted as a function of a dummy parameter, "X":

$$X = \frac{C_D A \rho}{W}$$

"X" combines factors which influence the acceleration of the particles by the gas stream.

Where:

- $C_D$  = drag coefficient of fragment, shape dependent
- $A$  = average cross-sectional area of fragment (in<sup>2</sup>)
- $\rho$  = average gas density in chamber (lb/in.<sup>3</sup>)
- $W$  = weight of fragment (grains)

An example of a calculation is given below for a cubical particle of 1 grain weight and approximately 1/10-in. edge dimension:

$$\begin{aligned}
 C_D &= 1.0, \text{ for a cubic shape} \\
 \rho &= 0.003 \text{ lb/in.}^3 \\
 W &= 1 \text{ grain} \\
 \text{Density of glass } &\sim 160 \text{ lb/ft}^3 \sim 650 \text{ grains/in.}^3 \\
 S^3 &= 0.00154\text{-in.}^3 \\
 S &= 0.115\text{-in.} \\
 A &= S^2 = (.1156)^2 = .0134\text{-in.}^2 \\
 X &= \frac{C_D A \rho}{W} = \frac{(1.0) (.014) (.003)}{1.0} = 4.02 \times 10^{-5}
 \end{aligned}$$

For this particle:

	ORIGIN OF FRAGMENT AS MEASURED FROM BREECH FACE				
	2"	4"	6"	8"	10"
Exit velocity, Fig.30 (fps)	19	60	140	235	355
Exit time (sec)	.44	.120	.060	.038	.026

During the time until exit, most fragments should fall less than 2-in. This value is small compared to the bore

diameter which leads one to assume that many particles may not hit the side walls of the bore once they are caught in the main gas stream.

Summary - The effect of the fragments upon round performance appears negligible. When a frangible case is used, the fragments will not move appreciably from the breech chamber until the projectile is almost at the muzzle. Therefore, the volume effect is not much different from having an unbroken case. The amount of energy used to accelerate the fragments is extremely small compared to the total available for work and compared to the energy imparted to the projectile. It will be less than 1% of the kinetic energy. It can be assumed that the motion of the fragments will have no effect upon round performance.

The analysis of the fragment motion indicates that if the case wall particles can be introduced into the main gas stream, most particles will be propelled out the muzzle. Unless turbulence during the burning of the propellant or the normal shattering behavior of highly stressed glass removes the rear case particles away from the rear of breech, they will not be accelerated toward the muzzle and will remain in situ.

## 8.2 Vented Bomb Experiments

The purpose of vented bomb experiments was to gain knowledge in the problems of designing glass cartridge cases and also to evaluate potential materials. A total of 5 sample cylinders were assembled and dynamically tested. All samples were successfully broken under the dynamic loads resulting from the propellant ignition. In this series of tests, a technique was developed so that the failure pressure of the cylinders could be measured.

The test cylinder was sealed into a modified 20 mm brass cartridge case base with room temperature vulcanizing silicon rubber sealant (RTV). The forward portion of the

cylinder was sealed into the 20 mm chamber by several different materials. All of them appeared to be effective. In the original test the forward end was sealed by molding a RTV seal with the sample glass cylinder located in the chamber. Although this seal appeared to function satisfactorily, a 24 hour cure time was required. Because of the time delay, this technique was not conducive to testing when the number of samples was increased. Therefore, alternate methods of sealing were investigated which would reduce the time required to prepare the samples for testing in the vented bomb.

Three alternate approaches were used in this test series. (1) 1/16-in. thick rubber electrical tape was wrapped around the forward end of the cylinder to form the seal. (2) An effective seal was obtained for a larger diameter cylinder by using self-adhesive Teflon tape, 10 mil thick, with the number of layers corresponding to the clearance. (3) The third method employed the forward section of a 20 mm brass case to seal the forward end. A prepared sample using this method is shown in Figure 31. The brass case base was sealed to the sample with RTV adhesive and the clearance between the cylinder and forward section of the case was taken up by using Teflon tape. This method of sealing was also used in a test with a steel cylinder to check out the effectiveness of the seal. Although only this last method of sealing was verified in an actual bomb test, it is believed that the other two methods were equally effective.

Instrumentation on these tests included two pressure gages and a photomultiplier light detector. Gage  $P_1$  was located over the cylindrical test sample and should not have read the pressure developed from the burning propellant until the test sample or the seal failed. Gage  $P_2$  monitored the pressure in the chamber. The photomultiplier light detector (P.M.) monitored the resulting flash when the burst diaphragm opened by means of a reflective surface located ahead of the vented bomb chamber. Two dual beam Tektronix oscilloscopes were used to monitor the

pressure gages and the P.M. detector. The oscilloscopes were triggered by the electrical supply of the firing system which was used to initiate the M52A3 electric primers. A drawing of the vented bomb apparatus was shown in the Third Monthly Report.

#### 8.2.1 Time-Pressure Results

The results of these vented bomb tests are summarized in Table IX. The first three tests were made to check out instrumentation and establish circuit and ignition time delay. A system delay of 11 to 13 milliseconds (MS) was established for this test series. The oscilloscope traces were delayed accordingly to permit a slower sweep rate of the pressure traces so the pressure-time history could be expanded to show more detail.

In Test No. 4 with a test sample made from CERVIT 206, Tube No. 9, the cylinder shattered, and the majority of the particles were expelled out of the vented bomb. The traces did not indicate a differential pressure between  $P_1$  and  $P_2$  in the firing cycle, thereby indicating that the cylinder failed early in the ignition cycle of the propellant. In Test No. 5 with Pyroceram 9611, Tube No. 9 failed at a pressure of approximately 8000 psi. The particles remained within the test chamber still in the original shape of the cylinder. Figure 32 shows the oscilloscope traces for Test No. 5. The top photograph shows the pressure trace of  $P_2$  and the P.M. detector. At approximately 11-msec after triggering the firing supply, the initial pressure rise starts at  $P_2$ . After 1.4-msec the P.M. detector first registers a reading, indicating the opening of the diaphragm at a pressure of approximately 10,500 psi. The lower photograph shows the traces of  $P_1$  and  $P_2$ . The initial pressure rise of  $P_2$  occurs at 11-msec while  $P_1$  does not rise until 0.5-msec later, when the pressure at  $P_2$  is 8000 psi. In test No. 6, a Corning 0313 sample was shattered in the vented bomb. However, as can be seen in Figure 32,  $P_1$  and  $P_2$  do not

indicate a significant pressure differential acting on the test sample, so that an early failure of the glass cylinder must have occurred.

For Test No. 7, Pyrocera 9611, Sample No. 10, the third sealing method was employed. Again the sample failed early and no pressure differential could be measured. There was speculation that possibly the seals were not holding. Test No. 8 was performed using a steel cylinder in place of the glass test cylinders. The same type of seal used in the previous test was also used to form the seal. The  $P_1$  and  $P_2$  traces for this test are given in Figure 33.  $P_2$  shows the normal pressure curve and  $P_1$  shows no pressure rise. Those traces indicate that this seal was good up to or above a pressure of 30,000 psi. Thus, it can be concluded that the failure to record the fracture pressure of the cylinder is not related to seal failure.

The 20 gram charge of IMR 5010 nearly completely filled the test samples in Test Nos. 1 through 8. This high loading density in the initial volume of the cylinder must have resulted in high pressure at the initial ignition of the propellant. The high transient pressure wave resulting from the initial ignition does not register on the pressure gages, but previous experience has shown such transients do exist. It is assumed that this type of transient exists in this case and resulted in the early failure of the cylinders. In order to lower or remove this transient pressure, the loading density was decreased.

In the final test of this series, the charge was reduced to 10 grams. The results was as shown in Figure 34. The rate of pressure rise is much lower for this loading condition and clearly shows the pressure of 7500 psi, when  $P_1$  recorded the failure of the cylinder.

This test series in the vented bomb apparatus has lead to a technique for measuring the failure pressure of glass

test cylinders. As additional samples of cylinders are obtained, the vented bomb will be used to obtain the required dynamic data of the fracture pressure in relationship with the glass properties and geometry. This test series has also given experience in seal design and performance. It indicates that the type of seals planned for the full-sized ballistic testing should be adequate.

### 8.2.2 Particle Size Data

The particles remaining in the vented bomb chamber after shattering of the cylinders were removed and their size distributions were measured. This data may be seen in Figure 36. As was the case with the O-I 202 glass reported last month, there was a significant reduction in particle size for CERVIT 206 and Chemcor 0313. This comparison may be seen in Table . In these cases there was a contribution to the internal stresses by the burning propellant that resulted in smaller particles.

The burning propellant did not show a contribution to particle size reduction of the Pyrocera 9611. In one of these samples the particles were actually larger than those resulting from diametral compression failures. The 9611 is an extremely highly stressed glass-ceramic, and a possible explanation for this behavior is that no additional internal energy can be developed in this material. Another possible explanation is that the 9611 is more sensitive to rapidly generated stresses and fails at lower stresses under explosive conditions.

The indications are that during Run Nos. 4, 6 and 7, the sample cylinders were broken by a high initial transient pressure that did not register on the pressure gages. On the other hand, the samples from Run Nos. 5 and 9 broke at recorded pressures of 8,000 and 7,500 psi. In both of the latter runs, the particle sizes were coarser than tubes of the same material that were shattered by the initial transient pressure. The

reason for this behavior is not understood but it could be related to the effectiveness of transferring energy into the glass cylinders by the different rates of loading.

All of the above data are subject to variability due to the tendency of glass samples to display scatter in strengths and due to the fact that only a portion of the particles were recovered in the vented bomb tests. Additional data would be required in order to properly analyze reasons for the observed results.

### 8.3 Mechanical Testing of Cartridge Cases

Mechanical testing is required to evaluate the ability of a material to withstand either gradually applied loads (static conditions), suddenly applied loads (impact conditions), or twisting loads (torsion). Such factors as shape configuration and stress raisers can be minimized to utilize the maximum potential of the material. The procedures employed in developing a frangible glass cartridge case indicate how the material would:

- a. break into small particles which could be easily removed from the breech of a 152 mm weapon, and
- b. withstand the impact stresses resulting from a 5-ft drop onto a steel deck.

#### 8.3.1 Materials Evaluation

Two phases were involved in evaluating the tempered glass and/or glass-ceramics: screening tests to determine the best possible materials and evaluation tests to determine the influence of case thickness and degree of tempering.

##### 8.3.1.1 Testing Procedures

Diametral tension tests were conducted in an Instron Universal Testing Machine having a maximum capacity of 20,000 lbs. Strips of 1/8-in. thick lead were placed on the upper

IIT RESEARCH INSTITUTE

and lower plates to minimize any effects of stress raisers in the nature of surface flaws. The specimens were carefully centered between the plates and care was taken to insure as equal a distribution of load across the entire length of the cylindrically shaped specimen as possible. Loading speed was maintained at 0.02-in./min for all tests and was continued until fracture. After each group of specimens had been tested the particles were analyzed for size using five sieves (Nos. 6, 8, 12, 14 and 16). The only exceptions to this procedure were the GCIRC unstressed cylinders which broke into much larger pieces than any of the screens.

Impact testing was conducted in a "drop-weight" machine. The equipment consists of a steel frame into which an electro-magnet on the end of an adjustable steel rod is placed. The electro-magnet supports a steel ball which can be dropped from any height onto the specimen. The procedure is to place the cylinder onto a metal support in such a way that the cylinder acts as a simply supported beam. The steel ball is positioned to strike the specimen at its center. Initially, the steel ball is placed only a few inches above the specimen, then raised by small increments until the specimen fractures. Again, the fractured specimens were analyzed for particle size in the same set of sieves used for analyzing the particles from the static tests.

The ultimate tensile strength of each specimen tested in diametral tension was calculated from:

$$\sigma_u = \frac{kP}{(D_1 - D_2)I}$$

where:

P = total applied load, lbs

D<sub>1</sub> = outer diameter, in.

D<sub>2</sub> = inner diameter, in.

MIT RESEARCH INSTITUTE

$l$  = length of the cylinder, in.  
and  $k$  = a stress concentration factor which is a  
function of the ratio  $D_2/D_1$ .

The impact strength of each specimen tested was  
calculated from:

$$i = \frac{6EWh}{\pi R t L}$$

where:

$E$  = Young's modulus of elasticity, psi  
 $W$  = weight of the steel ball, lbs  
 $h$  = height of steel ball at fracture, in.  
 $R$  = average radius of the cylinder, in.  
 $t$  = wall thickness of the cylinder, in.  
 $L$  = span length at center of supports, in.

These test results are plotted as "probability of failure" versus stress level for each specimen in every group tested. Because of the inherent nature of brittle materials, this form of graphical representation is widely accepted as being the most suitable for showing the range of stress that can be accepted for any sampling of the material. It then becomes evident that the narrower the range of stress, the more reproducible the material is for any sampling. The probability for any given population of a material sampling is expressed by:

$$P_n = \frac{n}{N+1}$$

where:

$P_n$  = probability of failure of the  $n$ -th sample  
in either ascending or descending order.  
 $n$  =  $n$ -th sample under consideration.  
 $N$  = total number of samples in the population.

From the curves, it becomes possible to select the material on the basis of its strength and reproducibility. In this project, desired properties were:

1. high tensile strength
2. high impact strength
3. good reproducibility

A particle size distribution analysis was conducted in order to study the frangibility behavior of the various materials. Particle sizes were determined by employing 6, 8, 10, 14 and 16 mesh sieves and recording the percentages passing through each sieve. For the particle size data a figure of merit, a "mean weighed particle size" is shown. This figure was calculated by adding the percentages for each size category times its size and dividing by 100.

#### 8.3.1.2 Screening Tests

Candidate materials in the form of tubes, approximately 1-in. o.d. x 3-in. long x 0.10-in. diameter, were tested in diametral tension and impact loading. Rectangular plates, approximately 1-in. wide x 4-in. long x 0.10-in. thick were tested in flextural loading. Specimens were contained in thin plastic bags during testing so that the particles could be retained for size analysis.

Data from the screening tests are presented in Table X. Figures 37, 38 and 39 show stress data while Figures 40-45 show particle size data.

Despite the wide range in mean strength for each sample group - 24,000 psi for 0313 to 77,800 psi for 9611 in diametral tension, and from 41,700 psi for 0313 to 94,600 psi for O-I 202 in impact strength - the mean weighed particle size for each group was fairly constant, with the range being 2.397 to 2.967 mm, with an average of 2.606 mm. Generally, within each sample group, the particle size tended to decrease

with increasing strength. This can be verified by noting the upward slope of the curves in Figures 40 through 45.

The GCIRC tubes were of unstressed glass and consequently did not shatter. The pieces of glass from this sample were in the range of 1/2-in. x 1/2-in. to 1.0-in. x 1.0-in. in size. The Corning 9608 also did not shatter in the manner of the other stressed pieces. Some of the pieces were in the range of 1/2-in. x 1/4-in. in size. Both of these materials were judged unsuitable for cases of additional samples. The Pyroceram 9611 was a suitable material but the cost of this material was high relative to the other materials and delivery times were very long. The Corning 0313, O-I 202 and O-I CERVIT 206 all had appreciable strength and broke into small pieces when stressed to failure. These were all considered adequate materials for further testing.

On the basis of these tests, sample cartridge cases, designed to meet specific requirements, were ordered. Modifications to the original design (Section 5.0) had already been made after ballistic firing (Section 6.0) and vented bomb tests (Section 8.2) had been carried out. From these tests, it appeared that one of the major problems to be overcome was to determine what geometric changes could be made so that the frangible glass cartridge case assembled with propellant and projectile would not break upon impact if it were accidentally dropped onto a metal or concrete deck from a height of 5 ft. Work on these problems is described in Section 8.3

#### 8.3.1.3 Wall Thickness and Tempering Variables

Two important engineering variables in designing glass cartridge cases are wall thickness and degree of chemical stressing (or tempering). The thicker the wall, the greater the anticipated stress; however, the greater the amount of glass to expel and the smaller the volume available for propellant. The more optimum the chemical tempering, the better

the combination of strength and particle size. As a result, the effects of thickness and degree of chemical stressing in the Corning 0313 was investigated. Specimens were divided into two groups based on their thicknesses and subdivided according to the amount of chemical stressing to which subjected. Groups I, II and III had an average thickness of 0.047-in. and and Groups IV, V and VI, 0.064-in. Group I was subjected to 6 hours of tempering, Groups II and IV, 12 hours, Groups III and V, 18 hours, and Group VI, 24 hours. Each specimen was enclosed in a thin plastic bag so that the particles could be retained and screened.

The impact and diametral compression test results are shown in Table XI and Figures 46 and 47. The in-group variation in impact strength was minimal, ranging from 1.8 to to 8.4%, indicating that reproducibility in impact strength was excellent. The strength differences between the individual groups was also smaller than anticipated. Group I showed an average impact strength of 32,315 psi, Group II, 30,380 psi and Group III, 29985 psi. The energy required to produce fracture averaged 2.61 in.-lb for Group I, 2.25 for Group II and 2.06 for Group III. The cylinder wall thickness for these groups averaged 0.047-in. with a deviation of only 4.5%, well within the limits prescribed for production.

The cylinders in Groups IV, V and VI exhibited impact strengths of 22,250, 21,630 and 20,630 psi and fracture energies of 15.25, 14.88 and 13.78-in.-lb respectively. Deviation in strengths averaged 2.7% for all these groups, again showing remarkably well controlled reproducibility of the materials. The cylinder thicknesses for these groups averaged 0.064-in. with a variation of only 1.5%. Again, these figures were well within the required tolerances specified in their manufacture.

For the diametrical tests, seven cylinders from each group were tested. The cylinders of Groups I, II and III showed diametral tensile strengths of 18,300, 17,400, and

IIT RESEARCH INSTITUTE

19,800 psi respectively with deviations of 14.7, 11.5 and 11.0%. Although higher than the variation exhibited by the glass cylinders in the impact tests, such variability is not uncommon in brittle materials. In fact, these deviations for diametral strength tests show very good reproducibility of the cylinders.

The cylinders of Groups IV, V, and VI had average strengths of 21,900, 16,400 and 15,900 psi with variations of 8.7, 14.7 and 7.6% respectively.

After testing, the fractured cylinders were analyzed to determine particle size distributions. The results are plotted in Figure 48. Generally, the percentage of particles passing through each sieve was almost constant with respect to the ultimate strength of the cylinders in each group. It can be observed that the particle size of each group was almost the same for cylinders tested in diametral compression as for those tested in impact.

The results of the mechanical testing indicate that for the wall thicknesses and degrees of tempering tested, no significant differences were observed in impact or diametral compression strengths. The data correlates with the tempering data that showed no significant increase in outer compressive layers thicknesses as a function of tempering time. The differences in particle sizes between samples also showed no significant differences.

These data indicate that for the thicknesses indicated, the Corning 0313 does not show great differences in properties as a function of tempering time. The properties also showed a great degree of uniformity and reproducibility. If this material were to be used for cartridge cases, indications are that it would be uniform, reproducible and probably easy to control in its properties.

The procurement of thicker tubes (0.100-in. thick wall) was attempted but delivery times were not adequate for use on this project.

### 8.3.2 Impact Studies

Untempered glass specimens, representative of the size and shape of 152 mm cartridge cases, were impact tested to determine ways and methods of improving their resistance to fracture when dropped onto a steel deck. Two variables were studied:

1. Variation in geometric configuration
2. Methods of protecting and distributing impact stresses

#### 8.3.2.1 Test Procedures

The types of specimens used were Mason jars and four-liter laboratory beakers. Three jars and a total of 21 beakers as well as 6 full-size stressed glass cartridge cases were tested. Use of the jars was not suitable because of their thickness and inability to be reshaped.

The beakers, which were first cut to eliminate the flare at the open end, closely resembled cartridge cases in both geometry and capacity for propellant. All specimens were filled with 6-1/2 lb of crushed and ground insulating firebrick, a material having a density of 0.023 lbs/in.<sup>3</sup>, closely approximating the density of the charge in a 152 mm cartridge case. The beakers were then sealed with 20 ga. sheet steel disks, epoxied to the inside diameter at the open end. Lugs were epoxied to the specimens for support and attitude control of the case in the testing machine.

The testing machine, shown in Figure 49 with a standard combustible base, includes a main support with an adjustable height, an electrically actuated release, a means of changing the attitude of the cartridge case in order to examine different angles of falls and a dark background with a graduated scale.

III RESEARCH INSTITUTE

### 8.3.2.2 Results

The first three tests were on beakers contained in plastic bags with no reinforcement or impact absorbing media. The first beaker, B1, was dropped in a vertical position starting from 1-in. above the steel table. Drops were continued in 1/4-in. increments until failure took place from a height of 2-in. Similar procedures for beakers B2 and B3, dropped horizontally and from an angle of 35°, were followed and fractures occurred at heights of 2-in. and 1-3/4-in. respectively. Test results together with dimensions and other pertinent data for all beakers are presented in Table XII.

Specimen B4: To improve its impact resistance, this specimen was provided with a rubber ring bonded to its base. The beaker, tested in a vertical position, bounced noticeably from each drop. It survived the 12-in. drop, but failed from a height of 13-in. Fracture was initiated in the base with the cracks extending to a height of about 3-in. into the sidewall, and a major crack which extended nearly to the steel cover plate. Failure was caused by the internal load of material pushing out the base.

Specimen B5: Additional reinforcement in the form of glass stiffeners were epoxied to its base. In addition, a rubber ring similar to that used previously, was bonded to the bottom of the beaker. At heights of 1, 3 and 4-1/2-in. the beaker did not bounce. Although barely perceptible bouncing took place at 6, 7-1/2 and 9-in., noticeable bouncing took place from this height on. Fracture occurred at the 14-in. drop, with the base remaining intact and the cylindrical sidewalls shattering.

Specimen B6: This beaker was also reinforced in the base. The reinforcement took the form of indentations, or semi-circular grooves which had been pressed into the heated and softened base of the beaker. Three such indentations were made, each being about 5-in. long x 1/4-in. deep and crossing each other

at 60° to form 6 nearly identical ribs. This beaker also had a rubber ring bonded to its base. The specimen broke at a 20-in. height. Unlike the sample which was reinforced by glass stiffeners, this beaker shattered in the base as well as in the sidewalls. Cracks propagated from a central point in the base of the beaker along the pre-formed ribs and up into the sidewalls.

Specimen B7: The base of this specimen was contoured in the form of a concave dish having a depth of 0.3-in. at the center. The sidewalls had four indentations averaging 3-1/2-in. long of hemispherical cross-section 1/4-in. deep pressed into the heated and softened glass. These indentations served to reinforce the sidewalls. The specimen survived a 28-in. drop but fractured from a height of 30-in. It bounced noticeably from a height of 9-in. and at 28-in. the bounce was about 10-in. Cracking was initiated near the base, but in the sides of the beaker, and cracks extended upward to the top of the beaker.

Specimen B8: This beaker was similar to B7 except that the contoured base was concaved to only 0.2-in. at the center. It was dropped from a maximum height of 24-1/2-in., fell over on one side, and cracked on an unprotected surface. The bottom remained intact and the only fracture occurred on the side receiving the secondary impact.

Specimen B9: This beaker had three indentations pressed into the heated, softened base. Each indentation was about 5-in. long by 1/4-in. deep and crossed each other at about 60° so that there were 6 almost identical ribs in the base similar to spokes in a wheel. This specimen was fitted with a thinner silicone rubber gasket than the other specimens. The thinner gasket eliminated the bouncing, but the specimen broke when dropped from a height of only 8-in. Cracking was initiated in the base and the fractures extended into the sides.

Specimen B10: Reinforcing indentations were made in the base of this beaker and in the sides. The four side indentations

were made to extend from the base to within 1/2-in. of the top and were made about 1/4-in. deep. From a height of 6-in., the beaker bounced and fell on one side. Fracture was initiated at the top and extended down the side of the beaker to the base.

Specimen 11: This specimen had a ribbed base similar to B9. The standard half-round silicone rubber gasket was used as in all specimens, except B9. It started to bounce noticeably from a height of 12-in., and fractured from a 15-in. drop, the fracture starting in the indented ribs in the base and extending into the sides.

Specimen B12: This specimen had a contoured base with the depth of the concavity being about 0.25-in. at the center. It failed from a 16-in. fall with the fractures starting around the perimeter of the base and extending in random fashion into the sidewalls.

Specimen B13: This specimen was tested in an upside down position. That is, the silicone rubber ring was epoxied to the steel cap plate and dropped with the steel cap acting as a base in place of the glass bottom of the beaker. The beaker broke from a height of 28-in. with the fractures confined to the sides.

Specimen B14: This specimen was dropped in a horizontal position having silicone rubber rings epoxied around its circumference near the top and bottom. From a height of 8-in., the beaker fractured in the base as well as on the side which received the impact.

Specimen 15: This specimen was made concave in the base and sides. From a drop of 23-in. fracture occurred in the base and sides. The fracture in the sides occurred in a band around the narrow part of the concavity with some cracks extending toward the base.

Specimen B16: Only the sides of this beaker were made concave. The specimen was dropped in a horizontal position, similar to B14. Again it broke from a height of 8-in. This time, however, cracking was confined to the sides and the base remained intact.

Specimen B17: The base of this beaker was contoured in the form of a concave dish. The beaker was sprayed inside and outside with a 0.005-in. thick coating of "Krylon" -- a crystal clear plastic. Impact testing started from a height of 6-in. and increased by 4-in. increments to 22-in. Increments were then reduced to 3-in. The specimen bounced noticeably from a height of 10-in. It survived seven drops and fracture occurred on the second drop from 28-in.

Specimen B18: This beaker was reinforced with a contoured base and four indentations, each about 4-in. long, in the sidewalls. In addition to the silicone rubber ring, a 1/4-in. layer of "Devcon L" -- a lead based putty with a Young's modulus of  $6.5 \times 10^5$  psi -- was used. This was appreciably higher than the 1000 psi for the silicone rubber ring previously used. The first drop was from a height of 6-in. with subsequent drops at 3-in. increments until failure occurred at 36-in. on the twelfth drop.

Specimen B19: This beaker was similar to B18 except that a 3/8-in. thick layer of "Devcon L" and not the silicone rubber ring was used. Testing started at 6-in. and by 3-in. increments until fracture occurred at 12-in. on the third drop.

Specimen B20: This specimen was contoured in the base and had four 4-in. x 1/4-in. indentations in the sidewalls. Two thin silicone rubber rings and segments cut from the tread of a bicycle were used as an impact medium. The first drop was made from a height of 6-in. and subsequently by 4-in. increments until the eighth drop when at 34-in. it bounced, fell on its side, and fractured.

Specimen B21: This specimen had a concave base and sidewalls, and was otherwise identical to B20. Testing started at a 6-in. height and increased by 4-in. increments. The specimen failed at 26-in. on the sixth drop, by falling on its side. Both of the tests on Specimen Nos. 20 and 21 were thus inconclusive. A need was shown for the development of a better testing technique that would catch the beakers on the first bounce.

The significance of the experimental impact testing was to demonstrate that the impact resistance of an untempered glass beaker of similar shape to a tempered glass cartridge case can be markedly improved by design modifications and the use of energy absorbing media. Similar approaches may be used to improve the impact resistance of a glass cartridge case although the degree of improvement will be larger due to the much higher strength obtainable in the tempered glass. Also greater design possibilities will be present with impact media as the tempered glass will tolerate higher stresses and greater rates of impact loading.

#### 8.3.2.3 Analysis of Stresses

A full evaluation of the various methods of reinforcement can only be made in terms of the impact stresses sustained by the glass, both in the base and sides, the stresses absorbed by the rubber gaskets, and the reinforcement provided by deforming the glass itself.

The tensile stress of Pyrex glass ranges from 7,500 to about 13,000 lb/in.<sup>2</sup>. In this range, the glass will fracture. Any calculated stresses above this value can, therefore, be considered as the contribution of any added reinforcement.

An analysis of impact stresses due to dropping specimens up to heights of 60-in. was conducted. A plate analysis for the base and a shell analysis for the side of the beaker were employed. In each case, the static stresses were

evaluated and the impact factors used to transpose them into impact stresses.

Analysis of Base: The base of the beaker was assumed to be a uniformly loaded circular plate with supported edges. In this case, the maximum static deflection is calculated from:

$$d_{\text{stat}} = \frac{(5 + \nu)qa^4}{64(1+\nu)D}$$

where:

q = intensity of load distributed over the surface  
= 0.24 lb/in.<sup>2</sup>

a = radius of beaker = 3-in.

ν = Poisson's ratio for Pyrex glass = 0.22

D =  $\frac{Et^3}{12(1-\nu^2)}$

E = Elastic Modulus for Pyrex glass =  $10 \times 10^6$  psi

t = thickness of plate = 0.12-in.

The maximum static stress in the base is calculated from:

$$\sigma_{\text{stat}} = \frac{3(3 + \nu)qa^2}{8t^2}$$

With  $d_{\text{max}}$  and  $\sigma_{\text{max}}$  calculated for static conditions, the impact stress was evaluated for drops up to 30-in. from:

$$\sigma_{\text{imp}} = \sigma_{\text{stat}} \left( 1 + \sqrt{1 + \frac{2h}{d_{\text{stat}}}} \right)$$

where:

h = height of the drop

For h = 0 to 30-in., the upper curve of Figure 14 shows the maximum impact stresses for a circular plate.

Analysis of Sides: The sides of the beaker were analyzed assuming that the beaker was a cylindrical tank with a uniform wall thickness, subjected to the action of an internal

pressure such as a liquid. It has been shown\* that the maximum stresses occur at a distance of  $0.1L$  where  $L$  is the length of the side of the tank and the distance is measured upward from the base.

$$d_{\text{stat}} = \frac{\gamma a^2}{Et} \left\{ L - x - e^{-\beta x} \left[ L \cos \beta x + \left( L - \frac{1}{\beta} \right) \sin \beta x \right] \right\}$$

where:

$\gamma$  = pressure in the cylinder =  $0.028 \text{ lb/in.}^3$

$a$  = radius of cylinder =  $0.3\text{-in.}$

$L$  = depth of tank =  $8\text{-in.}$

$x$  =  $0.1L$

$t$  = thickness of side =  $0.12\text{-in.}$

$E$  = Elastic Modulus =  $10 \times 10^6 \text{ psi}$

$\beta^4 = 3(1-\nu^2)/a^2 t^2$

$\nu$  = Poisson's ratio =  $0.22$

The static stresses in the cylinder are calculated from:

$$\sigma_{\text{stat}} = \frac{\gamma a}{t} \left\{ L - x - e^{-\beta x} \left[ L \cos \beta x + \left( L - \frac{1}{\beta} \right) \sin \beta x \right] \right\}$$

The impact stresses for this case are horizontal and as such are computed from:

$$\sigma_{\text{imp}} = \sigma_{\text{stat}} \sqrt{\frac{v^2}{384.6 d_{\text{stat}}}}$$

where  $v^2$  = velocity of impact in inches per second.

The lower curve of Figure 50 shows the maximum impact stresses in the sides of the cylinder.

Interpretation of Test Results: The test results are best interpreted by citing 3 examples of drops and showing how much stress is absorbed by the reinforcement.

---

\* Pfluger, A., Elementary Statics of Shells, F. W. Dodge Corp., N. Y., 2nd Ed. (1961).  
Timoshenko, S., Theory of Plates and Shells, McGraw Hill, N. Y., 2nd Ed., (1959).

The unreinforced specimen, B1, broke in the base when dropped from a height of 2-in. No fracture occurred in the sides of the beaker. Referring to Figure 50, the situation appears predictable; that is, the stress level in the base of the beaker is 12,500 psi and in the cylinder walls is only 6,250 psi, less than the tensile strength of Pyrex glass. With the addition of a half-round rubber gasket, the specimen B4 broke from a height of 13-in. At this level, the stress in the base is 31,500 psi and in the sides 19,000 psi. The fracture occurred in the sides. It is therefore concluded that the rubber gasket acts as a damper absorbing 19,000 psi that would normally have gone into the base and increasing the resistance to impact on the sides by 6,500 psi. With the base made concave, specimen B8, the level at which fracture occurred was 24-1/2-in. At this height, the stresses in the base and sides are 43,500 psi and 25,500 psi respectively. Since we know the contribution of the rubber gasket, we can calculate the effect of the concavity to be 12,000 psi in the base and 6,500 psi in the sides. That is, a 0.3-in. concave base will absorb a stress of 1,200 psi in the base and contribute an additional 6,500 psi to the ability of the sides to resist impact.

With the same concavity in the base, but fluting the sides of the cylinder, specimen B7, the height of the drop producing fracture was 30-in. At this stage, stresses in the base and sides were increased to 47,500 and 27,500 psi, respectively. Since the contribution of the rubber gasket and the concave base is known, the effects of the fluted sides contribute an additional 4,000 psi to the base and 2,000 psi in the sides of the beakers.

Using these examples, the effects of various methods of reinforcing the glass, either singly or in combination can be evaluated.

### 8.3.3 Impact Testing of Tempered Cartridge Cases

These tests included: (1) glass cartridge cases with simulated propellant without projectiles, (2) glass cartridge cases with simulated propellant and projectiles.

For the assembled 152 mm shells, they were filled with either a simulated inert charge material, supplied by Picatinny Arsenal, or crushed insulating brick of similar density. RTV silicone rubber adhesive was used to cement the projectile to the case. Two layers of 1/16-in. thick silicone rubber were used between the edge of the case and the projectile. These were also bonded in place with the RTV. Two of the assembled shells had plastic bags placed around the cases to collect fragments. The third was not protected in order to better observe the mode of failure.

Dimensions and weights of the specimens currently being reported are presented in Table XIII and test results are tabulated in Table XIV.

#### 8.3.3.1 Cartridge Cases with Simulated Propellant

The purpose of testing cartridge cases loaded with simulated propellant without projectiles was to obtain information about the failure mechanism. Knowing how a case fails enables redesigning to minimize stress concentration factors. Furthermore, if a case is unable to withstand a drop of five feet without a projectile, it obviously will not do so with a projectile attached. All test specimens, except as noted, employed a half round silicone rubber ring attached to the base to spread the load over a relatively larger area, particularly because the cases were not fully optimized for impact resistance.

Specimen O-I 202-4: This specimen was a closed end tempered glass case with a sealed ignitor hole in the base. The specimen was first dropped from a height of 30-in., and then in increments of 6-in. increase to 54-in. Thereafter, increments of

3-in. were employed. The specimen survived eight drops before fracture occurred on the ninth from a height of 66-in.

Specimen Corning 0313-6: This specimen was fitted with a sheet metal base and cap. Impact testing started from a height of 30-in. and increased at 3-in. increments until failure occurred on the second drop from 45-in. The specimen survived six drops before fracturing in the sidewalls on the seventh drop.

Specimen O-I 202-18: This specimen was an open-ended, tempered glass case fitted with a sheet metal base and cap plate. The first drop was from a height of 30-in. and then increased at 6-in. increments to 54-in. at which stage the increments were reduced to 3-in. From a height of 63-in., the metal base was driven into the cartridge case about 1/4-in. when the epoxy used to cement the base plate sheared. The cartridge case survived eight drops without fracturing. Attempts to safely remove the plate and retest the specimen failed.

#### 8.3.3.2 Cartridge Cases with Simulated Propellant and Projectile Specimens O-I 202-8 and O-I 202-11

These specimens were assembled 152 mm cartridges and shells. The major differences between the two were the wall thicknesses and a curved section in the thinner case between the sidewall and base. O-I 202-8 had an average wall thickness of about 0.129-in. and O-I 202-11, a thickness of 0.298-in. Impact tests started at 6-in. and increased at increments of 3-in. The thinner case survived three drops but broke at a height of 18-in.; the thicker one survived three drops and broke at 15-in.

Specimen O-I 202-9: This case and projectile assembly was similar to O-I 202-8. The difference was in the impact absorbant employed in the base. The reinforcement consisted of two layers of a thin silicone rubber plus segments of bicycle tire tread. No plastic bag was put around the cartridge case and the specimen was filmed at each drop on 16 mm movie film to

record the fracture. The assembly was dropped in increments of 6-in., starting from a height of 6-in. It survived three drops and fractured at 24-in.

### 8.3.3.3 Analysis of Stresses in Cartridge Cases

The previous analysis of impact stresses was described using a plate analysis for the base and a shell analysis for the sides of glass beakers. For this type of analysis the criteria for failure depends on the strength of the material. Using Equations (1) through (6), it can be shown that for a drop of 60-in., the impact stress in the base will be 64,000 psi and in the sidewalls, 40,000 psi. When the strength of the material exceeds these values, the criteria for failure is generally associated with some other mode. In the case of the stressed cartridge cases, the mode was attributed to a buckling type of failure.

For this mode of failure, it is assumed that the cartridge case is loaded in axial compression due to the weight of the projectile. For this condition, the maximum static deflection is calculated from:

$$d_{\text{stat}} = \frac{\nu N_x a}{Eh}$$

where:

$\nu$  = Poisson's ratio, dimensionless

$N_x$  = compressive force, lb/in.

$a$  = radius of cylinder, in.

$E$  = Young's modulus, psi

$h$  = thickness of the cylinder wall, in.

The static stress due to the weight of the projectile on the case is given by:

$$\sigma_{\text{stat}} = \frac{N_x}{h}$$

and the impact stress is obtained by multiplying the static stress by the impact factor, or:

$$\sigma_{\text{imp}} = \sigma_{\text{st}} \sqrt{1 + \frac{2h}{d_{\text{stat}}}}$$

where h = height of drop.

A plot of this curve is shown in Figure 50 for h = 0 to 60-in.

#### 8.3.4 Interpretation of Test Results

The range of stresses for the glass used in the Owens-Illinois cartridge cases is between 82,000 and 95,000 psi. According to analysis these stress levels will be reached by buckling when the cartridge is dropped from a height of between 12 and 17-in. It is significant to note that two of the cartridges tested, O-I 202-8 and O-I 202-9, fractured from heights of 18 and 15-in., respectively, indicating that buckling could be the failure mechanism. The third case, O-I 202-11, failed when dropped from 24-in.

The last case employed a composite impact medium -- a soft silicone rubber of 1,000 psi Young's modulus and a hard rubber of some higher, although unknown, Young's modulus. It is believed that the transfer of impact energy to the glass was modified by using the composite material. The use of an impact media influences the area of the impact and the time-force relationship to which the glass is exposed. Obviously, the greater the area of the impact load, the lower will be the stress the glass experiences at the point of impact. If the time-force relationship is spread out, the peak load the glass experiences will be reduced. A properly designed impact medium will match the transfer of energy from the types of loads the glass will experience to the mechanical properties of the glass.

1 There is obviously considerable potential for improvement in glass case design and impact media design in order to

optimize impact performance. In addition, the use of higher strength glass and glass-ceramic materials should improve the impact resistance situation even more.

#### 8.3.4.5 Analysis of Glass Cartridge Case

In its most basic form, a cartridge case is simply a closed end cylinder subject to internal pressure and an externally applied load. The internal pressure is caused by the charge or propellant, and the external load is provided by the projectile. Statically, these loads are not severe, but when applied dynamically, they introduce stresses and deformations which can seriously damage the cartridge case.

The cartridge case in taking the form of a closed cylinder, can be considered as a "shell" structure, and can be analyzed as such. Also, because a closed cylinder is symmetrical about an axis parallel to the cylinder walls, the cartridge case is a solid of revolution. Basically then, the stresses and deformations can be computed from the static application of loads and then by applying dynamic factors, the actual stress distribution for the same loads applied dynamically can be calculated.

Once this has been done, physical testing of the actual cartridge cases can be carried out and checked against the mathematical analysis. This was the procedure that was taken in the study made at IITRI in developing a glass cartridge case which would fracture into small particles when fired from a 152 mm weapon and yet withstand the stresses due to impact if dropped from a height of 5 feet onto a concrete floor or steel deck.

Figure 52 shows the stresses resulting from dropping a glass cylinder loaded with:

- a. a simulated propellant having the same density as the actual propellant (lower two curves)

b. an externally applied load of the same magnitude as the projectile of a 152 mm cartridge producing buckling in the cylinder walls (upper curve).

Tests were made using Pyrex beakers - first, as produced, then with a variety of reinforcing methods - filled with a simulated propellant. From Figure 52, it can be seen that fracture of an unreinforced beaker should take place in the sidewalls when dropped from a height of between 1.4 and 2.4-in. In the actual test, failure was initiated from a height of 2-in. and did occur in the sidewalls. By adding a silicone rubber ring to the base to act as a "shock absorber", the beaker was raised to a height of 13-in. before failure occurred. From the curve of Figure 52, it can then be read that the rubber ring will absorb 19,000 psi that would normally have been taken by the base. Thus the rubber ring acts as a damper (such as in a spring-mass-damper mechanical system) absorbing much of the stress that would normally act on the base and contributing to increasing the resistance of the sides against failure.

Various other methods of reinforcing were tried until a height of 36-in. was achieved before failure occurred. The beaker was reinforced as follows:

- a. the base was made concave with a center depth of 0.25-in.
- b. four 1/4-in. deep grooves x 4-in. long were made in the sidewalls.
- c. the rim of the base was provided with a damper consisting of a 1/4-in. layer of "Devcon L" (a lead-based putty) and a silicone rubber ring.

A previous test with a similarly prepared beaker but without the "Devcon L" added failed from a 30-in. drop. Based on these tests, it is assumed that:

- a. the silicone rubber absorbed 19,000 psi

- b. the "Devcon L" putty absorbed 7,000 psi
- c. the concave base and grooved sides increase the impact strength by about 36%.

Tests were then made using actual stressed glass cartridge cases with 152 mm projectiles epoxied in place and a simulated propellant. The stressed glass cartridge cases were made by the Owens-Illinois Glass Company from an experimental material, OI-202. This material had an impact strength of between 80,000 and 100,000 psi determined by laboratory tests on samples supplied by O-I. Predictably, the two assembled cartridges failed when dropped from heights of 18 and 24-in. In order for the cases to meet the requirements for impact the cartridge cases should be designed to withstand an impact strength of 180,000 psi. From the work done on the glass beakers, it is believed that this can be achieved by:

- a. making the base concave
- b. putting 4-1/2-in. x 4-in. long grooves in the sides
- c. by providing a damper which will absorb 26,000 psi (such as "Devcon L" plus a silicone rubber ring).

With these geometrics and damping materials added, the glass should be stressed to:

$$1.36 f_i = 26,000 + 180,000$$

$$f_i = \frac{154,000}{1.36} = 113,000 \text{ psi}$$

where  $f_i$  = impact stress of the glass.

These data show that with limited design and the use of arbitrarily selected impact absorbing media, we are quite close to being able to withstand a five foot vertical drop test for the 152 mm ammunition. Slightly stronger glass, more optimized designs or better impact media show enable a five foot drop.

#### 8.4 Stress Levels in Chemically Tempered Glass Cartridge Cases

Knowledge of the stress distribution in the glass cartridge cases is important since it has been shown that the stresses are related to its strength and resistance to impact. It was thus considered important to determine stress levels and to investigate various techniques for measuring these stresses.

The glasses used in this study were strengthened by chemical tempering. That is, ions in the surface of the glass were replaced by larger ions from a molten salt bath, producing compressive stresses in the surface. Generally, the compressive layers are fairly thin, 50 microns, and the center of the glass contains low tensile stresses.

The center tensile stress is measured using polarized light and a low power magnification. The stresses in the glass cause a difference in refractive index in different directions, producing a series of light and dark fringes. The number of fringes is directly proportional to the residual stress, although there is some error because of the effect of the compressive layer through which the light passes. These fringes are shown schematically in Figure 53. Stress can be determined from the following expression:

$$\sigma = \frac{500 \times N}{K \times a}$$

where:

N = no. of fringes

K = stress-optic coefficient,  $\frac{\text{millimicrons}}{\text{cm} \times \text{psi}}$

a = length of optic path, cm

The depth of the compressive layer can also be determined in this way, but the absolute magnitude of the compressive stress can not be determined because the fringes are too densely spaced for resolution.

A preferred method for measuring the stress distribution is by immersion in oil having the same index of refraction as the glass. The oil eliminates the surface effect. In this technique, the sample is viewed under polarized light in a petrographic microscope. The stresses can be measured either by counting the number of fringes and using the expression already given to calculate the stress, or by inserting quartz wedges having known retardations, until the retardation caused by the stress has been equalized. This retardation in millimicrons is then used to calculate the stress. By using a thin sample, the number of fringes in the compressive layer is reduced and the compressive stress can be calculated. O-I has used this method to calculate the stresses in glass bars. IITRI's measurement of the stresses in these bars using essentially the same technique gave comparable values.

A new technique for determining the compressive stress in glass has been developed by PPG, Inc. The actual device, called a differential surface refractometer (DSR), is based on the fact that the stress produces a difference in refractive index between light rays polarized parallel and perpendicular to the sample surface. The method is limited, however, to flat surfaces so that even in this instance, measurements could not be made directly on the cartridge cases, but must be made on flat bars having the same tempering treatment.

A new method for determining stresses in glass is through the use of a gas laser. Because the laser beam is extremely intense, the fringes produced by the scattered light can be seen in a direction perpendicular to that of the beam. This method eliminates the effect of changes in the stress along the light path. The stress at any interior point can be

IIT RESEARCH INSTITUTE

determined without interference from other stresses in the sample. Another key advantage of this technique is that its use is not limited to flat pieces; the stresses in any shaped body can be measured.

Three types of materials were investigated for use in the cartridge cases. The values of the central tensile stresses and depth of the compressive layer as measured by Corning and IITRI for two bars of Corning 0313 glass are given in Table XVII. The bars were tempered with the cases and are representative of the tempering treatment the cases received. The bars were 0.082-in. thick as compared to the 0.125-in. thickness of the actual cases. Stresses in cases composed of O-I 202 glass were measured on test bars, 2 x 1/2 x 1/8-in. in size. The thickness of these bars was approximately the same as that of the cases. An average surface compressive stress of 44,000 psi and an average internal tensile stress of 6,400 psi was measured on the bars. The higher compressive stress in these bars compared to the Corning samples accounts for their higher strength. In general it was found that the tempering treatments given both types of glasses was consistent with the stress distribution in bars examined at different times.

Stresses in O-I's CERVIT 206, which is a glass-ceramic, could not be examined because it was not transparent to the polarized light.

In summary, the normal photoelastic techniques, when applied in a microscope, seem to be adequate for the measurement of a stress profile. Their limitation of course is that a bar having the same stress distribution as the large body must be prepared in order to use these techniques. The DSR allows one to measure the surface stresses in any large piece provided that a flat surface can be obtained. The laser technique, although not completely perfected, would allow measurements to be made directly on an irregularly shaped glass body.

IIT RESEARCH INSTITUTE

## 9.0 TEMPERED GLASS CARTRIDGE CASES FOR ARMY EVALUATION

Three cartridge case designs have been selected for Army evaluation. These are:

1. Ten cases for ballistic or vulnerability testing of Corning 0313 Chemcor glass. The cases are of the design shown in Figure 11 with a 0.125-in. width and 6.03-in. o.d. The bases will be of the same material in accordance with the design shown in Figure 16. A view of this case in an assembled shell is shown in Figure 19 (third from the left).

2. Six cases for ballistic or vulnerability testing of O-I Glass 202. The cases are of the design shown in Figure 12 and have an integral glass base. A view of this case in an assembled shell is shown in Figure 19 (fourth from the left).

3. Four cases of O-I Glass 202 for impact testing. These cases were constructed without ignitor access holes in the base in order to eliminate stress rising sharp corners. There was a need to submit separate cases for impact testing as the impact strength of glasses and glass-ceramics are design sensitive. These cases also have impact absorbing media bonded to their bases. The media will: a) spread the impact load over a larger area of glass and b) reduce the force/time ratio of impact loading. The cases are of the design shown in Figure 19. The impact medium is of the type described for Specimen B20, Section 8.3.2.2, a combination of a soft silicone rubber and a much harder bicycle tire rubber.

Assembly of the cases is as follows: For (1): The base mounting flange, ignitor adaptor base are mounted as shown in Figure 17 using cellulose nitrate (Duco) cement as an adhesive. This can best be done with the case resting upright on a flat surface. Several spacers, the thickness of a combustible base, are used between the flat surface and the glass base to gauge the distance between the rear of the ignitor adapter and the rear of the glass base. After the adhesive has

set, a normal combustible ignitor tube is assembled to the ignitor adapter and black powder inserted into the tube. A normal charge plus an extra eight ounces of propellant is used. These are filled by having one person pour loose propellant into the case while the case is being shaken by another person. Lastly, cellulose nitrate is applied to the forward machined portion of the projectile and the projectile is inserted into the case. Seventeen hours is required for the cellulose nitrate adhesive between the case and projectile to harden.

For (2): The ignitor adapter is glued into place using cellulose nitrate adhesive.

Pieces of cardboard or wood about six inches square and slightly thicker than a combustible base are cut with a 1-3/4-in. diameter hole in their centers. These constitute mounting platforms for the integral base cartridge cases to rest in with their bases down. The ignitor adapter fits into the hole. The rest of the shell assembly is as (1).

For (3): The impact media for the rear portion of the case is bonded to the case using room temperature vulcanizing silicone rubber adhesive (RTV). The case is set base down and loose simulated propellant is added to the case with shaking, if necessary. Impact media is placed between the case edges and the projectile and bonded in place using RTV. After 48 hours the shell is ready for vertical drop tests as described in Section 8.3.2.

## 10.0 CONCLUSIONS

It has been demonstrated that:

1. Cartridge cases of tempered glass can be made for 152 mm ammunition, which disintegrate on ignition of the charge, into small particles. Up to 95% of the case is expelled by the exhausting gases without the use of a scavenger system.

2. Expulsion of glass particles is improved by increasing the clearance between the case and the breech walls. Elimination of seals appears to aid particle flow out of the gun tube.

3. A non-optimized glass cartridge case plus simulated propellant and projectile withstood an 18-in. vertical drop test with the use of an impact medium. The case, alone, withstands a 5-ft drop test. Impact strength is highly design dependent and further study should produce a case capable of meeting Army drop test specifications.

4. A properly working XM81 scavenger system can expel all residual particles from a glass cartridge case. Abrasion of the interior of the gun tube was observed due to direct impingement of the scavenger system inlet air with entrained glass particles on the wall of the tube. A properly designed and operating scavenger system should eliminate these problems.

## 11.0 RECOMMENDATIONS FOR FUTURE WORK

Based on the results to date, three areas in particular are recommended for future work. These include impact strength improvement, gun barrel effects and elimination of the need for a scavenger system.

1. The improvement of impact strength is dependent upon three variables: the strength of the materials, the case design and the use of impact absorbing media. The strength of the case material can be significantly increased by utilizing new materials coming out of the research or developmental stage. Further optimization of the tempering of present materials can

also serve to improve strength. The design of cases can be improved by incorporating ribs or contours that reduce stress concentrations. Finally, impact media can be improved by matching its mechanical properties to those of the glass and the loads to which the cartridge case will be exposed. It is recommended that a developmental improvement program be considered along these lines.

2. During the Series V ballistic tests, pitting or abrasion of the gun barrel bore were observed. It is recommended that a study be conducted to identify the type and nature of any such problems that could be caused by the glass cases, to isolate the causes of any such problems and, finally, to offer solutions to prevent their occurrence.

3. One of the problems of the 152 mm cartridge case system is the requirement for a scavenger system. Eliminating the need for the scavenger is considered a significant advantage. It is recommended that a study be conducted to develop concepts for a case that would take advantage of the highly desirable properties of the tempered glass, i.e., its high strength, durability, frangibility, etc. and not require a scavenger system. As an example, a plastic sheathed glass case could be shattered and collapse while still retained in a closed "bag" and be ejected out of the muzzle mechanically.

Respectfully submitted,  
IIT RESEARCH INSTITUTE

*W R Bratschun*

W. R. Bratschun  
Research Scientist  
Ceramics Research

APPROVED:

*M. A. Schwartz*

M. A. Schwartz  
Assistant Director  
Ceramics Research IIT RESEARCH INSTITUTE

Table I  
CANDIDATE MATERIALS

Material No.	Suppliers	Sample Shapes and Sizes	Type of Glass or Glass Ceramic
1	Corning	Tubular, nominal dimensions: 3-in. long x 1.00-in. O.D. x 0.100-in. wall thickness	Chemcor Glass No. 0313 or Chemcor Glass No. 0323
2	Corning	Plates, nominal dimensions: 3-in. x 1/4-in. x 1/8-in.	Pyroceram 9608, glass-ceramic
3	Corning	Plates, dimensions same as No. 2	Pyroceram 9611, glass-ceramic
4	Corning	Tubular, dimensions same as No. 1	Pyroceram 9611, glass-ceramic
5	Owens-Illinois	Tubular, dimensions same as No. 1	Development Glass No. 202
6	Owens-Illinois	Tubular, dimensions same as No. 1	CER-VIT, glass-ceramic
7	Glass Container Industry Research Corp.	Tubular bottles, final machined dimensions approximately as No. 1	Soda-lime-silica glass

Table II  
SUMMARY OF CARTRIDGE CASE MATERIAL STRENGTH

Supplier	Material Designation and Type	Static Strength, ksi Median	Static Strength, ksi Range	Impact Strength, ksi Median	Impact Strength, ksi Range
Corning	Chemcor 0313, tempered glass	25,000	19-30,000	40,000	35-45,000
Corning	Pyroceram 9608, tempered glass-ceramic	45,000	35-50,000	---	---
Corning	Pyroceram 9611, tempered glass-ceramic	80,000	55-105,000	---	---
Owens-Illinois	Glass No. 202, tempered glass	65,000	35-90,000	95,000	80-110,000
Owens-Illinois	Cervit 206, tempered glass ceramic	45,000	15-70,000	60,000	35-95,000
Glass Container Industry Research Corp.	Commercial container glass, untempered as received.	5,000	3- 8,000	1,500	1- 2,000

! 8 !

Table III  
SPECIFICATIONS FOR MECHANICAL TESTING CASES  
G6023-S-1

---

1. Continuous piece of glass as shown in IITRI Drawing No. G6023-C-34.
  2. Tolerances
    - (a) Out of round: 0.100-in.
    - (b) Wall thickness:  $\pm 0.050$ -in.
    - (c) Radius:  $3/4 \pm 1/2$ -in.
    - (d) Bottom thickness and thickness at radius:  $\pm 0.050$ -in.
  3. No openings are allowed to the outside or inside of the case on the surfaces such as broken bubbles, stones, surface flaws, etc. Cut edges shall be rounded by grinding and polishing.
  4. Internal flaws of limited size such as bubbles, stones, straitions, etc., are acceptable. Stones shall be no larger than  $1/32$ -in. in diameter. Bubbles shall be no longer than approximately 0.050-in. wide x 0.150-in. long.
  5. The case shall be chemically tempered for maximum strength and toughness.
  6. Sample plates for monitoring the tempering shall be made. These will be measured by O-I for thickness of compressive layer and maximum internal stress. The bars will then be sent to IITRI for measurements. Three bars will be made for each batch of glass and each tempering treatment used. It is not necessary to have test bars for each case.
  7. Mean thicknesses shall be from:  $0.100 \pm 0.050$  to  $0.250 \pm 0.050$ -in.
-

Table IV  
RESULTS OF BALLISTIC TESTING  
Series I and II

Program Firing No.	Date	Case Identification	Weight of Case, oz.	Velocity ft/sec	Peak Pressure psi	Weight of Particles in: Breech/Barrel oz.	Weight of Particles Expelled Oz.	Percent of Case Expelled	Variables Examined	Comments
1	1/28/69	Corning 0313-2 IITRI Drawing No. G6023-J01-C-2; front and rear seals as per Fig. 4, Second Monthly Report	32	2200	35000	16	4	37	Corning tempered 0313 glass, machined case, front and rear seals, combustible base, low sidewall clearance (0.062-in.) 0.125-in. wall.	Case successsfully shattered; front portion blown clear of muzzle; breech section jammed against wall
2	1/28/69	Corning 0313-2-IITRI Drawing No. G6023-J01-C-2; front seal at taper; seal 4 1/2-in. from rear	32	2220	35100	1.95	15.75	45.2	As No. 1 except rear gasket removed from breech and replaced a thin gasket 4 1/2-in. rear of case.	Case successsfully shattered; front portion blown clear of muzzle; portions of rear and central portions of case deposited mainly at origin of rifling
3	2/12/69	O-I CERVIT 206-1 IITRI Drawing No. G6023-J01-C-2; one seal 4 1/2-in. from rear	23.4	2216	34800	0.50	6.88	74.5	O-I glass-ceramic No. 206, single thin gasket 4 1/2-in. from rear of case, otherwise as No. 1.	Case successsfully shattered and off chamber walls; large particles up to 3/4-in. x 1/4-in. x 0.125-in. most particles at origin of rifling

Table IV (Cont'd)  
RESULTS OF BALLISTIC TESTING  
Series I and II

Program Firing No.	Date	Case Identification	Weight of Case, oz.	Velocity ft/sec	Peak Pressure psi	Weight of Particles in: Breech Barrel oz.	Weight of Particles Expelled oz.	Percent of Case Expelled	Variables Examined	Comments
4	2/19/69	Corning 0313; IITRI Drawing No. G6023-J01-C-2; one seal at taper	31.50	2212	35000	1.15	24.55	78.3	As No. 1 except a single seal at the taper was used.	Case broken successfully and off chamber walls; particles 1-4 mm in size; most particles remaining at origin of rifling
X1	2/19/69	Combustible case with MDF ignition along case wall	-	2133	32000	-	-	-	Evaluation of MDF ignition system without the use of black powder	Low velocity and low pressure indicating poor ignition
5	2/19/69	Corning 0313-4; IITRI Drawing No. G6023-J01-C-2; one seal at taper; MDF ignition along case wall	32.17	2179	31800	3.90	21.90	32.0	As No. 1 except single gasket 4 1/2-in. from rear and use of MDF ignition system without the use of black powder.	Case shattered; forward portion of case at origin of rifling and jammed against barrel wall; low velocity and low pressure indicating poor ignition

Table V  
RESULTS OF BALLISTIC TESTING  
Series IV

Firing No.	Case Identification	Wt of Case (oz)	Velocity ft/sec	Peak Pressure Psi	Wt of Part. in Breech (oz)	Wt of Part. in Barrel (oz)	Wt of Part. Expelled (oz)	% of Case Expelled	Variables Examined	Results and Comments
X-2	Combustible warmer round with MDF ignition along case wall		2191	35.4/36.0					MDF ignition system standard case.	Acceptable velocity, pressure.
6	(O-I CERVIT No. 206-2, IITRI Drawing No. G6023-J01-C-2, thin RTV gasket at taper, MDF ignition, see Fig. 3, loose powder	28.35	2216	36.2/36.0	0.48	3.37	24.93	87.8	O-I tempered glass-ceramic, MDF ignition, low sidewall clearance (0.062-in.) combustible base, loose powder 0.125 in. wall.	Case broken completely off chamber walls, fragments 0.3x0.25 x .125-in. and smaller, one piece in breech, remainder at origin of rifling.
7	Corning 0313-10, IITRI Drawing No. G6023-C-09, sidewall 0.100-in. thick, no seals, MDF ignition, loose powder.	23.01	2184	32.7/32.0	0.032	1.26	22.82	95.0	Corning tempered glass, MDF ignition, high sidewall clearance, (0.237-in.) 0.100-in. wall.	Case broken completely and off chamber walls, fragments 1-4mm in size, most particles at origin of rifling.

Table V (Cont'd)  
RESULTS OF BALLISTIC TESTING  
Series IV

Firing No.	Case Identification	Wt of Case (oz)	Velocity ft/sec	Peak Pressure Psi Indentation/Tranducer	Wt of Part. in Breech (oz)	Wt of Part. in Barrel (oz)	Wt of Part. Expelled (oz)	% of Case Expelled	Variables Examined	Results and Comments
8	Corning 0313-9, IITRI Drawing No. G6023-C-29, sidewall 0.100-in. thick, normal ignition, loose powder, combustible base.	22.97	2177	32.4/34.5	0.35	0.92	21.70	94.3	Corning tempered glass, normal ignition, high sidewall clearance (0.237-in.), 0.100-in. wall.	Case broken completely, about 2-in. of articles adhering to breech wall in four areas, particles 1 to 4 mm in size.
9	Corning 0313-8, IITRI Drawing No. G6023-C-20, sidewall 0.080-in. thick normal ignition, loose powder, combustible base.	18.23	2194	34.5/33.3	0.30	1.76	16.17	88.7	Corning tempered glass, normal ignition, high sidewall clearance (0.247-in.), 0.080-in. wall.	Case broken completely, about 2-in. of particles adhering to breech wall in two areas, particles about 1 to 4 mm in size.

Table VI  
RESULTS OF BALLISTIC TESTING  
Series IV

Firing No.	Case Identification	Wt of Case (oz)	Velocity ft/sec	Peak Pressure psi Indentation/Transducer	Wt of Part. in Breech (oz)	Wt of Part. in Barrel (oz)	Wt of Part. Expelled (oz)	% of Case Expelled	Variables Examined	Results and Comments
14	Corning 0313-18, Drawing No. G6023-C-32, combustible base.	31.48	2199	38.6/38.9	0.66	6.07	24.75	78.5	Corning 0313 tempered glass, machined, combustible base, influence of grooves machined on sides, low sidewall clearance (0.062-in.), 0.125 to 0.085-in. wall.	As No. 13, but more particles expelled.
15	O-I 202-14, Drawing No. G6023-C-28, separate glass base of Corning 0313 glass, Drawing No. G6023-C-17, normal ignition.	33.13	2167	- /33.2	0.038	1.61	32.48	95.2	O-I 202 tempered glass, blown glass separate glass base, normal ignition, high sidewall clearance (0.237-in.), approx. 0.090-0.149-in. wall.	Case broken successfully, off chamber walls, most of particles at open cylinder, the origin of rifling, particles 1-4mm in size.
16	O-I 202-15, as (15) except MDF ignition along the sidewalls.	36.94	2168	- /31.5	0.028	1.59	35.32	95.6	As (15) except MDF ignition along the sidewalls.	As No. 15.
17	O-I 202-16, as (15) except MDF ignition along the base.	33.91	2174	- /35.7	0.065	4.26	29.59	90.6	As (15) except MDF ignition along the base.	As No. 15, except a greater amount of particles were retained.

Table VI (Cont'd)  
RESULTS OF BALLISTIC TESTING  
Series IV

Firing No.	Case Identification	Wt of Case (oz)	Velocity ft/sec	Peak Pressure psi Indentation/Tranducer	Wt of Part. in Breech (oz)	Wt of Part. in Barrel (oz)	Wt of Part. Expelled (oz)	% of Case Expelled	Variables Examined	Results and Comments
X-3	Combustible warmer round with MDF spiraled inside along the base.		2183	36.5/37.8					MDF ignition system with concentration along the base.	Acceptable velocity, pressure.
1C	O-I 202-1, Drawing No. G6023-C-33, integral glass base.	31.52	2186	- / -	0.33	1.26	29.93	94.9	O-I 202 tempered glass, blown glass integral base, normal ignition, high sidewall clearance (0.237-in.) approx. 0.090-0.140-in. wall.	Case broken successfully off chamber walls, fragments 1-4 mm in size, most particles at the origin of rifling.
11	O-I 202-2, Drawing No. G6023-C-33, MDF ignition along the side-walls.	31.86	2182	- /33.2	0.34	2.10	29.42	92.4	As (10) except MDF ignition along sides.	As No. 10, except less particles expelled.
12	O-I 202-3, Drawing No. G6023-C-33, MDF ignition along the base.	32.08	2187	- /33.2	0.14	2.88	29.06	90.6	As (10) except MDF ignition along base.	As No. 10, except less particles expelled.
13	Corning 0313-15 Drawing No. G6023-C-31, combustible base, thin KTV seal at taper.	30.64	2215	39.1/39.2	0.16	11.45	19.19	62.0	Corning 0313 tempered glass, machined, combustible base, influence of flats machined on sides, low sidewall clearance (0.062-in.) breech, most particles 0.125 to 0.085-in. wall.	Case broken successfully, off chamber walls, silicone rubber was not completely cured and adhered to the taper, residual rubber interfered with particle flow out of breech, most particles at the origin of the rifling, fragments 1-4mm in size.

Table VII  
RESULTS OF BALLISTIC AND SCAVENGER SYSTEM  
TESTING - ABERDEEN PROVING GROUNDS  
Series V

Firing No.	Case Identification With scavenger system, normal ignition of case to projectile unless noted.	Wt of Case (oz)	Velocity ft/sec	Peak Pressure psi	Indentation/Transducer	Wt of Part. in Breech (oz)	Wt of Part. in Barrel (oz)	% of Case Expelled	Variables Examined Scavenger system operation in all firings, normal ignition, unless noted.	Target* Results (in y)	Results and Comments
X-4	Combustible sighting round.	-	2242	-	-	-	-	-	Spotter round, standard round.	+52/+68	Hit target, gun functioned properly.
X-5	Combustible warmer round with MDF along the sides.	-	2251	37.4/-	-	-	-	-	MDF ignition system, standard round.	+34/+25	MDF ignition system functioned properly.
18	Corning 0313-12, Drawing No. G6023-C-29, separate glass base of Corning tempered 0313 glass, Drawn; No. G6023-C-17, normal ignition.	32.0	2226	33.8/-	-	9.2 x 10 <sup>-5</sup>	-	<100%	Corning tempered glass, high sidewall clearance (0.245-in.), 0.080-in. wall, separate glass base.	+46/+12	Case broken success- fully off chamber walls, one particle in breech, one particle one foot from muzzle, particles about .050-in. dia, a number of smaller particles in the breech, galling observed at beginning of origin at 6, 8 and 10 o'clock positions.
19	As No. 18, except cellulose nitrate bonding of case to projectile.	32.0	2204	32.3/-	-	-	-	<100%	As No. 18, but weaker bonding of case to projectile.	Missed target.	Case broken success- fully off chamber walls particles ~.030-in. dia through barrel, scavenger system functioned at 720 instead of 630 psi during a second cycling of scavenger.

\* Target results are reported as x and y dimensions on Cartesian coordinates.

Table VII (Cont'd)  
RESULTS OF BALLISTIC AND SCAVENGER SYSTEM  
TESTING - ABERDEEN PROVING GROUNDS

Series V

Firing No.	Case Identification With scavenger system, normal ignition system, epoxy bonding of case to projectile unless noted.	Wt of Case (oz)	Velocity ft/sec	Peak Pressure psi Indenter/Transducer	Wt of Part. in Breech (oz)	Wt of Part. in Barrel (oz)	% of Case Expelled	Variables Examined Scavenger system operation in all firings, normal ignition, unless noted.	Target* Results (in) y/x	Results and Comments
20	As No. 18, except cellulose nitrate bonding of case to projectile.	32.0	2218	32.9/ -	0.78	3.08	88.0%	As No. 18 but weaker bonding of case to projectile.	Missed target.	Case broken successfully off chamber walls, scavenger system did not function.
21	O1202-5, Drawing No. G6023-C-33, integral glass base.	34.0	2223	34.0/ -	-	-	100%	O1202 tempered glass blown glass, integral base, high sidewall clearance (0.237-in.), approx. C.093-0.140-in. wall.	-70/+78	Case broken successfully off chamber walls, no particles observed, scratching at origin of rifling.
22	O1202-6, as No. 21, except MDF ignition along the sidewalls.	34.0	2239	34.9/ -	-	-	100%	As No. 21 except MDF igniter along the sidewall.	+16/+12	Case broken successfully off chamber walls, no particles observed, removal of carbonized deposits seems to be occurring.
23	O313-13, as No. 18, except MDF ignition along the sidewalls.	32.0	2219	35.1/ -	1.91 x 10 <sup>-4</sup>	-	<100%	As No. 18 except MDF ignition along the sidewalls.	+17/-13	Case broken successfully off chamber walls, one approx. 0.050-in dia particle in breech, all others expelled.

Table VII (Cont'd)  
RESULTS OF BALLISTIC AND SCAVENGER SYSTEM  
TESTING - ABERDEEN PROVING GROUND

Series V

Firing No.	Case Identification W/Ph scavenger system, normal ignition, epoxy bonding of case to projectile unless noted.	Wt of Case (oz)	Velocity ft/sec	Peak Pressure psi	Indentation/Transducer	Wt of Part. in Breach (oz)	Wt of Part. in Barrel (oz)	% of Case Expelled	Variables Examined Scavenger system operation in all firings, normal ignition, unless noted.	Target * Results (in) y/x	Results and Comments
24	O1202-17, Drawing No. G6023-C-28, Rev. A, B, separate glass base of Corning tempered G313 Glass, Drawing No. G6023-C-17.	34.0	2233	32.4/ -	-	-	-	<100%	O1202 tempered glass, blow glass, separate tempered glass base, high sidewall clearance, approx. 0.090-0.140-in. wall.	+8/-3	Case broken successfully off chamber wall, a few very small particles at origin of rifling approx. 0.010-0.020-in.
25	G313-17, as No. 18.		2230	34.1/ -	-	-	-	<100%	As No. 18.	+16/-5	Case broken successfully off chamber wall, pressure in scavenger tank was low (~1000 psi), a few particles approx. 0.010-0.1-in. dia in tube and breach.
26	G313-6, Drawing No. G5023-C-28, separate Glass Base - Drawing No. G6023-C-17.	34.0	2239	35.3/ -	-	-	-	<100%	Corning tempered G313 Glass, high sidewall clearance (0.247-in.) 0.160-in. wall separate glass base.	+6/+25	Case broken successfully off chamber wall, pressure in scavenger tank at ~1000 psi, a few small particles approx. 0.010-0.020 in. dia in tube and breach, recycled scavenger system to remove residual particles.

Table VII (Cont'd)  
 RESULTS OF BALLISTIC AND SCAVENGER SYSTEM  
 TESTING - AMERLEEN PROVING GROUNDS

Series V

Firing No.	Case Identification With scavenger system, normal ignition of case to projectile unless noted.	Wt of Case (oz)	Velocity ft/sec	Peak Pressure psi	Wt of Part. in Breech (oz)	Wt of Part. in Barrel (oz)	% of Case Expelled	Variables Examined Scavenger system operation in all firings, normal ignition, unless noted.	Target* Results (in) y/x	Results and Comments
27	0313-16, Drawing No. G6023-C-31, separate glass base to Drawing No. G6023-C-17 (O.D. 6.070-in.), MDF ignition along the sides.	34.0	2252	36.2/ -	0	0.98	97.1%	Corning tempered 0313 glass, machined, separate tempered glass base, influence of flats machined on outside walls, low sidewall clearance (0.062 to .102-in.), 0.125 to 0.087-in. wall.	-4/+17	Case broken successfully off chamber walls, breech clear, large accumulation of particles on the ground, <10 ft from muzzle, recycled scavenger system to remove residual particles.
28	0313-19, Drawing No. G6023-C-32, separate glass base of Corning 0313 glass to Drawing No. G6023-C-17 (6.070 in. dia).	34.5	2249	35.3/ -	0	4.7 x 10 <sup>-3</sup>	<100%	As No. 27, except influence of circumferential grooves machined on outside walls.	-13/+17	Case broken successfully off chamber wall, breech clear, large accumulation of particles on the ground, <10 ft from muzzle, a few particles in tube around a pressure gauge retained in the tube.

Table VIII

## GLASS CARTRIDGE CASE PARTICLE\* EVACUATION BY XM81 SCAVENGER SYSTEM

Test No.	Weight of Particles	Size Range of Particles	Location of Particles	Results and Comments
1.	30 gms; 1.05 oz	3.36-2.36 mm	Origin of Rifling	All particles expelled
2.	30 gms; 1.05 oz	2.36-1.68 mm	Origin of Rifling	All particles expelled
3.	30 gms; 1.05 oz	1.68-1.18 mm	Origin of Rifling	All particles expelled
4.	30 gms; 1.05 oz	1.18-1.00 mm	Origin of Rifling	All particles expelled
5.	30 gms; 1.05 oz	< 1.00 mm	Origin of Rifling	All particles expelled; a slight white dusting of the barrel appears to be occurring
6. †	106 gms; 3.5 oz	3.36-1.00 mm	Origin of Rifling	All particles expelled
7. †	100 gms; 3.5 oz	3.36-1.00 mm	Approx. 7 gms rear half of breech; 90 gms at origin of rifling	All particles expelled; noticed an area of possible erosion at taper of barrel 3 o'clock position when looking into barrel from rear of gun
8. †	100 gms; 3.5 oz	3.36-1.00 mm	Approx. 10 gms in rear half of breech; 90 gms spread from origin of rifling four feet into the barrel	All particles expelled; no noticeable difference in erosion area
9.	Approx. 200 gms; 7.0 oz	3.36-1.00 mm	Approx. 40 gms in rear half of breech; 160 gms spread from origin of rifling four feet into the barrel	All particles expelled; no noticeable difference in erosion area
10.	Approx. 300 gms; 10.5 oz	3.36-1.00 mm	Approx. 50 gms in rear half of breech; 250 gms spread along the entire barrel	All particles expelled; prior to test No. 10, the tapered section of the barrel including the erosion area was covered by a soft marking pencil. Indeterminate if additional erosion occurred.
11.	210 gms; 7.38 mm	Fragments, approx. 1/2-in x 1/2-in x 0.125-in down to cubes 1/8-in. on a side	Owens-Illinois fragments; 0.50 gms in rear of breech, 6.88 gms distributed in the barrel according to the residue in 19 Feb. 1969 - Program Firing No. 3	All particles expelled; portions of marking pencil removed in region of erosion during test Nos. 10 and 11

\* All of the tests except for No. 11 were performed using actual glass particles from the Corning 0313 cases tested on 28 Jan 1968

† Test Nos. 6, 7 and 8 had the particle size distribution measured for Program Firing No. 2

Table IX

SUMMARY OF VENTED BOMB EXPERIMENT  
(Charge IMR 5010)

Test No.	Charge Wt., Grams	Diaphragm Thickness, in.	Test Cylinder	Forward Seal Type	Diaphragm Burst Pressure, psi	P <sub>1</sub> Max, psi	P <sub>2</sub> Max, psi	Cylinder Failure Pressure, psi
1	25	.030	20 mm Brass Case	None	--	Off Scope	46,000	--
2	25	.0285	20 mm Brass Case	None	--	42,000	42,000	--
3	20	.0285	20 mm Brass Case	None	--	30,000	28,000	--
4	20	.0285	CERVIT 206-#9	Rubber Tape	10,500	31,000	30,000	--
5	20	.0285	Pyroceram 9611 #9	Rubber Tape	10,000	30,000	30,000	8,000
6	20	.0285	Corning 0313 #4	Teflon Tape	11,000	31,000	30,000	--
7	20	.0285	Pyroceram 9611 #10	Brass Case + Teflon Tape	9,500	26,000	25,000	--
8	20	.0285	Steel Cylinder	Brass Case + Teflon Tape	--	0	32,000	--
9	10	.0285	Corning 0313 #10	Brass Case + Teflon Tape	8,000	10,500	10,000	7,500

Table X  
ANALYSIS OF STRENGTH DATA ON LABORATORY SPECIMENS

Material Designation	Type of Test*	Specimen Configuration	Average Min. Thickness, in	Mean Strength, psi	Standard Deviation, %	Mean Weighted Particle Size, mm
OI 202	Diametral	Cylinder	0.1228	66,700	16.60	2.613
OI 202	Impact	Cylinder	0.0223	94,600	7.44	2.669
0313	Diametral	Cylinder	0.0623	24,200	1.35	2.520
0313	Impact	Cylinder	0.0633	41,700	6.83	2.563
9611	Diametral	Cylinder	0.0745	77,800	23.39	2.439
9611	Flexure	Bar	0.1250	84,300	16.50	2.397
9608	Flexure	Bar	0.1278	42,800	1.06	2.976
CERVIT 206	Diametral	Cylinder	0.0980	45,500	15.40	2.639
CERVIT 206	Impact	Cylinder	0.1030	61,600	30.60	2.643
GCIRC+	Diametral	Cylinder	0.0942	4,960	16.33	No Particles
GCIRC+	Impact	Cylinder	0.0924	1,330	10.50	No Particles
0326	Flexure	Bar	0.1271	38,340	7.56	3.054

\* Diametral Compression & Flexural Tests  
Produced Similar Strength Data

+ Unstressed Cylinders from Glass Container Industry Research Corporation (GCIRC)

Table XI  
ANALYSIS OF STRENGTH DATA FOR CORNING 0313 GLASS SPECIMENS

Group	Type of Test	No. Tested	Chemical Stressing, Hrs	Av.O.D. in.	Av.t in.	Mean Strength psi	Standard Deviation %	Mean Weighted Particle Size mm
I	Diametral	7	6	0.994	0.049	18,280	14.70	Groups I, II, III.
	Impact	4	6	0.999	0.047	32,315	5.70	
II	Diametral	7	12	0.994	0.045	19,400	11.50	Diametral - 2.488
	Impact	4	12	0.994	0.046	30,380	8.50	
III	Diametral	7	18	0.994	0.045	19,800	11.00	Impact - 2.551
	Impact	4	18	0.995	0.044	29,985	5.30	
IV	Diametral	7	12	0.993	0.064	21,860	1.90	Groups IV, V, VI.
	Impact	4	12	0.992	0.063	22,245	8.30	
V	Diametral	7	18	0.990	0.063	16,360	4.30	Diametral - 2.631
	Impact	4	18	0.988	0.064	21,635	14.60	
VI	Diametral	6	24	0.994	0.065	15,900	1.80	Impact - 2.680
	Impact	4	24	0.993	0.065	20,635	7.50	

Table XII

## RESULTS OF IMPACT TESTING USING GLASS BEAKERS

Specimen No.	O.D. in.	Thickness in.	Height in.	Testing Position	Weight lb	Height of Drop, in.	Remarks
B-1	6.340	0.108	8.370	Vertical	8.54	2.0	Base and wall shattered.
B-2	6.351	0.117	8.131	Horizontal	8.66	2.0	Side walls shattered, base cracked.
B-3	6.355	0.123	8.312	35°	8.55	1.75	Fracture initiated at point of impact. Base and sides shattered.
B-4	6.353	0.127	8.440	Vertical	8.59	13.0	Base cushioned with silicone rubber ring. Bounced from all heights by internal material pushing out bottom, fractured sidewall, fractures generally confined to 3-in. height above base, except for two cracks.
B-5	6.356	0.124	8.500	Vertical	8.99	14.0	Base reinforced with glass stiffeners epoxied in place, cushioned by silicone rubber ring. Noticeable bounce started at 10-1/2-in. drop. Sides fractured, bottom intact.

Table XII

## RESULTS OF IMPACT TESTING USING GLASS BEAKERS

Specimen No.	O.D. in.	Thickness in.	Height in.	Testing Position	Weight lb	Height of Drop, in.	Remarks
B-6	6.356	0.05	7.940	Vertical	8.54	20.0	Base reinforced by three grooves; each being approx. 5-in. long x 1/4-in. deep and crossing each other at 60°. Cushioned by silicone rubber ring. Base shattered by internal material pushing out bottom.
B-7	6.365	0.113	7.820	Vertical	8.62	30.0	0.3-in. concave base; grooved sides 3-1/2-in. x 1/4-in. deep. Cracked near base and in sides.
B-8	6.356	0.118	7.688	Vertical	8.43	24.5	0.2-in. concave base; grooved sides. Fell on one side after impact and fractured on sides. Base remained intact.
B-9	6.359	0.122	8.063	Vertical	8.52	8.0	Grooves in base, 5-in. x 1/4-in. crossing at 60°. Thin gasket on base. No bouncing. Broke in base and sides.
B-10	6.348	0.108	8.252	Vertical	8.68	6.0	Grooves in base and sides. Fell on one side and fractured on side.

Table XII

## RESULTS OF IMPACT TESTING USING GLASS BEAKERS

Specimen No.	O.D. in.	Thickness in.	Height in.	Testing Position	Weight lbs	Height of Drop, in.	Remarks
B-11	6.361	0.120	8.000	Vertical	8.63	15.0	Grooves in base. Bounced at 12-in. Fractures initiated in indentations in base and extended into sides.
B-12	6.360	0.120	8.000	Vertical	8.58	16.0	0.25-in. concave base. Fractures started at perimeter of base and into sides.
B-13	6.387	0.122	8.125	Vertical, upside down	8.83	28.0	Steel cap plate was the base. Fractured in sides only.
B-14	6.357	0.117	7.937	Horizontal	8.93	8.0	Plain beaker. Fractured in sides and base.
B-15	6.362	0.101	8.000	Vertical	8.65	23.0	Concave base and sides. Fractured in base and in sides around narrow part of concavity.
B-16	6.361	0.110	8.187	Horizontal	8.75	8.0	Concave sides. Cracked in sides only.
B-17	6.362	0.102	8.063	Vertical	8.73	28.0	0.25-in. concave base; sprayed inside and out with 0.005-in. of "Krylon". Rubber ring.

Table XII

## RESULTS OF IMPACT TESTING USING GLASS BEAKERS

Specimen No.	O.D. in.	Thickness in.	Height in.	Testing Position	Weight lbs	Height of Drop, in.	Remarks
B-18	6.355	0.114	8.175	Vertical	8.81	36.0	0.25-in. concave base; four, 4- x 1/2-in. deep indentations in sides. "Devcon L" + rubber ring base protection.
B-19	6.360	0.110	7.938	Vertical	9.11	12.0	0.25-in. concave base; four, 4- x 1/4-in. deep indentations in sides. "Devcon L" ring on base.
B-20	6.381	0.122	7.813	Vertical	8.40	34.0	0.25-in. concave base; four, 4- x 1/4-in. deep indentations in sides. Thin silicone rubber rings and segmented tire tread on the base.
B-21	6.377	0.122	8.000	Vertical	8.52	26.0	0.25-in. concave base; 0.35-in. concave sides; thin rubber rings and segmented tire tread on base.

Table XIII

## DIMENSIONS AND WEIGHTS OF SPECIMENS FOR IMPACT TESTING

Specimen Number	Type of Test	Avg. O.D., in.	Avg. Thickness in.	Avg. Height in.	Empty Case Weight, lb	Assembled Case Weight, lb
0-I 202-4	Cartridge Case + Simulated Propellant	6.029	0.126	8.549	1.559	8.859
0-I 202-6		6.030	0.090	8.800	2.138	9.098
0-I 202-18		6.024	0.143	8.811	2.269	9.190
0-I 202-8	Cartridge Case + Simulated Propellant + Projectile	6.017	0.129	8.599	2.207	49.200
0-I 202-9		6.013	0.132	8.549	2.145	48.250
0-I 202-11		6.010	0.298	8.613	4.460	49.800

Table XIV  
IMPACT TEST RESULTS OF CARTRIDGE CASES

Specimen Number	Total Weight, lb	No. of Drops	Height of Drop at Fracture, in.	Remarks
0-I 202-4	8.86	9	66	Closed end tempered glass case. Rubber silicone ring on base.
Corning 0313-6	9.09	7	45	Open end stressed cartridge case. Steel plates top and bottom. Rubber silicone ring on base.
0-I 202-18	9.19	8	63*	Open end stressed glass case with steel plates top and bottom. Silicone rubber ring on base. Epoxy used to cement steel base plate to glass sheared and the base was pushed into the cylinder. Glass intact.
0-I 202-8	49.20	5	18	Assembled cartridge. Silicone rubber ring on base and between case and projectile. Side walls collapsed at buckling strength of glass. Base shattered.
0-I 202-9	48.25	4	24	Assembled cartridge. Silicone rubber ring and segmented tire treads on base. Rubber ring between case and projectile. Failed by buckling of sides and base shattered. Not contained in plastic bag. Details of break shown in filmed sequence.
0-I 202-11	49.80	4	15	Assembled cartridge. Silicone rubber ring on base and between case and projectile. Side walls failed by buckling of glass. Base also shattered.

\*Did not fracture.

Table XV

CENTRAL TENSILE STRESS AND THICKNESS  
OF COMPRESSIVE LAYER IN CORNING TEMPERING CONTROL PLATES

Sample Number	<u>Central Tension (psi)</u>	<u>Case Thickness (in.)</u>
	<u>Corning Data</u>	<u>IITRI Data</u>
	<u>Corning Data</u>	<u>IITRI Data</u>
235	8830	7900
		0.012
241	5587	8800
		0.011
		0.01
		0.01

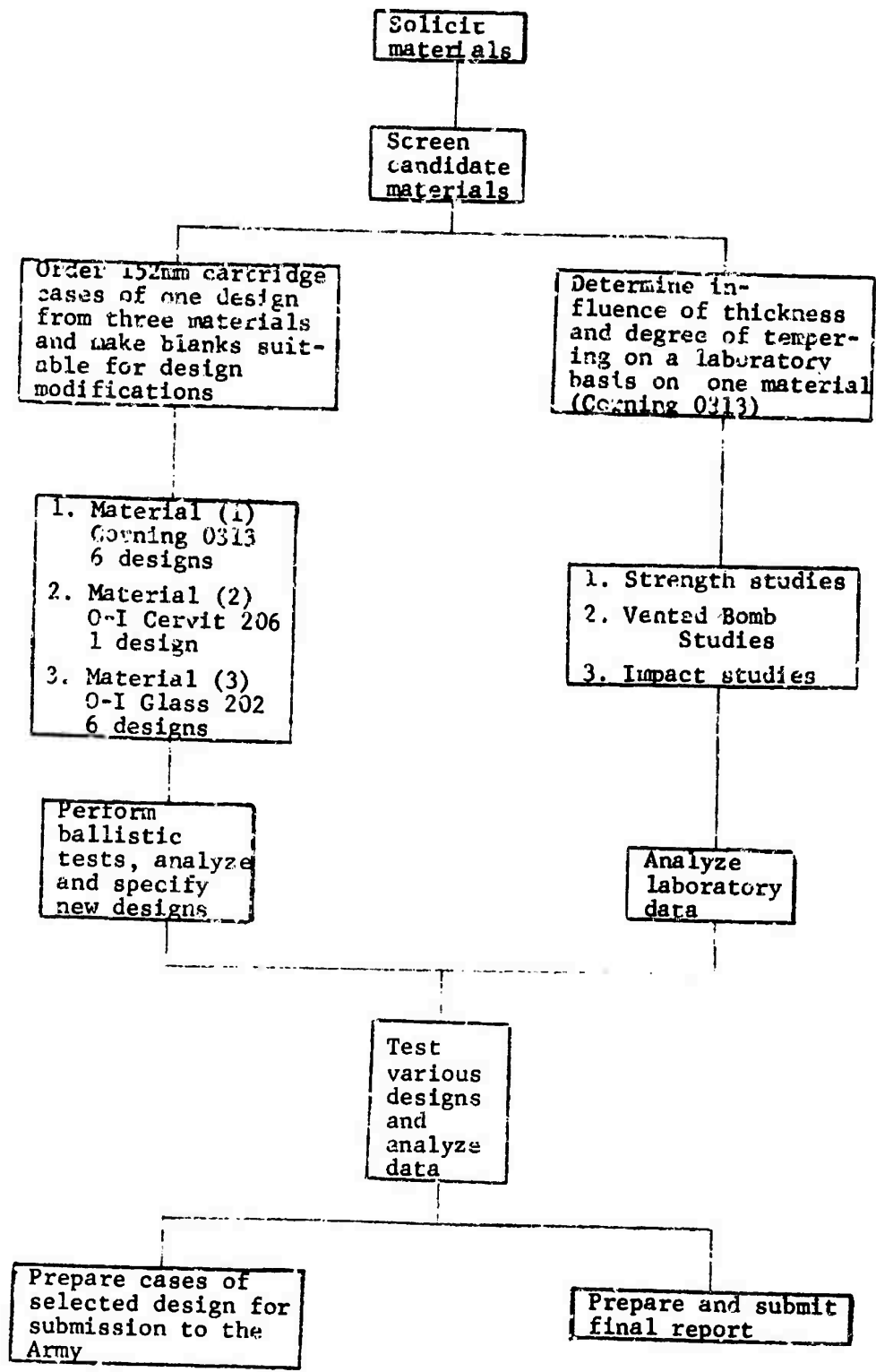

Figure 1 - PROGRAM PLAN

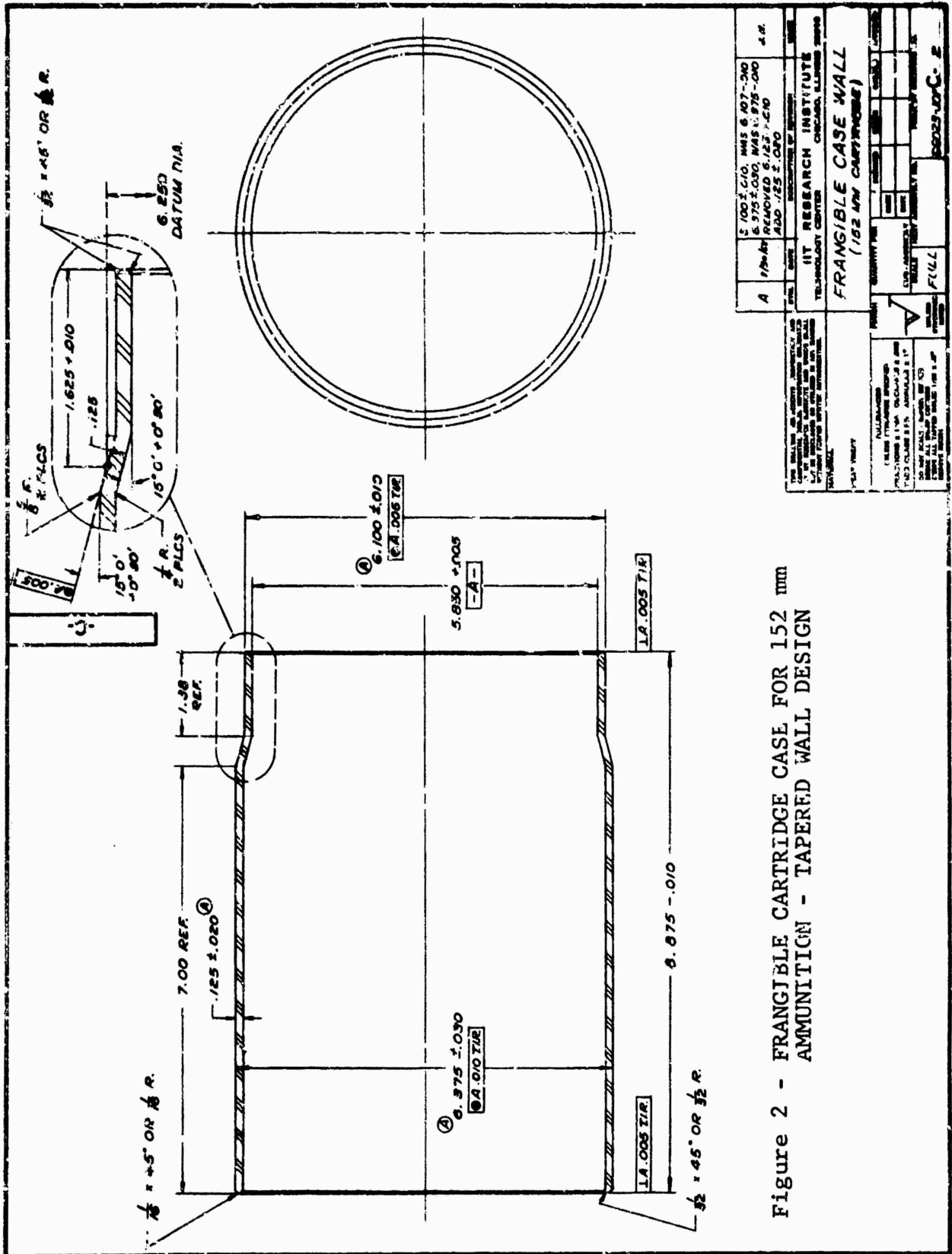
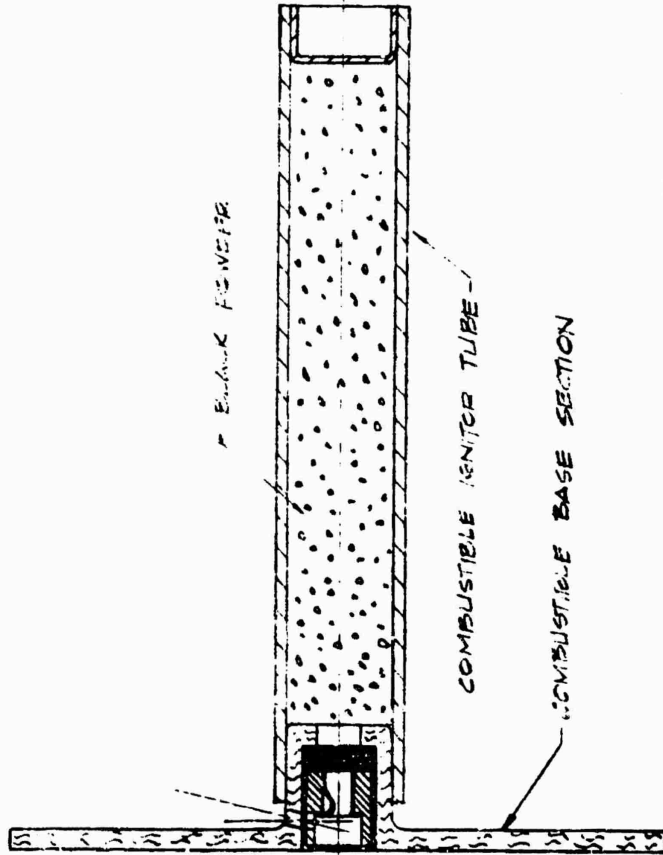

Figure 2 - FRANGIBLE CARTRIDGE CASE FOR 152 mm AMMUNITION - TAPERED WALL DESIGN

QTY	100	QTY	100
DATE	10/10/50	DATE	10/10/50
IIT RESEARCH INSTITUTE TECHNOLOGY CENTER CHICAGO, ILLINOIS 60631			
<b>FRANGIBLE CARTRIDGE CASE</b> (152 MM CARTRIDGE)			
DESIGNED BY	W. J. HENRY	DATE	10/10/50
CHECKED BY		DATE	
APPROVED BY		DATE	
ALL DIMENSIONS UNLESS OTHERWISE SPECIFIED ARE IN INCHES AND DECIMALS THEREOF. DIMENSIONS IN PARENTHESES ARE FOR INFORMATION ONLY. ALL DIMENSIONS ARE TO BE TAKEN FROM THE DRAWING UNLESS OTHERWISE SPECIFIED.			
DRAWING NUMBER: 10023-100-2			

-B-



FOR OTHER DIMENSIONS & NOTES SEE  
 PIGATINNY ARSENAL PART NO. 9209038  
 FIG. 3 COMBUSTIBLE BASE AND  
 IGNITOR ASSEMBLY

THIS DRAWING REPRESENTS PROPRIETARY AND CONFIDENTIAL DESIGN INFORMATION ORIGINATED BY THE UNITED STATES GOVERNMENT AND NOT BE DISCLOSED OR UTILIZED IN ANY MANNER WITHOUT PROPER WRITTEN AUTHORIZATION.

SYN.	DATE	DESCRIPTION	REVISION	NAME
		111 RESEARCH INSTITUTE TECHNOLOGY CENTER	CHICAGO, ILLINOIS 60618	
MATERIAL				
HEAT TREAT				
TOLERANCES UNLESS OTHERWISE SPECIFIED		FINISH		
FRACTIONS ± 1/64 DECIMALS ± .005		A		
THOSE CLASS 2 FIT ANGULAR ± 1°		UNLESS OTHERWISE INDICATED		
DO NOT SCALE REPORT ERRORS		QUANTITY PER		
CHECK ALL MOUNTING HOLES		NAME		
REMOVE BURRS		DATE		
		SUB-ASSEMBLY		
		NEXT ASSEMBLY NO.		
		SCALE		
		FULL		
		PROJECT DRAWING NO.		
		66023-B-19		

PRIMER, ELECTRIC





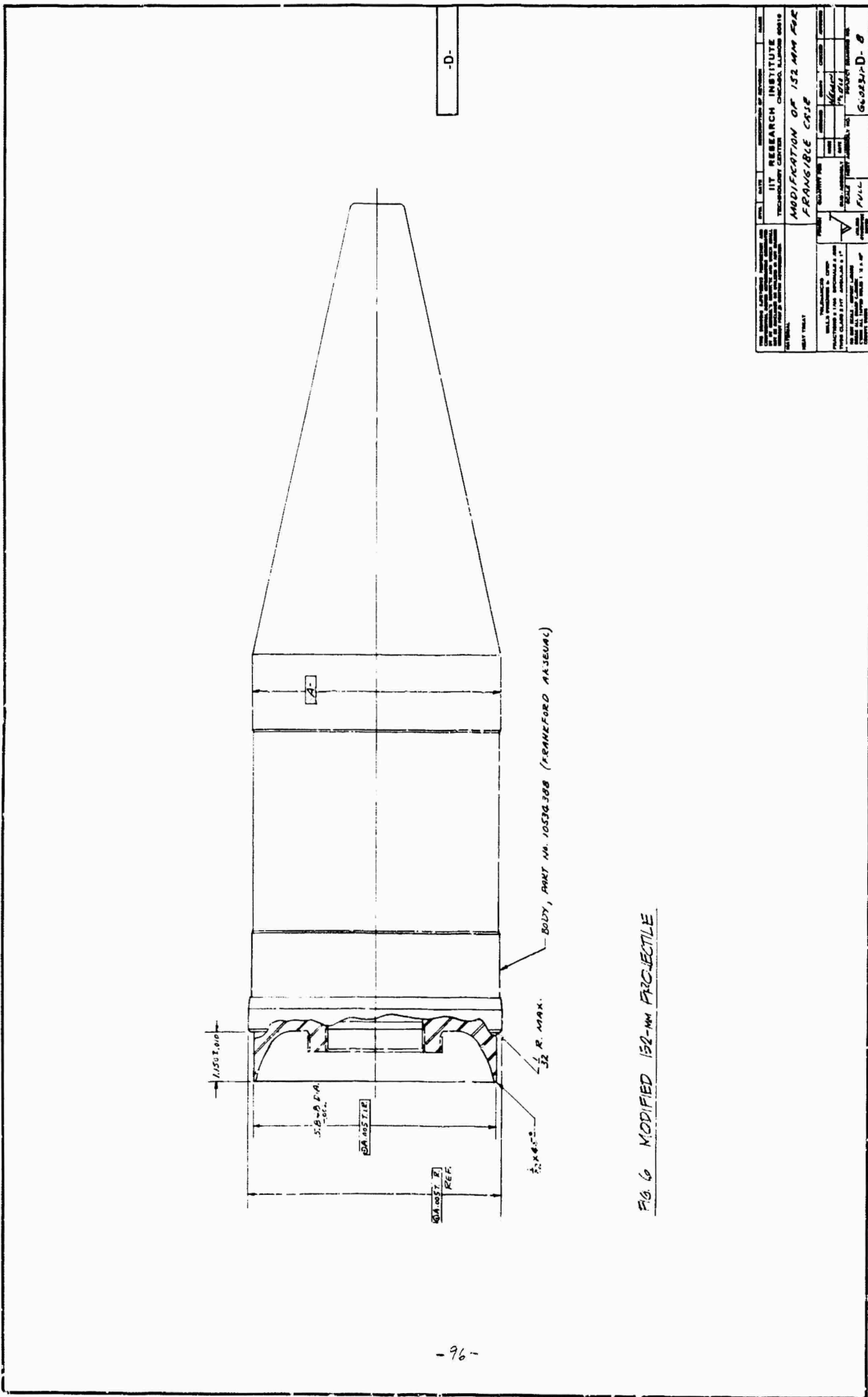

THE PROJECT, NAME, NUMBER AND DATE OF THIS DRAWING ITT RESEARCH INSTITUTE TECHNOLOGY CENTER CHICAGO, ILLINOIS 60610	
TITLE MODIFICATION OF 152-MM AIR FRANGIBLE CASE	
DRAWN BY CHECKED BY DATE	DESIGNED BY DATE
PROJECT NUMBER DRAWING NUMBER SHEET NUMBER	PROJECT TITLE DRAWING TITLE SHEET TITLE
APPROVED BY DATE	
PROJECT MANAGER DATE	
PROJECT ENGINEER DATE	
PROJECT SUPERVISOR DATE	
PROJECT DIRECTOR DATE	
PROJECT MANAGER DATE	
PROJECT ENGINEER DATE	
PROJECT SUPERVISOR DATE	
PROJECT DIRECTOR DATE	
PROJECT MANAGER DATE	
PROJECT ENGINEER DATE	
PROJECT SUPERVISOR DATE	
PROJECT DIRECTOR DATE	

FIG. 6 MODIFIED 152-MM PROJECTILE

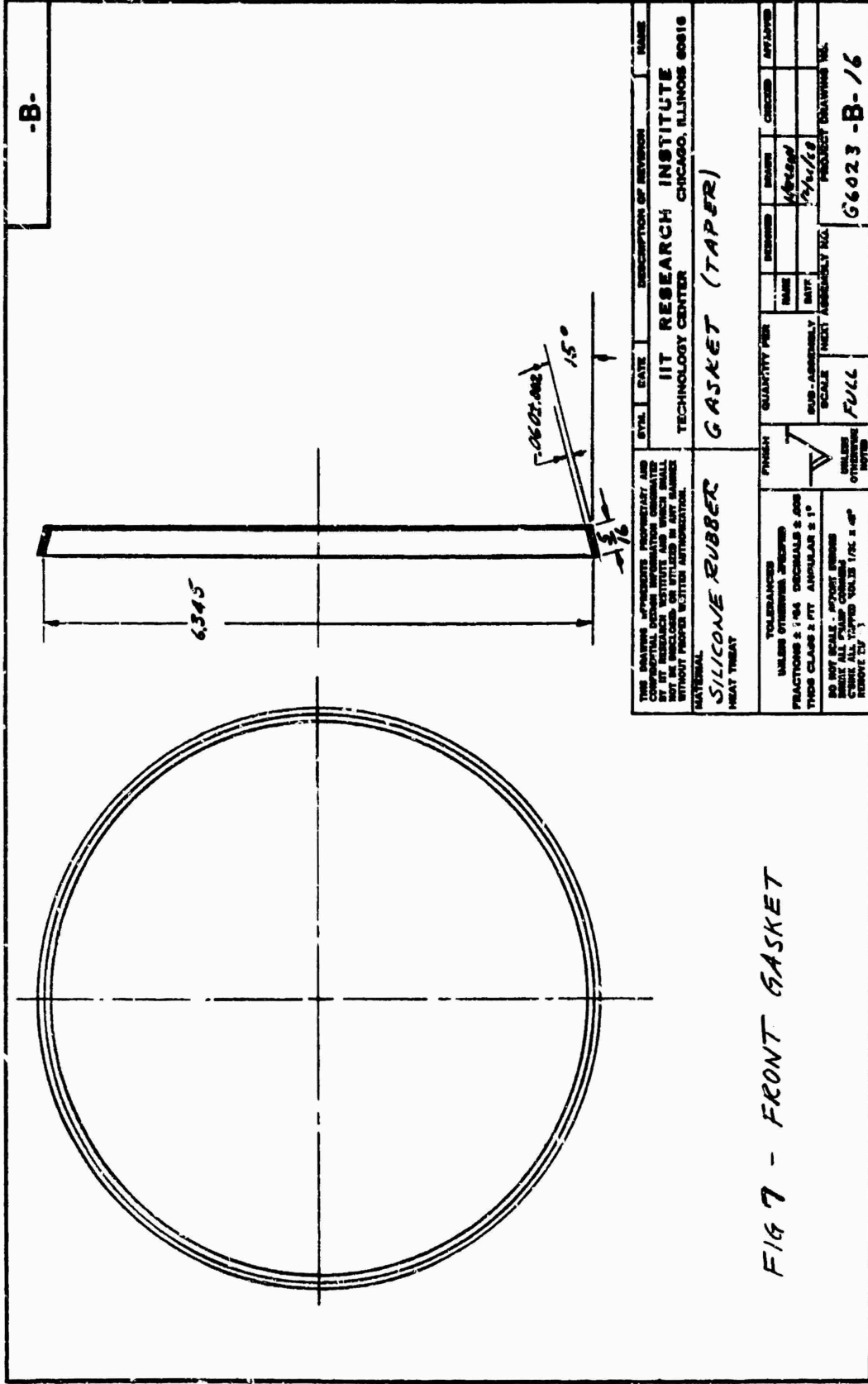
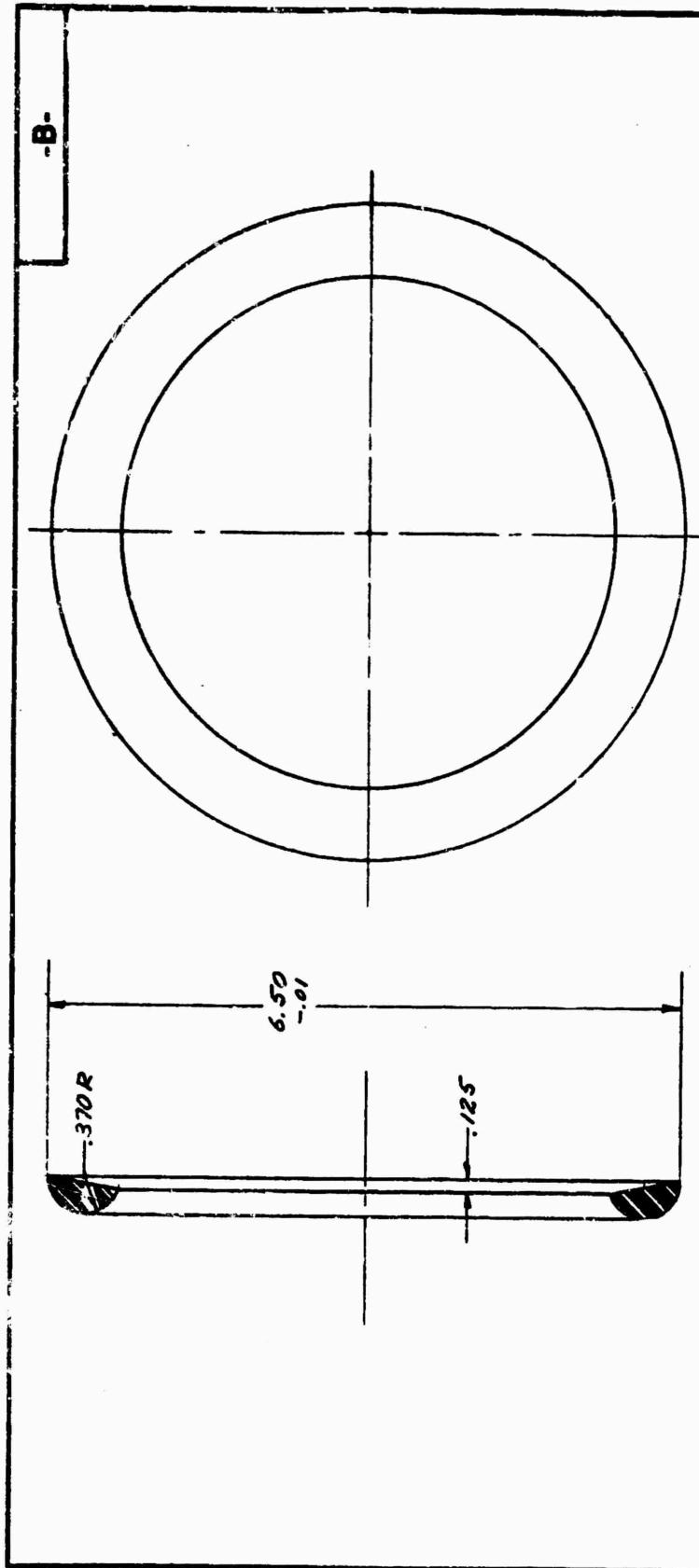

FIG 7 - FRONT GASKET

THIS DRAWING REPRESENTS PROPRIETARY AND CONFIDENTIAL DESIGN INFORMATION GENERATED BY THE ENGINEER OR UTILIZED IN ANY MANNER WITHOUT PROPER WRITTEN AUTHORIZATION.	SYN.	DATE	DESCRIPTION OF REVISION	NAME		
			IT RESEARCH INSTITUTE TECHNOLOGY CENTER	CHICAGO, ILLINOIS 60616		
MATERIAL <b>SILICONE RUBBER</b> HEAT TREAT	FINISH TOLERANCES UNLESS OTHERWISE SPECIFIED FRACTIONS $\pm$ 1/64 DECIMALS $\pm$ .005 THOSE CLASSED FIT ANGULAR $\pm$ 1°	QUANTITY PER	ISSUED	ISSUED	CHECKED	APPROVED
			NAME	DATE		
NO NET SCALE - POINTS BEING DRAWN ALL DIMENSIONS TO BE CHECKED ALL TYPED VALUES 1/8" $\pm$ .005 UNLESS OTHERWISE INDICATED	SUB-ASSEMBLY SCALE <b>FULL</b>	PROJECT ASSEMBLY NO.		PROJECT DRAWING NO.		
				<b>G6023-B-16</b>		



THIS DRAWING REPRESENTS PROPRIETARY AND CONFIDENTIAL INFORMATION OF IIT RESEARCH INSTITUTE AND WHICH SHALL NOT BE DISCLOSED OR UTILIZED IN ANY MANNER WITHOUT PROPER WRITTEN AUTHORIZATION. <b>SILICONE RUBBER</b> HEAT TREAT	STYLE <b>GASKET (REAR)</b>	DATE	DESCRIPTION OF REVISION	NAME		
	IIT RESEARCH INSTITUTE TECHNOLOGY CENTER CHICAGO, ILLINOIS 60616					
TOLERANCES UNLESS OTHERWISE SPECIFIED FRACTIONS ± 1/64 DECIMALS ± .005 THOS CLASS 3 FIT ANGULAR ± 1°	FINISH	QUANTITY PER	ORDERED	DRAWN	CHECKED	APPROVED
DO NOT SCALE - REPORT ERRORS CHECK ALL DIMENSIONS REMOVE PENS	SCALE	SUB-ASSEMBLY	NAME DATE	NAME DATE	NAME DATE	NAME DATE
	FULL	NEXT ASSEMBLY FOR	PROJECT OR DRAWING NO.	G6023 - B - 15		

FIG 8 - REAR GASKET

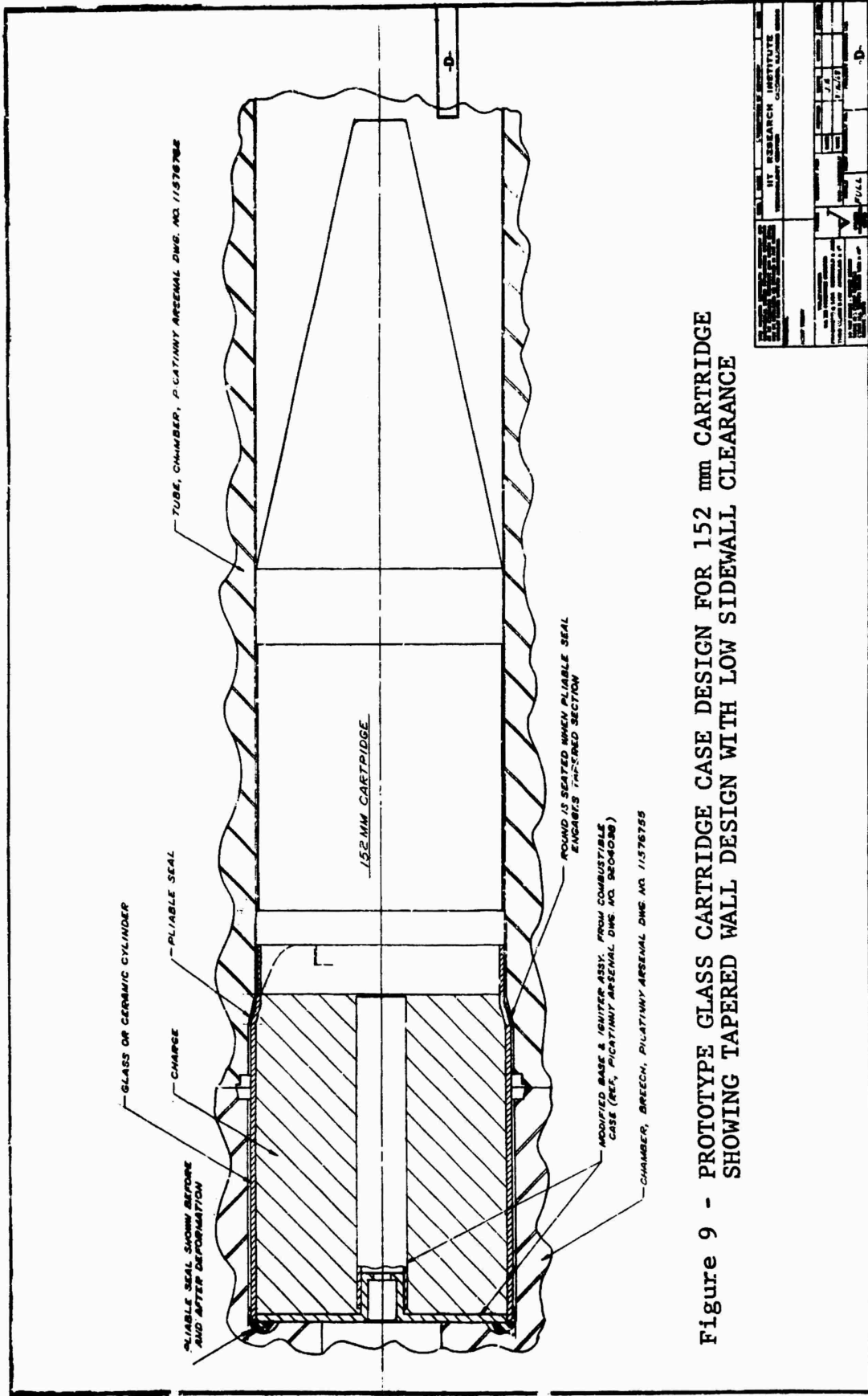
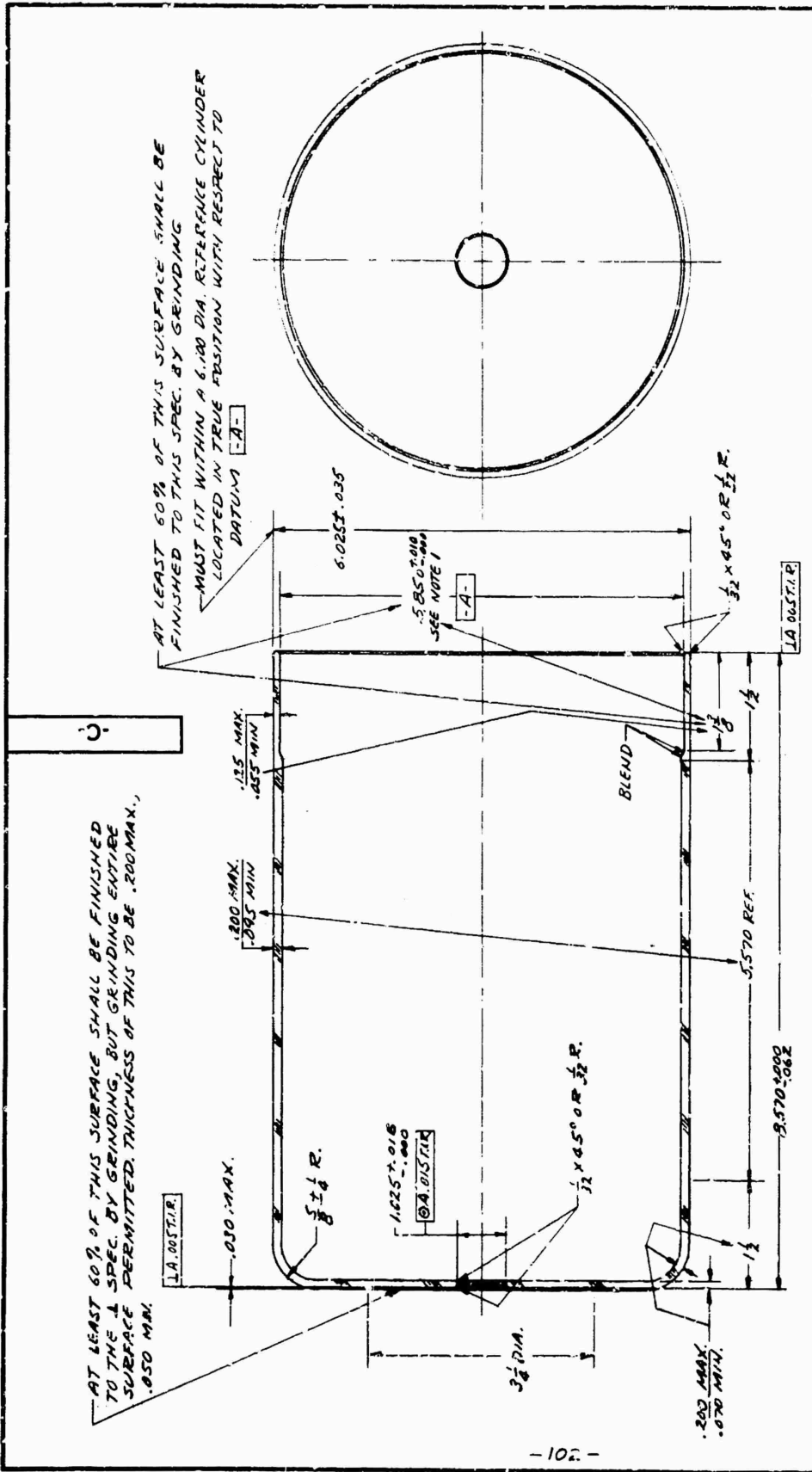

Figure 9 - PROTOTYPE GLASS CARTRIDGE CASE DESIGN FOR 152 mm CARTRIDGE SHOWING TAPERED WALL DESIGN WITH LOW SIDEWALL CLEARANCE







AT LEAST 60% OF THIS SURFACE SHALL BE FINISHED TO THIS SPEC. BY GRINDING TO THE 1 SPEC. BY GRINDING, BUT GRINDING ENTIRE SURFACE PERMITTED. THICKNESS OF THIS TO BE .200 MAX., .050 MIN.

AT LEAST 60% OF THIS SURFACE SHALL BE FINISHED TO THIS SPEC. BY GRINDING  
 MUST FIT WITHIN A 6.00 DIA. REFERENCE CYLINDER LOCATED IN TRUE POSITION WITH RESPECT TO DATUM A

NOTE  
 1. THIS DIAMETER MAY BE ACHIEVED WITH PART IN RESTRAINED CONDITION. IN FREE CONDITION, THE PART SHALL ACCEPT A 5.995" DIA. PLUG TO A DEPTH OF 1/4"

FIG. 12 SINGLE PIECE CARTRIDGE CASE - STRAIGHT WALL DESIGN WITH INTEGRAL BASE

THIS DRAWING REPRESENTS THE PART AND CONFIDENTIAL DESIGN INFORMATION CHARACTERISTICS AND SHALL BE KEPT IN THE PART NUMBER WITHOUT FURTHER WRITTEN AUTHORIZATION.		MATERIAL		HEAT TREAT		FINISH		TOLERANCES UNLESS OTHERWISE SPECIFIED		UNLESS OTHERWISE SPECIFIED	
DRAWG. REVISED TO CONFORM TO MFG. PRACTICE		DRAWG. REVISED TO CORRESPOND TO MARKED DRAWING DATED 2-27-55		DRWG. REVISED TO CONFORM TO MFG. PRACTICE		DRAWG. REVISED TO CORRESPOND TO MARKED DRAWING DATED 2-27-55		UNLESS OTHERWISE SPECIFIED		UNLESS OTHERWISE SPECIFIED	
REV. DATE	DESCRIPTION OF REVISION	REV. DATE	DESCRIPTION OF REVISION	REV. DATE	DESCRIPTION OF REVISION	REV. DATE	DESCRIPTION OF REVISION	REV. DATE	DESCRIPTION OF REVISION	REV. DATE	DESCRIPTION OF REVISION
B 5/1/54		A 3/1/55									
IT RESEARCH INSTITUTE TECHNOLOGY CENTER CHICAGO, ILLINOIS 60616				MATERIAL FRANGIBLE CASE (CLOSED END)				HEAT TREAT			
QUANTITY PER ORDER				QUANTITY PER ORDER				QUANTITY PER ORDER			
SCALE				SCALE				SCALE			
PAC. MFG. DRAWING NO.				PAC. MFG. DRAWING NO.				PAC. MFG. DRAWING NO.			
G6023 C-33				G6023 C-33				G6023 C-33			

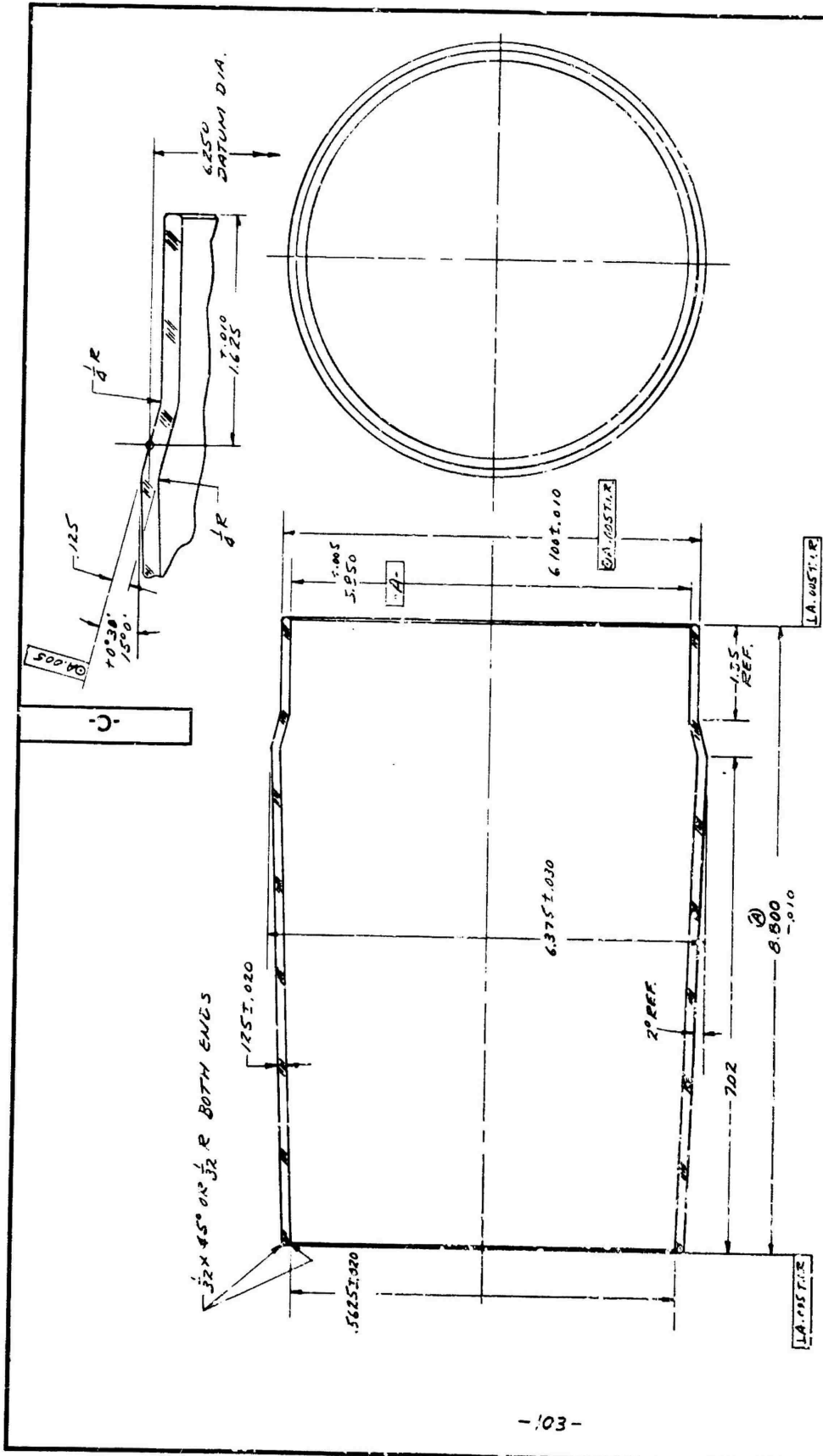
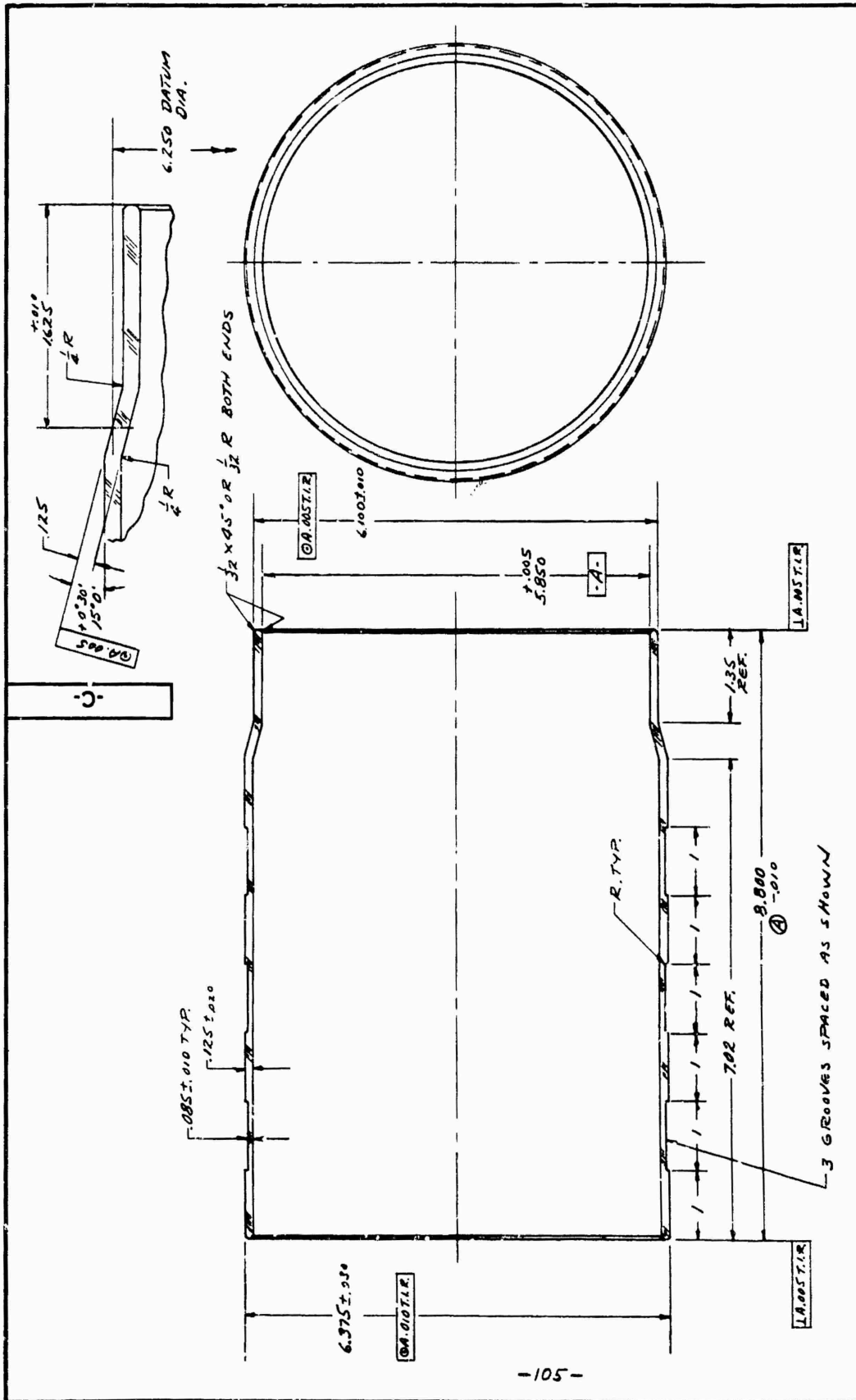

FIG. 13 DOUBLE TAPERED CARTRIDGE CASE

A 22209 SYN. DATE	B.800 WAS 887- DESCRIPTION OF REVISION	APPROVAL	
		DATE	NAME
IIT RESEARCH INSTITUTE TECHNOLOGY CENTER CHICAGO, ILLINOIS 60616		DESIGNED BY	DRAWN BY
FRANGIBLE CASE WALL (U.S. MM CARTRIDGE)		CHECKED BY	DATE
MATERIAL		QUANTITY REQ.	SCALE
HEAT TREAT		PROJ. ASSEMBLY NO.	PROJ. DRAWING NO.
TOLERANCES UNLESS OTHERWISE SPECIFIED		PROJECT ASSEMBLY NO.	
FRACTIONS 1/16 DECIMALS 2 JOES		PROJECT DRAWING NO.	
THIS DRAWING REPRESENTS PROPRIETARY AND CONFIDENTIAL INFORMATION OF IIT RESEARCH INSTITUTE AND SHALL BE KEPT SECRET AND NOT REPRODUCED OR DISCLOSED IN ANY MANNER WITHOUT EXPRESS WRITTEN PERMISSION OF IIT RESEARCH INSTITUTE.		G6023 - C - 30	
DO NOT SCALE - REPORT ERRORS TO PROJECT ENGINEER		G6023 - C - 30	
CHINA 1:1 1/16" 1/32" 1/64" 1/32" 1/64"		G6023 - C - 30	





DATE	A 22649	8.00.1945	8.07.5	REVISED	16.01.19
SYMBOL					
DESCRIPTION OF REVISED					
NAME	IIT RESEARCH INSTITUTE TECHNOLOGY CENTER CHICAGO, ILLINOIS 60610				
PROJECT	FRANGIBLE CASE WALL (152 MM CARTRIDGE)				
QUANTITY FOR	ORDERED	ISSUED	ISSUED	ISSUED	ISSUED
DATE					
BY - ASSEMBLY					
BY - CHECK					
SCALE	FULL				PROJECT DRAWING NO.
NEXT ASSEMBLY NO.					66023 - C-32
HEAT TREAT					
TOLERANCES	UNLESS OTHERWISE SPECIFIED				
FINISH	UNLESS OTHERWISE SPECIFIED				
THREADS	UNLESS OTHERWISE SPECIFIED				
ANGLES	UNLESS OTHERWISE SPECIFIED				
SPRINGS	UNLESS OTHERWISE SPECIFIED				
WELDS	UNLESS OTHERWISE SPECIFIED				
OTHER	UNLESS OTHERWISE SPECIFIED				

FIG. 15 TAPERED WALL CARTRIDGE CASE WITH GROOVES

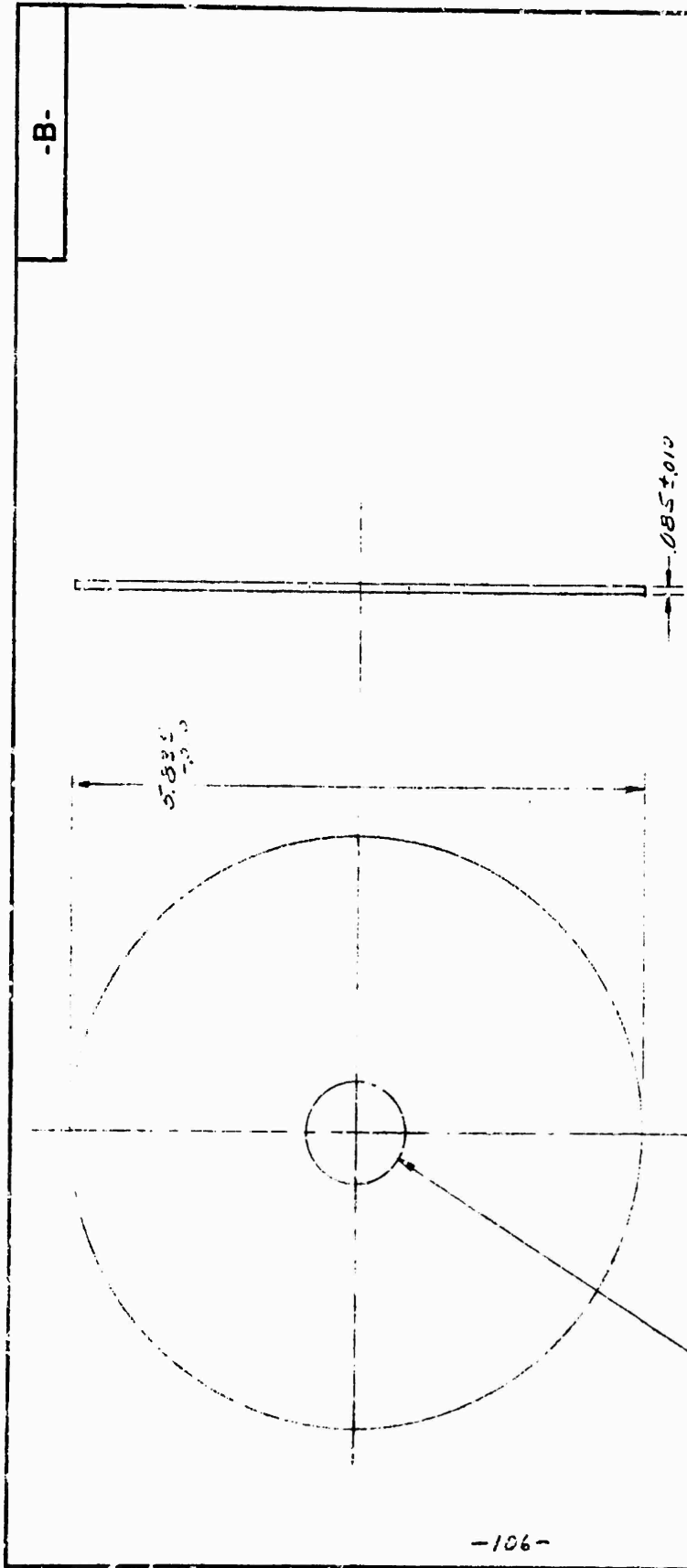

THIS DRAWING REPRESENTS PROVISIONAL AND CONFIDENTIAL DESIGN INFORMATION ORIGINATED BY IIT RESEARCH INSTITUTE AND WHICH SHALL NOT BE DISCLOSED OR UTILIZED IN ANY MANNER WITHOUT WRITTEN AUTHORIZATION.		SYM. DATE DESCRIPTION OF REVISION NAME
IIT RESEARCH INSTITUTE TECHNOLOGY CENTER CHICAGO, ILLINOIS 60613		DRAWN LACED APPROVED DATE 3/7/59
MATERIAL HEAT TREAT FINISH TOLERANCES UNLESS OTHERWISE SPECIFIED FRACTIONS ± 1/64 DECIMALS ± .005 THIS CLASS 2.00 ANGULAR ± 1° DO NOT SCALE - REPORT ERRORS UNLESS OTHERWISE NOTED		QUANTITY PER SUB-ASSEMBLY SCALE NEXT ASSEMBLY NO. PROJECT DRAWING NO.
FEMINOLE BRISE		1 F-11 G6023-B-27

FIG. 16 TEMPERED GLASS BULKHEAD -  
FLAT PLATE

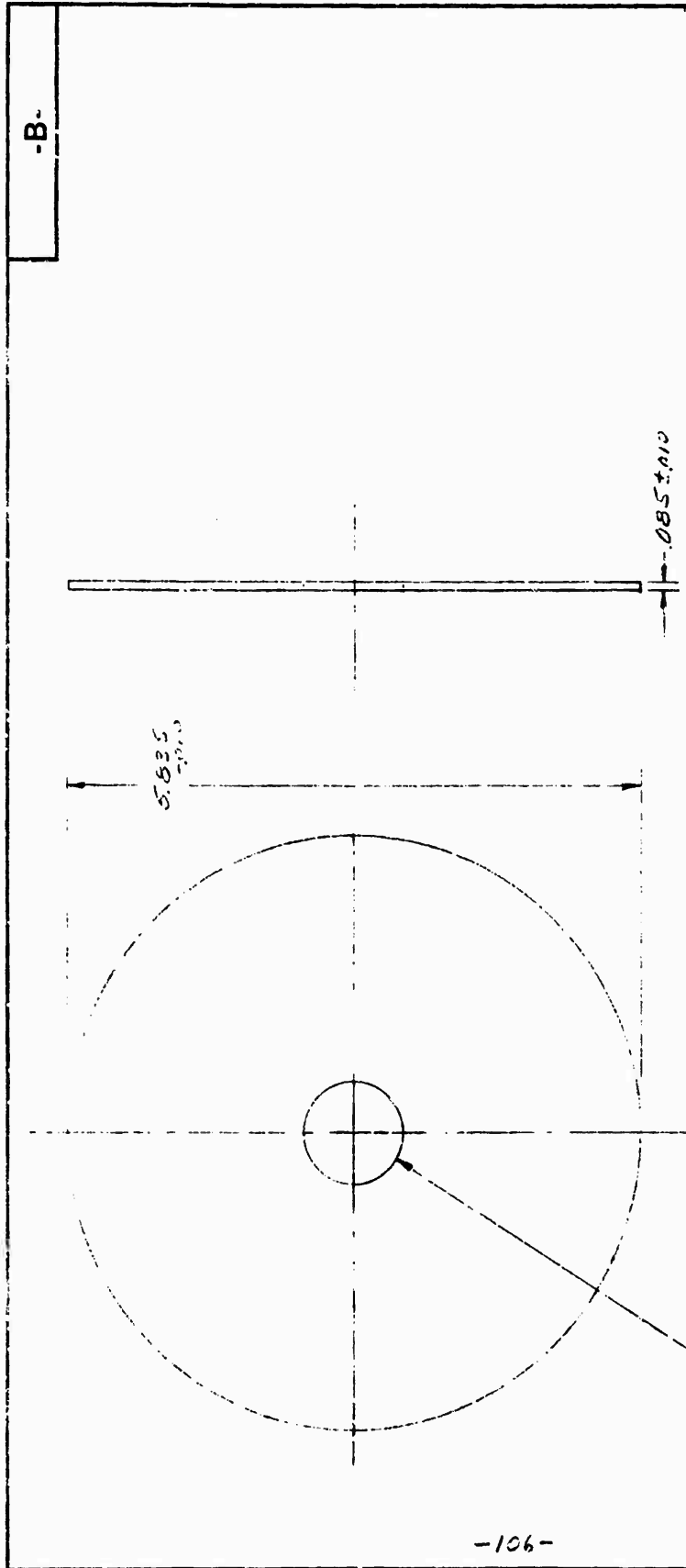

THIS DRAWING REPRESENTS PROPRIETARY AND CONFIDENTIAL DESIGN INFORMATION ORIGINATED BY IIT RESEARCH INSTITUTE. IT SHALL NOT BE DISCLOSED OR UTILIZED IN ANY MANNER WITHOUT PROPER WRITTEN AUTHORIZATION.

MATERIAL: HEAT TREAT

FINISH: UNLESS OTHERWISE SPECIFIED FRACTIONS ± 1/64 DECIMALS ± .005 THIS CLASS ± FIT ANGULAR ± 1° DO NOT SCALE. VERIFY DIMENSIONS FROM ALL DIMAP. CORRECT CHANGE ALL TAPPED HOLES 1/32 x 45° REMOVE BURRS UNLESS OTHERWISE NOTED

SYMBOL		DATE	DESCRIPTION OF REVISION				NAME

IIT RESEARCH INSTITUTE  
TECHNOLOGY CENTER  
CHICAGO, ILLINOIS 60616

FRANKLIN RICE

QUANTITY PER	DESIGNED	DRAWN	CHECKED	APPROVED
		NEC/SPM		

SUB-ASSEMBLY	DATE	PROJECT DRAWING NO.
SCALE: FULL	7/7/69	56073-B-27

FIG. 16 TEMPERED GLASS BULKHEAD -  
FLAT PLATE

-B-

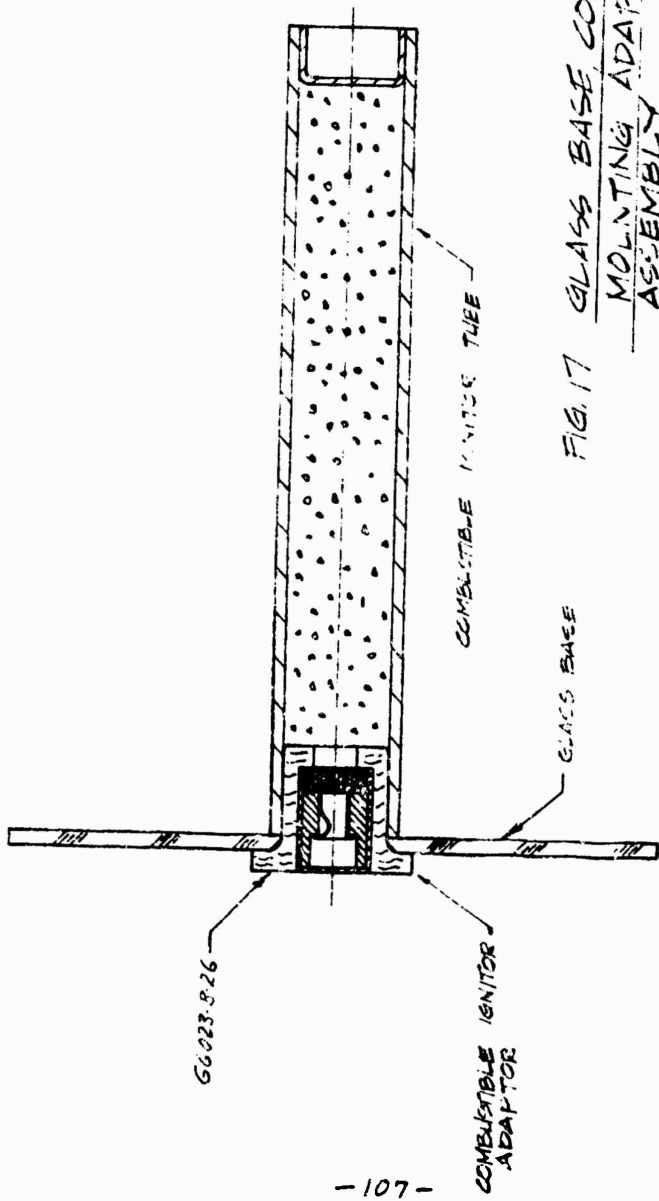

FIG. 17 GLASS BASE COMBUSTIBLE INITIATOR  
MOUNTING ADAPTER AND IGNITOR  
ASSEMBLY

FOR OTHER DIMENSIONS & NOTES SEE  
PICATINNY ARSENAL PART NO. 9204038

SYN.		DATE	DESCRIPTION OF REVISION	NAME
			III RESEARCH INSTITUTE TECHNOLOGY CENTER CHICAGO, ILLINOIS 60616	
MATERIAL		PRIMER, ELECTRIC		
HEAT TREAT				
TOLERANCES UNLESS OTHERWISE SPECIFIED FRACTIONS & 1/64 DECIMALS & .005 THOS CLASS & FIT ANGULAR & 1°		FINISH	QUANTITY PER	APPROVED
DO NOT SCALE - REPORT ERRORS UNLESS OTHERWISE NOTED CHECK ALL TAPPED HOLES 1/32 x 45° REMOVE BURRS		UNLESS OTHERWISE NOTED	IN BR	CHECKED
			DATE	APPROVED
			11/1/69	
		SCALE	PROJECT ASSEMBLY NO.	PROJECT DRAWING NO.
		FULL		G6023-B-23

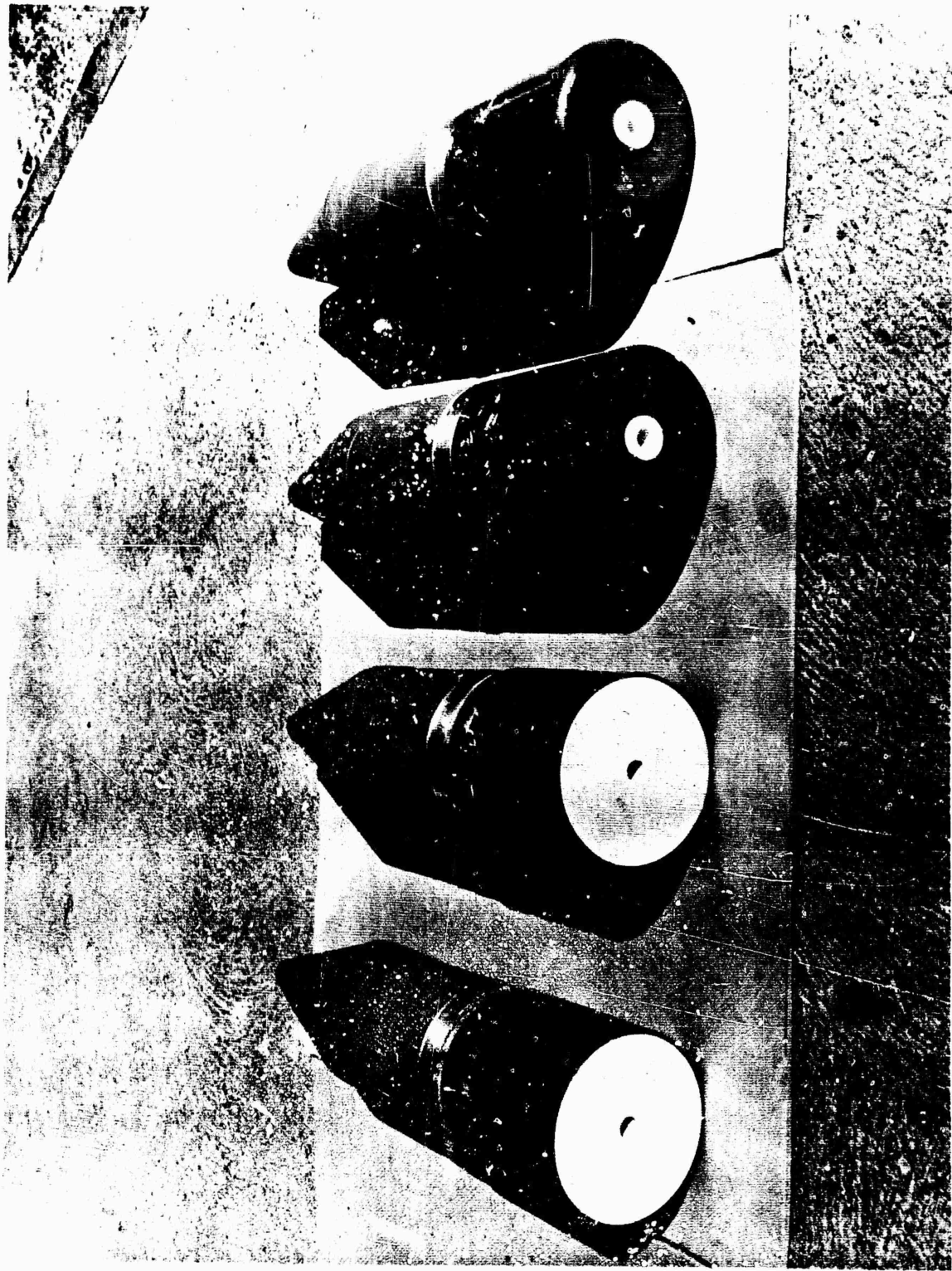

Figure 18. Assembled 152 mm ammunition employing tempered glass cartridge cases. Left to right: (1) tapered sidewall case with longitudinal flats and combustible base, (2) tapered sidewall case with circumferential grooves and combustible base, (3) straight sidewall case with separate glass base and (4) straight sidewall case with integral base. Cases are painted for color coding.



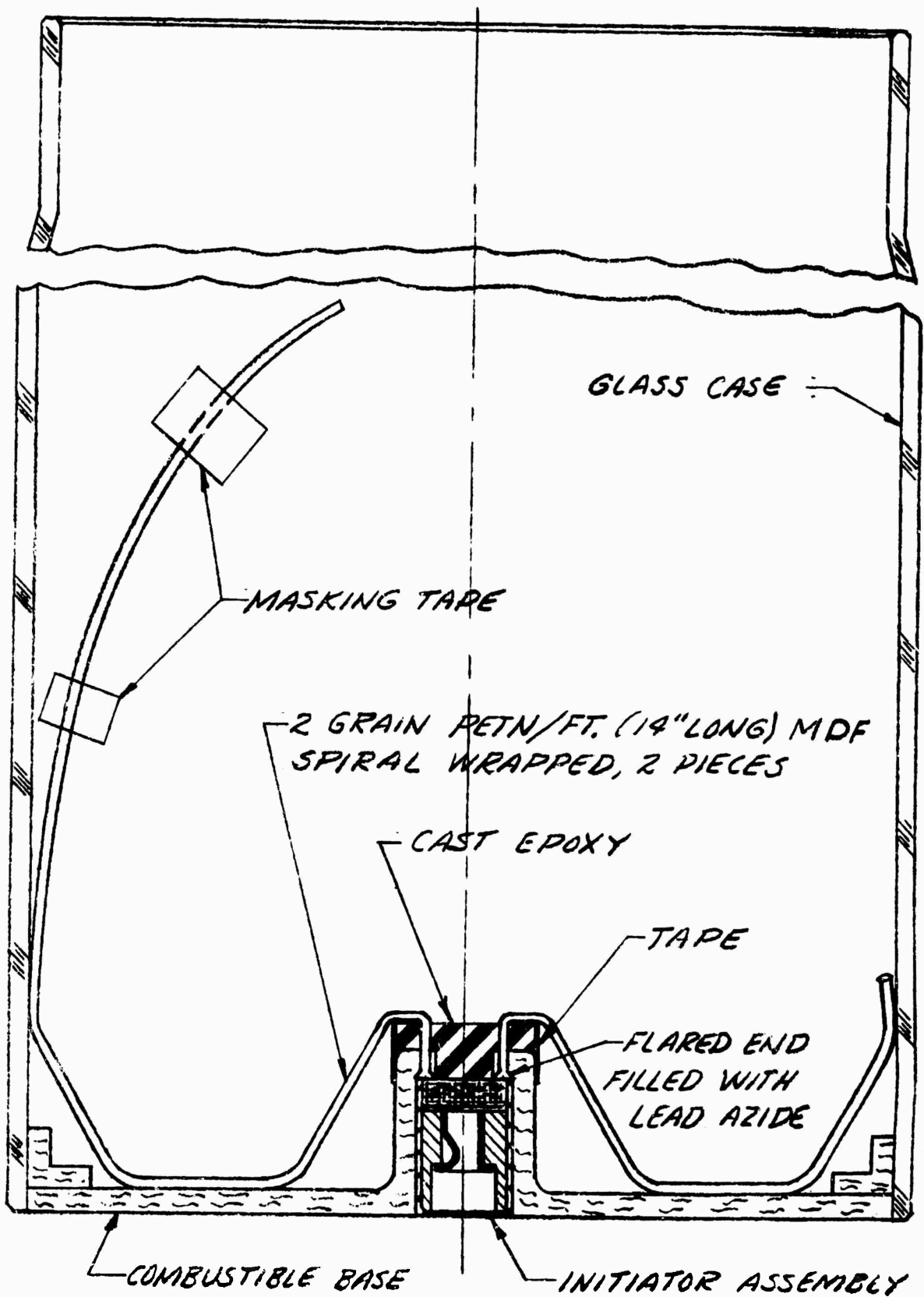

FIGURE 20 MDF INSTALLATION INTO PROTOTYPE GLASS CASE

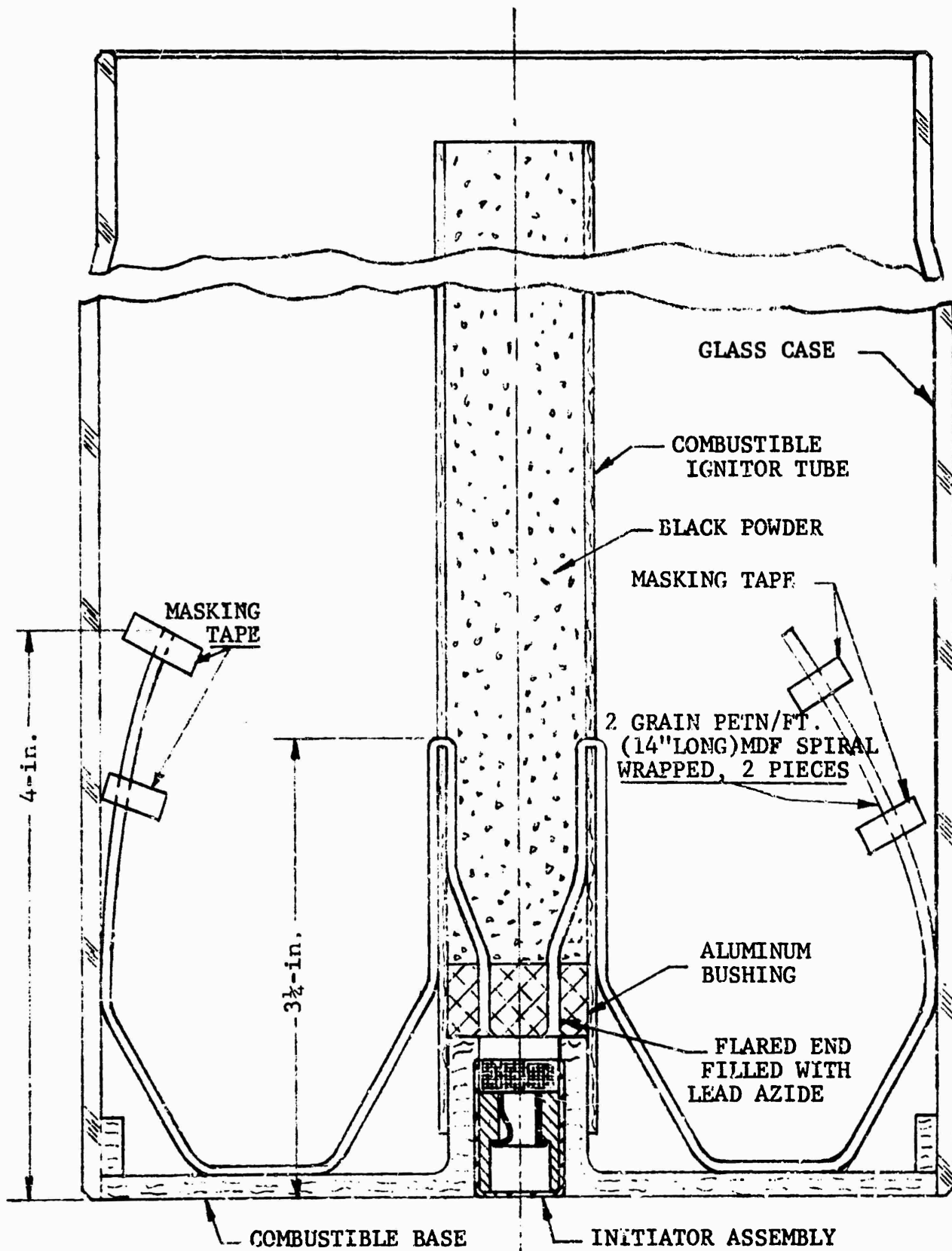

Figure 21 - MDF IGNITION AND TURBULANCE SYSTEM IN A GLASS CASE

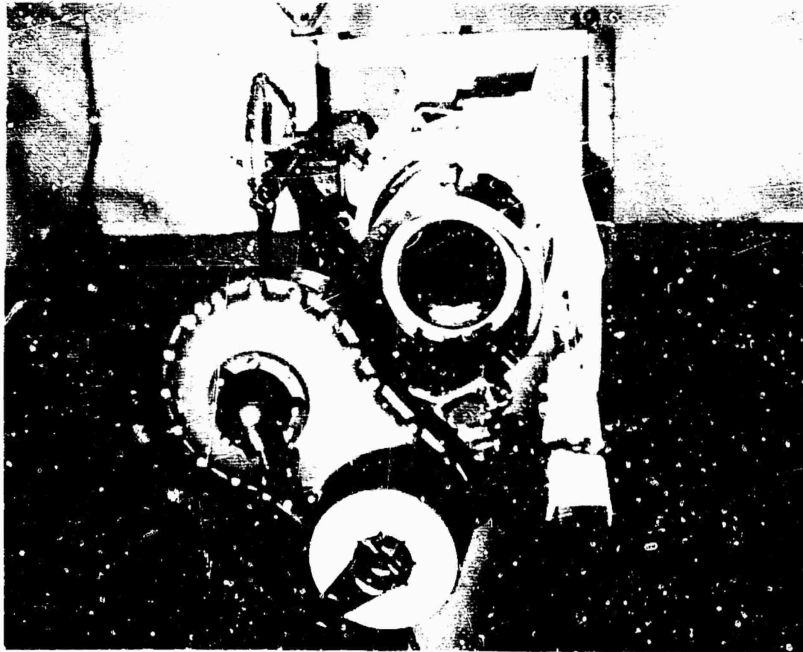

Figure 22 - DISTRIBUTION OF 30 gm OF CARTRIDGE CASE PARTICLES  
AT THE ORIGIN OF THE RIFLING IN THE XM81 GUN/LAUNCHER  
FOR TEST NO. 1.

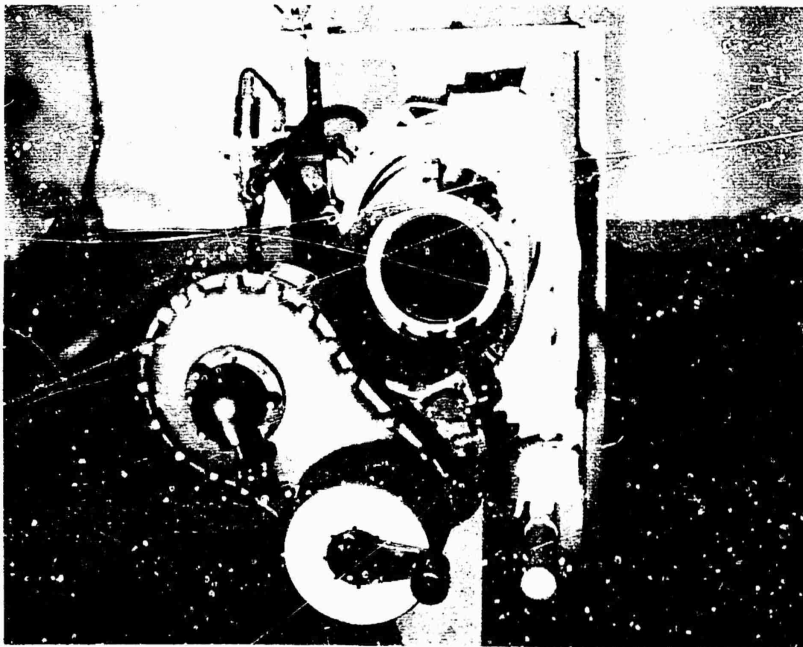

Figure 23 - THE CLEARED BARREL OF THE XM81 GUN/LAUNCHER  
AFTER TEST NO. 1.



Figure 24 - APPROXIMATELY 90 gm OF GLASS CARTRIDGE CASE PARTICLES SPREAD FROM THE ORIGIN OF THE RIFLING FOUR FEET INTO THE BARREL OF THE XM81 GUN/LAUNCHER FOR TEST NO. 8.



Figure 25 - APPROXIMATELY 10 gm OF GLASS CARTRIDGE CASE PARTICLES SPREAD IN THE REAR HALF OF THE BREECH OF THE XM81 GUN/LAUNCHER FOR TEST NO. 8.



Figure 26 - ERODED AREA OF XM81 GUN/LAUNCHER AFTER TEST NO. 11

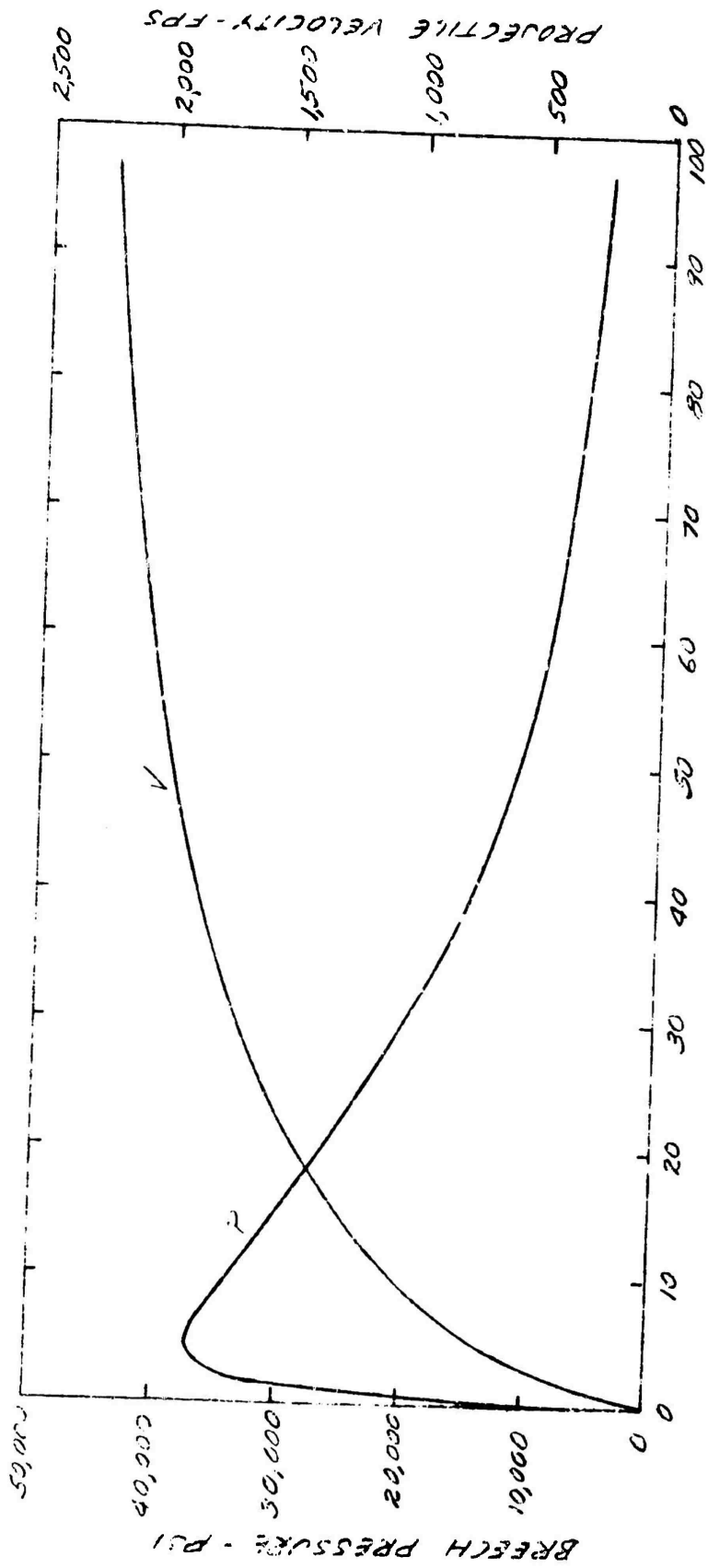
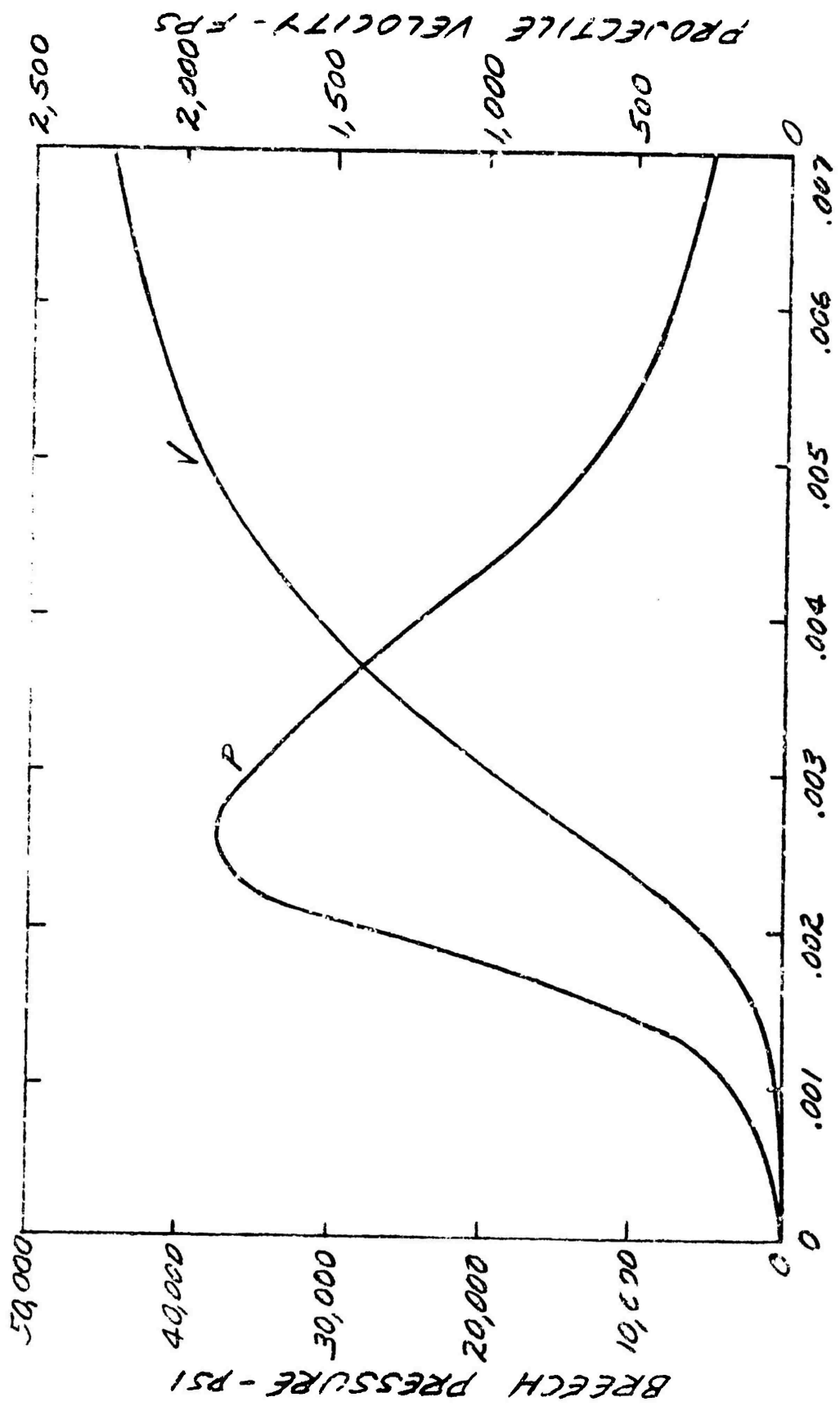

FIGURE 27 INTERIOR BALLISTICS OF 152 MM  
BORE TRAVEL - INCHES



TIME - SEC.

FIGURE 28 INTERIOR BALLISTICS OF 152MM

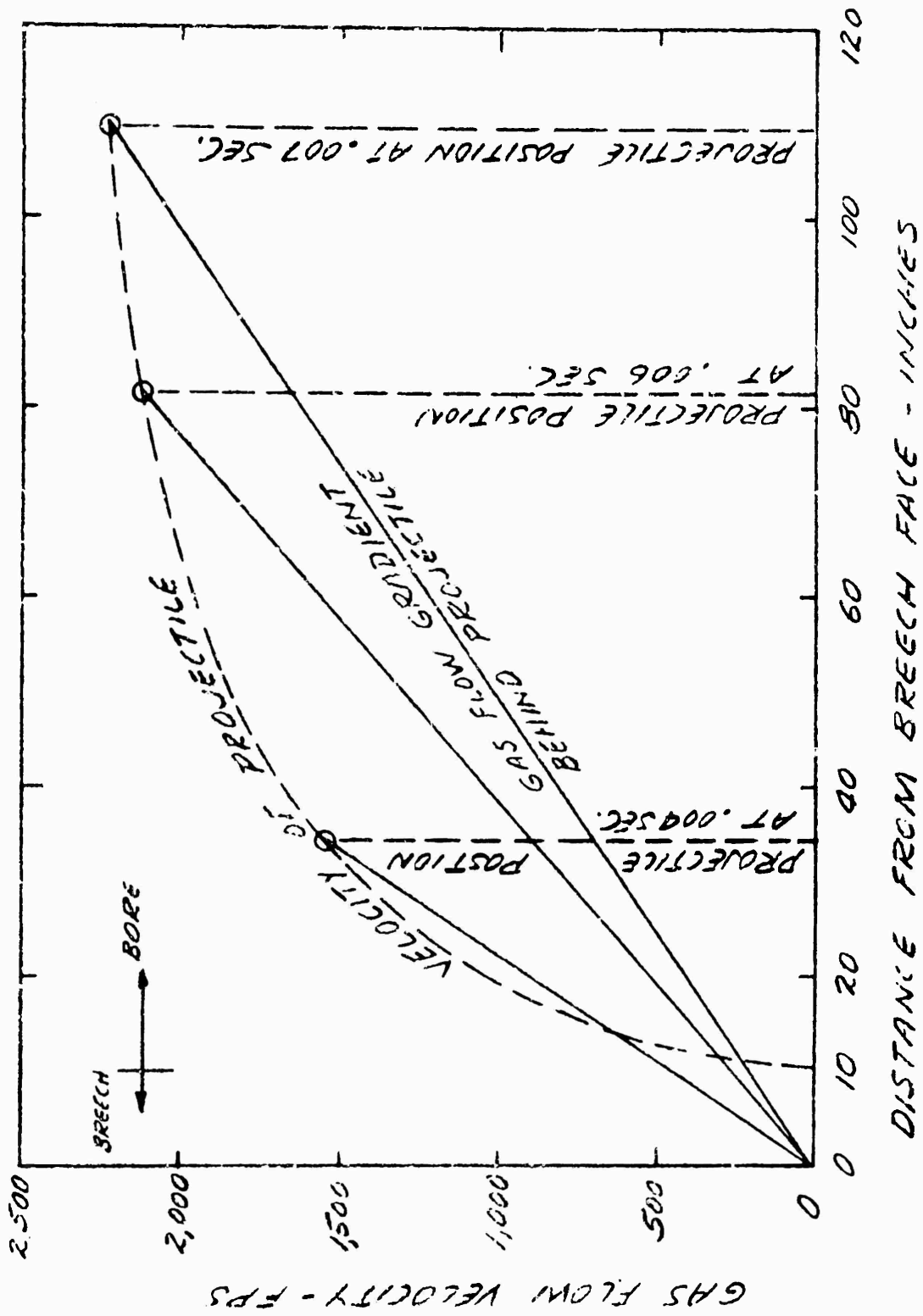
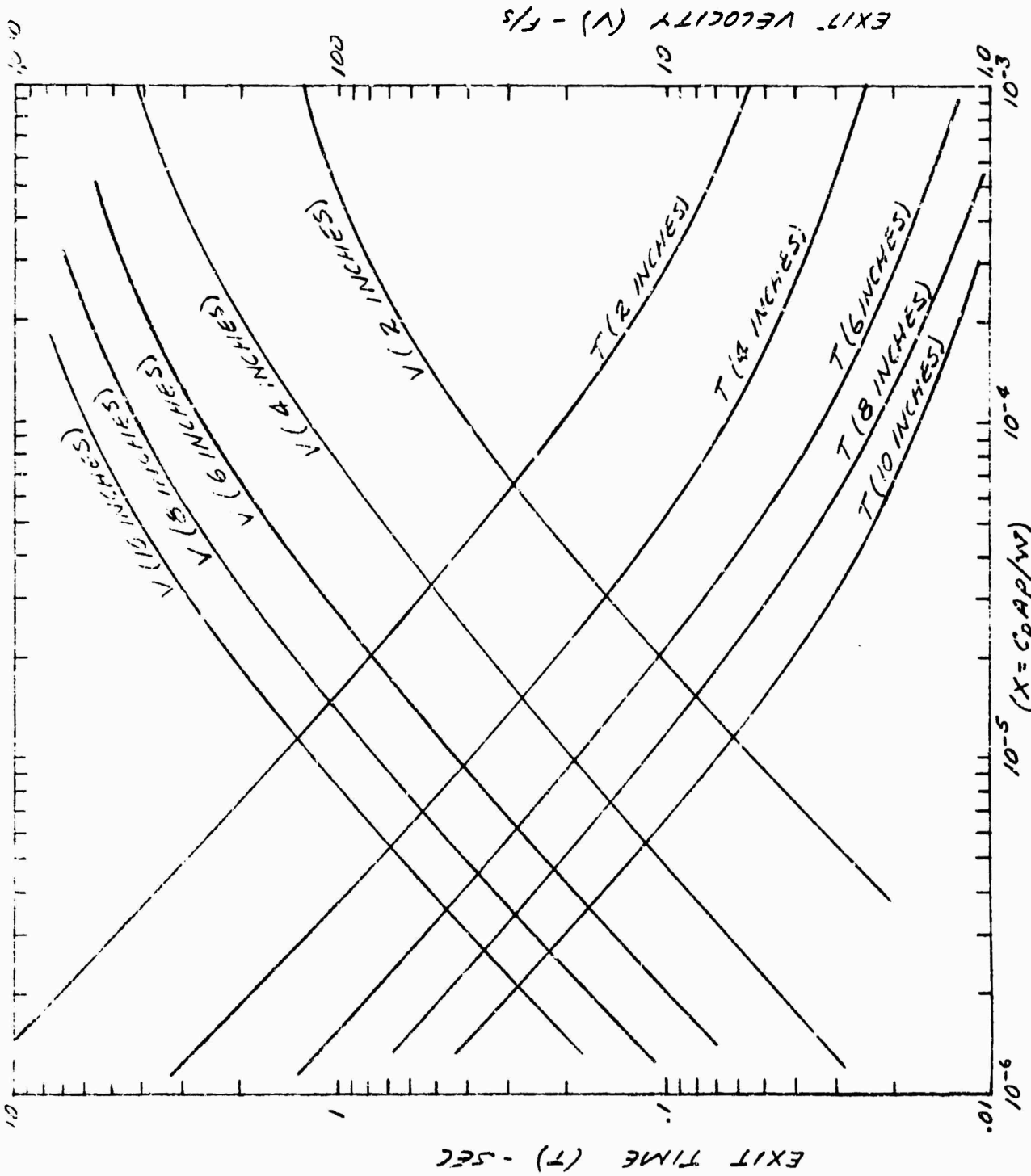

FIGURE 29 GAS FLOW GRADIENT AT VARIOUS PROJECTILE POSITIONS IN BORE



FRAGMENT EXIT TIME AND VELOCITY FOR VARIOUS INITIAL POSITIONS AS MEASURED FROM BREACH FACE

FIGURE 30 FRAGMENT MOTION



Figure 31 - CYLINDER PREPARED FOR TEST IN 20 MM  
CHAMBER USING 20 MM BRASS CASE SECTIONS  
TO SEAL FORWARD AND BASE END OF SAMPLE

Test # 5

Upper Trace,  $P_2$   
Sweep Delayed  
5 m sec.

Hor. sweep 2 m sec/cm  
Vert. sweep 10 KPSI/cm

Lower trace, P.M. Detector

Delayed 5 m sec.  
Hor. sweep 2 m sec/cm  
Vert. sweep 20 v/cm

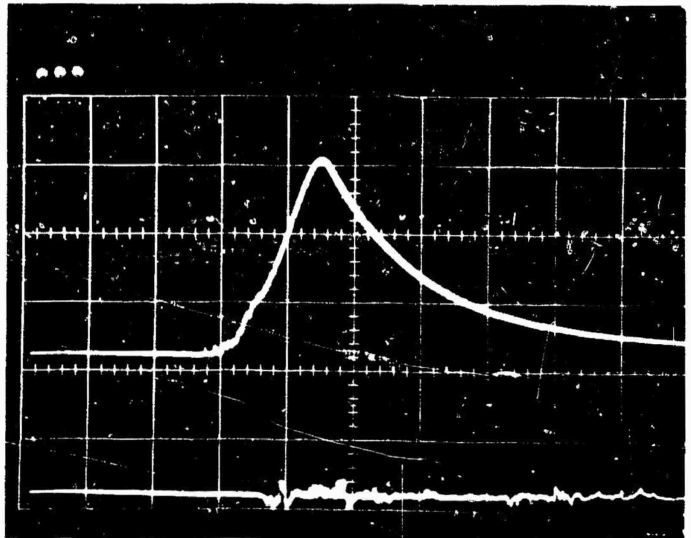

Test #5

Upper Trace,  $P_1$   
Lower trace,  $P_2$

Both traces  
Delayed 5 m sec.  
Hor. sweep 5 m sec/cm  
Vert. sweep 10 KPSI

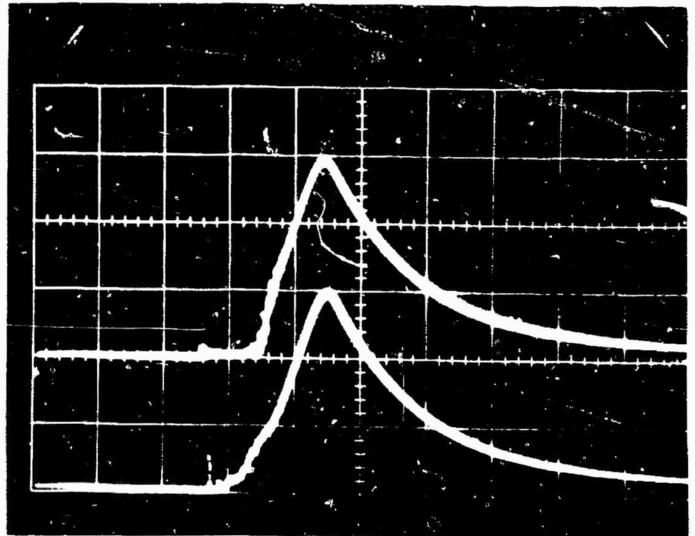

Figure 32 - VENTED BOMB RECORDS FOR TEST NO. 5

Upper Trace,  $P_1$   
Lower Trace,  $P_2$

Both traces delayed  
10 m sec

Hort. sweep 1 m sec/cm  
Vert. sweep 10 KPSI/cm

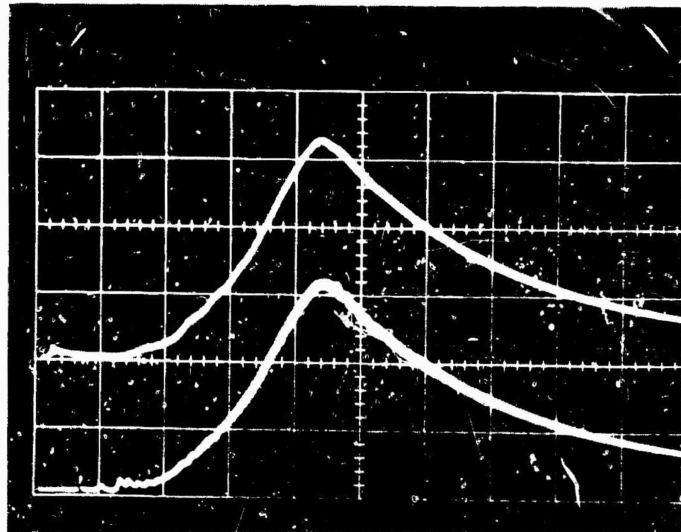

Figure 33 - VENTED BOMB RECORDS FOR TEST NO. 6

Flat Trace  $P_1$   
Curved Trace  $P_2$

Both traces delayed  
10 m sec

Hort. sweep 1 m sec/cm  
Vert. sweep 10 KPSI/cm  
(Steel cylinder in place  
of glass test cylinder)

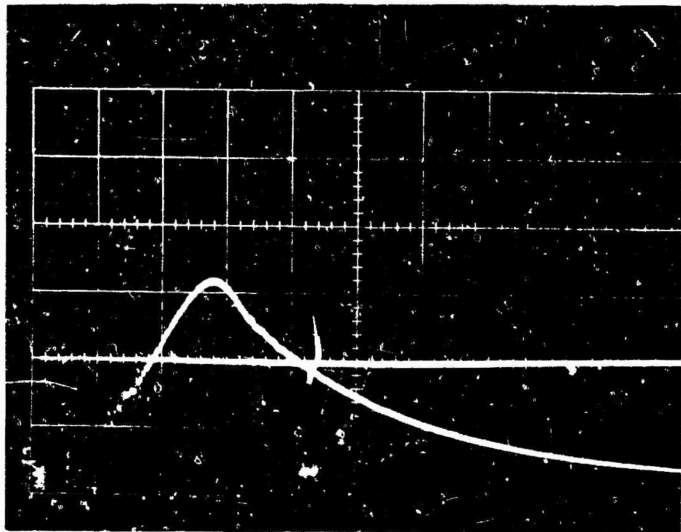

Figure 34 - VENTED BOMB RECORD FOR TEST NO. 8

Upper Trace P<sub>1</sub>

Lower Trace P<sub>2</sub>

Both delayed 10 m sec.

Hort. sweep 1 m sec/cm

Vert. sweep 5X SI (reduced  
propellant charge to eliminate  
high stress condition at time  
of ignition)

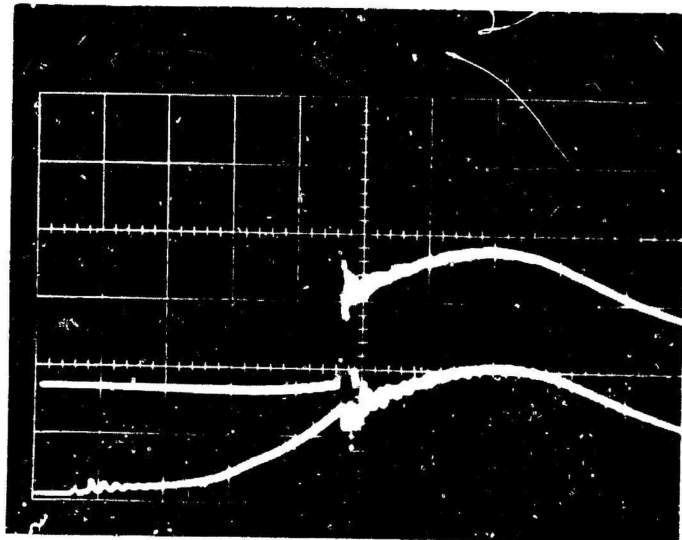

Figure 35- VENTED BOMR RECORD FOR TEST NO. 9

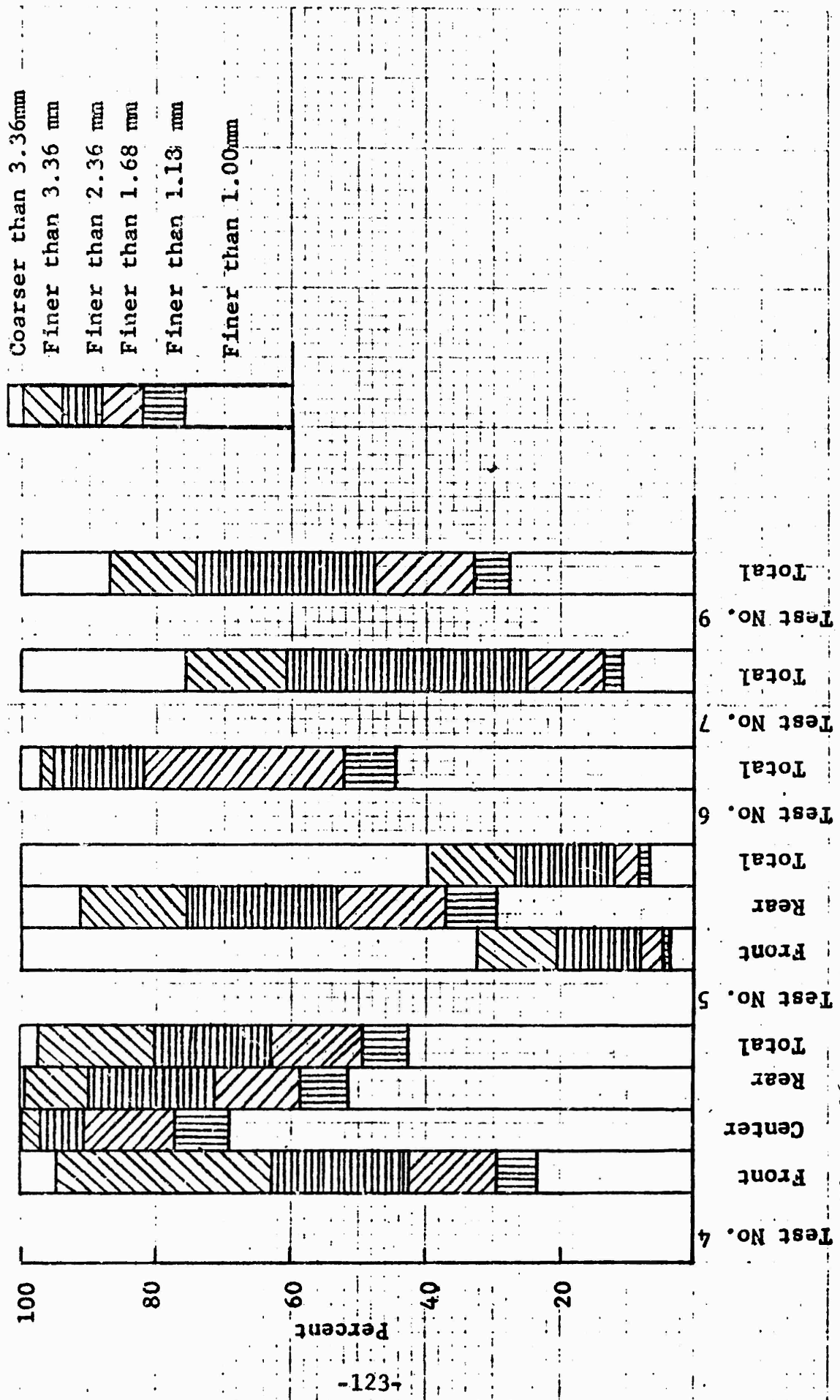

Figure 36 - PARTICLE SIZE DISTRIBUTION IN VENTED BOMB TESTS

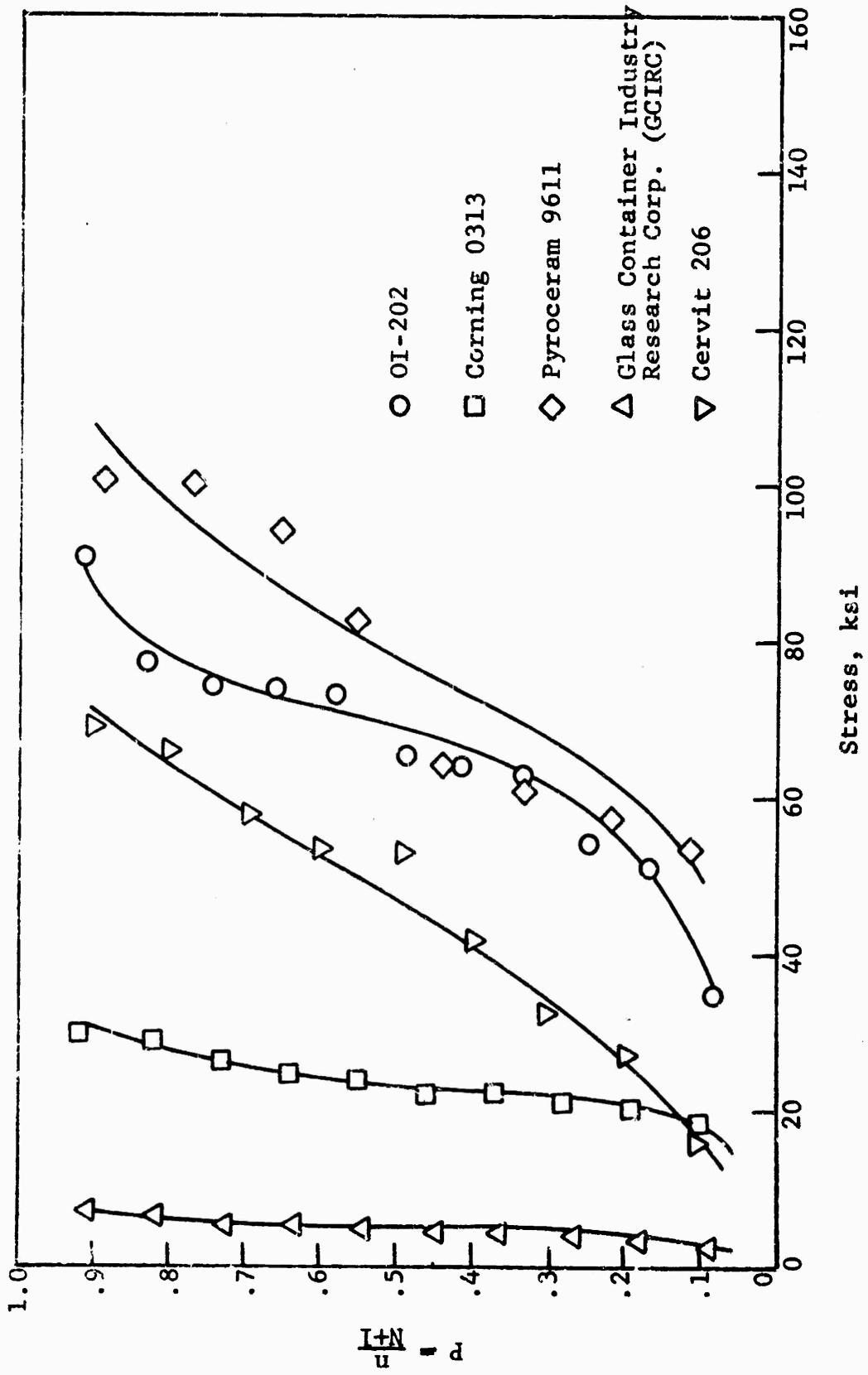

Figure 37 - DIAMETRAL TENSION STRENGTH FOR CANDIDATE MATERIALS

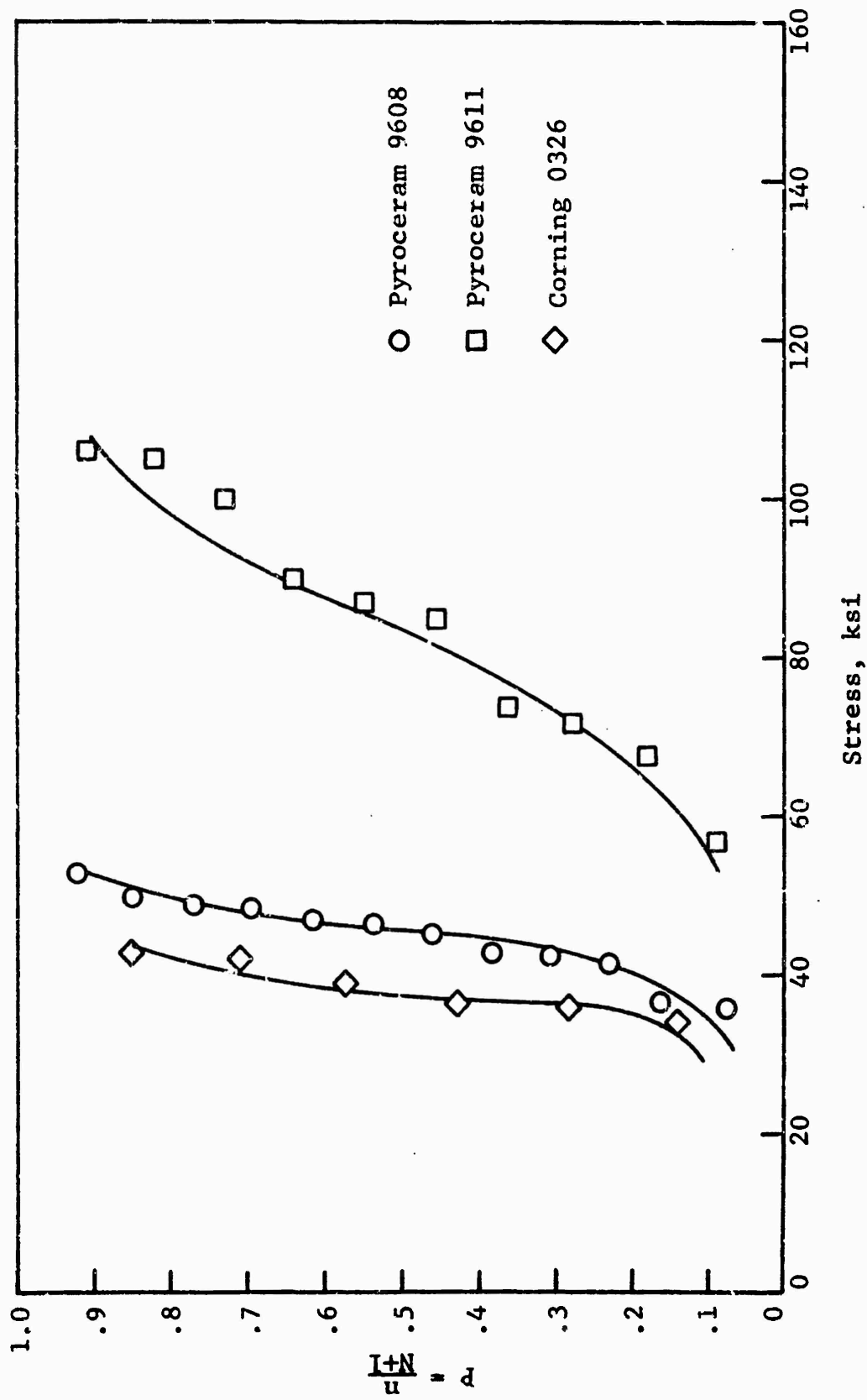

Figure 38 - FLEXURAL STRENGTH OF CANDIDATE MATERIALS

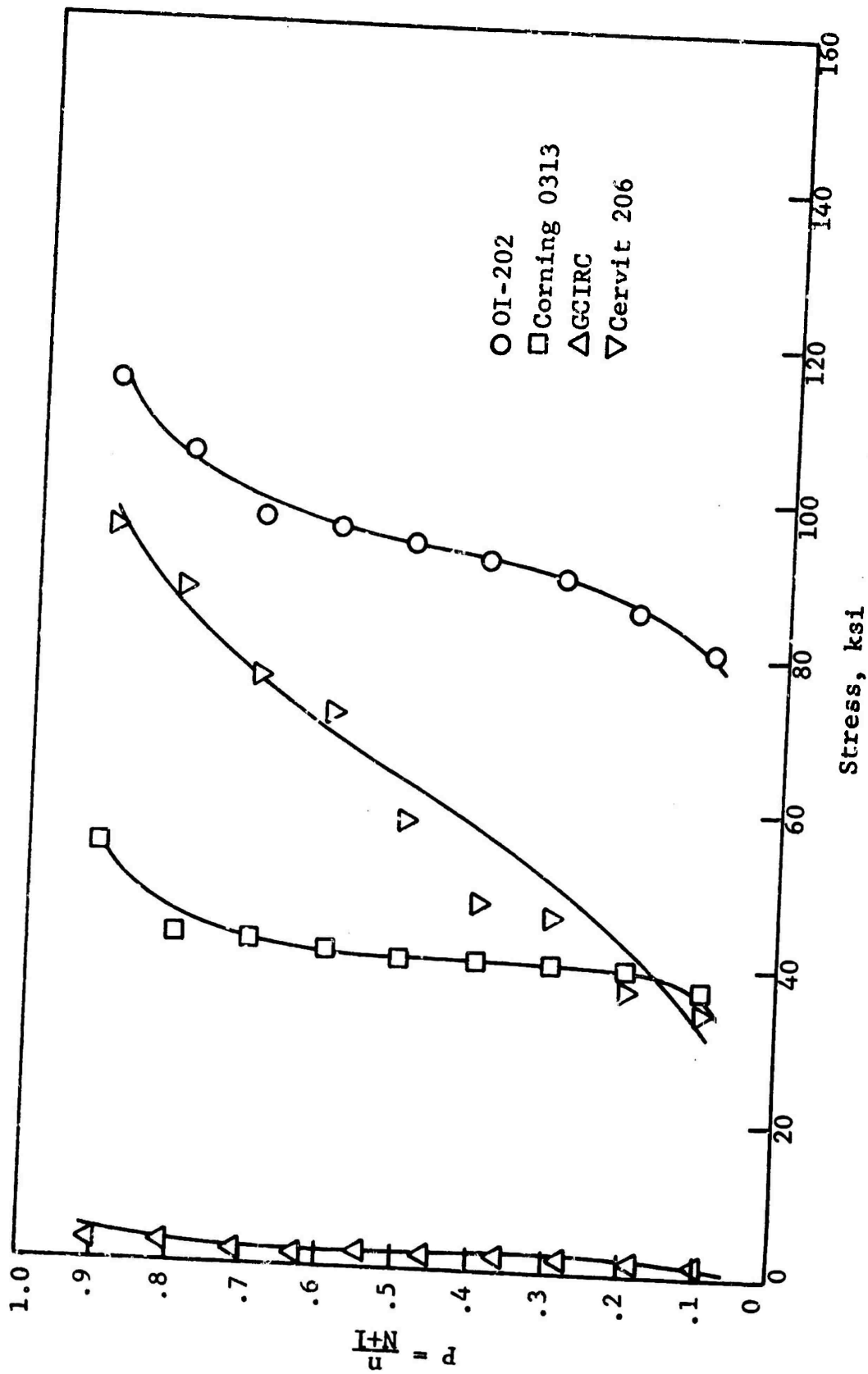

Figure 39 - IMPACT STRENGTH OF CANDIDATE MATERIALS

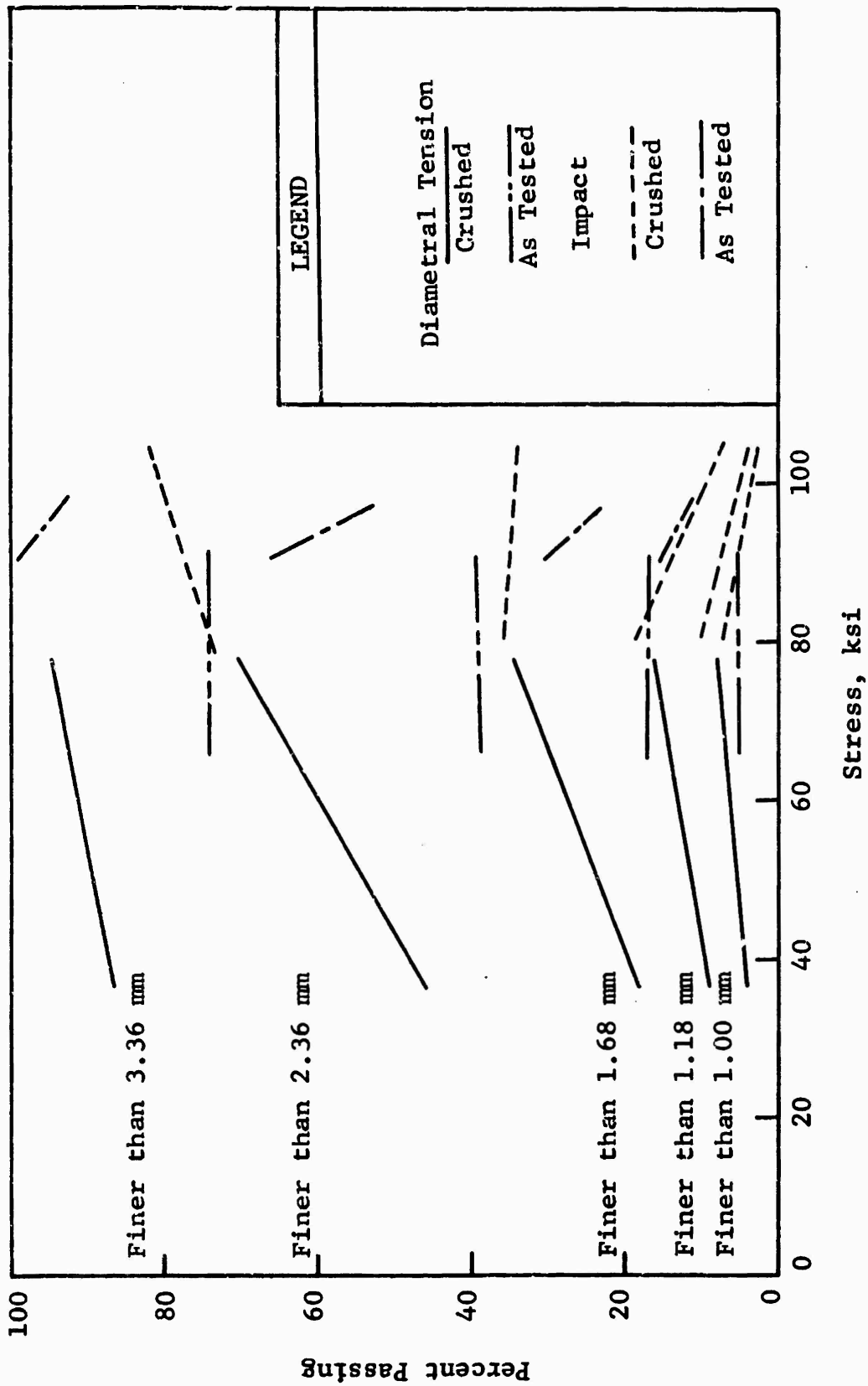

Figure 40 - PARTICLE SIZE ANALYSIS - OI 202 GLASS

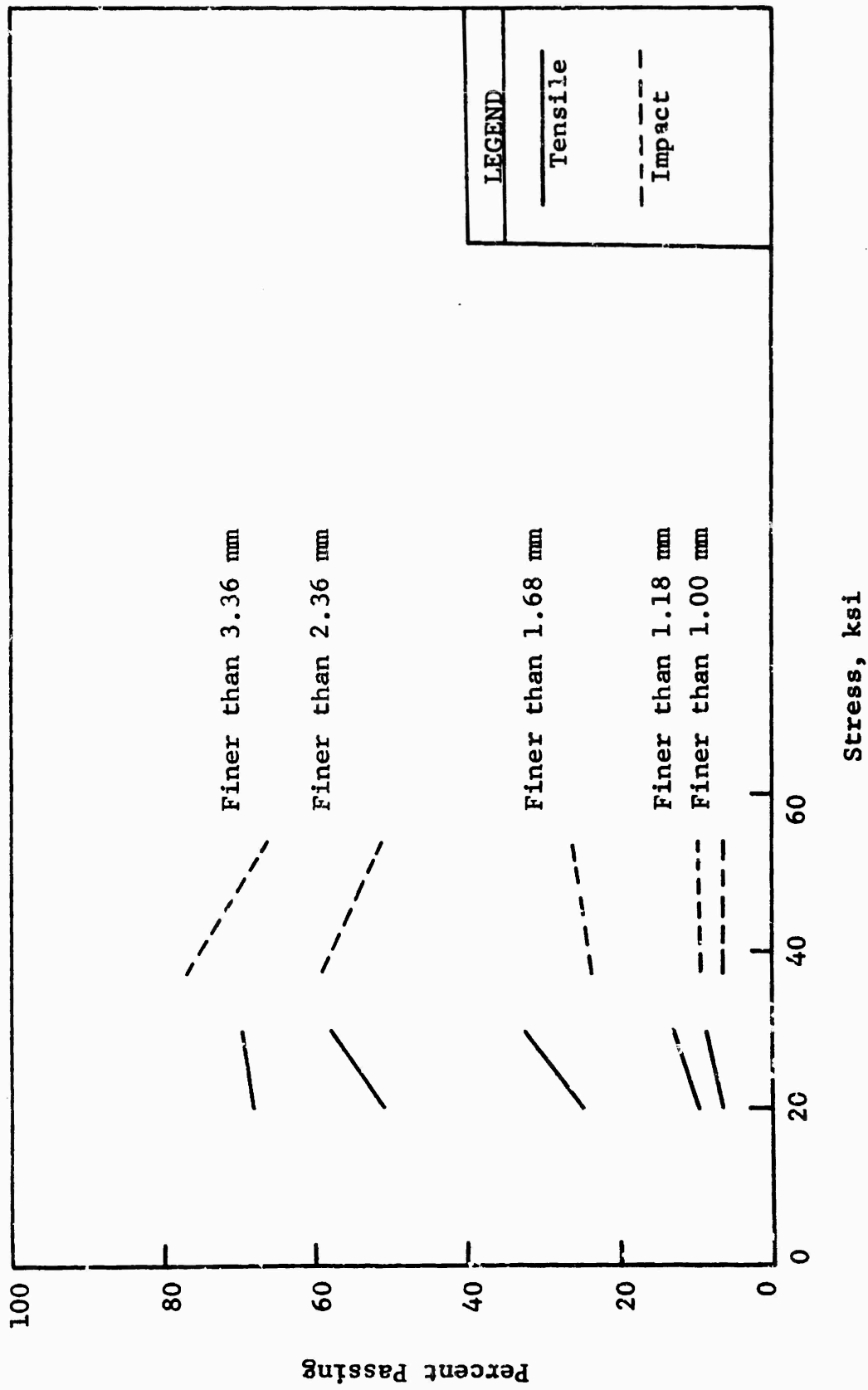

Figure 41 - PARTICLE SIZE ANALYSIS, CORNING 0313 GLASS

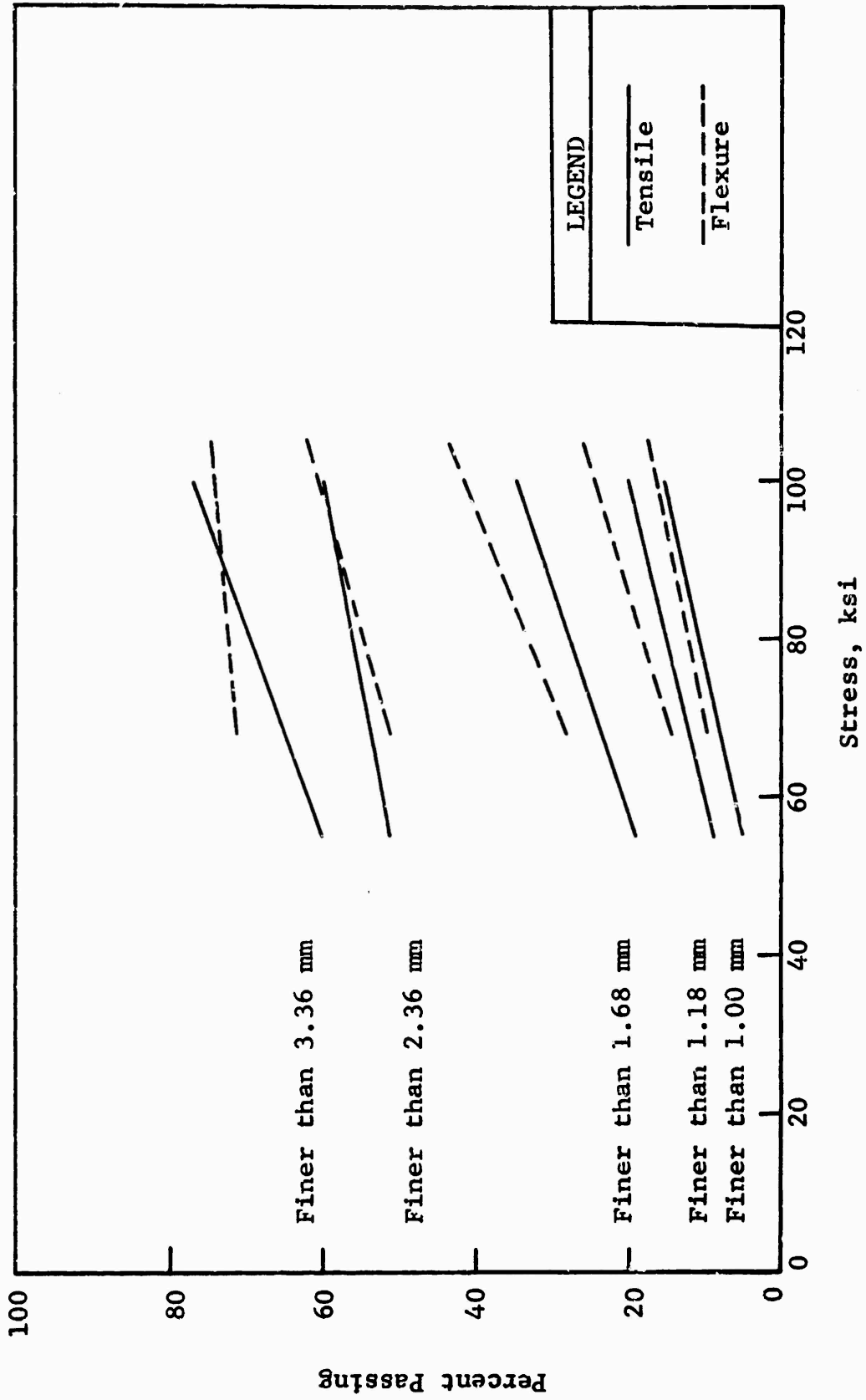
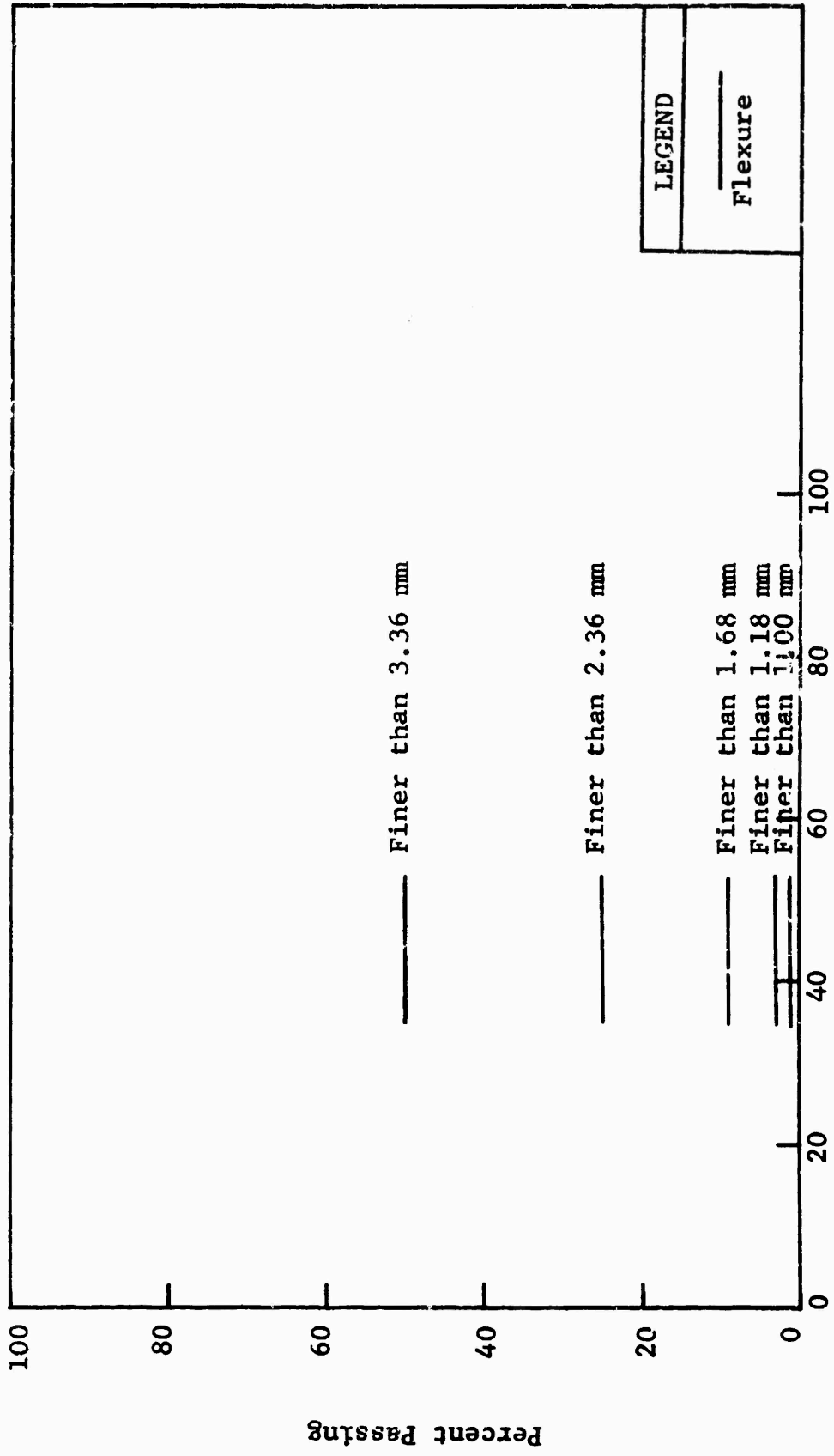

Figure 42 - PARTICLE SIZE ANALYSIS, PYROCERAM 9611 GLASS-CERAMIC



Stress, ksi

Figure 43 - PARTICLE SIZE ANALYSIS, PYROCERAM 9603 GLASS-CERAMIC

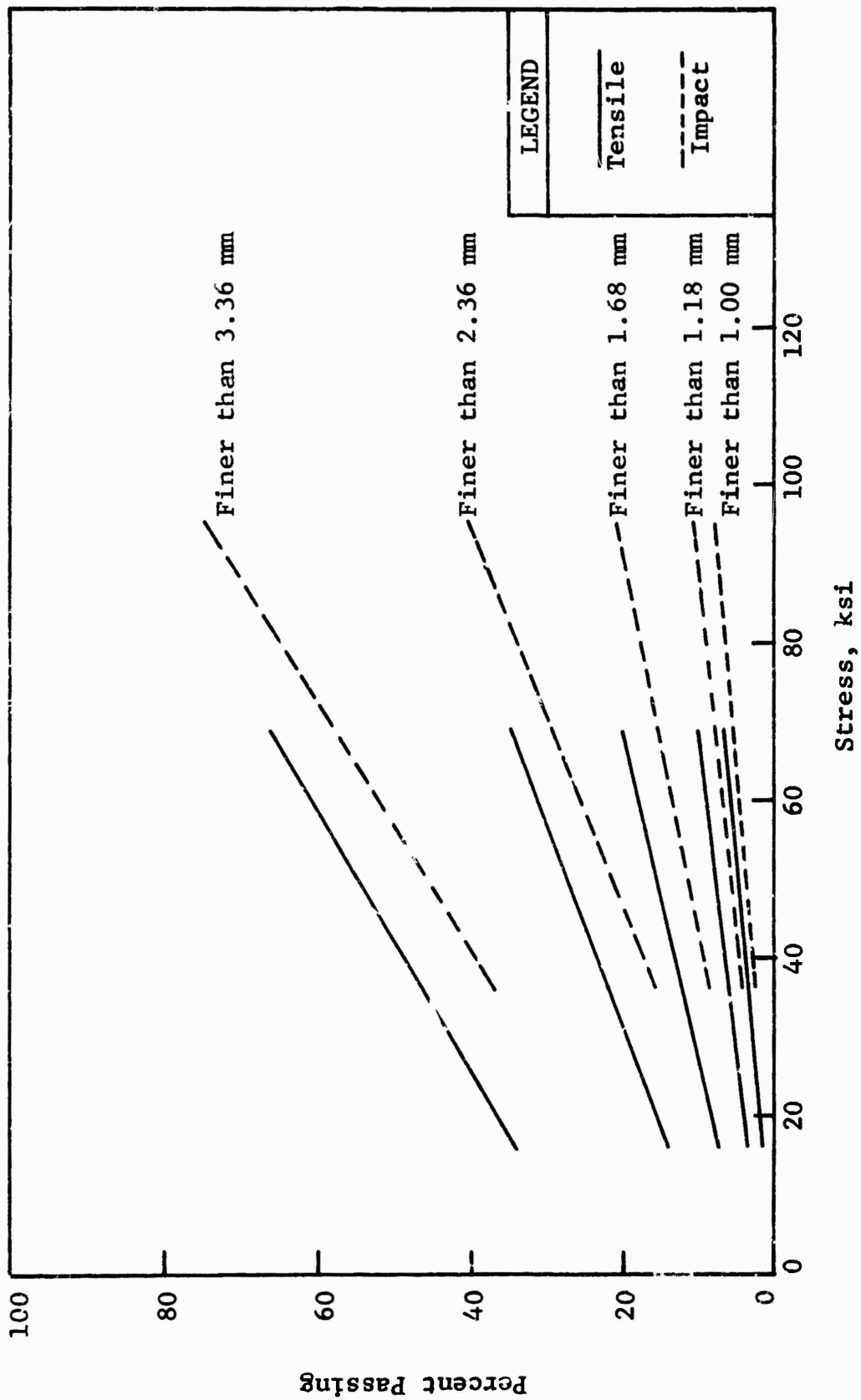

Figure 44 - PARTICLE SIZE ANALYSIS, CERVIT 206 GLASS-CERAMIC



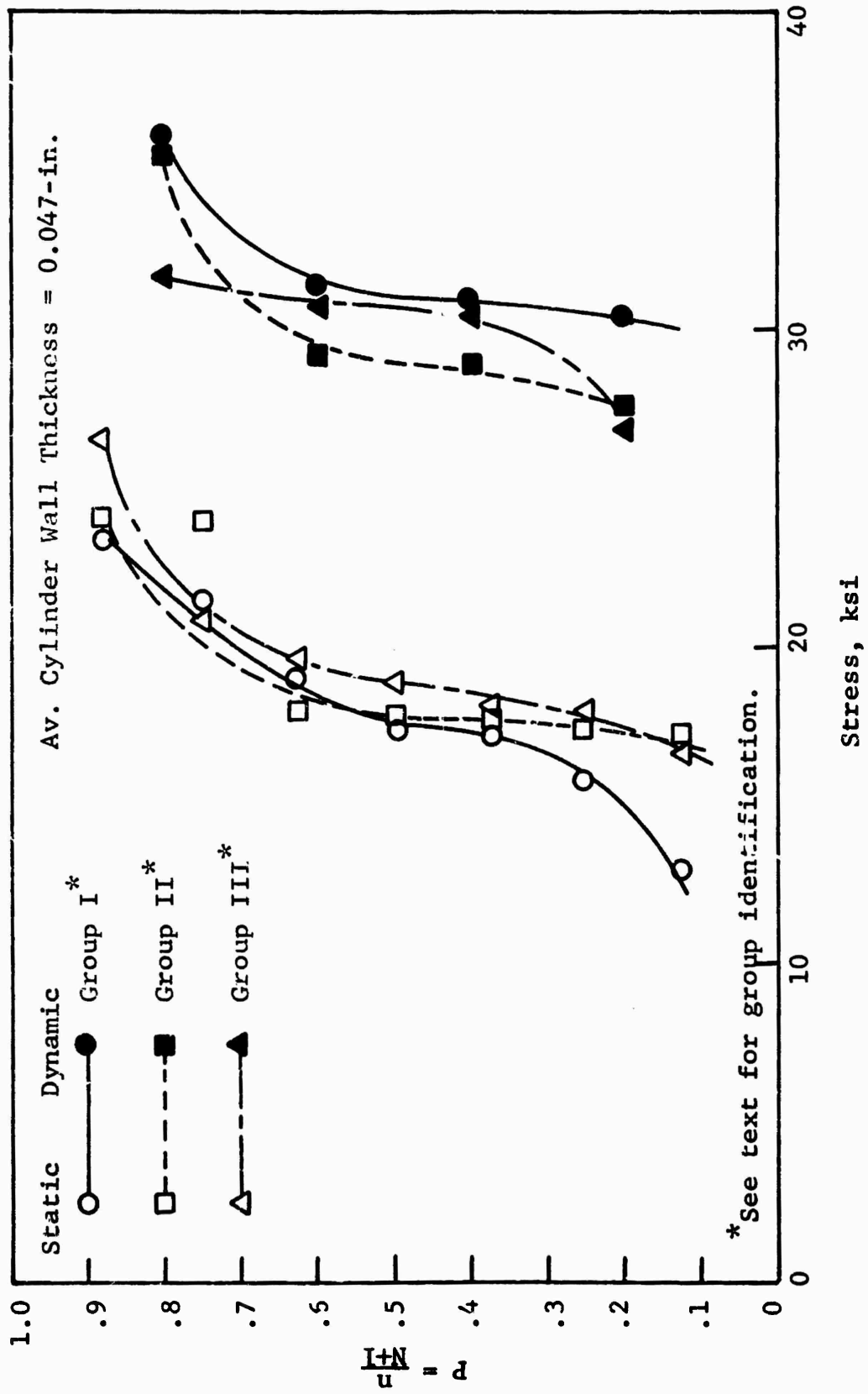

Figure 46 - STATIC AND DYNAMIC STRENGTH TESTS ON CORNING 0313 GLASS CYLINDERS - GROUPS I, II, AND III

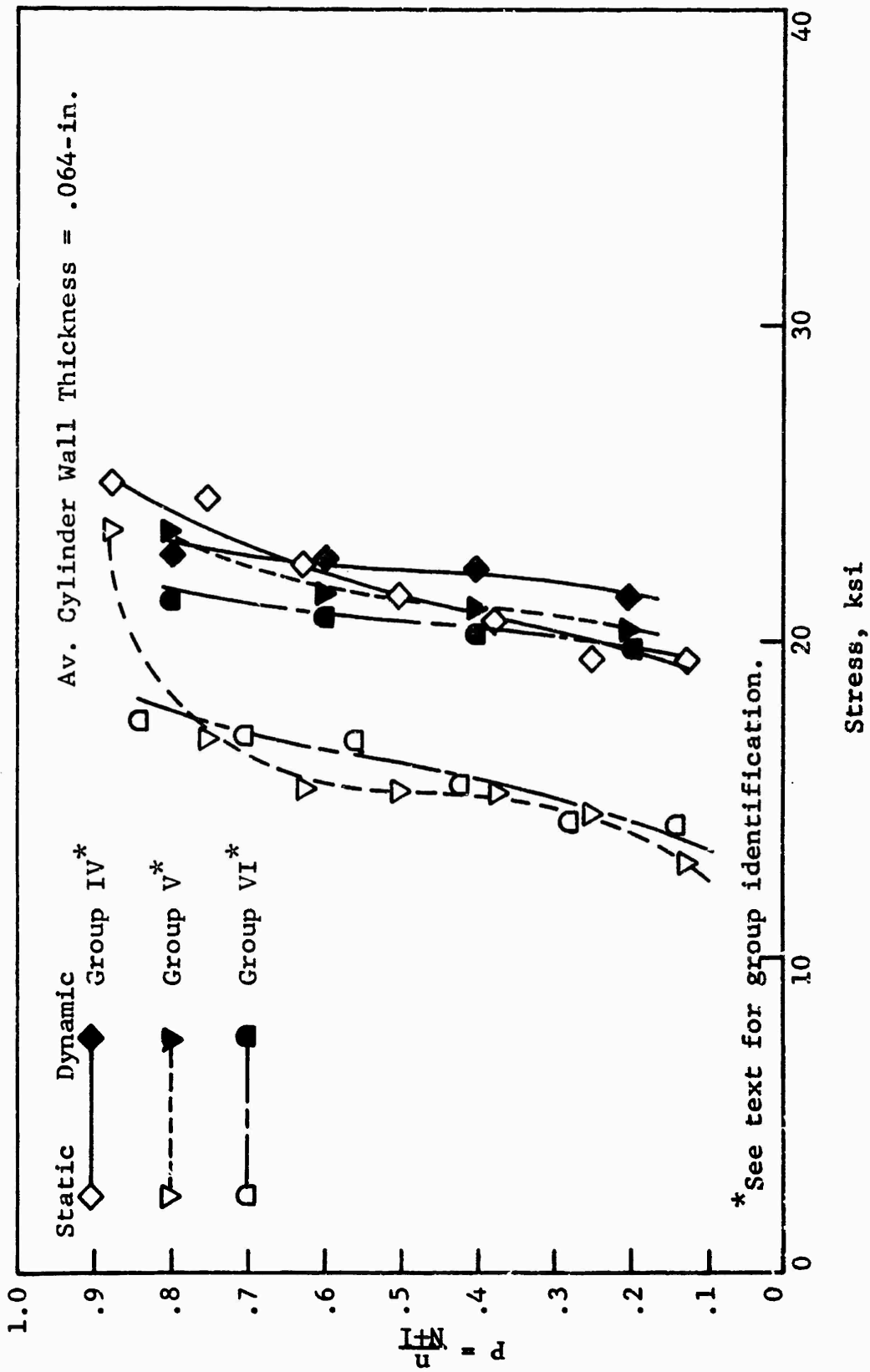
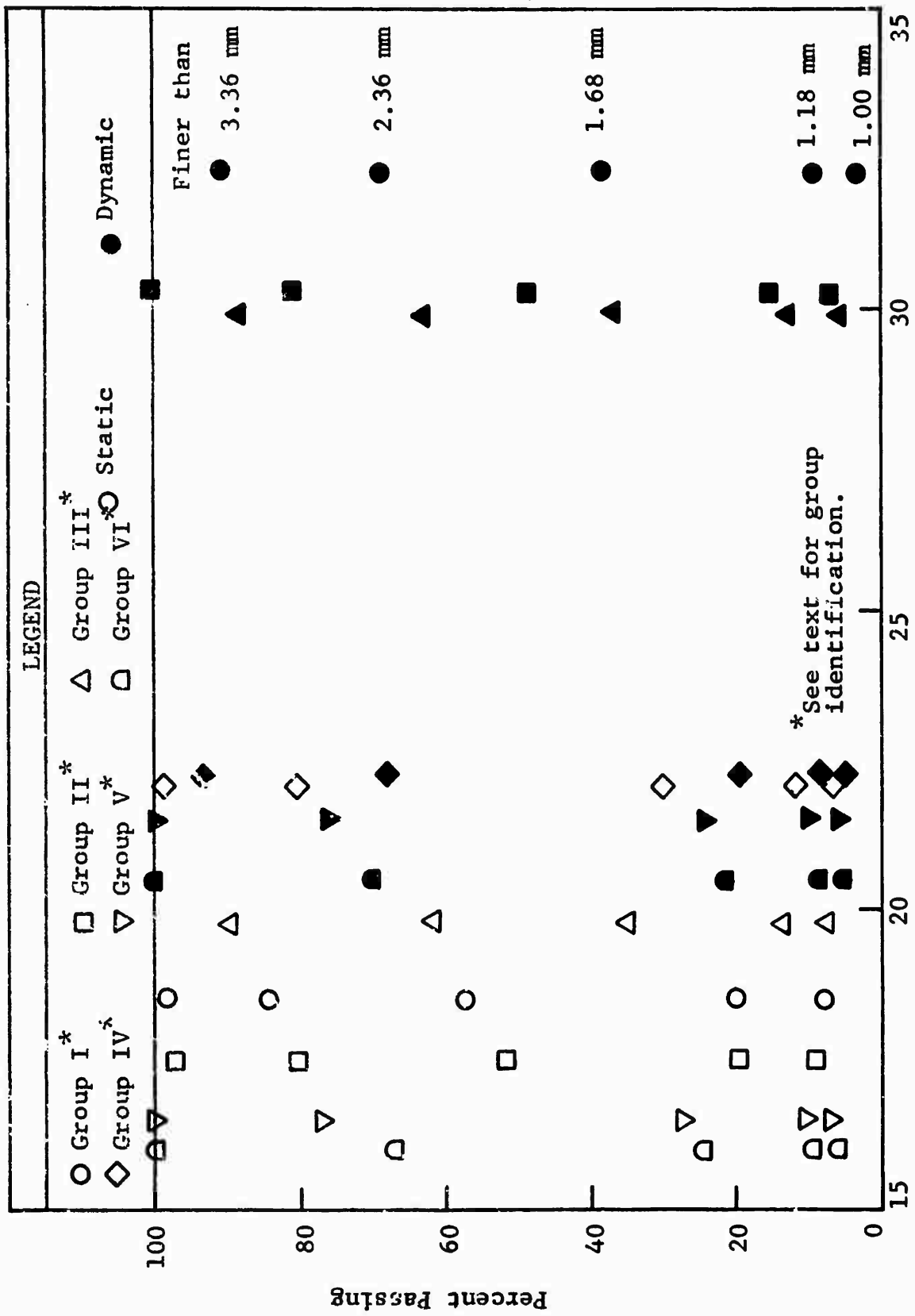

Figure 47 - STATIC AND DYNAMIC STRENGTH TESTS ON CORNING 0313 GLASS CYLINDERS - GROUPS IV, V AND VI.



Stress, ksi

Figure 48 - PARTICLE SIZE ANALYSIS FOR CORNING 0313 CYLINDERS

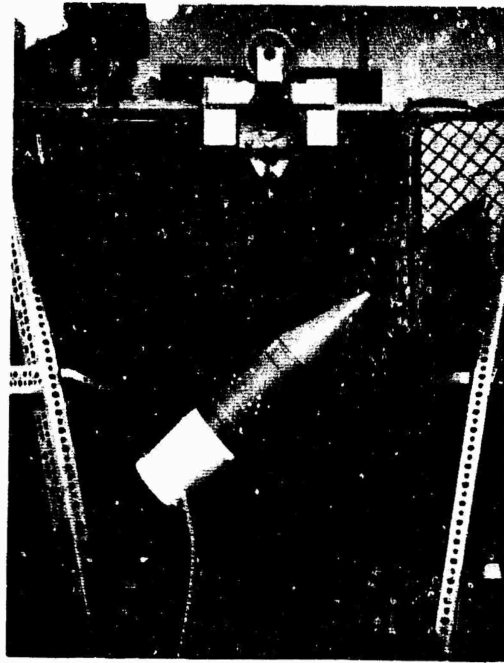

Figure 49. IITRI FACILITY FOR MECHANICAL TESTING  
OF 152 mm AMMUNITION

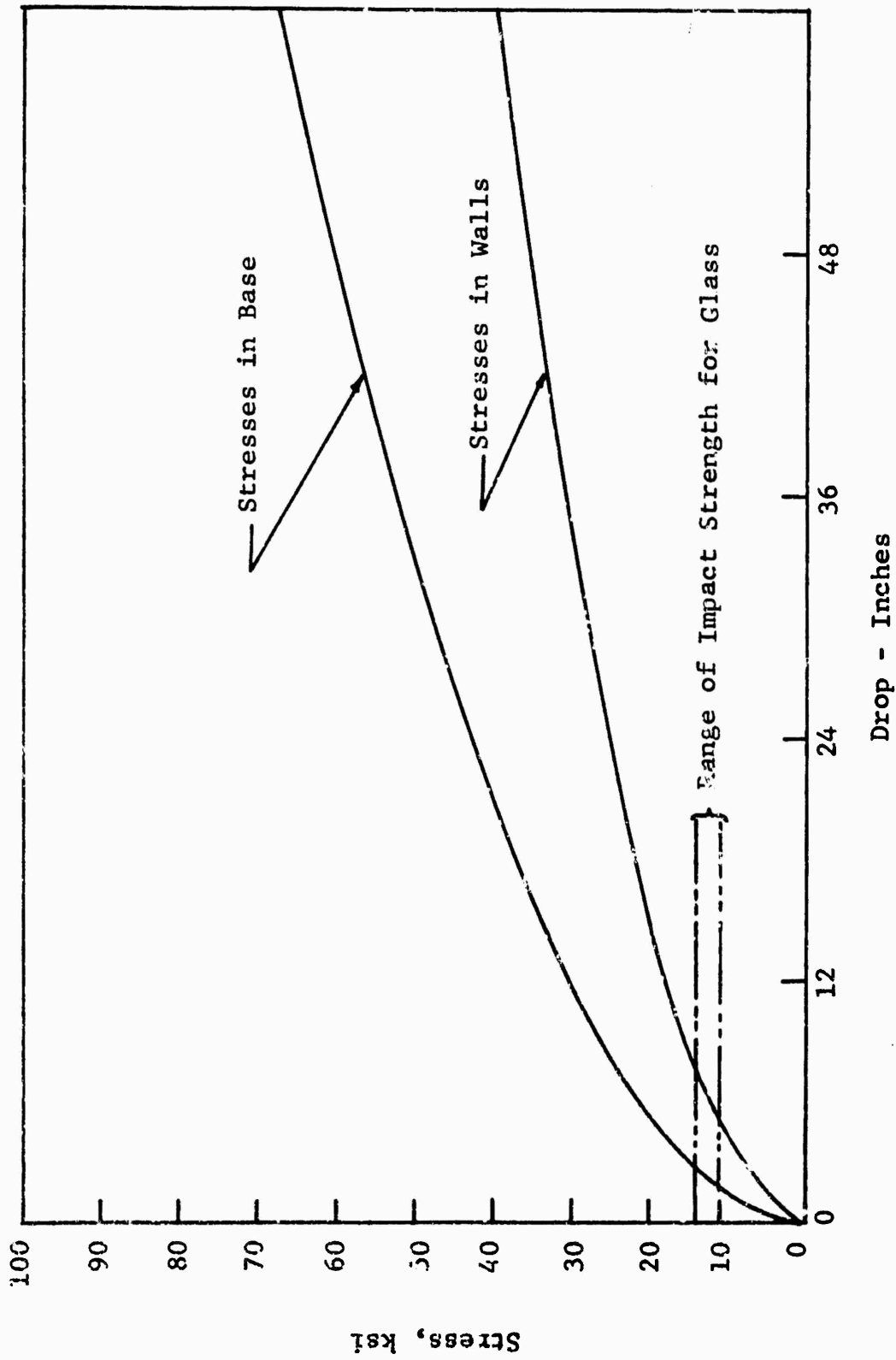

Figure 50 - IMPACT STRESSES IN GLASS VS HEIGHT OF DROP

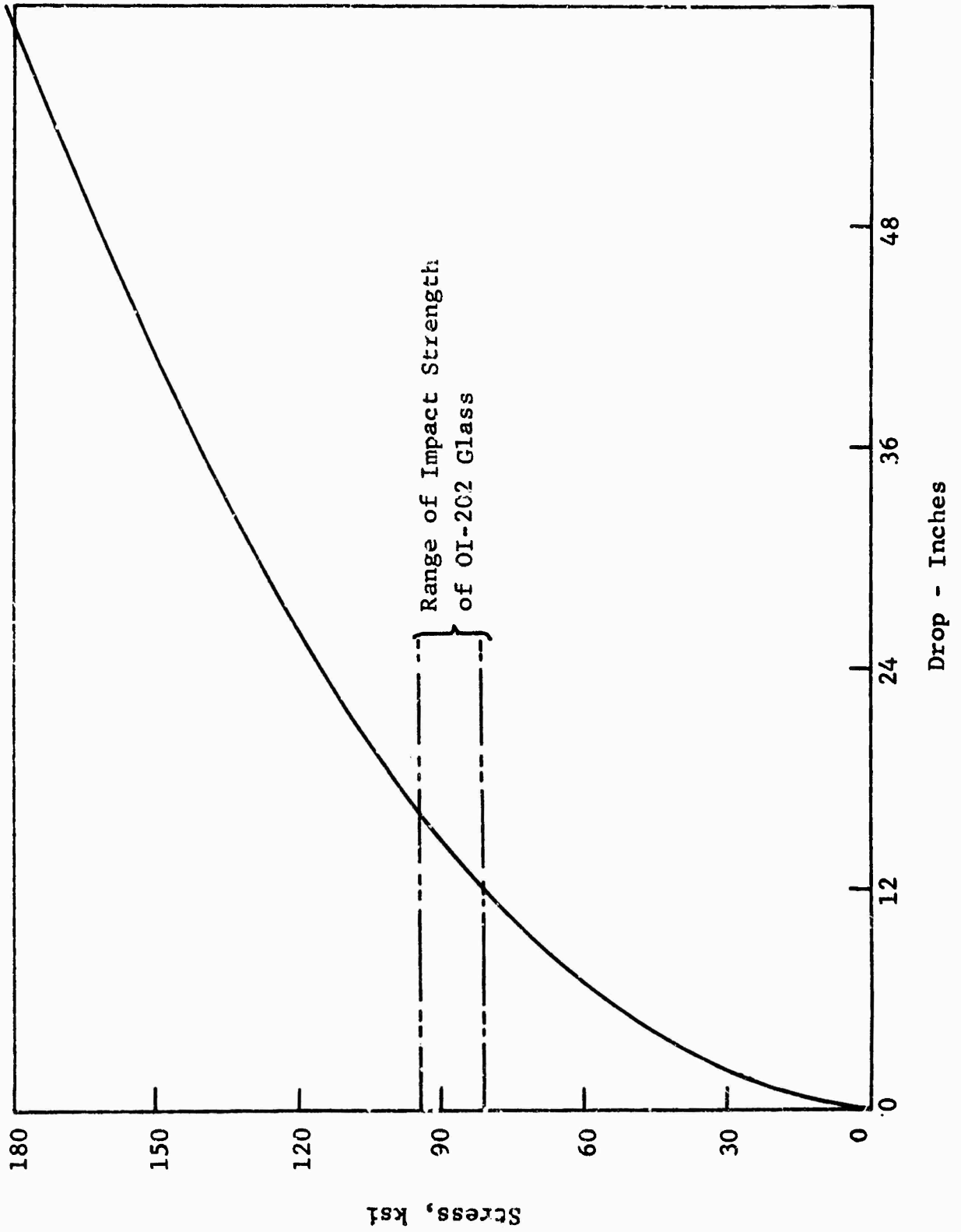

Figure 51 - BUCKLING STRENGTH OF GLASS CYLINDERS UNDER IMPACT LOADING

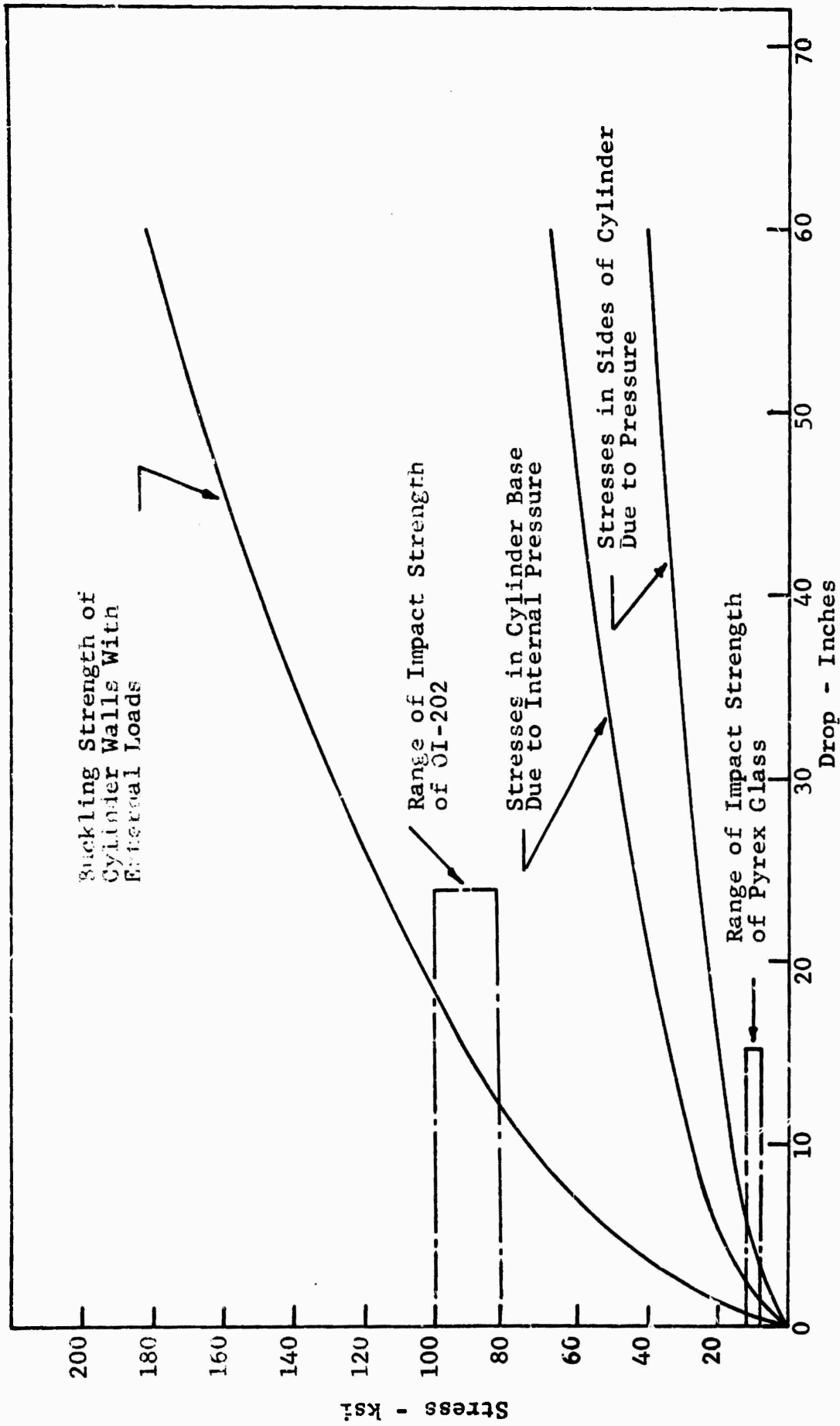

Figure 52 - IMPACT STRESSES IN CLOSED CYLINDERS

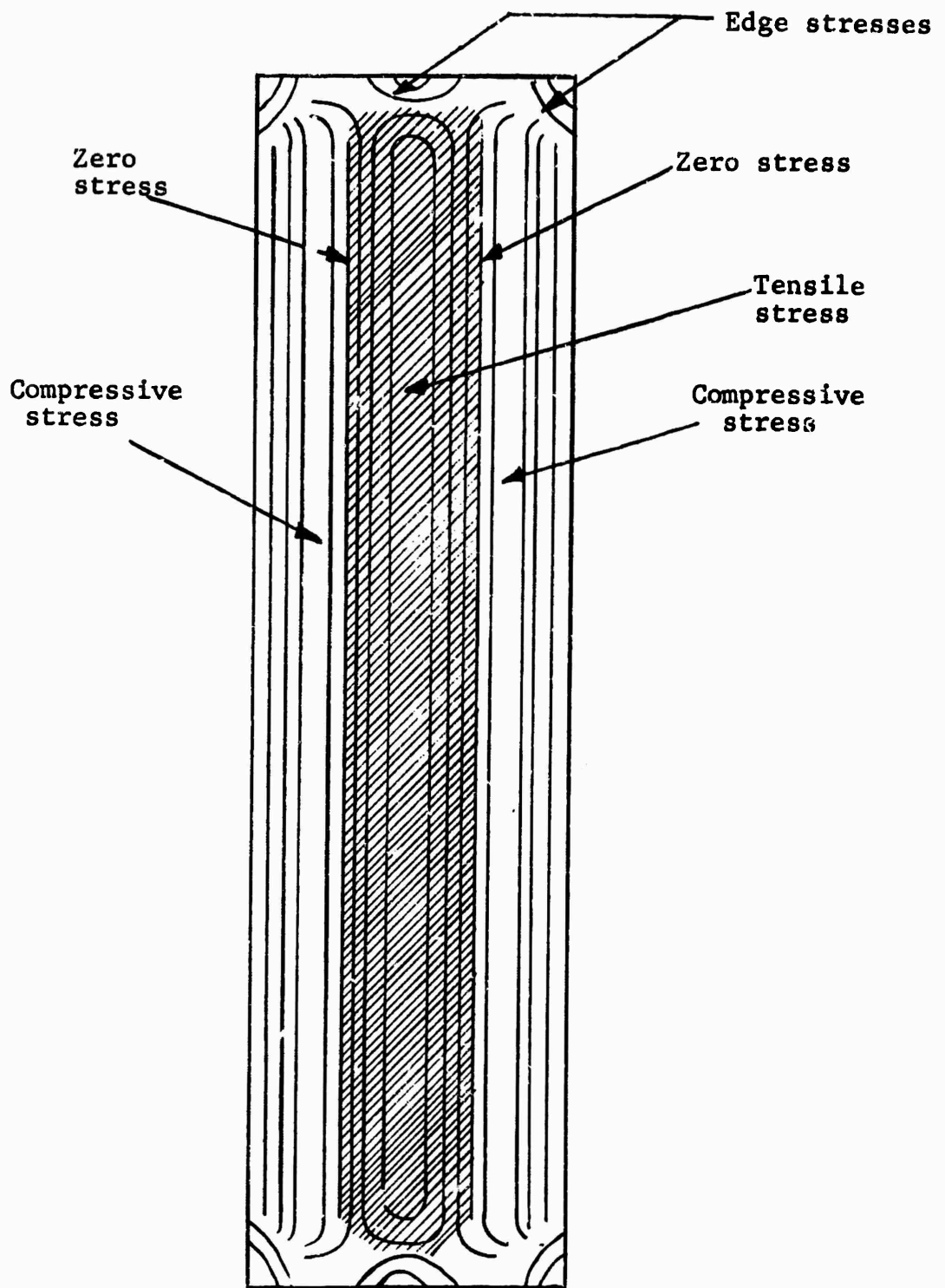

Figure 53. - SCHEMATIC REPRESENTATION OF THE STRESSES IN A CHEMICALLY TEMPERED GLASS PLATE (EDGE VIEW)