

NRL Report 7116

AD 713060

USNS MIZAR 1970

W. L. JONES

*Ship Facility Group
Oceanology Department*

September 17, 1970



NAVAL RESEARCH LABORATORY
Washington, D.C.

This document has been approved for public release and sale; its distribution is unlimited.

OCT 26 1970

CONTENTS

Abstract	iii
Problem Status	iii
Authorization	iii
Frontispiece	iv
INTRODUCTION	1
BACKGROUND	2
SHIP'S COMPLEMENT	6
SCIENTIFIC LIVING AND MESSING FACILITIES	6
LABORATORY AREAS AND SCIENTIFIC EQUIPMENT	7
SCIENTIFIC WORKSHOPS AND STOWAGE SPACES	10
LABORATORY POWER DISTRIBUTION SYSTEM	10
COMMUNICATION SYSTEM	12
ACOUSTIC RAY TRACKING SYSTEM	14
CENTER-WELL INSTALLATION	14
DECK MACHINERY	20
OTHER FEATURES	25
CONCLUSION	26
Appendix A – SHIP'S CHARACTERISTICS	28
Appendix B – DECK EQUIPMENT SUMMARY	29

ABSTRACT

The USNS MIZAR was built in 1957 to serve as a supply ship for American military bases and scientific expeditions in the polar regions. In 1964, MIZAR was acquired by the Naval Research Laboratory to function as a seaborne scientific research platform for oceanographic research. Since her reassignment, she has undergone four major modifications which are part of a six-step master plan to convert MIZAR from a polar cargo ship to a modern oceanographic research vessel.

At present, MIZAR is equipped to comfortably accommodate 19 scientists and allow them to perform many diversified operations at sea. The modern chemical and biological laboratory and variety of deck machinery allow the oceanographers to conduct numerous experiments from this steady working platform. MIZAR's electronic facilities, such as the laboratories, workshops, and power capability, meet the requirements for various acoustics operations. The center-well installation and acoustic-ray tracking system have made this ship well suited for deep-sea research work, as well as search and recovery of lost equipment.

MIZAR will be even more versatile when the conversion is completed. Future plans include the construction of a wet laboratory to be located on the main deck, and the installation of a work boat to provide the necessary transportation for short errands while operating at sea.

PROBLEM STATUS

This is a final report on one phase of the problem; work on the other phases is continuing.

AUTHORIZATION

NRL Problem K03-19
Project RR 104-03-41-5904

Manuscript submitted April 10, 1970

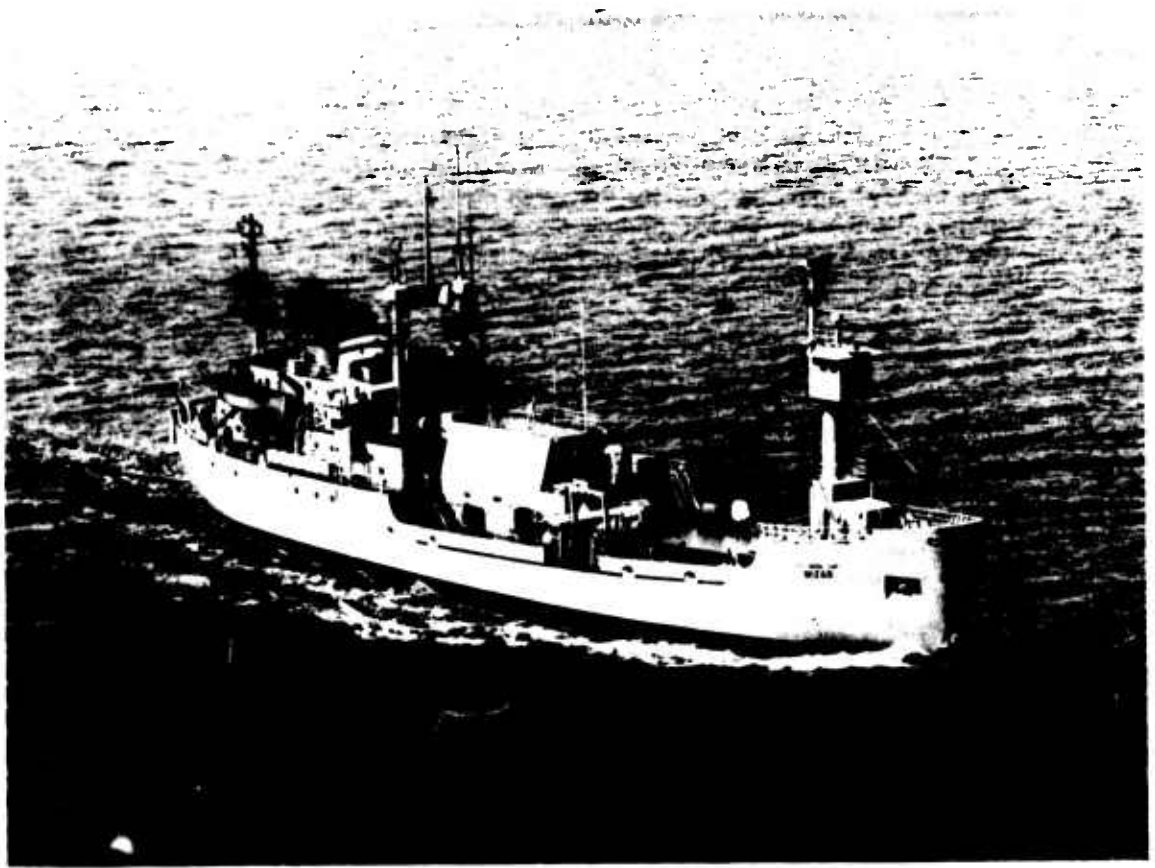

USNS MIZAR (T-AGOR 11)

USNS MIZAR, 1970

INTRODUCTION

The function of the oceanographic research ship is to carry scientists and instruments to sea for the purpose of conducting oceanographic research. This research consists of the study of sea-surface behavior, current structure of the ocean, oceanic temperatures, marine meteorology, environmental effects on instruments and techniques, earth's gravity and magnetic fields, bottom topography, sediments, and structure, heat flow through the ocean floor, sound transmission and velocities, ambient noise, biological activity and specimens, nuclear components, and water samples for salinities, phosphates, oxygen, and nitrates.

The research ship serves as the oceanographer's working platform and is a very important research tool. At present, a wide variety of ships is being utilized in research efforts. Some of these ships are originally designed and constructed for oceanographic research. Other oceanographic ships are conversions from other types of vessels. The Naval Research Laboratory has use of such a vessel, the USNS MIZAR (T-AGOR 11), which has been converted from an Arctic and Antarctic supply ship to a seaborne scientific research platform for oceanographic research.

The mission of USNS MIZAR is to serve as a general-purpose ocean-going vessel for the Naval Research Laboratory in the support of the Navy research effort in the areas of acoustics, ocean science, and ocean technology. NRL sponsors and technically controls the operation of MIZAR. Under this sponsorship, the operation and utilization of the vessel is coordinated, and the availability of facilities and equipment is assured. NRL provides assistance in the installation, maintenance, and at-sea operation of scientific systems and equipment utilized by the various research groups in the performance of experiments.

Since her assignment to NRL, MIZAR has engaged in oceanographic research operations for the following divisions of the Laboratory:

- Acoustics Division, for acoustic measurements and other data reflecting changes in oceanic properties to support research projects associated with undersea surveillance, acoustic warfare, sonar systems, and underwater sound propagation.

- Ocean Sciences Division, for collection of data and samples to support studies in chemical, biological, and physical oceanography, and marine atmospheric physics. Scientists of this division perform at-sea experiments aboard MIZAR to analyze seawater for dissolved gases, for halides, for particulates, for various types of microorganisms, and for biological productivity. They also investigate the relationships among the physical, chemical, and biological parameters of seawater. On-board techniques developed and practiced in this research include gas chromatography, electrochemistry, atomic absorption spectrophotometry, polarography, and reflectance spectrophotography.

- Ocean Technology Division, for collection of data to support research and development in ocean engineering and materials. Scientists and engineers of this division have also found MIZAR to be an extremely valuable deep-ocean search tool, since they located and photographed the lost submarines THRESHER, SCORPION, and EURYDICE, assisted

in the location and recovery of the lost H-Bomb off the coast of Spain, and located, photographed, and recovered the lost submersible ALVIN (Figs. 1,2).

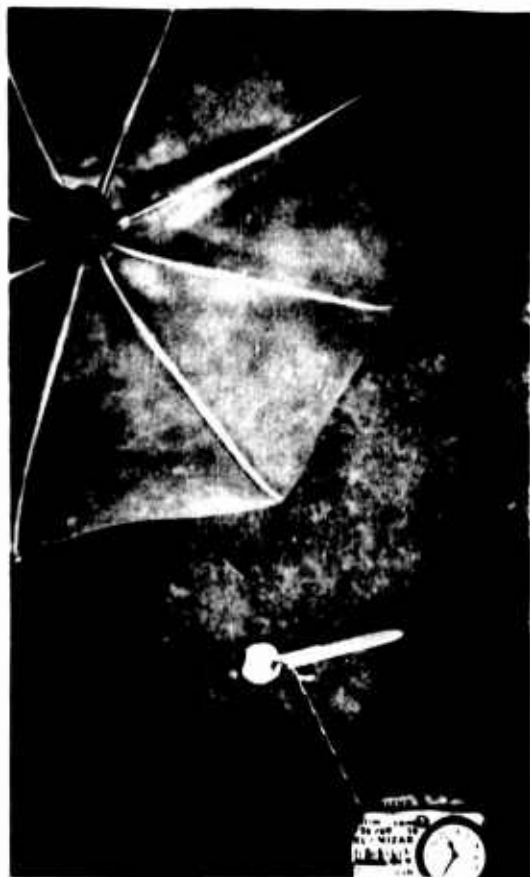

Fig. 1 - Photograph of octopus taken by cameras towed from MIZAR at a depth of about 13,000 ft off St. Croix, Virgin Islands, in November 1969

BACKGROUND

The USNS MIZAR was built in 1957 by Avondale Marine Ways, Incorporated, New Orleans, Louisiana. She is of welded steel construction, is 266 ft long by 51 ft 6 in. in the beam, has a full-load displacement of 3886 tons, and has a cruising speed of approximately 12 knots (Appendix A). Designed as an ice-strengthened supply ship, with double hull and ice-breaker bow, MIZAR made several trips to the Arctic and Antarctic regions supplying American military bases and scientific expeditions in the polar regions. She is named for one of the twin stars in the handle of the "Big Dipper," the constellation Ursa Major.

In 1964 MIZAR was modified at the Savannah Machine and Foundry Company, Savannah, Georgia, in the first step in a planned series of changes. This first modification was performed in an effort to provide a platform from which Naval Research Laboratory personnel could search for the lost submarine THRESHER, which had sunk the previous year, 220 mi east of Boston in 8400 ft of water. Almost immediately MIZAR gained international prominence by locating and photographing the hull of the nuclear submarine.



Fig. 2 - A part of the lost submarine THRESHER, photographed by NRL scientific personnel aboard MIZAR during Atlantic operations in August 1964

Further modification of MIZAR was continued at the Philadelphia Naval Shipyard in late 1965. One of the most important alterations was the installation of a 23 ft long by 10 ft wide well, down through the center of the ship (Fig. 3). This centerwell allows the lowering of equipment and materials into the sea without having to swing them over the side, as was done previously. Early in 1966, MIZAR again gained international recognition — this time for her participation in the search for the H-Bomb which was lost off the coast of Spain. Teaming with the submersibles ALVIN and ALUMINAUT, she was able to direct recovery of the bomb by providing navigational guidance for ALVIN and pinpointing the bomb's location once it had been sighted.

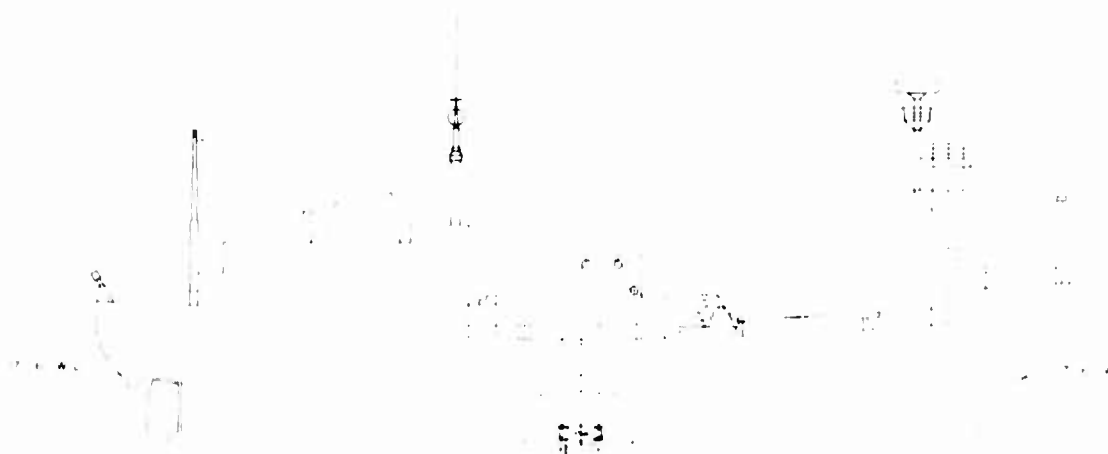

Fig. 3 - Outboard profile of USNS MIZAR (T-AGOR 11) showing outline of centerwell installation

MIZAR was again modified during 1967. This time the Surliss Ship Repair Company in Brooklyn, N.Y. was awarded the job of providing the ship with a chemistry and biology laboratory, a machine shop, a laundry, and six new staterooms for use by scientific personnel (Figs. 4 and 5).

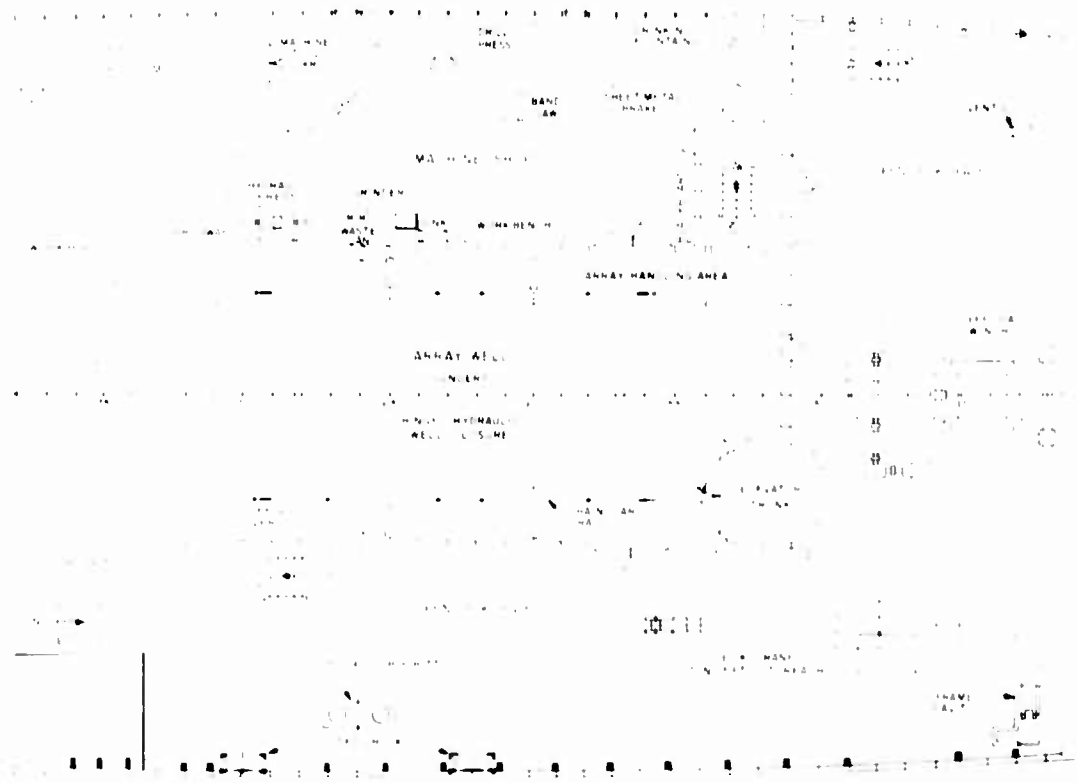
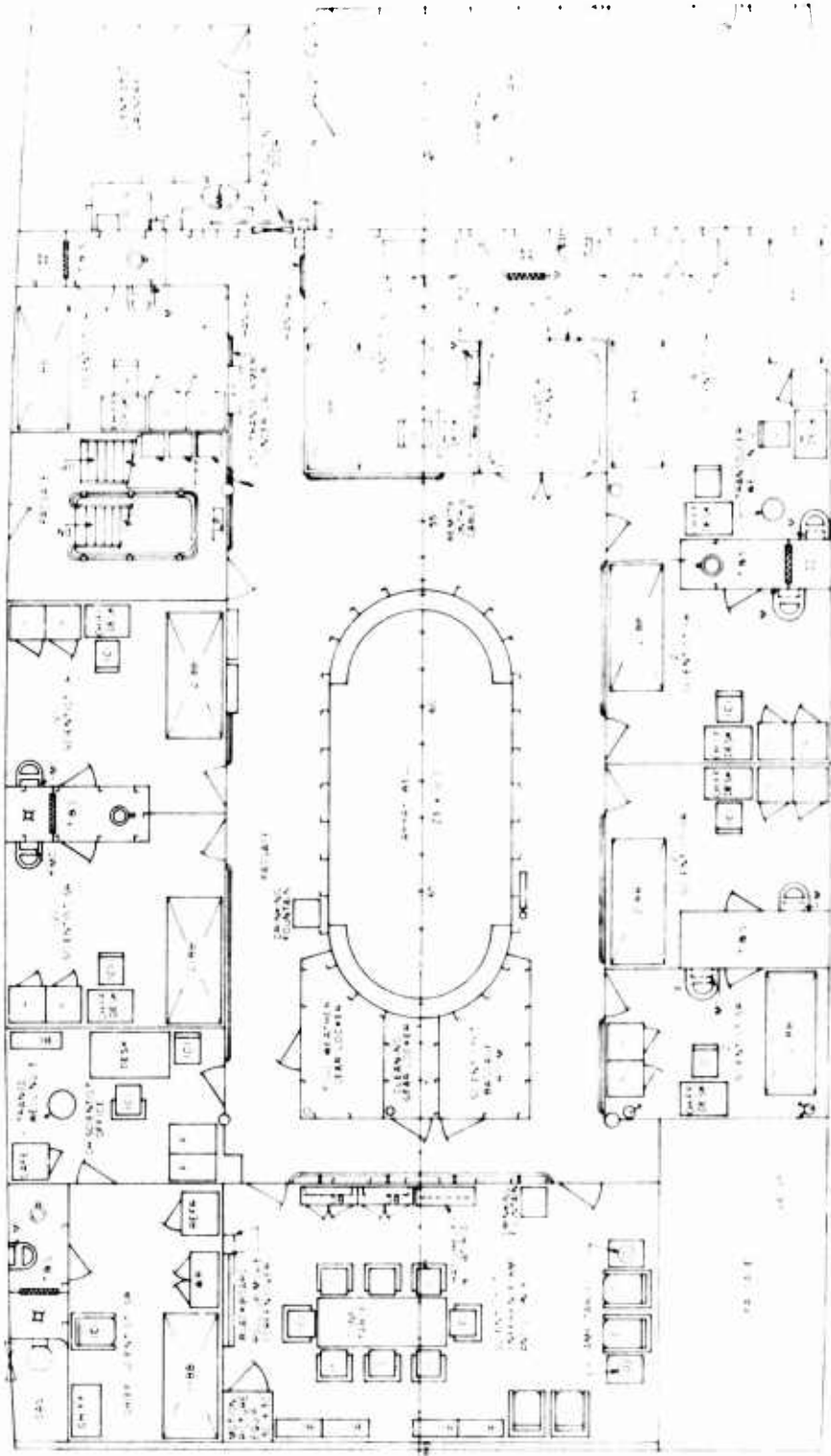

Fig. 4 - Main-deck plan (frames 41 to 78) showing centerwell, deep-sea winch, machine shop, and scientists' storeroom

For the next two years, MIZAR was engaged in a multitude of diversified research operations which included magnetic surveys, acoustic measurements, ocean engineering, chemical oceanography, marine biology, and deep-ocean photography. In June of 1968, MIZAR was sent to the Azores area of the mid-Atlantic to search for the missing nuclear submarine SCORPION. Towing her instrumented "fish" containing side-looking sonar, magnetometer, under-water cameras, and other detection equipment, MIZAR was again successful.

In early 1969, MIZAR was further modified at the Bender Machine and Welding Company, Mobile, Alabama. Habitability for the scientists, officers and crewmen was improved with the construction of new offices, staterooms, and messrooms, and the completion of the ship's air-conditioning system. After conducting oceanographic experiments in the Caribbean during the spring of 1969, MIZAR was sent to a site off the coast of Cape Cod, where the Woods Hole research submersible ALVIN had sunk in 5000 ft of water during a launching operation several months previously. MIZAR quickly located and photographed the sunken ALVIN. Later, with assistance from the deep-sea submarine ALUMINAUT, MIZAR lifted ALVIN to the surface and towed her to a shallow-water haven near Woods Hole. MIZAR completed the 1969 calendar year with a cruise to North Atlantic for acoustics measurements, ocean-engineering operations in the Caribbean, and a series of oceanographic experiments enroute to her home port at Washington, D.C.

During most of January and February 1970, MIZAR was again repaired and modified at the Surliss Ship Repair Company in Brooklyn, N.Y. This modification included replacing the large, space-consuming warping winch on the fantail with a more compact capstan.



BB - BUNK BED
TS - TOILET AND SINK
L - LOCKER
MC - MEDICINE CABINET
BK - BOOKCASE
MR - MIRROR
C - CHAIR
REF - REFRIGERATOR
SR - STATEROOM

Fig. 5 - Second-deck plan (frames 41 to 80), showing the Chemistry and Biology laboratory, scientists' conference room and lounge, and scientists' berthing area

Fairleads and unused booms were removed, bits were relocated, and in general, the entire fantail was modified to provide more open deck space for the scientific operations. The stores winch, which had previously been removed from the fantail area, was reinstalled on the forward bulkhead in the wellhouse to assist in handling heavy equipment in that area.

After completing one of several oceanographic operations which had been planned for the Spring, MIZAR was requested by the French Government and sent by our Navy Department to a site in the Mediterranean Sea, approximately ten miles southeast of Toulon, to search for the French submarine EURYDICE which had disappeared on March 4 with 57 men aboard. In less than three weeks, the NRL search team operating aboard MIZAR had located and photographed the sunken vessel. Among the many tributes paid MIZAR acclaiming her success, the French newspapers called her "the greatest research ship in the world."

SHIP'S COMPLEMENT

USNS MIZAR is under the operational and administrative control of the Commander, Military Sea Transportation Service, who in turn delegates these responsibilities to the MSTS Atlantic Commander (COMSTSLANT). The Master of MIZAR operates the ship in accordance with MSTS standard operating procedures and under orders transmitted to him by COMSTSLANT. He maneuvers the ship at sea in accordance with the recommendations of the Senior Scientist on Board and provides him with every reasonable facility and assistance required for effective execution of the program.

The Master retains final authority for the safety of the ship and all personnel assigned to or embarked on the ship. He enforces all laws of the United States and all applicable rules and regulations of the U.S. Coast Guard and Military Sea Transportation Service.

The 11 officers and 30 crewmen who are assigned to man MIZAR are all civil service marine personnel. The positions comprising the ship's complement are as follows:

Master	Chief Electrician
First Officer	Refrigeration Engineer
Second Officer	Engine Utilityman (3)
Third Officer	Oiler (3)
Radio Officer	Wiper (3)
Boatswain	Chief Steward
Able Seaman (6)	Chief Cook
Ordinary Seaman (3)	Messman (2)
Chief Engineer	Utilityman (4)
First Assistant Engineer	Cook-Baker
Second Assistant Engineer	Purser
Third Assistant Engineer	Yeoman - Storekeeper

SCIENTIFIC LIVING AND MESSING FACILITIES

MIZAR is equipped to comfortably accommodate 19 scientists. Nine staterooms, located on the second deck between frames 47 and 80, have been provided for the scientists (Fig. 5). The senior scientist's stateroom is equipped with a private toilet and shower and has an adjoining office. The space allocated to the senior scientist covers an area of 264 sq ft. Except for one large stateroom which accommodates four scientists, each of the other staterooms is intended to accommodate two persons. These rooms occupy an average deck area of 140 sq ft, have adjoining toilet and showers, and each is

equipped with double-decker bunks, lockers, book shelves, and chiffonier-desks. The entire ship is air conditioned to provide maximum comfort for the scientists, officers, and crew in any climate.

Located on the second deck in the scientist stateroom area is a combination scientists' lounge and conference room. This 14 by 24 ft room is furnished with a large conference table with chairs, book-cases, tables with lamps, lounge chairs, draperies, and motion-picture equipment.

Messing facilities are located on the main deck level, aft. The scientists share a common messroom with the ship's officers; each group has use of two six-place tables. This room, which also doubles as a wardroom, is equipped with a book and magazine rack and motion picture and television equipment. Other facilities available aboard MIZAR for the convenience of the scientific personnel are the scientist's laundry, which includes two automatic washing machines, an electric dryer, tandem laundry tubs, an ironing board and electric iron. A scientist baggage room is also located on the second deck. The ship's store, which is located on the main deck, provides an assortment of toilet articles, laundry detergents, cigars, cigarettes, candy, soft drinks, jewelry, and some articles of clothing.

LABORATORY AREAS AND SCIENTIFIC EQUIPMENT

The main laboratory area (Fig. 6) is located on the first platform level, which is two decks below the main deck. Included in this area are the control and display laboratory, the electronics and navigation laboratory, the power-amplifier room, the data-analysis room, and the photography laboratory.

The control and display laboratory (Fig. 7) covers an area of 736 sq ft and contains the following permanently installed equipment:

- Winch control console, with its closed-circuit television monitor
- Communications equipment for the NRL network
- Acoustic tracking system equipment, including digital computer underwater telephone system (UQC)
- Sonar depth sounder (UQN)
- Precision depth recorder (PDR)
- Precision clock with remote readout
- Wind speed and direction indicator
- Compass repeater from instrument on bridge
- Seawater thermometer.

Also included in this laboratory are a drafting table and work benches, with tool and spare parts stowage drawers. Attached to the deck are three pairs of equipment-mounting rails capable of securely holding at least 20 additional racks of electronic equipment.

On the same level, along the port side between frames 57 and 68, is the electronics and navigation laboratory. This 16 by 22 ft laboratory contains a plotting table with navigation chart files, a Sippican bathythermograph recorder, junction boxes with outlets from the satellite navigation antenna and Loran-C navigation antenna, a desk with desktop

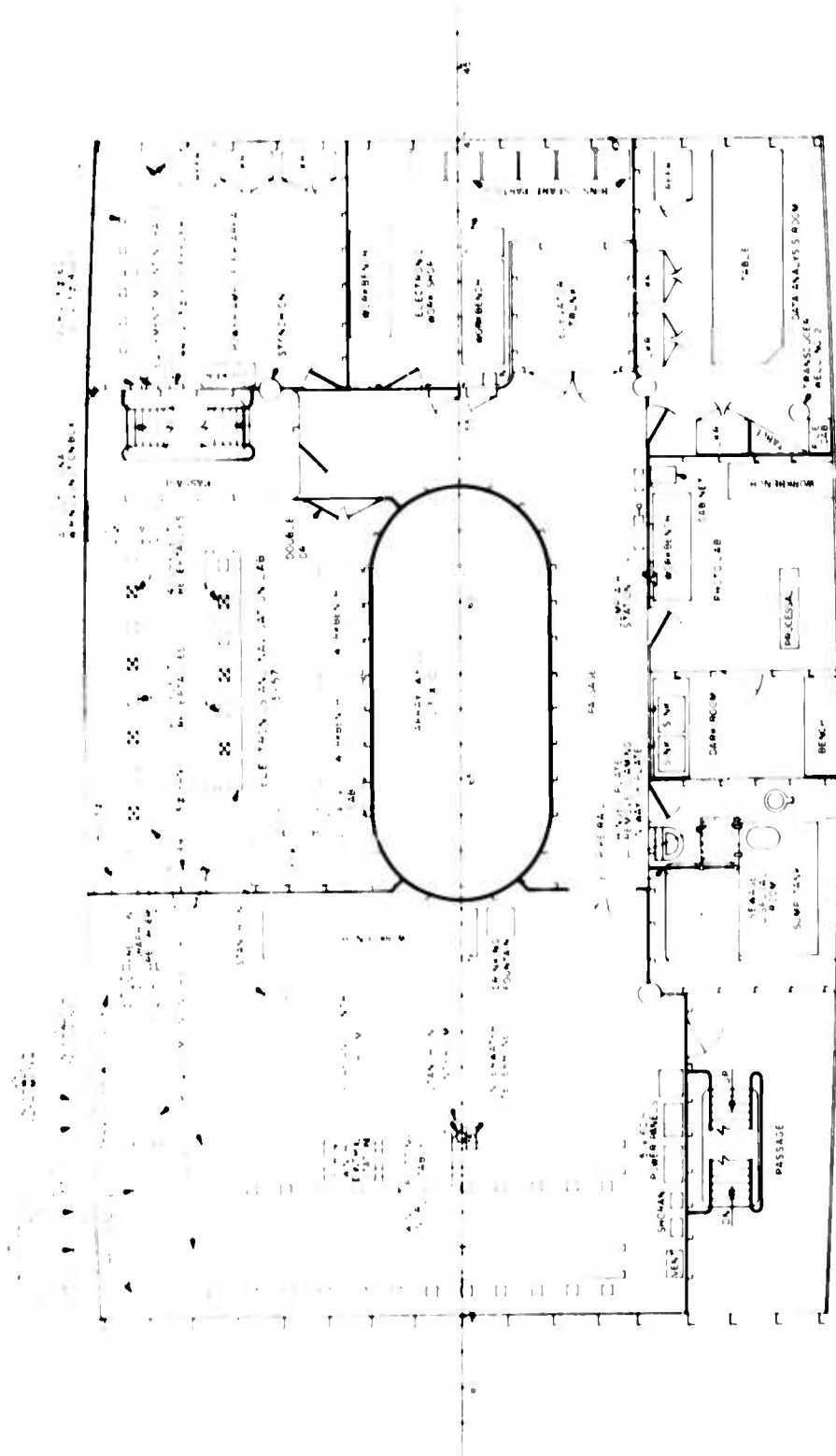

REFR-REFR GERATOR
LWR-LOCKED

Fig. 6 - First platform plan (frames 47 to 80), showing scientific laboratories and work areas

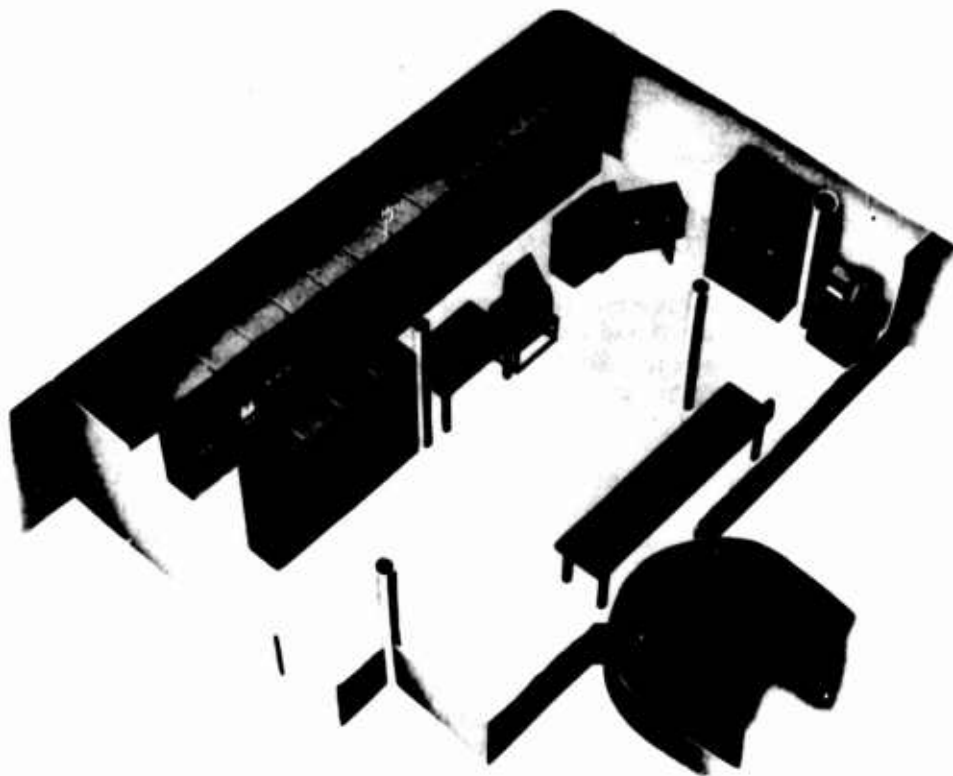

Fig. 7 - Control and display laboratory, including electronic racks, plotting table, winch control, and tracking system computer

calculator, work benches with tool and spare parts drawers, and two pairs of equipment-mounting rails to accommodate at least twelve racks of electronic equipment. This laboratory also houses the 24,000-BTU air-conditioning unit which provides cooling for this space and the power amplifier room. The power amplifier room measures 14 by 14 ft. Except for a refrigerator and three equipment-storage cabinets, this space is normally kept clear of permanent equipment, since the various scientific organizations that use MIZAR furnish their own particular power-amplifying equipment. Mounted on the after bulkhead are a junction box with leads from the control and display lab, and power outlets supplying 120 volts, 60 cycles, single-phase; 208 volts, 60 cycles, three-phase; 440 volts, 60 cycles, three-phase; and 120 volts, 400 cycles, three-phase. There is also a pair of equipment-mounting rails capable of accommodating six racks of power-amplifying equipment.

On the starboard side of the first platform, between frames 47 and 56, is the data-analysis room. The most prominent item in this 10 by 18 ft room is the 4 by 12 ft table. In addition to this, there is a refrigerator for film storage, a desk with typewriter, a copying machine, a file cabinet, three equipment-storage cabinets, and a coffee mess.

Just aft of the data-analysis room is the photography laboratory and its darkroom. Among the equipment permanently installed in this lab are two work benches, equipment-storage cabinets, and a Processall film developer. In the darkroom are a double sink and a work bench. This facility is sometimes used as a wet lab by the biological oceanographers.

On the second deck, just forward of the scientists' stateroom area, is the chemistry and biology laboratory. This lab measures 12 by 28 ft and is equipped with approximately

40 ft of laboratory bench space, equipment-storage cabinets above and below the benches, a fume hood with Coast Guard approved ventilation system, and outlets for various liquids and gases, a double sink, a refrigerator, several gas cylinder racks, and a water distillation unit. The steam autoclave which was originally installed in this lab was recently relocated across the passageway in the scientists' laundry.

SCIENTIFIC WORKSHOPS AND STOWAGE SPACES

MIZAR has the facilities to enable scientific personnel to make minor repairs and modifications on both their mechanical and electronic equipment. Most of the mechanical equipment is used in a well-equipped machine shop on the main deck level (Fig. 4). An amply stocked electronics workshop is on the first platform level, in close proximity to the electronic equipment.

The machine shop is located to the port side of the wellhouse area, between frames 54 and 70, and covers an area of nearly 500 sq ft. In addition to the work benches, tool drawers, supply cabinets, and sink, some of the machine tools installed in this shop include a lathe, drill press, grinder, band saw, bending brake, hydraulic press, and Heliarc welding machine. An adjoining lavatory is located forward of the machine shop.

The electronics workshop (Fig. 6) is located just inboard of the power amplifier room and covers an area of approximately 150 sq ft. Included in this workshop are two work benches with tool-storage drawers, electronic test instruments, soldering guns, hand tools, and a multitude of spare-parts cabinets.

Adequate storage space is also provided the scientist on MIZAR. There is a 16 by 16 ft scientific storeroom located on the main deck level, just aft of the machine shop. This area, which is intended to serve as a clean storage space for equipment in use, includes a work bench and several storage racks specifically designed to accommodate certain scientific instruments. Another space provided for the scientists' storage is in the inner bottom of the ship, on the starboard side between frames 47 and 65. The approximate deck area covered by this storage space is 450 sq ft. In addition to the deck space, there are also storage shelves attached to the forward, aft, and outboard bulkheads.

The most spacious area provided for the scientists' storage is the forward cargo hold (Fig. 8), which includes the full width and depth of the ship between frames 35 and 47. It is intended that this compartment be used for very heavy equipment and large, bulky equipment that is not in use. Access to this cargo hold is through the main deck hatch cover, which is folded open hydraulically. Equipment is handled by the deck crane, which has a lifting capacity of 2.9 tons with its 25 ft boom extended horizontally.

LABORATORY POWER DISTRIBUTION SYSTEM

MIZAR is equipped to provide the scientific laboratories with both 60-cycle and 400-cycle electric power (Fig. 9). Outlets from the following power sources are available in the main laboratory area: 120 volts, 60 cycles single-phase; 208 volts, 60 cycles, three-phase; 440 volts, 60 cycles, three-phase; and 120 volts, 400 cycles, three-phase. Outlets for the various power sources are all configured differently, so that plugs from the equipment cannot be connected to the wrong power source. The data-analysis room, photography laboratory, and chemistry-biology laboratory are furnished only 120-volt, 60-cycle, single-phase power.

The 60-cycle regulated power is provided by a 50-kilowatt ac/ac motor-generator set which is located in the air-conditioning machinery room on the inner bottom level, near frame 70. This set consists of four main components — an induction motor rated

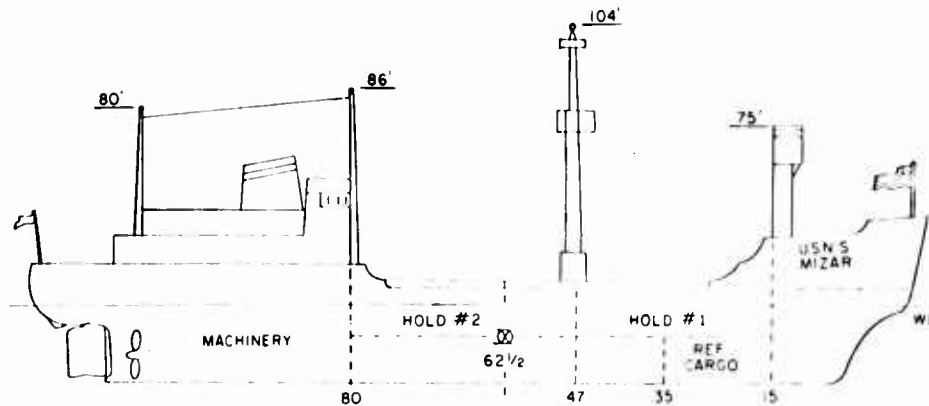

Fig. 8 - Outboard profile of USNS MIZAR (T-AK 272) as cargo ship prior to commencement of conversion to oceanographic research

at 75 hp, 440 volts, 60 cycles, three-phase, 1000 rpm (synchronous); a synchronous generator rated at 50 kilowatts, 450 volts (regulated ± 0.5 percent), 60 cycles, three-phase, 0.8 power factor; a dc exciter rated at 125 volts, 1.5 kilowatts; and a control panel. The motor-generator set is connected to three 25-KVA, 450/120 volt, single-phase, 60-cycle, delta-connected transformers which feed the lab space power panels with regulated 120-volt, 60-cycle, three-phase power.

There is also available in the scientific areas 120-volt, 60-cycle unregulated power which is used for lighting and at work-bench outlets. This power is taken from the ship's service bus. The 60-cycle laboratory power panels are located in the control and display lab, on the starboard bulkhead at frame 75.

The 400-cycle regulated power is provided by a ten-kilowatt ac/ac motor-generator power supply with its associated equipment. This system is also located in the air-conditioning machinery room, near the aforementioned 60-cycle machinery. When connected to a 440-volt, 60-cycle, three-phase power source, it will deliver up to ten kilowatts of voltage regulated power at 120 volts, 400 cycles, three-phase.

The complete system consists of two major assemblies — a motor-generator set and a control equipment enclosure. The motor-generator set is a two-bearing unit enclosed in a common housing. The deck-mounted control enclosure contains the speed regulator, voltage regulator, line regulator, and auxiliary control equipment required to furnish complete automatic control of the system. The motor is a high-slip squirrel-cage induction motor employing a magnetic amplifier type speed regulator to control the speed of the motor. A separate magnetic amplifier type voltage regulator is employed to control the generator field, which in turn controls the output voltage level of the 400-cycle generator. In addition to the voltage regulator, a magnetic amplifier type line regulator is furnished in each output line of the generator. The purpose of the line regulator is to maintain each individual phase voltage of the three-phase generator at a constant level, even on severely unbalanced loads. Provision is made for automatic flashing of the generator field. Sustained short-circuit current is also provided in order to trip the output circuit breaker. After the breaker has tripped, the generator is automatically flashed to restore the system for automatic operation. The system is designed to regulate the voltage under all conditions of line, load, and frequency changes to within ± 0.5 percent. This equipment is designed and built for automatic operation, and has no provision for manual control of voltage and frequency.

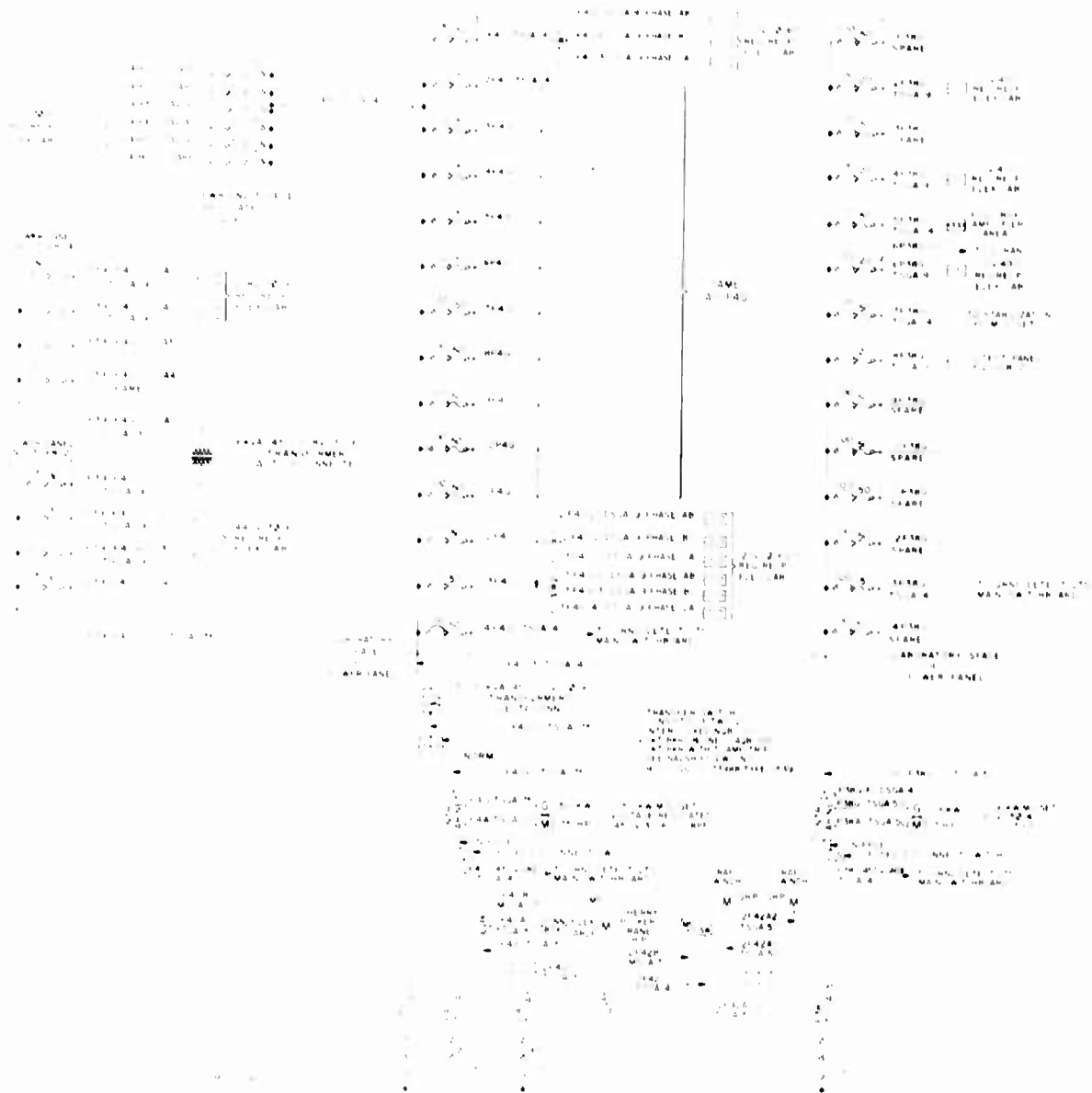

Fig. 9 - Diagram of MIZAR laboratory power-distribution system

There is also an auxiliary 400-cycle power supply. Located on the second deck, in compartment 2-66-2, is a 1-1/2-kilowatt motor-generator set which can be switched into the circuit in lieu of the ten-kilowatt machinery. The 400-cycle laboratory power panel is located in the control and display lab, on the port side of the forward bulkhead.

COMMUNICATION SYSTEM

The scientific radio station aboard MIZAR (Fig. 10) is a mobile unit of the NRL scientific radio communication system. Its primary function is to provide a means of obtaining logistic support for the scientific personnel embarked on the ship during NRL operations.

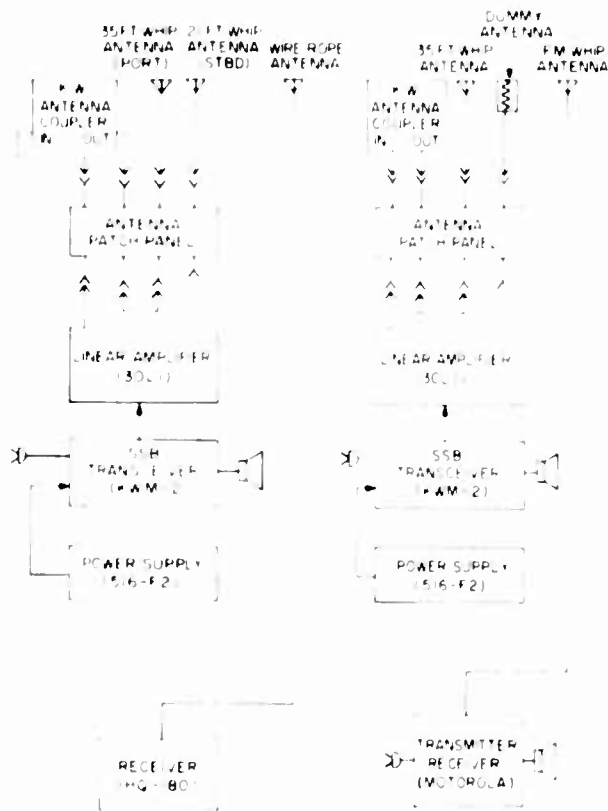

Fig. 10 - Diagram of MIZAR scientific radio station

The ship maintains daily schedules with the Laboratory on the logistics circuit. When MIZAR is operating with another ship, or with a land-based facility, the command circuit is used to transmit information related to the operation in progress. Logistic information is not normally passed on this circuit. Scientific data are processed for radio transmission and are sent and received over the data circuit during two-ship and ship-to-land operations. This circuit is not normally used for voice transmissions. The NRL scientific radio communication system is authorized to operate on five single-sideband frequencies and on four vhf FM frequencies. The selection of frequencies for use on a particular net is determined by the great circle ship-to-ship or ship-to-shore distances involved. The MIZAR's scientific radio station is installed, maintained, and operated by NRL personnel and is not connected with the ship's radio system.

The radio-station equipment is installed in two six-foot EMCO rack cabinets which are located in the display and control laboratory on the first platform level. A writing surface attached to the front of the cabinets at desk height completes the radio console. A Collins KWM 2 single-sideband transceiver and a Collins 30L1 linear amplifier are installed in each of the cabinets. The rf output of each linear amplifier is connected through a vswr bridge to a Johnson antenna coupler. A TMC quick-disconnect patch panel is used to connect the output signal of the station to the desired antenna. Three vertical whip antennas and a wire rope antenna are available for use when operating in the single-sideband mode. A Motorola vhf FM two-way radio set is installed in the lower right-hand section of the console, and is used for close-range voice or data communications. Its vertical whip antenna is located on the flying bridge. A Hammarlund HQ-180 communication receiver is installed in the lower left-hand section of the console, and is used for general-purpose monitoring. Due to variable requirements and transmission

modes, data transmitters are not installed as fixed equipment in the MIZAR radio station. The power output of the radio station when operated on the single-sideband mode is 500 watts (peak envelope power). The power output in the FM mode is 30 watts (effective radiated power).

To date the MIZAR's radio station has been capable of communicating with the Laboratory in Washington on the logistics circuit from all of its operating areas. The range and flexibility of this station is increased by use of a telephone patch circuit which has been installed in the system at NRL. Once radio contact with the Laboratory has been established, the ship can communicate with any point in the world where a telephone line is available. The telephone patch can also be connected to the AUTOVON system. Although the radio station at NRL is normally operated during working hours only, off-hours operation of the station can be arranged if the Senior Scientist on Board has such a requirement. The NRL radio system is authorized to operate at a power output of 1000 watts, and the output of the MIZAR radio station can be increased to that level if necessary.

A complete description of the NRL Scientific Radio Communication System is being prepared by M. Mahon of the Ship Facility Group, Oceanology Department.

ACOUSTIC RAY TRACKING SYSTEM

A ship positioning and underwater tracking system for general oceanographic work was developed at the Naval Research Laboratory and installed on the MIZAR in the spring of 1964 (Fig. 11). Relative positioning and tracking are accomplished by measuring the travel-time intervals of acoustic rays emitted from an underwater sound source and received at three ship-mounted hydrophones. Time intervals are converted to ray-path lengths, and their intersection point is determined by use of a small general-purpose digital computer. The sound source may be an acoustic transponder or responder which is moored to the ocean bottom or attached to an underwater vehicle. These sound sources transmit only when interrogated from the ship. The computer is programmed to provide solutions to the tracking equations; it also controls and monitors the auxiliary equipment which makes up the entire system.

The hydrophones for the tracking array are installed in three tubular trunks which extend from the second deck level down through the hull. The trunks were constructed at the following locations: frame 35, port side; frame 55, starboard side; and frame 71, port side (Figs. 12,13). Each of the hydrophones was attached to the end of a long sectional pipe, installed in the tubular trunk at the second deck opening, and lowered through the trunk to an operating position, 22-1/4 in. beneath the base of the trunk. Although the hydrophone trunks are free-flooding, a fairing was built around each one, and standard U.S. Navy 60-in. rubber-covered domes were attached to the fairings to serve as protective housings around the hydrophones (Fig. 14). There is a receiving hydrophone in each dome. The portside dome at frame 71 also contains the transducer for the underwater telephone (UQC). The computer and other components for this acoustic-ray tracking system are located in the control and display laboratory on the first platform level.*

CENTERWELL INSTALLATION

A feature of major importance to MIZAR is her centerwell. Research ships, in general, are intended to launch and retrieve unique scientific equipment; consequently

*For additional information on this subject, refer to NRL Report 6326, "An Acoustic Ray Ship Positioning and Tracking System," by H. N. Van Ness, R. L. Mills and K. R. Stewart, Oct. 12, 1965.

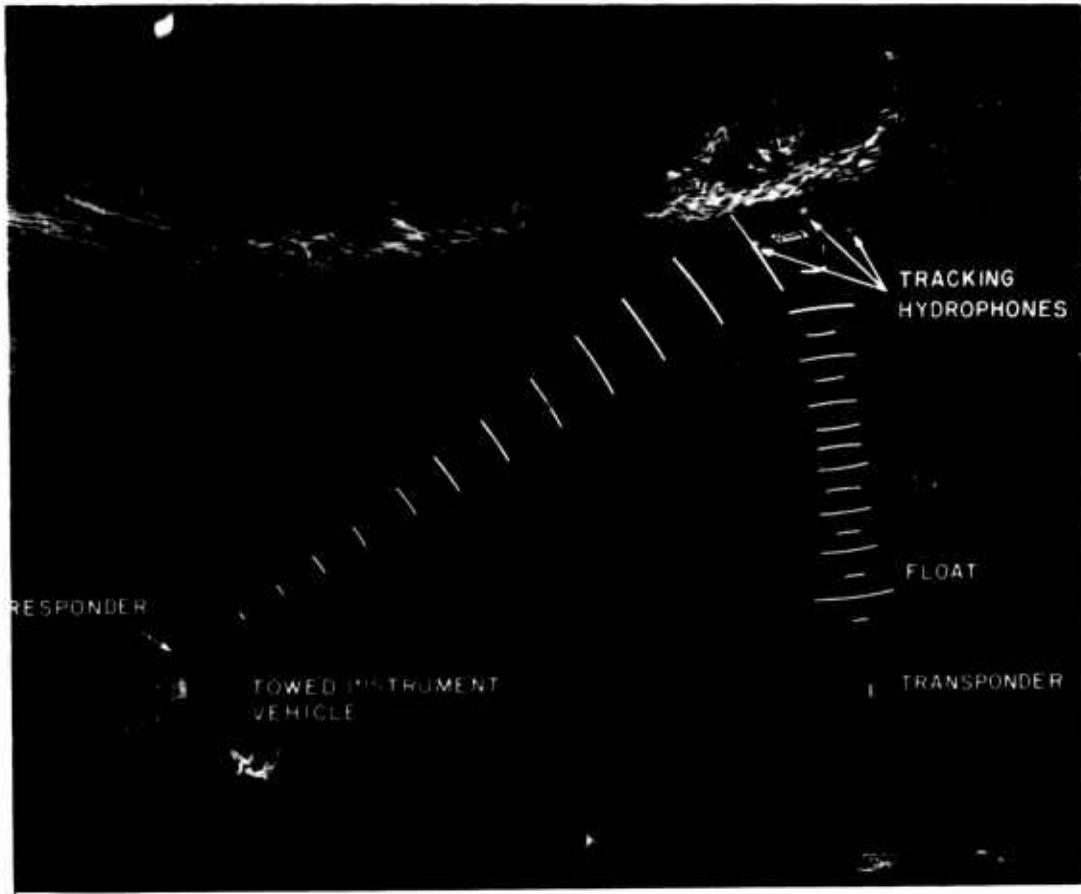

Fig. 11 - Schematic of acoustic-ray tracking system, showing three hull-mounted hydrophones receiving acoustic rays emitted from underwater sound sources

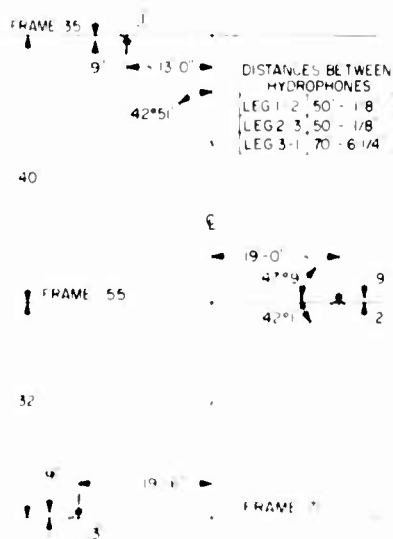

Fig. 12 - Locations of tracking system hydrophones in hull of MIZAR



Fig. 13 - Elevation drawing of hydrophone trunks

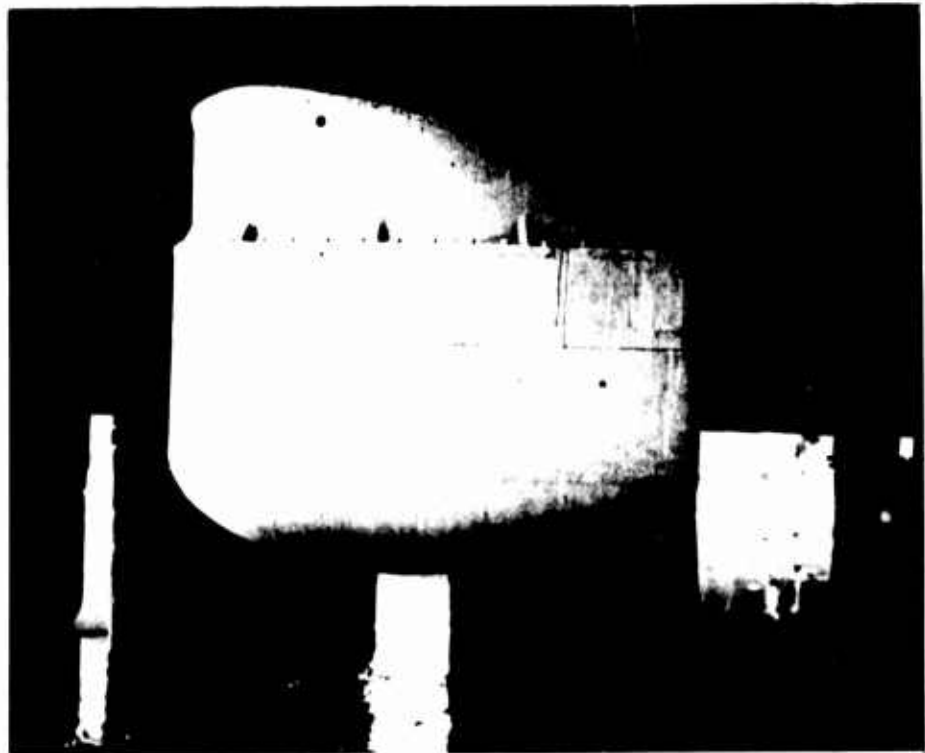
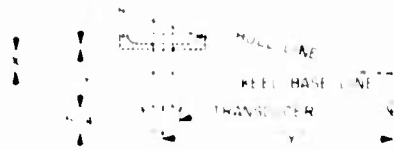

Fig. 14 - One of three domes housing the tracking system hydrophones

they must be provided with specialized handling gear which offers a safe, reliable mode of operation for the ocean scientists and engineers aboard. Other requirements are the safety of the operating personnel and the protection of the equipment, both from handling damage and from the elements. Comfort of personnel during launching operations also must be considered, since this is often reflected in the accuracy and efficiency of the tests being conducted.

Since MIZAR was originally constructed as an arctic cargo ship, it was perfectly configured for a centerwell installation. Cargo had been carried in two holds located in the forward portion of the ship, between frames 15 and 80 (Fig. 8). The 34-ft-long centerlined number two hatch straddled the ship's midpoint (frame 62-1/2), so the ideal location for the centerwell was already clear and available for the installation.

A 23-ft-long by 10-ft-wide well was installed through the ship from main deck to hull (Figs. 15, 16, and 17). The ends of the well are semicircular, and are fitted with nine baffle plates at 18-in. intervals, four of which are positioned below the waterline. The splash baffles, which are 21 in. wide on the horizontal plane and which have a six-inch vertical leg facing downward, are very effective in reducing the surging of the sea in the well by absorbing most of the kinetic energy generated by the pitch, roll, and heave of the ship, plus the tendency of the well to scoop water from beneath the ship while underway. The baffles span the semicircular bulkheads for the complete 180-degree arc.

At keel level, the opening to the sea is restricted to eight feet wide and 21 ft long. The semicircular fore-and-aft ends are concentric with the bulkhead ends of the well. This constriction reduces the cross-sectional area of the well from 208.5 sq ft above the keel level to 154.3 sq ft. The structure forming the constriction serves to reduce water turbulence within the well, and provides a solid support for the two-ton carriage which rests on it when heavy equipment is operated through the centerwell.

The well is closed over at the main deck level by a flush-mounted, hydraulically operated, watertight hatch cover, half of which opens forward and the other half aft. Each half consists of three sections; the two sections at each end of the well fold up, while the two sections closest to the center of the well slide away from center as the cover is opened. The hatch cover, which was designed to support 1000 lb/sq ft, is also used as a staging and equipment servicing area prior to launching equipment through the well. Compression of air under the closed hatch cover, due to rising of the water within the well, has been practically eliminated by providing large "breather," ducts from the well to outside.

A towpoint for the cable is provided by lowering a two-ton aluminum carriage through the well to rest on the aforementioned shelf at MIZAR's keel level. The carriage, which is a weldment of four-inch-diameter aluminum tubing, serves as a framework for a system of three 24-in.-diameter sheaves (Fig. 18). The sheaves are arranged to align themselves with the cable loading as they pivot about their longitudinal axes. The bottom or tow sheave pivots athwartships about a fixed fore-and-aft axis of rotation which is located above the action lines of the load forces, in order to prevent "over-toggling" of the sheave. The tow sheave protrudes nine inches below the carriage and three inches below the hull when the carriage is lowered to its towing position. This location is ideal for the towpoint, since the possibility of the tow cable fouling the ship's propellers is practically eliminated.

The carriage measures 12 ft in length, 8 ft, 6 in. in width, and 4 ft in height. It is held in position by two sets of shoes attached to its port and starboard sides. The shoes engage four rails which extend from the keel to the O2 level, giving the carriage a total vertical travel of 44 ft. The carriage is not self-powered; it is designed to ride atop the towed body as it is raised or lowered through the well. Beneath the carriage is a stand-off support structure, or "cradle," which serves to contain the towed vehicle as it passes

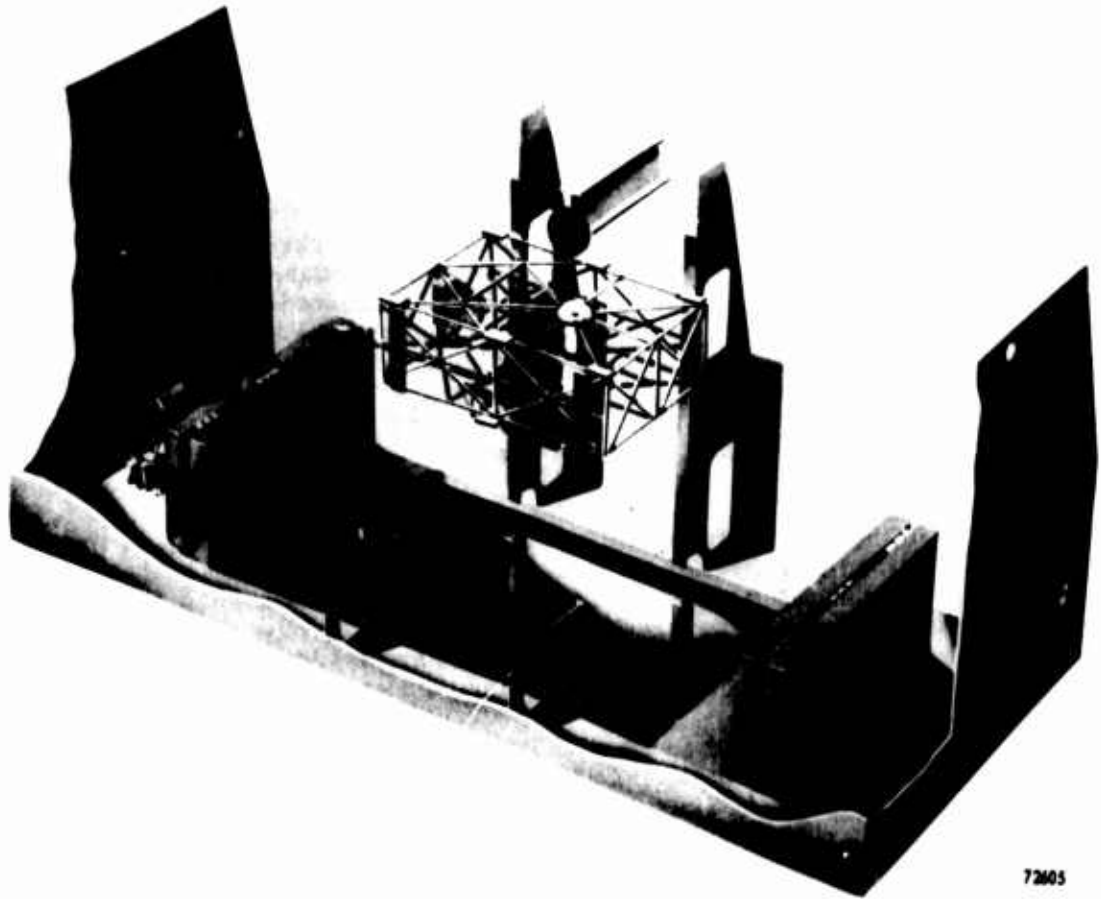

Fig. 15 - General arrangement of wellhouse, centerwell and carriage



Fig. 16 - Plan view of centerwell configuration

Fig. 17 - Cross-section view of centerwell configuration

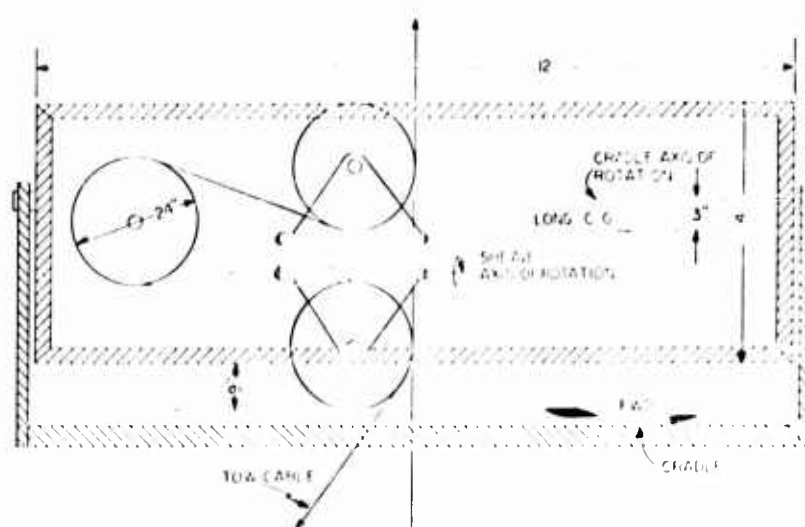
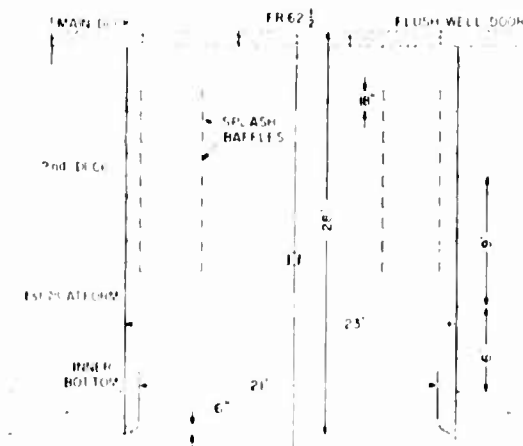

Fig. 18 - Tow sheaves and cradle as mounted on carriage (side view)

through the sea-surface interface (Fig. 19). The cradle extends the full length of the carriage and is attached to it by arms fore and aft which pivot about an axis on the centerline, just above the gravitational center of the carriage. This arrangement was necessary in order to avoid canting and jamming of the carriage against its guide rails. Since the athwartship motion of the tow sheave serves to measure the athwartship cable angle, the cradle must also be free to swing athwartships. Also, the cradle serves as a standoff which prevents the towed body from two-blocking (jamming) the tow sheave.

The overhead structure which supports all equipment passing through the centerwell is designed to take a 50-ton static payload. The vertical members supporting the overhead cross-member trusses are an integral part of the wellhouse. The longitudinal and athwartship girders which form the overhead cross-member trusswork, and also the overhead deck of the wellhouse, are all bolted in place. There are two 24-in.-diameter tow cable sheaves, having a load-carrying capacity of 12 tons, bolted in the overhead trusswork, and also another sheave of this type on the 01 level which feeds the tow cable from the winch to the overhead sheaves. The wellhouse completely encloses the well area and provides the capability and comfort for all-weather operation.*

*For additional information on this subject, refer to NRL Memorandum Report 1736, "Center-Well Installation of USNS MIZAR (T-AGOR 11)," by J.J. Gennari, Jan. 1, 1967.

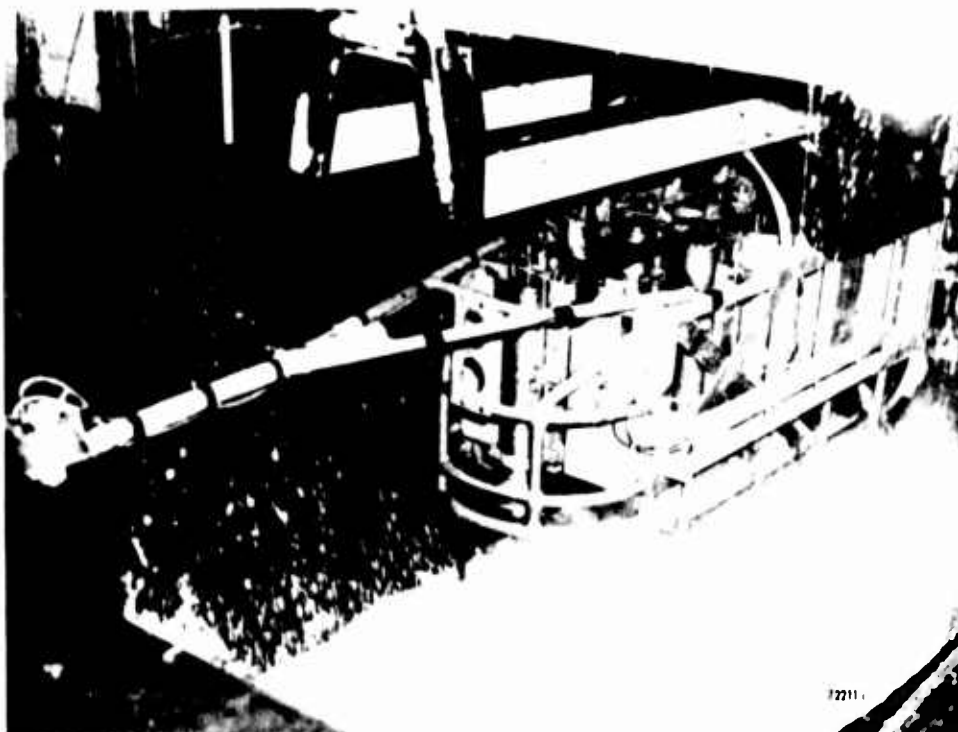

Fig. 19 - Towed instrument vehicle nested in cradle beneath carriage
(Notice water splashing up from centerwell)

DECK MACHINERY

The deck machinery directly serving MIZAR's scientific effort consists of a deep-sea winch, two medium-load "RAP" winches, a T-Mark-6 streaming winch, a standard bathy-thermograph winch, a U-frame davit, a stern davit, a wellhouse capstan, and the deck crane (Figs. 20-26).

The deep-sea winch was designed and built at NRL in 1959, as an all-electric-drive machine. It was converted to electric-hydraulic drive in 1963, and installed on MIZAR in 1964. In the present arrangement, a 75-horsepower, 440-volt squirrel-cage motor is coupled to a variable-displacement hydraulic pump. These units are mounted on a common base and installed on the second deck just beneath the winch. Fluid is pumped at a pressure of 2500 psi up to the hydraulic motor on the winch, which is located on the center-line of the main deck at frame 45. The hydraulic motor, driving through a gear reducer and chain drive, rotates the cable drum. The drum, which contains 22,000 ft of 0.675-in.-diameter armored submarine cable, has a core diameter of 44 in. and a pair of 84-in.-diameter flanges that are 26-1/2 in. apart.

The winch is also equipped with a ten-horsepower auxiliary electric drive system which is available for emergency use. Each of the drive systems for this winch is designed to provide a drumshaft torque of 26,000 ft-lb. The average lifting speed using the 32.8 ft min for the electric drive system. Braking is provided by a fail-safe electromagnetic brake on the driveshaft and an air-brake system which activates asbestos-lined bands on the drum; this system is used primarily for holding the load during operations. The winch is equipped with a slipping assembly capable of handling five electrical conductors. The cable levelwind system includes a differential transmission for making minor

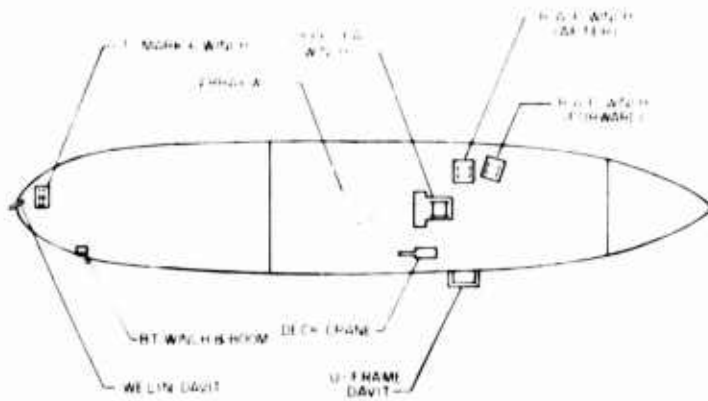

Fig. 20 - General arrangement of MIZAR deck machinery

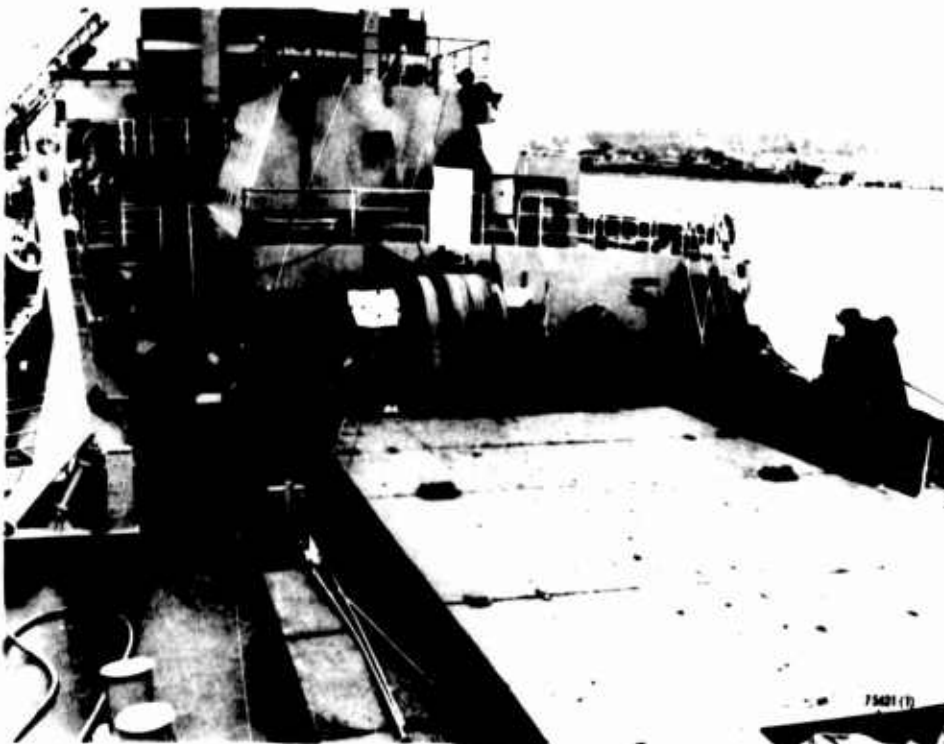

Fig. 21 - Machinery on main deck: U-frame davit, deck crane, deep-sea winch, and the two RAP winches



Fig. 22 - Deck crane and U-frame davit (looking forward from starboard side, 01 level)

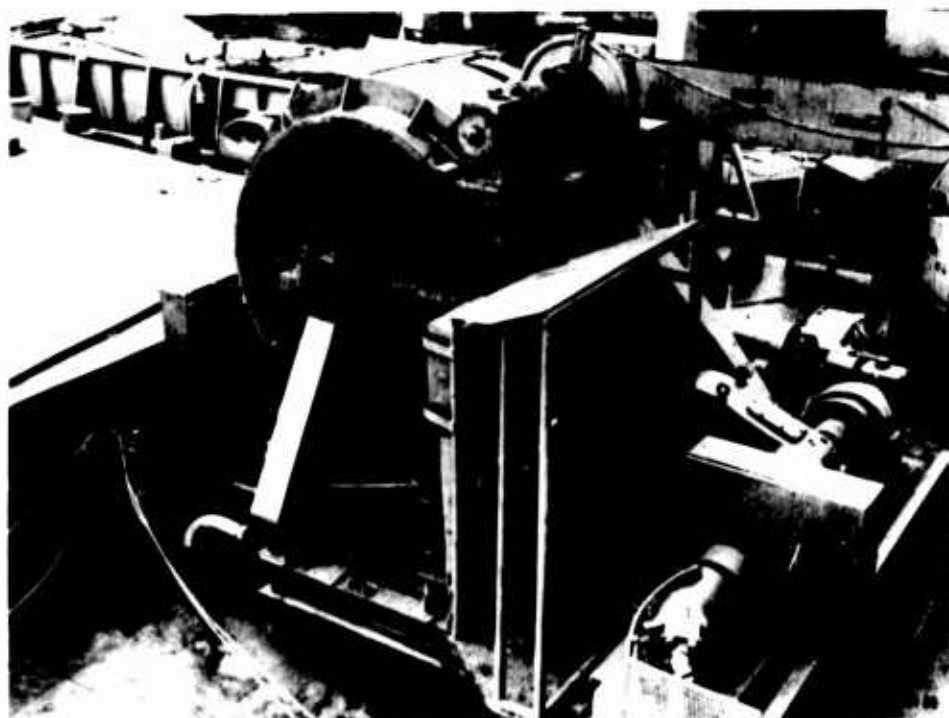

Fig. 23 - Deep-sea winch as shown from portside

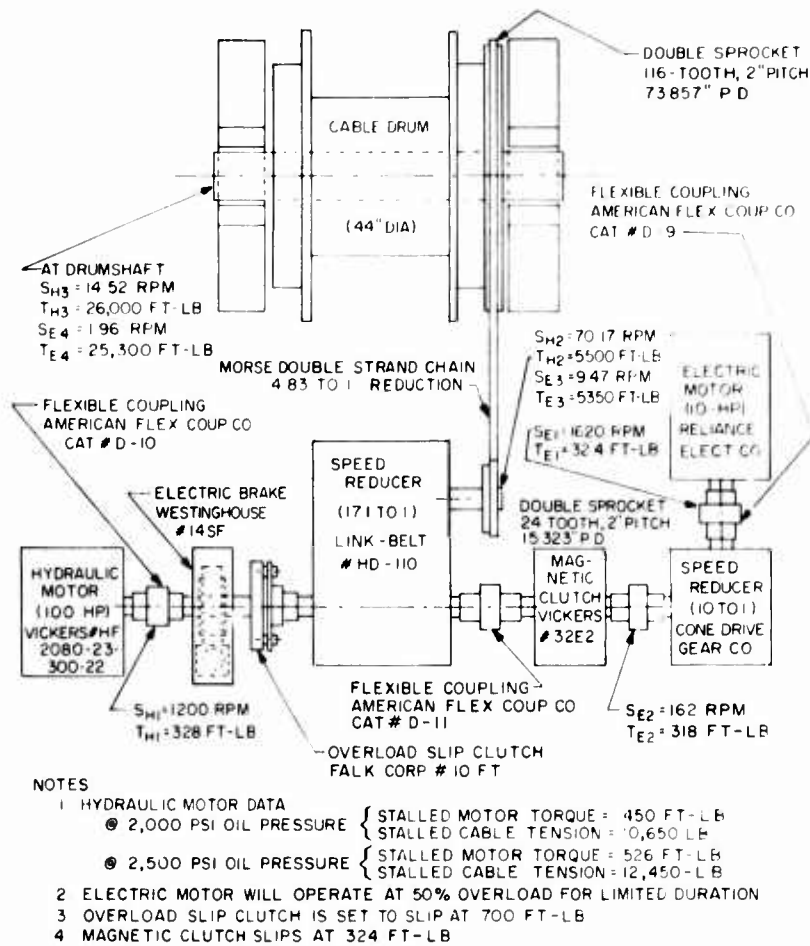

Fig. 24 - Diagram of deep-sea winch, showing rated torques and speeds at each shaft

corrections. The three control stations, each equipped with an electric pushbutton controller, a cable-speed indicator, and a cable footage counter, are located on the winch, in the wellhouse, and in the display and control lab.

The two RAP winches were originally designed to handle medium loads for the Reliable Acoustic Path experiments, which were conducted aboard other vessels several years ago. They are practically identical in appearance and are now powered by 25-hp variable-speed drives. The forward RAP winch, installed on the port side of the main deck at frame 35, is geared to lift loads of 4000 lb at line speeds in the range from 50 to 310 ft/min. The after RAP winch, located at frame 40, is geared to handle an 8000-lb load at line speeds ranging from 37 to 148 ft/min. These winches are controlled from a pendant pushbutton station at the winches, or from the winch control console in the display and control room. They are installed facing the U-frame davit which is located on the starboard side at frame 40, and are usually reeved to operate in conjunction with this unit. Since it is faster, the forward winch usually handles the long lengths of 3/16-in.-diameter oceanographic wire, while the after winch handles the multiple-conductor submarine cable. Both RAP winches are equipped with manually clutched levelwind systems, 20-conductor slip rings, cable footage, counters, and air brakes.



Fig. 25 - The two RAP winches located on portside of main deck near frame 40



Fig. 26 - Deck machinery on fantail: T-MK-6 streaming winch and Welin davit

There is a five-horsepower, electric-drive, double-drum T-Mark-6 streaming winch installed on the 01 level at frame 122. This winch consists of two clutched drums driven through a single gear reducer by an electric motor. The control is arranged for driving the drums at a single speed in either direction. An electric motor-mounted brake is provided for holding the load. The winch is intended for operation with one drum engaged at a time at a line speed of 105 ft/min and a line pull of 1200 lb. Each drum is provided with a ratchet and pawl, as well as a hand-operated band brake for holding or paying out cable under conditions where the motor is not used. Each drum is also provided with sliprings, wiring, and a receptacle to permit connection from electrical leads in the drum cable to others in the main laboratory area.

The bathythermograph winch is located on the starboard side of the 01 deck at frame 113. Its function is to lower and retrieve, at controlled speeds, the bathythermographic instruments. The winch consists of a five-horsepower, 440-volt ac electric motor that drives a drum through a two-step vertical spur-gear reduction unit contained in a gear housing. This winch is equipped with manually operated clutch, brake, and levelwind. It will develop a single line pull of 400 lb at cable speeds of 90 and 360 ft/min. The drum has a capacity of 3000 ft of 3/32-in.-diameter 7 x 7 wire rope.

MIZAR is equipped with a U-frame davit which is located on the starboard side of the main deck at frame 40. This hydraulically actuated davit was installed directly athwartship from the RAP winches and supports the sheaves over which their cables are reeved. In the 37.5-degree travel of the davit, the sheaves are carried from a position which is approximately 3-1/2 ft inboard to the operating position, which is approximately 4-1/2 ft outboard. The U-frame davit is capable of lifting a load of 6000 lb and supporting a load of 30,000 lb when resting on its outboard stops.

At the stern on the 01 level is the pedestal-mounted, boom-type Welin davit. The davit is rotated by hand-cranking a worm-drive unit. Its ten-foot boom is raised by manual operation of a hydraulic pump. It is positioned for over-the-stern operation with the T-Mark-6 streaming winch. This davit has a capacity of 3500 lb.

During a recent MIZAR modification, the stores-handling winch was relocated from the fantail to the wellhouse. The unit has been mounted on the bulkhead at frame 51 near the centerline; its new function is to assist in the handling of heavy equipment in the wellhouse. This winch is driven by a three-horsepower, 440-volt ac electric motor, and has a capacity of 1000 lb.

MIZAR is also equipped with a BLH Austin-Western model 410-P hydraulic crane. It is located on the starboard side of the main deck at frame 47. The crane is conveniently located for lifting equipment off of the dock and lowering it either on deck, into the forward hold, or down through the elevator trunk. It is capable of lifting five tons with its boom retracted, and 2.9 tons with its boom extended horizontally. The crane has a minimum reach of 15 ft and a maximum reach of 25 ft.

OTHER FEATURES

Some of the other features of MIZAR that contribute to the scientific effort are an equipment-handling elevator system, an expendable bathythermograph system, and a five-station intercommunication system.

A six-foot-square elevator trunk extends from a hatch in the 01 deck to the hull of MIZAR at frame 52. The open-top cage-type car may be loaded or unloaded through the overhead using an outside crane, as well as through doorways at the main deck, second deck, first platform, and inner bottom levels. Automatic calling-and-sending pushbutton controls are mounted on the bulkheads at each deck level. The elevator machinery is

installed in a space adjacent to the trunk at the inner bottom level. The capacity of the elevator is 3000 lb. The elevator is approved for use at sea under moderate pitch and roll conditions.

A Sippican expendable bathythermograph system has been installed on MIZAR. This system is an automatic recording instrument which is mounted on the after bulkhead in the electronics and navigation laboratory on the first platform level. The XBT probe launcher may be located on the starboard side of the main deck at frame 72 or on the port side of the 01 deck at frame 115. At both locations junction boxes contain leads which go to the recorder.

Scientists aboard MIZAR are also provided with a five-station intercommunication system. The stations have been installed at the following locations:

1. Chemical/biological laboratory-second deck-frame 47-after bulkhead
2. Wellhouse-main deck-frame 59-port side
3. Display and control lab — first platform-frame 75-centerline stanchion
4. After deck house — 01 level-frame 115-starboard side
5. Bridge — 03 level-after bulkhead-starboard side

CONCLUSION

The decision to select the polar cargo ship USNS MIZAR (T-AK272) for oceanographic research duty is considered a wise one, since very little structural rearrangement was required to effect the desired modifications. With the installation of the spacious laboratories and comfortable living facilities for the scientists, construction of the unique centerwell, removal of the bulky warping winch, and relocation of the mooring bitts on the fantail to provide the scientists with greater open deck work space, only two conversion operations remain to be accomplished; these are the installation of a work boat with its handling gear, and the enclosure of the forward portion of the main deck (Fig. 27). Addition of the work boat will provide a convenient means of transportation to nearby vessels, ocean platforms, or shore bases during scientific operations. The final modification will serve to shelter the winches from the elements and provide a wet laboratory for the oceanographers. Once this work is completed, the USNS MIZAR (T-AGOR 11) will rank as one of the nation's most versatile oceanographic research ships. Laboratory personnel, using the variety of unique equipment aboard, will be able to handle a wide range of ocean-science and engineering operations on a world-wide basis. NRL is proud of the performance of MIZAR.

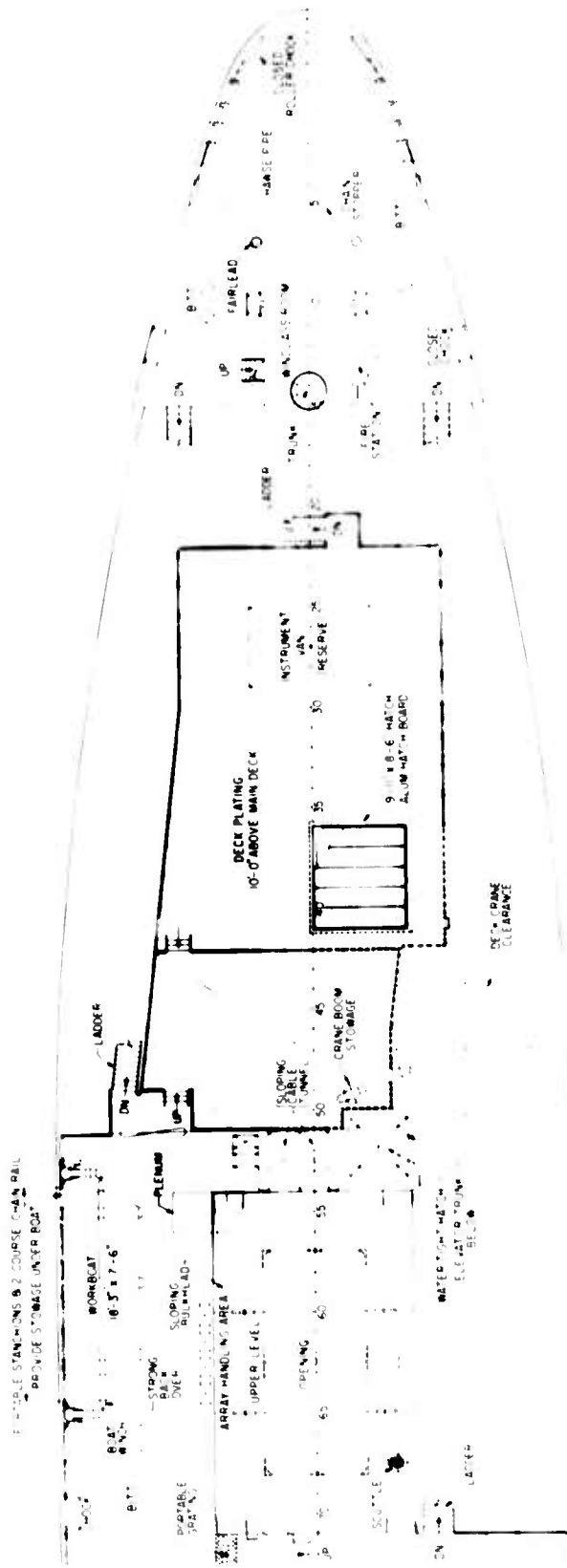

Fig. 27 - Plan view of forward portion of MIZAR, showing winch enclosure and work-boat installation, which are to be added later

Appendix A

SHIP'S CHARACTERISTICS

MIZAR has excellent maneuverability at slow speeds due to her dual propulsion system. She is equipped to operate in any climate, since she was originally constructed with a specially strengthened hull for operation in the polar ice regions; now all living and scientific work spaces have been completely air conditioned to provide maximum comfort for the embarked personnel when operating in the warmer areas. MIZAR's wide beam and deep draft make her a steady working platform from which various oceanographic instruments may be suspended into the sea. The centerwell/carriage arrangement allows safe handling and towing of heavy equipment with a minimum of pitch and roll at the tow point. Also, the wellhouse provides complete protection for operating personnel and equipment from the detrimental effects of rough weather.

Other characteristics of MIZAR are as follows:

Length Overall	266 ft 2 in.
Length at DWL	250 ft 0 in.
Beam	51 ft 6 in.
Draft	17 ft 6 in. (2 ft 6 in. additional draft for hydrophone domes)
Displacement (full)	3886 tons
Displacement (light)	2036 tons
Pitch period	11.5 sec
Roll period	4.5 sec
Fresh water process rate (two evaporators)	2000 gallons/day, each
Fresh water storage	34,460 gallons
Fuel oil capacity	680 tons at 95% full tank
Cruising speed	12 knots
Cruising range	20,000 naut mi
Endurance	60 days
Propulsion equipment	
Two main diesel engines, port and starboard, 3200 hp (1600 hp each)	
Two main propulsion motors, port and starboard 27 hp at 150 rpm	
Two propellers, 4 blades, solid type	
Power equipment	
Two 300 kw ship service generators (450 volt, 3 phase, 60 cycle)	
One 100 kw ship service generator (450 volt, 3 phase, 60 cycle)	
One 75 kw emergency diesel generator (440 volt, 3 phase, 60 cycle)	
Shore power capacity — 400 amp, 440 volt, 3 phase, 60 cycle	

Appendix B

DECK EQUIPMENT SUMMARY

Deep-Sea Winch

75 hp hydraulic drive, 10 hp electric drive
Drumshaft torque: 26,000 ft-lb
Drum dimensions: 84 ft diam flanges, 26-1/2 in. apart
44 ft drum diam
Average line speed: Main drive (75 hp), 243.5 ft/min
Aux drive (10 hp), 32.8 ft/min
Drum capacity: 22,000 ft of 0.675-in.-diam coaxial cable
Accessories: air brakes, sliprings, levelwind, counter, and speed indicator
Weight: 50,000 lb (including cable)

Forward RAP Winch

25-hp electric variable-speed drive
Max. load: 4000 lb
Speed range: 50 to 310 ft/min
Accessories: air brakes, sliprings, levelwind, counter
Weight: 13,500 lb (including cable)

After RAP Winch

25-hp electric variable-speed drive
Max. load: 8000 lb
Speed range: 37 to 148 ft/min
Accessories: air brakes, sliprings, levelwind, counter
Weight: 13,500 lb (including cable)

T-MK-6 Streaming Winch

5-hp electric drive
Double drum with sliprings
Line pull, 1200 lb
Line speed, 105 ft/min
Weight: 1400 lb

Bathythermograph Winch

5-hp electric drive
Line pull, 400 lb at 90 and 360 ft/min
Drum capacity, 3000 ft of 3/32-in.-diam wire rope
Weight: 800 lb (including wire)

U-Frame Davit

Hydraulically actuated
Maximum static load, 30,000 lb
Maximum dynamic load, 6000 lb
Arc of travel, 37-1/2 degrees
Weight: 4850 lb

Wellin Davit

Manually actuated
Maximum static load, 3500 lb
Maximum reach, 10 ft
Weight: 2500 lb

Wellhouse Winch

Electric drive, 3 hp
Maximum line pull, 1000 lb
Average line speed: 56 ft/min

Deck Crane

Hydraulic drive
Lifting capacity
2.9 tons from 25 ft horizontal boom
5.0 tons from 15 ft horizontal boom

DOCUMENT CONTROL DATA - R & D

Security classification of title, body of abstract and indexing annotation to be entered when the overall report is classified)

1. ORIGINATING ACTIVITY (Corporate author) Naval Research Laboratory Washington, D. C. 20390		2a. REPORT SECURITY CLASSIFICATION Unclassified	
2b. GROUP			
3. REPORT TITLE USNS MIZAR, 1970			
4. DESCRIPTIVE NOTES (Type of report and inclusive dates) A final report on one phase of the problem; work is continuing.			
5. AUTHOR(S) (First name, middle initial, last name) W. L. Jones			
6. REPORT DATE September 17, 1970	7a. TOTAL NO. OF PAGES 35	7b. NO. OF REFS None	
8a. CONTRACT OR GRANT NO. NRL Problem K03-19		9a. ORIGINATOR'S REPORT NUMBER(S) NRL Report 7116	
b. PROJECT NO. RR 104-03-41-5904		9b. OTHER REPORT NO(S) (Any other numbers that may be assigned this report)	
c.		d.	
10. DISTRIBUTION STATEMENT This document has been approved for public release and sale; its distribution is unlimited.			
11. SUPPLEMENTARY NOTES		12. SPONSORING MILITARY ACTIVITY Department of the Navy (Office of Naval Research) Arlington, Virginia 22217	
13. ABSTRACT The USNS MIZAR was built in 1957 to serve as a supply ship for American military bases and scientific expeditions in the polar regions. In 1964, MIZAR was acquired by the Naval Research Laboratory to function as a seaborne scientific research platform for oceanographic research. Since her reassignment, she has undergone four major modifications which are part of a six-step master plan to convert MIZAR from a polar cargo ship to a modern oceanographic research vessel. At present, MIZAR is equipped to comfortably accommodate 19 scientists and allow them to perform many diversified operations at sea. The modern chemical and biological laboratory and variety of deck machinery allow the oceanographers to conduct numerous experiments from this steady working platform. MIZAR's electronic facilities, such as the laboratories, workshops, and power capability, meet the requirements for various acoustics operations. The center-well installation and acoustic-ray tracking system have made this ship well suited for deep-sea research work, as well as search and recovery of lost equipment. MIZAR will be even more versatile when the conversion is completed. Future plans include the construction of a wet laboratory to be located on the main deck, and the installation of a work boat to provide the necessary transportation for short errands while operating at sea.			

14 KEY WORDS	LINK A		LINK B		LINK C	
	ROLE	WT	ROLE	WT	ROLE	WT
USNS MIZAR Research ships Oceanographic vessels Deep-sea research Ocean-bottom research Ocean engineering Ocean science Ocean technology Underwater acoustics Underwater photography Biological oceanography Chemical oceanography Physical oceanography						