

AD 729427

AFFDL-TR-71-62 VOLUME I

**DESIGN STUDIES AND MODEL TESTS OF
THE STOWED TILT ROTOR CONCEPT**

Volume I. Parametric Design Studies

Bernard L. Fry

The Boeing Company, Vertol Division

TECHNICAL REPORT AFFDL-TR-71-62

JULY 1971

Reproduced by
NATIONAL TECHNICAL
INFORMATION SERVICE
Springfield, Va. 22151

~~Restricted~~ For public release; Distribution unlimited

AIR FORCE FLIGHT DYNAMICS LABORATORY
AERONAUTICAL SYSTEMS DIVISION
AIR FORCE SYSTEMS COMMAND
WRIGHT-PATTERSON AIR FORCE BASE, OHIO

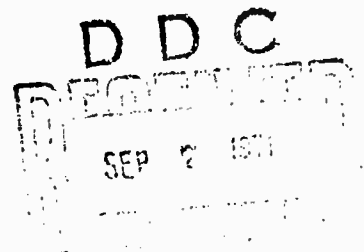

314

UNCLASSIFIED

Security Classification

DOCUMENT CONTROL DATA - R&D		
<i>(Security classification of title, body of abstract and indexing annotation must be entered when the overall report is classified)</i>		
1 ORIGINATING ACTIVITY (Corporate author) The Boeing Company, Vertol Division Boeing Center, P.O. Box 16858 Philadelphia, Pa., 19142		2a REPORT SECURITY CLASSIFICATION Unclassified
		2b GROUP
3 REPORT TITLE DESIGN STUDIES AND MODEL TESTS OF THE STOWED TILT ROTOR CONCEPT (R&D INTERIM REPORT OF PHASE I, Volume I - Parametric Design Studies)		
4 DESCRIPTIVE NOTES (Type of report and inclusive dates) R&D Interim Report		
5 AUTHOR(S) (Last name, first name, initial) Fry, Bernard L.		
6 REPORT DATE 30 September 1969	7a TOTAL NO OF PAGES 319	7b NO OF REFS 11
8a CONTRACT OR GRANT NO. F33615-69-C1577	8b ORIGINATOR'S REPORT NUMBER(S) D-213-10000-1	
c. d.	8c OTHER REPORT NO(S) (Any other numbers that may be assigned this report)	
10 AVAILABILITY/LIMITATION NOTICES Approved for public release; Distribution unlimited		
11 SUPPLEMENTARY NOTES	12 SPONSORING MILITARY ACTIVITY U.S. Air Force Aeronautical Systems Division, Flight Dynamics Laboratory Wright-Patterson Air Force Base, Ohio	
13 ABSTRACT The stowed-tilt-rotor stoppable rotor concept offers great potential for three missions requiring 2 combinations of relatively low down-wash characteristics, good hover efficiency, and relatively high cruise speed and efficiency. These missions are 1) high-speed long-range rescue, 2) capsule recovery, and 3) VTOL medium transport. The present study will provide information on design criteria including the size and configuration of aircraft required to fulfill each of the three missions. The current study indicates that there is reasonable compatibility between the rescue and capsule recovery aircraft because their speed capabilities and required useful loads are similar. However, a much larger aircraft is required to accommodate all three missions. (A reduction in cargo box size for the transport mission can however provide a single compromise airframe size.) Consequently, a baseline configuration has been selected with a common lift/propulsion system combined with different fuselages for rescue aircraft and medium transport aircraft. The compromise made in the transport fuselage box size still provides a capacity in excess of most current medium transports, both helicopter and fixed-wing. The preliminary component design studies have generally confirmed the practicality of the concept and have not revealed any serious problem areas.		

DD FORM 1473
1 JAN 64

UNCLASSIFIED

Security Classification

NOTICE

When Government drawings, specifications, or other data are used for any purpose other than in connection with a definitely related Government procurement operation, the United States Government thereby incurs no responsibility nor any obligation whatsoever; and the fact that the government may have formulated, furnished, or in any way supplied the said drawings, specifications, or other data, is not to be regarded by implication or otherwise as in any manner licensing the holder or any other person or corporation, or conveying any rights or permission to manufacture, use, or sell any patented invention that may in any way be related thereto.

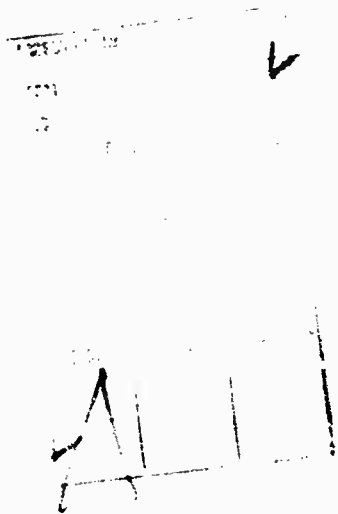

Copies of this report should not be returned unless return is required by security considerations, contractual obligations, or notice on a specific document.

14 KEY WORDS	LINK A		LINK B		LINK C	
	ROLE	WT	ROLE	WT	ROLE	WT
STOWED TILT ROTOR						
FOLDING ROTOR						
CONVERTIBLE ENGINES						
VTOL						
TILT ROTOR						
COMPOSITE AIRCRAFT						
ADVANCED TECHNOLOGY						

INSTRUCTIONS

1. ORIGINATING ACTIVITY: Enter the name and address of the contractor, subcontractor, grantee, Department of Defense activity or other organization (*corporate author*) issuing the report.

2a. REPORT SECURITY CLASSIFICATION: Enter the overall security classification of the report. Indicate whether "Restricted Data" is included. Marking is to be in accordance with appropriate security regulations.

2b. GROUP: Automatic downgrading is specified in DoD Directive 5200.10 and Armed Forces Industrial Manual. Enter the group number. Also, when applicable, show that optional markings have been used for Group 3 and Group 4 as authorized.

3. REPORT TITLE: Enter the complete report title in all capital letters. Titles in all cases should be unclassified. If a meaningful title cannot be selected without classification, show title classification in all capitals in parentheses immediately following the title.

4. DESCRIPTIVE NOTES: If appropriate, enter the type of report, e.g., interim, progress, summary, annual, or final. Give the inclusive dates when a specific reporting period is covered.

5. AUTHOR(S): Enter the name(s) of author(s) as shown on or in the report. Enter last name, first name, middle initial. If military, show rank and branch of service. The name of the principal author is an absolute minimum requirement.

6. REPORT DATE: Enter the date of the report as day, month, year; or month, year. If more than one date appears on the report, use date of publication.

7a. TOTAL NUMBER OF PAGES: The total page count should follow normal pagination procedures, i.e., enter the number of pages containing information.

7b. NUMBER OF REFERENCES: Enter the total number of references cited in the report.

8a. CONTRACT OR GRANT NUMBER: If appropriate, enter the applicable number of the contract or grant under which the report was written.

8b, 8c, & 8d. PROJECT NUMBER: Enter the appropriate military department identification, such as project number, subproject number, system numbers, task number, etc.

9a. ORIGINATOR'S REPORT NUMBER(S): Enter the official report number by which the document will be identified and controlled by the originating activity. This number must be unique to this report.

9b. OTHER REPORT NUMBER(S): If the report has been assigned any other report numbers (*either by the originator or by the sponsor*), also enter this number(s).

10. AVAILABILITY/LIMITATION NOTICES: Enter any limitations on further dissemination of the report, other than those

imposed by security classification, using standard statements such as:

- (1) "Qualified requesters may obtain copies of this report from DDC."
- (2) "Foreign announcement and dissemination of this report by DDC is not authorized."
- (3) "U. S. Government agencies may obtain copies of this report directly from DDC. Other qualified DDC users shall request through _____."
- (4) "U. S. military agencies may obtain copies of this report directly from DDC. Other qualified users shall request through _____."
- (5) "All distribution of this report is controlled. Qualified DDC users shall request through _____."

If the report has been furnished to the Office of Technical Services, Department of Commerce, for sale to the public, indicate this fact and enter the price, if known.

11. SUPPLEMENTARY NOTES: Use for additional explanatory notes.

12. SPONSORING MILITARY ACTIVITY: Enter the name of the departmental project office or laboratory sponsoring (paying for) the research and development. Include address.

13. ABSTRACT: Enter an abstract giving a brief and factual summary of the document indicative of the report, even though it may also appear elsewhere in the body of the technical report. If additional space is required, a continuation sheet shall be attached.

It is highly desirable that the abstract of classified reports be unclassified. Each paragraph of the abstract shall end with an indication of the military security classification of the information in the paragraph, represented as (TS), (S), (C), or (U).

There is no limitation on the length of the abstract. However, the suggested length is from 150 to 225 words.

14. KEY WORDS: Key words are technically meaningful terms or short phrases that characterize a report and may be used as index entries for cataloging the report. Key words must be selected so that no security classification is required. Identifiers, such as equipment model designation, trade name, military project code name, geographic location, may be used as key words but will be followed by an indication of technical context. The assignment of links, rules, and weights is optional.

***DESIGN STUDIES AND MODEL TESTS OF
THE STOWED TILT ROTOR CONCEPT***

Volume I. Parametric Design Studies

Bernard L. Fry

Approved for public release; Distribution unlimited

FOREWORD

This report was prepared by The Boeing Company, Vertol Division, Philadelphia, Pennsylvania, for the Air Force Flight Dynamics Laboratory, Wright-Patterson Air Force Base, Ohio, under Phase I of Contract F33615-69-C-1577. The contract objective is to develop design criteria and aerodynamic prediction techniques for the folding tilt rotor concept through a program of design studies, model testing and analysis.

The contract was administered by the Air Force Flight Dynamics Laboratory with Mr. Daniel E. Fraga (FV) as Project Engineer.

Acknowledgement is made of the following contributors to this volume: S. J. Davis, L. N. DeLarm, P. Ong, R. B. Shannon, A. D. Waltman and G. W. Wolfe.

The reports published under this contract for Design Studies and Model Tests of the Stowed Tilt Rotor Concept are:

Volume I	Parametric Design Studies
Volume II	Component Design Studies
Volume III	Performance Data for Parametric Study Aircraft
Volume IV	Wind Tunnel Test of the Conversion Process of a Folding Tilt Rotor Aircraft Using a Semi-Span Unpowered Model
Volume V	Wind Tunnel Test of a Powered Tilt Rotor Performance Model
Volume VI	Wind Tunnel Test of a Powered Tilt Rotor Dynamic Model on a Simulated Free Flight Suspension System
Volume VII	Wind Tunnel Test of the Dynamics and Aerodynamics of Rotor Spinup, Stopping and Folding on a Semi-Span Folding Tilt Rotor Model
Volume VIII	Summary of Structural Design Criteria and Aerodynamic Prediction Techniques

This report has been reviewed and is approved.

ERNEST J. CROSS, JR.
Lt. Colonel, USAF
Chief, V/STOL Technology Division

ABSTRACT

Recent design studies have indicated that the stoppable rotor aircraft concept offers a very effective solution for satisfying V/STOL missions requiring a combination of relatively low downwash characteristics, good hover efficiency, and relatively high cruise speeds and cruise efficiency. In particular, the stowed-tilt-rotor stoppable-rotor concept offers great potential for three missions: 1) high-speed long-range rescue, 2) capsule recovery, and 3) VTOL medium transport.

The Boeing Company, under USAF Flight Dynamics Laboratory Contract F33615-69-C-1577, is conducting a program of parametric design, analysis, and wind-tunnel testing to establish design criteria for the stowed-tilt-rotor stoppable-rotor concept.

The program is being conducted in two phases. Phase I covers parametric design studies to provide basic information on the size and configuration of aircraft required to fulfill three basic mission requirements and two multimission requirements. These parametric studies provide an appreciation of the compromises which result from multimission application. A baseline aircraft is then selected to provide a basis for various tradeoffs and preliminary component design studies. The Phase I studies provide the background needed to plan the Phase II program of wind tunnel testing and analysis to establish design criteria for the stowed-tilt-rotor concept.

Volume 1 of this report covers the first part of the Phase I studies including the basic mission designs, the multimission designs, the selection of a baseline aircraft, the basic characteristics of this baseline aircraft, and mission and technology tradeoffs. Volume 2 covers the preliminary component design studies.

The current study indicates that there is reasonable compatibility between the rescue and capsule recovery aircraft because their speed capabilities and required useful loads are similar. However, a much larger aircraft is required to accommodate all three missions. (A reduction in cargo box size for the transport mission can however provide a single compromise airframe size.) Consequently, a baseline configuration has been selected with a common lift/propulsion system combined with different fuselages for rescue aircraft and medium transport aircraft. The compromise made in the transport fuselage box size still provides a capacity in excess of most current medium transports, both helicopter and fixed-wing. The preliminary component design studies have generally confirmed the practicality of the concept and have not revealed any serious problem areas.

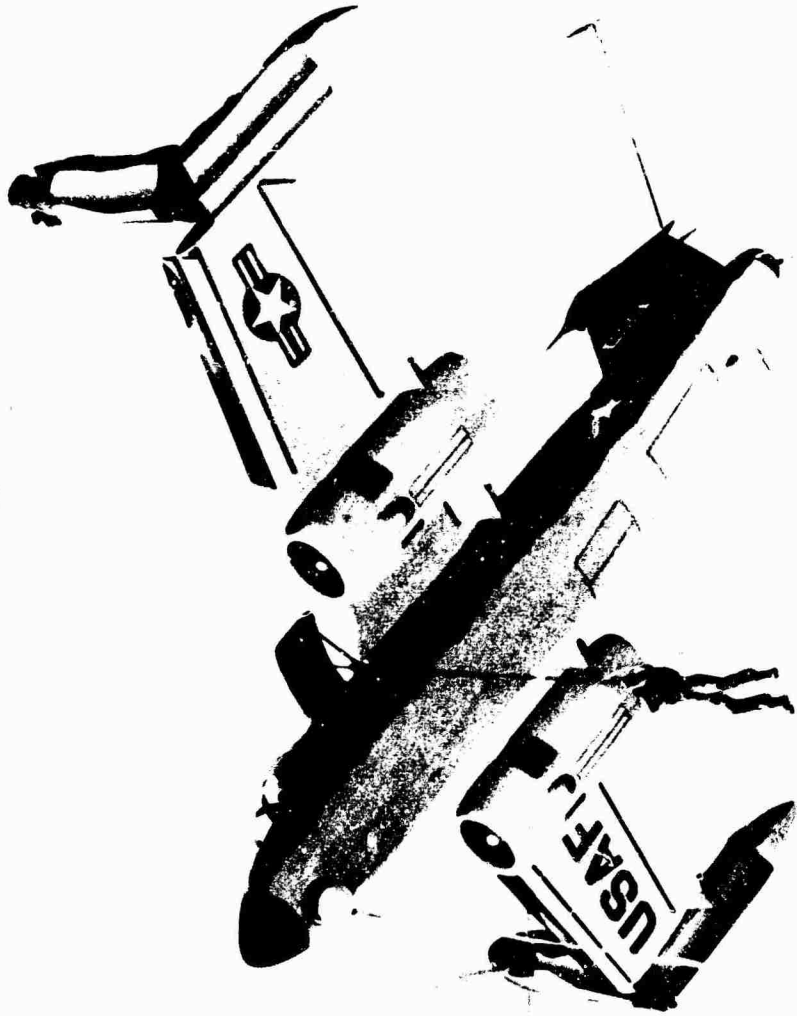

Stowed-Rotor Rescue Aircraft.

TABLE OF CONTENTS

<u>Section</u>	<u>Page</u>
I. INTRODUCTION	1
II. SUMMARY	3
1. The Missions and the Designs	3
2. The Baseline Selection	7
3. Technical Assessment	8
4. Mission and Technology Trade-Offs	10
III. MISSION AND DESIGN GROUND RULES	13
1. Mission Definitions	13
2. Design Ground Rules	18
IV. CONFIGURATION STUDIES	27
1. Configuration Approach	27
2. Basic Mission Designs	34
3. Multimission Designs	61
4. Selection of Baseline Aircraft	81
V. BASELINE CONFIGURATION DESCRIPTION	85
General Arrangement and Characteristics	85
VI. AERODYNAMICS	97
1. Required and Available Power	97
2. Advanced Airfoil Development	97
3. Autorotation Analysis	101
4. STOL Performance Methods	104
5. Thrust Margins Used in Engine Sizing and Performance Calculations	109
VII. WEIGHT AND BALANCE	111
1. Baseline Rescue Aircraft Weight and Balance	111
2. Baseline Transport Aircraft Weight and Balance	128

<u>Section</u>	<u>Page</u>
VIII. PROPULSION	147
1. Rotor Characteristics	147
2. Engine Characteristics	160
3. Drive System	172
IX. STRUCTURAL DYNAMICS ANALYSIS	179
1. Aeroelastic Stability	179
2. Whirl Flutter	179
3. Torsion Blade Divergence and Flutter	182
4. Classical Wing Flutter	182
5. Air Resonance	188
X. STABILITY AND CONTROL	193
1. Hover Control	193
2. Transition Control	198
3. Conversion Control	199
4. Static Stability	208
5. Control Characteristics	208
6. Dynamic Stability	212
XI. TRADE-OFF STUDIES	223
1. Design Point I Rescue Aircraft	223
2. Design Point IV Transport Aircraft	225
XII. WEIGHT PREDICTION METHODOLOGY	243
1. Weight Justification for Baseline Aircraft (1976 IOC)	243
2. Advanced Technology	268
3. Weight Improvement	274
4. Conclusions	284
XIII. TECHNOLOGY TRADE-OFFS	291
1. Demonstrator Aircraft with Separate Lift and Cruise Powerplants	291
2. Advanced Technology for 1980	291
XIV. CONCLUSIONS AND RECOMMENDATIONS	297
REFERENCES	299
APPENDIX: DRAG AND DETAIL PERFORMANCE DATA FOR DESIGN POINT AIRCRAFT	

(See Volume III, APPENDIXES.)

LIST OF ILLUSTRATIONS

<u>Figure</u>		<u>Page</u>
1	Summary of Mission Design Point Aircraft	5
2	Summary of Multimission Aircraft	6
3	Suggested Baseline Approach	9
4	Mission Profile for Design Point I Rescue Aircraft	14
5	Mission Profile for Design Point II Capsule Recovery Aircraft	15
6	Mission Profile for Design Point IV Transport Aircraft	16
7	Typical Wing Arrangement	28
8	Typical Wing Loading and Aspect Ratio Trade	29
9	Alternate Rotor Nacelle Configurations	30
10	Stowed-Tilt-Rotor (Helijet) with Wing-Tip-Mounted Engines and Fans	33
11	3-View of Design Point I Rescue Aircraft	35
12	Engine Characteristics at Cruise Design Points as a Function of Bypass Ratio	36
13	Design Point I Rescue Aircraft. Study of Number of Engines and Disc Loading Trend at Bypass Ratio of 6	38
14	Design Point I Rescue Aircraft. Trade-offs of Disc Loading and Bypass Ratio With Gross Weight at Midpoint	39
15	Design Point I Performance Summary	40
16	Design Point I Rescue Mission Profile and Performance	41
17	3-View of Design Point II Capsule Recovery Aircraft	43

<u>Figure</u>		<u>Page</u>
18	Design Point II Capsule Recovery Aircraft Number of Engines and Disc Loading Trend Study	44
19	Design Point II Capsule Recovery Aircraft Specific Range, Altitude, and Bypass Ratio Trend Study	45
20	Design Point II Performance Summary	46
21	Design Point II (and Capsule Recovery Version of Design Point III) Capsule Recovery Mission Profile and Performance	47
22	3-View of Design Point IV Transport Aircraft	49
23	Design Point IV Bypass Ratio and Disc Loading Trend Study	50
24	Design Point IV Performance Summary	51
25	Design Point IV Transport Mission Profile and Performance, 5-Ton Payload	52
26	Design Point IV Transport Mission Profile and Performance, 8.5 Ton Payload	53
27	3-View of Design Point III Multimission Aircraft, Rescue Version	62
28	Design Point III Performance Summary	63
29	Design Point III (Multimission) Rescue Mission Profile and Performance	64
30	3-View of Design Point V Multimission Aircraft, Transport and Capsule Recovery Versions	66
31	Design Point V Basic Mission Performance Summary	67
32	Design Point V (Multimission) Transport Mission Profile and Performance	68
33	3-View of Design Point V Multimission Aircraft, Rescue Version	69
34	Design Point V Capsule Recovery Aircraft Mission Profile and Performance	70

<u>Figure</u>		<u>Page</u>
35	Design Point V (Multimission) Rescue Mission Profile and Performance	71
36	Comparison of Baseline and Design Point IV Fuselage Cross Sections	82
37	3-View of Baseline Rescue Aircraft	86
38	3-View of Baseline Transport Aircraft	87
39	Baseline Aircraft Rescue Version Inboard Profile	91
40	Baseline Aircraft Performance Summary	96
41	Power Available and Required in Rotor Driven Flight Modes for the Baseline Rescue Aircraft . .	98
42	Thrust Available and Required for the Baseline Rescue Aircraft for Air Force Hot Day	99
43	Transonic Airfoil Development	100
44	Critical Mach Number of Advanced Airfoils	102
45	Ground Effect on Rotor Thrust at Constant Power .	103
46	Vertical Partial Power Descent With One Engine Inoperative	105
47	Stowed-Tilt-Rotor Power-Off Lift Characteristics	107
48	Tilt/Stowed Rotor Power-Off Drag Characteristics	108
49	Baseline Transport Cargo Loading Diagram	144
50	Rotor Wake Shape Parameter	151
51	Correlation of Test Data With Rotor Hover Performance Predicted by Explicit Vortex Influence Technique	152
52	Correlation of Test Data With Low Speed Rotor Cruise Performance Predicted by Explicit Vortex Influence Technique - Cruise Efficiency Versus Total Blade Twist	153

<u>Figure</u>		<u>Page</u>
53	Effect of Twist and Solidity on Hover Performance	154
54	Hover Rotor Performance - Figure of Merit Versus Thrust Coefficient	155
55	Hover Rotor Performance - Blade Angle Versus Thrust Coefficient	156
56	Cruise Rotor Performance - Cruise Efficiency Versus Thrust Coefficient	157
57	Cruise Rotor Performance - Blade Angle Versus Thrust Coefficient	158
58	Rotor Blade Characteristics	159
59	Fan Bypass Ratio Versus Pressure Ratio Optimization	161
60	Interim Convertible Engine	164
61	Interim Convertible Engine Drive System Schematic	165
62	Turbofan Thrust Performance at Bypass Ratio 6	168
63	Turbofan Referred Normalized Fuel Flow at Bypass Ratio 6	169
64	Engine Gas Generator Speed Characteristics	170
65	Engine Power Turbine Speed Characteristics	171
66	Stowed Tilt Rotor Drive System	173
67	Design Point I Drive Schematic	174
68	Design Point II Drive Schematic	175
69	Design Point III Drive Schematic	176
70	Design Point IV Drive Schematic	177
71	Design Point V Drive Schematic	178
72	Model Design is Stable From Whirl Flutter at 250 Knots EAS With Cyclic Feedback System Inoperative	181

<u>Figure</u>	<u>Page</u>
73 Rotor Speed Margin of Aircraft: Adequate at 250 Knots EAS	183
74 Model Design is Stable Over All Operating Velocities	184
75 Design Stability at Various Operating Power Settings	185
76 Typical Analytical Model of Program C-26	186
77 Blade is Free From Torsional Divergence at Forward Sweep Angles	187
78 Rotor and Aircraft Frequency Plot	189
79 Model is Free from Air Resonance Throughout Operating Range	190
80 Nine Degree-of-Freedom Propeller Whirl Model Analysis	191
81 Assumed Response Characteristics of Rotor Nacelle Tilt for Yaw Control	196
82 Cyclic Pitch and Nacelle Tilt Mixing for Yaw Control	197
83 Effect of Blade Folding on Lift Slope	202
84 Effect of Blade Folding on Longitudinal Stability	203
85 Time History of Typical Conversion Cycle	205
86 Time History of Typical Reconversion Cycle	206
87 Directional Stability with the CG at 33 Percent of Mean Aerodynamic Chord	207
88 Longitudinal Control Characteristics at Low Speed with CG at 33 Percent of the Mean Aerodynamic Chord	211
89 Rudder Control Power	213
90 Rudder Control Moments	214
91 Aileron Response Variation with Airspeed and Altitude	215

<u>Figure</u>		<u>Page</u>
92	Vertical Acceleration at CG Versus Short Period Frequency for a Stowed Rotor Configuration . . .	216
93	Longitudinal Short Period Roots with the CG Maximum Aft and a Gross Weight of 57,000 Pounds .	217
94	Longitudinal Phugoid Mode Roots with the CG Maximum Aft and a Gross Weight of 67,000 Pounds .	220
95	Lateral Dutch Roll Roots with the CG Maximum Aft and a Gross Weight of 67,000 Pounds	221
96	Design Point I Sensitivity of Weight, Bypass Ratio, and Installed Power to Sizing at Various Cruise Speeds	228
97	Design Point I Sensitivity of Wing Thickness and Rotor Diameter to Sizing at Various Cruise Speeds	229
98	Design Point I Sensitivity of Midpoint Gross Weight to Sizing at Various Dash Speeds and Altitudes for Air Force Hot Day	230
99	Design Point I Sensitivity of Midpoint Gross Weight to Sizing at Various Mission Radii	231
100	Design Point I Sensitivity of Midpoint Gross Weight to Sizing at Various Payloads	232
101	Design Point I Sensitivity of Midpoint Gross Weight to Sizing at Various Hover Times for 6,000-Foot Altitude, 95°F Temperature, HOGE, and T/W = 1.073	233
102	Design Point IV Sensitivity of Gross Weight to Sizing at Various Cruise Speeds for Air Force Hot Day and Aircraft Nonpressurized Cruise Altitude of 10,000 Feet	234
103	Design Point IV Sensitivity of Gross Weight to Sizing at Various Dash Speeds and Altitudes for Air Force Hot Day	235
104	Design Point IV Sensitivity of Aircraft Weight, Mission Fuel, and Installed Shaft Horsepower to Mission Radius (Sheet 1 of 2)	236
104	Design Point IV Sensitivity of Aircraft Weight, Mission Fuel, and Installed Shaft Horsepower to Mission Radius (Sheet 2 of 2)	237

<u>Figure</u>		<u>Page</u>
105	Design Point IV Sensitivity of Aircraft Weight, Mission Fuel, and Installed Shaft Horsepower to Payload (Sheet 1 of 2)	238
105	Design Point IV Sensitivity of Aircraft Weight, Mission Fuel, and Installed Shaft Horsepower to Payload (Sheet 2 of 2)	239
106	Design Point IV Sensitivity of Aircraft Weight, Mission Fuel, and Installed Shaft Horsepower to Total Mission Hover Time (Sheet 1 of 2)	240
106	Design Point IV Sensitivity of Aircraft Weight, Mission Fuel, and Installed Shaft Horsepower to Total Mission Hover Time (Sheet 2 of 2)	241
107	Design Point IV Sensitivity of Gross Weight to Hover Altitude and Temperature for Disc Loading of 16.0 psf	242
108	Rotor Group Weight Trend	244
109	Wing Weight Trend	247
110	Baseline Rescue and Transport Wing Design Conditions (Ultimate Conditions: 3.75g Vertical Plus 0.9 Rad/Sec ² (Pitch))	250
111	Stowed-Tilt-Rotor Torque Box Weight Density	252
112	Horizontal Tail Weight	255
113	Vertical Tail Weight	256
114	Basic Body Group Weight	258
115	Gearbox Weight	265
116	Fan and Nacelle Weight	267
117	Material Tensile Strength to Density Trend	270
118	Material Compressive Strength to Density Trend	271
119	Material Fracture Toughness to Density Trend	272
120	Material Stiffness to Density Trend	273
121	Comparison of Theoretical and Actual Tensile Strength of Materials	277

<u>Figure</u>		<u>Page</u>
122	Projected Design Usefulness of Lubricants	279
123	Turboshaft Engine Power to Weight Trend	281
124	Turbofan Engine Thrust to Weight Trend	282
125	Trends in Integrated Circuits	285
126	Avionics Component Reliability Trends	286
127	Avionics System Reliability Trends	287
128	Improvement in High Reliability Microcircuits	288
129	Complexity of Avionics	289
130	Demonstrator Aircraft with Separate Lift and Cruise Engines	292

LIST OF TABLES

<u>Table</u>	<u>Page</u>
I. Characteristics of Basic Mission Aircraft . . .	54
II. Weight Summary for Design Point I Rescue Aircraft	58
III. Weight Summary for Design Point II Capsule Recovery Aircraft	59
IV. Weight Summary for Design Point IV Transport Mission Aircraft	60
V. Characteristics of Multimission Aircraft . . .	72
VI. Weight Summary for Design Point III Multi-mission Aircraft in Rescue Role	76
VII. Weight Summary for Design Point III Multi-mission Capsule Recovery Role	77
VIII. Weight Summary for Design Point V Multimission Aircraft in Rescue Role	78
IX. Weight Summary for Design Point V Multimission Aircraft in Capsule Recovery Role	79
X. Weight Summary for Design Point V Multimission Aircraft in Transport Role	80
XI. Comparison of Medium Transport Aircraft Cargo Hold Dimensions	83
XII. General Characteristics of Baseline Aircraft .	88
XIII. Weight Summary for Baseline Rescue and Transport	93
XIV. Minimum Parasite Drag Breakdown of Baseline Aircraft, Transport Version	95
XV. Baseline Rescue Aircraft Group Weight Statement	114
XVI. Baseline Rescue Aircraft Balance Calculations .	118
XVII. Baseline Rescue Mission Gross Weights	126

<u>Table</u>	<u>Page</u>
XVIII. Summary of Moments of Inertia for Baseline Rescue Mission	127
XIX. Baseline Transport Aircraft Group Weight Statement	130
XX. Baseline Transport Aircraft Balance Calculations	134
XXI. Baseline Transport Mission Gross Weights	143
XXII. Moments of Inertia Transport	145
XXIII. Summary of Rotor Characteristics	148
XXIV. Engine and Fan Performance Data	162
XXV. Engine Data Symbols	166
XXVI. Parameters of Aircraft Used for Aeroelastic Stability Analysis	180
XXVII. Stowed-Tilt-Rotor Aircraft Conversion Cyclic Automatic Mode	200
XXVIII. Longitudinal Stability Derivatives	209
XXIX. Lateral-Directional Stability Derivatives	210
XXX. Results of Calculations and Densities used for Secondary Structure	257
XXXI. 463L Cargo Loading System Information (Brooks and Perkin Company)	259
XXXII. Summary of Landing Gear Weight in Percent of Gross Weight for V/STOL Aircraft	260
XXXIII. Baseline Aircraft Fixed Equipment Weights	269
XXXIV. Material Property Data Summary	275
XXXV. Summary of Some Current Aerospace Composite Weight Investigations	276
XXXVI. Demonstrator Aircraft Weight Summary	293
XXVII. Demonstrator Aircraft Engine Installation Weights	294
XXXVIII. Baseline Rescue 1980 Technology Tradeoffs	295

LIST OF ABBREVIATIONS AND SYMBOLS

Abbreviations

A	rotor disc area
AF	activity factor per blade
AFHD	Air Force hot day
b	wing span
c	wing chord
\bar{c}	wing mean aerodynamic chord
CBR	California bearing ratio
C_{L_i}	blade design lift coefficient
C_l	rolling moment coefficient, $\frac{\text{rolling moment}}{qSb}$
C_M	pitching moment coefficient, $\frac{\text{pitching moment}}{qS\bar{c}}$
C_n	yawing moment, coefficient $\frac{\text{yawing moment}}{qSb}$
C_r	wing root chord
C_{TP}	propeller thrust coefficient, $\frac{T}{\rho n^2 D^4}$
C_{TR}	rotor thrust coefficient, $\frac{\text{thrust}}{\rho AV_T^2}$
D	rotor diameter
DGW	design gross weight
E	modulus of elasticity
EAS	equivalent airspeed
EVIT	exploit vortex influence technique
FBA	fold back angle
F_n	thrust, pounds
F_n^*	thrust at maximum power, sea level standard, pounds

FOD	foreign object damage
G	shear modulus of elasticity
GW	gross weight
HOGE	hover out of ground effect
I	area moment of inertia
IGE	in ground effect
IOC	initial operational command
J	advance ratio, V/nD ; polar moment of inertia
L/D	lift drag ratio
M	mach number or pitching moment
MAC, mac	wing mean aerodynamic chord
M/H	bending moment divided by depth (as of a beam)
M_M, M_{MO}	maximum operating mach number
n	load factor; rotor rotational speed, revolutions per second
NRP	normal rated power
N_Z	airplane normal force load factor
q	dynamic pressure, $1/2 \rho V^2$
R/C	rate of climb
SAS	stability augmentation system
SFC	specific fuel consumption
T	temperature; time for full control displacement
t	time, seconds
T_4	gas generator turbine inlet temperature
T_5	power turbine inlet temperature
TAS	true airspeed

TBO	time between overhaul
t/c	thickness to chord ratio
TSFC	thrust specific fuel consumption
T/W	thrust to weight ratio
V_{CON}	that airspeed at which a load factor of 1.2 can be achieved with wing flaps retracted and with no lift produced by the rotors
V_{Cruise}	cruise speed
V_G	Speed for maximum gust intensity
V_H	level flight maximum speed
V_L	design limit speed in level flight
V_M, V_{MO}	maximum operating velocity
V_S	stalling speed in level flight at sea level in basic configuration with power off
V_T	tip velocity of rotor blade
W/A	disc loading
W_f	weight of fuel per hour

Symbols

$\beta_{0.75}$	blade angle at 75 percent of radius
$\Delta\alpha_T$	incremental nacelle tilt angle
$\dot{\Delta\alpha}_t$	angular velocity of nacelle tilt
$\ddot{\Delta\alpha}_t$	angular acceleration of nacelle tilt
$\Delta\beta$	tip path plane deflection due to cyclic blade angle
$\delta_{ambient}$	atmospheric static pressure ratio referred to sea level standard conditions
δ_r	rudder angle
θ_{amb}	ambient absolute temperature ratio referred to sea level standard conditions

- V advance ratio, $\frac{V}{V_T}$
 ρ air density, slugs per cubic foot
 σ density ratio referred to sea level standard

Sign Convention

The sign convention for axes originating at cg and parallel to butt, station, and water lines is:

- Pitch: positive, nose down
 Yaw: positive, nose to the right
 Roll: positive, left wing down
 Side Force: positive to the left
 Normal Force: positive downward
 Longitudinal Force: positive forward

Stability Derivatives

- C_{l_β} derivative of rolling moment coefficient with yaw angle, $\delta C_{l_1} / \delta \beta$
 $C_{l_{\delta_A}}$ derivative of rolling moment due to aileron deflection
 $C_{l_{\delta_r}}$ derivative of rolling moment due to rudder deflection
 C_{l_r} derivative of rolling moment coefficient with yaw rate, $\frac{\delta C_{l_1}}{\delta r} \left(\frac{1}{b/2v} \right)$
 C_{l_p} derivative of rolling moment coefficient with roll rate, $\frac{\delta C_{l_1}}{\delta p} \left(\frac{1}{b/2v} \right)$
 C_{M_α} derivative of pitch moment coefficient with angle of attack, $\delta C_{M_1} / \delta \alpha$
 $C_{M_\alpha \dot{\alpha}}$ derivative of pitch moment coefficient with angle of attack rate, $\delta C_{M_1} / \delta \dot{\alpha} \left(\frac{1}{c/2v} \right)$

$C_{M\delta_e}$	derivative of pitching moment due to elevator deflection
C_{Mq}	derivative of pitch moment coefficient with pitch rate, $\delta C_M / \delta \dot{\epsilon} \left(\frac{1}{\bar{c}/2v} \right)$
C_{Mu}	derivative of pitch moment coefficient with X component of velocity, $\delta C_M / \delta u$
$C_{n\beta}$	derivative of yawing moment coefficient with yaw angle, $\delta C_n / \delta \beta$
$C_{n\delta_A}$	derivative of yawing moment due to aileron deflection
$C_{n\delta_r}$	derivative of yawing moment due to rudder deflection
C_{nr}	derivative of yawing moment coefficient with yaw rate, $\frac{\delta C_n}{\delta r} \left(\frac{1}{b/2v} \right)$
C_{np}	derivative of yawing moment coefficient with roll rate, $\frac{\delta C_n}{\delta p} \left(\frac{1}{b/2v} \right)$
$C_{X\alpha}$	derivative of X force coefficient with angle of attack, $\delta C_X / \delta \alpha$
C_{Xq}	derivative of X force coefficient with pitch rate, $\delta C_X / \delta \dot{\epsilon}$
C_{Xu}	derivative of X force coefficient with X component of velocity, $\delta C_X / \delta u$
$C_{Y\beta}$	derivative of y force coefficient with yaw angle, $\delta C_Y / \delta \beta$
C_{Yr}	derivative of y force coefficient with yaw rate, $\delta C_Y / \delta r$
C_{Yp}	derivative of y force coefficient with roll rate, $\delta C_Y / \delta p$
$C_{Z\alpha}$	derivative of Z force coefficient with angle of attack, $\delta C_Z / \delta \alpha$

C_{z_q} derivative of Z force coefficient with pitch rate, $\delta C_z / \delta \dot{\theta}$

C_{z_u} derivative of Z force coefficient with X component of velocity, $\delta C_z / \delta u$

SECTION I

INTRODUCTION

VTOL concepts which retain the helicopter's advantage of relatively low disc loading without overly compromising the high-speed cruise characteristics have shown promise of high effectiveness in certain mission. Many comparative studies in recent years have pointed to the stoppable rotor, and in particular to the stowed tilt rotor, as the concepts providing the greatest potential for three missions: 1) high-speed long-range rescue, 2) capsule recovery, and 3) VTOL transport.

The stowed-tilt-rotor concept hovers and makes a transition to forward flight with the rotor shaft horizontal, in the same manner as a pure tilt-rotor aircraft. However, when the aircraft reaches a conversion speed of the order 120 to 180 knots, the rotors are feathered and stopped, and the blades are folded back into wing-tip-mounted nacelles. Power is provided by convertible engines which are capable of providing shaft power for the rotor drive or fan power for cruise flight with the rotors folded.

The stowed tilt rotor has other advantages which are natural fallouts of the configuration. For example, vulnerability is drastically reduced in the cruise mode compared to VTOL concepts which rely on rotor or propeller systems for cruise propulsion. The stowed tilt rotor is less susceptible to damage which renders the rotor blades, hubs and controls, rotor transmission system, and two of four engines inoperative and still return to make a conventional landing with the rotors stowed. The small proportion of rotor driven mode flight time (from five- to twenty-five percent of total flight time, depending on the mission) will reduce maintenance cost and bring overhaul time of the rotor-associated system in line with airframe overhaul periods. In addition, failure of the nacelle tilting mechanism does not force the aircraft to make a landing which involves heavy rotor or propeller damage. These advantages offset the complexities which accrue from the addition of rotor folding.

Investigation of the concept has steadily advanced to the point where preliminary wind-tunnel tests of the folding tilt rotor have been completed. However, much remains to be done to establish a firm base of technical data and design criteria for further development of the concept.

Under USAF Flight Dynamics Laboratory Contract, Boeing is conducting a program of parametric design, analysis, and wind-tunnel testing to establish design criteria for the stowed-tilt-rotor stoppable rotor concept. The program is being conducted in two phases.

The Phase I studies reported here provide the necessary background to plan the Phase II program of wind-tunnel testing and analysis required to establish design criteria for the stowed-tilt-rotor concept.

SECTION II

SUMMARY

1. THE MISSIONS AND THE DESIGNS

The first part of this report presents the results of a preliminary design study in which five basic folding-tilt-rotor aircraft have been designed. Three of these designs are for discrete design missions and two are multimission aircraft combining two, and then all three, of the basic missions. The missions and the design aircraft are:

<u>Mission</u>	<u>Aircraft</u>
o High-speed long-range rescue	Design Point I
o Capsule recovery	Design Point II
o V/STOL medium transport	Design Point IV
o High-speed long-range rescue and capsule recovery (multimission)	Design Point III
o High-speed long-range rescue, capsule recovery, and V/STOL medium transport (multimission)	Design Point V

The intent of the analysis was to determine the degree of compatibility between aircraft designed to the three missions, and the compromise necessary to combine these mission capabilities in substantially common airframes. As a minimum, this commonality was extended to the lift/propulsion system comprising the wing, engines, drive system, and rotors. The relative numbers of production aircraft which might be required for each mission was considered in determining the degree of commonality. The technology level used in these studies is appropriate to a 1976 IOC date time frame.

The results, presented in detail in subsequent sections of this report, are summarized in this section.

a. Basic Mission Aircraft

Salient characteristics of the three basic mission aircraft are given in Figure 1.

The basic rescue mission aircraft has a design takeoff gross weight of 67,000 pounds. The critical hover engine sizing criteria was at the midpoint, matching the engine size required for the 400-knot cruise speed at 20,000 feet. Disc loading at the midpoint is 15 pounds per square foot.

The capsule recovery aircraft, at 78,000 pounds, is heavier than the rescue vehicle. While both aircraft have approximately the same useful load of 20,000 pounds, the higher drag of the capsule recovery aircraft (caused by the fuselage configuration necessary to carry the capsule) and the weight penalties of the structural cutout to accommodate the capsule in the bottom of the fuselage caused the weight to escalate. This is reflected in the higher fraction of shaft horsepower to gross weight of the capsule recovery aircraft.

The VTOL medium transport aircraft is still larger, at 85,000 pounds. This was of course due to the considerably larger fuselage that was required to accommodate the 463L loading system. The conclusion, therefore, was that there was little compatibility between the sizes of aircraft required to fulfill these three basic missions.

b. Multimission Aircraft

The multimission aircraft are summarized in Figure 2. Understandably, a combination of the rescue and capsule recovery missions into Design Point III produces an aircraft of the same size as the larger of the two single-mission aircraft. The lift/propulsion system of the capsule recovery aircraft will also accommodate the rescue mission requirements if the drive system is up-rated slightly. Thus, the basic Design Point III vehicle is a capsule recovery lift/propulsion system with an up-rated drive system combined with a rescue mission fuselage for the Design Point I mission. This vehicle is then modified by the substitution of an enlarged center fuselage section for the Design Point II or capsule recovery mission. The required number of the latter configuration is likely to be small. Such a factory modification of a limited number of aircraft appears to be the most satisfactory solution, if only the rescue and capsule recovery missions are considered.

In configuring the Design Point V multimission aircraft to accomplish the three basic missions, certain ground rules were established:

MISSION	DESIGN GROSS WT (LB)	EMPTY WT (LB)	INSTALLED SHP	SHP/GW	HP/LB	ROTOR DIA (FT)	
500-NMI RADIUS. 400-KNOT CRUISE SPEED RESCUE VEHICLE	67,000	42,714	17,454	0.261	49.2	58.9'	
1500-NMI RADIUS (WITH AIR REFUELING) 400-KNOT CRUISE SPEED CAPSULE RECOVERY 15,000 LB PAYLOAD AIRCRAFT	78,000	55,795	22,400	0.288	57.5	70.5'	
250-NMI RADIUS. 350-KNOT CRUISE SPEED 10,000-LB PAYLOAD TRANSPORT	85,000	58,850	19,766	0.233	64.4	72.1'	

Figure 1. Summary of Mission Design Point Aircraft.

MISSIONS	TAKEOFF GROSS WT (LB)	EMPTY WT (LB)	INSTALLED SHP	ROTOR DIA	COMMENTS
RESCUE AND CAPSULE RECOVERY	88,460	57,732	22,400	57.5	BASIC AIRCRAFT HAS RESCUE FUSELAGE
RESCUE ROLE					
CAPSULE RECOVERY ROLE	78,000	50,055			NEW FUSELAGE CENTER SECTION (FACTORY MODIFICATION)
RESCUE, CAPSULE RECOVERY AND TRANSPORT					
TRANSPORT ROLE	104,200	74,532	29,704	64.4	BASIC AIRCRAFT IS TRANSPORT RESIZED FOR 400 KNOT CRUISE
CAPSULE RECOVERY ROLE	104,200	75,168			FUSELAGE FLOOR, HOIST BEAMS AND GEAR FAIRINGS MODIFIED
RESCUE ROLE	110,800	73,237			RESCUE MISSION EXCEEDS PERMISSIBLE MIDPOINT WEIGHT WITH BASIC TRANSPORT CONFIGURATION. NEW FUSELAGE REQUIRED TO DO RESCUE MISSION WITHOUT BASIC LIFT PROPULSION SYSTEM SIZE INCREASE

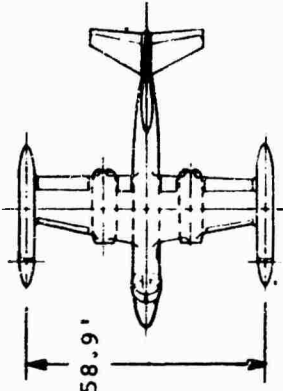
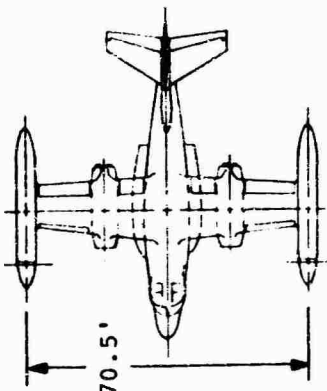
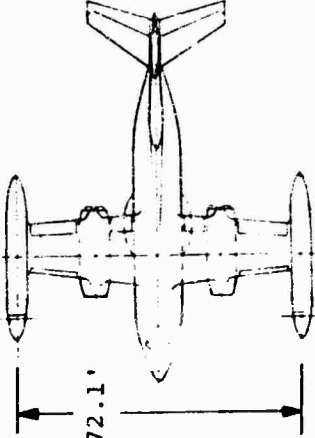
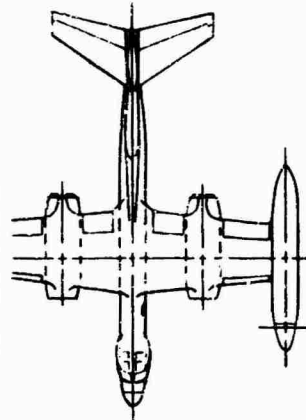
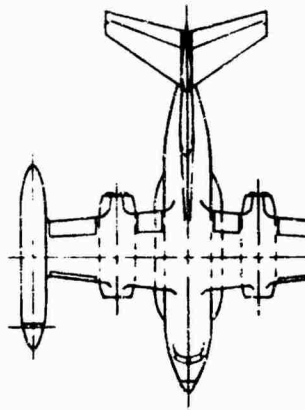
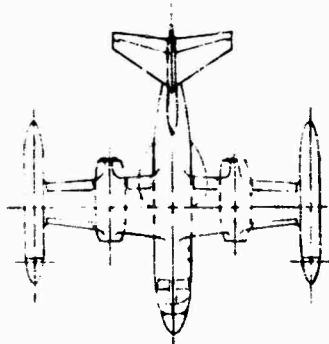

Figure 2. Summary of Multimission Aircraft.

- (1) The lift/propulsion system should be common.
- (2) The basic aircraft fuselage should be for the transport mission, since this is likely to be built in the largest quantities.
- (3) Since the number of capsule recovery aircraft required is likely to be small, they should require a minimum modification to the basic fuselage.
- (4) While the required quantities of rescue ships may not justify development of a new aircraft, the number would be sufficiently large to warrant major modification of an existing airframe. Therefore, a new fuselage is permissible for the rescue version if the weight and drag of the transport fuselage makes it impossible to do the rescue mission with the base airplane.

The first step in designing the Design Point V aircraft was to resize the basic transport aircraft to have a 400-knot speed capability for the capsule pickup mission. This resulted in a 104,000-pound design gross weight ship which was able to fulfill the capsule pickup role, with a suitably modified fuselage. While it was obviously desirable to do the rescue mission with the basic airframe unchanged, it was found that the drag and weight of the large fuselage forced the required takeoff weight for this mission up to 127,000 pounds. While this was tolerable, the resulting midpoint gross weight required 13 percent more power than is installed in the base transport capsule pickup aircraft. Therefore, rather than increase the size of the basic lift/propulsion system still further, a new smaller fuselage was designed for the rescue version of Design Point V. The resulting reduction in drag and weight makes it possible to do the rescue mission without increasing the size of the basic lift/propulsion system.

2. THE BASELINE SELECTION

Because the multimission aircraft designed to accomplish all three basic roles turned out to be so large, a further study was made of a compromise aircraft based on the Design Point I rescue aircraft. This design point lift/propulsion system was combined with a transport type fuselage based on a CH-47 helicopter box size widened to 96 inches at the floor line to accommodate 463L system pallets. This aircraft is capable of carrying the full 88 x 108-inch pallet and air-dropping the 88 x 54-inch half-pallet. Pallet loading is restricted to 72 inches in height. Although

this aircraft does not have the unrestricted 463L system pallet loading capability of the Design Point IV transport aircraft (i.e., maximum pallet height or air dropping of full pallets), it can nevertheless meet most of the transport mission requirements.

It was, therefore, decided that the baseline aircraft would be the design point I rescue aircraft, with a slightly increased span to permit the alternate installation of a wider transport fuselage. The baseline is, therefore, in reality two aircraft with common lift/propulsion systems.

This baseline aircraft approach is illustrated in Figure 3. A basic lift propulsion system is used with two different fuselages: one to fulfill the complete rescue mission, and the other to provide an aircraft which meets most of the mission requirements for the medium transport role. Further trade-offs might be made to establish the mission capabilities of a basic transport version with minimum modifications for both the rescue and capsule recovery missions.

3. TECHNICAL ASSESSMENT

A broad assessment has been made of the handling qualities and control systems, and the structural dynamic behavior of the baseline aircraft.

In principle, it has been established that hover control can be satisfactorily attained without the use of large amounts of cyclic pitch control, thus alleviating the tilt mechanism loads and the stresses in the hingeless rotor blades. The transient forces and moments on the aircraft during conversion (blade folding and rotor spin-up and stopping) do not appear to present severe problems. The conversion process has been considerably simplified, compared to concepts current at the beginning of the study, by the elimination of fan clutches and mechanical rotor indexing. Handling qualities in the stowed rotor mode are generally satisfactory. The problem areas are due to the short span and high roll and yaw inertias of the configuration. Thus low speed roll control response, roll subsidence and spiral divergence do not meet specifications at present, and further work must be done to provide solutions to these problems. An assessment of the major structural dynamics phenomena, using the component mass and stiffness distributions generated in the study and reported in Volume II, does not indicate any undesirable characteristics.

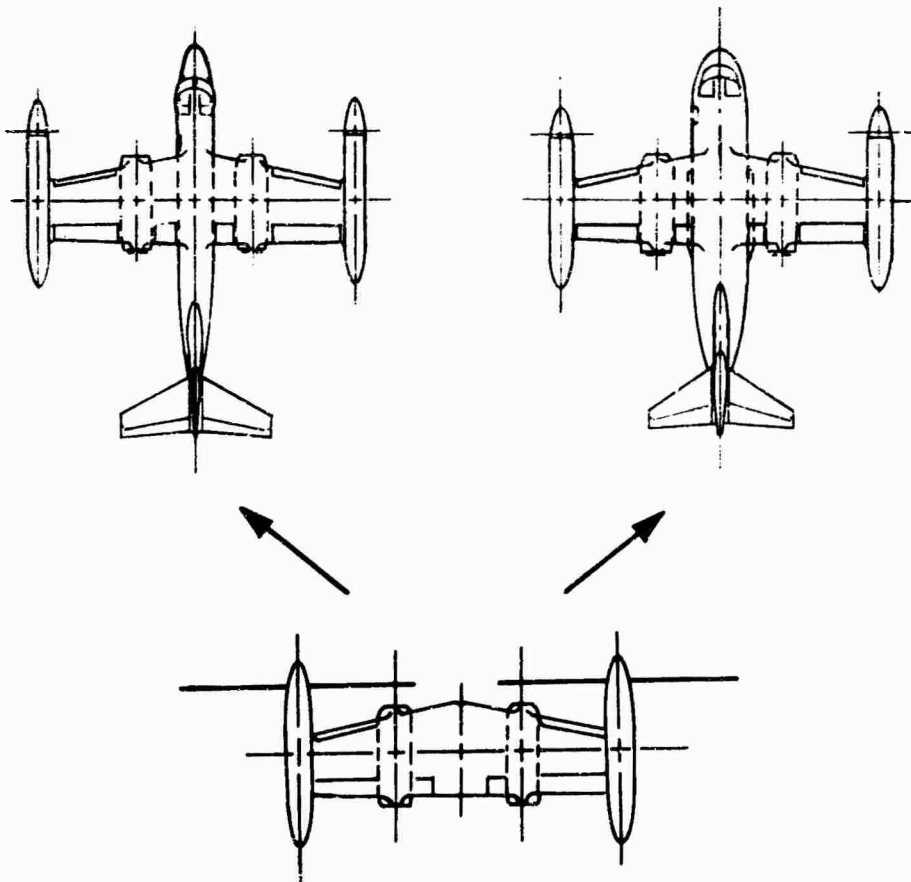

BASIC LIFT/PROPULSION SYSTEM

ROTOR DIA 49.2 FT
 SPAN 61.2 FT
 POWER 4 X 4350 SHP

RESCUE VERSION

MEETS ALL RESCUE MISSION REQUIREMENTS

CRUISE SPEED AT 20,000 FT 400 KN
 DESIGN GROSS WEIGHT 67,000 LB
 MIDPOINT GROSS WEIGHT 57,000 LB
 MIDPOINT DISC LOADING 15 PSF

TRANSPORT VERSION

TAKEOFF AT DESIGN GROSS WEIGHT 67,000 LB
 5 TONS PAYLOAD OVER 260 NMI RADIUS AT 350 KTS, 100 NMI INBOUND AND OUTBOUND AT 3000 FT
 TAKEOFF AT MAX TAKEOFF GR 80,000 LB
 8-1/2 TONS PAYLOAD OVER 375 N.M. RADIUS. AT 350 KTS, 150 N.M. INBOUND AND OUTBOUND AT 3000 FT.

MAX SPEED AT N.R.P. 380 KTS AT 2000 FT
 CARGO BOX: 7.75 X 7.1 FT X 30 FT

Figure 3. Suggested Baseline Approach.

4. MISSION AND TECHNOLOGY TRADEOFFS

The effect of variations of the major mission parameters on aircraft size and weight has been examined for the Design Point I rescue aircraft and the Design Point IV medium rescue aircraft. The principal results are summarized below:

a. Design Point I:

<u>Parameter</u>	<u>Mean Gross Weight Sensitivity</u>
(1) Cruise speed	200 pounds per knot
(2) Dash speed and altitude	25 to 30 pounds per knot -400 pounds per 1,000 feet
(3) Mission radius	For radii \leq 650 nautical miles: 52 pounds per nautical mile For radii $>$ 700 nautical miles: 310 pounds per nautical mile (and increasing)
(4) Payload	4.5 pounds per pound
(5) Hover time	At design point: 30,000 pounds per hour At twice the design point hover time: 36,750 pounds per hour
(6) Hover altitude temperature	Negligible below 6,000 feet, 95°F.

b. Design Point IV:

<u>Parameter</u>	<u>Mean Gross Weight Sensitivity</u>
(1) Cruise speed	180 pounds per knot
(2) Dash speed and altitude	For dash speed $<$ 350 knots: 17 pounds per knot, -400 pounds per 1,000 feet For dash speed $>$ 350 knots: 580 pounds per knot, -967 pounds per 1,000 feet

<u>Parameter</u>	<u>Mean Gross Weight Sensitivity</u>
(3) Mission radius	From 126 pounds per nautical mile at design point to 630 pounds per nautical mile at twice the design point mission radius
(4) Payload	Above the design point: 4.6 pounds per pound Below the design point: 2.7 pounds per pound
(5) Hover time	At design point: 27,500 pounds per hour At one hour of hover time: 115,000 pounds per hour
(6) Hover altitude and temperature	Negligible below design point, increasing to 92,800 pounds at 4,000 feet 100°F.

The change in the empty weight of the baseline aircraft has been assessed due to the omission of all advanced technology airframe materials and fabrication techniques and the use of separate turboshaft and turbofan engines for rotor drive and cruise propulsion. This is the logical approach for a demonstrator prototype aircraft, and the results show that such an aircraft would have an adequate payload for test and mission evaluation purposes.

Predictions have also been made of the reduction in weight for advanced technology appropriate to a 1980 IOC date. These predictions show that weight savings amounting to 15 percent of the useful load are probable relative to the datum 1976 IOC technology used in this study.

SECTION III

MISSION AND DESIGN GROUND RULES

1. MISSION DEFINITIONS

The mission profiles and requirements for the three basic missions are presented in Figures 4, 5, and 6. These missions are:

- I High-Speed Long-Range Rescue
- II Capsule Recovery
- III Medium V/STOL Transport

Additional requirements for these missions (both given and assumed) are presented as follows:

a. Additional Requirements for Design Point I

(1) Given:

- (a) Provide for aerial refueling. Use not allowed on above mission.
- (b) Ferry range of 2600 nautical miles with no refueling.
- (c) Crew and cabin compartments shall be pressurized.
- (d) Aerial retrieval capability to recover parachuting personnel and capsules at speeds up to 300 knots TAS and weight to 300 pounds.
- (e) With critical engine out at midpoint OGE hover, be able to convert to forward flight on emergency power of remaining engines with a maximum altitude loss of 5 feet.
- (f) Accommodate a crew of 5 at 240 pounds per man (includes parachutes).
- (g) Additional weight provisions:

Hoists and Equipment	500 pounds
Avionics	1500 pounds
Armament and Armor	2000 pounds

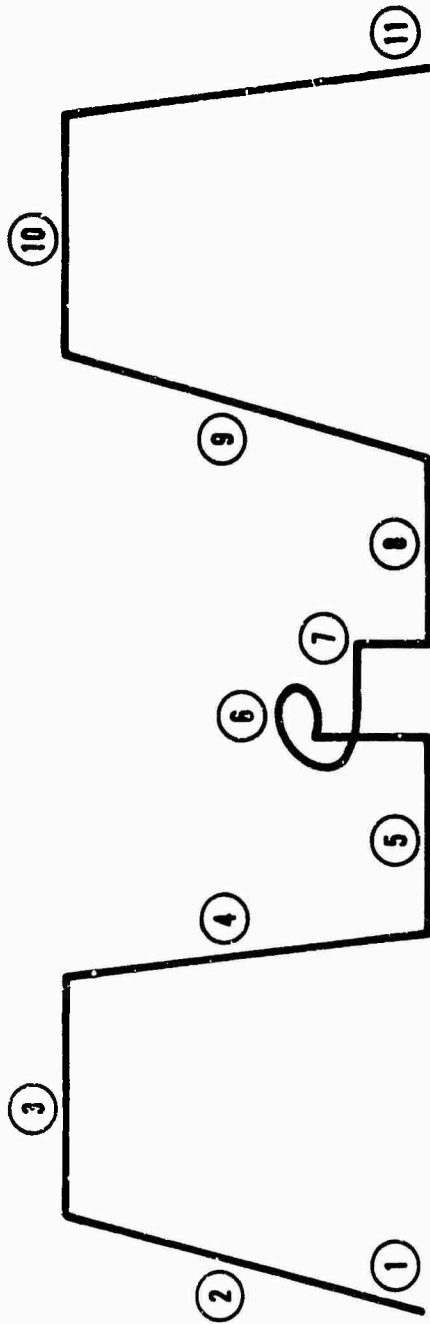

1. TAKEOFF (IGE) AT 3,000 FEET* AND 95°F
2. CLIMB (@ MIL PWR) TO 20,000 FEET
3. CRUISE FOR 300 NMI AT 400 KN TAS AND 20,000 FEET* MINIMUM
4. DESCEND TO 3,000 FEET
5. DASH FOR 200 NMI AT 350 KN TAS AND 3,000 FEET*
6. LOITER FOR 30 MINUTES AT 100 KN TAS AND 7,000 FEET*
 - (a) HOVER (OGE) FOR 30 MINUTES AT 6,000 FEET* AND 95°F
 - (b) PICK UP 1,200 POUNDS
8. DASH FOR 200 NMI AT 350 KN TAS AND 3,000 FEET*
9. CLIMB (@ MIL PWR) TO 20,000 FEET
10. CRUISE FOR 300 NMI AT 400 KN TAS AND 20,000 FEET* MINIMUM
11. LAND - FUEL RESERVE 5% OF MISSION FUEL PLUS 30 MINUTES AT BEST ENDURANCE SPEED AT SEA LEVEL

*PRESSURE ALTITUDE

Figure 4. Mission Profile for Design Point I Rescue Aircraft.

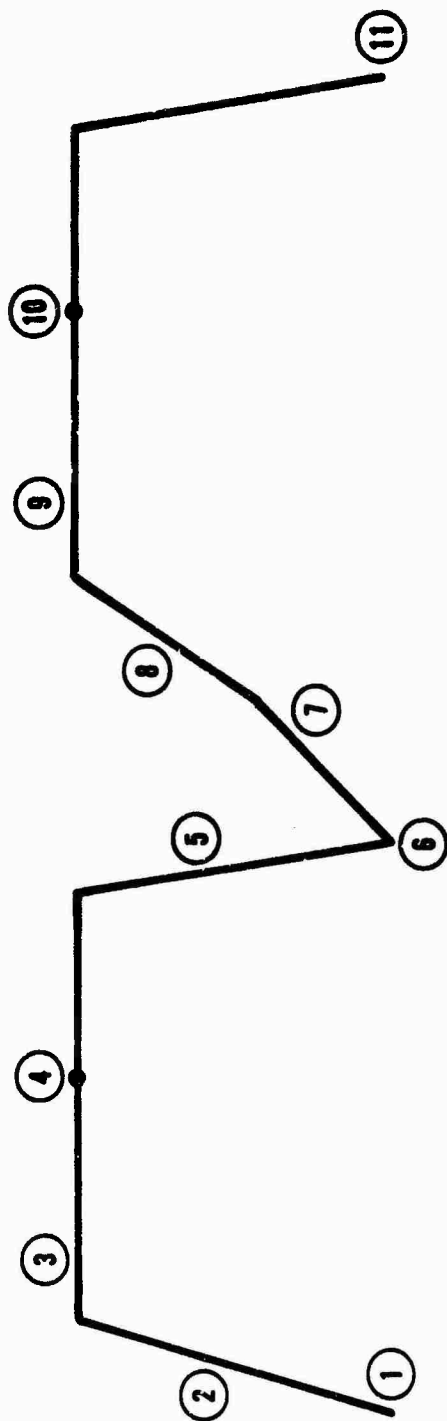

1. TAKEOFF (IGE) AT 3,000 FEET (PRESSURE ALTITUDE) AND 95°F
2. CLIMB (@ MIL PWR) TO OPTIMUM CRUISE ALTITUDE
3. CRUISE FOR 1,500 NMI AT 400 KN TAS AND OPTIMUM CRUISE ALTITUDE
4. AIRCRAFT REFUELED ONCE DURING CRUISE LEG
5. DESCEND TO SEA LEVEL
6. HOVER (OGE) FOR 15 MINUTES AT SEA LEVEL AND 95°F, PICK UP 15,000 POUNDS
7. CLIMB TO 10,000 FEET AND REFUEL
8. AFTER REFUELING, CLIMB TO OPTIMUM CRUISE ALTITUDE
9. CRUISE FOR 1,500 NMI AT BEST RANGE SPEED AND OPTIMUM CRUISE ALTITUDE
10. AIRCRAFT REFUELED ONCE DURING CRUISE LEG
11. LAND - FUEL RESERVE 5% OF FUEL ON BOARD AFTER LAST REFUELING PLUS 30 MINUTES AT BEST ENDURANCE SPEED AT SEA LEVEL

Figure 5. Mission Profile for Design Point II Capsule Recovery Aircraft.

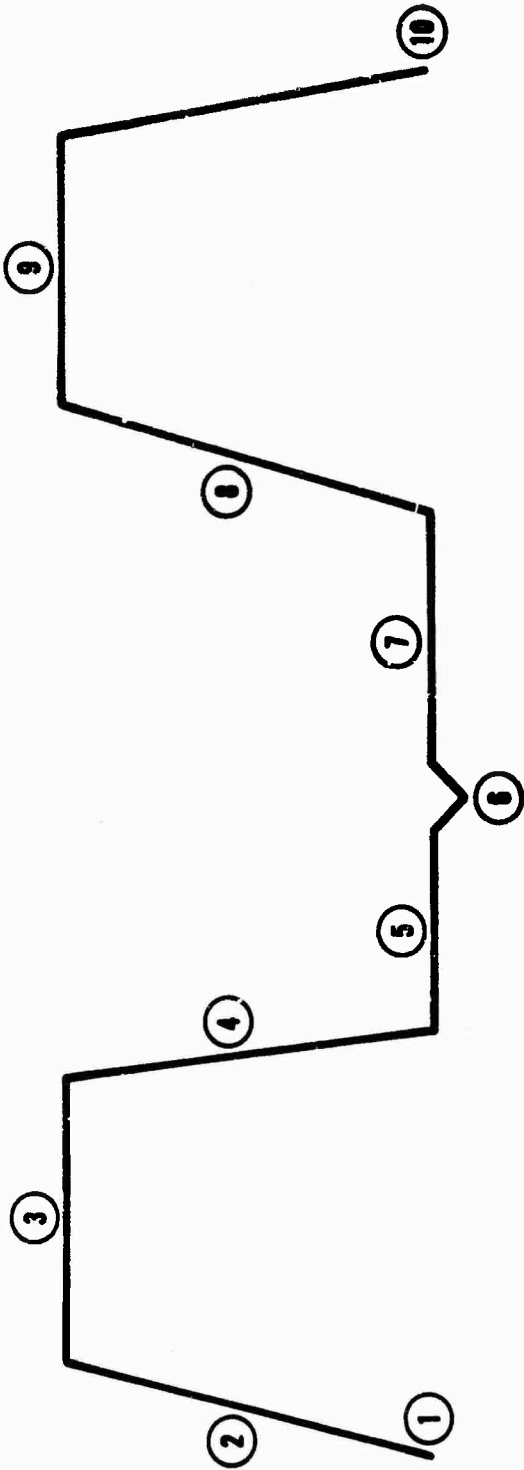

1. TAKEOFF (IGE) AT 2,500 FEET* AND 93°F WITH 10,000 POUNDS PAYLOAD VTOL, OR 17,000 POUNDS PAYLOAD STOL
2. CLIMB (@ MIL PWR) TO OPTIMUM CRUISE ALTITUDE
3. CRUISE FOR 150 NMI AT 350 KN TAS AND OPTIMUM CRUISE ALTITUDE
4. DESCEND TO 3,000 FEET
5. CRUISE FOR 100 NMI AT 350 KN TAS AND 3,000 FEET*
6. HOVER (OGE) FOR 2 MINUTES AT 2,500 FEET* AND 93°F UNLOAD PAYLOAD
7. CRUISE FOR 100 NMI AT 350 KN TAS AND 3,000 FEET*
8. CLIMB (@ MIL PWR) TO OPTIMUM CRUISE ALTITUDE
9. CRUISE FOR 150 NMI AT 350 KN TAS AND OPTIMUM CRUISE ALTITUDE
10. LAND - FUEL RESERVE 5% OF MISSION FUEL PLUS 30 MINUTES AT BEST ENDURANCE SPEED AT SEA LEVEL

*PRESSURE ALTITUDE

Figure 6. Mission Profile for Design Point IV Transport Aircraft.

(2) Assumed:

- (a) No fuel consumed, no distance credit for descent.
- (b) Mission flown at Air Force Hot Day conditions unless otherwise noted.
- (c) Sufficient power is provided only for one-engine-out hover, with no margin included for maneuver as per requirement (e) above.
- (d) Climb to cruise altitude is at maximum rate of climb, military power.

b. Additional Requirements for Design Point II

(1) Given:

- (a) Provide for aerial refueling and use as required on above mission.
- (b) Ferry range of 2600 nautical miles with no refueling.
- (c) Accommodate crew of 5 at 240 pounds per man (includes parachutes).
- (d) Midpoint payload size 13 feet in diameter by 12 feet in length.

(2) Assumed:

- (a) No fuel consumed, no distance credit for descent.
- (b) Mission flown at Air Force Hot Day conditions unless otherwise noted.
- (c) Climb to cruise altitude is at maximum rate of climb, military power.
- (d) Aircraft sized to have sufficient fuel left at midpoint to hover, pickup capsule, and climb to refueling altitude with sufficient reserves.
- (e) Reserve fuel requirement for refueling points 4, 7, and 10 in Figure 5 is 5 percent of fuel consumed only during the cruise leg since last refueling plus 30 minutes at best endurance speed at the refueling altitude.

c. Additional Requirements for Design Point IV

(1) Given:

- (a) STOL is defined as 1000-foot takeoff over a 50-foot obstacle.
- (b) Ferry range 2600 nautical miles with no refueling.
- (c) Landing gear sink speed shall be 15 fps.
- (d) Cargo compartment shall be compatible with the 463L loading system using an 88-inch by 108-inch pallet, 6000 pounds average pallet weight, 10,000 pounds maximum pallet weight.
- (e) Accommodate a crew of 5 at 240 pounds per man (includes parachutes).

(2) Assumed:

- (a) No fuel consumed, no distance credit for descent.
- (b) Mission flown at Air Force Hot Day conditions unless otherwise noted.
- (c) Climb to cruise altitude is at maximum rate of climb, military power.
- (d) Cargo compartment sized to accommodate 88-inch wide pallet with enough clearance for the passage of a man on either side.

Design Points III and V are multimission aircraft. The requirements of missions I and II are combined in Design Point III and all three basic missions are combined in Design Point V.

2. DESIGN GROUND RULES

These ground rules are only intended to cover those items necessary for the parametric design study definition. However, special specifications for items peculiar to the stowed-tilt-rotor concept are included for prominence in the report. A comprehensive review of major military specifications is presented in Volume III, Appendix II.

a. Structures

(1) Design Load Factors

All of the vehicles are assumed to be in the Air Force Class C (Assault) category.

The maximum positive design maneuver limit load factor shall be 3.0 for all gross weights from minimum flying gross weight to the basic flight design gross weight and at all speeds from the aircraft 3.0g maneuvering stall speed to design limit speed V_L . At weights greater than the basic flight design gross weight, strength shall be provided to maintain a constant NW except that the limit load factor N shall not be less than 2.0 at the maximum design gross weight. The maximum negative design limit load factor shall be -1.0 for all gross weights and all speeds from the aircraft -1.0g maneuver stall speed to the design level flight maximum speed V_L . At the design limit speed V_L , the negative maneuver limit load factor shall be zero.

During transition from the rotor lift to pure wing lift the stowed-tilt-rotor aircraft is a compound vehicle and both the wing and rotors are capable of contributing to the lift. The maximum design limit load factor to be applied during transition - zero forward speed to zero rotor lift - shall be determined by adding the maximum rotor lift and wing lift available at any given speed and dividing the resultant sum by the gross weight under consideration, except that the maximum maneuver load factor must not be less than 2.5g or exceed 3.0 at any speed.

THE LIMIT LOAD FACTOR DURING CONVERSION (I.E., AT ANY FLIGHT CONDITIONS WHERE THE ROTORS ARE NOT FULLY DEPLOYED AND ROTATING AT AT LEAST 70% OF MAXIMUM RPM) SHALL BE 1.5.

The design limit gust load factors shall be determined in accordance with the latest issue of MIL-S-8861. The speed for application of maximum gust intensity shall be $V_G = \sqrt{N} V_S$. Preliminary calculations indicate that the gust load factors are compatible with the design maneuver load factor of 3.0. Except when operating at minimum flying gross weights, the aircraft are not gust critical.

(2) Selection of Design Speeds

The design speeds selected are predicated on the two primary speed requirements specified in the mission requirements, namely that the vehicles be capable of operation at 400 knots TAS at 20,000 feet and 350 knots TAS at 3,000 feet. The engine cycle used for preliminary vehicle sizing is such that the aircraft is power critical for the 400-knot 20,000-foot design point and capable of exceeding the 350-knot dash speed at 3,000 feet. In order to minimize the structural weight, the decision was made to limit flight at lower altitudes to an arbitrary maximum dynamic pressure. Since the required 350 knots TAS at 3,000 feet is the equivalent of 335 knots TAS at sea level (standard day), the maximum level flight speed is limited to 340 knots equivalent airspeed (EAS).

Since the stowed-tilt-rotor concept, in common with other high speed aircraft, does not have a speed increase of 20 percent of maximum level flight speed due to gust or other upset, the design limit speed V_L is established as maximum level flight speed plus 50 knots. This establishes the design maximum dynamic pressure speed at 390 knots EAS. The aircraft presented in this study are q limited (390 knots EAS) from sea level to 16,000 feet and power limited at altitudes above 16,000 feet.

A Mach number limit of 0.7 was established for high altitude descents.

CONVERSION FROM ROTOR TO FAN DRIVEN FLIGHT AND RECONVERSION SHALL BE PERMISSIBLE BETWEEN 1.2 X FLAPS DOWN STALL SPEED TO THE GREATER OF (1.2 X FLAPS DOWN STALL SPEED + 50 KTS) OR 1.2 X FLAPS UP STALL SPEED.

(3) Landing Gear

For the initial configuration studies carried out in the first portion of this program the vehicle landing gear weights are estimated in accordance with the following ground rules:

- (a) Gear weights compatible with helicopter landing gear weights are assumed for Design Point aircraft I, II, and III. All landings and take-offs are assumed to be vertical and made on semi-prepared surfaces.

- (b) Gear weights compatible with normal transport landing gear weights are assumed for Design Point aircraft IV and V. All landings and takeoffs are assumed to be vertical and additional gear strength added to account for taxiing over rough and semi-prepared airfields.

All of the configurations have the ability to hover in ground effect at their respective basic mission design takeoff weights and the above assumptions for landing gear weight appear to be reasonable.

Note: New landing gear ground rules were selected by USA.FDL following the basic parametric studies. These revisions were used in the baseline aircraft studies and are quoted in that section.

(4) Pressurization Differentials

All of the configurations presented in this study, except the Design Point IV configuration, have been allocated weight increments to account for pressurization. The Design Point IV and baseline transport configurations are not pressurized because the optimum altitude for the performance of the mission has been determined at 10,000 feet or lower. For all of the other configurations a cabin altitude of 8,000 feet is maintained at a flight altitude of 20,000 feet. Using a proof pressure factor of 1.33 this amounts to a design limit pressure differential of 5.45 psi.

On all of the configurations requiring pressurization, the number of cutouts and/or door openings are kept to a minimum in the pressurized area in order to save weight. This is accomplished by the judicious placement of the aft pressure bulkhead and by eliminating the need for pressurization of the aft hatch on Design Points I, II, and III.

(5) Technology Level

Determination of the vehicle weights for Design Point I, II, III, IV, and V aircraft shall be based on technology for manufacturing techniques and materials appropriate to an IOC date of 1976.

b. Aerodynamics

(1) Airfoil

In the interests of obtaining the optimum wing weight, the airfoil section shall be of the maximum thickness possible consistent with the requirement of flight at Mach 0.635 and the need for a high-speed descent capability.

(2) Wing Loading

The aircraft wing loading shall not exceed 90 psf at any point in a mission where transition is made from hover to forward flight or back. This is done to insure maneuver capability during transition.

(3) Disc Loading

The aircraft disc loading shall not exceed 15 psf at the mission midpoint hovering gross weight in order to preserve a low downwash velocity during rescue, capsule recovery or resupply operations.

(4) Empennage

(a) Horizontal Tail

The horizontal tail shall be sized to provide a minimum static margin of 5 percent MAC at maximum cruise speed with the center of gravity at the aft limit. An allowance of 5 percent for neutral point shift due to aeroelasticity shall be included in the calculation. During low-speed operation with the rotors extended it is intended that rate and attitude stability augmentation will be provided, as necessary. This ground rule was adopted to avoid the large change in static margin which would occur during conversion if the tail were sized for stability with rotors deployed. It is considered justified by the availability of stability augmentation systems required for hover and transition.

(b) Vertical Tail

The vertical tail shall be sized to provide a minimum directional stability coefficient C_{n_z} of 0.0015 with the rotors in the stowed position. The condition of thrust asymmetry

due to loss of one engine at 1.1V_s, with the rotors folded and the center of gravity at the aft limit, shall be investigated, and adequate rudder control shall be provided to trim at no greater than 5 degree yaw and roll angles. It is assumed that stability augmentation shall be provided, as necessary, for increased rate damping and increased directional stiffness for operation at low-speed with the rotor extended.

c. Propulsion

(1) Powerplants

The same powerplants shall be utilized to power the cruise fans and the rotors. Means shall be provided to transfer power from the cruise fans to the rotors. Provisions shall be made to achieve particle separation in the engine airflow during hover.

Fan bypass ratios shall be selected to obtain best mission performance at minimum weight.

(2) Power Transmission System

A transmission system shall be provided which will adequately reduce the engine rpm to that desired at the rotors and the fans. The transmission shall also provide an interconnect between the two rotors so that equal power distribution will be achieved between the two rotors in the event of an engine failure.

The torque capabilities of the rotor transmission system shall meet the most severe of the following requirements:

- (a) Hover at design takeoff gross weight at the altitude and temperature appropriate to the mission, out of ground effect, with the thrust required for download control and 500 fpm rate of climb. The control applied shall give the most severe power absorption occasioned by 100 percent control about one axis and 50 percent about the other two axes. This is to be construed as a total power requirement. Shafts will be sized for full torque due to 100 percent yaw control. A 55 to 45 power split shall be used for gear weight estimation, the full yaw control case being considered a transient condition.

(b) A climb rate of 1500 fpm at 200 knots EAS (SL Std day).

(c) A level flight speed of 250 knots EAS, (SL Std day).

The rotor transmission components shall also be designed to the torque appropriate to one shaft engine failed conditions for the above cases.

The shafting shall be designed to take the torques imposed by maximum SL Std static power of all engines on one side with all engines failed on the other side. This is not to be applied as a design case for gearing.

The fan drive system shall be designed to take maximum SL Std day static power.

(3) Rotors

The rotors shall be hingeless and shall be provided with both cyclic and collective pitch control. In addition to adequate cyclic and collective pitch controls for normal low-speed helicopter flight, the cyclic control shall be adequate for both pitch and yaw control during hover and transition and the collective control shall be adequate for roll control during hover and transition.

The rotor shall be designed to have a thrust margin of 15 percent, over and above the thrust (including download) at any mission hover condition of weight, altitude, and temperature, before reaching the stall flutter condition. In the absence of blade torsion parameter data at the beginning of the study, the solidity of the rotors was chosen for optimum hover performance provided the thrust-coefficient-to-solidity ratio (helicopter notation) did not exceed 0.12 at the above conditions. This implied a stall flutter limit at $C_T/\sigma = 0.137$. This subject is further discussed under ROTOR BLADE in Volume II.

The maximum hover tip speed shall be 870 feet per second.

The rotor power limit shall be compatible with the criteria given for the rotor transmission.

The number of blades shall be selected on the basis of the following priorities:

- 1st - Minimum rotor nacelle size
- 2nd - Hover performance
- 3rd - Noise

d. Weights

Weight estimates shall be obtained using statistical weight trend equations and the specific mission requirements. Fixed inputs such as aspect ratio, taper ratio, fuselage geometry, etc., shall be utilized in the statistical trend equations and combined with mission requirements such as fixed equipment weights, fixed useful load, payload, etc., to iterate a total aircraft gross weight. The basic weight trends shall reflect current state-of-the-art materials and manufacturing techniques which will be factored to reflect a technology level consistent with an IOC date of 1976. Design features not covered by the statistical weight equations shall be estimated separately. One percent of the weight empty shall be added to the gross weight to allow for manufacturing variations.

e. Geometric Constraints

The minimum clearance between the rotor blade tips and the fuselage side shall be 18 inches.

With the nacelle in the locked down position the rotor plane shall be positioned to provide a minimum of 12 inches clearance between the blade trailing edge and the wing and/or engine nacelle leading edge. This clearance shall be obtained with the blade fully feathered and its quarter chord plane deflected aft through an angle of 5 degrees measured from the rotor hub and the blade tip quarter chord. When the nacelle is in the vertical position, the rotor plane shall be high enough above the wing upper surface to prevent the rotor blade from striking the wing when the blade is at a negative cone angle of thirteen degrees. The distance between the nacelle pivot point and the rotor plane shall be kept to a minimum consistent with the above requirement. Based on experience, these criteria are for preliminary design purposes and should be rewritten when critical maneuver blade property and motion data are available.

SECTION IV

CONFIGURATION STUDIES

1. CONFIGURATION APPROACH

The fuselage configuration for any given aircraft is primarily dictated by the mission requirements, and the tail group configuration by stability and control requirements. The size and layout of the latter will ultimately be chosen by wind tunnel testing. For the present designs where critical mach number considerations are not particularly demanding, the wing size and geometry has been chosen for the most efficient and simple structural arrangement and tip nacelle attachment, consistent with the required relationship between the nacelle tilt pivot and wing for proper center of gravity location in hover and cruise flight.

A typical planform resulting from these considerations is shown in Figure 7. This straight tapered planform was used for all of the initial configuration design studies. However, after the baseline aircraft was selected, additional consideration was given to planform in an attempt to further reduce nacelle overhang. These changes are presented in Section V, BASELINE CONFIGURATION DESCRIPTION. Figure 8 shows the trade-off of wing weight plus fuel weight with aspect ratio and wing loading. Weight increases with wing loading because of the higher drag of the higher area wing and, of course, the increased weight of the wing itself. At constant wing loading, increasing aspect ratio reduces induced drag thereby reducing fuel weight; but the reduction in wing root thickness causes the wing weight to increase because of the high root bending moment due to lift loads in hover, and the latter trend predominates. The conclusion is that the wing loading should be as high as possible and the aspect ratio as low as possible. However, as stated in the ground rules, the wing loading is restricted to a maximum of 90 psf in order to give good transition maneuverability. The minimum aspect ratio is determined by the minimum span that can be accommodated with a rotor to fuselage clearance limit of 18 inches.

a. Rotor Blade Stowing

Three different methods of stowing the rotor blades were considered. These basic approaches are shown in Figure 9. The nacelle at the top of this Figure shows

CROSS-SHAFT RUNS ALONG NEARLY CONSTANT
CHORDLINE ALLOWING BEARING AND SNUBBER
ATTACHMENTS TO INTERMEDIATE SPAR

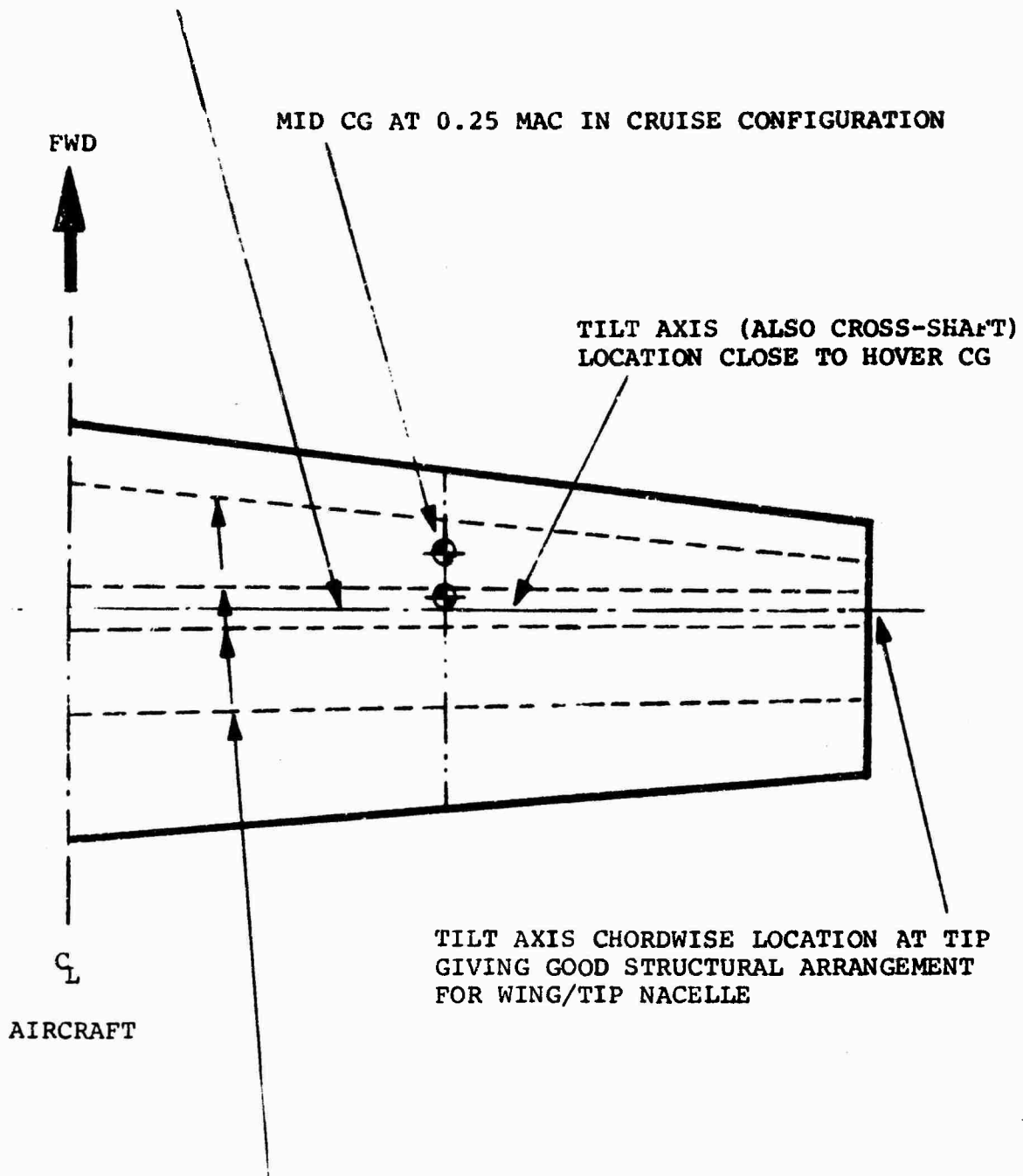

MULTISPAR ARRANGEMENT, GIVES FUEL TANKAGE FORE AND AFT OF ISOLATED
INTERFACE CROSS-SHAFT TUNNEL AND ACCESS TO CROSS-SHAFT THROUGH
PANELS LOCATED BETWEEN CENTER SPARS

Figure 7. Typical Wing Arrangement.

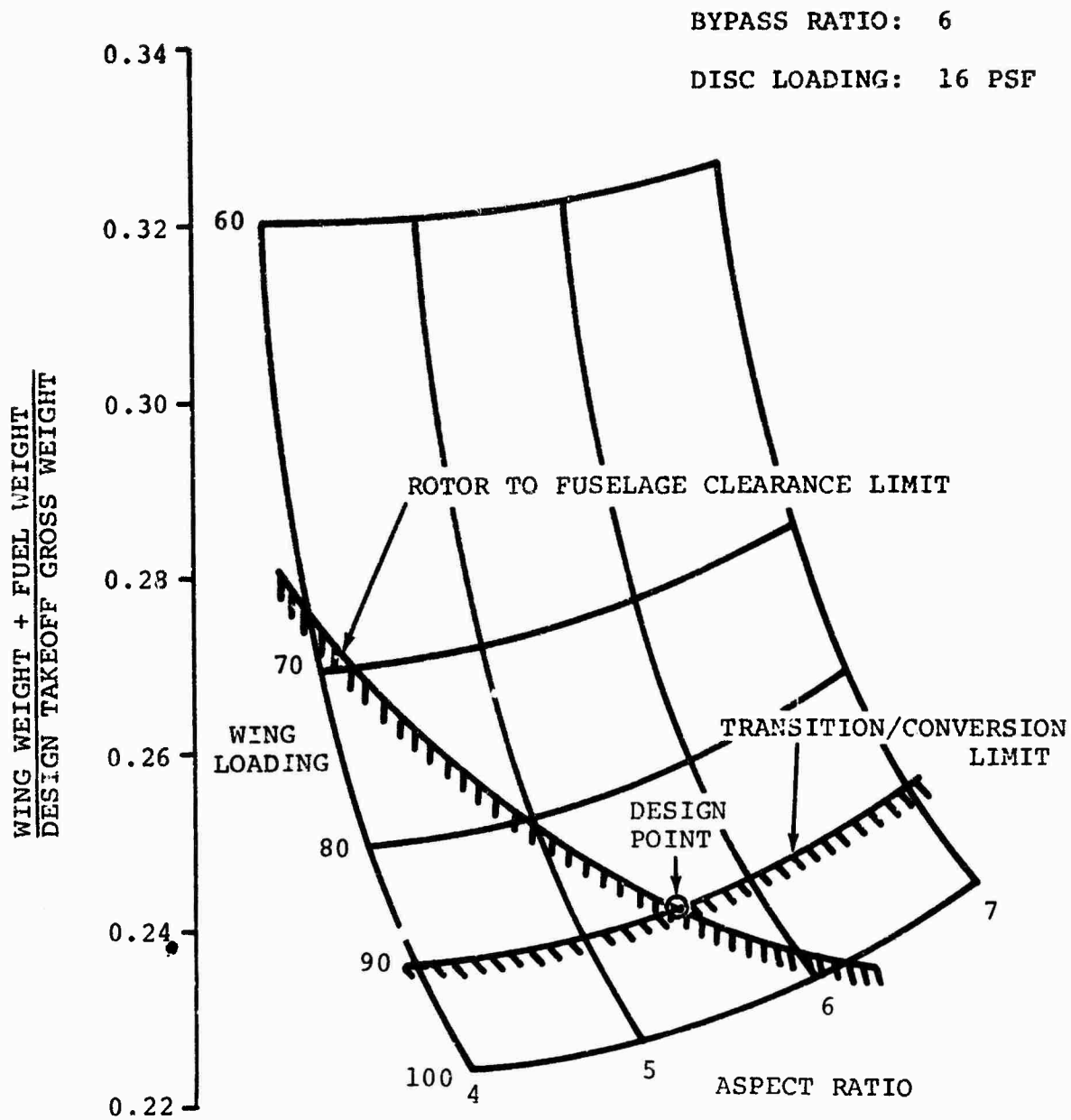

Figure 8. Typical Wing Loading and Aspect Ratio Trade.

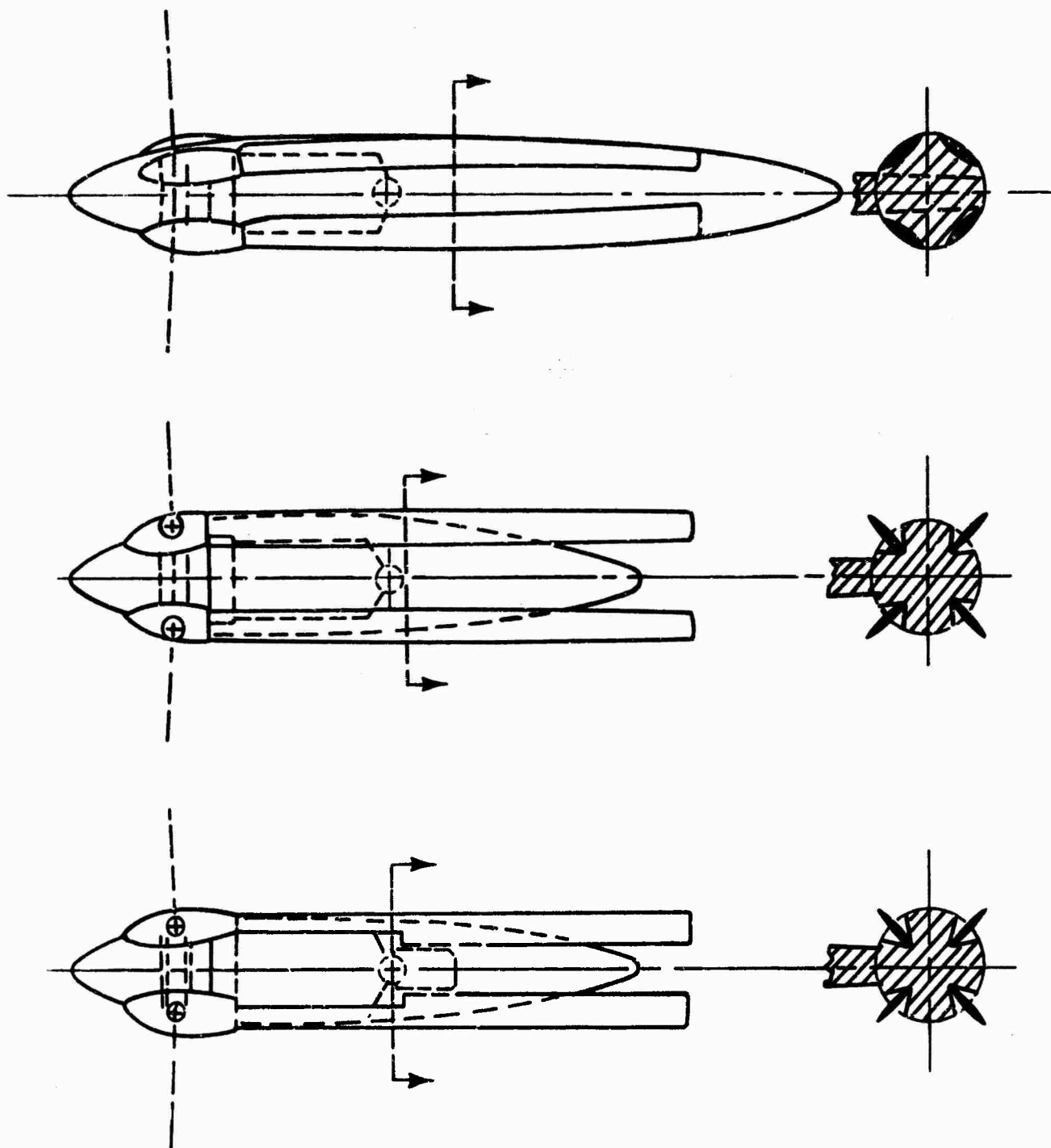

Figure 9. Alternate Rotor Nacelle Configurations.

the rotor blades folded flush with the surface of the nacelle, in sculptured recesses. This approach appears to offer the cleanest aerodynamic configuration but has the drawback of a complication of the folding system to turn the blade over from the feathered position during the last few degrees of the fold cycle so that the blades can lie flush in the nacelles.

The center drawing of Figure 9 shows what is perhaps the most simple folding system approach. The blades are maintained in a feathered position throughout the fold cycle and are knifed into the nacelle center body. From an aerodynamic standpoint, this method of stowing gives a high wetted area compared to the flush system. Together with the effect of blade twist, and the gaps in the nacelle which will be required to nest the rotor blades while accommodating any flap-wise motion that may occur during the final few degrees of the fold cycle, this high wetted area will give a higher drag than the flush method of folding. Wind tunnel tests show that this penalty may amount to 30 percent of the drag of the clean wing plus faired nacelle. The possibility of blade trailing-edge damage is also considered high due to blade flapwise motions caused by gust or maneuvers during the final stowing phase. On the other hand, in the flush stowing method, a blade would tend to slap the nacelle because of flap motions. This slapping will probably be aerodynamically cushioned; therefore, the flush folding system does appear to have an advantage, although the problem of blade motion during final folding requires further study.

The third stowing method considered is a variation of the edge-wise stowing method; however, the blade shanks are extended to a radial position in order to clear the rotor transmission and tilting nacelle structure. The blade proper then starts well outboard radially and permits the trailing edge of the blades to be knifed more deeply into the rear part of the nacelle where cutouts in the structure are less critical. This method of stowing should have a drag somewhat between the two methods already discussed but will suffer from all the other vicissitudes of the edge-wise folding system described previously. In addition, the figure of merit of the rotor in hover will suffer greatly, because of the non-optimum blade planform; however, this may be permissible for very high speed stowed-tilt-rotor aircraft which have surplus power in hover. Published wind-tunnel testing of flush and knife-edge folding methods indicates a much larger change in neutral point from blades-deployed to blades-folded for the knife-edge system of blade folding.

After weighing all of these factors, the flush method of blade stowing was adopted for these investigations. A method has been worked out to change blade pitch during the fold cycle to allow the blades to lie flush, and it appears to be a practical solution. Although this system appeared to be more complex than keeping the blades in the feathered position during the fold cycle, it produced fewer problems than knifing the blades into the nacelle.

The major consideration of propulsion system layout and location remains to be discussed. The basic studies have concentrated on turboshaft engines mechanically driving rotors and cruise fans. Earlier studies used an arrangement whereby the engines, transmissions, fans and rotors were all located in the wing tip (Figure 10). This layout had the advantages of unloaded cross-shafting and a minimum number of gear sets when compared to other layouts.

Subsequent studies showed that this configuration was unable to cope with the yawing moment developed after fan failure, especially in the wave-off condition from an approach to an emergency landing.

Difficulty was also encountered in installing four shaft engines in the rotor nacelles when more stringent hover criteria were given for certain missions.

b. Propulsion Concept

The propulsion system described in Section VIII, PROPULSION, was evolved to overcome these problems and was selected after consideration of two other propulsion concepts. The simplest approach would be to assume the availability of convertible turbofan engines. However, this assumption is not a good one because of the present low level of activity in this area. Also, this approach was inadvisable due to the need for four engines (caused by the stringent hover requirement of these missions) and the lack of provision for particle separators in proposed convertible turbofan concept. Gas drive systems were also considered; in particular the concept of gas generators driving turbines connected to the rotor system or tip turbine cruise fans through diverted valves. This system has an advantage inasmuch as rotor clutches can be eliminated, but the inability of the system to progress smoothly from rotor-drive to fan-drive without step functions (as each gas generator is diverted) presented a problem. In addition, shaft driven cruise fans have been fully developed, whereas tip-turbine-driven cruise fans have

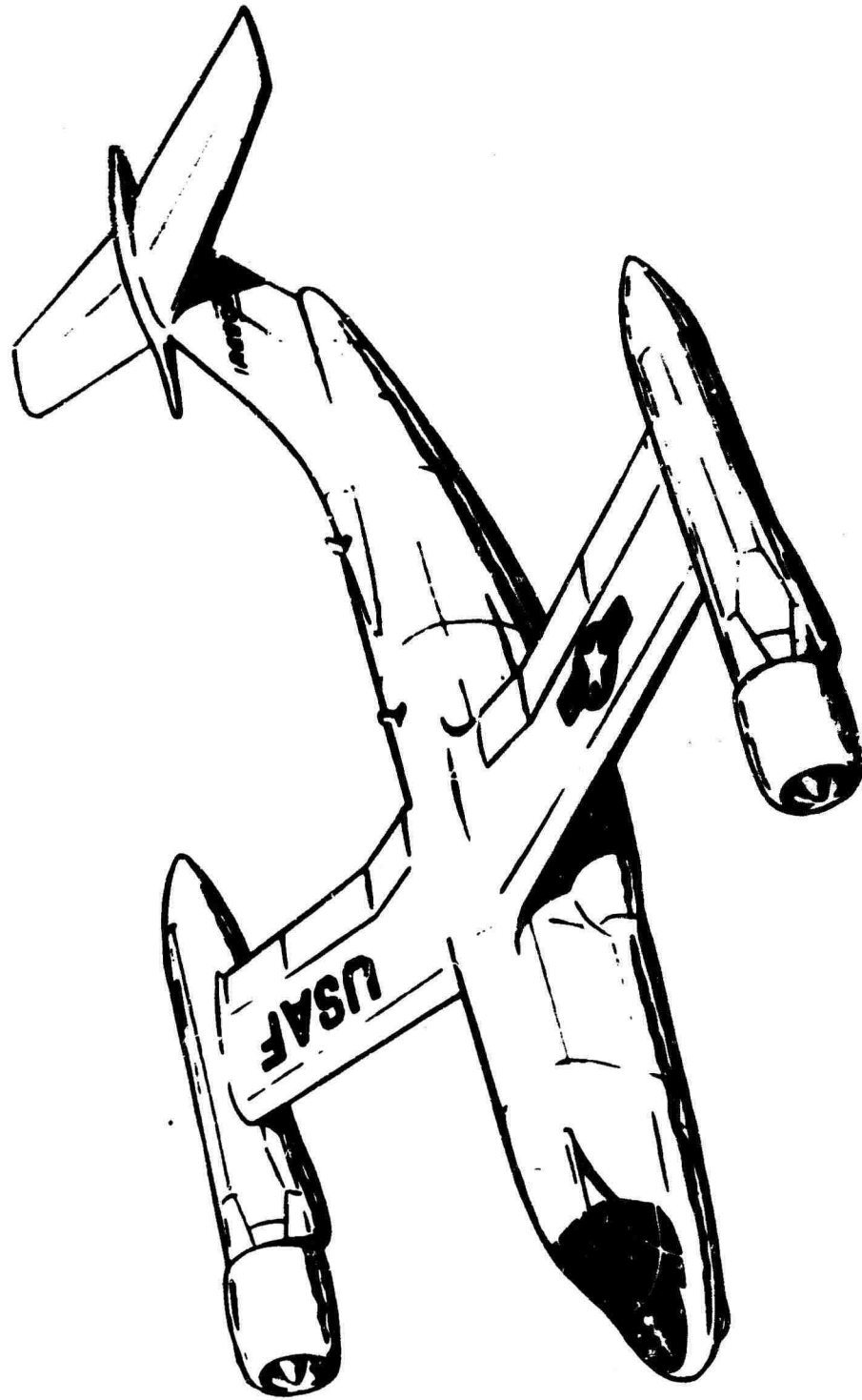

Figure 10. Stowed-Tilt-Rotor (Helijet) with Wing-Tip-Mounted Engines and Fans.

received less attention (although tip-turbine-lift-fan technology as used in the XV-5A is applicable). Therefore a system was selected where a pair of coupled turboshaft engines drive a front fan through reduction gearing and a clutch. The fan thrust can be modulated through the use of variable guide vanes or variable-pitch fan blades. A power takeoff and clutch is provided for the rotor drive. In the helicopter mode, air is drawn through auxiliary inlets in the fan duct walls provided with Donaldson tube separators.

The turbofan-type nacelles of the propulsion package were mounted immediately beneath the wing to minimize interference drag and keep the engine inlets as high as possible to minimize ingestion. A more ideal nacelle location from the point of view of interference drag would be further forward, well below the wing, but this is precluded by the proximity of the rotor plane; however, the location directly beneath the wing is preferable to intermediate positions. The spanwise position about one nacelle diameter from the fuselage side was also chosen to minimize interference drag.

2. BASIC MISSION DESIGNS

a. Design Point I Rescue Aircraft

This aircraft follows the general configuration outlined above. A 3-view drawing and the major characteristics of this aircraft are shown in Figure 11. The fuselage size was minimized consistent with the tail arm required, the cabin volume needed to accommodate the crew and payload, and the nose length needed to balance the aircraft. A landing gear with one main leg with two wheels, with conventional nose wheel gear, and with an outrigger mounted under each engine nacelle, was adopted to minimize landing gear weight and to make landing gear fairings unnecessary, and therefore, reduce drag. This system was judged the best arrangement in view of the high-speed long-range mission and the fact that the aircraft is expected to operate in the vertical takeoff and landing mode for most missions.

In determining the minimum size of aircraft necessary to perform the mission, tradeoffs were made with the number of engines, the bypass ratio of the engines, and the disc loading. Figure 12 shows the variations of cruise normal-rated power to maximum static horsepower ratio, as a function of bypass ratio, and the specific fuel consumption at cruise rating as a function of bypass ratio. It can be seen that bypass ratio has very little effect on fuel flow for bypass ratios

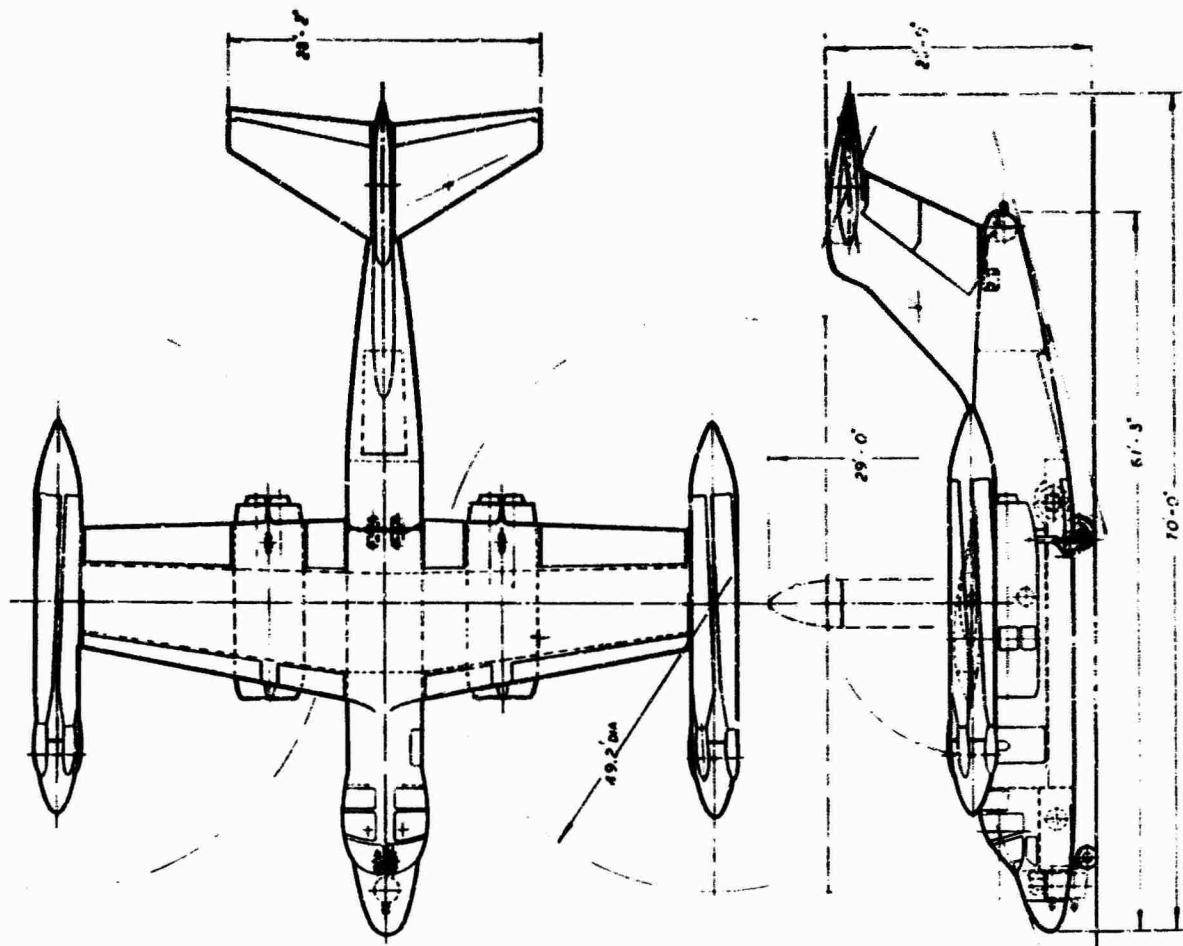

DESIGN TAKEOFF WEIGHT	67,049 LB
EMPTY WEIGHT	42,714 LB
INSTALLED POWER	17,464 HP
DISC LOADING	17.75 PSF
AT TAKEOFF GROSS WEIGHT	15 PSF
AT MIDPOINT WEIGHT	90 PSF
WING LOADING	19.66 SQ FT
AT TAKEOFF GROSS WEIGHT	
EQUIVALENT DRAG AREA	

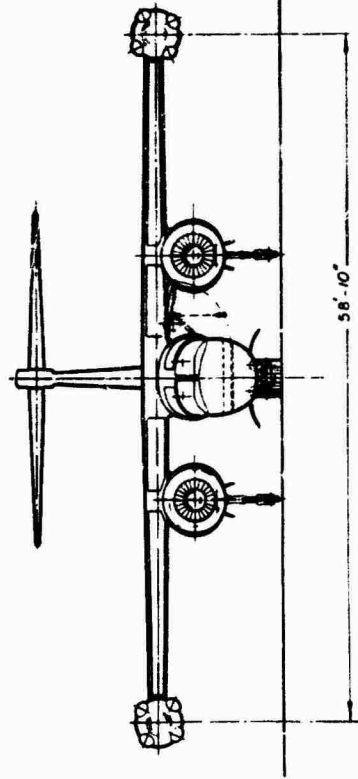

Figure 11. 3-View of Design Point I Rescue Aircraft

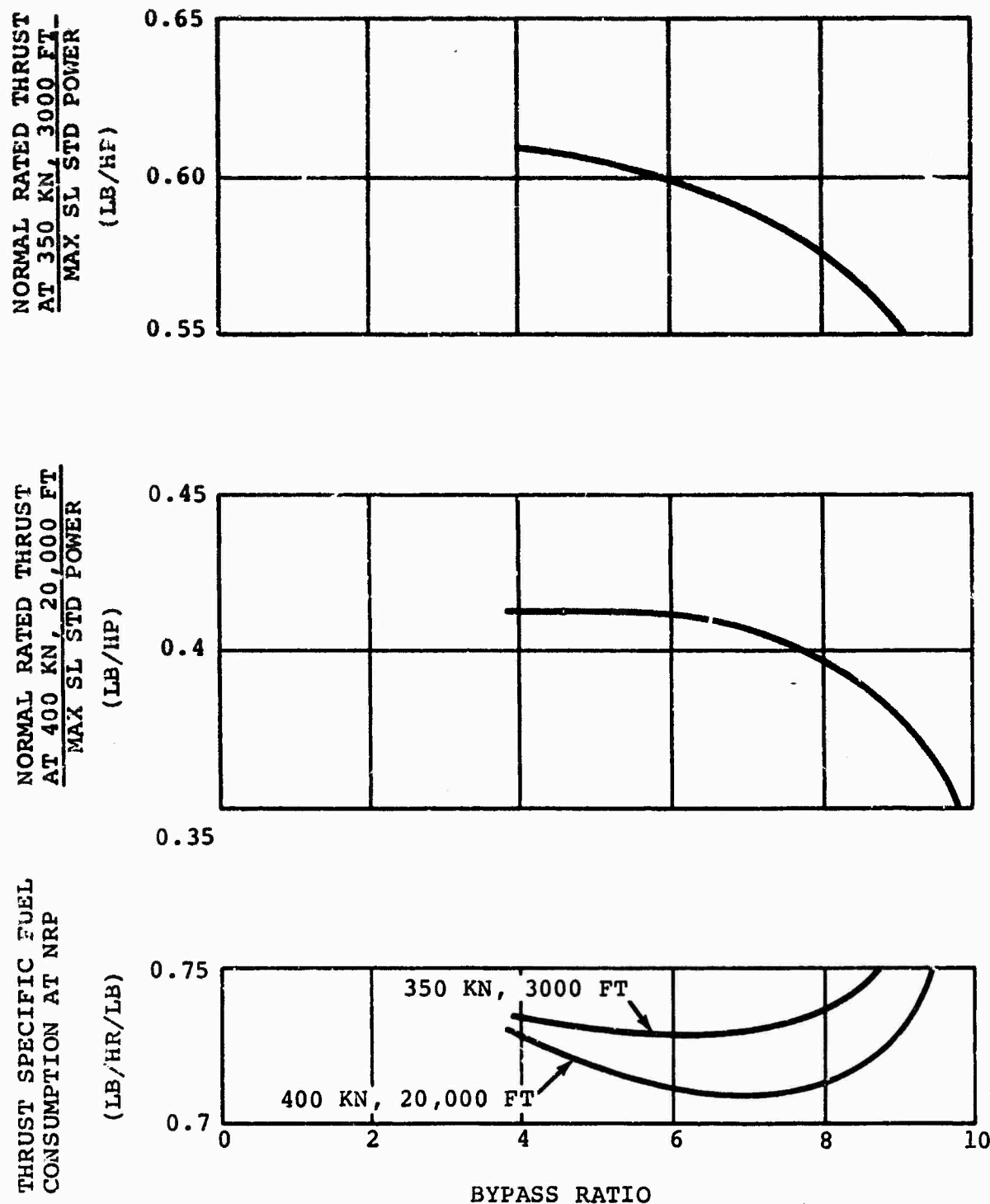

Figure 12. Engine Characteristics at Cruise Design Points as a Function of Bypass Ratio.

below eight for a given thrust requirement; it can also be seen that engines of bypass ratio four have about six percent more cruise thrust available for a given power than engines of bypass ratio eight. These low sensitivities led to the conclusion that the bypass ratio would have very little effect on the tradeoff of number of engines. Figure 13 shows this tradeoff for bypass ratio six and illustrates that the engine out hover requirement overwhelmingly leads to a choice of four rather than two engines. Three engines were not considered in this study due to the problem of installing them with a reasonable drive system configuration. The tradeoffs of disc loading and bypass ratios shown in Figure 14 are somewhat complex. The general trend with increasing disc loading is to lighter aircraft, because, the aspect ratio of the wing is reduced, a structural benefit is derived, and the length of the tip pods needed to accommodate the folded rotors is also reduced. Although Figure 12 shows low sensitivity of basic engine characteristics to bypass ratio, high bypass ratio generally leads to high drag nacelles and high engine weight. The high drag of the engine nacelles leads to lower lift-drag ratios than can be obtained at low bypass ratios, and therefore, the engines become cruise sized. These drag and weight penalties tend to give a general escalation of weight at high bypass ratio. At low bypass ratios, the lower drag, and therefore, the higher lift-drag ratios and the improved hover cruise thrust to hover horsepower ratios tend to give hover-sized engines, particularly at the high disc loadings. This condition accounts for the reversal in bypass ratio trend at the low bypass ratio end of the high-disc-loading curves. The trends show that minimum weight would have been obtained at a disc loading of 18 psf and a bypass ratio of six. However, this disc loading was backed off to 15 psf to minimize hover-downwash velocity at the midpoint of the mission.

The critical rotor-drive-system torque was found to occur at the 200 knot 1500 fpm rate of climb criteria.

A performance summary is shown in Figure 15 and the mission profile in Figure 16. A drag breakdown and detailed performance data are contained in Appendix I.

b. Design Point II Capsule Recovery Aircraft

Since air-to-air refueling was permitted on this mission, it was evident that the useful load required would be a minimum for hovering flight; if the aircraft arrived at midpoint with just enough fuel to hover, pick up the capsule, climb, and rendezvous with the

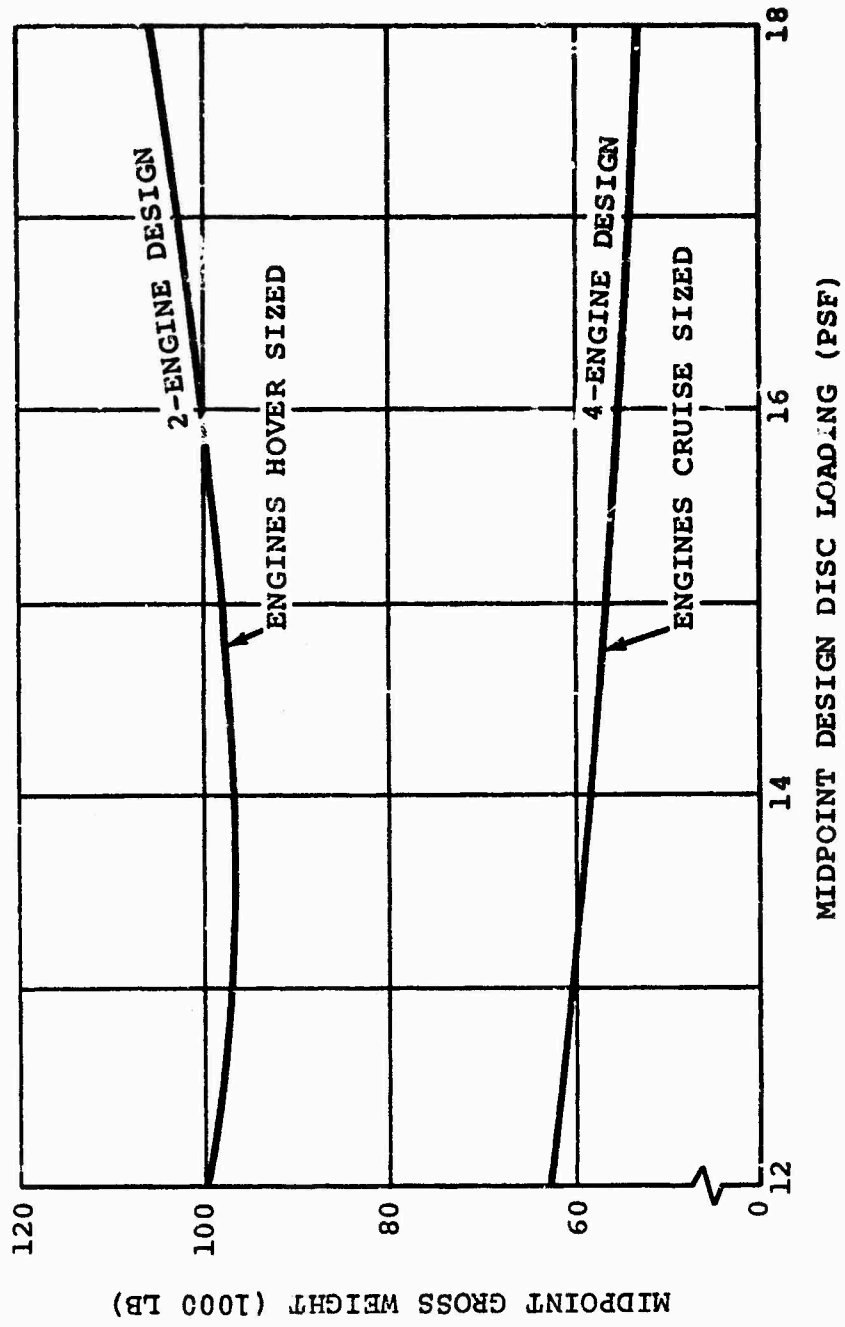

Figure 13. Design Point I Rescue Aircraft. Study of Number of Engines and Disc Loading Trend at Bypass Ratio of 6.

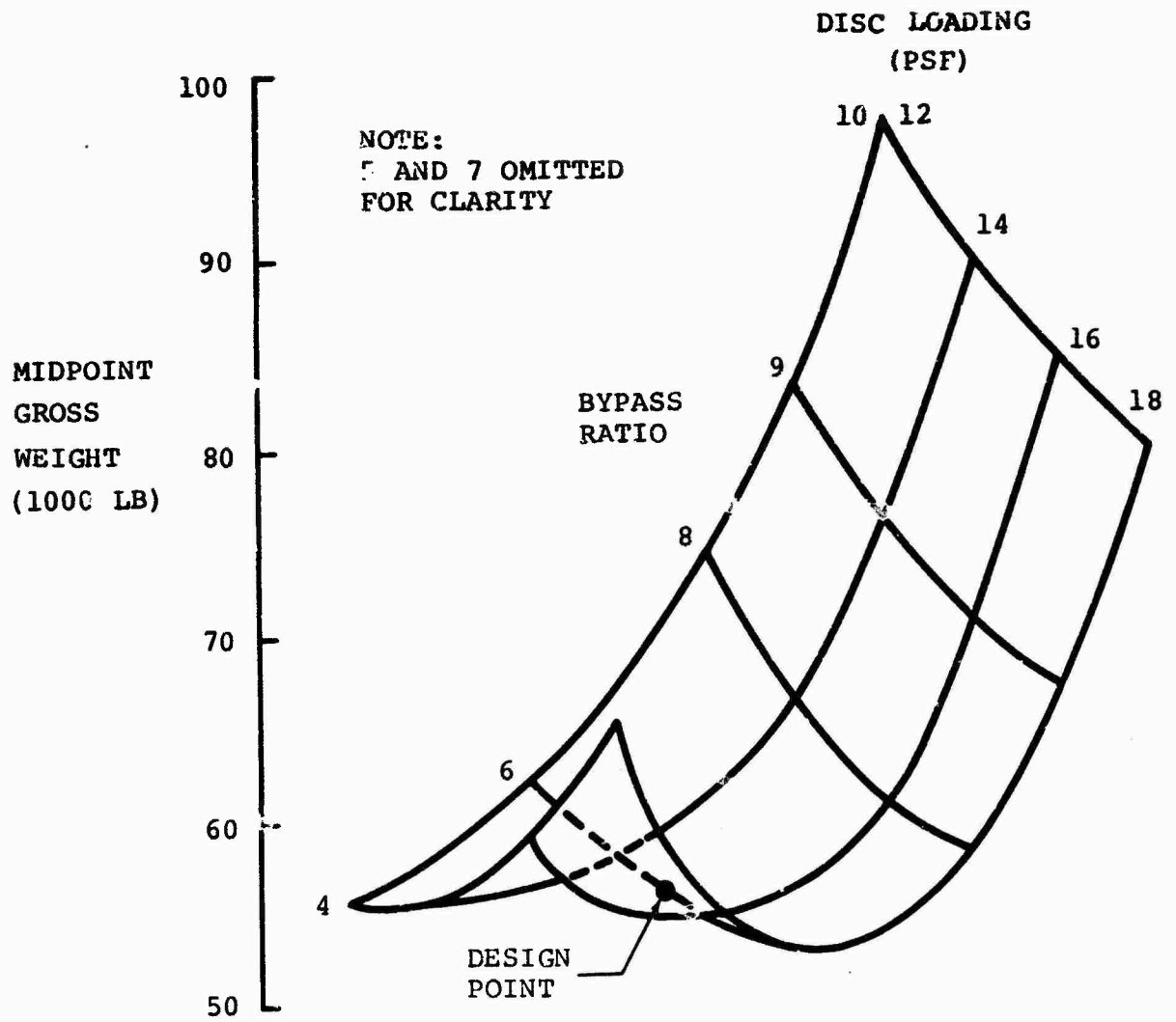

Figure 14. Design Point I Rescue Aircraft. Trade-offs of Disc Loading and Bypass Ratio With Gross Weight at Midpoint.

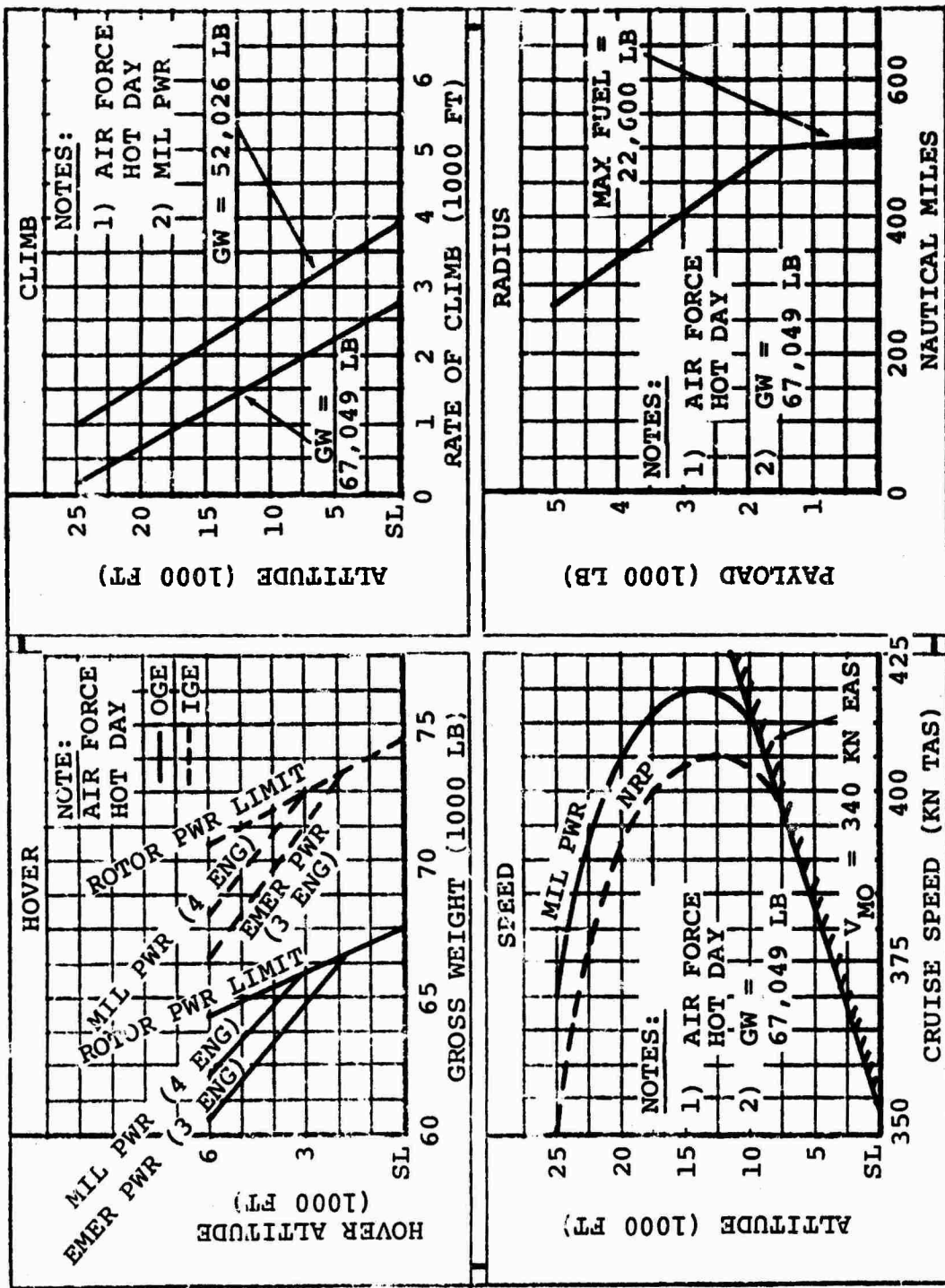

Figure 15. Design Point I Performance Summary.

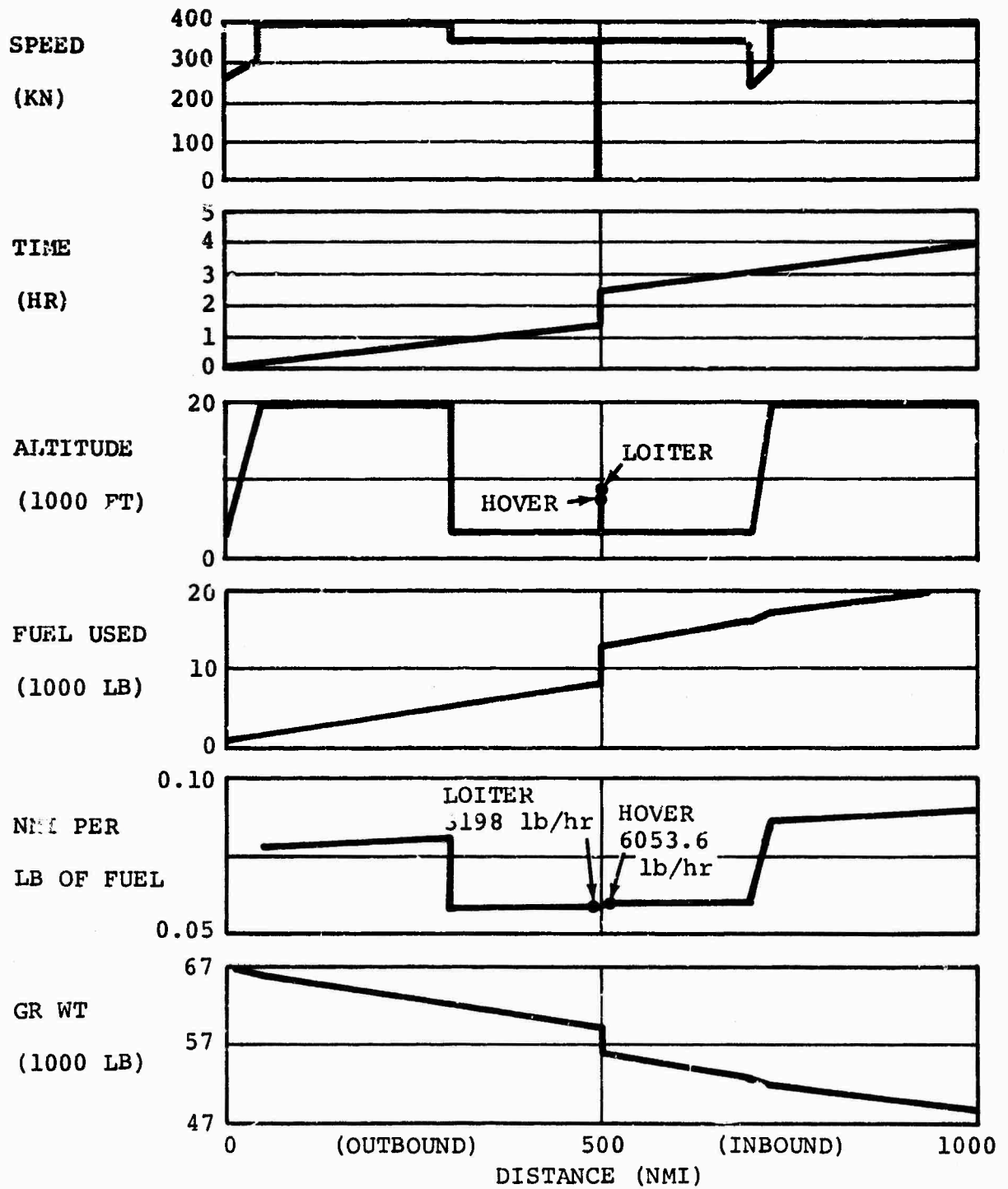
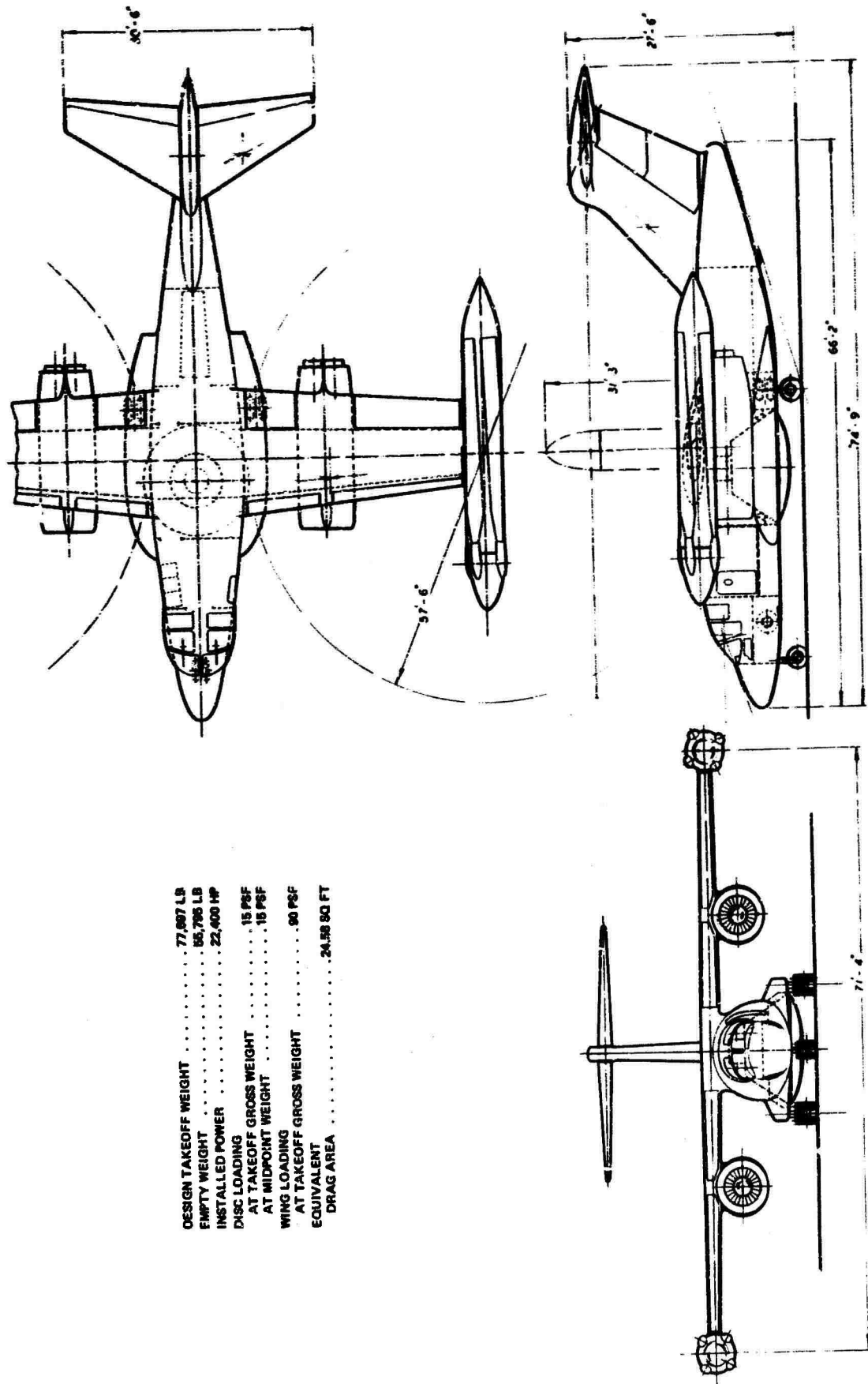

Figure 16. Design Point I Rescue Mission Profile and Performance.

tanker, and still have the stipulated reserves left at this point. It was found that if one refueling were made on the outbound leg, the initial takeoff fuel required gave an aircraft with compatible initial takeoff and midpoint takeoff gross weights. It was then necessary to refuel as stated, immediately after capsule pickup and on one more occasion on the returned leg. A 3-view of this aircraft and some salient characteristics are shown in Figure 17. The variation of gross weight with number of engines installed is shown in Figure 18. As might be expected from the less stringent hover conditions required compared with those of the rescue aircraft, the choice of number of engines is not quite as clear cut. However, four engines were still selected on the basis that this was a long over-water mission, and that compatibility with Design Point I should be kept, wherever possible, without compromising the design for capsule recovery. The trade-offs made for Design Point I showed that engine sizing was not a major factor in selection of bypass ratio or disc loading. Since the capsule recovery mission is a long-range mission, it was decided that a bypass ratio and a cruise altitude trade-off should be made as a function of the specific range, as shown in Figure 19. The bypass ratio was optimized at a value of 6 at an altitude of 20,000 feet. Again the disc loading was restricted to 15 for good hover downwash characteristics.

Since the return minimum speed of 200 knots could be met with a capsule carried almost entirely external, an aircraft could have been designed to perform the mission with a lower gross weight than that shown here. Two practical factors prompted the decision to carry the capsule partially buried within the fuselage. First, this method made it possible for sick or injured capsule crew members to leave the capsule and enter the aircraft cabin. Second, in the event of a failure of the capsule winching system, the aircraft could land safely on the landing gear with the capsule in place.

The fuselage is pressurized only forward of the capsule bay. This gives sufficient pressurized-cabin space to accommodate the aircraft crew and six more people. When flying without the capsule, the hole in the bottom of the cabin is covered with a folding hatch. Just prior to pickup, this hatch is folded, lifted by the capsule hoist, transferred to the rear of the cabin, and lowered onto a cradle. The winch is then brought back on the overhead rail, ready for capsule pickup. Inflatable seals are provided around the edge of the hole to accommodate the capsule.



DESIGN TAKEOFF WEIGHT	77,007 LB
EMPTY WEIGHT	66,706 LB
INSTALLED POWER	22,400 HP
DISC LOADING15 PSF
AT TAKEOFF GROSS WEIGHT15 PSF
AT MIDPOINT WEIGHT15 PSF
WING LOADING90 PSF
AT TAKEOFF GROSS WEIGHT90 PSF
EQUIVALENT DRAG AREA	24.56 SQ FT

Figure 17. 3-View of Design Point II Capsule Recovery Aircraft.

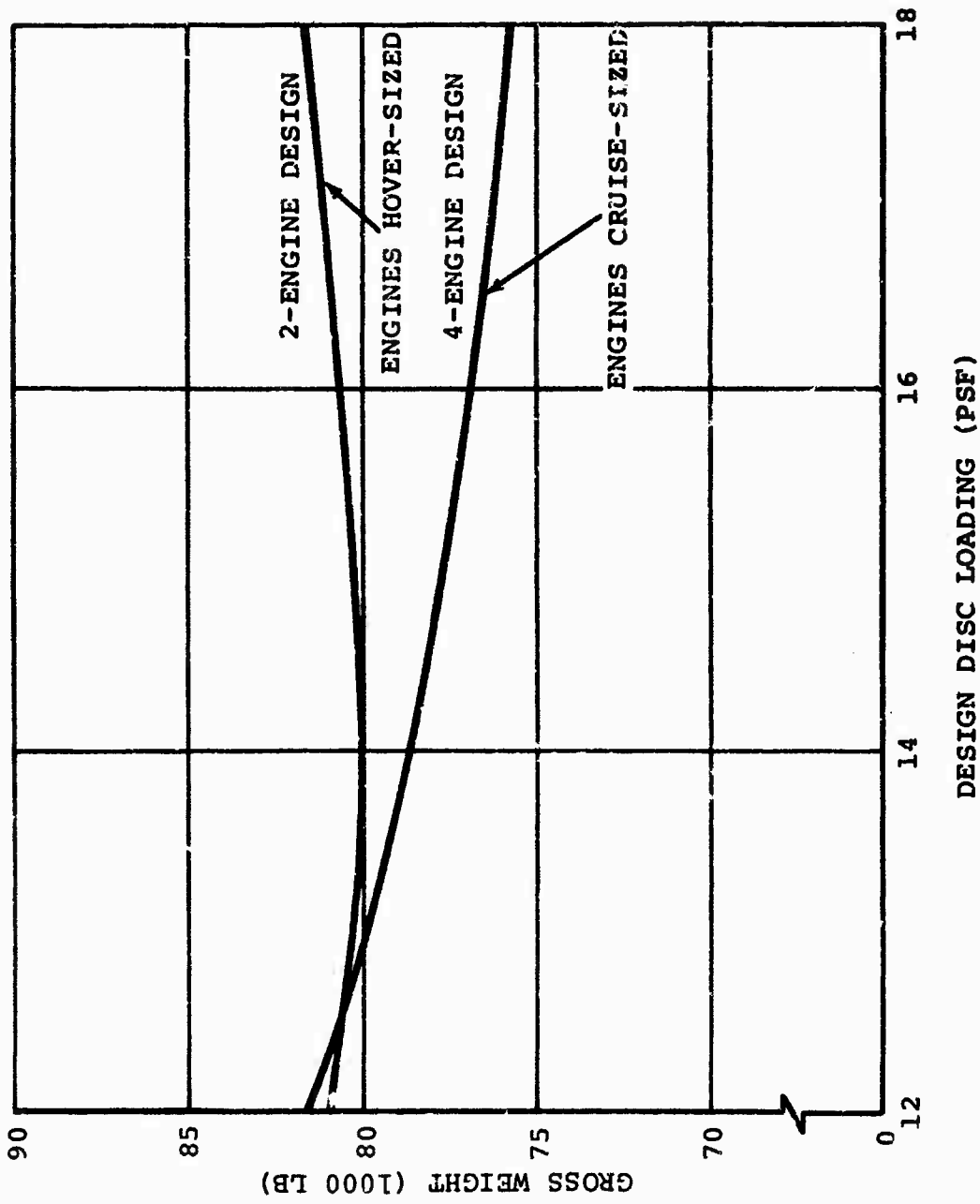

Figure 18. Design Point II Capsule Recovery Aircraft Number of Engines and Disc Loading Trend Study.

DESIGN POINT (DISC LOADING: 15 PSF)

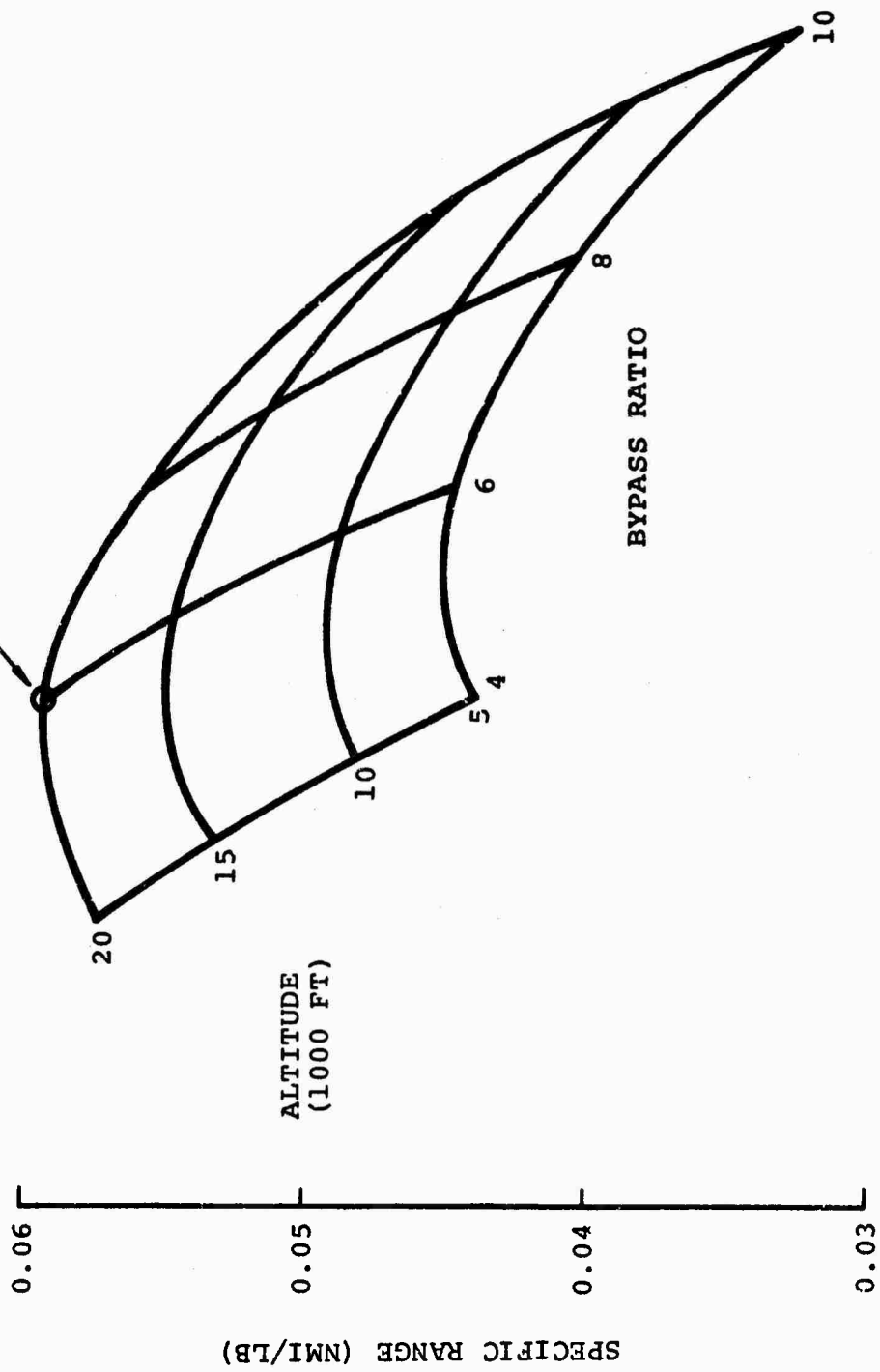

Figure 19. Design Point II Capsule Recovery Aircraft Specific Range, Altitude, and Bypass Ratio Trend Study.

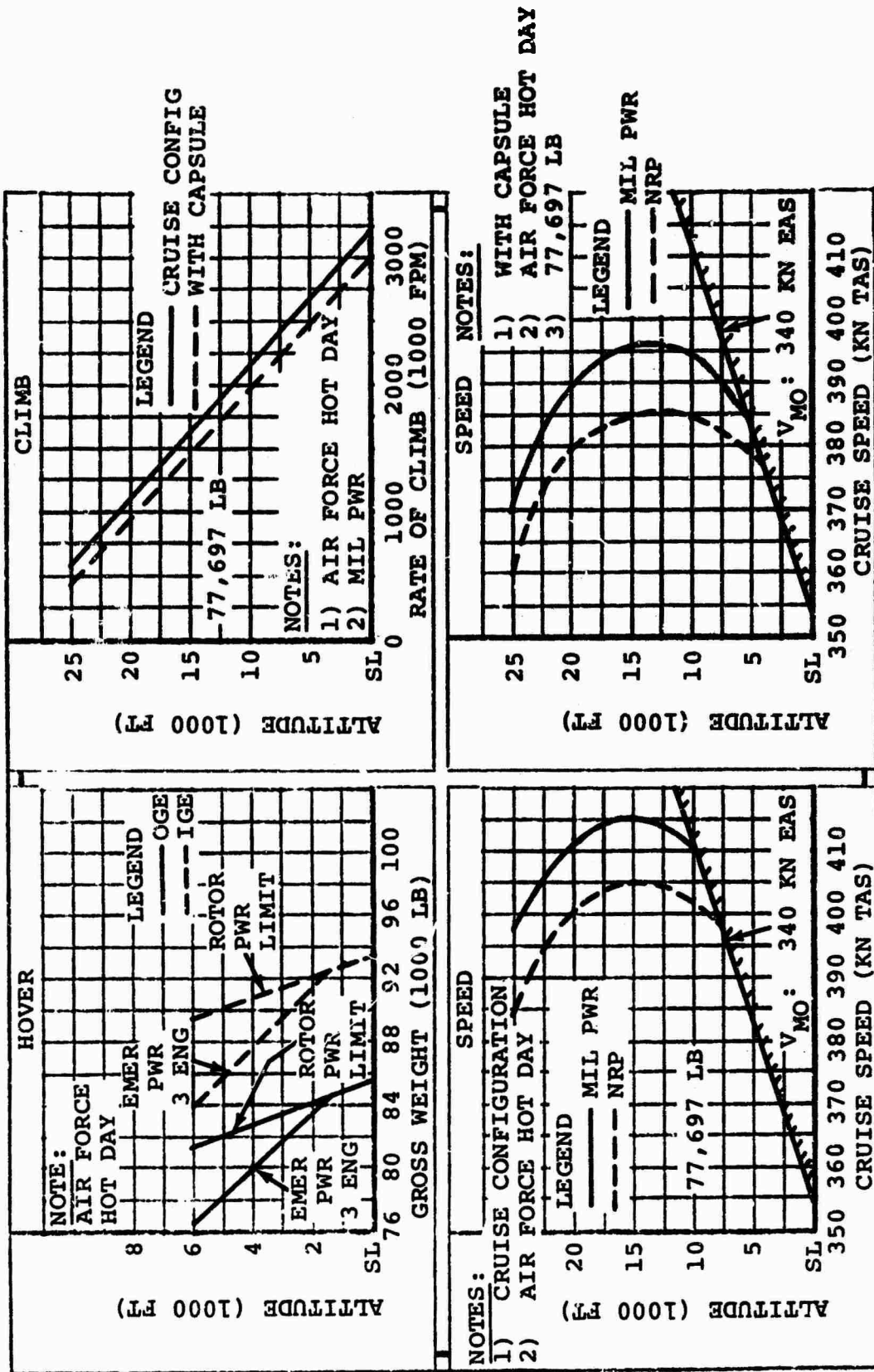

Figure 20. Design Point II Performance Summary.

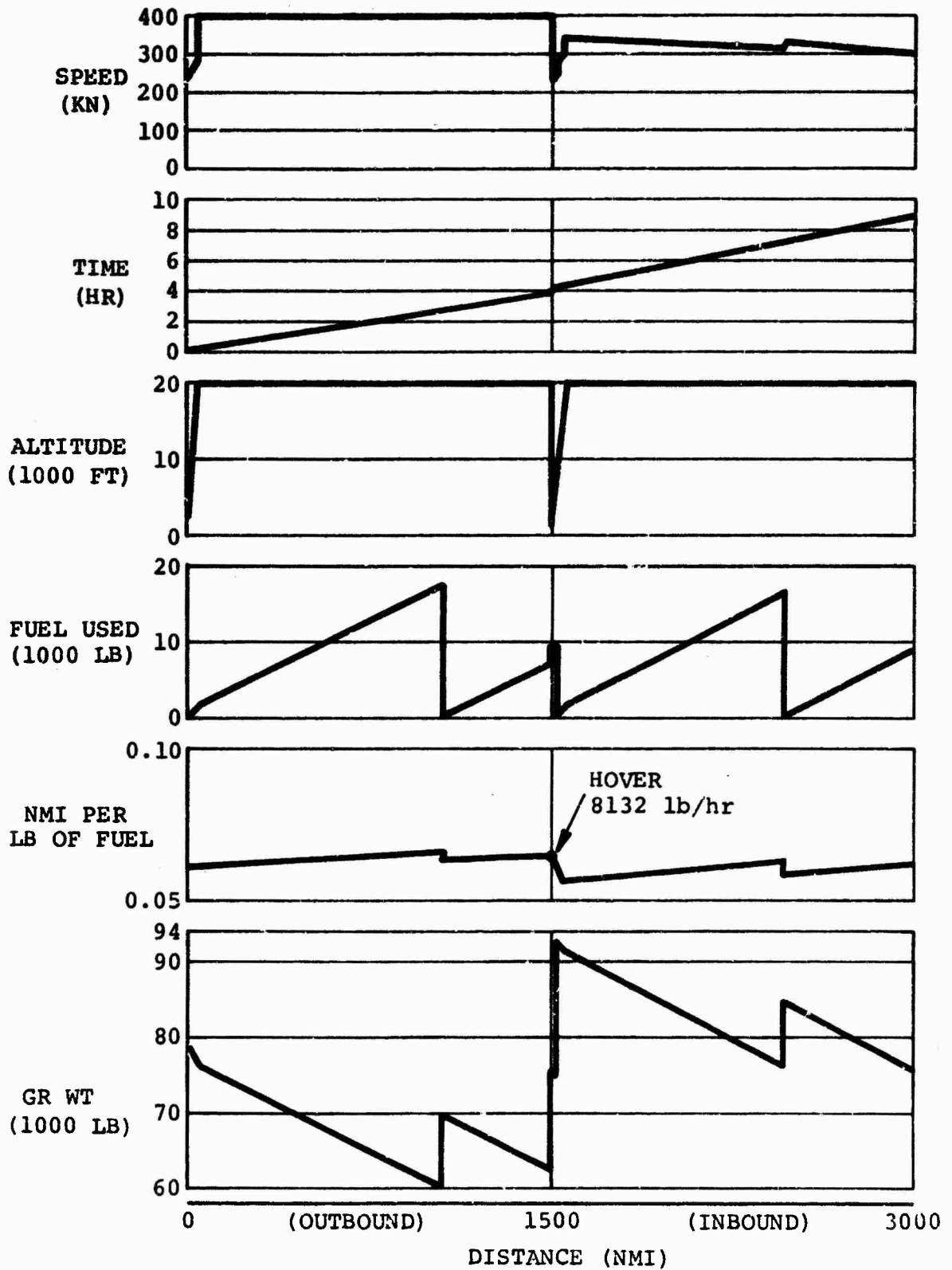

Figure 21. Design Point II (and Capsule Recovery Version of Design Point III) Capsule Recovery Mission Profile and Performance.

Appendix I gives a drag breakdown and detailed performance data for this aircraft. A performance summary is shown in Figure 20 and the mission profile is shown in Figure 21.

c. Design Point IV Medium Transport Aircraft

It was found that a design gross weight of 85,000 pounds was required for an aircraft to perform this mission. This weight is 18,000 pounds higher than the Design Point I Rescue Vehicle. The general arrangement and the basic characteristics of this vehicle are shown in Figure 22.

In the trade-offs made to establish the minimum gross weight aircraft, the choice between four or two engines was just as clear cut in favor of four engines as for the Design Point I aircraft. The trade-off of gross weight with bypass ratio and disc loading, as shown in Figure 23, was generally similar, for the same reasons as the Design Point I trade-off. The optimum occurred at a bypass ratio of six and a disc loading of 16. In this case, the disc loading is for the initial takeoff gross weight, and is therefore much lower at the midpoint of the mission.

The fuselage was sized to take four 463L system pallets. In order to minimize the fuselage width, it was assumed that these pallets could be loaded with the 88-inch dimension across the width of the cargo box, and room was left for a man to walk by on each side for inflight unloading of the pallets for air-drop or dump-truck unloading techniques.

A summary of the performance of the transport aircraft is shown in Figure 24, and it can be seen that the 17,000 pound payload mission can be accomplished well within the 1,000 foot takeoff and landing distance. The drag breakdown of the aircraft, and more detailed performance, is given in Appendix I. Figures 25 and 26 are mission profiles for the 10,000- and 17,000-pound payload missions.

Detailed characteristics of the three basic mission designs are given in Table I and weight summaries in Tables II, III and IV.

DESIGN TAKEOFF WEIGHT 84,972 LB
 EMPTY WEIGHT 59,860 LB
 INSTALLED POWER 19,766 HP
 DISC LOADING
 AT MIDPOINT WEIGHT 16 PSF
 WING LOADING
 AT TAKEOFF GROSS WEIGHT 82 PSF
 EQUIVALENT
 DRAG AREA 30.13 SQ FT
 CABIN SIZE
 LENGTH 29.00 FT
 WIDTH 8.34 FT
 HEIGHT 9.00 FT

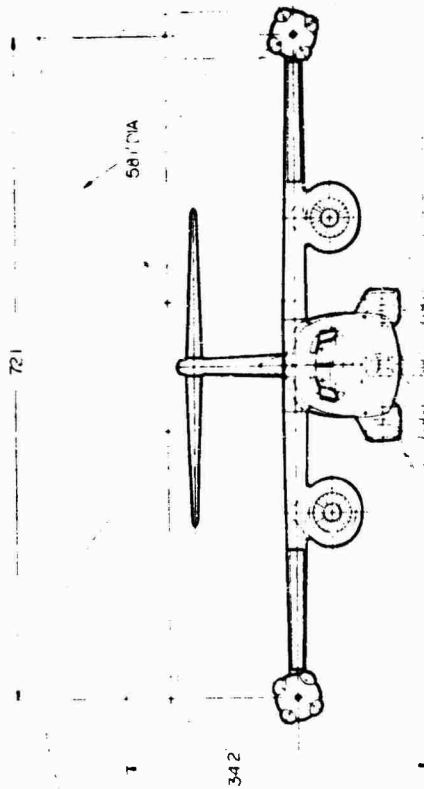
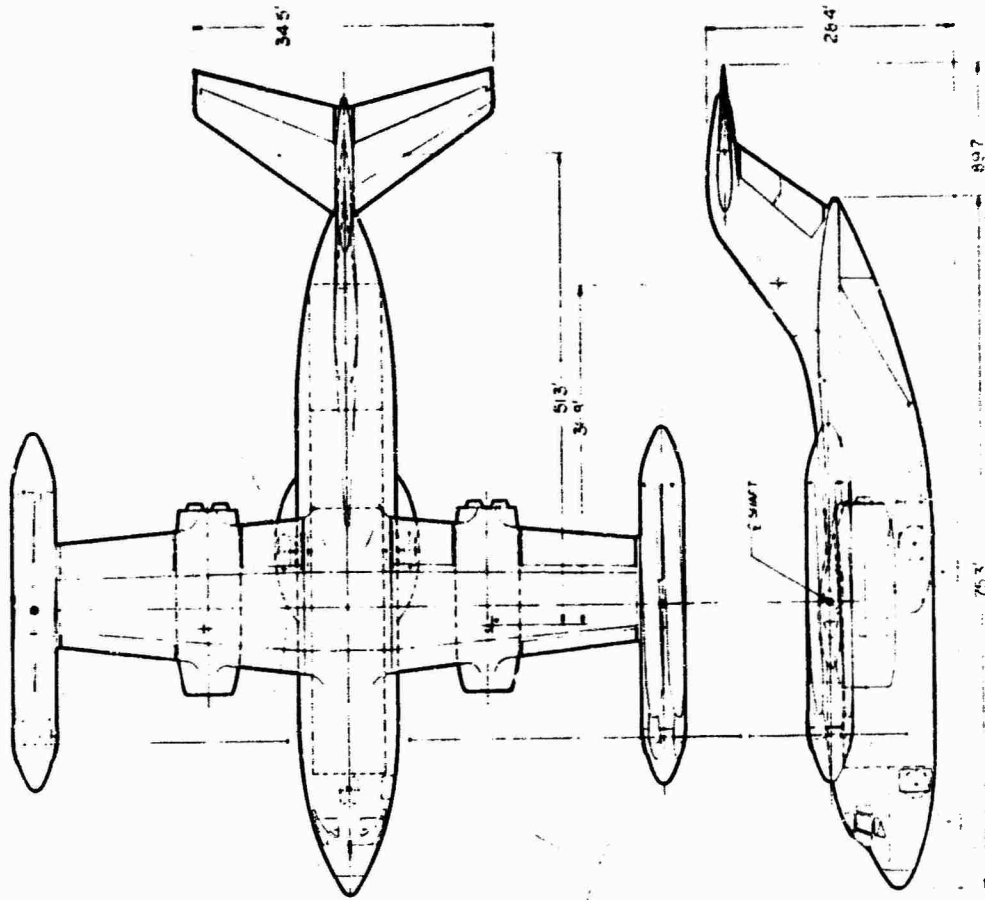

Figure 22. 3-View of Design Point IV Transport Aircraft

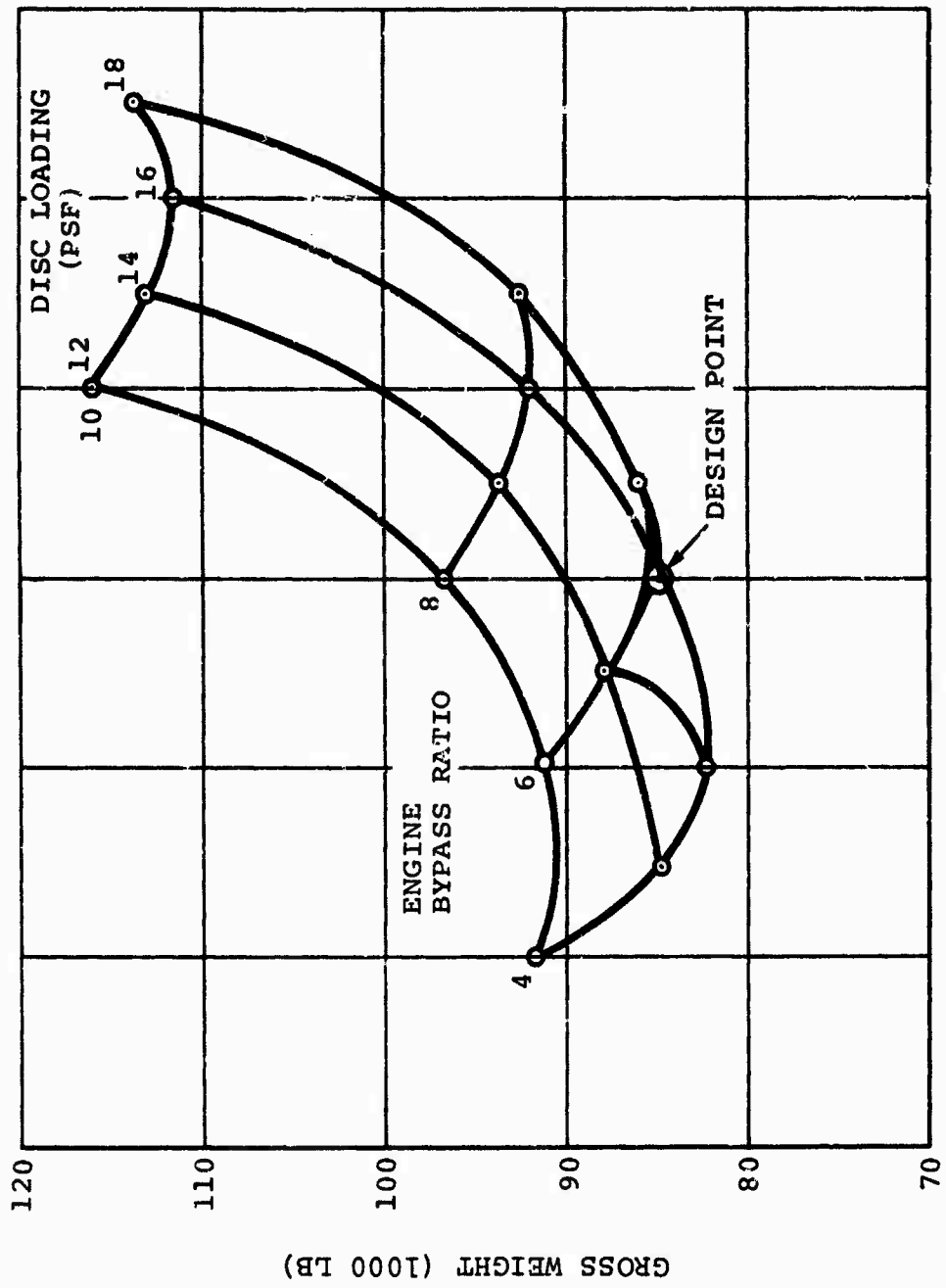

Figure 23. Design Point IV Bypass Ratio and Disc Loading Trend Study.

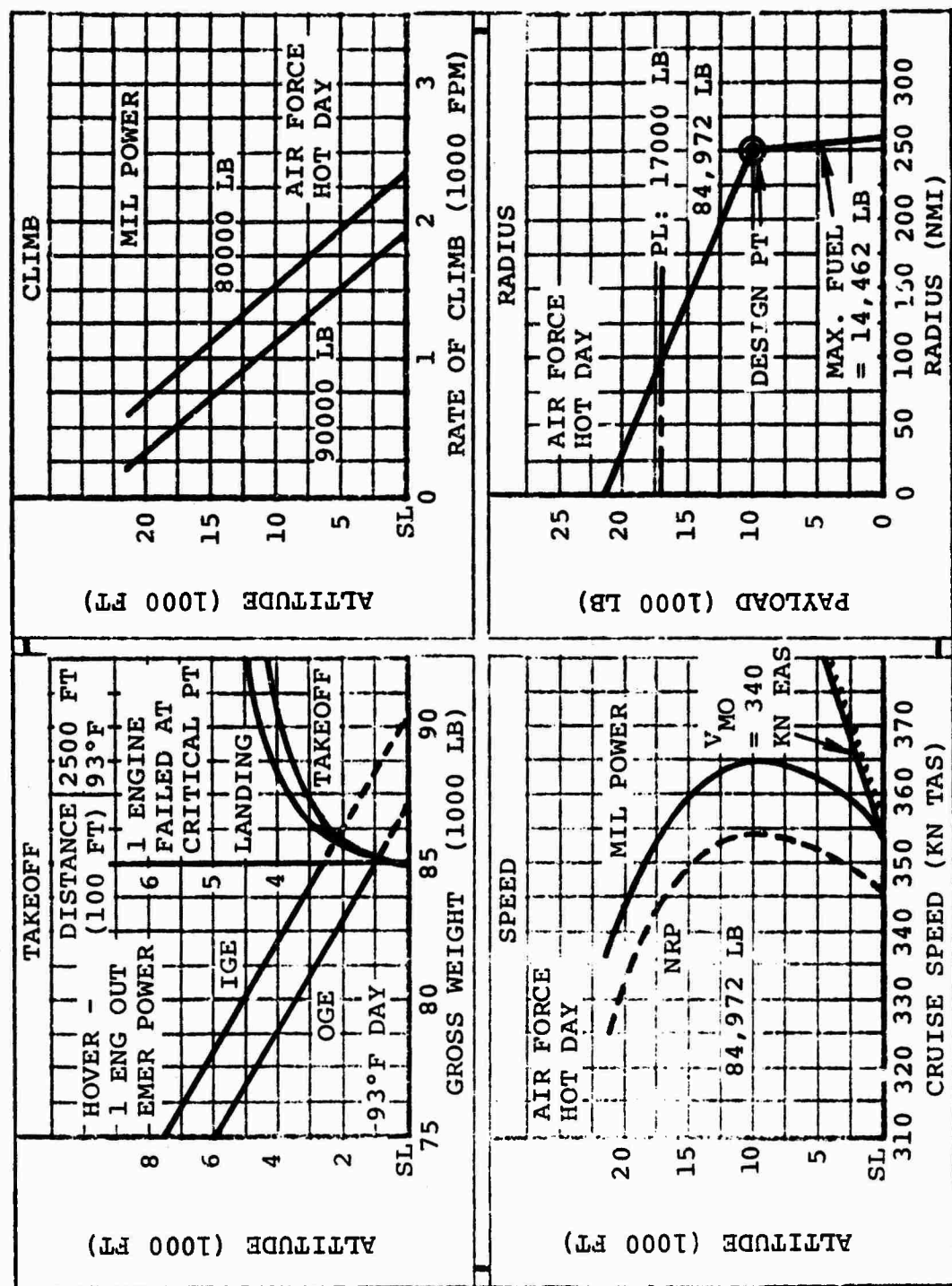

Figure 24. Design Point IV Performance Summary.

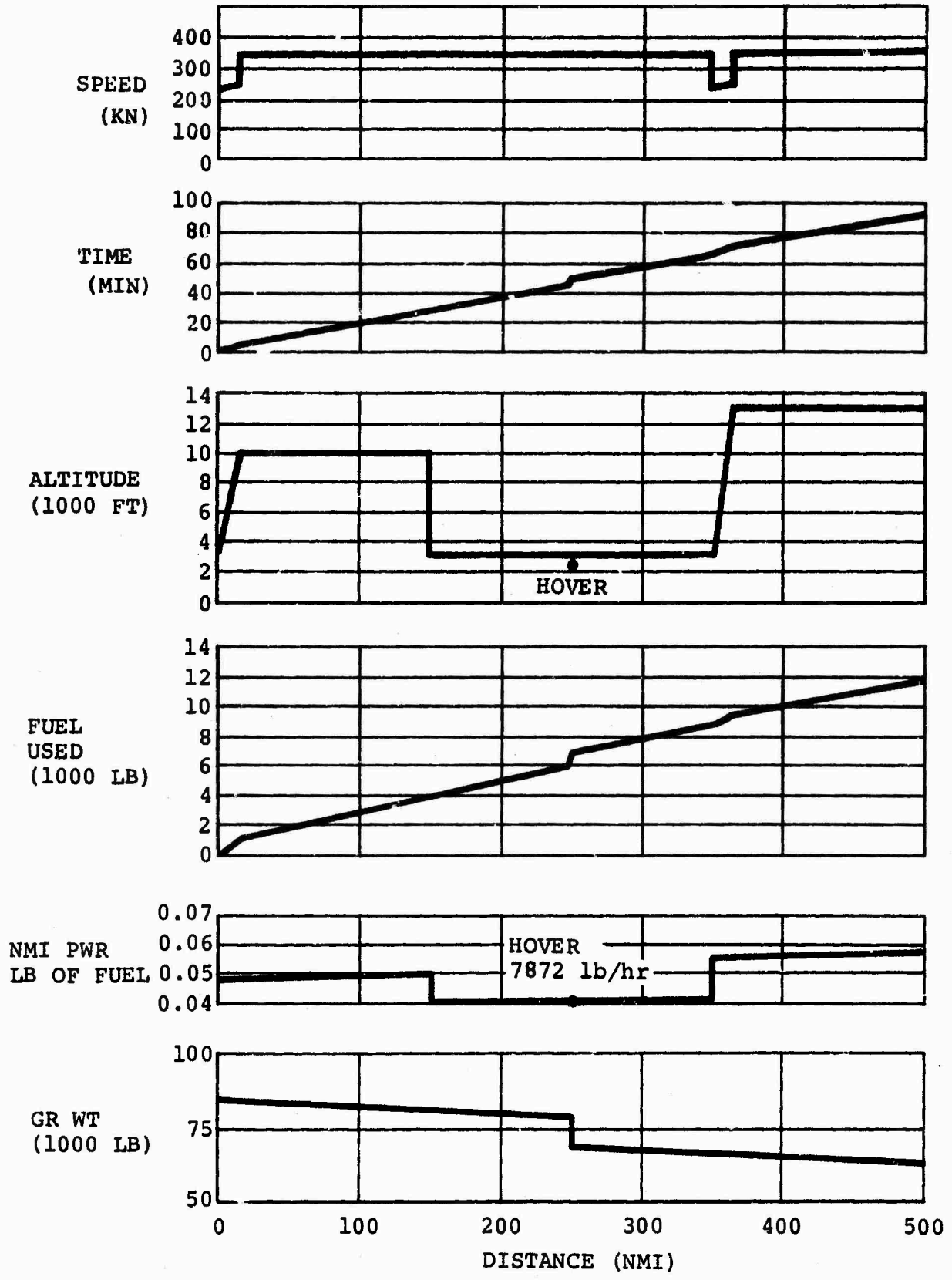

Figure 25. Design Point IV Transport Mission Profile and Performance, 5-Ton Payload.

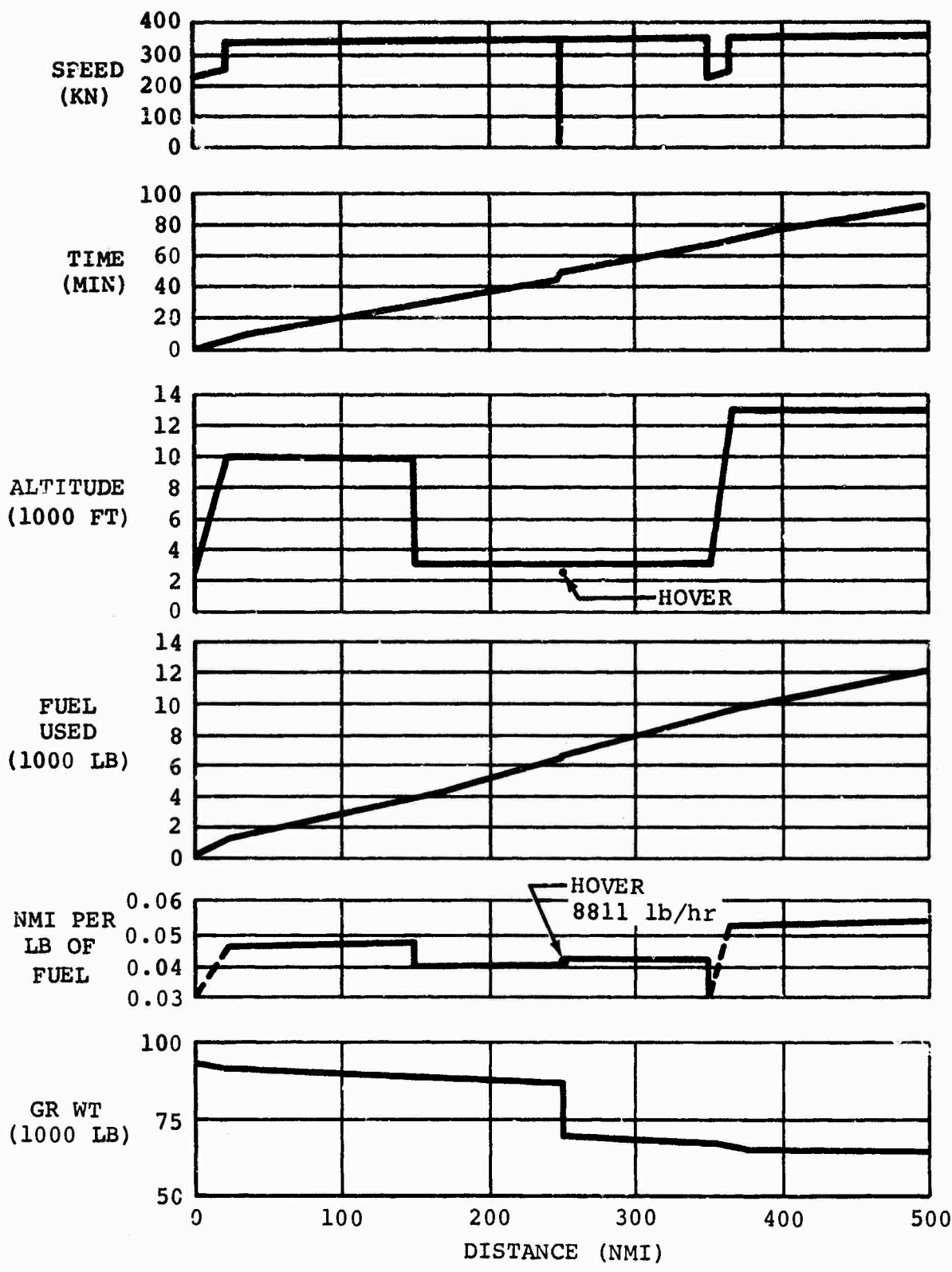

Figure 26. Design Point IV Transport Mission Profile and Performance, 8.5 Ton Payload.

TABLE I. CHARACTERISTICS OF BASIC MISSION AIRCRAFT

Characteristic	Design Point I Rescue	Design Point II Capsule Pickup	Design Point IV Transport
<u>WEIGHTS</u>			
Design Takeoff Weight (lb)	67,049	77,697	84,972
Maximum Takeoff Weight, Ferry (lb)	77,900	111,400	110,200
Empty Weight (lb)	42,714	55,795	58,850
Design Mission Fuel (lb)	22,600	20,000	14,462
Fuel Tank Capacity, Wing Only (lb)	22,600	24,200	30,065
<u>POWER</u>			
Total Horsepower SL Std Max (hp)	17,454	22,400	19,766
Number of Engines	4	4	4
Horsepower Each (hp)	4,363	5,600	4,941
Bypass Ratio	6.0	6.0	6.0
Rotor Transmission Torque Limit (at the following conditions)	6,300 hp at 79 percent rpm (climb)	6,710 hp at 70 percent rpm (climb)	6,250 hp at 70 percent rpm (climb)
<u>ROTOR</u>			
Diameter (ft)	49.20	57.50	58.10
Number of Rotors	2	2	2
Rotor Power Limit (each at 100 percent rpm, hover) (hp)	6,215	7,585	7,800
Disc Loading	15 psf at midpoint gr wt	15 psf at midpoint gr wt	16 psf at takeoff gr wt
Solidity	0.100	0.100	0.1035
Number Blades per Rotor	4	4	4
Average Blade Chord (ft)	1.93	2.25	2.36
<u>DIMENSIONS (Overall)</u>			
Length, Rotors Folded (ft)	70.00	74.75	89.70

TABLE I. (Continued)

Characteristic	Design Point I Rescue	Design Point II Capsule Pickup	Design Point IV Transport
Width, Rotors Folded (ft)	63.33	75.25	78.00
Height, Rotors Folded (ft)	23.75	27.50	28.40
Length, Rotors Unfolded (ft)	70.00	74.75	89.70
Width, Rotors Unfolded (ft)	108.08	128.00	130.20
Height, Rotors Unfolded (ft)	29.00	31.25	34.20
<u>FUSELAGE</u>			
Fuselage Length (ft)	61.25	66.17	75.30
Fuselage Width (ft - in.)	6.67 - 80	11.67 - 140	11.33 - 136
Fuselage Height (ft - in.)	8.75 - 105	9.58 - 115	12.25 - 147
<u>CABIN SIZE (Internal Dimensions)</u>			
Length (ft)	22.00	8.25*	29.00
Width (ft - in.)	5.50 - 66	8.00 - 96*	8.34 - 100
Height (ft - in.)	7.00 - 84	6.50 - 78*	9.00 - 108
<u>WING</u>			
Span (ft)	58.88	70.50	72.10
Area (sq ft)	746	867	1,038
Aspect Ratio	4.65	5.72	5.02
Wing Loading at Take-off Gross Weight (psf)	90	90	82
Sweep 1/4 Chord (degrees)	7	4	3.5
Taper Ratio	0.60	0.60	0.60
MAC (ft)	12.90	12.65	14.70
\bar{C} (ft)	12.65	12.30	14.40
C _R (ft)	15.80	15.40	17.96
C _T (ft)	9.50	9.23	10.78
T/C Root and Tip (percent)	16	16	16

*Internal Dimensions

TABLE I. (Continued)

Characteristic	Design Point I Rescue	Design Point II Capsule Pickup	Design Point IV Transport
Dihedral	zero	zero	zero
Incidence (degrees)	3	3	2
Twist	none	none	none
<u>HORIZONTAL TAIL</u>			
Span (ft)	28.17	30.50	34.50
Area (sq ft)	199	231	298
Aspect Ratio	4.0	4.0	4.0
Tail Volume	0.805	0.800	1.000
Moment Arm (ft)	38.60	38.00	51.30
	(3 mac)	(3 mac)	(3.5 mac)
Taper Ratio	0.333	0.300	0.400
Sweep 1/4 Chord (degrees)	25	25	30
MAC (ft)	7.60	8.16	9.25
<u>HORIZONTAL TAIL</u>			
\bar{C} (ft)	7.00	7.52	8.65
C_R (ft)	10.50	11.30	12.35
C_T (ft)	3.50	3.75	4.94
T/C Root and Tip (percent)	15	15	15
Dihedral	zero	zero	zero
Incidence (degrees)	+25, -8	+25, -8	+25, -8
<u>VERTICAL TAIL</u>			
Span, Height (ft)	12.42	14.90	11.17
Area (sq ft)	154	222	175.2
Aspect Ratio	1.00	1.00	0.712
Tail Volume	0.100	0.100	0.0862
Moment Arm (ft)	28.30	28.60	36.80
	(2.2 mac)	(2.26 mac)	(2.44 mac)
Taper Ratio	0.535	0.535	0.620
Sweep 1/4 Chord (degrees)	42	42	42
MAC (ft)	12.75	15.30	14.34
\bar{C} (ft)	12.43	14.90	15.71
C_R (ft)	16.20	19.40	19.40
C_T (ft)	8.66	10.40	12.02
T/C Root and Tip (percent)	14	14	15

TABLE I. (Continued)

Characteristic	Design Point I Rescue	Design Point II Capsule Pickup	Design Point IV Transport
<u>ROTOR POD</u>			
Length (ft)	35.00	38.88	39.00
Diameter (ft)	4.16	4.57	5.07
<u>LANDING GEAR</u>			
Nose, Tires (Type and Size)	Type VII 22 x 6.6	Type VII 30 x 7.7	Type III 12.50-16
Main, Tires (Type and Size)	Type VII 36 x 11	Type VII 32 x 8.8	Type III 17-16
Auxiliary Outrigger Tires (Type and Size)	Type III 7.00-6	none	none
Tread (ft)	20.80	15.00	12.32
Wheel Base (ft)	28.00	30.75	27.00
Turn Over Angle (degrees)	> 27	27	31
Tip Back Angle (degrees)	30	30	20
Flare Angle (degrees)	15	16	15

TABLE II. WEIGHT SUMMARY FOR DESIGN POINT I RESCUE AIRCRAFT

	DESIGN GROSS WEIGHT	MID- POINT	2600 NMI FERRY MISSION			
WATER GROUP	5285					
ENGINE GROUP	4490					
FUEL GROUP	975					
BODY GROUP	3260					
BASE						
SECONDARY						
ENGINE ACCESS, ETC.						
ALIGNMENT GEAR	2480					
ENGINE CONTROLS	3890					
ENGINE SECTION	920					
Tip Pdg	1370					
PROPULSION GROUP	12658					
ENG. NEES(S)	2510					
AIR INTAKE	260					
EXHAUST SYSTEM	-					
COOLING SYSTEM	15					
LUBRICATING SYSTEM	130					
FUEL SYSTEM	2130					
ENGINE CONTROLS	85					
STARTING SYSTEM	148					
PROPELLER INST.						
*DRIVE SYSTEM	4810					
Fan Instl.	2570					
AUX. POWER PLANT	182					
INST. AND NAV.	400					
WWR, AND PNEU.	292					
ELECTRICAL GROUP	775					
ELECTRONICS GROUP	1500					
ARMAMENT GROUP	2000					
ENV. & EQUIP. GROUP	1152					
PERSON. ACCON.						
MISC. EQUIPMENT						
FURNISHINGS						
EMER. EQUIPMENT						
AIR COND. & DE-ICING	519					
PHOTOGRAPHIC						
LANDING GEAR	140					
Cargo Handling						
WEIG. VARIATION	426					
WEIGHT EMPTY	42714	42714	42714			
FIXED USEFUL LOAD	1335	1335	855			
CREW (5)	1200	1200	720			
TRAPPED LIQUIDS	135	135	135			
ENGINE OIL						
Combat Equip.	400	400	200*			
FUEL	22600	11345	33456			
CARGO						
PASSENGERS/TROOPS		1200				
Ferry Tanks			675		*Survival Equipment	
GROSS WEIGHT	67049	56994	77900			

TABLE III. WEIGHT SUMMARY FOR DESIGN POINT II CAPSULE RECOVERY AIRCRAFT

	DESIGN GROSS WEIGHT	MID-POINT	MAX FUEL ON RETURN	2600 NMI FERRY MISSION	
WING GROUP	7105				
LANDING GEAR	6060				
TAIL GROUP	1610				
FUSELAGE	7465				
DOORS					
EXTERIOR					
WING DOORS, ETC.					
LANDING GEAR	2880				
EXTERIOR DOORS	5150				
TAIL SECTION	1380				
2600 NMI	2010				
WING GROUP	16517				
ENGINE(S)	3410				
AIR INTAKE	340				
EXHAUST SYSTEM					
EXHAUST SYSTEM	20				
LUBRICATING SYSTEM	175				
FUEL SYSTEM	1635				
STARTING SYSTEM	115				
STARTING SYSTEM	212				
PROPELLER INST.					
PROPELLER	7120				
PROPELLER	3490				
PROP. POWER PLANT	182				
PROP. AND NAV.	400				
PROP. AND NAV.	292				
PROP. GROUP	775				
PROP. GROUP	800				
PROP. GROUP	-				
PROP. EQUIP. GROUP	1152	5060			
PROP. EQUIP.					
PROP. EQUIPMENT					
PROP. EQUIPMENT					
PROP. EQUIPMENT	519				
PROP. EQUIPMENT					
PROP. EQUIPMENT	940				
PROP. EQUIPMENT					
PROP. EQUIPMENT	558				
WEIGHT EMPTY	55795	55795	55795	55795	
FUEL (DEF. LEAD)	1430	1430	1430	950	
PROP.	1200	1200	1200	720	
TRAPPED LIQUIDS	230	230	230	230	
PROP. OIL					
Survival Equip.	200	200	200	200	
PROP.	20000	5000	20000	52213	
PROP.		15000	15000		
PROP.				1970*	
Hatch	272	272	272	272	*Ferry Tanks
GRAND WEIGHT	77697	77697	92697	111400	

TABLE IV. WEIGHT SUMMARY FOR DESIGN POINT IV TRANSPORT MISSION AIRCRAFT

	DESIGN GROSS WEIGHT	OVER-LOAD	2600 NMI FERRY MISSION			
ENGINE GROUP	7120					
WATER GROUP	6750					
TAIL GROUP	1160					
PROP. GROUP	7290					
MISC. P.						
SECONDARY						
SEATING, CROCKERS, ETC.						
AL. STARTING GEAR	4250					
FLIGHT CONTROLS	6122					
ENGINE SECTION	1634					
Air Pcd	2190					
PROP. SECTION GROUP	14710					
AIR INDUCTION	2940					
AIR INDUCTION	360					
EXHAUST SYSTEM						
COOLING SYSTEM	20					
LUBRICATING SYSTEM	180					
FUEL SYSTEM	1430					
ENGINE CONTROLS	115					
STARTING SYSTEM	205					
PROPELLER INST.						
ENGINE SYSTEM	6320					
For Instl.	3140					
WIN. PUMP PLANT	182					
INST. AND NAV.	400					
HYDR. AND PNEU.	292					
ELECTRICAL GROUP	775					
ELECTRONICS GROUP	950					
ARMAMENT GROUP	50					
PROP. & EQUIP. GROUP	2330	6736				
PERSON. ACCOM.						
MISC. EQUIPMENT						
FURNISHINGS						
EMERG. EQUIPMENT						
AIR COND. & DE-ICING	727					
PHOTOGRAPHIC						
LANDING GEAR	40					
Cargo Handling	990					
WHEEL MOUNTING	588					
WEIGHT EMPTY	58850	58850	58850			
MAX. USEFUL LOAD	1660	1660	1180			
CREW (5)	1200	1200	720			
TRAPPED LIQUIDS	460	460	460			
ENGINE OIL						
Survival Equip.			200			
FUEL	14462	15640	17970			
CARGO	10000	17000	-			
PASSENGERS/TROOPS						
Ferry Tanks			2000			
GROSS WEIGHT	84972	93150	110200			

3. MULTIMISSION DESIGNS

The intent of this analysis was to determine the degree of compatibility between aircraft designed first to the rescue and capsule recovery missions (Design Point III), and then to all three missions (Design Point V), and the compromise necessary to combine these mission capabilities in substantially common airframes. As a minimum, this commonality was extended to the lift/propulsion system comprising the wing, engines, drive system, and rotors. The relative numbers of production aircraft which might be required for each mission was considered in determining the degree of commonality.

A combination of the rescue and capsule recovery missions into Design Point III (Figure 27) naturally results in an aircraft of the same size as the larger of the two single-mission aircraft. The lift/propulsion system of the capsule recovery aircraft will also accommodate the rescue mission requirements if the drive system is uprated slightly. Thus the basic Design Point III vehicle is a capsule recovery lift/propulsion system with an uprated drive system combined with a rescue mission fuselage for the Design Point I mission. This vehicle is then modified by the substitution of an enlarged center fuselage section for the capsule recovery role and is then identical to the Design Point II aircraft. The required number of the latter configuration is likely to be small. Such a factory modification of a limited number of aircraft appears to be the most satisfactory solution, if only the rescue and capsule recovery missions are considered. Performance in the rescue role is shown in Figure 28 and the corresponding mission profile is given in Figure 29. In the capsule recovery role, these are the same as Design Point II (Figures 20 and 21).

As might be expected, the aircraft size for the Design Point IV medium transport role, with a fuselage tailored to the 463L cargo handling system, is considerably larger than either the Mission I or II aircraft. In configuring the Design Point V multimission aircraft to accomplish the three basic missions, certain ground rules were established. These ground rules were:

- a. The lift-propulsion system should be common.
- b. The base aircraft fuselage should be for the transport mission since this is likely to be built in the largest quantities.
- c. Since the number of capsule recovery aircraft required is likely to be small, this role should entail a minimum modification to the basic fuselage.

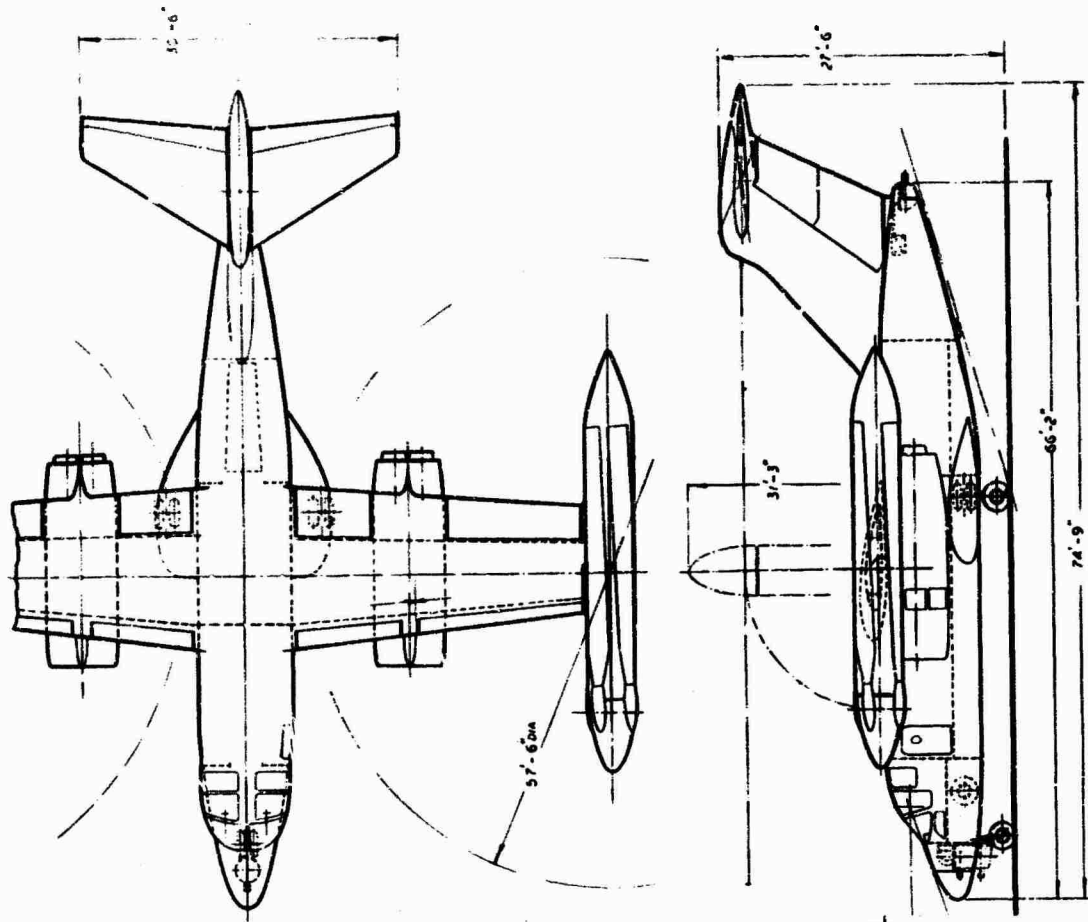

DESIGN TAKEOFF WEIGHT	88,482 LB
EMPTY WEIGHT	57,632 LB
INSTALLED POWER	22,400 HP
DISC LOADING	
AT TAKEOFF GROSS WEIGHT	.17 PSF
AT MIDPOINT WEIGHT	.14.5 PSF
WING LOADING	
AT TAKEOFF GROSS WEIGHT	102 PSF
EQUIVALENT DRAG AREA	24.08 SQ FT

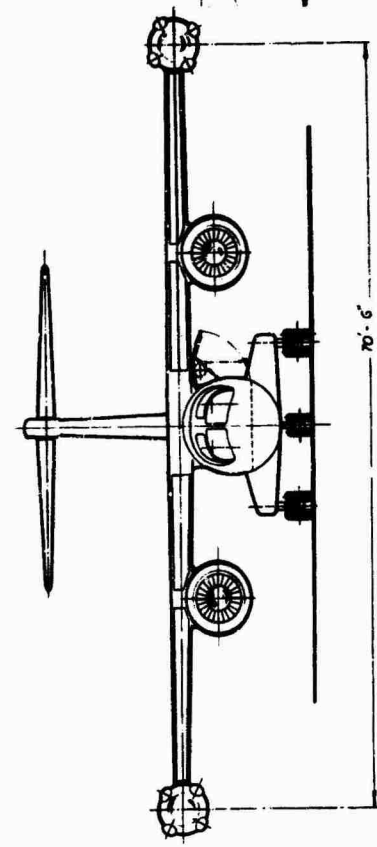

Figure 27. 3-View of Design Point III Multimission Aircraft, Rescue Version.

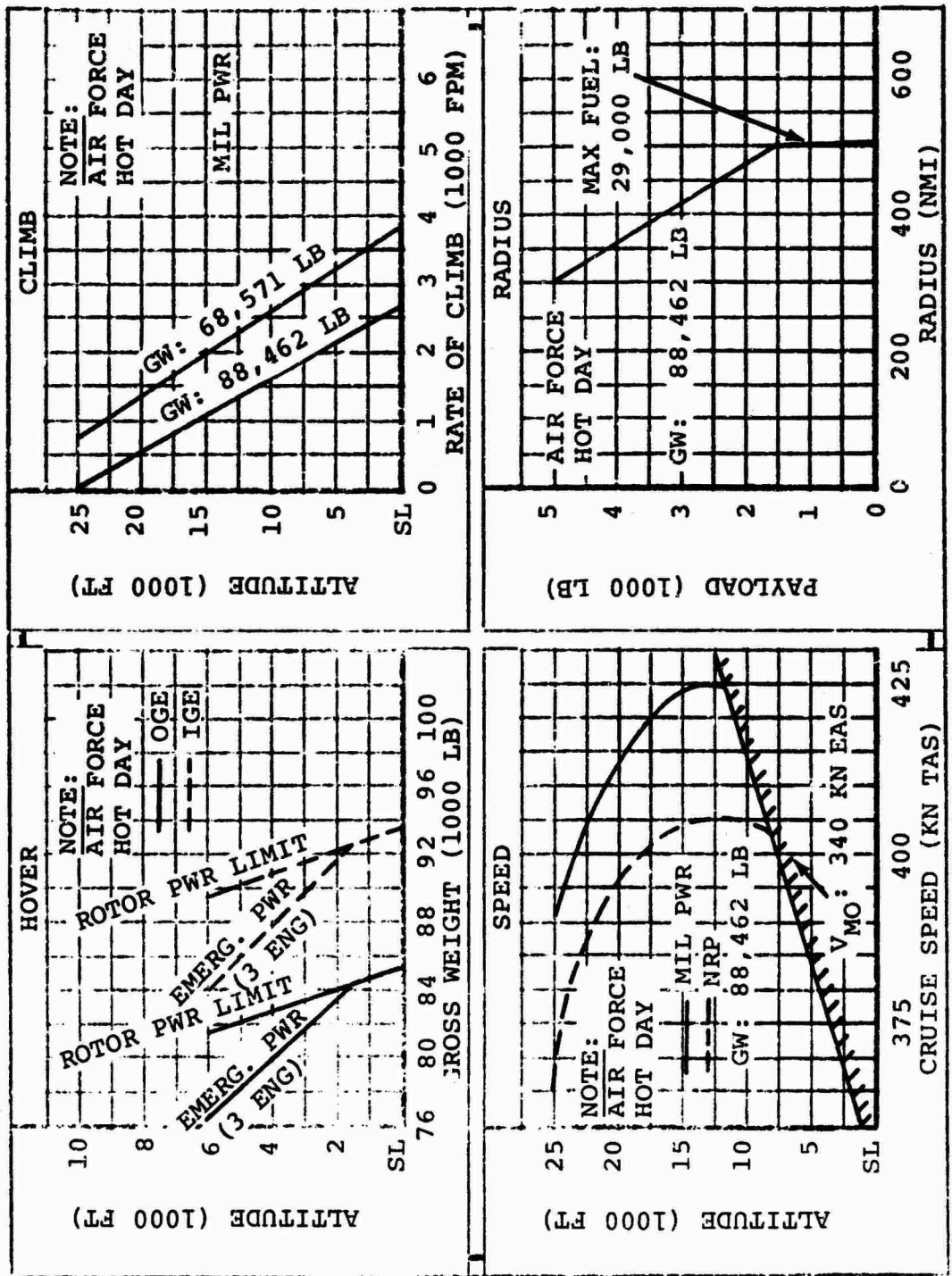

Figure 28. Design Point III Performance Summary.

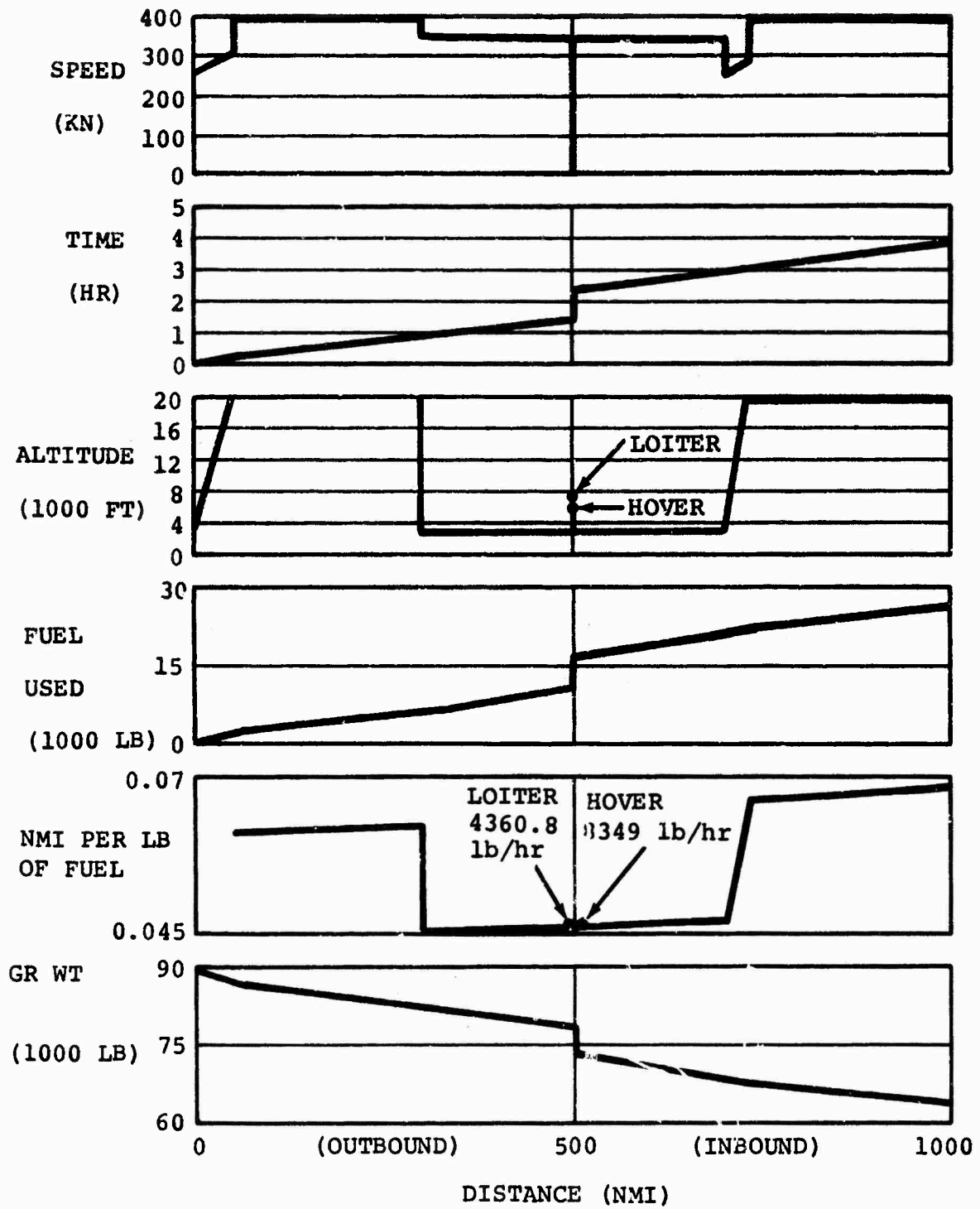

Figure 29. Design Point III (Multimission) Rescue Mission Profile and Performance.

- d. While the required quantities of rescue ships may not justify development of a new aircraft, the number would be sufficiently large to warrant major modification of an existing airframe. Consequently, a new fuselage is permissible for the rescue version if the weight and drag of the transport fuselage makes it impossible to do the rescue mission with the basic airplane.

The first step in designing the Design Point V (Figure 30) aircraft was to resize the basic transport aircraft for a 400-knot speed capability for the capsule pickup mission. This resulted in a 104,000-pound design gross weight aircraft, which, with a suitably modified fuselage, was able to fulfill the capsule pickup role. The performance of the transport is shown in Figure 31 and the mission profile in Figure 32. While it was obviously desirable to do the rescue mission with the basic airframe unchanged, it was found that the drag and weight of the large fuselage forced the required takeoff weight for this mission up to 127,000 pounds for a mission fuel weight of 49,000 pounds. While this was tolerable in itself, the resulting midpoint gross weight required 18 percent more power than is installed in the base transport/capsule pickup aircraft. Therefore, rather than increase the size of the basic lift/propulsion system still further, a new smaller fuselage was designed for the rescue version of Design Point V. The resulting reduction in drag and weight makes it possible to do the rescue mission without increasing the size of the basic lift/propulsion system, since the midpoint gross weight was reduced to 94,000 pounds, which is permissible from a power standpoint. The modified rescue version of Design Point V is shown in Figure 33. Mission profiles for the capsule recovery and rescue missions are given in Figures 34 and 35.

Detailed characteristics of the multimission aircraft variants are shown in Table V and weight summaries are given in Tables VI through X.

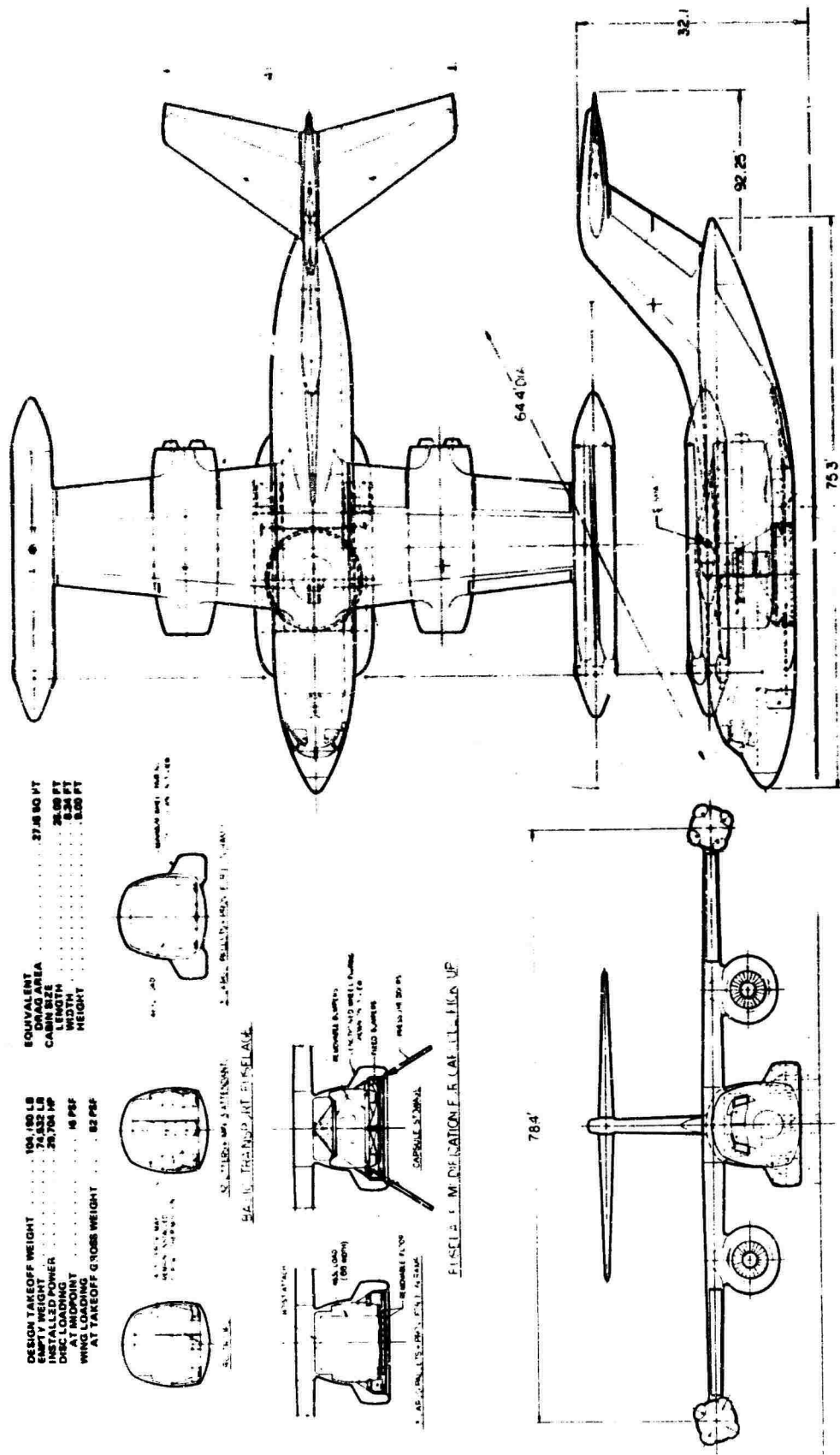

Figure 30. 3-View of Design Point V Multimission Aircraft, Transport and Capsule Recovery Versions.

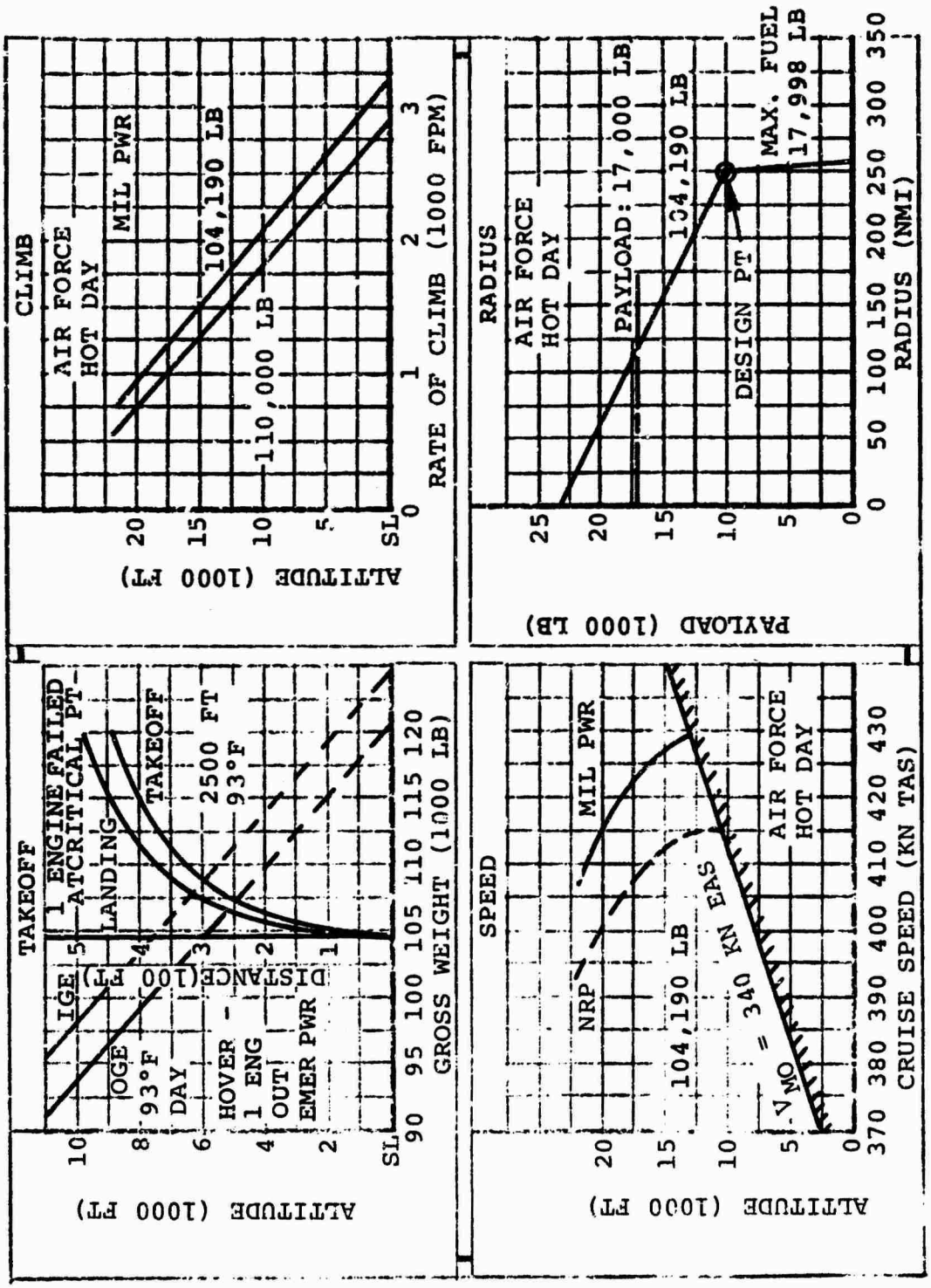

Figure 31. Design Point V Basic Mission Performance Summary.

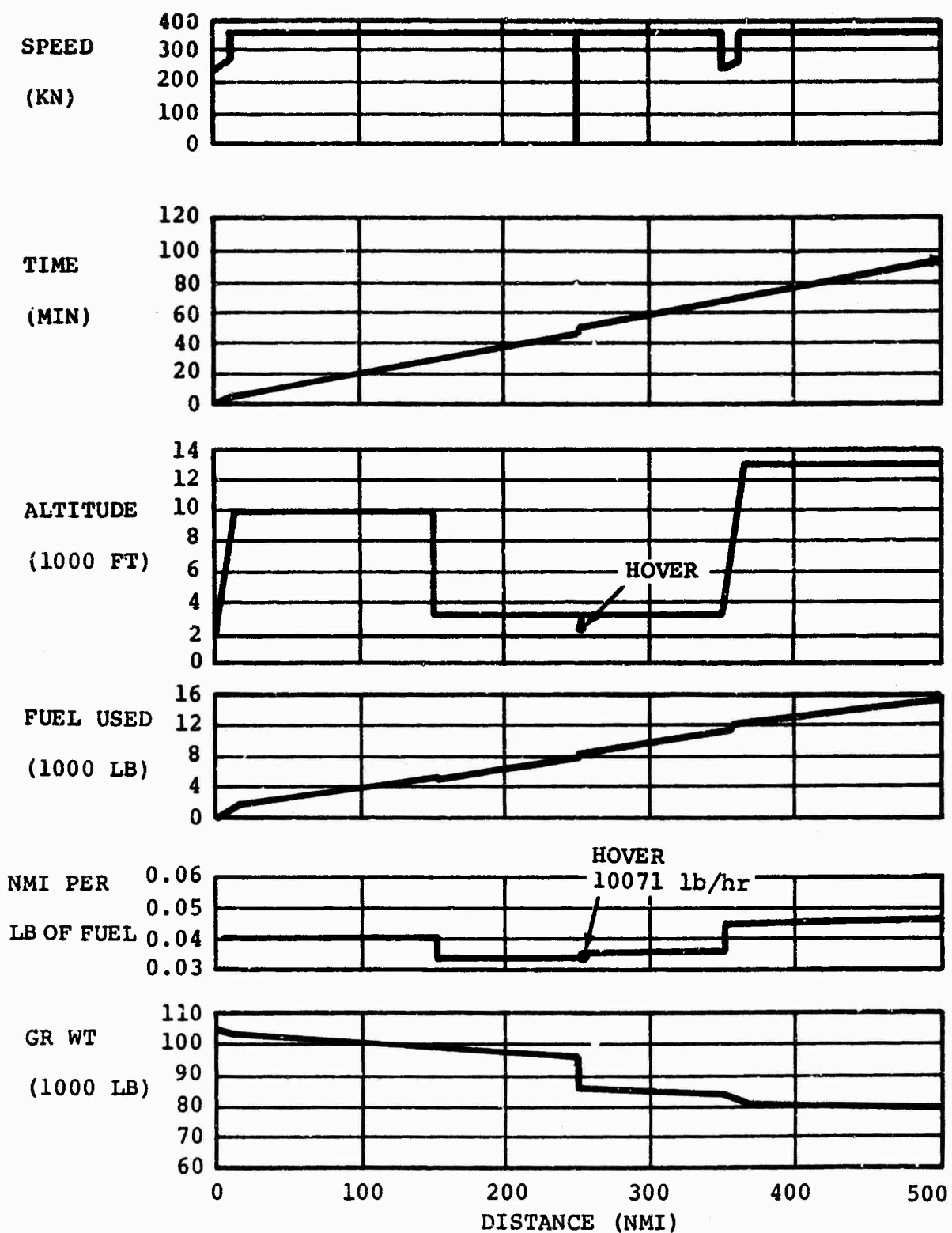
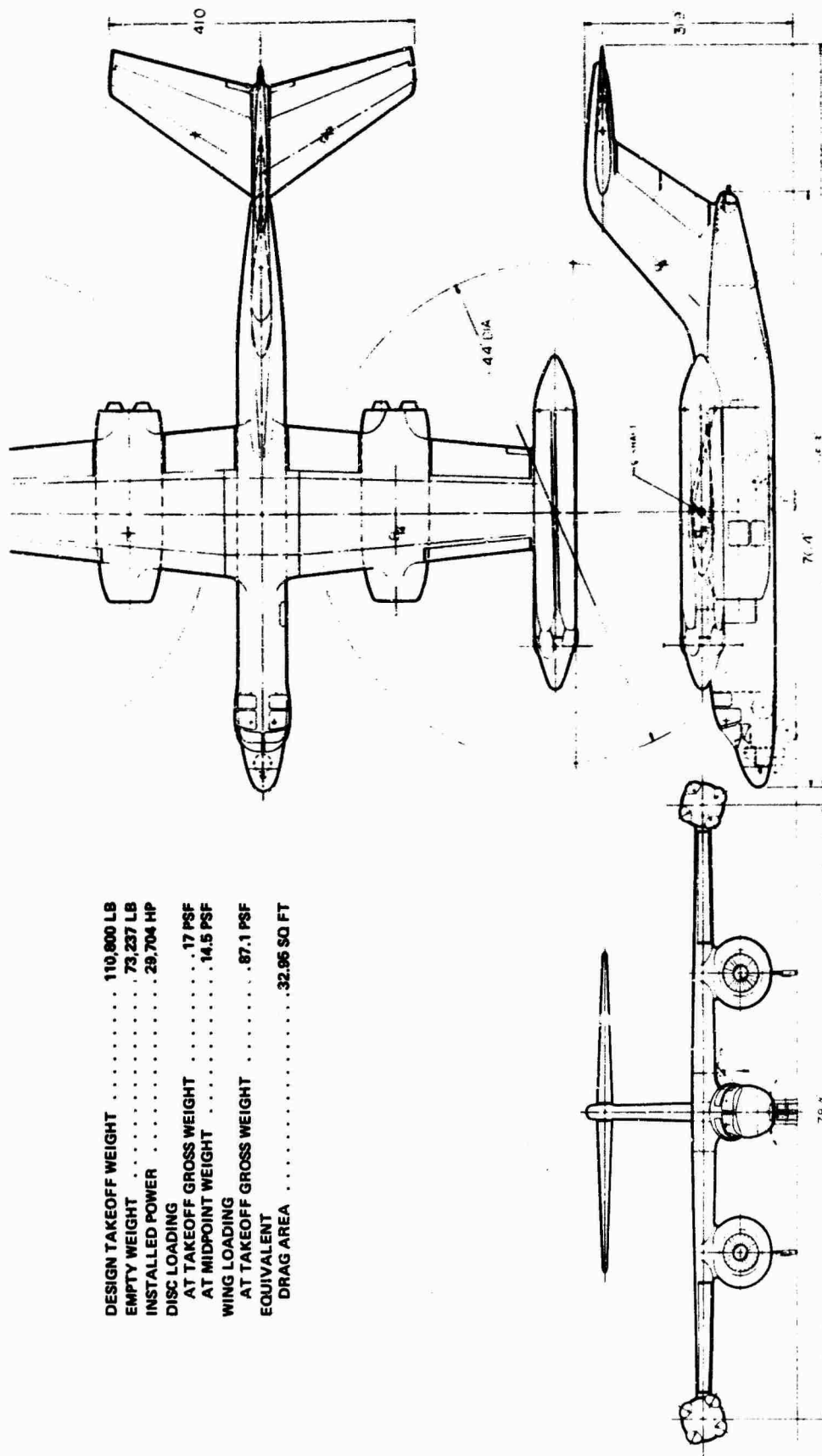

Figure 32. Design Point V (Multimission) Transport Mission Profile and Performance.



DESIGN TAKEOFF WEIGHT	110,800 LB
EMPTY WEIGHT	73,237 LB
INSTALLED POWER	28,704 HP
DISC LOADING	
AT TAKEOFF GROSS WEIGHT	.17 PSF
AT MIDPOINT WEIGHT	14.5 PSF
WING LOADING	
AT TAKEOFF GROSS WEIGHT	.87.1 PSF
EQUIVALENT	
DRAG AREA	32.86 SQ FT

Figure 33. 3-View of Design Point V Multimission Aircraft, Rescue Version

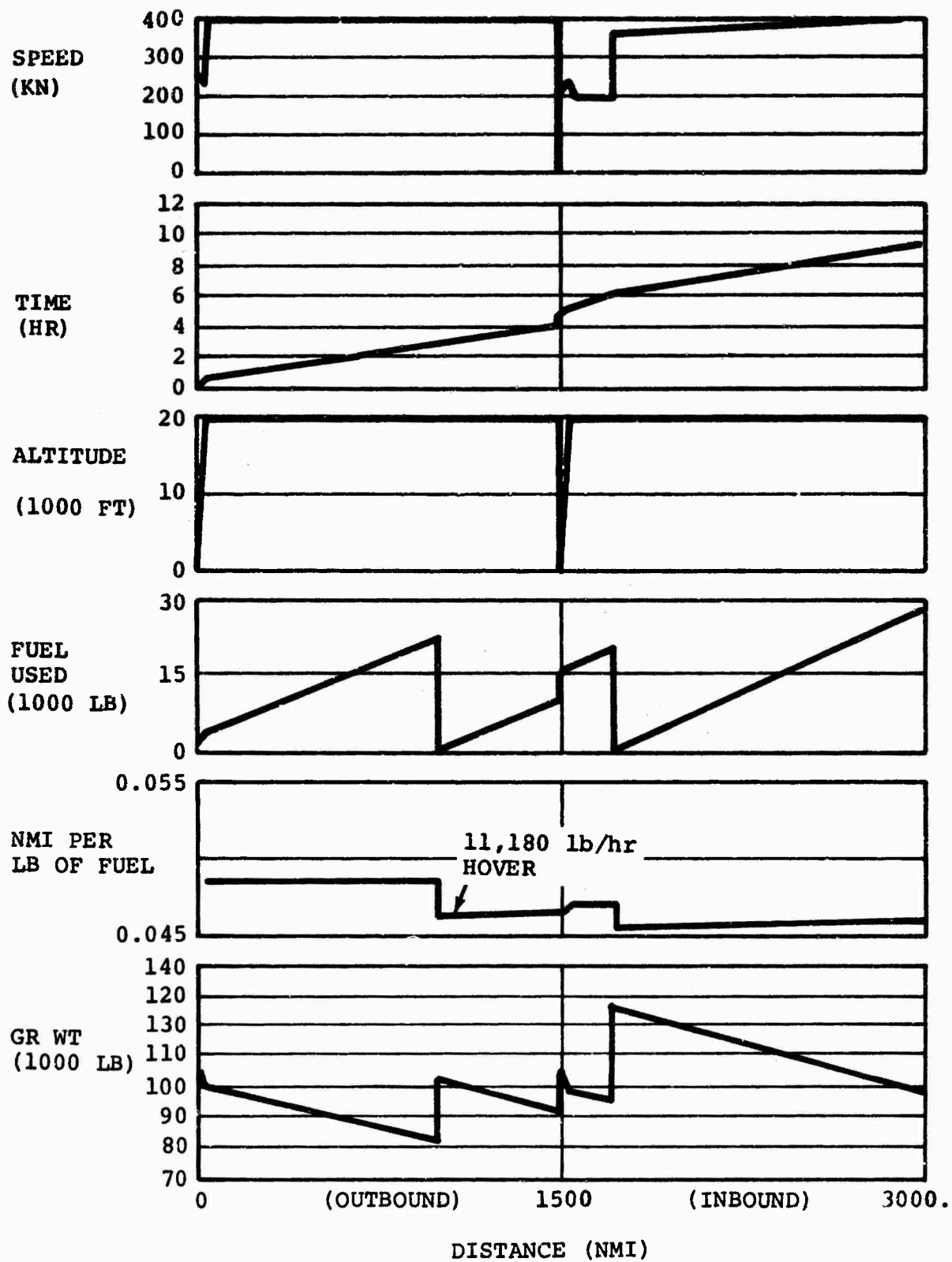

Figure 34. Design Point V Capsule Recovery Aircraft Mission Profile and Performance.

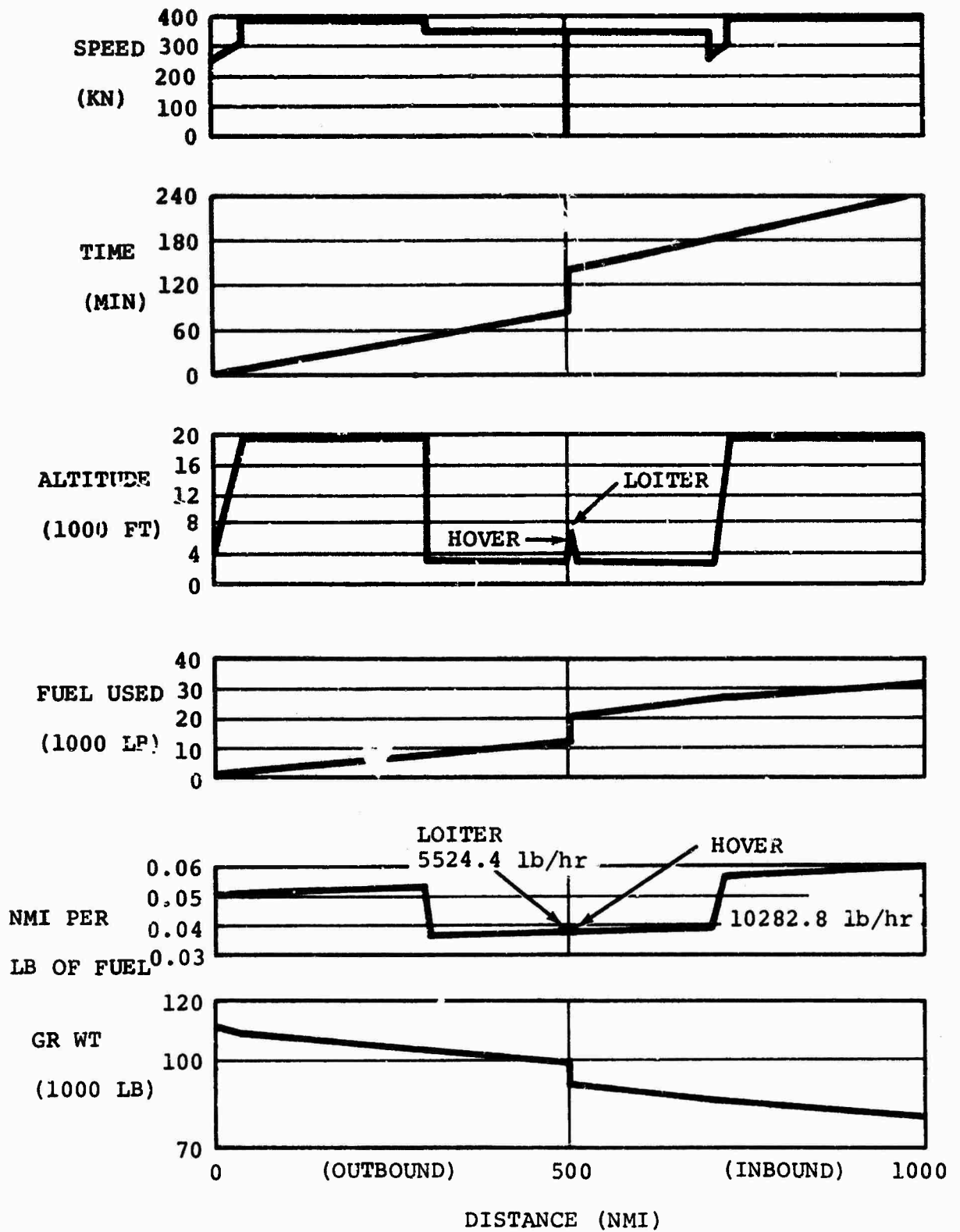

Figure 35. Design Point V (Multimission) Rescue Mission Profile and Performance.

TABLE V. CHARACTERISTICS OF MULTIMISSION AIRCRAFT

Characteristic	Design Point III Multimission (Rescue)	Design Point V Multimission (Rescue)	Design Point V Multimission (Transport)
<u>WEIGHTS</u>			
Design Takeoff Weight (lb)	88,462	110,800	104,190
Maximum Takeoff Weight, Ferry (lb)	105,312	128,717	145,112
Empty Weight (lb)	57,632	73,237	74,532
Design Mission Fuel (lb)	29,000	35,503	17,998
Fuel Tank Capacity, Wing Only (lb)	29,100	41,400	41,400
<u>POWER</u>			
Total Horsepower SL Std Max (hp)	22,400	29,704	29,704
Number of Engines	4	4	4
Horsepower Each (hp)	5,600	7,426	7,426
Bypass Ratio	6.0	6.0	6.0
Rotor Transmission Torque Limit at the Following Conditions (hp)	7,600 hp at 79 percent (climb)	7,772 hp at 70 percent (cruise)	7,772 hp at 70 percent (cruise)
<u>ROTOR</u>			
Diameter (ft)	57.50	64.40	64.60
Number of Rotors	2	2	2
Rotor Power Limit (each at 100 percent rpm, hover) (hp)	8,045	9,565	9,565
Disc Loading	14.5 psf at midpoint gr wt	17 psf at takeoff gr wt	16 psf at takeoff gr wt
Solidity	0.100	0.1035	0.1035
Number of Blades per Rotor	4	4	4
Average Blade Chord (ft)	2.25	2.61	2.61

TABLE V. (Continued)

Characteristic	Design Point III Multimission (Rescue)	Design Point V Multimission (Rescue)	Design Point V Multimission (Rescue)
<u>DIMENSIONS (Overall)</u>			
Length, Rotors Folded (ft)	74.75	95.30	92.25
Width, Rotors Folded (ft)	75.25	84.60	84.60
Height, Rotors Folded (ft)	27.50	31.90	32.10
Length, Rotors Unfolded (ft)	74.75	95.30	92.25
Width, Rotors Unfolded (ft)	128.00	142.80	142.80
Height, Rotors Unfolded (ft)	31.25	35.30	37.50
<u>FUSELAGE</u>			
Fuselage Length (ft)	66.17	76.40	75.30
Fuselage Width (ft-in.)	9.00 - 108	6.67 - 80	11.33 - 136
Fuselage Height (ft-in.)	9.58 - 115	8.75 - 105	12.25 - 147
<u>CABIN SIZE (Internal Dimensions)</u>			
Length (ft)	27.00	27.00	29.00
Width (ft - in.)	7.50 - 90	5.50 - 66	8.34 - 100
Height (ft - in.)	6.50 - 78	6.00 - 72	9.00 - 108
<u>WING</u>			
Span (ft)	70.50	78.40	78.40
Area (sq ft)	867	1,270.6	1,270.6
Aspect Ratio	5.72	4.84	4.84
Wing Loading at Takeoff gr wt (psf)	102	87.1	82
Sweep 1/4 Chord (degrees)	4	3.5	3.5
Taper Ratio	0.60	0.60	0.60
MAC (ft)	12.65	16.54	16.54
\bar{C} (ft)	12.30	16.20	16.20
C_R (ft)	15.40	20.25	20.25
C_T (ft)	9.23	12.16	12.16
T/C Root and Tip (percent)	16	16	16

TABLE V. (Continued)

Characteristic	Design Point III Multimission (Rescue)	Design Point V Multimission (Rescue)	Design Point V Multimission (Rescue)
<u>WING</u>			
Dihedral	zero	zero	zero
Incidence (degrees)	3	2	2
Twist	none	none	none
<u>HORIZONTAL TAIL</u>			
Span (ft)	30.50	41.00	41.00
Area (sq ft)	231	421	421
Aspect Ratio	4.0	4.0	4.0
Tail Volume	0.800	1.028	1.028
Moment Arm (ft)	38.00	51.30	51.30
	(3 mac)	(3.1 mac)	(3.1 mac)
Taper Ratio	0.300	0.400	0.400
Sweep 1/4 Chord (degrees)	25	30	30
MAC (ft)	8.16	10.90	10.90
\bar{C} (ft)	7.52	10.25	10.25
C_R (ft)	11.30	14.64	14.64
C_T (ft)	3.75	5.86	5.86
T/C Root and Tip (percent)	15	15	15
Dihedral	zero	zero	zero
Incidence (degrees)	+25, -8	+25, -8	+25, -8
<u>VERTICAL TAIL</u>			
Span, Height (ft)	14.90	15.50	15.50
Area (sq ft)	222	243.5	243.5
Aspect Ratio	1.00	0.985	0.985
Tail Volume	0.100	0.0840	0.0840
Moment Arm (ft)	28.60	34.18	34.18
	(2.26 mac)	(2.065 mac)	(2.065 mac)
Taper Ratio	0.535	0.620	0.620
Sweep, 1/4 Chord (degrees)	42	45	45
MAC (ft)	15.30	16.08	16.08
\bar{C} (ft)	14.90	15.80	15.80
C_R (ft)	19.40	19.50	19.50
C_T (ft)	10.40	12.10	12.10
T/C Root and Tip (percent)	14	15	15

TABLE V. (Continued)

Characteristic	Design Point III Multimission (Rescue)	Design Point V Multimission (Rescue)	Design Point V Multimission (Rescue)
<u>ROTOR POD</u>			
Length (ft)	38.88	42.90	42.90
Diameter (ft)	4.57	5.62	5.62
<u>LANDING GEAR</u>			
Nose, Tires (Type and Size)	Type VII 30 x 7.7	Type III 12.50-16	Type III 9.50-16
Main, Tires (Type and Size)	Type VII 32 x 8.8	Type III 17-16	Type III 17-16
Auxiliary Outrigger Tires (Type and Size)	none	Type III 7.00-6	none
Tread (ft)	15.00	35.70	12.32
Wheel Base (ft)	30.75	29.30	30.00
Turn Over Angle (degrees)	27	> 27	32
Tip Back Angle (degrees)	30	18	20
Flare Angle (degrees)	16	10	18

TABLE VI. WEIGHT SUMMARY FOR DESIGN POINT III MULTIMISSION AIRCRAFT IN RESCUE ROLE

	DESIGN GROSS WEIGHT	MID-POINT	FERRY MISSION			
MOTOR GROUP	7313					
WING GROUP	6060					
TAIL GROUP	1610					
BODY GROUP	5370					
BASIC						
SECONDARY						
SECOND. DOORS, ETC.						
ALIGNING GEAR	3242					
FLIGHT CONTROLS	5150					
ENGINE SECTION	1380					
Tip Pod	2010					
PROPULSION GROUP	17762					
ENGINES(S)	3410					
AIR INDUCTION	340					
EXHAUST SYSTEM						
COOLING SYSTEM	20					
LUBRICATING SYSTEM	175					
FUEL SYSTEM	2830					
ENGINE CONTROLS	115					
STARTING SYSTEM	212					
PROPELLER INST.						
*DRIVE SYSTEM	7170					
Fan Instl.	3490					
AUX. POWER PLANT	182					
INSTR. AND NAV.	400					
HYDR. AND PNEU.	292					
ELECTRICAL GROUP	775					
ELECTRONICS GROUP	1500					
ARMAMENT GROUP	2000					
EQUIP. & EQUIP. GROUP	1152	6960				
PERSON, ACCOM.						
MISC. EQUIPMENT						
FURNISHINGS						
EMERG. EQUIPMENT						
AIR COND. & DE-ICING	519					
PHOTOGRAPHIC						
AUXILIARY GEAR	140					
Cargo Handling						
WGT. VARIATION	575					
WEIGHT EMPTY	57632	57632	57632			
FIXED USEFUL LOAD	1430	1430	950			
CREW	1200	1200	720			
TRAPPED LIQUIDS	230	230	230			
ENGINE OIL						
Combat Equip.	400	400	200*			
FUEL	29000	14750	45500			
PARACH.						
PASSENGERS/TROOPS		1200	--			
Ferry Tanks			1030	*Survival Gear		
GROSS WEIGHT	88462	75412	105312			

TABLE VII. WEIGHT SUMMARY FOR DESIGN POINT III MULTIMISSION CAPSULE RECOVERY ROLE

	DESIGN GROSS WEIGHT	MID-POINT	MAX FUEL ON RETURN	2600 NMI FERRY MISSION		
ROTOR GROUP	7313					
WING GROUP	6060					
TAIL GROUP	1610					
BODY GROUP	7665					
BASIC						
SECONDARY						
SECOND-DOORS, ETC.						
ALIGHTING GEAR	2880					
FLIGHT CONTROLS	5150					
ENGINE SECTION	1380					
Tip Ped	2010					
PROPULSION GROUP	16567					
ENGINES(S)	3410					
AIR INDUCTION	340					
EXHAUST SYSTEM						
COOLING SYSTEM	20					
LUBRICATING SYSTEM	175					
FUEL SYSTEM	1635					
ENGINE CONTROLS	115					
STARTING SYSTEM	212					
PROPELLER INST.						
DRIVE SYSTEM	7170					
Fan Instl.	3490					
AUX. POWER PLANT	182					
INSTR. AND NAV.	400					
HYDR. AND PNEU.	292					
ELECTRICAL GROUP	775					
ELECTRONICS GROUP	800					
ARMAMENT GROUP	-					
EQUIP. & EQUIP. GROUP	1152	5060				
PERSON. ACCOM.						
MISC. EQUIPMENT						
FURNISHINGS						
ENERG. EQUIPMENT						
AIR COND. & DE-ICING	519					
PHOTOGRAPHIC						
AUXILIARY GEAR	940					
Cargo Handling						
MCG. VARIATION	560					
WEIGHT EMPTY	56055	56055	56055	56055		
FIXED USEFUL LOAD	1430	1430	1430	950		
CREW	1200	1200	1200	720		
TRAPPED LIQUIDS	230	230	230	230		
ENGINE OIL						
Survival Equip.	200	200	200	200		
FUEL	20000	5000	20000	52300		
CARGO		15000	15000			
PASSENGERS/TROOPS				1980*		
Hatch	272	272	272	272	*Ferry Tanks	
GROSS WEIGHT	77957	77957	92957	111757		

TABLE VIII. WEIGHT SUMMARY FOR DESIGN POINT V MULTIMISSION AIRCRAFT IN RESCUE ROLE

	DESIGN GROSS WEIGHT	MID-POINT	2600 MI FERRY MISSION		
BASIC PRIME	9316				
BASIC FERRY	8760				
TAIL GROUP	1935				
BODY GROUP	5088				
BASIC					
SECONDARY					
SEATING, DOORS, ETC.					
ALL OTHERS (EAR)	5150				
ENGINE CONTROLS	7796				
ENGINE INST.	2530				
Flt Pod	2870				
PROP. SYSTEM GROUP	22000				
ENGINE(S)	4730				
AIR INDUCTION	590				
EXHAUST SYST.					
COOLING SYSTEM	35				
LUBRICATING SYSTEM	290				
FUEL SYSTEM	3500				
ENGINE CONTROLS	190				
STARTING SYSTEM	330				
PROPELLER INST.					
ENGINE SYSTEM	7275				
Fun Instl.	5050				
ANA. POWER PLANT	182				
INSTR. AND NAV.	400				
HYDR. AND PNEU.	292				
ELECTRICAL GROUP	775				
ELECTRONICS GROUP	1500				
ARMAMENT GROUP	2000				
EQUIP. & EQUIP. GROUP	1152	76960			
PERSON. ACCOM.					
MISC. EQUIPMENT					
FURNISHINGS					
EMERG. EQUIPMENT					
AIR COND. & DE-ICING	519				
PHOTOGRAPHIC					
A VENTIL. TRAP	160				
Cargo Handling					
NEG. VARIATION	732				
WEIGHT EMPTY	73237	73237	73237		
FIXED USEFUL LOAD	1660	1660	1180		
CREW (5)	1200	1200	720		
TRAPPED FUGITIVE	460	460	460		
FUEL OIL					
Combat Equip.	400	400	200*		
F.F.	35503	17803	53000		
MISC.					
PARACHUTES/TROOPS		1200			
Ferry Tanks			1100	*Survival Equip.	
GROSS WEIGHT	110800	94300	128717		

TABLE IX. WEIGHT SUMMARY FOR DESIGN POINT V MULTIMISSION AIRCRAFT IN CAPSULE RECOVERY ROLE

	DESIGN GROSS WEIGHT	MID-POINT	MAX FUEL ON RETURN	2600 NMI FERRY MISSION		
WING GROUP	9316					
ENGINE GROUP	8760					
TAIL GROUP	1935					
BODY GROUP	9620					
BASIC						
SECONDARY						
SECOND-RODES, ETC.						
ALIGNING GEAR	5150					
FLIGHT CONTROLS	7796					
ENGINE SECTION	2630					
Tip Pcd	2870					
PROPELLION GROUP	21280					
ENGINES(S)	4730					
AIR INDUCTION	590					
EXHAUST SYSTEM						
COOLING SYSTEM	35					
LUBRICATING SYSTEM	290					
FUEL SYSTEM	2780					
ENGINE CONTROLS	190					
STARTING SYSTEM	330					
PROPELLER INST.						
*DRIVE SYSTEM	7275					
Fan Instl.	5060					
ALX. POWER PLANT	182					
INSTR. AND NAV.	400					
HYDR. AND PNEU.	292					
ELECTRICAL GROUP	775					
ELECTRONICS GROUP	800					
ARMAMENT GROUP						
EQUIP. & EQUIP. GROUP	1152	5060				
PERSON. ACCOM.						
MISC. EQUIPMENT						
FURNISHINGS						
EMERG. EQUIPMENT						
AIR COND. & DE-ICING	519					
PHOTOGRAPHIC						
& AUXILIARY GEAR	940					
Carro Handling						
NET. VARIATION	751					
WEIGHT EMPTY	75168	75168	75168	75168		
FIXED USEFUL LOAD	1660	1660	1660	1180		
CREW (5)	1200	1200	1200	720		
TRAPPED LIQUIDS	460	460	460	460		
ENGINE OIL						
Survival Equip.	200	200	200	200		
FUEL	27162	12162	36100	66700		
CARGO		15000	15000			
PASSENGERS/TROOPS						
Ferry Tanks				1900		
GROSS WEIGHT	104190	104190	128194	145214		

TABLE X. WEIGHT SUMMARY FOR DESIGN POINT V MULTIMISSION AIRCRAFT IN TRANSPORT ROLE

	DESIGN GROSS WEIGHT	OVER (LOAD	2400 MI 1 MISSION			
WATER GROUP	9316					
WHEEL GROUP	8760					
TAIL GROUP	1935					
BODY GROUP	8310					
MISC.						
SECONDARY						
SEATING, BENCHES, ETC.						
LIGHTING GEAR	5150					
PILOT CONTROLS	7796					
ENGINE SECTION	2630					
Tip Pcs	2870					
PROP. SECTION GROUP	20285					
ENGINES(S)	4730					
AIR INDUCTION	590					
EXHAUST SYSTEM						
COOLING SYSTEM	35					
LUBRICATING SYSTEM	290					
FUEL SYSTEM	1785					
ENGINE CONTROLS	190					
STARTING SYSTEM	330					
PROPELLER INST.						
DRIVE SYSTEM	7275					
Fan Instl.	5060					
AUX. POWER PLANT	182					
INSTR. AND NAV.	400					
HYDR. AND PNEU.	292					
ELECTRICAL GROUP	775					
ELECTRONICS GROUP	950					
ARMAMENT GROUP	50					
ENVN. EQUIP. GROUP	2330	6736				
PERSON. ACCOM.						
MISC. EQUIPMENT						
FURNISHINGS						
EMERG. EQUIPMENT						
AIR COND. & DE-ICING	727					
PHOTOGRAPHIC						
AUX. GEAR	40					
Carro Handling	990					
MISC. VARI.	744					
WEIGHT EMPTY	74532	74532	74532			
FIXED USEFUL LOAD	1660	1660	1180			
CREW	1200	1200	720			
TRAPPED LIQUIDS	460	460	460			
ENGINE OIL						
Survival Equip.			200			
FUEL	17998	17998	66200			
CARGO	10000	17000				
PASSENGERS/TROOPS						
Ferry Tanks			3000			
GROSS WEIGHT	104190	111190	145112			

4. SELECTION OF BASELINE AIRCRAFT

The above studies show that the aircraft required to fulfill all of the requirements of the three basic missions is large, certainly for the first of a new VTOL aircraft type such as the stowed tilt rotor. This is so even if the degree of commonality is restricted to the basic lift/propulsion system. In establishing a baseline aircraft for further studies it was decided that the weight should be no higher than that of the basic rescue aircraft but other versions of this design should be investigated to determine their usefulness. It was found that a transport aircraft, based on the rescue aircraft lift/propulsion system, could exceed the medium transport mission requirements if some compromise were made in fuselage box size.

The Design Point IV transport aircraft has a cargo compartment measuring 29 feet in length, 100 inches width between the wheel wells, and 110 inches in height. These dimensions are predicated on loading either 10,000 or 17,000 pounds of cargo and utilizing the 463L cargo handling system; providing adequate width to permit the crew to traverse the entire length of the aircraft when fully loaded; and allowing the pallets to be loaded to a height of 8 feet.

The baseline transport aircraft configuration can carry the same cargo weights as the Design Point IV transport (10,000 or 17,000 pounds) with restrictions only on the low density cargos. Palletized loads 88 inches wide by 5 feet in height may be loaded from trucks or by using fork lifts and keeping the ramp horizontal. Eighty-eight inch wide pallet load height may be increased to 80 inches if the width is decreased from 88 inches at a 60-inch height to a maximum width of 70 inches at 80-inch height. Pallet loads 88 inches wide by approximately 4 feet in height may be loaded over the sloping ramp. The baseline transport cargo-hold dimensions will not permit the crew to move aft alongside the cargo when fully loaded but there is sufficient headroom to permit their going aft over the top of rectangular loads which are 80 inches wide. Loads 80 inches wide and 75 inches high may be loaded over the ramp.

The above concessions to volume and crew mobility have permitted a reduction in fuselage cross-section from a floor width of 100 inches to 96 inches and in floor to ceiling height of from 110 inches to 84 inches. A comparison of the two fuselage cross-sections is shown on Figure 36.

Table XI presents a comparison of the cargo hold dimensions of some aircraft of similar capacity.

The resulting baseline aircraft are described in Section V, BASELINE CONFIGURATION DESCRIPTION.

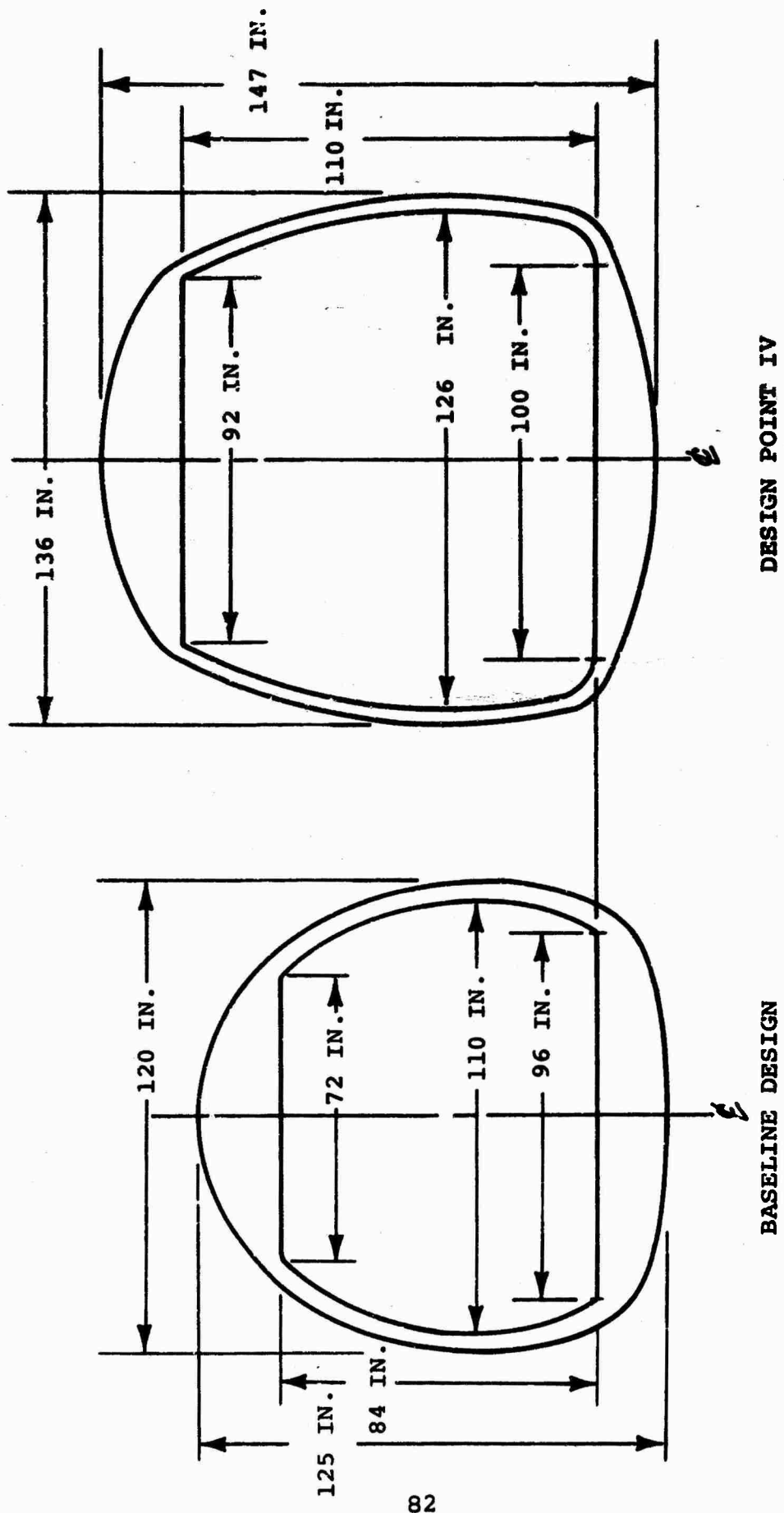

Figure 36. Comparison of Baseline and Design Point IV Fuselage Cross Sections.

**TABLE XI. COMPARISON OF MEDIUM TRANSPORT AIRCRAFT
CARGO HOLD DIMENSIONS**

Aircraft Designation	Length (ft - in.)	Width (in.)	Height (in.)
Design Point IV	29	100	110
Baseline Aircraft	30	96	84
CH-46	24 - 2	79	70
CH-47	30 - 2	90	78
CH-53	30	90	78
XC-142	30	90	84
CV-7A	31 - 4	93	74
C123	28 - 9	110*	97
C-2A	31 - 8	98 to 84	75
CV-2B	28 - 9	73	75
C-119G	36 - 11	110	92

*Between Wheel Wells

SECTION V

BASELINE CONFIGURATION DESCRIPTION

GENERAL ARRANGEMENT AND CHARACTERISTICS

As described in the previous Section, the baseline approach is to use the Design Point I aircraft with some modifications for the rescue mission, and to use an identical lift propulsion system with a new larger fuselage and STOL landing gear for transport application. The major differences between the Design Point I aircraft and the baseline rescue aircraft are:

- a. A small increase in span to preserve rotor tip to fuselage side clearance for the transport variant.
- b. The wing thickness was increased from 16 percent to 20 percent thickness-chord ratio using a new advanced-technology airfoil described in Section VI, Aerodynamics.
- c. A change in wing geometry from a straight taper to a cranked planform to reduce the nacelle pivot to rotor plane overhang. This planform and its development is described more fully in Volume II.
- d. Elimination of the under-floor fuel in view of the increased fuel volume available in the thicker wing.
- e. For the baseline aircraft configured for the transport mission the landing gear was designed in accordance with the following requirements:
 - (1) California bearing ratio (CBR) 4
 - (2) Number of passes 75
 - (3) Maximum sinking speed 15 fps
 - (4) Limit landing load 3.0g at aircraft cg
factors 2.0g at gear
 - (5) Capable of rough field operation

Three-view drawings of the baseline rescue aircraft and transport aircraft are shown in Figures 37 and 38, and an inboard profile of the rescue vehicle fuselage in Figure 39.

While more detailed data on the baseline aircraft are available in other parts of this report, the principal items of interest are summarized here for convenience. Table XII gives the major weights, dimensions, and other data on the two baseline aircraft; and Table XIII gives

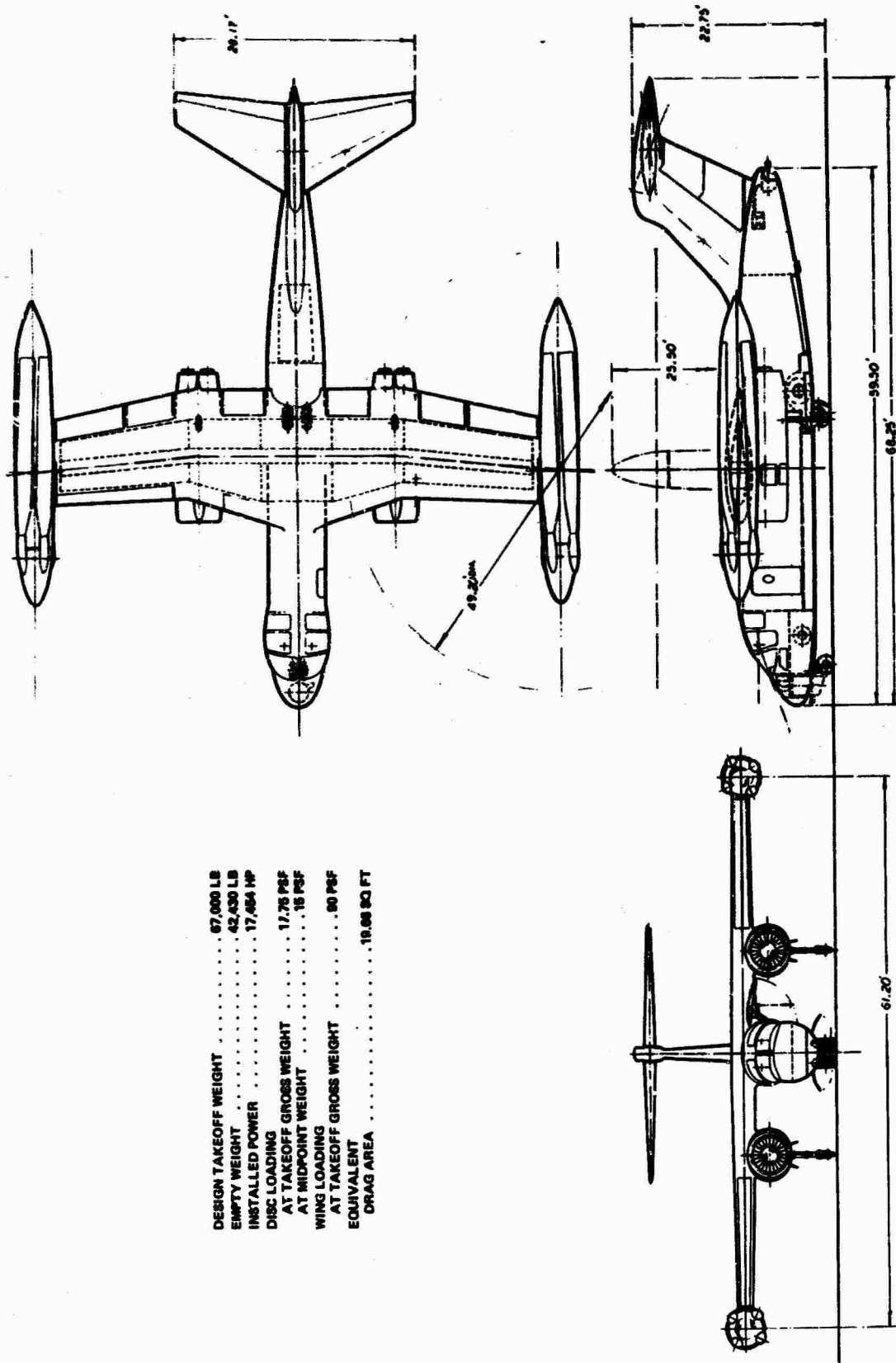
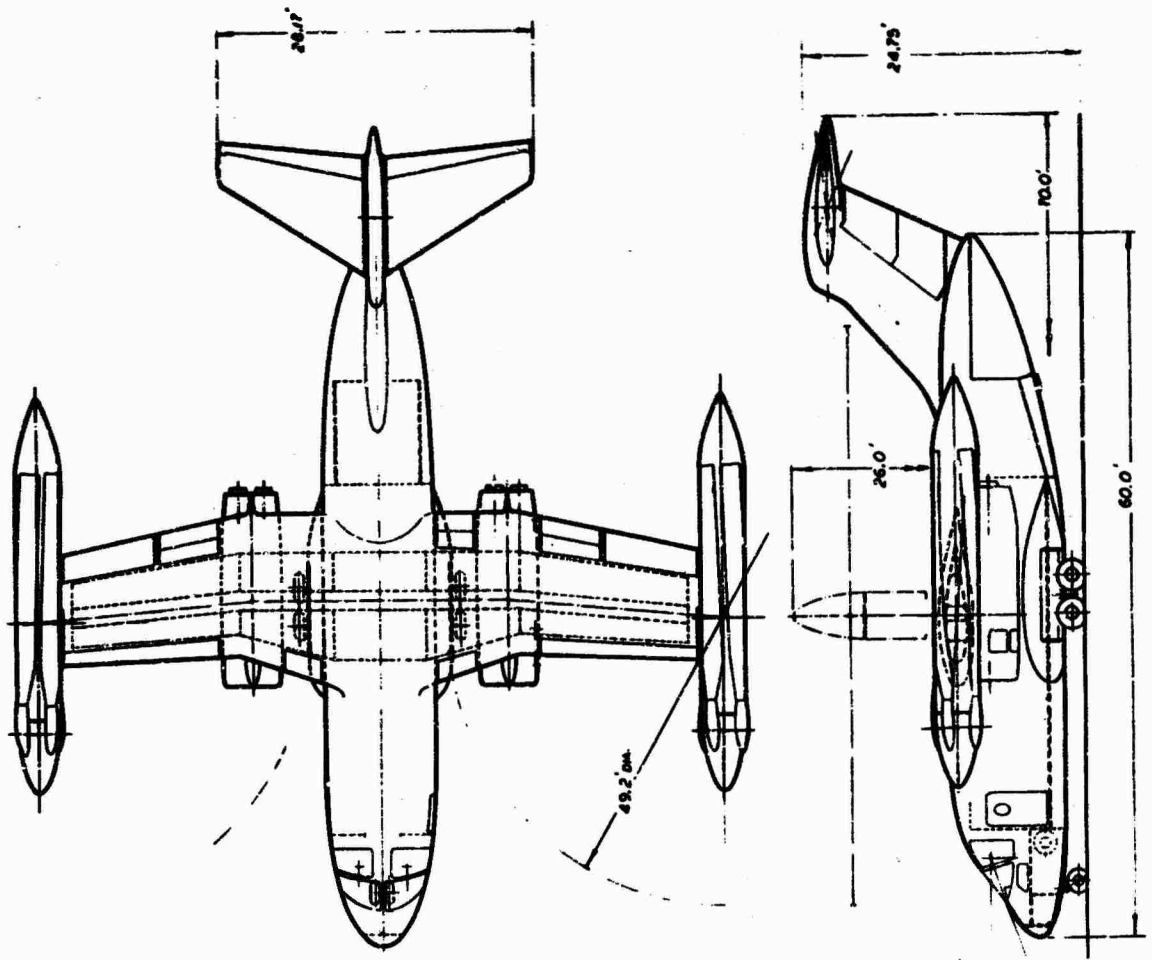

Figure 37. 3-View of Baseline Rescue Aircraft.



DESIGN TAKEOFF WEIGHT	67,000 LB
EMPTY WEIGHT	44,220 LB
INSTALLED POWER	17,464 HP
DISC LOADING	17.75 PSF
WING LOADING AT TAKEOFF GROSS WEIGHT90 PSF
EQUIVALENT DRAG AREA	20.79 SQ FT
CABIN SIZE	30.00 FT
LENGTH	8.34 FT
WIDTH	7.00 FT
HEIGHT	

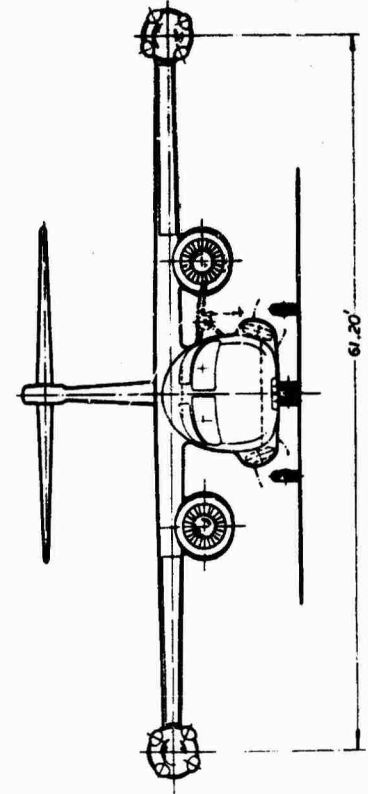

Figure 38. 3-View of Baseline Transport Aircraft.

TABLE XII. GENERAL CHARACTERISTICS OF BASELINE AIRCRAFT

Characteristics	Baseline Aircraft	
	Rescue Version	Transport Version
<u>WEIGHTS</u>		
Design Takeoff Weight (lb)	67,000	67,000
Maximum Takeoff Weight, Ferry (lb)	78,522	80,387
Empty Weight (lb)	43,336	44,607
Design Mission Fuel (lb)	21,929	11,058
Fuel Tank Capacity, Wing Only (lb)	22,000	22,000
<u>POWER</u>		
Total Horsepower SL Std Max (hp)	17,454	17,454
Number of Engines	4	4
Horsepower Each (hp)	4,363	4,363
Bypass Ratio	6.0	6.0
Rotor Transmission Torque Limit	6,300	6,300
At the Following Conditions (hp)	79 per- cent (climb)	79 per- cent (climb)
<u>ROTOR</u>		
Diameter (ft)	49.20	49.20
Number of Rotors	2	2
Rotor Power Limit (Each)	6,215	6,215
At the Following Conditions (hp)	100 per- cent rpm (hover)	100 per- cent rpm (hover)
Disc Loading at Midpoint Gross Weight (psf)	15	15
Solidity	0.100	0.100
Number Blades/Rotor	4	4
Average Blade Chord (ft)	1.93	1.93
<u>DIMENSIONS (Overall)</u>		
Length, Rotors Folded (ft)	68.25	70.00
Width, Rotors Folded (ft)	66.10	66.10
Height, Rotors Folded (ft)	22.75	24.74
Length, Rotors Unfolded (ft)	68.25	70.00
Width, Rotors Unfolded (ft)	110.40	110.40
Height, Rotors Unfolded (ft)	25.50	26.00

TABLE XII. (Continued)

Characteristics	Baseline Aircraft	
	Rescue Version	Transport Version
<u>FUSELAGE</u>		
Fuselage Length (ft)	59.50	60.00
Fuselage Width (ft - in.)	6.67 - 80	10.00 - 120
Fuselage Height (ft - in.)	8.75 - 105	10.42 - 125
<u>CABIN SIZE (Internal Dimensions)</u>		
Length (ft)	22.00	30.00
Width (ft - in.)	5.50 - 66	8.34 - 100
Height (ft - in.)	7.00 - 84	7.00 - 84
<u>WING</u>		
Span (ft)	61.20	61.20
Area (sq ft)	744	744
Aspect Ratio	5.04	5.04
Wing Loading at Takeoff Gross Weight (psf)	90	90
Sweep 1/4 Chord, Two Stage (degree)	-14 +5	-14 +5
Taper Ratio, Two Stage	0.77/ 0.72	0.77/ 0.72
MAC (ft)	12.40	12.40
\bar{C} (ft)	12.20	12.20
C_R (ft)	16.20	16.20
C_T (ft)	9.20	9.20
T/C Root and Tip (percent)	20	20
Dihedral	zero	zero
Incidence (degrees)	3	3
Twist	none	none
<u>HORIZONTAL TAIL</u>		
Span (ft)	28.17	28.17
Area (sq ft)	199	199
Aspect Ratio	4.0	4.0
Tail Volume	0.805	0.765
Moment Arm (ft)	36.6 (2.96 mac)	35.30 (2.85 mac)
Taper Ratio	0.333	0.333
Sweep 1/4 Chord (degrees)	25	25

TABLE XII. (Continued)

Characteristics	Baseline Aircraft	
	Rescue Version	Transport Version
<u>HORIZONTAL TAIL</u>		
MAC (ft)	7.60	7.60
\bar{C} (ft)	7.00	7.00
C_R (ft)	10.50	10.50
C_T (ft)	3.50	3.50
T/C Root and Tip (percent)	15	15
Dihedral	zero	zero
Incidence (degrees)	+25, -8	+25, -8
<u>VERTICAL TAIL</u>		
Span, Height (ft)	12.42	12.42
Area (sq ft)	154	154
Aspect Ratio	1.00	1.00
Tail Volume	0.100	0.088
Moment Arm (ft)	26.60	26.00
	(2.15 mac)	(2.10 mac)
Taper Ratio	0.535	0.535
Sweep 1/4 Chord (degrees)	42	42
MAC (ft)	12.75	12.75
\bar{C} (ft)	12.40	12.40
C_R (ft)	16.20	16.20
C_T (ft)	8.66	8.66
T/C Root and Tip (percent)	14	14
<u>ROTOR POD</u>		
Length (ft)	34.20	34.20
Diameter (ft)	4.65	4.65
<u>LANDING GEAR</u>		
Nose Tires (Type and Size)	TYPE VII 22 x 6.6	TYPE VII 30 x 7.7
Main Tires (Type and Size)	TYPE VII 36 x 11	TYPE VII 32 x 8.8
Auxiliary Outrigger Tires (Type and Size)	TYPE III 7.00 - 6	none
Tread	22.66	14.25
Wheel Base	28.00	24.25
Turn Over Angle	> 27	27
Tip Back Angle	30	20
Flare Angle	15	15

A

NOMENCLATURE KEY

CREW AND EQUIPMENT

1. PILOT
2. COPILOT
3. RESCUE CREW (3)
4. JUMP SEAT
5. INSTRUMENT PANEL
6. ENGINE CONTROL PEDESTAL
7. SIDE CONSOLES
8. OVERHEAD INSTRUMENT PANEL
9. MONOCYCLIC CONTROL STICK
10. COLLECTIVE PITCH STICK
11. RUDDER PEDALS (MAIN GEAR BRAKES)
12. FLIGHT DECK ENTRANCE
13. SIDE ACCESS DOOR (RESCUE)
14. RESCUE HOIST AND WINCH
15. CRASH AXE
16. PORTABLE FIRE EXTINGUISHER
17. PORTABLE OXYGEN BOTTLE AND MASK (2)
18. REMOTE CONTROLLED TURRET (2)
19. AMMO STOWAGE (2)
20. AMMO BELT
21. GUN SIGHT
22. LITTERS (6)
23. FOLDING SEATS (3)
24. DAVIT
25. WINCH
26. POLES (2)
27. LOUD HAILER
28. FOREST CANOPY PENETRATOR

STRUCTURE

101. RADOME
102. FLIGHT DECK
103. FORWARD MAIN BULKHEAD
104. NOSE GEAR WHEEL AND STRUT
105. NOSE GEAR DOORS
106. PRESSURE BULKHEAD
107. DOOR
108. VERTICAL STABILIZER
109. RUDDER
110. HORIZONTAL STABILIZER
111. MAIN GEAR
112. MAIN GEAR DOORS
113. AIR RESCUE DOORS

SUBSYSTEMS

201. IN FLIGHT
202. SEARCHLIGHT
203. PITOT TUBE
204. ANTI-COLLISION
205. NAVIGATION
206. AVIONICS
207. TERRAIN
208. GLIDE SLOPE
209. FM HOMING
210. X BAND A
211. TACAN/IFF
212. VHF/FM A
213. IFF INTERFER
214. HF-SSB A
215. VOR/LOC
216. RADAR W
217. VHF ANTI
218. RADAR A
219. LOW LIGHT
220. DOPPLER
221. IFF INTERFER
222. MARKER
223. VHF/UHF
224. SENSE AN
225. ADF LOOP
226. SEXTANT
227. CRASH BE
228. DRIVE SH

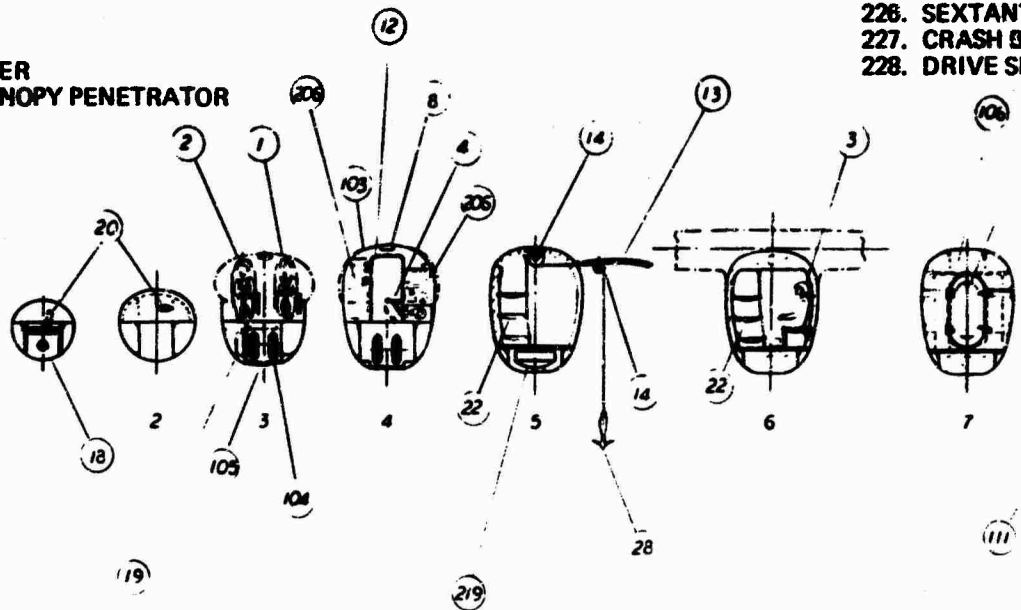

Figure 39. Baseline Aircraft Rescue Version Inboard Profile.

- EMS
- FLIGHT REFUELING PROBE (OPTIONAL)
- SEARCHLIGHT (2)
- TOT TUBE
- ANTI-COLLISION LIGHT (3)
- NAVIGATION LIGHT (3)
- AVIONICS COMPONENTS RACK
- TERRAIN RADAR ANTENNA
- SLIDE SLOPE RCVR ANTENNA
- HOMING ANTENNA
- BAND ANTENNA (2)
- VACAN/IFF TRANSPONDER (2)
- HF/FM ANTENNA
- VHF INTERROGATOR (VHF)
- VHF-SSB ANTENNA
- DR/LOC ANTENNA (2)
- RADAR WARNING SENSOR
- HF ANTENNA
- RADAR ALTIMETER
- DW LIGHT LEVEL TV
- DOPPLER ANTENNA
- VHF INTERROGATOR
- MARKER BEACON
- HF/UHF ADF
- SENSE ANTENNA - LF ADF
- DF LOOP ANTENNA
- EXTANT
- FLASH BEACON
- DRIVE SHAFT

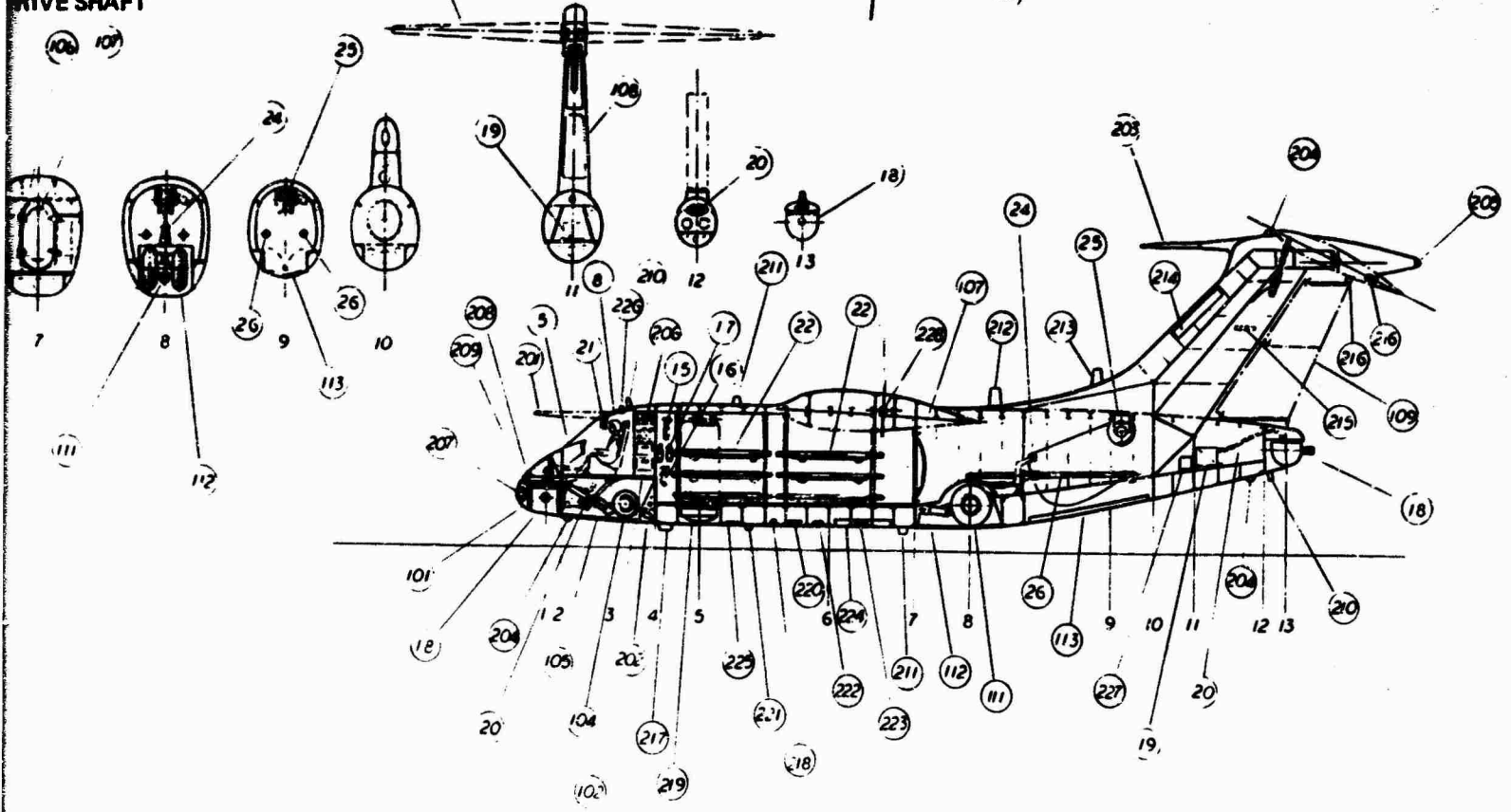
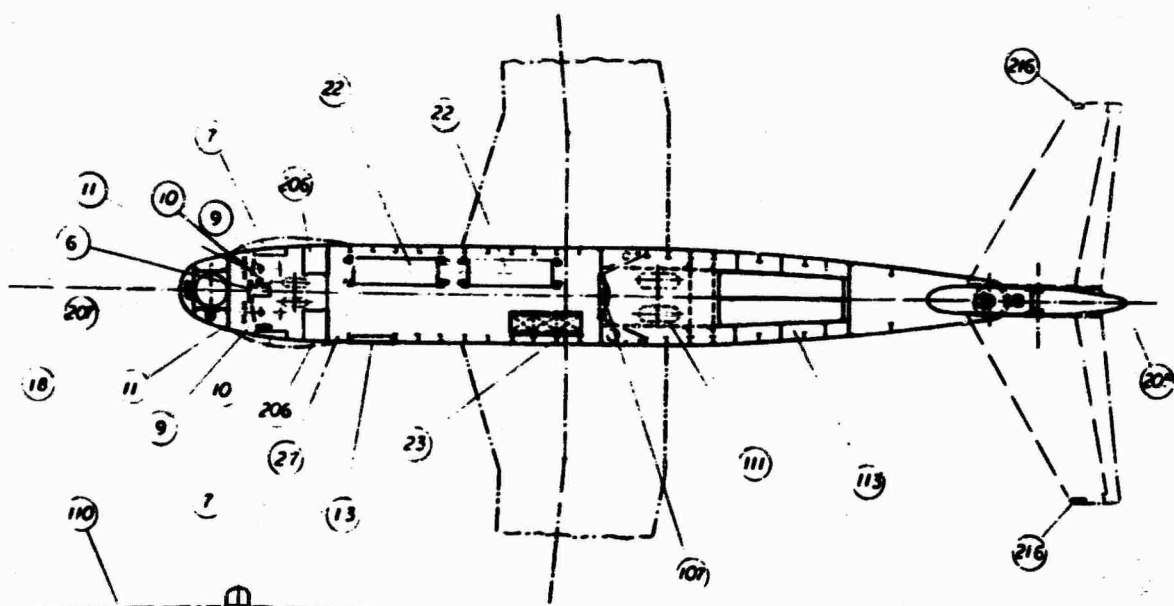

TABLE XIII. WEIGHT SUMMARY FOR BASELINE RESCUE AND TRANSPORT

	RESCUE VERSION			TRANSPORT VERSION		
	PRELIM. ESTIMATE	CURRENT ESTIMATE		PRELIM. ESTIMATE	CURRENT ESTIMATE	
ENGINE GROUP	5,285	4,936		5,285	4,936	
LAND TROL	4,490	5,710		4,220	5,710	
TAIL GROUP	975	982		975	982	
WING GROUP	3,260	3,250		5,900	5,060	
ENGINE						
SECONDARY						
SECOND DOORS, ETC.						
ALIGNING GEAR	2,480	2,385		3,340	3,195	
ALIGNMENT CONTROLS	3,890	3,636		3,890	3,636	
ENGINE SECTION	920	1,250		970	1,250	
Tip Pod	1,370	1,811		1,370	1,811	
PROPULSION GROUP	12,658	11,983		12,528	11,983	
ENGINE(S)	2,510	2,134		2,510	2,134	
AIR INDUCTION	260	360		260	360	
EXHAUST SYSTEM	-	-		-	-	
SCHEMATIC SYSTEM	15	15		15	15	
LUBRICATING SYSTEM	130	26		130	26	
FUEL SYSTEM	2,130	2,489		2,000	2,489	
ENGINE CONTROLS	85	42		85	42	
STARTING SYSTEM	148	148		148	148	
PROPELLER INST.						
DRIVE SYSTEM	4,810	4,485		4,810	4,485	
Fan Instl.	2,570	2,284		2,570	2,284	
AUX. POWER PLANT	182			182	182	
INST. AND NAV.	400			400	400	
HYD. AND PNEU.	292			292	292	
ELECTRICAL GROUP	775			775	775	
ELECTRONICS GROUP	1,500			950	950	
ARMAMENT GROUP	2,000			50	50	
ENV. & EQUIP. GROUP	1,152	6,960		1,152	1,470	
PERSON. ACCOM.						
MISC. EQUIPMENT						
FURNISHINGS						
EMERG. EQUIPMENT						
AIR COND. & DE-ICING	519			519	519	
PHOTOGRAPHIC						
UTILITY GEAR	140			40	40	
Cargo Handling				990	920	
WEIGHT VARIATION	426	433		442	446	
WEIGHT EMPTY	42,714	43,336	+622	44,220	44,607	+ 387
FIXED USEFUL LOAD	1,335	1,335		1,335	1,335	
CREW	1,200			1,200		
TRAPPED LIQUIDS	70			135		
ENGINE OIL	65					
Combat Equip.	400	400				
FUEL	22,600	21,979		11,445	11,058	
CARGO				10,000	10,000	
PASSENGERS/TROOPS						
GROSS WEIGHT	67,049	67,000		67,000	67,000	

summaries of the weights. This summary shows the changes in weight which have occurred from the initial selection of the baseline aircraft to the end of the study, and reflects the weight changes due to refinement of the analysis and inclusion of analyses of the component designs. The weight increase shown for the rescue ship, if the mid-point hover design criteria are adhered to, would reduce the radius by 40 nautical miles. The detailed performance and the drag breakdown given for the Design Point I rescue aircraft in Appendix I also apply to the baseline rescue aircraft. The drag breakdown of the transport version is given in Table XIV, and a performance summary in Figure 40.

The VTOL outrigger-type landing gear of the Design Point I aircraft was retained for the baseline rescue vehicle, but commonality with the STOL gear essential to the transport variant would be desirable. Continuing work should give consideration to a basically common complete airframe for rescue and transport roles using the basic transport fuselage and making minimum modifications to this fuselage for installation of the rescue systems and armament installation for the rescue role. Such an approach would permit the rescue mission requirements to be met if air to air refueling could be tolerated after completion of the low level dash on the return leg.

TABLE XIV. MINIMUM PARASITE DRAG BREAKDOWN OF
BASELINE AIRCRAFT, TRANSPORT VERSION

COMPONENT	WETTED		INCREMENT		f_e (sq ft)
	AREA	C_f^*	%	Δf_e	
FUSELAGE	1553	0.001901		2.9523	
3-D Effects				0.3299	
Excrescences				0.2442	
Canopy				0.2062	
Afterbody (Base Drag)				0.4575	
					4.1901
WING	1245.3	0.002361		2.9402	
3-D Effects				0.9817	
Excrescences				0.1651	
flaps, slats					
Gap ailerons, spoilers				0.3170	
Body Interference				0.9188	
					5.323
HORIZONTAL TAIL	375.3	0.00257		0.9645	
3-D Effects				0.2946	
Excrescences & Gaps				0.1124	
Interference				0.5395	
					1.9110
VERTICAL TAIL	310.3	0.002379		0.7382	
3-D Effects				0.2059	
Excrescences & Gaps				0.0844	
Interference				0.0677	
					1.0962
ROTOR NACELLES	390.3	0.002048		0.7993	
3-D Effects (per nacelle)				0.0673	
Excrescences				0.1845	Total
Interference				0.1252	
Blades Folded				0.2445	
					2.8416
ENGINE NACELLES	241.6	0.00228		0.5509	
Effects of Boattail				0.0461	
Excrescences (per nacelle)				0.2223	Total
Interference				0.4645	
Inlets				0.4762	
					3.520
LANDING GEAR POD	154.	0.002264		0.3487	
3-D Effects				0.0820	
Excrescences				0.1138	
Interference				0.1138	
					.6583
MISCELLANEOUS					
Roughness (% C_f^{AWFT})				0.7339	
Cooling			$*R_e/ft =$	0.4472	
			2.592×10^6		
Trim				0.0652	
Air Conditioning					
					1.2463
TOTAL (sq ft)	4901.7	0.002172			20.79

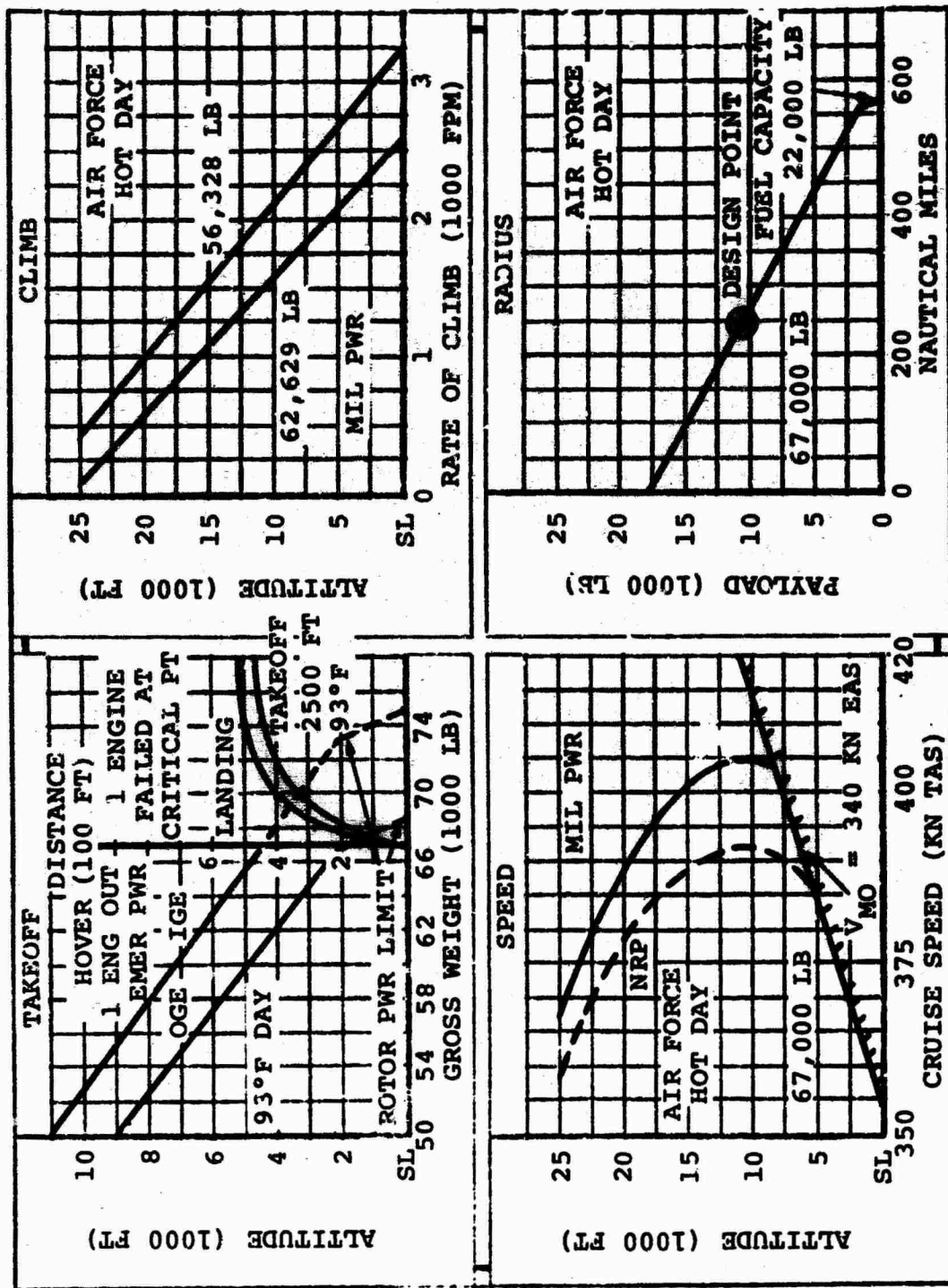

Figure 40. Baseline Aircraft Performance Summary.

SECTION VI

AERODYNAMICS

1. REQUIRED AND AVAILABLE POWER

Figure 41 shows the power required and available for all modes of rotor driven flight up to 250 knots. These data are given for the baseline rescue aircraft at the 3,000 feet, 95°F condition for the initial takeoff weight. The thrust required and available for the baseline rescue aircraft in the conventional fan driven flight mode is given in Figure 42. The two mission cruise altitudes were selected for this plot. Note that the level flight speed at normal rated power is 412 knots at 20,000 feet, hot day conditions. The speed at 3,000 feet is limited to 370 knots by the maximum operating speed (V_M, q limited).

2. ADVANCED AIRFOIL DEVELOPMENT

Due to the problems of wing to rotor clearance and nacelle overhang the stowed-tilt-rotor configuration is constrained to an essentially upswept wing. High critical Mach numbers must, therefore, be attained through the use of low thickness to chord ratio airfoils. However, thin wings are undesirable from a structural standpoint, especially so when the aircraft is literally picked up by the wingtips in hover.

Fortunately, recent development of so called "peaky" airfoil sections shows considerable promise of a significant increase in critical Mach number for a given airfoil thickness as compared to conventional sections. The special merits of sections with peaky pressure distributions are due to the favorable way in which the supersonic flow develops, thereby keeping the shock weak and delaying the onset of wave drag and shock-induced separation.

Boeing research has concentrated on sections of approximately 0.10 thickness chord ratio for high subsonic speed transport aircraft and rotor blade outboard sections. Figure 43 shows some of the results of this research progress made up to 1968, and projects the capability expected in 1972. The 20-percent thick section of the baseline aircraft was generated by transonic similarity techniques (Reference 1) to give a drag divergence Mach number of 0.65. This is compatible with the 400-knot cruise speed of the rescue version and was used to replace

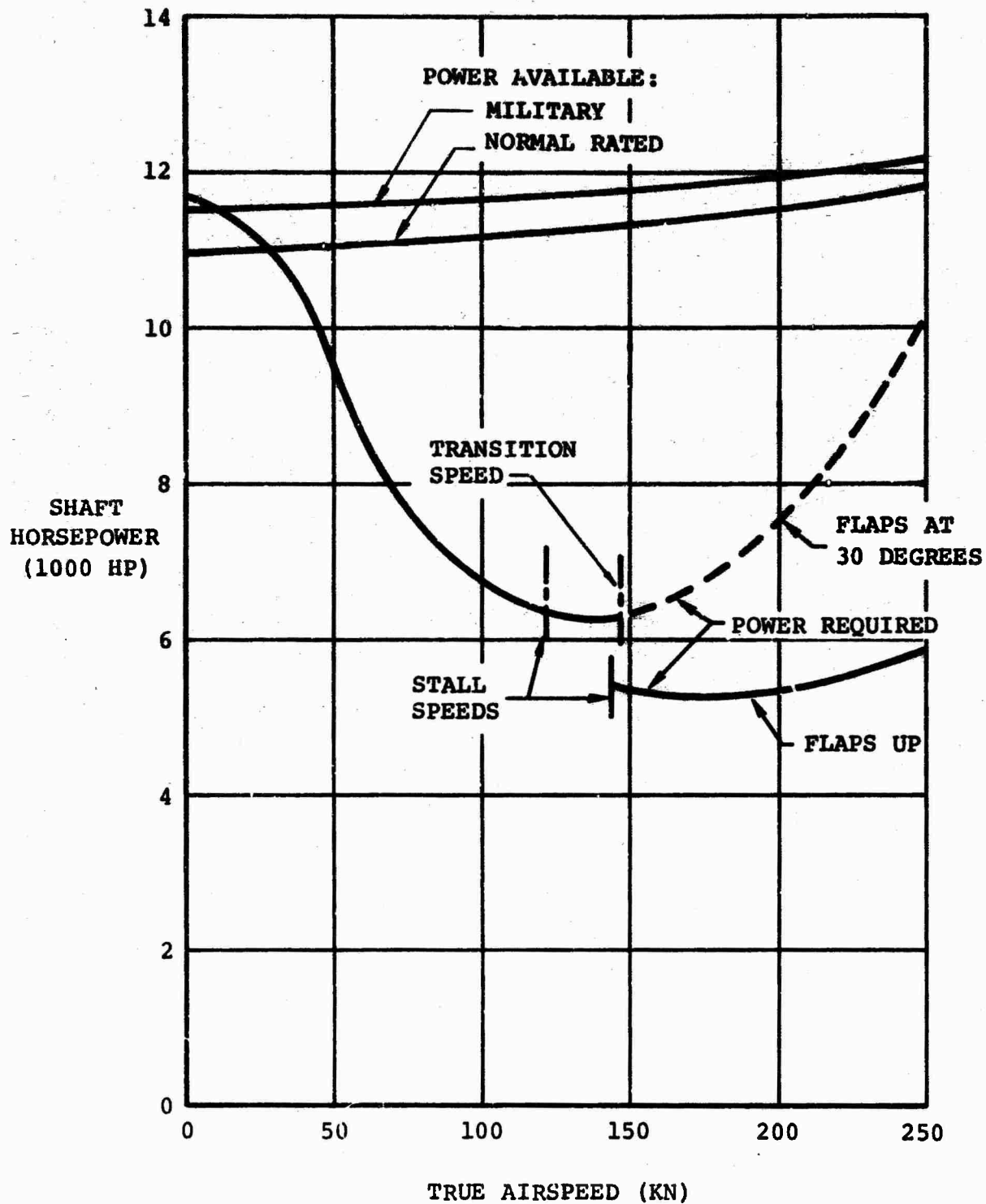

Figure 41. Power Available and Required in Rotor Driven Flight Modes for the Baseline Rescue Aircraft.

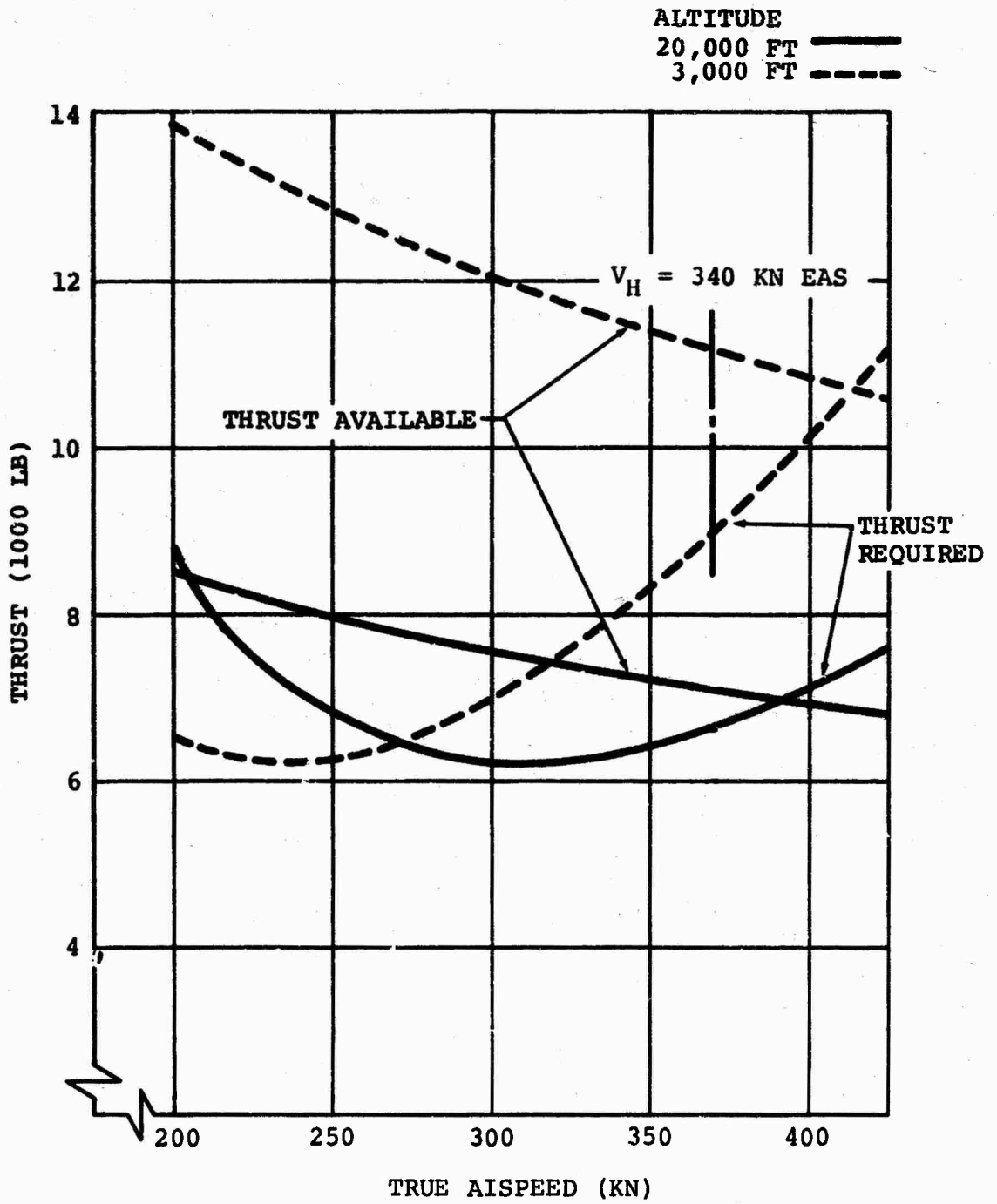

Figure 42. Thrust Available and Required for the Baseline Rescue Aircraft for Air Force Hot Day.

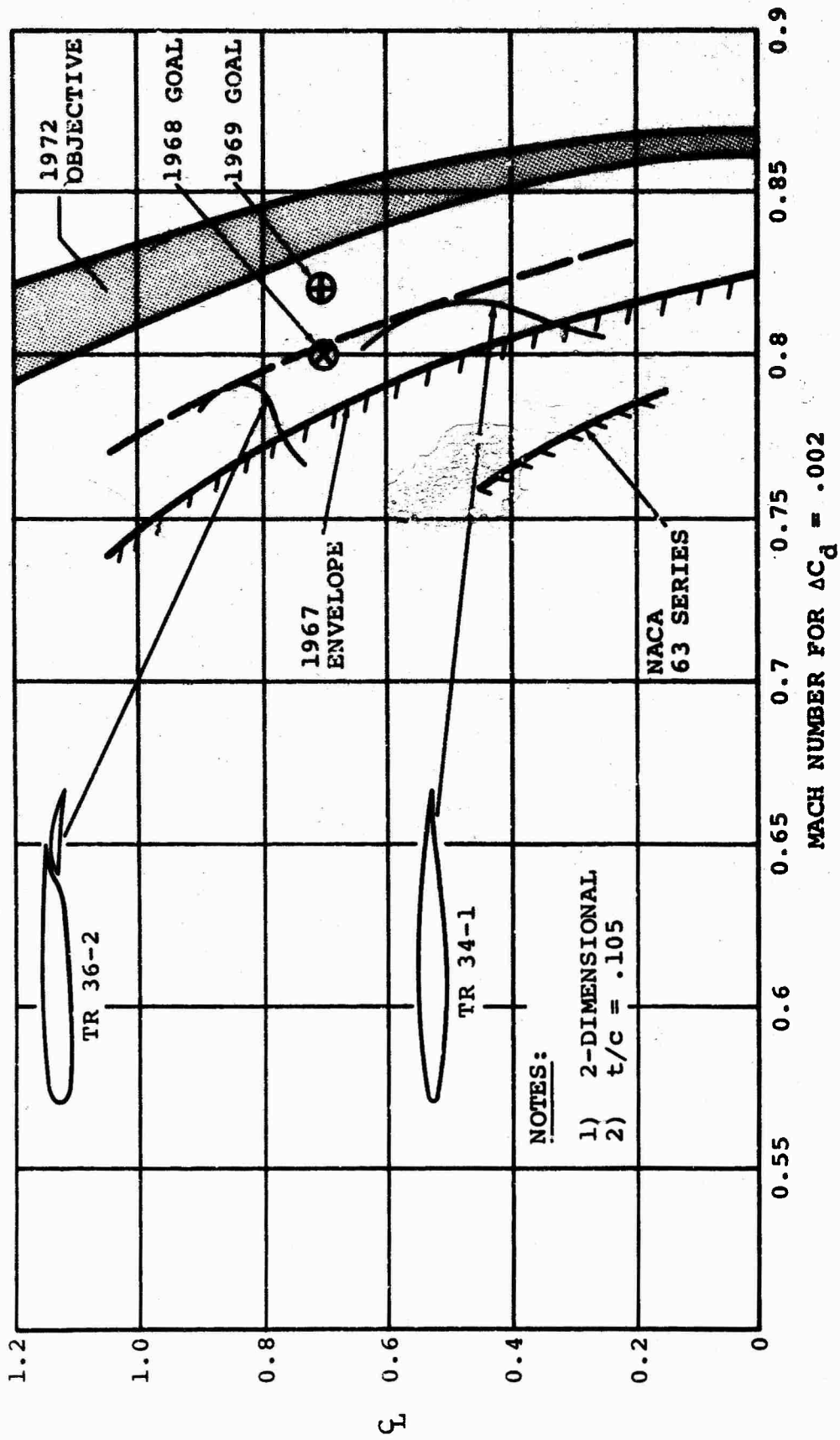

Figure 43. Transonic Airfoil Development.

the 16-percent conventional section used in the preliminary studies; it reduces the wing box weight by thirteen percent. The data of Figure 4, was derived from Figure 43 and the drag divergence projection for the 20-percent thick airfoil. The expected 1972 capability trend was used in the speed trade-off study of Section V.

3. AUTOROTATION ANALYSIS

One of the advantages of a low-disc-loading tilt-rotor aircraft is that it possesses a fair degree of autorotative capability. To investigate this capability a simple analysis of the motion of a tilt-rotor aircraft in a partial power descent was derived.

Briefly stated, the analysis was based on a simple point-mass simulation of the motion of the airframe and the variation of rotor speed during the descent. The acceleration of the airframe was computed from the summation of the rotor thrust, and the airframe weight and download force vectors, using Newton's third law. The estimate of thrust accounted for the power available (which defined a static thrust), the variation of thrust with rate of sink, and the increase in thrust due to ground effect. The time rate of change of rotor speed was obtained from the relationship between the power required from the rotor and the time rate of change of rotor kinetic energy. The power required is a function of the required thrust which, in turn, is obtained from a specified value of average blade lift coefficient.

Simple axial momentum theory was used to give an estimate of the variation of thrust with rate of sink. This theory has been found to give good results at low descent rates in the range required for the vortex-ring state but does not apply for the turbulent-brake or windmill states. The increase in thrust due to ground effect was given by empirical ground effect curves obtained from various sources. The curves, shown in Figure 45, were also used for the STOL performance analysis.

The assumed descent profile consisted of the following: the aircraft was assumed to be at some wheel height with an initial rate-of-sink and all engines operating. At time zero, a number of engines fail, and power drops instantly to the level of output of the remaining engines. After a 0.2 second delay, the pilot commands emergency power and the power begins to ramp up to the emergency level on the remaining engines. At some given wheel height (flare height), the pilot pulls in collective pitch to reduce the rate of sink for touchdown. The simulation ends when the aircraft contacts the ground.

NOTES:

- 1) MACH NUMBER
FOR $\Delta C_d = 0.002$
- 2) $C_l = 0.3$
- 3) 2-DIMENSIONAL

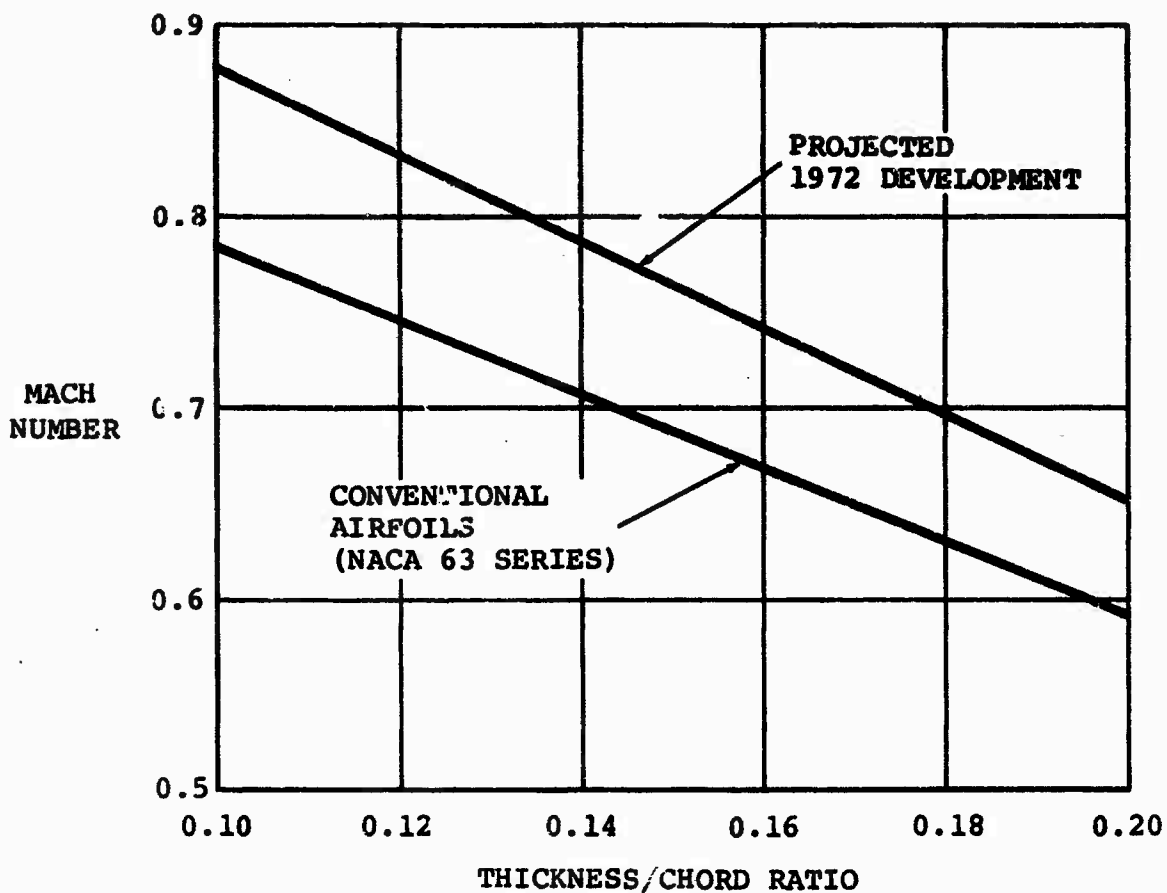

Figure 44. Critical Mach Number of Advanced Airfoils.

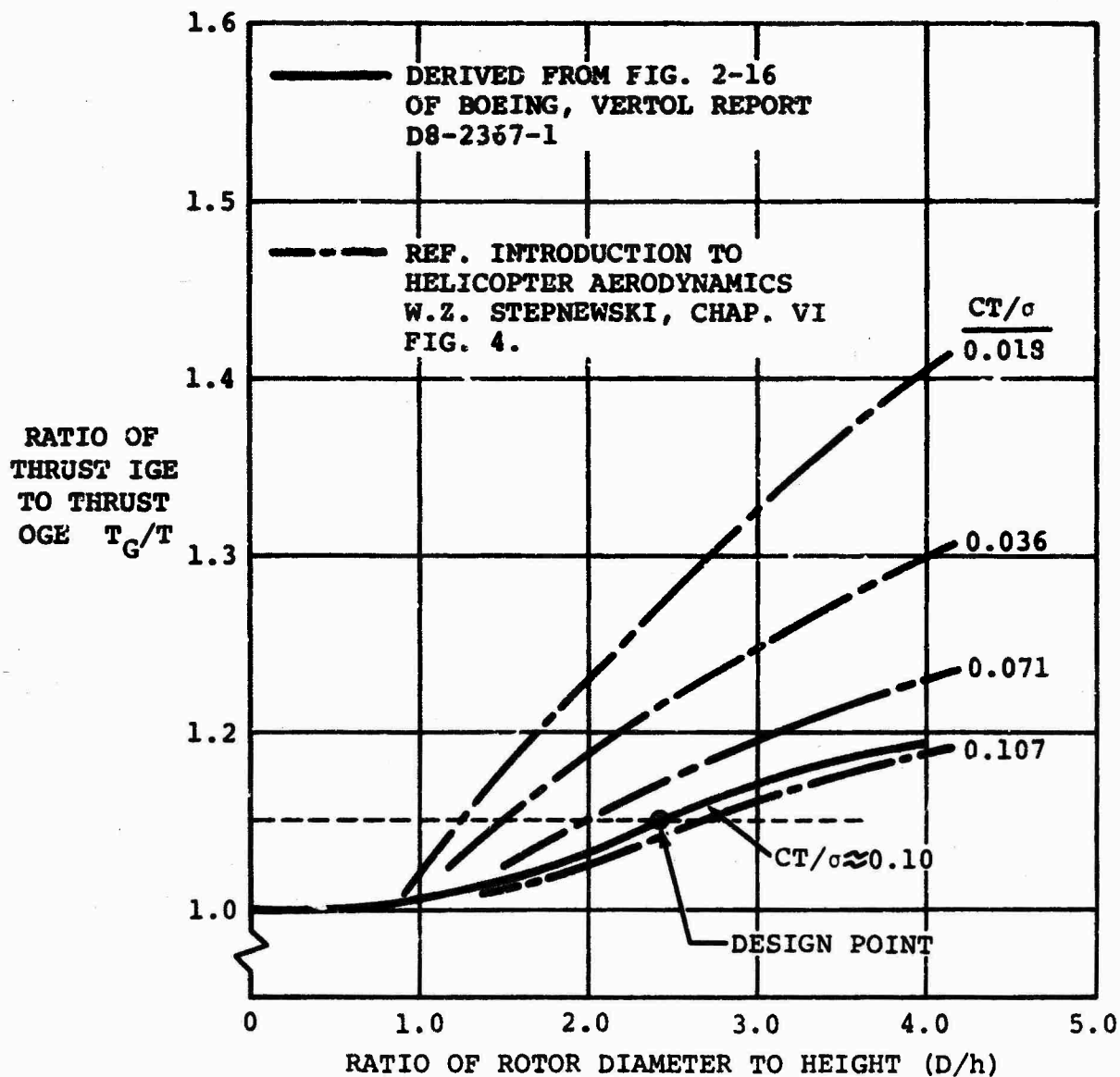

Figure 45. Ground Effect on Rotor Thrust at Constant Power.

The (differential) equations of motion were solved using numerical integration techniques to produce time-histories of wheel height, rate-of-sink, and rotor speed from engine failure at the 50-foot wheel height to ground contact.

Typical results of the analysis are shown in Figure 46. These curves show time histories of rate-of-sink, rotor speed, and thrust to weight ratio with various assumed flare heights. These results indicate that when the pilot initiates the collective pitch flare at about 10-foot wheel height, the rate of sink at touchdown is reduced to about 4 fps with about 60 rpm decrease in rotor speed. These results are to be expected since the aircraft was sized initially to hover in ground effect with one engine inoperative. This data is for the Design Point IV aircraft.

4. STOL PERFORMANCE METHODS

The STOL take-off data shown in the performance summaries was computed with a program which uses a two-degree-of-freedom point mass trajectory analysis of the takeoff. Inclined disc momentum theory is used to compute rotor performance. This theory has been found to give a conservative estimate of the thrust in the velocity range of interest for STOL takeoff. As a first approximation, it has been assumed that there is no interaction between the wing and rotor slipstream. This gives an overestimate of the lift and drag of the airframe which tends to counter the underestimate in thrust given by the momentum theory.

The program has three operational simulation modes: rolling STOL takeoff, helicopter-type takeoff, and a helicopter accelerate-stop maneuver. In operation, the program first computes the critical speeds for takeoff based on stall speed margins and engine-out climb requirements. The program then proceeds to compute the ground and air run segments. During the ground run the program considers limitations on nose wheel height and fuselage pitch angle in determining the attitude of the aircraft. Also, if the lift-to-weight (L/W) ratio exceeds 1.0 during the ground run the program depresses angle of attack to maintain L/W equal to 1.0. When velocity reaches a specified rotation or lift-off speed the program enters the air run segment. Five pilot technique options are included to control the attitude of the aircraft in this segment. The simulation ends when the aircraft passes the obstacle height.

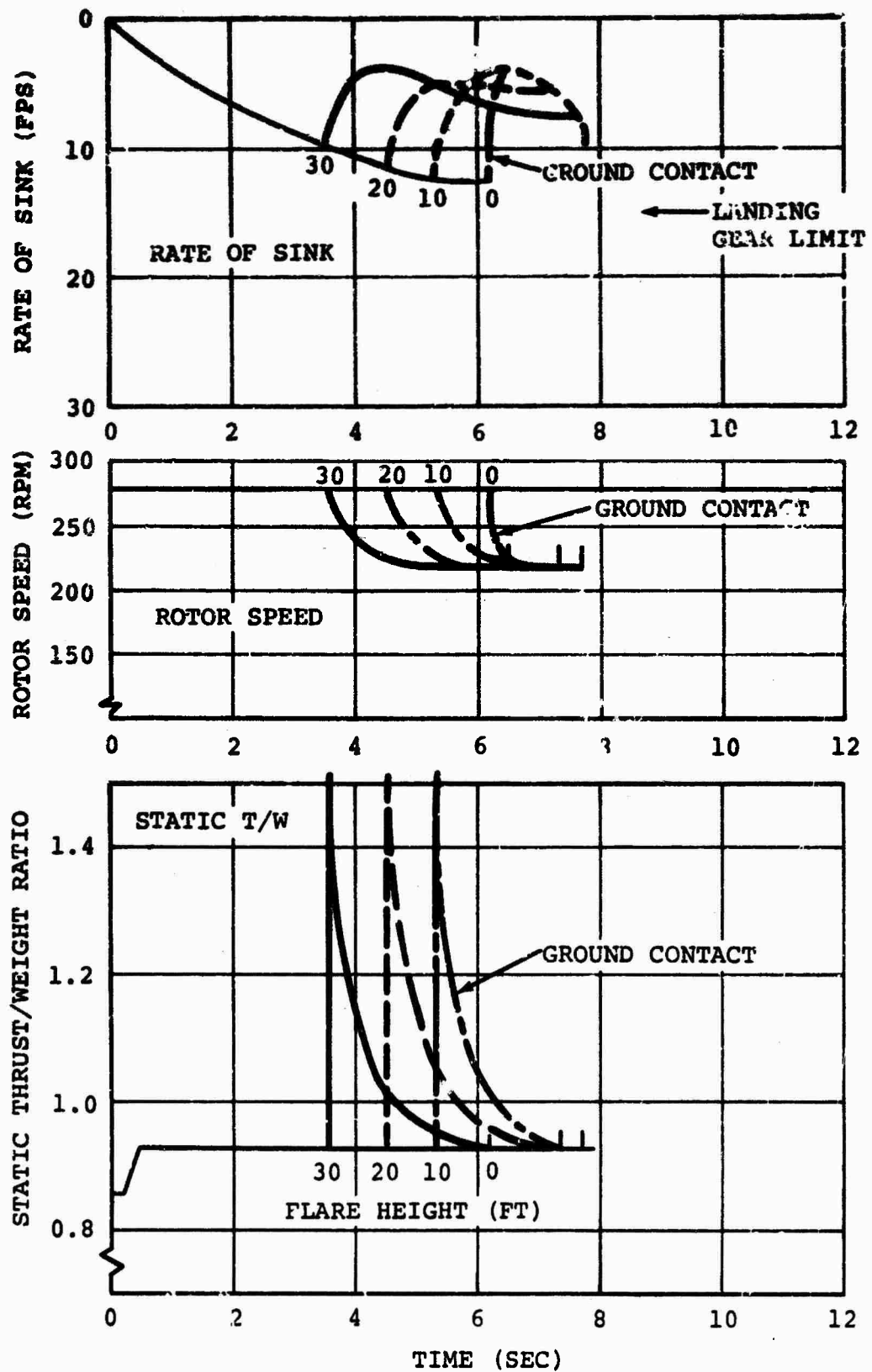

Figure 46. Vertical Partial Power Descent With One Engine Inoperative.

The power-off aerodynamic characteristics of the aircraft were computed using the USAF DATCOM. These are shown in Figures 47 and 48 for 0 and 30 degree flaps.

In the analysis, lift-off speeds were limited by a critical speed boundary defined as the largest of the speeds given by the following conditions:

Minimum speed for $L/W = 1.2$ (All Engines Operating)

$1.2 \times$ Minimum speed for $L/W = 1$ (One-Engine Inoperative)

(Minimum speed for $L/W = 1$) + 10 Knots (One-Engine Inoperative)

Minimum speed for $L/W = 1.1$ (One-Engine Inoperative)

Minimum speed for
climb angle = 3-degrees (One-Engine Inoperative)

Takeoff angle of attack was limited to $1.0 C_{L_{MAX}}$; no angle-of-attack limit was assumed for landing.

Seventy-degree angle nacelle incidence (α_N) appears to be a minimum for rolling takeoff maneuvers. At 55-degree nacelle incidence, the aircraft develops insufficient lift for takeoff when the angle of attack is limited by the maximum lift angle. The reason for this is that since the rotor supplies the bulk of the lift the inclination of the thrust vector has a large effect on the lift. The thrust contribution to the total lift is $T \sin \alpha_N$ or, in terms of lift to weight ratio, $T/W \sin \alpha_N$. When T/W is less than $1/\sin \alpha_N$, the deficiency in lift must be made up by the wing. For α_N less than 80 degrees, the thrust of the rotor decreases as speed increases. This adds an additional increment in lift to be supplied by the wing. The result is that the speed must be fairly large before L/W equal to 1 can be attained. As speed increases the combination of thrust decay and increase in drag causes longitudinal acceleration to decrease. In the 55-degree nacelle incidence cases the acceleration fell to zero before the speed for L/W equal to 1 could be reached and the cases were rejected.

The 30-degree flap setting was chosen as the one giving the best compromise between drag and maximum lift. The Model 150 power-off wind tunnel tests results indicate that the 30-degree flap setting lies on the knees of the C_L versus flap angle and C_D versus flap angle curves.

The takeoff and landing curves have been faired to use tilt angles from 90 degrees at vertical takeoff weight to 70

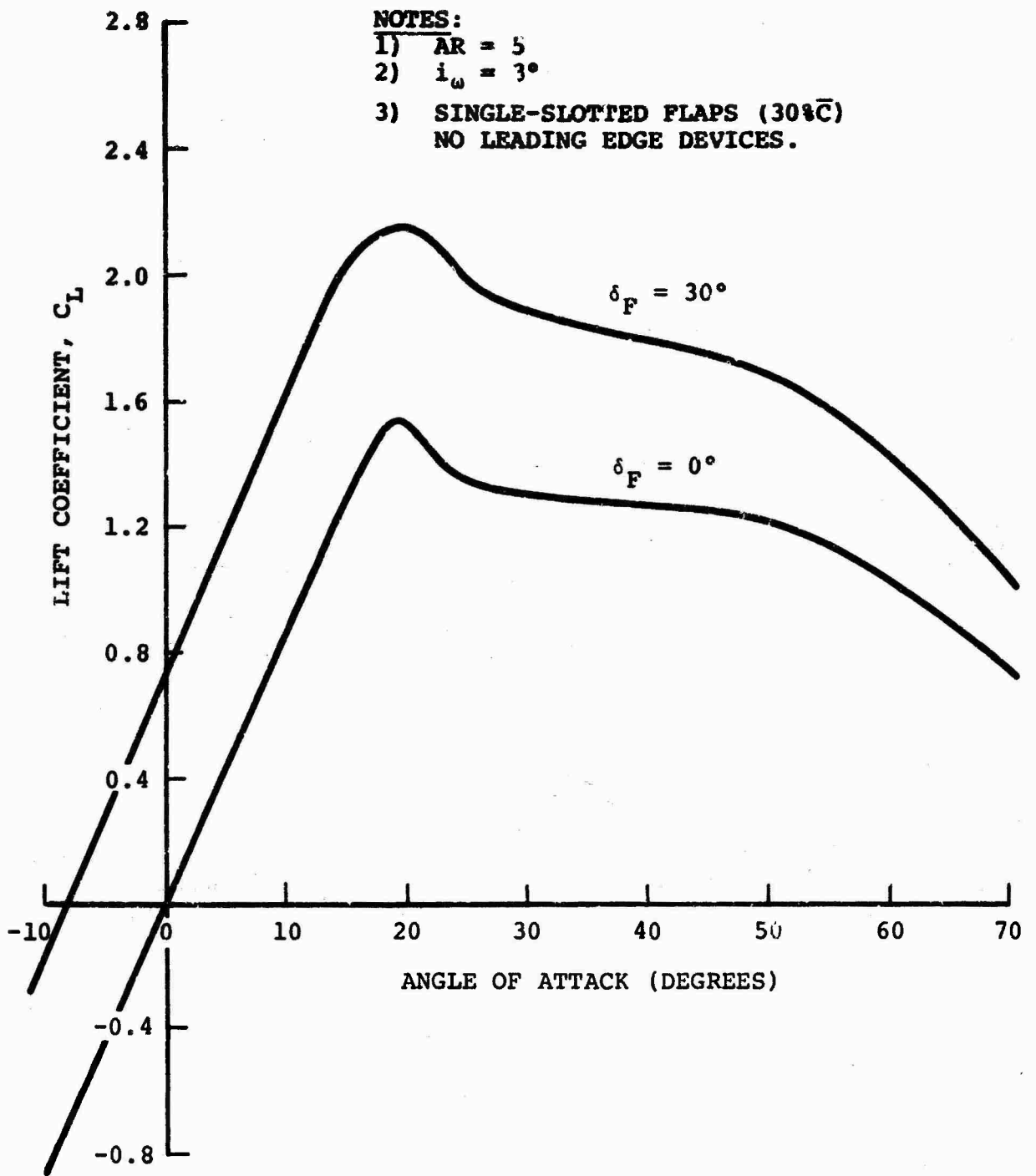

Figure 47. Stowed-Tilt-Rotor Power-Off Lift Characteristics.

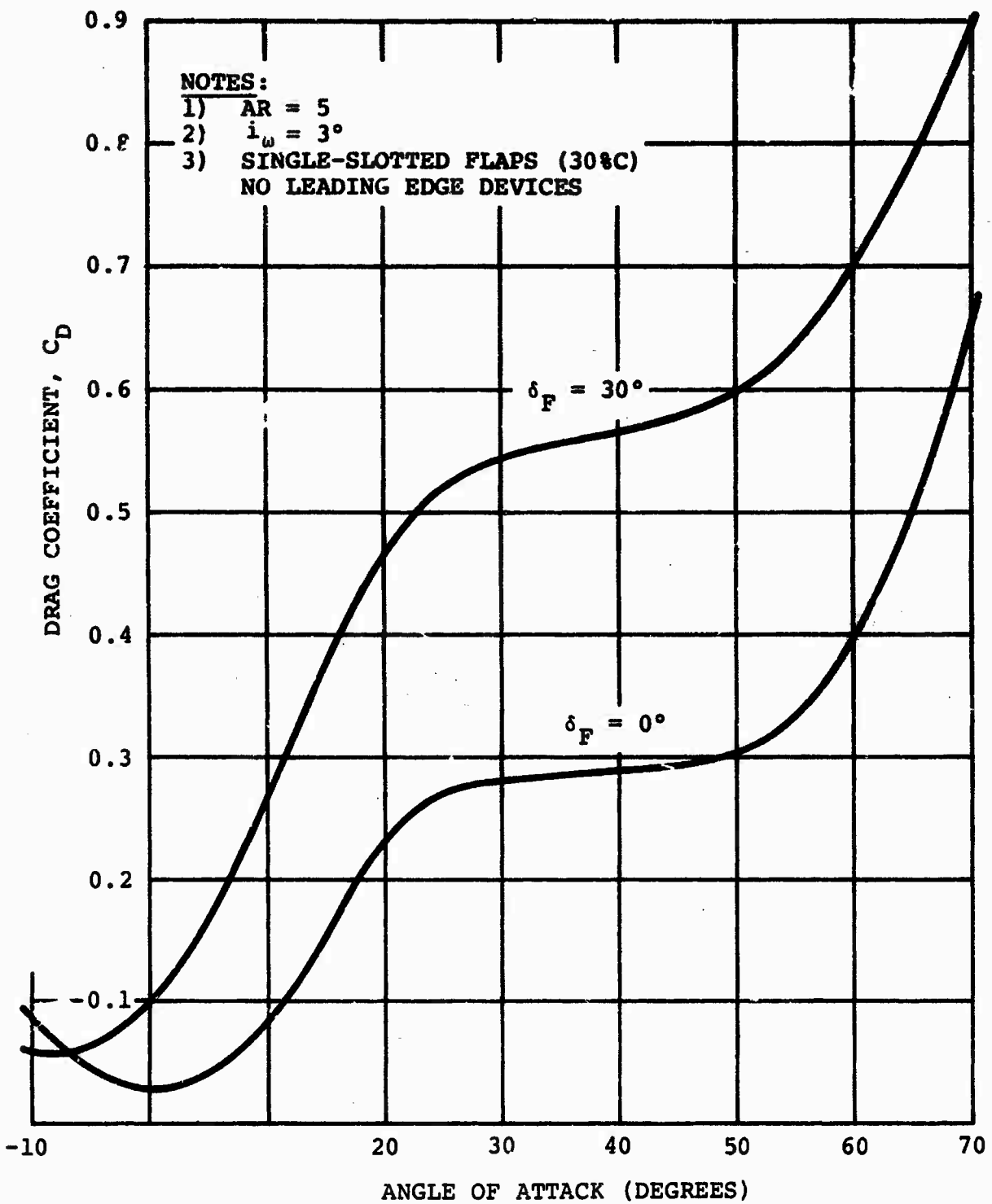

Figure 48. Tilt/Stowed Rotor Power-Off Drag Characteristics.

degrees at some higher gross weight. The takeoff distances calculated are shown in Figures 24, 31, and 40. Landing distances did not vary by more than 50 feet from the takeoff distance at any given gross weight.

The performance of the aircraft in the helicopter mode gave distances approximately 60 feet longer than rolling takeoffs. It was found that the accelerate-stop distances were consistently lower than the distances for continuing the takeoff after engine failure.

5. THRUST MARGINS USED IN ENGINE SIZING AND PERFORMANCE CALCULATIONS

a. Download (T/W)

The basic downloads assumed in hover flight were based on tests of a tilt-rotor full-scale wing under a CH-47 helicopter rotor on the Flight Dynamics Laboratory whirl tower at Wright-Patterson Air Force Base. The actual download, area of impingement, and disc loading were used to obtain an equivalent download coefficient.

$$C_{D_e} = \frac{\text{Download}}{S_{WI} \cdot W/A_{\text{test data}}} \quad (1)$$

where S_{WI} = total wing area of impingement

(Note: This includes the advantages of leading-edge slats, and trailing-edge flaps, as shown in the subject configurations.)

then, $T = GW + C_{D_e} \cdot W/A \cdot S_{WI}$ (2)

finally,

$$T/W_{\text{basic}} = \frac{1}{1 - C_{D_e} \cdot S_{WI}} \quad (3)$$

where S_{WI} (total)

$$= C_t (0.707 D_R - D_{\text{Nac}})$$

$$+ \frac{1}{AR} (5D_R^2 - D_{\text{nac}}^2)$$

- A = Total disc area (sq ft)
 C_t = Wing tip chord (ft)
 D_R = Rotor Diameter (ft)
 D_{nac} = Rotor nacelle diameter (ft)

The drag of the nontilting portion of the nacelle in the rotor downwash was calculated and included in the final C_{D_e} .

b. Trim and Maneuverability

The analysis used assumes trim plus 100 percent control about the critical axis and 50 percent control about the other two. For the small amount of cyclic used for trim and pitch control, cyclic rotor hover tests have shown the thrust loss to be negligible. Yaw control lift loss is due to the cosine effect of differentially tilting the thrust vectors. Application of roll control causes the rotors to operate above and below the optimum C_T value, consequently reducing the figure of merit. In summary, these effects for the design point aircraft are:

	$\Delta \frac{\text{THRUST}}{\text{WEIGHT}}$ Required
Trim	-
Pitch Control	-
Yaw Control	0.015
Roll Control	0.025

c. Rate of Climb (500 fpm)

The analysis used separates the rate of climb T/W increase into two contributions: 1) due to the power expended to achieve vertical climb; and 2) due to wing drag in vertical climb. The following is a summary of the combined thrust to weight values used in the performance studies:

	<u>Design Point</u>			
	I and III	IV	V	VI
T/W (with download)	1.040	1.0416	1.046	1.053
Trim and Maneuver	0.033	0.0290	0.0290	0.0290
Rate of Climb (500 fpm)	0.052	0.0510	0.0480	0.0480

SECTION VII

WEIGHT AND BALANCE

This section contains the proposed 1976 weights for the baseline aircraft. AN-9103-D weight statements, group weight and balance, mission gross weights, center of gravity limits, and inertias are presented for both the rescue and the transport baseline aircraft. Justification is contained in Section XII.

1. BASELINE RESCUE AIRCRAFT WEIGHT AND BALANCE

Weight and balance information for the Design Point baseline rescue aircraft is presented in Tables XV and XVI.

The center of gravity and balance calculations for the various baseline rescue design gross weight conditions are summarized in Table XVII.

Vertical flight center of gravity limits have been determined to be between 26- and 40-percent MAC. The rotor pod pivot point and center line of thrust are located at 33-percent MAC.

The horizontal flight center of gravity limits have been determined to be between 13- and 33-percent MAC.

Reference data for the center of gravity calculations are:

- a. Horizontal arms are given as fuselage stations.
- b. Vertical arms are given as waterlines.
- c. Fuselage station 0 is 200 inches forward of the forward cargo compartment bulkhead.
- d. Waterline 0 is 100 inches below the cargo floor.
- e. Leading edge of MAC is at fuselage station 371.
- f. Length of MAC is 149 inches.
- g. Rotor pivot point is at fuselage station 420 and waterline 190.

Table XVIII summarizes the moments of inertia for the baseline rescue aircraft.

GROUP WEIGHT STATEMENT

ESTIMATED - ~~ENGINE XXXX~~ ~~MODEL XXX~~

(Cross out those not applicable)

BASELINE RESCUE AIRCRAFT

CONTRACT NO. _____
AIRPLANE, GOVERNMENT NO. _____
AIRPLANE, CONTRACTOR NO. _____
MANUFACTURED BY _____

		MAIN	AUXILIARY
ENGINE	MANUFACTURED BY		
	MODEL		
	NO.		
PROPELLER	MANUFACTURED BY		
	DESIGN NO.		
	NO.		

TABLE XV. BASELINE RESCUE AIRCRAFT GROUP WEIGHT STATEMENT
(WEIGHT EMPTY)

1	WING GROUP				5710
2	CENTER SECTION - BASIC STRUCTURE				
3	INTERMEDIATE PANEL - BASIC STRUCTURE				
4	OUTER PANEL - BASIC STRUCTURE (INCL. TIPS LBS.)				
5					
6	SECONDARY STRUCTURE (INCL. WINGFOLD MECHANISM LBS.)				
7	AILERONS (INCL. BALANCE WEIGHT LBS.)				
8	FLAPS - TRAILING EDGE				
9	- LEADING EDGE				
10	SLATS				
11	SPOILERS				
12	SPEED BRAKES				
13					
14					
15	TAIL GROUP				982
16	GROUP HORIZONTAL				491
17	FINS - BASIC STRUCTURE (INCL. DORSAL LBS.)				
18	GROUP VERTICAL				491
19	ELEVATOR (INCL. BALANCE WEIGHT LBS.)				
20	RUDDERS (INCL. BALANCE WEIGHT LBS.)				
21					
22					
23	BODY GROUP				3250
24	FUSELAGE OR HULL - BASIC STRUCTURE				2500
25	BOOMS - BASIC STRUCTURE				
26	SECONDARY STRUCTURE - FUSELAGE OR HULL				750
27	- BOOMS				
28	- SPEEDBRAKES				
29	- DOORS, PANELS & MISC.				
30					
31	ALIGHTING GEAR GROUP - LAND (TYPE:)				2385
32	LOCATION	WHEELS, BRAKES TIRES, TUBES, AIR	STRUCTURE	CONTROLS	
33					
34					
35					
36					
37					
38					
39					
40	ALIGHTING GEAR GROUP - WATER				
41	LOCATION	FLOATS	STRUTS	CONTROLS	
42					
43					
44					
45					
46	SURFACE CONTROLS GROUP				3636
47	COCKPIT CONTROLS				103
48	AUTOMATIC PILOT SAS				131
49	GROUP ROTOR(LBS.)				1350
50	HYD. = 500, CONVENTIONAL = 502, TILT MECH. = 1050				2052
51	ENGINE SECTION OR NACELLE GROUP				3061
52	GROUP ENGINE				1250
53	GROUP ROTOR POD				1811
54	OUTBOARD				
55	DOORS, PANELS & MISC.				
56					
57	TOTAL (TO BE BROUGHT FORWARD)				19024

**TABLE XV. BASELINE RESCUE AIRCRAFT GROUP WEIGHT STATEMENT
(WEIGHT EMPTY)**

1 PROPULSION GROUP				16919
2		AUXILIARY	MAIN	
3	ENGINE INSTALLATION		2134	
4	AFTERBURNERS (IF FURN. SEPARATELY)			
5	ACCESSORY GEAR BOXES & DRIVES			
6	SUPERCHARGERS (FOR TURBO TYPES)			
7	AIR INDUCTION SYSTEM		360	
8	EXHAUST SYSTEM			
9	COOLING SYSTEM		15	
10	LUBRICATING SYSTEM		26	
11	TANKS			
12	COOLING INSTALLATION			
13	DUCTS, PLUMBING, ETC.			
14	FUEL SYSTEM		2489	
15	TANKS - PROTECTED			
16	- UNPROTECTED			
17	PLUMBING, ETC.			
18	WATER INJECTION SYSTEM			
19	ENGINE CONTROLS		42	
20	STARTING SYSTEM		148	
21	PROPELLER INSTALLATION		4936	
22	FAN SYSTEM		2284	
23	DRIVE SYSTEM		4485	
24	AUXILIARY POWER PLANT GROUP			182
25	INSTRUMENTS & NAVIGATIONAL EQUIPMENT GROUP			400
26	HYDRAULIC & PNEUMATIC GROUP			292
27				
28				
29	ELECTRICAL GROUP			775
30				
31				
32	ELECTRONICS GROUP			1500
33	EQUIPMENT			
34	INSTALLATION			
35				
36	ARMAMENT GROUP (INCL. GUNFIRE PROTECTION LBS.)			2000
37	FURNISHINGS & EQUIPMENT GROUP			1152
38	ACCOMMODATIONS FOR PERSONNEL			
39	MISCELLANEOUS EQUIPMENT			
40	FURNISHINGS			
41	EMERGENCY EQUIPMENT			
42				
43	AIR CONDITIONING & ANTI-ICING EQUIPMENT GROUP			519
44	AIR CONDITIONING			
45	ANTI-ICING			
46				
47	PHOTOGRAPHIC GROUP			
48	AUXILIARY GEAR GROUP			140
49	HANDLING GEAR		40	
50	ARRESTING GEAR			
51	CATAPULTING GEAR			
52	ATO GEAR			
53	RESCUE WINCH		100	
54				
55	MANUFACTURING VARIATION - CONTINGENCY			433
56	TOTAL FROM PG. 2			
57	WEIGHT EMPTY			43336

**TABLE XV. BASELINE RESCUE AIRCRAFT GROUP WEIGHT STATEMENT
(USEFUL LOAD AND GROSS WEIGHT)**

LOAD CONDITION			DESIGN GROSS	MID-POINT	FERRY
CREW (NO. 5)			1200	1200	720
PASSENGERS (NO.)				1200	
FUEL	Type	Gal.			
UNUSABLE			70	70	70
INTERNAL			21929	11345	33456
EXTERNAL					
BOMB BAY					
OIL					
TRAPPED ENGINE			65	65	65
FUEL TANKS (LOCATION AUX-FUSELAGE)					675
WATER INJECTION FLUID (GALS)					
BAGGAGE					
CARGO					
COMBAT EQUIPMENT			400	400	
ARMAMENT					
GUNS (Location)	Pos. or Pos.	Qty.	Cal.		
AMMUNITION					
INSTALLATIONS (BOMB, TORPEDO, ROCKET, ETC.)					
BOMB OR TORPEDO RACKS					
EQUIPMENT					
PYROTECHNICS					
PHOTOGRAPHIC					
SURVIVAL EQUIPMENT					200
OXYGEN					
MISCELLANEOUS					
USEFUL LOAD			23,664	14,280	35,186
WEIGHT EMPTY			43,336	43,336	43,336
GROSS WEIGHT			67,000	57,616	78,522

*If not specified as weight empty.

**TABLE XV. BASELINE RESCUE AIRCRAFT GROUP WEIGHT STATEMENT
(DIMENSIONAL AND STRUCTURAL DATA)**

1 LENGTH - OVERALL (FT.)	HEIGHT - OVERALL - STATIC (FT.)		
	Wing	Eng.	Wing Tip
2			
3 LENGTH - MAX. (FT.)	59.5		
4 DEPTH - MAX. (FT.)	8.75		
5 WIDTH - MAX. (FT.)	6.67		
6 WETTED AREA (SQ. FT.)	1300	406	788
7 FLOAT OR HULL DISPL. - MAX. (LBS.)			
8 FUSELAGE VOLUME (CU. FT.)	PRESSURIZED	TOTAL	
9		Wing	Eng.
10 GROSS AREA (SQ. FT.)		744	199
11 WEIGHT GROSS AREA (LBS./SQ. FT.)		7.7	2.5
12 SPAN (FT.)		61.2	28.2
13 FOLDED SPAN (FT.)			12.4
14			
15 SWEEPBACK AT 25% CHORD LINE (DEGREES)			
16 AT 50% CHORD LINE (DEGREES)			
**17 THEORETICAL ROOT CHORD - LENGTH (INCHES)		194	126
18 - MAX. THICKNESS (INCHES)			194
***19 CHORD AT PLANFORM BREAK - LENGTH (INCHES)		147	
20 - MAX. THICKNESS (INCHES)			
***21 THEORETICAL TIP CHORD - LENGTH (INCHES)		110	42
22 - MAX. THICKNESS (INCHES)			104
23 DORSAL AREA, INCLUDED IN (FUSE.) (HULL) (V. TAIL) AREA (SQ. FT.)			36.7
24 TAIL LENGTH - 25% MAC WING TO 25% MAC H. TAIL (FT.)			26.7
25 AREAS (SQ. FT.)	Flaps	L.E.	
26 Lateral Controls	Slats	Staircase	Ailerons
27 Speed Brakes	Wing	Fuse. or Hull	
28			
29			
30 ALIGHTING GEAR (LOCATION)			
31 LENGTH - OLEO EXTENDED - ϕ AXLE TO ϕ TRUNNION (INCHES)			
32 OLEO TRAVEL - FULL EXTENDED TO FULL COLLAPSED (INCHES)			
33 FLOAT OR SKI STRUT LENGTH (INCHES)			
34 ARRESTING HOOK LENGTH - ϕ HOOK TRUNNION TO ϕ HOOK POINT (INCHES)			
35 HYDRAULIC SYSTEM CAPACITY (GALS.)			
36 FUEL & LUBE SYSTEMS	Location	No. Tanks	****Gals. Protected
37 Fuel - Internal	Wing	8	3490
38	Fuse. or Hull		
39 External			
40 Bomb Bay			
41			
42 Or:			
43			
44			
45 STRUCTURAL DATA - CONDITION		Fuel in Wings (Lbs.)	Stress Gross Weight
46 FLIGHT		21,929	67,000
47 LANDING		10,950	56,021
48			45,071
49 MAX. GROSS WEIGHT WITH ZERO WING FUEL			45,046
50 CATAPULTING			
51 MIN. FLYING WEIGHT			
52 LIMIT AIRPLANE LANDING SINKING SPEED (FT. SEC.)			
53 WING LIFT ASSUMED FOR LANDING DESIGN CONDITION (GW)			
54 STALL SPEED - LANDING CONFIGURATION - POWER OFF (KNOTS)			
55 PRESSURIZED CABIN - ULT. DESIGN PRESSURE DIFFERENTIAL - FLIGHT (P.S.I.)			5.45
56			
57 AIRFRAME WEIGHT (AS DEFINED IN AN-W-11) (LBS.)			

*Lbs. of sea water @ 64 lbs./cu. ft.
**Parallel to ϕ at ϕ airplane.

117

***Parallel to ϕ airplane.
****Total usable capacity

TABLE XVI. BASELINE RESCUE AIRCRAFT BALANCE CALCULATIONS
(WEIGHT EMPTY)

ITEM	WEIGHT	STATIONS			
		HORIZONTAL		VERTICAL	
		ARM	MOMENT	ARM	MOMENT
Cruise (Blades Folded)					
Rotor Group	(4936)	(353.1)	(1,767,500)	(190)	(937,840)
Hub	1690	305	515,450	190	321,100
Blade Fold	750	305	228,750	190	142,500
Blades	2196	425	933,300	190	417,240
Spinners	300	300	90,000	190	57,000
Wing Group	(5710)	(426)	(2,432,460)	(190)	(1,084,900)
Tail Group	(982)	(750)	(736,500)	(241.5)	237,153
Horizontal	491	855	419,805	328	161,048
Vertical	491	645	316,695	155	76,105
Body Group	(3250)	(425)	(1,381,250)	(135)	(438,750)
Alighting Gear	(2385)	(377.9)	901,200	(100.1)	238,650
Nose	645	140	90,300	90	58,050
Main	1140	485	552,900	90	102,600
Auxiliary	600	430	258,000	130	78,000
Flight Controls	(3636)	(3574)	(1,299,463)	(186.5)	678,185
*Cockpit	103	190	19,570	130	13,390
*Fuselage	345	360	124,200	190	65,550
*Engine Section	175	488	85,400	153	26,775
*Wing					
Inboard	178	491	87,398	190	33,820
Outboard	260	477	124,020	190	49,400
*Tip Pod	175	365	63,875	190	33,250
Rotor Controls	1350	305	411,750	190	256,500
Tilt Mechanism	1050	365	383,250	190	199,500
Engine Section	(1250)	(468)	(585,000)	(153)	(191,250)
Tip Pod	(1811)	(450.3)	815,495	(190.0)	344,090
Tilting	935	385	359,975	190	177,650
Fixed	876	520	455,520	190	166,440
Engines	(2134)	(508)	(1,084,072)	(153)	(326,502)
Air Induction	(360)	(453)	(163,080)	(153)	(55,080)
Cooling	(15)	(488)	(7,320)	(153)	(2,295)
Lubrication	(26)	(453)	(11,778)	(153)	(3,978)
*Indicates Location					

TABLE XVI. BASELINE RESCUE AIRCRAFT BALANCE CALCULATIONS

ITEM	WEIGHT	STATIONS			
		HORIZONTAL		VERTICAL	
		ARM	MOMENT	ARM	MOMENT
Cruise Mode (Blades Folded)					
Fuel System	(2489)	(439.7)	(1,094,465)	(190)	(472,910)
Inboard - Forward	750	405	303,750	190	142,500
- Aft	675	475	320,625	190	128,250
Outboard - Forward	430	415	178,450	190	81,700
- Aft	634	460	291,640	190	120,460
Engine Controls	(42)	(488)	(20,496)	(153)	(6,426)
Starting System	(148)	(488)	(72,224)	(153)	(22,644)
Drive System	(4485)	(365.5)	(1,639,055)	(190)	(852,150)
Wing Gear Box	440	488	197,120	190	83,600
Wing Tip Gear Box	470	420	197,400	190	89,300
Main Gear Box	2730	330	900,900	190	518,700
Lubrication	420	390	163,800	190	79,800
Shafting - Tip Pod	95	375	35,625	190	18,050
- Wing	330	437	144,210	190	62,700
Fan Installation	(2284)	(386.7)	(883,262)	(153)	(349,452)
Fan and Shroud	574	368	211,232	153	87,822
Drive System	1710	393	672,030	153	261,630
Auxiliary Power Plant	(182)	(510)	(92,820)	(100)	(18,200)
Instruments and Navigation	(400)	(291)	(116,400)	(155)	(62,000)
Hydraulics	(292)	(510)	(148,920)	(100)	(29,200)
Electrical	(775)	(376)	(291,400)	(166)	(128,650)
Electronics	(1500)	(200)	(300,000)	(160)	(240,000)
Armor	(2000)	(358.5)	(717,200)	(164.6)	(329,200)
Fuselage	1200	300	360,000	160	192,000
Wing	200	440	88,000	190	38,000
Engine Section	400	508	203,200	153	61,200
Tip Pods	200	330	66,000	190	38,000
Furnishings & Equipment	(1152)	(305.7)	(352,210)	(162)	(186,620)
Personal Accommodations	310	170	52,700	160	49,600
Misc.	110	170	18,700	100	17,600
Furnishings	517	380	196,460	160	82,720
Emergency - Fuselage	15	170	2,550	160	2,400
- Engine Sect.	100	488	48,800	153	15,300
- Tip Pod	100	330	33,000	190	19,000

TABLE XVI. BASELINE RESCUE AIRCRAFT BALANCE CALCULATIONS

ITEM	WEIGHT	STATIONS			
		HORIZONTAL		VERTICAL	
		ARM	MOMENT	ARM	MOMENT
Cruise Mode (Blades Folded)					
Air Conditioning & De-ice	(519)	(369.9)	(191,820)	(177.3)	(92,640)
Air Conditioning	219	380	83,220	160	35,600
De-ice - Eng. Sect.	100	393	39,300	153	15,300
- Tip pod	100	305	30,500	190	19,000
- Wing	100	388	38,800	190	19,000
Auxiliary Gear	(140)	(265.7)	(37,200)	(160)	(22,400)
Aircraft Handling	40	360	15,200	160	6,400
Rescue Winch	100	220	22,000	160	16,000
Manufacturing Variation	(433)	(393)	(170,169)	(168)	(72,744)
Weight Empty	(43,336)	(392.3)	(17,021,359)	(168.3)	(7,254,659)
Fixed Useful Load	(1,335)	(212.8)	(284,136)	(132.5)	(176,845)
Crew -Pilot & Co-Pilot	480	165	79,200	140	67,200
-Crew Chief	240	180	43,200	120	28,800
-Winch Opr/Gunner	480	220	105,600	120	57,600
Trapped Liquids					
Eng. Oil	65	393	25,545	153	9,945
Fuel - Inboard	35	442	15,470	190	6,650
Outboard	35	432	15,120	190	6,650
Fuel (5 percent)	(1,095)	(440)	(481,800)	(190)	(208,050)
Combat Equipment	(400)	(350)	(140,000)	(130)	(52,000)
Operating Weight Empty	(46,166)	(388.3)	(17,927,295)	(167.5)	(7,731,554)
Less Winch/Gunner	480	220	- 105,600	120	- 57,600
Crew Chief	240	180	- 43,200	120	- 28,800
Combat Equip.	400	350	- 140,000	130	- 52,000
Minimum Operating Weight	(45,046)	(391.6)	(17,638,495)	(168.6)	(7,593,154)

TABLE XVII. BASELINE RESCUE MISSION GROSS WEIGHTS

Design Condition	Weight (lb)	Cruise on Fan		Cruise on Rotor		Hover		
		Fuselage Sta	Water-line	Fuselage Sta	Water-line	Fuselage Sta	Water-line	
			MAC %		MAC %		MAC %	
Operating Weight Empty	46,166	388	168	383	168	406	191	23.5
Design Gross Weight	67,000	404	174	400	174	416	190	30.0
Landing Gross Weight	56,021	403	174	399	174	418	193	31.5
Max. Gross Weight (Ferry)	78,522	404	171	401	171	414	184	28.8

*The horizontal flight center of gravity limits are between 13- and 33-percent MAC. The wing location is not far enough forward and will be moved to the optimum position.

TABLE XVIII. SUMMARY OF MOMENTS OF INERTIA FOR BASELINE RESCUE MISSION

Item	Weight (lb)	Center of Gravity		Inertia (Slug Ft ²)		
		Fuselage Sta	Water- line	Roll	Pitch	Yaw
<u>Design Gross Weight</u>						
Cruise on Fan	67,000	404.0	174.0	695,994	205,999	837,879
Cruise on Propeller	67,000	400.1	174.0	695,887	206,077	844,153
Hover	67,000	416.2	190.2	738,050	228,024	830,202
<u>Maximum Design Gross Weight</u>						
Cruise on Fan	67,000	404.0	174.0	695,994	205,994	837,879
Cruise on Propeller	67,000	400.1	174.0	695,887	206,077	844,153
Hover	67,000	416.2	190.2	738,050	228,024	830,202
<u>Landing Gross Weight</u>						
Cruise on Fan	56,021	403.3	173.0	647,402	201,885	785,138
Cruise on Propeller	56,021	398.6	173.6	647,729	201,968	791,452
Hover	56,021	417.9	193.0	689,458	223,915	777,501

2. BASELINE TRANSPORT AIRCRAFT WEIGHT AND BALANCE

Tables XIX through XX present the weight and balance information for the baseline transport version.

The center of gravity and balance calculations for the various baseline transport design gross weight conditions are summarized in Table XXI.

Vertical flight center of gravity limits have been determined to be between 26- and 40-percent MAC. The rotor pod pivot point and center line of thrust are located at 33-percent MAC.

The horizontal flight center of gravity limits have been determined to be between 13- and 33-percent MAC.

Reference data for the center of gravity calculations are:

- a. Horizontal arms are given as fuselage stations.
- b. Vertical arms are given as waterlines.
- c. Fuselage station 0 is 200 inches forward of the forward cargo compartment bulkhead.
- d. Waterline 0 is 100 inches below the cargo floor.
- e. Leading edge of MAC is at fuselage station 371.
- f. Length of MAC is 149 inches.
- g. Rotor pivot point is at fuselage station 420 and waterline 190.

Figure 49 shows the forward and aft cargo loading limitations.

Table XXII summarizes the moments of inertia for the baseline transport mission.

GROUP WEIGHT STATEMENT

ESTIMATED - [REDACTED]

(Cross out those not applicable)

BASELINE TRANSPORT AIRCRAFT

CONTRACT NO. _____
AIRPLANE, GOVERNMENT NO. _____
AIRPLANE, CONTRACTOR NO. _____
MANUFACTURED BY _____

		MAIN	AUXILIARY
ENGINE	MANUFACTURED BY		
	MODEL		
	NO.		
PROPELLER	MANUFACTURED BY		
	DESIGN NO.		
	NO.		

TABLE XIX. BASELINE TRANSPORT AIRCRAFT GROUP WEIGHT STATEMENT
(WEIGHT EMPTY)

1	WING GROUP				5710
2	CENTER SECTION - BASIC STRUCTURE				
3	INTERMEDIATE PANEL - BASIC STRUCTURE				
4	OUTER PANEL - BASIC STRUCTURE (INCL. TIPS LBS.)				
5					
6	SECONDARY STRUCTURE (INCL. WINGFOLD MECHANISM LBS.)				
7	AILERONS (INCL. BALANCE WEIGHT LBS.)				
8	FLAPS - TRAILING EDGE				
9	- LEADING EDGE				
10	SLATS				
11	SPOILERS				
12	SPEED BRAKES				
13					
14					
15	TAIL GROUP				982
16	HORIZONTAL			491	
17	LBS.)				
18	VERTICAL			491	
19	ELEVATOR (INCL. BALANCE WEIGHT LBS.)				
20	RUDDERS (INCL. BALANCE WEIGHT LBS.)				
21					
22					
23	BODY GROUP				5980
24	FUSELAGE OR HULL - BASIC STRUCTURE				2670
25	BOOMS - BASIC STRUCTURE				
26	SECONDARY STRUCTURE - FUSELAGE OR HULL				2390
27	- BOOMS				
28	- SPEEDBRAKES				
29	- DOORS, PANELS & MISC.				
30	CARGO LOADING SYSTEM				920
31	ALIGHTING GEAR GROUP - LAND (TYPE:)				3195
32	LOCATION	WHEELS, BRAKES TIRES, TUBES, APR	STRUCTURE	CONTROLS	
33					
34					
35					
36					
37					
38					
39					
40	ALIGHTING GEAR GROUP - WATER				
41	LOCATION	FLOATS	STRUTS	CONTROLS	
42					
43					
44					
45					
46	SURFACE CONTROLS GROUP				3636
47	COCKPIT CONTROLS				103
48	AUTOMATIC PILOT SAS				131
49	ROTOR				1250
50	HYDRAULICS = 500, CONVEN. = 502, TILT MECH. = 1050				2052
51	ENGINE SECTION OR NACELLE GROUP				3061
52	ENGINE				1250
53	CENTER ROTOR POD				1811
54	OUTBOARD				
55	DOORS, PANELS & MISC.				
56					
57	TOTAL (TO BE BROUGHT FORWARD)				22,564

**TABLE XIX. BASELINE TRANSPORT AIRCRAFT GROUP WEIGHT STATEMENT
(WEIGHT EMPTY)**

1 PROPULSION GROUP				16,919
		AUXILIARY	MAIN	
2				
3	ENGINE INSTALLATION			
4	AFTERBURNERS (IF FURN. SEPARATELY)		2134	
5	ACCESSORY GEAR BOXES & DRIVES			
6	SUPERCHARGERS (FOR TURBO TYPES)			
7	AIR INDUCTION SYSTEM		360	
8	EXHAUST SYSTEM			
9	COOLING SYSTEM		15	
10	LUBRICATING SYSTEM		26	
11	TANKS			
12	COOLING INSTALLATION			
13	DUCTS, PLUMBING, ETC.			
14	FUEL SYSTEM		2489	
15	TANKS - PROTECTED			
16	- UNPROTECTED			
17	PLUMBING, ETC.			
18	WATER INJECTION SYSTEM			
19	ENGINE CONTROLS		42	
20	STARTING SYSTEM		148	
21	PROPELLER INSTALLATION		4936	
22	FAN SYSTEM		2284	
23	DRIVE SYSTEM		4485	
24	AUXILIARY POWER PLANT GROUP			182
25	INSTRUMENTS & NAVIGATIONAL EQUIPMENT GROUP			400
26	HYDRAULIC & PNEUMATIC GROUP			292
27				
28				
29	ELECTRICAL GROUP			775
30				
31				
32	ELECTRONICS GROUP			950
33	EQUIPMENT			
34	INSTALLATION			
35				
36	ARMAMENT GROUP (INCL. GUNFIRE PROTECTION	LBS.) (PROVISIONS ONLY)		50
37	FURNISHINGS & EQUIPMENT GROUP			1470
38	ACCOMMODATIONS FOR PERSONNEL			
39	MISCELLANEOUS EQUIPMENT			
40	FURNISHINGS			
41	EMERGENCY EQUIPMENT			
42				
43	AIR CONDITIONING & ANTI-ICING EQUIPMENT GROUP			519
44	AIR CONDITIONING			
45	ANTI-ICING			
46				
47	PHOTOGRAPHIC GROUP			
48	AUXILIARY GEAR GROUP			40
49	HANDLING GEAR		40	
50	ARRESTING GEAR			
51	CATAPULTING GEAR			
52	ATO GEAR			
53				
54				
55	MANUFACTURING VARIATION - CONTINGENCY			446
56	TOTAL FROM PG. 2			22,564
57	WEIGHT EMPTY			44,607

**TABLE XIX. BASELINE TRANSPORT AIRCRAFT GROUP WEIGHT STATEMENT
(USEFUL LOAD AND GROSS WEIGHT)**

LOAD CONDITION	DESIGN GROSS		PERRY			
CREW (NO. 5)		1200		720		
PASSENGERS (NO.)						
FUEL	Type	Gals.	70	70		
UNUSABLE			11058	34000		
INTERNAL						
EXTERNAL						
BOMB BAY						
OIL						
TRAPPED						
ENGINE			65	65		
FUEL TANKS (LOCATION AUXILIARY - FUSEL...)				725		
WATER INJECTION FLUID (GALS)						
BAGGAGE						
CARGO			10000			
ARMAMENT						
GUNS (Location)	Fin. or Fin.	Qty.	Cal.			
AMMUNITION						
INSTALLATIONS (BOMB, TORPEDO, ROCKET, ETC.)						
BOMB OR TORPEDO RACKS						
EQUIPMENT						
PYROTECHNICS						
PHOTOGRAPHIC						
SURVIVAL EQUIPMENT				200		
OXYGEN						
MISCELLANEOUS						
USEFUL LOAD			22393	35780		
WEIGHT EMPTY			44607	44607		
GROSS WEIGHT			67000	80387		

*If not specified as weight empty.

TABLE XIX. BASELINE TRANSPORT AIRCRAFT GROUP WEIGHT STATEMENT
(DIMENSIONAL AND STRUCTURAL DATA)

1 LENGTH - OVERALL (FT.)	HEIGHT - OVERALL - STATIC (FT.)			Eng. Wing Tip		
	Main Floater	Aux. Floater	Beam	Fuse or Hull	Inboard	Outboard
2 LENGTH MAX (FT.)				60.0'		
3 DEPTH MAX (FT.)				10.4		
4 WIDTH - MAX. (FT.)				10.0		
5 WETTED AREA (SQ. FT.)				1761	406	788
6 FLOAT OR HULL DISPL. - MAX. (LBS.)						
7 FUSELAGE VOLUME (CU. FT.)	PRESSURIZED			TOTAL		
8				Wing	H. Tail	V. Tail
9				744	199	154
10 CROSS AREA (SQ. FT.)				7.7	2.5	3.2
11 WEIGHT/GROSS AREA (LBS./SQ. FT.)				61.2	28.2	12.4
12 SPAN (FT.)						
13 FOLDED SPAN (FT.)						
14						
15 SWEEPBACK - AT 75% CHORD LINE (DEGREES)						
16 AT 5% CHORD LINE (DEGREES)						
17 THEORETICAL ROOT CHORD - LENGTH (INCHES)				194	126	194
18 - MAX. THICKNESS (INCHES)						
19 CHORD AT PLANFORM BREAK - LENGTH (INCHES)				147		
20 - MAX. THICKNESS (INCHES)						
21 THEORETICAL TIP CHORD - LENGTH (INCHES)				110	42	104
22 - MAX. THICKNESS (INCHES)						
23 WING AREA, INCLUDED IN (FUSE.) (HULL) (V. TAIL) AREA (SQ. FT.)					36.7	26.7
24 TAIL LENGTH - 25% MAC WING TO 25% MAC H. TAIL (FT.)						
25 ARFAS (SQ. FT.)	Flops	L.E.	T.E.			
26	Lateral Controls	Slats	Spollers		Ailerons	
27	Speed Brakes	Wing	Fuse. or Hull			
28						
29						
30 ALIGHTING GEAR (LOCATION)						
31 LENGTH - OLEO EXTENDED - ϕ AXLE TO ϕ TRUNNION (INCHES)						
32 OLEO TRAVEL - FULL EXTENDED TO FULL COLLAPSED (INCHES)						
33 FLOAT OR SKI STRUT LENGTH (INCHES)						
34 ARRESTING HOOK LENGTH - ϕ HOOK TRUNNION TO ϕ HOOK POINT (INCHES)						
35 HYDRAULIC SYSTEM CAPACITY (GALS.)						
36 FUEL & LUBE SYSTEMS	Location	No. Tanks	****Gals. Protected	No. Tanks	****Gals. Unprotected	
37 Fuel - Internal	Wing	8	3490			
38	Fuse. or Hull					
39 External						
40 Bomb Bay						
41						
42 Oil						
43						
44						
45 STRUCTURAL DATA - CONDITION			Fuel in Wings (Lbs.)	Stress Gross Weight	Ult. L.F.	
46 FLIGHT			11058	67000	4.5	
47 LANDING			5525	68467		
48						
49 MAX GROSS WEIGHT WITH ZERO WING FUEL				62942		
50 CATAPULTING						
51 MIN. FLYING WEIGHT				45774		
52 LIMIT AIRPLANE LANDING SINKING SPEED (FT./SEC.)						
53 WING LIFT ASSUMED FOR LANDING DESIGN CONDITION (%W)						
54 STALL SPEED - LANDING CONFIGURATION - POWER OFF (KNOTS)						
55 PRESSURIZED CABIN - ULT. DESIGN PRESSURE DIFFERENTIAL - FLIGHT (P.S.I.)				0		
56						
57 AIRFRAME WEIGHT (AS DEFINED IN AN-W-11) (LBS.)						

*Lbs. of sea water @ 64 lbs./cu. ft.
**Parallel to ϕ at ϕ airplane.

***Parallel to ϕ airplane.
****Total usable capacity

TABLE XX. BASELINE TRANSPORT AIRCRAFT BALANCE CALCULATIONS
(WEIGHT EMPTY)

ITEM	WEIGHT	STATIONS			
		HORIZONTAL		VERTICAL	
		ARM	MOMENT	ARM	MOMENT
Cruise Mode (Blades Folded)					
Rotor Group	(4936)	(358)	(1,767,500)	(190)	(937,840)
Hub	1690	305	515,450	190	321,100
Blade Fold	750	305	228,750	190	142,500
Blades	2196	425	933,300	190	417,240
Spinners	300	300	90,000	190	57,000
Wing Group	(5710)	(426)	(2,432,460)	(190)	(1,084,900)
Tail Group	(982)	(750)	(736,500)	(242)	(237,153)
Horizontal	491	855	419,805	328	161,048
Vertical	491	645	316,695	155	76,105
Body Group	(5980)	(425)	(2,541,500)	(130)	(775,100)
Fuselage	5060	425	2,150,500	135	683,100
Cargo Loading System	920	425	391,000	100	92,000
Landing Gear	(3195)	(379.4)	(1,212,300)	(90)	(287,550)
Nose	645	140	90,300	90	58,050
Main	2550	440	(1,122,000)	90	229,500
Flight Controls	(3636)	(357.4)	(1,299,463)	(1865)	(678,185)
*Cockpit	103	190	19,570	130	13,390
*Fuselage	345	360	124,200	190	65,550
*Eng. Section	175	488	85,400	153	26,775
*Wing					
Inboard	178	491	87,398	190	33,820
Outboard	260	477	124,020	190	49,400
*Tip Pod	175	365	63,875	190	33,250
Rotor Controls	1350	305	411,750	190	256,500
Tilt Mechanism	1050	365	383,250	190	199,500
Engine Section	(1250)	(468)	(585,000)	(153)	(191,250)
Tip Pod	(1811)	(450.3)	(815,495)	(190)	(344,090)
Tilting	935	385	359,975	190	177,650
Fixed	876	520	455,520	190	166,440
Engines	(2134)	(508)	(1,084,072)	(153)	(326,502)
Air Induction	(360)	(453)	(163,080)	(153)	(55,080)
Cooling	(15)	(488)	(7,320)	(153)	(2,295)
Lubrication	(26)	(453)	(11,778)	(153)	(3,978)
*Location Indicated					

TABLE XX. BASELINE TRANSPORT AIRCRAFT BALANCE CALCULATIONS

ITEM	WEIGHT	STATIONS			
		HORIZONTAL		VERTICAL	
		ARM	MOMENT	ARM	MOMENT
Fuel System	(2489)	(439.7)	(1,094,465)	(190)	(472,910)
Inboard - Forward	750	405	303,750	190	142,500
- Aft	675	475	320,625	190	128,250
Outboard - Forward	430	415	178,450	190	81,700
- Aft	634	460	291,640	190	120,460
Engine Controls	(42)	(488)	(20,496)	(153)	(16,426)
Starting System	(148)	(488)	(72,224)	(153)	(22,644)
Drive System	(4185)	(365.4)	(1,639,055)	(190)	(852,150)
Pylon Gear Box	440	448	197,120	190	83,600
Pivot Gear Box	470	420	197,400	190	89,300
Main Gear Box	2730	330	900,900	190	518,700
Lubrication	420	390	163,800	190	79,800
Shafting - Tip Pod	95	375	35,625	190	18,050
- Wing	330	437	144,210	190	62,700
Fan Installation	(2284)	(386.7)	(883,262)	(153)	(349,452)
Fan & Shroud	574	368	211,232	153	87,822
Gear Boxes	1710	393	672,030	153	261,630
Aux. Power Plant	(182)	(510)	(92,820)	(100)	(18,200)
Instruments & Navig.	(400)	(291)	(116,424)	(155)	(62,150)
Hydraulics	(292)	(510)	(148,920)	(100)	(29,200)
Electrical	(775)	(376)	(291,790)	(166)	(128,075)
Electronics	(950)	(200)	(190,000)	(160)	(152,000)
Armor	(50)	(170)	(8,500)	(160)	(8,000)
Furnishings & Equipment	(1470)	(324)	(476,230)	(161.6)	(237,500)
Personal Accommodations	628	281	176,720	160	100,480
Misc.	110	170	18,700	160	17,600
Furnishings	517	380	196,460	160	82,720
Emergency - Fuselage	15	170	2,550	160	2,400
- Eng. Sect.	100	488	48,800	153	15,300
- Tip Pod	100	330	33,000	190	19,000
Air Cond. & De-Icing	(519)	(370)	(191,820)	(170.2)	(88,340)
Air Conditioning	219	380	83,220	160	35,040
De-Icing - Eng. Sect.	100	393	39,300	153	15,300
- Tip Pod	100	305	30,500	190	19,000
- Wing	100	388	38,800	190	19,000

TABLE XXI. BASELINE TRANSPORT MISSION GROSS WEIGHTS

Design Condition	Weight (lb)	Cruise on Fan			Cruise on Rotor			Hover		
		Center of Gravity Fuselage Sta	Center of Gravity Waterline	MAC %	Center of Gravity Fuselage Sta	Center of Gravity Waterline	MAC %	Center of Gravity Fuselage Sta	Center of Gravity Waterline	MAC %
Operating Weight Empty	46,494	402	166	20.8	396	166	16.8	419	189	32.2
Design Gross Weight	67,000	406	166	23.5	402	166	20.8	418	182	31.5
Landing Gross Weight	68,467	401	161	20.0	398	161	18.0	413	177	28.2
Maximum Gross Weight	74,000	404	164	22.1	401	164	20.0	415	178	29.5
Max. Gross Weight (Ferry)	80,387	409	170	25.5	406	170	23.5	419	184	32.2

The horizontal flight center of gravity limits are between 13- and 33-percent MAC. The vertical flight center of gravity limits are between 26- and 45-percent MAC.

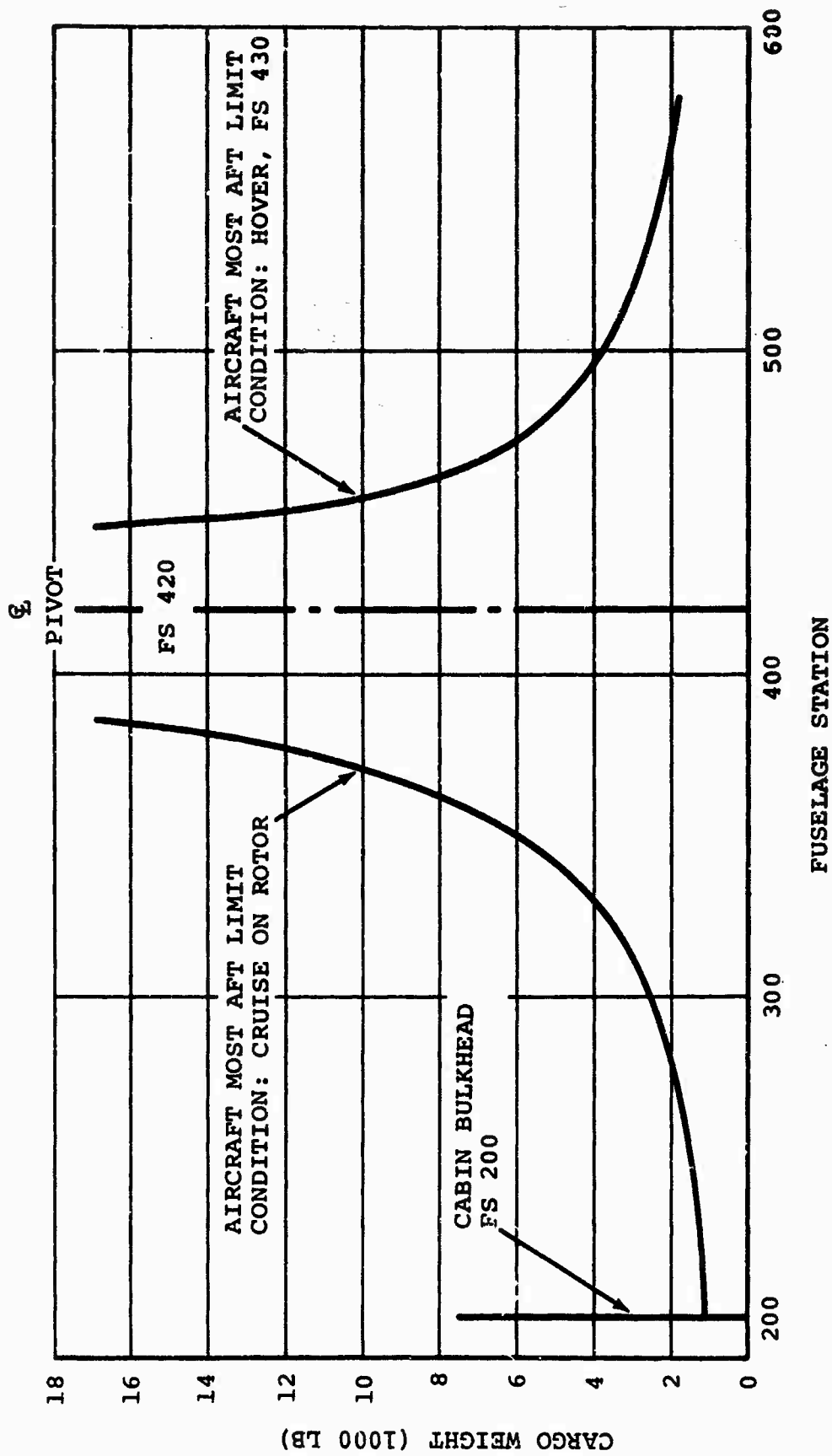

Figure 49. Baseline Transport Cargo Loading Diagram.

TABLE XXII. MOMENTS OF INERTIA TRANSPORT

Item	Weight (lb)	Center of Gravity		Inertia (Slug Ft ²)		
		Fuselage Sta	Water- line	Roll	Pitch	Yaw
<u>Design Gross Weight</u>						
Cruise on Fan	67,000	405.7	166.0	651,958	205,757	787,602
Cruise on Propeller	67,000	401.8	166.0	651,851	207,835	793,876
Hover	67,000	417.6	181.8	694,014	229,782	779,925
<u>Maximum Design Gross Weight</u>						
Cruise on Fan	74,000	404.2	163.5	657,091	211,871	789,301
Cruise on Propeller	74,000	400.6	163.5	656,984	211,949	795,575
Hover	74,000	413.0	177.9	699,147	233,896	781,624
<u>Landing Gross Weight</u>						
Cruise on Fan	68,467	401.3	161.4	581,426	209,817	712,970
Cruise on Propeller	68,467	397.5	161.4	581,319	209,895	719,244
Hover	68,467	413.0	176.9	634,820	231,842	705,293

SECTION VIII

PROPULSION

1. ROTOR CHARACTERISTICS

The purpose of this section is to determine the sensitivity of rotor performance to major rotor parameters and to define a suitable rotor blade configuration for the stowed-tilt-rotor aircraft which will yield optimum hover performance at the following operating conditions:

a. Altitude	6000 feet
b. Ambient Temperature	95°F
c. Disc Loading	15.0 psf
d. Tip Speed	870 fps
e. Hover Thrust to Weight Ratio	1.12

In addition, the following geometric constraints were established:

- a. Four blades (principally minimize rotor nacelle diameter but also desirable to minimize noise).
- b. Constant blade chord (minimize rotor nacelle diameter).
- c. Ratio of hub diameter to rotor diameter: 1:12 (.083).

These geometric conditions have been fulfilled in the design presented (Reference Volume II, Section V), and summarized in Table XXIII.

A performance evaluation of the rotor was undertaken and the significant performance characteristics of the blade, based on this evaluation, are presented in the attached data plots. The method used to obtain the rotor performance data which was utilized in the optimization of the aircraft for the mission requirements is presented below.

The Boeing propeller/rotor performance analysis consists of a strip analysis procedure coupled with nonuniform in-flow calculations. Each blade is treated as a rotating lifting line, trailing a vortex wake which is mathematically approximated by a finite number of concentrated vortex filaments. An iterative computation is followed to make the induced flow at the disc (determined by the trailing vortices) mutually consistent with the spanwise aerodynamic loading distribution. The wake shape for the hovering

TABLE XXIII. SUMMARY OF ROTOR CHARACTERISTICS

Design Conditions	V (kn)	HP	V _T (fps)	Altitude (ft)	Temp	Required η or FM	Actual η or FM
Hover	0	10,600	870	6,000	95°F	Optimum	0.761
Climb	200	7,200	696	SL	Std Day	NA	0.625
Level Flight	250	5,030	609	SL	Std Day	NA	0.515

NOTES:

- 1) Number of Blades = 4
- 2) Activity Factor or Solidity = 62/.100
- 3) Rotor Diameter = 49.2 feet
- 4) Thickness Ratio: Root t/c = 20 percent
Tip t/c = 6 percent
- 5) Twist (20 percent radius to tip) = 23.5 degrees

prop/rotor is determined empirically as shown in Figure 50. The proper definition of the contraction characteristics is necessary to properly orient the trailed vortices in space in such a way that correct induced velocities are computed at the prop/rotor. (The program is documented in Boeing Report R-372A, ANALYSIS OF PROPELLER AND ROTOR PERFORMANCE IN STATIC AND AXIAL FLIGHT BY AN EXPLICIT VORTEX INFLUENCE TECHNIQUE (EVIT)).

The method and analysis for calculating the performance of rotors was checked against the available test data as shown on Figures 51 and 52. Note that at the hover condition the calculated performance accurately predicts the test performance. This would be expected since the wake shape parameter had been adjusted to provide agreement with test data. The blades to be used on this aircraft will cover the same parameters as this test data; therefore, it is anticipated that the quoted performance will agree with the actual performance, with good accuracy.

At the cruise condition, the agreement with test data is shown for two cases: 1) the agreement with the test data conducted in the Ames 40 X 80-foot wind tunnel on the XC-142 propeller, and 2) the agreement with tests run on ONERA. In both cases, the calculated performance agrees well with the test data; therefore, the achievement of the in-flight efficiency quoted in this document can be expected.

Advanced Boeing-Vertol airfoil sections were selected to provide the moderate camber required for hover performance. These airfoil sections have been extensively wind-tunnel tested for a range of Mach numbers and lift coefficients.

Figure 53 shows the effect of blade twist and solidity on the Figure of Merit. The total blade twist of the selected configuration is near the optimum indicated by the shaded area of the upper figure. The blade twist over the effective portion of the blade (i.e., 0.2 radius to tip) is 23.5 degrees. The lower figure shows design point solidity very close to that which gives maximum efficiency. The solidity appears slightly below the 0.108 at maximum efficiency (i.e., $\sigma = 0.10$) because it was necessary to achieve a CT/σ not exceeding 0.12 as required in the basic criteria.

Hover performance for the 15 psf baseline aircraft rotor is described in Figure 54 and blade angles are given in Figure 55 as functions of tip Mach number and thrust coefficient.

The cruise performance (Figures 56 and 57) for the same rotor covers the range of advance ratios and thrust coefficients expected for the low speed prop/rotor cruise and climb flight modes. Figure 58 shows the selected blade characteristics.

Toward the end of the study, the thickness to chord ratio was increased at the aerodynamic blade root from 16 to 20 percent because of increased loads and other design considerations. The t/c then decreased towards the tip to 10.6 percent at approximately 0.3 radius and continues as shown in Figure 58 to 6.0 percent at the tip. This change will have a negligible effect on the rotor performance. Further blade definition, load criteria, and recommendations are presented in Volume II, Section V, of this report.

LEGEND

- CH-47B
- ◇ 10 FT ROTOR NASA TND245
- ◊ BOEING LDL PROP/ROTOR
- HS 2FE163A
- ☆ HS SK59868-12.2
- HS SK59868-17.2
- ▷ HS 2J17G3-26R
- △ CH-47A

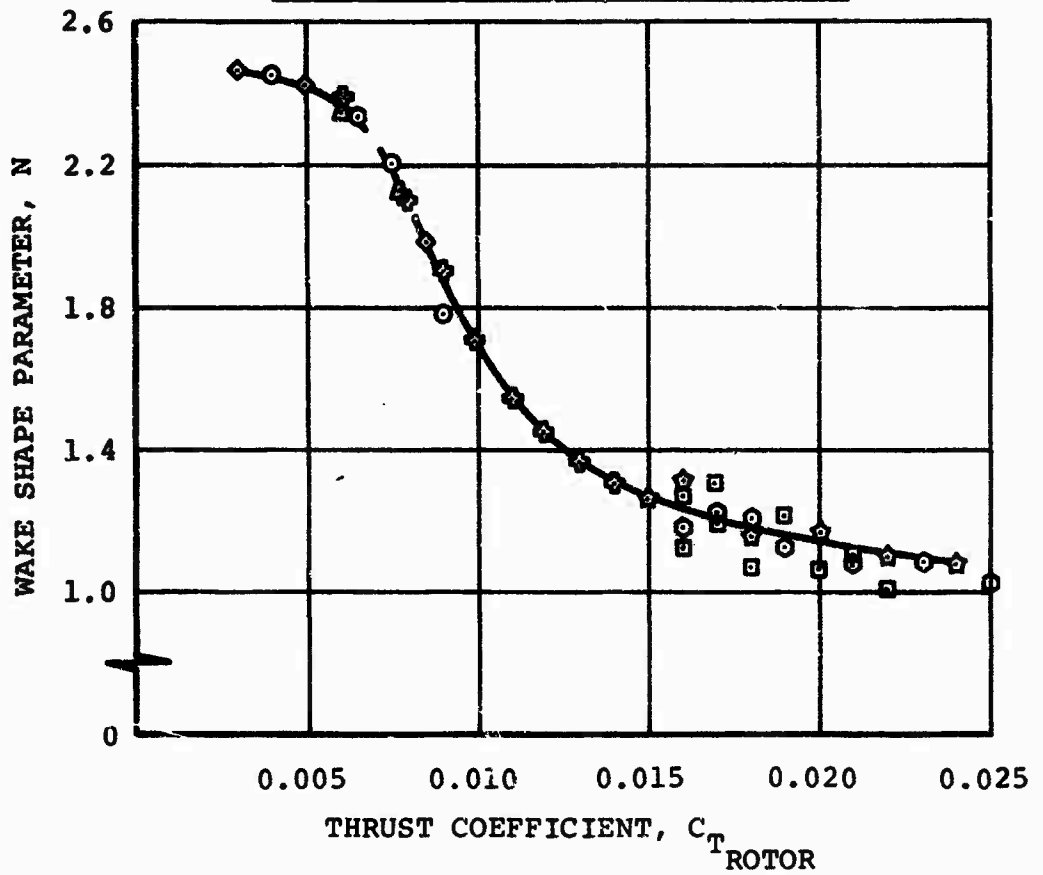

Figure 50. Rotor Wake Shape Parameter.

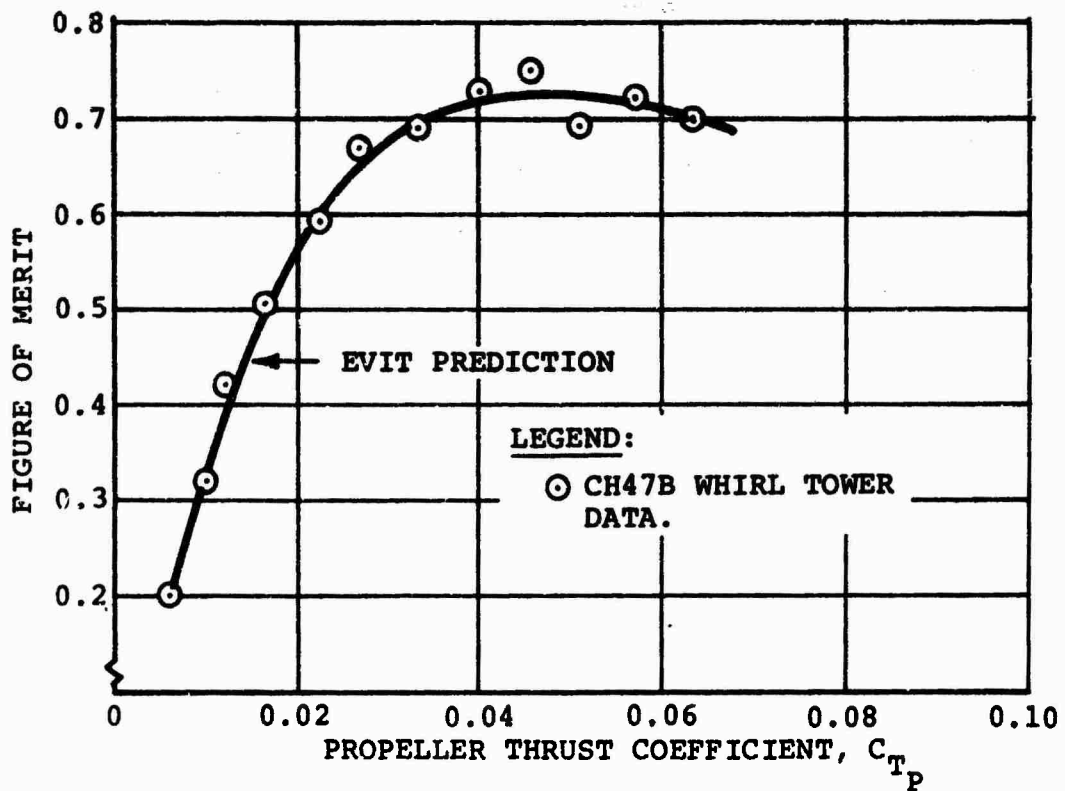
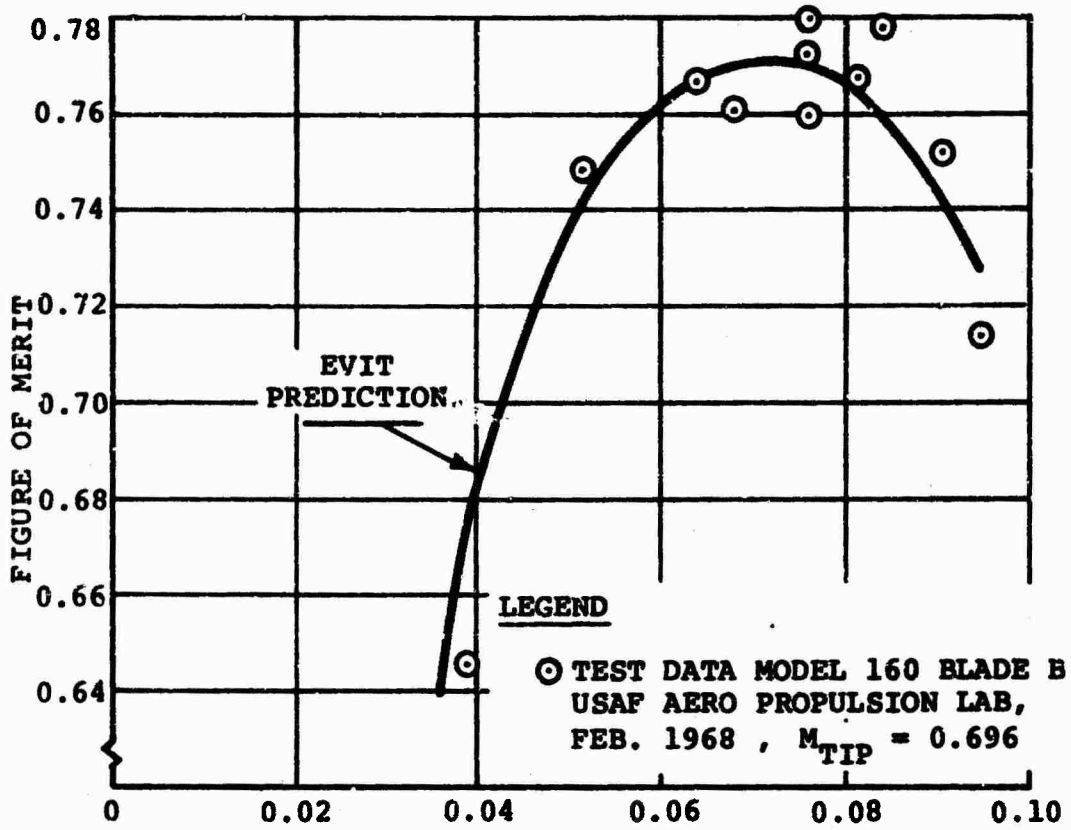

Figure 51. Correlation of Test Data With Rotor Hover Performance Predicted by Explicit Vortex Influence Technique.

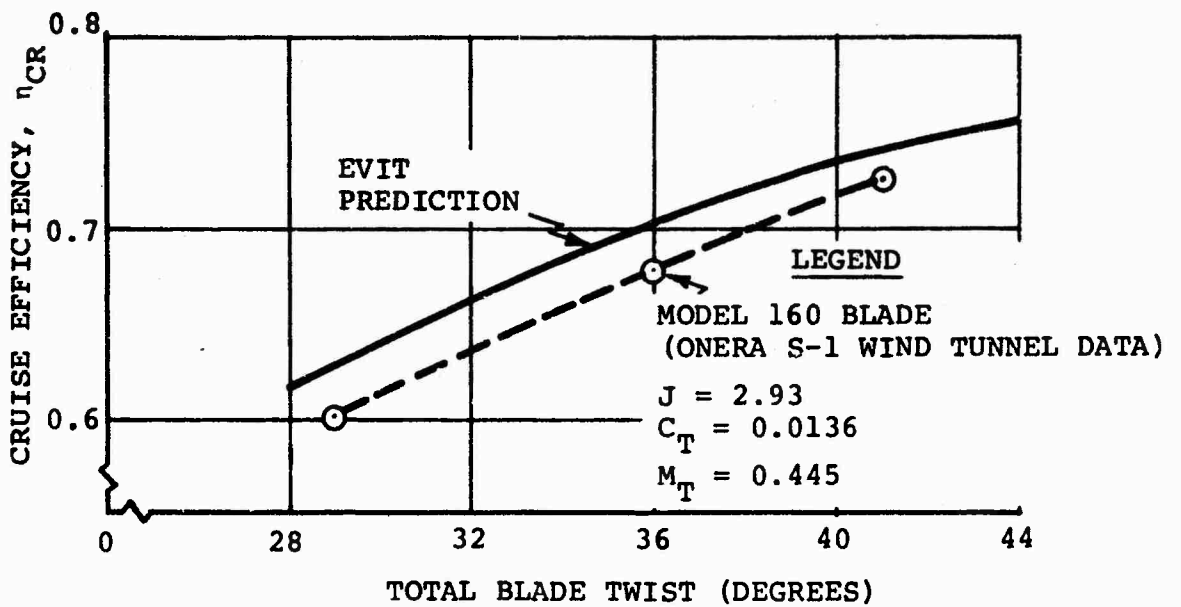
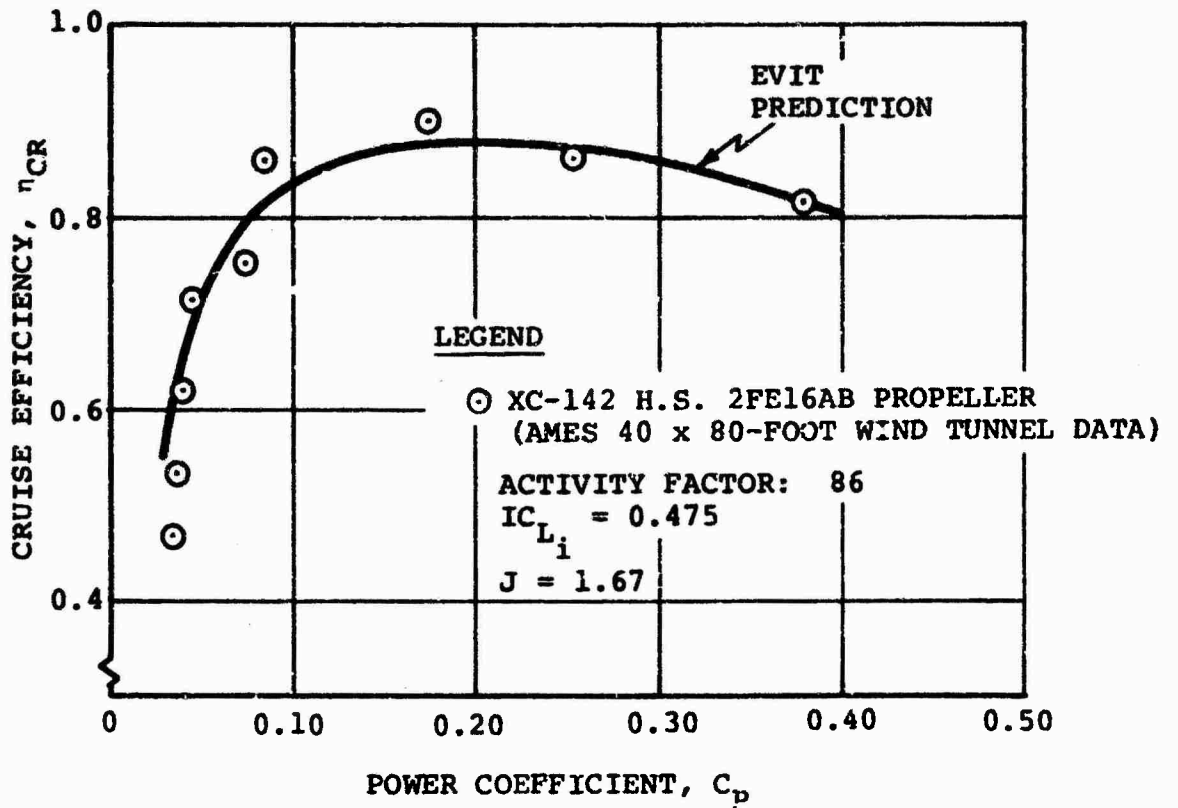
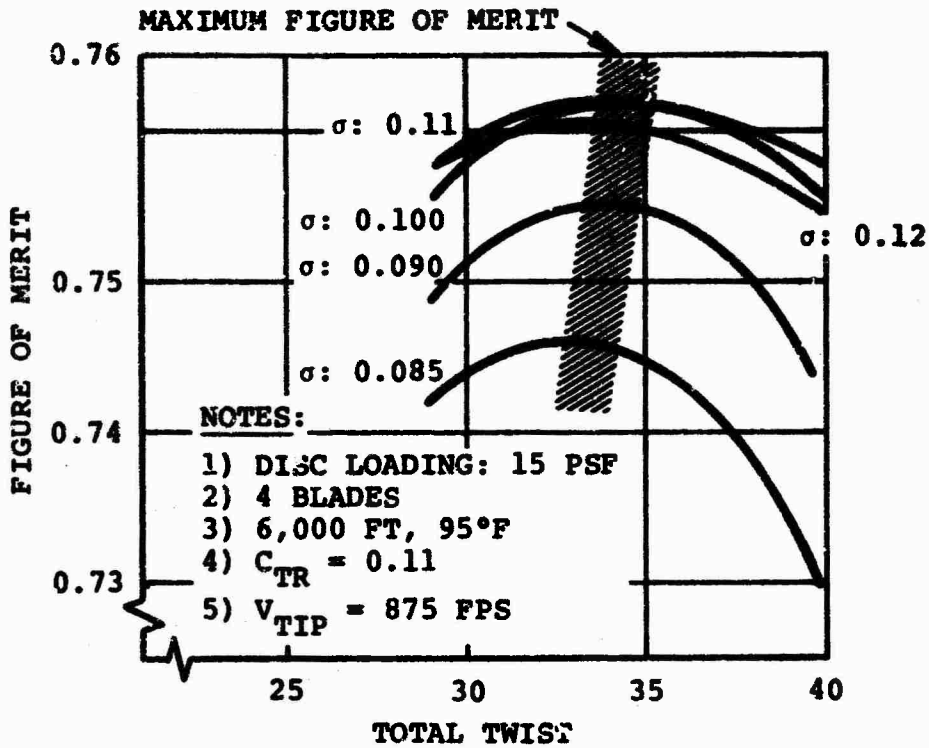

Figure 52. Correlation of Test Data With Low Speed Rotor Cruise Performance Predicted by Explicit Vortex Influence Technique - Cruise Efficiency Versus Total Blade Twist.

A. EFFECT OF TWIST



B. EFFECT OF SOLIDITY

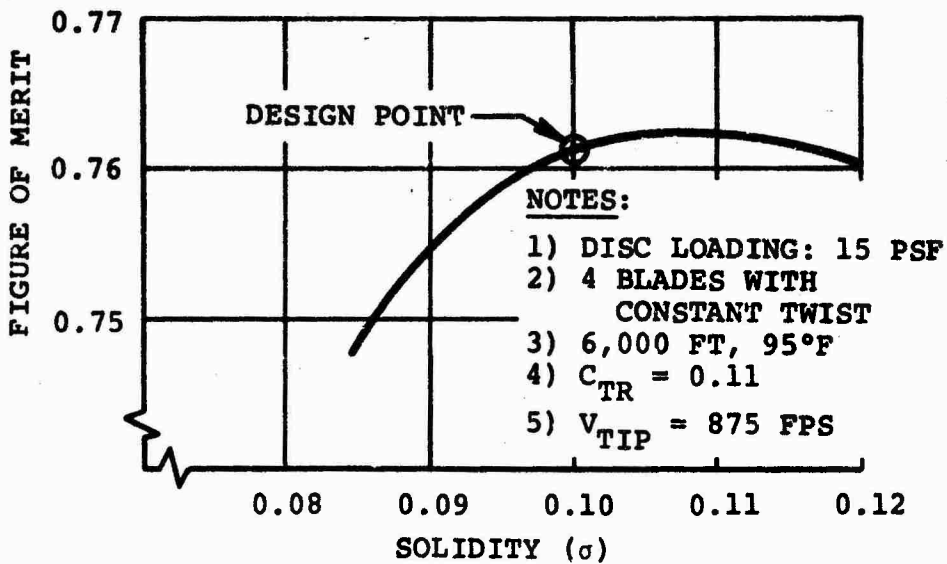

Figure 53. Effect of Twist and Solidity on Hover Performance.

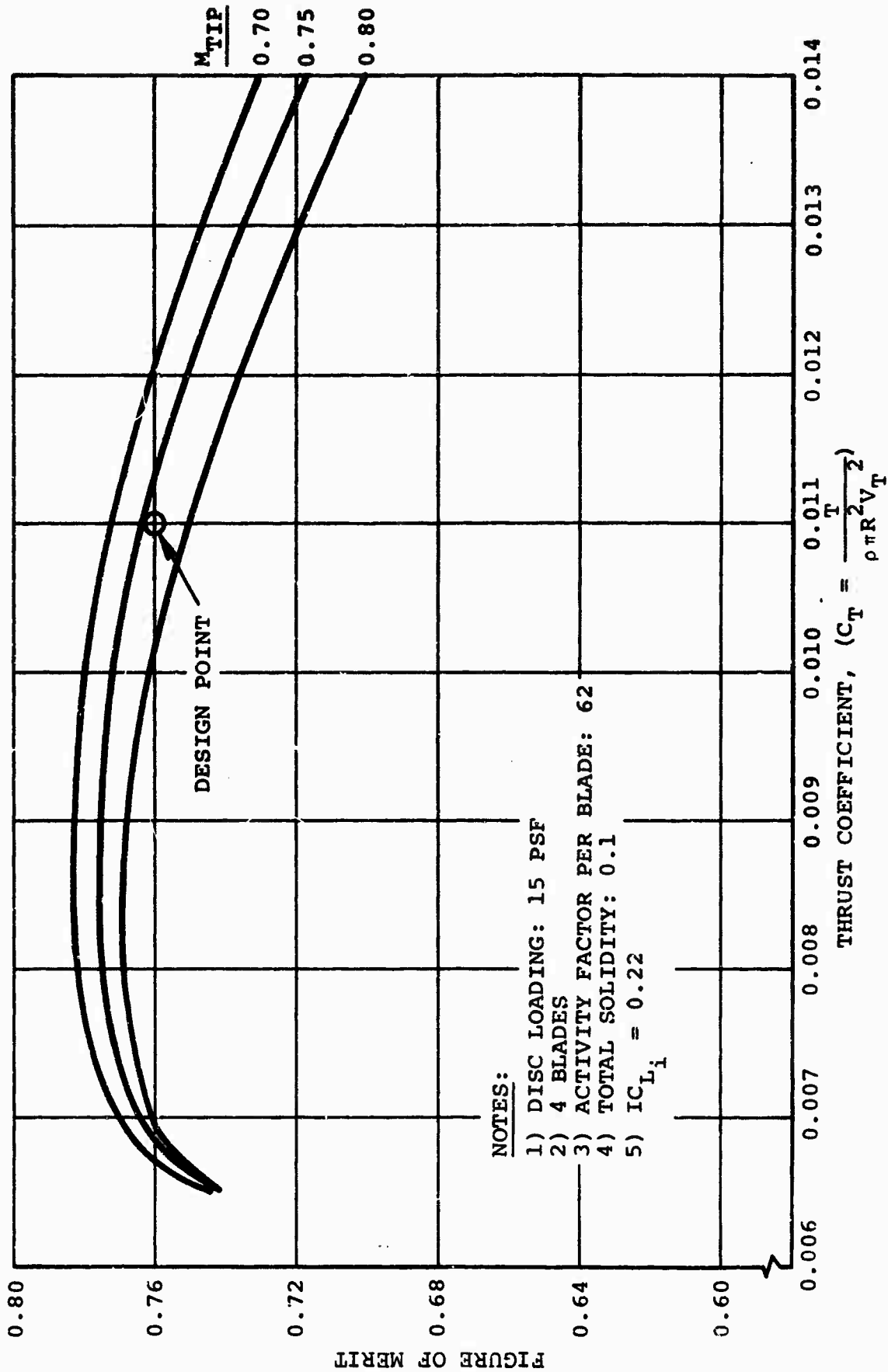

Figure 54. Hover Rotor Performance - Figure of Merit Versus Thrust Coefficient.

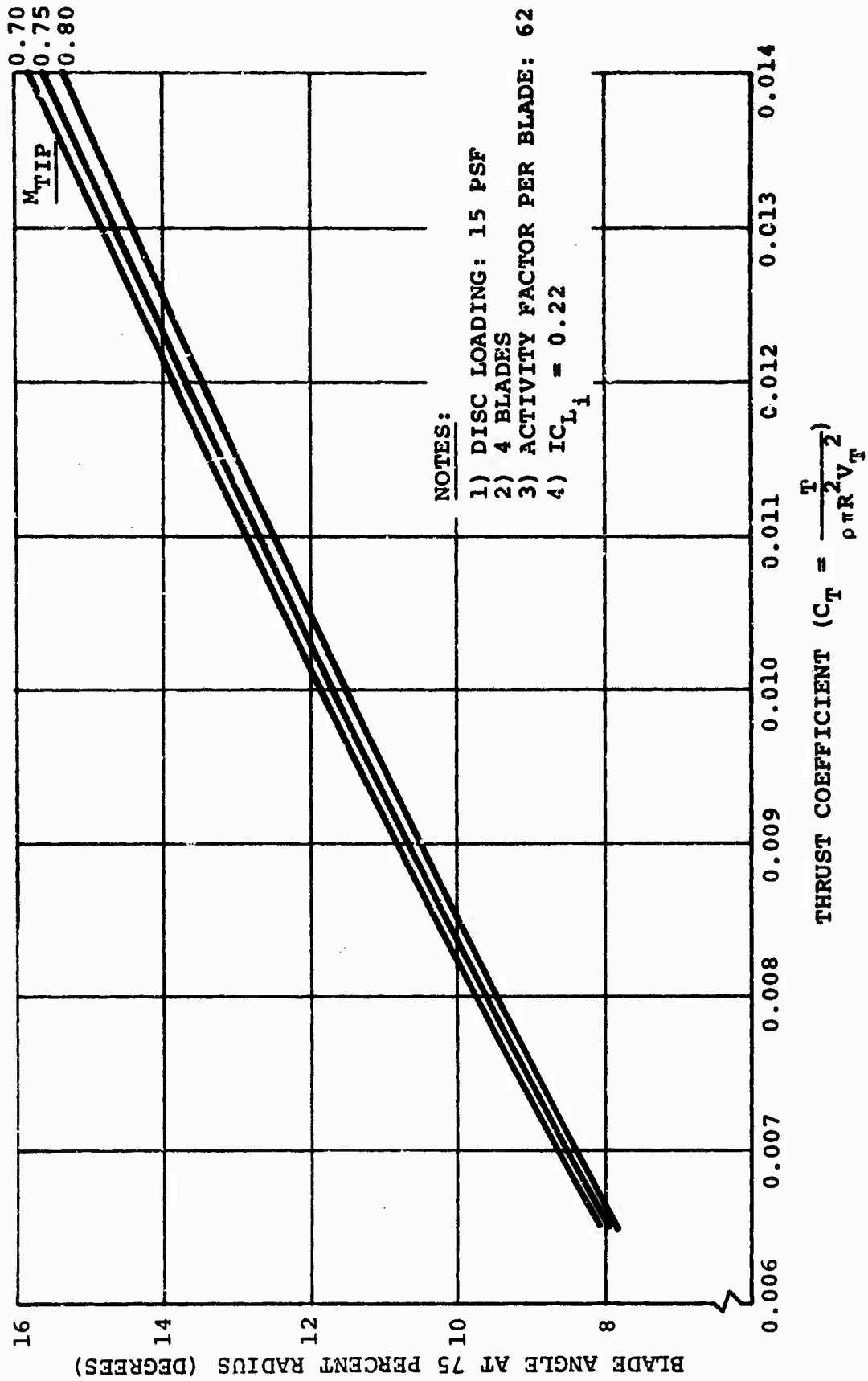

Figure 55. Hover Rotor Performance - Blade Angle Versus Thrust Coefficient.

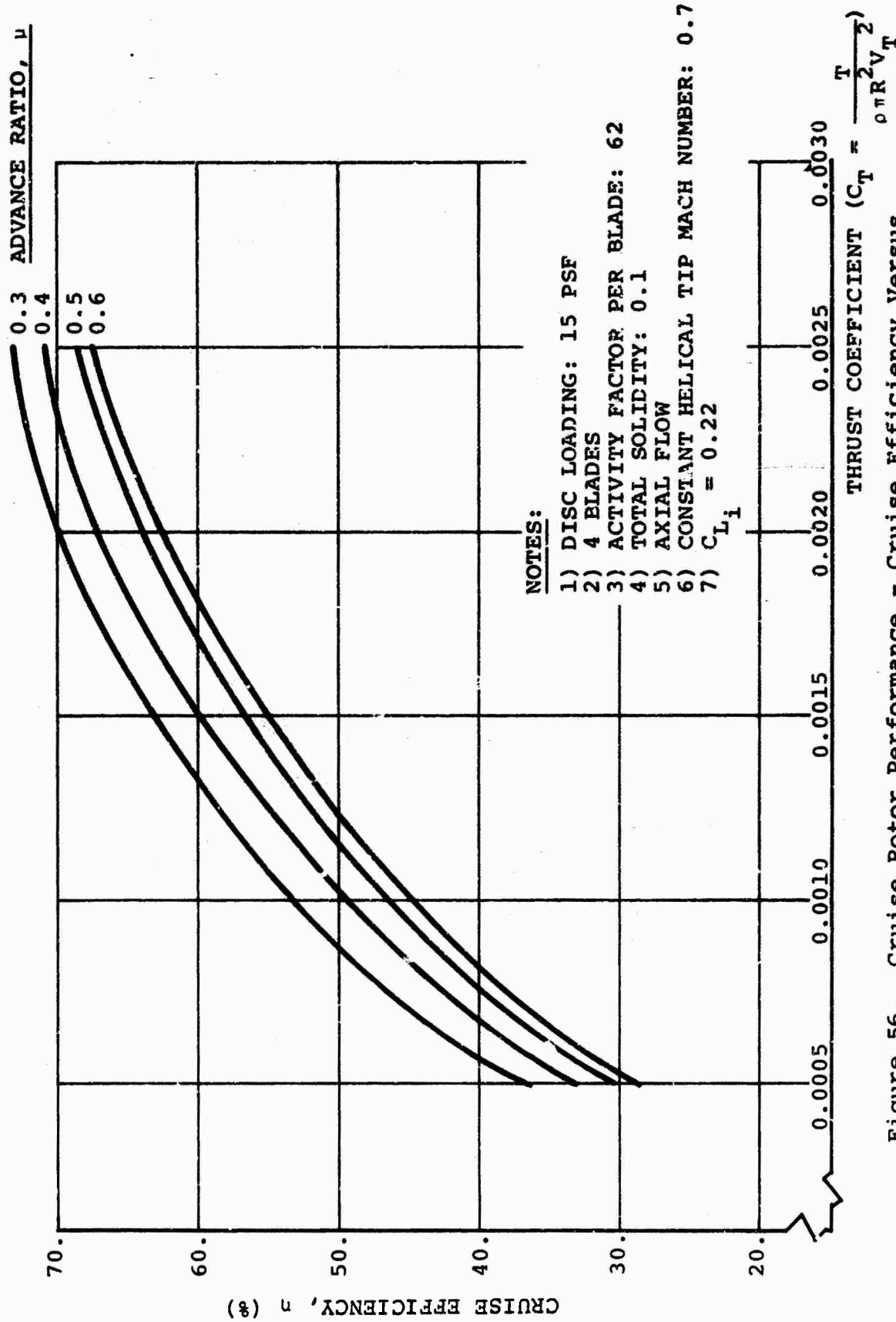
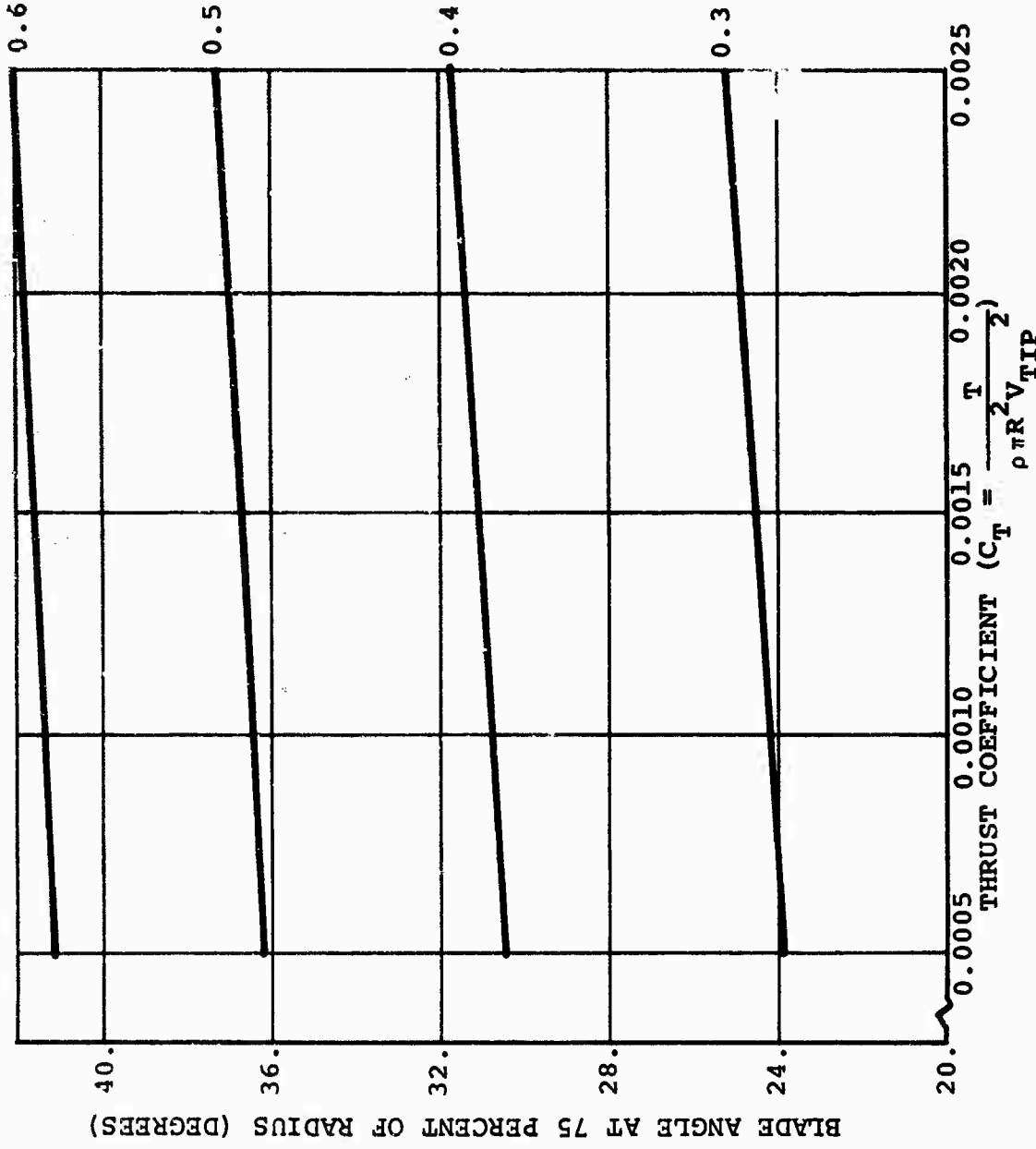

Figure 56. Cruise Rotor Performance - Cruise Efficiency Versus Thrust Coefficient.

ADVANCE RATIO, μ



NOTES:

- 1) DISC LOADING: 15 PSF
- 2) 4 BLADES
- 3) ACTIVITY FACTOR
PER BLADE: 62
- 4) TOTAL SOLIDITY: 0.1
- 5) AXIAL FLOW
- 6) CONSTANT HELICAL
TIP MACH NUMBER: 0.7
- 7) IC_{Li} = 0.22

Figure 57. Cruise Rotor Performance - Blade Angle Versus Thrust Coefficient.

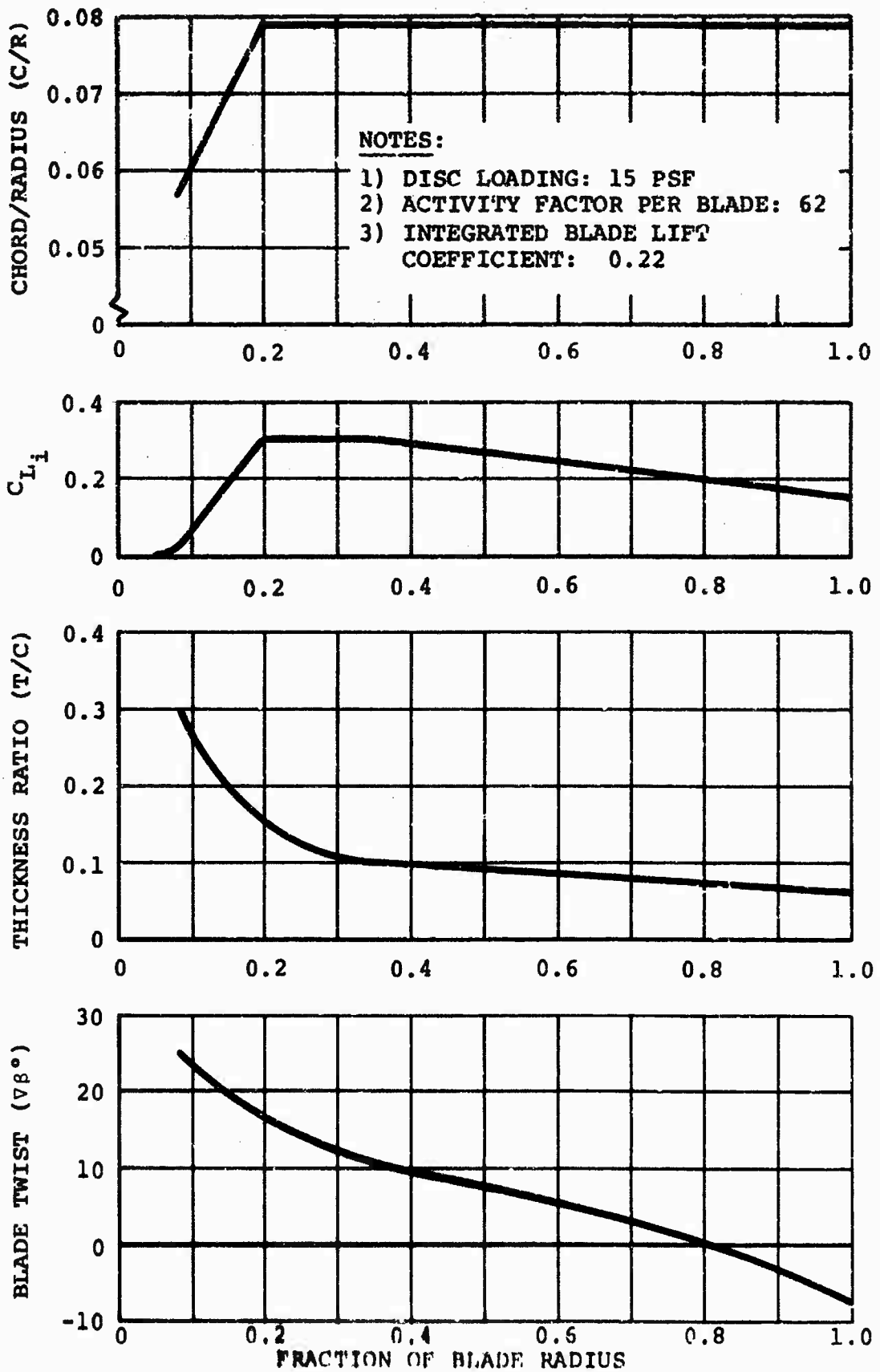

Figure 58. Rotor Blade Characteristics.

2. ENGINE CHARACTERISTICS

a. General Engine Characteristics

Planned military aircraft development programs (Air Force LIT and ARRS, Army HLH) have spurred engine manufacturers to propose advanced turboshaft engine candidates for these aircraft. These are growth versions of existing engines, shaft power derivatives of turbofans funded through development, derivatives of component test hardware, or new engines. Proposed schedules are such that their qualification tests would come in about the 1973 time period. This time frame is generally consistent with the schedule for development of the stowed-tilt-rotor aircraft. Performance and weight characteristics of one of the General Electric derivative engines were selected to the power requirements scale of the study aircraft. Turboshaft engine design parameters are as follows:

Compressor Pressure Ratio	15.5
Maximum Turbine Inlet Temperature	2195°F
Specific Horsepower, SHP/Wa	173.5 hp/lb/sec
Specific Fuel Consumption, SFC	0.44 lb/hr/hp
Shaft Horsepower/Engine Weight	7.2 hp/lb

The performance data supplied by General Electric were used to develop design-point component pressure ratio, temperature, and efficiency characteristics and turbine cooling-air requirements. Additional General Electric data were used to generate the compressor performance characteristics in terms of pressure ratio, referred inlet flow, referred compressor speed, and efficiency along the engine generating line.

The cruise exhaust nozzle area of the engine was sized to optimize (for cruise flight) the division of the energy available from the gas generator, between the shaft power to the fan and the engine exhaust kinetic energy. The proper exhaust nozzle produces a maximum combined fan-plus-engine thrust, and, consequently, a minimum cruise thrust specific fuel consumption (TSFC). The carpet plot in Figure 59 illustrates, for a typical altitude cruise condition, this minimum TSFC for each bypass ratios intersected by dashed lines of constant fan pressure ratio. The large static exhaust area of the variable engine exhaust nozzle was selected to maximize the shaft power supplied to the rotors.

20,000 FEET ALTITUDE

430 KNOTS CRUISE SPEED

ENGINE SPECIFIC HORSEPOWER = 177 HP/LB/SEC

(REFERENCE 3)

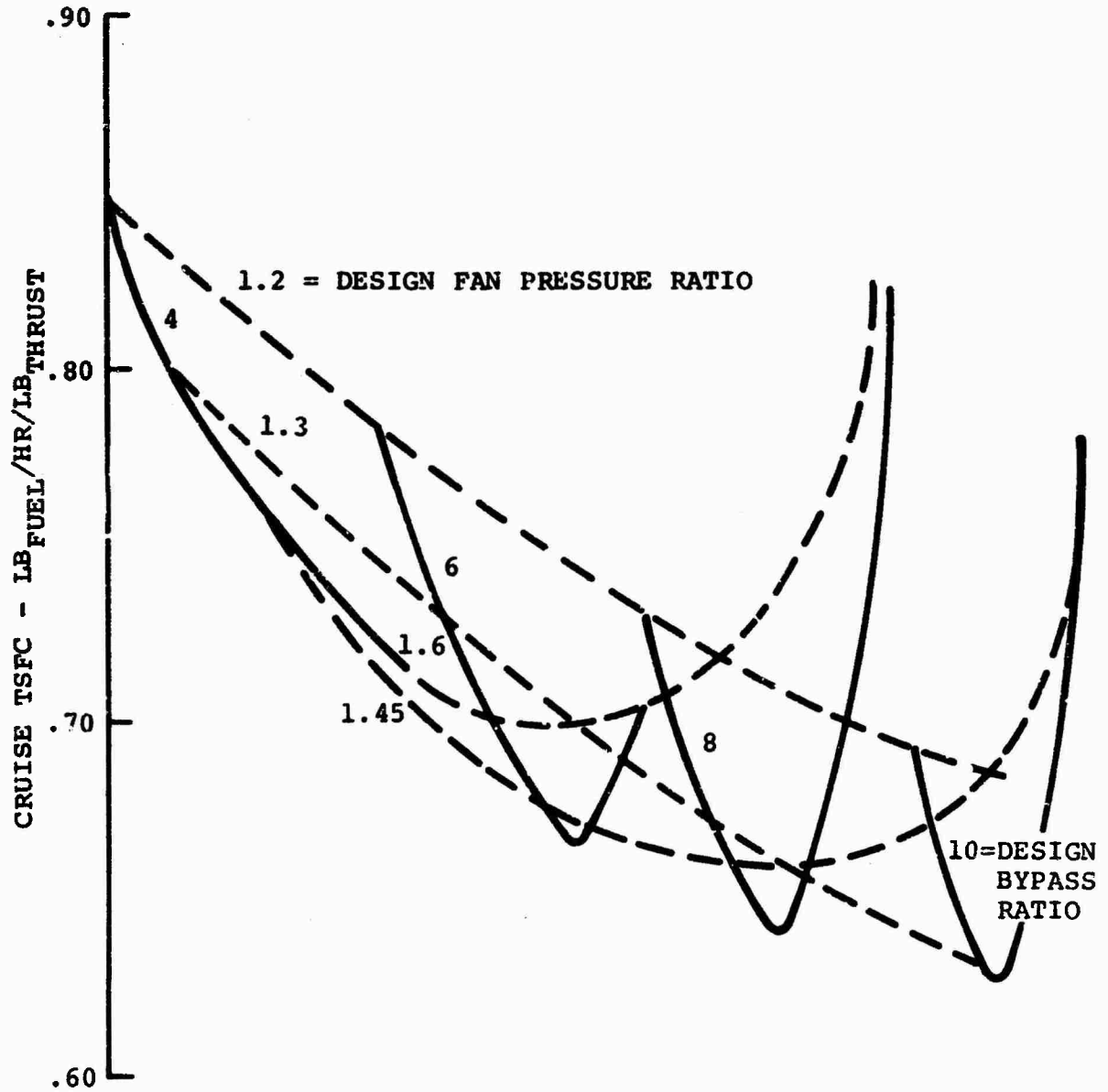

Figure 59. Fan Bypass Ratio Versus Pressure Ratio Optimization.

The design-point aerodynamic match of the supercharging fan to the shaft engine was planned to be at compressor design speed to prevent stress problems due to high gas generator speeds. Because of the temperature increase through the fan, there was a compressor referred speed lower than that of the shaft engine and, consequently, a lower pressure ratio developed by the compressor. The turbine inlet temperature at the design point was selected as 2220°F to produce the correct referred flow conditions at the inlet of both the gas generator turbine and the power turbine. This engine match was chosen to reproduce the same compressor operating line for the shaft engine and the engine driving a supercharging fan stage.

Design-point performance of the fan and engines was calculated with a fan adiabatic efficiency of 0.87 and an efficiency of 0.97 for both fan and gas generator exhaust nozzles. Trends of the thrust performance of the system as a function of altitude, ambient temperature, and flight speed were developed by interpolation of the data for a parametric family of fan engines with turbine inlet temperatures of 2600°F, overall engine pressure ratios between 15 and 30, and bypass ratios from 2 to 16 (Reference 4). Table XXIV is a summary of engine and fan performance parameters.

The installation losses for the powerplant system were assumed to be 95 percent ram recovery and 2 percent inlet pressure loss.

TABLE XXIV. ENGINE AND FAN PERFORMANCE DATA

Performance Parameter	Fan Design Bypass Ratio			
	4.0	6.0	8.0	10.0
Fan Design Pressure Ratio	1.75	1.51	1.37	1.31
Engine Overall Pressure Ratio	21.5	20.4	19.4	19.0
Fan and Engine Thrust per Engine SHP (lb/hp) (SL Std, Max Pwr)	1.35	1.47	1.565	1.667
Engine Specific Fuel Con- sumption (SFC) (lb/hr/hp)				
SL Std Max Pwr	0.443	0.443	0.443	0.443
6000 ft, 95°F Mil Pwr	0.450	0.450	0.450	0.450
Thrust Specific Fuel Con- sumption (TSFC) (lb/hr/hp)				
20,000 ft, AFHD, Mach 0.635, NRP	0.722	0.70	0.698	0.77

The compressor pressure ratio is typical of those for the advanced turboshaft engine candidates, which cover a range from 13.5 to 20.1. Turbine inlet temperature also is typical of these advanced engines and matches the generally projected 30°F rise per year from the baseline of contemporary production engine turbine temperatures.

Emergency ratings were assumed to be a reasonable 110 percent maximum power.

b. Engine Installation

There are many possible propulsion system configurations in terms of engine and fan placement. The system pictured in Figure 60 was the one selected by Boeing as the best for the folding tilt rotor aircraft; it has many advantages. The propulsion package is generally similar in installation to a fully-integrated convertible engine and could readily be replaced by such an engine in a systems prototype program leading to production aircraft.

Auxiliary inlet doors in the outer cowl provide air to the engines when the fan is decoupled and to guide vanes which are fully modulated in hover and low speed flight. Provision for particle separation in the engine airflow during hover can be made by installing banks of Donaldson tubes in the auxiliary inlets and adding a particle-extraction reverse flow of exhaust gases through the fan duct. Anti-icing the Donaldson tube separator presents a problem for which solutions must be determined.

In the conventional cruise flight mode, engine air is supplied through the fan inlet, providing the engine with the fan supercharging noted above. This mode is advantageous for high speed aircraft configurations in which cruise is the critical engine sizing criterion; also, the increased overall engine pressure ratio with supercharging produces an improvement in cruise thrust specific fuel consumption (TSFC). Figure 61 is included here to show the location of the engine in relation to the fan and rotor transmission drives.

c. Selected Engine Characteristics

The above engine data was utilized to predict the performance and size (gross weight) of the design point configuration within the specified mission profiles. Based on these studies, the bypass ratio 6.0 engine was selected as the most effective combined thrust and

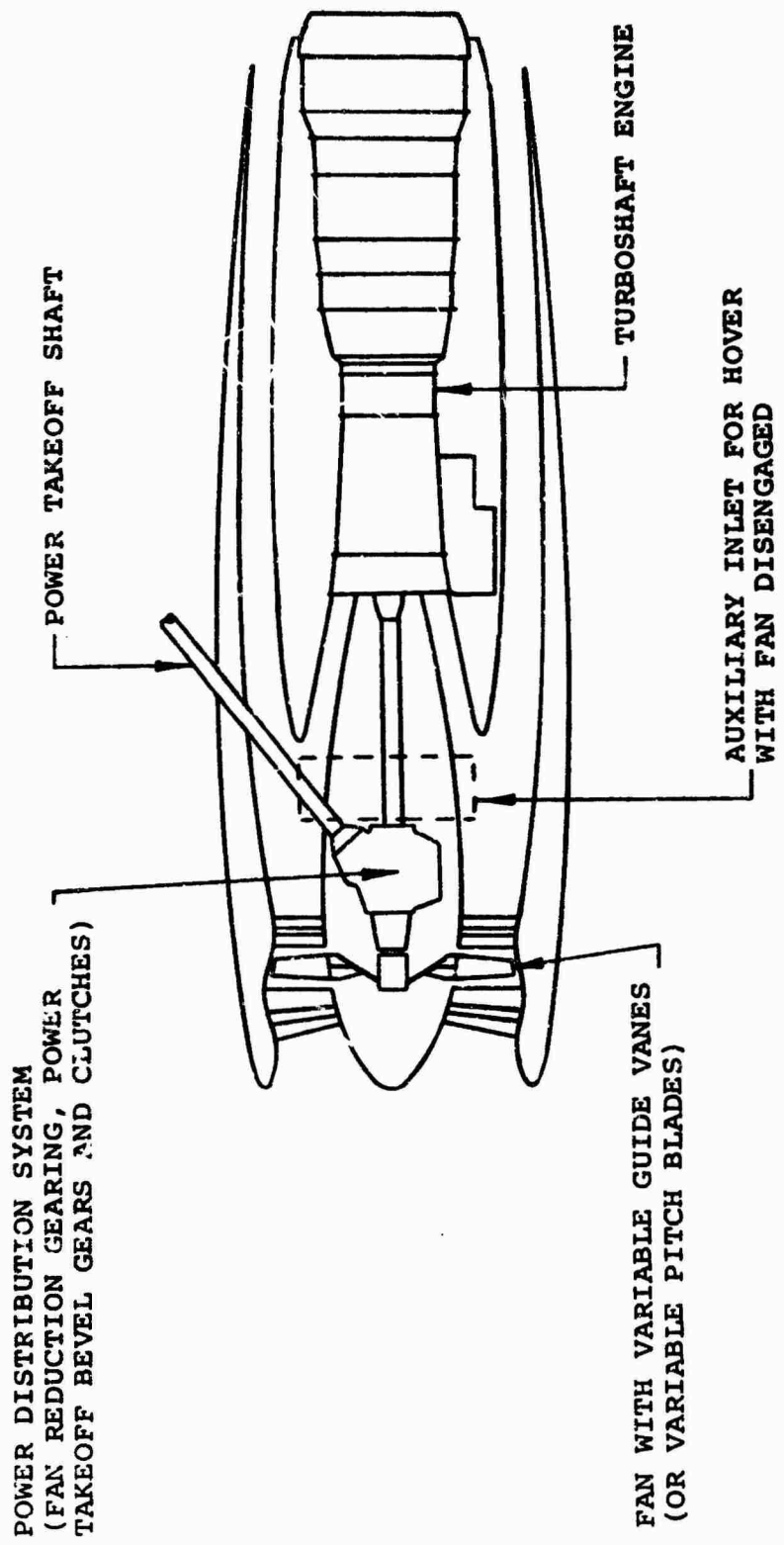

Figure 60. Interim Convertible Engine.

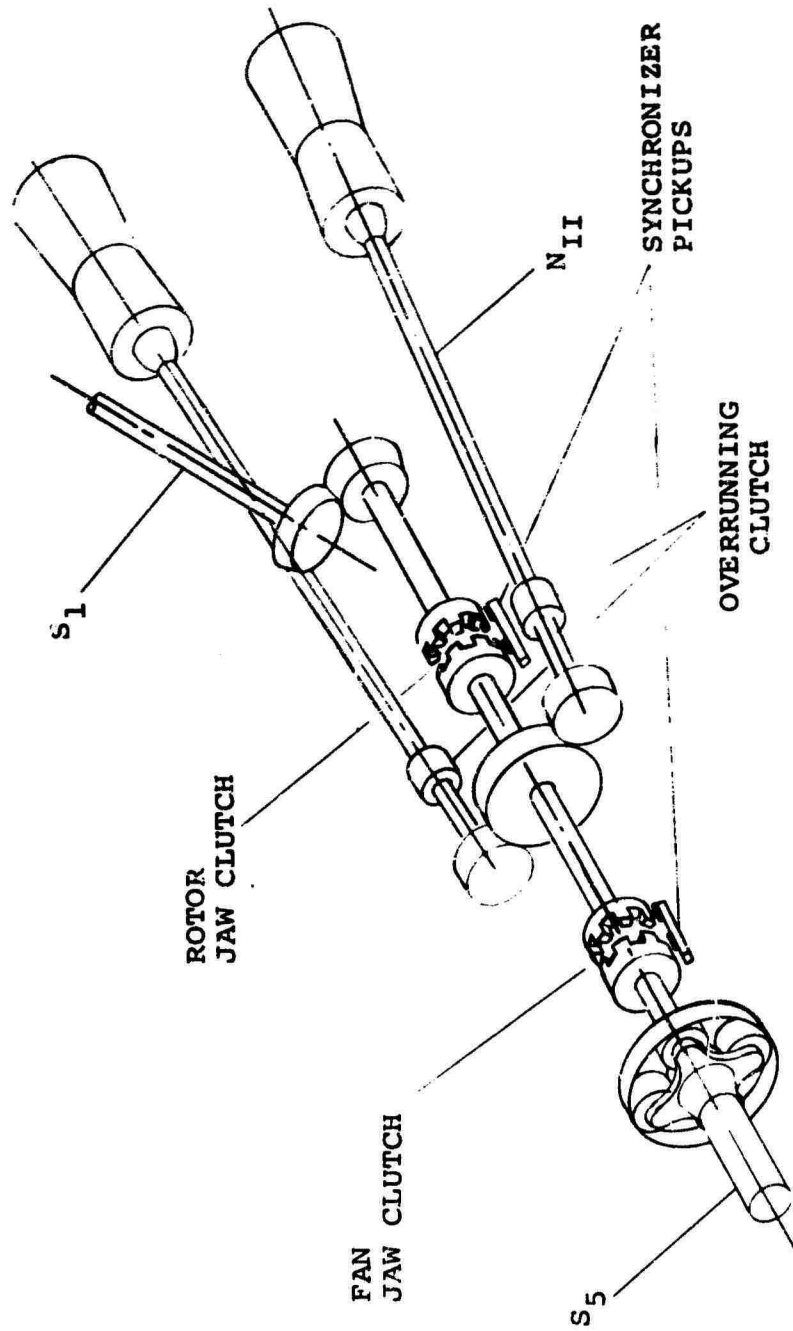

Figure 61. Interim Convertible Engine Drive System Schematic.

shaft power producer when integrated to the configuration and mission requirements. The basic engine performance data consists of plots showing the value of four variables: thrust (power), fuel flow (SFC), gas generator shaft rpm, and power turbine shaft rpm. These plots are presented in Figures 62, 63, 64, and 65 respectively. These plots show the significant characteristics as a function of Mach number and turbine inlet temperature. All data are in referred normalized format as shown in Table XXV below.

TABLE XXV. ENGINE DATA SYMBOLS

Variable	Symbol	Referred Normalized Form
Thrust	F_N	$F_N / \delta F_N^*$
Power	SHP	$SHP / \delta \sqrt{\theta} SHP^*$
Gas Generator RPM	N_I	$N_I / \sqrt{\theta} N_I^*$
Power Turbine RPM	N_{II}	$N_{II} / \sqrt{\theta} N_{II}^*$
Fuel Flow	\dot{W}_F	$\dot{W}_F / \delta \sqrt{\theta} F_N^*$
Power Turbine Inlet Temperature	T_5	T_5 / θ

NOTES:

* = Maximum power setting, Static, Sea level, standard day

θ = Ambient temperature ($^{\circ}R$) divided by $518.69^{\circ}R$

δ = Ambient Pressure (psia) Divided by 14.696 psia

d. Zero-Flow Controllable Fan

The preliminary design analysis and weights shown in this report include fan clutches. There are now considered unnecessary. Discussions with engine manufacturers lead to the conclusion that the power absorbed by the fan, when it runs in virtually a still-air environment in hover with the auxiliary inlet inner doors closing off the fan duct aft of the fan, will be a very small percentage of the total power available. This change is not expected to significantly alter the engine performance characteristics as presented in this report.

Control of fan thrust from hover to the point where thrust is transferred to the fans will be accomplished by the following system. Dynamic pressure, ahead of and behind the fan, will be sensed and compared; fan blade angle or inlet guide vane position will be automatically controlled to give zero pressure rise across the fan, and therefore, zero net thrust. When thrust transfer is commanded, the fan control will be automatically switched to a conventional constant-speed system, and fan thrust will be a function of the pilot's thrust lever position.

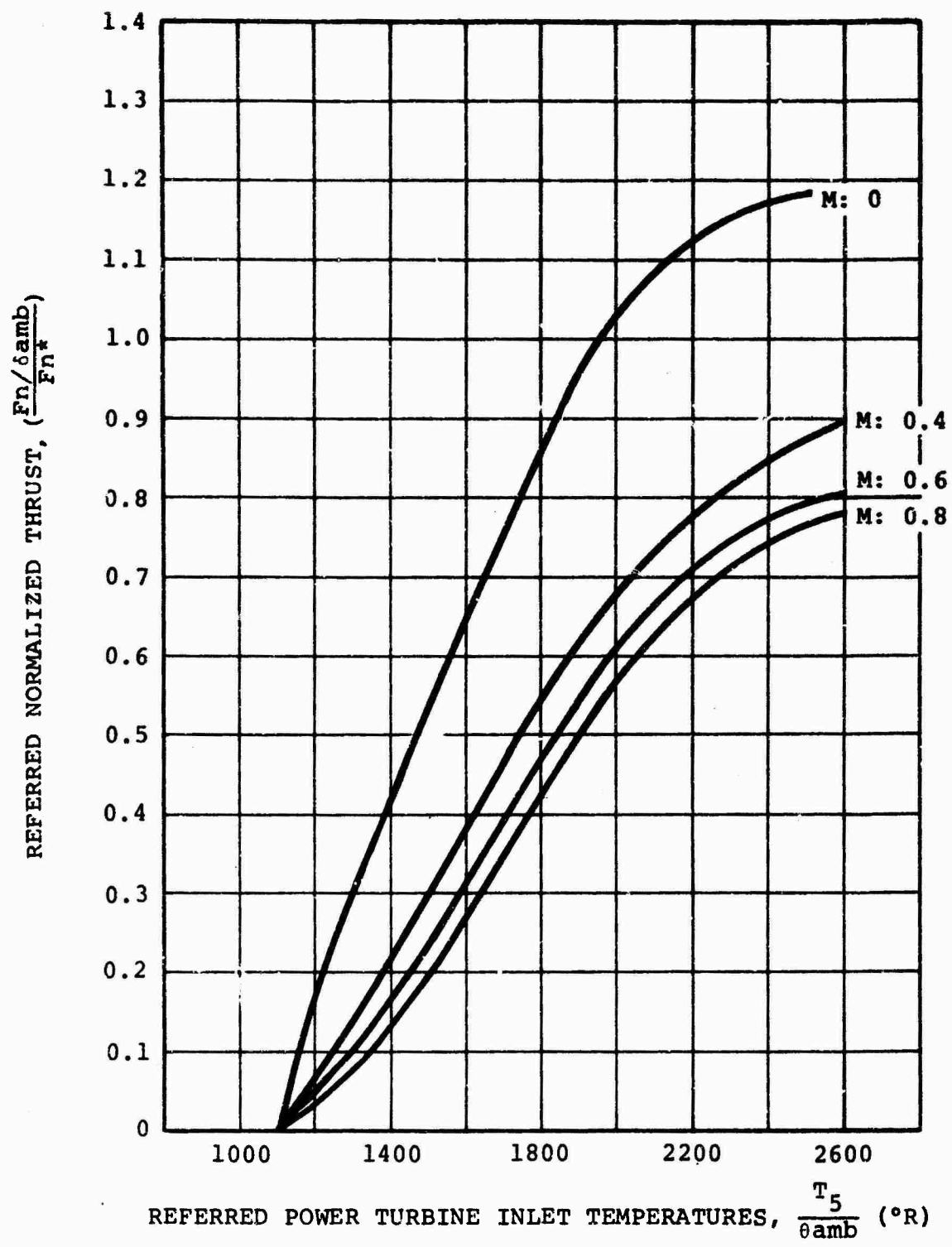

Figure 62. Turbofan Thrust Performance at Bypass Ratio 6.

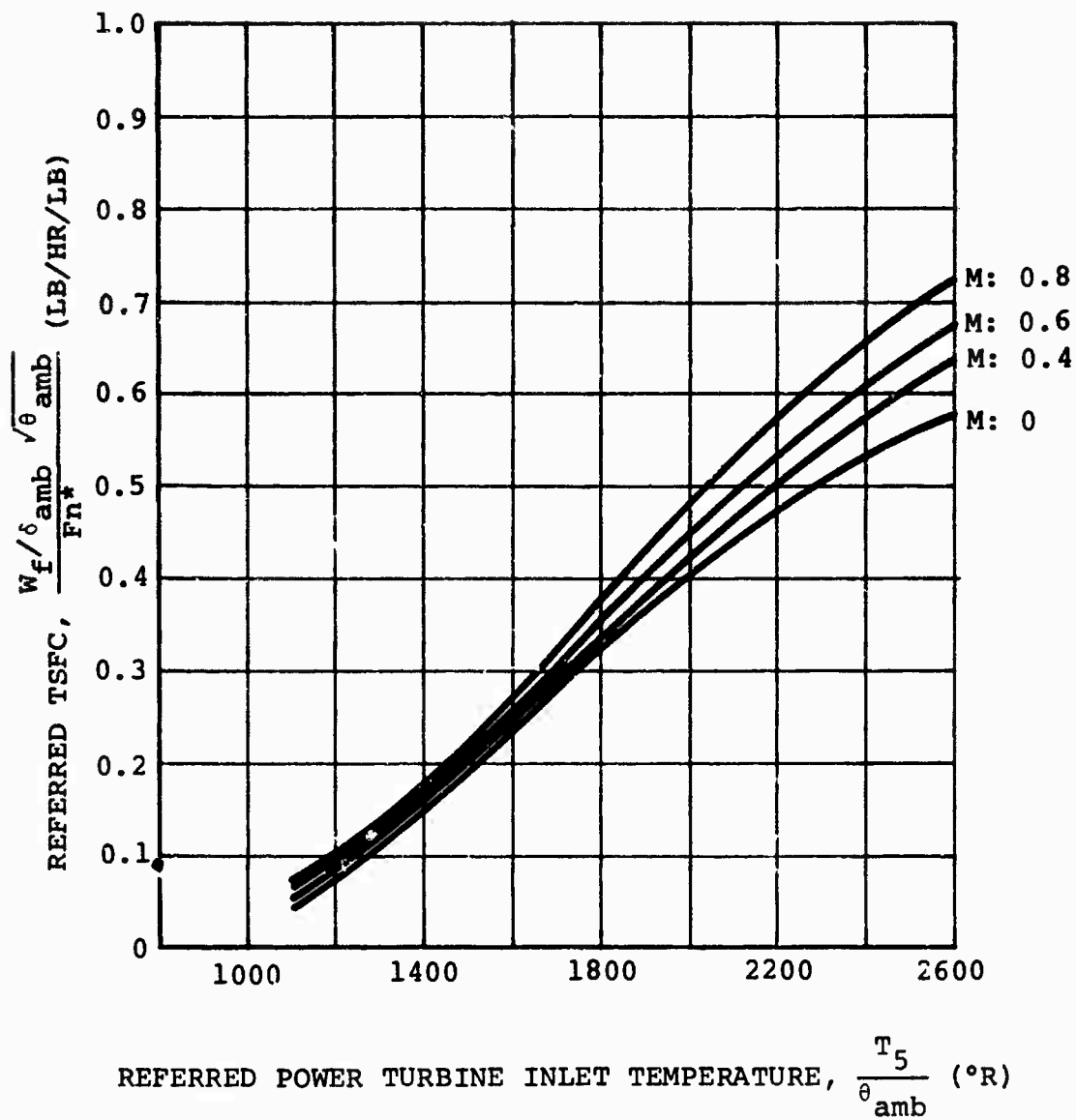

Figure 63. Turbofan Referred Normalized Fuel Flow at Bypass Ratio 6.

TURBOSHAFT ENGINE WITH
 SUPERCHARGING FRONT FAN
 GAS GENERATOR SPEED
 FAN BYPASS RATIO = 6.0

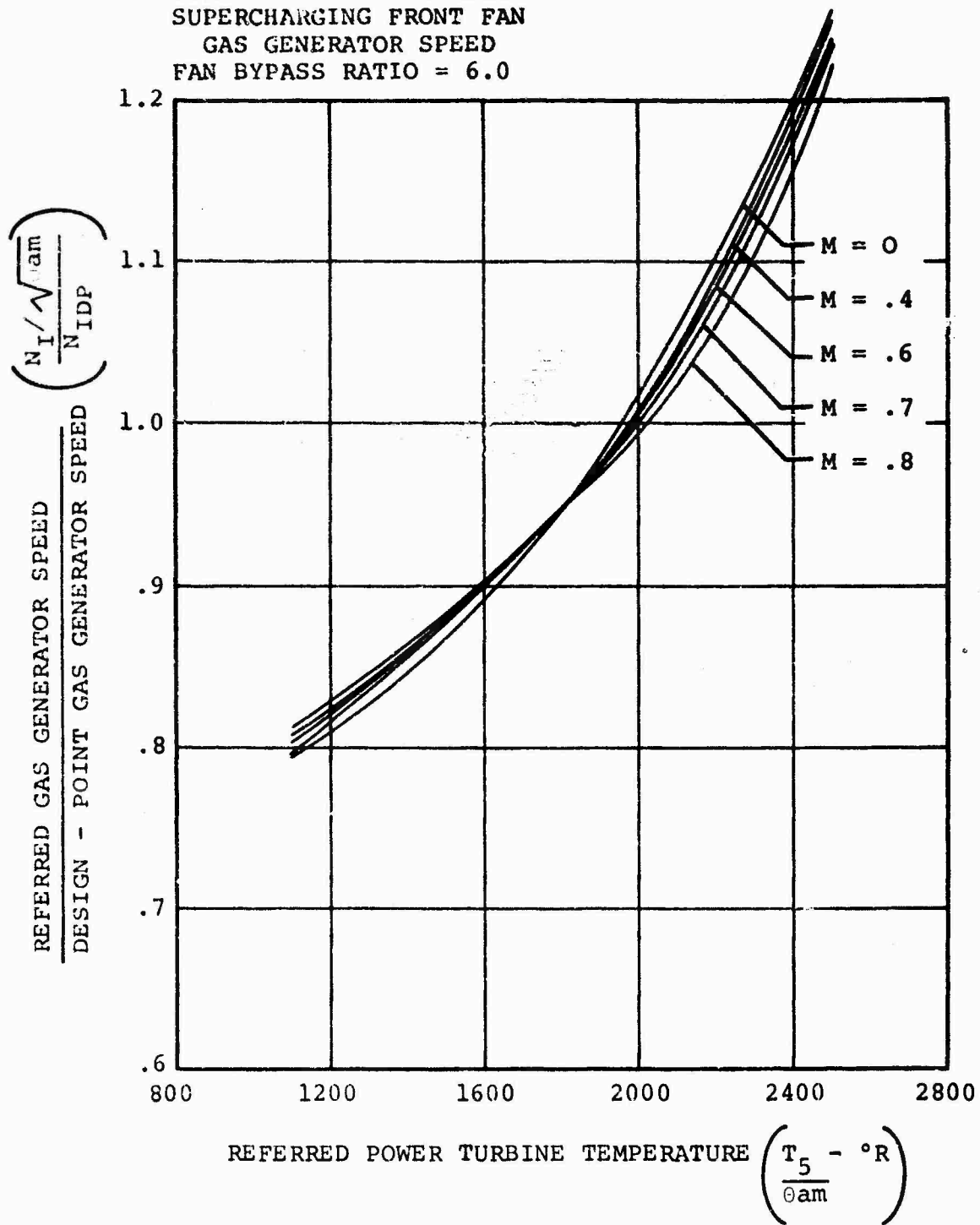

Figure 64. Engine Gas Generator Speed Characteristics.

TURBOSHAFT ENGINE WITH
 SUPERCHARGING FRONT FAN
 FAN TURBINE SPEED
 FAN BYPASS RATIO = 6.0

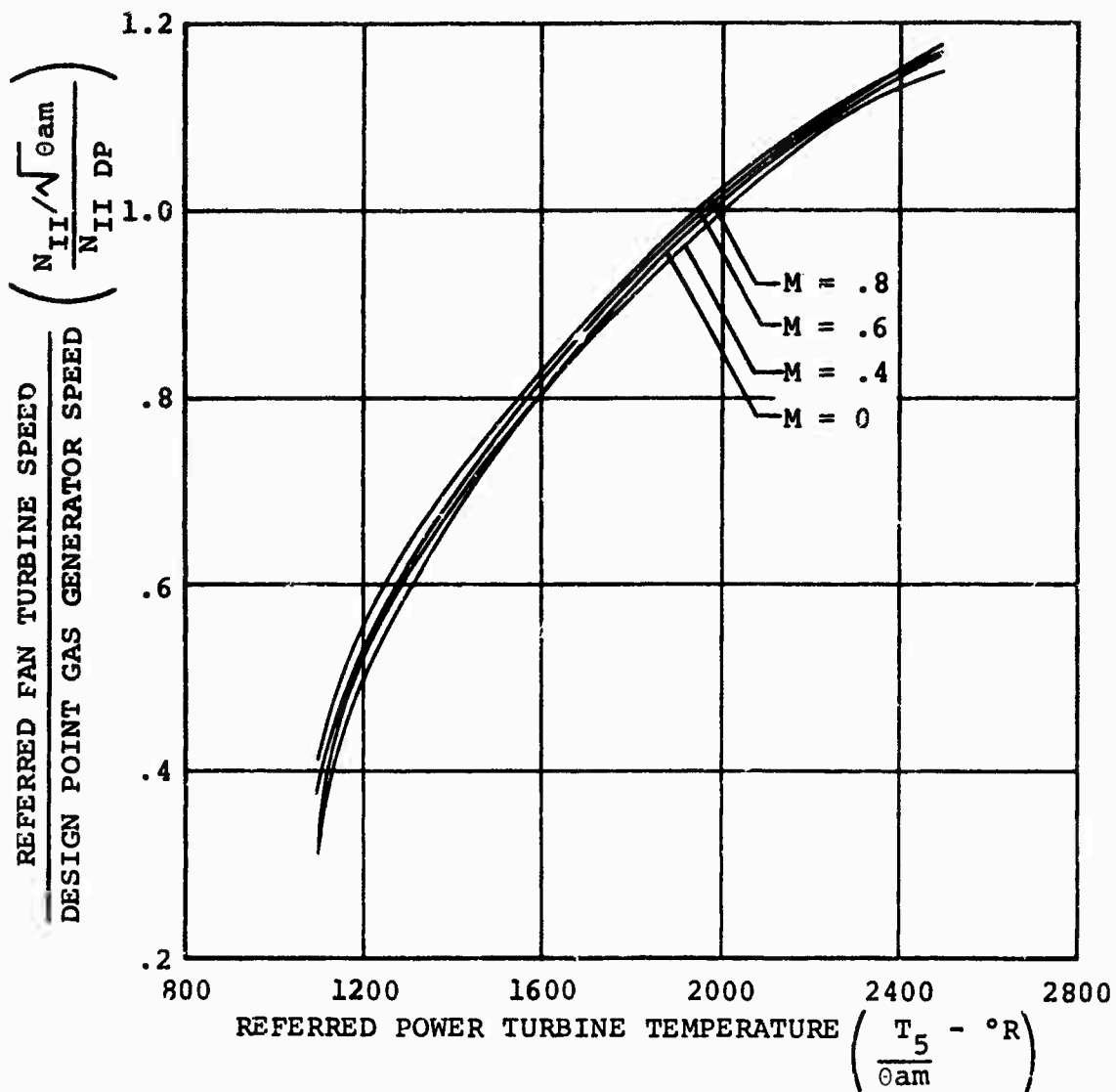

Figure 65. Engine Power Turbine Speed Characteristics.

3. DRIVE SYSTEM

The rotor drive system is shown schematically in Figure 66. The drive system design approach is to utilize drive system techniques appropriate to the 1976 IOC date in order to minimize weight and cost. Therefore, all shafts along the wing (cross-shaft S₂) are designed to be supercritical and to run at 10,000 rpm. The nacelle bevel gear transmissions provide the proper sense of rotation to the rotors without reversing gears, thus affording additional savings in cost, weight and power loss. The rotor transmission provides approximately a 30:1 reduction. This requirement is best provided by the use of a single herringbone offset first stage and two planetary stages. The offset arrangement allows the central hydraulic control elements of the rotor control system to fit within the hollow central region of the transmission.

The choice of six and eight planets, respectively, in the planetary stages, and the highest possible numerical reduction per stage with this number of planets, produces the minimum weight tradeoff. This philosophy allows the herringbone reduction to carry the lowest possible numerical reduction and thereby provides the lightest weight design.

The drive system is described in more detail in the COMPONENT DESIGN STUDIES in Volume II. Summaries of the drive system data for the three basic design point aircraft and the two multimission designs are given in Figures 67 through 71.

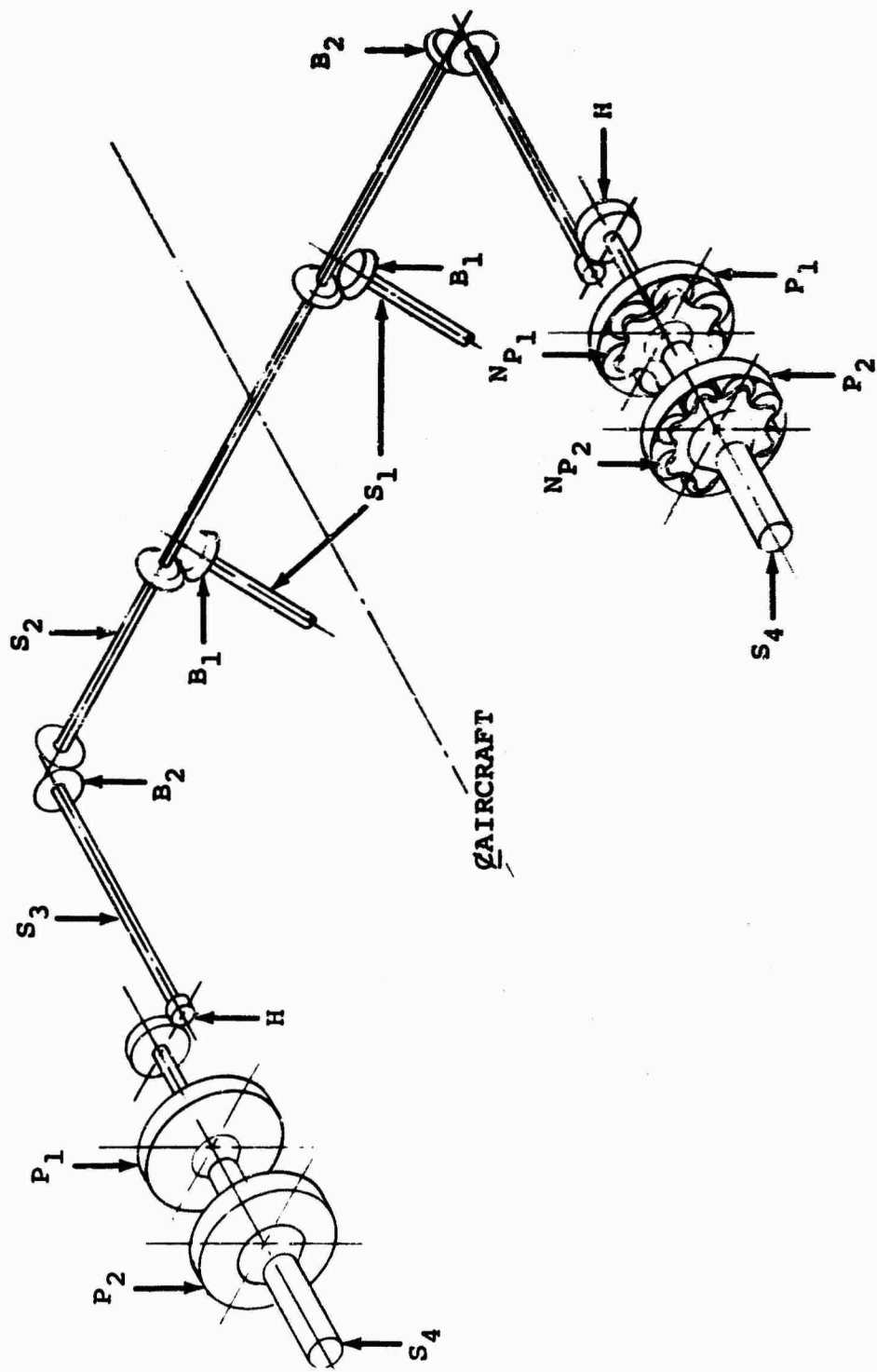

Figure 66. Stowed Tilt Rotor Drive System.

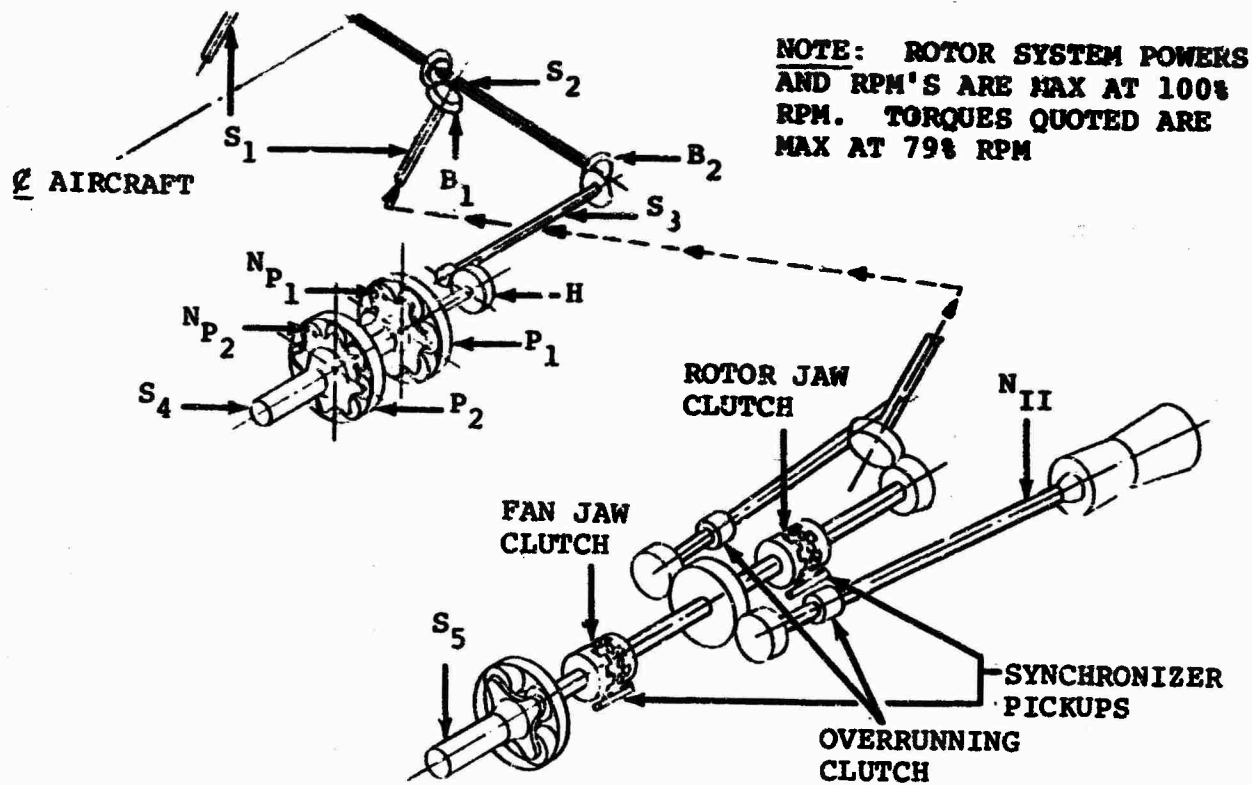

Figure 67. Design Point I Drive Schematic.

DESIGN POINT I DRIVE SYSTEM DATA

Item	Qty	Power	Torque (ft-lb)		RPM		Ratio
			In	Out	In	Out	
Engine Shaft N _{II}	4	4,363		1,283		17,850	
Overrunning Clutch	4	4,363	1,283	1,283	17,850	17,850	
Engine Reduction	2	4,363	1,283	4,582	17,850	10,000	1.785:1
Fan Jaw Clutch	2	8,726	4,582	4,582	10,000	10,000	
Fan Planetary Reduction	2	8,726	4,582	6,740	10,000	6,800	1.471:1
Fan Shaft S ₅	2	8,726	6,740	6,740	6,800	6,800	
Rotor Jaw Clutch	2	*6,215	4,190	4,190	10,000	10,000	1.0:1
Rotor Bevel Set	2	*6,215	4,190	4,190	10,000	10,000	
Vertical Shaft S ₁	2	*6,215	4,190	4,190	10,000	10,000	
Cross Shaft Bevel B ₁	2	*6,215	4,190	4,190	10,000	10,000	1.0:1
Cross Shaft S ₂	1	*6,215	4,190	4,190	10,000	10,000	
Rotor Nacelle Bevel B ₂	2	*6,215	4,190	4,190	10,000	10,000	1.0:1
Longitudinal Shaft S ₃	2	*6,215	4,190	4,190	10,000	10,000	
Herring Bone Reduction H	2	*6,215	4,190	10,540	10,000	3,977	2.5145
1st Stage Planetary P ₁	2	*6,215	10,540	40,243	3,977	1,041	3.8181
2nd Stage Planetary P ₂	2	*6,215	40,243	124,389	1,041	336.7	3.0909
Rotor Shaft S ₄	2	*6,215	124,389	124,389	336.7	336.7	

*Limited by rotor at 100% rpm.

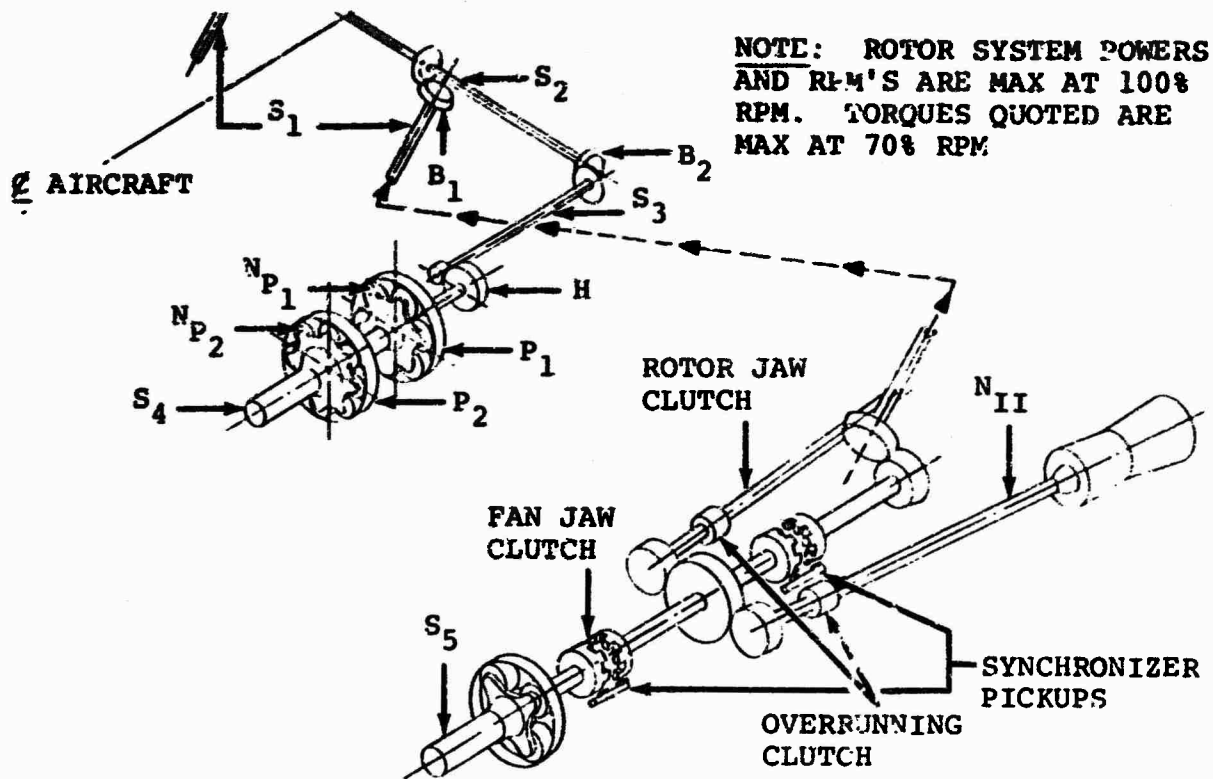

Figure 68. Design Point II Drive Schematic.

DESIGN POINT II DRIVE SYSTEM DATA

Item	Qty	Power	Torque (ft-lb)		RPM		Ratio
			In	Out	In	Out	
Engine Shaft N _{II}	4	5,600		1,870		15,720	
Overrunning Clutch	4	5,600	1,870	1,870	15,720	15,720	
Engine Reduction	2	5,600	1,870	5,879	15,720	10,000	1.572:1
Fan Jaw Clutch	2	11,200	5,880	5,880	10,000	10,000	
Fan Planetary Reduction	2	11,200	5,880	7,920	10,000	6,050	1.653:1
Fan Shaft S ₅	2	11,200	7,920	7,920	6,050	6,050	
Rotor Jaw Clutch	2	*7,585	5,034	5,034	10,000	10,000	
Rotor Bevel Set	2	*7,585	5,034	5,034	10,000	10,000	1.0:1
Vertical Shaft S ₁	2	*7,585	5,034	5,034	10,000	10,000	
Cross Shaft Bevel B ₁	2	*7,585	5,034	5,034	10,000	10,000	1.0:1
Cross Shaft S ₂	1	*7,585	5,034	5,034	10,000	10,000	
Rotor Nacelle Bevel B ₂	2	*7,585	5,034	5,034	10,000	10,000	1.0:1
Longitudinal Shaft S ₃	2	*7,585	5,034	5,034	10,000	10,000	
Herringbone Reduction H	2	*7,585	5,034	14,710	10,000	3,423	2.9217
1st Stage Planetary P ₁	2	*7,585	14,720	56,165	3,423	879	3.81818
2nd Stage Planetary P ₂	2	*7,585	56,165	173,600	879	290	3.0909
Rotor Shaft S ₄	2	*7,585	173,600	173,600	290	290	

*Limited by rotor at 100% rpm.

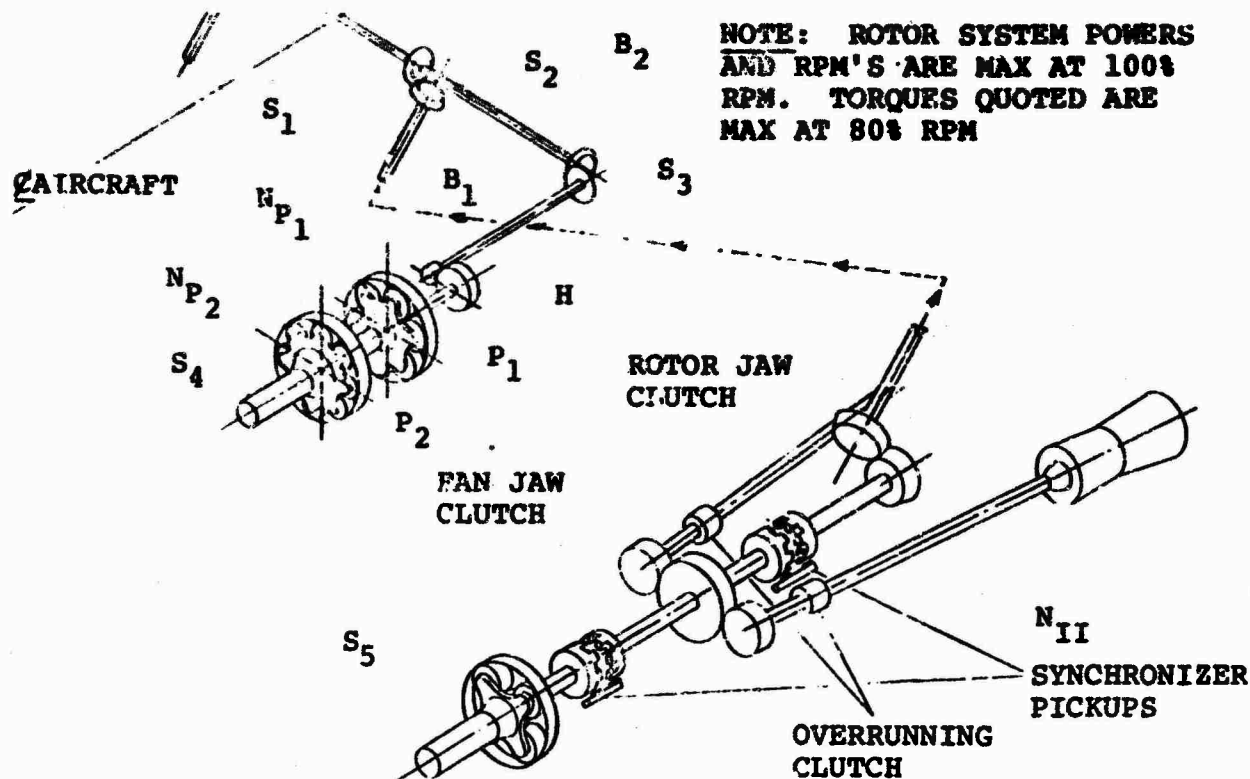

Figure 69. Design Point III Drive Schematic.

DESIGN POINT III DRIVE SYSTEM DATA

Item	Qty	Power	Torque (ft-lb)		RPM		Ratio
			In	Out	In	Out	
Engine Shaft N _{II}	4	5,600		1,870		15,720	
Overrunning Clutch	4	5,600	1,870	1,870	15,720	15,720	
Engine Reduction	2	5,600	1,870	5,879	15,720	10,000	1.572:1
Fan Jaw Clutch	2	11,200	5,880	5,880	10,000	10,000	
Fan Planetary Reduction	2	11,200	5,880	7,920	10,000	6,050	1.653:1
Fan Shaft S ₅	2	11,200	7,920	7,920	6,050	6,050	
Rotor Jaw Clutch	2	*8,045	4,987	4,987	10,000	10,000	
Rotor Bevel Set	2	*8,045	4,987	4,987	10,000	10,000	1.0:1
Vertical Shaft S ₁	2	*8,045	4,987	4,987	10,000	10,000	
Cross Shaft							
Bevel B ₁	2	*8,045	4,987	4,987	10,000	10,000	1.0:1
Cross Shaft S ₂	1	*8,045	4,987	4,987	10,000	10,000	
Rotor Nacelle							
Bevel B ₂	2	*8,045	4,987	4,987	10,000	10,000	1.0:1
Longitudinal Shaft S ₃	2	*8,045	4,987	4,987	10,000	10,000	
Herringbone Reduction H	2	*8,045	4,987	14,570	10,000	3,423	2.9217
1st Stage							
Planetary P ₁	2	*8,045	14,570	55,663	3,423	879	3.81818
2nd Stage							
Planetary P ₂	2	*8,045	55,663	172,046	879	290	3.0909
Rotor Shaft S ₄	2	*8,045	172,046	172,046	290	290	

*Limited by rotor at 100% rpm.

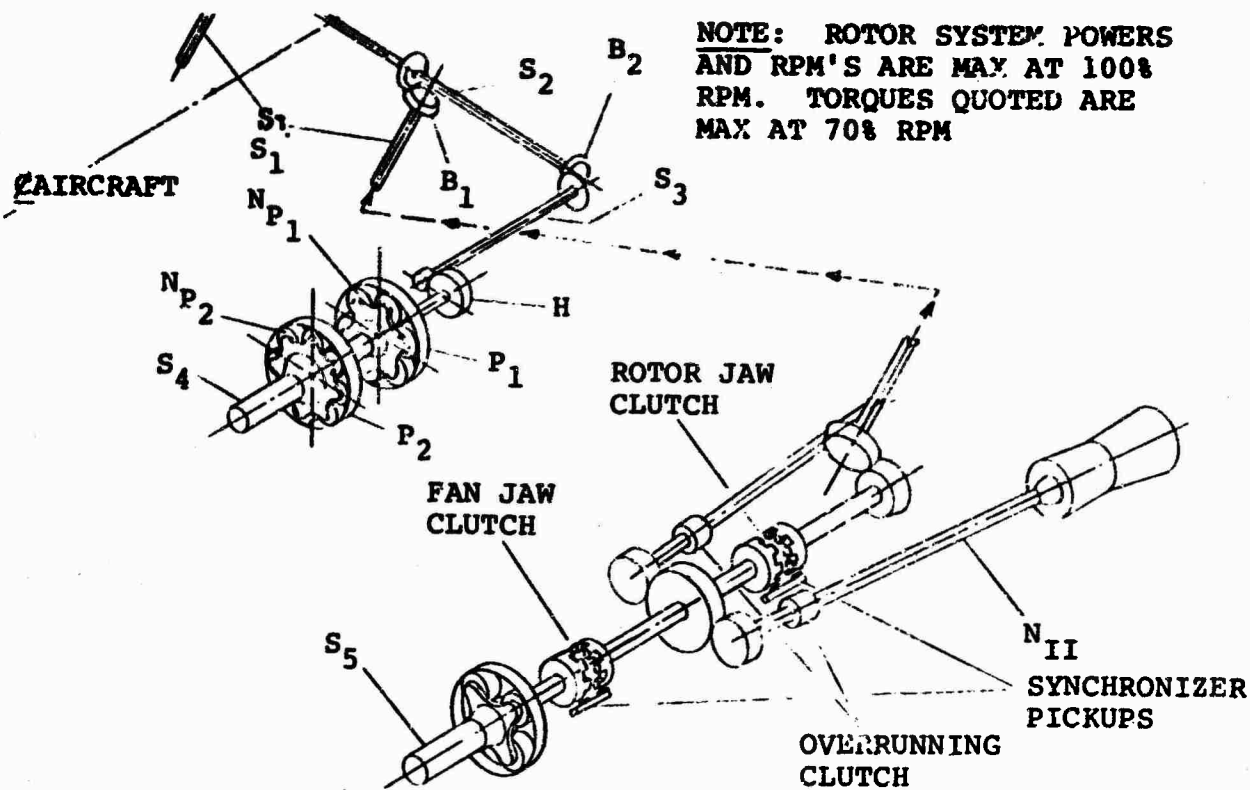

Figure 70. Design Point IV Drive Schematic.

DESIGN POINT IV DRIVE SYSTEM DATA

Item	Qty	Power	Torq (ft-lb)		RPM		Ratio
			In	Out	In	Out	
Engine Shaft N _{II}	4	4,941		1,554		16,700	
Overrunning Clutch	4	4,941	1,554	1,554	16,700	16,700	
Engine Reduction	2	4,941	1,554	5,190	16,700	10,000	1.67:1
Fan Jaw Clutch	2	9,882	5,190	5,190	10,000	10,000	
Fan Planetary Reduction	2	9,882	5,190	8,034	10,000	6,460	1.548:1
Fan Shaft S ₅	2	9,882	8,034	8,034	6,460	6,460	
Rotor Jaw Clutch	2	*7,800	4,904	4,904	10,000	10,000	
Rotor Bevel Set	2	*7,800	4,904	4,904	10,000	10,000	1.0:1
Vertical Shaft S ₁	2	*7,800	4,904	4,904	10,000	10,000	
Cross-Shaft Bevel B ₁	2	*7,800	4,904	4,904	10,000	10,000	1.0:1
Cross-Shaft S ₂	1	*7,800	4,904	4,904	10,000	10,000	
Rotor Nacelle Bevel B ₂	2	*7,800	4,904	4,904	10,000	10,000	1.0:1
Longitudinal Shaft S ₃	2	*7,800	4,904	4,904	10,000	10,000	
Herringbone Reduction H	2	*7,800	4,904	14,530	10,000	3,375	2.9626
1st Stage Planetary P ₁	2	*7,800	14,530	55,478	3,375	884	3.8181
2nd Stage Planetary P ₂	2	*7,800	55,478	171,478	884	286	3.0909
Rotor Shaft S ₄	2	*7,800	171,478	171,478	286	286	

*Limited by rotor at 100% rpm.

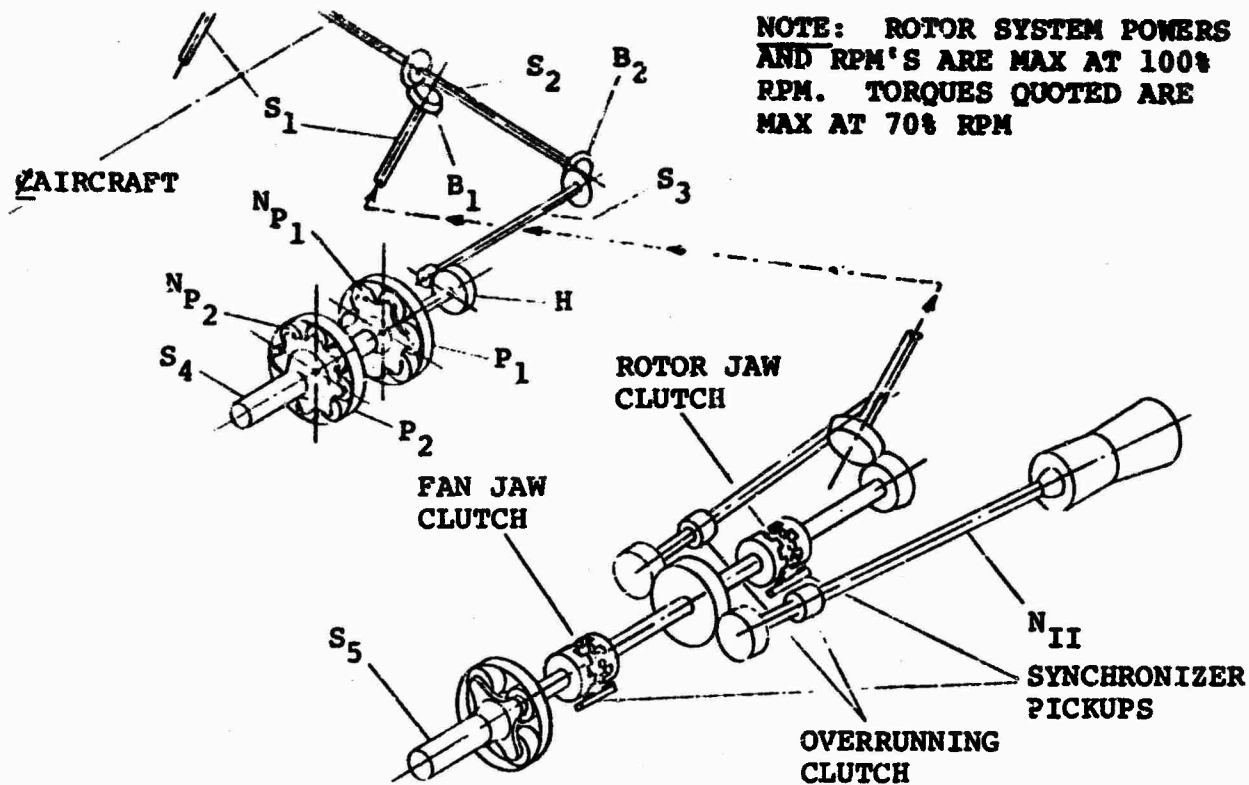

Figure 71. Design Point V Drive Schematic.

DESIGN POINT V DRIVE SYSTEM DATA

Item	Qty	Power	Torque (ft-lb)		RPM		Ratio
			In	Out	In	Out	
Engine Shaft NII	4	7,426		2,851		13,680	
Overrunning Clutch	4	7,426	2,851	2,851	13,680	13,680	
Engine Reduction	2	7,426	2,851	7,800	13,680	10,000	1.362:1
Fan Jaw Clutch	2	14,852	7,800	7,800	10,000	10,000	
Fan Planetary Reduction	2	14,852	7,800	14,718	10,000	5,300	1.387:1
Fan Shaft S5	2	14,852	14,718	14,718	5,300	5,300	
Rotor Jaw Clutch	2	*11,320	6,498	6,498	10,000	10,000	
Rotor Bevel Set	2	*11,320	6,498	6,498	10,000	10,000	1.0:1
Vertical Shaft S1	2	*11,320	6,498	6,498	10,000	10,000	
Cross Shaft							
Bevel B1	2	*11,320	6,498	6,498	10,000	10,000	1.0:1
Cross Shaft S2	1	*11,320	6,498	6,498	10,000	10,000	
Rotor Nacelle							
Bevel B2	2	*11,320	6,498	6,498	10,000	10,000	1.0:1
Longitudinal Shaft S3	2	*11,320	6,498	6,498	10,000	10,000	
Herringbone Reduction H	2	*11,320	6,498	21,341	10,000	3,045	3.2841
1st Stage Planetary P1	2	*11,320	21,241	81,486	3,045	798	3.8181
2nd Stage Planetary P2	2	*11,320	81,488	251,864	798	258	3.0909
Rotor Shaft S4	2	*11,320	251,864	251,864	258	258	

*Limited by rotor at 100% rpm.

SECTION IX

STRUCTURAL DYNAMICS ANALYSIS

1. AEROELASTIC STABILITY

Analyses are made to ensure that there are no whirl flutter, air resonance, or classical wing flutter problems with the folding-tilt-rotor aircraft. Whirl flutter, air resonance and classical wing flutter prevention are investigated in order to determine whether or not the wing stiffness, based on ultimate strength is adequate. Rotor blade aeroelastic stability is treated in a limited way. For the condition of zero rpm and zero foldback angle blade torsional flutter is checked. Blade torsional divergence is checked as a function of equivalent forward sweep. More detailed blade analyses will be carried out during Phase II. The blade wing mass, and stiffness properties given in Volume 2 are used to obtain the design conditions used in analyses shown here. The configuration analyzed is adequately stable. Detailed results for the parameters are given in Table XXVI.

2. WHIRL FLUTTER

Results of a study using program C-26 with wing/nacelle chordwise bending frequency and wing/nacelle pitch frequency varying and other parameters fixed at nominal are shown in Figure 72.* The Model aircraft was considered to be in the maximum velocity propeller flight mode of 250 knots EAS with no control feedbacks. This is the most critical velocity for whirl flutter. Aircraft design is stable. There is no flutter region present even if the structural damping is considered to be zero.

As shown in Figure 72, a very significant parameter for both whirl flutter and divergence is the wing torsional stiffness and corresponding frequency. For nominal aircraft properties, increasing the wing/nacelle torsional stiffness significantly improves the stability of the system. The wing/nacelle chordwise bending stiffness has a relatively minor effect on the stability boundaries for practical variations around nominal.

* Nacelle and joint stiffness was assumed to be infinitely rigid.

TABLE XXVI. PARAMETERS OF AIRCRAFT USED FOR AEROELASTIC STABILITY ANALYSIS

Description	Value
Radius of Rotor (in.)	275.2
Number of Blades	4
First Moment of 1 Blade About Flap Hinge (lb-sec ²)	125.5
Inertia of 1 Blade About Flap Hinge (lb-sec ² -in.)	21,015
Ratio of Blade Cut Out to R (nondimensional)	0.2
Blade Twist at 75 percent R - Root Reference (degrees)	-16.5
Mean Chord (in.)	23.04
Lift Slope Coefficient (1/rad)	5.73
Distance from Center of Hub to Nacelle Pivot (in.)	115
Distance Between Nacelle Pivot and Effective Wing Root (To be approximately 61 percent of wing semispan) (in.)	220
Distance Between Nacelle Pivot and cg of Rotor Nacelle Combination (in.)	94.2
Nacelle (Including Blades and Hub) Moment of Inertia in Pitch (lb-sec ² -in.)	136,204
Weight of Nacelle Including 4 Blades and Hub (lb)	6,730
Wing/Nacelle Pitch (Torsion) Frequency (cps)	2.75
Wing/Nacelle Yaw (Chordwise) Frequency (cps)	2.87
Wing/Nacelle Vertical Bending Frequency (cps)	2.51
Rotor Speed, Propeller Mode (rpm)	262
Maximum Forward Speed, Propeller Mode (kn)	250
Blade Flap Frequency (cps)	5.37
Blade Angle-of-Attack at 75 Percent Radius (degrees)	0
Effective Hinge Offset (in.)	59
Blade Pitch Axis	at 25% Percent Blade Chord
Wing Pitch Axis	at 40 percent Section Chord

NOTES:

1. Blade parameters used were for the baseline aircraft design. Infinite blade control system stiffness was assumed.
2. The six degree-of-freedom analysis computer program (C-26) was used for the whirl flutter analysis. This analysis consists of a system of 6, second order, linear differential equations. Basic assumptions made in the analyses include quasi-state aerodynamics, out-of-plane blade flapping, zero blade-flap hinge offset, and constant rotor velocity.
3. Computer program C-27 was used for the ground resonance analysis. This is a second order linear set of 9 differential equations which include 2 normal blade modes. Quasi-static aerodynamics was utilized. The program contains in and out-of-plane bending of the blades.

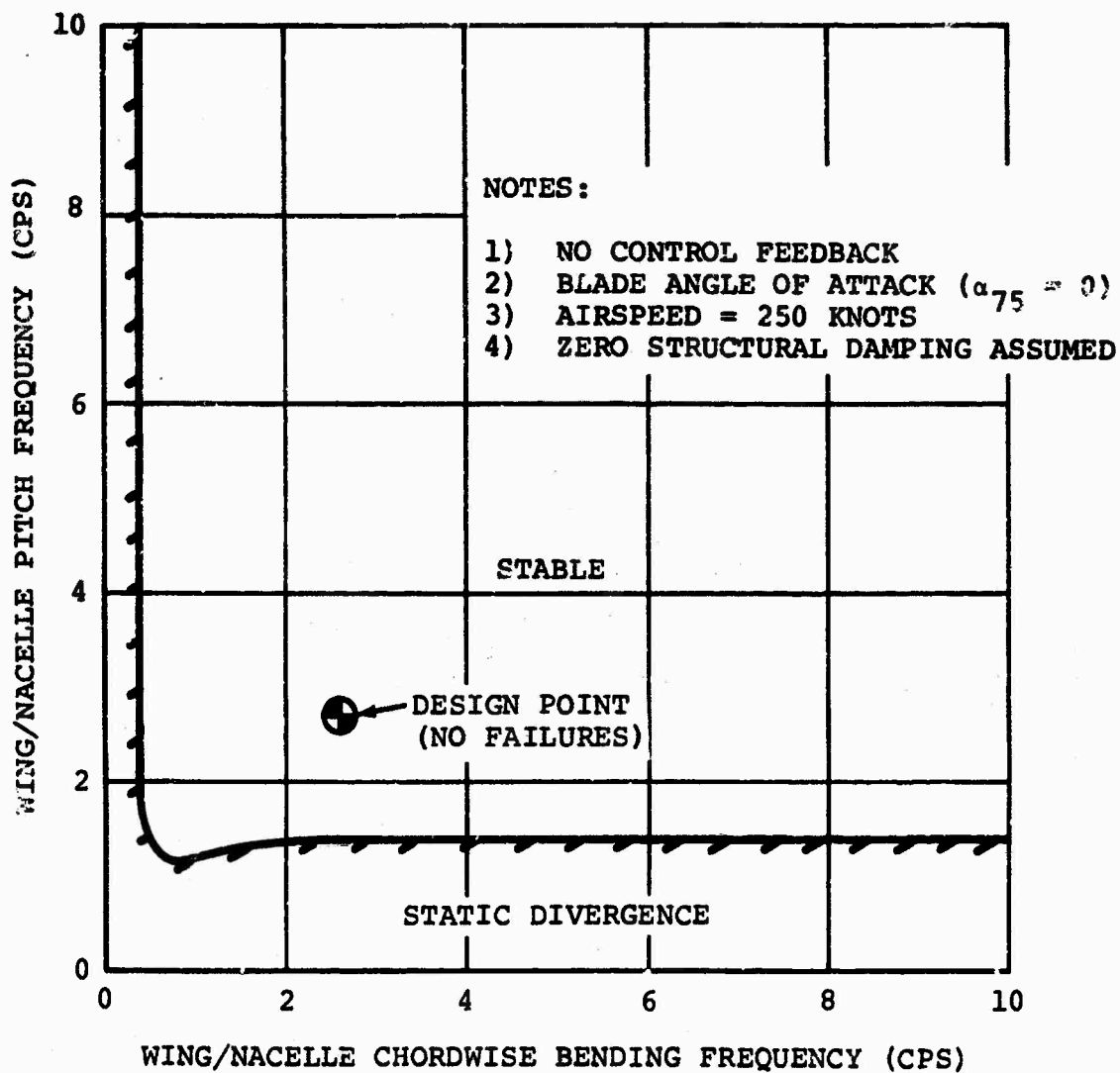

Figure 72. Model Design is Stable From Whirl Flutter at 250 Knots EAS With Cyclic Feedback System Inoperative

The rotor speed margin of the aircraft is adequate at the maximum propeller cruise velocity of 250 knots (EAS). The margin of safety on rotor speed is at least 140 rpm (see Figure 73). The aircraft stability is quite insensitive to rotor rpm over the studied range of 0-400 rpm.

The model design is stable (with significant margins of safety) over all operating velocities as shown in Figure 74. Also, this figure again emphasizes the importance of wing/nacelle pitch stiffness (or frequency) on whirl flutter/divergence safety margins.

The model is also stable at all operating power settings as shown in Figure 75. The propellers could approach a windmilling condition during slowdown from dash speed and still remain stable even if a cyclic system were not provided.

The analytical model used for this study is shown in Figure 76. This is a 6-degree-of-freedom analysis which describes the blade coning, pitch and yaw of the disc plane, wing/nacelle vertical bending (vertical translation), torsion (wing/nacelle pitch), and chordwise bending (wing-nacelle yaw). The capability of treating both the effects of structural damping and feathering feedback are included. The analysis computes the stability boundary as a function of variation in pitch and yaw natural frequencies.

3. TORSION BLADE DIVERGENCE AND FLUTTER

The blade is considered to be feathered and stopped. It is treated as a cantilevered slender wing with zero lift (Sections 8-3 and 8-4 Reference 5) and is found to be free from torsional divergence for all forward sweep angles (Figure 77). The most critical angles of forward sweep are from 30 degrees to 50 degrees. The blade is found, by conservative calculations, to be free of blade flutter for the deployed blade, zero rpm, situation to 350 knots. The maximum anticipated forward sweep due to maneuver and gust is approximately 20 degrees.

4. CLASSICAL WING FLUTTER

The wing is analyzed as a uniform cantilever wing by the method defined in Section 9-2 of Reference 5 and is found to be free of classical flutter up to a conservative minimum forward airspeed of 600 knots.

NOTES:

- 1) 2 PERCENT STRUCTURAL DAMPING
- 2) AIRSPEED = 250 KNOTS
- 3) ANGLE OF ATTACK ($\alpha_{75} = 0^\circ$)
- 4) NO FEEDBACK CONTROL

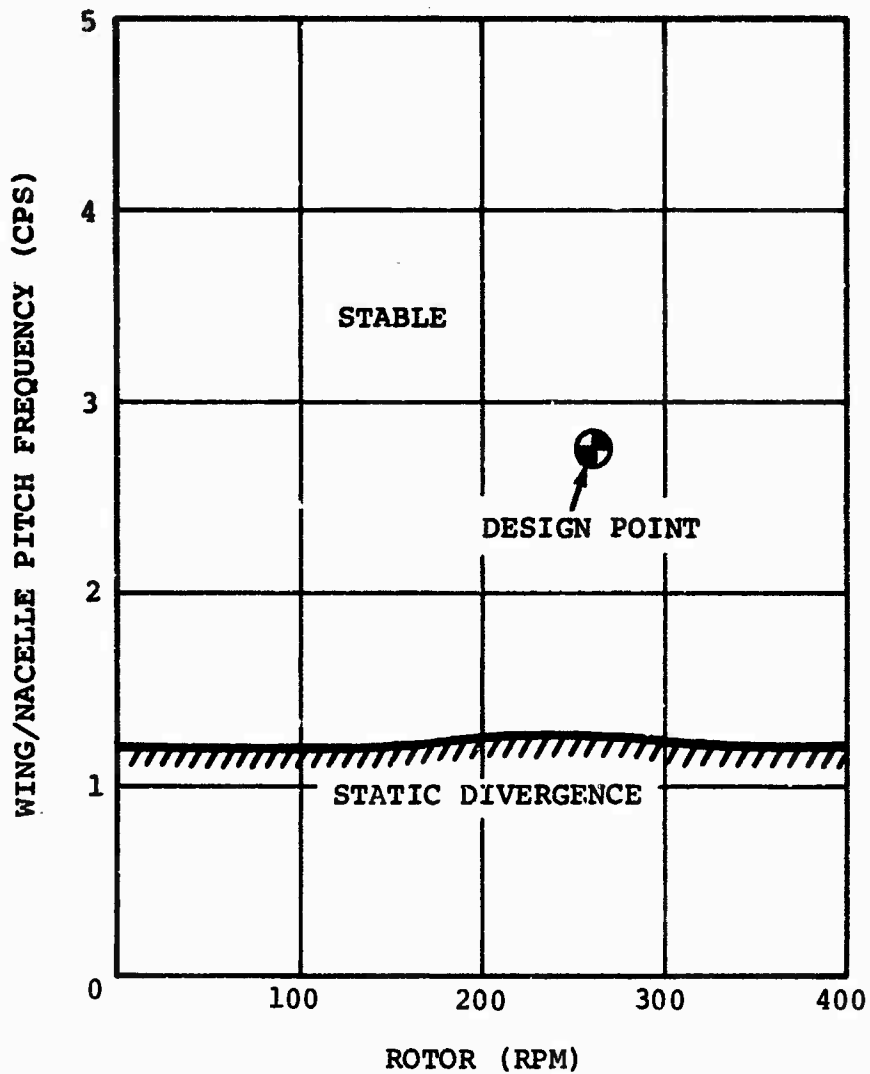

Figure 73. Rotor Speed Margin of Aircraft: Adequate at 250 Knots EAS.

NOTES:

- 1) 2 PERCENT STRUCTURAL DAMPING
- 2) 262 RPM
- 3) BLADE ANGLE OF ATTACK ($\alpha_{75} = 0$)
- 4) NO CYCLIC FEEDBACK

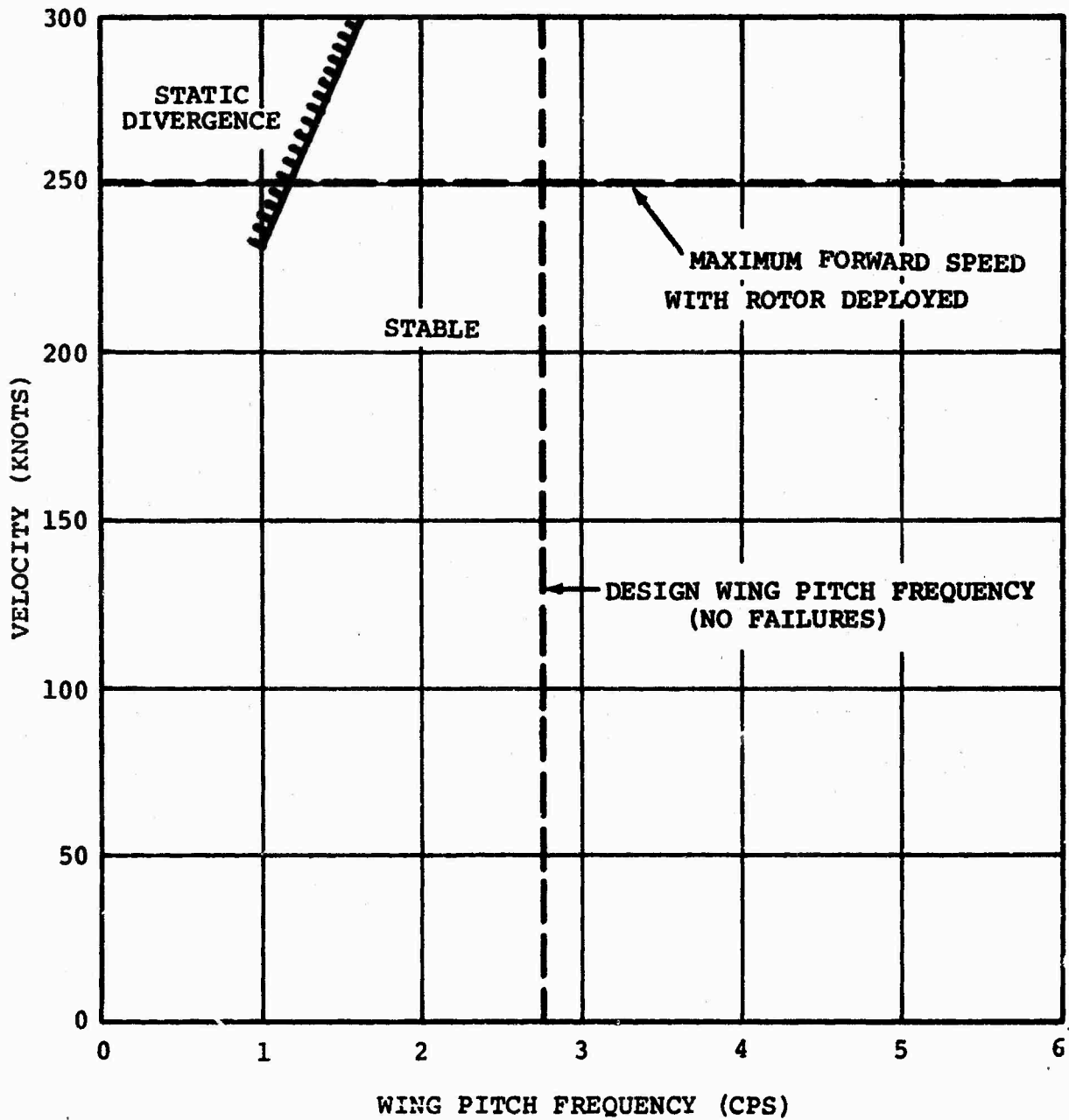

Figure 74. Model Design is Stable Over All Operating Velocities.

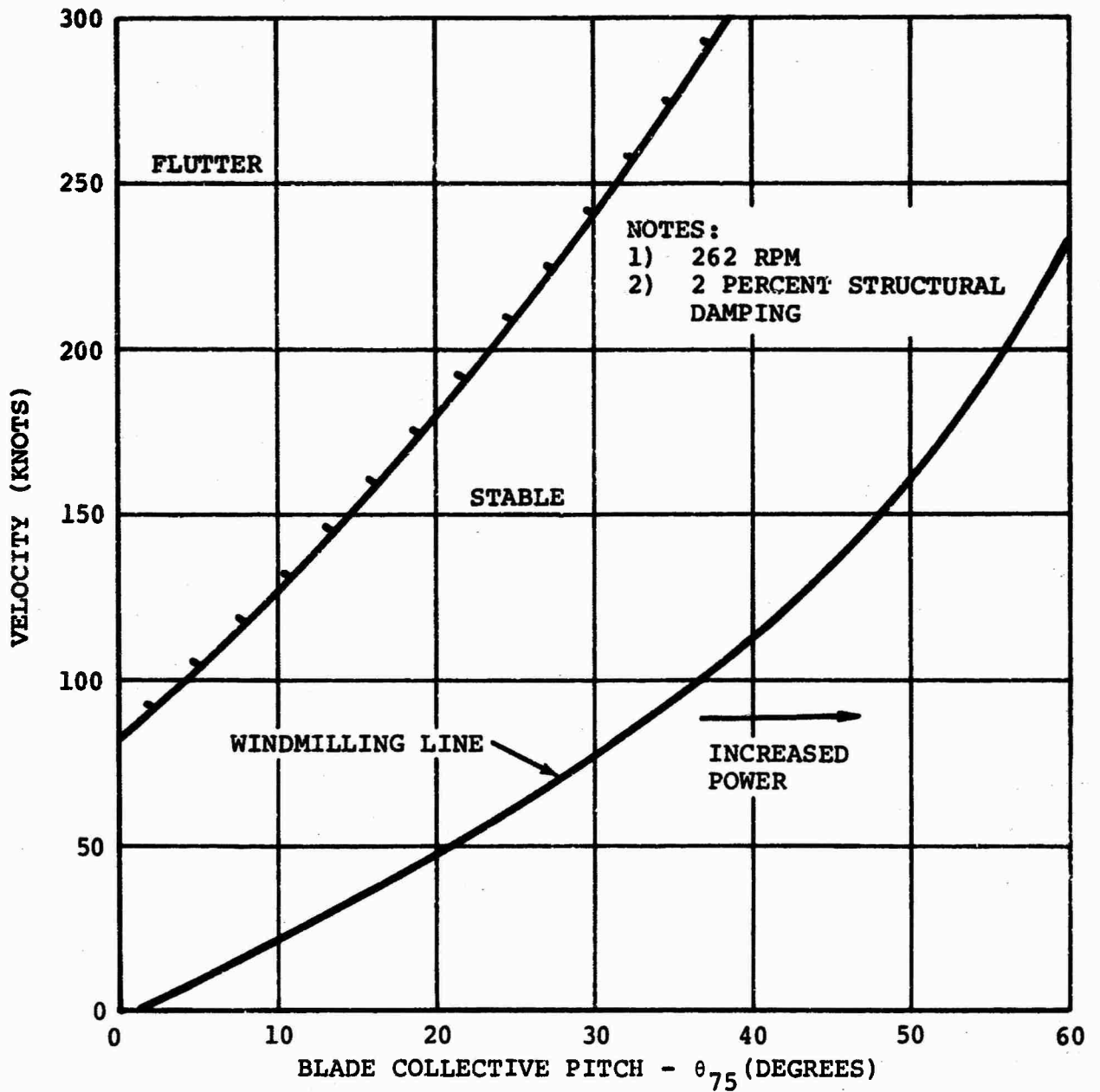
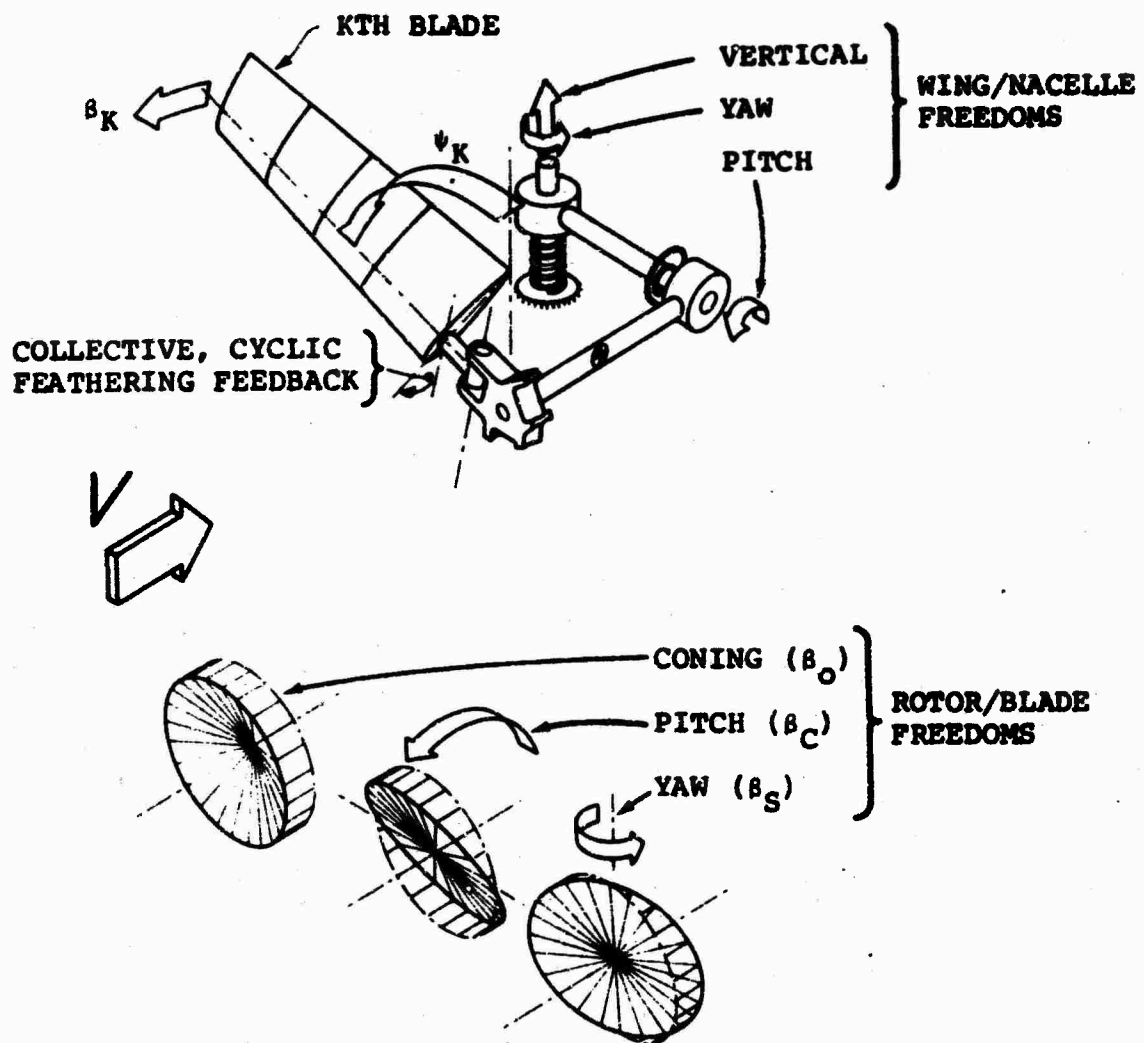

Figure 75. Design Stability at Various Operating Power Settings.



MOTION OF THE KTH BLADE:-

$$\beta_K = \beta_O + \beta_C \cos \left\{ \psi_K + \frac{2\pi}{\eta} (K-1) \right\} + \beta_S \sin \left\{ \psi_K + \frac{2\pi}{\eta} (K-1) \right\}$$

Figure 76.. Typical Analytical Model of Program C-26.

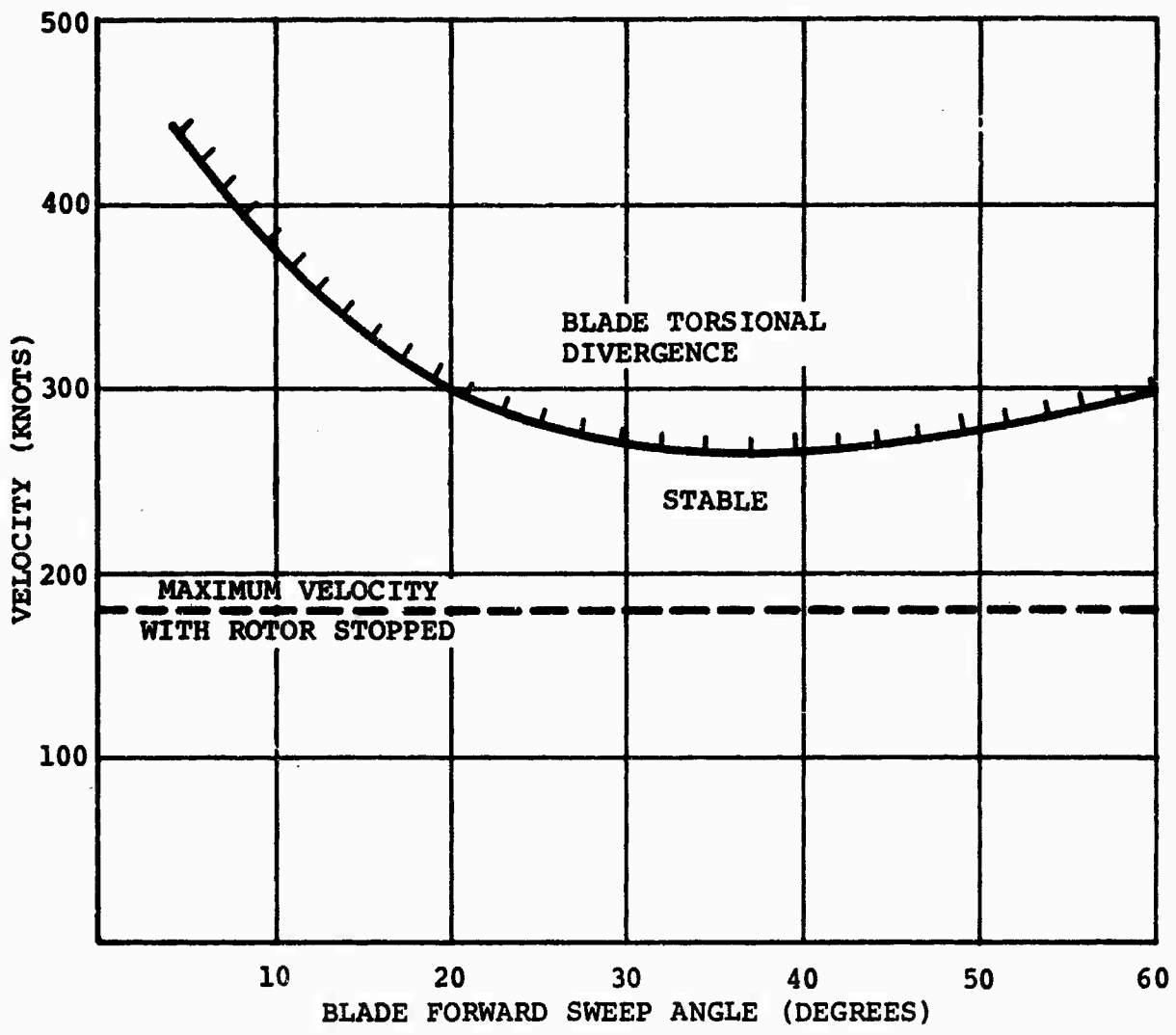

Figure 77. Blade is Free from Torsional Divergence at Forward Sweep Angles.

5. AIR RESONANCE

The folding-tilt-rotor aircraft can have air resonance stability problems due to blade chordwise (lag) bending coupling with an aircraft mode. Such resonance conditions, if they occur within the aircraft operating regime, must be damped by the airframe and blade structural damping and rotor blade and wing aerodynamic damping.

Figure 78 shows rotor and aircraft freedoms as a function of rotor speed. There are three regions of coalescence of rotor and aircraft frequencies as a function of rotor speed. Instabilities might be expected at any of these three intersections. Coalescence with the upper blade mode has never been found to be a problem and is not one here.

The coalescence between the lower blade mode and the rotor-wing vertical bending intersection is found to be stable (Figure 79) when nominal structural damping and rotor aerodynamic damping effects are considered. The area of instability, due to the coalescence between the lower blade mode and the wing chordwise bending mode, is sufficiently removed from the rotor operating speed that it does not present a problem.

The analytical model used for this study is shown in Figure 80. This is a 9-degree-of-freedom analysis which includes torsion (wing/nacelle pitch), chordwise bending (wing/nacelle yaw), roll (wing/nacelle) and 2 linear blade modes each described by a constant blade angle and pitch yaw of the tip path plane.

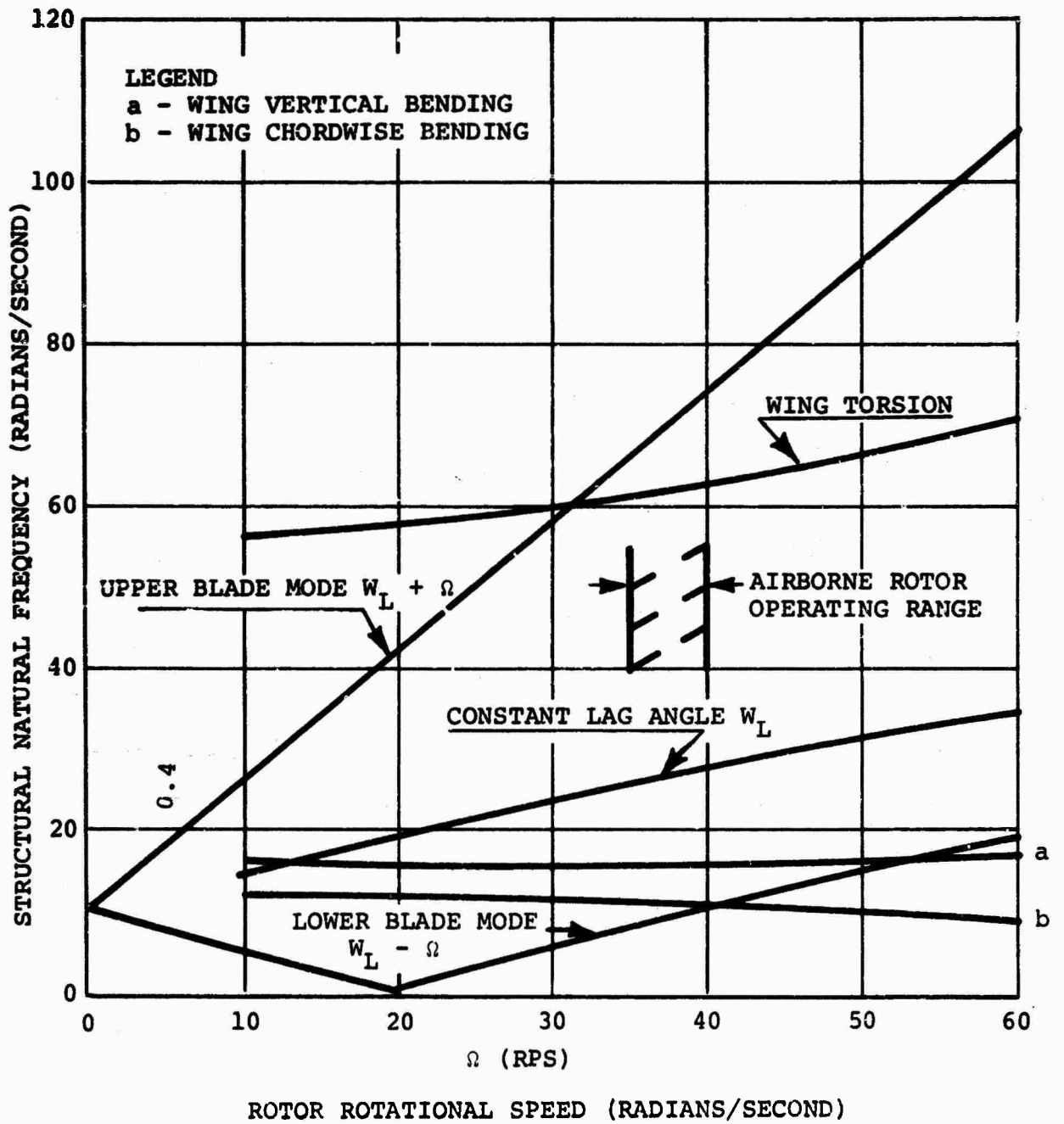

Figure 78. Rotor and Aircraft Frequency Plot.

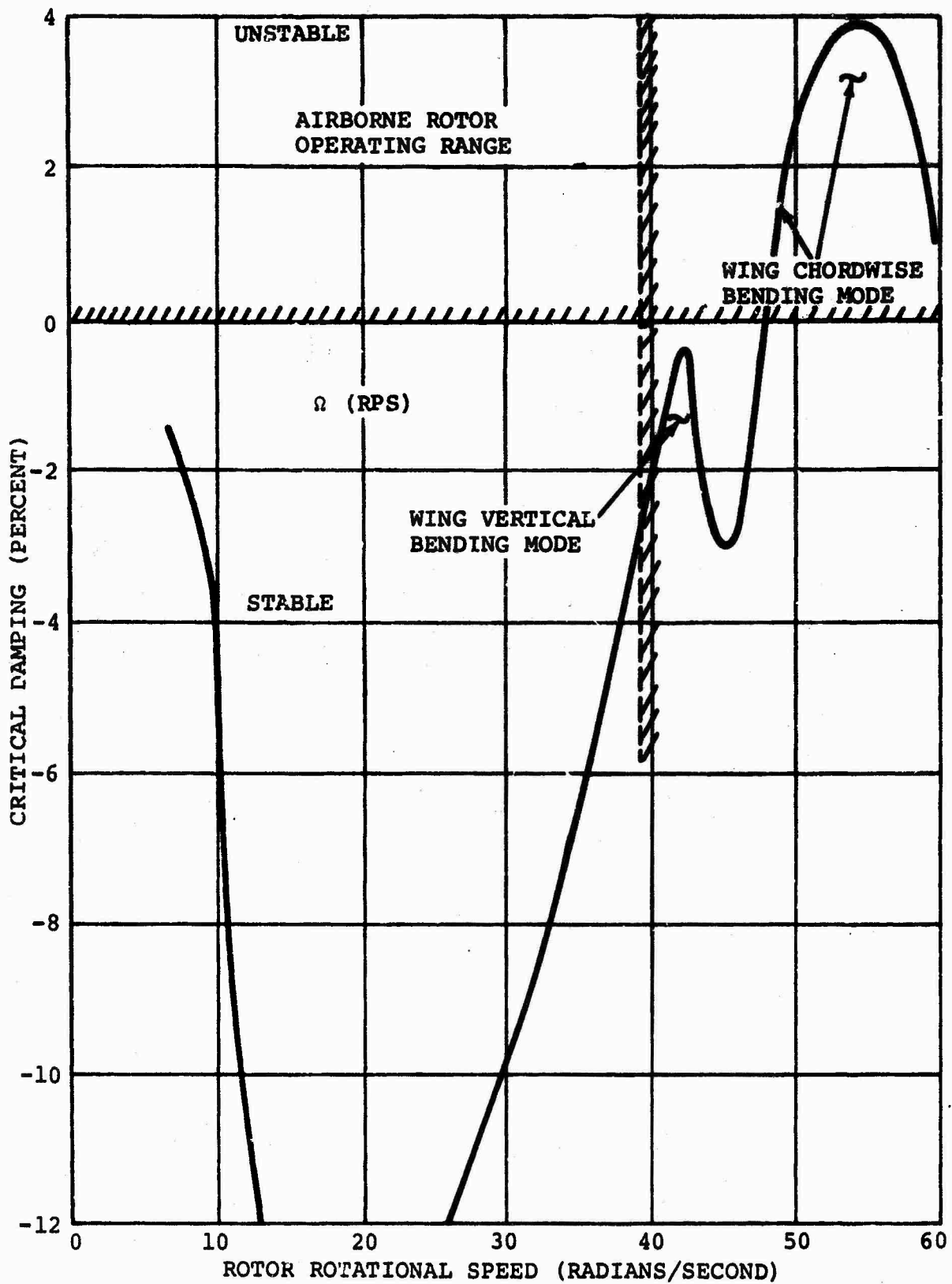

Figure 79. Model is Free from Air Resonance Throughout Operating Range.

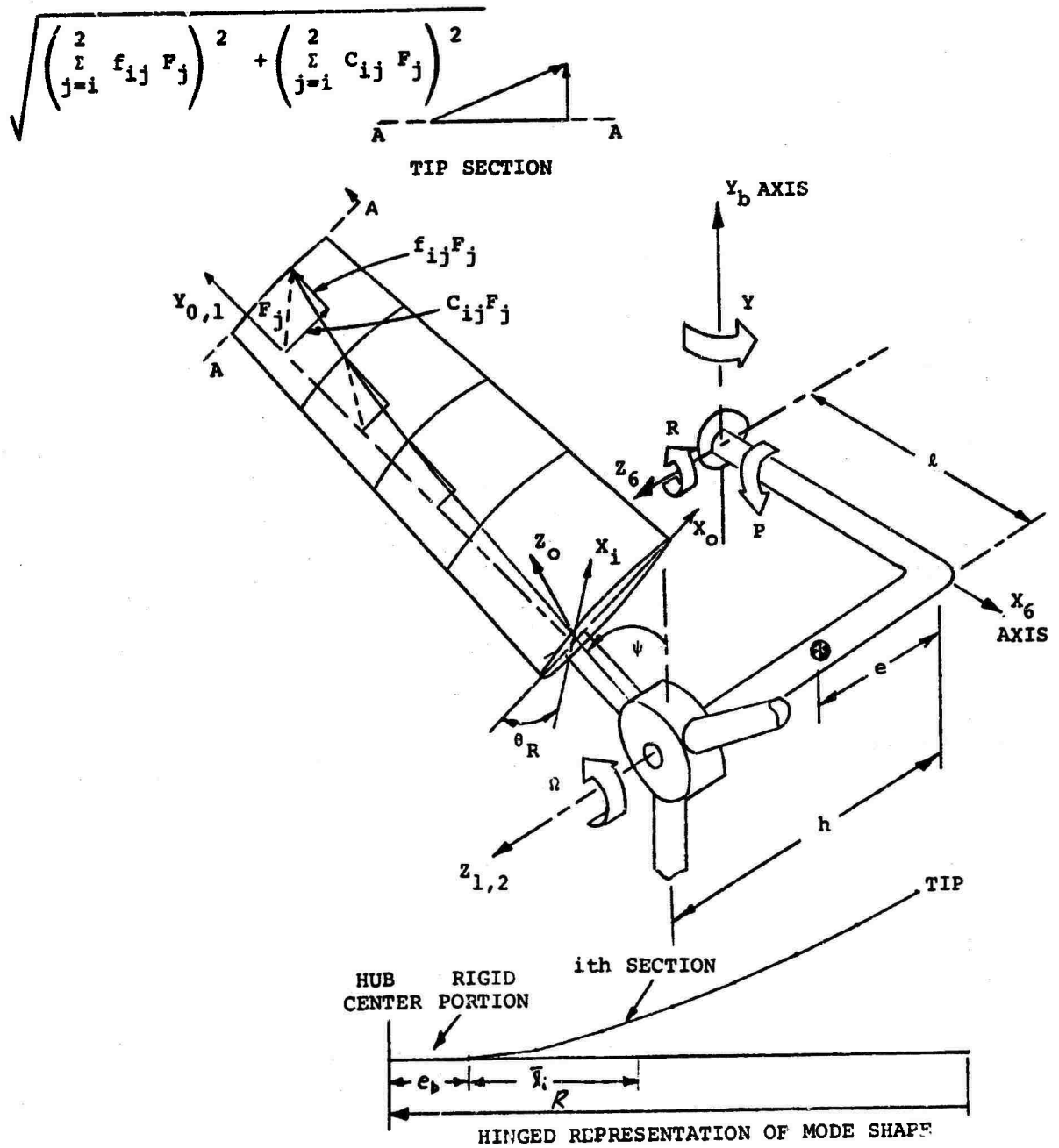

Figure 80. Nine Degree-of-Freedom Propeller Whirl Model Analysis.

SECTION X

STABILITY AND CONTROL

1. HOVER CONTROL

To date, analysis of hover control has been confined to determining how control is to be obtained and what forces, moments, and control movements are required to give specified initial angular accelerations. Control response rates and dynamic stability in hover have not been investigated.

Control in hover is provided by the rotor system without the use of pitch or yaw fans or wing control surfaces. The system has been designed to provide the initial angular accelerations specified in the flying qualities criteria (i.e., roll: 1.0 radians/sec²; pitch: 0.6 randian/sec²; and yaw: 0.5 radians/sec²) while minimizing as far as possible the loads which control applications apply to the rotor, tip nacelle and tilting mechanism, and wing.

a. Roll Axis

Roll control is provided by differential collective pitch on the two rotors. For the hover roll inertia of 688,000 slugs ft² at design takeoff gross weight (67,000 pounds) a differential thrust of +11,250 pounds is required to provide 1.0 radians⁷/sec² initial angular acceleration. This is given by changes in collective pitch of +3 degrees.

b. Pitch Axis

Longitudinal cyclic control is used for longitudinal trim and pitch control. The trim requirement at design takeoff gross weight is for cg movement 10 inches forward and aft of the zero trim position. The initial pitch angular acceleration requirement of 0.6 radians/sec² requires a control moment of 133,800 ft-lb for the pitch inertia of 223,000 slugs ft². One degree of tip path plane deflection due to cyclic gives 32,700 ft-lb of hub moment per rotor and 6,700 ft-lb due to thrust line offset at the cg height for a total of 78,800 ft-lb per degree for both rotors. A trim capability of +10 inches is thus provided by 0.71 degrees of cyclic tip path plane deflection. The control moment will require 1.7 degrees of tip path plane deflection giving a total longitudinal control requirement of 2.41 degrees.

c. Yaw Axis

Yaw control is obtained by differential inclination of the rotor tip path planes. This can be accomplished by differential longitudinal cyclic control and/or by differential tilting of the rotor nacelles. Cyclic control produces a hub moment as well as tip path plane tilt and this moment does not, of course, contribute to yaw control. Thus, the use of cyclic control alone may lead to high blade stresses, large moments in the nose mount rotor bearings and tilt actuator attachment structure, and high actuator loads. On the other hand, yaw control through differential nacelle tilt alone will require large actuator powers in order to obtain satisfactory control response. The objective in this preliminary assessment of yaw control system principles is to obtain an optimum compromise between these factors. An analysis has therefore been made to determine the mix of differential cyclic and nacelle tilting which will provide the driving moment for nacelle tilting, from the moment about the nacelle pivot due to cyclic. The solution must also ensure satisfactory response and total control moment.

The total control moment required to give 0.5 rad/sec^2 initial yaw acceleration is 375,000 ft-lb for the 750,000 slugs ft^2 yaw inertia at design takeoff gross weight. The equivalent differential in-plane force is 6,100 pounds giving a tilt per rotor of 9.65 degrees. Thus, any combination of nacelle tilt and tip path plane deflection due to cyclic whose sum is 9.65 degrees will give the required control moment. The total moment about a nacelle pivot is 38,700 ft-lb per degree of tip path plane deflection due to cyclic (32,700 ft-lb direct hub moment and 6,000 ft-lb due to thrust offset from the pivot). This moment is therefore available to drive the nacelle tilt. The moment required to drive nacelle tilt is the product of the angular acceleration of the nacelle and its inertia. If we assume a sinusoidal variation of nacelle angular acceleration, the acceleration, velocity, and angular velocity time histories shown in Figure 81 are obtained. The aerodynamic moments generated for representative angular velocities are small and can be neglected.

These analyses have been used to obtain the summary plot presented in Figure 82. In this figure, the pivot moments required to tilt the nacelle by the amounts on the abscissa scale are shown for various total response times. The pivot moments generated by tip path plane deflections due to cyclic ($\Delta\beta$) are also shown, including the additional moments due to full fore and aft trim. The sum of the corresponding values of $\Delta\beta$ and $\Delta\alpha_T$ is 9.65 degrees at all

points on the abscissa scale. It can be seen that control by cyclic alone, point (1), generates high moments which will result in large blade loads and tilt actuator forces. However, if rudder pedal movement demands both cyclic and nacelle tilt of the amounts given by point (2) then 2.0 degrees of cyclic will generate the moment required to tilt the nacelle 7.65 degrees in 0.5 seconds and together they will give the required control. In this example the adverse effect on one side of moment due to longitudinal trim is included and a response time of 0.5 seconds to full control (which is considered adequate) has been used. Compared to Point (1) the pivot moment due to yaw control only, Point (3), is reduced by a factor of 5 but there is still no hydraulic power required by the tilt actuators. Actually, in considering yaw control cases only, the maximum column load on the actuator will occur when the maximum moment required to decelerate the nacelle angular movement is added to the cyclic moment. If the response is as shown in Figure 81, then this maximum moment will be twice the cyclic moment, which is still a reduction by a factor of 2.5 when compared to all-cyclic control.

Another possibility is to use nacelle tilt only to produce the control moment and to use 2.3 degrees of cyclic (point (4) of Figure 82) as a servo control to provide the pivot moment needed to accelerate and stop the nacelle tilting motion. This would require a sinusoidal cyclic control input matched to the nacelle tilt motion. Such a system would have the advantage of further minimizing tilt actuator loads. However, the control system design implications for such a system need to be investigated.

In summary, it has been shown that, in principle, adequate yaw control can be obtained on a tilt-rotor aircraft with hingeless rotors without the use of large amounts of cyclic control leading to high blade and other loads, and without the necessity for a brute force approach of large nacelle tilt actuators to drive a differential nacelle tilt system with adequate response. The system advocated at this time is that which uses 2 degrees of differential tip path plane deflection due to cyclic, coupled with 7.65 degrees of differential nacelle tilt.

WHERE T = TIME FOR FULL CONTROL DISPLACEMENT

$\Delta\alpha_T$ = FULL CONTROL DISPLACEMENT

$$\frac{\Delta\alpha_t}{\Delta\alpha_T} = \frac{t}{T} - \frac{\sin(2\pi\frac{t}{T})}{2\pi}, \quad \frac{\Delta\dot{\alpha}_t}{\Delta\dot{\alpha}_T} = \frac{1}{T} - \frac{\cos(2\pi\frac{t}{T})}{T}, \quad \frac{\Delta\ddot{\alpha}_t}{\Delta\ddot{\alpha}_T} = \frac{2\pi\sin(2\pi\frac{t}{T})}{T^2}$$

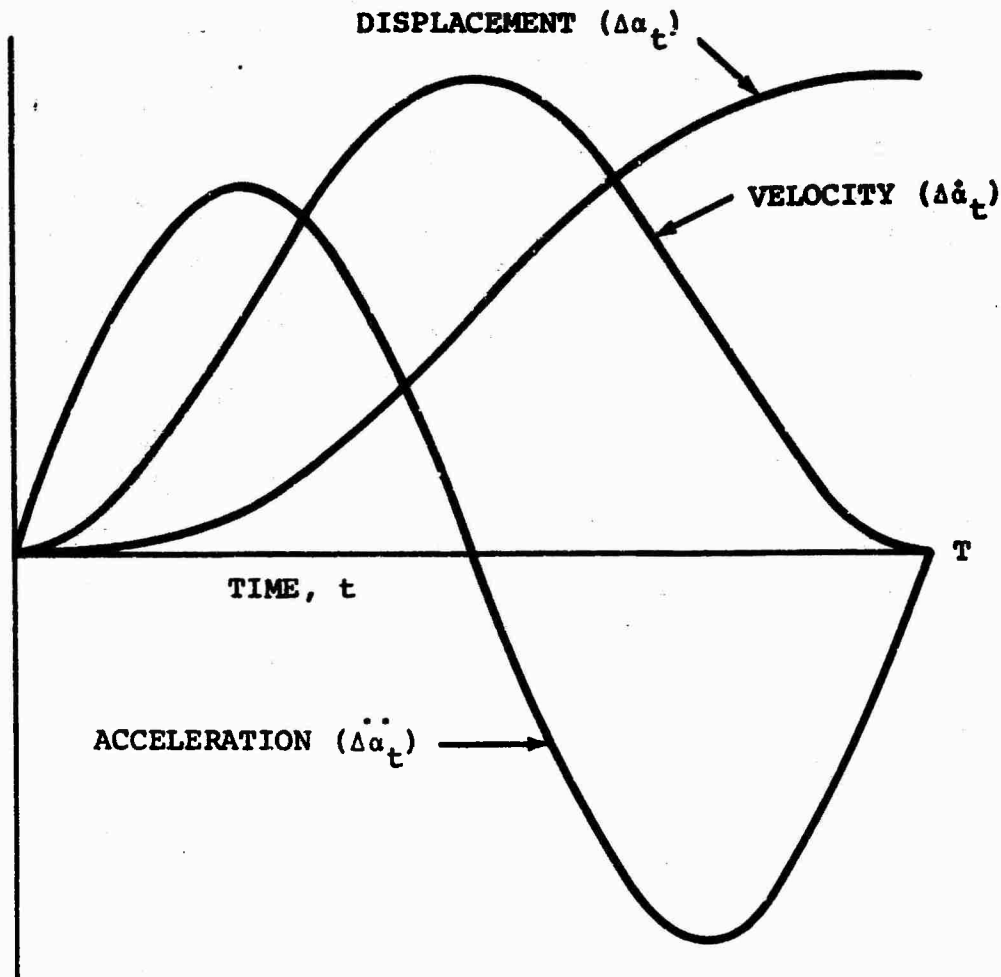

Figure 81. Assumed Response Characteristics of Rotor Nacelle Tilt for Yaw Control.

MOMENT ABOUT
NACELLE PIVOT
(FT-LB X 10⁴)

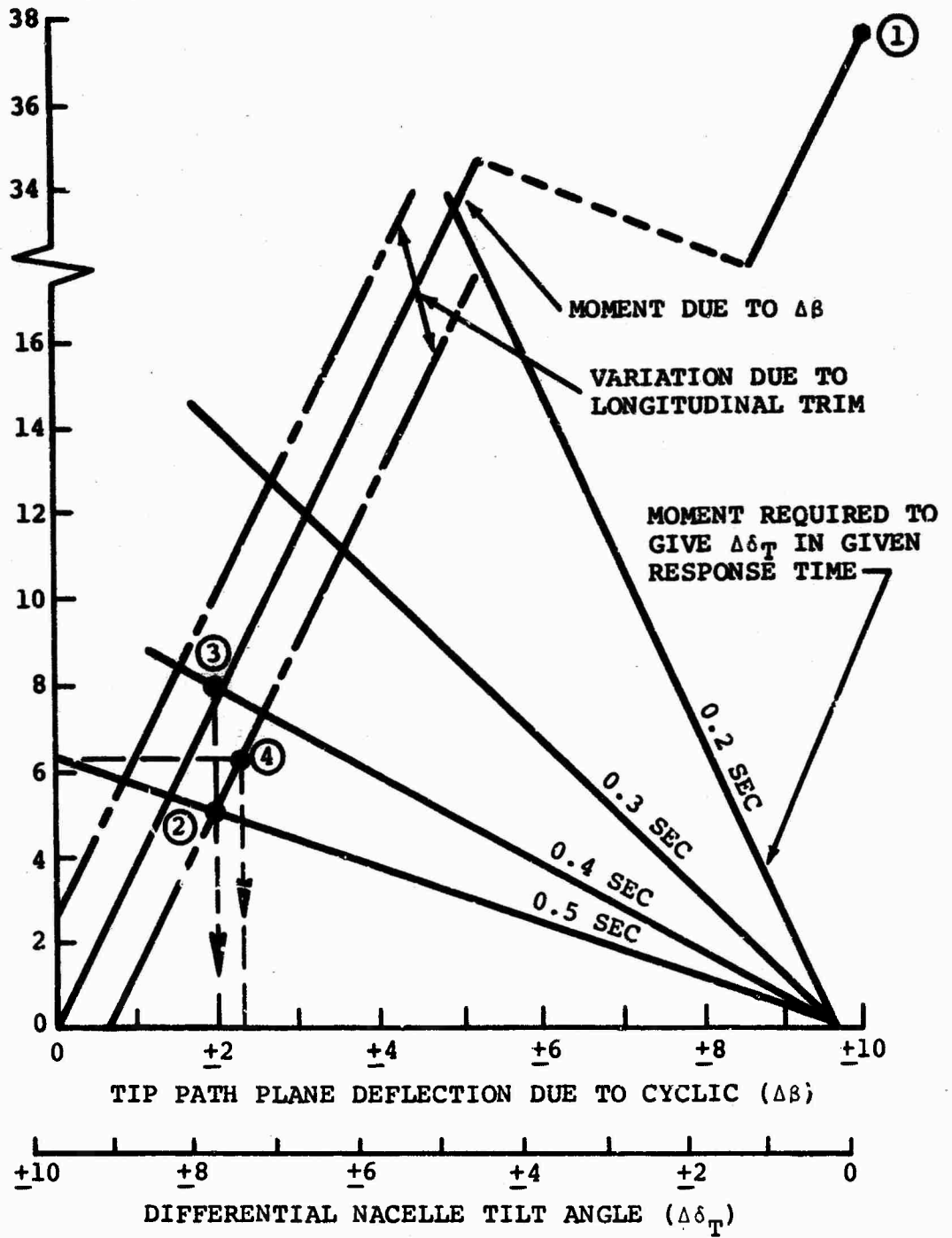

Figure 82. Cyclic Pitch and Nacelle Tilt Mixing for Yaw Control.

2. TRANSITION CONTROL

The control system will be designed to provide uncoupled control about each axis, with conventional basic response to control stick and rudder pedal movement. Longitudinal control will be phased from longitudinal cyclic pitch to the horizontal tail surface as speed increases from hover to forward flight. Automatic programming of horizontal tail incidence will be used to help minimize trim changes during transition. Roll control will be transferred from differential collective pitch in hover to differential flap deflection in flaps-down conventional flight; and yaw control will be transferred from combined differential longitudinal cyclic and nacelle tilt in hover to rudder in conventional flight. Phasing and mixing of controls will be a function of transition speed and/or nacelle tilt angle as determined by future analysis and model tests.

3. CONVERSION CONTROL

Conversion and reconversion from rotor to fan-driven flight and back must be accomplished with minimum pilot effort. Although the conversion events may be individually commanded by the pilot (e.g., for test purposes or to inspect rotor blades after combat), the pilot will normally select "convert" or "reconvert" and the sequences of events described in Table XXVII will occur automatically. An annunciator panel on the console will have sequenced lights corresponding to each event for pilot information, switches for pilot control of individual events, and master switches for selection of automatic conversion or reconversion. While all actuators, power supplies, sequencing switches, and circuitry would be duplicated, failure warning and diagnostic features would also be provided.

With this automatic feature the pilot will be free to control aircraft height and speed in the normal fashion.

While the preliminary design analysis and weights shown in this report are based on a propulsion system which included fan clutches they are not now thought to be necessary. Discussions with engine manufacturers led to the conclusion that the power absorbed by the fan running in virtually a still air environment in hover, with the auxiliary inlet inner doors closing off the fan duct aft of the fan, will be a very small percentage of the total power available. Therefore, Table XXVII is based on a system which does not have fan clutches. It is assumed that dynamic pressure sensing systems, in front of and behind the fan, will be used to sense the pressure difference across the fan and that this will signal inlet guide vane or fan blade pitch to maintain zero net thrust on the fan during transition to forward flight. When thrust transfer is initiated this system will be cut out and control of the inlet guide vanes or fan pitch transferred to a normal constant speed system.

Wind tunnel tests show that lift coefficient increases by 0.15 in a linear fashion as the blades are folded at the low wing angle-of-attack typical of conversion with flaps down. Trim changes did not exceed a ΔC_m of 0.05, well below the trim changes experienced with flap retraction on conventional aircraft. Drag reduction during folding correlates well with analysis and it was found that the blades lying flush in sculptured recesses, but not sealed in the nacelle, did not increase the drag significantly as compared to a completely faired nacelle. The effect of blade-folding on lift slope and longitudinal stability is illustrated in Figures 83 and 84. The change in neutral point of 10.6 percent as the blades are folded is expected to be

**TABLE XXVII. STOWED-TILT-ROTOR AIRCRAFT CONVERSION
CYCLE AUTOMATIC MODE**

Function	Action Required	Input
<u>Rotor Feathering and Folding</u>		
Thrust Transfer and Rotor Disengagement	Decrease rotor blade pitch and actuate rotor clutches so that they disengage as rotor torque approaches zero. Increase fan blade pitch through constant speed system.	Pilot command for conversion
Rotor Stopping	Drive rotor blade pitch to slightly past feather	Rotor clutches disengaged (microswitch signal)
Rotor Locking	Rotor stops and reverses rotation	
	Electro hydraulic unit applies rotor locks	Microswitch signal from antirotation locking dog
Fold Blades	Blade fold actuator	Rotor locked at correct azimuth position
	Blade tip restraints actuated and locked	Fold angle approximately 85 degrees (microswitch signal)
Retract Flaps	Pilot manual selection	Conversion complete indicated on panel, and IAS checked
<u>Rotor Deployment and Spinup</u>		
Slw to Allowable Conversion Speed Range and Lower Flaps	Pilot action	
Deploy Blades	Blade fold actuator	Pilot selects reconversion

TABLE XXVII. (Continued)

Function	Action Required	Input
Blades Locked	Hydraulic locking pins engaged	Fold actuator position
Rotor Spinup and Engagement	Decrease rotor blade pitch, then rpm/blade-pitch feedback to match rpm across rotor clutches.	Blade lock micro-switches
	Rotor clutches in	Clutch synchronized signal
Thrust Transfer	Increase rotor pitch to setting dictated by constant speed governor for pilot controlled power setting and actuate automatic system for zero fan thrust	Rotor clutches engaged micro-switches

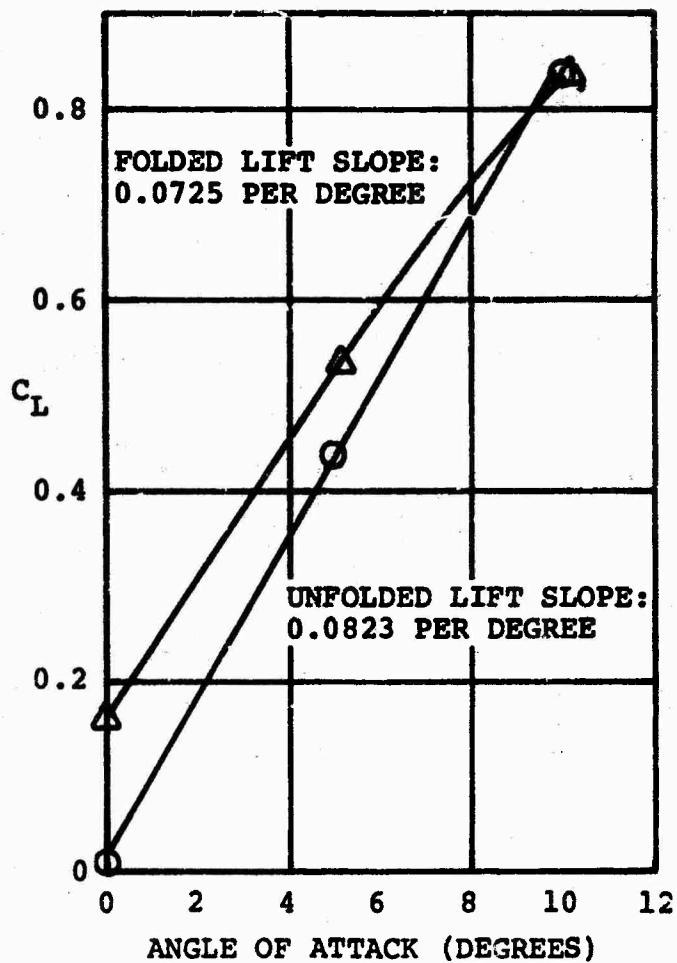

Figure 83. Effect of Blade Folding on Lift Slope.

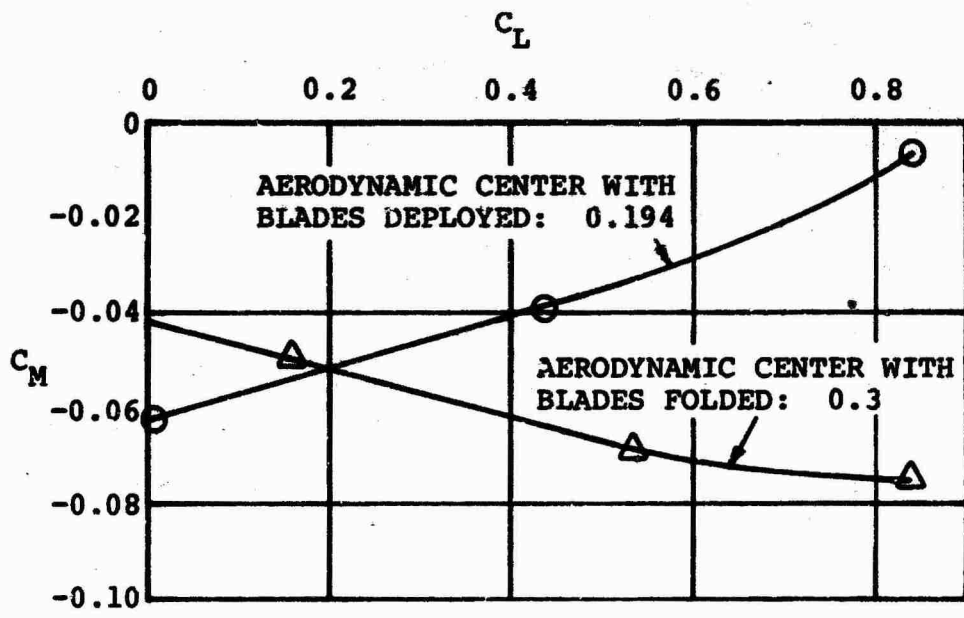

Figure 84. Effect of Blade Folding on Longitudinal Stability.

(approximately 17 percent) at full scale, since the model Reynolds number based on blade chord is less than 10^5 . This loss of stability is accompanied by an aft cg shift of approximately 5 percent MAC and an increase in longitudinal damping, so that the short period mode is not substantially affected. While the tail could be sized to give inherent stability in this case, it would result in excessive static stability in the fan-driven cruise mode which would give very high tail loads in high speed maneuvers as well as compromising handling qualities. A more attractive solution would be to utilize the stability augmentation necessary for hover and transition to stabilize the aircraft in rotor driven flight and size the tail for satisfactory handling qualities in fan-driven flight. The SAS systems would of course have the necessary redundancies to insure safety of flight in the basically unstable rotor mode.

Rotor spinup and stopping are accomplished aerodynamically without the aid of mechanical spinup devices or brakes. Model tests have shown that lift and pitching moment changes are negligible for either spinup or stopping. However, the energy required to spin up the rotor results in a drag transient and stopping gives a thrust transient. The transient thrust levels during rotor stopping are less than the transient spinup drag values. Figures 85 and 86 give typical time histories of pertinent parameters for conversion and reconversion. Preliminary analysis of wind tunnel test results indicates that the spinup drag transient does not peak above available thrust values; and will therefore not cause any speed or altitude change if fan thrust is controlled to match the transient (by autopilot height hold for instance). Spinup times are expected to be about 20 seconds.

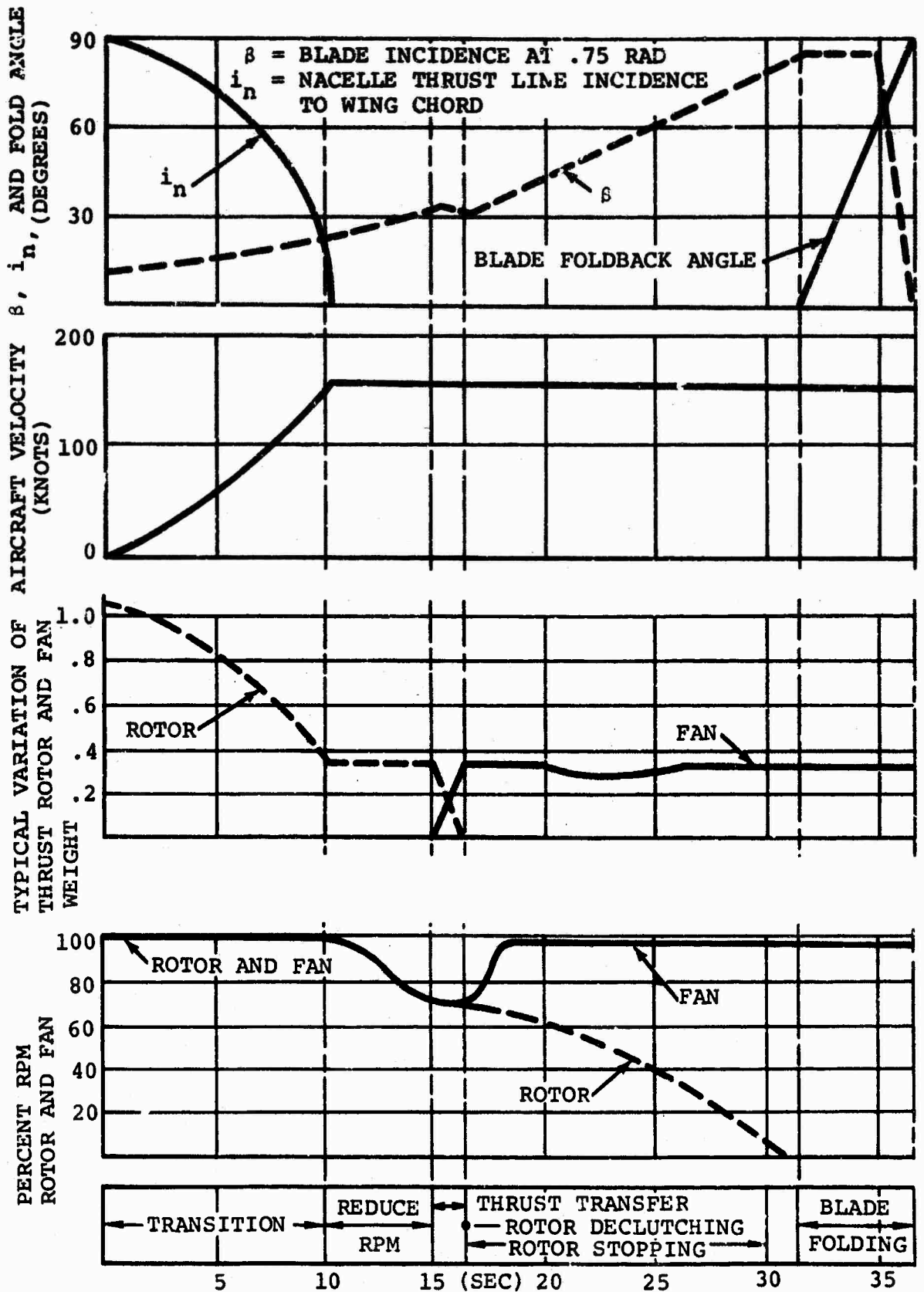

Figure 85. Time History Of Typical Conversion Cycle.

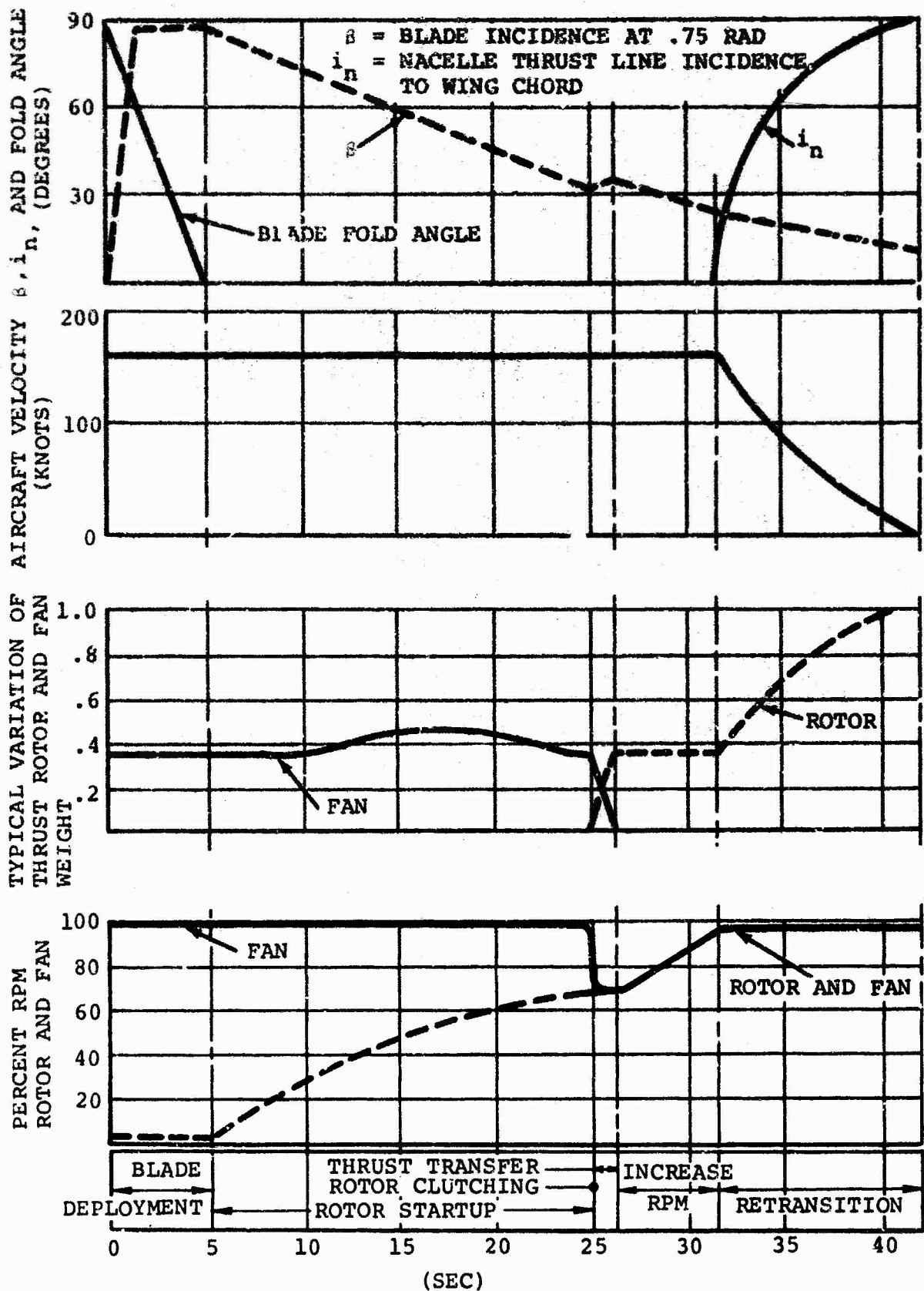

Figure 86. Time History of Typical Reversion Cycle.

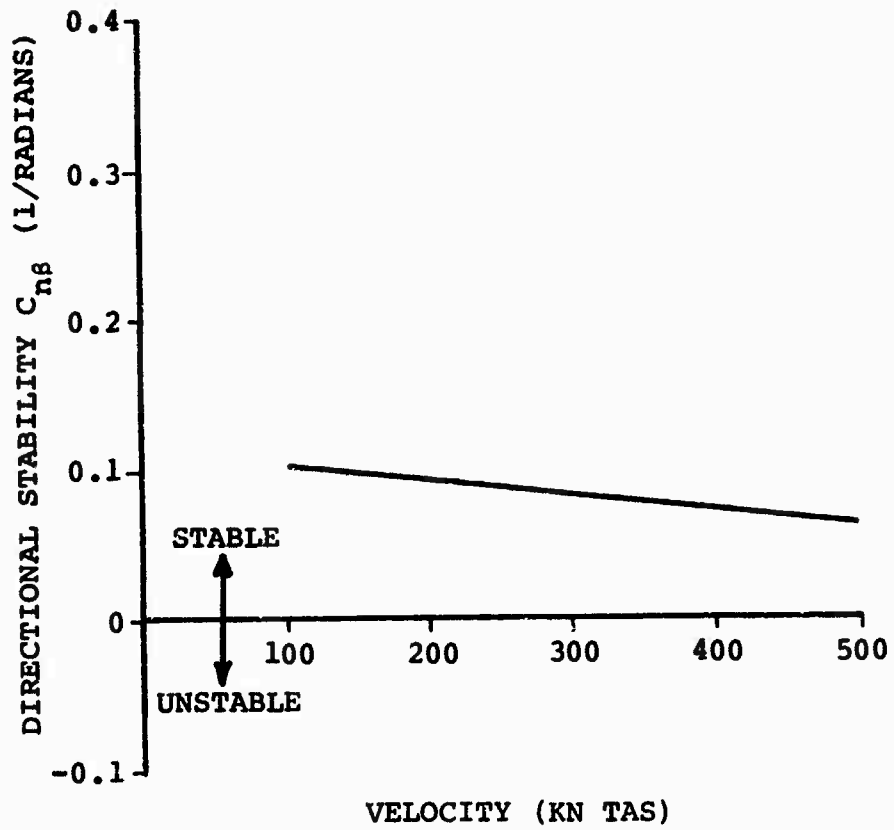

Figure 87. Directional Stability with the CG at 33 Percent of Mean Aerodynamic Chord.

4. STATIC STABILITY CHARACTERISTICS

The empennage was sized to provide adequate static stability margins throughout the cruise flight envelope with the rotors folded. The stability augmentation system (SAS), which is required to provide acceptable flying qualities during hover and transition, will be used to neutralize the destabilizing effects of the rotor during the rotor extended cruise phase and the folding operation. This is desirable to eliminate large stability and control sensitivity changes between the extended and folded flight modes of the rotor. A static margin (SAS OFF) of at least 15 percent exists throughout the cruise speed range for the farthest aft location of the center of gravity. The horizontal tail area and tail volume coefficient (referred to the most aft cg) are 199 square feet and 0.78 respectively.

The unaugmented directional stability ($C_{N\beta}$) is at least 0.08 per radian at the most aft center of gravity location throughout the rotors folded flight envelope, as indicated in Figure 87. Vertical tail area and volume coefficient are 154 square feet and 0.087 respectively.

By locating the horizontal tail on top of the vertical tail, destabilizing wing downwash and dynamic pressure effects are minimized. The high horizontal tail also acts as an endplate on the vertical tail to increase the vertical tail effective aspect ratio. The static and dynamic stability derivatives, used in the following dynamic stability analysis, are summarized in Tables XXVIII and XXIX. Conventional methodology from References 6 and 7 was utilized to predict the cruise stability derivatives (rotors folded). This procedure involved a buildup from two dimensional airfoil data and a correction for three dimensional effects, compressibility effects, interference, etc. This procedure was performed on the Model 160 tilt rotor, which is similar configuration, and showed good correlation with wind tunnel test data.

5. CONTROL CHARACTERISTICS

a. Elevator

A flying tail configuration was selected for longitudinal control. Control authority of the tail configuration is shown as C_M versus tail incidence in Figure 88. From this data it can be shown that elevator per g requirements for the positive V-n maneuver corner at 256 knots are satisfied only for the nominal and maximum aft cg configurations.

TABLE XXVIII. LONGITUDINAL STABILITY DERIVATIVES

CG = 33 Percent MAC			
		V = 180 Kn 10,000 Ft	V = 420 Kn 10,000 Ft
C_{X_u}	(ft/sec) ⁻¹	0.00058	-0.00008
C_{X_α}	(rad) ⁻¹	0.144	-0.215
C_{X_q}	(rad/sec) ⁻¹	0	0
C_{Z_u}	(ft/sec) ⁻¹	-0.0077	-0.00058
C_{Z_α}	(rad) ⁻¹	-5.49	-6.0
C_{Z_q}	(rad/sec) ⁻¹	0	0
C_{M_u}	(ft/sec) ⁻¹	0.00179	0
C_{M_α}	(rad) ⁻¹	-0.855	-0.898
C_{M_q}	(rad/sec) ⁻¹	-0.216	-0.102
$C_{M_{\dot{\alpha}}}$	(rad/sec) ⁻¹	-0.086	-0.043
$C_{M_{\delta_e}}$	(rad) ⁻¹	-2.96	-3.36

TABLE XXIX. LATERAL-DIRECTIONAL STABILITY DERIVATIVES

	V = 180 Kts 10,000 FT	V = 420 Kts 10,000 Ft
$C_{Y_{\beta}}$	-0.578	-0.593
C_{Y_r}	0.412	0.428
C_{Y_p}	-0.0762	-0.0956
$C_{n_{\beta}}$	0.0868	0.052
C_{n_r}	-0.354	-0.369
C_{n_p}	0.145	0.0624
$C_{l_{\beta}}$	-0.1699	-0.1301
C_{l_r}	0.3013	-0.0854
C_{l_p}	-0.3991	-0.403
$C_{n_{\delta_r}}$	-0.122	-0.124
$C_{l_{\delta_r}}$	0.0266	0.027
$C_{l_{\delta_A}}$	-0.184	-0.189
$C_{n_{\delta_A}}$	-0.040	-0.041

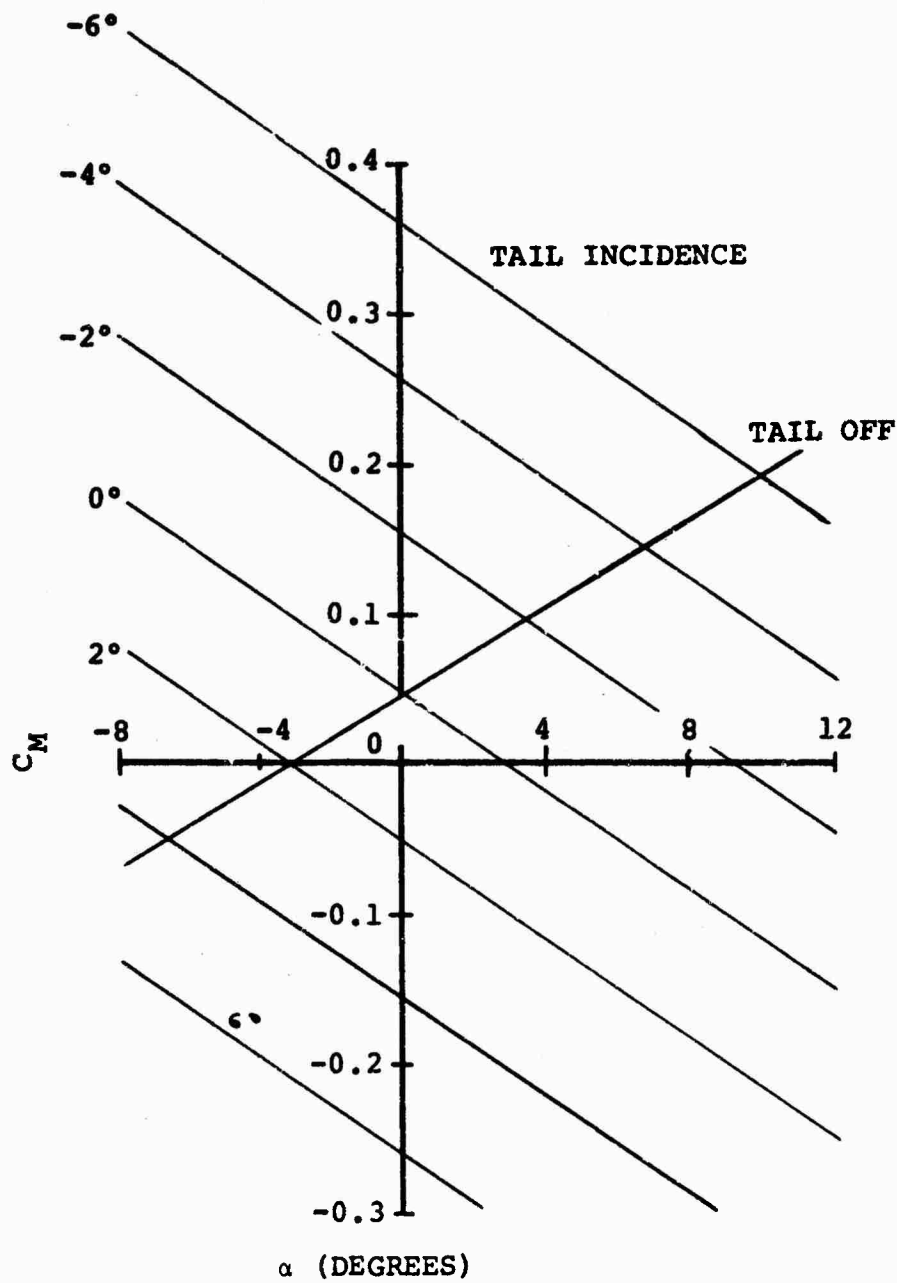

Figure 88. Longitudinal Control Characteristics at Low Speed with CG at 33 Percent of the Mean Aerodynamic Chord.

For the maximum forward cg tail, saturation will be experienced prior to attainment of the maneuver g. This problem is expected to be solved with inverse camber on the tail surface or a geared elevator. Briefly, the elevator per g data is

CG at 20 percent MAC is 8.6°/g
CG at 30 percent MAC is 5.0°/g,

and tail saturation (stall) is predicted at 17 to 18 degrees incidence.

b. Rudder

The rudder must be adequate to hold 5 degrees or less of sideslip with one engine inoperative and the rotors stowed. This condition can be satisfied at zero bank and sideslip with 7.5 degrees deflection of a 40-percent chord rudder, as shown in Figure 89. While a smaller-chord rudder would meet the criteria, the 40-percent-chord surface has been retained since, as shown in Figure 90, it permits a 1.2 V_S two-engine-out condition with 5 degrees sideslip. This is considered desirable for the two-engine-out emergency landing case.

c. Aileron

A plain flaperon configuration was considered for this analysis. The analysis also assumed no yawing moment due to flaperon deflection. The roll response predictions are shown in Figure 91. These show that roll response is not adequate at speeds below 180 knots. Development of a slotted flaperon to permit stalling of the wing with the downward-deflected flaperon should produce adequate response. Adverse yaw effects could require a flaperon-spoiler arrangement.

6. DYNAMIC STABILITY

a. Stick Fixed

(1) Longitudinal

(a) Short Period Mode

Short period information is displayed in the W_{sp} versus n_z/α format in Figure 92 and in complex format in Figure 93. In both cases, the data is compared with the criteria set out in MIL-F-008785 with the observation that

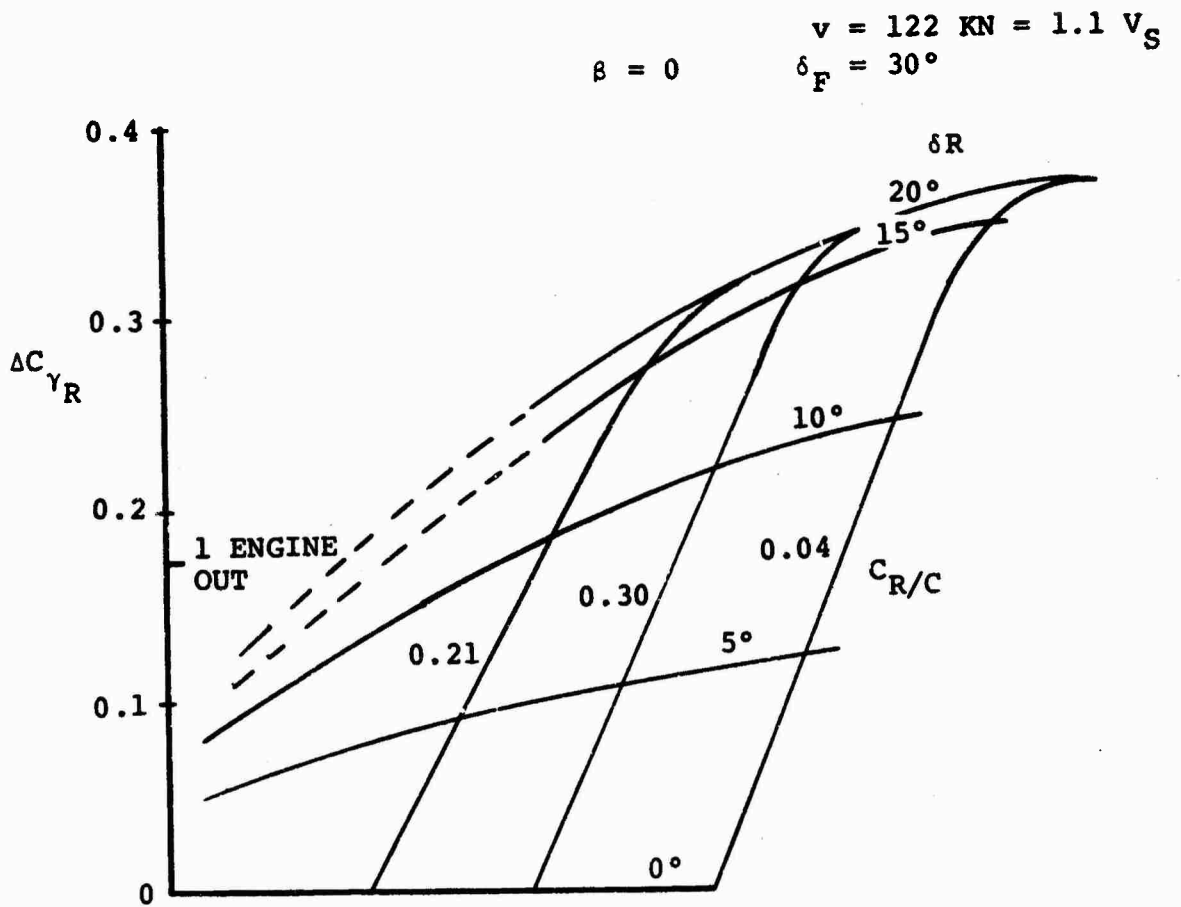

Figure 89. Rudder Control Power.

C_N = YAWING MOMENT
 β = SIDESLIP ANGLE
 δ_R = RUDDER DEFLECTION AFT CG
 $C_{L_{MAX}} = 2.15$ at $\delta_F = 30^\circ$
 $C_r = 0.4$

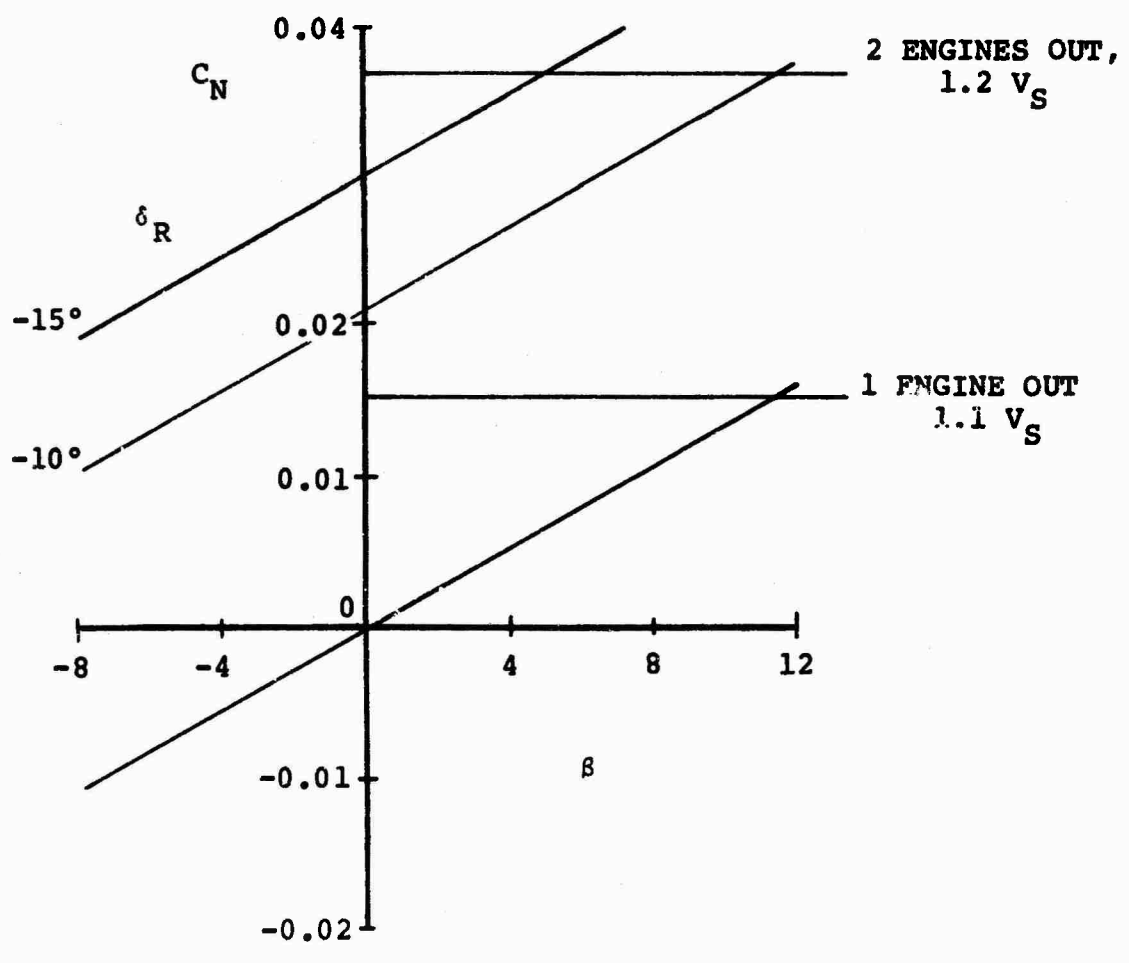

Figure 90. Rudder Control Moments.

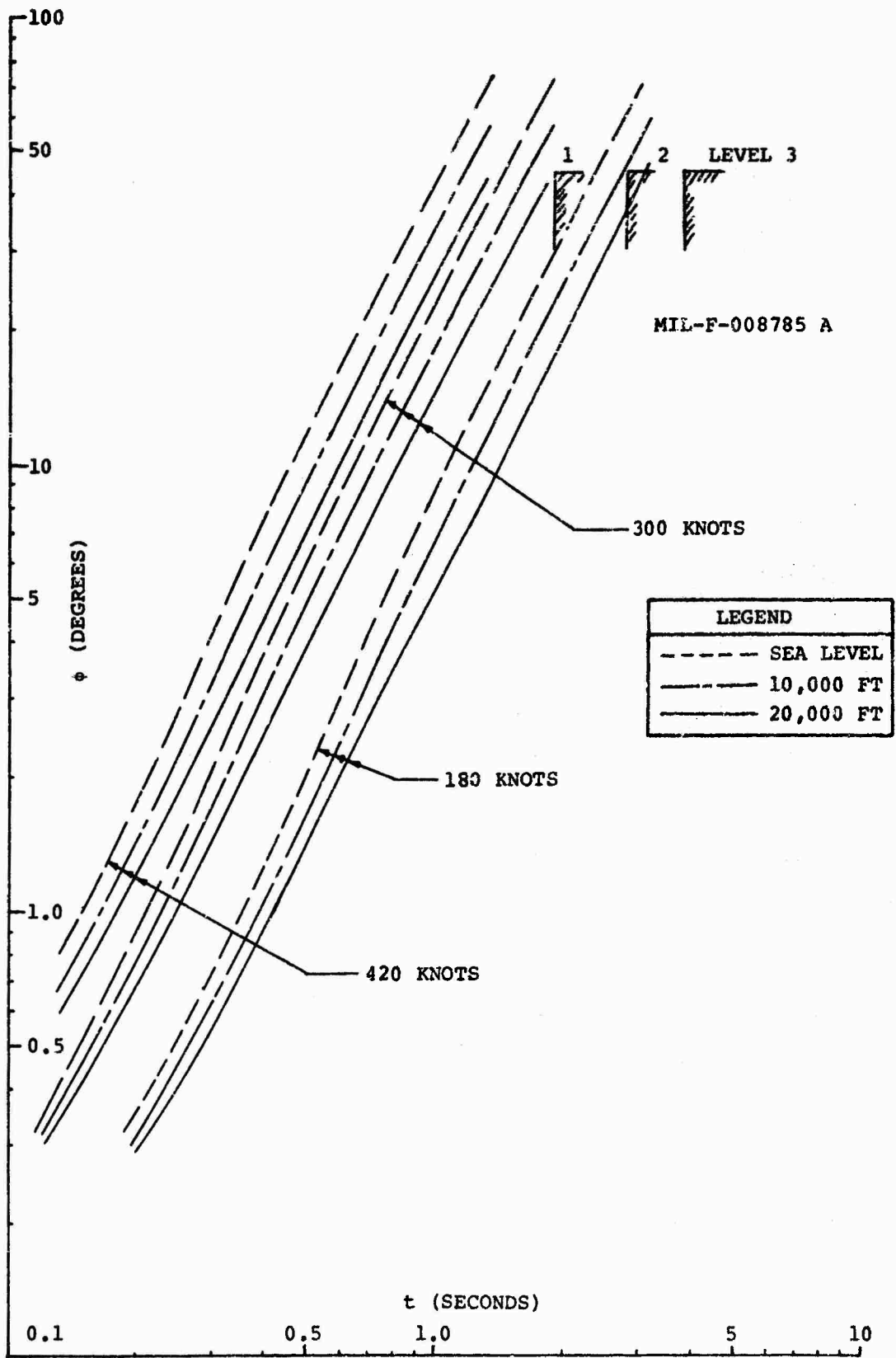

Figure 91. Aileron Response Variation with Airspeed and Altitude.

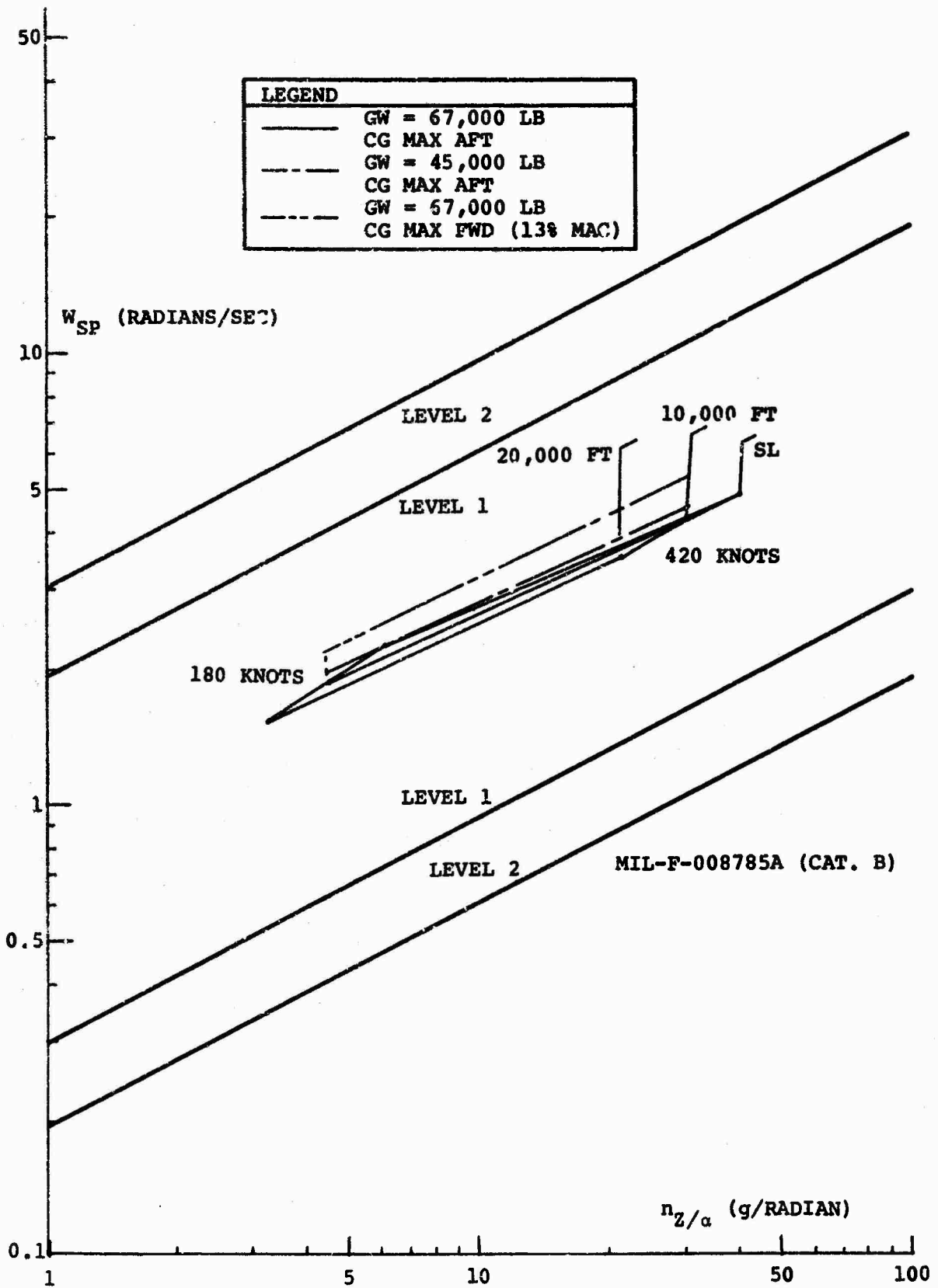

Figure 92. Vertical Acceleration at CG Versus Short Period Frequency for a Stowed Rotor Configuration

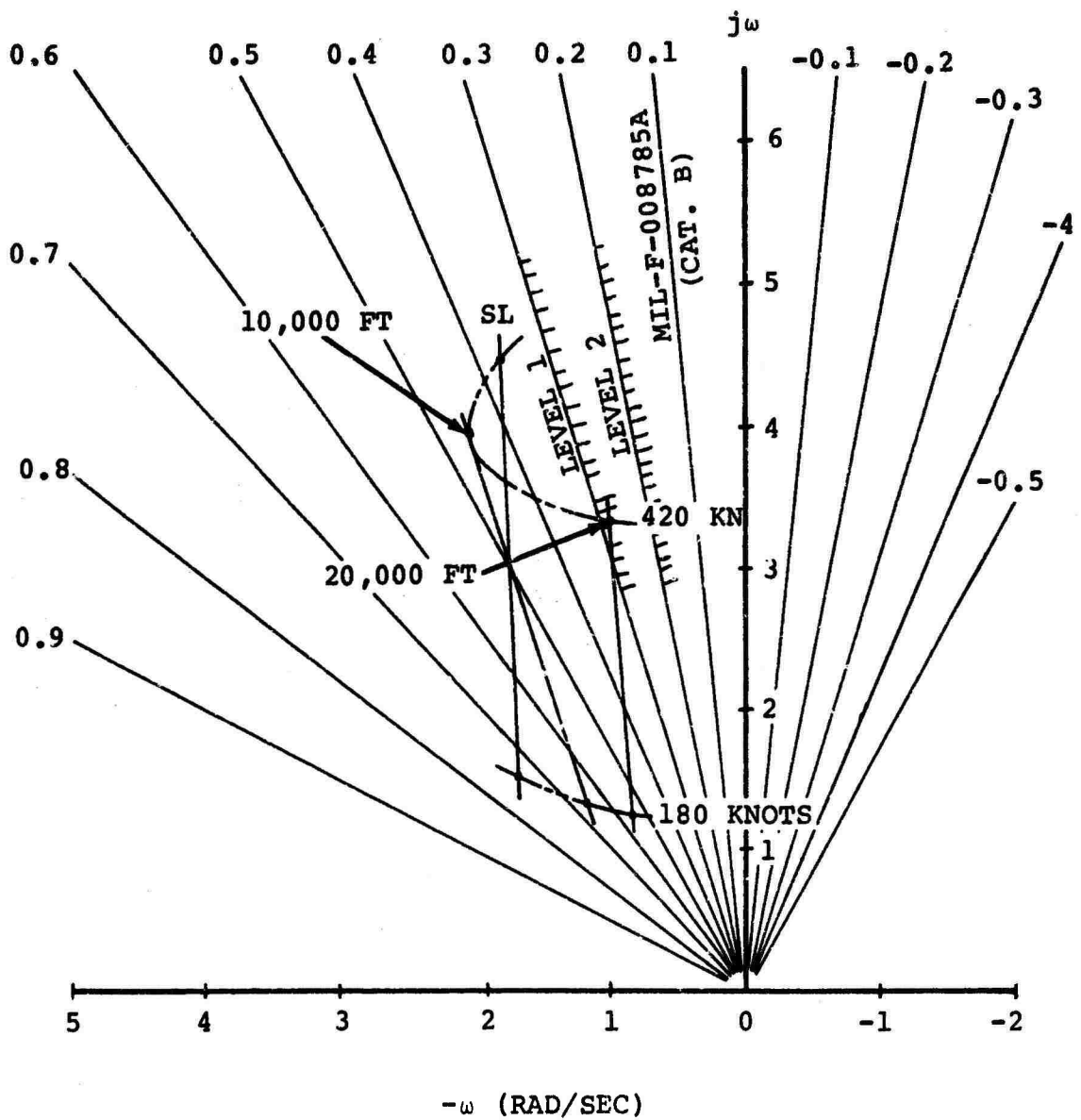

Figure 93. Longitudinal Short Period Roots with the CG Maximum Aft and a Gross Weight of 67,000 Pounds.

the acceleration performance is well within the level 1 constraints, and the damping is only marginally outside the Level 1 criteria for the high altitude, high velocity mission corner.

(b) Phugoid Mode

The phugoid mode is displayed in complex form in Figure 94, with the observation that levels 1 and 2 are violated for the low speed domain, and level 1 is violated for the high speed domain. Within the mission and payload constraints, suggested correction of the phugoid through configuration is unfavorable since a reduction in L/D is indicated. Since, as previously stated, a SAS based on air data pickoffs will be installed, pickoffs will be available to augment the phugoid.

(2) Lateral

(a) Dutch Roll

Dutch roll data is displayed in complex format in Figure 95, and the exhibited behavior is outside level 1 constraints only for the low-speed high-altitude mission corner. Any corrections of this deficiency through manipulation of geometry (dihedral and vertical tail) are at the expense of the spiral mode which is already unacceptable. Consequently, the corrections must come in the form of lateral rate and attitude augmentation. No further adjustment of the configuration is suggested at this time to accommodate the dutch roll.

(b) Roll Subsidence

The aircraft is generally deficient in roll damping as result of high roll inertia versus low aspect ratio. In general, only level 3 criteria are met. However it is suggested that no changes in the configuration be made, since it is believed that boundary layer behavior over the tip nacelles may produce higher damping coefficients than those estimated using standard techniques.

(c) Spiral Divergence

Spiral behavior over the whole mission envelope following conversion is generally unacceptable by MIL-F-008785 standards. For this configuration, the most effective technique of reducing this deficiency is to increase the body end plate effect on the vertical tail by broadening the aft fuselage and by adding dihedral. Again, rather than introducing unfavorable payload volumetric distribution, it is felt that yaw rate augmentation is a more appropriate fix both from spiral and dutch roll standpoint.

(3) Stick Free

General

No stick-free dynamic analysis is provided at this time. Since artificial feel is required for an all-power-control aircraft such as this, there should be no problem with stick-free dynamics.

Methods of solving the aileron deficiency are:

- (a) Control surface leading edge design
- (b) Added aileron chord
- (c) Nacelle shaping for end plate effect and local velocity distribution.
- (d) Segmenting rudder surface and gearing with stick.

Probably the most effective technique will be nacelle shaping in the vicinity of the surface, both for stall control and authority.

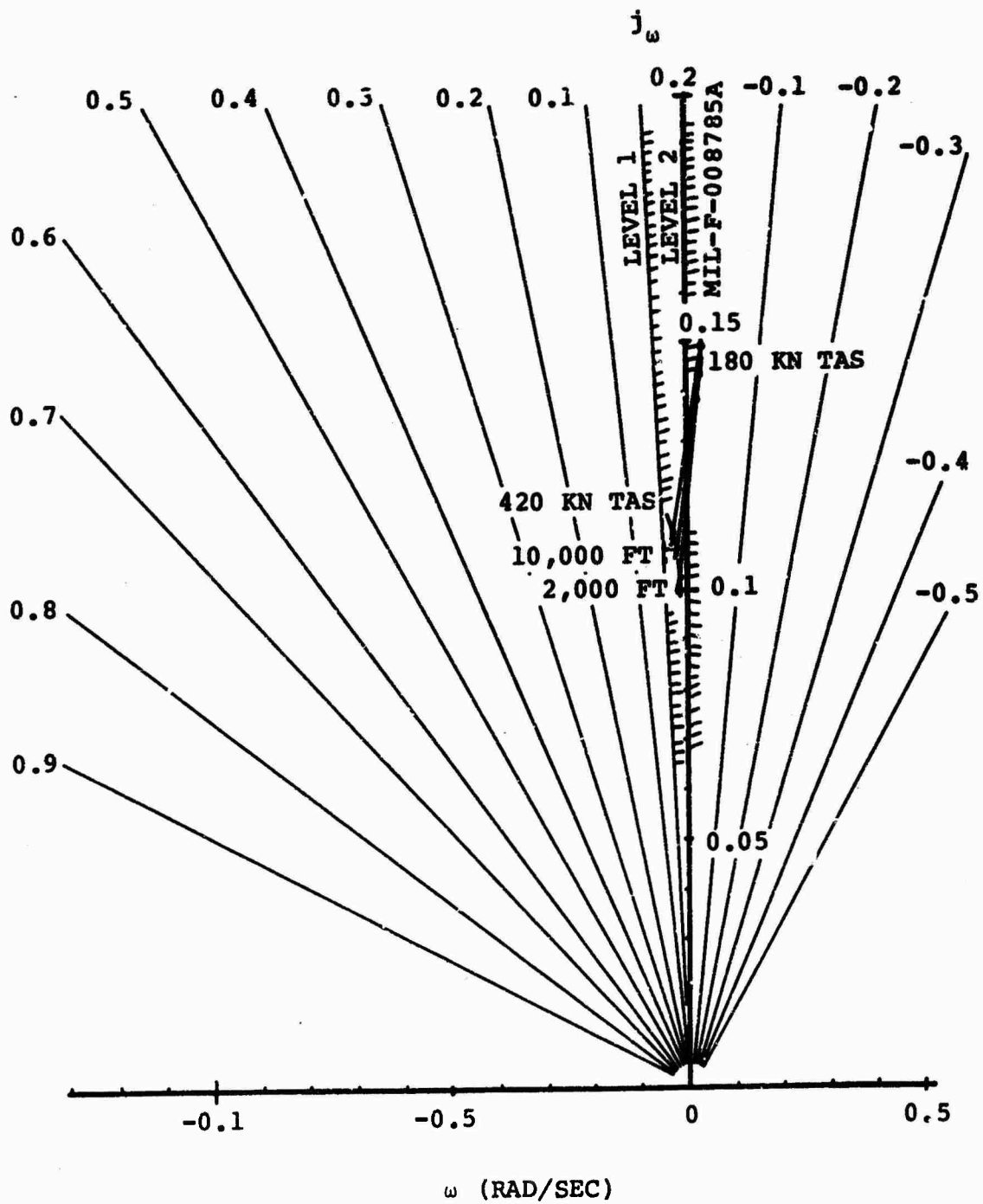

Figure 94. Longitudinal Phugoid Mode Roots with the CG Maximum Aft and a Gross Weight of 67,000 Pounds.

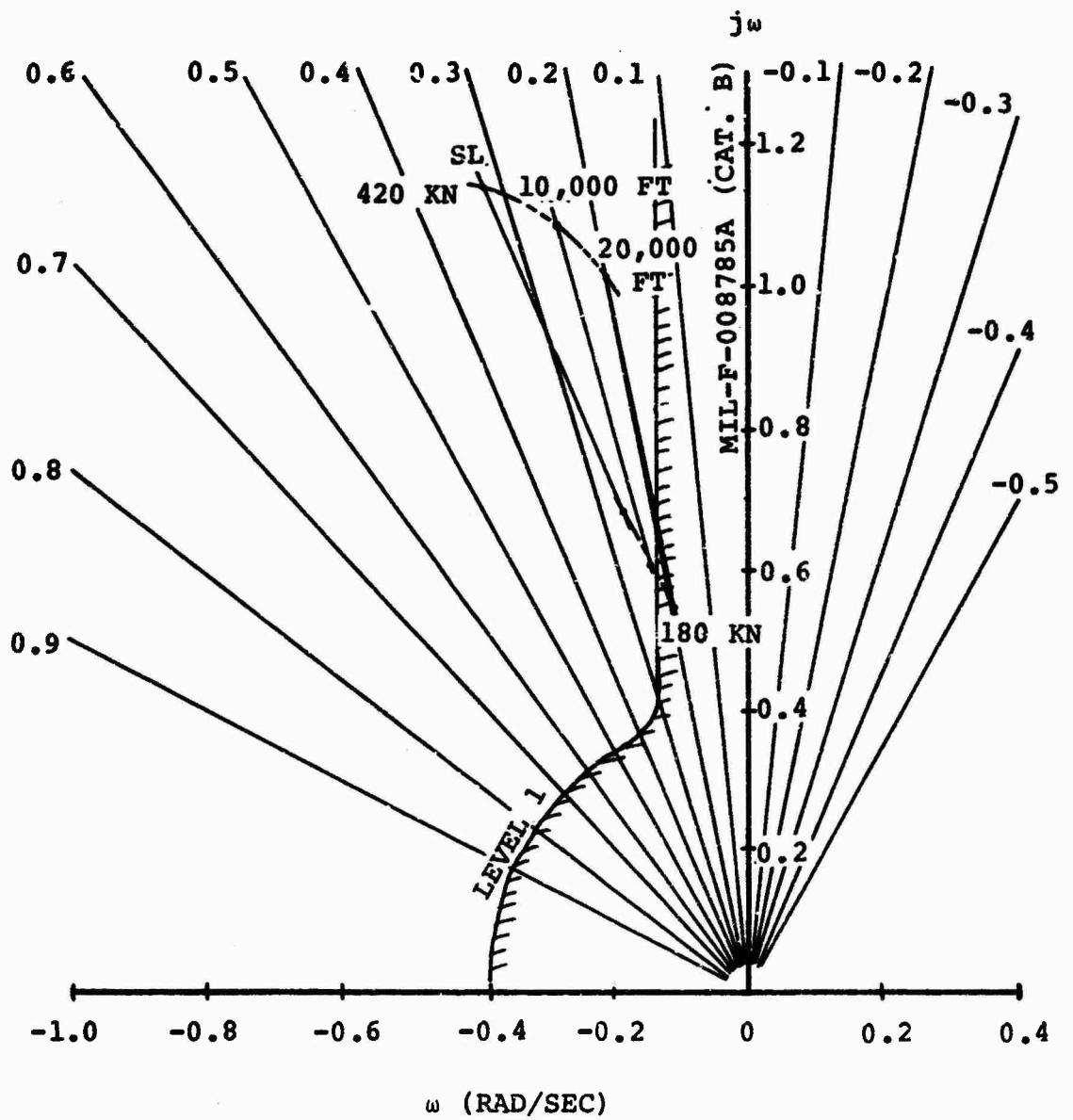

Figure 95. Lateral Dutch Roll Roots with the CG Maximum Aft and a Gross Weight of 67,000 Pounds.

SECTION XI

TRADE-OFF STUDIES

1. DESIGN POINT I RESCUE AIRCRAFT

a. Cruise Speed Sensitivity

Figures 96 and 97 show the results of sizing the Design Point I rescue aircraft to fly at various cruise speeds. As cruise speed thrust requirements increase, installed power (and therefore, bare engine weight) increases. As bypass ratio (and therefore, fan diameter) increases, so does the extra weight associated with the fan and its shroud, along with the profile drag of the engine/fan nacelle.

The optimum bypass ratio for a given design V_{Cruise} will be the one which maximizes the ratio of installed thrust/installed power, while minimizing specific fuel consumption and profile drag. Investigation has shown that these factors combine to dictate a reduction in bypass ratio with increasing cruise speed. Figure 96 shows that mid-point gross weight is relatively insensitive to varying bypass ratio at a given design V_{Cruise} within the narrow band shown.

Matched power aircraft exhibit an increase in hover disc loading with increasing cruise speed. In the case of the stowed-tilt-rotor aircraft, however, an upper limit on disc loading ($W/A = 15$ psf) has been set in order to maintain reasonably low hover downwash velocities. So, although $W/A = 10.5$ psf for $V_{\text{Cruise}} = 350$ knots, W/A has been limited to 15 psf at $V_{\text{Cruise}} \geq 400$ knots (See Figure 97).

To forestall compressibility drag rise, wing thickness has been reduced with increasing V_{Cruise} and "peaky" airfoil sections employed.

b. Dash Speed and Altitude Sensitivity

The effect of varying the dash speed and altitude of the Design Point I aircraft is illustrated in Figure 98. All aircraft represented by the plot have engines sized by the requirement for a 400 kt cruise at 25,000 feet. So, any sensitivity to variation of dash speed and altitude is caused by variations in power settings (and, therefore, fuel flows) at the various dash

conditions. For example, at a given dash speed, the power required decreases as dash altitude increases, hence a reduction in fuel consumption (and gross weight).

c. Mission Radius Sensitivity

Figure 99 illustrates the effect of sizing the Design Point I aircraft at various mission radii. As mission radius increases, cruise fuel weight and gross weight increase.

d. Payload and Hover Time Sensitivity

Figures 100 and 101 show the effects of varying, respectively, the payload weights and mid-point hover times of the Design Point I aircraft. All aircraft represented in the Figures have engines sized by the 400 kt cruise requirement.

e. Hover Altitude and Temperature Sensitivity

The Design Point I aircraft has a design hover condition of 6,000 feet at 95° Fahrenheit. So, any less stringent variation in hover conditions will have no effect on engine sizing, it would only cause slight changes in the amount of hover fuel required. The actual sensitivities are:

- (1) 100 lb mid-point gross weight/1000 ft of altitude
- (2) 120 lb mid-point gross weight/10° Fahrenheit

f. Aerial Refueling Sensitivity

The Design Point I mission does not allow aerial refueling. If this requirement is relaxed and the aircraft resized, it is possible to effect a considerable saving in weight. In such a case, the refueling point is assumed to be at the end of the inbound 350 knot dash; this allows refueling at a safe distance from any hostile environment. Assuming the present return leg reserves 5 percent of the mission fuel plus 30 minutes at the best endurance speed, at sea level before refueling, the midpoint gross weight would be reduced by approximately 14,000 pounds.

2. DESIGN POINT IV TRANSPORT AIRCRAFT

a. Cruise Speed Sensitivity

A study was done to determine the sensitivity of the design gross weight to variation of the design cruise speed capability. Horsepower installed per pound of gross weight was calculated for various cruise speeds over a range of altitudes, as a function of by-pass ratio. Also, matched power points in hover and cruise were provided by obtaining the fuel flow per pound of gross weight and the disc loading in hover flight, at 2500 feet, 93° Fahrenheit, IGE. An evaluation of the results indicated the cruise altitude and disc loading for each design cruise speed which would yield the lowest design gross weight. From this it was determined that 10,000 feet was the near-optimum altitude over the range of speeds considered, when the weight advantage of a non-pressurized fuselage was included. A combination of power installed and specific fuel flow variations, taken together within the mission profile, determined the optimum by-pass ratio. The optimum disc loading was used wherever its value was less than the 16.0 psf that was established for the design point transport aircraft.

Figure 102 shows the resultant sensitivity of gross weight to sizing at various cruise speeds. A small increment in gross weight is noted when the mission cruise and dash speeds are allowed to increase to take advantage of the full capability of the installed power.

b. Dash Speed and Altitude Sensitivity

Sensitivity of design gross weight to aircraft sizing at various dash speeds and altitudes is presented in Figure 103. The engine is sized by the cruise or dash speed in all cases. Since the dash at 350 knots at 3000 feet (the design point) is nearly a power match in cruise and hover flight, a lower dash speed decreases the gross weight iteratively, and the cruise at 350 knots at 10,000 feet becomes critical in the sizing process. The gross weight is reduced and power available for hover flight at 2500 feet, 93° Fahrenheit, is greater than that required.

As the dash altitude increases, the drag in the dash portion of the mission decreases. The fuel required for dash decreases. Gross weight, and consequently, installed power decrease, thus creating a trend of decreasing gross weight with increasing dash altitude.

As the speed of the dash segment increases, the aircraft drag increases. Power installed and fuel required in dash increase. Cruise at 350 knots at 10,000 feet is critical in sizing to the matched power point (design point). Dash speeds above 350 knots become the critical factor in engine sizing, and the gross weight increase is an iterative result of increase in engine size and fuel required.

The apparent abrupt increase in gross weight with dash speed beyond the design point is due to the departure from quasi-constant power sizing at dash speeds below 350 knots and the ever-increasing power sizing required beyond the design point dash speed.

c. Mission Radius Sensitivity

Figure 104 shows the sensitivity of significant parameters to the variation in mission radius. The figure is almost self-explanatory. As the mission radius is incremented, the amount of fuel required changes. This change alters the weight throughout the mission and therefore, the power installed requirements in all segments of the mission are changed. With constant wing loading and disc loading, component sizes are changed. Drag is changed. The result is an iterative sizing process until the gross weight, power installed, drag, and fuel quantity are again matched. The curve-slope-rate change is indicative of this process.

d. Design Payload Sensitivity

Figure 105 shows the sensitivity of significant parameters to the variation in design payload. The increment in payload is analogous to the initial increment in fuel weight in c. above. However, the payload increment itself is not subject to iteration as was the initial fuel increment. The slope rate change is noticeably less.

e. Mission Hover Time Sensitivity

Figure 106 shows the sensitivity of significant parameters to the variation in hover time during the mission. The increment in mission time was varied proportionally to the initial time of the hover phases within the specified mission. As the hover time is increased, the amount of fuel required to hover is increased. The power required to hover (under the same conditions and efficiencies) is increased. The iterative process is now analogous to that described in c.

f. Hover Altitude and Temperature Sensitivity

Figure 107 shows the sensitivity of the design gross weight to hover altitude and temperature. At points below the dashed line the engines are cruise sized at the design-point dash criteria of 350 knots (TAS) at 3000 feet, 95° Fahrenheit. Hover flight at design point conditions will then be possible at reduced power and fuel flow. The reduction in fuel required in hover causes the noted small reduction in the iterated gross weight. Above the dashed line, the engines are sized for hover flight. In addition to the increase in power and fuel flow; the rotors, drive system, controls, and supporting structure have entered the iterative cycle and the design gross weight increases rapidly.

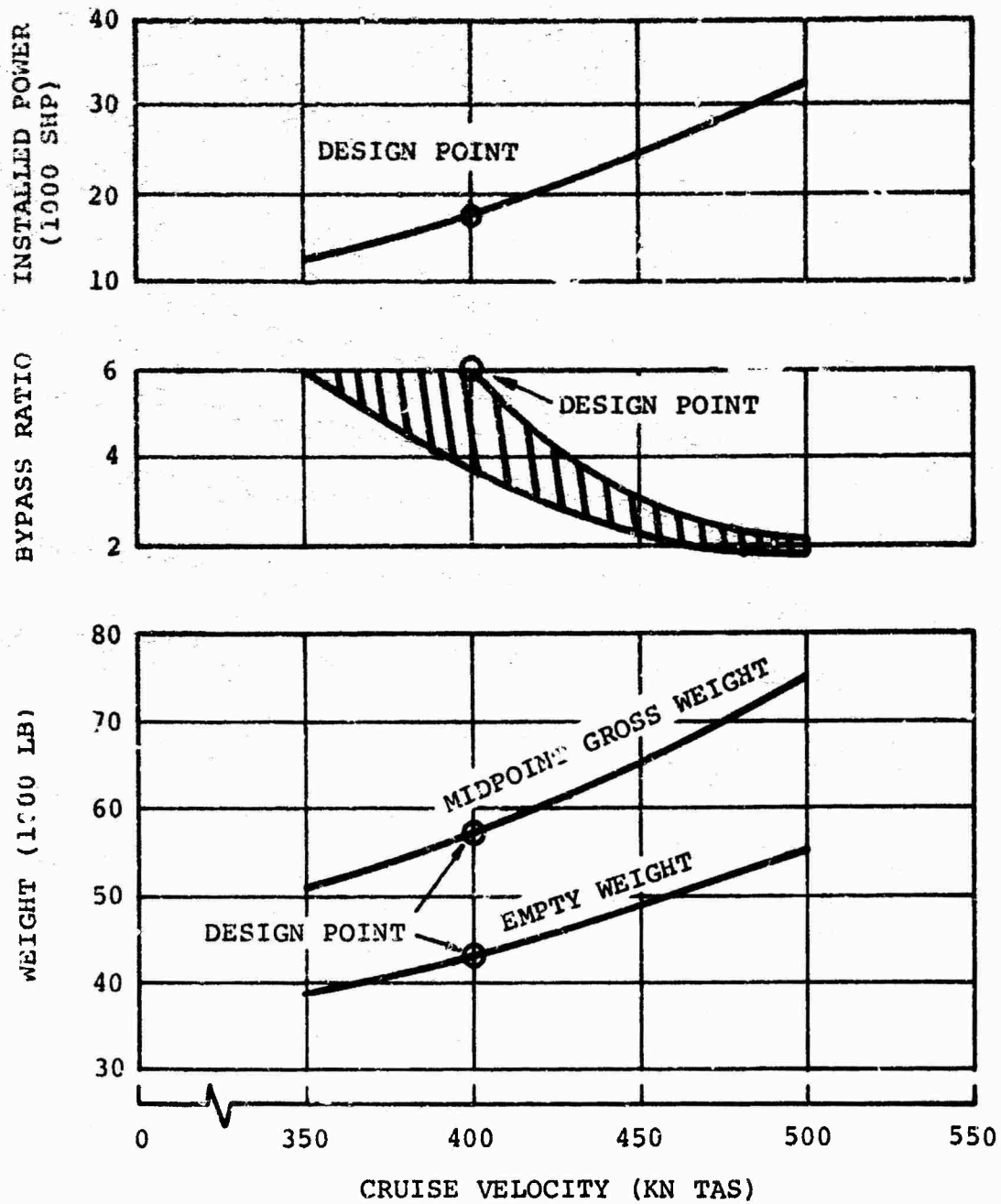

Figure 96. Design Point I Sensitivity of Weight, Bypass Ratio, and Installed Power to Sizing at Various Cruise Speeds.

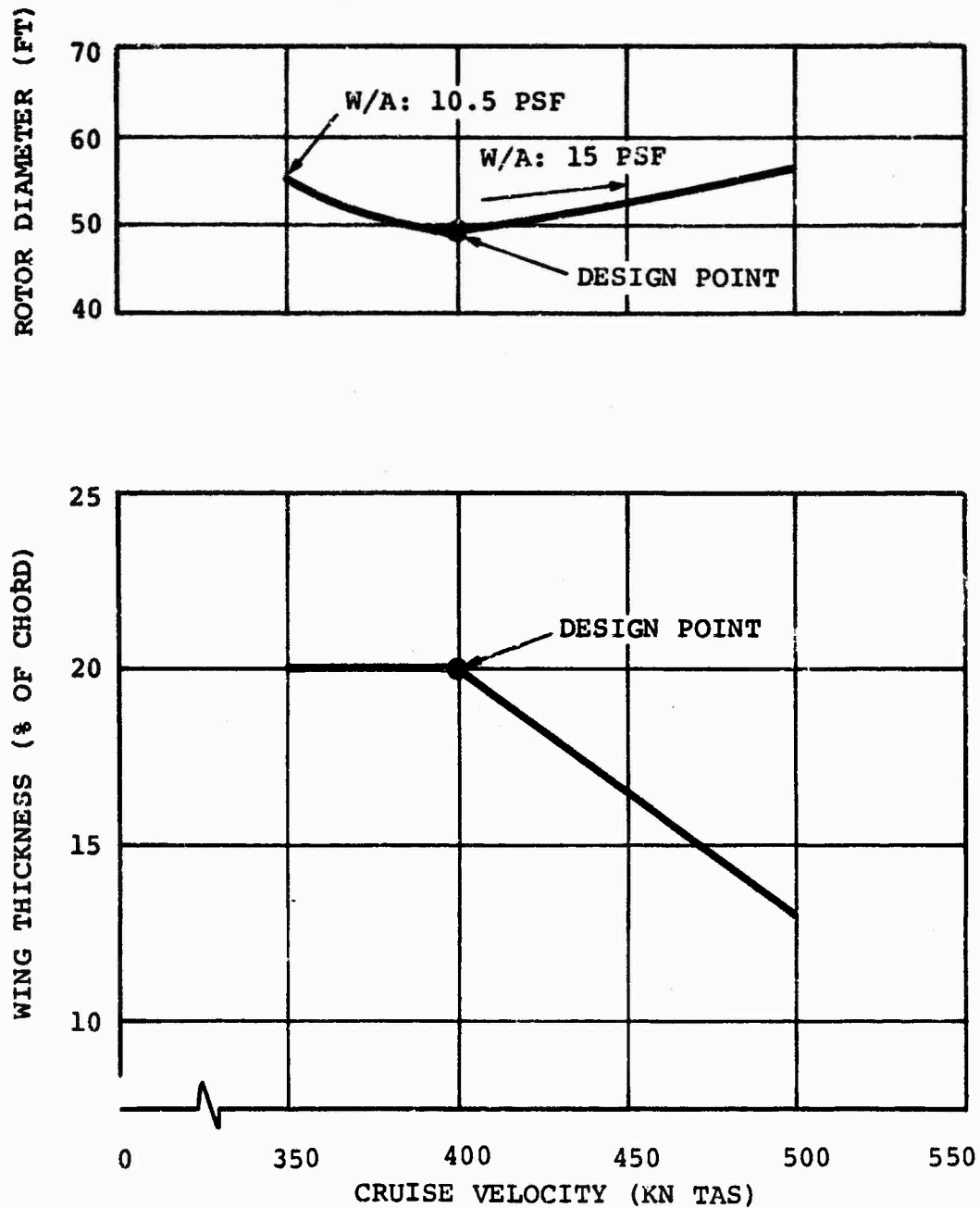

Figure 97. Design Point I Sensitivity of Wing Thickness and Rotor Diameter to Sizing at Various Cruise Speeds.

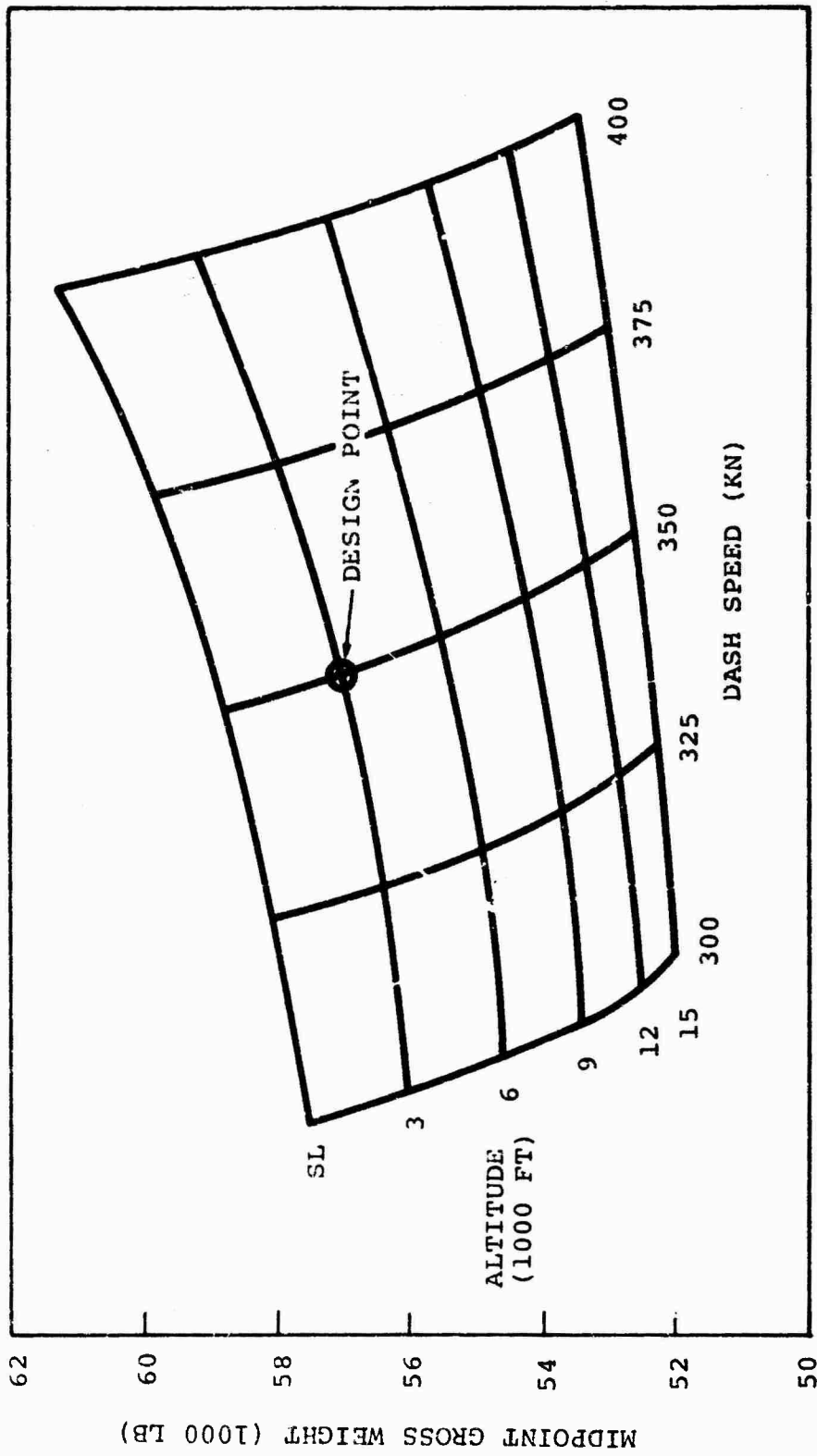

Figure 98. Design Point I Sensitivity of Midpoint Gross Weight to Sizing at Various Dash Speeds and Altitudes for Air Force Hot Day.

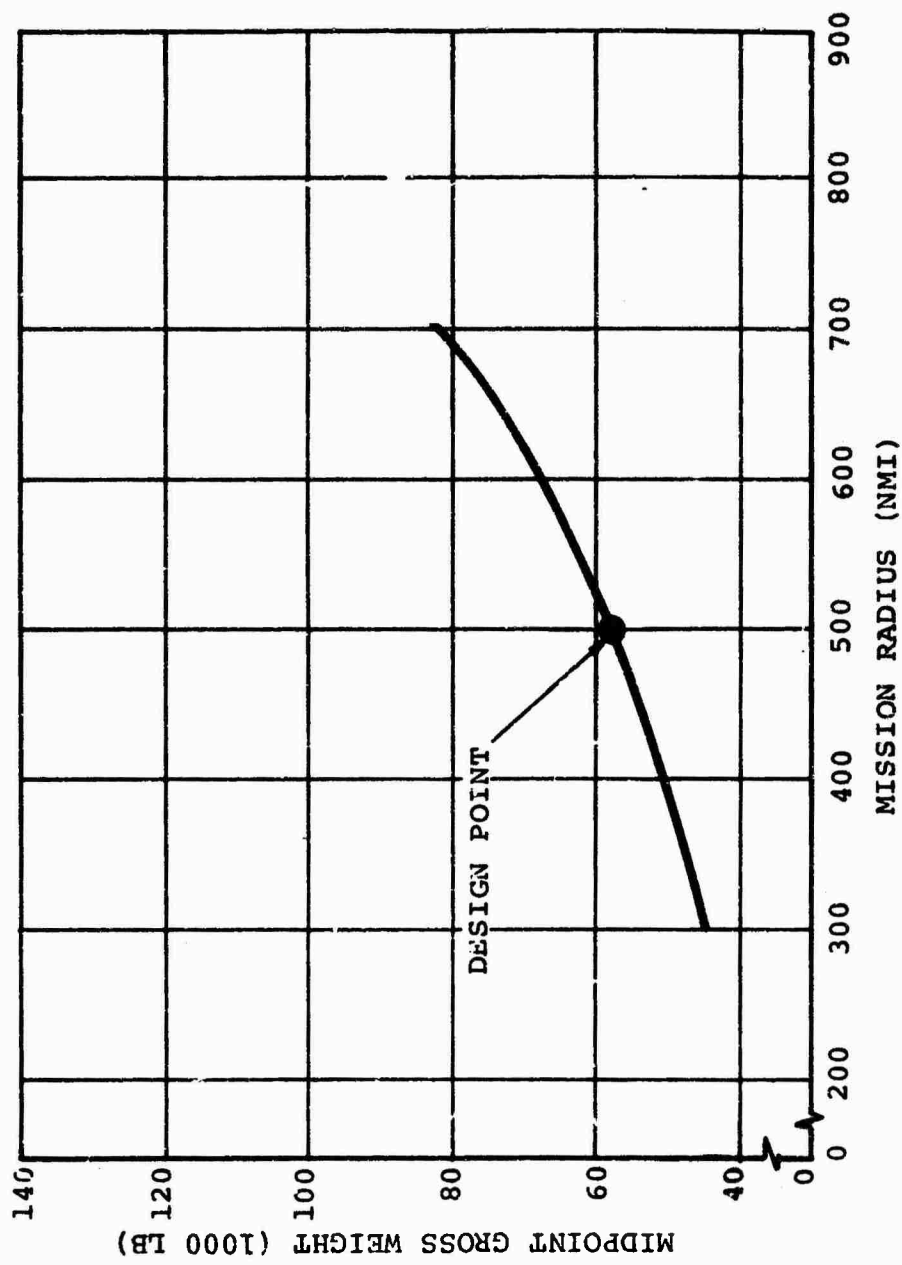

Figure 99. Design Point I Sensitivity of Midpoint Gross Weight to Sizing at Various Mission Radii.

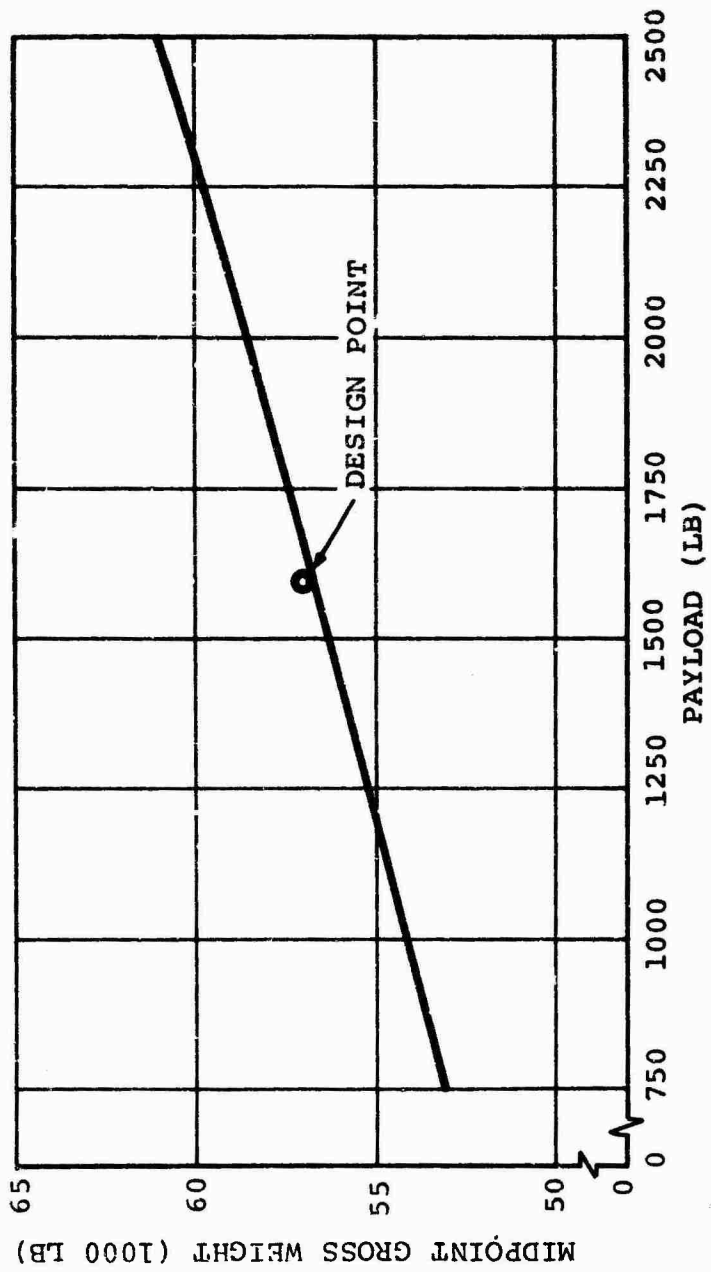

Figure 100. Design Point I Sensitivity of Midpoint Gross Weight to Sizing at Various Payloads.

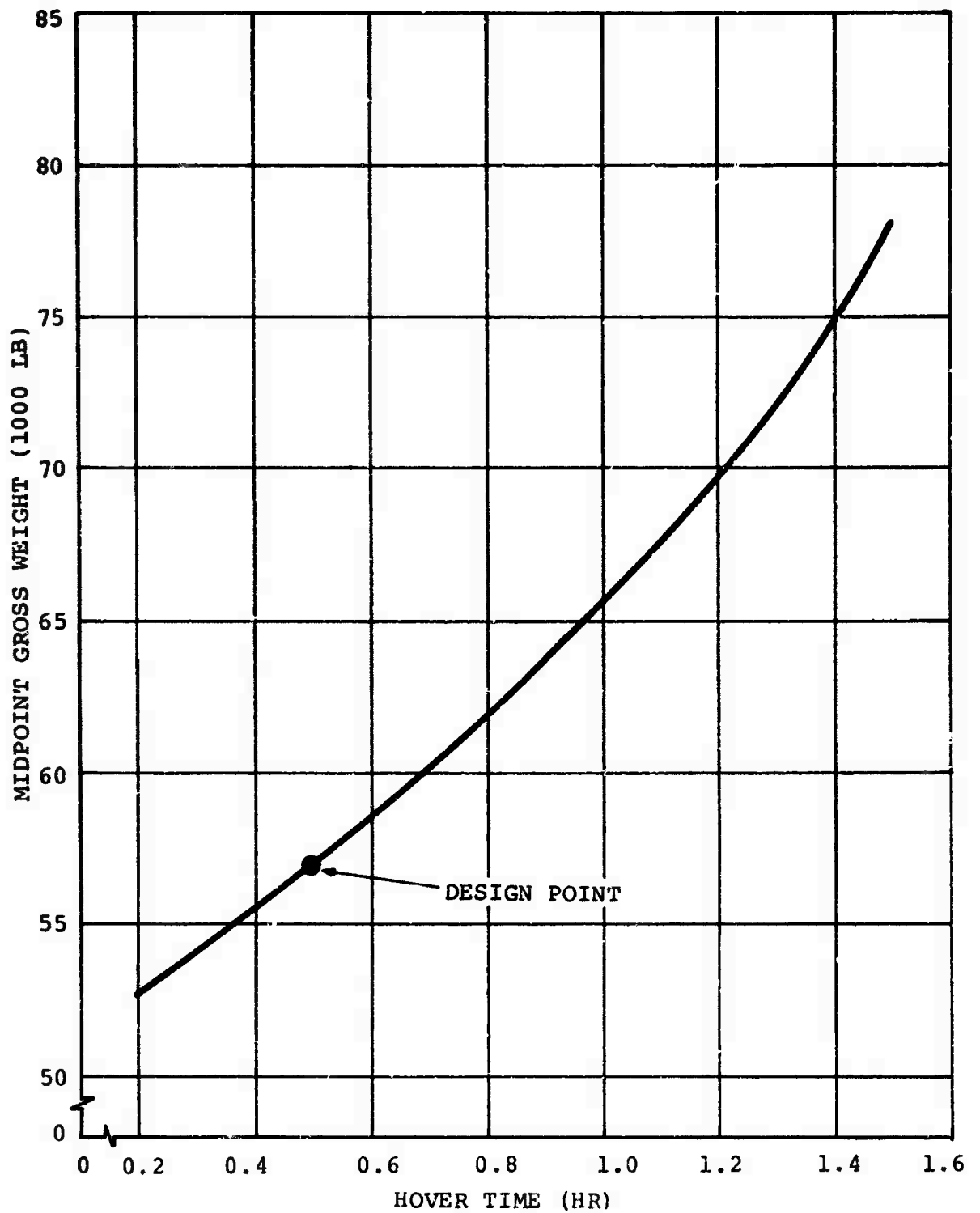

Figure 101. Design Point I Sensitivity of Midpoint Gross Weight to Sizing at Various Hover Times for 6,000-Foot Altitude, 95°F Temperature, HOGE, and T/W = 1.073.

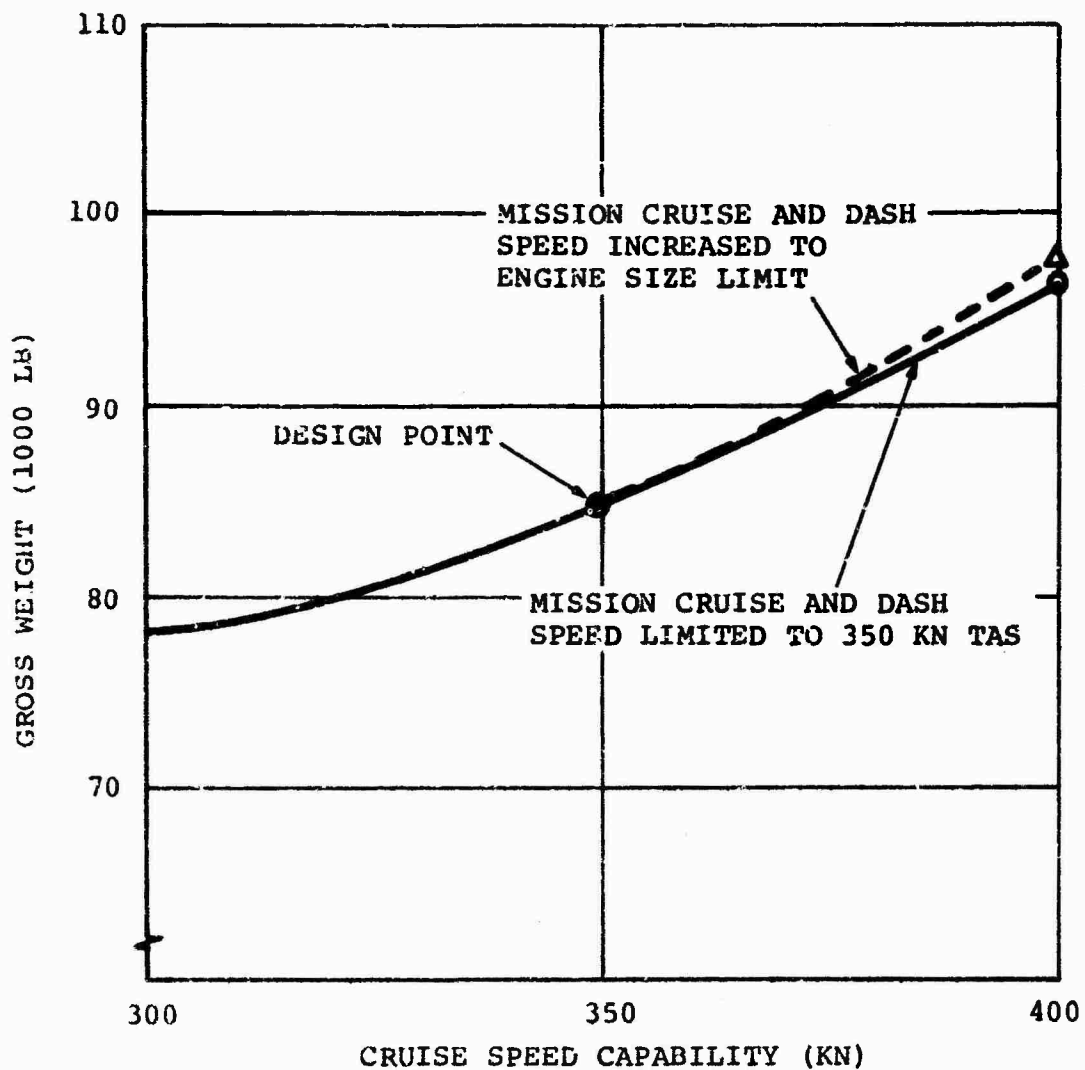

Figure 102. Design Point IV Sensitivity of Gross Weight to Sizing at Various Cruise Speeds for Air Force Hot Day and Aircraft Nonpressurized Cruise Altitude of 10,000 Feet.

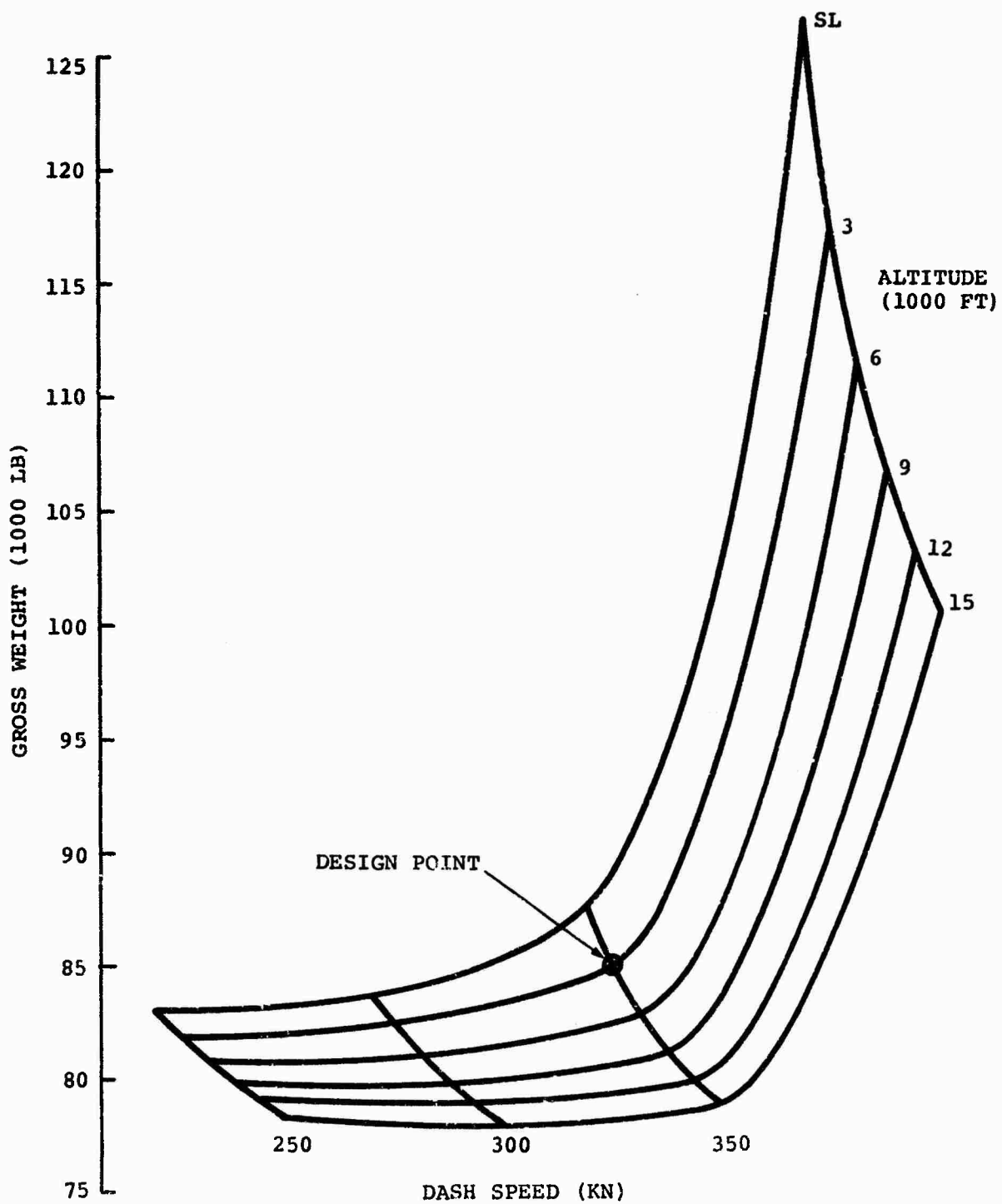

Figure 103. Design Point IV Sensitivity of Gross Weight to Sizing at Various Dash Speeds and Altitudes for Air Force Hot Day.

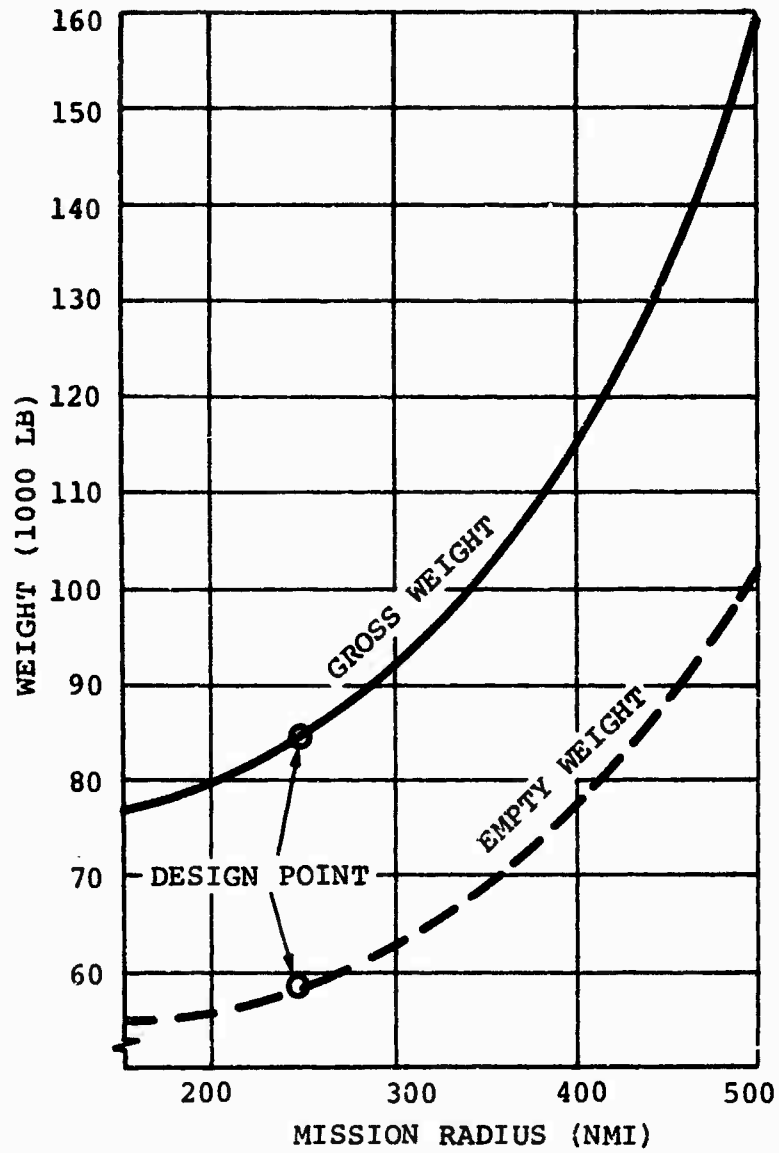

Figure 104. Design Point IV Sensitivity of Aircraft Weight, Mission Fuel, and Installed Shaft Horsepower to Mission Radius (Sheet 1 of 2).

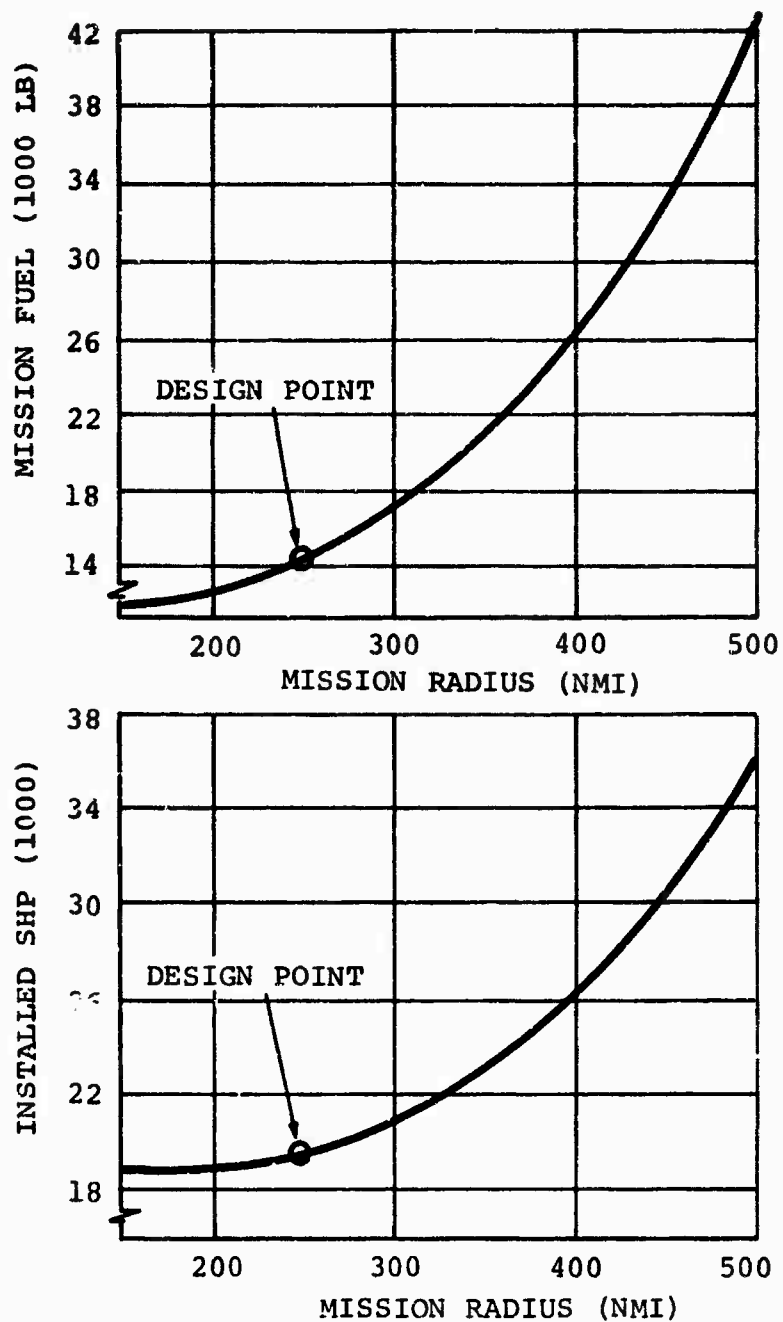

Figure 104. Design Point IV Sensitivity of Aircraft Weight, Mission Fuel, and Installed Shaft Horsepower to Mission Radius (Sheet 2 of 2).

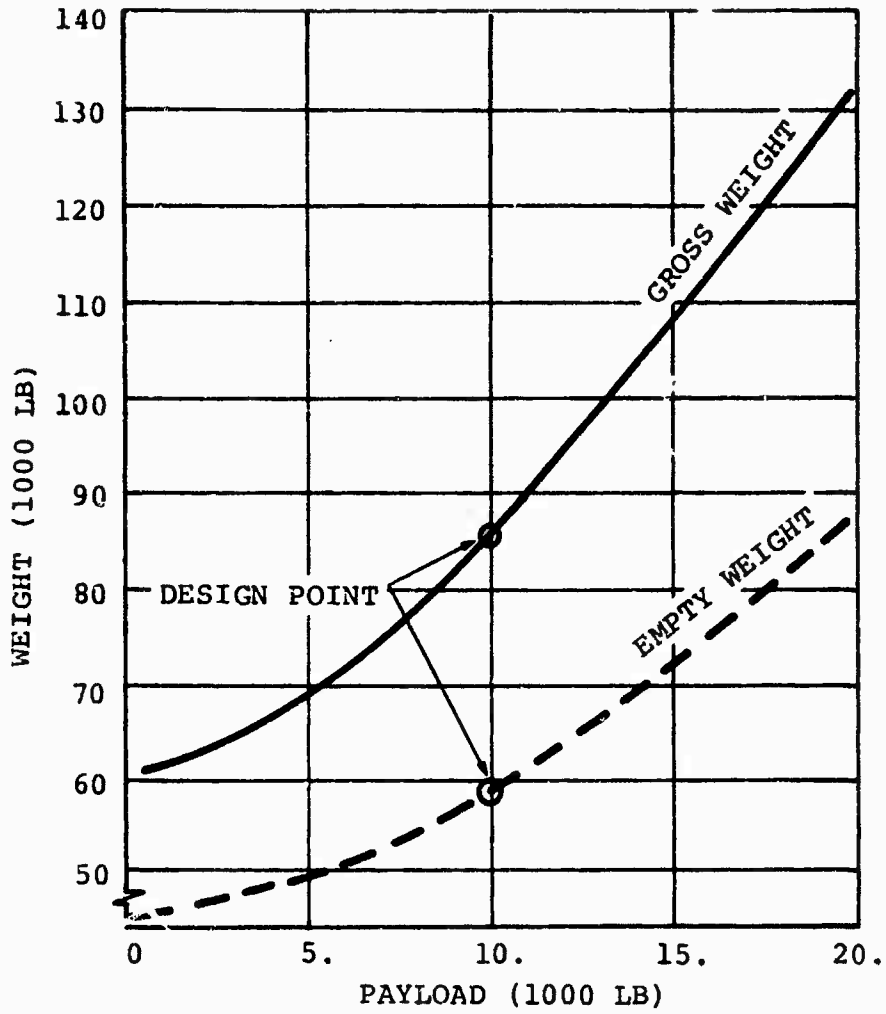

Figure 105. Design Point JV Sensitivity of Aircraft Weight, Mission Fuel, and Installed Shaft Horsepower to Payload (Sheet 1 of 2).

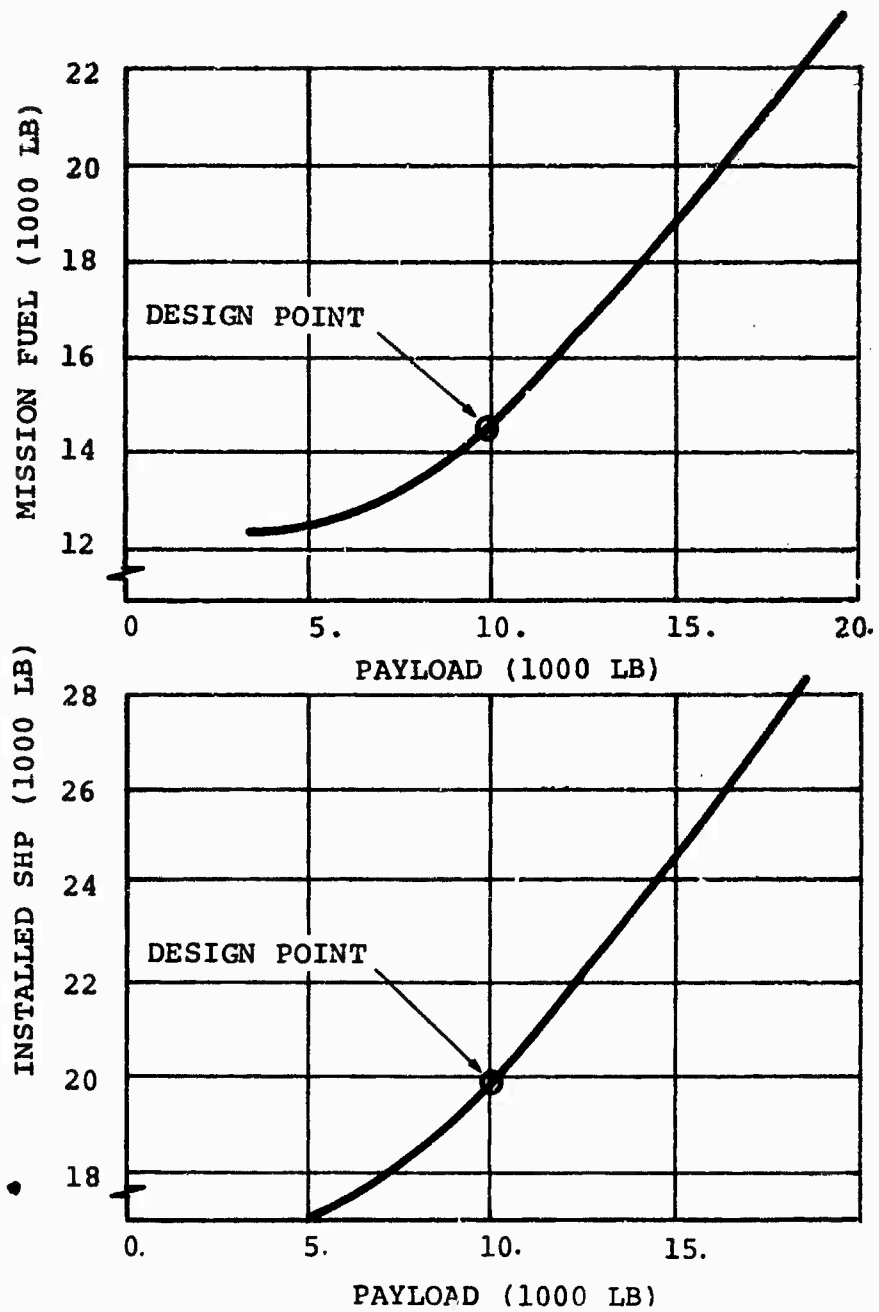

Figure 105. Design Point IV Sensitivity of Aircraft Weight, Mission Fuel, and Installed Shaft Horsepower to Payload (Sheet 2 of 2).

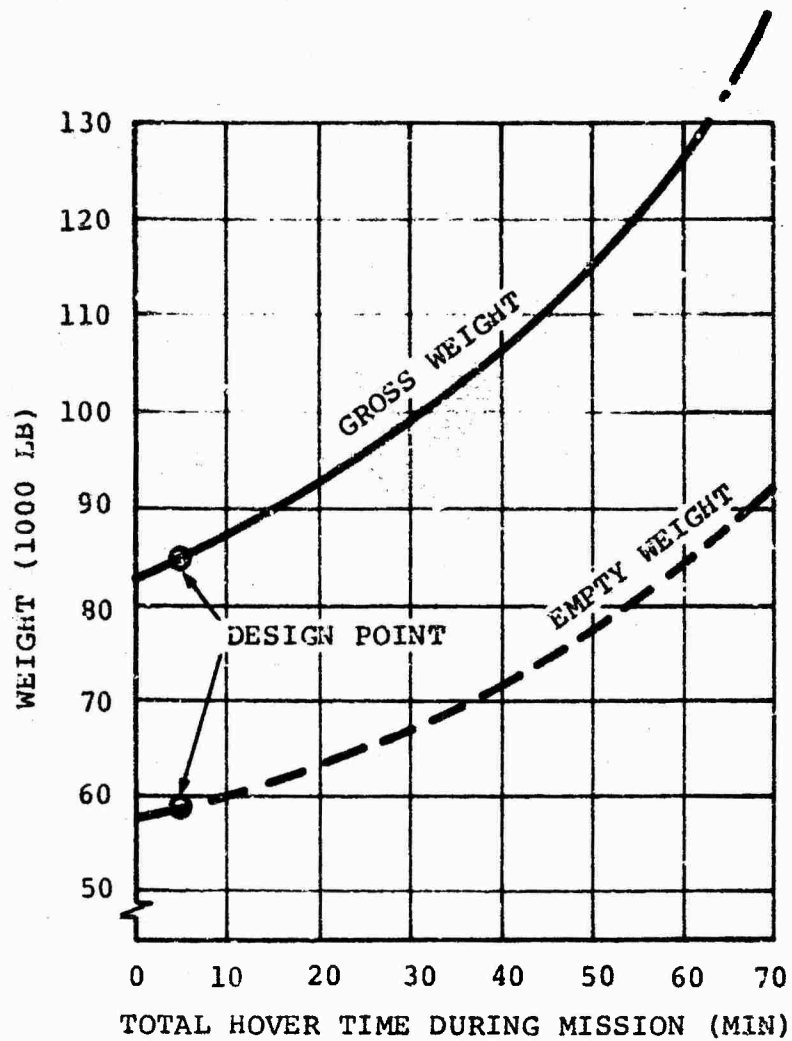

Figure 106. Design Point IV Sensitivity of Aircraft Weight, Mission Fuel, and Installed Shaft Horsepower to Total Mission Hover Time (Sheet 1 of 2).

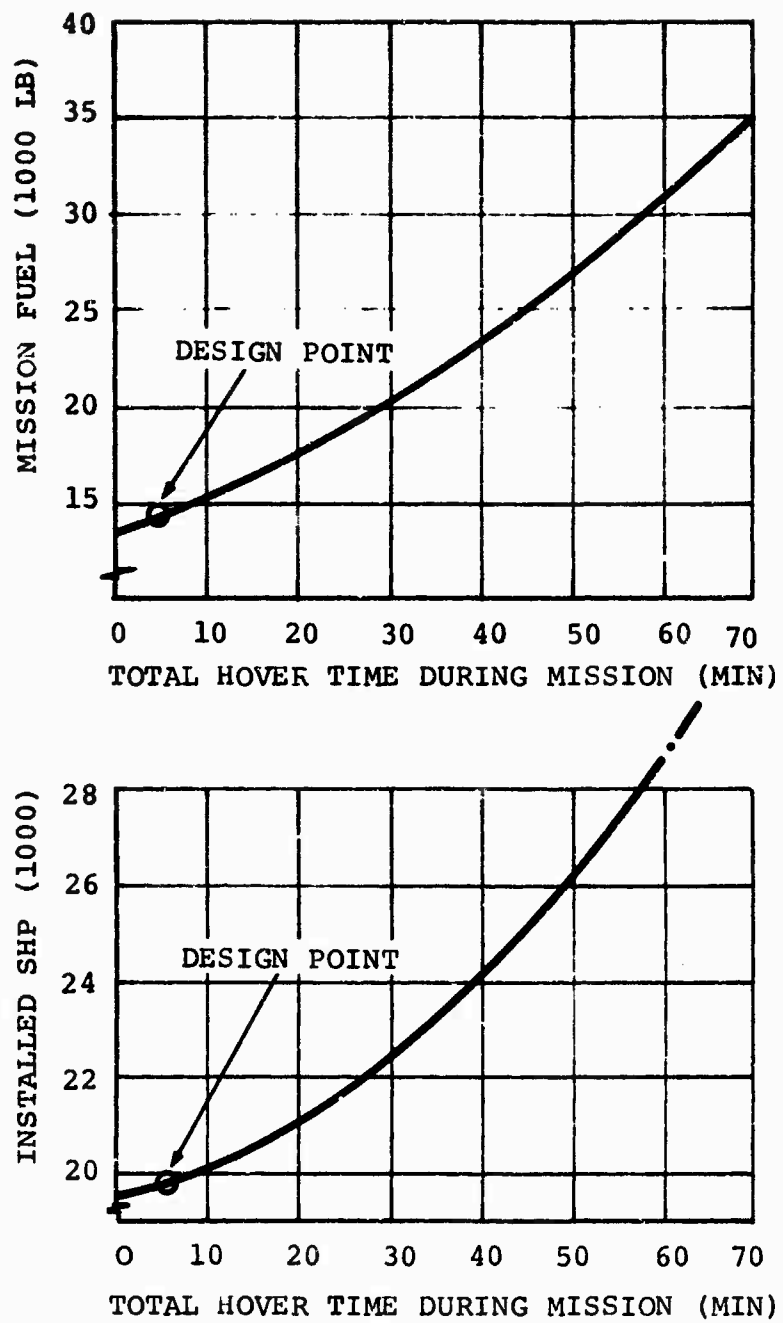

Figure 106. Design Point IV Sensitivity of Aircraft Weight, Mission Fuel, and Installed Shaft Horsepower to Total Mission Hover Time (Sheet 2 of 2).

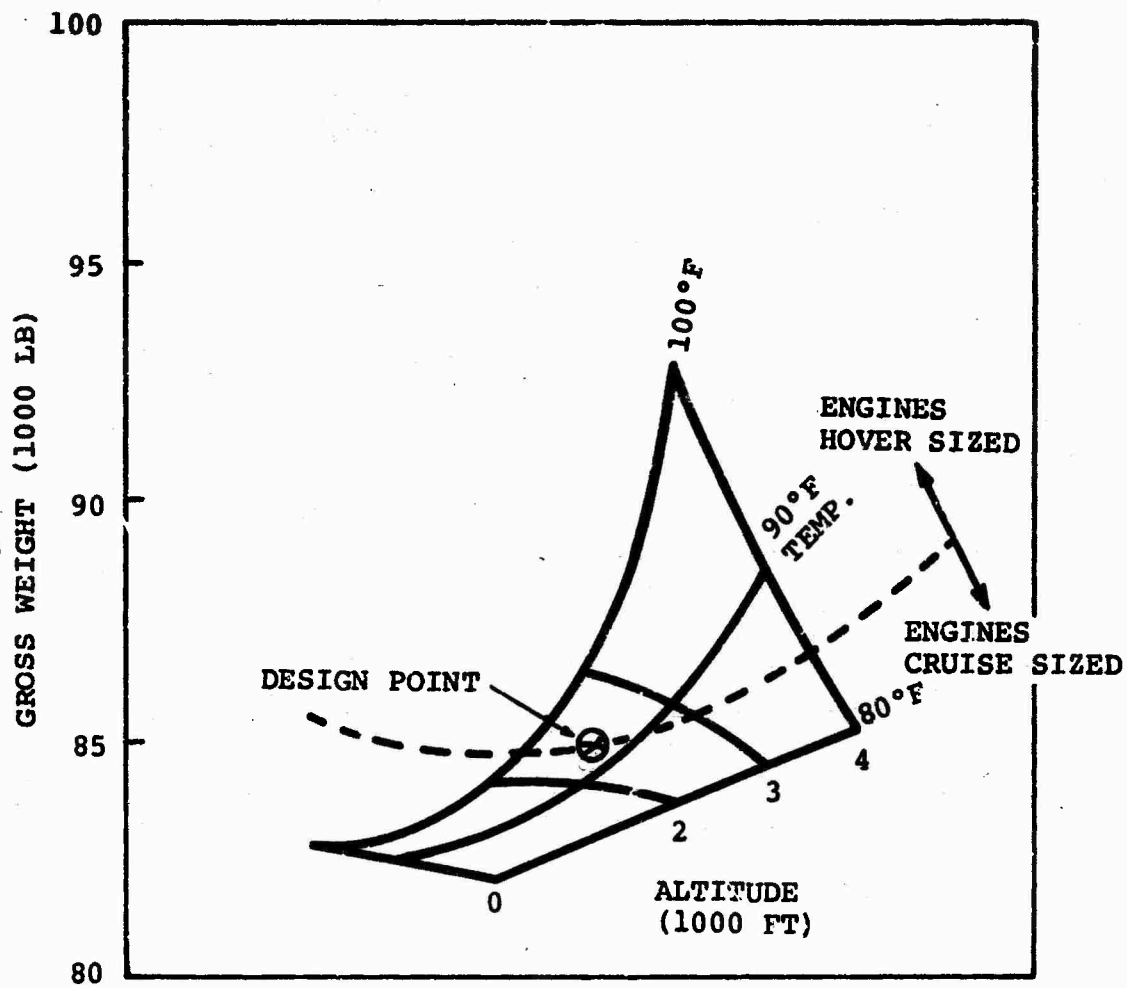

Figure 107. Design Point IV Sensitivity of Gross Weight to Hover Altitude and Temperature for Disc Loading of 16.0 psf.

SECTION XII

WEIGHT PREDICTION METHODOLOGY

This section is in two parts. The first part presents the basic weight trend methodology, the increments used for special features, and the 1976 technology reduction factors used to justify the weights of the baseline aircraft. The second part describes the advanced technology that may reasonably be expected to apply to aircraft introduced into service in 1976 and in 1980. Weight reduction factors are projected from early 1970 through 1980.

1. WEIGHT JUSTIFICATION FOR BASELINE AIRCRAFT (1976 IOC)

a. Rotor Group (4,936 Pounds)

The rotor group trend equation is:

$$W_{RG} = 2 W_{rg} + \text{spinner} \quad (4)$$

$$W_{rg} = C_a (k)^{0.67} \quad (5)$$

$$k = (r)^{0.25} \frac{(\text{HP} \times 1.1)^{0.5}}{(100)} \frac{V_T \times 1.1}{100} \frac{\rho A^2}{10} \quad (6)$$

where	r	=	Blade attach point (ft)	=	1.42
	HP	=	Design horsepower/rotor (hp)	=	6300
	V _T	=	Design tip speed (fps)	=	870
	ρ	=	Solidity	=	0.100
	A	=	Disc area (sq ft)	=	1,900
	D	=	Diameter (ft)	=	49.2
	C	=	Rotor group coefficient	=	14.2
	a	=	Adjusting factor - blade fold penalty	=	1.2

Figure 108 is the rotor group weight trend curve. For the stowed-tilt-rotor configuration the rotor trend coefficient of 14.2 reflects a four-bladed rotor with a titanium hub and S-glass blades. (The coefficient for a similar three-bladed rotor would be 13.5.)

The stowed-tilt-rotor blade fold penalty is 20 percent of the total rotor and blade weight. Direct comparison and/or projection from existing designs like the CH-53A or the CH-46 is difficult due to the differences in design and design criteria. Specifically, the

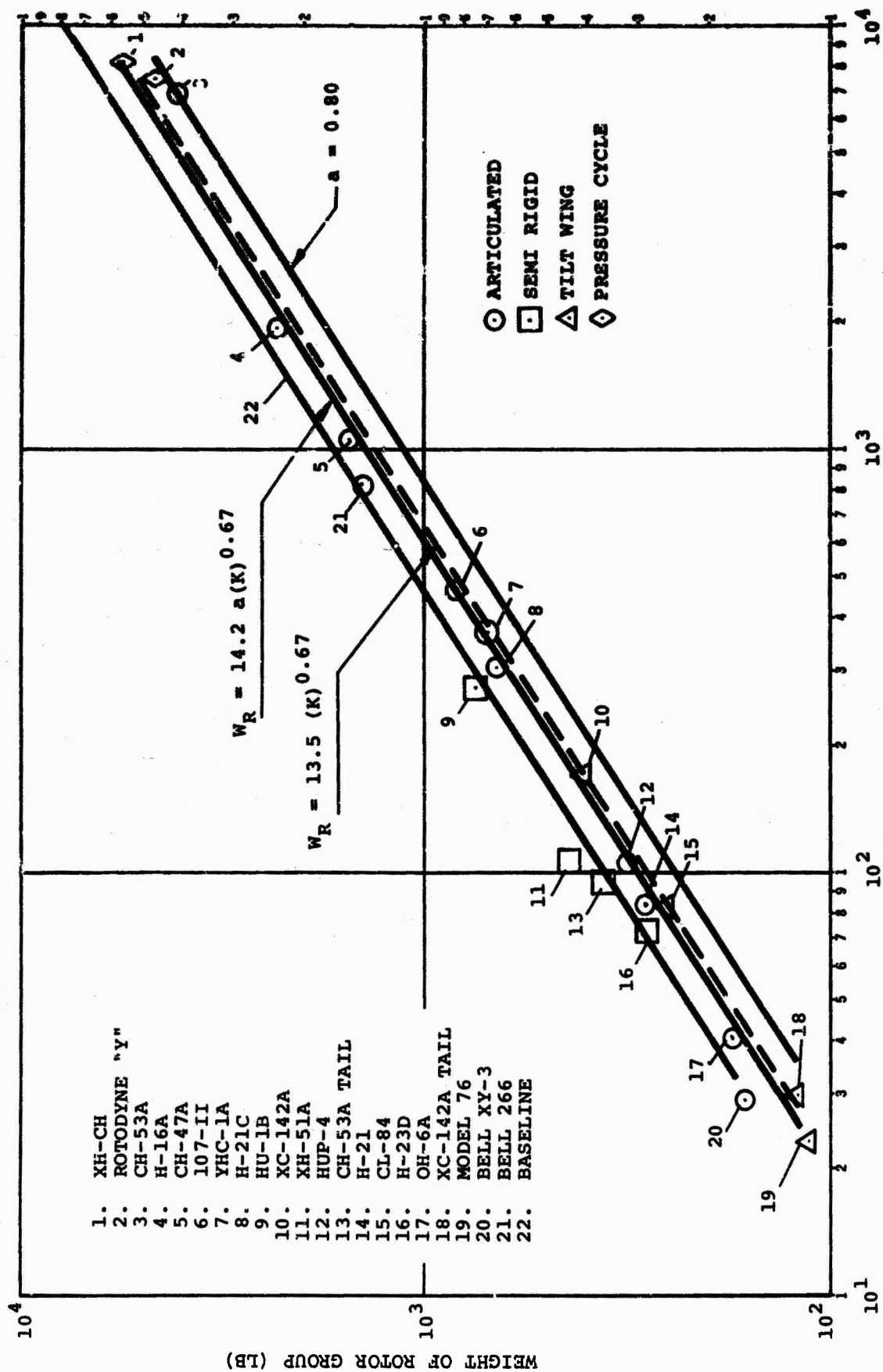

Figure 108. Rotor Group Weight Trend.

CH-46 and the CH-53A blade-fold mechanisms consist of external hydraulic cylinders mounted on a one-to-one basis with each blade. The stowed-tilt-rotor design consists of an internal (inside the hub) rotary actuator which is linked to all four blades through push-pull rods and universal joints (See Volume II, Section VI for a more complete description). This latter is a much more compact design which has the capability of exerting high forces (233,000 in.-lb ultimate torque and 21,500 pounds ultimate tension per blade). The 20-percent weight penalty physically reflects the stowed-tilt-rotor design and is also a measure of what a reasonable weight penalty should be for the given design criteria. In fact, preliminary weight calculations show that the blade fold mechanism, linkages, and locking mechanism (blades deployed) weighs very close to the 20-percent penalty allotted.

The weight of the rotor group is:

	<u>Pounds</u>
Weight of Rotor Group	2,440
Weight of Spinner (per Aircraft)	<u>300</u>
Total 1969 Rotor Group	5,180

For 1976 the only weight improvements considered are in the blade weight, which is reduced 10 percent to account for improved and refined design, boron/epoxy in lieu of S-glass and improved resin strength. The blade weight for the stowed-tilt-rotor configuration is equivalent to 50 percent rotor group weight. Therefore, the 1976 rotor group weight is:

	<u>Pounds</u>
Hub and Fold	2,440
Blades (1976)	2,196
Current Blades	2,440
1976 reduction	.90
Spinner	<u>300</u>
Total 1976 rotor group	4,936

b. Wing Group

(1) Justification I

Wing weights are derived from the following equation:

$$W_W = 220a(k)^{0.585} \quad (7)$$

where:

$$K = \left(\frac{R_m W_x}{10^4} \right) \left(\frac{S_w}{10^2} \right) \left(\log \frac{b}{B} \right) \sqrt{\frac{1 + \lambda}{2k_r}} \sqrt{N} \left(\log_{10} V_D \right) \left(\log_{10} AR \right)$$

where	W_W	=	Weight of wing (lb)	
	S_w	=	Planform area of wing (sq ft) (taken from ℓ of aircraft)	= 744 sq ft
	b	=	Wing span (ft)	= 61.2
	B	=	Maximum fuselage width (rescue ship) (ft)	= 6.67
	λ	=	Taper ratio	= 0.57
	N	=	Ultimate load factor	= 4.5
	V_D	=	Dive velocity (kn)	= 457
	AR	=	Aspect ratio	= 5.04
	k_r	=	Wing root thickness divided by root chord	= 0.204
	W_x	=	Gross weight less tip pod and contents (lb)	= 52,142
	R_m	=	Relief term	= 1.0
	a	=	Adjusting factor	= 1

The equation shown above and previously in Figure 109 was derived for a conventional wing designed by airloads resulting from forward flight, whereas the stowed-tilt-rotor configuration wing design requirements stem from vertical

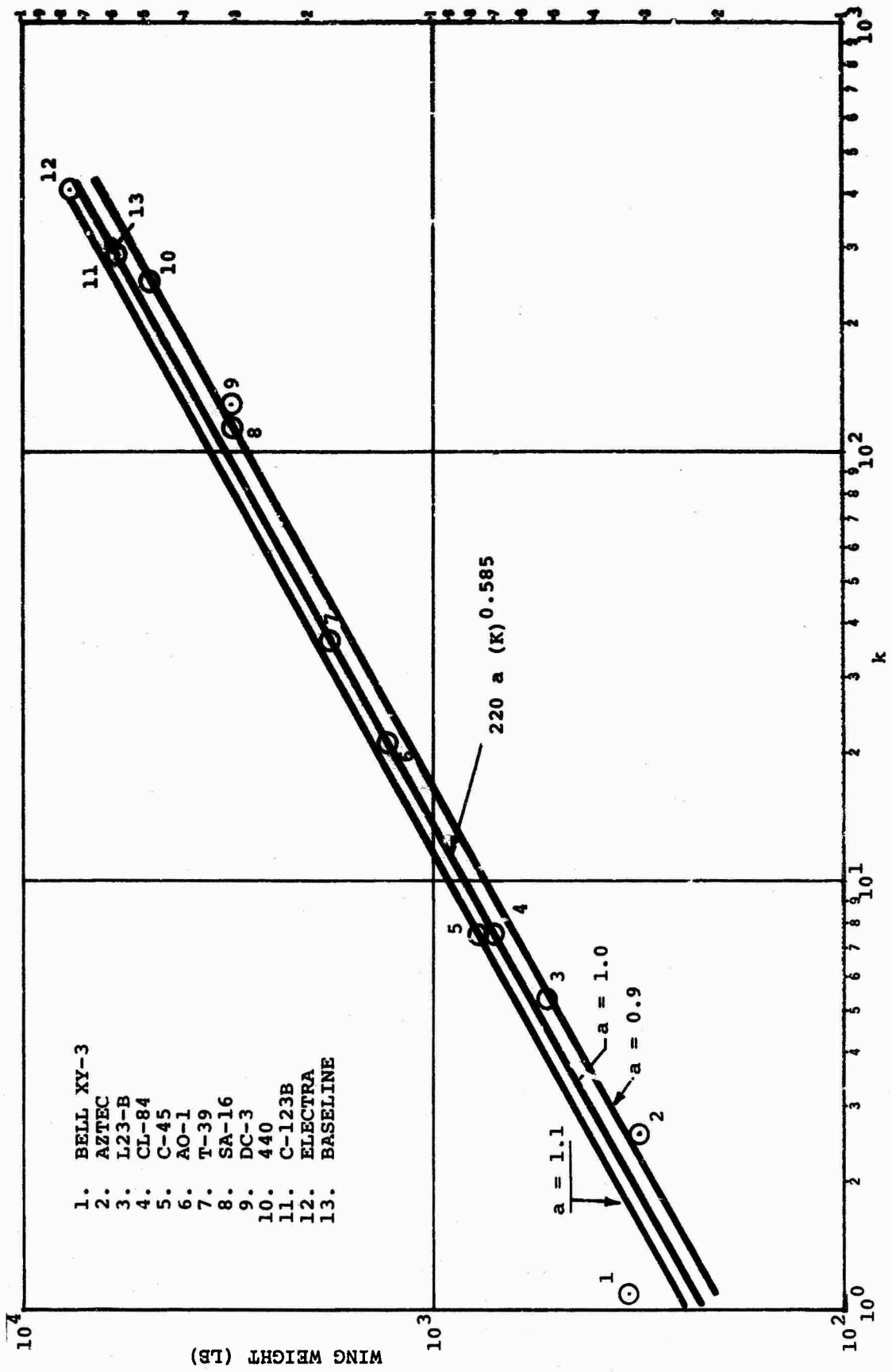

Figure 109. Wing Weight Trend.

flight and from transition modes. However, since the term " $R_m W_x$ " is a parameter which indicates the magnitude of the resultant wing shear and bending loads, relative to the location of the semi-span center-of-lift in forward flight, the above wing weight equation can still be used for the stowed-tilt-rotor configuration wing if " $R_m W_x$ " is reinterpreted by locating the center-of-lift at the thrust line of the rotor. Then W_x is defined as:

$$W_x = \text{Gross weight less the weight of the tip pods and contents} = 52,142 \text{ pounds}$$

and

$$R_m = 1.0$$

In addition, a penalty of one percent of gross weight is taken in the wing group to account for the wing tip pod attachments. The weight of the wing group is:

	<u>Pounds</u>
Weight of Wing	6,060
Tip Attachments	670
Total 1969 Wing Group	6,730
1976 Reduction	<u>0.85</u>
Total 1976 Wing Group	5,710

(2) Justification Method II

The 1969 wing weight of 6,060 pounds (less tip attachment) is further verified by the "simplified bending moment" method. This method derives the weight of the wing torque box to which is added the estimated weights of the leading and trailing edges (moving surfaces) and tip fitting for total wing group weight. The method is as follows:

$$W_{\text{Torque box}} = (\rho) (\Sigma V) (k_1) (k_2) (k_3)$$

where ΣV = Material volume of box
required due to bending

ρ = Density aluminum = 0.10
 k_1 = Fatigue factor = 1.10
 k_2 = Shear and bending factor = 1.38
 k_3 = Non-optimum, rib, fitting factor = 1.67

ΣV is determined by using the bending moment curve shown in Figure 110 and correcting for the high shear and torsional loads at the tip. The resultant torque box weight is 4,900 pounds.

Then:

	<u>Pounds</u>
Torque Box	4,900
Leading and Trailing Edges	1,100
Leading Edge (including moving surfaces) 115 square feet x 4 psf	460
Trailing Edge (including moving surfaces) 220 square feet x 3.75 psf	<u>825</u>
Total	1,285
Composite delta	<u>0.85</u>
	<u>1,100</u>
Total 1969 Wing Weight	6,000

The wing weight by this method is 6,000 pounds which compares with 6,060 pounds from the first method.

(3) Justification Method III

The third method of wing weight justification is a "rough" weight calculation of the wing from preliminary drawings. The torque-box spar

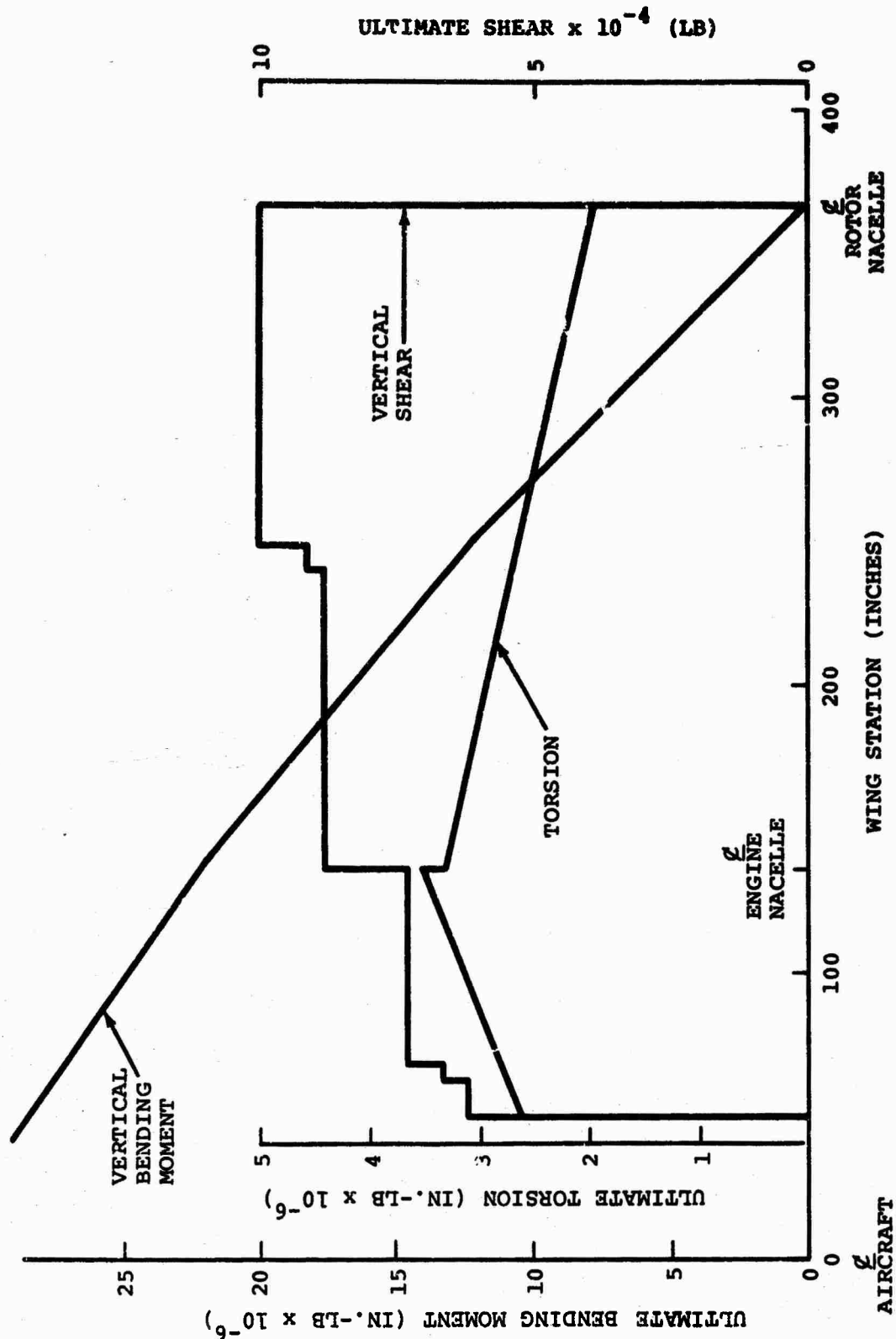

Figure 110. Baseline Rescue and Transport Wing Design Conditions (Ultimate Conditions: 3.75g Vertical Plus 0.9 Rad/Sec² (Pitch)).

caps, stringers, webs, and skins of these drawings have been stressed-checked to available loads. Figure 111 shows the resultant pound/spanwise inch-plot of this torque box and includes the items mentioned above. This "stressed" weight is 3,826 pounds which does not include ribs, major splices, cut-outs or hardware. The following itemizes the remainder of the wing:

	<u>Pounds</u>
Torque box	3,826
Ribs	455
Splice (wing station 150)	250
Hardware (10 percent TB)	<u>382</u>
Total weight	4,913
Leading and trailing edges	<u>1,100</u>
Total wing weight	6,013

In summary, the first method yields a total 1969 wing group weight of 6,730 pounds; the second, 6,670 pounds; and the third, 6,683 pounds.

c. Tail Group

The tail group weights are derived from the following trends:

(1) Horizontal Tail

$$W_{HT} = 360 (K)^{0.54} \quad (8)$$

where

$$K = (F_H) \left(\frac{S_H}{10^2} \right) \left(\frac{\log_{10} V_D}{TMA \times t} \right)$$

and

$$F_H = \left(\frac{W_G}{10^4} \right) \left(\frac{ky}{10} \right) \left(\frac{b_H}{10} \right) \left(\frac{1 + 2\lambda \frac{H}{H}}{1 + \lambda \frac{H}{H}} \right) (k_{TL})$$

NOTES:

- (1) TOTAL WEIGHT UNDER CURVE (X2)
EQUALS 3826 POUNDS.
- (2) WEIGHT DOES NOT INCLUDE: RIBS,
HARDWARE, SPLICE, CUTOUTS

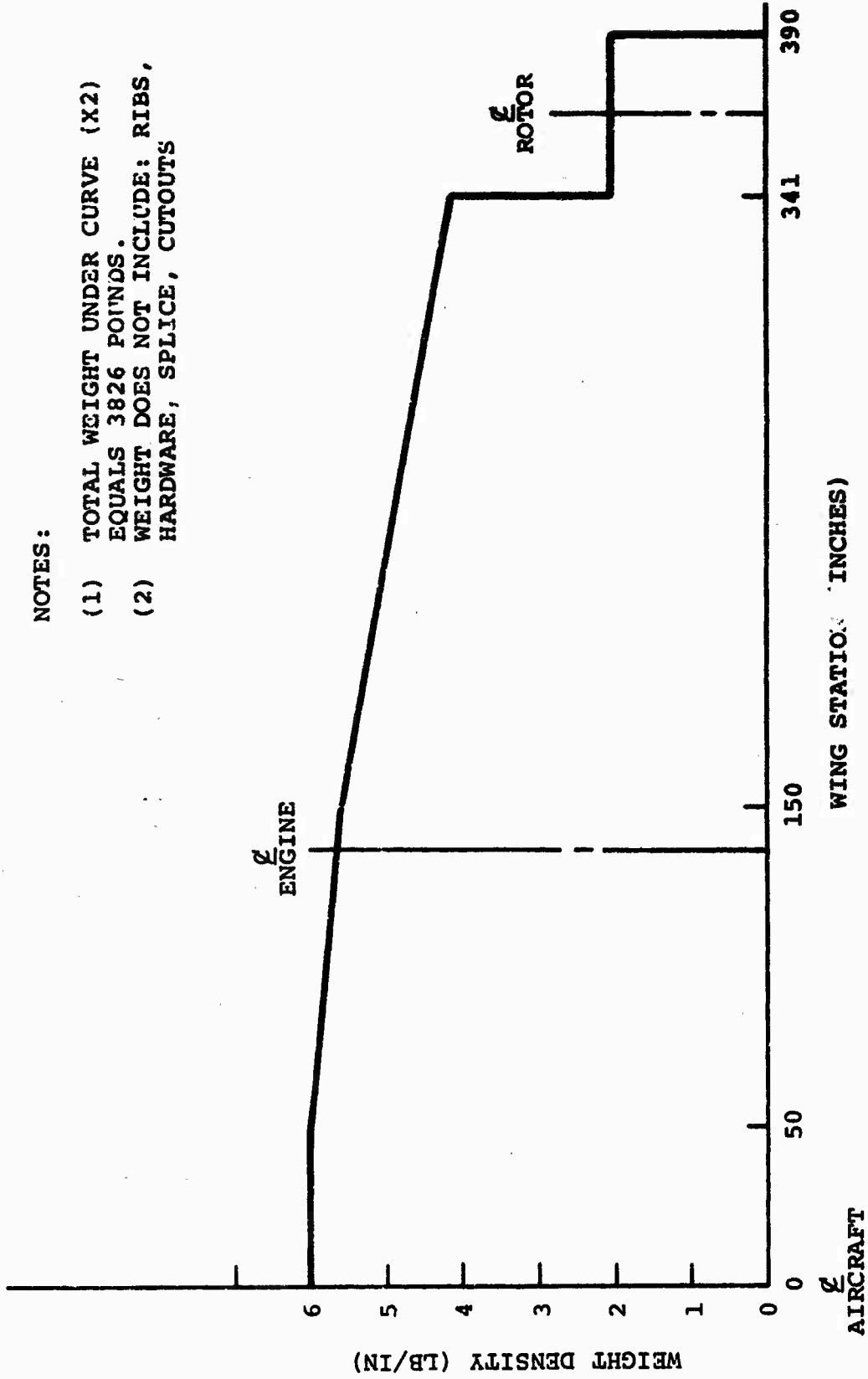

Figure 111. Stowed-Tilt-Rotor Torque Box Weight Density.

(2) Vertical Tail

$$W_{VT} = 380 (K)^{0.54} \quad (9)$$

where

$$K = \left(F_V + \frac{a F_H}{2 b_v} \right) \left(\frac{S_v}{10^2} \right) \left(\frac{\log_{10} V_D}{TMA \times t} \right)$$

and

$$F_v = \left(\frac{W_G}{10^4} \right) \left(\frac{k_z}{10} \right) \left(\frac{b_v}{10} \right) \left(\frac{1 + 2 \lambda v}{1 + \lambda v} \right)$$

where:		<u>Horizontal</u>	<u>Vertical</u>
W_G	= Design gross weight (lb)	67,000	
k_y	= Pitch radius of gyration (ft)	10.8	
k_z	= Yaw radius of gyration (ft)		17.0
b	= Tail span (ft)	28.2	12.4
	= Taper ratio $\frac{\text{(chord at tip)}}{\text{(chord at root)}}$	0.33	0.535
S	= Planform area (sq ft)	199	154
F	= Tail load parameter		
V_D	= Dive velocity (kn)	457	457
TMA	= Tail moment arm (measured from wing 1/4 chord to tail 1/4 chord) (ft)	34.5	26.0
t	= Root thickness (ft)	1.59	2.26
a	= Height of horizontal tail attachment to vertical tail (measured from root of vertical tail) (ft)		12.4
H	= Subscript H denotes horizontal tail		
V	= Subscript v denotes vertical tail		
k_{TL}	= Tail load factor		

Figures 112 and 113 show the horizontal and vertical tail trends with the 1969 weights plotted. The following chart shows the results of the calculation:

<u>Item</u>	<u>Weight in Pounds</u>		
	<u>Horizontal</u>	<u>Vertical</u>	<u>Total</u>
Total 1969 Tail Group	584	584	1168
1976 Reduction	0.85	0.85	-
TOTAL 1976 Tail Group	491	491	982

d. Body Group (Transport-5,980 lbs; Rescue-3,250 lbs)

(1) Body

The weight of the primary body group structure is determined from the following equation:

$$W_{\text{BBG}} = 280 k^{0.5} \quad (10)$$

where

$$k = \left(\frac{W_x}{10^4} \right) \left(\frac{S_f}{10^3} \right) (L_f + L_{\text{RW}})^{0.5} (\text{Log}_{10} V_D) (\Delta P + 1)^{0.2} Nk$$

		<u>Rescue</u>	<u>Transport</u>
where	W_{BBG} = Weight of primary structure		
	W_x = Weight of fuselage and contents (including empennage) (lb)	22,967	26,341
	S_f = Wetted area of fuselage (sq ft)	1,300	1,761
	L_f = Length of fuselage (ft)	59.5	60
	L_{RW} = Length of rampwell (ft)	0	8.3
	V_D = Dive velocity (kn)	457	457
	ΔP = Limit differential cabin pressure	5.45	0
	N = Ultimate load factor	4.5	4.5
	k = Load density versus length ration	0.2	0.2

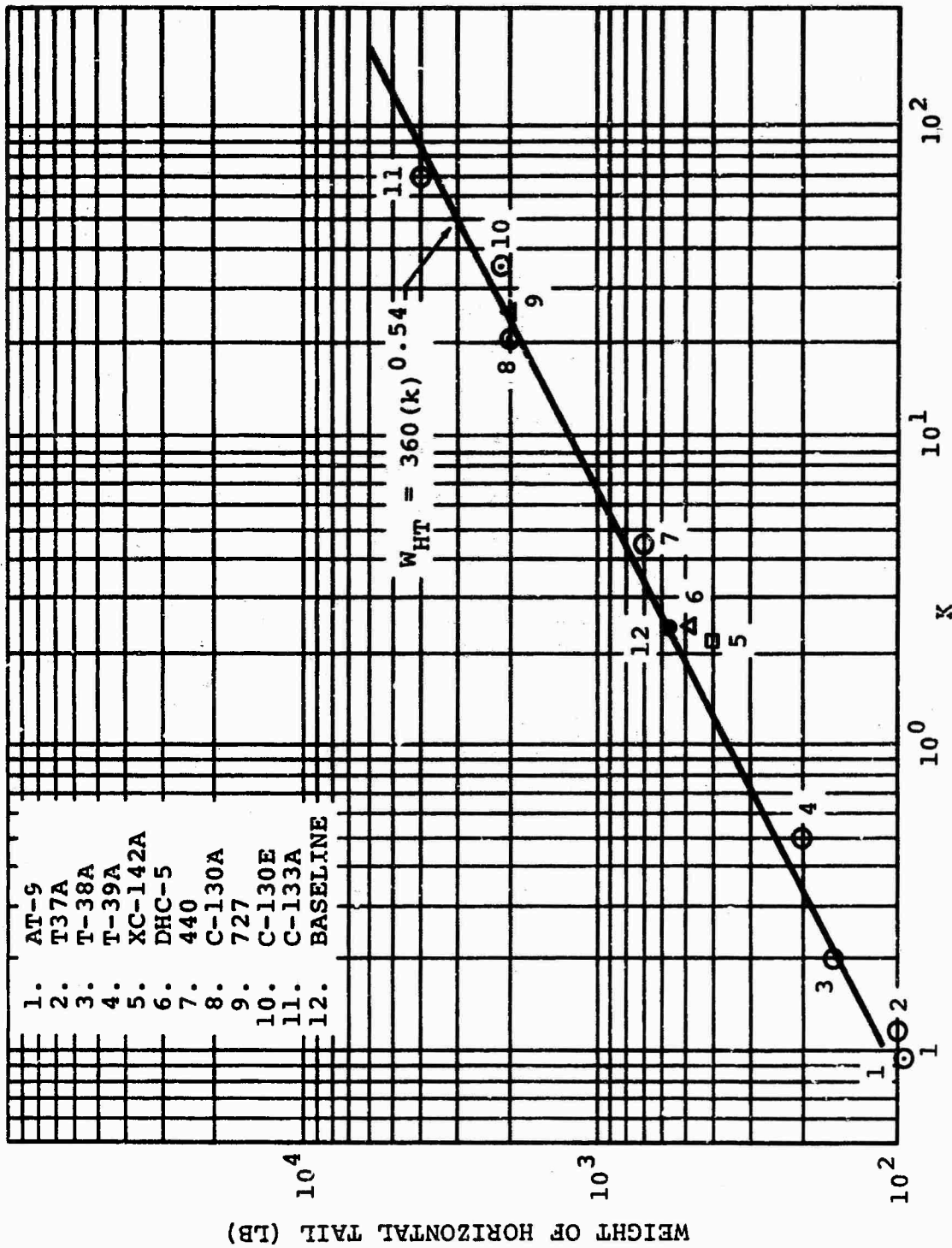

Figure 112. Horizontal Tail Weight.

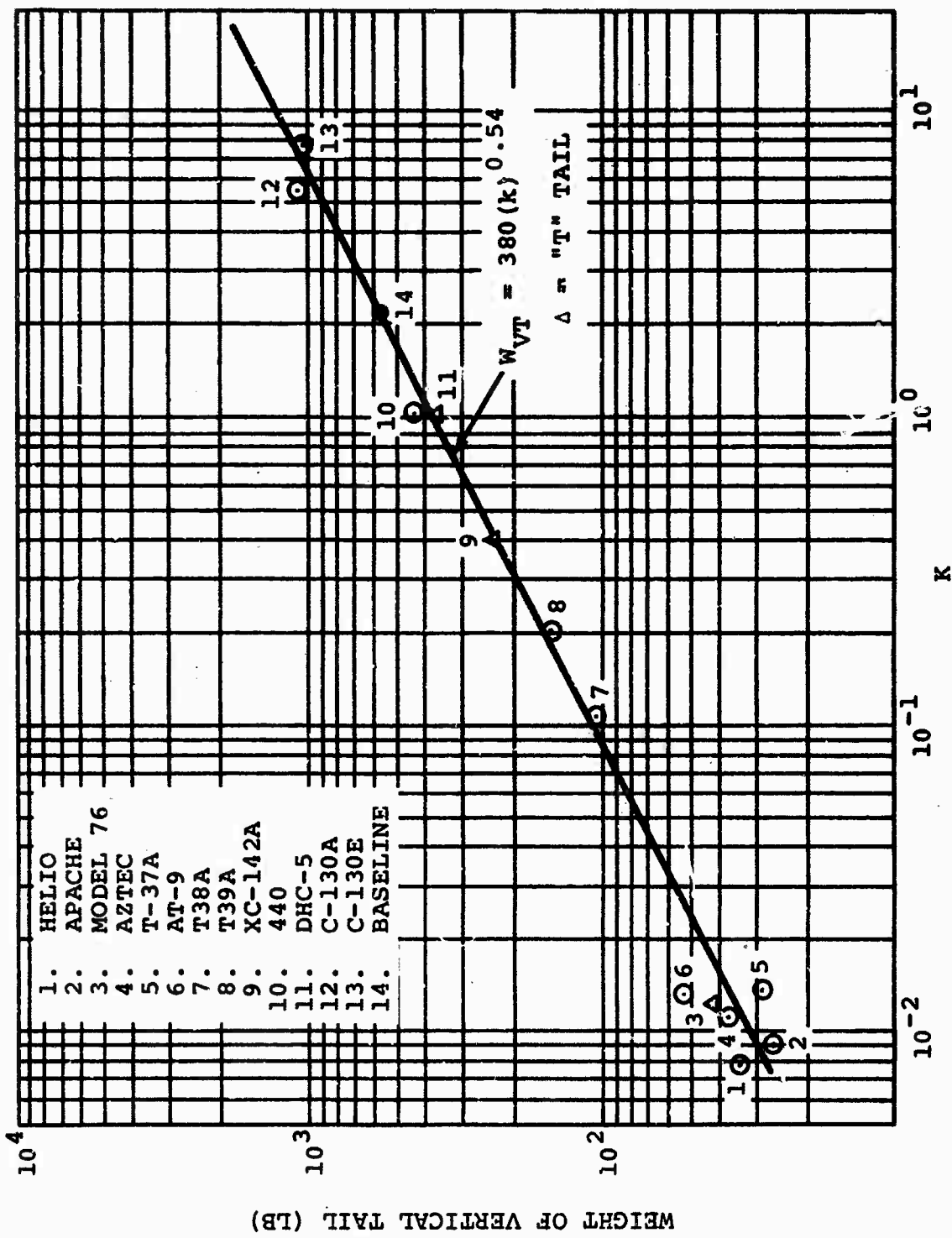

Figure 113. Vertical Tail Weight.

To the weight of the primary structure increments are then added in the weights for the floors, ramps, doors, etc. Figure 114 shows the primary structure trend with the 1969 body weight plotted. Table XXX shows the details of the body group calculation, including the cargo loading system.

TABLE XXX. RESULTS OF CALCULATIONS AND DENSITIES USED FOR SECONDARY STRUCTURE

Item	Density (psf)	Transport		Rescue	
		Area (sq ft)	Weight (lb)	Area (sq ft)	Weight (lb)
Primary structure			2,670		2,500
Floors: Rescue	2.0			100	200
Transport	4.5	232	1,040		
Flight deck	1.5	26	40	34	51
Ramp	8.0	65	520	-	-
Ramp extensions	6.0	13	78	-	-
Clamshell doors	4.5	150	675	35	156
Doors	5.0	31	155	31	155
Windshield			175		350*
Windows			200		200
Radome			100		100
Miscellaneous (10 percent)			298		121
Total 1969 Body Group			5,951		3,833
1976 Reduction			0.85		0.85
Total 1976 Body Weight			5,060		3,250
463L Loading System			920		-
Total 1976 Body Group			5,980		3,250

*Bubble Type Canopy

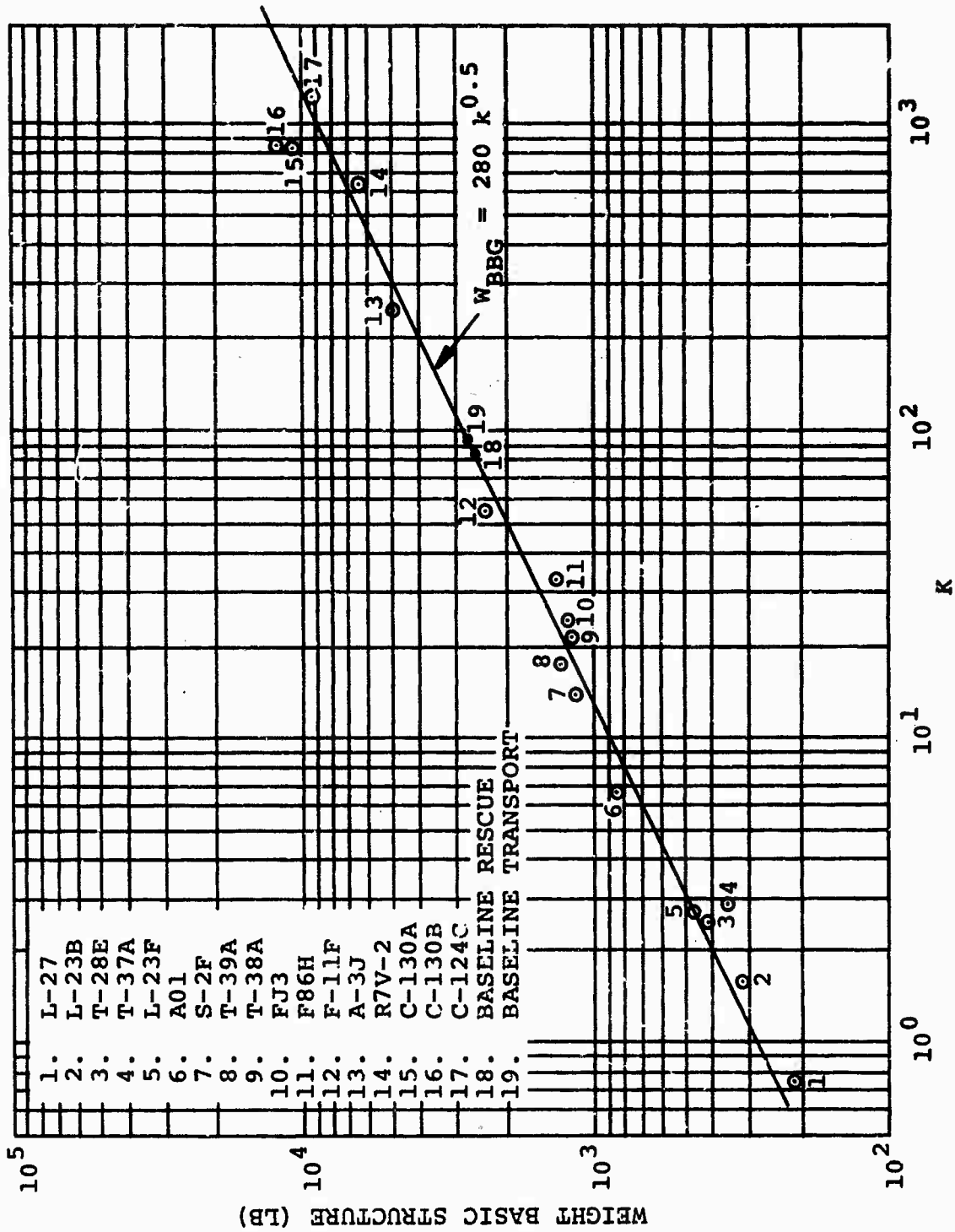

Figure 114. Basic Body Group Weight.

(2) Cargo Loading

The 463L cargo loading system is based on information received from Brooks and Perkin Company for a proposed 463L cargo loading system for the CH-47 (Table XXXI).

TABLE XXXI. 463L CARGO LOADING SYSTEM INFORMATION
(Brooks and Perkin Company)

Item	Length (ft)	Quantity	Density (lb-ft)	Weight (lb)
<u>CABIN</u>				
Side rails	29	2	1.3	76
Roller trays	29	4	1.05	122
Roller assembly		140	0.5 (lb ea)	70
Teeter rollers				8
Pallet Locks		16	6.5 (lb ea)	104
Master control				8
Winch - HCU-9JA				289
Miscellaneous hardware				34
Crash barrier net				100
Total Cabin				811
<u>RAMP</u>				
Side rails	10.8	2	1.3	28
Roller trays	10.8	4	1.05	46
Roller assembly		58	0.5 (lb ea)	29
Miscellaneous hardware				6
Total ramp				109
Total 463L System Weight				920

- e. Alighting Gear (Rescue: 2,385 pounds; Transport: 3,195 pounds)

The weight of the alighting gear is determined by taking a percentage of design gross weight. For the rescue aircraft which has a tandem wheel arrangement, this percentage is 3.6 percent, typical of vertical takeoff and landing aircraft. For the transport, the landing gear criteria is the same as that of the LIT

transport with the exception of the number of landing passes which is reduced to 75 from the LIT's 200. However, rough field conditions are the critical design criteria and no reduction is taken from the LIT landing gear percentage of 5.3 percent of design gross weight. Table XXXII lists various aircraft and their landing gear/gross weight ratios.

For the sake of commonality, the rescue aircraft will share the same nose gear as the transport. The nose gear weight is approximately 20 percent of the total gear weight. The landing gear weight of the two aircraft is therefore:

	Weight in Pounds	
	Rescue	Transport
Gross Weight	67,000	67,000
Landing Gear Weight	2,425	3,550
Nose Gear: Transport	710	
Rescue	485	
Increment	225	
Revised 1969 Landing Gear	2,650	3,550
1976 Reduction	0.90	0.90
Total 1976 Landing Gear	2,385	3,195

TABLE XXXII. SUMMARY OF LANDING GEAR WEIGHT IN PERCENT OF GROSS WEIGHT FOR V/STOL AIRCRAFT

Helicopters	Gross Weight (percent)	Airplane	Gross Weight (percent)
CH-46A	3.1	Bell XV-3	3.1
CH-46D	2.8	XC142A	3.2
CH-46E	3.1	Bell 266	3.6
CH-47	3.4		
CH-47C	3.3	DeHavilland*	
CH-3C	3.4	DHC-5	4.2
CH-53A	2.9	Breguet. 941S*	4.5
CH-54	4.7	DeHavilland*	
CH-54A	4.7	DHC	5.4
107-2	3.1	C130*	4.1
AH-56A	3.6	C123	4.3
HH-52A	5.9		
HUP-2	3.2		
UH-34D	3.7		
SH-3A	4.2		
H-21C	3.6		

*Rough Field Requirements

f. Flight Controls

Weight of the flight controls is determined by the following equations:

$$\text{Cockpit} \quad W_{CC} = 26 \frac{(GW)^{0.41}}{10^3} \quad (11)$$

$$\text{Upper Controls} \quad W_{UC} = 0.30 (W_{Rtotal}) \quad (12)$$

$$\text{Hydraulics} \quad W_M = 25 \left(\frac{W_{Rtotal}}{100} \right)^{0.84} \quad (13)$$

$$\text{Fixed Wing Controls} \quad W_{FM} = 0.10 (GW) \quad (14)$$

$$\text{SAS} = 175$$

$$\text{Tilt Mechanism} = 0.015 (GW)$$

The weights are:

<u>Item</u>	<u>1969 Weight (lb)</u>	<u>1976 Reduction</u>	<u>1976 Total Weight (lb)</u>
Cockpit	137	0.75*	103
Upper Controls	1,500	0.90	1,350
Hydraulics	667	0.75*	500
Fixed Wing	670	0.75*	502
SAS	175	0.75*	131
Tilt Mechanism	1,050		1,050
Total	4,199		3,636

(*Fly-by-wire)

g. Engine Section (1,250 pounds)

The engine-section fairing is in three sections; an engine fairing (inner pod), a fan shroud, and an extended fan shroud (outer pod). The extended fan shroud is a drag-reducing fairing which runs aft of the fan section to the end of the engine section.

Weight of the engine fairing and the extended fan shroud is contained in this section. The weight of the fan shroud proper is included with the fan installation.

<u>Item</u>	<u>Unit Area (sq ft)</u>	<u>Qty</u>	<u>Density (psf)</u>	<u>Weight (lb)</u>
Engine Fairing	123	2	2.25	554
Extended Fan Shroud	203	2	2.25	916
Total 1969 Engine Section				1,470
1976 Reduction				0.85
Total 1976 Engine Section				1,250

h. Tip Pod (1,811 Pounds)

The tip pod weight is determined in a similar manner to the engine section. However, the area density for the tilting section of the tip pod is 4 psf. This density includes both the surface fairing and the transmission support structure. It is determined from in-house studies of similar type tilting rotor nacelles.

<u>Item</u>	<u>Unit Area (sq ft)</u>	<u>Qty</u>	<u>Density (psf)</u>	<u>Total Weight (lb)</u>
Tilting Section	137	2	4	1,100
Fixed Section	257	2	2	1,030
Total 1969 Weight				2,130
1976 Reduction				0.85
Total 1976 Weight				1,811

i. Engines (4) (2,134 Pounds)

Engine weight is determined from statistical engine cycle data. The weight of a variable exhaust nozzle is included in the engine weight.

	<u>Pounds</u>
Total 1969 Engine Weight	2,510
1976 Reduction	0.85
Total 1976 Engine Weight	2,134

j. Engine Accessories (596 Pounds)

The 1969 engine accessories weight is taken as 25 percent of engine weight. This is distributed as:

	<u>Pounds</u>
Air Induction (including FOS)	360
Cooling (drain lines)	15
Lubricants	30
Engine controls	85
Starting System	<u>148</u>
Total 1969 accessories	638

For 1976, the engine controls are reduced 50 percent for fly-by-wire.

Total 1976 accessories	596
------------------------	-----

k. Fuel System (2,439 Pounds)

The weight of the fuel system (3490 gallon capacity) is taken as 0.775 pound/gallon of fuel. This includes nitrogen gas inerting, plumbing, pumps, and 100-percent .50-caliber self-sealing.

	<u>Pounds</u>
Total 1969 Fuel System	
3490 gallon x 0.775 pound/gallon	2,620
1976 Reduction	0.85
Total 1976 Fuel System	2,489

l. Drive System (4,485 Pounds)

The weight of the drive system is determined by estimating each individual gear section, such as a bull gear or planetary set, and then adding in required penalties. The weight of the individual gear sections is derived from the following equation:

$$W_{\text{Box}} = 150 \left(\frac{QPUA}{NSB} \right)^{0.8} \quad (15)$$

where W_{Box} = Weight of the individual gear (pounds)

Q = Non-dimensional weight factor for gear set or planetary stage

P = Design horsepower

- U = Function (or use) factor
- A = Gear box support factor
- N = Rpm
- \bar{S} = Hertz stress factor
- B = Bearing support factor

The parameters used in this trend have been adjusted so that the resultant estimated weight accurately reflects the helijet drive system configuration. Adjustment of the parameters is based on previous tilt rotor/nacelle drive system studies and on the stowed-tilt-rotor configuration drawings themselves. Figure 115 shows the trend and the following chart summarizes the weight of the drive system and penalties.

<u>Item</u>	<u>Unit Weight (lb)</u>	<u>Qty</u>	<u>Total Weight (lb)</u>
Wing bevel gear box	271	2	543
Wing tip gear box	283	2	566
Main gear box	1,503	2	3,006
spur set	244		
1st stage planet	233		
2nd stage	991		
accessories	35		
Lubrication			517
Shafting			
tip pod	57	2	115
wing			400
Main bearing housing			250
Rotor brake			<u>50</u>
Total 1969 drive system			5,447
1976 Reduction			0.825
Total 1976 Drive System			4,485

m. Fan Installation (2,284 Pounds)

The fan installation includes the cruise fan, the fan shroud, and the fan drive system. The basic weight of the fan is derived from manufacturer's data and represents a typical metal-bladed cruise fan. This weight is reduced 25 percent to represent early 1970 advanced technology (such as Rolls-Royce Hyfill) in the fan blades and inlet guide vanes. A weight, gas generator airflow, and bypass ratio "carpet-plot" is shown in Figure 116. The fan drive system is derived by the same methods as the rotor drive system. Weights are itemized below:

<u>Fan and Fan Shroud</u>	<u>Pounds</u>
Light alloy fan and shroud (2)	870
Current composite technology	0.75
Total early 1970 fan weight	652
1976 Reduction	0.85
Total 1976 Fan Weight	574

FAN DRIVE SYSTEM WEIGHTS

<u>Item</u>	<u>Unit</u> <u>(lb)</u>	<u>Qty</u>	<u>Total</u> <u>(lb)</u>
Combining box	856	2	1,712
engine input (2)	114		
bull gear	115		
star planetary	222		
bevel output	261		
accessories	35		
fan jaw clutch	56		
rotor jaw clutch	53		
Lubrication			174
Shafting	94	2	188
pylon	46		
engine (2)	48		
Total 1969 fan drive			2,074
1976 reduction			0.825
Total 1976 Fan Drive			1,710
Total 1976 Fan and Shroud			574
Total 1976 Fan Installation			2,284

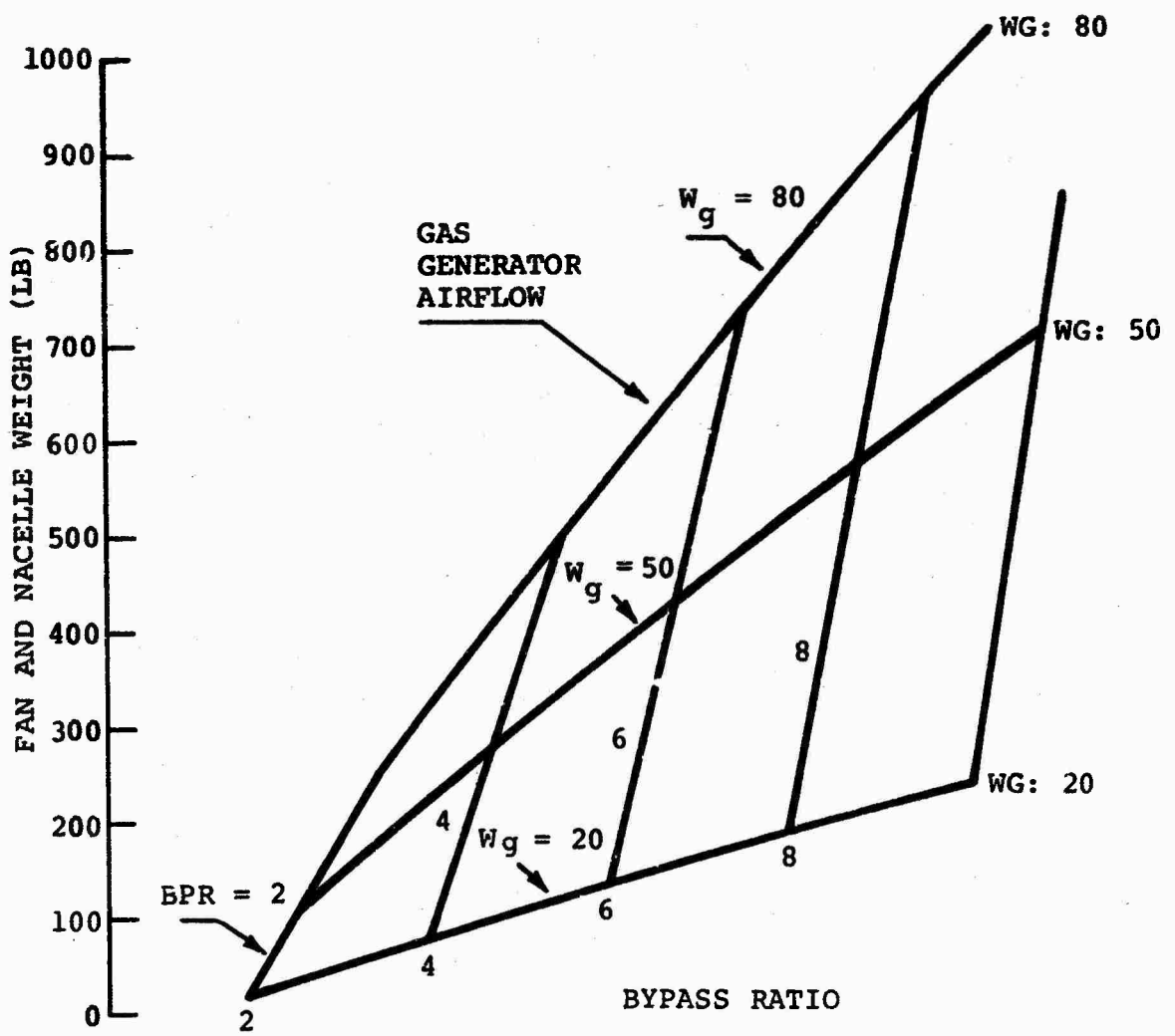

Figure 116. Fan and Nacelle Weight.

- n. Fixed Equipment (Rescue: 6,960 pounds, Transport: 4,678 pounds)

The fixed equipment weights for the baseline aircraft are distributed and itemized in Table XXXIII.

With the exception of the transport, these fixed equipment weights are unchanged from the midterm. The transport furnishings group has been increased by 318 pounds to account for 44 troop seats.

Fixed equipment will be revised in the next phase.

2. ADVANCED TECHNOLOGY

The field of advanced materials and structures technology has advanced more rapidly than envisioned five or ten years ago. There has been an increasing demand for new materials with higher strength-to-weight ratios, higher temperature capability, increased corrosion resistance, and improved fatigue properties. References 8 through 11 were used in this advanced technology assessment.

a. Metals

However, the search for improved metals has not resulted in any quantum jumps in metal properties. Through the past decade aircraft metals have exhibited a slow evolutionary development and while dramatic new improvements (e.g., 500 ksi UTS steel has been attained in the laboratory) have been made. It is likely that the metals as used in aerospace will continue in the same evolutionary manner as illustrated in Figures 117, 118, 119, and 120.

b. Processes

New processes and manufacturing techniques have also been developed. These include new alloy treatments for increased hardness (gear teeth) and better welds, high energy-rate forgings (large, almost perfect net forging dimensions), solid-state diffusion bonding coupled with improved bond/weld testing techniques (elimination of splices, seams, material buildup, and hardware), and advanced adhesives (few rivets, bolts, less material buildup).

c. Composites

While metals have evolved on an evolutionary basis, in the field of composites we are on the threshold of a radical breakthrough in structural design and weight

TABLE XXXIII. BASELINE AIRCRAFT FIXED EQUIPMENT WEIGHTS

Item	Rescue (lb)	Transport (lb)
Auxiliary Power Plant	182	182
Instruments and Navigation	400	400
Flight	80	
Engine	190	
Drive	50	
Hydraulic	25	
Advisory panels	30	
Miscellaneous	25	
Hydraulic	292	292
Electrical	775	775
Alternating Current	490	
Direct Current	285	
Electronics	1,500	950
Communications	135	135
Countermeasures	55	55
Ground fire detection	14	14
LLLTV	338	
Radio Navigation	180	230
Crash beacon	70	70
Self-contained navigation	260	260
Stationkeeping		75
Terrain radar	260	
Loud hailer	95	
Miscellaneous shelving and installation	93	111
Armament	2,000	50
Mini-guns	360	
Armor		
crew	500	
aircraft	1,140	
Provisions		50
Furnishings and Equipment	1,152	1,470
Personal accommodations	310	628
Miscellaneous equipment	110	110
Furnishings	517	517
Emergency	215	215
Air Conditioning and Anti- Icing	519	519
Air conditioning	225	
Anti-Icing	294	
Auxiliary Gear	140	40
Aircraft handling	40	40
Rescue hoist	100	
Capsule hoist		
Total	6,960	4,678

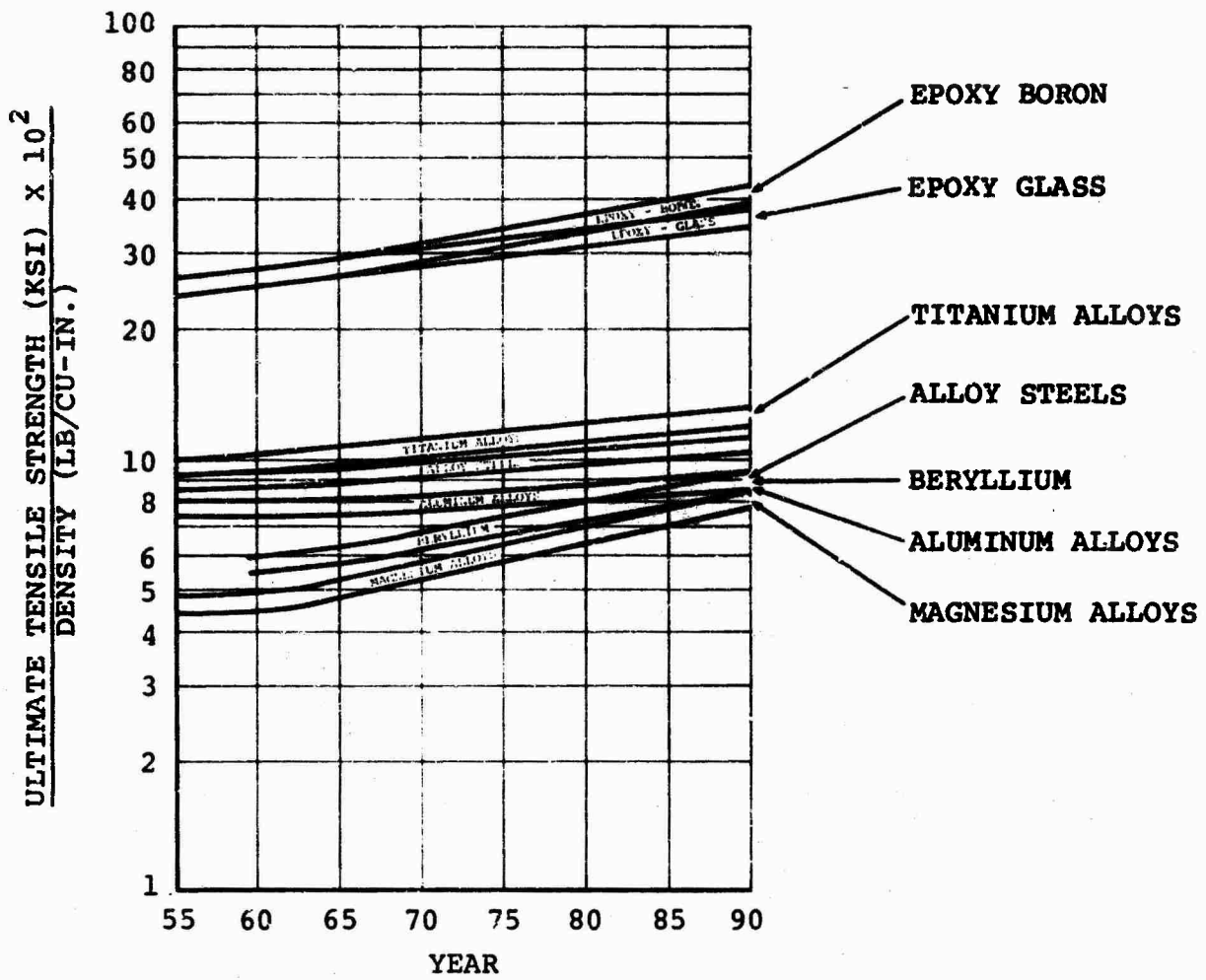

Figure 117. Material Tensile Strength to Density Trend.

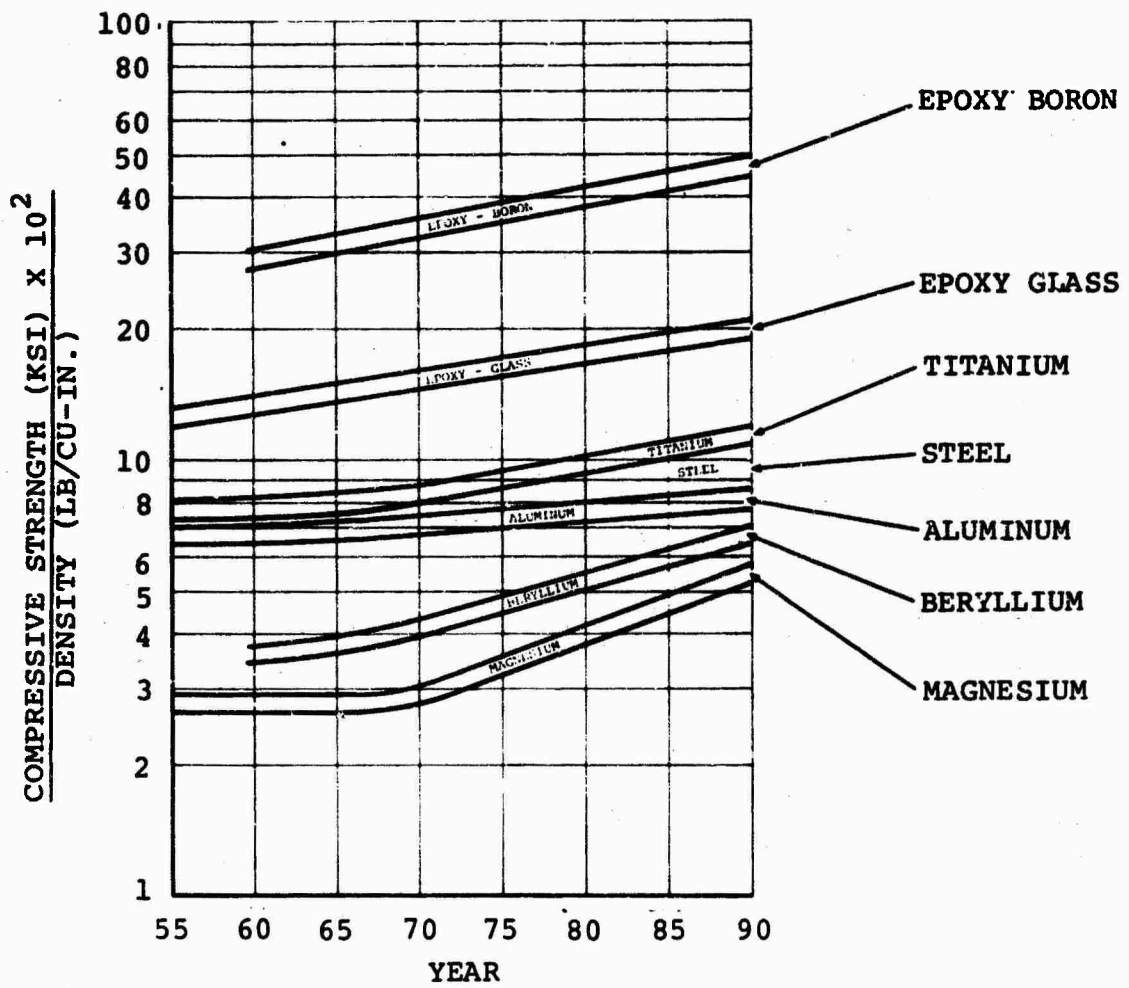

Figure 118. Material Compressive Strength to Density Trend.

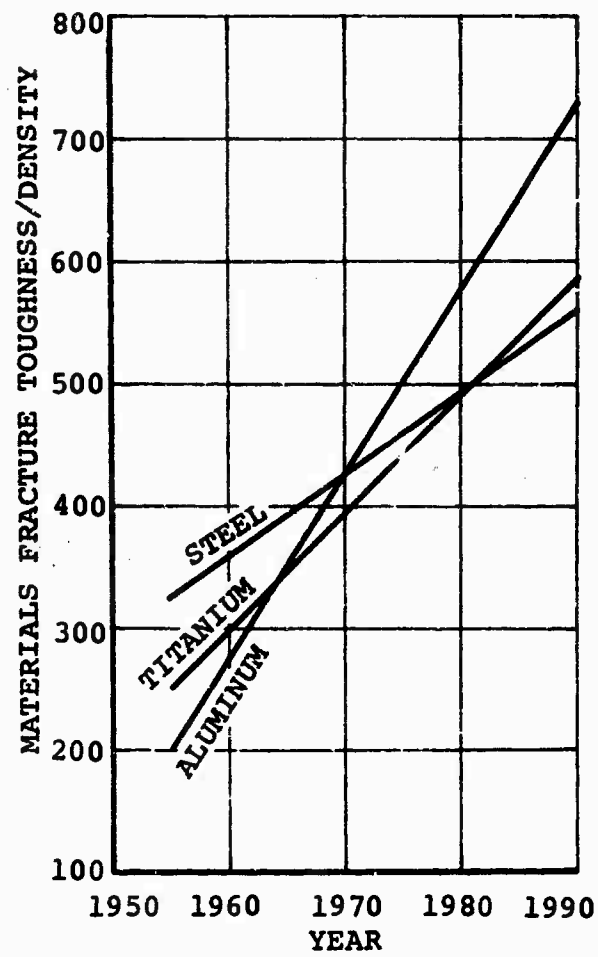

Figure 119. Material Fracture Toughness to Density Trend.

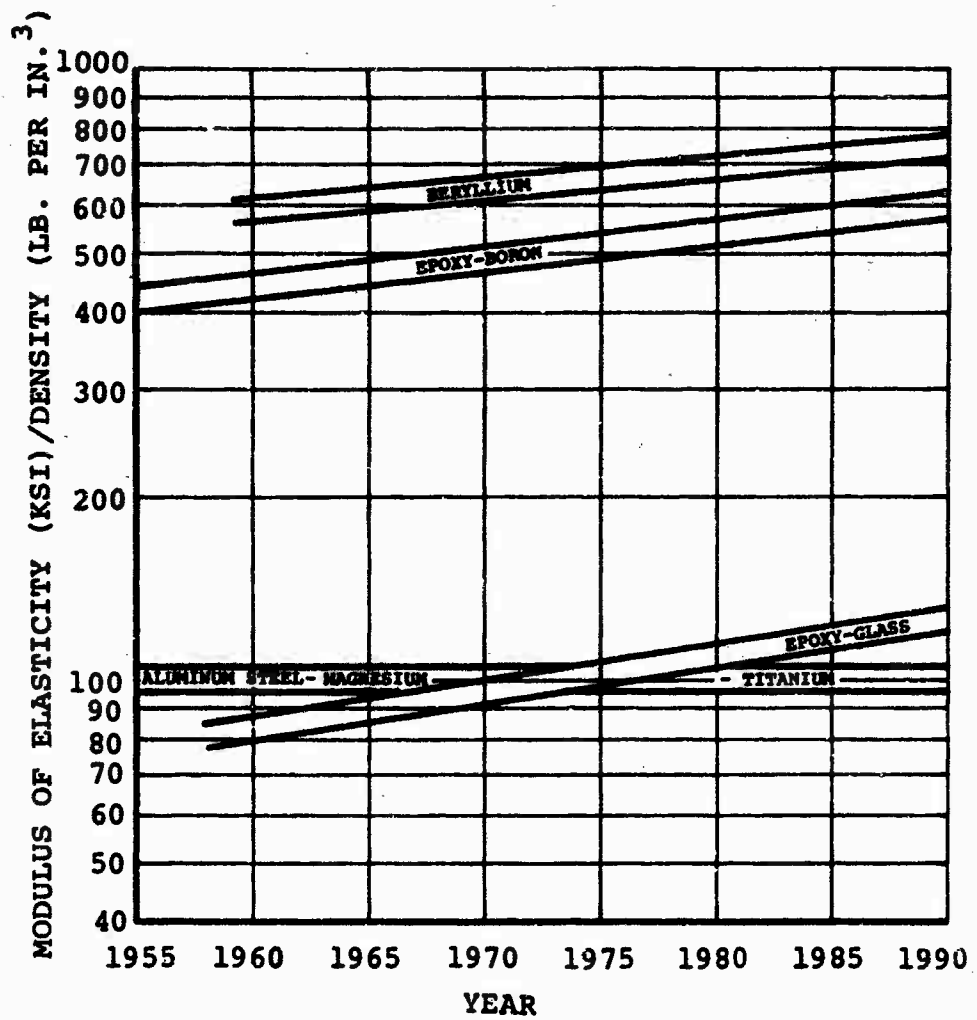

Figure 120. Material Stiffness to Density Trend.

improvements, particularly in conjunction with the development of manufacturing techniques such as automatic tape lay-up machines. A brief material property summary is shown in Table XXXIV, which compares a few of the advanced alloys, composites, and present materials that are now available.

Structural design and manufacturing with the composites has numerous problems, most of them being associated with the composite being physically and structurally two-dimensional. (Tape shape and basic load-carrying direction is that of the filament axial alignment.) Despite these problems, substantial effort is going into integration of these composite tapes into structural design. Table XXXV summarizes some of the current aerospace investigations into composites.

d. Metal Matrices

Further down the path of general aerospace application, but also of the greatest promise in terms of improved strengths, are the metal matrix filament reinforced composites otherwise known as "whisker" matrices. These "whisker" matrices are vastly superior to the current resin matrix composites for the following reasons:

- (1) The metal matrix is capable of protecting the enclosed filaments from hostile environment such as corrosion or high temperature, whereas the resin matrix is not.
- (2) Due to the plastic flow of metal, the metal matrix is superior to the resin in transferring load to the enclosed filaments.

As a result, usable values approaching what is termed the "theoretical maximum" strength of the filaments may be obtained. A comparison of these "theoretical maximum" and current strength values is shown in Figure 121. Unfortunately, "whisker" matrices are basically still in the laboratory stage although some limited use is being found in turbine blades (Pratt and Whitney Aircraft). However, the great potential involved would indicate that "whisker" matrices would be in some sort of general use by 1980.

3. WEIGHT IMPROVEMENT

With respect to the above discussion it is possible to assert specific weight reduction values through the next decade.

TABLE XXXIV. MATERIAL PROPERTY DATA SUMMARY

Material	Density (lb/in. ³) ρ	Specific Strength ($\text{uts}/\rho \times 10^{-3}$)	Specific Fatigue Strength ($\text{ufc}/\rho \times 10^{-3}$)	Specific Tension Modulus ($E/c \times 10^{-6}$)	Coef		Approximate Cost (dollars/lb)
					Linear Exp ($\text{in.}/\text{in.}/\text{°F}$) $\times 10^{-6}$	Linear Exp ($\text{in.}/\text{in.}/\text{°F}$) $\times 10^{-6}$	
<u>Advanced Alloys</u>							
300 Maraging	0.289	1,040	415	92	5.6	4.	10.
Cryogenic 301	0.283	849	406	88	-	100.	170.
Modified Ti-6-6-2	0.164	1,229	518	101	5.0	5.	12.
Be	0.066	1,140	758	636	6.4	60.	600.
Be-Al Alloy	0.076	660	370	384	-	60.	600.
Mg-Y Alloy	0.067	895	313	97	-	180.	
<u>Advanced Composites*</u>							
Boron/Epoxy (48%)**	0.074	2,780	2,200	448	2.4	260.	
Boron/Alum. (50%)	0.096	1,730	-	327	-	-	-
Boron/Mag. (30%)	0.071	1,940	-	440	-	-	-
Graphite/Epoxy (50%)	0.054	2,410	-	530	-0.4	485.	8.
S-Glass/Epoxy (63.5%)	0.059	3,300	980	109	-	-	-
Steel/Epoxy (50%)	0.164	1,530	-	93	-	-	-
<u>Present Materials</u>							
7075-T6	0.101	752	396	102	12.9	.70	3.80
2024-T3	0.100	660	360	105	12.9	.70	3.80
6061-T6	0.090	429	276	101	13.0	.70	3.80
Ti 6-4	0.160	838	468	100	4.9	5.00	12.00
Ti 6-6-2	0.164	1,036	518	101	5.0	5.00	12.00
4340 (150 ksi)	0.283	530	424	103	6.3	.25	2.10
4340 (260 ksi)	0.283	918	389	103	6.3	.25	2.10
Az - 80	0.65	740	493	100	14.0	1.50	3.00
E-Glass/Epoxy	0.66	2,430	750	86	4.8	1.50	3.00

*0° Unidirectional Fiber

** % Fiber Volume

TABLE XXXV. SUMMARY OF SOME CURRENT AEROSPACE COMPOSITE WEIGHT INVESTIGATIONS

Company	Component	Aircraft	Description	Weight Saving (Percent)
Boeing (Commercial)	Floor Beam	707	Caps: Boron/Titanium Sandwich	40
		747	Webs: Titan Skin/Aluminum Honeycomb	34
	Foreflap	707	Boron/Epoxy Skins, Aluminum Honeycomb Titanium Fittings	25
	Spoiler	737	Boron/Epoxy X-Ply Skins, Aluminum Honeycomb, Titanium Spar Moulded Boron Fittings	37
Lockheed	Slat	C5A	Boron, Aluminum, Fiberglass	20
McDonnell	Rudder	F-4	Boron/Epoxy	NA
Gen Dynamics	Horizontal Stabilizer	F-111	Boron/Epoxy, Honeycomb	30
Convair	Bulkhead	F-106	Aluminum/Boron Caps Over Titanium Carrier	43
Pratt and Whitney	Turbine Blade	JT-8D Eng	Boron Whisker/Aluminum Matrix Coated with Silicon Carbide	38
BAC	Aileron Actuator Strut	VC-10	Carbon Filament	33
Boeing Vertol	Cockpit Structure	CH-47A	Boron Epoxy	29-39
		CH-45	Boron Epoxy	29-39
	Fuselage Structure	CH-47	Boron Epoxy	11
Boeing (Commercial)	Body	747	Boron Epoxy	7
Grumman	Wing Torque Box	F-14	Boron/Epoxy Skins on Honeycomb Core Titanium Spars	30
North American Rockwell	Structure, Props, Landing Gear Components	OV-10A	Boron Epoxy	16

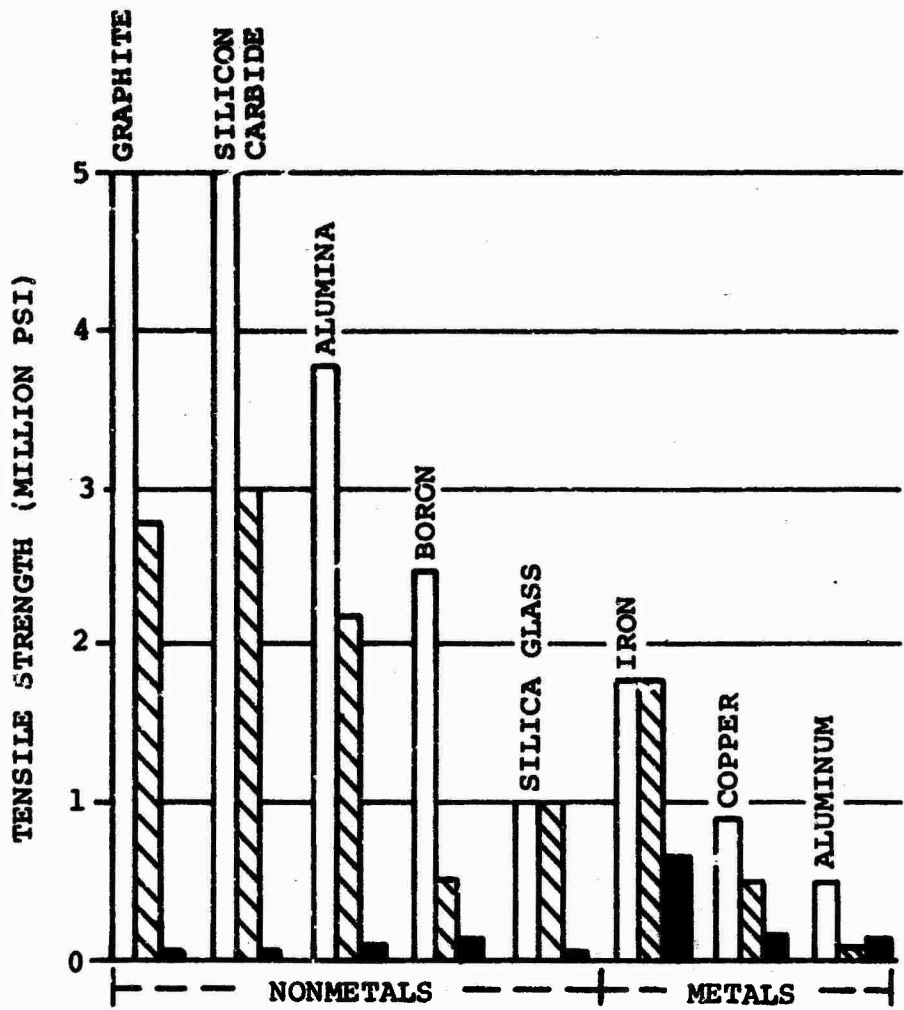

NOTE:

The THEORY AND PERFORMANCE of the materials are contrasted. Each set of bars shows, from left to right, the theoretical strength of the material, the strength achieved experimentally with fibers, and the highest observed strength of large pieces of the material. In the case of aluminum, the middle bar refers to the strength achieved with aluminum wire.

Figure 121. Comparison of Theoretical and Actual Tensile Strength of Materials.

a. Airframe

Reductions in airframe structural weight will apply to the stowed-tilt-rotor wing, tail, body, engine section and tip pod. The starting point of a 1970-1980 weight reduction projection is represented by the existing component studies as summarized in Table XXXV. These studies generally represent "substitution" techniques; i.e., the structural design and manufacturing remains essentially of conventional nature except that boron/epoxy replaces aluminum metal. A group weight reduction value of 10 percent can be initially placed on this type of composite usage.

For 1976, an accumulative reduction value of 15 percent may be used. This will be meant to include advanced designs and manufacturing methods (small-scale automatic tape layup machines) more compatible with the physical properties of the filament/resin composite.

By 1980, maximum integration of design concept and manufacturing equipment is likely to be the deciding factor. This includes large scale tape layup machines and design concepts that are of the maximum compatibility with the filament/resin composites. Designs will include semi-integral and integral frames and ribs. The composites themselves will be substantially stronger than present composites due to improved resin properties. An evolutionary 20-percent reduction factor will be used for this time period.

b. Dynamic Structures

During the next decade the materials most directly applicable to weight improvements in gears, rotor hubs, and landing gear struts are improved alloys such as D6AC steel and Ti-6AL-6V-25N titanium. Advanced materials such as moulded boron/epoxy can be utilized in gear box housings, while laminated boron/epoxy is already being applied to rotor blades.

(1) Drive Systems

In the gear boxes, improved steels (such as VASCO X2), will allow a projected increased Hertz stress of 19 percent. This is equivalent to a theoretical 14 percent decrease in gear box weight. Moulded boron/epoxy gear box housings, proven fluorosilicon lubricants (Figure 122), higher gear contact ratios and improved gear tooth

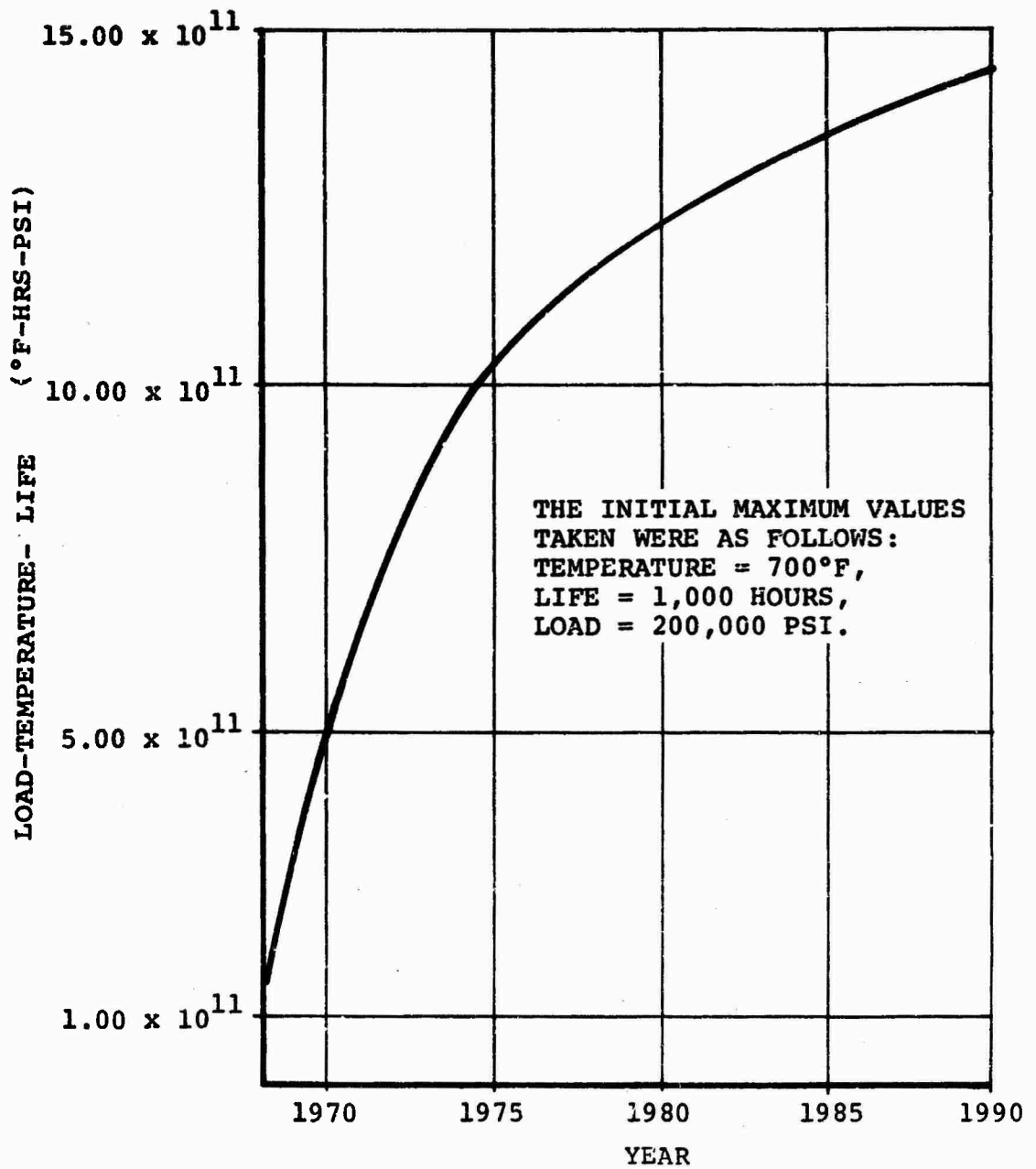

Figure 122. Projected Design Usefulness of Lubricants.

forms will all combine for a total drive system reduction of 17.5 percent in 1976. In 1980 nitrided D6AC (currently used in ball screw actuator gear boxes - Hertz stress value at 350,000 psi) will be applicable in large gear boxes. Assuming the Hertz stress taken is 300,000 psi the equivalent weight reduction is 25 percent. A total evolutionary value of 22.5 percent will be used for the 1980 time period.

(2) Rotor Group

The proposed stowed-tilt-rotor designs include the use of titanium in the rotor hub and S-glass/epoxy in the rotor blades. For 1976 the only proposed weight reduction is the use of improved resins, boron in lieu of S-glass, and filament reinforced root-end fittings to decrease the rotor group blade weight a total of 10 percent. For 1980, improved higher strength titanium will reduce the hub weight 10 percent. Refined design and still better resins will reduce blade weight an additional 5 percent from 1976.

(3) Alighting Gear

For the landing gear the use of high strength steel such as D6AC will affect approximately 30 percent of the landing gear group. This will result in a 10 percent decrease in group weight for 1976. For 1980 the alighting gear is considered a prime area for metal matrix application. An additional 5 percent reduction over 1976 will be taken.

c. Propulsion Systems

Powerplant power and thrust-to-weight ratios will continue to improve due to higher turbine inlet temperatures and higher bypass ratios (Figures 123 and 124). More important will be the continuing development of advanced fan and compressor blade materials such as Rolls-Royce's present "Hyfill" or Pratt and Whitney's boron "whisker"/aluminum matrix material. As a result of these current efforts, propulsion studies project a total power-to-weight-ratio improvement of 22 percent for 1976. A more conservative value of 15 percent weight reduction will be taken for the proposed stowed-tilt-rotor in both engines and fan. In 1980, the power-to-weight-ratio improvement is 32 percent. A weight reduction value of 25 percent will be taken for this later time.

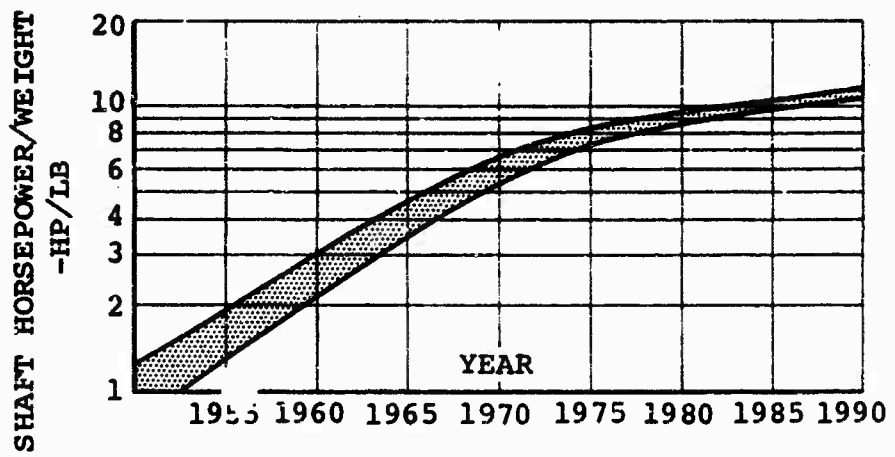

Figure 123. Turboshaft Engine Power to Weight Trend.

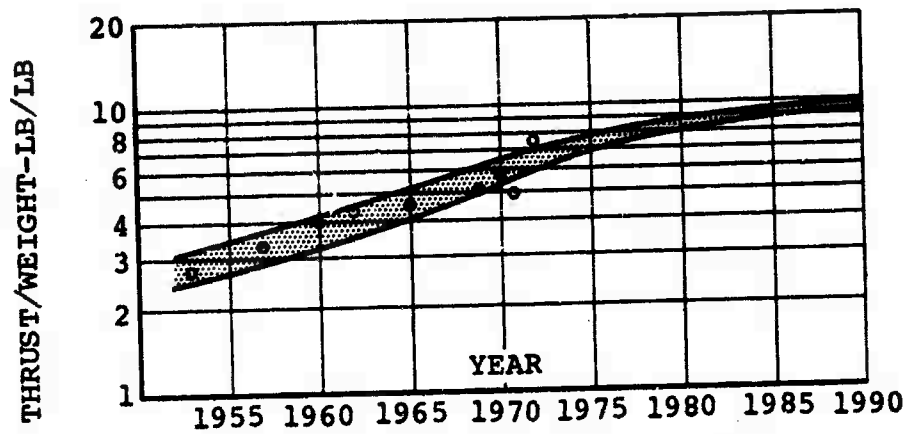

Figure 124. Turbofan Engine Thrust to Weight Trend.

d. Subsystems

(1) Flight Controls and Engine Controls

The flight controls and engine controls groups offer promising areas for weight improvements with the utilization of "fly-by-wire". Previously, confidence in "fly-by-wire" system reliability was the main deterrent to such installations since effective and reliable transducers and "black boxes" were not attainable. However, the increasing use (Figure 125) of integrated circuits, together with their decreasing costs, makes "fly-by-wire" electronic reliability easily attainable, (Figures 126, 127 and 128). Also, the low weight of integrated circuit design makes duplication or triplication of key components more and more feasible. A recent (June 1967) study by the Air Force* of the B-52H, F-111, and the CH-46 indicates an average 50-percent saving in pitch, yaw, and roll subsystems. For conservatism a weight reduction of 25 percent will be taken for the proposed stowed-tilt-rotor baseline aircraft. This only pertains to point-to-point flight control linkages, but includes complete use of electronics for flight data inputs, summing, and outputs. Redundant installations are also included.

In the upper controls, advanced materials will be assumed to produce a 10-percent reduction in component weight.

e. Instruments - Electrical and Electronic

Improved and advanced design of integrated circuits will all yield significant weight volume and power improvements in these groups. At the same time the military trend of increasing requirements for more cockpit displays, built-in test equipment, higher reliability, easier maintenance and increasing functional capability, Figure 129, will tend to negate actual weight improvements. Accordingly, while actual component weight decreases are expected, no group weight reductions are projected for 1976 or 1980.

*"Fly-by-wire techniques"; Miller, EM Finger, TR AFFDL-TR-67-53, July 1967.

4. CONCLUSIONS

The weight savings available to the above described advanced technology are considered to be realistic for 1976 IOC. It will be noted that the development costs of material and tooling was not considered in making the advanced technology appraisal, whereas in actuality cost will be a major factor in the evaluation of the next decade's technology. However, the cost argument may be countered with an awareness that aerospace manufacturers are already pressing forward structural designs with advanced material. The best example of this is the fact that the most advanced air superiority aircraft to date, the Grumman F-14, is proceeding into the production stage with a boron composite wing. Grumman also has a conventional metal wing as a "backup" design, but nevertheless, this example demonstrates the ready willingness of aerospace to go into major components with new materials. This willingness is a major indication of the fact of significant weight reductions with advanced technology.

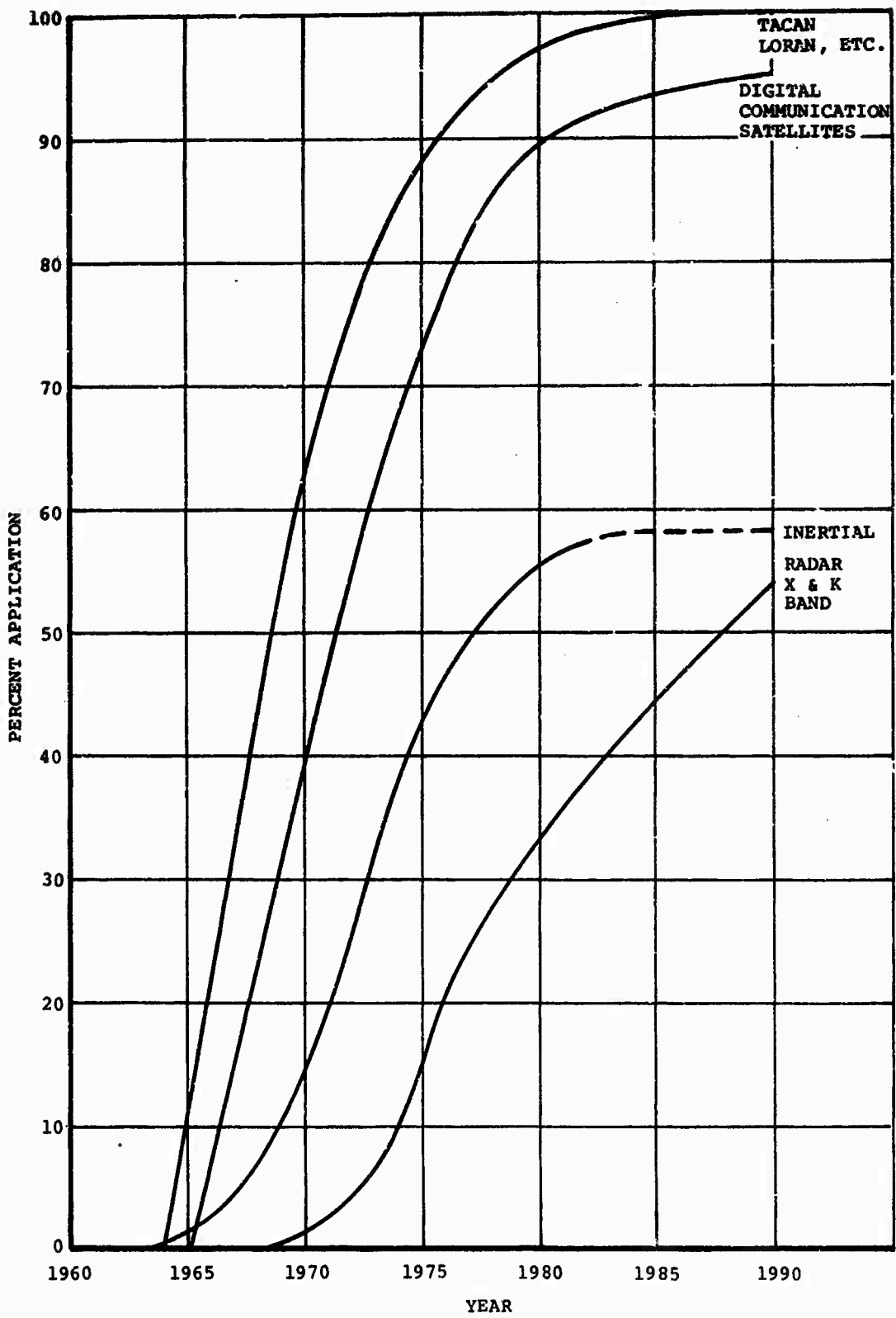

Figure 125. Trends in Integrated Circuits.

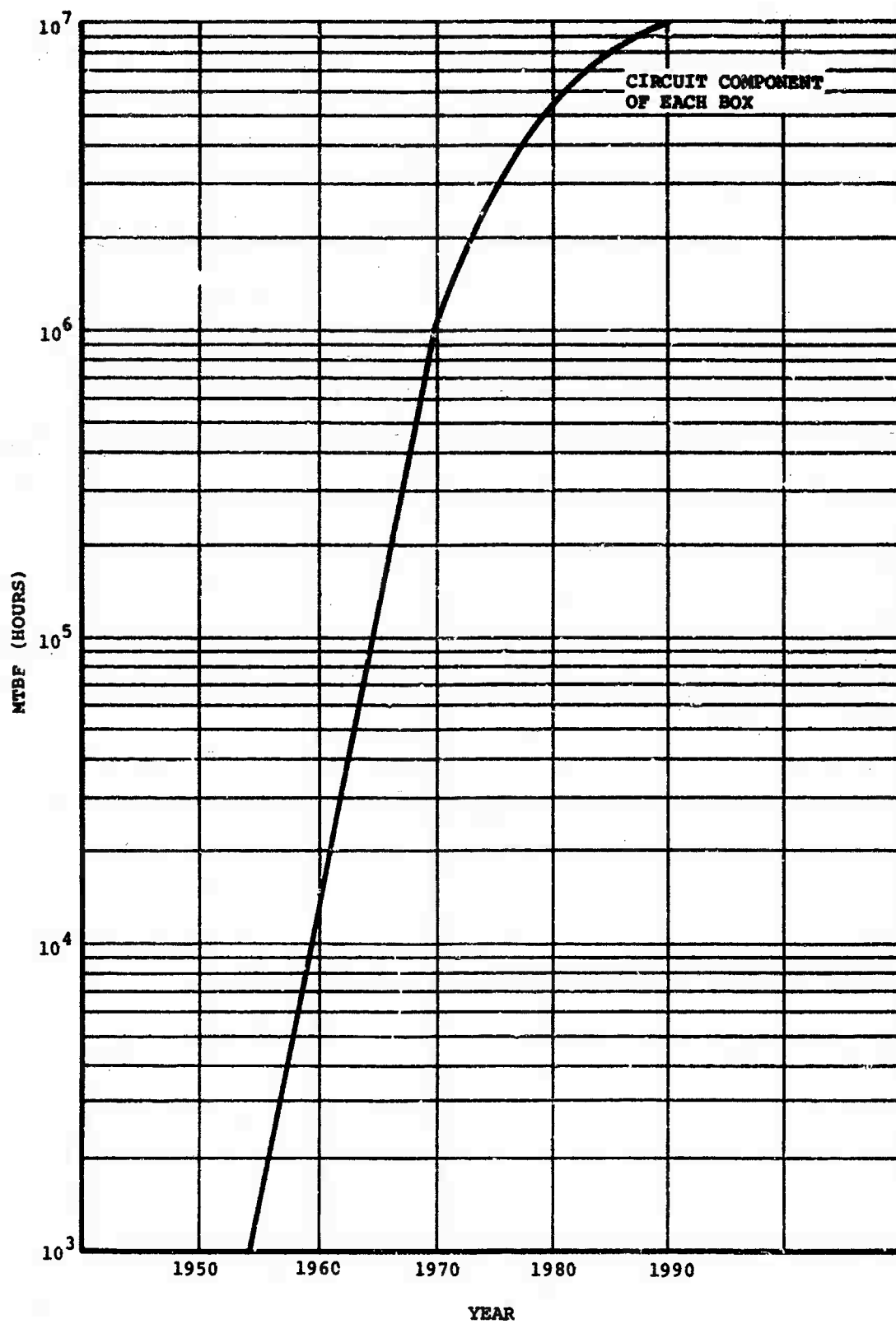

Figure 126. Avionics Component Reliability Trends.

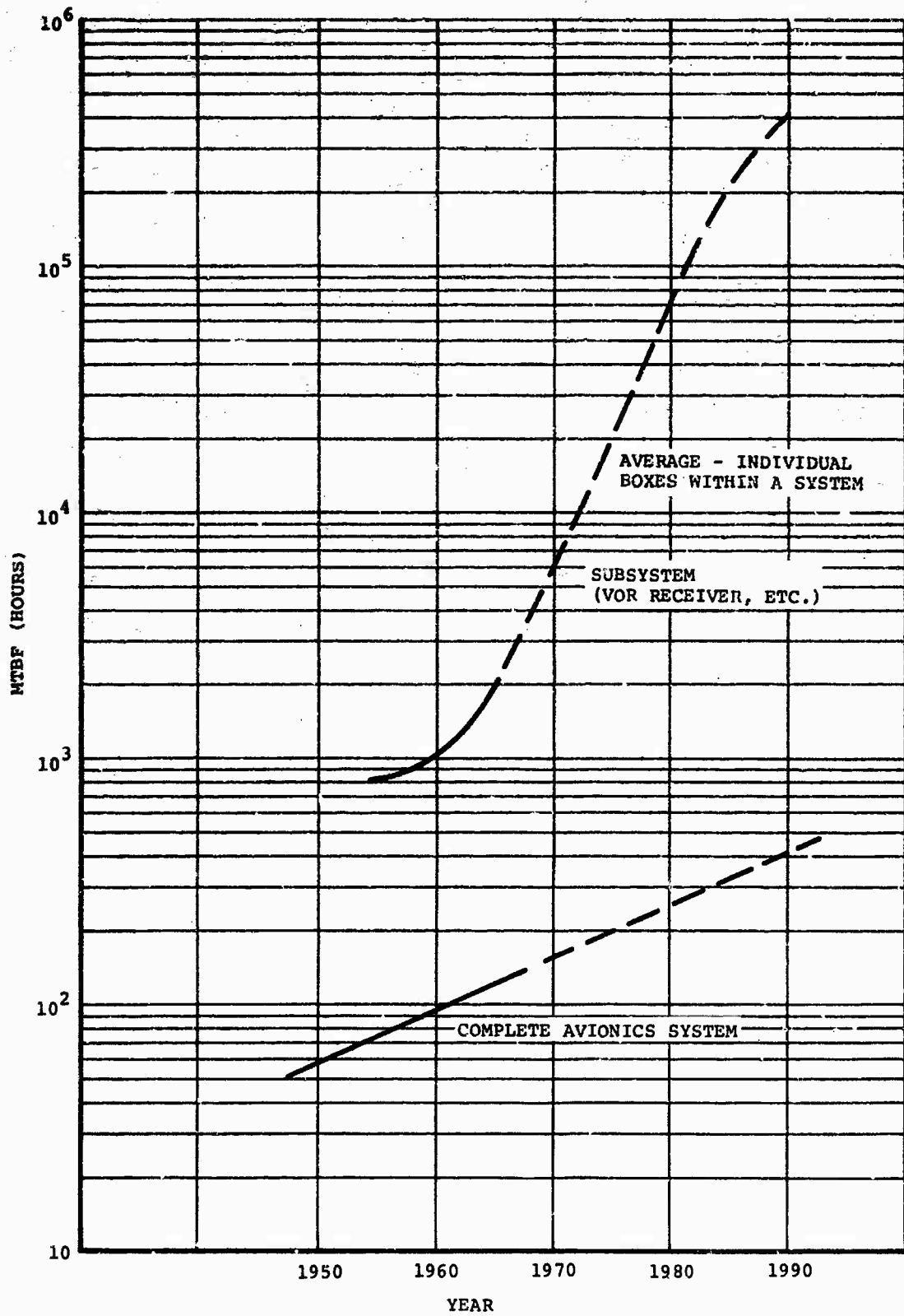

Figure 127. Avionics System Reliability Trends.

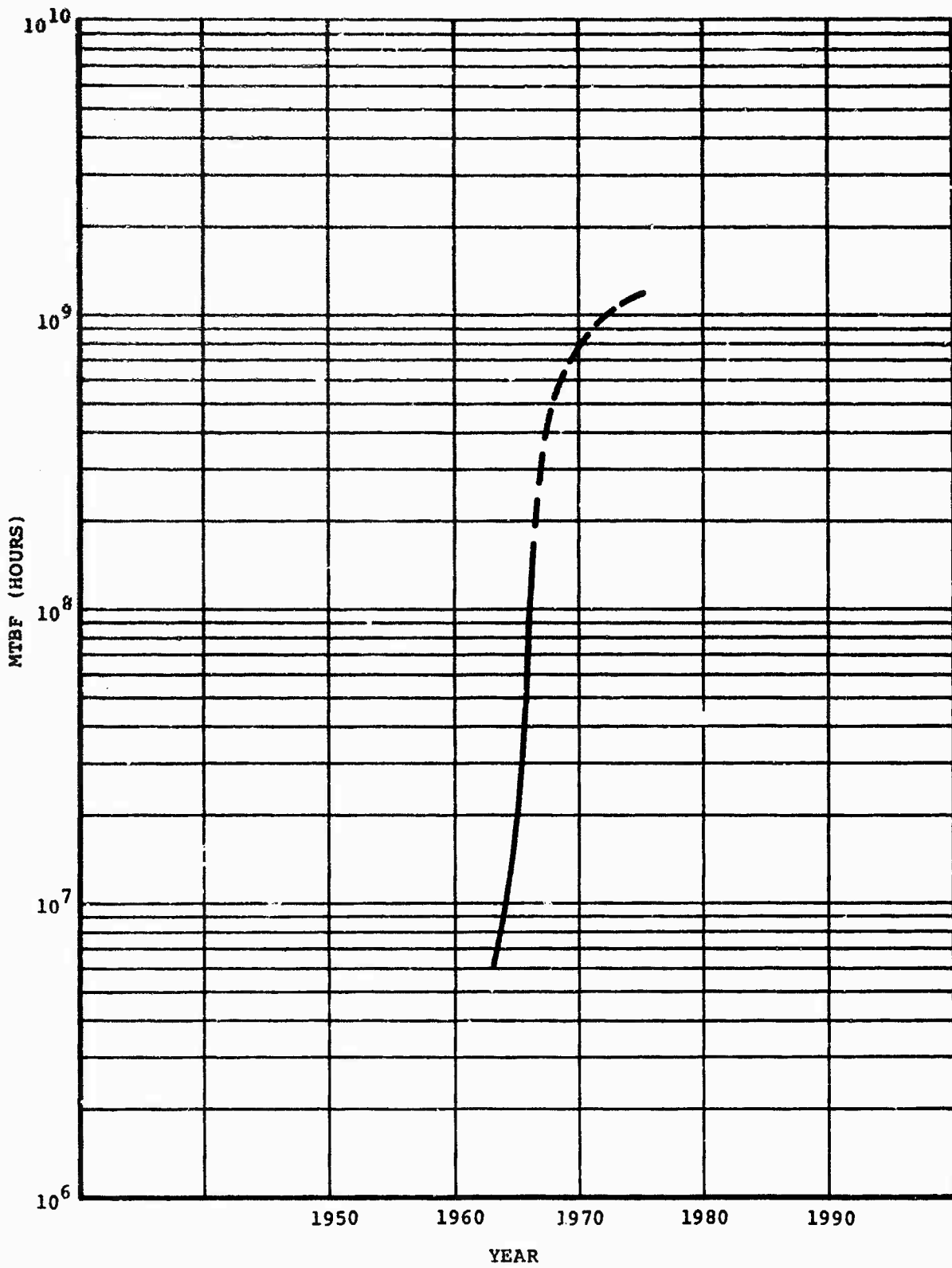

Figure 128. Improvement in High Reliability Microcircuits.

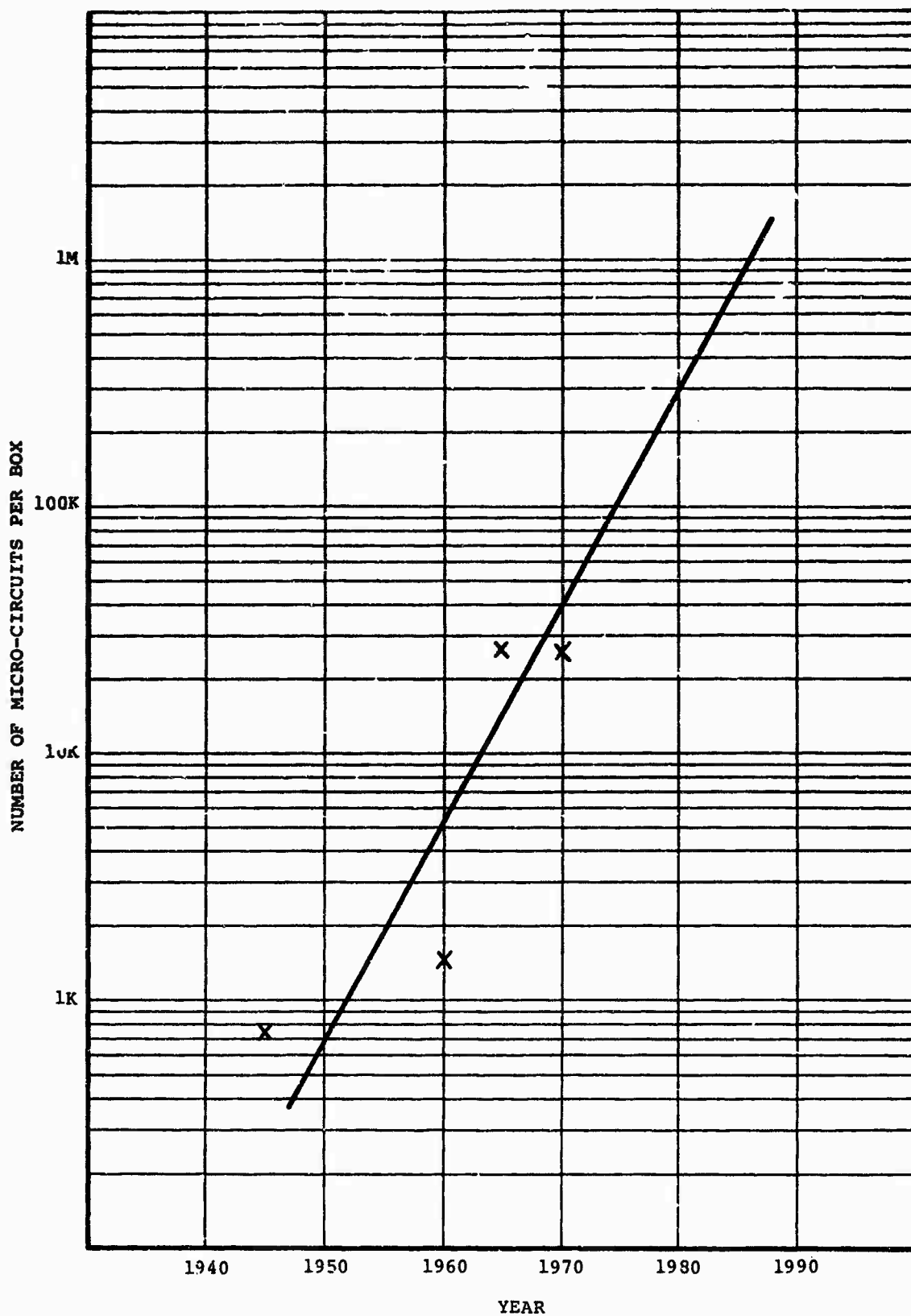

Figure 129. Complexity of Avionics.
289

SECTION XIII

TECHNOLOGY TRADE-OFFS

1. DEMONSTRATOR AIRCRAFT WITH SEPARATE LIFT AND CRUISE POWERPLANTS

A production version of a stowed-tilt-rotor aircraft is likely to be preceded by a concept demonstrator. A brief study has been made of a version of the baseline rescue aircraft with no advanced airframe, materials, or propulsion technology concepts. The resulting aircraft is shown in Figure 130 and a weight summary is given in Table XXXVI. The rotor, wing, tail, body, alighting gear, flight controls and tip-pod groups are identical with the 1969 weights for the baseline rescue aircraft. Fixed equipment is also identical, except all of the armament and 1,000 pounds of electronics equipment is removed. The convertible turbofan units have been replaced with two turboshaft engines; cruise turbofan engines have been added on the aft fuselage. Although the two turboshaft engines replace four gas generators in the baseline aircraft, the demonstrator is still able to hover at sea level 90 degrees Fahrenheit, which is considered adequate for a demonstrator aircraft. With a test crew of two pilots and two flight test engineers the aircraft has a useful load of over 18,000 pounds for fuel and test instrumentation and equipment. This should be entirely adequate for extended test flights. Since the shaft engines can be run at idle power setting with the output shaft stationary, a normal situation for helicopter startup, rotor clutches can be dispensed within the demonstrator aircraft. Table XXXVII shows a breakdown of the turboshaft and cruise fan installation weights.

2. ADVANCED TECHNOLOGY FOR 1980

Table XXXVIII shows the anticipated reductions in weight empty for the baseline rescue aircraft if the advanced technology, airframes, materials, systems, and propulsion improvements discussed in the last section are incorporated. The total reduction in weight for a 1980 IOC date aircraft is 2,360 pounds. This would increase the radius capability of the aircraft by approximately 160 nautical miles or alternatively an aircraft built to the mission requirements would have an initial takeoff gross weight of approximately 59,000 pounds as compared to the 67,000 pounds of the 1976 technology aircraft.

PRECEDING PAGE BLANK

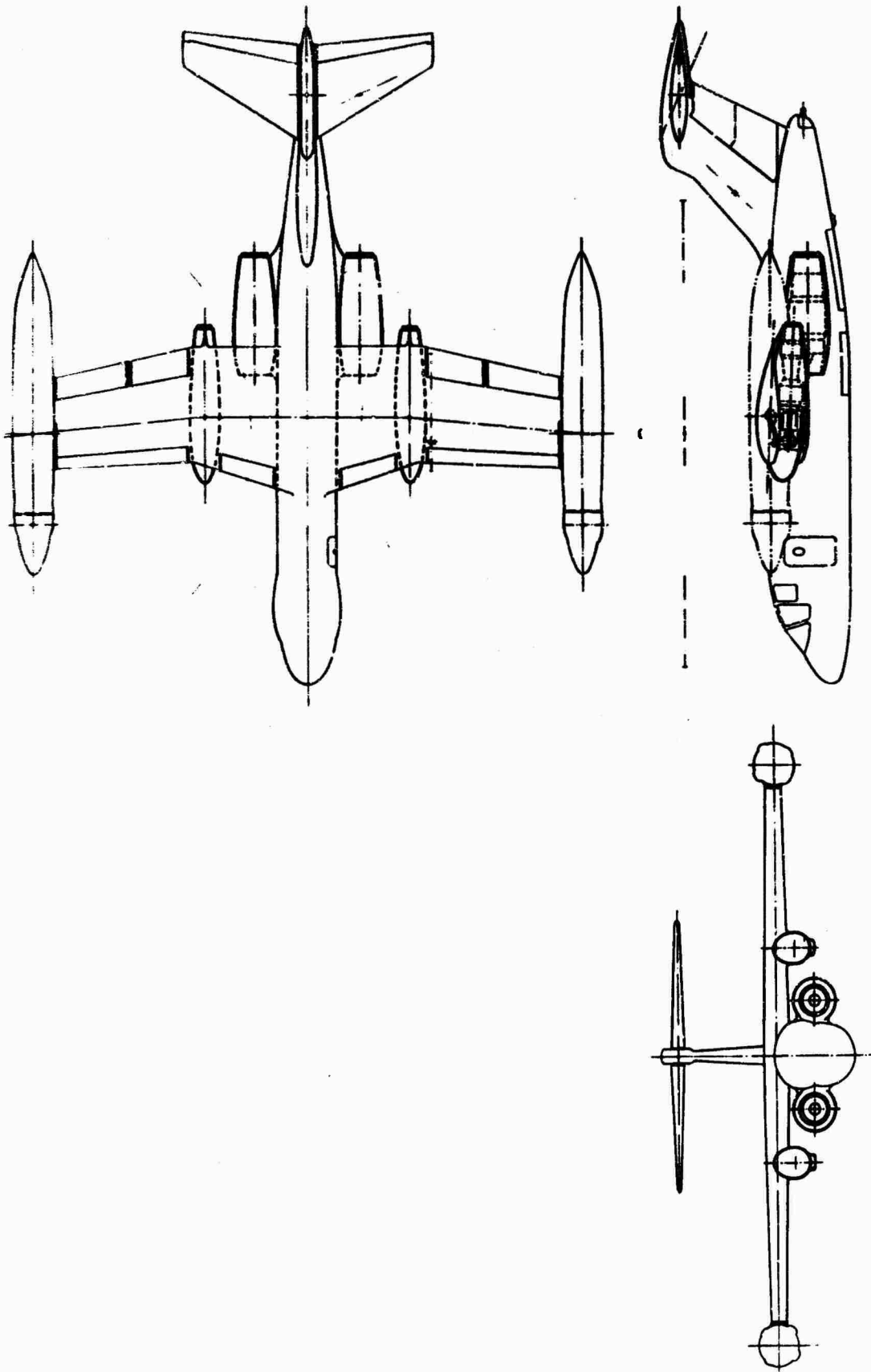

Figure 130. Demonstrator Aircraft with Separate Lift and Cruise Engines

TABLE XXXVI. DEMONSTRATOR AIRCRAFT WEIGHT SUMMARY

	WEIGHT (lb)				
ROTOR GROUP	5,180				
WING GROUP	6,730				
TAIL GROUP	1,168				
BODY GROUP	3,250				
BASIC					
SECONDARY					
SECOND.-DOORS, ETC.					
ALIGNING GEAR	2,650				
FLIGHT CONTROLS	4,199				
ENGINE SECTION	1,665				
Tip Pod	2,130				
PROMULSION GROUP	16,522				
ENGINES(S)	6,958				
AIR INDUCTION	300				
EXHAUST SYSTEM	350				
COOLING SYSTEM	30				
LUBRICATING SYSTEM	60				
FUEL SYSTEM	2,100				
ENGINE CONTROLS	150				
STARTING SYSTEM	350				
PROPELLER INST.					
*DRIVE SYSTEM	6,224				
ALX. POWER PLANT	182				
INSTR. AND NAV.	400				
HYDR. AND PNEU.	292				
ELECTRICAL GROUP	775				
ELECTRONICS GROUP	500				
ARMAMENT GROUP	-				
FURN. & EQUIP. GROUP	1,152				
PERSON, ACCOM.					
MISC. EQUIPMENT					
FURNISHINGS					
EMERG. EQUIPMENT					
AIR COND. & DE-ICING	519				
PHOTOGRAPHIC	-				
AUXILIARY GEAR	140				
Cargo Handling	-				
MFG. VARIATION	480				
WEIGHT EMPTY	47,934				
FIXED USEFUL LOAD	935				
CREW	800				
TRAPPED LIQUIDS	65				
ENGINE OIL	70				
FUEL AND CARGO	18,131				
CARGO					
PASSENGERS/TROOPS	-				
GROSS WEIGHT	67,000				

*Includes _____ Pounds of Transmission Oil

TABLE XXXVII. DEMONSTRATOR AIRCRAFT ENGINE
INSTALLATION WEIGHTS

Item	Turboshaft Installation (lb)	Cruise Fan (lb)	Total (lb)
Engine Section	765	900	1,665
Engines	2,570	4,388*	6,958
Air Induction (FOS)	300		300
Exhaust		350	350
Cooling	15	15	30
Lubricating	30	30	60
Fuel System	2,000	100**	2,100
Engine Controls	75	75	150
Starting	200***	150	350
Drive	6,224		6,224
Total	17,179	6,008	18,187

* Spey Jr.
 ** Lines Only
 *** Multiple Start

TABLE XXXVIII. BASELINE RESCUE 1980 TECHNOLOGY TRADEOFFS

ITEM	BASELINE RESCUE	AIRFRAME REDUCTION	SYSTEM REDUCTION	PROPELLER REDUCTION	TOTAL 1980 REDUCTION
ROTOR GROUP	4,936	4,570	4,936	4,936	4,570
WING GROUP	5,710	5,384	5,710	5,710	5,384
TAIL GROUP	982	935	982	982	935
BODY GROUP	3,250	3,067	3,250	3,250	3,067
BASIC					
SECONDARY					
SECOND.-DOORS, ETC.					
ALIGNING GEAR	2,385	2,253	2,385	2,385	2,253
FLIGHT CONTROLS	3,636	3,636	3,636	3,636	3,636
ENGINE SECTION	1,250	1,176	1,250	1,250	1,176
Tip Pod	1,811	1,704	1,811	1,811	1,704
PROPULSION GROUP	11,983	11,590	11,613	11,648	10,885
ENGINES(S)	2,134	2,134	2,134	1,883	1,883
AIR INDUCTION	360	360	360	360	360
EXHAUST SYSTEM	-	-	-	-	-
COOLING SYSTEM	15	15	15	15	15
LUBRICATING SYSTEM	26	26	26	26	26
FUEL SYSTEM	2,489	2,096	2,489	2,489	2,096
ENGINE CONTROLS	42	42	42	42	42
STARTING SYSTEM	148	148	148	148	148
PROPELLER INST.					
DRIVE SYSTEM	4,485	4,485	4,220	4,485	4,220
Fan Instl.	2,284	2,284	2,179	2,200	2,095
A. V. POWER PLANT	182				
INSTR. AND NAV.	400				
HYDR. AND PNEU.	292				
ELECTRICAL GROUP	775				
ELECTRONICS GROUP	1,500				
ARMAMENT GROUP	2,000				
FURN. & EQUIP. GROUP	1,152	6,960	6,960	6,960	6,960
PERSON. ACCOM.					
MISC. EQUIPMENT					
FURNISHINGS					
EMERG. EQUIPMENT					
AIR COND. & DE-ICING	519				
PHOTOGRAPHIC					
AUXILIARY GEAR	140				
MFG. VARIATION	433	416	429	430	409
WEIGHT EMPTY	43,336	41,691	42,962	42,998	40,979
FIXED USEFUL LOAD	1,335	1,335	1,335	1,335	1,335
CREW	1,200				
TRAPPED LIQUIDS	70				
ENGINE OIL	65				
Combat Equip.	400	400	400	400	400
FUEL	21,979	22,000	22,000	22,000	22,000
CARGO		1,574	303	267	2,286
PASSENGERS/TROOPS					
GROSS WEIGHT	67,000	67,000	67,000	67,000	67,000

SECTION XIV

CONCLUSIONS AND RECOMMENDATIONS

The studies presented in this Volume show that:

1. The three basic mission aircraft (rescue, capsule recovery, and transport) have design gross weights of 67,000, 78,000, and 85,000 pounds, respectively.
2. A multimission aircraft capable of fulfilling all the requirements of the three missions has a design gross weight of 104,000 pounds; even if the use of a common propulsion system with different fuselages for each mission version is adopted.
3. The rescue mission and the transport mission can be performed by aircraft of 67,000-pound design gross weight, having a common lift/propulsion system, if some reduction in the transport cargo box cross section is made. This compromise still gives a cargo volume larger than most fixed-wing or helicopter medium transport aircraft.
4. A broad assessment of the baseline aircraft handling qualities shows that the short span and high inertia of the configuration gives rise to the problems of inadequate roll response at low speeds, and roll subsidence and spiral stability characteristics which do not meet military specifications.
5. Preliminary assessment of the structural dynamic characteristics, based on the preliminary component design stiffness and mass properties, does not indicate any problem areas.
6. A prototype vehicle could be designed and constructed utilizing present day materials and fabrication techniques, and conventional turboshaft and turbofan engines, which would be satisfactory for concept demonstration and operational evaluations.

Based on the aircraft and component characteristics determined in the Phase I Design Studies, the test program detailed in the Test Plan for Phase II, Document D-213-10001-1, is recommended.

PRECEDING PAGE BLANK

REFERENCES

1. H. H. Pearcey, The Aerodynamic Design of Section Shapes for Swept Wings, Aerodynamic Division, National Physical Laboratory, Teddington, United Kingdom.
2. Analysis of Propeller and Rotor Performances in Static and Axial Flight by an Explicit Vortex Influence Technique (EVIT), Boeing Report R-372A.
3. Parametric and Preliminary Design Studies of High and Low Speed Cruise Fan Propulsion Systems, Report R65FPD217, Advanced Engine and Technology Department, General Electric Company, 19 August 1965.
4. Turbofan Power Plant Optimization Study, Report AK.0000-191, Allison Division, General Motors Corporation, 21 February 1966.
5. R. L. Bisplinghoff, H. Ashley, and R. L. Halfman, Aeroelasticity, Addison - Wesley Publishing Company, Inc., Reading, Mass.
6. The Royal Aeronautical Society Data Sheets, London, England.
7. USAF Stability and Control DATCON, Contract No. AF 33(616)-6460, AF 33(615)-1605, and F33615-67-C-1156, August 1968.
8. "Advanced Filament Composite Materials", Study of Aircraft in Short Haul Transportation Systems, Contract No. NAS 2-3862, The Boeing Company, Renton, Washington, August 1967.
9. "Advanced Materials and Structural Techniques" Proposal to Determine Design Criteria and Demonstrate Technology of a Prop/Rotor Aircraft, Report No. D8-2367-1, The Boeing Company, Vertol Division, Philadelphia, Pa., February 1969.
10. J. R. Meyer, "Advanced Materials and Structural Techniques", 1970 Long Range Environmental Forecast, Company Limited, Report No. D8-2298-1, The Boeing Company, Vertol Division, Philadelphia, Pa., December 1968.
11. A. Kelly, "Fiber-Reinforced Metals", Scientific America, 1968, ("Metalliding", August 1969).

PRECEDING PAGE BLANK