

AD-772 857

AMORPHOUS SEMICONDUCTORS

James C. Thompson

Texas University

Prepared for:

Army Research Office - Durham

1973

DISTRIBUTED BY:

NTIS

National Technical Information Service
U. S. DEPARTMENT OF COMMERCE
5285 Port Royal Road, Springfield Va. 22151

ARO-9687.6-②

Semiannual Technical Report
1 April 1973--30 September 1973

ARPA Order Number 1562

Grant Number DA-ARO-D-31-124-73-G81

Program Code Number OD10

James C. Thompson 512/471-5926

University of Texas at Austin--Grantee

James C. Thompson 512/471-5926

Effective Date: 1 April 1973

Amorphous Semiconductors

Expiration Date: 31 March 1973

Amount of Grant: \$29,296.00

AD772857

D D C
RECEIVED
JAN 11 1974
RECEIVED
C

Sponsored by
Advanced Research Projects Agency
ARPA Order No. 1562

The views and conclusions contained in this document are those of the authors and should not be interpreted as necessarily representing the official policies, either expressed or implied, of the Advanced Research Projects Agency or the U. S. Government.

Approved for public release; distribution unlimited. The findings in this report are not to be construed as an official Department of the Army position, unless so designated by other authorized documents.

Reproduced by
**NATIONAL TECHNICAL
INFORMATION SERVICE**
U S Department of Commerce
Springfield VA 22151

DOCUMENT CONTROL DATA - R & D

(Security classification of title, body of abstract and indexing annotation must be entered when the overall report is classified)

1. ORIGINATING ACTIVITY (Corporate author) University of Texas		2a. REPORT SECURITY CLASSIFICATION Unclassified	
		2b. GROUP NA	
3. REPORT TITLE AMORPHOUS SEMICONDUCTORS			
4. DESCRIPTIVE NOTES (Type of report and inclusive dates) Semiannual Technical Report: 1 April 1973 - 30 September 1973			
5. AUTHOR(S) (First name, middle initial, last name) James C. Thompson			
6. REPORT DATE 1973		7a. TOTAL NO. OF PAGES 21	7b. NO. OF REFS
8a. CONTRACT OR GRANT NO. DA-ARO-D-31-124-73-681		9a. ORIGINATOR'S REPORT NUMBER(S) NA	
b. PROJECT NO.		9b. OTHER REPORT NO(S) (Any other numbers that may be assigned this report) AROD- 9687.6-P	
c.			
d.			
10. DISTRIBUTION STATEMENT Approved for public release; distribution unlimited.			
11. SUPPLEMENTARY NOTES None		12. SPONSORING MILITARY ACTIVITY U. S. Army Research Office Box CM, Duke Station Durham, North Carolina 27706	
13. ABSTRACT Section I contains the text of a paper (Effects of Pressure on Amorphous Semiconductors) read at the Fifth International Conference on Amorphous and Liquid Semiconductors (Garmisch-Partenkirchen, Germany, 1973). Section II contains an outline of the source of the errors in the A.c. data reported at Garmisch. Section III describes an improvement made in data taking procedures for sound speed measurements.			
14. KEY WORDS Semiconductors (materials) Germanium Amorphous materials Tellurium Pressure effects Arsenic Transport properties Sound velocity Arsenic selenides			

INTRODUCTION

The past half year has been a near disaster. The a.c. conductivity data accumulated seems to have been largely in error. The high pressure cell ordered on 31 August 1972 was not delivered until mid-October and when delivered had broken leads so was returned. Not until the third delivery (in mid-November 1973) was a functioning apparatus received.

Section I contains the text of a paper read at the Fifth International Conference on Amorphous and Liquid Semiconductors (Garmisch-Partenkirchen, Germany, 1973). Section II contains an outline of the source of the errors in the A.c. data reported at Garmisch. Section III describes an improvement made in data taking procedures for sound speed measurements.

Effects of Pressure on Amorphous Semiconductors*

K. E. Bailey, B. A. Joiner, P. L. Sherrell[†] and

J. C. Thompson

Physics Department, The University of Texas at Austin

Austin, Texas 78712

We report on measurements of sound speed, compressibility κ_T , T_g , and dc and ac conductivity in As:Te:Ge and As₂Se₃ up to 10 k bar. Mechanical properties are similar to those of conventional glasses: $\kappa_T \sim 6 \times 10^{-12}$ cm²/dyn and decreases on increasing pressure. The value of τ_{ac} does not seem to depend on pressure.

1. INTRODUCTION

The application of pressure permits one to determine the influence of interatomic spacing on the various properties of a material. In some cases these effects are the result of an explicit volume dependence, but there is more often an indirect dependence through other parameters which themselves vary with interatomic distance. Furthermore, knowledge of the density dependence of parameters which are temperature dependent enables one to separate the effects of thermal expansion from temperature changes so that the intrinsic temperature dependence may be obtained. We report here measurements of the pressure, temperature, and frequency dependence of compressibility and electrical conductivity in some amorphous chalcogenide alloys.

*This research was supported in part by the Advanced Projects Agency of the Department of Defense and was monitored by U. S. Army Research Office under Grant No. DA-ARO-D-31-124-73-G81.

[†]NDEA Title IV Fellow

2. COMPRESSIBILITY

Both isothermal and adiabatic compressibilities have been measured in the alloy $\text{Te}_{15}\text{Ge}_3\text{As}_2$ as a function of hydrostatic pressure up to 7 k bar. The isothermal measurements were made dilatometrically using a Linear Variable Differential Transformer (LVDT) to observe the change in sample length under pressure. As in all these experiments, we used a 10 kbar Bridgeman-type apparatus using nitrogen gas as the pressure medium. Calibration of the LVDT was accomplished by measuring the known dilatation (Vaidya and Kennedy, 1970) of single crystals of NaCl, KCl, KBr, and KI. The apparatus was then used to record the dilatation in the chalcogenide samples. The data are shown in Fig. 1, except for the As_2Se_3 sample. From these measurements the isothermal compressibilities κ_T were calculated from the equation:

$$\kappa_T = -\frac{1}{V} \left. \frac{\partial V}{\partial P} \right|_T = -\frac{1}{(1 + \Delta V/V_0)} \left. \frac{\partial(\Delta V/V_0)}{\partial P} \right|_T$$

where V is the volume of the sample, ΔV is the change in volume, and V_0 is the volume at atmospheric pressure. The results are shown in Table I.

In the determination of the adiabatic compressibility κ_S the actual experimental parameter (Bailey and Thompson, 1972) is the transit time of a short pulse of ultrasonic waves in a cylindrically shaped sample. Conversion of the measured transit time to sound speed requires a knowledge of the change in sample length with pressure. This change in sample length is calculated by the method of Cook (1957) which yields:

$$\kappa_S = \left\{ y(P) \rho_0^2 \ell_0^2 \left[\frac{1}{t_t^2(P)} - \frac{4/3}{t_t^2} \right] \right\}^{-1},$$

where

$$y(P) = 1 + \frac{y}{3\rho_0 \ell_0^2} \int_0^P \left[\frac{1}{t_t^2} - \frac{4/3}{t_t^2} \right]^{-1} dP.$$

At zero pressure the length is l_0 , the density ρ_0 ; t_l and t_t are the longitudinal and transverse transit times, and γ is the ratio of specific heats C_p/C_v and is taken to be independent of pressure.

Values of κ_S for $\text{Te}_{15}\text{Ge}_3\text{As}_2$ are shown in Fig. 2 for an assumed γ of unity. κ_S varies smoothly from 0-10 kbar, decreasing with increasing pressure. This is, of course, expected since the atoms resist compression more strongly as they are pushed together (Gray, 1963). We find that $\kappa_S = 5.76 \times 10^{-12} \text{ cm}^2/\text{dyne}$ at atmospheric pressure and the pressure coefficient varies smoothly from -2.4×10^{-13} at $P = 0$ to $-1.3 \times 10^{-13} \text{ cm}^2 \text{ dyne}^{-1} \text{ kbar}^{-1}$ at 10 kbar.

While the results for κ_S and κ_T are related they cannot be directly compared nor can γ be calculated since the LVDT measurements have error bars of about 5%. Values of γ are expected to be quite close to unity in these as in other solids (e. g., in vitreous silica $1.000 < \gamma < 1.001$). Our error arises primarily from the use of the high pressure data of Vaidya and Kennedy in this, relatively, low pressure range.

It is clear, nevertheless, that there is no great difference between these and other glasses insofar as κ_T , κ_S or γ is concerned. The compressibility of the chalcogenide glasses considered here are two-to-three times greater than those of silicate glasses and about the same as those of the borate glasses (Weir and Shartis, 1955).

No permanent densification was observed below 9 kbar to within 0.04%.

3. CONDUCTIVITY

It has generally been assumed that the presence of an ac conductivity σ_{ac} proportional to the frequency is evidence for electronic hopping (Pollak and Geballe, 1961). Fritzsche (1972) has emphasized that there may be other, equally tenable, explanations which do not involve electronic hopping at all. Finally, Pollak and Pike (1972) have shown the pervasive nature of the ω^α behavior whenever the two-center relaxation times are exponential functions of a random variable. While the disagreement over the temperature dependence of σ_{ac} is yet unresolved we have undertaken a series of experiments to look at the pressure dependence of hopping to contribute to the resolution of these discrepancies.

If we follow Pollak and Pike then the pressure dependence of the conductivity is just compensated by the pressure dependence of the form factor of the sample so that $dR/dP \equiv 0$ where R is the resistance. This is just the result reported for As_2Se_3 by Ivkin, et al. (1972).

We have studied the alloy $Te_{72}As_{19}Ge_9$ up to 2 kbar and 5 MHz. Figure 3 shows R as a function of $1/T$. Clearly the pressure dependence of σ_{ac} is less than that of σ_{dc} . Figure 4 shows the frequency dependence of R^{-1} at two pressures; the difference between the two curves at the highest frequency is due entirely to the shift in σ_{dc} produced by a 6 K shift in temperature during the run. We therefore confirm Ivkin, et al., and also Pollak and Pike insofar as this material is concerned.

We would like to further suggest that the strong pressure dependence reported (Ivkin, et al., 1972) for $As_2Te_3 \cdot As_2Se_3$ is an artifact resulting from the larger σ_{dc} of that material and the attendant difficulties in resolving σ_{ac} at (apparently) 300 kHz.

We therefore see no conflict with Pollak and Pike (1972). Higher pressures and a wider temperature range will be required for a real understanding.

REFERENCES

- Bailey, K. E., and Thompson, J. C., 1972, *Mat. Res. Bull.*, 7, 363.
- Cook, R., 1957, *J. Acoust. Soc. Am.*, 29, 445.
- Fritzsche, H., 1972, *Ann. Rev. Mat. Sci.*, 2, 697.
- Gray, D. E., 1963, *American Institute of Physics Handbook* (McGraw-Hill, New York), pp 3-38.
- Ivkin, E. B., Kolomiets, B. T., Raspopova, E. M., and Tsendin, K. D., 1972, *Sov. Phys.-Semicond.*, 5, 1558.
- Pollak, M., and Geballe, T. H., 1961, *Phys. Rev.*, 122, 1742.
- Pollak, M., and Pike, G. E., 1972, *Phys. Rev. Letters*, 28, 1449.
- Vaidya, S. N., and Kennedy, G. C., 1970, *J. Phys. Chem. Solids*, 31, 2329.
- Weir, C. E., and Shartis, L., 1955, *J. Am. Ceram. Soc.*, 38, 299.

Table 1.

Compressibilities κ_T and κ_S for the glasses at 23°C

	κ_T (cm ² /dyne) P in dynes/cm ²	κ_S * (cm ² /dyne)
Te ₁₅ Ge ₃ As ₂	(6.00 ± 0.3) × 10 ⁻¹² - (0.7 ± 1.0) × 10 ⁻²² P	(5.76 ± 0.1) × 10 ⁻¹²
Te ₁₅ Ge ₂ As ₃	(5.58 ± 0.3) × 10 ⁻¹² + (0.3 ± 1.0) × 10 ⁻²² P	(7.11 ± 0.1) × 10 ⁻¹²
As ₂ Se ₃	(6.30 ± 0.3) × 10 ⁻¹² - (0.8 ± 1.0) × 10 ⁻²² P	(7.13 ± 0.1) × 10 ⁻¹²

* At atmospheric pressure

FIGURE CAPTIONS

1. Change in length of the samples under hydrostatic pressure.
2. Adiabatic compressibility of $\text{Te}_{15}\text{Ge}_3\text{As}_2$.
3. Temperature dependence of sample resistance for $\text{Te}_{72}\text{As}_{19}\text{Ge}_9$. Circles - D.C., Squares - 1 MHz., Triangles - 2.15 MHz, Open - 200 PSI, Filled - 30,000 PSI.
4. Frequency dependence of sample conductance for $\text{Te}_{15}\text{As}_3\text{Ge}_2$. 0-3000 PSI, 207K; Δ - 15000, 213 K. Corrections for lead-ins have not been applied to the 4.65 MHz point.

$\Delta I/I_0$ (Arbitrary Units)

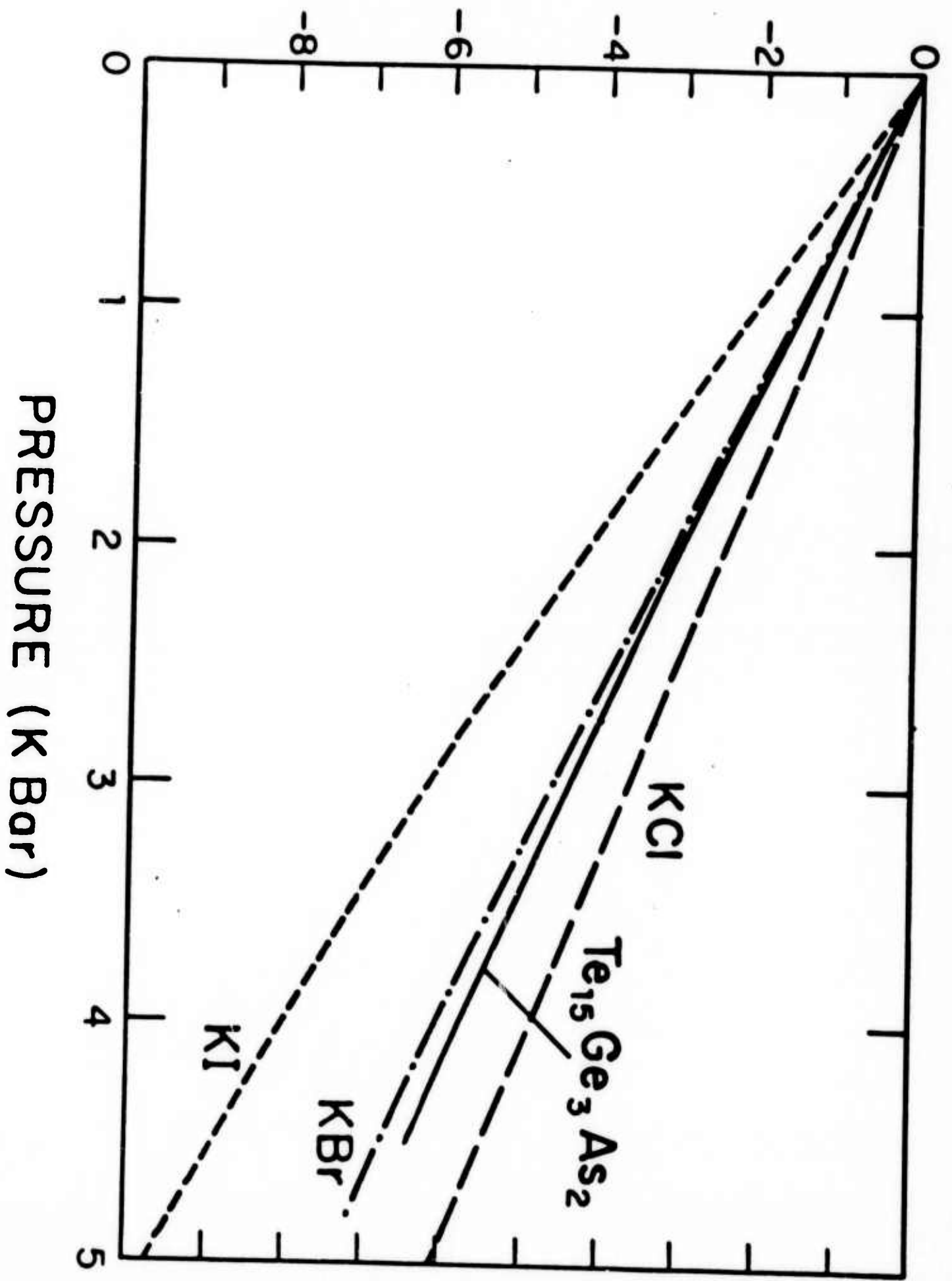

K_s (10^{-12} cm²/dyne)

PRESSURE (K bar)

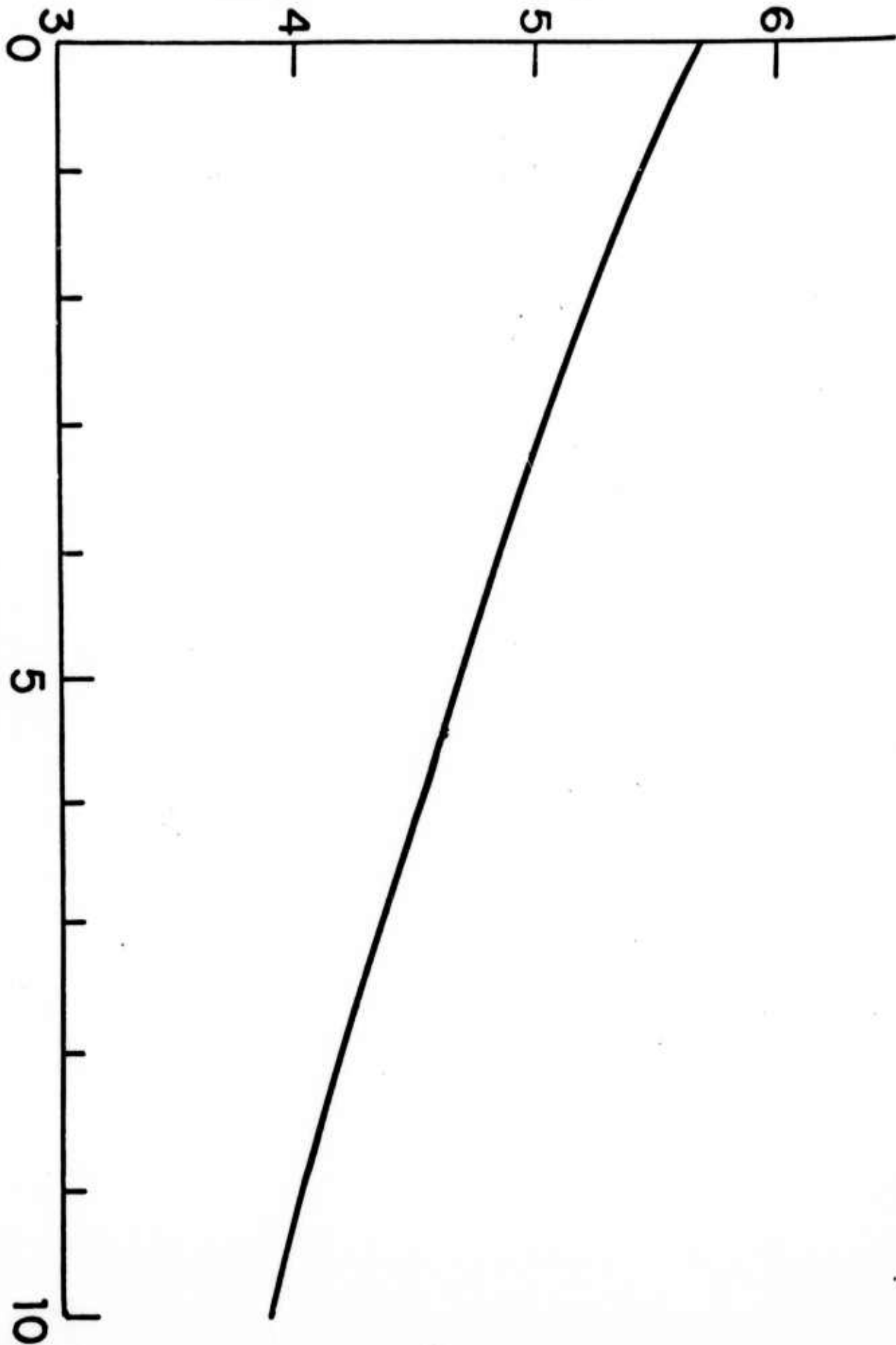

||

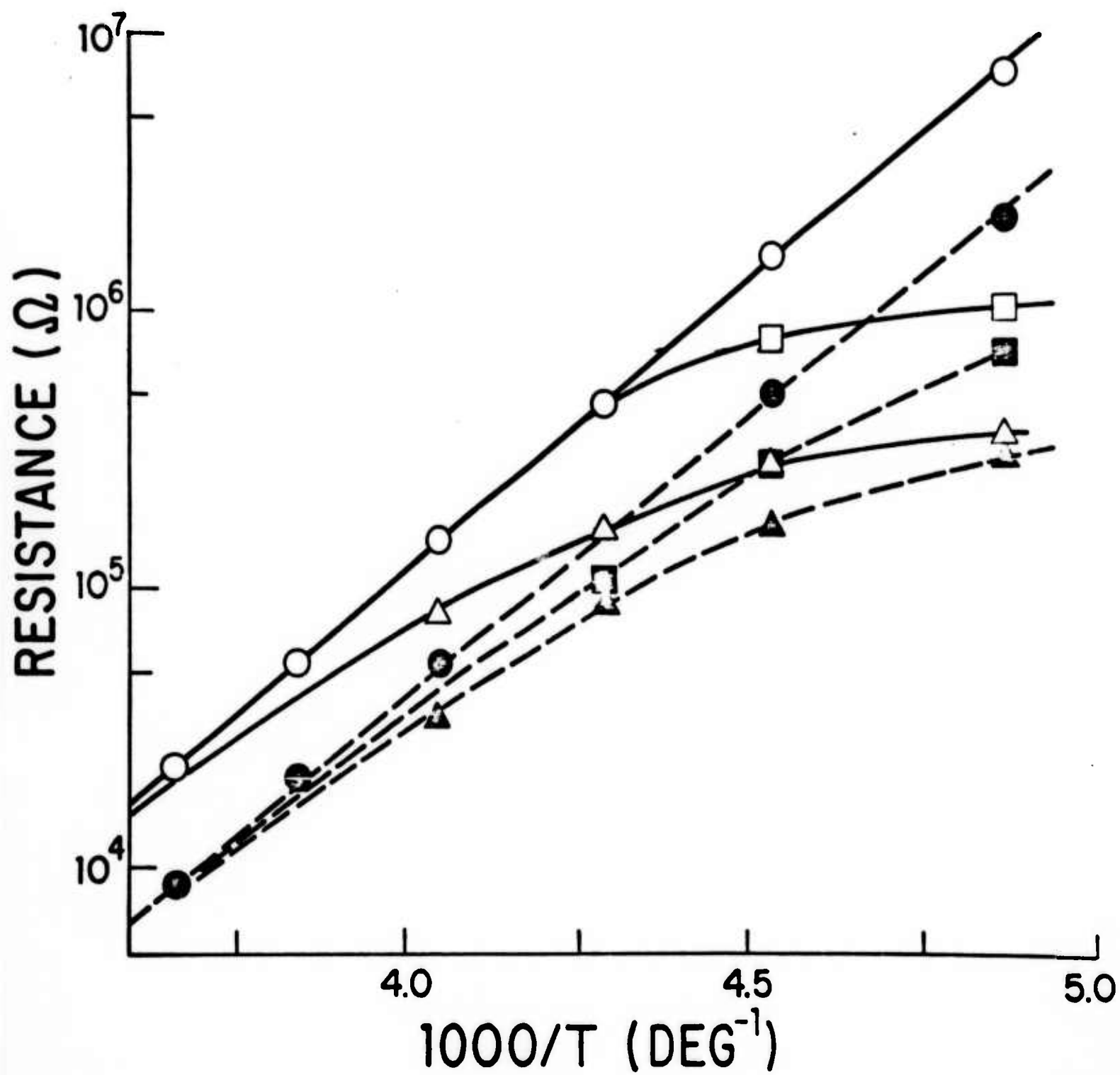

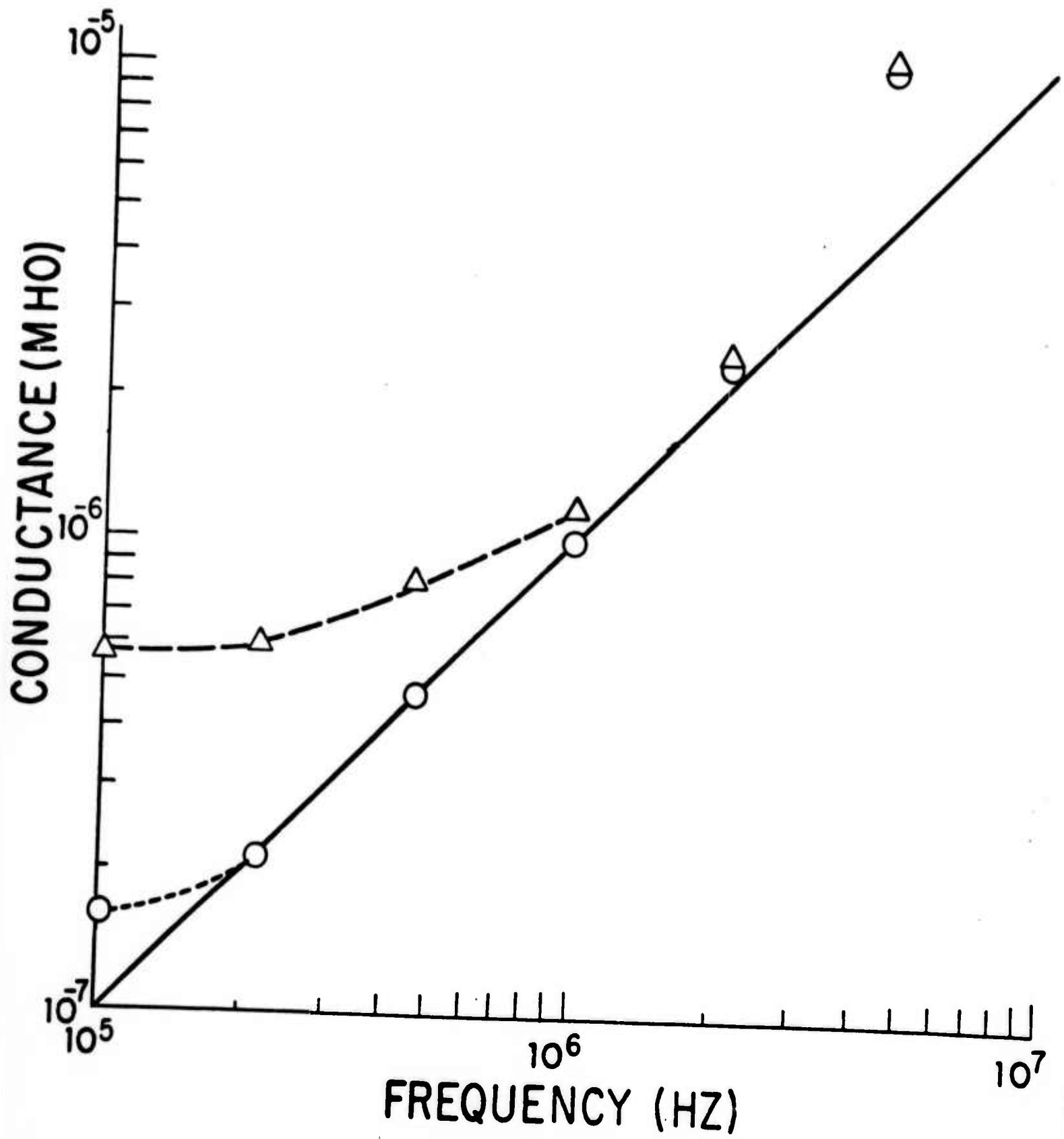

Section II: Measurement Problems with the Wayne Kerr Universal R. F. Bridge B602

In preparation for the Garmisch Conference, we attempted to measure the a.c. conductivity of a sample of $\text{Te}_{72}\text{As}_{19}\text{Ge}_9$. As the raw data had a strong resemblance to a.c. conductivity data on other samples measured by other investigators (i.e. $\sigma \sim \omega^\alpha$ where $\alpha \sim 1$), we made extensive measurements at atmospheric pressure and at other pressures up to 2 kbar.

Upon reduction of the data, it was found that there were large deviations from the expected behavior at the highest frequencies. In trying to understand the reason for the discrepancies, we made measurements on a capacitor which had an impedance very similar to that of our sample. We discovered that the sample's frequency dependence which we had observed in the course of our high pressure measurements was due to phase shifts caused by interaction of the bridge with cables which were used to transmit signals between the bridge and the sample.

In making a.c. bridge measurements, one is interested in obtaining two unknown values, the sample resistance and the sample capacitance or inductance. In order to measure these two unknowns, what is done in effect is to apply a known a.c. voltage to the sample and measure the in-phase current to determine the sample resistance and measure the out-of-phase current to determine the sample capacitance or inductance. If both the real and imaginary impedances are similar in size, small phase shifts are relatively unimportant; however, if one component is several orders of magnitude larger than the other, the large current in the smaller impedance will appear to be partly due to the quadrature impedance if there is a small phase shift, and this spurious effect may even dominate the measurement of the high impedance. This is what appears to have happened in our measurements. In our experiment, the d.c. sample resistance is between two and five orders of magnitude greater than the capacitive reactance. Thus a very small phase shift can cause the error in the indicated sample resistance to dominate the real sample resistance.

There are two possible sources of this error. The cables which are used to carry signals to a remote sample and back to the bridge may introduce a phase shift. If one makes the assumptions that there is a perfect mismatch between cables and sample and if one assumes that the cables are not lossy, there will be no phase shift in the cables, although there will be an amplitude difference between the ends of each cable (this correction has been made). The first assumption above is known to be fairly good; the cable impedance is 17.1 Ω while the minimum

sample impedance is $\sim 3000 \Omega$ and usually much higher. Furthermore, a correction for phase changes due to imperfect reflections at sample-cable interface has been applied to some of the measurements and has been found to be negligible.

The second assumption above, that the cables are not lossy is not as easy to check. According to the manufacturer, the cables should not be lossy at our frequencies; however, they may be. The simplest method of determining phase shifts from any source in the cables appears to be measurements near the bridge and at the ends of the cables to determine the differences. Due to the second possible source of error to be described below, measurements near the bridge as well as those at the ends of the cables must be made with the cables attached to the bridge.

The second possible source of error is phase errors which should be corrected by the so called "three-terminal measurement." In a transformer ratio arm bridge such as the B602, the series resistance of the matching transformers and stray inductances can cause errors if a sample jig or cables shunt the sample leads of the transformers to the neutral side which is used as a shield between voltage and current leads. It is theoretically possible to determine the stray inductances and series resistances of the transformers. To make the three-terminal corrections, it is necessary to know these values. In practice, however, it has been impossible so far to determine these values within a factor of two. We are presently making further measurements to see if we can resolve this difficulty. Even if this does not prove feasible, it should be possible to determine the three-terminal errors due to the shunting effect of the cables by attaching the cables while taking measurements and determining the resulting changes in the observed sample impedance. This may have the disadvantage that it is dependent on the magnitude of the sample impedance.

In addition to the possibility of errors due to loading of the transformers by the cables, it is possible that the sample itself is loading the transformers. This may be possible because we are attempting to use the bridge in a manner in which it was not intended to be used. In order to increase the sensitivity of the bridge to the sample resistance, we have connected the sample to terminals for a range for which the sample has too low a capacitive reactance. To balance the bridge in this mode of operation, we have connected a capacitor to the standards side of the bridge to cancel the excess out-of-phase signals. The result may be that the

large out-of-phase currents may be saturating the transformers and thus causing a spurious reading. If this is in fact happening, it may be observable by varying the applied voltage and looking for shifts in the indicated impedances. We still need to make this check.

III.

We have set up a procedure whereby a cheap, permanent record of the acoustic pulses used in sound speed measurements may be easily obtained. The 10 MHz signal is reduced by sampling techniques to a 10Hz signal which is then recorded on a strip chart recorder. Time measurements are derived from a time mark generator and superposed on the paper chart. Pulse shape, echo delays, etc. may then be taken from the chart at leisure and are subject to inspection if questions arise. These records do not improve on photographic records but are somewhat easier to handle.

The technique is illustrated in Fig. III-1 where the lower sawtooth is the oscilloscope sweep and the upper is the signal to be studied. The central trace is obtained as shown by the sampling device and provides an 8:1 expansion in the sketch. Figure III-2 is a simplified block diagram, with time reference generator omitted.

The third figure shows two traces with the timing pulses and acoustic echos superposed. Simple measurements of the position of one cycle within a pulse with respect to a nearby time pulse are required to obtain the time interval between pulses and, therefrom, the sound speed.

This procedure will be employed in pressure studies on compressibility.

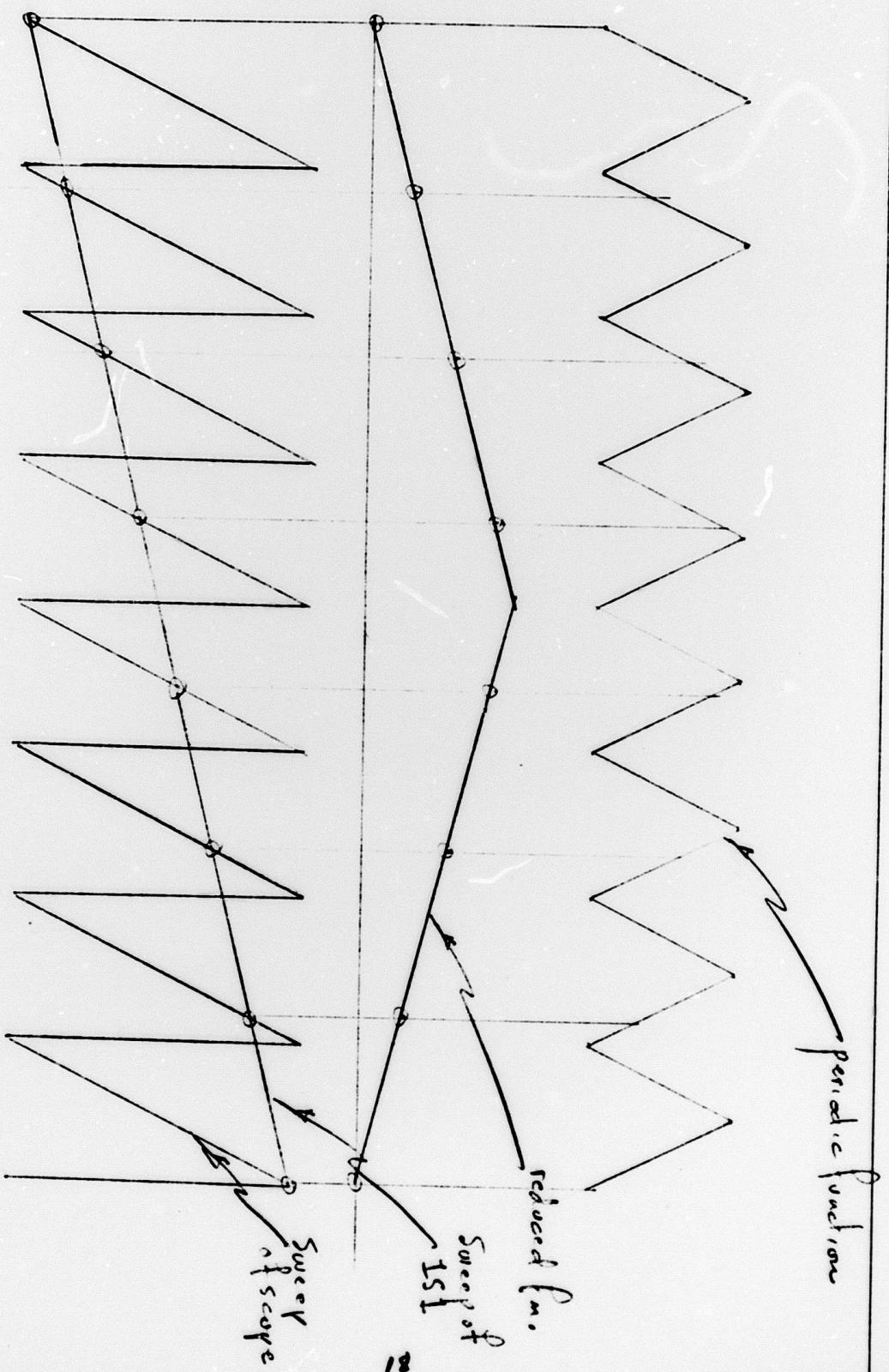

III-1 How Sampling is accomplished.

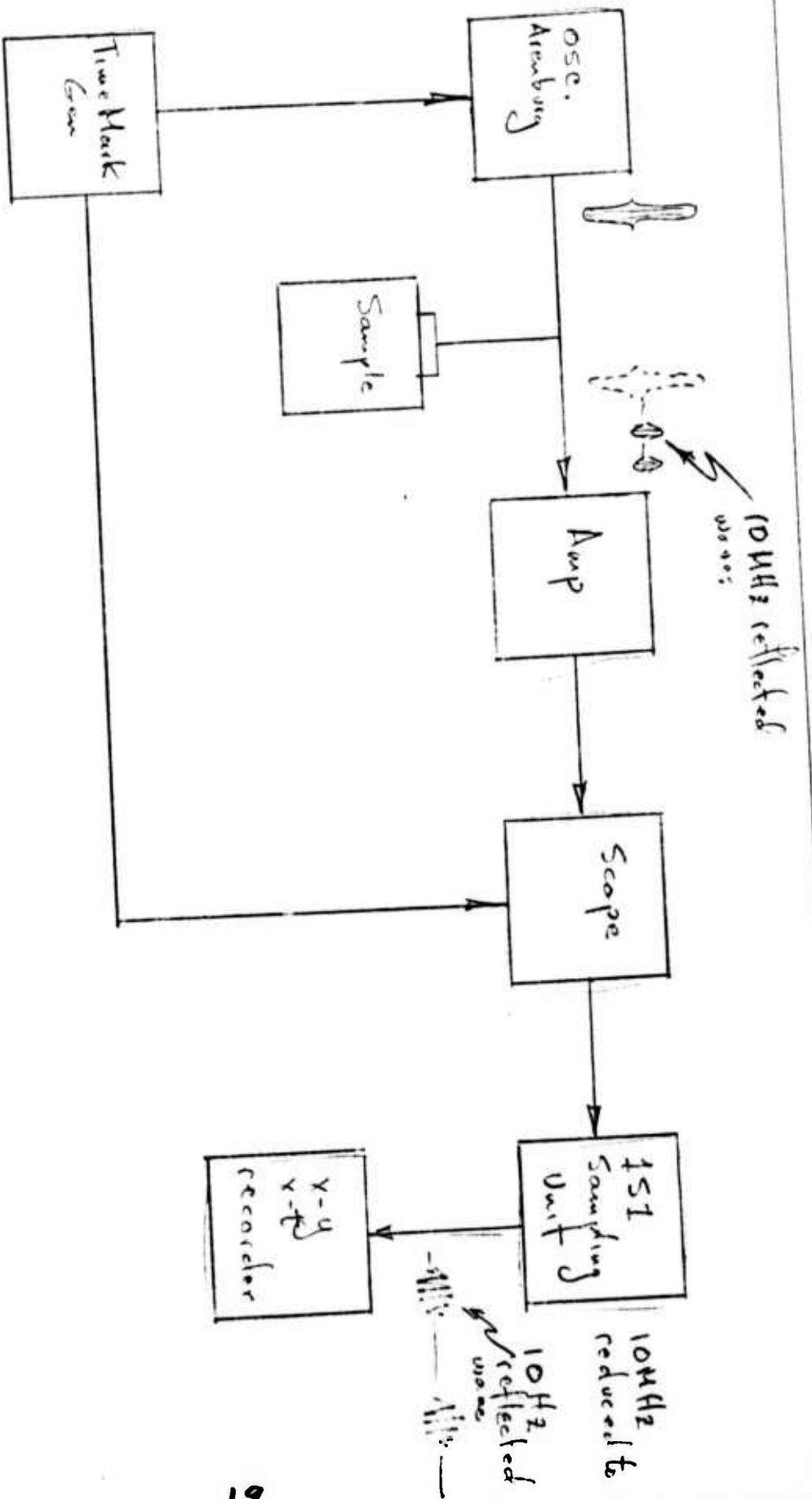

III-2

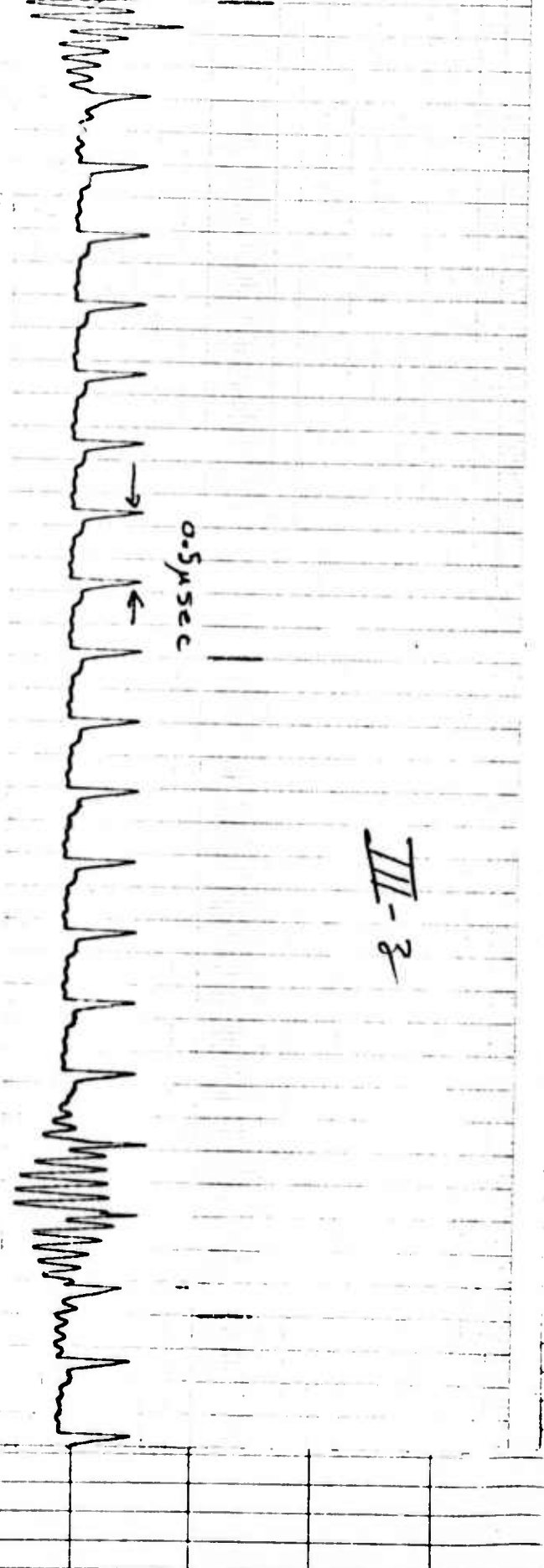
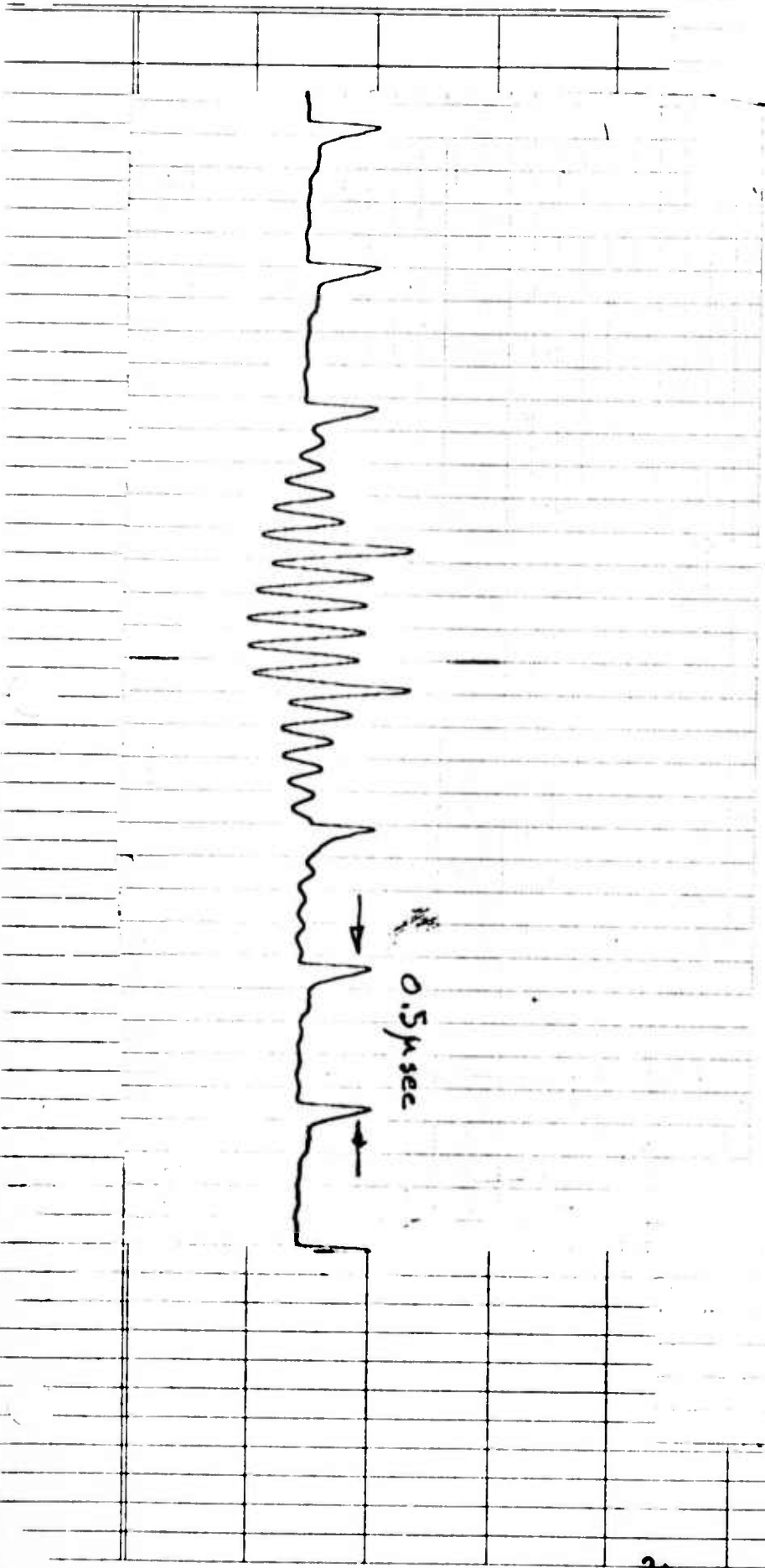

Personnel

K. E. Bailey-----research scientist assistant
P. L. Thomas-----secretary
B. A. Joiner-----research scientist assistant
P. L. Sherrell-----NDEA Title IV Fellow
J. C. Thompson-----principal investigator