

AD-773 024

ANALYSIS OF CRITERIA FOR ON-CONDITION
MAINTENANCE FOR HELICOPTER TRANSMISSIONS

J. J. Dougherty, III, et al

Boeing Vertol Company

Prepared for:

Army Air Mobility Research and Development
Laboratory

September 1973

DISTRIBUTED BY:

NTIS

National Technical Information Service
U. S. DEPARTMENT OF COMMERCE
5285 Port Royal Road, Springfield Va. 22151

DISCLAIMERS

The findings in this report are not to be construed as an official Department of the Army position unless so designated by other authorized documents.

When Government drawings, specifications, or other data are used for any purpose other than in connection with a definitely related Government procurement operation, the United States Government thereby incurs no responsibility nor any obligation whatsoever; and the fact that the Government may have formulated, furnished, or in any way supplied the said drawings, specifications, or other data is not to be regarded by implication or otherwise as in any manner licensing the holder or any other person or corporation, or conveying any rights or permission, to manufacture, use, or sell any patented invention that may in any way be related thereto.

Trade names cited in this report do not constitute an official endorsement or approval of the use of such commercial hardware or software.

DISPOSITION INSTRUCTIONS

Destroy this report when no longer needed. Do not return it to the originator.

ie

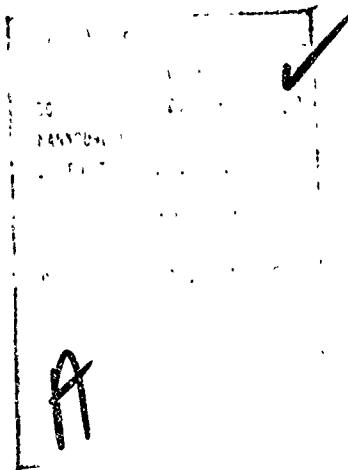

~~UNCLASSIFIED~~
Security Classification

AD 773024

DOCUMENT CONTROL DATA - R & D		
<i>(Security classification of title, body of abstract and indexing annotation must be entered when the overall report is classified)</i>		
1. ORIGINATING ACTIVITY (Corporate author) Boeing Vertol Company (A Division of The Boeing Company) P.O. Box 16858 Philadelphia, Pa.		2a. REPORT SECURITY CLASSIFICATION UNCLASSIFIED
3. REPORT TITLE ANALYSIS OF CRITERIA FOR ON-CONDITION MAINTENANCE FOR HELICOPTER TRANSMISSIONS		2b. GROUP
4. DESCRIPTIVE NOTES (Type of report and inclusive dates) Final Report		
5. AUTHOR(S) (First name, middle initial, last name) J. J. Dougherty III S. J. Blewitt		
6. REPORT DATE September 1973	7a. TOTAL NO. OF PAGES 280	7b. NO. OF REFS 16
8a. CONTRACT OR GRANT NO. DAAJ02-72-C-0068	9a. ORIGINATOR'S REPORT NUMBER(S) USAAMRDL Technical Report 73-58	
b. PROJECT NO. 1F162205A11902	9b. OTHER REPORT NO(S) (Any other numbers that may be assigned this report) D210-10593-1	
10. DISTRIBUTION STATEMENT Approved for public release; distribution unlimited.		
11. SUPPLEMENTARY NOTES		12. SPONSORING MILITARY ACTIVITY
13. ABSTRACT This report presents the results of a study which develops a rational approach for evaluating the potential of a helicopter transmission for on-condition operation. Integral to this study is the presentation of the mathematical relationship between component operating time and component hazard rate. It is postulated that the component hazard function is the crux of an on-condition analysis. Various methods of determining hazard functions were evaluated, and a conclusion is presented defining the most powerful of these techniques. An evaluation of the impact of on-condition transmission operation upon reliability, safety, availability, maintainability, mission reliability, and cost was developed. Detailed analysis of transmission test and overhaul data was performed to evaluate the hazard functions of various transmission elemental failure modes. The result of this analysis provides a baseline for determination of the areas most significant to on-condition transmission operation. The conclusions of the study present the criteria for evaluating the potential of a newly designed or existing helicopter transmission for on-condition operation.		

DD FORM 1473
1 NOV 65

REPLACES DD FORM 1473, 1 JAN 60, WHICH IS OBSOLETE FOR ARMY USE.

UNCLASSIFIED
Security Classification

NATIONAL TECHNICAL
INFORMATION SERVICE

ia

14. KEY WORDS	LINK A		LINK B		LINK C	
	ROLE	WT	ROLE	WT	ROLE	WT
on-condition hazard rate hazard function reliability safety availability maintainability mission reliability						

ib



DEPARTMENT OF THE ARMY
U. S. ARMY AIR MOBILITY RESEARCH & DEVELOPMENT LABORATORY
EUSTIS DIRECTORATE
FORT EUSTIS, VIRGINIA 23604

This report was prepared by the Boeing Vertol Company under the terms of Contract DAAJ02-72-C-0068. It consists of a discussion of the criteria and procedures necessary to achieve an on-condition maintenance support concept (operating without scheduled overhauls) for future helicopter drive system gearboxes. Achievement of on-condition maintenance has long been recognized as offering significant life-cycle cost savings over the use of the "time-between-overhaul" (TBO) approach imposed on current helicopters.

This Directorate concurs with the contractor's position that on-condition maintenance for future gearboxes is readily achievable with currently available design and diagnostic techniques. The contractor has convincingly shown that most safety-related failure modes can be "designed-out" or treated such that their frequency of occurrence is so low that they remain statistically insignificant even if they have an increasing hazard function. Additionally, the contractor's position that on-condition maintenance is achievable with certain current gearboxes and related diagnostic devices appears to be well founded and should be seriously considered by appropriate helicopter project managers.

The discussion of diagnostics in this report was limited to the on-condition issue and should not be construed as a complete analysis of Army helicopter diagnostic requirements. Maintenance troubleshooting, false removals, and maximizing component useful life were not considered in this analysis, but they should be considered in the final selection of a diagnostic system.

The analytical techniques developed in this report for estimating Weibull distribution parameters are considered to be excellent and offer a highly responsive approach for supporting acceptance or rejection of gearbox on-condition maintenance early in an equipment operational phase.

The Project Engineers for this effort were Messrs. Victor W. Welner and Thomas L. House, Military Operations Technology Division.

Task 1F162205A11902
Contract DAAJ02-72-C-0068
USAAMRDL Technical Report 73-58
September 1973

ANALYSIS OF CRITERIA FOR ON-CONDITION
MAINTENANCE FOR HELICOPTER TRANSMISSIONS

Final Report

Boeing Document D210-10593-1

By
J. J. Dougherty III
S. J. Blewitt

Prepared by

Boeing Vertol Company
(A Division of The Boeing Company)
Philadelphia, Pennsylvania

for

EUSTIS DIRECTORATE
U.S. ARMY AIR MOBILITY RESEARCH AND DEVELOPMENT LABORATORY
FORT EUSTIS, VIRGINIA

Approved for public release;
distribution unlimited.

SUMMARY

This report presents the results of a study which develops a rational approach for evaluating the potential of a helicopter transmission for on-condition operation. Integral to this study is the presentation of the mathematical relationship between component operating time and component hazard rate. Hazard rate is the value that a component hazard function assumes at a given time, t . Hazard function is the mathematical model which relates a conditional instantaneous failure rate to component operating time. It is postulated that the component hazard function is the crux of an on-condition analysis and therefore requires rigorous definition and quantification. Various methods of determining hazard functions were evaluated, and a conclusion is presented defining the most powerful of these techniques.

An evaluation of the impact of on-condition transmission operation upon reliability, safety, availability, maintainability, mission reliability, and cost was developed.

Detailed analysis of transmission test and overhaul data was performed to evaluate the hazard functions of various transmission elemental failure modes. The result of this analysis provides a baseline for determination of the areas most significant to on-condition transmission operation. A further objective of this analysis was the identification of those transmission elements (components/parts) requiring appropriate design changes, failure warning and inspection criteria, or test approaches, and the development of criteria for application to future designs.

The conclusions of the study present the criteria for evaluating the potential of a newly designed or existing helicopter transmission for on-condition operation.

FOREWORD

This report covers a study to analyze the criteria necessary to evaluate the potential for on-condition maintenance of helicopter transmissions, conducted under Contract DAAJ02-72-C-0068, Task 1F162205A11902, for the Eustis Directorate, U.S. Army Air Mobility Research and Development Laboratory (USAAMRDL), Fort Eustis, Virginia.

USAAMRDL technical direction was provided by Mr. V. Welner and Mr. T. House.

The principal investigator for The Boeing Vertol Company was Mr. J. J. Dougherty III of Product Assurance Methodology, who was assisted by Messrs. S. J. Blewitt of the same department, D. B. Board of R&M Engineering, and personnel from Advanced Drive Systems Technology. Program management and technical direction were provided by Mr. G. W. Windolph, Director, Product Assurance and GSE Department, and Mr. R. B. Aronson, Unit Chief, Product Assurance Methodology.

TABLE OF CONTENTS

	<u>Page</u>
SUMMARY	iii
FOREWORD	v
LIST OF ILLUSTRATIONS	ix
LIST OF TABLES	xiv
LIST OF SYMBOLS	xvii
INTRODUCTION	1
THE CONCEPT OF ON-CONDITION OPERATION	4
INTRODUCTION	4
TIME BETWEEN OVERHAULS (TBO)	4
THE BATHTUB CURVE	4
Infant Mortality	5
Constant Failure Rate	7
Wearout	7
HAZARD FUNCTION	7
WEIBULL DISTRIBUTION	8
ON-CONDITION MAINTENANCE	11
MTBUR, MTBR	13
RELATION OF ON-CONDITION OPERATION TO RELIABILITY, SAFETY, MAINTAINABILITY, AVAILABILITY, AND COST	16
INTRODUCTION	16
SUMMARY	16
RELIABILITY	17
SAFETY	20
MAINTENANCE BURDEN	20
AVAILABILITY	22
COST	23
HAZARD FUNCTION VARIATIONS	26
RELATION OF HAZARD FUNCTION TO ON-CONDITION/TBO	26
SUMMARY OF CRITERIA AND CONSIDERATIONS	31
INTRODUCTION	31
SUMMARY	31
FAILURE MODE EFFECTS AND CRITICALITY ANALYSIS (FMECA)	33
DEVELOPMENT OF MODAL AND ASSEMBLY HAZARD FUNCTIONS	33

	<u>Page</u>
New Design	33
Existing Design	34
PERFORMANCE OF SAFETY EVALUATION	34
DEVELOPMENT OF LIMITING COST-EFFECTIVENESS HAZARD FUNCTION	35
DETERMINATION OF THE OPTIMUM COST-EFFECTIVENESS TBO OR SUBSTANTIATION OF ON-CONDITION POTENTIAL FROM THE COST-EFFECTIVENESS HAZARD FUNCTION	35
IMPACT OF REDESIGN, TESTING, OR FAILURE WARNING AND INSPECTION SYSTEM	36
SUBSTANTIATION OF ON-CONDITION OR ESTABLISHMENT OF TBO	39
CONCLUSIONS AND RECOMMENDATIONS	40
LITERATURE CITED	41
APPENDIXES	
I. DEVELOPMENT OF LIMITING COST-EFFECTIVENESS HAZARD FUNCTION	43
II. DESIGN-RELATED CRITERIA	73
III. FAILURE WARNING AND INSPECTION CRITERIA FOR ON-CONDITION TRANSMISSIONS	130
IV. TESTING-RELATED CRITERIA	196
V. METHODS OF EVALUATING FAILURE DATA	206
VI. SAMPLE FAILURE MODE EFFECTS AND CRITICALITY ANALYSES	226
VII. DEVELOPMENT OF MATHEMATICAL MODELS	238
VIII. DATA REDUCTION	244
IX. DEVELOPMENT OF ELEMENTAL HAZARD FUNCTIONS	256
DISTRIBUTION	264

LIST OF ILLUSTRATIONS

<u>Figure</u>		<u>Page</u>
1	CH-47A Direct Maintenance Cost Including Field and Depot Labor and Material	2
2	Flow Chart for Analysis of Criteria for On-Condition Maintenance of Helicopter Transmissions	3
3	The Bathtub Curve	6
4	Representative Hazard Functions of a Helicopter Transmission	9
5	Form for Presentation of Weibull Distribution	12
6	Summary of On-Condition Concepts	15
7	Effect of TBO on Reliability	19
8	Effect of TBO on Total Removals	21
9	Relationship of TBO to MTBF for a Decreasing Hazard Function	27
10	Hazard Functions Possible for Most Transmissions	28
11	Effect of TBO on Hazard Rate	30
12	Method of Evaluating On-Condition Capability	32
13	Relationship of Cost to β' and θ'	48
14	Equal Cost Indifference Curve	49
15	Limiting Cost Hazard Function	51
16	Relationship of Maintenance Man-Hours to β' and θ'	53
17	Equal MMH Indifference Curve	54
18	Limiting MMH Hazard Function	55
19	Relationship of Mission Reliability to β' and θ'	58

<u>Figure</u>		<u>Page</u>
20	Relationship of Availability to β' and θ'	60
21	On-Condition Safety Evaluation	62
22	Relationship of Cost-Effectiveness to β' and θ'	66
23	Equal Cost-Effectiveness Indifference Curve	67
24	Limiting Cost-Effectiveness Hazard Function	68
25	Comparison of the Effect of MTBF Upon Inherent Availability and Mission Reliability	70
26	High-Contact-Ratio Gears	77
27	Typical Turboshaft Engine Transmission	79
28	Modified Turboshaft Engine Transmission Tapered Roller Design	80
29	Split-Power Transmission	83
30	Basic Construction of a Cyclo-Drive Transmission	85
31	Model of the Nutating (Maroth) Drive Principle (Reduction Ratio 20:1)	86
32	CH-47C Aft Transmission Cross Section	88
33	Aft Transmission With Integral Vertical Shaft	89
34	Modularized Transmission With Integral Module Lubrication	90
35	Modularized Transmission With Multi-Module Lubrication	91
36	Distribution of CH-47 Failures per Trans- mission Removal (Showing Percentage of Removals Containing Only One Failure)	95
37	Comparison of Vacuum-Melted and Air-Melted Steels of Same Composition and Hardness	102
38	Comparison of Log-Normal and Weibull Distributions	106

<u>Figure</u>		<u>Page</u>
39	Dry Lube Bearing Life Criteria	110
40	Backup Lube System	111
41	Flow-Monitoring Jets	113
42	CH-47 Forward Transmission Redundant Single Bearing Gear/Sun Gear (Full Scale)	114
43	CH-47C Redundant Ring Gear Design	115
44	Photo of Restrictor Installed on Sun Gear	118
45	Photo of Simulated Completely Failed Planet Carrier	119
46	Transmission Component Restrictor	120
47	Weibull Plot of 1140S240 Bearing Failures	123
48	Failure Rate Versus B_{10} Life	125
49	Relationship of Mission-Affecting and Safety- of-Flight Mode Versus Failure Warning Requirements	136
50	Failure Warning and Inspection System Criteria Decision Flow Chart	138
51	On-Aircraft Maintenance Burden	144
52	Transmission Debris-Monitoring Device	161
53	Particle Detector Circuitry	162
54	Point-Sensitive Level Indicator	187
55	Continuous Readout Level Indicator	187
56	Clutch Slip Monitoring	192
57	Sample Signal-Conditioning and Fault Statements	193
58	Sample Signal Flow Analysis	195
59	Failure Progression Rate for a CH-47 Input Finion Roller Bearing	199

<u>Figure</u>		<u>Page</u>
60	Effect of Power on Transmission Elemental Failure Rates	203
61	Bell Method for Evaluation of Constant Failure Rate	208
62	Sikorsky Method for Evaluation of Constant Failure Rate	209
63	Massey Ferguson Weibull Plot on Standard Weibull Paper	210
64	Boeing Vertol Weibull Plot on Modified Weibull Paper	212
65	Probable Error of β as a Function of Number of Failures	214
66	Ninety Percent Error of β as a Function of Number of Failures	215
67	Flow Chart of Mathematical Model of Component Fleet Operation	217
68	Sample Output From Component Fleet Operation Model	219
69	Observed β Versus Operating Time for a True β of 1.0	220
70	Observed β versus Number of Failures for a True β of 1.0	221
71	Block Diagram of Doubly Redundant Berteau Swashplate Driver Actuator, Part No. 228850	227
72	Hazard Function Plots for Transmission Bearings	257
73	Hazard Function Plots for Transmission Gears	258
74	Hazard Function Plots for Transmission Lubrication Systems	259
75	Hazard Function Plots for Transmission Retention and Mounting Hardware	260
76	Hazard Function Plots for Transmission Nonrotating Structures	261

<u>Figure</u>		<u>Page</u>
77	Hazard Function Plots for Transmission Shafting	262
78	Hazard Function Plots for Transmission Clutches	263

LIST OF TABLES

<u>Table</u>		<u>Page</u>
I	Effect of Eliminating TBO Upon Reliability, Safety, Maintainability, Availability, and Cost	17
II	Cost for Various Values of β' and θ' Encountered by Removing TBO	47
III	Simulation Results for $\beta'=2$, $\theta'=2,500$	71
IV	Simulated Costs for Various Cost Ratios	72
V	Comparative Design Study of Ball/Roller Bearing Versus Tapered Roller Bearing	81
VI	CH-47 Transmission Life-Limited Parts	96
VII	Failure Modes Analysis - Bevel Gear	116
VIII	On-Condition Design Considerations	122
IX	Failure Warning and Inspection Sensor Package Parameters and Considerations (Criteria)	148
X	Relative Weighting Guideline Values	151
XI	Nature of Indication Parameter	153
XII	Detection Capability Parameter	153
XIII	Sensor Suitability Parameter	154
XIV	Associated Hardware Parameter	155
XV	Sensor Suitability and Associated Hardware Parameters (Constant Considerations)	156
XVI	Gear Failure Terms/Types/Degrees	157
XVII	NSIA Sensor Tradeoff, Summary Score Chart; Component Class, Gearing	165
XVIII	NSIA Tradeoff for Alternate Failure Warning and Inspection of Gear Tooth Fracture and Breakage	166

<u>Table</u>	<u>Page</u>
XIX Gearing Chip Detector Failure Warning and Inspection for Tooth Fracture and Breakage - NSIA Tradeoff Data Sheet	167
XX Gearing Shock Detector Failure Warning and Inspection for Tooth Fracture and Breakage - NSIA Tradeoff Data Sheet	168
XXI Gearing In-Line Oil Debris Monitor Failure Warning and Inspection for Tooth Fracture and Breakage - NSIA Tradeoff Data Sheet . . .	169
XXII Gearing Transmission Monitoring Device Failure Warning and Inspection for Tooth Fracture and Breakage - NSIA Tradeoff Data Sheet	170
XXIII Failure Warning and Inspection Technique Evaluation Matirx; Component Class: Gearing	171
XXIV NSIA Sensor Tradeoff, Summary Score Chart; Component Class: Bearings	172
XXV NSIA Tradeoff for Alternative Failure Warning and Inspection of Bearing Abnormal Wear	173
XXVI Bearing Chip Detector Failure Warning and Inspection for Abnormal Wear - NSIA Tradeoff Data Sheet	174
XXVII Bearing Shock Detector Failure Warning and Inspection for Abnormal Wear - NSIA Tradeoff Data Sheet	175
(XVIII) Bearing In-Line Oil Monitor Failure Warning and Inspection for Abnormal Wear - NSIA Tradeoff Data Sheet	176
XXIX Bearing Radioactive Tracer Failure Warning and Inspection for Abnormal Wear - NSIA Tradeoff Data Sheet	177
XXX Abnormal Wear Failure Mode With Thermo-couples Alternative (Component Class Bearings) - NSIA Tradeoff Data Sheet	178
XXXI Abnormal Wear Failure Mode with Advanced XMD Alternative (Component Class Bearings) - NSIA Tradeoff Data Sheet	179

<u>Table</u>	<u>Page</u>
XXXII Failure Warning and Inspection Technique Evaluation Matrix, Component Class - Bearings	180
XXXIII Sliding and Rolling Element Bearing Failure - Terms, Types and Degrees	181
XXXIV Lube System Failure Modes and Failure Warning and Inspection Techniques	185
XXXV Back-to-Back Test Stand Results	201
XXXVI Failure Mode Effects Analysis	229
XXXVII Criticality Analysis	236
XXXVIII Generic Failure Mode Distribution	248
XXXIX Failure Mode Distribution by Component Class	249
XL CH-47 Failure Mode Distribution by Component Class	250
XLI CH-47 Failure Distribution by Component Class and Transmission Type	253
XLII CH-46 Failure Mode Distribution by Component Class	254
XLIII Limits on β for Various Failure Modes on CH-47C Transmissions	255

LIST OF SYMBOLS

A_a	achieved availability
A_i	inherent availability
A_o	operational availability
B_{10}	10th percentile probability of failure point (generally employed with Weibull distributed components)
FMECA	failure mode effect and criticality analyses
$F(t)$	cumulative distribution function
$f(t)$	probability density function
HCR	high contact ratio
$H(t)$	hazard function
$LCC_{O.C.}$	nondimensional life-cycle cost when operated on condition
LCC_{TBO}	nondimensional life-cycle cost when operated with a certain TBO
MDT	mean down time
MMH	maintenance man-hours
MMH/FH	maintenance man-hours/flight hour
MOE	measure of effectiveness
MTBF	mean time between failures
MTBR	mean time between removals
MTBUR	mean time between unscheduled removals
MTR	mean time to repair
NORM	not operationally ready - maintenance
NORS	not operationally ready - supply
$R(t)$	reliability function
$\bar{R}(t)$	unreliability function

SOF	safety-of-flight
TBO	time between overhauls
β	Weibull shape parameter
β'	Weibull shape parameter modified after TBO
θ	Weibull scale parameter
θ'	Weibull scale parameter modified after TBO
λ MAINTENANCE	maintenance malfunction rate
λ MISSION ABORT	mission affection malfunction rate

INTRODUCTION

Historically, high levels of helicopter transmission mean time between removals (MTBR) have not been achieved until the aircraft have been far into the operational portions of their life cycles. Even then, MTBR levels have been artificially limited by established time-between-overhaul (TBO) intervals. Furthermore, scheduled overhaul of transmissions contributes a significant amount to the total operating cost of helicopters, as shown in Figure 1.

A recent Boeing-Vertol study, CAPABILITY OF CH-47C FORWARD, AFT, AND COMBINING GEARBOXES FOR ON-CONDITION OPERATION¹, and the related paper, A CRITERION FOR ON-CONDITION TRANSMISSIONS AND ITS APPLICATION TO THE CH-47C², indicate that the capability for transmission on-condition operation is currently achievable. Furthermore, it has been established that analysis of field and test experience can be used to substantiate this capability. If transmissions lack true on-condition capability, the same analysis of test and field data can determine the correct TBO from a system effectiveness and cost viewpoint.

Criteria and analytical methods for evaluation of product compliance with an on-condition objective must be established so that the life-cycle cost and effectiveness benefits of extended MTBR's can be achieved. To fulfill this requirement, Boeing-Vertol has developed and documented in this report the following:

- o Rigorous detailed methodology for examining test and field data from operational components to determine or to establish appropriate TBO levels or the capability for on-condition operation.
- o Design and test criteria which permit determination of the TBO or on-condition capability of components early in the system life cycle.

This was accomplished by performing the tasks described in the flow chart in Figure 2.

The result of this study is that a rigorous, clear method of identifying the capability of a helicopter transmission for on-condition operation has been established and is available for use where none existed previously. This method gives the user a means for evaluating the potential for discontinuing costly scheduled overhauls without sacrificing safety and effectiveness, or establishing the TBO interval at a level where it will be most effective.

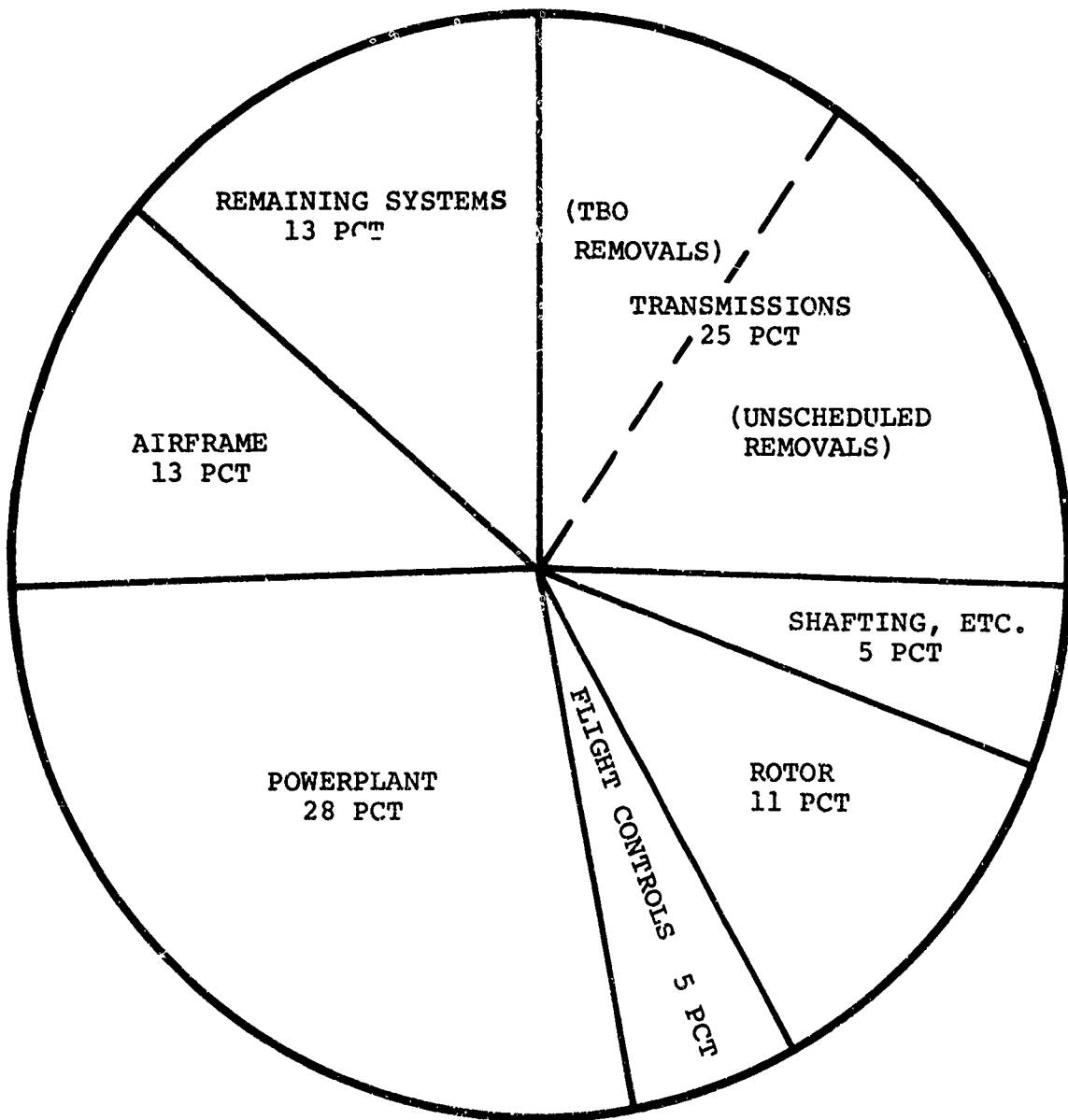

Figure 1. CH-47A Direct Maintenance Cost Including Field and Depot Labor and Material.

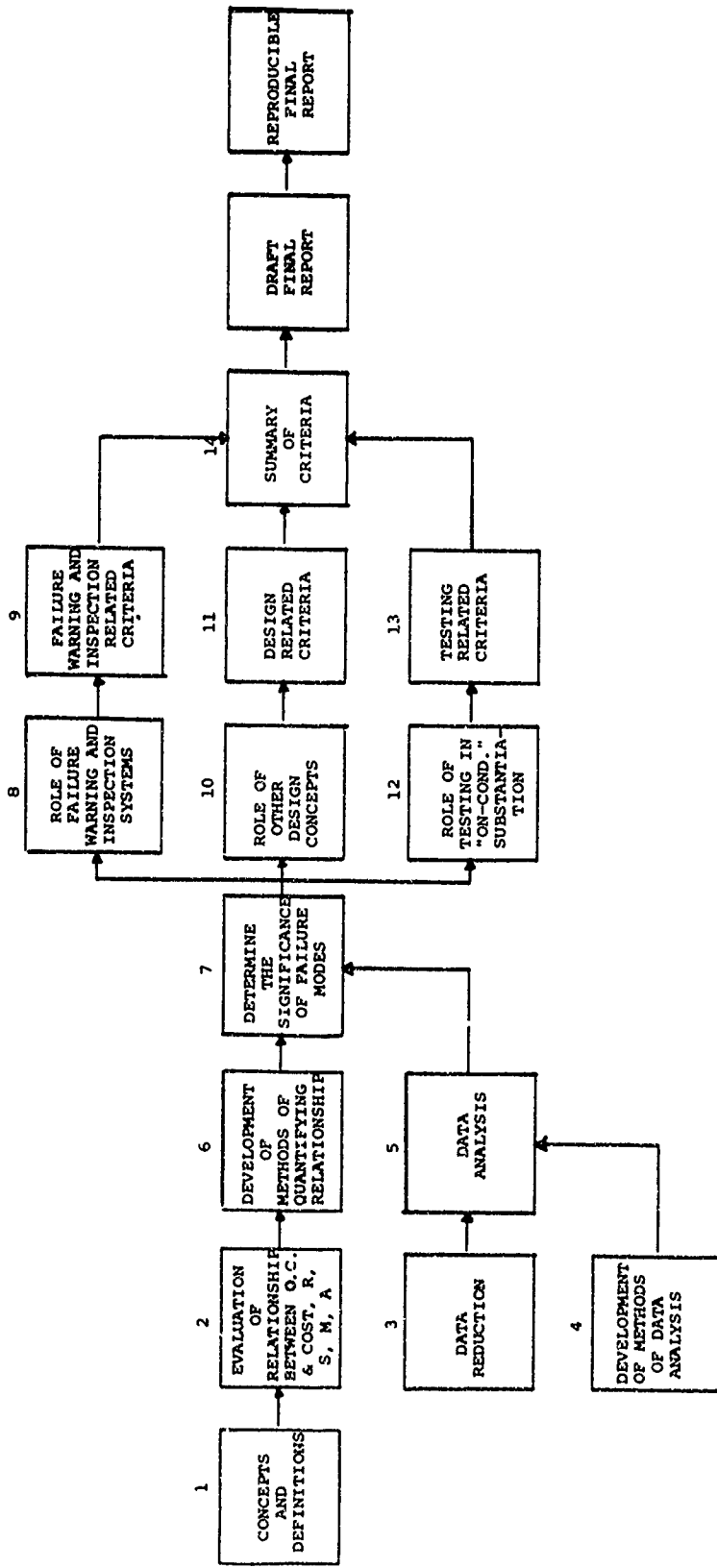

Figure 2. Flow Chart for Analysis of Criteria for On-Condition Maintenance of Helicopter Transmissions.

THE CONCEPT OF ON-CONDITION OPERATION

INTRODUCTION

Essential to any rigorous discussion of on-condition maintenance is the definition and understanding of certain basic terms, some of which may appear to the reader to be self-explanatory. Over the years, some of these terms have been used improperly and the meanings have become distorted. Therefore, to avoid confusion, this first section will rigorously define terms for subsequent use in the study.

TIME BETWEEN OVERHAULS (TBO)

Time between overhauls (TBO) is a scheduled operating period after which an item is mandatorily overhauled. The key word in this definition is scheduled. It is a numerical value, typically hours of operation, established by a manufacturer of hardware or hardware user to limit the duration of usage of a particular part. The important point to remember is that the figure is an established one, derived for various reasons which will be discussed. TBO is not the average time on components which have been overhauled; that is, it is not the total number of hours on overhauled parts divided by the number of parts overhauled.

At the time of scheduled overhaul of a TBO item, various components of the item are replaced, the life limits of which have been reached or will be reached before the next scheduled overhaul. For example, a transmission scheduled to be overhauled after 1,200 hours of operation will have all components replaced whose individual life limits are 1,200 hours, plus those whose life limits are between 1,200 hours and 2,400 hours, the next scheduled time of overhaul. Additionally, upon inspection, any components exhibiting a condition which could result in performance degradation are replaced. After scheduled overhaul the component is considered to possess the same capabilities and performance characteristics which it possessed when new.

The purposes and objectives of a TBO include: reduction of total overhaul costs, attainment of high aircraft availability by maintenance scheduling, and detection of unanticipated and otherwise undetectable failure modes. The validity of these objectives will be examined in detail in this study.

THE BATHTUB CURVE

Integral to any discussion of TBO is a graphic illustration

known to reliability students as the bathtub curve. As shown in Figure 3, this curve depicts one of the assumptions implied by advocates of a TBO; that is, at some future time in the life of a component the undesirable occurrence of an increasing rate of failure will take place.

The bathtub curve in reality is composed of three curves, representing three stages which might be expected to occur in the life time of a part. S. R. Calabro states the following:

"In general, a device goes through three separate and distinct stages. The first is called a break-in or infant stage, during which the equipment is characterized by a relatively high failure rate. The second is called the operating stage, during which we experience a constant failure rate. This is also called the stable or operating period. The third stage is called the wear-out phase, which is the time when the frequency of failure, or the failure rate, increases rapidly. When this happens it is an indication that the equipment has aged or become worn."³

Infant Mortality

There are several reasons for a high rate of failure in the early stage of a part life cycle. Many early failures result from poor manufacturing techniques during the production process and the subsequent appearance of those substandard parts which were missed by the quality control program. If a certain sampling inspection program produces results such that 98 percent of all parts manufactured are up to standards, then it is known that on the average 2 of every 100 parts will be defective. The infant mortality portion of the bathtub curve illustrates the failure and replacement of these parts. The curve slopes downward to the right since the weak specimens in a large population of good components, being replaced by a substantial percentage of good components when they fail, die out very fast. Theoretically, early failures should be quickly eliminated; however, they can occur every time a piece of equipment is overhauled or repaired, either by improper selection of replacement components or by improper installation and other maintenance errors. As components are in service longer, maintenance-induced failures tend to decrease. Additionally, items may be replaced due to contamination from systems external to the component; yet, due to incomplete flushing of the external system, the replacement part fails after only a few hours of operation since it too becomes contaminated.

Early failures can be eliminated by the so-called debugging or burn-in process, whereby a part is operated for a number of

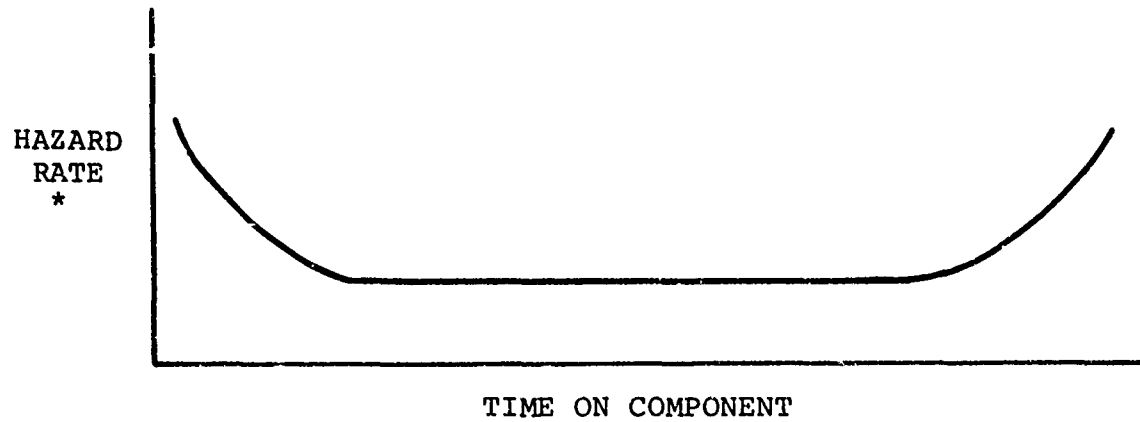

*THIS IS THE INSTANTANEOUS FAILURE RATE OF A COMPONENT AT ANY TIME GIVEN THAT IT HAS BEEN OPERATED UP TO THAT TIME.

Figure 3. The Bathtub Curve.

hours before entering actual service. Estimates of this period range up to 200 hours, depending on the equipment.

Constant Failure Rate

The second stage of the component life cycle appearing on the bathtub curve is characterized by a constant failure rate. A constant failure rate is produced by random failures of various modes, occurring on different components of an assembly, which when combined result in a failure rate that neither increases nor decreases. The important point to remember about a constant failure rate is that the failures occur independently of time, irregularly and unexpectedly. Chance failures can be caused by sudden stress accumulations beyond the design strength of the component, and neither good debugging techniques nor the best maintenance techniques can eliminate them. Also, random failures cannot be prevented by a replacement policy, since, at best, the replacement components have the same characteristic as had the removed components. Replacement of good nonfailed components at fixed intervals would improve nothing, and could do harm, since the reintroduction of infant mortality would increase the overall assembly failure rate.

Wearout

The third stage of an assembly life cycle, which is illustrated on the bathtub curve by an upward slope after a period of constant failure rate, is the phase which results in an increase in the failure rate with increasing age or operating hours. These are failures which may be predictable on the basis of known characteristics and which therefore can be avoided by means of preventive maintenance. The ages at which wearout occurs differ widely and are a function of component design. Most wearout modes are detectable during operation of the system.

HAZARD FUNCTION

The general term for the figure just described as the bathtub curve is hazard function. It describes how the failure rate of a given unit changes as its operating time increases. The important point to remember is that it is a conditional expression; that is, if the component reaches a certain operating time it will have the indicated failure rate.

The figure is therefore very appropriate to the issue of TBO placement. The alternatives at any given point in time are either to impose a TBO and cause the removal of the component from service, or allow it to continue to operate and be exposed to its future failure rate.

It is possible for there to be more than one hazard function for a component, each describing a different failure consequence. The most serious consequence is the complete inability to perform the assigned function. Other less serious failures can be grouped into distinct categories, each with its own hazard function, which differ in magnitude and shape. For example, a transmission in a helicopter with its different hazard functions could appear as Figure 4.

The three hazard functions illustrated could each be used to determine a different, but proper, location for placement of the TBO interval, depending on the desired objectives. On the surface it would seem to be a simple matter to decide at which point the TBO interval should be established; that is, removals should take place at the point where the failure rate begins to increase. However, after safety considerations have been made, it is essential to determine whether or not removing and repairing the components which will fail due to the increasing hazard function will be more or less expensive than overhauling all components at a certain interval. The hazard function is integral to any process involving a TBO versus on-condition decision.

WEIBULL DISTRIBUTION

For years the assumption that failure rate remains constant with respect to time (exponential distribution) was accepted, allowing the engineer to make the single-point estimate of reliability, which is known as mean time between failures (MTBF). More recently, however, the realization that failure rates do, in fact, change with time has led to the evaluation of other distributions, notably the normal, log normal, beta, and Weibull distributions.

The Weibull distribution has been found to be most powerful in the analysis of failure data--primarily because the Weibull distribution is an excellent approximation for all the previously mentioned distributions.

The two-parameter Weibull distribution is completely defined over all values of time, t , by the estimation of the parameters β (beta) and θ (theta).

β is the Weibull shape parameter. It is indicative of the manner in which the probability is distributed in relation to time. As the following plots show, $\beta=1$ represents a constant hazard function, $\beta<1$ represents a decreasing hazard function (infant mortality), and $\beta>1$ represents an increasing hazard function (wearout).

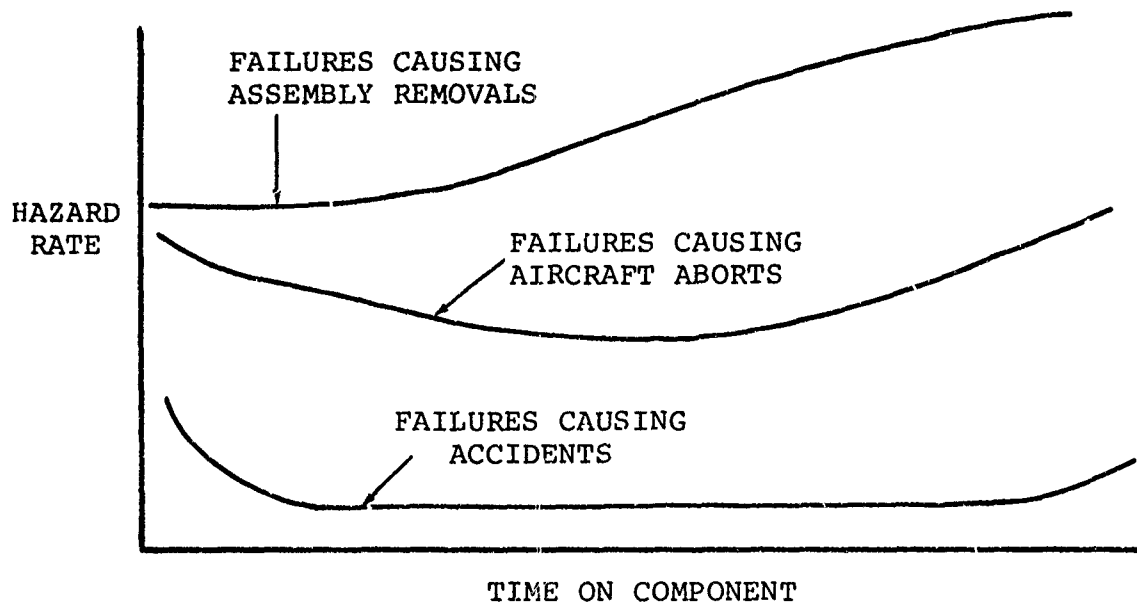
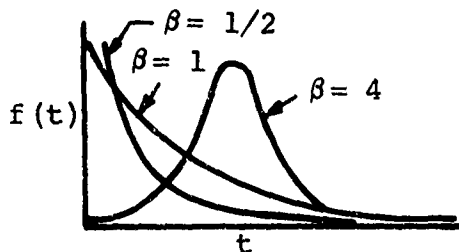

Figure 4. Representative Hazard Functions of a Helicopter Transmission.

θ is the Weibull scale parameter. It is inversely indicative of the height of the hazard function--that is, for the same β , if θ_2 is greater than θ_1 , then $H(t)_2$ is less than $H(t)_1$. Physically θ is equal to the time at which the cumulative probability of failure is equal to 63 percent. It is of value to note, that for $\beta=1$, the Weibull distribution is identical to the exponential distribution with $\theta=MTBF$.

Some of the different forms in which a Weibull distribution can be expressed are:

$$f(t) = \text{Probability Density Function (PDF)} = \beta/\theta (t/\theta)^{\beta-1} e^{-(t/\theta)^\beta}$$



PDF is an expression of propensity toward failure versus a discrete time t . Dimensions of $f(t)$ are relative and should not be misconstrued as probabilities.

$$F(t) = \text{Cumulative Distribution Function (CDF)} = \bar{R} = \int_0^t f(t) dt = 1 - e^{-(t/\theta)^\beta}$$

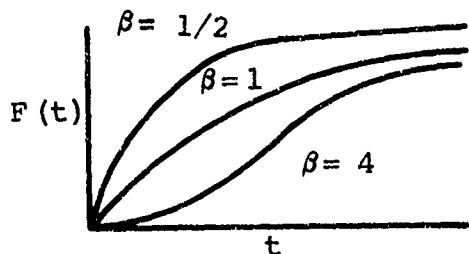

CDF is an expression of probability of failure prior to time t .

$$H(t) = \text{Hazard Function} = \frac{\beta}{\theta} \left(\frac{t}{\theta}\right)^{\beta-1} = \frac{\text{PDF}}{\text{CDF}}$$

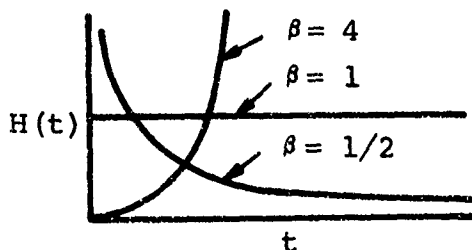

$H(t)$ is an expression of propensity toward failure at time $t + E$ (where $E \rightarrow 0$), given that a component has successfully operated to time t .

The following discussion presents one simple manner of estimating the parameters (β, θ) necessary for defining a Weibull distribution. This graphical method enables the engineer to make quick and accurate estimates of the parameters by plotting the failure points on Weibull paper. Once the estimates of β and θ are obtained, the ultimate goal of hazard function

display can be achieved by calculating the hazard rate for varying times t . (See Figure 5 for an example of Weibull paper.)

β is determined by erecting a line perpendicular to the plotted line and passing through the estimation point. β is then read off the β scale.

θ in hours is determined by where the plotted line intersects the 63-percent cumulative failure line. This is the dashed horizontal line with the θ in the margins.

In plotting data on this paper, the following procedure is performed:

1. Arrange all data in order of ascending component operating hours.

2.
$$\bar{R}(t') = \frac{m_{t'}}{n - S_{t'}}$$

where $m_{t'}$ = number of failures up to and including time t' .

$S_{t'}$ = number of scheduled removals prior to time t' .

n = number of observations, both scheduled removals and failures, in the data set.

3. Plot the points $(t', \bar{R}(t'))$ for all values of t' at which failures have occurred.

4. Estimate β , θ employing the method previously discussed.

ON-CONDITION MAINTENANCE

On-condition maintenance is the practice whereby repair or overhaul is performed only on items exhibiting performance degradation, as opposed to having all items overhauled at specifically established intervals. The item under consideration remains installed and is used until a failure occurs or until a diagnostic system or inspection indicates a degrading performance situation or an incipient failure. At this time, the item is removed, disassembled, and the defective component replaced. During disassembly, any other component whose condition indicates that it would impair the ability of the item to perform properly is also replaced.

It should be noted here that all components are maintained under a mitigated form of on-condition operation. That is, all

ESTIMATION POINT	
PREPARED BY	DATE
TECHNICAL	DATA SOURCE
11-4D1200 FORWARD TRANSMISSION	ITEM NAME
	ITEM NUMBER
β	1
θ	1.00 Hrs
INTERVAL	0-1200 Hrs

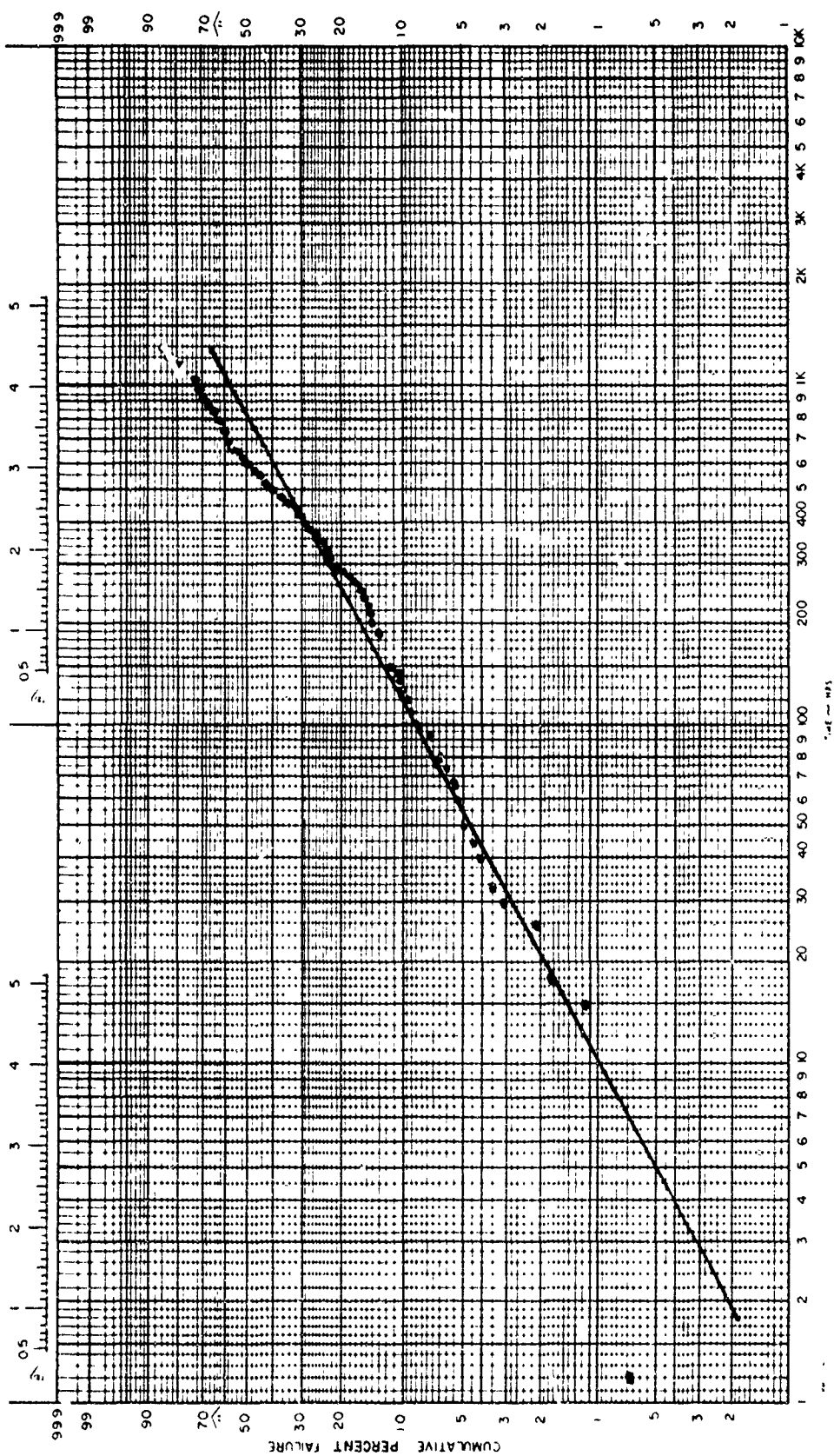

Figure 5. Form for Presentation of Weibull Distribution.

components are on-condition up to their TBO points since they are only removed after detection of a failure or incipient failure mechanism.

There are at least two objectives to be considered in the establishment of an on-condition maintenance philosophy. The first is that the removal of the TBO interval should result in a decrease or, at least, no increase in the number of failures which could possibly cause an accident. This is most important since increased risk in this area can never be offset by increased cost effectiveness, which is the second objective of on-condition maintenance. Removal of the TBO interval should result in an increase or, at least, no decrease in cost effectiveness where cost effectiveness is a function of availability, mission reliability, and operating costs. These costs include the expense of removal and replacement of units and the subsequent repair and overhaul costs of the removed components.

Designing components for on-condition operation requires that careful attention be paid to preventing the presence of failure modes having a potentially catastrophic failure progression or having increasing failure rates, which might justify placement of a TBO interval. Where catastrophic modes are unavoidable on-condition operation can be achieved by ensuring that adequate failure warning and inspection devices are provided to reduce potentially catastrophic modes to a merely maintenance affecting consequence. These issues will be examined and their relative effects discussed in later sections of this study.

MTBUR, MTBR

One of the standard measurements of component reliability is the mean time between unscheduled removals (MTBUR). MTBUR pertains to failures which result in the removal of the particular item from the aircraft; for major helicopter dynamic components, the term can be equated with mean time between failures (MTBF) since these items, when failed, can almost never be repaired without being removed from the aircraft. MTBUR can be defined as the average value of operating time between removals of failed items. It is the ratio of the total operating time on all components to the total number of unscheduled removals. The equation to calculate MTBUR is simply

$$\text{MTBUR} = \frac{\text{Accumulated time on all items}}{\text{Total items removed for failure}}$$

In the case of a constant failure rate (the flat portion of the bathtub curve), the MTBUR is the reciprocal of the failure rate.

On the other hand, mean time between removals (MTBR) considers both the unscheduled removals due to failure and the scheduled removals for preventive maintenance (TBO-caused removals). The value of MTBR is inherently limited by the inclusion of scheduled removals in the data base and can never be greater than the TBO value. MTBR is defined as the average value of operating time between all removals of components for both scheduled and unscheduled reasons. It is calculated in the same manner as MTBUR with the inclusion of scheduled removals in the denominator. Alternatively, if there is a constant failure rate and if the MTBUR and TBO interval are known, one can calculate MTBR using the following equation:

$$MTBR = [1 - e^{(-TBO/MTBUR)}] \cdot MTBUR$$

Summary of On-Condition Concepts (Figure 6)

A decision to implement an on-condition maintenance philosophy is based on considerations of cost, mission effectiveness and safety. When compared with operating with a TBO, on-condition must be less expensive with little or no degradation of mission effectiveness, nor an increase in the accident rate. Figure 6 presents a brief comparison of on-condition versus TBO, and summarizes the concepts leading to a decision for on-condition maintenance. Operating on-condition may lead to a change in the hazard rate at some future time. Imposition of a TBO stops the hazard function from changing but generates maintenance cost increases at the time of overhaul. The problem then is to reduce costs by elimination of the TBO, without incurring the mission and/or safety risks of an increasing hazard rate.

Generally, failure warning and inspection systems reduce all three hazard functions: maintenance, mission abort and safety. The maintenance malfunction hazard rate is reduced by eliminating unnecessary removals; the mission abort rate is reduced due to improvements in ground maintenance detection of actual or incipient mission affecting failures; and the flight safety failure rate is reduced by providing sufficient pilot warning for accident avoidance. When failure warning and inspection systems are combined with sound design and redesign practices, along with a solid test program, the mission abort and safety hazard functions can be changed in shape and magnitude to the point where on-condition maintenance becomes more desirable than a TBO. The role of design and testing, specifically for an on-condition objective, is to act in concert with diagnostics to eliminate the increasing hazard rates. It is not necessary that the maintenance malfunction hazard function for on-condition be lower than the average hazard function for TBO, because on-condition maintenance invariably tends to be more cost-effective than a TBO due to the high costs involved in scheduled overhaul.

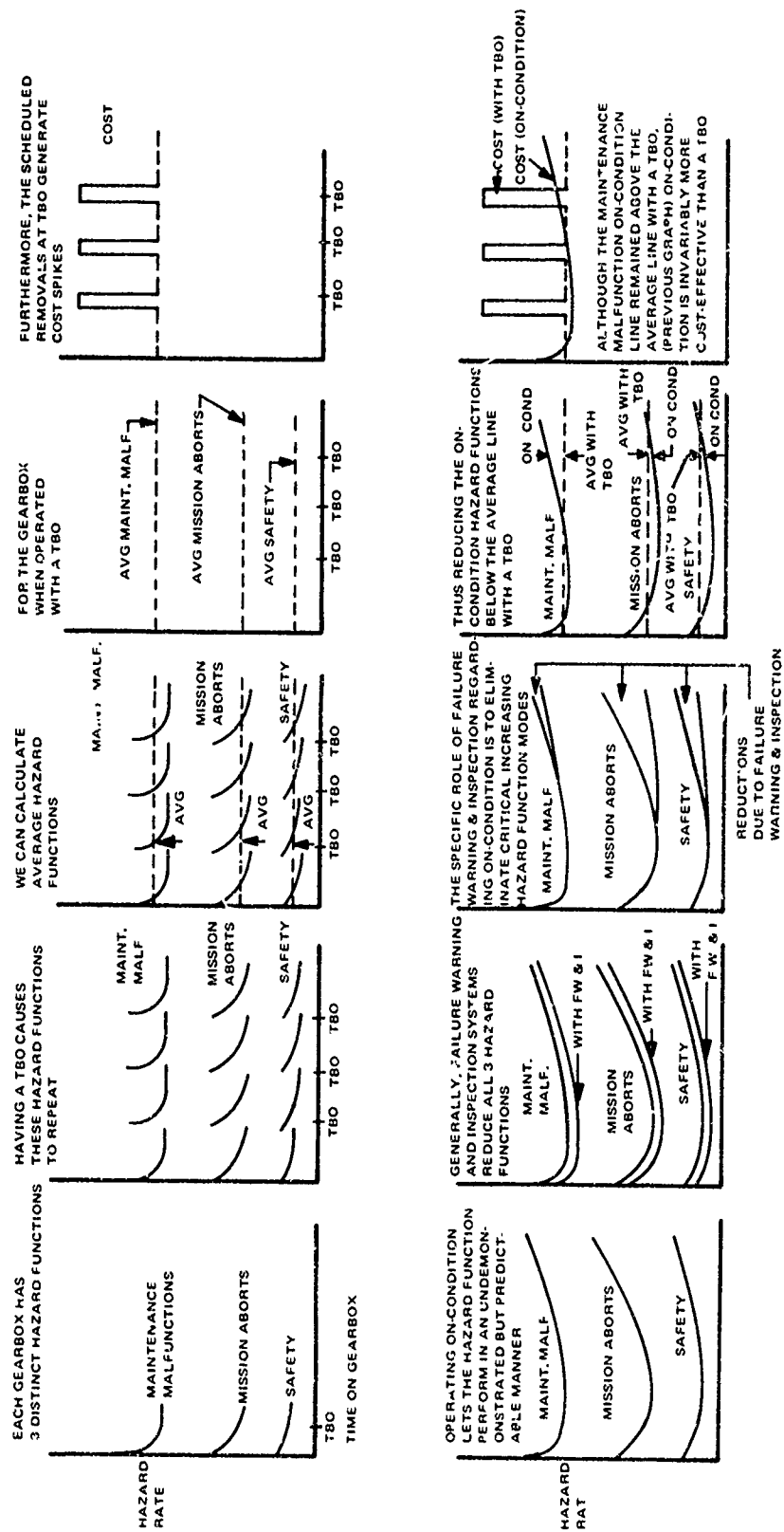

Figure 6. Summary of On-Condition Concepts.

RELATION OF ON-CONDITION OPERATION TO RELIABILITY, SAFETY, MAINTAINABILITY, AVAILABILITY, AND COST

INTRODUCTION

The intent of this section is to qualitatively identify the relationship between on-condition operation and reliability, safety, maintainability, availability, and cost.

Due to the inherent relationships between on-condition operation and these parameters, this can be done for each parameter independently, in those cases when the hazard function is decreasing or constant. Thus, this section draws conclusions about the value of on-condition operation for these situations.

Furthermore, this section identifies those areas (namely, the cases of increasing hazard functions) when the effect of on-condition is indeterminate without rigorous mathematical treatment.

The methods for quantitatively evaluating the effect of on-condition operation upon these parameters, both independently and interactively, are developed in Appendix I.

Appendix I will also qualitatively introduce the more complex issue of the effect of having different hazard functions over different segments of a component's life (as in the case with the bathtub curve).

SUMMARY

As stated previously, the hazard function is the mathematical expression around which the formulation of on-condition criteria takes place. Table I summarizes the effect of the various types of simple hazard functions upon product assurance parameters. From this table, it should be apparent that in the case of a decreasing or constant hazard function, on-condition is beneficial from the aspect of every parameter considered. For an increasing hazard function, the impact of eliminating the TBO upon several areas (notably unscheduled MMH/FH, availability, and cost) requires unique assessment. That is, for these cases, generalities of the form postulated for decreasing or constant hazard functions are meaningless.

The following pages of this section discuss in greater detail the rationale which formulated the conclusions of Table I.

In reading this section it should be remembered that components are now, in fact, operating on-condition up to their TBO values, and that when we speak, in the context of this report, of operating on-condition, we are merely postulating the extrapolation of a previously existing maintenance philosophy.

TABLE I. EFFECT OF ELIMINATING TBO UPON RELIABILITY, SAFETY, MAINTAINABILITY, AVAILABILITY, AND COST

Hazard Function Class Parameter	Decreasing	Constant	Increasing
MTBUR	Improves	Unchanged	Degrades
MTBR	Improves	Improves	Improves
MTTR (Organizational)	Independent	Independent	Independent
Unscheduled MMH/FH (Organizational)	Improves	Improves	Indeterminate*
Safety	Improves	Unchanged	Degrades
Availability (Inherent)	Improves	Unchanged	Degrades
Availability (Operational)	Improves	Improves	Indeterminate*
Availability (Ach.)	Improves	Improves	Improves
Overhaul Costs	Improve	Improve	Indeterminate*

*Evaluation of the effect of an increasing hazard function upon this parameter, when eliminating TBO, must be made using the methods developed in Appendix I.

RELIABILITY

The previous discussion dealt exclusively with component hazard function as the important indication of a system's capability for on-condition operation. Although the hazard function display lends itself to an evaluation of proper position for TBO, it is not directly indicative of component reliability. Hazard rate is the instantaneous failure rate of a component at time T, conditional upon its successfully operating up to time T; reliability, however, is a cumulative function. A widely accepted definition is:

"Reliability is the probability of a device performing its purpose adequately for the period of time intended under the operating conditions encountered."⁵

The critical phrase differentiating reliability from hazard function is "...period of time intended" Generally the period of time extends from time zero to some time T. Thus when we say that a component has 90-percent reliability at 600 hours, we mean that the probability the component will successfully operate between zero and 600 hours is 90 percent. It should be remembered that reliability is a nonincreasing function. That is, if a component had 90-percent reliability of successfully operating to 600 hours, its reliability at 1,200 hours cannot be greater than 90 percent. Figure 7 displays typical reliability plots for components having decreasing, constant, and increasing failure rates.

As displayed in this figure, all three components have 90-percent reliability at 600 hours; at 1,200 hours the component with a decreasing failure rate has 87-percent reliability, the component with the constant rate has 81-percent reliability, and the component with the increasing rate has 50-percent reliability. From these figures the following example will identify in which case a 600-hour versus 1,200-hour TBO would be beneficial.

Let us assume that the intended period of time for operating an aircraft is 1,200 hours. For the three reliability functions plotted on the previous figure the following probabilities of successfully operating 1,200 hours would be expected.

	Probability of 0 Failures in 1,200 Hours With 600-Hour TBO	Probability of 0 Failures in 1,200 Hours With 1,200-Hour TBO
Decreasing	0.81	0.87
Constant	0.81	0.81
Increasing	0.81	0.50

Thus it would appear that, in the case of a decreasing or constant failure rate, reliability may not decrease with an increase in TBO, but actually may, as in the case of the decreasing failure rate, increase.

Thus we will find that components with constant or decreasing failure rates will incur no detrimental effects in terms of reliability from on-condition operation. Those exhibiting an increasing failure rate will generally suffer a decrease in reliability due to on-condition operation.

For those components having complex failure rates (e.g., DCI - decreasing, constant, increasing) an evaluation must be

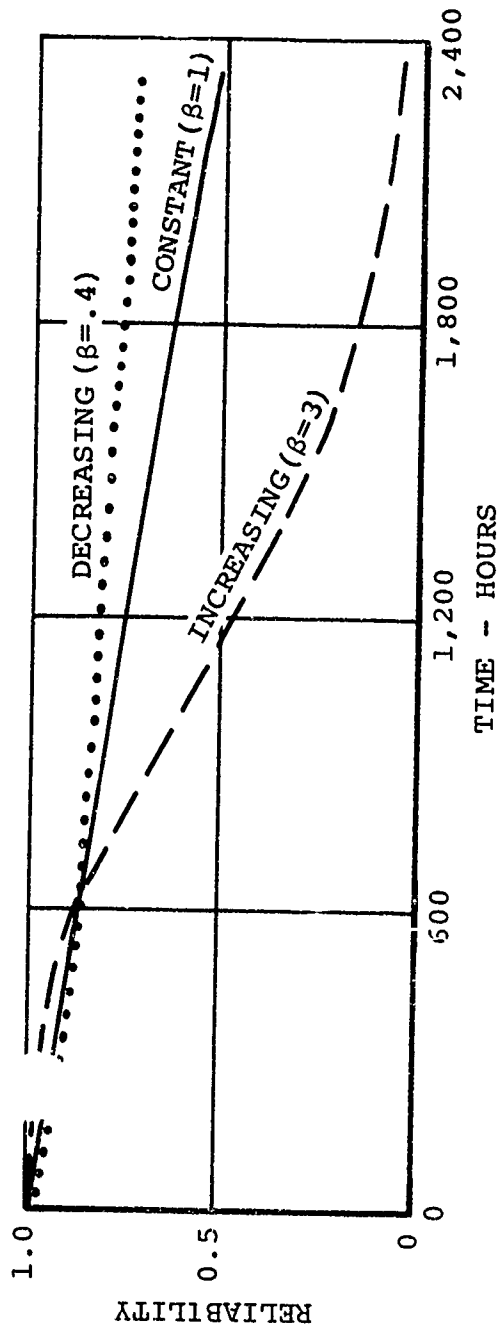

Figure 7. Effect of TBO on Reliability.

made case by case. Generalizations for these cases are impractical.

The tools by which these complex cases can be evaluated will be developed in Appendix I.

SAFETY

In an evaluation of the criteria for TBO extension or removal, the issue of safety is the dominant concern. Safety, however, poses two perplexing points. First, any discussion of safety has a tendency to deteriorate to an emotional rather than analytical discourse. Second, it is an unfortunate fact that safety is difficult to quantify as rigorously as reliability or cost. This is due to the relatively few accidents caused by helicopter transmissions.

In the context of this study, safety will be considered the most important reason for TBO establishment. If a transmission is not considered safe to operate on-condition, any mission accomplishment or cost payoffs are irrelevant. The mathematical models for evaluating the optimum position for TBO will be developed in Appendix I. For the reasons just stated, it is not necessary that safety be evaluated interactively with the other parameters under consideration.

MAINTENANCE BURDEN

Maintenance burden is one of the areas where a payoff is expected from on-condition operation.

In the case of a decreasing hazard function, the expected number of failures over time for an on-condition transmission will be less than with a TBO, due to the fact that the on-condition items are not resubjected to the infant mortality phase. This is illustrated in Figure 8.

With a constant failure rate, the expected number of failures is the same for items operating either on-condition or with a TBO, due to the random occurrence of failures. Assuming that the mean time to repair an item (MTTR) remains the same for both maintenance philosophies, the following conclusions become apparent regarding maintainability of items with constant or decreasing failure rates. Since MTBR and MTBUR for an item operating on-condition will be greater than or equal to that exhibited by the same item when operating with a TBO, unscheduled downtime, total downtime, and maintenance manhours per flight hour for on-condition items will be less than or equal to that exhibited by the same items operating with a TBO.

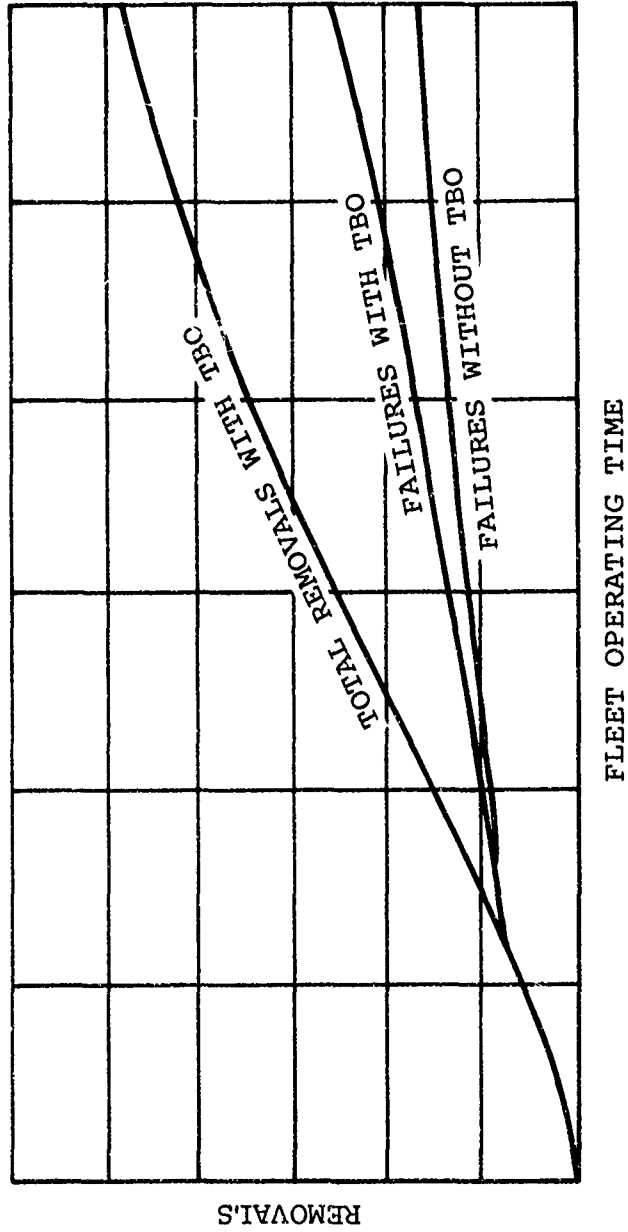

Figure 8. Effect of TBO on Total Removals.

In the case of an increasing hazard function, the MTBUR on-condition may be lower than with a TBO. However, the MTBR on-condition must be higher than the MTBR with a TBO; and consequently, the total downtime/flight hour and maintenance man-hours/flight hour will be reduced. Thus, there is still a potential maintainability payoff due to the elimination of the scheduled removals necessitated by a TBO.

Determination of whether or not on-condition operation provides a maintainability benefit for those components having increasing hazard functions must be made on a case-by-case basis. The mathematical model to perform these analyses will be developed in Appendix I.

AVAILABILITY

As was previously discussed in this section, the total maintenance downtime per flight hour is reduced through on-condition operation if the item has a constant or decreasing hazard function. Furthermore, for items with hazard functions in this category (namely, constant or decreasing), a reduction in not-operationally-ready-supply (NORS) can be expected due to the increase in MTBUR and MTBR associated with on-condition operation. That is, since the MTBUR and MTBR increase (or at least remain the same), the quantity of spares and probability of requiring spares decreases. Thus, NORS will be reduced by on-condition operation and availability will be increased, since

$$\text{Availability} = 1.0 - (\text{NORS} + \text{NORM})$$

Another generally accepted definition of availability that can be used to demonstrate the payoff expected from on-condition operation is presented by Reference 6, page 15:

$$\text{Inherent Availability} = \frac{\text{MTBF}}{\text{MTBF} + \text{MTTR}}$$

Thus it should be obvious that for constant MTTR, as MTBF (which is equal to MTBUR here) increases, inherent availability increases.

A second form of availability defined in Reference 6, page 150, is:

$$\text{Operational Availability} = \frac{\text{MTBF}}{\text{MTBF} + \text{Mean Downtime (MDT)}}$$

Since total downtime per flight hour for transmissions with decreasing or constant hazard functions will decrease or at

least remain constant, similarly the MDT will not increase and the operational availability will increase.

An additional definition of availability which one may encounter is:

$$\text{Achieved Availability} = \frac{\text{MTBR}}{\text{MTBR} + \text{MDT}}$$

It should be noted that MDT includes both scheduled and unscheduled maintenance and that some removals occur as a part of or during scheduled maintenance, making it possible for a removal to occur without the aircraft being charged with downtime against that removal. Employing inherent availability eliminates the problem of whether or not scheduled removals cause aircraft downtime. Furthermore, it seems apparent that inherent availability is a more conservative measure to be used in evaluating on-condition potential, since the on-condition transmission does not derive any benefit from a lack of scheduled removals. In other words the on-condition transmission is compared with the TBO unit on the basis of failure rate and not the artificial restraint of TBO.

For transmissions in the class of increasing hazard functions, a case-by-case evaluation of the sensitivity of availability to on-condition operation must be performed. The mathematical models required to perform this analysis will be developed in Appendix I.

COST

For those components in the constant failure rate class, a TBO is never cost-effective since the number of failures generated by a population of components with a constant failure rate is a function of fleet operating hours, not time on individual parts. That is, in X hours of fleet operation, X divided by MTBUR yields the number of transmission failures that can be expected.

For a TBO to be beneficial to life-cycle cost, the following inequality must hold:

$$\text{LCC}_{\text{TBO}} < \text{LCC}_{\text{O.C.}}$$

where LCC_{TBO} = life-cycle cost of operation with a TBO

$\text{LCC}_{\text{O.C.}}$ = life-cycle cost of operation on condition

Now in the case of a constant failure rate:

$$\begin{aligned} LCC_{TBO} &= \frac{X}{MTBUR} \cdot (\text{Unscheduled Cost}) \\ &+ \frac{X \cdot R(TBO)}{MTBUR \cdot \bar{R}(TBO)} \cdot (\text{Scheduled Cost}) \end{aligned}$$

Proof:

$$MTBR = MTBUR (1 - e^{-TBO/MTBUR})$$

$$\begin{aligned} \therefore \text{Number of removals} \\ \text{in X hours} &= \frac{X}{MTBR} \\ &= \frac{X}{MTBUR (1 - e^{-TBO/MTBUR})} \\ &= \frac{X}{MTBUR - MTBUR (e^{-TBO/MTBUR})} \end{aligned}$$

Now the expected number of unscheduled removals is:

$$X/MTBUR$$

\therefore The number of scheduled removals is:

$$\begin{aligned} &\frac{X}{MTBUR - MTBUR \cdot (e^{-TBO/MTBUR})} - \frac{X}{MTBUR} \\ &= \frac{X}{MTBUR} \left(\frac{1}{1 - e^{-TBO/MTBUR}} - 1 \right) \\ &= \frac{X}{MTBUR} \left(\frac{1}{\bar{R}(TBO)} - 1 \right) \\ &= \frac{X}{MTBUR} \left(\frac{1 - \bar{R}(TBO)}{\bar{R}(TBO)} \right) \\ &= \frac{X}{MTBUR} \cdot \frac{R(TBO)}{\bar{R}(TBO)} \end{aligned}$$

where R = reliability and

\bar{R} = cumulative probability of failure

$$\begin{aligned} \text{Thus, } LCC_{TBO} &= \frac{X}{MTBUR} \cdot (\text{Unscheduled Cost}) \\ &+ \frac{X}{MTBUR} \cdot \frac{R(TBO)}{\bar{R}(TBO)} (\text{Scheduled Cost}) \end{aligned}$$

Now, the $LCC_{O.C.} = \frac{X}{MTBUR} \cdot (\text{Unscheduled Cost})$

since there is no TBO.

Thus, the inequality

$$LCC_{TBO} < LCC_{O.C.}$$

becomes

$$\begin{aligned} & \frac{X}{MTBUR} (\text{Unscheduled Cost}) + \frac{X \cdot R(TBO)}{MTBUR \bar{R}(TBO)} \cdot (\text{Scheduled Cost}) \\ & < \frac{X}{MTBUR} (\text{Unscheduled Cost}) \end{aligned}$$

or

$$\frac{X \cdot R(TBO)}{MTBUR \cdot \bar{R}(TBO)} \cdot (\text{Scheduled Cost}) < 0$$

Since X , $R(TBO)$, $\bar{R}(TBO)$, and $MTBUR$ are all positive values, this relationship is never fulfilled.

Therefore, a TBO is never profitable for components with constant hazard functions.

Similarly, components of the class of decreasing hazard functions will always operate more cost effectively on condition than with a TBO.

Proof:

$$\begin{aligned} MTBF_{TBO} &= \int_0^{TBO} \left(\frac{t}{\theta}\right)^{\beta} \beta \cdot e^{-\left(\frac{t}{\theta}\right)^{\beta}} dt \\ MTBF_{O.C.} &= \int_0^{\infty} \left(\frac{t}{\theta}\right)^{\beta} \beta \cdot e^{-\left(\frac{t}{\theta}\right)^{\beta}} dt = \theta \Gamma\left(1 + \frac{1}{\beta}\right) \end{aligned}$$

and for $\beta < 1$

$$\int_0^{TBO} \left(\frac{t}{\theta}\right)^{\beta} \cdot \beta \cdot e^{-\left(\frac{t}{\theta}\right)^{\beta}} dt < \theta \Gamma\left(1 + \frac{1}{\beta}\right)$$

The above inequality cannot be demonstrated using closed-form mathematical techniques. However, in order to demonstrate

the validity of the inequality, Figure 9 has been developed using numerical integration to solve the finite integral.

For transmissions in the class of increasing hazard functions, a case-by-case analysis must be performed to determine the cost effectiveness of on-condition operation. The mathematical model required to do this analysis will be developed in Appendix I.

HAZARD FUNCTION VARIATIONS

The previous discussions dealt solely with monotonic hazard functions that are always decreasing, always constant, or always increasing. However, all three classes of hazard functions (decreasing, constant, and increasing) may be present in the same transmission over different operating time periods. This is the case for those transmissions whose hazard functions follow the traditional bathtub curve (Figure 3).

Inclusion of all possible permutations and combinations of the three classes of hazard functions (without class repetition) yields 15 possible assembly hazard functions. Each of these combinations has been coded and sketched in Figure 10 to reinforce the concept of hazard functions and to provide an easy reference for future discussions. The notation D, C, or I has been employed to signify decreasing, constant, or increasing. Thus, the code DCI has been employed to represent the bathtub curve (sketch 10).

Obviously, a representation of this type could be carried on indefinitely with hypothetical transmission hazard functions combining four or more different types of hazard functions theoretically possible. However, experience shows that most transmissions fall into classes 1 through 15, thus obviating the necessity for more complex variations.

RELATION OF HAZARD FUNCTION TO ON-CONDITION/TBO

The majority of transmission hazard functions actually fall into one of the following classes: D, C, I, DC, DI, CI, DCI (Figure 10, sketches 1 through 6, 10).

A discussion of the potential of these seven hazard functions for on-condition operation can now be initiated. The hazard function after overhaul is assumed to be reset to the shape it had at time zero. Thus, classes D, C, and DC present no potential for TBO placement since they are either constant or decreasing hazard functions; and, as previously stated, the only valid basis for TBO placement is to preclude the undesirable event of increasing hazard function. Thus components

$\beta = 0.9$
 $\theta = 1,218$
 $\gamma (1 + \frac{1}{\beta}) = 1.0526$
 $MTBF_{O.C.} = 1,282$

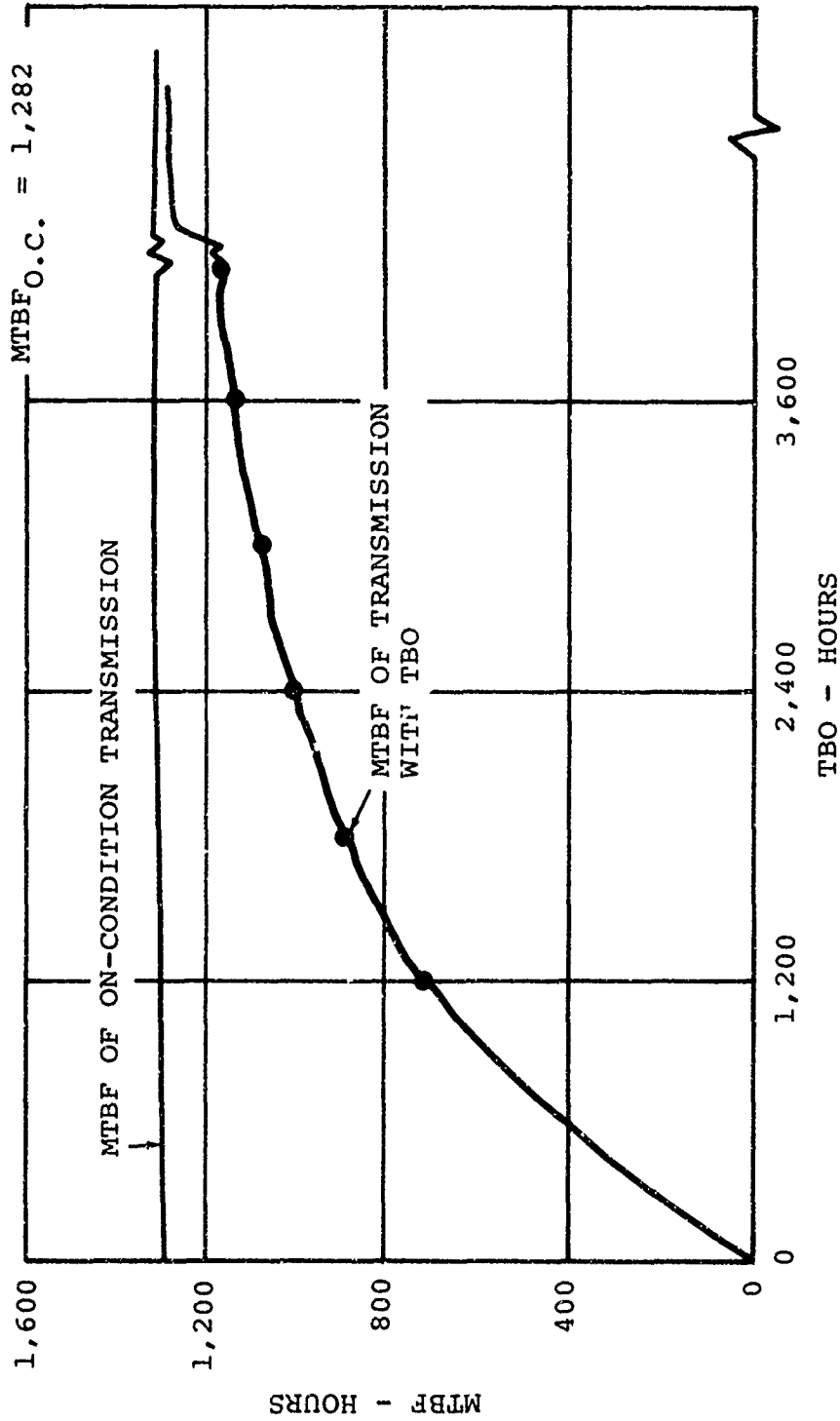

Figure 9. Relationship of TBO to MTBF for a Decreasing Hazard Function.

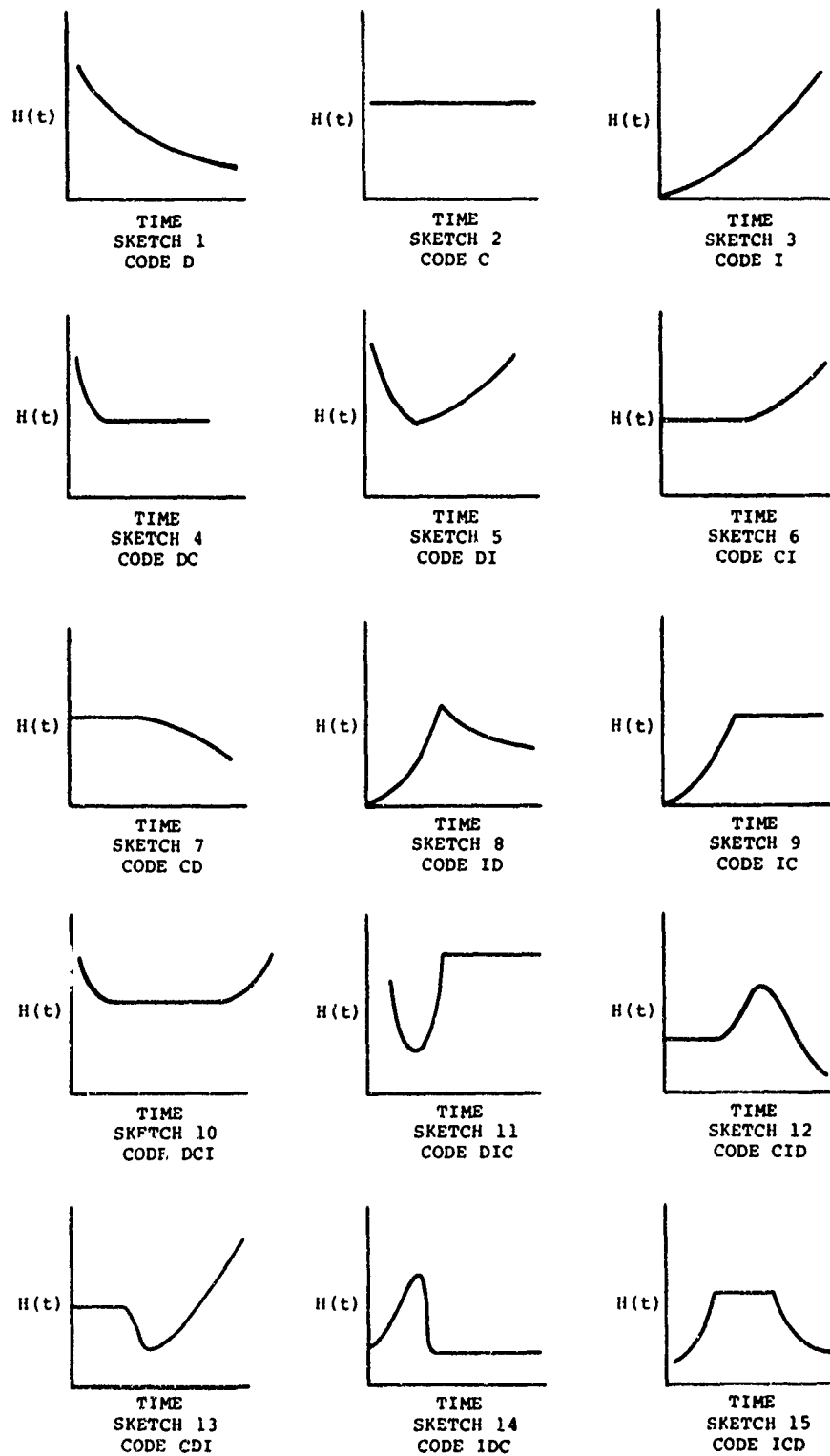

Figure 10. Hazard Functions Possible for Most Transmissions.

having hazard functions of the form of D, C, and DC are excellent candidates for on-condition operation.

Classes I, DI, CI, and DCI meet the requirement for TBO placement of having an increasing hazard function. However, the positioning of the TBO is at times a critical decision. Class I, which increases from time zero, presents no obvious point for TBO placement. Class DI presents a hazard function which on the surface appears to require a TBO positioned at the time where the hazard function begins to increase; this is also the case with classes CI and DCI. It is natural that the first reaction when viewing these classes is to conclude that they require a TBO which would prevent an increase in hazard rate. This may not actually minimize the effect of the hazard function. To illustrate this point, let us consider a member of class DI.

In Figure 11, two conditions are shown for a component--one condition where the component is allowed to operate for the life of the aircraft (say, 3,600 hours) and the other condition where a TBO is established at 1,200 hours (where the failure rate was beginning to increase). In this second condition, a potential is present for scheduled removals and the associated exposure to the high failure rate, infant mortality, portion of the hazard function. Because of this the number of failures over a 3,600-hour operating period could be greater in the second condition where the 1,200-hour TBO was imposed. Clearly, the TBO may not reduce the total number of failures, but could indeed produce more failures. Additionally, higher total costs might also be incurred as a result of having to perform a scheduled overhaul on the units that reach the TBO.

Thus it should be obvious that determination of a suitable point for TBO placement, even in those classes of hazard functions where an increasing rate is present, requires some kind of optimization process. The mathematical models required to perform this optimization will be developed in Appendix I.

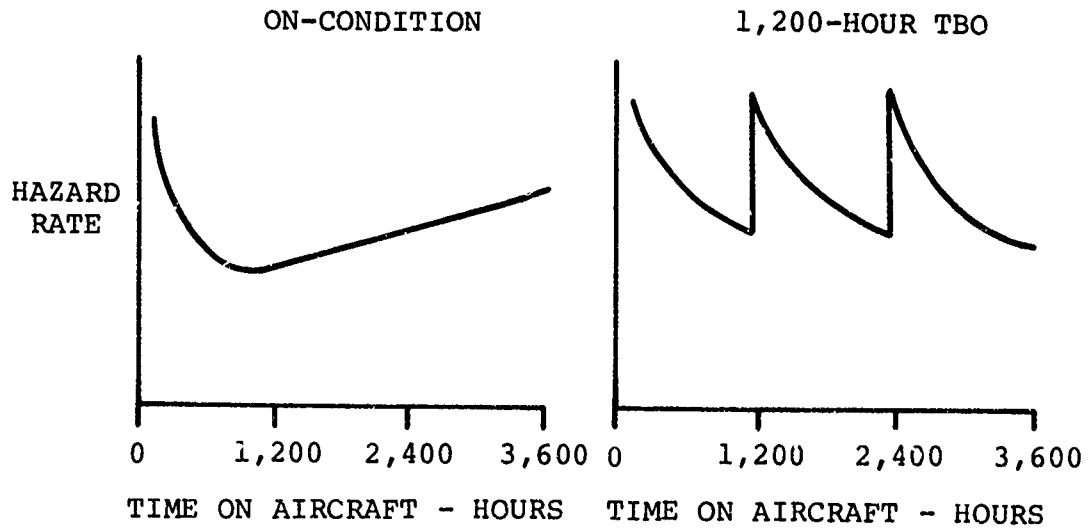

Figure 11. Effect of TBO on Hazard Rate.

SUMMARY OF CRITERIA AND CONSIDERATIONS

INTRODUCTION

The intent of this section is to identify the method to be used for the evaluation of the on-condition potential of helicopter transmissions.

This section integrates the various mathematical models, design and testing concepts, and failure warning and inspection system considerations which enter into the substantiation of on-condition potential or, if on-condition is not practical, the determination of the optimum transmission TBO.

SUMMARY

The evaluation of the potential of helicopter transmissions for on-condition operation requires the application of elements of several mathematical and engineering disciplines. These elements and the way they interact are identified in Figure 12.

Basically, the analysis can be summarized into seven steps:

1. Perform Failure Mode Effects and Criticality Analysis (FMECA)
2. Develop hazard functions by mode and combine into an assembly hazard function.
3. Perform a safety evaluation.
4. Develop limiting cost-effectiveness hazard function.
5. Determine optimum cost-effectiveness TBO or substantiate on-condition potential from cost-effectiveness hazard function.
6. If on-condition operation is not safe and cost-effective, consider impact of redesign, testing, or failure warning and inspection system.
7. Substantiate on-condition or finalize establishment of TBO.

This section provides a frame of reference for the detailed mathematical and engineering analyses described in the appendixes and shows how they relate to each other and to the entire evaluation. Furthermore, it summarizes each step in the on-condition evaluating process, identifying only those

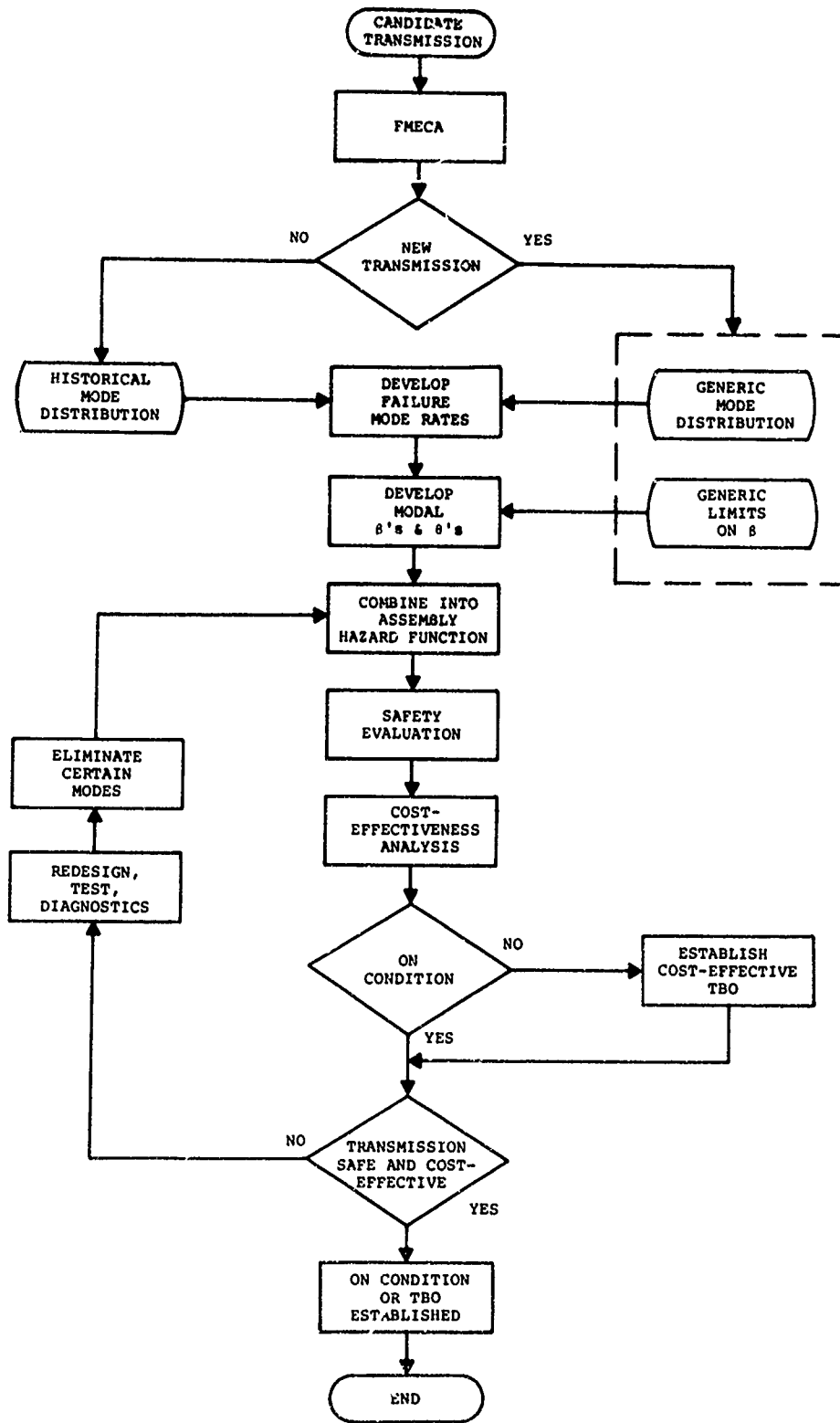

Figure 12. Method of Evaluating On-Condition Capability.

points which are necessary for an understanding of the general methodology employed in evaluating on-condition potential.

The following segments of this section describe the steps of the analysis shown in Figure 12.

FAILURE MODE EFFECTS AND CRITICALITY ANALYSIS (FMECA)

In order to develop an adequate mathematical model of the transmission hazard function and provide a basis for evaluating design, test, or failure warning and inspection system impacts upon on-condition potential, it is necessary that a transmission FMECA be developed.

Basically, the FMECA performs three functions:

1. Aids the designer and reliability engineer in understanding the failure modes, effects of failure, and component criticality for the components of the transmission.
2. Forces identification of and attention to all potentially significant failure modes.
3. Allows for the development of modal hazard functions which can be synthesized into an assembly hazard function using the program identified in Appendix VII.

To illustrate the manner in which an FMECA is performed, a typical example has been included as Appendix VI.

Once the FMECA has been performed, the next major task is the development of the modal and subsequent assembly hazard functions.

DEVELOPMENT OF MODAL AND ASSEMBLY HAZARD FUNCTIONS

The manner in which the hazard functions are calculated is dependent upon whether or not the gearbox under consideration is a new design. Thus, the following discussion will consider old and new transmissions independently.

New Design

The preceding section identifies the detailed steps and provides the historical data base necessary for developing modal hazard function. Basically, the task involves two steps:

1. Since it is a new design and no past data on the transmission is available, use CH-46, CH-47, UH-1E, SH-3A, or the generic combination data from all four aircraft can be used to determine the distribution of failure modes, and the failure rates.
2. CH-47 modal β values can be used to estimate the modal β parameters of the transmission under consideration.

The data required to perform these two steps is supplied in Appendix VIII. If data on a gearbox of a type similar to that being analyzed is available, it should be used to replace/supplement the data of Appendix VIII.

Having identified the modal failure rates and β values, the program supplied in Appendix VII which relates β , θ , and failure rate can be used to determine modal β values. Thus, the parameters of all modal hazard functions are determined.

Existing Design

In Appendix V the least-squares fit to the Weibull Distribution is cited as the mathematical model for data analysis best suited to the on-condition evaluation. This model (for which a computer program is discussed in Appendix V is employed for each transmission failure mode to determine modal β and θ values when historical data on the transmission is available.

Once the modal hazard functions have been determined for either a new or existing design, they can be combined into an assembly hazard function using the program in Appendix VII.

PERFORMANCE OF SAFETY EVALUATION

Appendix I identifies the detailed steps which must be taken to ensure that a transmission is safe for operating on condition. Resulting from the safety analysis is a conclusion regarding on-condition acceptability from a safety aspect.

Basically, the steps identified in Appendix I for the performance of the safety evaluation are as follows:

1. Identification of all potentially safety-affecting failure modes as determined by the FMECA.
2. Determination of those modes which will be precluded from occurring through application of failsafe design practices.
3. Determination of those modes which will be precluded from occurring through use of a failure warning and inspection system.

4. Determination of those modes which are not fail safe or detectable but for which the modal hazard function is not significantly increasing during the expected transmission life cycle.

If there are any modes which are not fail safe or detectable and have significantly increasing hazard functions, they must be eliminated through improvements in design, testing, or failure warning and inspection system before the transmission can safely be operated on condition.

To aid in the performance of the safety analysis, a discussion regarding advanced drive system designs, design-related criteria, and fail-safe design practices is contained in Appendix II. A discussion regarding failure warning and inspection system criteria is contained in Appendix III, and a discussion regarding testing is contained in Appendix IV.

DEVELOPMENT OF LIMITING COST-EFFECTIVENESS HAZARD FUNCTION

Provided that on-condition operation has been determined to be safe, the area of real benefit of on-condition operation, namely cost, is next evaluated. This involves the development of a limiting cost-effectiveness hazard function. This hazard function represents the point beyond which operating on condition becomes more costly and less effective than operating with a TBO. As long as the hazard function for the transmission assembly under consideration is less than the limiting one, on-condition operation is preferable. Appendix I describes in detail how to calculate the limiting cost-effectiveness hazard function. Basically, this calculation involves considerations of availability, mission reliability, and life-cycle cost.

DETERMINATION OF THE OPTIMUM COST-EFFECTIVENESS TBO OR SUBSTANTIATION OF ON-CONDITION POTENTIAL FROM THE COST-EFFECTIVENESS HAZARD FUNCTION

This step in the on-condition evaluation process involves a comparison of the assembly hazard function with the limiting cost-effectiveness hazard function. This requires plotting both hazard functions on the same graph for all values of t up to the expected life of the transmission. If the assembly hazard function is lower, then the potential of this assembly for on-condition operation has been substantiated from the cost-effectiveness standpoint. If the assembly hazard function is not lower than the limiting cost-effectiveness hazard function, the potential for on-condition operation has not been substantiated. However, further analysis can determine the optimum TBO for cost-effectiveness.

IMPACT OF REDESIGN, TESTING, OR FAILURE
WARNING AND INSPECTION SYSTEM

When on-condition operation has not been substantiated from both the safety and cost-effectiveness aspects, three courses of action are available if the user still desires to eliminate scheduled removals:

1. Certain components of the transmission with restrictive hazard functions can be redesigned to eliminate the mode or change the hazard functions.
2. The transmission can be manufactured and run in a test to evaluate the modal hazard functions predicted. In this case, the hazard functions may not be as bad as expected or additional information from testing will lead to the insight required for design elimination of this mode. Furthermore, transmission green runs (which are the mechanical equivalent of burn-in testing) may act to eliminate infant mortality hazard functions.
3. In the case where on-condition operation is unsafe or not system-effective, the installation of failure warning and inspection systems to provide ample time for safe action or efficient transmission removal can be considered.

When any of these courses of action are chosen, the assembly hazard function is then recalculated without those modal hazard functions which have been eliminated.

Redesign, failure warning and inspection systems, and testing, are discussed in detail in Appendixes II, III, and IV, respectively.

Appendix II emphasizes those areas of design that could possibly limit TBO extension or removal. The dual issues of failure consequence and Hazard Function shape are the prime concerns. In instances where a β greater than 1 might be present for a failure mode, the designer must assure that the assembly is tolerant of that failure mode. That is, the consequence must not be an undetected functional failure. If safety concerns can be eliminated from any failure mode, a β greater than 1 can generally be tolerated.

Several advanced gearbox configurations (e.g., modularized, roller gear, and lubricant sealed transmissions) as well as elemental advances (non-involute tooth forms, improved lubricants, improved materials) which are reviewed in Appendix II, appear to have great potential for improving the suitability of helicopter gearboxes for on-condition operation. Furthermore, a review of the data supplied in Appendixes VIII and IX leads to the conclusion that present generation gearboxes

(CH-46, CH-47, UH-1E, SH-3A) have very few significantly increasing, potentially catastrophic, undetectable modes which could preclude their operating on-condition. Finally, Appendix II shows that in most instances even the fatigue failure modes (which are generally considered those requiring life limits, and consequently a TBO) should not prohibit operating on-condition since they do not exhibit a significantly increasing hazard function.

Appendix III presents the proper role for diagnostics or condition monitoring in the TBO question. These devices or systems contribute to an on-condition status by removing failure modes from a safety arena and thereby increasing the acceptability of $\beta > 1$. In the justifiable desire to ease maintenance troubleshooting and reduce component damage, the fact that diagnostics do not change the frequency of occurrence or the shape of the distribution is sometimes overlooked. Providing a 30-minute warning of a bearing failure does not alter the shape of the hazard function for the bearing.

In this light, it might be concluded that the historical emphasis on diagnostics is inappropriate. Instead of efforts to increase the detectability of bearings (which have generally constant failure rates: $\beta = 1$), the real need is to detect potentially catastrophic failure modes that have shown a propensity to high β 's (e.g., low-cycle fatigue-sensitive internal structure such as supports or shafts). The dual objectives for diagnostics of minimum maintenance/costs and improved safety, are not mutually satisfying. Clearly, specific objectives must be defined. Appendix III of this report is a step towards the development of the role of diagnostics in an on-condition evaluation.

Appendix IV identifies the manner in which testing influences an on-condition analysis. The great variability in hazard function parameters that is exhibited by small random samples has led to the conclusion that developmental testing is of little value in affirming or denying the existence of a high β parameter.

The primary value of developmental testing from an on-condition aspect lies in the identification of failure modes and establishment of failure mechanisms which facilitate redesign to eliminate the mode when possible. Furthermore, developmental testing can be of great value in establishing failure progression rates for critical components.

The manner in which on-condition operation can be most profitably supported through developmental testing is by the establishment of a truly adequate reliability test program. It is postulated that improving reliability will of necessity also enhance on-condition potential.

An example of the kind of trade which could be required in an on-condition analysis is contained in the following paragraphs.

Consider a situation where a gear in a high speed critical load path application is mated to a shaft via a bolted flange. This type of design is frequently prone to flange fretting at the bolted connection, which can progress to web cracking and subsequent loss of load carrying capability resulting in a catastrophic failure. Fretting failures have been historically undetectable due to the extremely small size of the particulate debris generated. Flange and web cracking have also been virtually undetectable since little or no debris is generated prior to catastrophic failure.

For the sake of this example assume that flange fretting has a significantly increasing Hazard Function. Then, since it is undetectable and progresses to an undetectable catastrophic mode, the problem would have to be resolved before the gearbox would be acceptable for on-condition operation.

Several alternative solutions to this problem can be considered. Three that come immediately to mind are as follows:

- (1) Redesign the gear/shaft combination to integrally forge the unit thus eliminating the bolted surface
- (2) Electron-beam-weld the gear to the shaft, again eliminating the bolted connection
- (3) Improve the detectability of the fretting mode via kryptonation or some other failure warning technique.

Each of these suggested solutions has certain drawbacks.

- o Manufacturing an integral gear/shaft assembly is more difficult and costly than producing the two items individually
- o E. B. welded joints, tend to present a catastrophic cracking mode of failure if the weld is imperfect (E. B. welds are discussed in the roller-gear drive section of Appendix II).
- o As shown in the trade study of Table XXIII of Appendix III, the radioactive tracer has the highest rating with regard to diagnosing flange fretting. (Radioactive tracers, and in particular Kryptonation are discussed in Appendix III). Radioactive tracers do require that sensitive built-in or externally supplied sensors be provided if they are to be effective. Kryptonation also requires a modification to the manufacturing process to allow for impregnation with the kryptonate.

Which of these solutions (or any other that can be postulated) should be employed is a decision that must be based on the engineering and economic factors of the specific application. The previous discussion was provided to demonstrate the kind of trades which could be conducted in an on-condition analysis.

SUBSTANTIATION OF ON-CONDITION OR
ESTABLISHMENT OF TBO

Once the modified assembly hazard function has been calculated, it is again compared with the limiting cost-effectiveness hazard function. If the potential for on-condition operation is still not substantiated, one must decide the cost and time feasibility of iterating the process described under the preceding heading or establish the TBO as acceptable. If the TBO course of action is chosen, this does not eliminate the possibility of operating on condition in the future. As failed and TBO samples are returned and analyzed, the predicted hazard functions will or will not be verified; and various transmission modifications will be incorporated, eliminating certain modes and making on-condition operation more viable.

CONCLUSIONS AND RECOMMENDATIONS

NOTE: The conclusions presented here are based primarily on the detailed analyses contained in the appendices.

As a result of this study, it is evident that on-condition operation for helicopter transmissions would be extremely cost-effective. In almost every case imaginable, the on-condition transmission would generate lower costs with little degradation of performance when compared to a transmission operated with a TBO.

Thus, the entire on-condition question really reduces to a safety issue: can state-of-the-art transmissions be operated safely in the 1,000- to 5,000-hour regimes? The answer posed as a result of this study is yes, with mitigation.

Experience has shown that very few failure modes have significantly increasing hazard functions. In fact, as supported by the data in Appendix IX of this study, most failure modes have a tendency toward decreasing hazard rate. When conservative design practices are employed, as is the case in most current helicopter gearboxes, problems encountered in operation tend to be those generated by material inclusions, out-of-tolerance parts, or improper assembly. These problems tend to surface rapidly when they exist, thus supporting the aforementioned tendency of failure modes to have decreasing hazard functions. Thus, the great majority of failure modes support (through their decreasing hazard rates) the capability of on-condition transmission operation.

For those few modes that are potentially catastrophic and which do exhibit increasing rates, there are state-of-the-art diagnostic techniques which can and are being employed to reduce their impact from safety-affecting to merely mission- or maintenance-affecting. The fact that present diagnostics systems are providing adequate safety measures for gearboxes is attested to by the paucity of gearbox caused accidents. Again it should be reiterated that although the concept of operation on-condition is new, it is not untested, since, as previously stated, all components do in fact operate on-condition to some extent right now.

Thus it is concluded that through application of the methodology defined herein, coupled with conservative design practices, adequate developmental and problem-identification testing, and prudent application of state-of-the-art diagnostic techniques, on-condition operation of helicopter transmissions can now become a reality for current and future systems.

LITERATURE CITED

1. Dougherty, J., and Rummel, K., CAPABILITY OF CH-47C FORWARD, AFT, AND COMBINING GEARBOXES FOR ON-CONDITION OPERATION, The Boeing Company, Vertol Division, Philadelphia, Pennsylvania, Boeing Document D210-10367-1, December 1971.
2. Dougherty, J., and Rummel, K., A CRITERION FOR ON-CONDITION TRANSMISSIONS AND ITS APPLICATION TO THE CH-47C, American Gear Manufacturers Association paper AGMA 109.28, January 1972.
3. Calabro, S. R., RELIABILITY PRINCIPLES AND PRACTICES, McGraw-Hill Publishing Company, New York, New York, 1969, p. 5.
4. TRANSPORT DIVISION RELIABILITY MANUAL, The Boeing Company, Seattle, Washington, Boeing Document D6-2770-1, 1967, p. 16.
5. Knight, C. R., Jervis, E. R., and Herd, G. R., TERMS OF INTEREST IN THE STUDY OF RELIABILITY, Aeronautical Radio, Inc., Washington, D.C., ARINC Monograph No. 2, May 1955.
6. MAINTENANCE ENGINEERING ANALYSIS, U.S. Army Logistics Management Center, Fort Lee, Virginia, ALM-43-3248-LC(B).
7. SYSTEM EFFECTIVENESS, U.S. Army Logistics Management Center, Fort Lee, Virginia, ALM-3234-LC(A).
8. NSIA TRADEOFF TECHNIQUE, U.S. Army Logistics Management Center, Fort Lee, Virginia, ALM-43-3566-LC(A).
9. Rummel, K. G., HELICOPTER DEVELOPMENT RELIABILITY TEST REQUIREMENTS, USAAMRDL Technical Report 71-18A, Eustis Directorate, U.S. Army Air Mobility Research and Development Laboratory, Fort Eustis, Virginia, April 1971.
10. Bowen, C. W., ANALYSIS OF TRANSMISSION FAILURE MODES, SAE Paper 710454, May 1971.
11. STUDY OF HELICOPTER TRANSMISSION SYSTEM DEVELOPMENT TESTING, FINAL REPORT, Sikorsky Aircraft Division of United Aircraft Corporation, SER50547, June 1968.
12. Mouradian, G., RELIABILITY ANALYSIS OF TRANSMISSIONS, Proceedings of the 1972 Annual Reliability and Maintainability Symposium, January 1972.

13. Menon, M. V., ESTIMATION OF THE SHAPE AND SCALE PARAMETERS OF THE WEIBULL DISTRIBUTION, International Business Machines Corporation, Research Paper RJ228, November 1962.
14. Johnson, L. G., THE STATISTICAL TREATMENT OF FATIGUE EXPERIMENTS, American Elsevier Publishing Company, New York, New York, April 1959.
15. Kao, John H. K., COMPUTER METHODS FOR ESTIMATING WEIBULL PARAMETERS IN RELIABILITY STUDIES, Transactions on Reliability and Quality Control, Institute of Radio Engineers, July 1958, pages 15-22.
16. Bowen, G. W., Dyson, L. I., and Walko, MODE OF FAILURE INVESTIGATIONS OF HELICOPTER TRANSMISSIONS, USAAVLABS Technical Report 73-58, Eustis Directorate, U.S. Army Air Mobility Research and Development Laboratory, Fort Eustis, Virginia, January 1971.

APPENDIX I
DEVELOPMENT OF LIMITING COST-EFFECTIVENESS HAZARD FUNCTION

INTRODUCTION

The intent of this section is to:

1. Develop and demonstrate the methodology for evaluating the effect of on-condition operation upon cost, reliability, maintainability, availability, and safety.
2. Identify the manner in which the limiting cost-effectiveness hazard function can be calculated.

The limiting cost-effectiveness hazard function is the mathematical relationship used to establish the optimum TBO or, conversely, to substantiate the potential for on-condition operation.

SUMMARY

In the following segments of this section, each of the parameters (cost, reliability, maintainability, availability, and safety) is looked at independently. For all parameters except safety, the effect of a change in β and θ caused by TBO removal is evaluated parametrically by using the simulation model discussed in Appendix V. For these four parameters, carpet plots* are developed, identifying the effect of changes in β and θ upon each parameter. Furthermore, in the case of cost and maintainability, limiting hazard functions are developed by comparing the results of a baseline run, generated with a 1,200-hour TBO, with the results shown on the respective carpet plots.

Limiting hazard functions are not developed for mission reliability or availability. It should be obvious from previous discussions regarding hazard functions that any increase in hazard rate after TBO will result in a decrease in effective MTBF for the transmission. Thus, availability and mission reliability, which are essentially dependent only upon MTBF, must decrease whenever the hazard function is increasing. Thus, it should be reiterated that in operating on-condition with an increasing hazard function, slightly decreased effectiveness is being traded against greatly decreased cost.

*A carpet plot is a 2-dimensional display capable of representing a relationship between 3 variables by using a sliding scale for locating the 2 independent variables.

Another comment regarding limiting hazard functions seems in order. These relationships (limiting hazard functions) are developed for cost and maintainability merely to give a visual representation of the amount of increase in hazard rate that can be tolerated from operating on-condition and still be more effective than operating with a TBO. It is postulated that for some people employing the methodology developed in this study, cost or maintainability could be of such great importance that cost-effectiveness trades may not be considered. In this case, it would then be mandatory that the limiting cost or maintainability hazard function be developed.

For those employing the total methodology (that is, all parameters up to and including cost-effectiveness), there is no need to develop the limiting hazard function for cost and maintainability. Work in these areas can be terminated with the completion of the respective carpet plots for cost and maintainability.

The relationship of cost-effectiveness to changes in β and θ resulting from TBO removal is identified through the application of a cost-effectiveness model developed in this section. A carpet plot relating cost-effectiveness to changes in β and θ is developed. Finally, this carpet plot is compared to the baseline run (1,200-hour TBO) and a limiting cost effectiveness hazard function is developed.

Safety requires and receives a separate treatment in this section. A methodology is identified for evaluating whether a transmission is safe for operation on condition. This methodology is then used to make a decision regarding the optimum position for a TBO (if on condition is not possible) from a safety aspect.

LIMITING COST HAZARD FUNCTION

To determine the limiting cost hazard function (LCHF), it is necessary that the following data be known (as in the case of a CH-47 transmission) or hypothesized (as would be the case with a new design):

1. Logistics costs (shipping, administration, MMH's, etc.)
2. Scheduled overhaul cost
3. Unscheduled overhaul cost
4. Unscheduled repair cost
5. Present TBO

6. β , θ , up to TBO

7. Utilization, life-cycle duration, and fleet size

Assuming that data items 1-4 will remain unchanged with an increase in TBO (or OC operation), we incrementally evaluate increased (or decreased) values of β and θ , past TBO, to identify the number of unscheduled removals for each combination of β and θ .

All cost factors (1 through 4) should now be added to determine the relative cost of scheduled versus unscheduled removal; that is, if a scheduled removal and subsequent overhaul are assumed to cost 1.0 cost units, then unscheduled overhaul will cost a cost units, where

$$a = \frac{\text{unscheduled overhaul cost (total)}}{\text{scheduled overhaul cost (total)}}$$

where unscheduled overhaul cost (total) = unscheduled overhaul cost and logistics cost

and scheduled overhaul cost (total) = scheduled overhaul cost and logistics cost.

Similarly, the relative cost of unscheduled repair would equal b cost units, where

$$b = \frac{\text{unscheduled repair cost (total)}}{\text{scheduled overhaul cost (total)}}$$

and unscheduled repair cost (total) = unscheduled repair cost and logistics costs.

Thus, using the values 1.0, a, and/or b for scheduled and unscheduled overhaul/repair cost ratios, one simulates two cases--first with the original TBO, and then with a new TBO (or on condition)--and identifies the total number of scheduled and unscheduled removals. The number of removals is then multiplied by the appropriate cost ratios to determine which manner of operation costs less.

The following example has been developed to identify the steps necessary for the development of a limiting cost hazard function.

1. Identify Pertinent Data

Typical Transmission Data

Logistics costs	\$1,784
Scheduled overhaul cost	\$11,000 = 1.00 unit
Unscheduled overhaul cost	\$22,000 = 2.00 units = 2
Unscheduled repair cost	\$7,481 = 0.68 unit = b
Present TBO	1,200 hours
β	1.0
θ	2,870.0 hours
Utilization, life-cycle duration, and fleet size	60 hours per aircraft per month 9 years 100 aircraft

- Employing the simulation model discussed in Appendix V, run the baseline run and then delete the TBO and parametrically vary β and θ past the original TBO to identify the number of unscheduled removals that would be generated if the TBO were removed and the hazard function were to change. This data is presented in Table II for the example case.
- Plot the cost versus β and θ after TBO, as shown in Figure 13. Cost equals \underline{a} times the number of unscheduled removals plus one times the number of scheduled removals.
- Construct a line on the cost chart at the cost value derived for the baseline case. This line is shown as the dotted line in Figure 13.
- Construct an indifference curve using the points where the carpet plot of Figure 13 intersects the baseline dotted line. The indifference curve is shown in Figure 14. In this case, goodness is above the line.
- Find the point on the indifference curve which satisfies the following criteria:

$$\left(\frac{\beta}{\theta}\right) (tBO)^{\beta-1} = \left(\frac{\beta'}{\theta' B'}\right) (tBO)^{\beta'-1}$$

TABLE II. COST FOR VARIOUS VALUES OF β' AND θ' ENCOUNTERED BY REMOVING TBO

β'	θ'	Failures	Cost
0.5	1,000	243	486
1.0	1,000	462	924
2.0	1,000	510	1,020
3.0	1,000	536	1,072
4.0	1,000	562	1,124
5.0	1,000	570	1,140
1.0	1,500	363	726
2.0	1,500	399	798
4.0	1,500	409	818
1.0	2,000	296	592
2.0	2,000	312	624
3.0	2,000	332	664
4.0	2,000	336	672
5.0	2,000	338	676
1.0	2,500	248	496
2.0	2,500	275	550
3.0	2,500	284	568
4.0	2,500	285	570
0.5	3,000	161	322
1.0	3,000	213	426
2.0	3,000	243	486
3.0	3,000	247	494
4.0	3,000	242	484
5.0	3,000	238	476
3.0	3,500	219	438

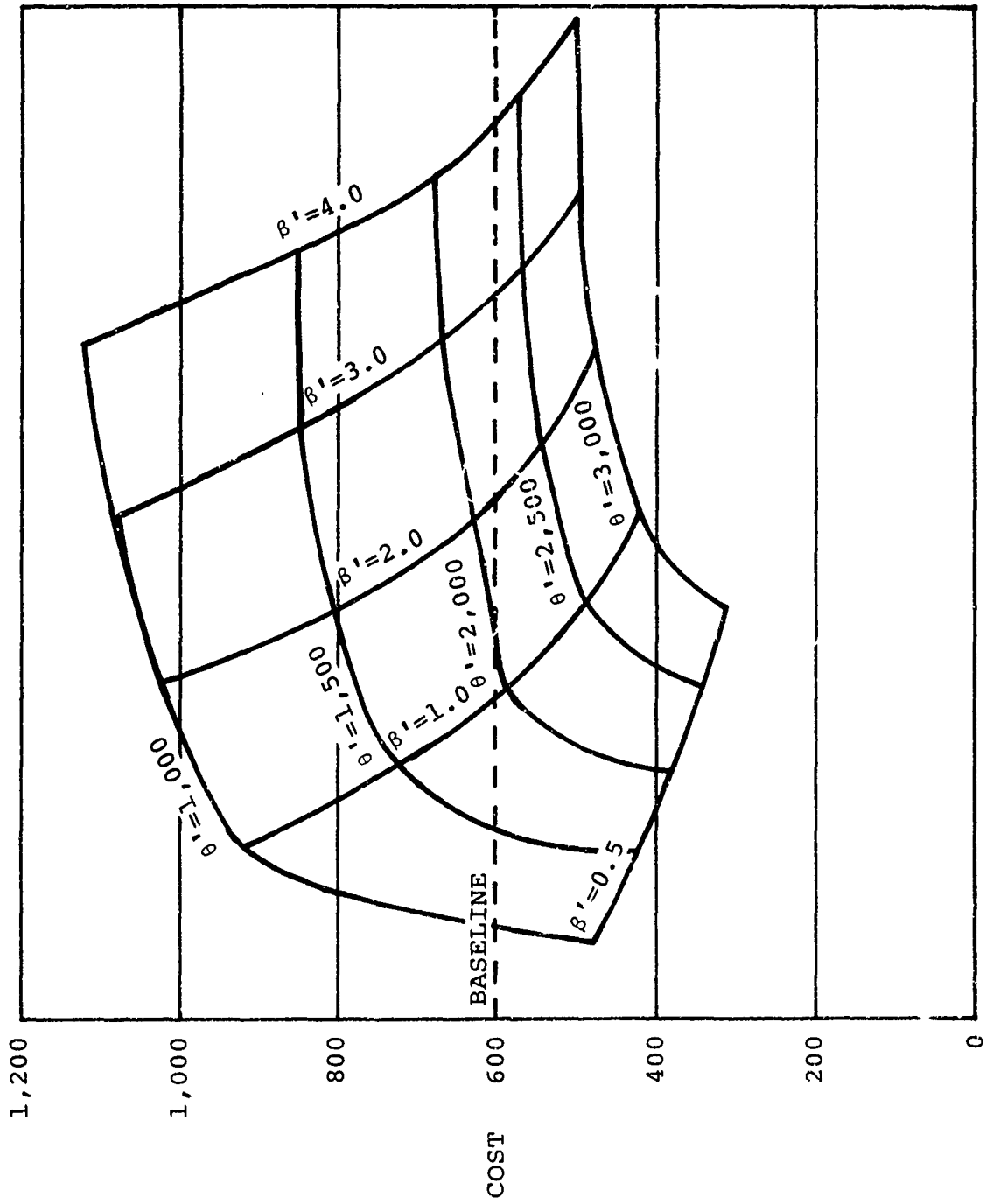

Figure 13. Relationship of Cost to β' and θ' .

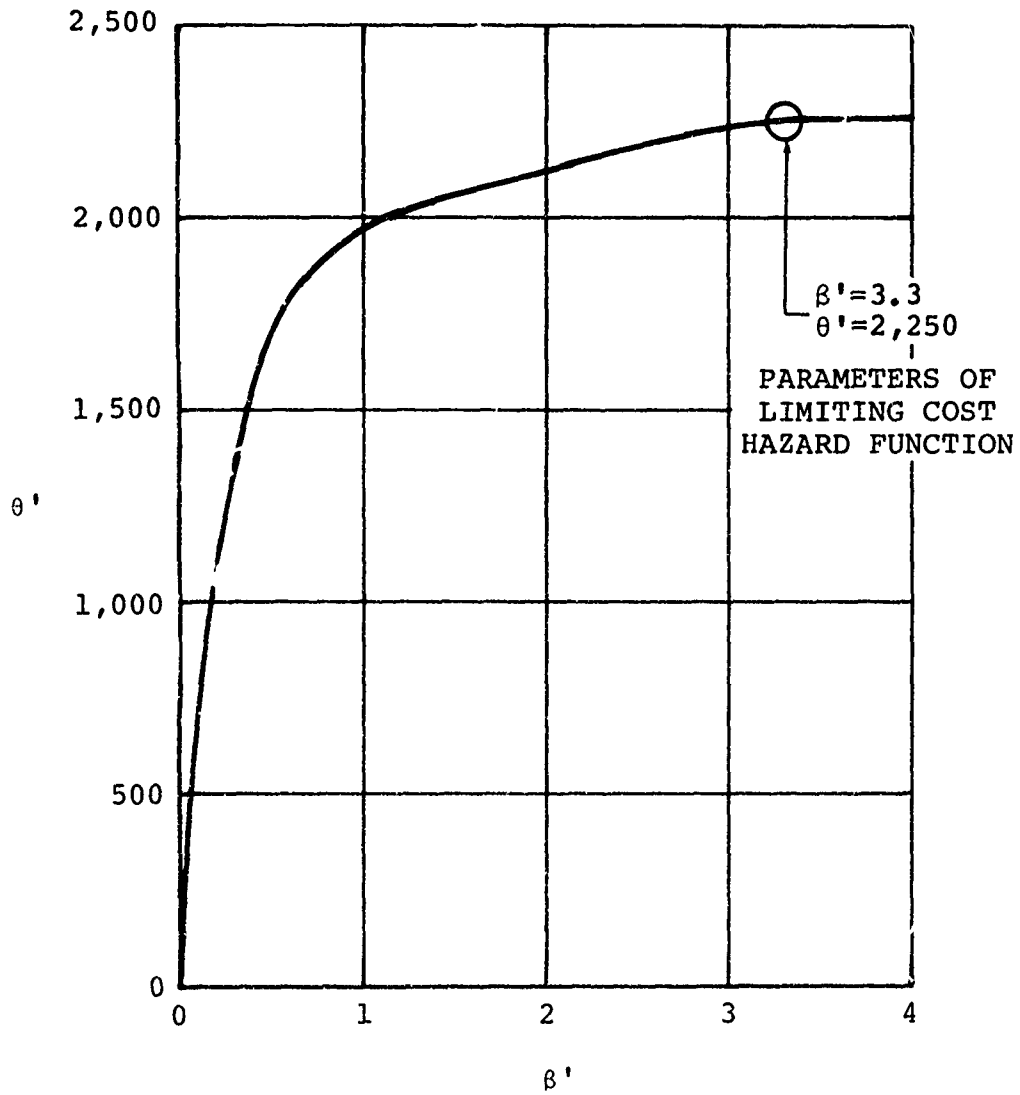

Figure 14. Equal Cost Indifference Curve.

where β , θ , and TBO are the baseline values, and β' and θ' are the values off the indifference curve.

It is necessary that this equality be satisfied to fulfill the requirement that the hazard function should not be discontinuous at time equals TBO. In other words, it is unlikely that one hour after $t = TBO$, the hazard function would become entirely different. Rather, it would change continuously as time increased.

7. Construct the limiting cost hazard function using the β and θ values to calculate the hazard rate up to TBO and using β' and θ' resulting from Step 6 to calculate the hazard rate past TBO. This plot is shown in Figure 15.

LIMITING HAZARD FUNCTION FOR MAINTAINABILITY

In order to construct a limiting hazard function for maintainability, the following data must be identified:

1. Unscheduled MMH/removal
2. Scheduled MMH/removal
3. Present TBO
4. β , θ up to TBO
5. Utilization, life-cycle duration, and fleet size

With the assumption that item 1 would be the same for an on-condition transmission, it is possible to evaluate the limiting hazard function for maintainability.

Let unscheduled MMH/removal = 1.0 unit and scheduled MMH/
removal = a unit

where a, in most instances for a transmission since there is no need for troubleshooting, is less than 1.0. For the example plots of this section, let $a = 0.5$.

The equal MMH relationship that must hold for an on-condition versus TBO-limited component is

$$a \cdot \text{no. of scheduled removals (with TBO)} + \text{no. of unscheduled removals (with TBO)} = \text{unscheduled removals (on condition).}$$

Now the procedure for evaluating the limiting maintainability hazard function is the same as for the limiting cost hazard function.

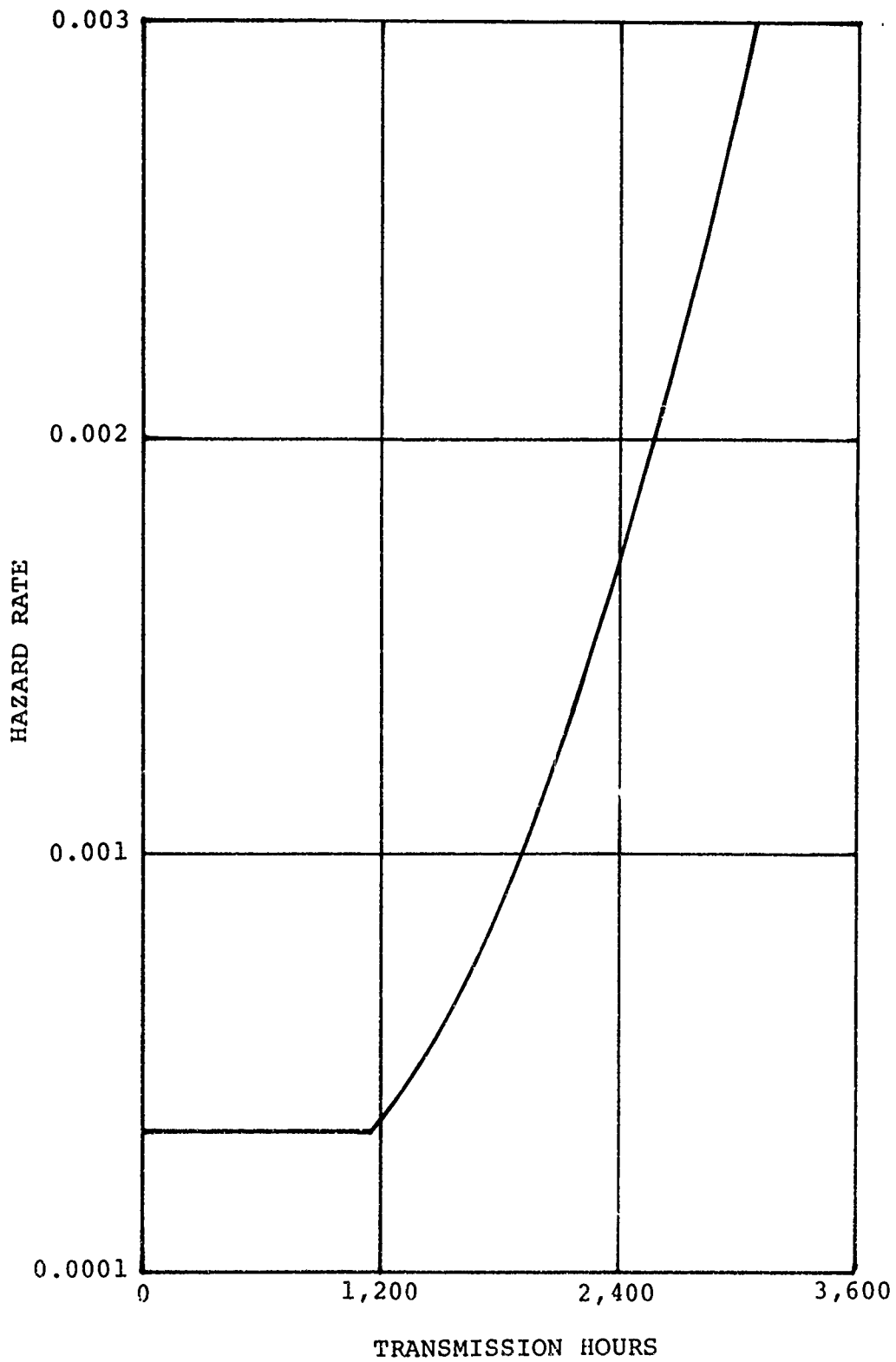

Figure 15. Limiting Cost Hazard Function.

1. Using the baseline data for β , θ and TBO, simulate fleet operation over a time frame and calculate total scheduled and unscheduled removals.
2. Parametrically vary β' and θ' past TBO for on-condition components to establish the relationship between β' , θ' and total unscheduled removals. Since this data could be--and in this example is--the same as that developed in the previous section and shown in Table II, this table is not repeated. Now use this data to construct a plot of unscheduled maintenance man-hours versus β' and θ' . This relationship is shown in Figure 16.
3. Using the relationship

a . no. of scheduled removals (with TBO) + no. of unscheduled removals (with TBO) = baseline MMH units,

calculate the number of unscheduled MMH which are generated with a TBO (baseline MMH units).
4. Place this line on the carpet plot (Figure 16) and distinguish points which are used to generate the indifference curve (Figure 17).
5. Calculate hazard rate for original β and θ at TBO.
6. Pick out points on the indifference curve and calculate hazard rates by trial and error until a solution (β' , θ') is found that yields the same value for the hazard function at TBO, as does the baseline hazard rate.
7. Construct the limiting maintenance man-hours hazard function using the values of β , θ previous to TBO and the β' and θ' values found earlier for calculation of the hazard rate after TBO. See Figure 18.

RELIABILITY

For transmissions, there are three kinds of reliability: maintenance reliability, mission reliability and safety reliability. Safety reliability will be addressed as a separate entity in a following section of the paper. Maintenance reliability impacts the following areas: cost, maintenance, and availability. The sensitivity of cost and maintenance to on-condition operation has been discussed in the preceding sections, while availability will be discussed independently in a following section. Therefore, the analysis that will be performed in this section will deal solely with the effect of on-condition operation upon mission reliability.

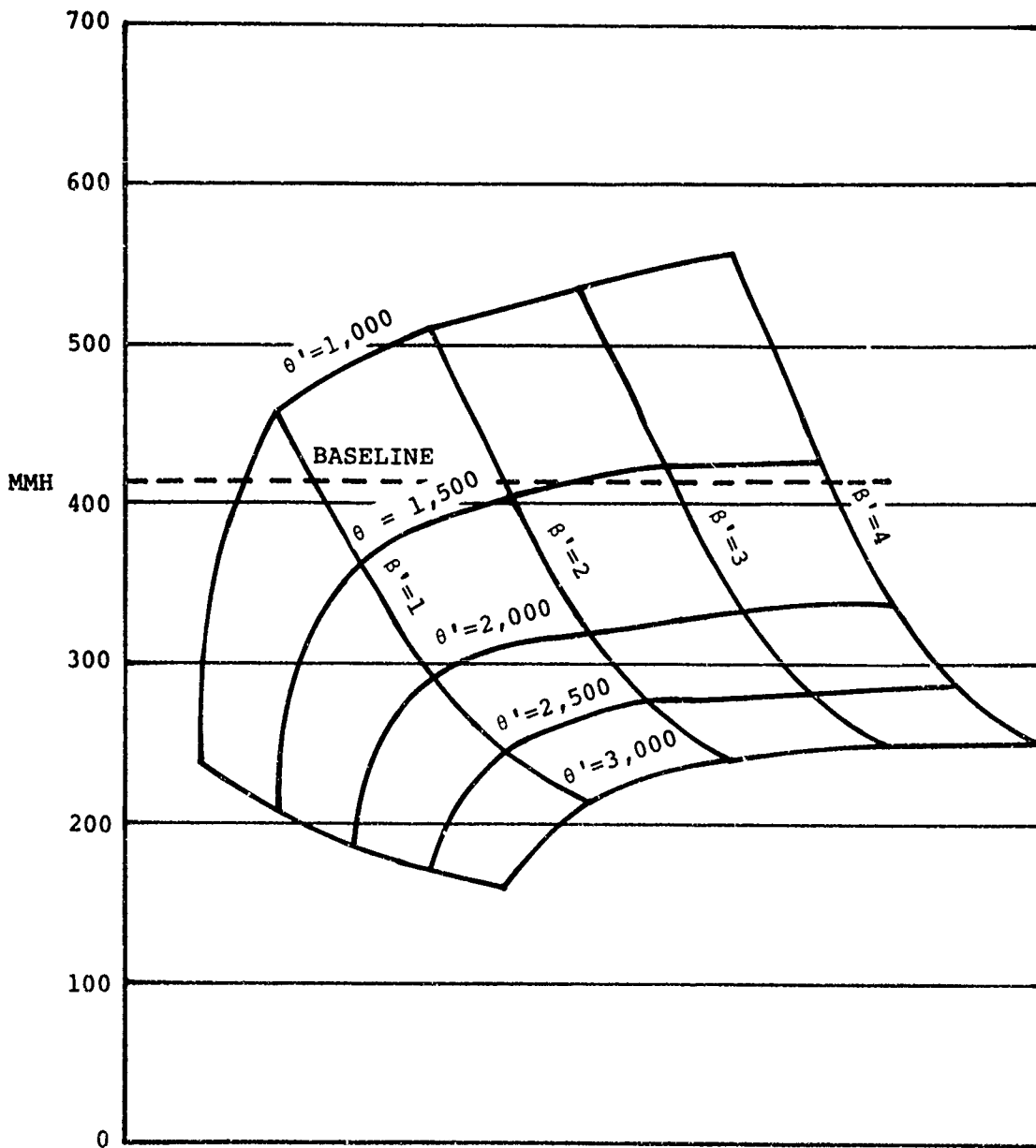

Figure 16. Relationship of Maintenance Man-Hours to β' and θ' .

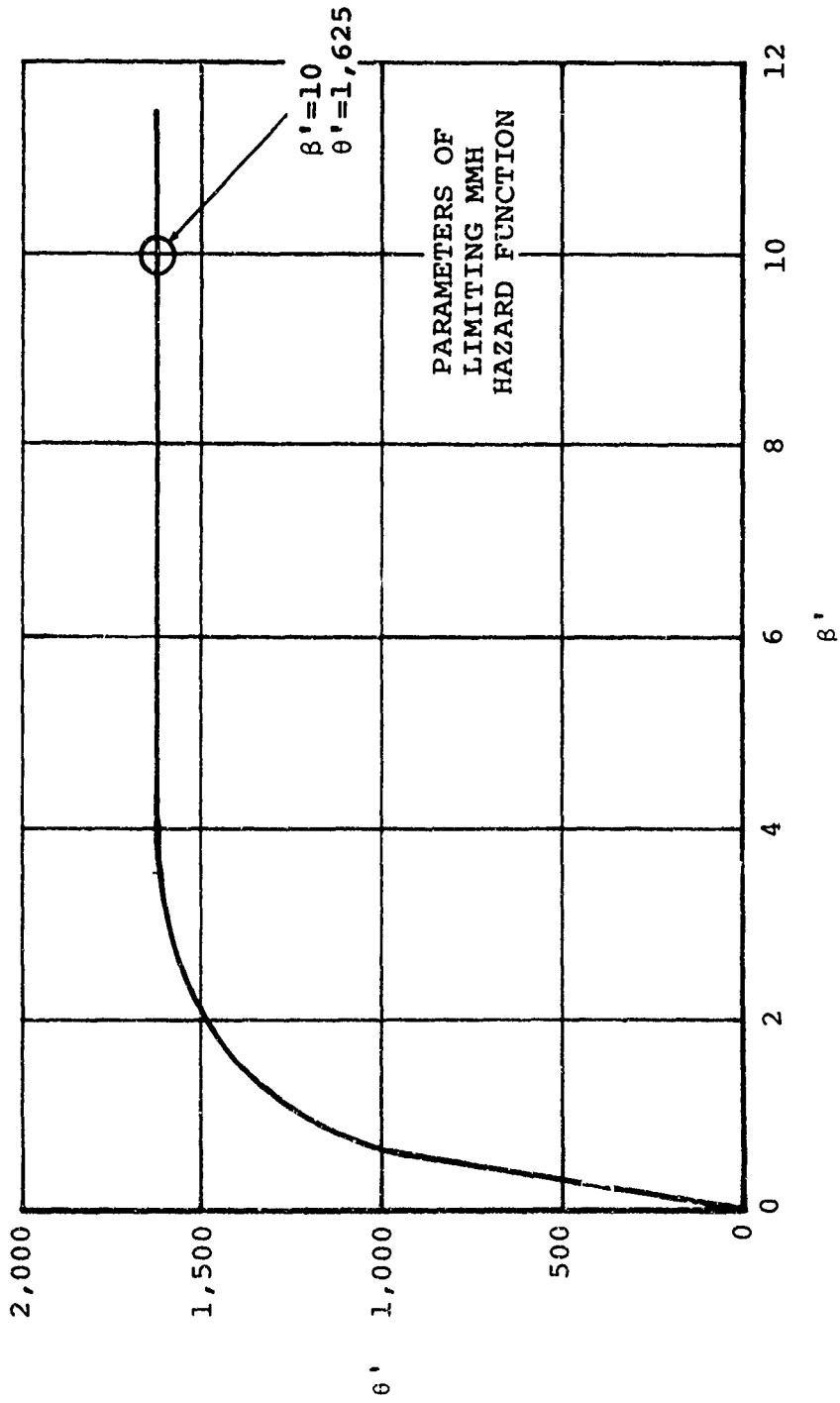

Figure 17. Equal MMH Indifference Curve.

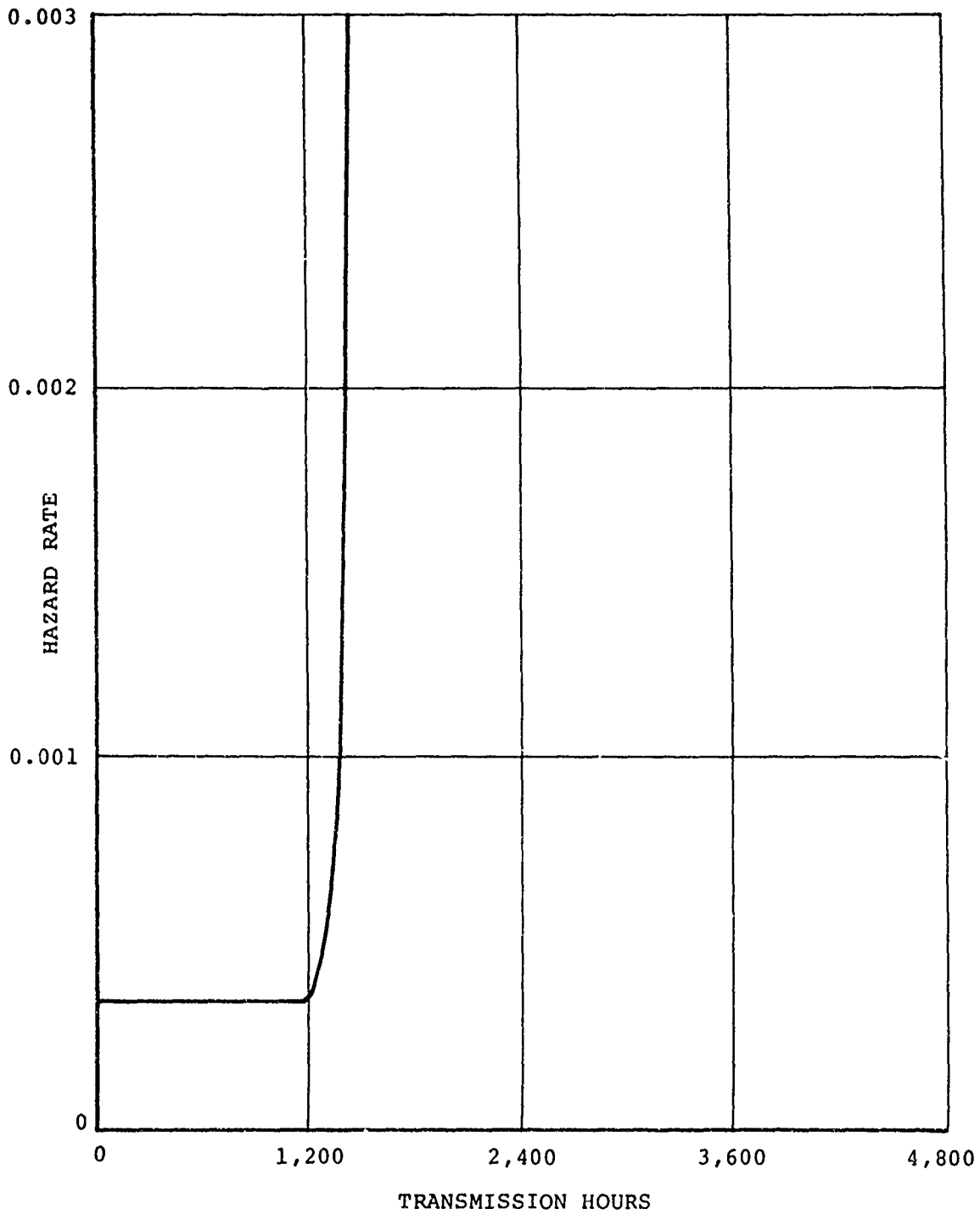

Figure 18. Limiting MMH Hazard Function.

The method for evaluating the effect of on-condition operation upon mission reliability is based upon the assumption that mission aborts can be predicted as a function of the unscheduled removal rate. This is, mathematically

$$\lambda_{\text{Mission Abort}} = K (\lambda_{\text{Maintenance}})^C$$

where K and C are proportionality constants (C is generally assumed to = 1.0) dependent upon gearbox configuration, rather than the magnitude of the maintenance malfunction rate.

Now if we assume that K and C are independent of TBO, the manner in which the impact of on-condition maintenance upon mission reliability can be evaluated is as follows:

1. Estimate K and C either from historical data or based upon reliability predictions and failure mode effect and criticality analysis.

The following example illustrates this point.

For gearbox X in 815,000 hours of fleet operation, 284 unscheduled removals and 1 mission affecting malfunctions have occurred. Thus,

$$\lambda_{\text{Mission Abort}} = \frac{1}{815,000} = 0.000001227$$

$$\lambda_{\text{Maintenance}} = \frac{1}{2870} = 0.0003484$$

Therefore, $0.000001227 = K (0.0003484)^C$ and for $C = 1.0$, we find $K = 0.00352147$

2. Using the failure distribution parameters, β , θ and TBO for the gearbox, run the previously utilized simulation model to identify the number of failures generated for the baseline. Convert this to a failure rate and multiply this by K to develop the mission affecting λ resulting from the baseline simulation.

Next calculate the baseline mission reliability using the formula

$$R_{\text{Mission}} = e^{-\lambda_{\text{Mission}} \cdot t}$$

where t = the length of the particular mission for which the aircraft being simulated is employed.

3. Now parametrically vary the β and θ after TBO (as was done to develop the limiting cost and maintainability hazard function) and run the simulation to identify the number of unscheduled removals that would be generated in on-condition gearbox operations. Again convert this to a rate per hour and multiply by K to develop a set of mission affecting λ 's. Again use the equation

$$R_{\text{Mission}} = e^{-\lambda_{\text{Mission}} \cdot t}$$

to develop a set of mission reliability values for parametrically varying levels of increasing hazard rate past TBO.

4. Now develop a carpet plot of mission reliability versus β' and θ' . Although a limiting hazard function will not be developed for mission reliability, these values will be employed in the final step of the analyses which is the development of the limiting hazard function for cost-effectiveness. To construct a carpet plot for mission reliability for the example, employ the value for K which was previously calculated and assume $C = 1.0$. This value is based on 815,000 hours of CH-47A aft transmission experience. See Figure 19.

This carpet plot will be utilized in developing the limiting cost-effectiveness hazard function in the last segment of this section.

AVAILABILITY

As stated in the main text of the report,

$$\text{Inherent Availability} = \frac{\text{MTBF}}{\text{MTBF} + \text{MTTR}}$$

where MTTR = organizational mean time to remove.

The MTTR is independent of TBO; therefore, the limiting hazard function for availability is really dependent only upon MTBF. It should be obvious from previous discussions that if a transmission has an increasing hazard function past TBO, the average MTBF will be decreased by on-condition operation. Thus, for components exhibiting an increasing hazard function, on-condition operation will result in a decrease in availability. However, the magnitude of this decrease must be

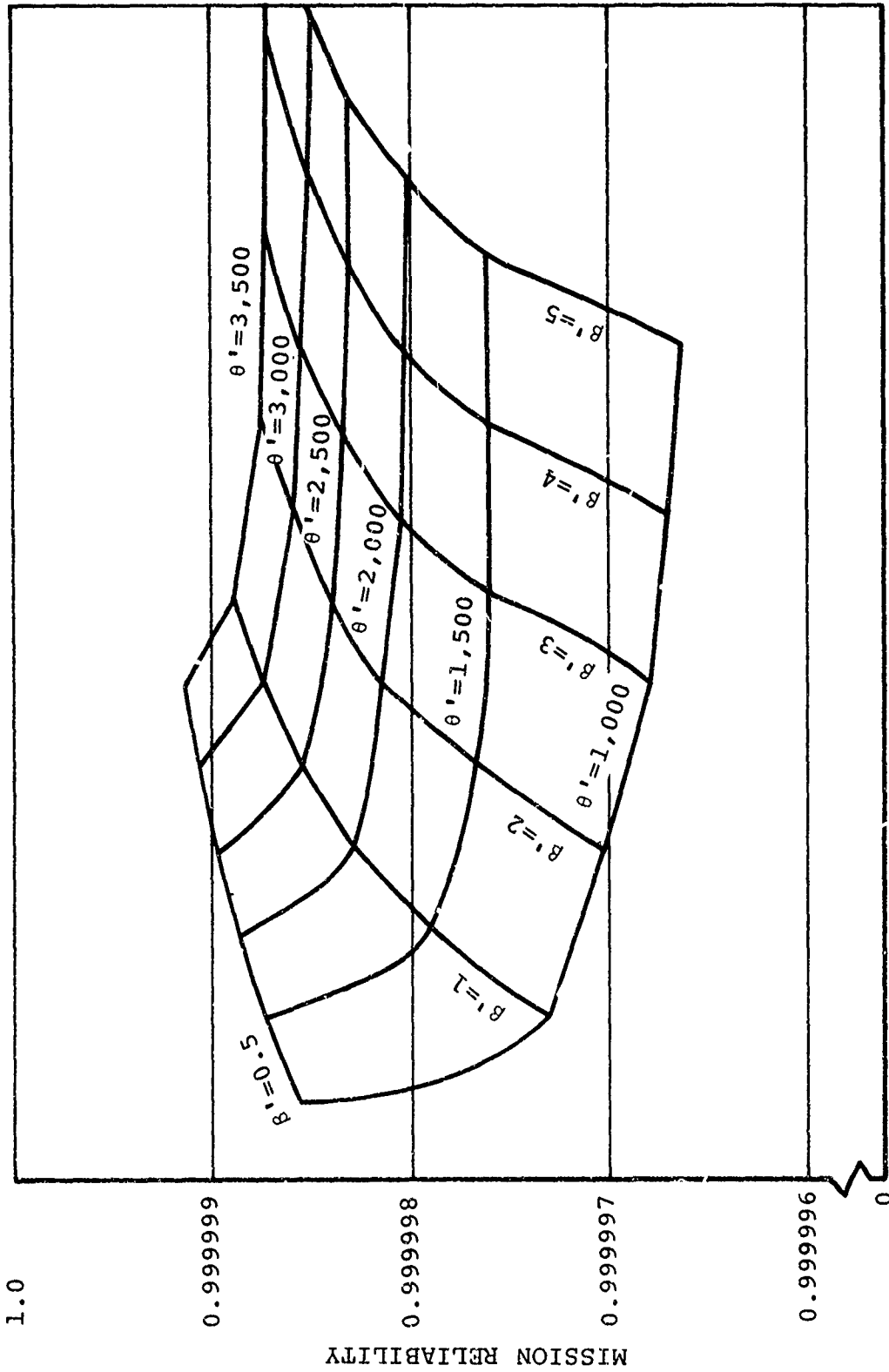

Figure 19. Relationship of Mission Reliability to θ' and θ' .

quantified before a loss in availability can be traded off against potential increases in cost-effectiveness resulting from on-condition operation. Thus, it is necessary to parametrically investigate the sensitivity of availability to on-condition operation. To do this, the following steps must be taken:

1. Using the failure distribution parameters β , θ and TBO for the gearbox, run the previously utilized simulation model to identify the number of failures generated for the baseline. Convert this figure into an MTBF and calculate the baseline availability using the equation

$$A_i = \frac{MTBF}{MTBF + MTTR}$$

(where MTTR is known from experience or estimated by maintenance engineering analysis).

2. Parametrically vary β' and θ' after TBO and run the simulation model to identify the number of unscheduled removals that would be generated in on-condition gearbox operation. Again convert the values into MTBF's and calculate the resulting availability values.
3. Develop a carpet plot of availability versus β' and θ' (Figure 20). These values will be used in the development of the limiting hazard function for cost-effectiveness.

At this time the conservative nature of inherent availability as a tool for measuring the potential of on-condition operation should be restated.

Achieved availability has been stated as

$$A_a = \frac{MTBR}{MTBR + MDT}$$

If one were to use achieved availability in this evaluation, scheduled removals resulting from TBO imposition would have to be used in the comparison. When this happens, on-condition operation always yields fewer total removals and therefore, higher availability than operating with a TBO. For example, using the simulation model of fleet operation developed in Appendix IV, the following results were produced. With a β of 2.0 and a θ of 3500 hours, the fleet operating with a TBO had accumulated 481 total removals after more than 600,000 hours of operation. Holding everything constant, but eliminating the TBO, resulted in only 169 removals. Although this 169

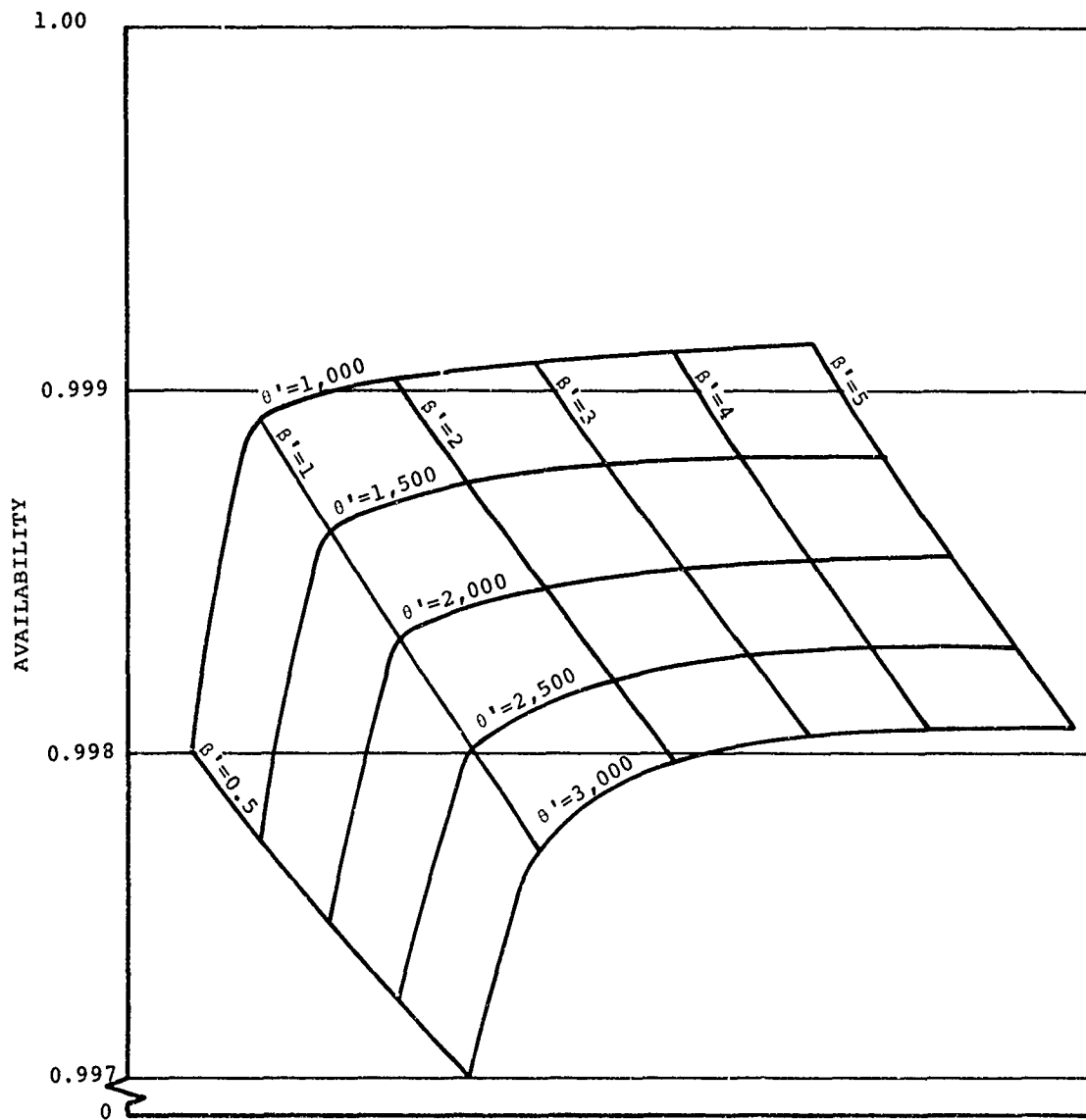

Figure 20. Relationship of Availability to β' and θ' .

represented failures, while the 481 was comprised of 64 failures and 417 scheduled removals, achieved availability would have been higher and cost lower for operation without a TBO. It would seem rather easy to justify on-condition operation using achieved availability.

Instead of achieved availability, using inherent availability compares the on-condition transmission with the TBO unit on the basis of failure rate and eliminates the artificial factor of scheduled removals which results in a conservative contrast.

SAFETY

On-condition transmission operation can be a viable maintenance philosophy only if safety does not deteriorate after TBO. As previously stated, due to the few transmission-caused helicopter accidents, it is virtually impossible to rigorously define a safety hazard function. Thus, the approach used in evaluating safety is necessarily very different from that used in the preceding sections of this report.

The major steps in the safety evaluation (Figure 21) are to:

1. Perform a failure modes effects and criticality analysis (FMECA) which generates a list of all critical modes.
2. Consider the fail-safe design features of the gearbox to determine those remaining modes which are not fail safe (fail catastrophic modes).
3. Consider the failure warning and inspection system of the gearbox to identify the fail catastrophic modes which are undetectable and unpredictable.
4. Consider the historically expected β to identify which of these modes have increasing hazard functions and are, therefore, adverse to on-condition operation.
5. For those undetectable, fail catastrophic components with β values greater than 1, estimate modal θ values using historical data or reliability predictions. Next, employ the program relating β_{10} or θ to hazard rate to evaluate whether they have significantly increasing hazard rates within their maximum expected life (i.e., 5,000 hours).
6. Any modes remaining (i.e., undetectable, fail catastrophic, and significantly increasing hazard rate) should be eliminated by design, test or failure warning if the gearbox is to operate on condition.

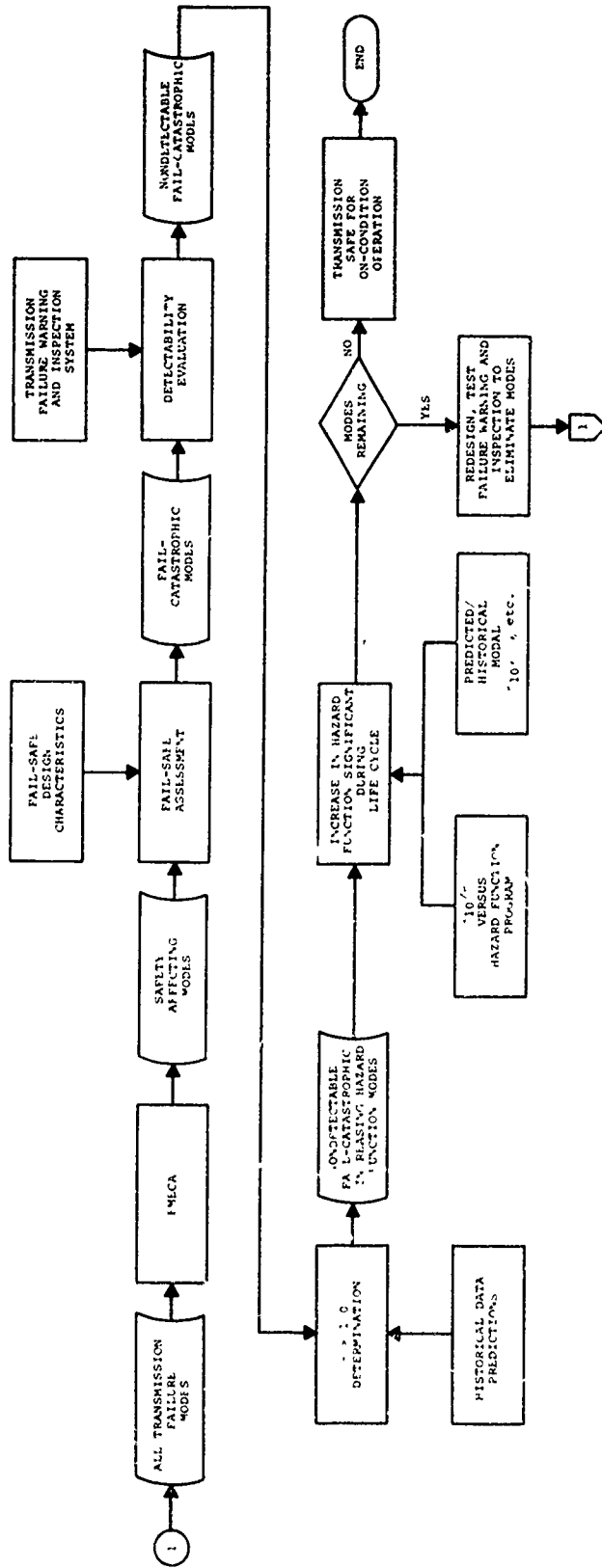

Figure 2.1. On-Condition Safety Evaluation.

As was the case for mission reliability and availability, it is not necessary to develop a limiting hazard function for safety. Also, as previously stated, due to the impact of safety considerations upon aircraft operation, it is not a parameter for tradeoff versus cost-effectiveness and therefore will not be included in the model for cost-effectiveness.

In conclusion, it should be reiterated that since transmission safety affecting failure data is scarce, performance of tasks (4) and (5) may be exceedingly difficult. It is anticipated that a great deal of engineering analysis, rather than rigorous mathematics, may be required to make decisions.

This potential lack of ability to perform these tasks should not be permitted to prohibit completion of the safety analysis.

DEVELOPMENT OF COST-EFFECTIVENESS

As demonstrated in ALCM - 3234-LC(A), a measure of effectiveness (MOE) which can be employed to monitor system effectiveness is

$$\text{MOE} = F (\text{inherent availability, dependability, capability}).$$

As identified in the Army document and modified for pertinence to helicopter transmissions,

$$[\text{AI}] = \text{Availability Index} = [\text{Avail}, 1 - \text{Avail}]$$

$$[\text{DI}] = \text{Dependability Index} = \begin{bmatrix} R_{\text{Mission}}, & 1 - R_{\text{Mission}} \\ 0, & 0 \end{bmatrix}$$

$$[\text{CI}] = \text{Capability Index} = \begin{bmatrix} 1 \\ 0 \end{bmatrix}$$

Therefore, $\text{MOE} = [\text{AI}] \cdot [\text{DI}] \cdot [\text{CI}]$ which simplifies upon matrix multiplication to $\text{MOE} = \text{Availability} \cdot R_{\text{Mission}}$.

Thus, one can extrapolate to development of a cost-effectiveness measure (CMOE) by using the relationship

$$\text{CMOE} = \frac{\text{MOE}}{\text{LCC}}$$

where LCC equals some measure of life cycle cost--possibly cost per flight hour. Since the MOE values will be less than one, values for LCC should be kept down to some reasonable unit (i.e., cost values should probably be in the range of one to 1,000) so that the range of values for CMOE will not be so

infinitesimal that fluctuations will be undetectable due to calculating machinery limitations.

The performance of this analysis is demonstrated using, as an example, the baseline data previously employed.

$$\begin{aligned}
 \theta &= 2,870 \text{ hr} \\
 \beta &= 1.0 \\
 \text{TBO} &= 1,200 \text{ hr} \\
 \text{No. of Aircraft} &= 100 \\
 \text{No. of Months} &= 108 \\
 \text{Average Utilization} &= 60 \text{ hours/aircraft/month} \\
 \\
 \text{Scheduled Removal Cost} &= 1.0 \text{ Unit} \\
 \text{Unscheduled Removal Cost} &= 2.0 \text{ Units}
 \end{aligned}$$

Thus, the equation to be solved is

$$\begin{aligned}
 \text{CMOE} &= \frac{\text{Availability} \cdot R_{\text{Mission}}}{\text{LCC}} \\
 &= \frac{\frac{\text{MTBF}}{\text{MTBF} + \text{MTTR}} \cdot e^{-K \cdot \lambda \cdot t}}{\text{Number of Removals} \cdot \text{Cost per Removal}} \\
 &= \frac{\frac{\text{Number of Hours}}{\text{Number of Unscheduled Removals} + \text{MTTR}} \cdot e^{-\frac{K \cdot \text{No of Unsch. Removals}}{\text{Number of Hours}}}}{\text{Number of Total Removals} \cdot \text{Cost per Removal}}
 \end{aligned}$$

- o Now for the baseline run and all subsequent simulation runs, Number of Hours is approximately constant at 600,000.
- o From historical data, K (the ratio of mission affecting transmission failures to total unscheduled removals) is approximately

$$K = \frac{2,870}{815,000} = 0.003521$$

- o Historically, the MTTR for unscheduled transmission removals has run about 5.0 hours.
- o Let t = mission length = 1.0 hour

Now for simplicity let N_U = number of unscheduled removals
and N_T = number of total removals

Then, the equation for CMOE becomes

$$\begin{aligned} \text{CMOE} &= \frac{\frac{600,000}{N_U} \cdot e^{-\frac{0.003521}{600,000} \cdot N_U}}{\frac{600,000}{N_U} + 5.0} \\ &= \frac{1 - \frac{1}{\frac{120,000}{N_U} + 1}}{2 \cdot N_U + (N_T - N_U)} \left(1 - 0.0000000059 \cdot N_U \right) \\ &= \frac{\left(1 - \frac{1}{\frac{120,000}{N_U} + 1} \right) \left(1 - 0.0000000059 \cdot N_U \right)}{N_T + N_U} \end{aligned}$$

Now calculate CMOE for the baseline case in order to construct a limiting hazard function for CMOE.

For the baseline case

$$N_U = 221$$

$$N_T = 603$$

$$\begin{aligned} \text{CMOE} &= \frac{1 - \frac{1}{\frac{120,000}{221} + 1}}{603 + 221} \cdot 1 - 0.0000000059 \cdot 221 \\ &= 0.00121135972977 \end{aligned}$$

For on-condition operation to be more efficient than operating with a TBO (at 1,200 hours), the solution to the CMOE equation must be greater than 0.00121135972977.

Thus, using the numbers of failures generated by parametrically varying β' and θ' in the limiting cost hazard function section of this chapter, it is now possible to develop a carpet plot of CMOE versus β' and θ' after TBO (Figure 22). This establishes the foundation for development of the equal cost-effectiveness indifference curve (Figure 23) and subsequently the limiting cost-effectiveness hazard function (Figure 24).

It should be noted here that the model for cost-effectiveness

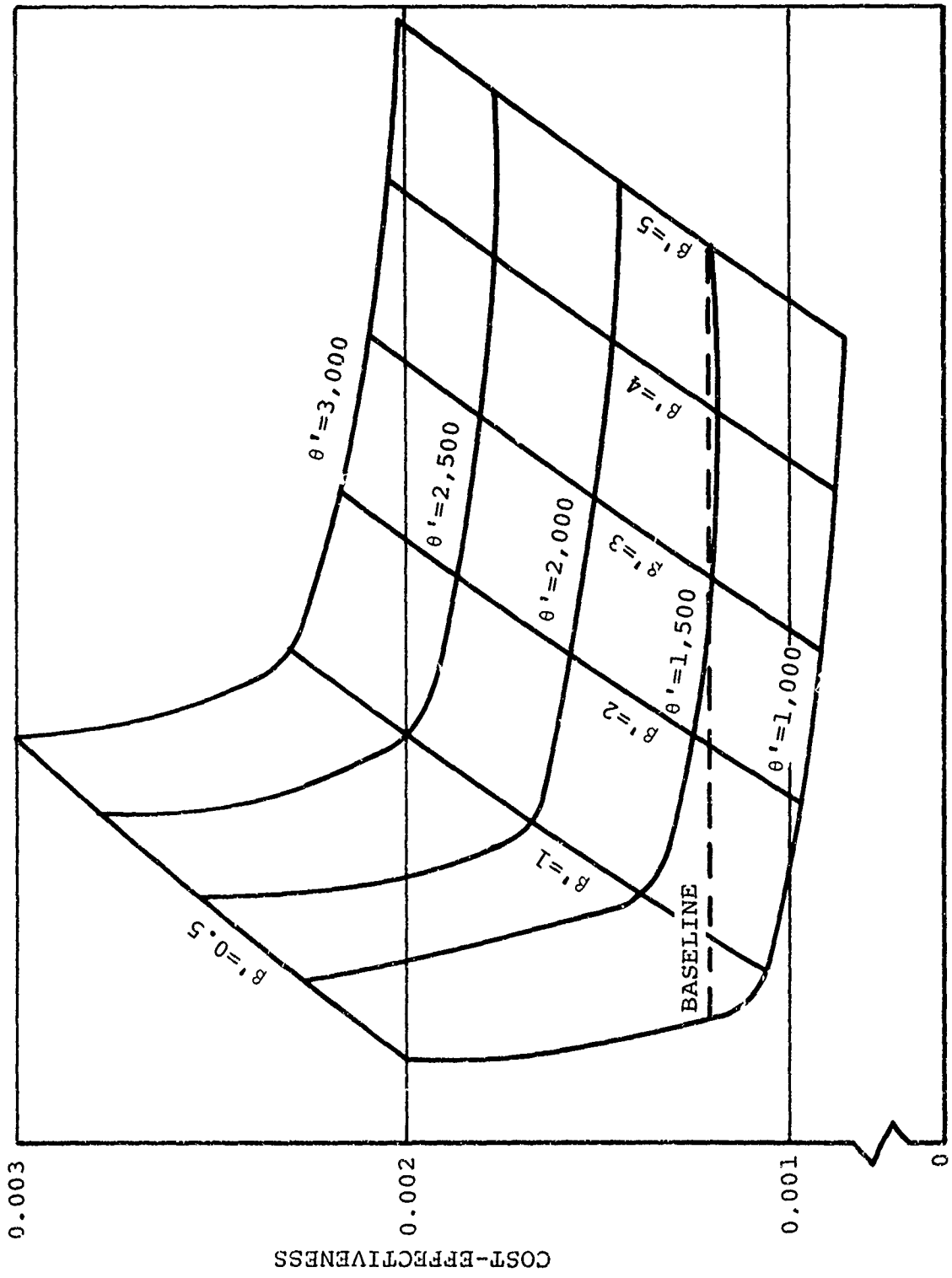

Figure 22. Relationship of Cost-Effectiveness to β' and θ' .

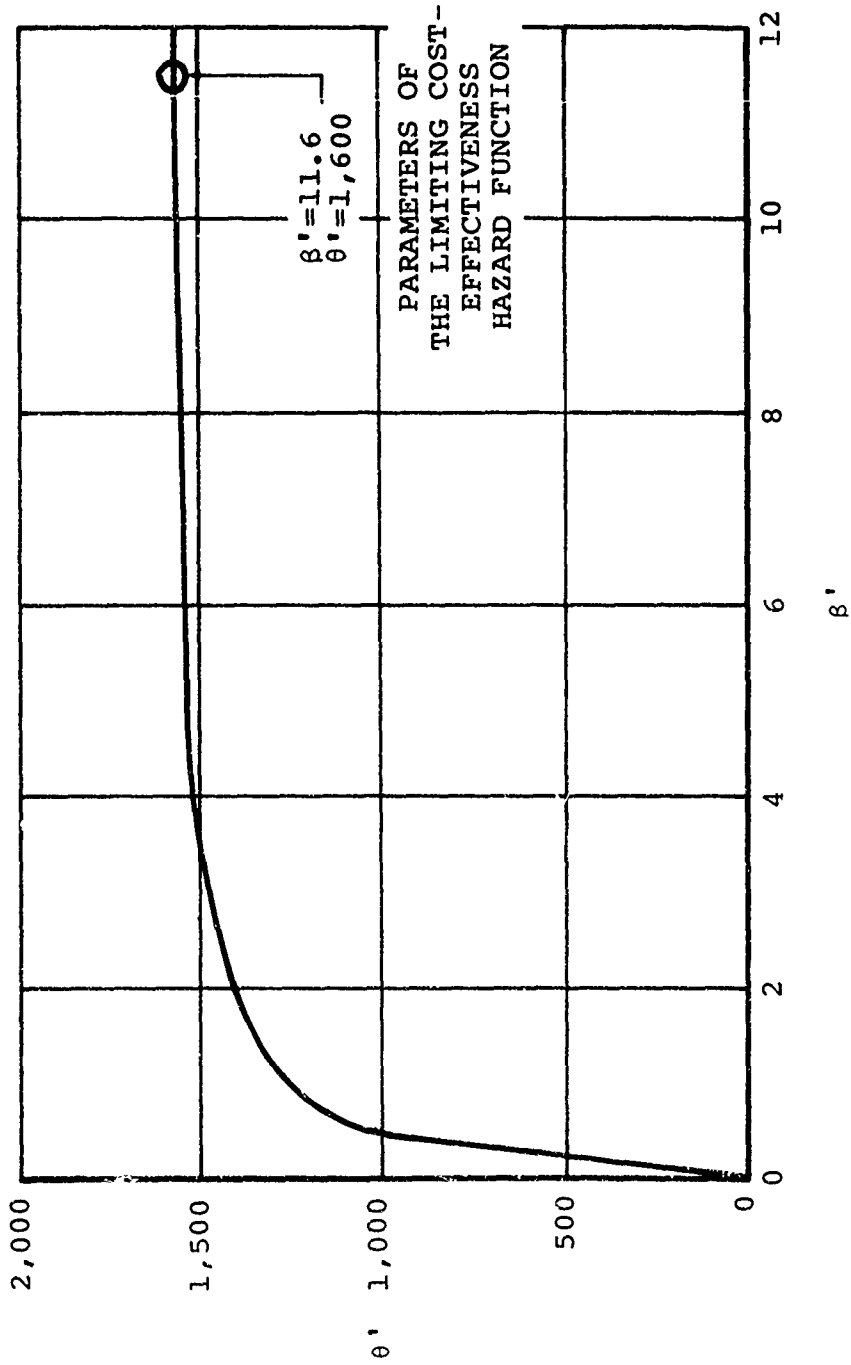

Figure 23. Equal Cost-Effectiveness Indifference Curve.

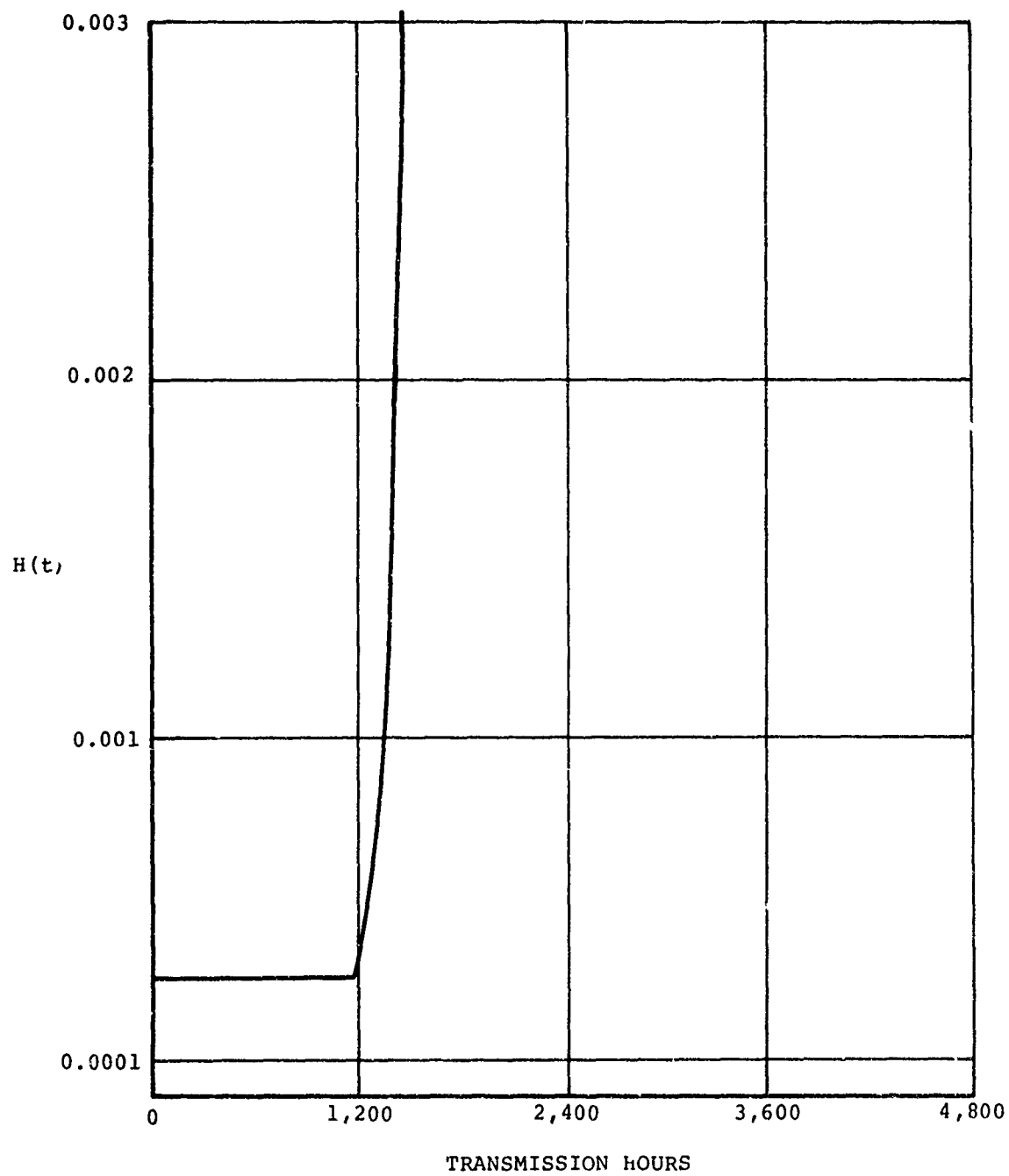

Figure 24. Limiting Cost-Effectiveness Hazard Function.

developed in this section gives availability, mission reliability, and cost equal attention. However, if based upon the specific application of the aircraft under consideration one parameter is significantly more important than another, the CMOE equation can be modified simply by using a weighting factor on each parameter. It is suggested that an equation of the following form would be most applicable in the weighted case

$$\text{CMOE} = \frac{(1 - (1 - A_{\text{inherent}})^V) \cdot (1 - (1 - R_{\text{Mission}})^L)}{M \cdot (\text{Life-Cycle Cost})}$$

where V, L, M are weighting factors for availability, mission reliability and life-cycle cost, respectively.

Finally, Figure 25 has been developed to identify the effect of changes in MTBF upon both availability and mission reliability.

For Figure 25, an MTTR value of 5 hours and a K value of 0.003521 were used in the availability and mission reliability equations previously developed.

Optimum TBO

The transmission data analyzed for this study report was almost exclusively concerned with transmissions which have operated for 1,200 hours or less, since few have operated beyond this regime. The modal hazard functions observed in this data have shown β 's predominantly around 1.0 or less. With β 's of 1.0 or less, the assembly hazard function will almost always be less than the limiting cost-effectiveness hazard function derived from a baseline TBO case, and on-condition operation will always be preferable to operation with a TBO.

When the assembly hazard function, however, has a β greater than 1.0, operation with a TBO may be more cost-effective and require a case-by-case evaluation. The method of determining the optimum TBO is straightforward, and involves four steps:

1. Determine the assembly hazard function.
2. Determine the relative costs of scheduled and unscheduled removals.
3. Using the computer program developed in Appendix V, simulate fleet operation up to the expected life of the transmission, assuming the assembly hazard function just determined and varying the TBO for each run, up to its expected life. This will yield the expected number of scheduled and unscheduled removals for each TBO.

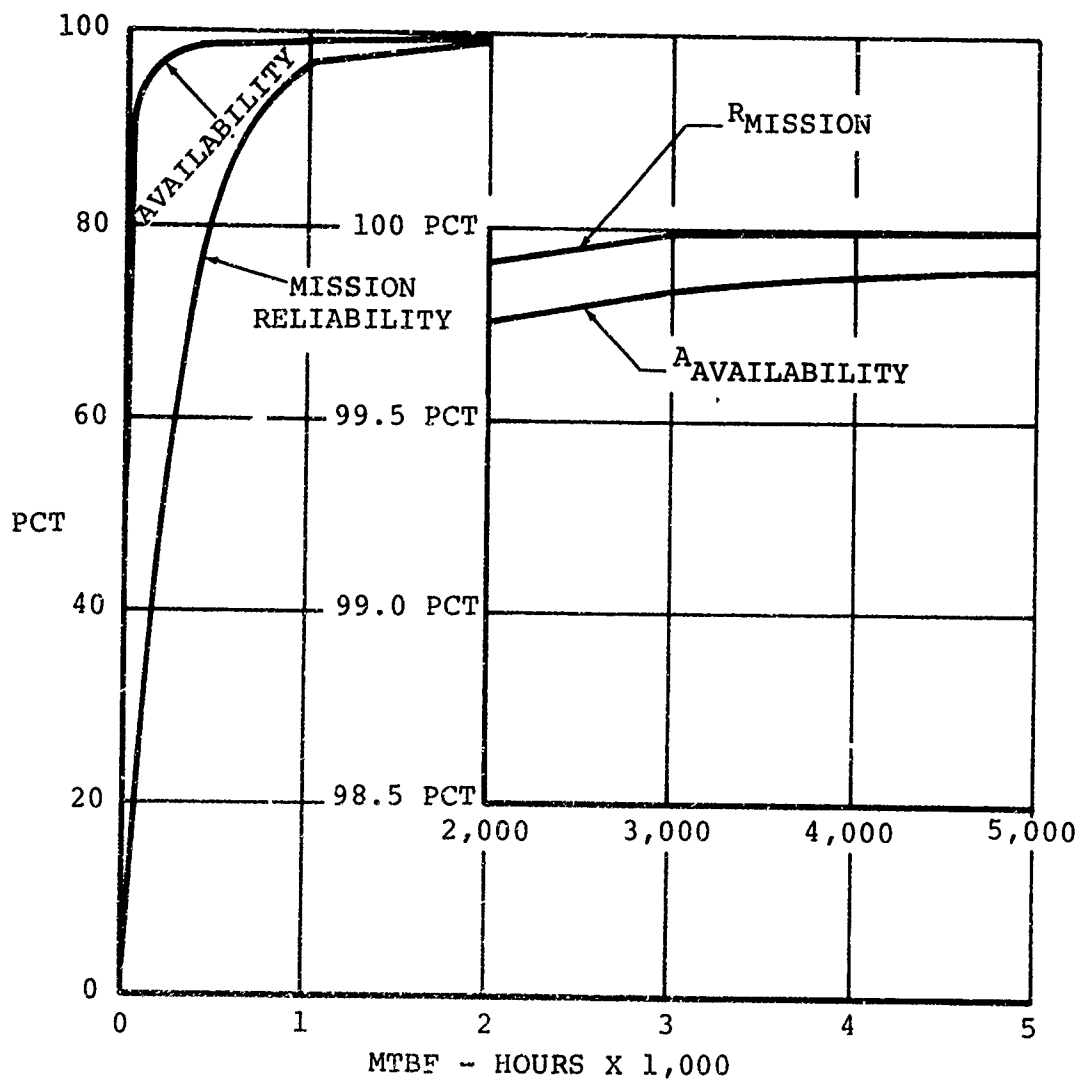

Figure 25. Comparison of the Effect of MTBF Upon Inherent Availability and Mission Reliability.

- Using the relative costs determined in step 2, calculate the expected total cost for scheduled and unscheduled removals, for various TBO's.

The optimum TBO will yield the lowest cost. Although this seemingly is based on cost and ignores cost-effectiveness, this is not so. Cost-effectiveness is a function of cost, mission reliability and inherent availability. With an increasing hazard function, raising the TBO above the lowest cost TBO results in additional failures. Since mission reliability is a function of unscheduled removal rate, choosing a higher TBO in this case would result in reduced mission reliability. Furthermore, inherent availability is based on MTBF; therefore choosing a higher TBO yielding more failures results in a lower MTBF and a lower inherent availability. As a result, the lowest cost TBO is the optimum TBO.

An example best illustrates this process. Using the steps just described:

- Assume a hazard function with a β' of 2.0 and a θ' of 2,500 hours.
- Assume that an unscheduled removal costs twice as much as a scheduled removal.
- The computer program yields the following data shown in Table III.

TABLE III. SIMULATION RESULTS FOR $\beta'=2$, $\theta'=2,500$		
TBO	Scheduled Removals	Unscheduled Removals
1,000	517	100
2,000	174	175
3,000	61	221
3,600	23	235
3,800	19	237
4,000	14	241
4,200	8	243
5,000	3	248

- Using the relative cost of 2 to 1 and 1 to 1, for unscheduled and scheduled removals, Table IV can be developed.

TABLE IV. SIMULATED COSTS FOR VARIOUS COST RATIOS				
TBO	Removals		Total Cost	
	Scheduled	Unscheduled	1:2	1:1
1,000	517	100	717	617
2,000	174	175	524	349
3,000	61	221	503	282
3,600	23	235	493	258
3,800	19	237	493	256
4,000	14	241	494	255
4,200	8	243	496	251
5,000	3	248	499	251

In the 1:2 case, the optimum TBO should be 3,600 hours. Although a TBO of 3800 hours yields the same costs, it results in more failures and consequently is not cost-effective since mission reliability and inherent availability would be lower.

It should be noted that as the cost of unscheduled removals approaches or even goes below the cost of scheduled removals, this analysis for optimum TBO becomes irrelevant, since it almost always becomes more cost effective to go on condition. As is shown in the 1:1 cost column of Table IV, costs never rise again with increases in TBO as evidenced in the 1:2 column.

APPENDIX II DESIGN-RELATED CRITERIA

INTRODUCTION

This appendix contains:

- (1) A discussion of the effect of using advanced transmission elements to improve on-condition transmission potential
- (2) A qualitative evaluation of several advanced drive system concepts for on-condition operation
- (3) The effect of stress allowables on fatigue life
- (4) The design criteria for fail-safe transmissions
- (5) State-of-the-art considerations for on-condition design

Items 1 and 2, dealing with advanced design concepts and component improvement, are closely interrelated; consequently, they are discussed in a mutual framework (and make up the main part of this appendix).

Summary of Design Considerations

This appendix is intended to emphasize those areas of design that could possibly limit TBO extension or removal. The dual issues of failure consequence and hazard function shape are the prime concerns. In instances where a β greater than 1 might be present, the designer must assure that the assembly is tolerant of failure, that is, the consequence must not be an undetected functional failure. If safety concerns can be eliminated from any failure mode, a β greater than 1 might be tolerated.

Those associated with the design of a transmission have, of course, a responsibility to minimize the frequency and effects of all modes, independent of where they occur during the life of the transmission. Achievement of this objective will produce reliable and safe aircraft. The importance and value of these efforts is not diluted by suggesting that special attention must be directed at certain modes. It is simply the honest recognition that designers and the design process are not perfect, and unexpected failures will occur. These failures need not limit TBO extension or removal even if an increasing failure rate with time ($\beta > 1$) exists, as long as its consequences are not serious.

The proper role for diagnostics or condition monitoring in the TBO question is clear. These devices or systems contribute to an on-condition status by removing failure modes from a safety arena and thereby increasing the acceptability of $\beta > 1$. In the justifiable desire to ease maintenance troubleshooting and reduce component damage, we sometimes overlook the fact that diagnostics do not change the frequency of occurrence or the shape of the distribution. Providing a 30-minute warning of a bearing failure does not alter the shape of the hazard function for that bearing.

In this light, it might be concluded that the historical emphasis on diagnostics is inappropriate. Instead of efforts to increase the detectability of bearings (which have generally constant failure rates: $\beta = 1$), the real need is to detect potentially catastrophic failure modes that have shown a propensity to high β 's (e.g., low-cycle fatigue-sensitive internal structure such as supports or shafts). The dual objectives for diagnostics of minimum maintenance/costs and improved safety are not mutually satisfying. Clearly, specific objectives must be defined. Appendix III of this report is a step toward the development of the role of diagnostics in an on-condition evaluation.

TRANSMISSION ADVANCED DESIGN CONCEPTS

It is appropriate to distinguish between transmission component/element improvements and improved transmission design concepts.

o Component Improvements

Component improvements involve advanced technology including metallurgical, gear geometry, contact ratio, lubrication, high-speed tapered roller bearing, forged gear, and like improvements. Failure data for these improvements do not exist in sufficient quantity. Lead tests have been successfully conducted, and are continuing at this writing.

o Advanced Transmission Design Concepts

Advanced transmission design concepts include roller gear transmissions, nutating (Maroth) drive transmissions, split-power (split-torque) transmissions, lubricant-sealed integral transmissions, modularized transmissions, gas-cycle (no mechanical element) drives, cyclo-drive transmissions, harmonic-drive transmissions, and other epicyclic and non-epicyclic drive systems. Many variations and/or combinations of these

concepts have been conceived but few tests have been conducted to indicate conclusive superiority (as a power transmitting system) in terms of performance or weight-to-power ratio. Still less has been done to derive failure data and associated confidence levels.

Projected Applications of Advanced Concepts

In general, while improved transmission component/element designs are applicable to all gearbox-type drive systems, advanced design concepts of transmission types have their applicability on a selective basis.

1. TRANSMISSION COMPONENT IMPROVEMENTS

Because of the lubricant/coolant environment required in a gearbox, the main elements are generally designed to parameters which ensure unlimited life for gears and safe life for bearings. In the meantime, fail safe concepts for gear/bearing elements are being pursued in lead tests for both lubricated and nonlubricated operation.

a. Metallurgical Advances:

- (1) VASCO-X2 steels for gears which promise to raise the threshold for fatigue failure.
- (2) M-50 steels for rolling element bearings which promise to increase B_{10} life through improved load-carrying capability.
- (3) Precision forged gears which may lead to superior metallurgical grain flow to as-machined gears thus improving load-carrying capability and resistance to surface fatigue. Rotating load tests have yet to be conducted.

b. Gear Geometry Developments

(1) High Contact Ratio (HCR) Gears

The profile contact ratio for standard spur gearing is generally in the range of 1.3 to 1.5, that is, two pairs of teeth share the load at the entrance and exit points of the mesh cycle while only a single tooth pair carries the full load during the remainder of the cycle. In contrast,

high contact ratio gears (Figure 26), with profile contact ratio ≥ 2.0 , share the load among three tooth pairs during entrance and exit while two tooth pairs share the load during the remainder of the cycle. The improved load sharing of HCR gearing results in a quieter, smoother operating system with increased load capacity.

One drawback to the HCR gear is the rise in sliding friction presented by increasing the number of teeth always in contact. However, the significant reductions in per-tooth loads resulting from improved load sharing results in a net improvement in gear scoring resistance and gear fatigue life.

(2) Noninvolute Tooth Form

The surface load capacity of a gear set is related to its relative radius of curvature at the most critical load position. The relative radius of curvature varies drastically along the active profile of a standard involute gear set, often by a factor of 2 or more. In order to maximize the surface load capacity of spur gearing, the basic kinematic and geometric equations defining their conjugate action may be resolved with the additional constraint of maintaining a constant relative radius of curvature. If this is done, the resulting tooth form is visually quite similar to an involute and may be manufactured and inspected on existing involute gearing machinery. The resulting profile, by virtue of its constant curvature shows potential for increased surface load capability, thus improving system reliability through a reduction of gear scoring hazard and an increase in resistance to bending fatigue failures.

c. Advanced Lubricant Development(s)

At least two candidate lubricants (Navy Spec. XAS-2354 and USAF Spec. MIL-L-27502) show promise in test stages to be superior to MIL-L-7808 and MIL-L-23699 oils in terms of improved load-carrying capability and high resistance to nonoptimum operating conditions. Evaluations of performance of these oils in a host transmission are being planned. If successful, they will be especially useful in the development of lubricant-seal integral transmissions.

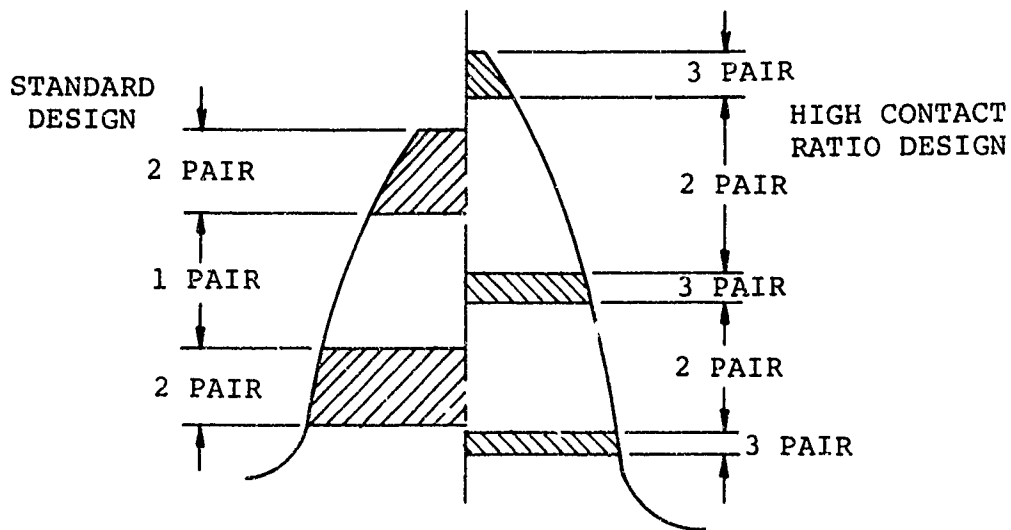
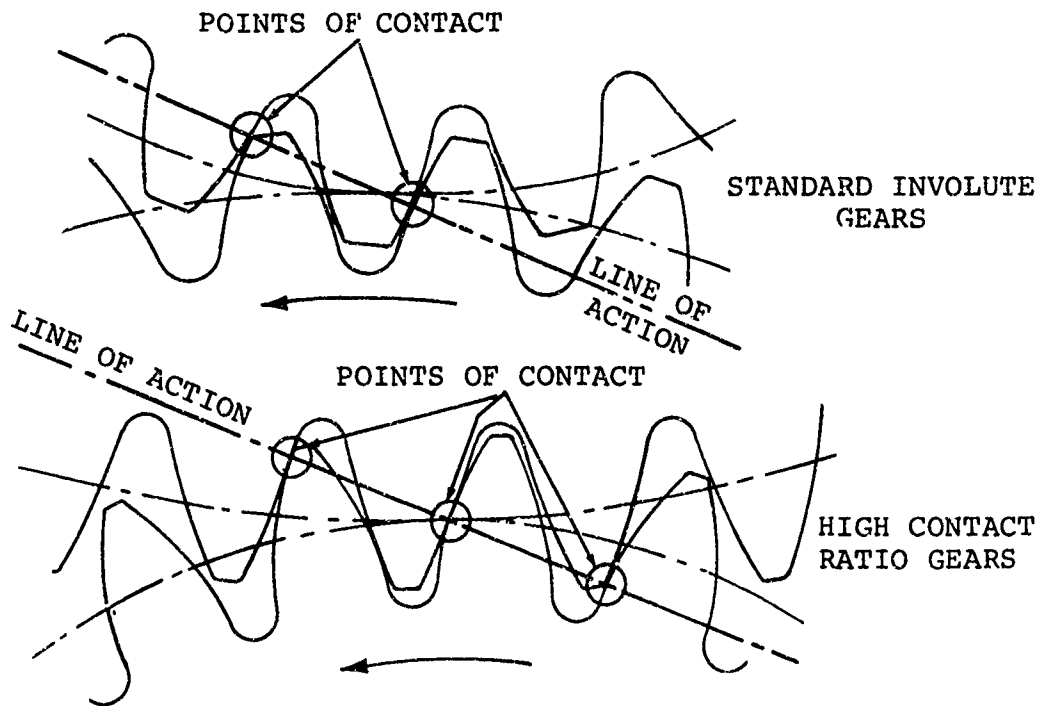

DIAMETRAL PITCH	4.50	4.50
PRESSURE ANGLE	25°	21°
CONTACT RATIO	1.38 MIN	2.20
TRANSMITTED TORQUE	133,624 IN.-LB	
BENDING STRESS	49,916 PSI	41,609 PSI
CONTACT STRESS	192,000 PSI	162,000 PSI

Figure 26. High-Contact-Ratio Gears.

d. Tapered Roller Bearings

A number of transmission studies have revealed that high-speed (over 10,000 fpm) tapered roller bearings offer great potential for increased load capacity and bearing life, and a corresponding reduction in bearing size and weight, as compared to a system of ball and cylindrical roller bearings.

One such design study was made on a CH-47C engine nose transmission. The standard design is shown in Figure 27. The goal of this study was to increase the single engine power from 2200 horsepower to 3750 horsepower and provide a growth potential to 4500 horsepower within the same envelope size. One facet of the study revealed five basic requirements for the bearing system in order to achieve this goal:

- o Reduce centrifugal force on rolling elements
- o Reduce number of bearings in system
- o Reduce internal heat generation
- o Increase bearing system reliability
- o Increase system stiffness
- o Increase operating efficiency

The standard engine nose transmission was redesigned by incorporating four tapered roller bearings in place of the two ball and four roller bearings. A detailed analysis of the advanced tapered roller system design (as compared to the standard design) revealed a 5-pound weight savings, a 33-percent increase in system reliability, a 20-percent reduction in friction power loss and a fourfold improvement in radial stiffness. Figure 28 shows the advanced design, and Table V shows its advantages over the standard design.

e. Grease Lubrication

Grease lubrication has been accepted in transmission elements even when running at high speeds where the grease acts as a lubricant (as opposed to lubricant/coolant). Here fore, greases have generally been excluded in gearboxes where heat must be dissipated, and the lubricant must perform the double role of lubricant and coolant. As a lubricant, grease has previously been limited on helicopter drive systems almost exclusively to shaft support bearings.

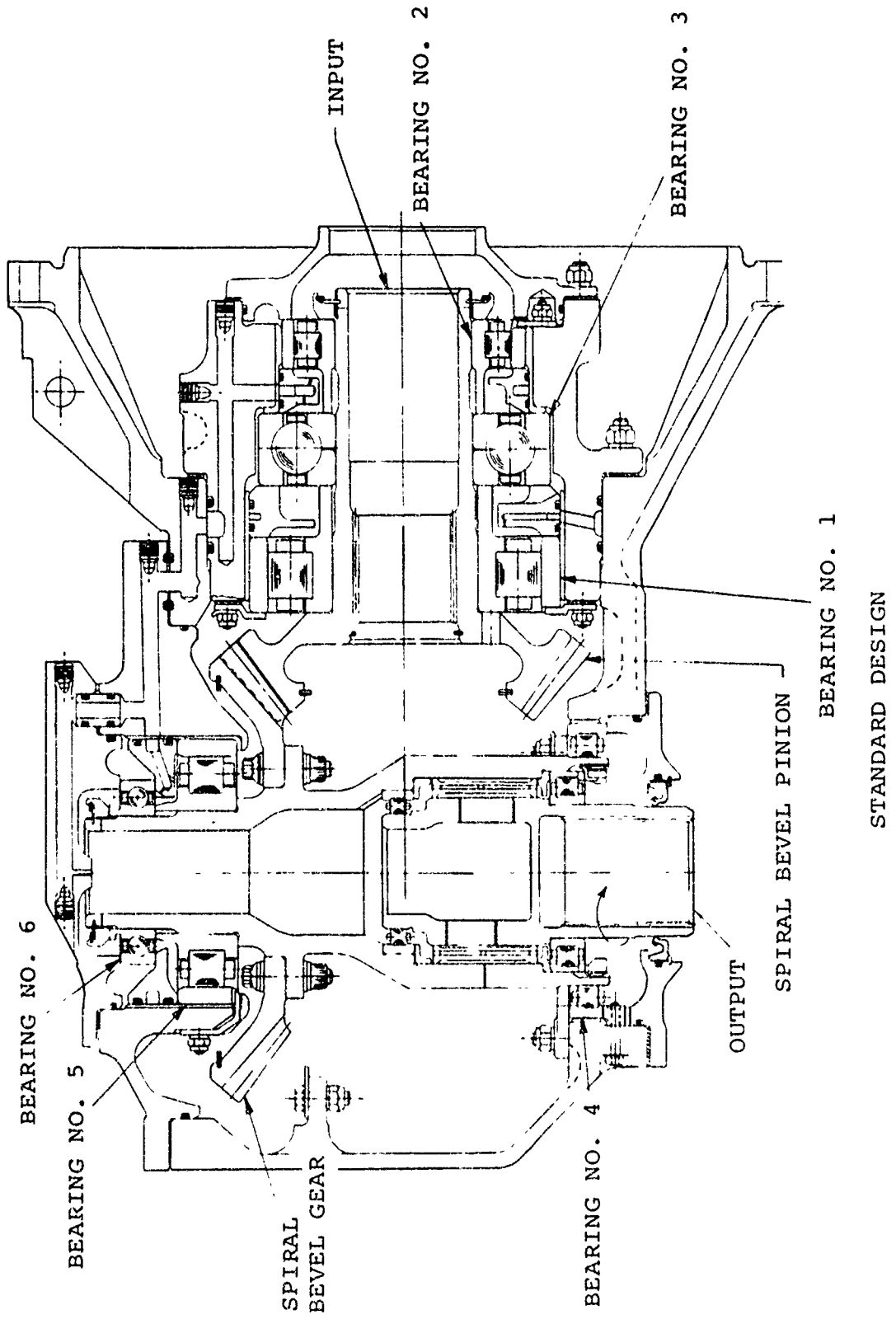

Figure 27. Typical Turboshift Engine Transmission.

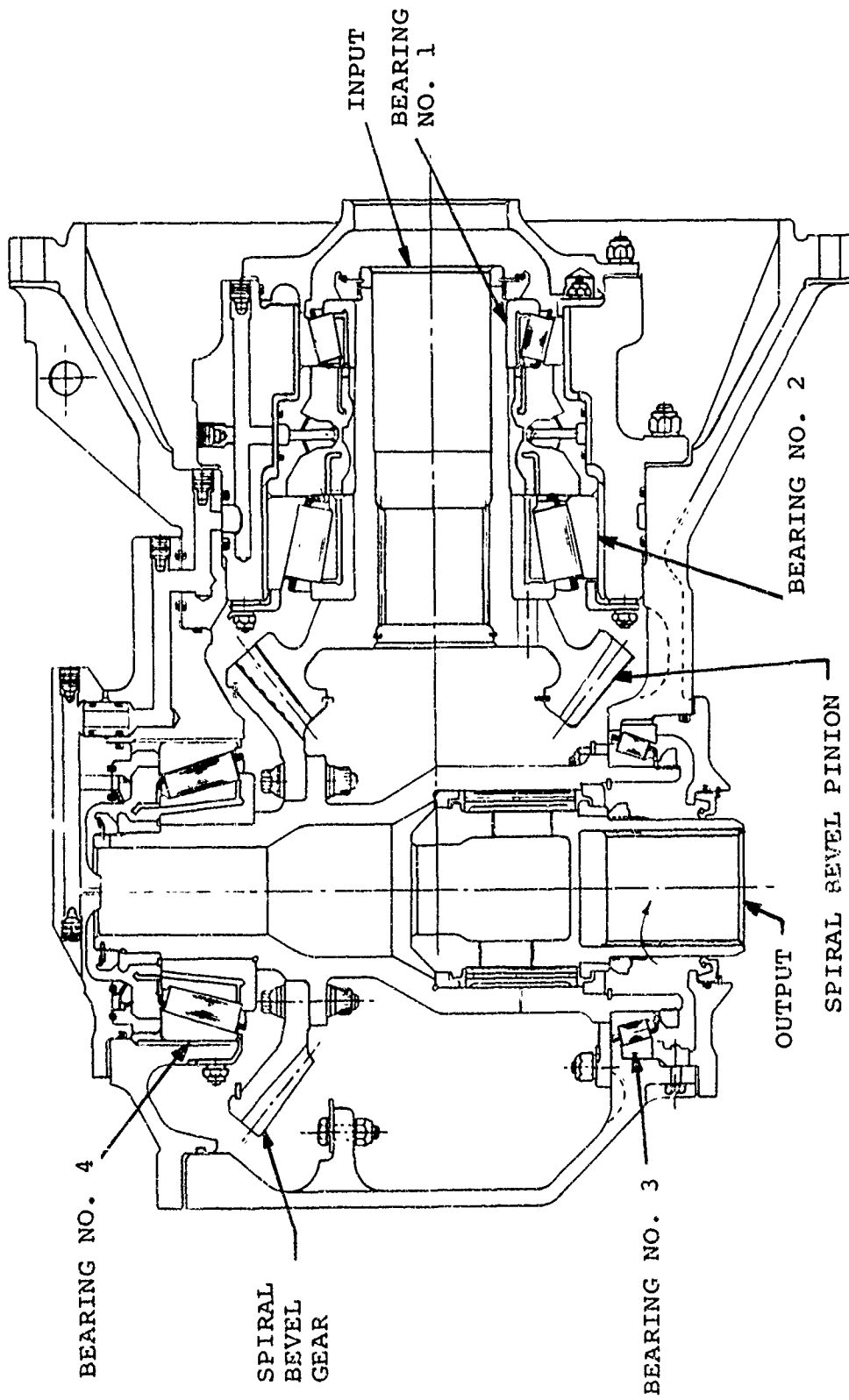

Figure 28. Modified Turboshaft Engine Transmission on Tapered Roller Design.

TABLE V. COMPARATIVE DESIGN STUDY OF BALL/ROLLER BEARING VERSUS TAPERED ROLLER BEARING

Parameter	Current Technology	Advanced Technology
Configuration	SK20308	SK20548
Number of Bearings	2 Ball and 4 Roller	4 Tapered Roller
Bearing Weight (lb)	26	21
System Reliability	Baseline	33% Increase
Friction Losses	Baseline	20% Reduction
System Stiffness		
Axial - K_x (lb/in.)	2.12×10^6	2.66×10^6
Radial - K_z (lb/in.)	2.07×10^6	8.02×10^6
Moment - K_θ (lb-in./rad)	3.73×10^7	8.25×10^7

Late developments by at least one aerospace company include the successful use of grease lubrication in a high-speed (input) section of a rotor transmission gearbox. If subsequent testing proves successful, it is possible that grease lubricants may qualify as a candidate lubricant for lubricant-sealed integral transmissions.

Due to the manner in which grease adheres to the bearings and gears, its use is extremely attractive from both safety and survivability aspects since it essentially eliminates lubrication starvation.

2. ADVANCED TRANSMISSION DESIGN CONCEPTS

On a selective basis, the various advanced transmission designs find their applicability in various drive systems only after vehicular constraints and trade studies are defined. For an air vehicle system, the relatively high weight-to-power ratio has focused attention on the efficiency of candidate transmission types in the trade-study/decision process. In general, the number of gear meshes from the prime-mover(s) (engines) to the absorber(s) (rotor/props) is a direct indication of system efficiency. Epicyclic (planetary) gear trains are generally more efficient than nonepicyclic gear trains.

a. Roller Gear Transmission

The roller gear concept is presently undergoing lead tests. The concept can be in a fixed or free "planet" configuration. In the free planet configuration, the planet sets are in an epicyclic mode of precession. The main feature of the system is the elimination of the planet bearings by substituting gear-integral torus rings that radially contact mating gears at the pitch lines. The gears are matched (paired) helical sets with opposite helices which obviate the necessity of thrust bearings. The disadvantages include the precision of manufacture required and means of assembly which may approach torsional "tuning" of the system elements and generate a requirement for significant increases in quality control tolerance levels. The design can give high ratios, and in general approaches a "pancake" design of large diameter and shallow height which has value from the aspect of survivability.

b. Split-Power (Split-Torque) Transmission (Figure 29)

Many forms of the split-power transmission exist. A

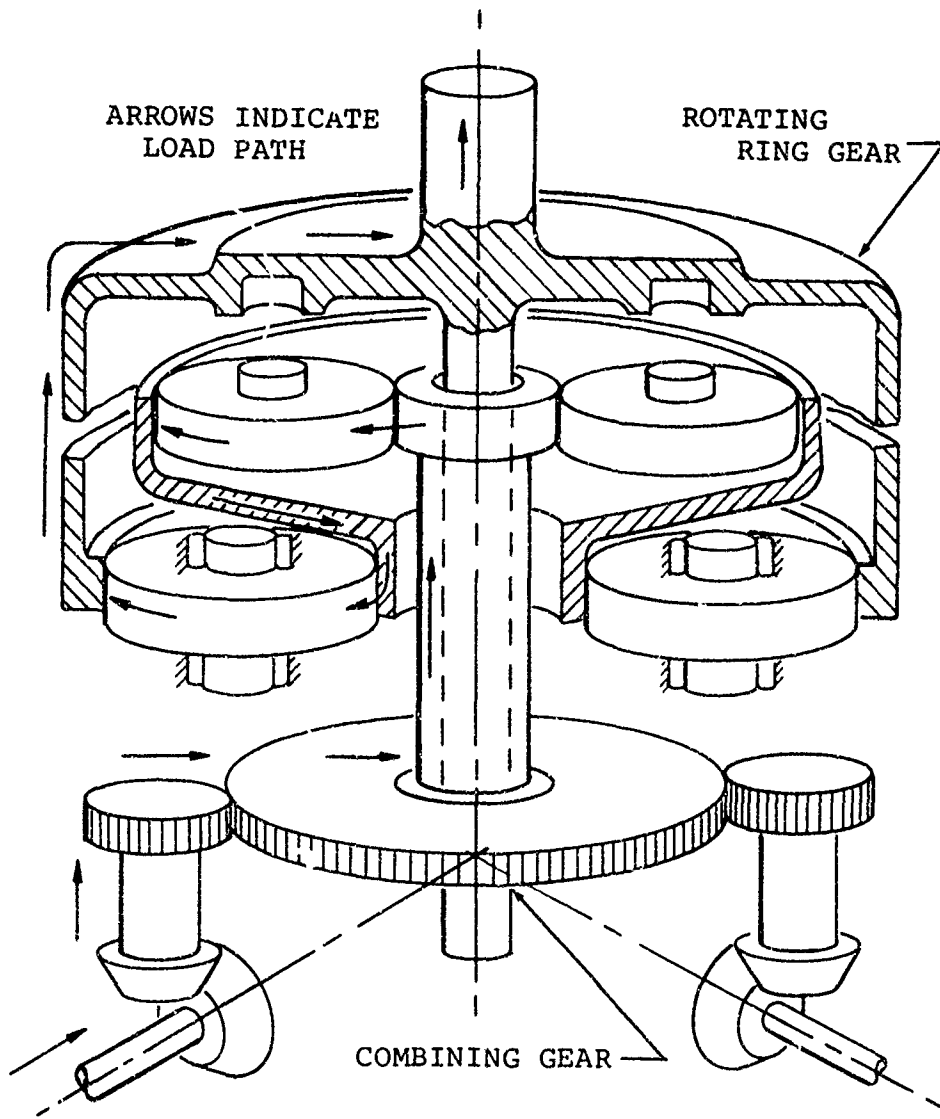

Figure 29. Split-Power Transmission.

Components

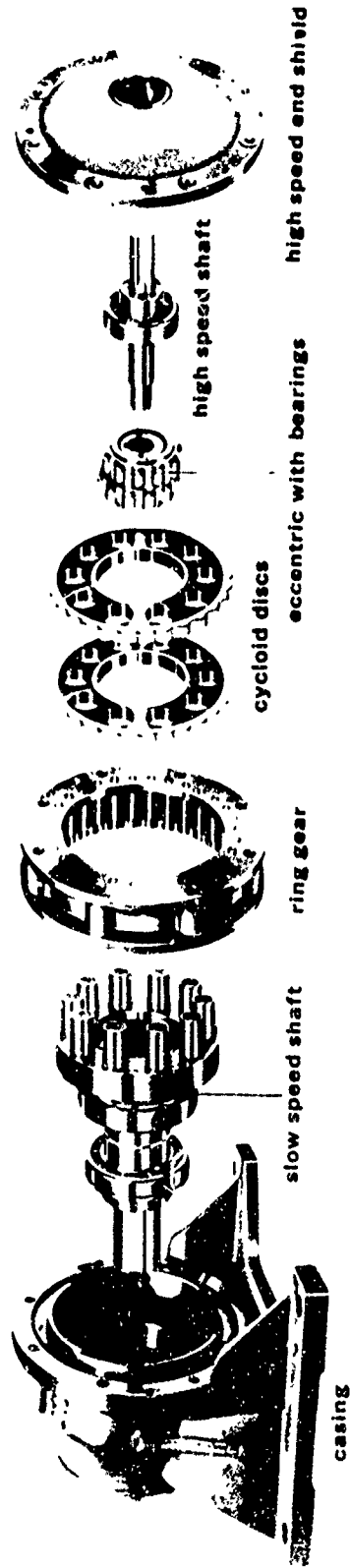

Figure 30. Basic Construction of a Cyclo-Drive Transmission.

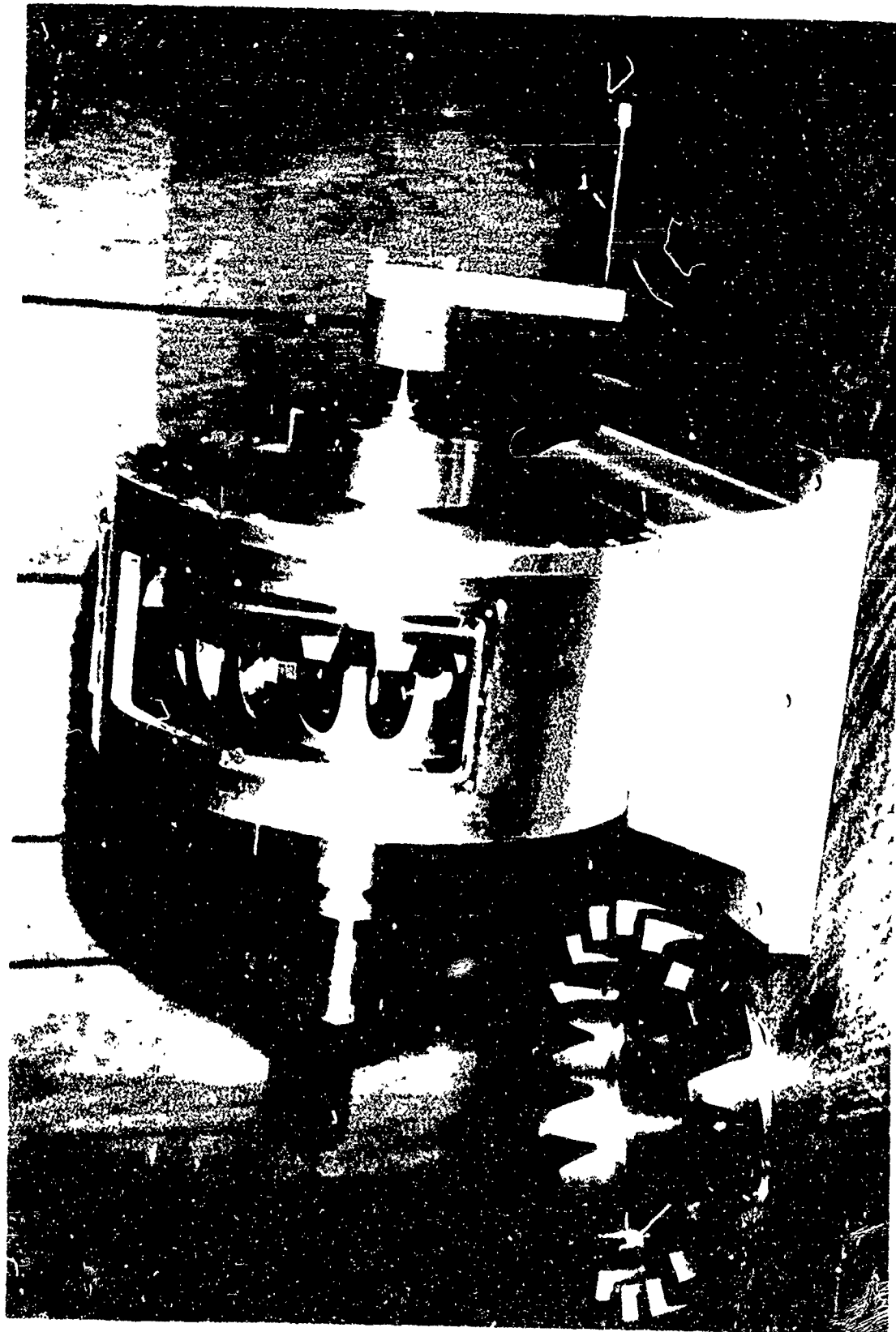

Figure 31. Model of the Nutating (Maroth) Drive Principle
(Reduction Ratio 20:1).

bearings need to be assessed for a projection of system reliability.

f. Gas-Cycle (No Mechanical Element) Drive

Many studies have been made of hot-cycle, warm-cycle, and cold-cycle drives. To date, high fuel requirements and low overall efficiency have made this mode of power transmission unsuitable for aircraft use.

g. Modularized Transmission (Figures 32 through 35)

This transmission concept is a carryover from the "throwaway" concept of maintenance. Reliability and maintainability can sometimes be opposing concepts; it is a well-known fact that maintenance generates maintenance. The modularization principle recognizes that parts do fail (especially systems that contain limited-life parts). The objective of such modularization is the partitioning of subsystems and elements in a macro-system in a way that will facilitate heavy servicing and maintenance of well-identified limited-life components. Most aircraft systems presently incorporate some modularization; the "new" emphasis is toward optimization.

h. Lubricant-Sealed Integral Transmission

Power loss in transmission systems manifests itself as parasitical heat which must be rejected. This is conventionally done by ducting the lubricant/coolant oil to a heat exchanger and blowing the heat overboard. The heat-exchanger/fan system is usually remote from the gearbox; together with its oil lines, it has been identified as the single most vulnerable subsystem in the helicopter drive system. A lubricant-sealed integral transmission would obviate the necessity for external oil lines and would therefore be less vulnerable to oil loss from any cause. First steps have been taken in the direction of this development. Near-term new designs include an integral oil cooler/fan system contiguous to the host transmission it serves. The heat exchanger and fan are external to the transmission, but long external lines have been eliminated. The next-generation approach to a self-contained lubricated transmission is in the planning stages.

Thermal mapping tests have been conducted to determine the temperatures of all main elements in the transmission. The tests (together with the search for superior high-temperature oils) were planned to indicate the relative tolerance of a transmission to use

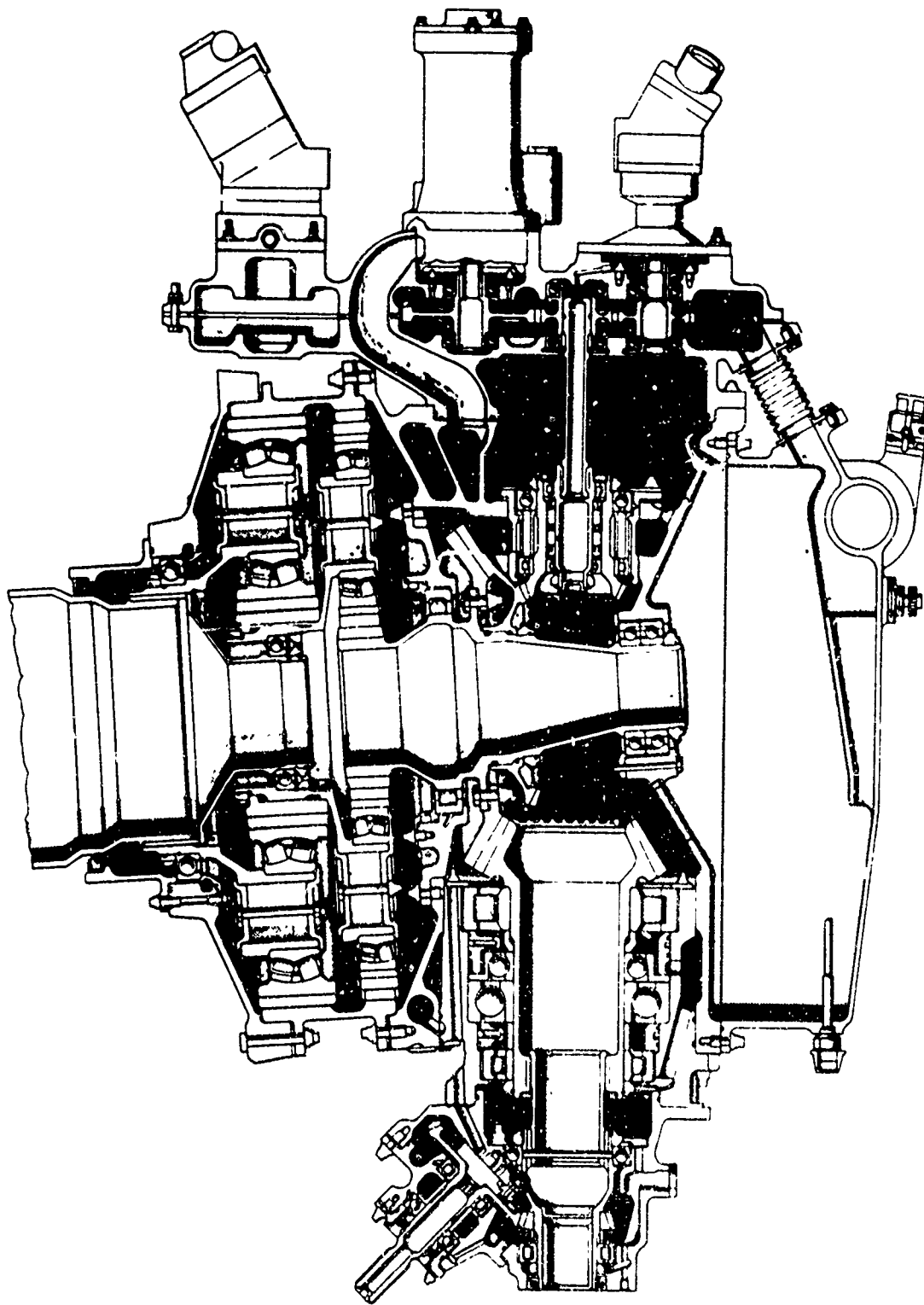

Figure 32. Cih-47C Aft Transmission Cross Section.

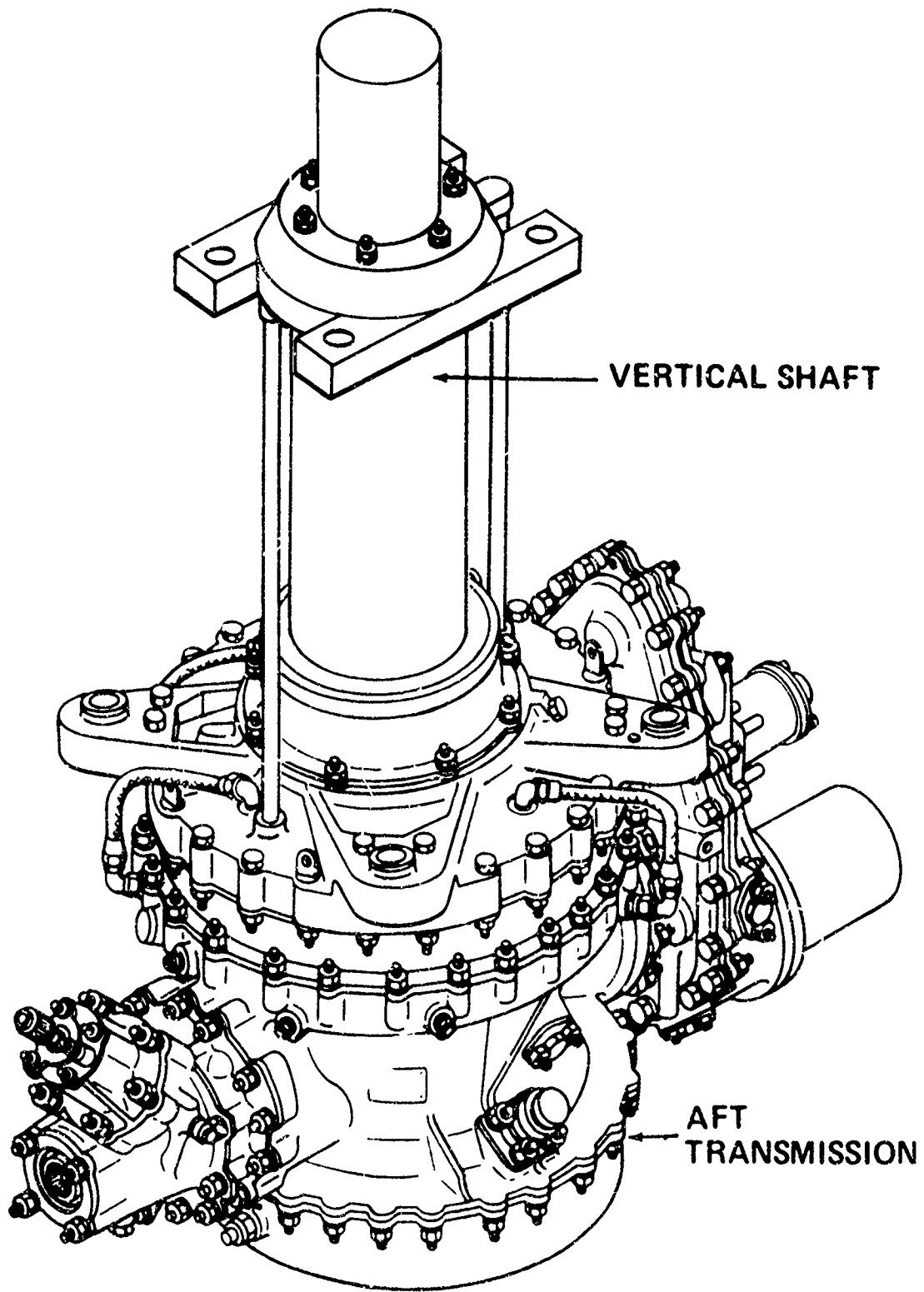

Figure 33. Aft Transmission With Integral Vertical Shaft.

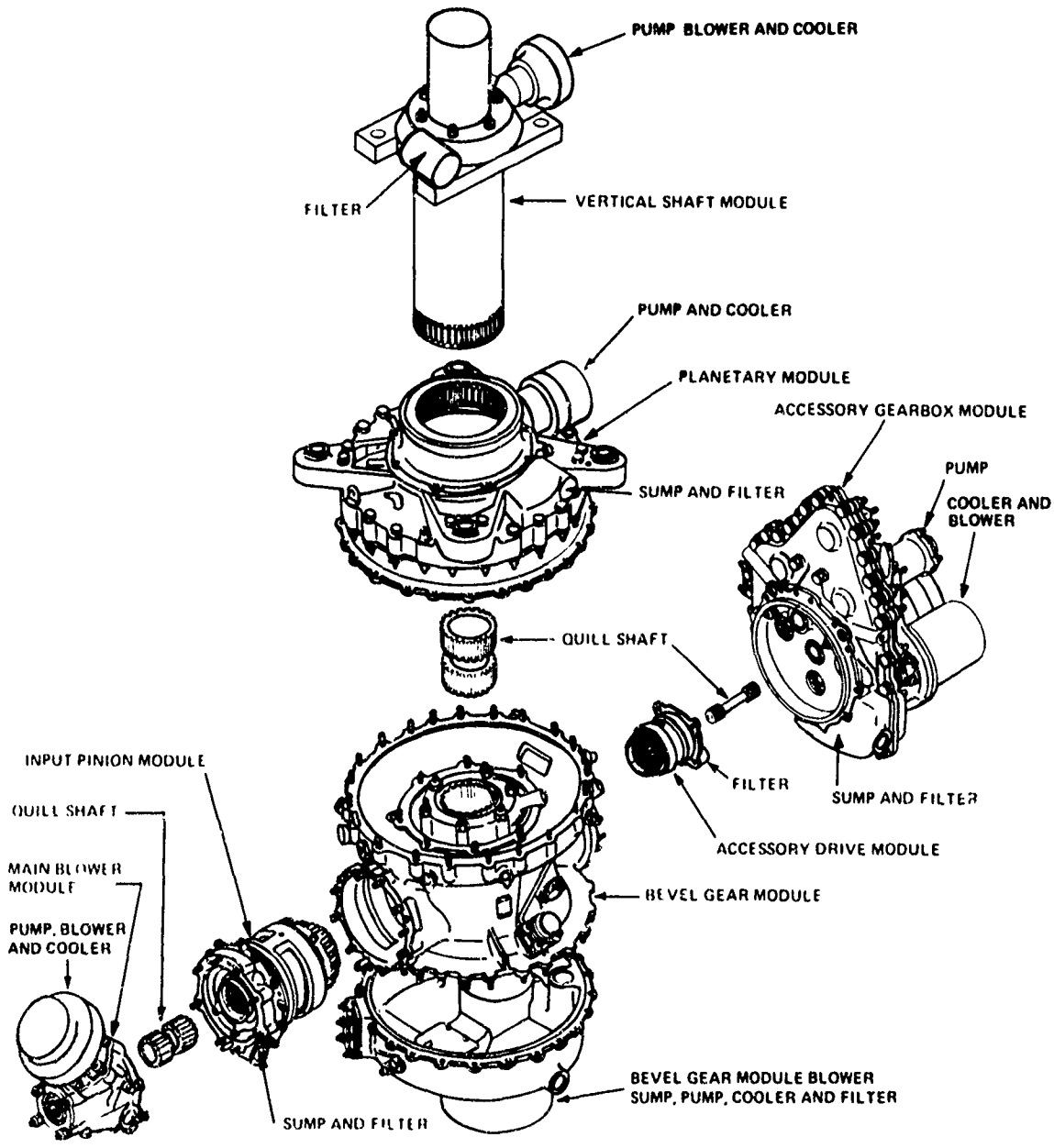

Figure 34. Modularized Transmission With Integral Module Lubrication.

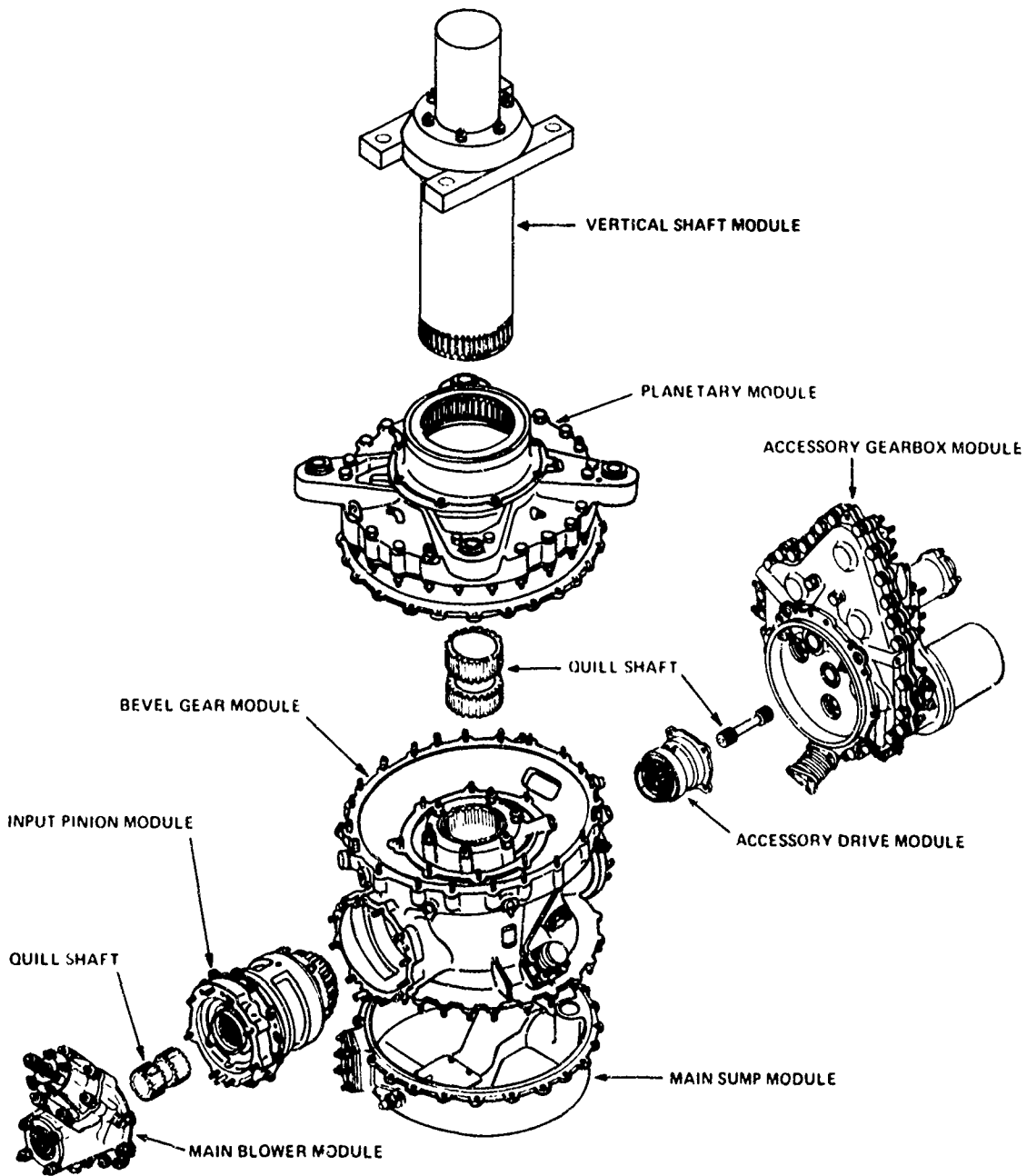

Figure 35. Modularized Transmission With Multi-Module Lubrication.

elevated temperatures for both continuous and emergency operation.

1. Effect of New Design Concepts and Component Improvement or On-Condition Operation

On-condition maintainance is based upon existing operational fleets. Much data exists on these existing transmissions and drive systems. The application of on-condition practices in early design and feasibility studies of new concepts is a necessary goal in any true systems engineering effort. Achievement of this goal will be evaluated by trade studies made with the assumption development, and/or use of mathematical models (reference Appendix I) that simulate the design process. In this regard, the dominating (and sometimes transient) modes of failure must be clearly identified. Matrices for the identification of modes of failure of transmission components are identified in Appendix VIII. These modes of failure are identified for normal lubricated operation. Except for load tests, statistical modes of failure for non-lube operation do not exist for helicopter transmissions.

Based upon these non-lube tests it has been possible to hypothesize the fundamental relationship that exists between dry-running-time-to-failure and component design parameters such as speed, load, and size, for bearings and gears. The mathematical models derived are discussed under the fail-safe design criteria topic of this appendix.

(1) Risk Assessment of New Design Concepts

(a) Component and Element Advances

A low risk is assigned to all aforementioned advanced elemental and component concepts. A single exception may be non-lube element designs; however, their eventual development for emergency operation remains probable even if at a moderate risk level.

(b) Advanced Transmission Designs

Assignment of low risk is given to split-power, harmonic, cycloidal, modularized, and lubricant-sealed integral transmission drive systems. A moderate risk is assigned to the roller gear, and nutating (Maroth) drive.

(2) Impact of New Design Concepts on On-Condition Capability

Three of the new design concepts identified in this section warrant additional discussion due to their impact upon on-condition capability. These designs are the roller gear drive, modularized transmission, and lubricant-sealed integral transmission.

(a) Roller Gear Drive

Theoretically, this concept offers great promise for on-condition operation, due to the elimination of thrust bearings by use of gear-integral torus rings that radially contact mating gears. Thus, the high reliability generally exhibited by gears replaces the relatively low reliability of thrust bearings.

Furthermore, applications of component/element advances such as VASCO-X steel and improved lubricants, when coupled with the roller gear drive concept, present an even more favorable outlook for on-condition transmission operation.

One point of concern does exist regarding the roller gear drive. This is the EB-weld generally employed to unite the gear to the shaft. The acceptable performance of this weld in the high time regimes required for on-condition maintenance, as yet unproven, is of some concern since failure of this weld could be potentially catastrophic and possibly undetectable.

However, it is anticipated that a resolution of this problem is within the state-of-the-art either due to demonstration of existing capability of EB-welds or advancements in welding techniques.

Thus, the roller-gear drive appears to be a good candidate for on-condition operation.

(b) Modularized Transmission

This concept enhances on-condition potential in two aspects: (1) by offering a manner of removing failed parts without removing total

assemblies, and (2) by allowing on-condition operation for gearboxes having certain life-limited parts. The justification of these statements appears in the following paragraphs.

For the CH-47, a large percentage of unscheduled transmission removals has contained only one failed item (Figure 36). Furthermore, in those boxes where more than one failed item was found, a high percentage had all their failed items in a physically localized area (e.g., area of planetary assemblies). This reflects the progression of an initial failure to the point of causing secondary damage to those parts in relative proximity. Modularization should allow the field repair of a large percentage of failed transmissions through replacement of only one module of the assembly.

Again for the CH-47, all of the currently life-limited transmission parts in the 1200-hour domain are in a fairly localized area. In the forward and aft gearboxes, the first and second stage planet gear/bearing assemblies (114DS281 and 114DS282, respectively) and the second stage carrier support bearing (114DS250) are the only parts in this 1200-hour domain. All others are above 1900 hours (Table VI). Thus, a modularized design which permits the removal of both planet assemblies as one module could allow an increase in TBO from 1200 to 1900 hours for the remaining module(s). For transmissions prevented from operating "on-condition" by one or two parts, it may be possible to have a time-phased removal of a module containing these parts, thus rendering the remainder of the transmission "on-condition".

Finally, it should be noted that the development of an adequate modularization scheme is a complex task. It is recognized that casual modularization can be detrimental to transmission reliability. Since the modularization concept can only become a reality through the efficient exercise of design and maintainability practices, it must preclude any requirement for excessively meticulous shimming or adjustments, which would be unreasonable at the Army organizational maintenance level.

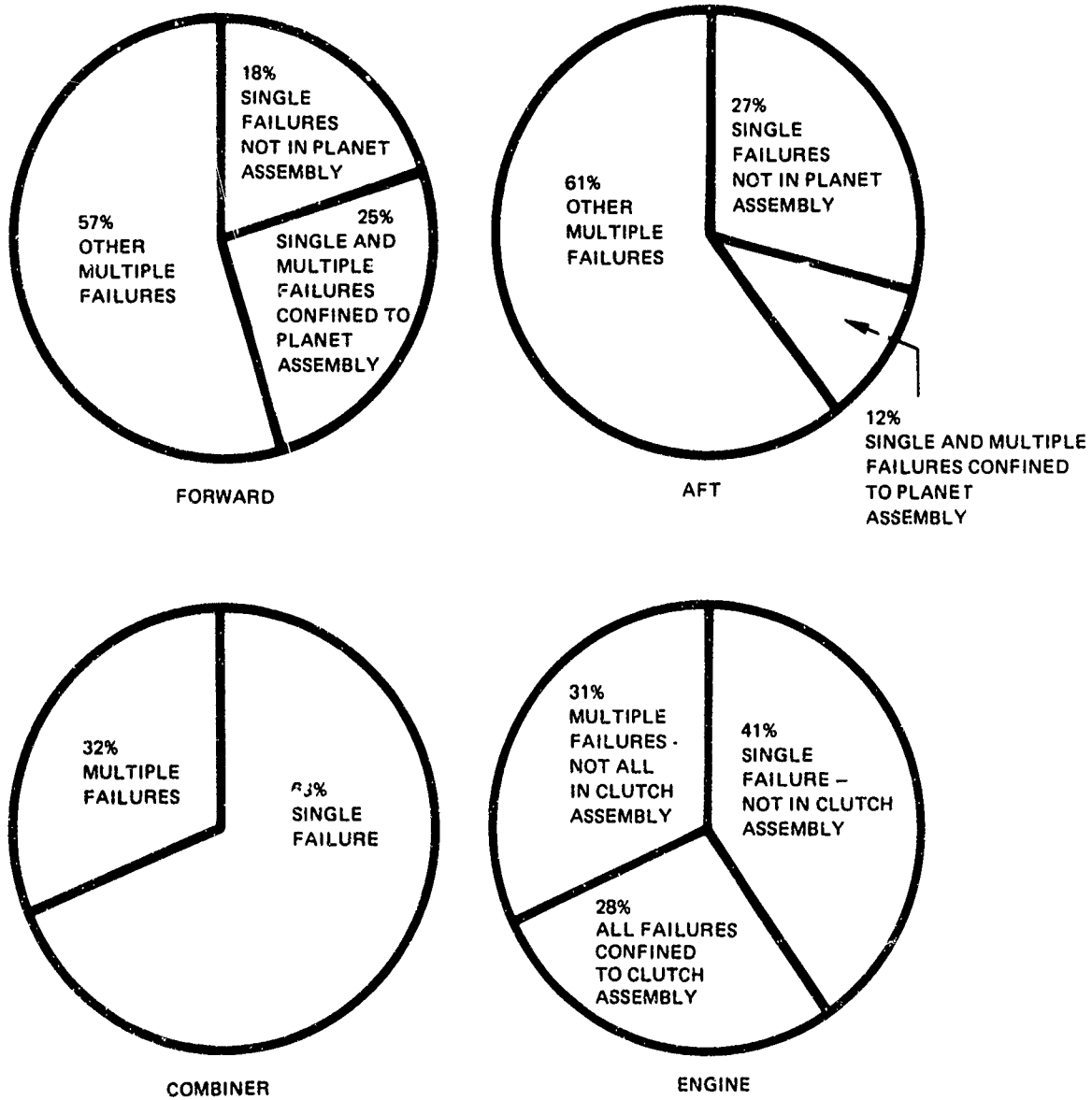

Figure 36. Distribution of CH-47 Failures per Transmission Removal (Showing Percentage of Removals Containing Only One Failure).

TABLE VI. CH-47 TRANSMISSION LIFE-LIMITED PARTS									
Forward Xmsn		Aft Xmsn		Combining Xmsn		Engine Xmsn			
P/N	Life Limit	P/N	Life Limit	P/N	Life Limit	P/N	Life Limit	P/N	Life Limit
114D1247-1	10,000	114DS240-2	1,900	114DS541-2	4,600	114DS661-1	10,000		
114DS160-1	2,900	114DS241-1	2,200	114DS548-1	10,000	114DS662-1	10,000		
114DS161-1	3,000	114DS250-1	1,200	114DS549-1	10,000	114DS664-1	10,000		
114DS162-1	4,700	114DS262-1	6,800	114DS550-1	10,000	114DS665-1	5,000		
114DS240-2	1,900	114DS281-1	1,300	114DS571-1	10,000	114DS666-2	10,000		
114DS241-1	2,200	114DS282-1	1,200	114DS572-1	1,200	114DS668-4	4,900		
114DS250-1	1,200	114DS283-1	1,900	114DS574-1	10,000	114DS669-1	10,000		
114DS262-1	6,800	114DS284-1	2,200	114DS576-1	10,000	114DS670-1	4,900		
114DS281-1	1,300	114DS274-1	4,000	114DS667-1	4,100				
114DS282-1	1,200	114DS280-1	2,300						
114DS283-1	1,900								
114DS284-1	2,200								

(c) Lubricant-Sealed Integral Transmission

The concept of the lubricant-sealed integral transmission has as its ultimate goal the elimination of presently necessary cooling and pressurizing components outside the transmission boundary. Intermediate steps to this all-radiation/natural-convection-cooled transmission include present fan and cooler integral transmissions (fan and cooler contiguous to the transmission boundary) and modularized forms. The extreme form of a lubricant-sealed integral transmission is a sealed-for-life transmission.

For the sealed-for-life transmission, on-condition operation as a unit is a necessity. Since the gearbox may be sealed upon assembly, it should be designed for extended life and on-condition unit operation in order to be cost effective. All design practices should be slanted toward the development of a transmission which has a high MTBR. If the lubricant-sealed integral transmission is sealed for life, it may not be repairable since the inherent design concept may negate the potential for disassembly and overhaul.

Thus, in order to achieve this high level of MTBR, the proponents of this design concept intend to employ several component/element advances. First, VASCO-X2 steel will be employed for all gears and M-50 steel will be employed for all bearings. Thus, a significant increase in MTBR due to improved bearing and gear fatigue lives is expected.

Second, it is intended that improved low-load testing will be employed to reduce the potential for infant mortality. The low-load (green-run) testing may be made in increments accumulating in the order of 24 hours of test time, as compared to present 3-hour runs. Upon completion of the test, a complete flushing of the transmission will eliminate any debris resulting from prior fabrication and processing.

Third, new and improved lubricants will be employed (such as MIL-L-27502, U.S. Navy

experimental XAS-2354 candidates, and others presently being tested) with significantly better load carrying and higher temperature tolerance characteristics than present lubricants.

Fourth, advanced gear geometry will be used to provide high contact ratios which may give quantum improvement in gear fatigue lives.

Fifth, and possibly most significant from an on-condition aspect, the inherent design philosophy is such that a significant reduction in retention and mounting hardware may take place. This is of great importance since, as Appendix VIII shows, a large percentage of all transmission failures fall into this category.

It should be noted that the application of the first four points above (and possibly the fifth) are not unique to sealed transmissions. The comment regarding these points is that their application on the sealed-for-life transmission is considered a virtual necessity, not a luxury. If the transmission design specialists intend to make this concept a reality, these techniques must be employed, and thus the lubricant sealed integral transmission appears a viable approach to on-condition maintenance.

3. RELATION OF FATIGUE FAILURES TO STRESS ALLOWABLES

It is essential to on-condition operation that components have fatigue lives that allow safe operation in the 5000-hour regime. Numerous parameters must be considered in evaluating the effect of alternating stress fatigue upon component safe life. Typically, the major parameters of concern are:

- Surface finish
- Size effect
- Fretting
- Corrosion
- Nonmetallic inclusions
- Grain direction
- Decarburization
- Residual stresses
- Speed of testing
- Steady loads
- Component shape

Various design criteria related to these eleven parameters are identified in the following paragraphs.

a. Surface Finish

The effect of surface finish on fatigue allowables is important but should not be overemphasized since other effects such as surface stress condition may be much more important. Several design criteria are:

- (1) No highly stressed dynamic components should have a surface finish greater than $125\sqrt{\text{in}}$.
- (2) In extremely critical areas, finer finishes are recommended to lessen the possibilities of machining tears.
- (3) Finishes up to $250\sqrt{\text{in}}$ may be permitted in low stress areas if grit blasting is used subsequently.

b. Size Effect

The effect of size on fatigue strength has produced great consternation among fatigue investigators. The reason is that the number of test data points is usually small and, therefore, subject to questions of whether or not scatter due to some other variable is responsible for the apparent variations.

WADC Technical Report 59-230, "Qualitative Aspects of Fatigue of Materials," by H. Cummings identifies a definite decrease in fatigue strength with increased specimen size.

This is explained by the "weakest link" theory (i.e., the chance effects of finding weaker constituents in the high stressed zones is increased because of the size of the member). However, this factor is almost negated by advances in technology resulting in clean (almost inclusion-free) materials.

c. Fretting

Whenever two surfaces of any material are placed in contact with each other and subjected to the slightest relative movement, even though the movement is microscopic, a special form of corrosion may take place. This corrosion makes itself evident by the appearance of irregular patches of oxide which will begin to develop even under very low pressures and within the first half cycle of movement.

Fretting corrosion is primarily of mechanical rather than chemical nature. Although fretting does not occur when no motion takes place, it can occur with small relative motions of the order of molecular dimensions.

One theory which states that "molecular effects and forces are at the root of fretting corrosion" holds that direct oxidation of the surface is a result of high local heat from severance of cohesion bonds between the surface molecules.

Some general solutions to fretting are:

- (1) Elimination or exclusion of oxygen at contact surfaces
- (2) Provision of an adequate lubricant or surface coating to reduce friction
- (3) Provision of a plated or treated surface to prevent or minimize relative motion between mating surfaces
- (4) Provision of a gasket to absorb motion without metal pickup or welding
- (5) Increase the hardness of one or both surfaces
- (6) Induce residual compressive stresses at the contact surfaces through shot peening, surface rolling, nitriding, or carburizing

Since fretting causes a significant reduction in fatigue strength, a fretting fatigue strength reduction factor should be used. A value of 2 is frequently employed.

d. Corrosion

Experience has shown that corrosion significantly reduces the fatigue strength if the corrosion occurs while the item is being stressed. For items corroded but stressed dry, the reduction is not great unless significant corrosion pits have occurred to produce severe stress raisers.

Corrosion is a chemical and electrochemical phenomenon. One, or more likely, both occur under the usual fatigue stressing conditions. Even under static tensile stressing corrosion proceeds faster (in corrodible metals) than when they are unstressed. Moreover, many metals

corrode in air, provided it is not absolutely dry. It is possible that corrosion fatigue is to be expected, in some degree, wherever cyclic stressing exists. Protecting the surface from contact with the air results in better fatigue properties, presumably because corrosion is inhibited by a covering of oil.

e. Nonmetallic Inclusions (Stringers)

Nonmetallic inclusions in the material can be harmful, depending on the location and orientation relative to the load direction. Inclusions that start out spherical in shape, say 0.0010 to 0.0060 inch in diameter, may be stretched out during forging to hairline stringers a number of inches in length.

The direction of surface stringers can be established by inspection techniques using zyglo or magnaflux. If the load is parallel to the stringer direction, there is very little effect. If the load is normal to the stringer direction, the reduction in strength can be substantial, depending upon the length.

Acceptable stringer lengths and intensities vary from component to component, and must be established uniquely as a function of the performance requirements and criticality of the component.

Inclusions at the surface can sometimes be ground out, but if the steel is "dirty" the grinding may only uncover more stringers.

If inclusions and stringers tend to become a problem in a specific design, air melt steel may be replaced (at increased cost) by vacuum melt steel. This does not improve the fatigue strength directly, but will reduce the probability of stringer occurrence and the possibility of the failure originating at an inclusion or stringer. This is demonstrated in Figure 37.

f. Grain Direction

Although grain flow plays an important part in the ultimate strength characteristics of a material (i.e.; longitudinal versus transverse), the effect is not so pronounced in fatigue applications. Experience has shown that the difference in fatigue strength between longitudinal and transverse directions is slight, and does not require consideration.

However, this does not mean that proper grain flow should not be specified in forgings, because the

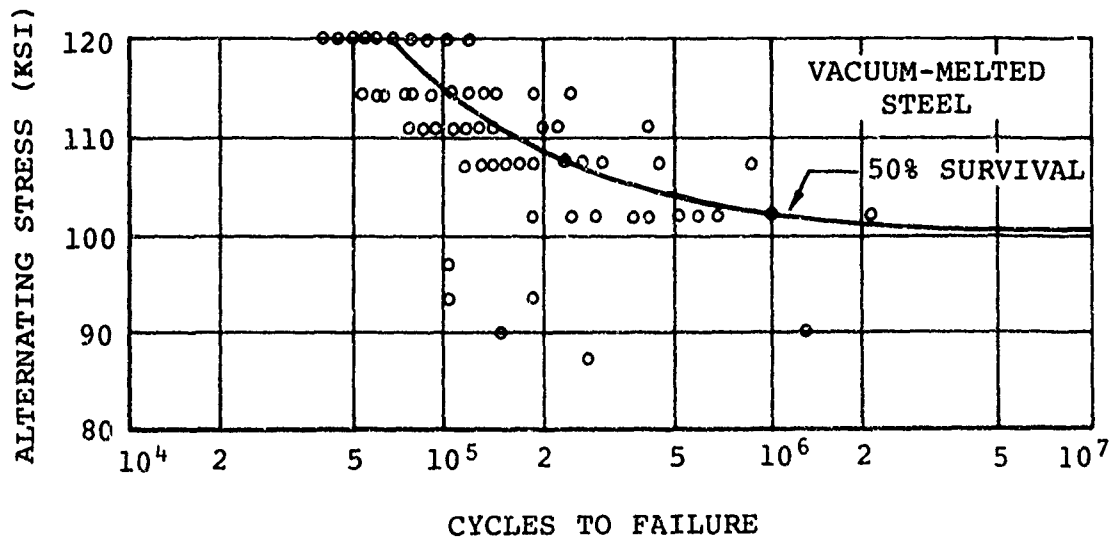
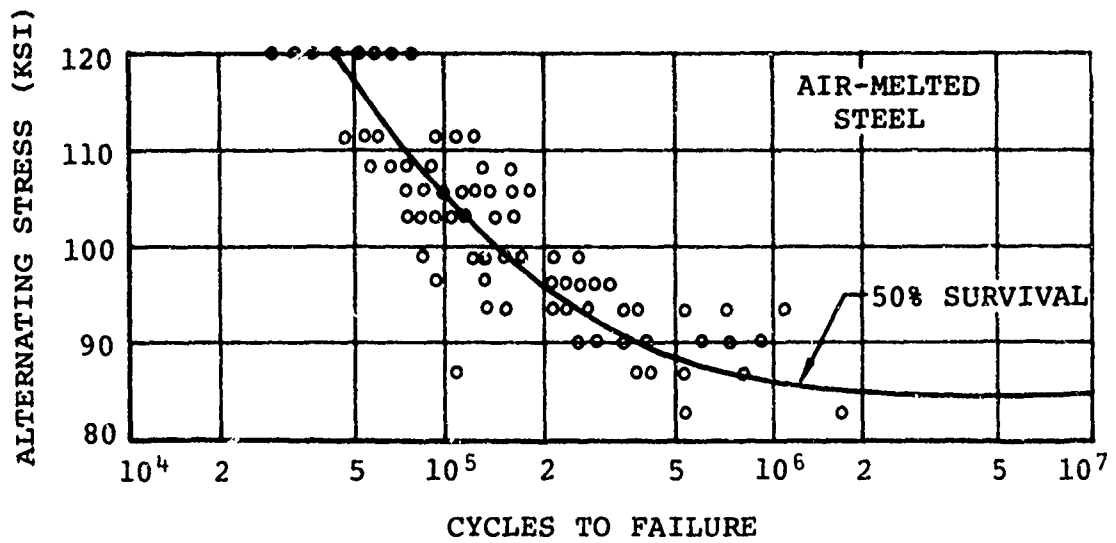

Figure 37. Comparison of Vacuum-Melted and Air-Melted Steels of Same Composition and Hardness.

possibility of nonmetallic inclusions and stringers still exists.

Several conclusions are notable:

- (1) Ultimate failures occur primarily at grain boundary.
- (2) Transverse loading encounters more grain boundary.
- (3) Fatigue failures are primarily transverse.
- (4) In fatigue applications with high mean stresses there may be a reduction in fatigue strength similar to the ultimate condition.

g. Decarburization

The fatigue strength of steel can be greatly reduced by the loss of carbon. Decarburization exists on almost all forged surfaces; it reduces the surface ultimate tensile strength and consequently reduces fatigue strength.

Lipsitt and Horne (in an ASTM paper on "Fatigue Behavior of Decarburized Steel") present data on fatigue strength reduction of decarburized mild steel. Based on some 75 specimens, the strength reduction factor varies from 1.55 to 1.8. For higher strength steels, the expected reduction may be greater.

It is interesting to note that AN bolts permit considerable decarburization while fatigue type NAS bolts have tight decarburization control. In this case the allowable ratio is almost 2 to 1 (however, it also includes effects of larger root radius).

Present design practices generally require that all high stressed forged surfaces have sufficient material removed so that all decarburized surfaces are removed. There are relatively few exceptions to this rule. The exceptions are usually thoroughly evaluated by fatigue testing.

It should be noted that there are processes that can be utilized to restore the lost carbon and thereby improve the fatigue strength.

h. Residual Stresses

Residual compression stresses will invariably increase

fatigue strength, especially in areas of high stress concentration. It should be noted, however, that in order for residual compression to exist, residual tension must also exist (to provide internal equilibrium of stress).

Numerous methods of inducing or reducing residual stresses of metals exist including machining, shot peening, electroplating, chrome plating, and chem-milling.

Not all these techniques provide an increase in fatigue strength. Notably, electroplating (without simultaneous wetting) and chrome plating (without previous peening) may reduce fatigue strength. These two techniques are primarily intended to increase wear resistance.

Conservative design practices recommend that components should meet their fatigue strength requirements without the use of peening. These techniques are intended for application only as a means of providing additional margins against failure.

i. Speed of Testing

Tests conducted at less than 100,000 CPM provide small improvements upon fatigue strength of most steels unless accompanied by considerable heating of the specimen.

The effect of testing speed is discussed in greater detail in Appendix IV of this report.

j. Steady Loads

Fatigue strength can be affected by the magnitude of the steady loads on the part, as well as the oscillating loads. (The Goodman curves relating steady stress to oscillating stress for steels can be found in MIL-HDBK-5.) It should be noted, however, that fatigue failures can take place in parts subjected to completely compressive steady stresses.

k. Component Shape

Shape is known to affect the endurance limit of components. This is explained by the susceptibility to localized inelastic action, which is a function of cross-section shape. It is further hypothesized that the larger the volume of the thin surface layer, the higher the probability that it will contain serious stress spots.

1. Relation of S/N Curves to Hazard Functions

Two basic assumptions are made in the development of S/N curves:

- (1) Stress for a given life is distributed normal.
- (2) Life for a given stress is distributed log normal.

The second of these assumptions is of great importance to an on-condition analysis. Mathematically, this assumption means that

$$\bar{R}(t) = \int_0^t \frac{1}{\sqrt{2\pi} \sigma} x^{-1} e^{-(\ln x - \alpha)^2 / .2\sigma^2} dx$$

where $x, \sigma > 0$

$$\alpha = \left(\sum_{i=1}^n \ln x_i \right) / n = \text{mean}$$

$$\sigma = \sqrt{\frac{n}{\left(\sum_{i=1}^n (\ln x_i - \alpha)^2 \right) / n}} = \text{standard deviation}$$

The hazard rate of the log normal distribution can be calculated using the follow equation:

$$H(t) = \frac{f(t)}{\bar{R}(t)} = \frac{\frac{1}{\sqrt{2\pi} \sigma} t^{-1} e^{-(\ln t - \alpha)^2 / .2 \cdot \sigma^2}}{\int_0^t \frac{1}{\sqrt{2\pi} \sigma} t^{-1} \cdot e^{-(\ln t - \alpha)^2 / .2 \cdot \sigma^2} dt}$$

As in the case of the normal distribution, this equation for hazard rate cannot be reduced to a tractable form. It can be evaluated, however, by using normal tables for the values of $f(t)$ and $\bar{R}(t)$.

In order to discuss the impact of the assumption of log normality upon on-condition capability, Figure 38 has been developed to show the similarity of the log-normal distribution to the Weibull distribution.

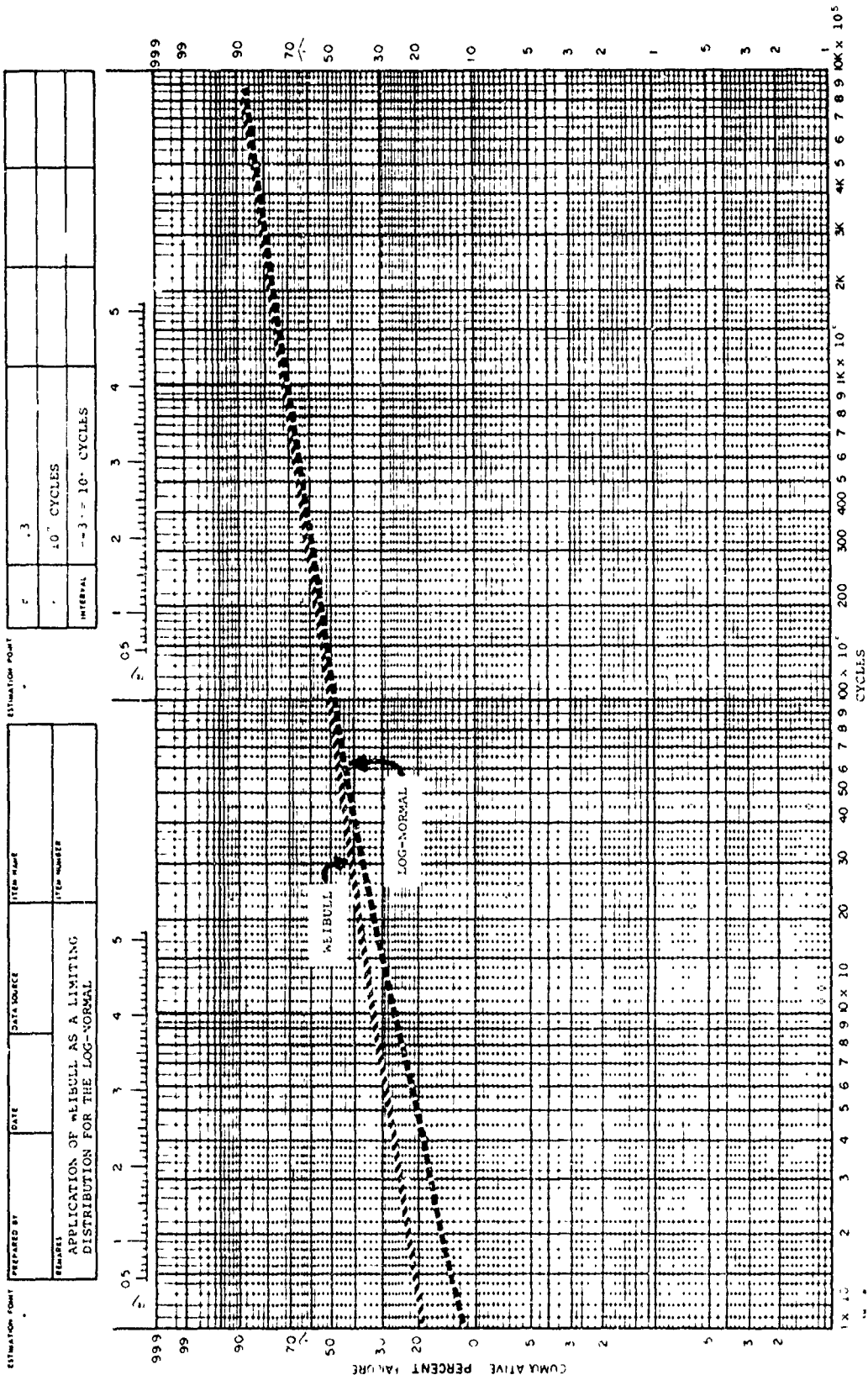

Figure 38. Comparison of Log-Normal and Weibull Distributions.

Thus, the log-normal hazard rate can now be discussed in the same manner as a Weibull distribution with the corresponding β and θ parameters. It should be apparent from Figure 38, that for times in excess of 10^7 cycles (and in some cases a significantly lower number of cycles), the hazard function is decreasing with increasing time (i.e., β is less than 1.0).

This should be of no surprise to those familiar with S/N curves, since the stress man generally assumes that the S/N curve flattens out at 10^7 cycles. In the terminology of the reliability engineer, "flattening of the S/N curve" means that the cumulative probability of failure remains constant over that period of time when the S/N curve is flat. This also means that during the flat period, the hazard rate is 0.

This notion of a zero hazard rate is unacceptable to the reliability engineer. In the case of a log-normal distribution, the hazard function must have some finite value (albeit small) for times in excess of 10^7 cycles. However, as stated above, the decreasing hazard rate, coupled with the extremely small magnitude of the hazard function, supports on-condition operation from the standpoint of fatigue life.

4. FAIL-SAFE DESIGN CONCEPTS

Generally, a fail-safe system can be described as one which can sustain a partial or complete failure of one or more of its components but still perform its required functions. The technical approaches to achieving fail-safety are threefold:

- (1) Load path redundancy
- (2) Design and test components with slow failure progression rates
- (3) Incipient failure warning/inspection systems

Present-generation helicopters employ these techniques to some extent. Fail-safe drive system concepts are presented in the following examples:

a. Load Path Redundancy

(1) Gears

Because of the angle of the teeth in a helical gear, two or more teeth of each of the mating

gears are always in contact simultaneously, thus providing an inherent redundancy.

A mechanical gap which interrupts the otherwise continuous tooth at one or more points along the gear face can be used to prevent crack progression across the entire face. An example of this can be seen in the Boeing-Vertol Model 107-II helicopter first stage (high-speed herringbone) reduction gear.

The renewed emphasis on high-contact-ratio gears promises to add multiple load path redundancy to otherwise "straight" spur gears.

Spiral bevel gears can be considered to have inherent load path redundancy, since they are the "equivalent" of helical spur gears except that power is distributed through an angular-displaced plane.

(2) Shaft Couplings

The multi-plate flexible couplings on synchronizing shafts allow for deflections in the airframe without damage to drive-line components. Tests have demonstrated that the failure of a limited number of plates in the coupling pack does not destroy the load carrying capabilities of this component.

(3) Shaft Coupling Adapters

Tests and field experience have demonstrated that these adapters are capable of continuous service even after the complete failure of one lug and a partial failure of another where three or more lugs make up the design. Adapters with multiple rivets and/or spline teeth are likewise inherently redundant.

b. Design of Components with Slow Failure Progression Rates

(1) Shaft Couplings

The multiplicity and independence of coupling plates previously cited also greatly retards failure propagation through the assembly.

(2) Shaft Coupling Adapters

During testing, an adapter with a crack continued functional operation after 25 flight hours without appreciable propagation. On the assumption that the crack might eventually progress across the entire element, a cut was made to simulate lug complete failure. No subsequent failure occurred.

(3) Bearings and Gears

Failure progression rates on gears and bearings will be discussed in detail in Appendix IV.

c. Incipient Failure Warning and Inspection Systems

This subject is discussed in detail in Appendix III of this report.

d. Current Fail-Safe Design Evaluations

Testing is under way on various transmission designs and components. The following are examples of additional work in progress or in the planning stages:

(1) Rolling-Element Bearings - Self-Lubrication

Steps should be taken to assure that bearings have sufficient dry running capability to enable the pilot to take corrective action (forced landing, abort, etc.) if all lubrication is lost. Figure 39 shows a relationship developed using historical H-46, H-47, H-21, and H-25 data which can be employed to estimate bearing dry running time to failure. It is recommended that all bearings be designed to survive at least 30 minutes without lubrication. If this is not attainable, backup lubrication must be provided to critical bearings.

(2) Drain-Back Lubrication of Critical Bearings

Two types of supply of drain lubricant were successful in permitting a high-speed CH-47 bevel pinion and bearing assembly to function at tolerable but stabilized temperatures, thus improving the resistance to catastrophic bearing failures. (See Figure 40.)

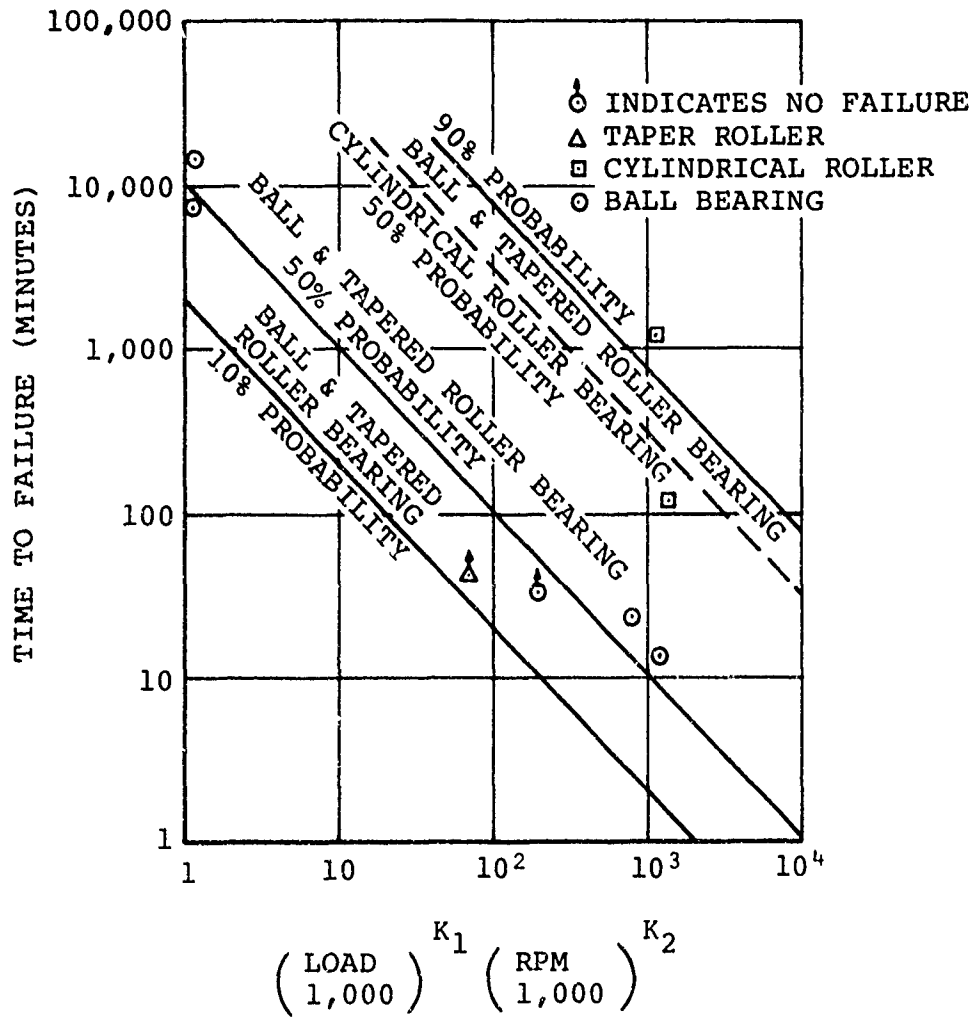

Figure 39. Dry Lube Bearing Life Criteria.

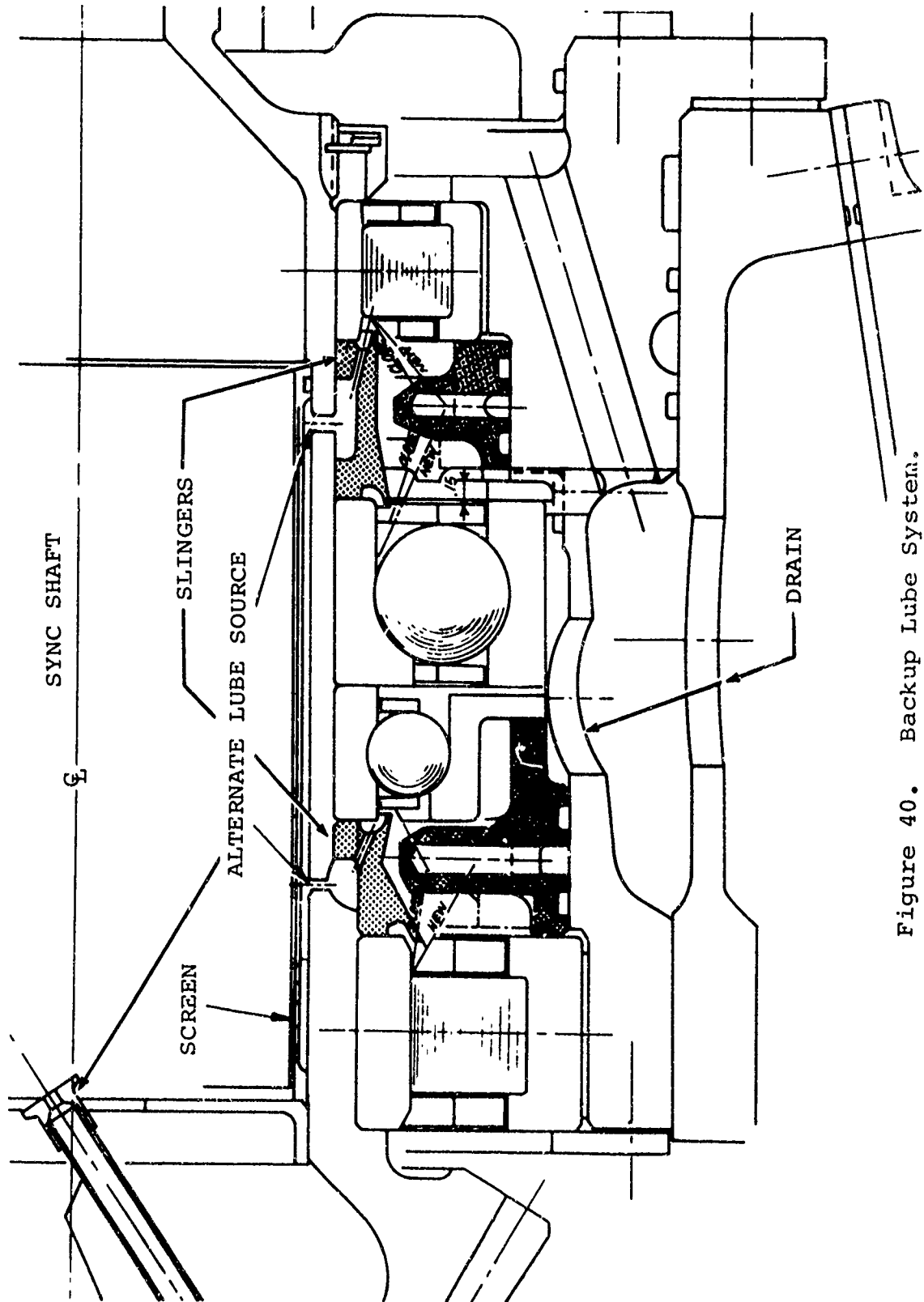

Figure 40. Backup Lube System.

(3) Detection of Oil Starvation Condition of Bearings

To date, various tests have indicated that a method to measure inner race temperature rise may provide some advantage in failure detection. It was evident that the inner race temperature rise preceded the outer race rise by as much as 5 minutes during a 25-minute run to failure (after oil supply cut-off). Among the candidate oil starvation detection concepts were two jet flow ground checking devices. (See Figure 41.)

(4) Redundant Design Study for Bevel Gear, Shaft and/or Bearing Failure with Built-In Warning System

This concept employs the strategic placement of EBW, fail-safe shoulders, and encapsulated/pressurized shaft/gear cavity failure warning agents to evaluate seven discrete types of failures in the first and second torque distributing stages (spiral bevel mesh and first stage sun) of the CH-47 rotor transmissions. (See Figures 42 and 43 and the Failure Modes Analysis, Table VII.)

(5) Fail-Safe Restraint for Planetary Gear Stage Component Failure

A failure modes and effects analysis and subsequent testing indicated that a fail-safe restraint against loss of an individual planet gear and sun gear can be successfully incorporated in a CH-46 type rotor transmission. In addition, a simulated fatigue failure of a planet carrier was tested. This test showed that the planet carrier was sufficiently redundant and load relieving so that the fatigue failure did not progress. (See Figures 44 through 46.)

5. STATE-OF-THE-ART CONSIDERATIONS FOR ON-CONDITION DESIGN

Designing a helicopter transmission to be operated "on-condition" requires considerations not unlike designing for high reliability. However, a different emphasis must be applied to certain failure modes: modes having a potentially catastrophic failure progression or modes having increasing failure rates ($\beta > 1$) during the expected life of the transmission must be examined very critically.

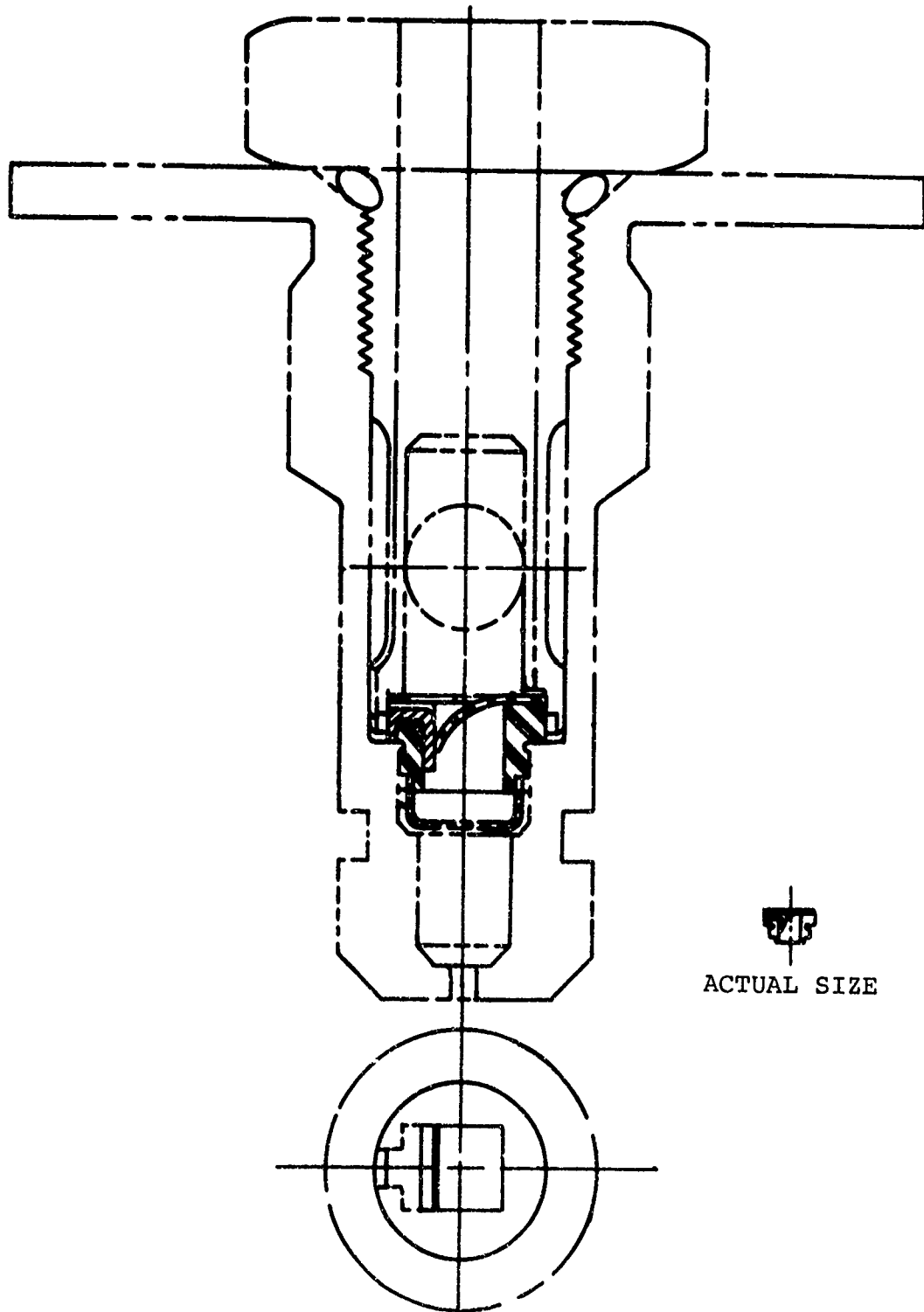

Figure 41. Flow-Monitoring Jets.

DESIGN FEATURES:

1. REDUNDANT MAIN DRIVE TORQUE PATH
2. REDUNDANT AXIAL SHAFT SUPPORT
3. SINGLE BEARING RING GEAR
4. REDUNDANT WEB
5. REDUNDANT RADIAL SUPPORT FOR SINGLE BEARING FAILURE A OR B (PLANETARY PROVIDES RADIAL SUPPORT) STRUCTURAL FAILURE INDICATION (CRACK) VIA INDICATING MEDIA

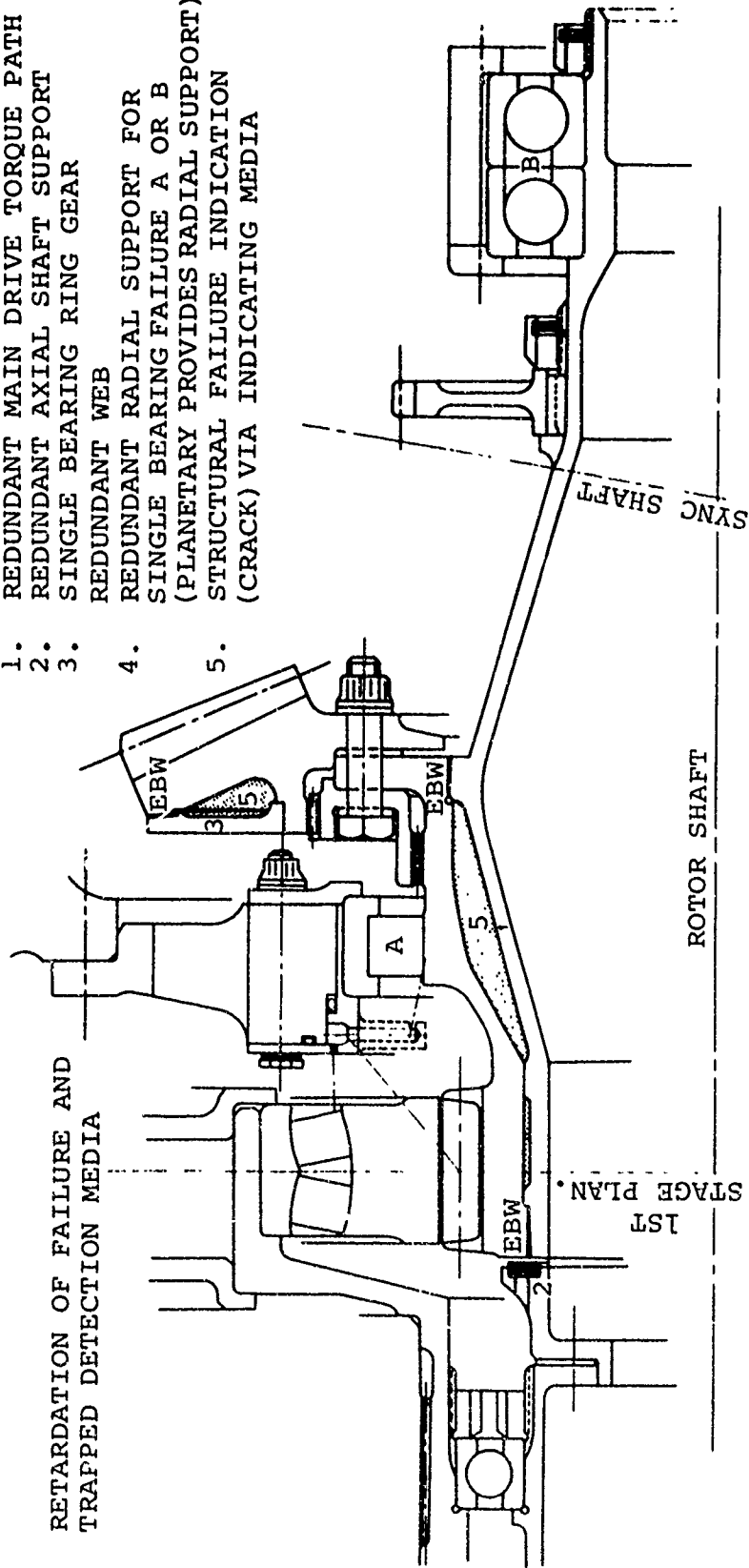
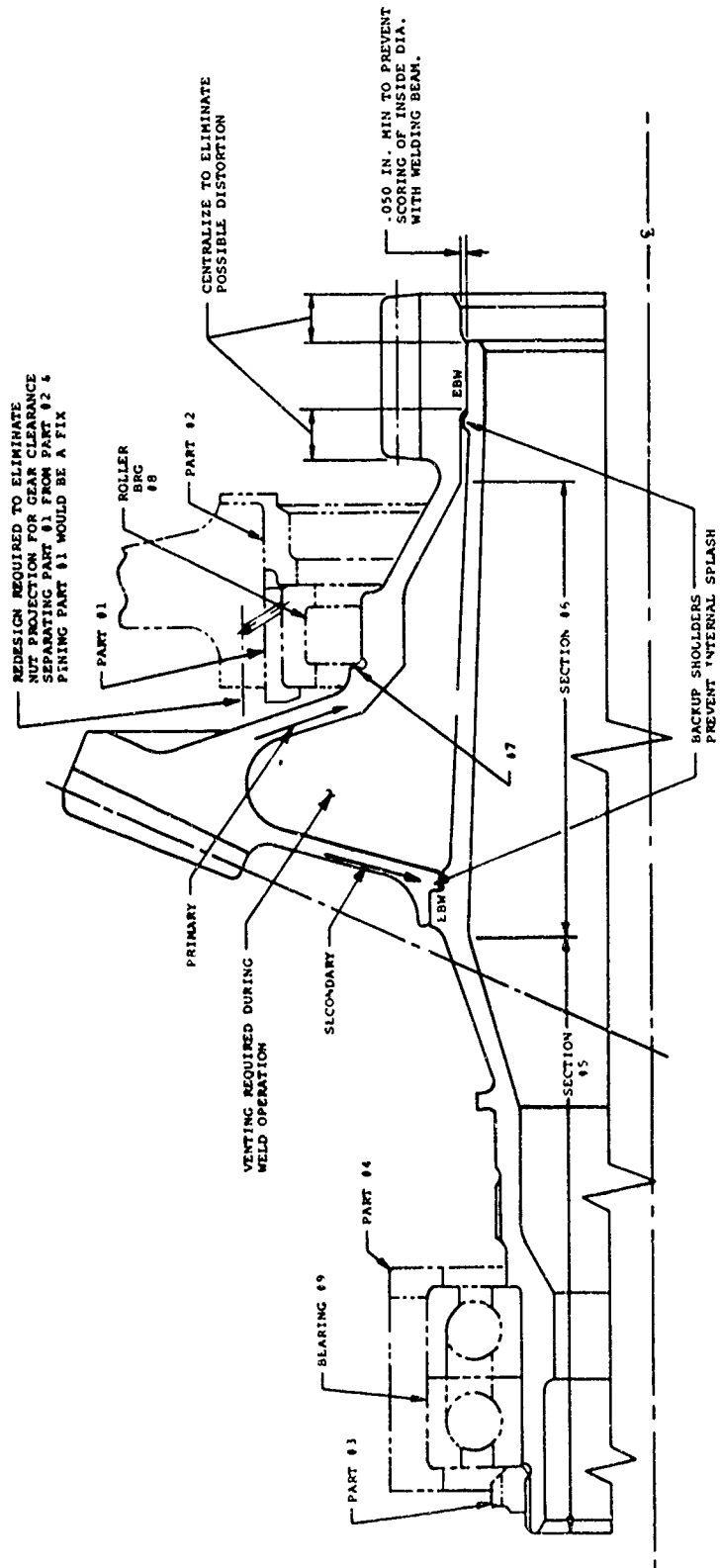

Figure 42. CH-47 Forward Transmission Redundant Single Bearing Gear/Sun Gear (Full Scale).



CRITERIA

1. WELD JOINTS ARE NOT PRIMARY
2. WELD JOINTS ARE REDUNDANT
3. REDUNDANCY THROUGH BEVEL GEAR TO SUN GEAR
4. WELD IS PERPENDICULAR 90° TO BEAM PATH
5. INTERNAL PRESSURIZED SYSTEM FOR FAILURE WARNING
6. INCREASED STIFFNESS FOR GEAR

Figure 43. CH-47C Redundant Ring Gear Design.

TABLE VII. FAILURE MODES ANALYSIS - BEVEL GEAR

Failure Mode	Effect	Results
1. Nut back-off (Part #3)	Ring gear is axially displaced but restrained by thrust shoulder #7 against roller bearing #8 which in turn is retained by Part #2 flange.	1. Flange of Part #2 would shear, causing an ultimate failure. 2. If flange of Part #2 would hold, bearing #8 would deteriorate and initiate a warning system while maintaining power.
2. Looseness or failure of Part #4	Same as failure #1	Same as failure #1
3. Bearing #9 failure	Same as failure #1	Same as failure #1
4. Shaft failure in section #5	1. Ring gear is axially displaced but restrained by thrust shoulder #7 against roller bearing #8, which in turn is restrained by Part #2 flange. 2. Moment reaction is carried by sun gear and roller bearing #8. 3. Gear tooth loads would be increased. 4. Roller bearing loads would be increased. 5. Rapid deterioration of gear and bearing would occur. 6. Bearing #8 retainer flange Part #2 would have to take thrust load.	1. Flange of Part #2 would shear causing an ultimate failure. 2. If flange of Part #2 would hold, roller bearing #8 and sun gear would deteriorate but power would be maintained. 3. If flange of Part #2 would hold bearing and gear, deterioration would initiate a warning system while maintaining power.

TABLE VII - Continued

Failure Mode	Effect	Results
5. Shaft failure in primary torque path (ring gear to sun gear) of section #6	<ol style="list-style-type: none"> 1. Torque path would be through the secondary path. 2. Pressurized cavity would emit a medium detectable by a warning system. 	<ol style="list-style-type: none"> 1. Power would be maintained. 2. Warning system would be initiated.
6. Shaft failure in secondary torque path (ring gear to sun gear) of section #6	<ol style="list-style-type: none"> 1. Pressurized cavity would emit a medium detectable by a warning system. 	<ol style="list-style-type: none"> 1. Power would be maintained indefinitely. 2. Warning system would be initiated.
7. Bearing #8 failure	<ol style="list-style-type: none"> 1. Sun gear would react the gear mesh loads. 2. Increased sun gear loads would cause tooth deterioration. 	<ol style="list-style-type: none"> 1. Power would be maintained. 2. Gear tooth deterioration would be detected by a warning system.

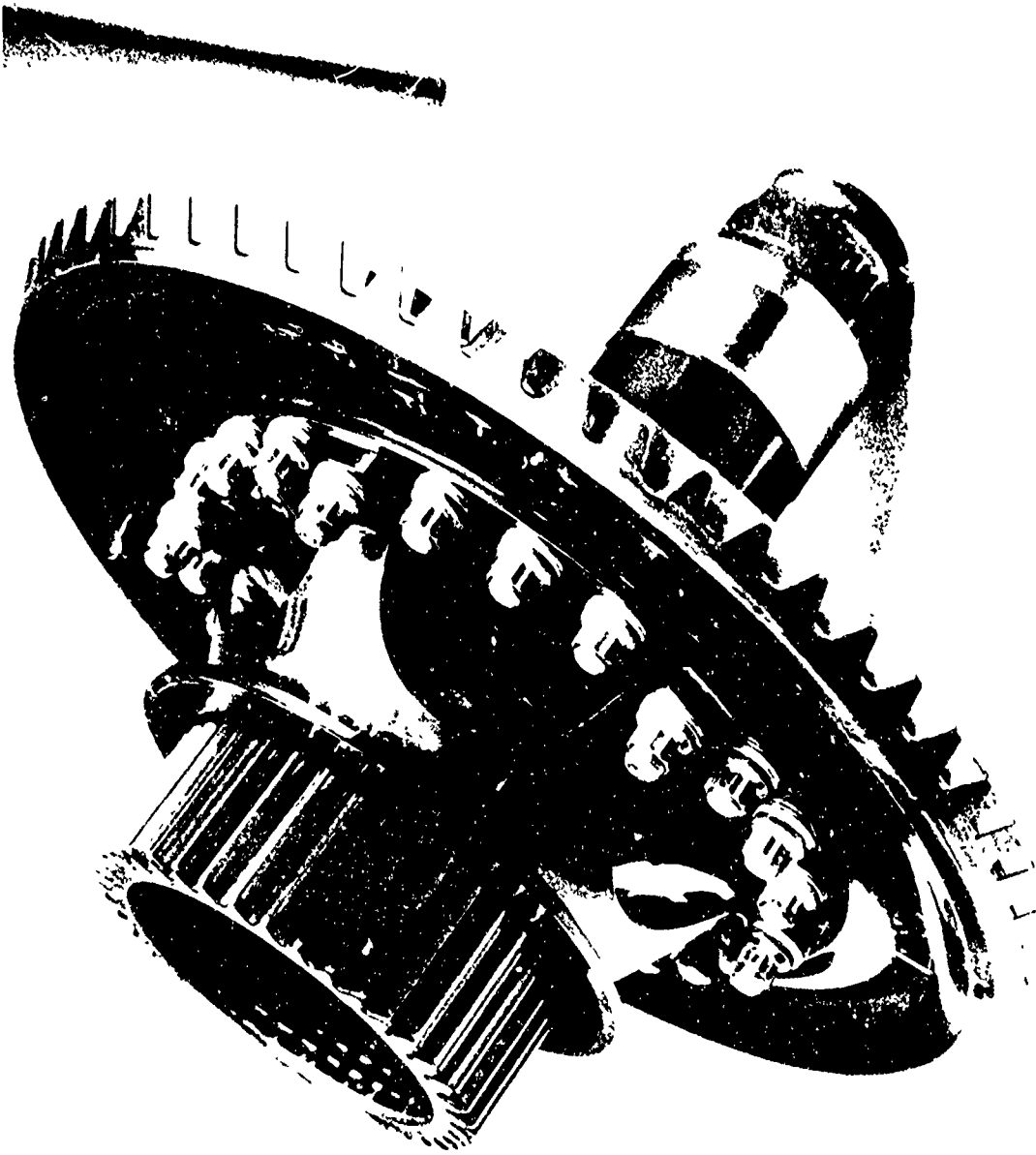

Figure 44. Photo of Restrictor Installed on Sun Gear.

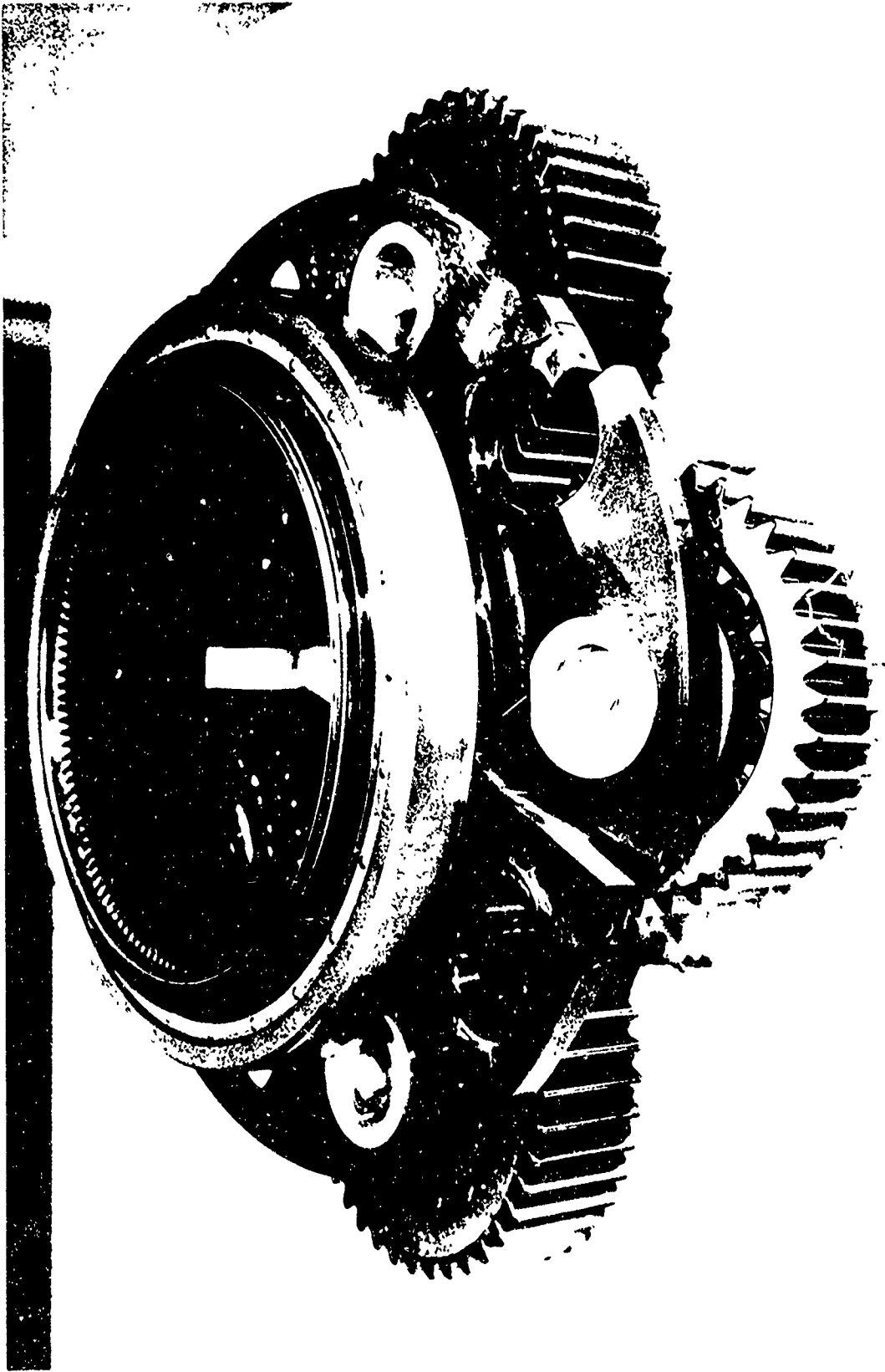

Figure 45. Photo of Simulated Completely Failed Planet Carrier.

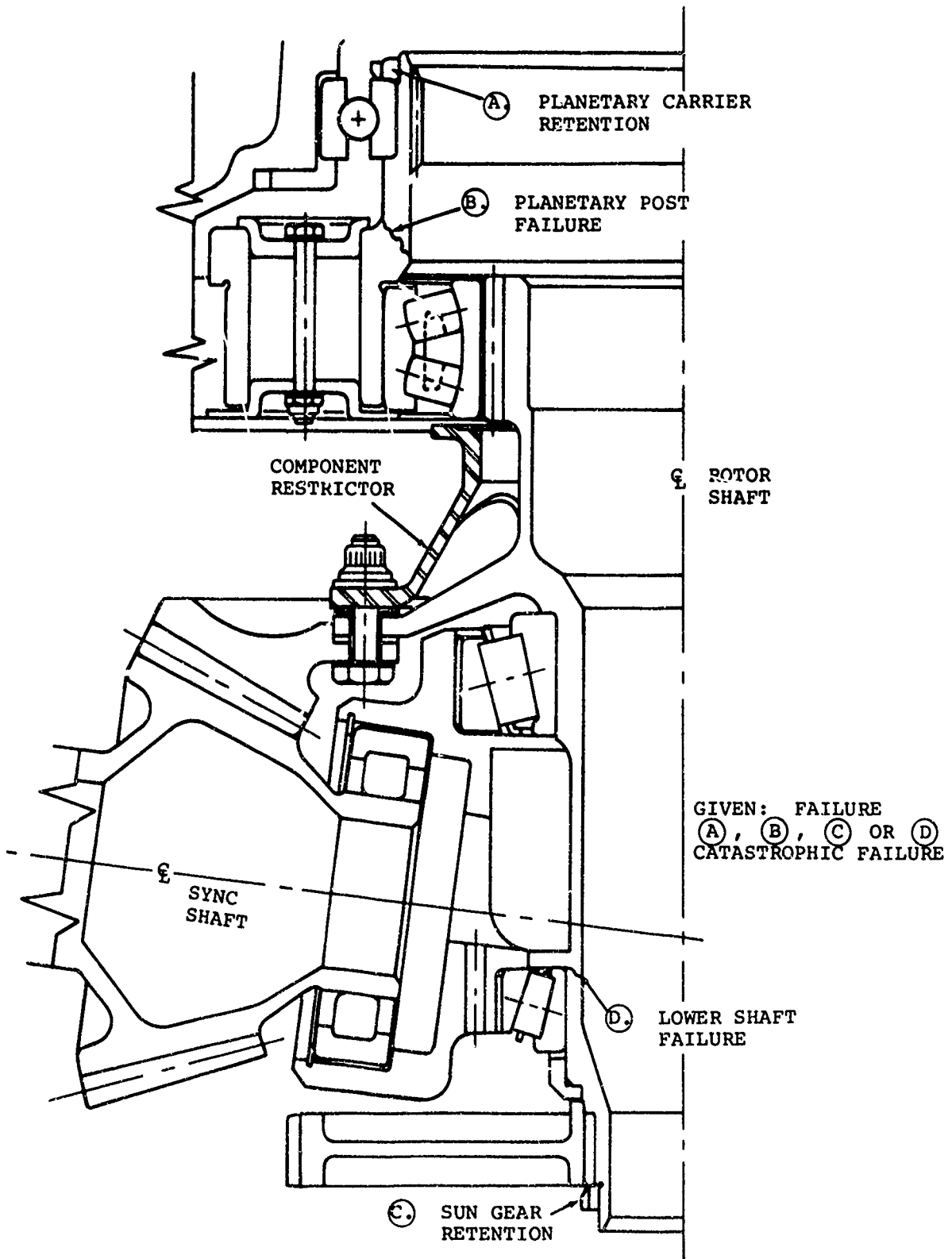

Figure 46. Transmission Component Restrictor.

This section addresses the major categories of components in helicopter transmissions from the viewpoint of consequences and hazard function shape; the two factors which affect the need for TBO's. From this discussion a pattern will emerge in those design areas requiring special attention when attempting to achieve an on-condition status. Table VIII presents an overview of the discussion.

a. Bearings

Bearings have historically been cited as the prime reason for a TBO. Traditionally, the lowest B_{10} life of a bearing in the transmission has defined the TBO interval. Implicit in this approach is the suggestion that an increase in the failure rate will occur at the B_{10} point. This, of course, is not necessarily so. The B_{10} life simply means that theoretically 10% of the units will have failed by that point and says nothing about how the failures were distributed up to that point or will be distributed after that point. The β factor in the Weibull equation expresses the change in failure rate as a function of time. Certain tests conducted on bearings (Reference 5) have indicated that the β past the B_{10} point is approximately 1. This means that the failure rate is basically constant and the failures randomly distributed. These same tests indicated an increasing failure rate (β approximately 1.5) up to the B_{10} point. Even higher β 's were evident in certain bearings in the CH-47C transmissions reviewed. The bearing data shown in Figure 47 had a β of 2.6. Why this slope is higher than the 1.5 value cited in Reference 5 and other bearing literature is not clear. With higher loadings on a bearing, there appears to be a shift of β as well as the expected shift in B_{10} life. This area is further discussed in Appendix IV of this report.

The Reference 5 tests were conducted on the bench under ideal operating conditions and the resultant β 's prior to the B_{10} point may not be applicable to bearings installed in helicopter transmissions. Some bearings have exhibited a generally constant failure rate throughout their early periods and some have even shown a marked infant mortality. This is most likely due to the fact that the failure mechanism in many bearings is not basic subsurface fatigue originated spalling. Quality defects, installation damage, or improper alignment all contribute to an infant mortality shape on installed bearings.

TABLE VIII. ON-CONDITION DESIGN CONSIDERATIONS

Component	Hazard Function Tendency	Present Detectability	Safety Affecting	Design Improvement Candidate
Bearings	β 1.5 up to B_{10} β 1.0 after B_{10}	Highly detectable	No	No
Nonrotating Seals	Decreasing	Detectable	No	No
Rotating Seals	$\beta > 1.0$	Detectable	No	Permit repair without ass'y removal
Retention and Mounting Hardware	Decreasing, constant	Difficult	Yes	Minimize hardware; improve detectability
Nonrotating Structure	Decreasing, constant	Case and housing leak; support and web cracks difficult	Yes	Improve detectability
Shafting	Decreasing, constant	Undetectable	Yes	Improve fretting surface integrity; improve detectability
Gearing	Constant, increasing	Detectable	Yes	Conservative design allowables
Splines	Increasing	Relatively Undetectable	Yes	Conservative design allowables; improve detectability
Clutches	Constant, increasing	Difficult	Yes	Permit repair without assembly removal; improve detectability

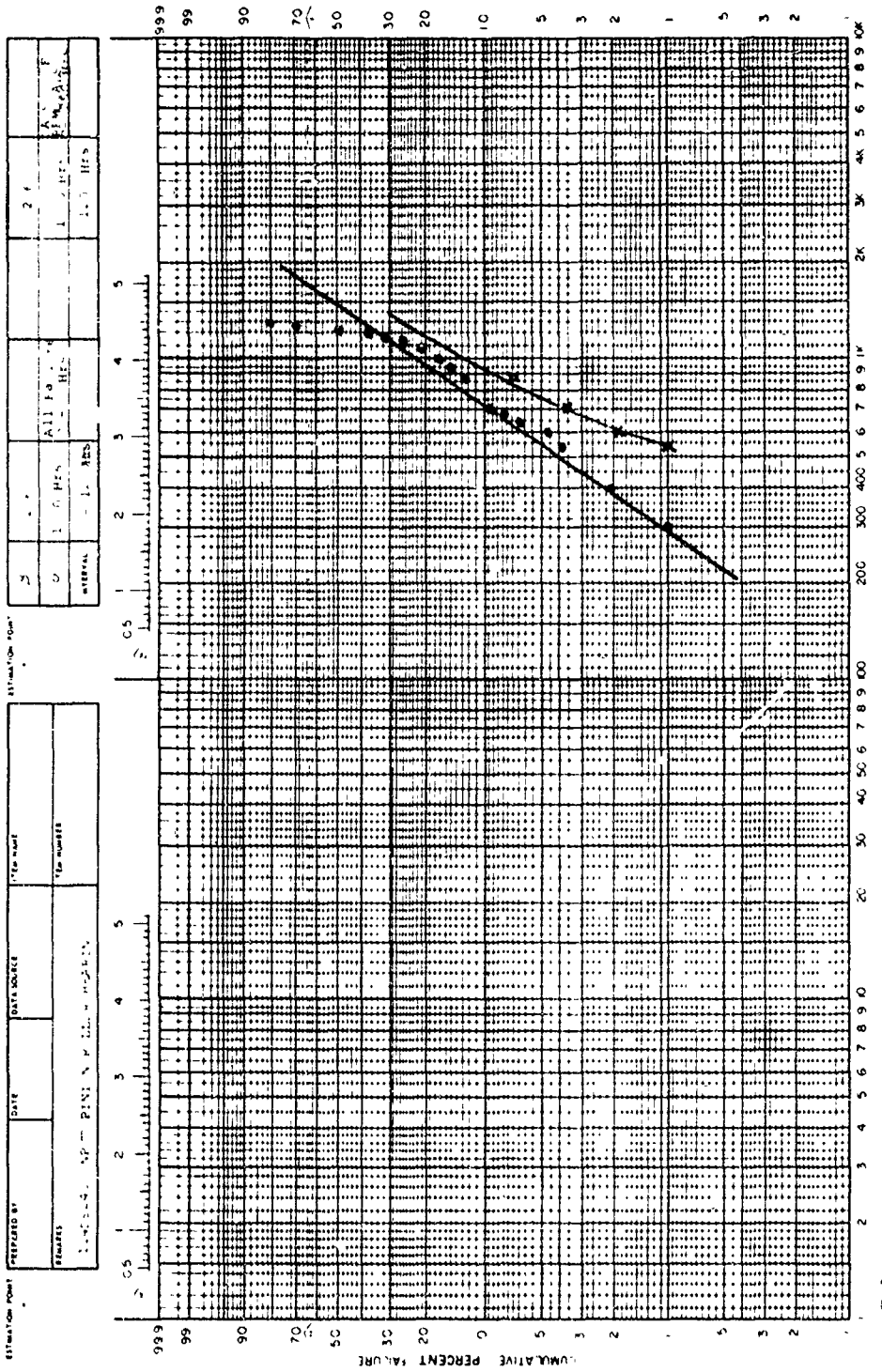

ESTIMATOR NAME	DATE	DATA SOURCE	TEST NAME	TEST NO.
PREPARED BY	DATE	DATA SOURCE	TEST NAME	TEST NO.
REMARKS	114DS240 BEARING FAILURES			
	1. 114DS240 BEARING FAILURES			
	2. 114DS240 BEARING FAILURES			
	3. 114DS240 BEARING FAILURES			
	4. 114DS240 BEARING FAILURES			
	5. 114DS240 BEARING FAILURES			

Figure 47. Weibull Plot of 114DS240 Bearing Failures.

Regardless of this infant mortality region, bearings should not determine TBO when the β is even as high as 2.0 or 3.0. The highest β that can be tolerated depends on the reliability of the bearing. The higher the B_{10} life or θ (both measures of the reliability), the higher the tolerable β . For example, Figure 48 displays the average failure rate throughout the life of an aircraft (3600 hours) as a function of β and B_{10} life. This figure indicates that β 's as high as 3.0 can be cost-effective when operated without a TBO if the B_{10} is as high as 3000 hours.

Most bearing failures are highly detectable. A normally slow failure progression coupled with adequate detection systems usually produces a warning before structural integrity is lost. One example is in Figure 47 which plots the basic failure data from the bearing, and adds the data points of those failures which progressed to the point of causing an unscheduled removal of the transmission. This later data can also be described in Weibull equation form with a β and θ similar to the basic failure data, but with a C value of 250 hours. This failure progression of 250 hours is typical of roller bearings where the failure originates within the bearing itself and is not due to the complete loss of lubrication, as in the case of jet blockage.

With this failure progression, bearings are not a safety concern but rather a cost issue. As such, they can exhibit an increasing failure rate with β 's as high as 2.0 or 3.0 when the B_{10} lives are 1 or 2 times the life of the transmission as long as these failures are detectable.

b. Seals

Nonrotating seals such as "O" rings and gaskets are rarely, if ever, a safety issue. Slight external leakage is usually the indication of problems. More importantly, the hazard function for these seals will usually have a decreasing failure rate with time. Their susceptibility to installation damage or quality/manufacturing problems contribute to this infant mortality shape.

Rotating seals, on the other hand, may have a β greater than 1 depending on the mechanism of failure. If continual running contact is present, it is likely that a real wear-out characteristic might be manifested. This possibility can be minimized through design approaches which permit repair of the seals without assembly

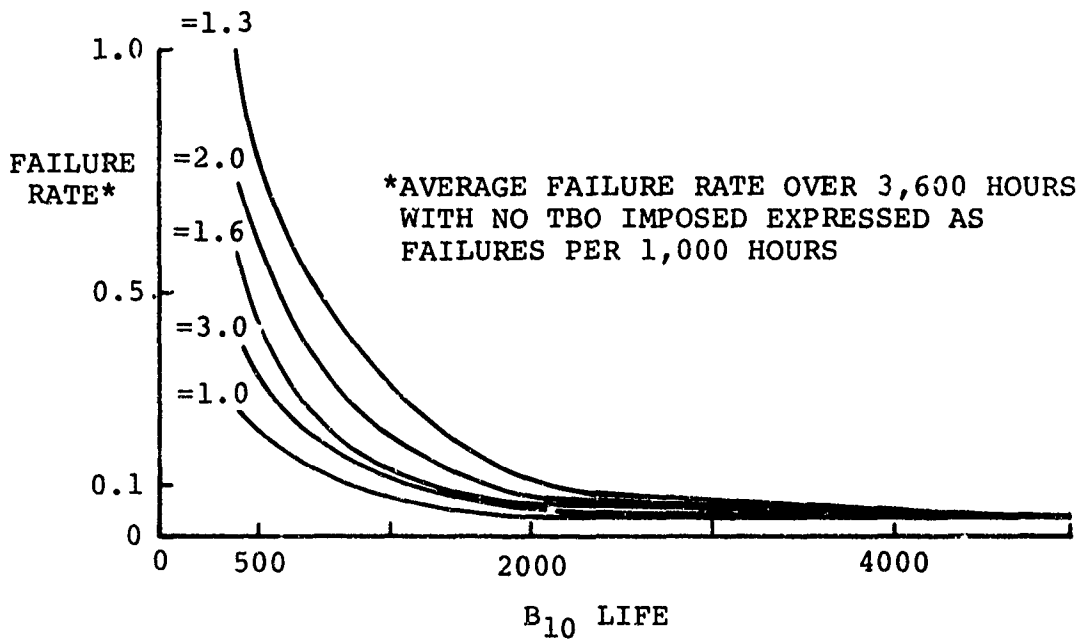

Figure 48. Failure Rate Versus B₁₀ Life.

removal. Thus, neither nonrotating nor rotating seals need ever define a TBO interval.

c. Retention and Mounting Hardware

Unfortunately, design areas such as locknuts, bearing outer race liners, bearing inner race spacers, and similar types of components have frequently been high failure items. In many instances, there have been distinct wearout type failure mechanisms associated with these components; however, these components are very subject to installation variation which result in infant mortality ($\beta < 1$) hazard functions. These two factors have combined to result in generally constant failure rates in current transmission experience. In the future, however, exposures to higher operating times may lead to clearly increasing failure rates.

This potential can probably be tolerated if the modes are detectable. This has been a difficult task on slowly accumulating wear or on relatively nonfunctional components. The debris generated by wear of these parts is generally of minute quantities and requires more sophisticated indicating devices than are currently in production. In instances where detection of the prime mode is impossible, the failure progression or sequence could be designed so that a signal is generated through the degradation of an associated component. Redundancy of function of a nondetectable component must be accompanied by an increase in detection capability to realize any practical benefit. This detection capability is an area which requires the designer's attention. Alternately (and preferably), efforts should be made to minimize this type of hardware through simplified design concepts, if the design is to eventually operate without a TBO.

d. Nonrotating Structure

Transmission cases, including internal webs and supports plus external mounting lugs and hardware, do not usually exhibit failure modes whose frequency increases with time. Material or process errors have contributed to a high percentage of case or lug cracks, and maintenance damage causes many hardware problems with studs, bushings, etc. These causal factors tend to produce a relatively constant or even decreasing failure rate with time. Because of the relatively high frequency of load application on transmission structure, manufacturing or quality defects (as well as basic errors in load predictions) will be manifested in a relatively short operating time.

Consider, for instance, a load application from the rotor head which occurs at 250 rpm. One million cycles of load (where the S/N curve flattens) will be reached in 60 hours of transmission operation. Beyond this point no significant increase in failure probability is likely. Thus, extensions of TBO from, say, 1200 hours to 3000 hours are not likely to introduce a fatigue problem.

One area of concern is the future use of composites for cases: some research has indicated composites have a tendency to wide ranges of β in their failure distributions. Designs incorporating composites should receive special attention to assure that the θ is well beyond the expected life of the transmission.

Another potential problem to extended life of transmissions is the failure mechanism of stress corrosion. Because of the calendar time effects on this mode it has been difficult to relate the probability of failure to operating time. This mechanism and means of prevention require further study.

From a detectability standpoint, case and housing cracks have traditionally been evidenced through external oil leakage and are therefore a cost, rather than safety concern. Cracks of supports or webs are not as easily detectable. Fatigue cracks do not usually produce sufficient debris to trigger the traditional oil system devices (chip detectors, filters, etc.). Although high-frequency-load fatigue failures are unlikely (as discussed previously), low-cycle fatigue problems (due to landings and takeoffs, or certain maneuver conditions) are possible. Design attention should therefore be directed at improving failure detectability in these areas of design.

e. Rotating Structure

This area of design is perhaps most critical to successfully removing TBO's. Shafting, gearing, splines, and clutches have each presented real restraints to TBO removal due to the relative undetectability of failures, the seriousness of the failures, and a historically increasing failure rate with component time.

(1) Shafting

The major area of shafting concern is not the classical fatigue crack. Most of the prior discussion of high frequency loading is applicable here, even more dramatically. At a shaft speed

of 7000 rpm, the flat portion of a steel S/N curve is reached in only two operating hours of the transmission. The real areas of concern are fatigue problems originating from fretting. This mechanism is time dependent and virtually undetectable by traditional oil system devices.

Splines, gear mounting surfaces, and shaft/bearing interfaces are all sources of fretting. This is an area where design approaches can have real pay-offs: EB welding, for instance, can eliminate many heretofore bolted joints and their attendant problems. Where fretting surfaces remain in designs, their integrity must be assured by a combination of appropriately conservative design allowables, and, in addition, endurance tests must be run to verify that the fretting endurance limit is sufficiently above operating load to assure safe operation with an extremely high statistical probability. Improved detectability of shafting failures could relieve the urgency of these requirements. New and innovative approaches will have to be studied.

(2) Gearing

Gear tooth spalling from either surface or sub-surface origins is generally detectable. The potential for high β , however, requires that conservative design allowables be employed in order to minimize its appearance.

In a similar manner, gear tooth root bending fatigue problems would not be detectable until a complete tooth was lost, at which time a catastrophic seizure could occur. Experience has shown, however, that conservative design allowables can effectively preclude the occurrence of this mode of failure.

(3) Splines

Wear and/or fretting mechanisms on spline teeth have been a constant reliability problem in past designs. Both are time dependent phenomena which are relatively undetectable. As in the case of shafting and gearing, conservative design approaches can significantly reduce the probability of failure. Close attention to inspection capability can assist in removing spline wear from a safety domain. Additional research must be directed at the reliability and detectability of

this design area. It can be a real restraint to TBO extensions, in certain instances, because of its inherently high β characteristic, unless the θ is high enough to shift the increasing hazard rate beyond the component's service life.

(4) Clutches

Based on past experience, clutch designs, especially those used in high speed applications, must be considered a high risk item. Most failure modes are time dependent, being of a wear (sprags, discs, etc.) or fatigue (cages, drag clips, etc.) nature. Inspection or diagnostics capabilities have been limited due to an inadequate understanding of the effects of wear upon clutch operations. Precise wear limits, drag readings, engagement times, etc., have not proven to be accurate indications of the clutch's ability to perform. Particle or debris generation has been of such small size and at such a slow rate of accumulation that oil system debris sensors have not been able to consistently detect clutch wear.

Although there is some research under way to investigate alternate clutch concepts, it appears that near-term designs should attempt to place the clutch in a location which allows removal/replacement without total assembly removal.

APPENDIX III
FAILURE WARNING AND INSPECTION CRITERIA
FOR ON-CONDITION TRANSMISSIONS

INTRODUCTION

Previous sections have dealt with the capability of transmissions to be operated on-condition based primarily upon their inherent values of β , θ and flight safety reliability. However, by incorporating a failure warning and inspection system, the consequences of failure modes and rates can be significantly altered. For instance, a 5-minute airborne failure warning for a mode that would cause loss of a flight-critical function removes that mode from the safety of flight category since the pilot has time to take corrective action. Similarly, a failure warning and inspection system can impact mission reliability, maintenance man-hours per flight hour, and life cycle costs. Thus, the critical question is that for those transmissions which cannot meet the criteria for on-condition maintenance through their inherent design can a failure warning and inspection system be defined which would enable such transmissions to be operated on-condition safely and economically?

SUMMARY

This section develops the criteria for defining failure warning and inspection requirements for transmissions to be operated on-condition and develops methods of optimizing the implementation of such requirements. First, the role of a failure warning and inspection system is discussed and the methods of identifying maintenance significant failure modes for new and existing transmissions are outlined. Next, mathematical and logical tests are developed for classification of failure modes relative to the type of diagnostic requirements they generate (i.e., airborne versus ground failure warning versus ground inspection), and for identification of failure modes that do not require any type of failure warning or inspection. Sample trade studies are then performed to illustrate a method of ranking the relative suitability of alternative sensing techniques to detect representative failure modes on gears and bearings. Signal conditioning requirements are discussed relative to the need for conversion of raw transducer signals into truth values for fault statements which can be processed by fault-isolation logic. Finally, there is a brief discussion of signal flow analysis which is the methodology for developing fault-isolation logic to evaluate all permutations and combinations of fault statement truth values. This then allows the required failure warning and inspection messages to be displayed to the flight crew and maintenance personnel.

Figure 50 of this section identifies the decision criteria for evaluating those modes requiring failure warning and inspection in order that a gearbox operate on condition. Stepping through this decision chart with the data provided in Tables XL and XLIII of Appendix VIII and in Figures 72 through 78 of Appendix IX for the CH-47C, it is determined that no additional failure warning and inspection gear are required to render the CH-47C transmissions suitable for on-condition operation. An analysis¹ performed by Boeing Vertol in 1971 reiterates this position.

Thus, although the decision criteria identified in Figure 50 may appear prohibitive, it is postulated here that if these criteria are applied, it may be found that many present generation helicopter gearboxes are capable of on-condition operation with a minimal addition of failure warning and inspection equipment.

THE ROLE OF FAILURE WARNING AND INSPECTION SYSTEMS FOR ON-CONDITION TRANSMISSIONS

The failure warning and inspection system can be configured to play a role in as many as four basic areas: flight safety reliability, mission reliability, life cycle overhaul costs, and aircraft maintenance burden and availability. The degree to which a failure warning and inspection system influences each of these areas is a function of the system's design concept.

The section on failure warning and inspection-related criteria will more fully discuss the various system design concepts, while this section will identify the means by which a maximum capability system plays a role in each of the above four areas.

Flight Safety Reliability

Failure warning and inspection offers potential improvement to flight safety reliability through basic approaches:

- Warning of impending failures
- Reduction of exposure to transmission infant mortality

Failure warning provides advance notice of impending flight safety failures. This then allows the pilot increased time in which to take corrective action. Secondly, it provides maintenance personnel with an improved capability for differentiating between failure modes which are serious enough to justify transmission removal and those which are minor and do not warrant transmission removal. As a result, unwarranted transmission removals are reduced with a consequent reduction in exposure to the infant mortality associated with newly manufactured or newly overhauled transmissions.

Mission Reliability

Improvements in mission reliability can be expected because of the ability of a failure warning and inspection system to provide maintenance personnel with a more accurate and detailed inspection capability for internal components along with time to failure prognosis, reducing both ground and air aborts. In addition, the ability to provide notification and quantification of specific failure modes gives the pilot additional ability upon which to base a ground or air abort decision.

Maintenance Burden and Availability

A failure warning and inspection system will decrease the maintenance man-hours per flight hour required

to perform routine inspections. This will in turn also reduce the required skill levels of the on-aircraft maintenance personnel.

The time-to-failure prognosis capability provided by failure warning will supply maintenance planning data to facilitate spares provisioning along with more effective use of personnel and facilities, increasing aircraft availability.

Life Cycle Overhaul Costs

Increased MTBR, through the reduced quantity of unnecessary unscheduled removals discussed previously, has an obvious impact in the reduction of life cycle overhaul costs. In addition, there is a small potential cost benefit from the reductions in secondary damage that will occur where adequate impending failure warning is provided. Further cost reductions can result from some previously life-limited parts that no longer need be discarded at overhaul, while improved life-extension data can be gathered for those life-limited parts that remain.

Summary

A successful failure warning and inspection system can:

- Improve flight safety reliability
 - Reduce exposure to infant mortality via fewer premature removals
 - Provide pilot notification of impending SOF failures
- Improve mission reliability
 - Provide more accurate and detailed inspection capability of internal components not normally accessible to quality control personnel
 - Provide real-time notification and quantification of in-flight failures
- Reduce aircraft MMH/FH and increase availability
 - Reduce scheduled maintenance requirements
 - Provide maintenance planning data for maintenance facility

- Reduce life cycle overhaul costs
 - Extend MTBR (equals MTBO) through reduced premature removal rate
 - Reduce secondary damage
 - Reduce effect of life limited parts and provide life extension data for those that remain

FAILURE WARNING AND INSPECTION RELATED CRITERIA

The task sequence to be followed in determining the failure warning and inspection requirements for any transmission is to identify failure modes, classify failure mode, trade off sensor packages, meet signal conditioning requirements and analyze signal flow. This section is divided into segments corresponding to these tasks, and each segment includes the criteria from which the requirements are generated. It must be emphasized here that the failure warning and inspection requirements for a specific transmission configuration are unique to that configuration and not directly transferable to a different configuration. This does not mean, however, that similar techniques, sensors and signal processing equipment cannot be used for a number of different configurations if proper judgement is exercised in combining the above elements according to the criteria defined in this report.

The sample sensor package tradeoffs contained in this section are not intended to be applicable to any specific transmission configuration, but are included only to illustrate methodology and some of the alternative sensing techniques available.

Identification of Failure Modes

For the purpose of evaluating the potential of various failure warning and inspection systems for improving transmission on-condition potential, it is necessary that a failure mode effect and criticality analysis (FMECA) be performed for the considered transmission

For existing transmissions on which historical field experience or test data is available, identification of failure modes should be fairly straightforward. Modes should be identified in terms of their hazard function parameters, β and θ . These values can be calculated from historical data using the methods identified in Appendix V of this report.

For new design transmissions, estimates must be made of the frequency at which each mode will occur. For assistance in this area, the generic failure mode distribution identified

in Appendix VIII of this report can be employed. The values determined for the frequency of mode occurrence can then be transformed into the θ parameter of the mode hazard functions using the MTBF versus B_{10}/θ program in Appendix VII. Generic limits of the β parameter have been developed and presented in Appendix VIII of this report. Thus, utilizing the data presented in Appendix VIII of this report along with the reliability prediction for the total assembly, the parametric representation of the hazard function for each failure mode can be developed.

Failure Mode Classification

Having identified all the significant maintenance failure modes for a specified gearbox configuration, the next task is to classify each mode and part combination according to its impact on safety of flight (SOF) mission reliability, maintenance burden and life cycle costs so that the failure warning and inspection requirements can be defined. For the purposes of this analysis, a safety of flight failure mode is defined as any mode which results in immediate loss of a flight critical function. Thus, gear breakage, bearing seizure or disintegration, shaft breakage, and missing or broken critical retention and mounting hardware are SOF modes; however, destructive pitting and spalling, scoring, and abrasive wear, although definitely mission affecting, are non-SOF modes.

Figure 49 is a Venn diagram representing the relationship of mission affecting and safety of flight failure modes to failure warning requirements. The innermost circle contains all the SOF modes that can be tolerated while still meeting the gearbox flight safety reliability requirement where for an on-condition analysis the requirement is equal to the total safety affecting failure rate that would be encountered if the gearbox were operated with a TBO. The second circle represents the boundary of all SOF modes inherent in the transmission design, including those which can be eliminated from the SOF category by failure warning. Thus, the area between the first and second circles contains all the failure modes that must be removed from the SOF category by providing real time failure warning to the flight crew. This failure warning must provide advance notification sufficient for corrective action (i.e., a different mode of operation or precautionary landing) to be taken. The area within the third circle contains all the allowable mission affecting modes compatible with the transmission's reliability requirement (note that all the inherent SOF modes, including those removed from the SOF category by failure warning, are included as mission-affecting modes). Again, for an on-condition analysis, the requirement is equal to the total mission affecting malfunction rate that would be encountered if the gearbox were operated on condition. The fourth circle contains all the mission affecting failure

TRANSMISSION RELIABILITY

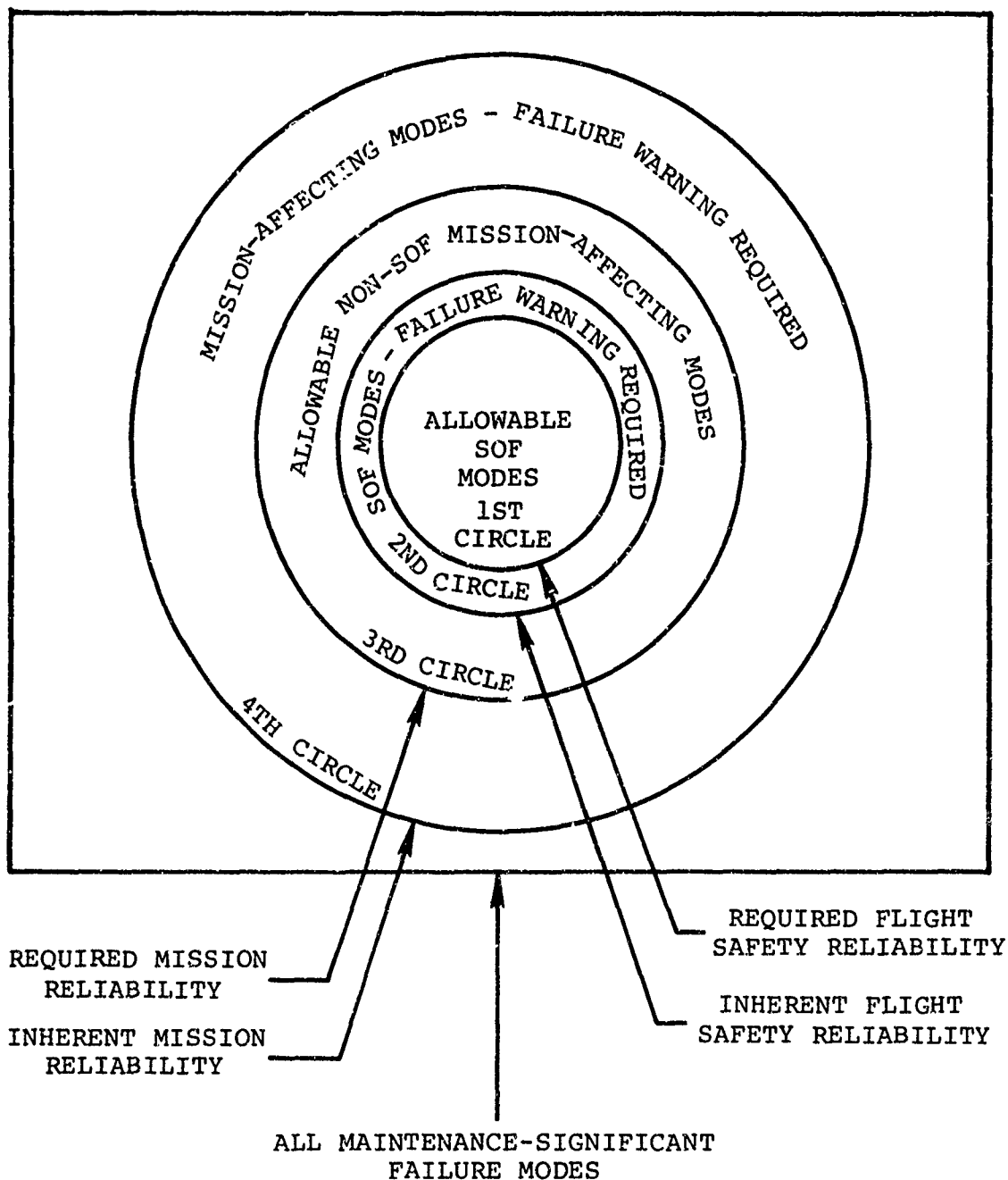

Figure 49. Relationship of Mission-Affecting and Safety-of-Flight Mode Versus Failure Warning Requirements.

modes inherent in the gearbox design, including those which can be removed from the mission affecting category by failure warning or inspection. The area between the third and fourth circles, therefore, represents all those modes which require sufficient failure warning so that maintenance personnel are notified or impending failure prior to initiation of flight.

It should be noted at this point that a subtle, but significant difference exists between failure warning requirements for mission-affecting and SOF modes. The SOF mode failure warning must be real time and therefore requires on-board signal conditioning and analysis; but the non-SOF mission-affecting mode failure warning is intended primarily for pre-flight indication to maintenance personnel. Therefore the signal processing and analysis can be performed by a piece of GSE through evaluation of recorded raw data transferred from the airborne portion of the failure warning and inspection system. The exception to this rule is the rapidly progressing non-SOF mission-affecting mode that must be diagnosed to provide failure warning for a safety of flight mode such as lube starvation leading to a critical bearing seizure.

Figure 50 is a decision flow chart which defines the criteria by which failure warning and inspection requirements are generated for each mode and part combination. The first step is to perform a failure mode effect and criticality analysis (FMECA). Secondly, proceed with the analysis of the safety of flight modes to determine which ones have MTBF's less than the flight safety reliability limit factor, K_1 , times the MTBUR of the gearbox when operated with a TBO. It should be noted here, that for simplicity in the following discussion, the modal θ is used in a manner similar to the way one would usually use MTBF, that is, the θ values are meant to be inversely representative of the rate at which the mode occurs. Here we are making use of two facts which allow us to use θ rather than MTBF. First, for θ values much greater than 5000 hours, failure modes with β values greater than 1 increase very little in the 0 to 5000 hour operating regime. Secondly, since we do a β test on those modes with low θ 's, we are merely simplifying the process by using θ synonymously with MTBF, since the β issue does come into play for the critical low θ modes.

Identification of these modes and determination of K_1 is accomplished as follows:

1. List all inherent SOF failure modes in order of increasing θ . Thus, for a transmission with n safety of flight modes

$$\theta_1 \leq \theta_2 \leq \theta_3 \leq \dots \leq \theta_p \leq \theta_{p+1} \leq \dots \leq \theta_n \quad (1)$$

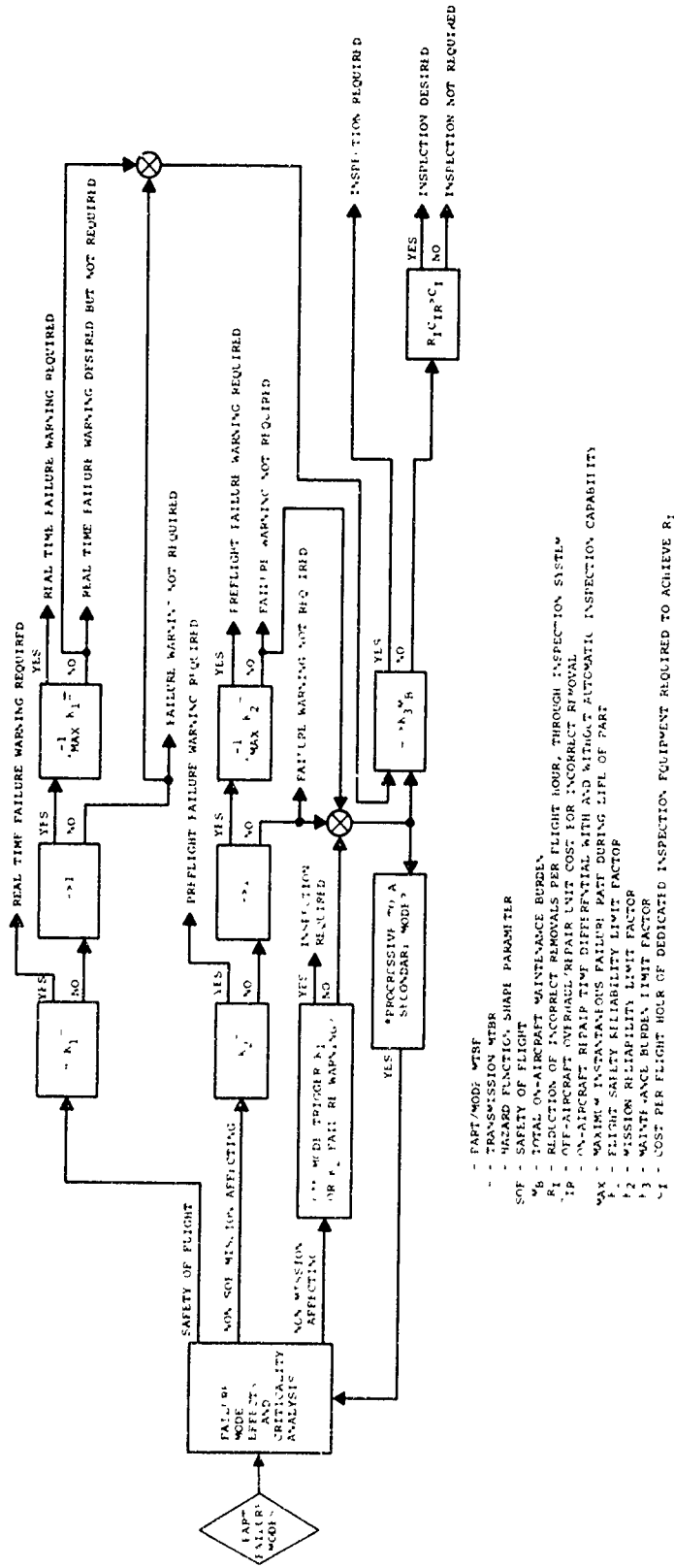

IF THE MODE WHICH IS BEING ANALYZED WILL PROCEED TO A SECONDARY MODE WITHIN THE LIFE EXPECTANCY OF THE PART, PROCEED TO CONDUCT A FAILURE MODE EFFECTS AND CRITICALITY ANALYSIS FOR THE SECONDARY MODE.

Figure 50. Failure Warning and Inspection System Criteria Decision Flow Chart.

2. Determine θ_p such that

$$\frac{1}{\theta_p} + \frac{1}{\theta_{p+1}} + \frac{1}{\theta_{p+2}} + \dots + \frac{1}{\theta_n} = 1 - R_s \quad (2)$$

where R_s = transmission flight safety reliability
which results from operating with a
certain TBO.

3. Set $K_1 = \frac{\theta_p}{\bar{\theta}}$, where $\bar{\theta}$ = transmission MTBUR when
operated with a certain
TBO.
4. Check to see if modes 1 through P-1 can be removed
from the safety of flight category by providing
failure warning. If this cannot be accomplished
with a reasonable probability of success, K_1 must
be revised according to Steps 5 through 7.
5. If modes X, Y and Z cannot be diagnosed by use of
the criteria of Step 4, determine a revised value
of θ_p such that

$$\frac{1}{\theta'_p} + \frac{1}{\theta'_{p+1}} + \frac{1}{\theta'_{p+2}} + \dots + \frac{1}{\theta'_n} + \frac{1}{\theta'_x} + \frac{1}{\theta'_y} + \frac{1}{\theta'_z} = 1 - R_s \quad (3)$$

$$\text{If } \frac{1}{\theta'_x} + \frac{1}{\theta'_y} + \frac{1}{\theta'_z} > 1 - R_s$$

the transmission cannot go on condition without at
least one of the following modifications:

- Suitable redesign to reduce the magnitude

$$\frac{1}{\theta'_x} + \frac{1}{\theta'_y} + \frac{1}{\theta'_z}$$

- Suitable redesign to allow failure warning to be accomplished for modes X, Y and Z.
- Testing to evaluate failure mechanisms, failure progression rates and/or modal hazard functions to determine whether the modes can or cannot be tolerated from a safety aspect.

6. When equation (3) is true, calculate a revised value of K_1 :

$$K_1' = \frac{\theta_P'}{\bar{\theta}} \quad (4)$$

7. Return to step 4 and test for the revised value of P. If the requirements are not met, repeat steps 5 through 7 and if they are met, a final value for K_1 has been determined in equation (4) (note that modes X, Y, and Z have been exempted from their failure warning requirement in spite of their MTBF's being less than K_1 times the transmission MTBUR when operated with a TBO).

Thus, SOF modes 1 through P-1 from equation (1) will all have MTBF's less than the flight safety reliability limit factor times the transmission MTBR and therefore require real-time failure warning. However, for modes P through n where $\theta > K\bar{\theta}$, additional criteria must be satisfied to establish whether or not failure warning will be required. If the mode's hazard function is constant or decreasing, the MTBF then will not decrease to less than $K_1\bar{\theta}$ and failure warning will not be required. If the mode's hazard function is, however, increasing ($\beta > 1$), we must establish whether or not the minimum MTBF during the life of the part will drop below the $K_1\bar{\theta}$ limit. If the MTBF will drop below this limit, then failure warning is required to assure continued compliance with the required flight safety reliability. If the MTBF will not fall below

the $K_1\bar{\theta}$ limit, failure warning is not required (although it may be desirable due to the increasing failure rate).

Next we proceed with a similar analysis of the non-SOF, mission-affecting failure modes to identify those modes with θ parameters less than the mission reliability limit factor, K_2 , times the transmission MTBUR when operated with a TBO. Determination of the mission reliability limit factor is accomplished as follows:

1. Let ϕ represent the summation of all the SOF failure rates whose modes were removed from the safety of flight category by providing real-time failure warning. Thus, from equation (1) of the SOF modes analysis,

$$\phi = \frac{1}{\theta_1} + \frac{1}{\theta_2} + \dots + \frac{1}{\theta_{p-2}} + \frac{1}{\theta_{p-1}} \quad (5)$$

2. List all the inherent non-SOF mission affecting failure modes in order of increasing θ . Thus for a transmission with m such modes,

$$\theta_1 \leq \theta_2 \leq \theta_3 \leq \dots \leq \theta_q \leq \theta_{q+1} \leq \dots \leq \theta_m \quad (6)$$

3. Determine θ_q such that

$$\frac{1}{\theta_q} + \frac{1}{\theta_{q+1}} + \dots + \frac{1}{\theta_m} + \phi + (1-R_S) = 1-R_M \quad (7)$$

where R_M = transmission's mission reliability which results from operating with a certain TBO.

4. Set $K_2 = \theta_q/\bar{\theta}$
5. Check to see if modes 1 through $q-1$ can be removed from the mission-affecting category by providing preflight failure warning. If this cannot be accomplished with a reasonable probability of success, K_2 must be revised according to steps 6 through 8.
6. If modes U, V, and W cannot be diagnosed through use of the requirements of step 5, determine a revised value of θ_q such that

$$\frac{1}{\theta_q} + \frac{1}{\theta_{q+1}} + \dots + \frac{1}{\theta_m} + \phi + (1-R_S) + \frac{1}{\theta_U} + \frac{1}{\theta_V} + \frac{1}{\theta_W} = 1-R_M \quad (9)$$

$$\text{If } \phi + (1-R_S) + \frac{1}{\theta_U} + \frac{1}{\theta_V} + \frac{1}{\theta_W} > 1-R_M \quad (10)$$

The transmission cannot go on condition without one of the following modifications:

- Suitable redesign to reduce the magnitude of $\phi + (1-R_S) + \frac{1}{\theta_U} + \frac{1}{\theta_V} + \frac{1}{\theta_W}$ to less than $1-R_m$.
 - Suitable redesign to allow preflight failure warning to be accomplished for modes U, V, and W.
 - Testing to evaluate failure mechanisms, failure progression rates and modal hazard functions to determine whether the modes can or cannot be tolerated from a mission reliability aspect.
7. When equation (9) is true, calculate a revised value of K_2 :

$$K_2' = \theta' / \bar{\theta} \quad (11)$$

8. Return to step 5 and test for the revised value of q . If the requirements are not met, repeat steps 6 through 8 and if the requirements are met, a final value for K_2 has been determined in equation (11) (note that modes U, V, and W have been exempted from their failure warning requirement in spite of their MTBF's being less than K_2 times the transmission MTBUR when operated with a TBO).

As shown then, non-SOF mission-affecting modes 1 through $q-1$ from equation (6) will all have MTBF's less than the mission reliability limit factor times the transmission MTBUR and therefore will require preflight failure warning. However, for modes q through m where $\theta > \theta K_2$, additional criteria must be satisfied to establish whether or not failure warning will be required. If the mode's hazard function is constant or decreasing, then its MTBF cannot decrease to less than $K_2 \bar{\theta}$ and failure warning is not required. But if the modes' hazard function is increasing ($\beta > 1$), we must establish whether or not the minimum MTBF during the life of the part will drop below the $K_2 \bar{\theta}$ limit. If the MTBF will drop below this limit, then failure warning is required to assure continued compliance with the mission reliability requirement; but if it will not fall below the $K_2 \bar{\theta}$ limit, failure warning is not required.

We now proceed to analyze the non-mission-affecting failure modes. An intrinsic concern of these modes is that they should not falsely activate the failure warning sensors for the SOF and mission-affecting modes. If a non-mission-affecting mode can activate the sensor, then an inspection capability is required to provide direct indication of its nature (i.e., non-mission-affecting). If this inspection capability

cannot be provided, the SOF and mission-affecting modes' analyses must be reiterated to account for the removal of confused failure warning capabilities. Having accomplished this, we must list all the non-SOF mission-affecting and non-mission-affecting modes that do not require failure warning or inspection and determine if each will progress to a secondary mode within the life expectancy of its associated part.

If a secondary mode appears to be imminent, then the entire preceding analysis must be carried out for the secondary mode.

The next phase of failure mode classification is to identify those modes which heavily impact the on-aircraft maintenance burden (maintenance man-hours per flight hour) and derive the criteria which will identify their inspection requirements. The basic assumption here is that the MTTR for many failure modes can be significantly reduced through shorter troubleshooting times available with an inspection system.

Figure 51 is a Venn diagram illustrating the relationship of on-aircraft maintenance burden due to modes with previously defined failure warning or inspection requirements, mode whose total maintenance burden falls within the allowable limit and all the inherent maintenance-significant failure modes. Figure 51 shows that the modes in the area between the middle and outer circles will require inspection capability sufficient to reduce the inherent maintenance burden to the required maintenance man-hours per flight hour. These modes are identified as those for which the MMH/FH savings due to inspection is greater than the maintenance burden limit factor, K_3 , times the total transmission maintenance burden. The maintenance burden limit factor is calculated as follows:

1. Let τ = reduction in on-aircraft MTTR due to inspection capability. Let $\Delta M_B = \text{Required } \frac{\text{MMH}}{\text{FH}} - \text{Inherent } \frac{\text{MMH}}{\text{FH}}$
2. Arrange all maintenance significant modes without previously defined failure warning or inspection requirements in order of decreasing $\frac{\text{MMH}}{\text{FH}}$ reductions attributable to an inspection capability (this involves first defining the inspection capability for each mode). Thus for a transmission with ℓ such modes,

$$\frac{\tau_1}{\theta_1} \geq \frac{\tau_2}{\theta_2} \geq \frac{\tau_3}{\theta_3} \geq \dots \geq \frac{\tau_r}{\theta_r} \geq \dots \geq \frac{\tau_{e\ell}}{\theta_{e\ell}}$$

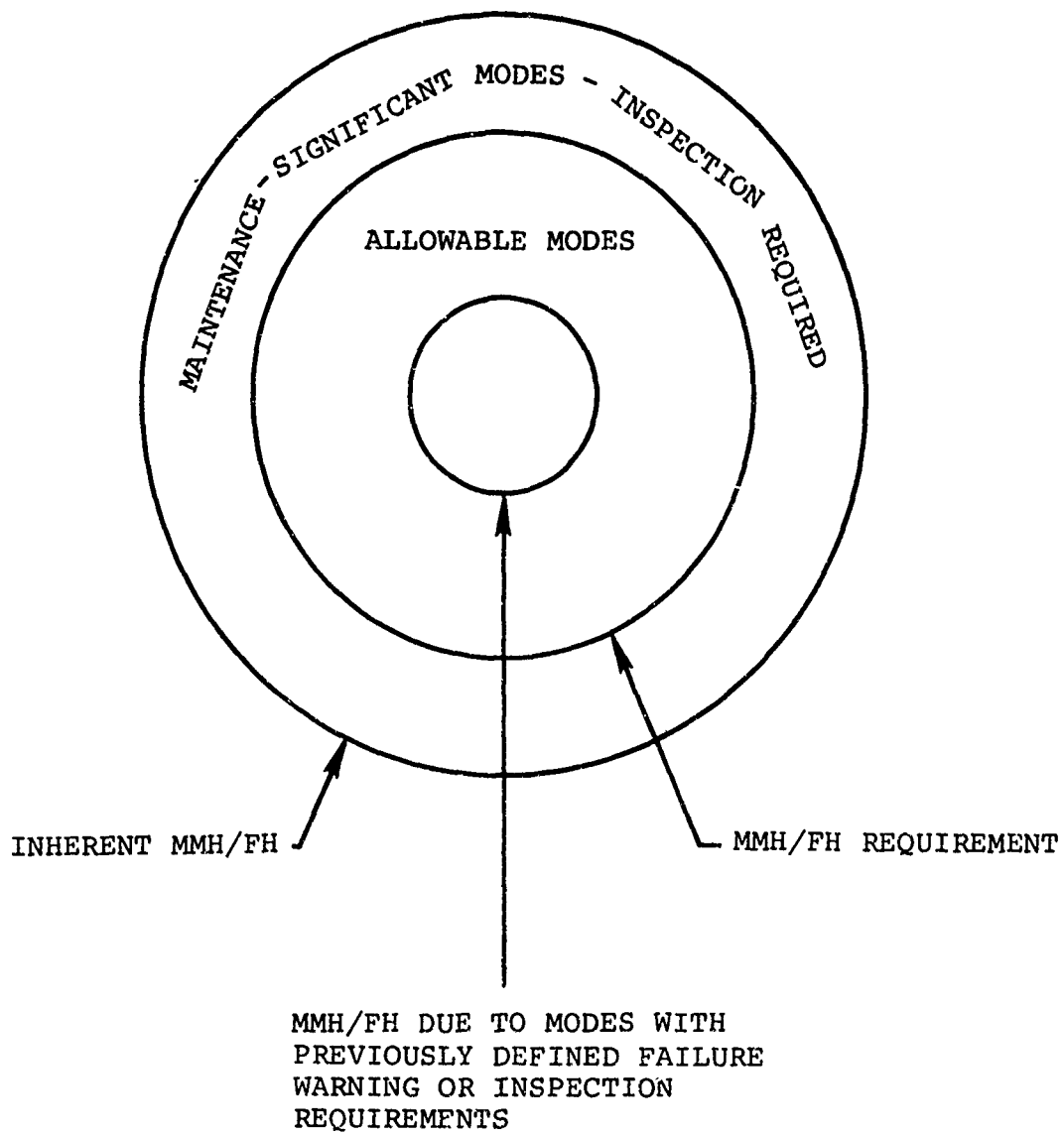

Figure 51. On-Aircraft Maintenance Burden.

3. Determine $\frac{\tau_r}{\theta_r}$ such that

$$\frac{\tau_1}{\theta_1} + \frac{\tau_2}{\theta_2} + \frac{\tau_3}{\theta_3} + \dots + \frac{\tau_r}{\theta_r} = \Delta M_B$$

4.
$$K_3 = \frac{\tau_r}{M_B \theta_N}$$

where M_B = total transmission maintenance burden encountered when operating with a TBO. Thus, modes 1 through $r-1$ will each contribute a MMH/FH savings greater than the maintenance burden limit factor times the total transmission on-aircraft maintenance burden requirement. This means that the timesaving inspection techniques available for these modes are required to achieve the transmissions $\frac{MMH}{FH}$ goal.

The remaining undiagnosed modes r through ℓ , do not require failure warning or inspection to comply with flight safety reliability, mission reliability or maintenance man-hour per flight hour requirements; however, an inspection capability may be desirable from the life cycle costs point of view. The assumption made here is that by having an inspection capability to diagnose a given failure mode, the incorrect removal rate for the mode will decrease. This lower incorrect removal rate translates into cost savings by decreasing logistics costs, pipeline spares requirements and off-aircraft repair parts and labor costs. Thus, if the decrease in incorrect removals per flight hour times the cost per incorrect removal is greater than the cost per flight hour of the added inspection capability, then the additional inspection gear is cost effective and therefore desirable. Thus, when

R_I = decrease in incorrect removals per flight hour due to added inspection capability

C_{IR} = cost per incorrect removal

C_I = cost per flight hour of added inspection capability

then if

$$R_I \cdot C_{IR} > C_I$$

the additional inspection gear is desirable.

For an expression of R_I which includes a 95-percent probability that the actual rate will be equal to or greater than the calculated value, let

r_s = reduction of incorrect removal rate due to additional inspection capability

T = life cycle fleet flight hours

t = life cycle component hours

$\bar{\theta}_M$ = MTBUR due to failure mode

Then

$$R_{I \text{ 95 PCT}} = \frac{r_s (t/\bar{\theta}_M - 1.63\sqrt{t/\bar{\theta}_M})}{T}$$

For the cost per flight hour of added inspection gear, let

N = no. of units procured for fleet life cycle

M_{BI} = direct maintenance costs (per flight hour)

A_S = unit acquisition cost differential due to the added inspection gear

Then

$$C_I = \frac{N \cdot A_S + N \cdot M_{BI} \cdot T}{T}$$

Thus, for a 95-percent confidence level, that inspection gear will be desirable for cost savings on modes r through l ,

$$\frac{r_s (t/\bar{\theta}_M - 1.63\sqrt{t/\bar{\theta}_M})}{T} \cdot C_{IR} > \frac{N \cdot A_S + N \cdot M_{BI} \cdot T}{T}$$

In summary then, each failure mode and part combination identified for the transmission must be analyzed according to the procedure outlined in Figure 50. In this way, the failure warning and inspection requirements are derived directly from the transmission's performance, maintainability and operating cost requirements, rather than through a haphazard approach. This assures that the failure warning and inspection hardware will not be overdesigned for diagnostics overkill and will provide easily visible information for the sensitivity of transmission performance to individual failure warning and inspection requirements.

Finally, when all the aircraft diagnostic requirements are identified and the failure warning and inspection system is designed, the system itself must undergo the same analysis to identify its own required built-in test equipment (BITE).

Sensor Package Tradeoffs

Having identified all significant failure modes, grouped them according to their mechanism and classified them as to their hazard functions and effect on safety of flight, etc., next evaluate the various sensing techniques available to detect each failure mode in each component class.

The NSIA Tradeoff Technique (Ref. ALM-43-3566-LC(A)) is used to objectively develop quantitative scores indicative of the relative values of alternative sensing techniques in performing failure warning and inspection of a given failure mode on a specific component. Three scores are calculated for each sensing technique. The total score considers all parameters and considerations listed on the tradeoff data sheet, while the detection score considers only the asterisked (*) considerations which relate purely to the ability of the alternative sensing techniques to find and/or predict failures. The summary score is simply the sum of the total score plus the detection score.

NSIA TRADEOFF SCORING RATIONALE

Relative Weighting

The relative weighting values vary from 1 to 4 and are intended to represent the relative importance of each of the parameter considerations shown in Table IX and included in the NSIA tradeoff (4 is the most important). These values are held constant for all of the failure warning and inspection techniques being evaluated for a specific failure mode. However, weighting factors may be varied between failure modes to account for individual variations in failure mode characteristics such as secondary damage, safety, and type of hazard function. The following text is a detailed description of the rationale used as guidelines to assign relative weighting values to each of the parameter considerations.

Failure Warning - This consideration is weighted as a function of the individual failure mode hazard function, impact on safety of flight (SOF) and secondary damage/failure mode considerations. As a general guideline, this is given a relative weighting of 2 for non-SOF failure modes with decreasing or constant hazard functions and 4 for modes with increasing hazard functions or near term effects on SOF.

TABLE IX. FAILURE WARNING AND INSPECTION SENSOR
PACKAGE PARAMETERS AND CONSIDERATIONS
(CRITERIA)

Parameter	Considerations
Capability	Failure warning and inspection*
Nature of indication	Direct or indirect* for mode and part
Sensor suitability	Reliability Cost Accuracy versus requirement* Multiple function capability component design impact
Associated hardware	Complexity, reliability, versatility, and cost
Other	As warranted

*Items include in NSIA detection score

Inspection - This consideration is weighted on a basis similar to that for failure warning, but with the additional assumption that, generally, the total number of occurrences of a particular failure mode during the life cycle of an on-condition transmission is directly proportional to the hazard function of the mode. This means that a mode with a decreasing hazard function will result in fewer total failures during the life cycle than a mode with a significant constant hazard function which in turn results in fewer total failures than a mode with an increasing hazard function. The guideline values for inspection capability are 2, 3, and 4 for non-SOF failure modes with decreasing, constant, and increasing hazard functions respectively, and 4 for all safety of flight failure modes.

Direct or Indirect Indication - This consideration refers to the ability of a failure warning and inspection technique to directly detect symptoms of a specific failure mode rather than indirectly via a secondary mode, and identify a particular discrepant part or assembly within the transmission. For non-SOF failure modes with decreasing or constant hazard functions, this consideration is given a relative weighting of 2 and for increasing hazard function modes a weighting of 3. A weighting of 4 is assigned to all SOF failure modes.

Sensor Reliability - This consideration has been assigned the maximum weighting of 4 and is constant for all failure modes. The criticality of sensor reliability is primarily due to three factors: (1) the serious consequences of undetected failures in terms of both SOF degradation and secondary damage; (2) the high costs of processing incorrect removals resulting from false failure indications; and (3) the cost of performing sensor maintenance due to accessibility restrictions and/or calibration requirements.

Sensor Cost - Sensor costs must be minimized to prevent on-condition O&M cost savings from being wiped out by increased component acquisition costs. This consideration is given a relative weighting of 3 and is not considered to vary as a function of failure mode.

Sensor Accuracy Versus Requirement - It is important that the sensor adequately distinguish between a failure mode which has progressed to an unacceptable limit and one which has begun but not yet progressed to a stage requiring corrective action. The relative weighting of this consideration can vary considerably between failure modes. The value assigned is based primarily on engineering judgment. The following is used as a guideline: non-SOF failure modes with decreasing or constant hazard functions are weighted at 2 and those with increasing hazard functions are weighted at 3, while all SOF failure modes are 4.

Sensor Multiple Function Capability - Considerable improvements in sensor package reliability and overall component cost can be achieved if a particular sensor can adequately perform two or more functions. This consideration therefore is assigned a relative weighting of 3 and is considered non-variable as a function of failure mode.

Component Design Impact - The impact of the sensor on component design can be of considerable importance to the component cost. This is particularly true if sensor output is transmitted via hard wiring and slip rings internal to the transmission or if structural modifications to a production design are required. Therefore this consideration is assigned a non-variable relative weighting of 4.

Associated Hardware Complexity - This item is of moderate importance because it may impose cost, weight, and power penalties and require skilled maintenance personnel for checkout and repair. The relative weighting assigned is 2 and is considered a constant.

Associated Hardware Reliability - Although associated hardware reliability is somewhat critical in relation to undetected failures, it will be external to the monitored component and therefore more easily accessible for checkout and repair. Relative weighting is 2 and considered nonvariable.

Associated Hardware Versatility and Cost - These considerations are similar to sensor multiple function capability and cost, therefore they are assigned the same relative weighting of 3 which is considered nonvariable.

It should be emphasized that the above discussion is the rationale used to develop the guideline values for relative weighting and that minor variations to these values for individual failure modes are considered permissible when the variations can be backed by sound engineering judgment. Table X is a summary of the relative weighting guideline values discussed.

BASIC RATINGS

The basic rating values range from -100 to +100 for each of the parameter considerations used to evaluate the worth of a failure warning and inspection technique relative to a specific failure mode. Any positive rating indicates a desirable feature and therefore, any negative value indicates undesirability directly proportional to the absolute value of the assigned basic rating. The basic ratings correspond to qualitative evaluations based upon field experience, test data and engineering judgment. Basic rating guidelines which relate

TABLE X. RELATIVE WEIGHTING GUIDELINE VALUES

Parameters	Considerations	Non-SOF Failure Mode Hazard Function			Safety of Flight Failure Mode
		Decreasing	Constant	Increasing	
Capability	Failure warning inspection	2	2	4	4
		2	3	4	4
Nature of indication	Direct or indirect	2	2	3	4
Sensor suitability	Reliability	4	4	4	4
	Cost	3	3	3	3
	Accuracy versus requirement	2	2	3	4
	Multiple function capability	3	3	3	3
	Component design impact	4	4	4	4
Associated hardware	Complexity	2	2	2	2
	Reliability	2	2	2	2
	Versatility	3	3	3	3
	Cost	3	3	3	3

guideline numerical values to the qualitative evaluations of each of the parameter considerations are tabulated in Tables XI through XIV.

Table XV is a comparison of sensor suitability and associated hardware parameter considerations which remain constant for each failure warning and inspection technique, regardless of the failure mode to which the technique is applied.

BEARING/GEARING NSIA TRADE STUDY

The following discussion provides a detailed example of the manner in which NSIA trade studies would be performed for the component class gears and bearings.

It should be noted that this trade study has been performed as an example of methodology contingent upon some general assumptions about gearbox configuration. Thus, the results of the trades should not be construed as representative of the ideal/universal diagnostics package.

Sensor Evaluations for Gearing Failure Modes

The significant failure modes for the component class gearing are listed in Table XVI, and six sensing techniques have been selected for comparative evaluation. In the following paragraphs each of these techniques is described in terms of conceptual design and functional capability.

Chip Detector

Conceptual Design - A coarse mesh screen made of parallel, alternately polarized conducting wires laid on a grid of neutral, nonconducting filaments which run normal to the conducting wires is located at the entrance of the sump scavenge oil line. A second set of wires which run parallel to the conducting loops form a locking weave which binds the conducting loop wires to the neutral nonconducting filaments. Resistors are wired in series with each sensing loop to control the flow of current as a function of debris quantity.

Functional Capability Assumptions -

1. Exposure to 100 percent of oil flow and 90 percent of sedimentary debris.
2. Not sensitive to particles of normal wear size or an accumulation of normal wear particles.
3. Not sensitive to electrically nonconduction particles.

TABLE XI. NATURE OF INDICATION PARAMETER			
Nature of Indication			Basic Rating
Direct	Indirect	None	
Mode & Part			+100
Mode	Part		+ 75
Part	Mode		+ 50
	Mode & Part		+ 25
Mode		Part	0
	Mode	Part	- 25
Part		Mode	- 50
	Part	Mode	- 75
		Part & Mode	-100

TABLE XII. DETECTION CAPABILITY PARAMETER				
Failure Warning or Inspection Capability	Non-Safety of Flight Failure Modes			Safety of Flight Failure Mode
	Decreasing Hazard Function	Constant Hazard Function	Increasing Hazard Function	
Yes	+60	+80	+90	+100
Maybe	+10	+20	+40	+ 50
No	0	0	-90	-100

TABLE XIII. SENSOR SUITABILITY PARAMETER

Consideration	Qualitative Evaluation	Basic Rating
Reliability	Excellent	+100
	High	+ 75
	Good	+ 50
	Fair	0
	Low	- 50
	Poor	- 75
Cost	Unacceptable	-100
	Low	+100
	Moderate	0
Accuracy versus requirement	High	-100
	Excellent	+100
	High	+ 75
	Good	+ 50
	Acceptable	0
	Fair	- 50
Multiple function capability	Low	- 75
	Unacceptable	-100
	All modes	+100
	High	+ 75
	Good	+ 50
	Fair	0
Component design impact	Low	- 50
	Poor	- 75
	None	-100
	None	+100
	Low	+ 75
	Moderate	0
	High	- 75
	Very high	-100

TABLE XIV. ASSOCIATED HARDWARE PARAMETER

Consideration	Qualitative Evaluation	Basic Rating
Complexity	Low	+100
	Moderate	0
	High	-100
Reliability	Excellent	+100
	High	+ 75
	Good	+ 50
	Moderate	0
	Low	- 50
	Poor	- 75
Versatility	Unacceptable	-100
	All signals	+100
	High	+ 50
	Moderate	0
	Low	- 50
Cost	None	-100
	Low	+100
	Moderate	0
	High	-100

TABLE XV. SENSOR SUITABILITY AND ASSOCIATED HARDWARE PARAMETERS
(CONSTANT CONSIDERATIONS)

Detection Technique	Sensor Suitability				Associated Hardware			
	Reliability	Cost	Multiple Function Capability	Component Design Impact	Complexity	Reliability	Versatility	Cost
Chip detector	High (+75)	Low (+100)	Good (+50)	Low (+75)	High (+100)	High (+75)	None (-100)	Low (+100)
Shock detector	Good (+50)	Moderate (0)	High (+75)	Mod-High (-50)	Moderate (0)	Moderate (0)	High (+50)	Mod-High (-50)
In-line oil monitor	Fair-Good (+25)	Mod-High (-50)	High (+75)	Low (+75)	Moderate (0)	Moderate (0)	High (+50)	Mod-high (-50)
Infrared sensor	High (+75)	Mod-Low (+50)	Fair (0)	High (-75)	Mod-Low (+50)	Good (+50)	Moderate (0)	Moderate (0)
Radioactive tracer	Good (+50)	Moderate (0)	Low (-50)	Low (+75)	Mod-Low (+50)	Good (+50)	Moderate (0)	Moderate (0)
Thermocouples	High (+75)	Low (+100)	Poor (-75)	Low (+75)	Mod-Low (+50)	Good (+50)	High (+50)	Mod-Low (+50)
Advanced XMD	High (+75)	Moderate (0)	High (+75)	Low (+75)	Mod-Low (+50)	Good (+50)	High (+50)	Moderate (0)

TABLE XVI. GEAR FAILURE TERMS/TYPES/DEGREES

Type	Degree		
	Slight	Moderate	Severe
<u>Wear</u> - Wearing away of the surface (clean and/or higher viscosity oil required).	Nondestructive polishing	Improper oil film moderate wear (prolonged wear may become severe). Interference wear.	Involute destruction by prolonged wear. Debris/abrasive wear. Chemical action corrosive wear.
<u>Pitting</u> - Surface fatigue failure beyond endurance limit.	Initial pitting (removal of high contact spots). (Alignment problem.)	Destructive pitting caused by uncorrected initial pitting (sometimes bending fracture occurs).	Spalling: similar to destructive pitting in medium and full hard material. Case crushing to case-carburized or nitrided gears.
<u>Scoring</u> - Surface rapid wear due to thermal breakdown of oil film.	Frosting appearance on driving gear caused by overheating in the mesh breaking down oil film (may polish itself away).	Moderate scoring on dedendum/and addendum in patches Localized scoring due to misalignment.	Destructive scoring, aggravated radial marks above and below pitch-line. Tip/root interference scoring due to unmodified on center-tight gears.
<u>Plastic Flow</u> - Cold working of tooth surfaces by high contact surface deformation and rolling/sliding action of surface and subsurface yielding.	Slow rate of destruction peening/rolling.	Yielding to slipstick friction (lack of lubrication).	Cold flow Rippling Ridging

TABLE XVI. CONTINUED

Type	Degree		
	Slight	Moderate	Severe
Fracture - Breakage or cracking of whole or part of a tooth by overload or cyclic stress beyond bending endurance limit.	Quenching crack	Fracture	Fatigue breakage
	Grinding cracks	Rim failure	Overload breakage
Other	Stress riser (residual) subsurface defect.	Web failure	Stress concentration random
		Chipped teeth	(Fracture: any part of tooth.)
	Corroded	Scratched	Gouged
	Fretting (usually associated with working splines)	Dented	Distorted
		Nicked	Mutilated

4. Provides continuous indication of debris quantity (rate optional) for metallic particles of larger than normal wear size.
5. High reliability.

Shock Detector

Conceptual Design - Shock pulses with a high energy rise and very short duration originate from tooth contacts in the rotating gear mesh and bearing rolling element contacts with the bearing races. A ringing accelerometer with a resonance of 38 kHz is mounted on a nonrotating structure (i.e., a bearing housing) and resonates due to the shock pulses propagating at the speed of sound through the gear or bearing materials. An amplifier tuned to the accelerometer resonance picks up the results of the shock pulse while ignoring the lower frequency background vibration due to elastic resonances within the gear and bearing elements and surrounding structure.

Functional Capability Assumptions -

1. A shock pulse is a sharp rise, short duration pulse of energy related directly to the severity of dynamic contact between two surfaces.
2. Shock pulse amplitude is attenuated markedly (empirical data indicates 14 db or 80 percent) at mechanical interfaces.
3. Normal shock pulse amplitude from dynamic tooth contact in a gear mesh is sufficiently large to be detectable through a nearby support bearing on the gear shaft.
4. Shock pulse propagation is independent of gear, bearing, or mounting structure elastic resonance and thus is not affected by changes in this property with load or wear.
5. The ringing accelerometer will have good reliability for a permanent but highly inaccessible installation.

In-Line Oil Monitor

Conceptual Design - The in-line oil monitor employs a transducer mounted in the oil line and a signal conditioner which can be remotely located. The oil is monitored by measuring light scattering caused by suspended particulates, and light attenuation resulting from chemical/thermal degradation. An output corresponding to flow rate is also provided. The design incorporates internal stable references to make the monitor automatically and continuously self-calibrating. The use of sealed fiber optics in the transducer eliminates conventional windows and lenses in the optical path.

Functional Capability Assumptions -

1. High sensitivity to provide early indication of incipient malfunction.
2. Ability to detect metallic, nonmetallic, particulate or dissolved impurities for debris quantity and rate.
3. Capable of detecting chemical/thermal degradation of the oil.
4. Continuous flow monitoring provided.
5. Fair to good reliability.

Advanced Transmission Monitoring Device (XMD)

Conceptual Design - Figure 52 is a cutaway view of the XMD which would be mounted in an oil line downstream of the chip detector, and Figure 53 outlines the signal conditioning circuitry. The sensing screen is similar to that of the chip detector incorporating resistors wired in series with each sensing loop to control the flow of current as a function of metallic debris quantity. In order to provide a capability of detecting nonmetallic debris, the XMD incorporates a differential pressure switch to activate a warning after a certain percentage of the screen becomes blocked.

Functional Capability Assumptions -

1. High sensitivity to metallic debris quantity and rate.
2. Gross sensitivity to nonmetallic debris.
3. No sensitivity to dissolved impurities or chemical/thermal degradation of the oil.
4. High reliability.

Radioactive Tracer

Conceptual Design - A radiation sensor is installed in an oil line or sump with close proximity to the filter screen or debris trapping mechanism. Critical wear parts are impregnated with specific radioactive tracer elements. As wear progresses to critical limits, the radioactive tracer element particles are counted by the radiation sensor and the discrepant part is identified by the energy level of the radiation corresponding to the tracer element with which it was treated. The extent of wear and rate of progression can then be made available by signal conditioning similar to that of the transmission monitoring device (XMD). It should be noted that the central cone

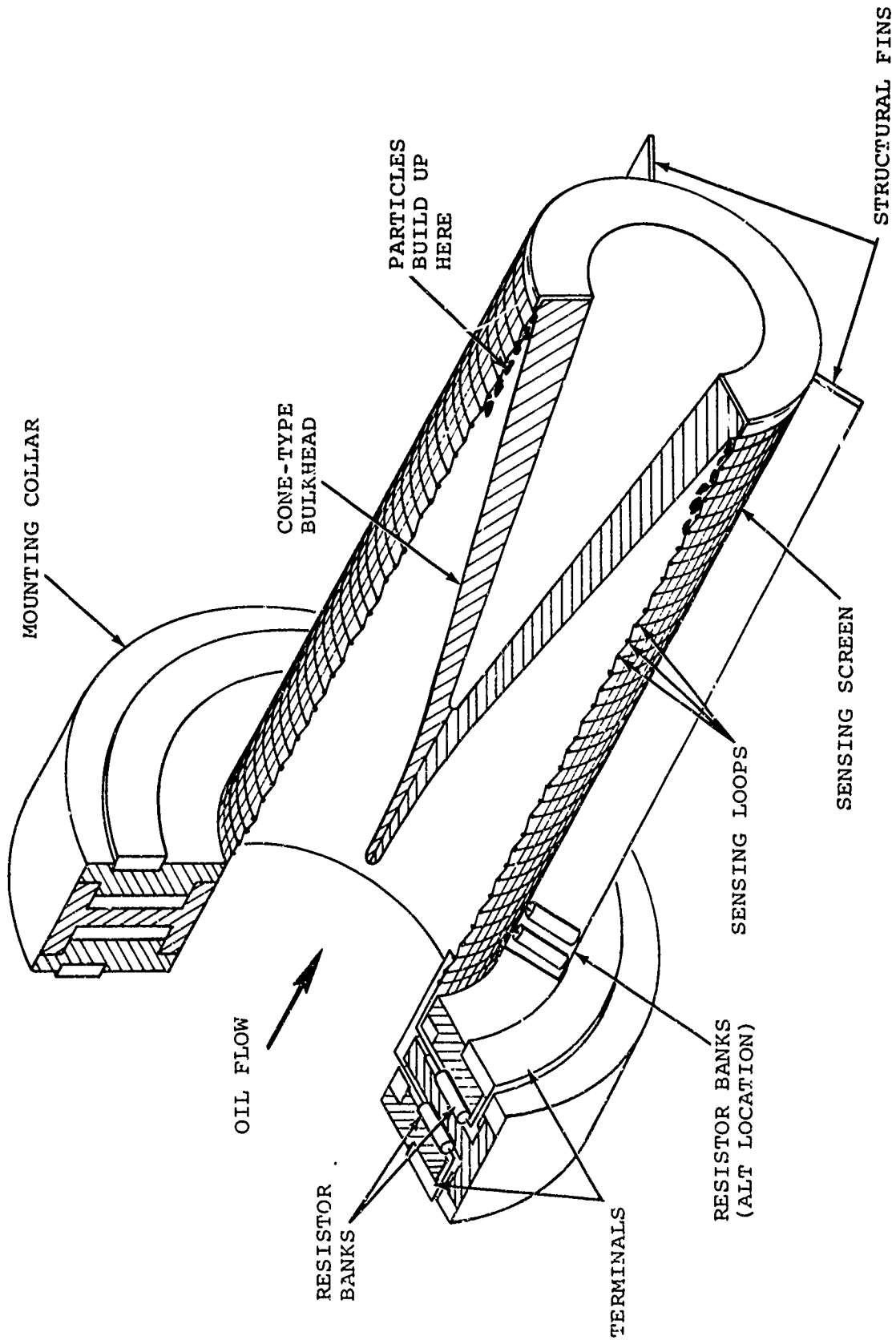

Figure 52. Transmission Debris-Monitoring Device.

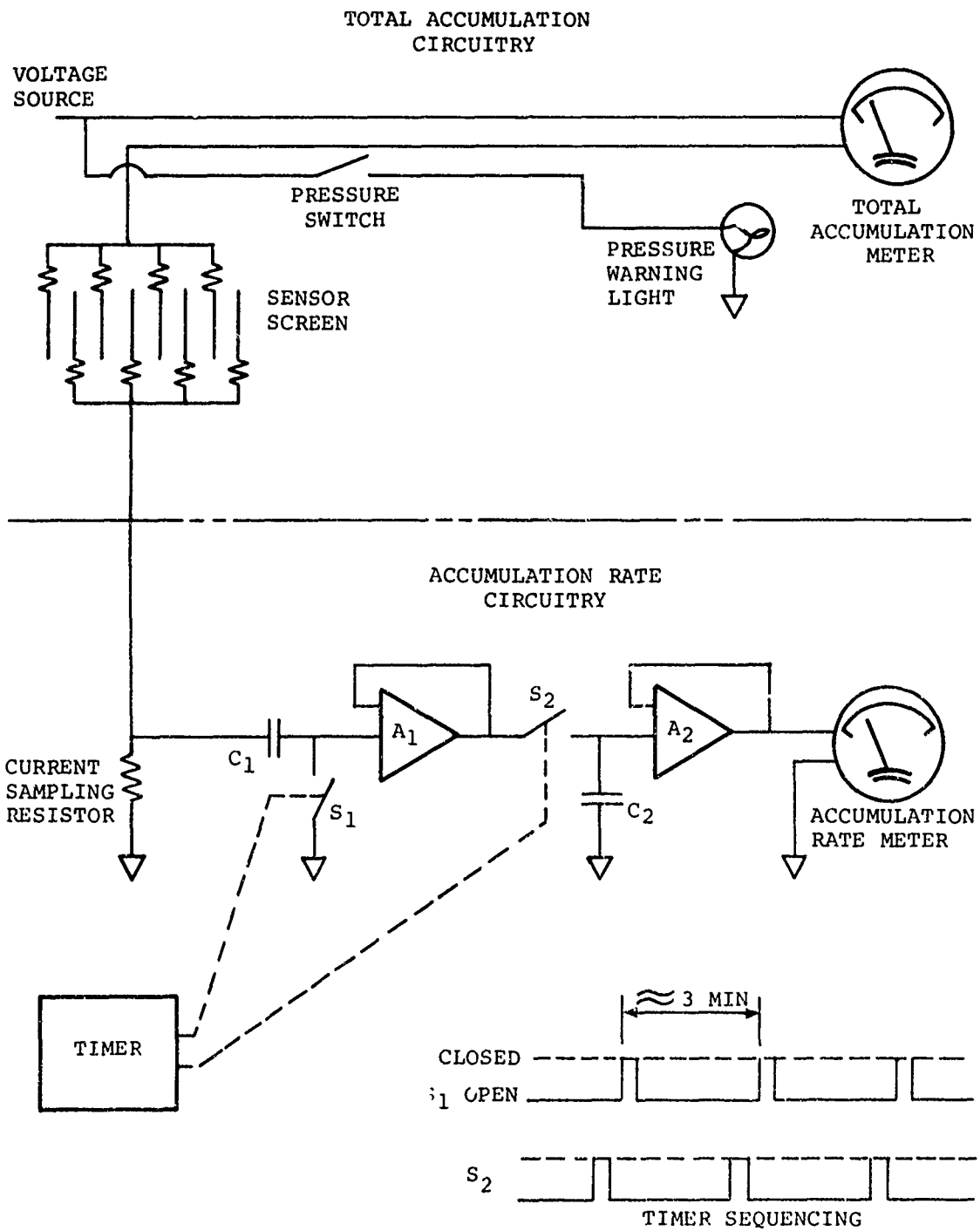

Figure 53. Particle Detector Circuitry.

of the transmission monitoring device (XMD) would be the ideal location of the radiation sensor, particularly if the chip detector screen were located at the entrance of the transmission monitoring device. Also in an alternate configuration, the radioactive sensor could be a piece of GSE used to periodically check debris traps and oil for tracer radioactivity.

One variation of this technique is known as kryptonation. A kryptonate is a solid which has been impregnated by radioactive krypton -85 gas. Forming a kryptonate (called kryptonation) is accomplished by diffusion of the gas into the material under temperature. A kryptonated metal releases a portion of its krypton upon being heated to the initial temperature at which the gas was introduced, and further heating at or below this temperature results in no further loss of radioactivity. Additional krypton -85 is emitted only when the maximum temperature attained during the previous heating is exceeded. Consequently, the maximum surface temperature of a gear mesh can be monitored in an actual operating transmission and krypton-impregnated wear particles can be detected by a radiation sensor in the transmission monitoring device.

Functional Capability Assumptions -

1. Accurate treatment of critical wear parts with radioactive tracer elements is practical.
2. Tracer elements with sufficiently distinctive radiation energy levels are available without generating hazards to human health.
3. Critical wear limits can be accurately defined.
4. Radiation sensor will have good reliability.
5. Tracer elements will remain in oil.
6. Satisfactory shelf life for tracer treated components (due to isotope half-life).

Magnetic Plug

The magnetic plug type of sensor was not included in the sensor tradeoffs due to the following inherent deficiencies:

1. Failure warning is accomplished through a random collection of about 2 percent of the generated debris.
2. A safe gap setting results in numerous false pilot warnings from an accumulation of normal wear particles.

3. The magnetic plug has no capability to provide indication of debris quantity or rate of generation.
4. The magnetic plug provides no indication of the following failure modes which would be found by the screen type chip detector and/or transmission monitoring device.
 - The generation of aluminum or magnesium filings (a bearing retaining nut which backs off against a housing can produce this condition).
 - Bronze particles from a failed bearing cage.
 - Oxides produced in the gearbox sump.

NSIA TRADEOFF - GEARING

Table XVII presents a summary of the NSIA tradeoff performed for the component class gearing. A sample tradeoff for gearing tooth fracture and breakage is shown in the following pages.

Tables XVIII through XXII demonstrate the format of the work sheets employed as an intermediate step toward the development of Table XXIII.

NSIA TRADEOFF - BEARINGS

Table XXIV presents a summary of the NSIA tradeoff performed for the component class bearings. A sample tradeoff for bearing abnormal wear is shown in the following pages.

Tables XXVI through XXXI demonstrate the format of the work sheets employed as an intermediate step toward the development of Table XXV.

Sensor Evaluations for Bearing Failure Modes

The significant bearing failure modes are listed in Table XXXIII and six types of sensors have been selected for comparative evaluation. Five of these six sensor types are described in the gearing sensor evaluations, the sixth type is described below.

Thermocouples

Conceptual Design - Redundant thermocouples are mounted on a bearing housing. These thermocouple sets from a number of

TABLE XVII. NSIA SENSOR TRADEOFF, SUMMARY SCORE CHART; COMPONENT CLASS, GEARING

Failure Mode	Detection Technique	NSIA Tradeoff Scores	
		Total	Detection Summary
Tooth fracture and breakage	Chip detector	+37.5	+ 6.3
	Shock detector	+30.0	+75.0
	In-line oil monitor	+14.4	+ 6.3
	Advanced XMD	+31.9	+ 6.3
Scuffing, scoring and frosting	Infrared sensor	+33.4	+83.5
	In-line oil monitor	+15.7	+ 5.0
	Shock detector	+19.2	+45.5
	Advanced XMD	+38.0	+ 5.0
Pitting, spalling and chipping	Chip detector	+42.9	+ 9.1
	In-line oil monitor	+27.6	+44.5
	Shock detector	+34.0	+87.7
	Radioactive tracer	+19.3	+11.4
	Advanced XMD	+49.7	+51.3
Rim or web fractures and cracks	Shock detector	+30.1	+55.0
	Chip detector	-13.6	-100.0
	In-line oil monitor	-14.2	- 55.0
Interference and heavy end loading	Chip detector	+42.0	+ 3.0
	Shock detector	+10.4	+23.0
	In-line oil monitor	+21.9	+37.0
	Infrared sensor	+25.6	+52.0
	Advanced XMD	+46.9	+42.0
Gear hub, flange fretting and spline wear	Chip detector	+25.2	-27.6
	Shock detector	+ 2.8	- 7.7
	In-line oil monitor	+12.3	+ 0.3
	Radioactive tracer	+34.8	+53.6
	Advanced XMD	+35.4	+13.7
			+ 43.8
			+105.0
			+ 20.7
			+ 38.2
			+116.9
		+ 20.7	
		+ 64.7	
		+ 43.0	
		+ 52.0	
		+ 72.1	
		+121.7	
		+ 30.7	
		+101.0	
		+ 85.1	
		-113.6	
		- 69.2	
		+ 45.0	
		+ 33.4	
		+ 51.9	
		+ 77.6	
		+ 88.9	
		- 2.4	
		- 4.9	
		+ 12.6	
		+ 88.4	
		+ 49.1	

TABLE XVIII. NSIA TRADEOFF FOR ALTERNATE FAILURE WARNING AND INSPECTION OF GEAR TOOTH FRACTURE AND BREAKAGE

Parameter	Considerations	Alternative Failure Warning and Inspection Techniques			
		Chip Detector (See Table XV)	Shock Detector (See Table XVI)	In-Line Oil Monitor (See Table XVII)	Advanced XMD (See Table XVIII)
Capability	Failure warning	No	Maybe	No	No
	Inspection	Yes	Yes	Yes	Yes
Nature of indication	Direct or indirect	M-I P-N	M-D P-D	M-I P-N	M-I P-N
Sensor suitability	Reliability Cost Accuracy versus requirement Multiple function capability Component design impact	High Low Good	Good Moderate Good	Fair-good Moderate-high Good	High Moderate Good
Associated hardware	Complexity Reliability Versatility Cost	Low High None Low	Moderate Moderate High Moderate-high	Moderate Moderate High Moderate-high	Low-moderate Good High Moderate
Other					

TABLE XIX. GEARING CHIP DETECTOR FAILURE WARNING AND INSPECTION FOR TOOTH FRACTURE AND BREAKAGE - NSIA TRADEOFF DATA SHEET

Parameters	Considerations	Relative Weighting	Basic Rating		Adjusted Values	
			Undesir- able	Desir- able	Undesir- able	Desir- able
Capability	Failure warning	4*	-100		-400	
	Inspection	4*		+100		+400
Nature of indication	Direct or indirect	4*	-25		-100	
Sensor suitability	Reliability	4		+75		+300
	Cost	3		+100		+300
	Accuracy versus requirement	4*		+50		+200
	Multiple function capability	3		+50		+150
	Component design impact	4		+75		+300
Associated hardware	Complexity	2		+100		+200
	Reliability	2		+75		+150
	Versatility	3	-100		-300	
	Cost	3		+100		+300
Other						
Detection* ratings		16*			-500	+600
Totals		40			-800	+2300
NSIA Total Score		+37.5	NSIA Detection Score		+6.3	

TABLE XX. GEARING SHOCK DETECTOR FAILURE WARNING AND INSPECTION FOR TOOTH FRACTURE AND BREAKAGE - NSIA TRADEOFF DATA SHEET						
Parameters	Considerations	Relative Weighting	Basic Rating		Adjusted Values	
			Undesirable	Desirable	Undesirable	Desirable
Capability	Failure warning	4*		+ 50		+200
	Inspection	4*		+100		+400
Nature of indication	Direct or indirect	4*		+100		+400
Sensor suitability	Reliability	4		+ 50		+200
	Cost	3	0			
	Accuracy versus requirement	4*		+ 50	0	+200
	Multiple function capability	3		+ 75		
	Component design impact	4	- 50		-200	
Associated hardware	Complexity	2	0		0	
	Reliability	2	0		0	
	Versatility	3		+ 50		+150
	Cost	3	- 50		-150	
Other						
Detection* ratings		16*			0	1200
Totals		40			-350	1550
NSIA Total Score		+30.0	NSIA Detection Score		+75.0	

TABLE XXI. GEARING IN-LINE OIL DEBRIS MONITOR FAILURE WARNING AND INSPECTION FOR TOOTH FRACTURE AND BREAKAGE - NSIA TRADEOFF DATA SHEET						
Parameters	Considerations	Relative Weighting	Basic Rating		Adjusted Values	
			Undesir-able	Desir-able	Undesir-able	Desir-able
Capability	Failure warning	4*	-100		-400	
	Inspection	4*		+100		+400
Nature of indication	Direct or indirect	4*	- 25		-100	
Sensor suitability	Reliability	4		+ 25		+100
	Cost	3	- 50		-150	
	Accuracy versus requirement	4*		+ 50		+200
	Multiple function capability	3		+ 75		+225
	Component design impact	4		+ 75		+300
Associated hardware	Complexity	2	0		0	
	Reliability	2		0	0	
	Versatility	3		+ 50		+150
Other	Cost	3	- 50		-150	
Detection* Ratings		16*			-500	+600
Totals		40			-800	1375
NSIA Total Score		+14.4	NSIA Detection Score		+6.3	

TABLE XXII. GEARING TRANSMISSION MONITORING DEVICE FAILURE WARNING AND INSPECTION FOR TOOTH FRACTURE AND BREAKAGE - NSIA TRADEOFF DATA SHEET

Parameters	Considerations	Relative Weighting	Basic Rating		Adjusted Values	
			Undesirable	Desirable	Undesirable	Desirable
Capability	Failure warning	4*	-100		-400	
	Inspection	4*		+100		+400
Nature of indication	Direct or indirect	4*	-25		-100	
Sensor suitability	Reliability	4		+75		+300
	Cost	3	0		0	+200
	Accuracy versus requirement	4*		+50		
	Multiple function capability	3		+75		+225
	Component design impact	4		+75		+300
Associated hardware	Complexity	2		+50		+100
	Reliability	2		+50		+100
	Versatility	3		+50		+150
	Cost	3	0		0	
Other						
Detection Ratings*		16 ^w			-500*	+600*
Totals		40			-500 ^r	+1775
NSIA Total Score		31.9	NSIA Detection Score		+6.3	

TABLE XXIV. NSIA SENSOR TRADEOFF, SUMMARY SCORE CHART
 COMPONENT CLASS: BEARINGS

Failure	Detection Technique	NSIA Tradeoff Scores	
		Total	Detection Summary
Abnormal wear	Chip detector	+14.7	-72.5
	Shock detector	+26.2	+60.0
	In-line oil monitor	+33.6	+61.2
	Radioactive tracer	+38.9	+70.8
	Thermocouples	+46.0	+40.0
Pitting and spalling	Advanced XMD	+53.0	+61.2
	Chip detector	+39.2	+6.4
	Shock detector	+33.2	+75.7
	In-line oil monitor	+30.5	+48.9
	Advanced XMD	+45.0	+48.9
Scoring, scuffing, galling, burning, and discoloration	Shock detector	+30.6	+62.5
	In-line oil monitor	+34.4	+56.2
	Thermocouples	+61.9	+81.2
	Advanced XMD	+41.9	+31.2
	Shock detector	-1.9	-18.7
Fretting	In-line oil monitor	-0.6	-31.2
	Radioactive tracer	+18.7	+12.5
	Advanced XMD	+16.9	-31.2
	Chip detector	+33.2	-27.0
	Shock detector	+20.4	+47.0
Cavitation	In-line oil monitor	+25.6	+39.5
	Thermocouples	+36.9	+18.0
	Advanced XMD	+38.1	+17.0
	Chip detector	+40.2	+3.8
	Shock detector	+30.4	+72.5
Dented, nicked, gouged, distorted, and mutilated	In-line oil monitor	+24.8	+35.0
	Thermocouples	+32.8	+8.8
	Advanced XMD	+44.3	+35.0
	Chip detector	+44.0	+44.0
	Shock detector	+102.9	+102.9
			+59.8
			+41.6
			+79.3

TABLE XXV. NSIA TRADEOFF FOR ALTERNATIVE FAILURE WARNING AND INSPECTION OF BEARING ABNORMAL WEAR

Parameters	Considerations	Alternative Failure Warning and Inspection Techniques					
		Chip Detector (See Table XXVI)	Shock Detector (See Table XXVII)	In-Line Oil Monitor (See Table XXVIII)	Radioactive Tracer (See Table XXIX)	Thermocouples (See Table XXX)	Advanced XMD (See Table XXXI)
Capability	Failure warning	No	Maybe	Yes	No	Maybe	Yes
	Inspection	No	Yes	Yes	Yes	Maybe	Yes
Nature of indication	Direct or indirect	M-N P-N	M-I P-D	M-D P-N	M-D P-D	M-D P-D	M-D P-N
Sensor suitability	Reliability	High	Good	Fair-good	Good	High	High
	Cost	Low	Moderate	Mod-high	Moderate	Low	Moderate
	Accuracy versus requirement	Unaccept	Good	High	Excellent	Acceptable	High
	Multifunction capability	Good	High	High	Low	Poor	High
	Component design impact	Low	Mod-high	Low	Low	Low	Low
Associated hardware	Complexity	Low	Moderate	Moderate	Mod-low	Mod-low	Mod-low
	Reliability	High	Moderate	Moderate	Good	Good	Good
	Versatility	None	High	High	Moderate	High	High
	Cost	Low	Mod-high	Mod-high	Moderate	Mod-low	Moderate
Other							

TABLE XXVI. BEARING CHIP DETECTOR FAILURE WARNING AND INSPECTION FOR ABNORMAL WEAR - NSIA TRADEOFF DATA SHEET

Parameters	Considerations	Relative Weighting	Basic Rating		Adjusted Values	
			Undesirable	Desirable	Undesirable	Desirable
Capability	Failure warning	2*	- 45		- 90	
	Inspection	4*	- 45		-180	
Nature of indication	Direct or indirect	3*	-100		-300	
Sensor suitability	Reliability	4		75		300
	Cost	3		100		300
	Accuracy versus requirement	3*	-100		-300	
	Multiple function capability	3		50		150
	Component design impact	4		75		300
Associated hardware	Complexity	2		100		200
	Reliability	2		75		150
	Versatility	3	-100		-300	
	Cost	3		100		300
Other						
Detection* Ratings		12*			-870*	0
Totals		36			-1170	1700
NSIA Total Score:		+14.7	NSIA Detection Score:		-72.5	

TABLE XXVII. BEARING SHOCK DETECTOR FAILURE WARNING AND INSPECTION FOR ABNORMAL WEAR - NSIA TRADEOFF DATA SHEET						
Parameters	Considerations	Relative Weighting	Basic Rating		Adjusted Values	
			Undesir- able	Desir- able	Undesir- able	Desir- able
Capability	Failure warning	2*		30		60
	Inspection	4*		85		340
Nature of indication	Direct or indirect	3*		50		150
Sensor suitability	Reliability	4		50		200
	Cost	3	0	50	0	150
	Accuracy versus requirement	3*		75		225
	Multiple function capability	3				
	Component design impact	4	-50		-200	
Associated hardware	Complexity	2	0		0	
	Reliability	2	0		0	
	Versatility	3		50		150
	Cost	3	-50		-150	
Other						
Detection* Ratings		12*			0*	720*
Totals		36			-350	1295
NSIA Total Score:		+26.2	NSIA Detection Score:		60.0	

TABLE XXVIII. BEARING IN-LINE OIL MONITOR FAILURE WARNING AND INSPECTION FOR ABNORMAL WEAR - NSIA TRADEOFF DATA SHEET						
Parameters	Considerations	Relative Weighting	Basic Rating		Adjusted Values	
			Undesirable	Desirable	Undesirable	Desirable
Capability	Failure warning	2*		85		170
	Inspection	4*		85		340
Nature of indication	Direct or indirect	3*	0		0	
Sensor suitability	Reliability	4		25		100
	Cost	3	- 50		-150	225
	Accuracy versus requirement	3*		75		225
	Multiple function capability	3		75		225
	Component design impact	4		75		300
Associated hardware	Complexity	2	0		0	
	Reliability	2	0		0	
	Versatility	3		50		150
	Cost	3	- 50		-150	
Other						
Detection* Ratings		12*			0*	735*
Totals		36			-300	1510
NSIA Total Score:		+33.6	NSIA Detection Score: +61.2			

TABLE XXIX. BEARING RADIOACTIVE TRACER FAILURE WARNING AND INSPECTION FOR ABNORMAL WEAR - NSIA TRADEOFF DATA SHEET						
Parameters	Considerations	Relative Weighting	Basic Rating		Adjusted Values	
			Undesir- able	Desir- able	Undesir- able	Desir- able
Capability	Failure warning	2*	- 45		- 90	
	Inspection	4*		85		340
Nature of indication	Direct or indirect	3*		100		300
Sensor suitability	Reliability	4		50		200
	Cost	3	0		0	
	Accuracy versus requirement	3*		100		300
	Multiple function capability	3	- 50		-150	
	Component design impact	4		75		300
Associated hardware	Complexity	2		50		100
	Reliability	2		50		100
	Versatility	3	0		0	
	Cost	3	0		0	
Other						
Detection* Ratings		12*		- 90*		940*
Totals		36		-240		1640
NSIA Total Score:		+38.9	NSIA Detection Score: +70.8			

TABLE XXX. ABNORMAL WEAR FAILURE MODE WITH THERMOCOUPLES ALTERNATIVE
(COMPONENT CLASS BEARINGS) - NSIA TRADEOFF DATA SHEET

Parameters	Considerations	Relative Weighting	Basic Rating		Adjusted Values	
			Undesir- able	Desir- able	Undesir- able	Desir- able
Capability	Failure warning	2*		30		60
	Inspection	4*		30		120
Nature of indication	Direct or indirect	3*		100		300
Sensor suitability	Reliability	4		75		300
	Cost	3		100		300
	Accuracy versus requirement	3*	0		0	
	Multiple function capability	3	- 75		-225	
	Component design impact	4		75		300
Associated hardware	Complexity	4		50		100
	Reliability	2		50		100
	Versatility	3		50		150
	Cost	3		50		150
Other						
Detection* ratings		12*			0*	480*
Totals		36			-225	1880
NSIA Total Score:		+46.0	NSIA Detection Score:		+40.0	

TABLE XXXI. ABNORMAL WEAR FAILURE MODE WITH ADVANCED XMD ALTERNATIVE
(COMPONENT CLASS BEARINGS) - NSIA TRADEOFF DATA SHEET

Parameters	Considerations	Relative Weighting	Basic Rating		Adjusted Values	
			Undesir- able	Desir- able	Undesir- able	Desir- able
Capability	Failure warning	2*		85		170
	Inspection	4*		85		340
Nature of indication	Direct or indirect	3*	0		0	
Sensor suitability	Reliability	4		75		300
	Cost	3	0		0	225
	Accuracy versus requirement	3*		75		225
	Multiple function capability	3		75		225
	Component design impact	4		75		300
Associated hardware	Complexity	2		50		100
	Reliability	2		50		100
	Versatility	3		50		150
	Cost	3	0		0	
Other						
Detection ratings*		12*			0*	735*
Totals		36			0	1910
NSIA Total Score:		+53.0	NSIA Detection Score:		+61.2	

TABLE XXXII. FAILURE WARNING AND INSPECTION TECHNIQUE EVALUATION MATRIX, COMPOUND CLASS - BEARINGS									
Primary Failure Mode (Standard)	Secondary	Primary Secondary	Mode	Potential Techniques	Potential Application	Comments	NSIA Total Score	NSIA Detection Score	NSIA Score
D = Decreasing I = Increasing C = Constant U = Unknown	I = Increasing C = Constant U = Unknown	Failure Consequence	Potential Techniques	Potential Application	Comments	NSIA Total Score	NSIA Detection Score	NSIA Score	NSIA Score
Overloads	Dimensional instability, abnormal wear, seizure	High temperature operation, loose centers, misalignment, seizure	D	Chip detector	Inspection	Not acceptable	+14.7	+72.5	+60.0
Insufficient lubrication	Dimensional instability, abnormal wear, seizure	High temperature operation, loose centers, misalignment, seizure	D	Shock detector	Inspection		+31.6	+61.2	
Wear	Dimensional instability, abnormal wear, seizure	High temperature operation, loose centers, misalignment, seizure	D	In-line oil monitor	Inspection	For critical bearings and surfaces only	+38.9	+70.8	
Abnormal wear	Dimensional instability, abnormal wear, seizure	High temperature operation, loose centers, misalignment, seizure	D	Radi active tracer	Inspection		+46.0	+40.0	
Seizure	Dimensional instability, abnormal wear, seizure	High temperature operation, loose centers, misalignment, seizure	D	Thermocouples	Failure and inspection		+53.0	+61.2	
Advanced XMD	Dimensional instability, abnormal wear, seizure	High temperature operation, loose centers, misalignment, seizure	D	Advanced XMD	Failure and inspection		+49.0	+8.9	
Advanced XMD	Dimensional instability, abnormal wear, seizure	High temperature operation, loose centers, misalignment, seizure	D	Advanced XMD	Failure and inspection		+39.2	+6.4	
Advanced XMD	Dimensional instability, abnormal wear, seizure	High temperature operation, loose centers, misalignment, seizure	D	Chip detector	Inspection		+33.2	+75.7	
Advanced XMD	Dimensional instability, abnormal wear, seizure	High temperature operation, loose centers, misalignment, seizure	D	Shock detector	Inspection		+30.5	+48.9	
Advanced XMD	Dimensional instability, abnormal wear, seizure	High temperature operation, loose centers, misalignment, seizure	D	In-line oil monitor	Failure and inspection		+30.6	+62.5	
Advanced XMD	Dimensional instability, abnormal wear, seizure	High temperature operation, loose centers, misalignment, seizure	D	Shock detector	Failure and inspection		+34.4	+56.2	
Advanced XMD	Dimensional instability, abnormal wear, seizure	High temperature operation, loose centers, misalignment, seizure	D	In-line oil monitor	Failure and inspection		+61.9	+81.2	
Advanced XMD	Dimensional instability, abnormal wear, seizure	High temperature operation, loose centers, misalignment, seizure	D	Thermocouples	Failure and inspection		+41.9	+31.2	
Advanced XMD	Dimensional instability, abnormal wear, seizure	High temperature operation, loose centers, misalignment, seizure	D	Advanced XMD	Failure and inspection		-1.9	-18.7	
Advanced XMD	Dimensional instability, abnormal wear, seizure	High temperature operation, loose centers, misalignment, seizure	D	Shock detector	Inspection		-0.6	-31.2	
Advanced XMD	Dimensional instability, abnormal wear, seizure	High temperature operation, loose centers, misalignment, seizure	D	In-line oil monitor	Inspection		+18.7	+12.5	
Advanced XMD	Dimensional instability, abnormal wear, seizure	High temperature operation, loose centers, misalignment, seizure	D	Radi active tracer	Inspection		+16.9	+31.2	
Advanced XMD	Dimensional instability, abnormal wear, seizure	High temperature operation, loose centers, misalignment, seizure	D	Advanced XMD	Inspection		+31.2	+27.0	
Advanced XMD	Dimensional instability, abnormal wear, seizure	High temperature operation, loose centers, misalignment, seizure	D	Chip detector	Inspection	Not acceptable	+20.4	+47.0	
Advanced XMD	Dimensional instability, abnormal wear, seizure	High temperature operation, loose centers, misalignment, seizure	D	Shock detector	Inspection		+25.6	+39.5	
Advanced XMD	Dimensional instability, abnormal wear, seizure	High temperature operation, loose centers, misalignment, seizure	D	In-line oil monitor	Inspection		+36.9	+18.0	
Advanced XMD	Dimensional instability, abnormal wear, seizure	High temperature operation, loose centers, misalignment, seizure	D	Thermocouples	Inspection		+38.1	+17.0	
Advanced XMD	Dimensional instability, abnormal wear, seizure	High temperature operation, loose centers, misalignment, seizure	D	Advanced XMD	Inspection		+44.3	+35.0	
Advanced XMD	Dimensional instability, abnormal wear, seizure	High temperature operation, loose centers, misalignment, seizure	D	Advanced XMD	Inspection		+40.2	+3.8	
Advanced XMD	Dimensional instability, abnormal wear, seizure	High temperature operation, loose centers, misalignment, seizure	D	Chip detector	Inspection		+30.4	+72.5	
Advanced XMD	Dimensional instability, abnormal wear, seizure	High temperature operation, loose centers, misalignment, seizure	D	Shock detector	Inspection		+24.8	+35.0	
Advanced XMD	Dimensional instability, abnormal wear, seizure	High temperature operation, loose centers, misalignment, seizure	D	In-line oil monitor	Failure and inspection		+32.8	+8.8	
Advanced XMD	Dimensional instability, abnormal wear, seizure	High temperature operation, loose centers, misalignment, seizure	D	Thermocouples	Inspection				

*Advanced mode

TABLE XXXIII. SLIDING AND ROLLING ELEMENT BEARING FAILURE - TERMS, TYPES AND DEGREES			
Type	Degree		
	Slight	Moderate	Severe
Wear - Wearing away of the bearing surface (lighter start-up loads or pressure, clean and/or higher viscosity oil required).	Nondestructive polishing	Improper oil film moderate wear (prolonged wear may become severe and catastrophic, especially in sliding or plain bearings, and rolling element bearing cages).	Adhesive wear between bushing or plain bearing and shaft producing seizure or excessive dimensional instability in assembly performance.
Pitting - Surface fatigue failure beyond endurance limit-also called spalling.	Initial pitting (removal of high contact spots and indicative of alignment problem). Inner and outer raceways are susceptible (failure propagation rate usually slow).	Interference wear in cages may result at elevated temperatures.	Debris/abrasive wear in sliding or plain bearing cages or retainers of rolling element bearings. Chemical action corrosive wear.
Scoring - Surface rapid wear due to thermal breakdown of oil film. Also called scuffing, seizing, galling, burning, discoloration.	This phenomenon not normally identified with bearing failures except under aggravated skidding of rolling elements at high load. Catastrophic. Rotation of races on shafts and in housings and liners at high speeds are susceptible. (loose and uncaptivated races/plain bearings).	Destructive pitting (caused by uncorrected initial pitting in raceways).	Spalled (indicated by rough spots and dents in raceways).

TABLE XXXIII. CONTINUED

Type	Degree	
	Slight	Severe
<p>Plastic flow - Cold working of bearing elements by high contact surface deterioration and rolling/sliding action of surface and subsurface yielding.</p> <p>Fretting - Also known as false brinelling. Localized oscillatory micromotion wears away metals as debris (metal on metal).</p> <p>Cavitation - Erosion or cavitation corrosion is surface damage and material removal caused by fluid high temp. Pressure pulses acting on a single surface.</p> <p>Dimensional instability - Improper fits, assembly, loss of strength.</p>	<p>This phenomenon is a severe manifestation of rolling element bearing disintegration.</p> <p>Plain and sliding bearings are susceptible in this failure mode which is catastrophic.</p>	<p>Flaking and formation of debris</p> <p>Galvanic corrosion</p> <p>Crack propagation</p> <p>May be present together with galvanic corrosion, appears as cavities.</p>
<p>Minor form appears as discoloration warning.</p> <p>Minor form appears (micro-pits and/or discoloration).</p> <p>Axial and radial displacement evident indicative of improper torque-up, or assembly.</p>	<p>Stress corrosion (leads to crack propagation - micro-pits).</p> <p>Appears as micro-pits.</p> <p>Excessive axial and radial motion of sub-assemblies.</p>	<p>Hot-hard looseness assembly/either bearing or spacer failure indicated.</p>

TABLE XXXIII. CONTINUED

Type	Degree		
	Slight	Moderate	Severe
Other	Carbonized/coked appearance (oil breakdown).	Dented Nicked Out-of-round	Gouged Distorted Mutilated

bearings can time-share a single resistance bridge type signal conditioner with built-in temperature compensation. The individual bearing thermocouples are calibrated by subjecting the temperature-compensating resistor to known temperature changes.

Functional Capability Assumptions -

1. Meaningful temperature limits can be established for correlation with probability of component damage or failure.
2. Adequate thermocouple bonding materials are available to withstand the oil/heat/vibration environment on the bearing housings.
3. Sensors will have high in-situ reliability.

SENSOR EVALUATIONS FOR LUBE SYSTEM FAILURE MODES

Table XXXIV lists lube system failure modes and potential failure warning and inspection techniques. Present studies indicate that the NSIA tradeoff technique can be useful in developing optimum sensing technique recommendations for specific applications within a well defined lube system configuration, but that a more generalized application for a typical lube system would be misleading. For this reason, the following paragraphs will discuss the various sensing techniques in a general manner, but with a minimum of recommendations for specific applications which would principally be a function of individual system configuration.

Visual Inspection

Most types of noncatastrophic leakage due to a gradual deterioration of seals, lines, couplings, or small fatigue cracks in oil cooler lines can be adequately detected by daily visual inspections. However, this technique would not be adequate for internal or catastrophic leaks such as those resulting from combat damage or ruptured lines.

Oil Level Indication

Two basic types of level sensors, acoustic and capacitance, seem most suitable for rapid oil level indication of catastrophic leaks. Each of these types can be configured for either point indication or continuous readout. However, the accuracy of capacitance type sensors may be adversely affected by conditions that change the dielectric constant of the oil such as temperature, entrained gases, or suspended solids. Conversely, acoustic devices can be obtained for operation not affected by changes in dielectric constant, viscosity,

TABLE XXXIV. LUBE SYSTEM FAILURE MODES AND FAILURE WARNING AND INSPECTION TECHNIQUES

Component	Failure Mode	Candidate Failure Warning and Inspection Techniques
Seals	Leakage	Visual inspection
Pumps	Cavitation Wear	Oil level indication Shock detection
Lube lines	Undesirable transient flow Internal/leakage Leakage	Shock detection Debris monitoring (chip detect, XMD, ILOM) Flow versus rpm Pressure versus rpm Flow versus rpm Pressure versus rpm Differential flow or pressure Oil level indication
Lube jets	Blockage Introduction of contamination Blockage Misorientation	Visual inspection Differential flow or pressure Debris monitoring (XMD, ILOM) Flow (drag, turbine, obstruction and thermal flow meters)
Lube oil cooler	Leakage Blockage Insufficient heat transfer Introduction of contamination	Infrared sensing Thermocouples Differential flow Differential pressure Oil level indication Visual inspection Differential flow Differential pressure Resistance thermometers or thermistors Debris monitoring (XMD, ILOM)

temperature, resistance, pressure, clinging droplets, coating buildup or foam. Figures 54 and 55 illustrate typical point indication and continuous reading acoustic level sensors. Some of the principal elements that must be considered when selecting level sensors for a specific gearbox and lube system configuration are:

- Lube system redundancy and isolation (cross connections)
- Achievable safe dry running time
- Normal and acceptable limits of oil level and oil level fluctuations in all sumps and reservoirs

Shock Detection

A shock detector (operating principle previously described) mounted on an oil pump housing should be sensitive to cavitation, debris and bearing damage within the pump.

Differential Pressure Indication

Differential pressure sensors would find their principal area of application in detecting restrictions to flow prior to total line blockage. To a lesser degree, they may be used for leak detection, but would probably be far less sensitive than flow indication for all but extreme cases of this mode. In addition, differential pressure sensing can be used as a backup or checking technique for flow monitoring.

Flow Monitoring

Flow sensors are the primary means for diagnosing pump, line, or cooler leakage and blocked lubrication jets. There are several types of flow sensors with a wide variation in cost, size and accuracy. Some of the more promising techniques are discussed with observations of strengths and weaknesses; however, actual recommendations cannot be made without a specific gearbox and lube system configuration.

Drag (or Lift) Meters - These may be defined as meters that are acted upon by the fluid stream so that a force is manifested, allowing the flow rate to be inferred. In practice, the configuration is such that the force is directly proportional to the kinetic energy of the fluid stream. Due to the unavailability of suitable force transducers, this technique has poor potential for continuous readout, but finds its primary application in flow/no-flow indication.

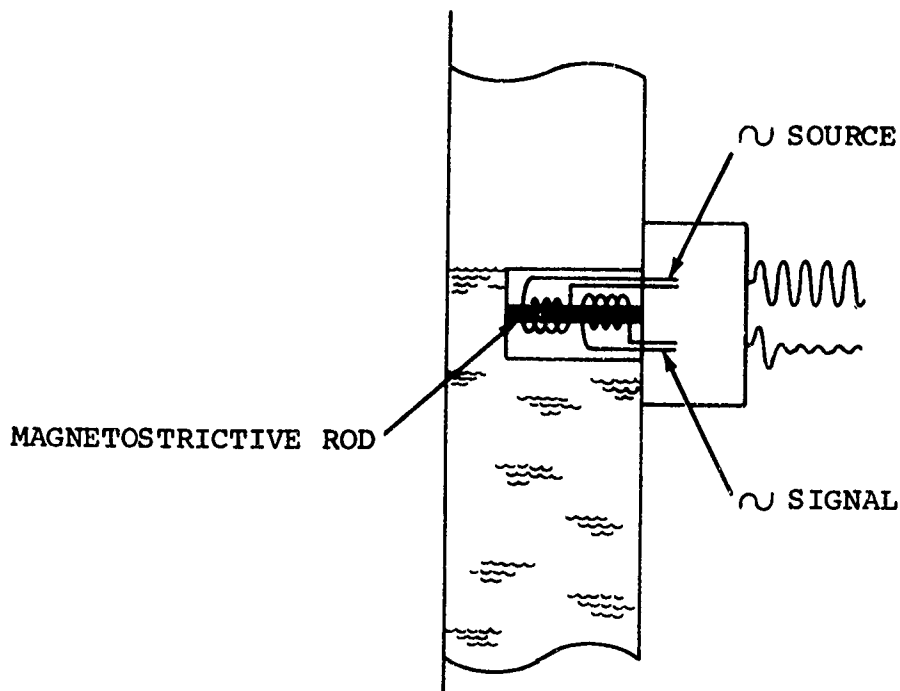

Figure 54. Point-Sensitive Level Indicator.

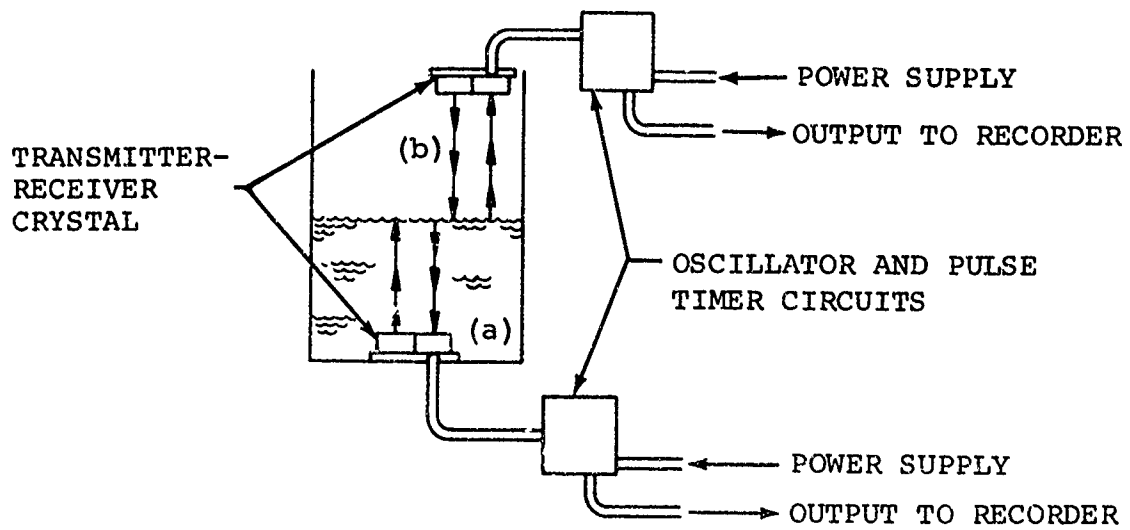

Figure 55. Continuous Readout Level Indicator.

Turbine Meters - A rotor, with its centerline coincident with the center of flow, turns at a speed directly proportional to the stream velocity. The rotor rpm provides an electrical output for continuous readout with relatively good accuracy; however, the cost is somewhat high and the sensor will not fit in very small lines.

Obstruction Meters (Venturi, Flow Nozzle, Orifice) - The basic meter is placed in the path of a flowing fluid as an obstruction and causes localized changes in velocity. Concurrently with velocity change, there is a pressure change, with the minimum pressure occurring at the point of maximum restriction (and velocity). Thus the differential pressure across the maximum and minimum restrictions is proportional to the fluid flow through the meter. High accuracy and good pressure recovery are the primary advantages of the venturi. These are offset, however, by considerably greater cost and space requirements as compared with the orifice and nozzle. The orifice is inexpensive and may often be installed between existing line flanges. However, its pressure recovery is poor and it may be damaged by pressure transients due to its lower physical strength. The flow nozzle possesses the advantages of the venturi, except that it has lower pressure recovery plus the added advantage of shorter length. It is expensive compared with the orifice and is sometimes difficult to install properly.

Thermal Flow Meter - When an electrically heated wire element is placed in a flowing stream, heat will be transferred between the two, depending on a number of factors, including the flow rate. The element consists of a short length of fine wire stretched between two electrode supports. Two methods are employed to measure flow. The first technique uses a constant current passing through the sensing wire. Variation in flow results in changed wire temperature and therefore changed resistance which then becomes a measure of flow. The second technique employs a servo system to maintain wire resistance and resultant wire temperature. In this case, a change in flow results in a corresponding change in electrical current which is then interpreted as a flow analog. The two methods are called constant-current and constant-temperature, respectively.

When flow past the wire is varying with time, the sensing element response will lag behind the actual flow fluctuations because of the heat capacity of the wire. To a considerable extent, it is possible to compensate for this lag in the signal conditioning circuitry. When a constant-current system is employed, compensation is achieved by means of a passive network of inductance and resistance or capacitance and resistance or through use of a suitable transformer. However, compensation, adjusted for the particular flow condition being measured, is, in general, usable only for fluctuations moving

up to magnitudes of about 15 percent of the mean stream velocity.

In the constant temperature technique, compensation forms an inherent part of the basic system. The sensing element is incorporated in an electrical bridge whose unbalance is employed as a measure of current required to maintain constant wire temperature. Fluctuations of the required current thereby become a measure of the flow variations. An advantage of this system is that a wide range of conditions does not affect the ability of the system to provide a flat response. Another very practical advantage is that the system provides inherent protection against wire burnout.

Advantages of the thermal flow sensing technique, regardless of the signal conditioning method used, are

- Simplified redundancy through use of multiple wire elements in parallel.
- Built-in, functional self-check capability due to large magnitude step function of current flow and total resistance if sensing wire opens.
- Sensors can fit into relatively small diameter oil lines.
- High sensitivity to flow fluctuations.

Temperature Indication

Temperature sensing techniques which may find application in lube system diagnostics are infrared sensors, thermocouples and thermistors. The infrared sensor and thermocouples would be applied to diagnose misoriented lube jets on critical gears and lube-starved bearings, respectively. The thermistors (or resistance thermometers) could be used to measure oil cooler efficiency by monitoring T_{in} , T_{out} , and ambient temperature.

SENSOR TECHNIQUES FOR VARIOUS FAILURE MODES

Sensing Techniques for Retention and Mounting Hardware Failure Modes

Although retention and mounting hardware failure modes may comprise a rather large percentage of the total gearbox failure rate, most of the significant modes such as abnormal wearing, cracking, stripping, breaking, denting, spalling, working, and fretting are causes for debris generation and in some cases will result in abnormal shock and noise levels due to looseness of retained parts. It is also a mandatory design requirement to eliminate safety-of-flight failure modes through self

retention features and Murphy proof installation procedures for all critical parts. For these reasons, it does not seem prudent to include failure warning and inspection equipment in the gearbox design, but rather to rely on debris-monitoring and shock detection equipment included for gear and bearing failure modes.

Sensing Techniques for Nonrotating Structure Failure Modes

This component class accounts for a very small percentage of the total failure rate and is a design requirement to eliminate safety-of-flight failure modes such as cracks in load bearing members. The remaining failure modes are mainly corrosion and indentation of finished surfaces that can be detected by debris monitoring. Cracks in oil line passages should be eliminated through design and test, but are easily detectable by visual inspection.

Sensing Techniques for Shafting Failure Modes

Shafting failures generally account for less than 5 percent of the total failures in a gearbox and are generally confined to three modes: cracks, fretting, and wear. The fretting and wear generate debris which, if treated with a radioactive tracer, can easily identify critical component failure. Shafting cracks should be eliminated through design and test, but if the shaft is impregnated with a radioactive gas (i.e., kryptonation), there is some chance that gasses escaping from fatigue cracks in an oil mist atmosphere would result in sufficient lubricant radioactivity to activate a warning.

Sensing Techniques for Spline Failure Modes

Splines exhibit failure modes very similar to those that occur in gearing and thus are best monitored by similar failure warning and inspection techniques. However, due to the fact that critical amounts of spline debris can be masked by the normal wear debris, it is advisable to treat splined surfaces with radioactive tracers in order to differentiate spline wear particles from the larger amounts of other wear particles.

Sensing Techniques for Clutch Failure Modes

Clutch failures have two modes: loss of drive (slippage) or failure to fully disengage (hang-up). The first mode, slippage, is a safety-of-flight malfunction with a sufficiently low θ to warrant failure warning capability. The second mode, hang-up, although it has a comparable value of θ , is not by itself a safety-of-flight malfunction.

For clutch hang-up to compromise safety of flight, there must also be an engine failure in the same drive path and the clutch must be fully seized as opposed to merely dragging. The value of θ for this series of conditions is quite high and there is no evidence to support a $\beta > 1$; therefore failure warning is not required for the hang-up mode.

Because the failure mechanisms leading to slippage are not well understood, monitoring spalling, breakage, wear, and galling cannot provide a sufficiently accurate failure warning capability. The apparent alternative is to monitor clutch performance based on the assumption that mini-slips, not apparent to operational personnel, occur with increasing severity prior to the loss of function to a degree detectable by flight personnel. This technique for indicating clutch life can be called clutch slip monitoring.

In slip monitoring, drive element rpm and driven element rpm are monitored by a comparator with high rpm sensitivity. For each engagement when the driver element rpm momentarily exceeds the driven element rpm, a counter records the event and the comparator records the extent of slippage. For N clutch engagements, the area under the curve of Figure 56 will have a recorded value which can be compared either with the similar value of the previous N clutch engagements or a limit value (assuming such a limit value can be determined by test and operational experience). Hopefully, the rate of increase of this clutch life index will provide an indication of useful clutch life.

FAILURE WARNING AND INSPECTION SIGNAL CONDITIONING AND SIGNAL FLOW ANALYSIS

Signal Conditioning

The outputs of the sensors selected for failure warning and inspection systems are not generally directly compatible with pilot and maintenance displays and often require further processing to provide meaningful information to operational personnel. This processing includes limit detection, variable limit programming, total accumulation circuitry, accumulation rate circuitry, resistance bridges and servo loops, signal filters, damping and attenuation networks, excitation and demodulation circuitry, and signal converters. This is called signal conditioning. Broadly stated, a signal conditioner is any processing element that converts raw transducer output into useful intelligence. In this case the useful intelligence is an analog or digital electrical circuit parameter that corresponds to truth values of specific fault statements about the monitored gearbox. A simplified example is illustrated in Figure 57.

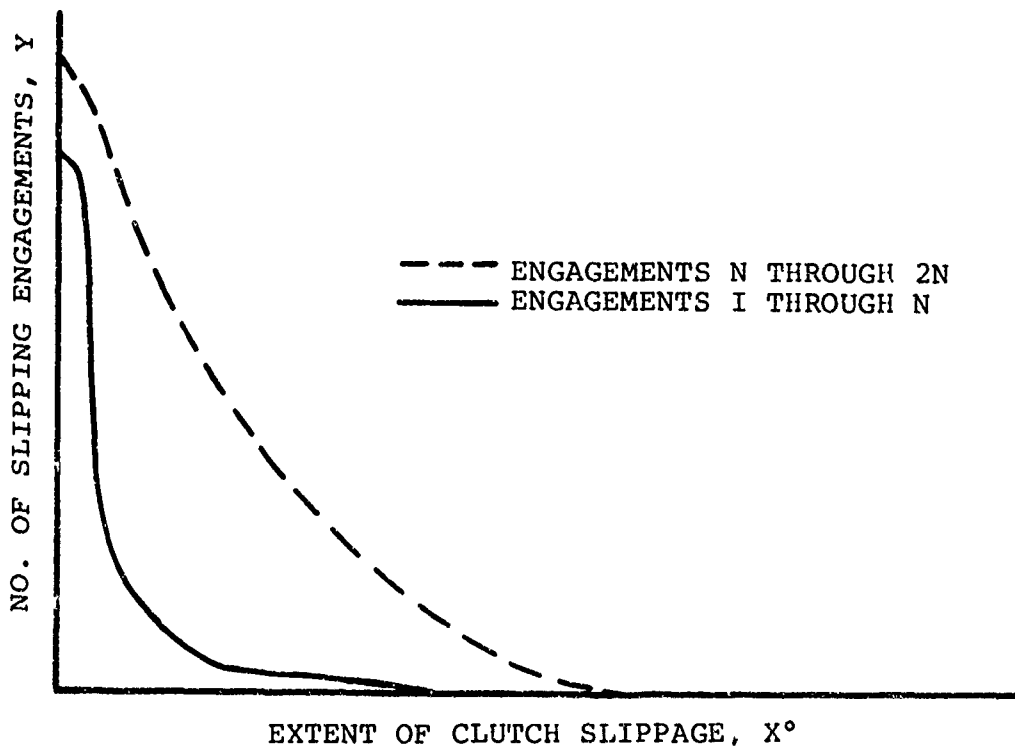

$$\int y dx = I_{CH} = \text{CLUTCH HEALTH INDEX}$$

SIGNAL FLOW ANALYSIS (LOGIC)

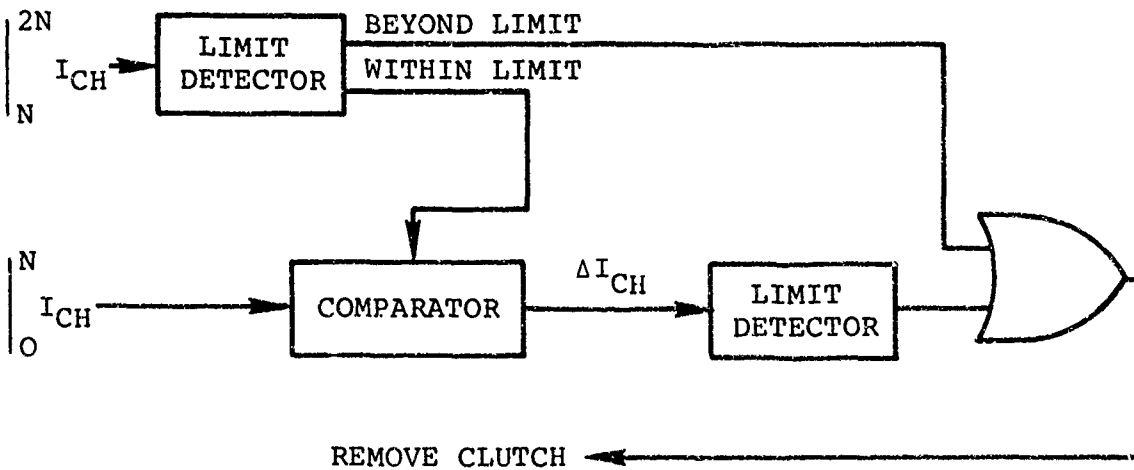

Figure 56. Clutch Slip Monitoring.

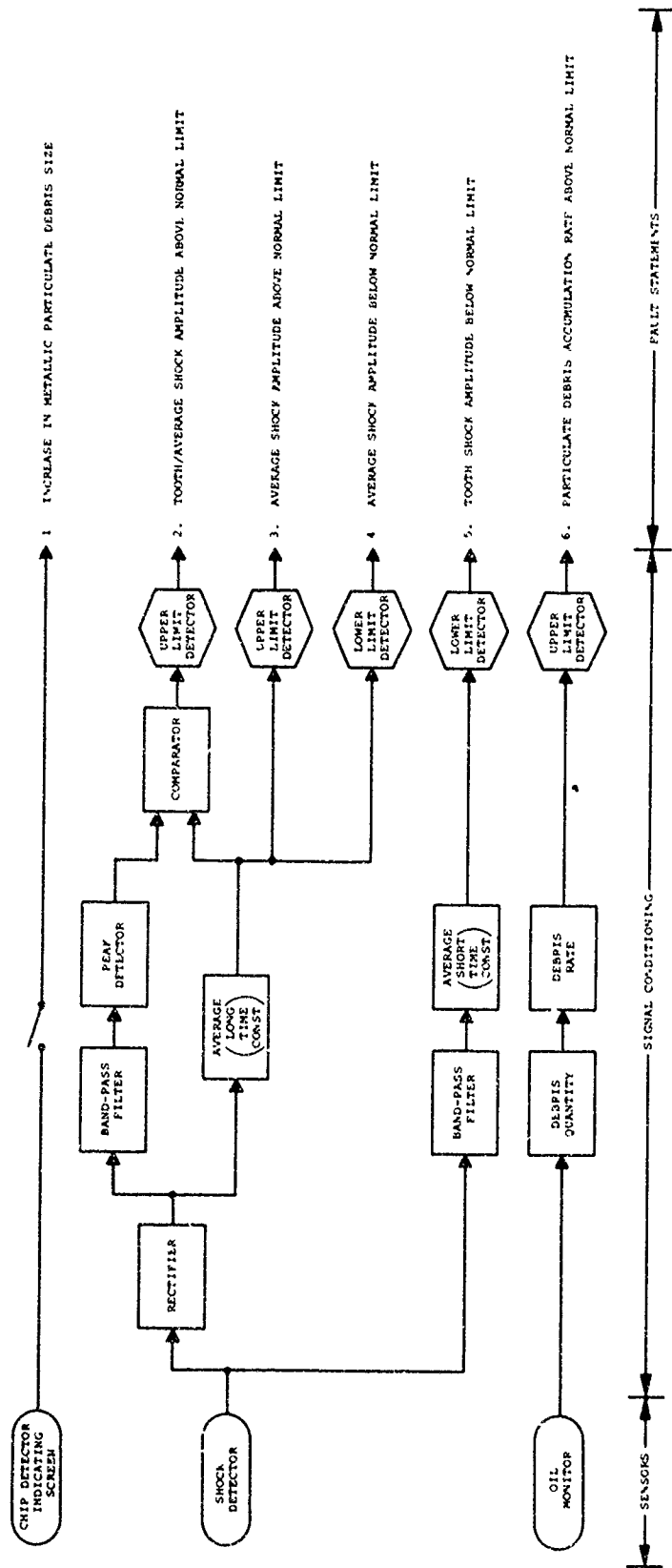

Figure 57. Sample Signal-Conditioning and Fault Statements.

Signal Flow Analysis

Once the signal conditioning is determined, all the possible combinations of true or false fault statements must be listed and evaluated. Certain combinations will be self contradicting and indicative of sensor or signal conditioning failures. Some combinations will be possible but highly unlikely; therefore they are unsuitable for conclusive failure warning and inspection. The remaining combinations will correspond to sets of monitored conditions which are highly indicative of specific failure modes within the transmission. These combinations (as well as the self-contradictory sets) can be analyzed by a hard-wired logic network or a computer which activates the appropriate failure warning or inspection display. The process of generating all possible combinations of fault statement values, evaluating their meanings, and synthesizing the appropriate logic network is referred to as signal flow analysis. Figure 58 is an example corresponding to the signal conditioning of Figure 57. Since there are six fault statements, each which can be either true or false, the number of possible combinations is $2^6 = 64$. For brevity, the logic corresponding to only 12 of these combinations is shown.

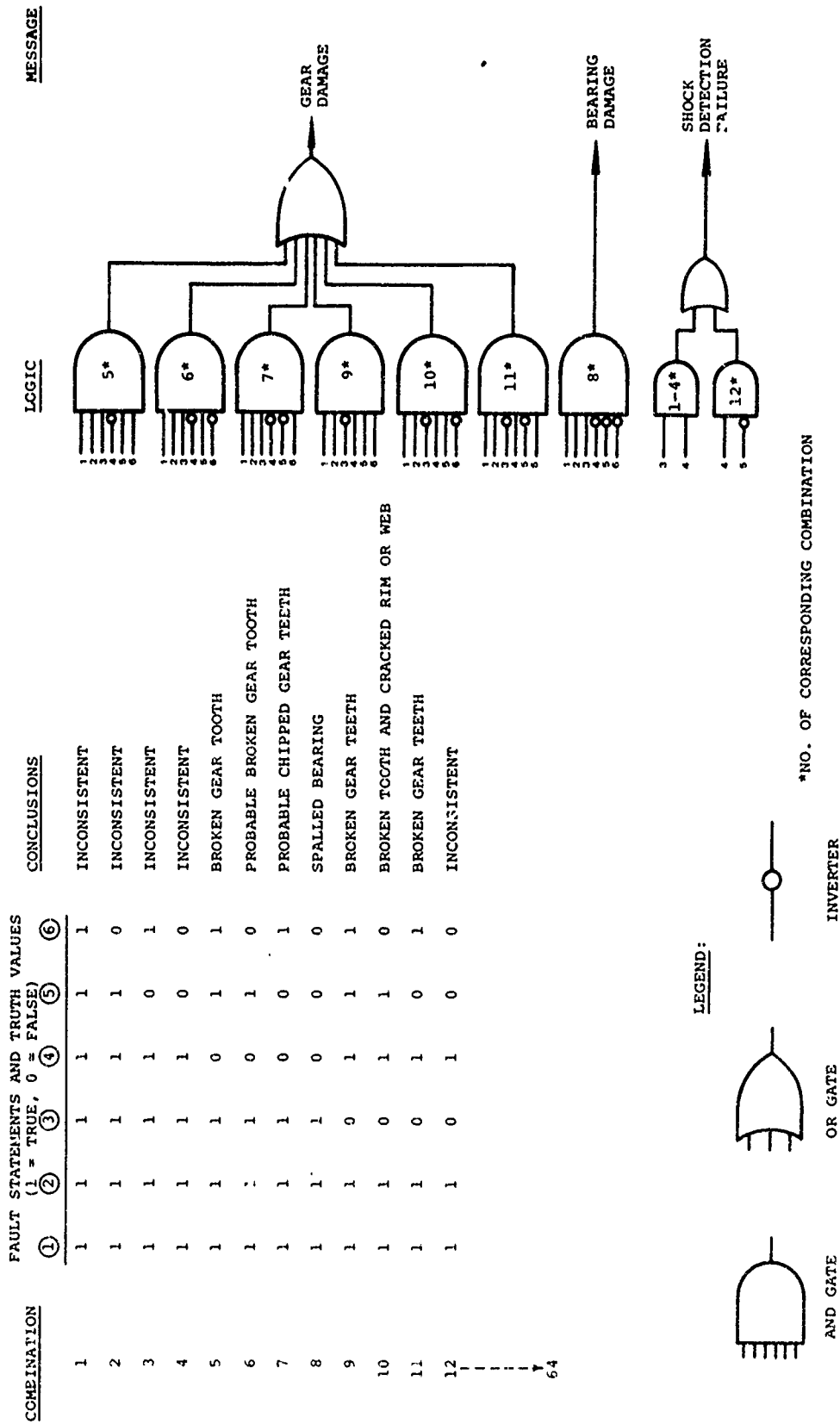

Figure 58. Sample Signal Flow Analysis.

APPENDIX IV TESTING-RELATED CRITERIA

INTRODUCTION

The intent of this section is to identify the role of testing in an on-condition transmission evaluation. Various constraints that affect the establishment of transmission developmental test plans are discussed with regard to their impact upon the early substantiation of transmission on-condition potential. The impact of overload/accelerated testing upon on-condition substantiation is discussed. Finally, a discussion on the types and sizes of test programs necessary to substantiate on-condition potential is provided.

SUMMARY

The great variability in hazard function parameters that is exhibited by small random samples has led to the conclusion that developmental testing is of little value in affirming or denying the existence of a high β parameter.

The primary value of developmental testing from an on-condition aspect lies in the identification of failure modes and establishment of failure mechanisms which facilitate redesign to eliminate the mode when possible. Furthermore, developmental testing can be of great value in establishing failure progression rates for critical components.

The manner in which on-condition operation can be most profitably supported through developmental testing is by the establishment of a truly adequate reliability test program. It is postulated that improving reliability will of necessity also enhance on-condition potential.

ROLE OF TESTING IN ON-CONDITION EVALUATIONS

Testing impacts an on-condition analysis in the following three ways:

- Establishment of failure mechanisms
- Establishment of failure progression rates
- Determination of modal hazard functions

The succeeding paragraphs will discuss these three points in detail.

Establishment of Failure Mechanisms

Rummel, in his recent Army study, HELICOPTER DEVELOPMENT RELIABILITY TEST REQUIREMENTS, has indicated that high transmission reliability is rarely, if ever, achievable as the design comes off the drawing board. Rather, high reliability is achieved through a process of problem identification through testing and subsequent redesign to eradicate or reduce the problem. This process generates the phenomenon currently referred to as reliability growth.

The steps which result in reliability growth analogously generate an improvement in gearbox on-condition potential. That is, elimination of failure modes detected during developmental testing will undoubtedly eradicate some modes which are on-condition limiting.

In testing to enhance or substantiate on-condition capability, special attention should be focused on the elimination of modes which could be undetectable in an aircraft, potentially catastrophic, quickly progress to a catastrophic mode, or have high β parameter.

Establishment of Failure Progression Rates

Gearing

Use of carburized steel has significantly reduced crack-propagation rates for gears in which it is applied. Recent fail-safe design criteria have identified crack-propagation times greatly in excess of 30 hours as being state of the art. Thus, there would appear to be adequate time in which to detect gear fatigue failures before they progress to a catastrophic stage. This is the case provided that some form of detection sensor (shock detector, vibration analysis, etc.) is employed in the transmission. It appears that gear progression rates are slow enough to be detected through a ground-based signal-analyzing system.

Surface-initiated gear failures such as scuffing and pitting have very slow progression rates (much greater than 30 hours). Furthermore, they are normally detectable through debris-monitoring systems. Thus the potential for a surface distress problem progressing to a catastrophic tooth failure seems very remote.

The following data taken from a test report on the CH-46 helicopter aft transmission demonstrates typical gear failure progression time. During the test program, a test log was maintained which retains a permanent record of all pertinent test data. Inspections of the magnetic plug

and filters were made at specified intervals during the test. At these intervals, debris from the filter and magnetic plugs was retained as a permanent part of the test log at the specified test hours before each inspection. During this specific test, chips were first detected at 23 test hours from inspection of the magnetic plug; additional chips were detected on the magnetic plug at 42 test hours. Metallic debris was detected from inspection of the filters at test intervals of 56, 61, 131, 136, 141, 146, and 150 hours. Metallurgical evaluation of the chips from this test established that they were from the gears in this transmission. Visual inspection of these chips confirmed the fact that their geometric shape and general appearance were typical of debris associated with a normal spalling-type gear failure. Therefore, it is logical to assume that the first indication of chips at 23 test hours can be considered as the point of incipient failure. The period from this point to the conclusion of the test run could be considered as the remaining useful life.

Bearings

Experience on ball and roller bearings has shown that progression from incipient spall to the point of detectability through standard debris-monitoring systems is generally in excess of 50 and 200 hours for ball and roller bearings, respectively. Figure 59 shows a progression time of 250 hours for a CH-47 input pinion roller bearing.

A test program was conducted to evaluate the progression rate characteristics of the CH-47 aft rotor thrust bearing deterioration which resulted in eventual failure of this bearing. The specimens tested are ball thrust bearings, part no. 114DS342. These bearings have bronze cages and split inner races. A pretest history consisted of the following:

- Serial No. 57 (-1 Bearing) - This bearing was received from the field after 506 hours 35 minutes flight time. Field damage consisted of a 3/4-inch-long spall on the inner race.
- Serial No. 52 (-1 Bearing) - This bearing was received from the field after 338 hours flight time. No field damage was evident.
- Serial No. 25 (-2 Bearing) - This bearing was taken from new stock at random.

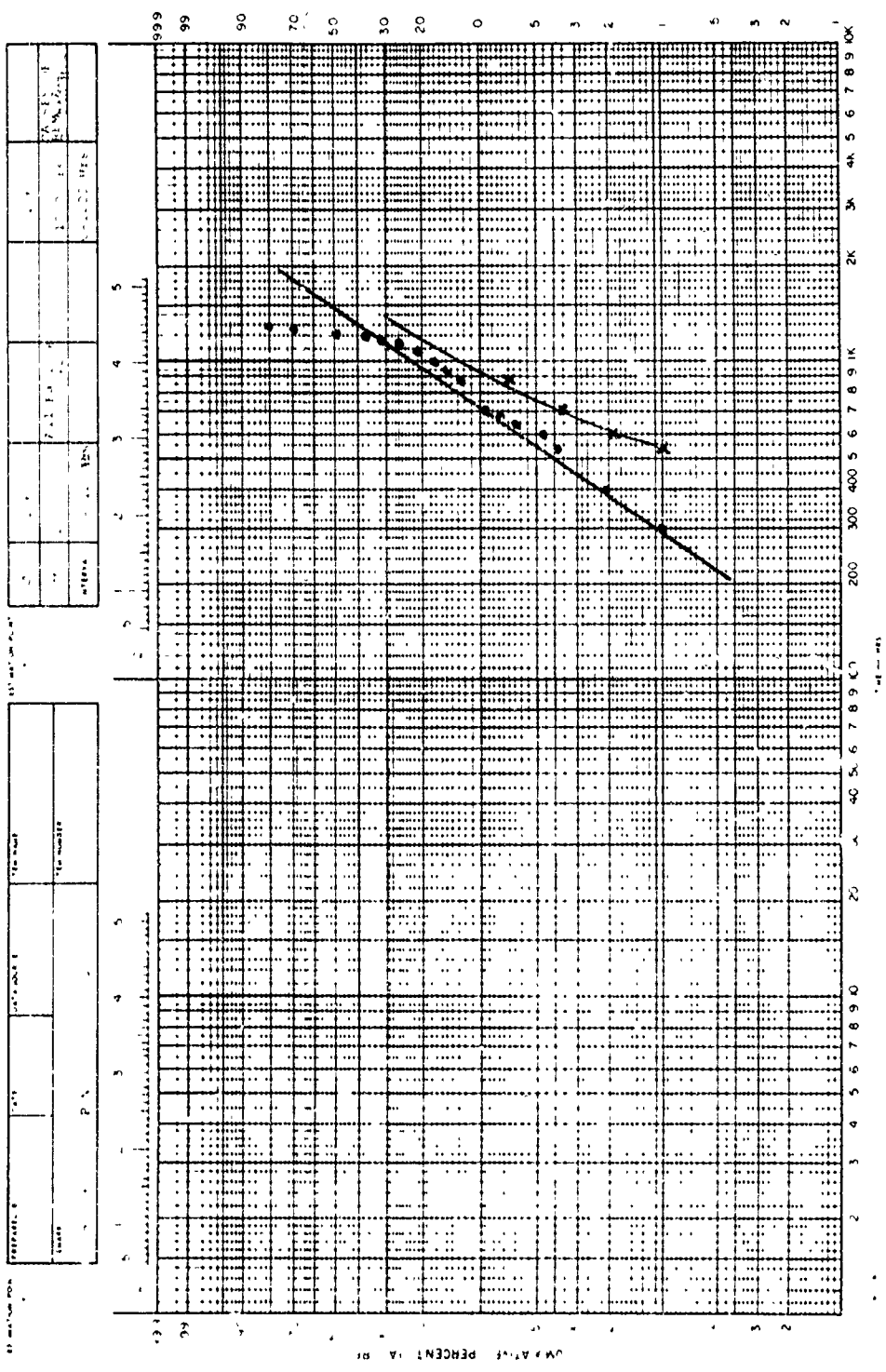

Figure 59. Failure Progression Rate for a CH-47 Input Pinion Roller Bearing.

To accomplish the objectives of this test program, a special back-to-back test stand was designed and fabricated consisting of a structural framework, drive system, and lubrication system. The bearings were installed in a dummy rotor shaft assembly.

During the duration of the test runs, the various instrumentation devices were monitored every half-hour and values for oil pressure and temperature, rod tension, upper and lower housing temperatures, and run time were recorded in the test log. Oil and chip samples were taken at the discretion of the test engineer for each workday shift and sent to the material and process laboratory for analysis.

Approximately 10 hours before failure (seizure) occurred, the spectrographic analysis of the oil indicated a rapid increase in iron, copper, and aluminum content. The chip detectors used in the test were very effective in showing significant chip buildup early in the test runs. However, when chips were being produced at a rapid rate, the chip detector shutdown circuit created a problem because shutdown would occur too frequently.

The results of this test program (Table XXXV) demonstrated a definite and repeatable fatigue failure progression rate in the 114DS342 bearing. Failure began with spalling on the inner race, followed by ball spalling, cage wear, and damage to the outer race, followed by ball fracture and fracture of the inner and outer races. The failure of the cage and outer race was secondary in nature although it contributed to the eventual seizure of the bearing.

Shafting, Clutches, Etc.

Little test data on failure progression rates for these component classes is available. However, enough of these failure modes have been observed in high-time and failed gearboxes that it is generally felt that these components progress to a catastrophic mode at a slow enough rate that they would be detectable via airborne or ground diagnostic systems.

Determination of Modal Hazard Functions

The data presented in Table XLIII of Appendix VIII shows a rather significant spread in β values over the four gearboxes of the CH-47. Thus it is important, when evaluating the on-condition potential of a new design, to use the data on the transmission most similar to the configuration being evaluated. Furthermore, for the sake of being conservative, test data

TABLE XXXV. BACK-TO-BACK TEST STAND RESULTS

Run No.	Bearing Serial No.		Speed (rpm)	Thrust (lb)	Pitching Moment (in.-lb)	Hours per Run	Results
	Upper	Lower					
1	57	52	240	10,300	22,890	49.8	New areas started to spall on inner race of serial no. 57 bearing.
2	57	52	240	17,200	5,000	25.0	Chips collected from serial no. 57 bearing 6 hours after start of this run. Original 3/4-inch spall extended to 4-1/2 inches plus a new 1/2-inch spall; cage material collected in filter and on chip detector in small amounts.
3	57	52	240	17,200	5,000	17.4	Serial no. 57 - Two balls broken, others severely spalled. Cage worn, debris damage to outer race, housing worn with debris damage to liner. Small crack in housing near jet hole. Serial no. 52 - Very small spall started in inner race.
4	25	52	240	17,200	5,000	52.5	Serial no. 25 (new bearing) - 3/4-inch spall on inner race. Debris damage inside outer race. Serial no. 52 - Spall on inner race 1 inch long. Debris damage inside outer race.
5	25	52	240	17,200	5,000	65.6	Serial no. 25 - Spall on inner race extended to 1-3/4 inches. Serial no. 52 - Approximately 2-inch-long segment broken off outer race, balls broken and jammed in badly scored cage. Cage and ball assembly could not be removed from outer race. Inner race completely spalled with load lip fractured off in approximately 9 pieces 1/2 to 5 inches in length. Heavy debris damage to housing liner and shoulder.

should be analyzed to ensure that the β values predicted for gearbox modes are being exhibited by the new design. Thus the test results should always be evaluated to identify any high β modes unique to the transmission under consideration.

Conversely, testing can show that a mode which generally exhibits a high β has a significantly reduced β in the design being considered. This could result in the elimination of some modes from the on-condition limiting category.

It is anticipated, however, that a fairly large sample size is necessary before very much faith can be put in the β values derived from test results.

ACCELERATED/OVERLOAD TESTING

The effect of speed and load upon reliability is considered in the B_{10} equations for bearing life. That is,

$$B_{10} = \frac{\left(\frac{\text{CAPACITY}}{\text{LOAD}}\right)^e \cdot 16667}{N}$$

where N = speed in rpm

$e = 10/3$ for roller bearings, $9/3$ for ball bearings.

However, recent work on the CH-47 helicopter has shown that the effect of power upon transmission failure rate may be significantly greater than a cubic effect. Figure 60 is a plot of failure rate versus cubic mean loads for three configurations and power ratings of the CH-47 forward and aft gearboxes. Plots have been made for various bearings and gears within the assemblies.

These plots indicate that the effect of power upon failure rate is not very well understood in a quantitative sense. The same statement should be made about the effect of speed of testing upon failure rate. Thus it appears that overload/accelerated tests are of primary value in expediting the identification of failure modes and mechanisms, rather than establishing absolute failure rates; it should be reiterated here that quantitative evaluation of the results of overload/accelerated tests is extremely hazardous due to our lack of understanding of the K factor relating power to failure rate.

TEST SIZE

In order to evaluate the viability of using the Weibull distribution for making fleet projections from sample estimates, the simulation model explained in Appendix V was used. More

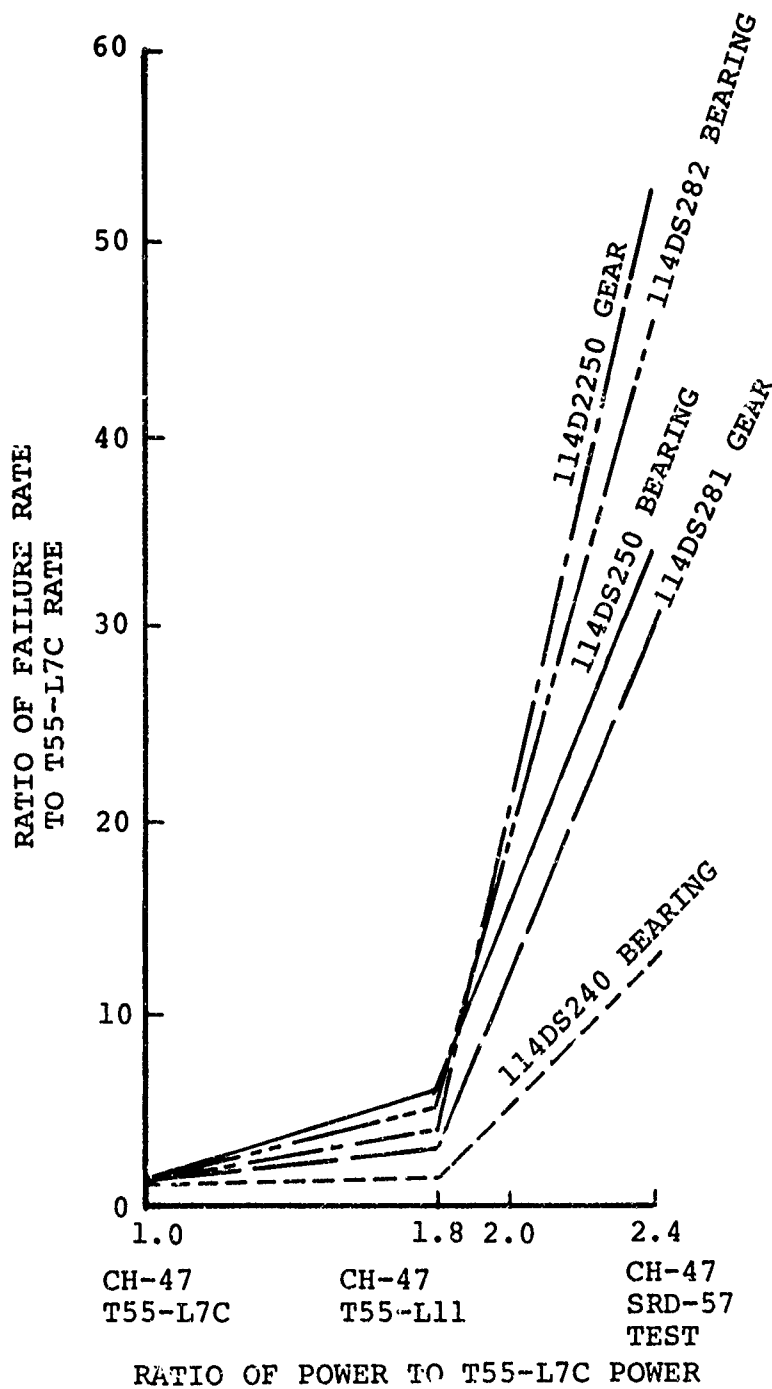

Figure 60. Effect of Power on Transmission Elemental Failure Rates.

than 60 simulation runs were made using the following parameters:

<u>Months/ Periods</u>	<u>Units</u>	<u>Utilization Per Month/Period</u>	<u>Input β</u>	<u>Input θ</u>
36	3	60	0.5	100
	5	120	1.0	500
	10		2.0	1,000
				3.0

The important aspect to be examined was not necessarily that the observed β predict exactly or even very closely the true β , but rather that increasing hazard rates manifest themselves as such and not be misconstrued as decreasing or constant failure rates. One of the constraints experienced in this exercise was that it took certain amounts of simulated time to develop enough failures for what were considered to be valid uses of the least-squares fit method. A minimum of four data points were deemed necessary for the calculated parameters to be useful.

In nearly all cases of true β greater than 1.0, the observed β was greater than 1.0. However, in the cases of true β less than 1.0, specifically 0.5, observed β tended to be above 1 at times, and high utilizations to accumulate greater hours and additional failures had to be employed to generate observed β 's less than 1. In general, observed β was nearly always higher than true β , at times to a large degree. Consequently, when using the Weibull distribution to estimate β , during testing the observed β will be higher than true β to an even greater extent than previously discussed in Appendix V.

A stepwise multiple regression analysis was considered using the testing simulation data to develop a predicting equation to modify the observed β into a better estimate of the true β , but this was discarded due to the wide variations in the data. It is possible that additional work in this area could yield a satisfactory method of converting the β generated by the Weibull distribution into a more satisfactory estimate; however, the work involved was considered too extensive with respect to the relationship of this area to the rest of the study. It seems that the inability of this method to predict well lies in the inherent limitations of the method due to the small size of the data base. It should be remembered nonetheless on the positive side that true β 's of greater than 1 are observed as such.

The predicting equation explained previously in Appendix V can be used to modify β if desired. However, due to variations seen at the lower end, i.e., few failures, it should be used

prudently, tempered with engineering judgment. based on qualitative test data combined with knowledge of historical hazard functions.

An alternative use of the failure data obtained in testing is to compare the failure modes with modes observed in similar transmissions and the generic failure modes shown in Appendix VIII. From these, the historical hazard functions for the modes observed in test can be found and combined into an assembly hazard function. This can then be compared with the predicted assembly hazard function and appropriate revisions made in the prediction.

Thus, due to the poor correlation of test data with the theoretical distribution, very little quantitative faith should be put in the results of the test. In order to optimize transmission on-condition potential via testing, it is recommended that the test planner define the best test program possible from the pure reliability sense, considering the constraints of calendar time, test specimen availability, test technique effectiveness, etc. It is anticipated that the development of a good test program, in the reliability sense, is the best way to improve on-condition potential through testing.

APPENDIX V
METHODS OF EVALUATING FAILURE DATA

INTRODUCTION

The intent of this section is to identify and review several methods for evaluating failure distributions that are employed throughout the helicopter industry, and to draw conclusions regarding the method most applicable to the rigorous quantification of hazard functions intrinsic to the evaluation of on-condition operation of helicopter transmissions.

SUMMARY

There are probably almost as many different methods of evaluating failure data as there are reliability organizations within the various segments of the military and industrial communities. In order to present a cross section of methods relevant to this study, the techniques employed at Bell, Sikorsky, Massey Ferguson, and Boeing Vertol have been evaluated. It is felt that the products of these companies are representative of the majority of Army helicopter transmission applications.

Two of these methods fail to quantify the hazard function if it is nonconstant and hence were rejected since, as previously stated, rigorous quantification of the hazard function is the nucleus of the analysis of on-condition operation.

The remaining two methods both satisfactorily quantify the hazard function. Both use a form of Weibull paper to estimate the hazard function parameter and both yield equally precise results. Since one method involves a geometric construction that is slightly easier than the other, it was selected as the preferred method for this study.

REVIEW OF METHODS

The discussion presented on the following pages will deal with each of the methods independently.

Bell

Bowen, in his paper, ANALYSIS OF TRANSMISSION FAILURE MODES , states that,

"Although the existence of a constant failure rate for a developed production system has often been used by reliability engineers, our statistics do not support this conclusion."

Thus, to evaluate the validity of the assumption of exponentiality, the method demonstrated in Figure 61⁹ is employed by Bell.

Although one can, upon inspection, identify the areas where the failure rate is nonconstant, this identification is more qualitative than quantitative. The failure rate is nonconstant when the slope of the failure data is not parallel to the constructed line. This lack of quantification renders this method unacceptable to the requirements of mathematical rigor. Rather, this method is useful to identify areas of nonconstant failure rate which should be investigated further for causality.

Sikorsky

Sikorsky's method is essentially the same as that employed by Bell. One point of possible difference, although Bell may also use this technique, is in the construction of confidence limits on the constant-failure-rate line, as shown in Figure 62.

Here the null hypothesis is that the transmission does in fact have a constant failure rate, which will be accepted unless the data violates the confidence limit.

One problem with this method is that it allows for significant variations in slopes over segments of time, without the rejection of the hypothesis of exponentiality. Furthermore, as in the Bell method, quantification of the amount of nonexponentiality is not provided. Thus, this method does not meet the requirements of this study.

One additional point should be made regarding the use of the hypothesis of exponentiality. This hypothesis places the burden of disproof upon the data. What can be considered minor deviations in the statistical sense may be rather significant in the engineering sense if the transmission does in fact have a nonconstant failure rate. Thus the hypothesis of exponentiality which, as is the case in most hypothesis testing, is difficult to disprove without major deviations, may be unduly optimistic. In order to preserve conservative design and analytical practices, it would appear better to take the approach of assuming an increasing rate of failure and then require that the data disprove this assumption.

Massey Ferguson

This method is the same as that employed at Boeing Vertol except for one minor difference. The paper employed by Massey Ferguson¹² in Figure 63 is standard Weibull paper which requires construction of a parallel line through the estimation point to estimate the Weibull slope parameter. The Vertol paper

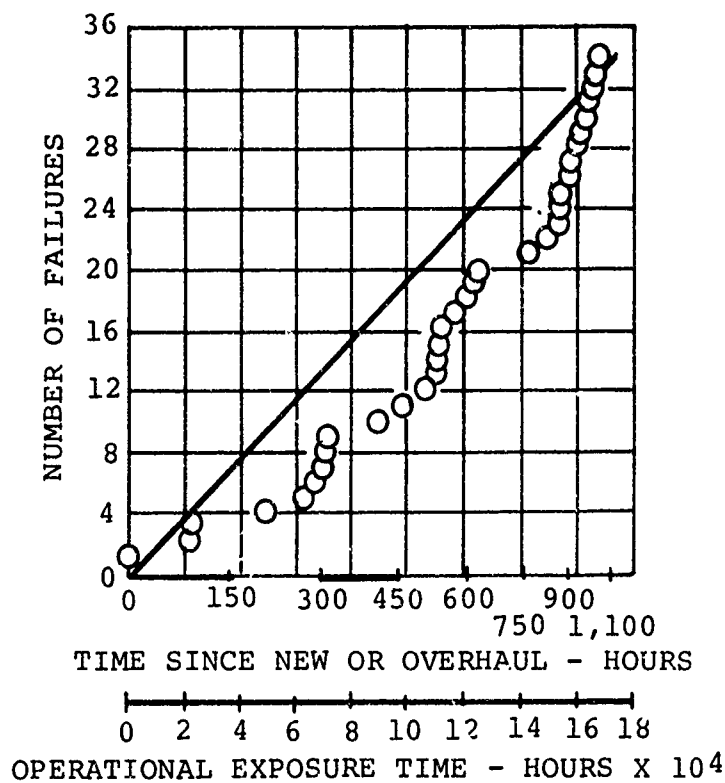

OPERATIONAL INFORMATION

GEARBOXES SURVEYED	173
NUMBER OF FAILURES REQUIRING REMOVAL	34
TOTAL OPERATIONAL TIME - HOURS	172,431
MEAN TIME BETWEEN FAILURES - HOURS	5,071

Figure 61. Bell Method for Evaluation of Constant Failure Rate.

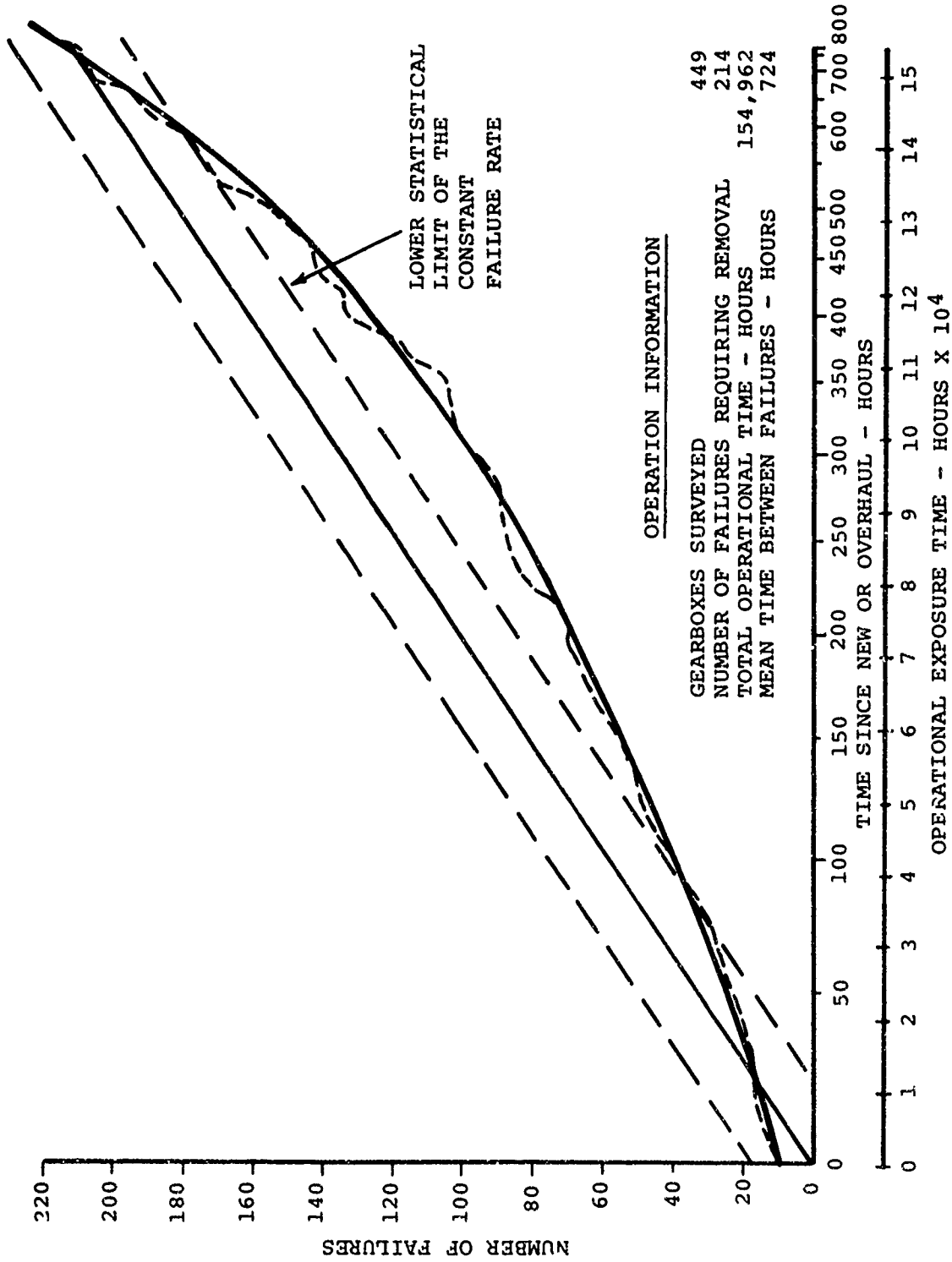

Figure 62. Sikorsky Method for Evaluation of Constant Failure Rate.

WEIBULL PLOT OF BEARING ON REAR OF
 MAIN SHAFT MRC 310SFFG
 MASSEY FERGUSON 1500/1800 TRACTOR

$B_{10} = 2,100$ HOURS
 $\beta = 1.1$
 1 FAILURE AT 9⁹7 HOURS

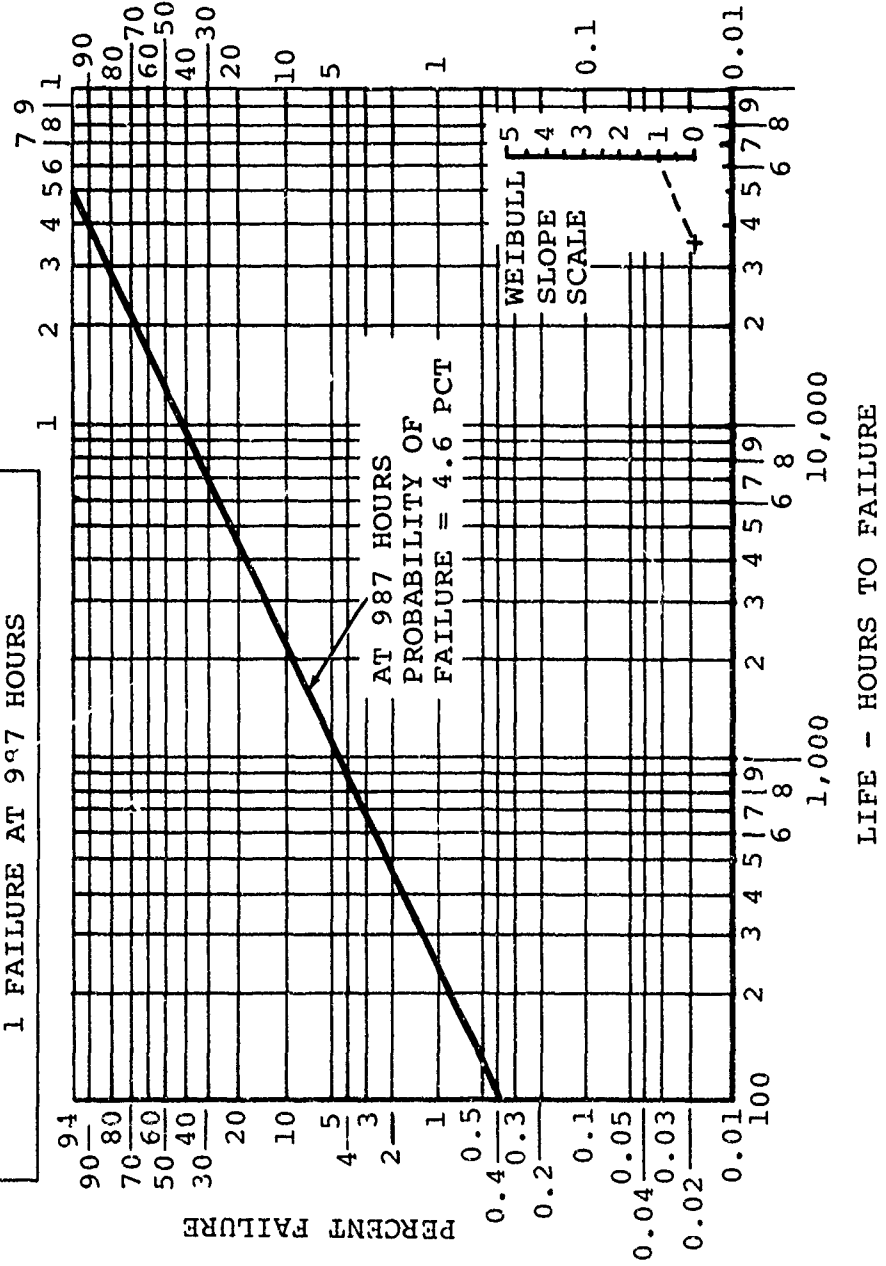

Figure 63. Massey Ferguson Weibull Plot on Standard Weibull Paper.

uses construction of a perpendicular line to estimate β . Selection of the Vertol method over the Massey Furguson method is, therefore, just a matter of personal preference.

The details of this method are discussed under the Boeing Vertol heading due to their similarity.

Boeing Vertol

The method employed at Boeing Vertol for determining transmission failure distribution assumes the Weibull distribution to be the mathematical expression underlying the sample of failure data. In the section entitled THE CONCEPT OF ON-CONDITION OPERATION, a discussion was presented of the manner in which failure data is plotted on the Boeing Vertol Weibull paper and how estimates of β and θ are made.

The Vertol method allows for quantifying β and θ with the best estimates available from the data. Furthermore, data can be transformed using binomial transforms or median ranks into 50-percentile, 90-percentile, 95-percentile (or whatever) estimates to develop confidence intervals on β and θ . Finally, in applying this method if one line does not adequately fit the data, different lines (and therefore different distributions) can be employed over different segments of time. This feature becomes important when working with data that has several severely dominating but transient modes of failure which drive the slope of the line for short periods of time and then subside.

A Vertol-developed, computerized, least-squares regression program, which calculates β and θ from inputted failure and scheduled-removal data, can be found in the Program Documentation Volume of this study. An example of the Weibull paper used at Boeing Vertol is shown in Figure 64.

EFFECT OF SAMPLE SIZE ON HAZARD FUNCTION PARAMETERS

Introduction

The intent of this section is to develop equations which can be used to estimate true values for β and θ , based on a limited sample of data from on-condition operation. A computer simulation was developed to generate the data necessary for the performance of this analysis and is discussed in detail in this section.

Literature Search of Effect of Sample Size on β and θ

The variation of sample estimates as a function of sample size has been acknowledged by reliability engineers and statisticians

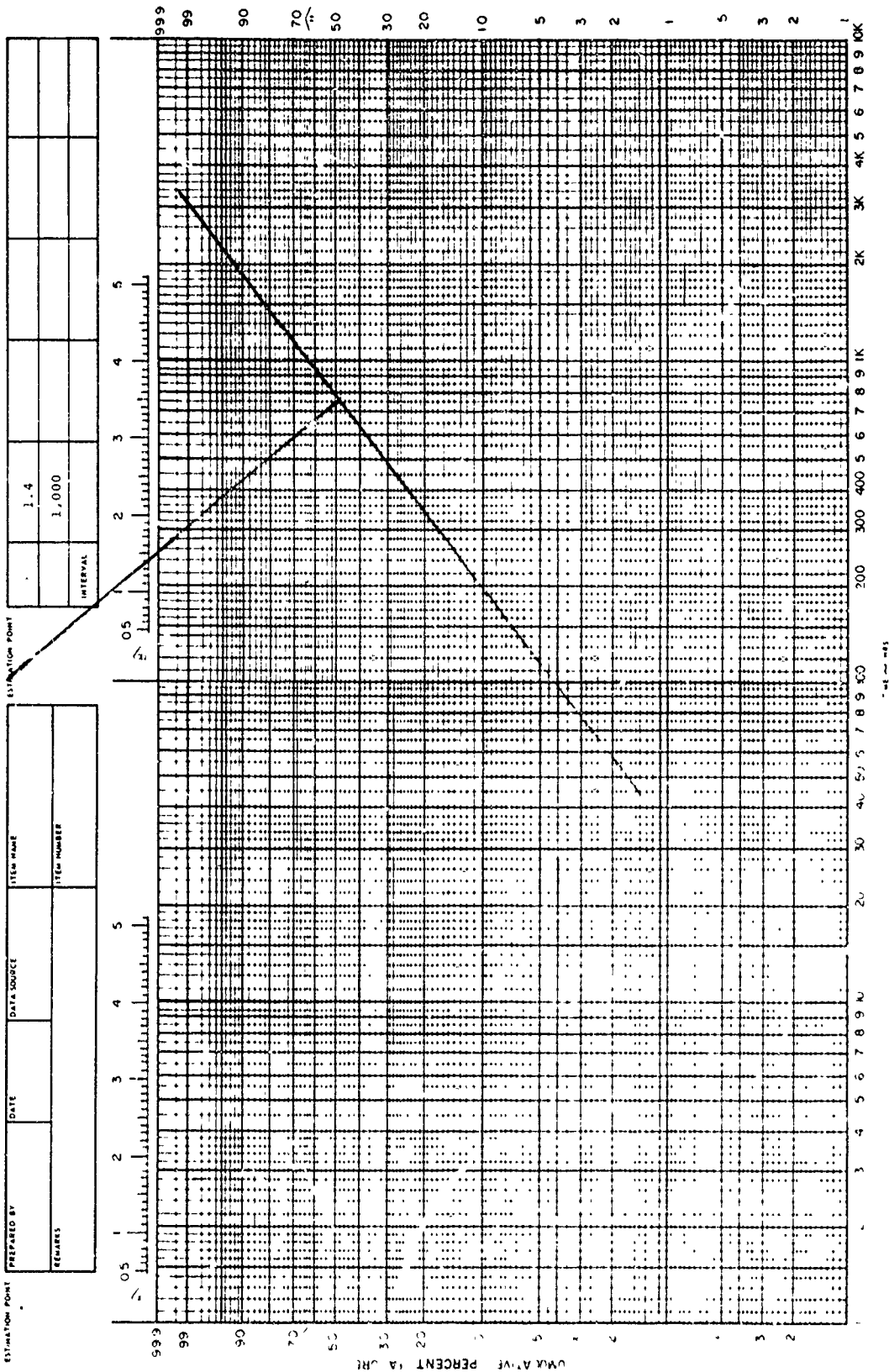

Figure 64. Boeing Vertol Weibull Plot On Modified Weibull Paper.

alike. M. V. Menon in his paper, ESTIMATION OF THE SHAPE AND SCALE PARAMETERS OF THE WEIBULL DISTRIBUTION¹³, discusses methods of estimating expected variation in β and θ as a function of sample size.

L. G. Johnson in his textbook¹⁴ recognizes the effect of sample size upon β and θ and has, in fact, developed confidence limits on β . These confidence limits are shown in Figures 65 and 66.

Fundamental to the development of estimates of β variation or confidence limits of β in the methods of Menon or Johnson is the assumption of sampling from a static, infinite population. Thus, as would be expected by any statistician knowledgeable of the Central Limit Theorem, estimates will be normally distributed around the true value of β . However, in the case of a finite, dynamic population (such as a fleet of helicopter transmissions), the assumption of normality may not be valid. The results of the simulations detailed in the following pages tend to dispute this assumption for application to a helicopter transmission; that is, one almost invariably overestimates the true value of β when the estimate is based on a finite sample of data. Thus the equations generated in the following pages seem more applicable for transforming β estimates into true β values for helicopter transmission applications.

Analysis of Hazard Function

The hazard function for an item describes how the failure rate changes as operating time increases. It is a conditional expression which states that if the item reaches a certain operating time it will have the indicated failure rate. Once the β and θ parameters of the Weibull distribution are known for a set of data, the hazard function can be constructed from the equation in the section entitled THE CONCEPT OF ON-CONDITION OPERATION.

The importance of the hazard function has been recognized, since it provides a basis for deciding whether to impose a TBO and cause component removal, or to allow it to continue to operate and be exposed to its future failure rate. For this reason it was felt that this area should be examined in detail, to determine the effect of sample size on the parameters of the hazard function, and to develop a method of projecting sample estimates into fleet estimates.

Computer Simulation of Fleet Operation

In order to properly analyze the behavior of the hazard function under varying circumstances, a large base of component failure and removal data was necessary. The data had to contain numbers of removed items with their respective operating

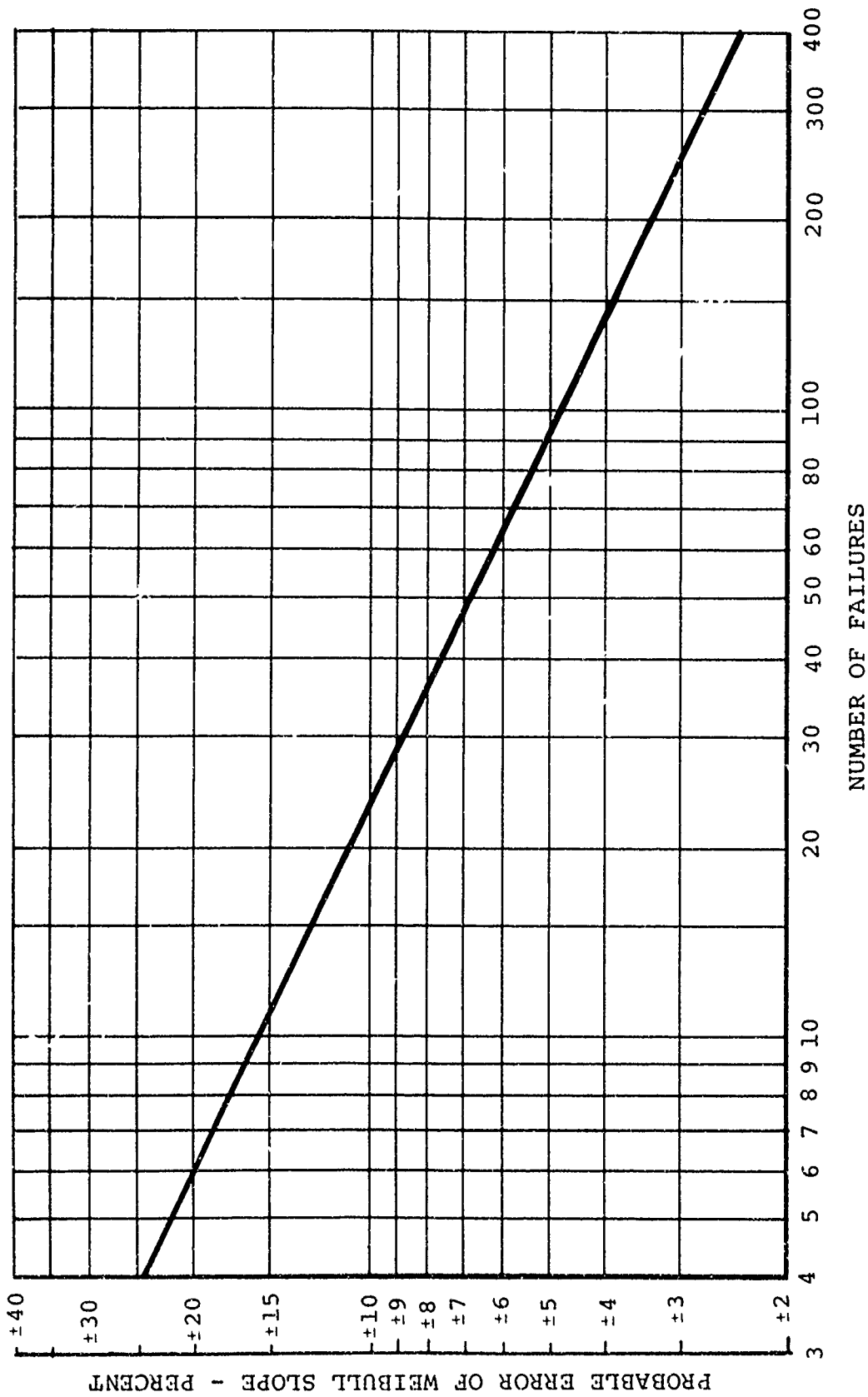

Figure 65. Probable Error of $\hat{\beta}$ as a Function of Number of Failures.

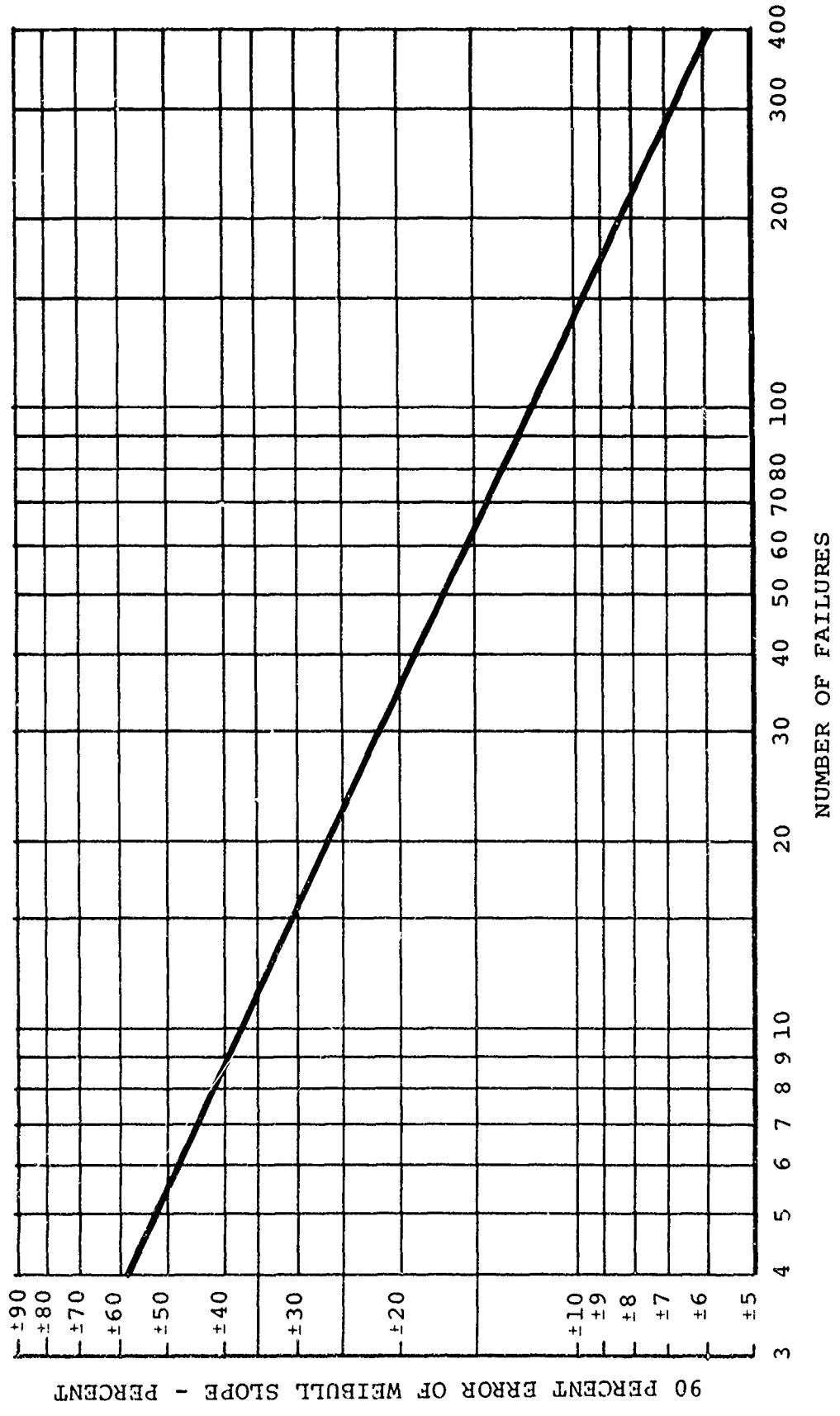

Figure 66. Ninety Percent Error of β as a Function of Number of Failures.

hours at time of removal, total items in the population, total fleet operating time, and other pertinent information. Although some data of the kind required was available, it was not always in the proper form or of the quality and quantity needed for this analysis. Therefore a computer simulation model was developed to generate data quickly and efficiently and of sufficient variation for the purposes of this study.

To analyze the role of hazard function, the model was exercised in the following manner. A fleet of 100 components was put into operation in the first time period. Hours of operation for each component for the time period were then randomly selected from a uniform distribution around a mean utilization which is input to the program. In succeeding time periods the hours were added to the total operating time on each component. The change in the unreliability resulting from the increase in operating time was calculated for each component, using time and inputted β and θ . (The β and θ inputs to the program are used to generate failures according to component time, but these failures are later ordered and a β and θ for this sample are estimated.) The changes in unreliability for the individual items were summed, with the total representing the number of failures which were expected during this time period. The program then called a subroutine which weighted each item according to its hazard rate, so that the components with the highest instantaneous probability of failure had the greatest chance of being selected as failures for the time period. The weighted failures were then selected at random and replaced with zero-time components. The next subroutine ordered the failures and calculated β and θ according to the method of least-squares on transformed data. Output was printed for this period and the program repeated the whole process for the next time period.

A simple flow chart of the model in this mode of operation is shown as Figure 67. The equations used in the model and a detailed discussion of the program appear in the Program Documentation Volume of this report.

Use of the Model

Looking at the model from a different viewpoint for a moment, one sees the user assuming the role of a reliability engineer. He receives data describing the operation of a fleet of components: time period, total operating hours, number of failures, hours on the failed items, the β and θ parameters, and so forth. From this he evaluates fleet performance.

However, the model was used in this portion of the analysis to study the parameters of the hazard function. β and θ were inputs to the program and were used to generate failures. These were the true values of the failure data, but due to

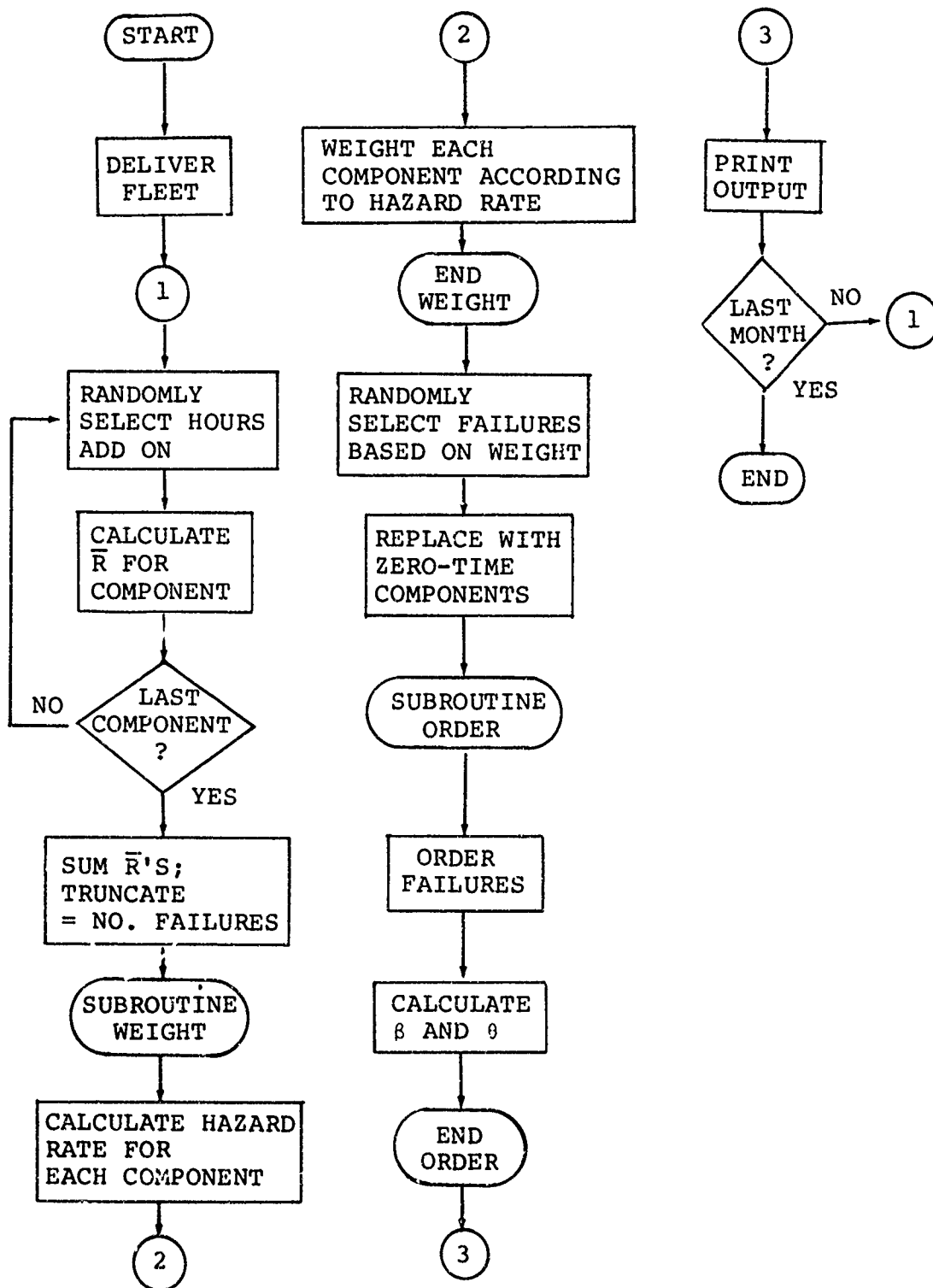

Figure 67. Flow Chart of Mathematical Model of Component Fleet Operation.

small sample size and clustering of the data as occurs in actual fleet operations, the calculated β and θ which a reliability engineer would observe may or may not indicate the true values. The calculated values were plotted and analyzed over time and with increasing sample size and were compared with the true input values to determine the relationship between the true and observed values. The input β and θ parameters were then changed to see if the relation between true and observed values was consistent. Furthermore, the utilization was altered to determine its effect. The resulting data was then correlated with the intent of having a method of predicting, from the observed β and θ for a given sample size, the true β and θ parameters of the hazard function. From this exercise, insight was gained into the effect of sample size upon these parameters.

Results

A large number of simulation runs were made, with β 's of 0.5, 0.75, 1.0, 1.5, and 2.0. These were felt to be reasonable, accounting for a decreasing (infant mortality) failure rate, a constant (random) failure rate, and an increasing (wearout) failure rate. θ 's used were 1,000, 3,000, 3,500, and 6,000 hours. Utilization was either 60 or 180 hours per period. Output was requested at varying intervals, from as frequently as every 6 periods to every 18 periods. Each run comprised 108 periods.

A typical page of output is shown in Figure 68. Input β and θ for the run were 1.0 and 6,000 hours, respectively. As can be seen, at the end of 18 periods, 17 failures had been generated, and the observed β and θ for this sample were 1.6078 and 555.8 hours. The term cumulative MTBUR is used for the statistic employed as a sample estimate of the true MTBUR. Cumulative MTBUR is calculated by dividing the total number of failures into the total number of hours on removed components. As such it should probably be labeled MTTUR not MTBUR to be consistent with standard reliability terminology. It can be demonstrated, however, that the statistic cumulative MTBUR, as defined herein, is in fact an unbiased estimate of the true MTBUR, although for small sample sizes it is generally significantly lower than true MTBUR. True MTBUR is calculated by taking all the hours on all the gearboxes in the fleet, both removed and still running, and dividing by the total number of failures.

In this run, as sample size increases β decreases, approaching the true β of 1.0, and θ increases in the direction of the true θ of 6,000 hours. A plot of all the data points generated using a true β of 1.0 appears as Figure 69. This shows observed β versus number of failures (sample size). This data was also plotted as observed β versus fleet operating hours in Figure 70. This process was repeated for the various β 's,

0's, and utilizations, resulting in over 200 data points. These points were employed in developing the equations shown in the succeeding paragraphs of this section.

The next step in this phase of the study was to correlate the data, in order to discover which parameters were related and would therefore prove useful in developing a predictive technique. For this work a stepwise, multiple-regression program was used. This program enables the user to input a set of data and specify the dependent variable and the independent variables to be used in each sub-problem of the program. Each

```

INPUTS :   TBO 99999, THETA 6000., MONTHS 109, UTIL. 60., BETA 1.00
          ZBETA 1.00, ZTHETA 6000., ZTBO 99999.
  
```

```

PERIOD                18
HOURS CUMULATIVE      107450
SCHEM. REMS. CUMULATIVE  0
FAILURES CUMULATIVE   17
CUMULATIVE MTBUR       518
TRUE MTBUR             6320
BETA                   1.6078
THETA                  555.8
CORR. COEFF.          0.9924
  
```

```

PERIOD                36
HOURS CUMULATIVE      213365
SCHEM. REMS. CUMULATIVE  0
FAILURES CUMULATIVE   35
CUMULATIVE MTBUR       998
TRUE MTBUR             6096
BETA                   1.2938
THETA                  1057.0
CORR. COEFF.          0.9832
  
```

```

PERIOD                54
HOURS CUMULATIVE      321898
SCHEM. REMS. CUMULATIVE  0
FAILURES CUMULATIVE   53
CUMULATIVE MTBUR      1400
TRUE MTBUR             6073
BETA                   1.2588
THETA                  1505.3
CORR. COEFF.          0.9872
  
```

```

PERIOD                72
HOURS CUMULATIVE      428122
SCHEM. REMS. CUMULATIVE  0
FAILURES CUMULATIVE   70
CUMULATIVE MTBUR      1666
TRUE MTBUR             6116
BETA                   1.2316
THETA                  1798.4
CORR. COEFF.          0.9854
  
```

```

PERIOD                90
HOURS CUMULATIVE      536709
SCHEM. REMS. CUMULATIVE  0
FAILURES CUMULATIVE   89
CUMULATIVE MTBUR      1995
TRUE MTBUR             6098
  
```

Figure 68. Sample Output From Component Fleet Operation Model.

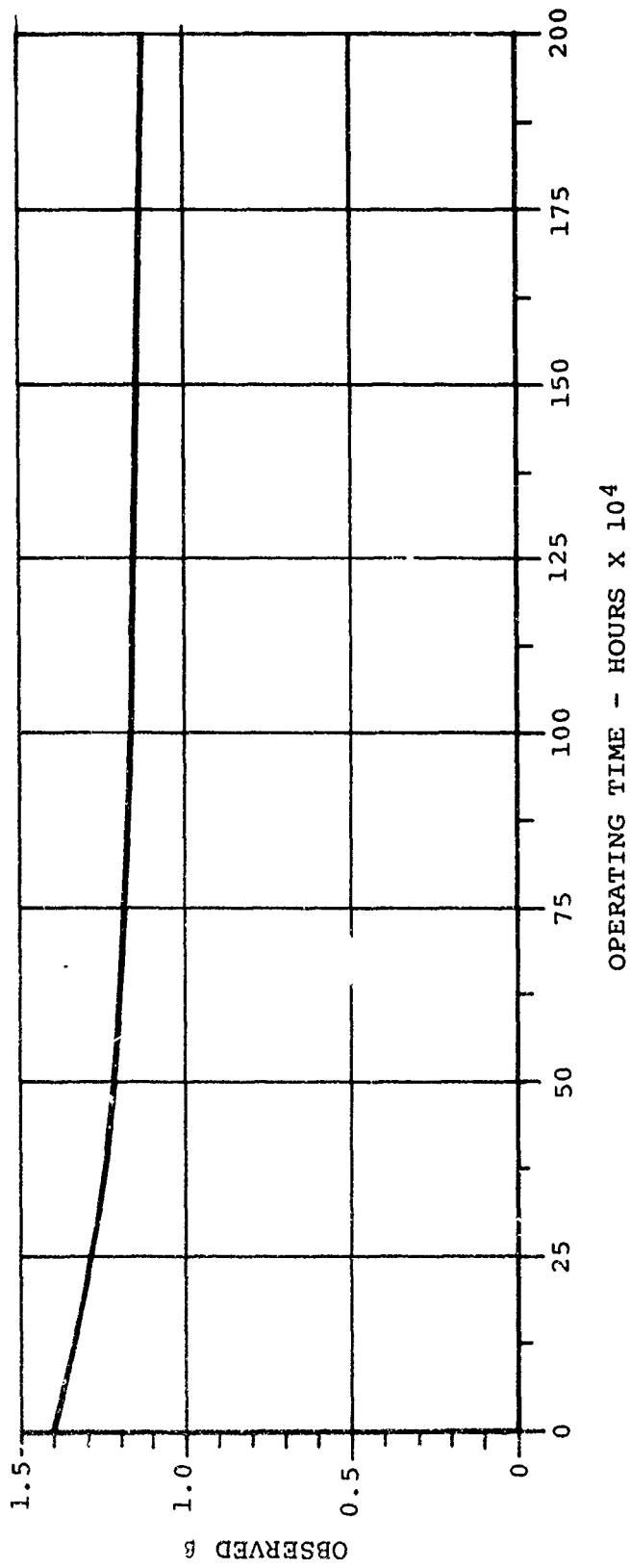

Figure 69. Observed β Versus Operating Time for a True β of 1.0.

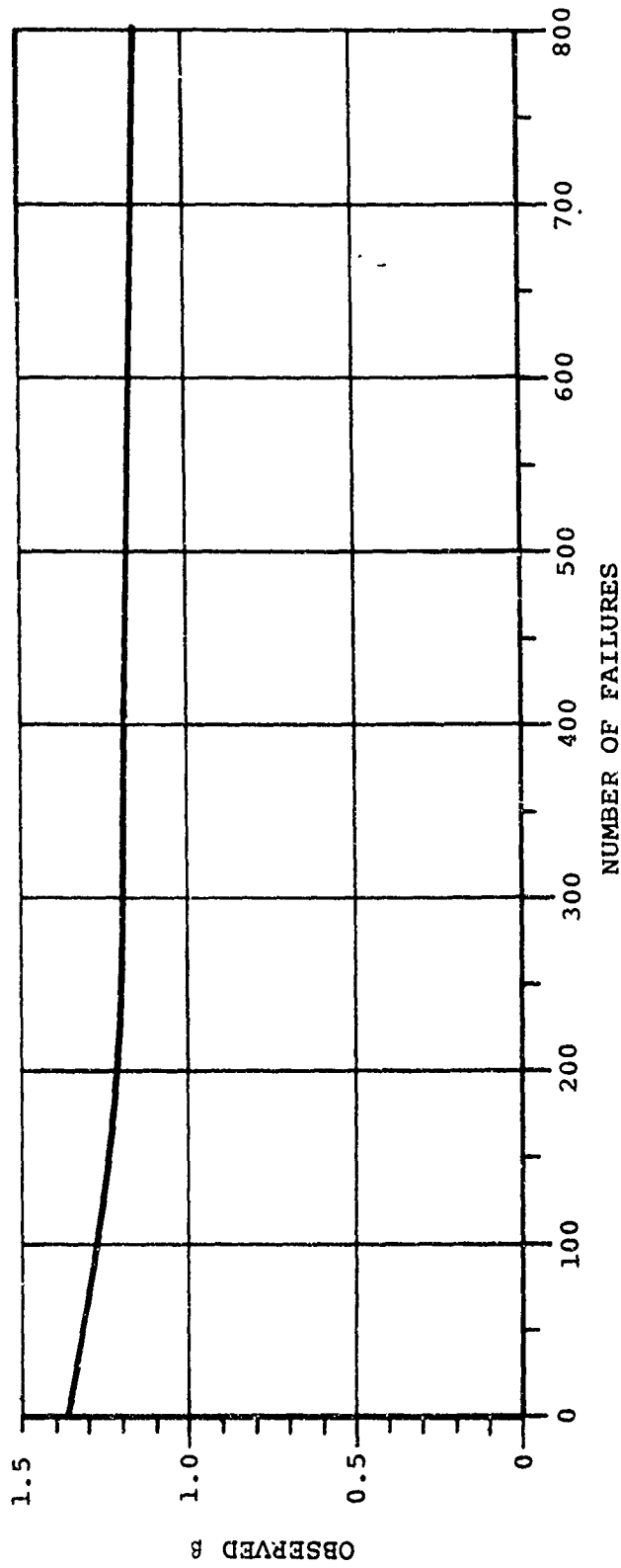

Figure 70. Observed β Versus Number of Failures for a True β of 1.0.

subproblem varies either the dependent or independent variables. The program then performs a least-squares, stepwise, multiple regression on the data. The output includes, among other things, the mean and standard deviation of each variable, the multiple correlation coefficient, standard error of estimate, analysis of variance, and the constants used in the generated predictive equation.

The variables used were true β , true θ , observed β , observed θ , operating hours, number of failures, and the natural logarithms of each, thereby comprising 12 variables. Sixteen subproblems were used in order to find the best equations for predicting true β and true θ .

The best correlations were found in the logarithmic relationships between the variables. Two equations were generated which it is felt can be used to predict true β , since both had a multiple correlation coefficient above 0.95. These equations showed the log of true β to be a function of the log of observed β and the log of the number of failures, or the log of observed β and the log of total operating hours. The equations are as follows:

$$\text{True } \beta = e^{-0.59796 \text{ obs } \beta^{1.46985} \text{ no. failures}^{0.05658}}$$

$$\text{True } \beta = e^{-1.41821 \text{ obs } \beta^{1.40309} \text{ hours}^{0.08655}}$$

The log of true θ was found to be a function of the logs of observed β , observed θ , and number of failures. Although the multiple correlation coefficient at 0.88 was not as high as the previous two, the standard error of estimate, 0.3465, divided by the mean value of the log of true θ , 7.95, yields an acceptable coefficient of variation of 4.4 percent. The resulting equation is:

$$\text{True } \theta = e^{5.08188 \text{ obs } \beta^{-1.05683} \text{ obs } \theta^{0.81260} \text{ no. failures}^{-0.54431}}$$

The conclusions to be drawn from this analysis are as follows. First, observed β has a tendency to be greater than the true β , decreasing and approaching true β as operating hours or sample size increase. Observed θ , on the other hand, starts out in early observations as a small fraction of true θ , increasing with number of failures in the direction of true θ . These equations were transformed to predict observed β and θ for a given true β and θ .

In summary, then, one should be wary when analyzing sample data, since observed or measured β 's overestimate the true β , which could lead to the misreading of a constant failure rate as an increasing failure rate. Additionally, observed or measured θ 's tend to underestimate the true θ , which could lead to the imposition of a TBO at a value less than necessary.

Model Operation with 1,200-Hour TBO

Although the purpose of this section is to develop equations useful in estimating true values for β and θ while operating on condition, it was felt that a TBO case should be examined to determine its effect on the modifying equations. Accordingly, the baseline TBO of 1,200 hours was chosen and 15 simulation runs were made, resulting in output of almost 100 data points.

Generally, the results were as expected. Compared to the on-condition simulation runs, operating with a TBO caused the number of failures generated to be higher, identical, and lower, for β 's of less than 1, 1, and greater than 1, respectively. θ 's calculated were higher when using a TBO than when operating on condition, holding all other factors constant. β 's were alternately higher or lower, depending on the other input parameters, and no clear-cut generalizations can be made.

As was done previously with the output from the on-condition simulation runs, the data was fed into a stepwise multiple-regression program to correlate the data and generate the modifying equations.

The results were basically the same, in that observed β tended to be greater than true β , decreasing and approaching true β as operating hours and sample size increased. Again, similar to the on-condition results, observed θ tended to be less than true θ , increasing and approaching true θ as operating hours and sample size increased. For comparison, the coefficients generated using the two sets of input data are:

	<u>Exponent</u>	<u>Obs β</u>	<u>Removals</u>	<u>Coefficients to Be Used in</u>	
On-Condition	-0.58988	1.46279	0.05624	β Modifying Equation	
TBO	-0.81492	1.21914	0.10212		
	<u>Exponent</u>	<u>Obs β</u>	<u>Obs θ</u>	<u>Removals</u>	<u>Coefficients to Be Used in</u>
On-Condition	5.15163	-1.02614	0.80499	-0.55118	θ Modifying Equations
TBO	4.71191	-0.63505	0.81524	-0.46392	

An example was chosen to compare the modifications that result from using the two sets of equations, given that certain θ 's, removals, and β 's are observed. The results are shown using the equations developed from the on-condition simulation runs and the TBO runs:

β	Observed		Modified β		Modified θ	
	θ	Removals	On-Cond	TBO	On-Cond	TBO
0.5	3,500	200	0.27	0.33	13,514	11,461
0.75	3,500	200	0.49	0.54	8,917	8,858
1.0	3,500	200	0.75	0.76	6,636	7,377
1.5	3,500	200	1.35	1.25	4,376	5,704
2.0	3,500	200	2.06	1.77	3,257	4,750
3.0	3,500	200	3.73	2.90	2,152	3,673

In order to develop a valid modifying equation for changing sample estimates to fleet estimates, simulation runs for a variety of TBO's would be necessary, meaning that 4 to 5 times as many runs would have to be made as have already been completed. This was not the intent of this section, although from this TBO case it appears that differences are not major. It is felt that no further conclusions in this area can be made.

Justification of Use of Least-Square Fit for β and θ

John H. K. Kao of Cornell University (and more recently NYU) in his paper, COMPUTER METHODS FOR ESTIMATING WEIBULL PARAMETERS IN RELIABILITY STUDIES¹⁵, identified four methods of estimating the parameters of the Weibull distribution:

1. Method of least-squares on transformed data
2. Method of maximum likelihood for ungrouped data
3. Method of maximum likelihood for grouped data
4. Method of minimized X-squares for grouped data

Of these four methods only the first two are truly applicable to transmission reliability analyses because they are independent of data grouping. Although the maximum likelihood estimate gives the theoretically more correct estimates of the Weibull parameters, it requires solution of the following simultaneous equations* via trial-and-error methods.

*A derivation of the maximum likelihood equations for a 3-parameter Weibull distribution can be found in MAXIMUM LIKELIHOOD ESTIMATION OF THE PARAMETERS OF GAMMA AND WEIBULL POPULATIONS FROM COMPLETE AND FROM CENSORED SAMPLES, Harter, H. Leon, and Moore, Albert H., Technometrics, Volume 7, No. 4. November 1965.

The equations to be solved are:

$$\theta^\beta = \frac{1}{r} \sum_{i=1}^r t_i^\beta + (n-r) t_r^\beta$$
$$\theta^\beta = \frac{\sum_{i=1}^r t_i^\beta \ln t_i + (n-r) t_r^\beta \ln (t_r)}{\frac{r}{\beta} + \sum_{i=1}^r \ln t_i}$$

As observed by Kao¹⁵, the results of the MLE method are, in general, not too different from the estimates developed by the least-squares method.

Thus, the least-squares method has been used in this analysis to estimate the Weibull distribution parameters on the basis of acceptable accuracy and ease of application.

APPENDIX VI
SAMPLE FAILURE MODE EFFECTS AND CRITICALITY ANALYSES

INTRODUCTION

This FMECA* was prepared by the Bertea Corporation, Irvine, California, to fulfill the requirements of The Boeing Company Data Item Sheet No. R0050A. The information is applicable to the end item of Swashplate Driver Actuator, Boeing Specification Number S301-10035. It is considered an excellent example of the manner in which an FMECA should be performed.

COMPONENT DESCRIPTION

The component described herein is the Bertea-furnished equipment for the flight control system of the Model 347 helicopter as modified for fly-by-wire.

The Swashplate Driver Actuator (SDA) is a dual failure-operate, triple-channel (ram force) unit (see Figure 71). Each channel is operated as a separate conventional electrohydraulic actuator except for an electrically selected mode of operation.

The SDA utilizes an active/on-line redundancy concept wherein only one channel is actually controlling the actuator output. The controlling channel is fully active and is at high-force gain. Redundant channels, although engaged or on-line, are incapable of carrying any load. This is accomplished by closing a high-gain lagged load pressure (ΔP) feedback loop around the actuator electrically via the electrohydraulic servovalve.

In the event of failure of the active channel, its associated servovalve is disengaged and the channel is isolated from the system and bypassed. Simultaneously, the high-gain pressure feedback signal is switched out from one on-line channel, making that channel the controlling channel. Failure of an on-line channel results in disengagement of that channel.

Authority of the ΔP feedback is intentionally limited such that the on-line channels oppose a failed active channel and/or load-share as soon as the limit is exceeded.

Each channel of the SDA provides dual capability for disengagement and bypass. Disengagement is accomplished by use of two in-series solenoid valves and bypass by two independent bypass features, one in the electrohydraulic servovalve and one in the ΔP sensor/bypass valve.

*This FMECA has been extracted from Bertea Document 228800, Rev. A, 15 September 1972.

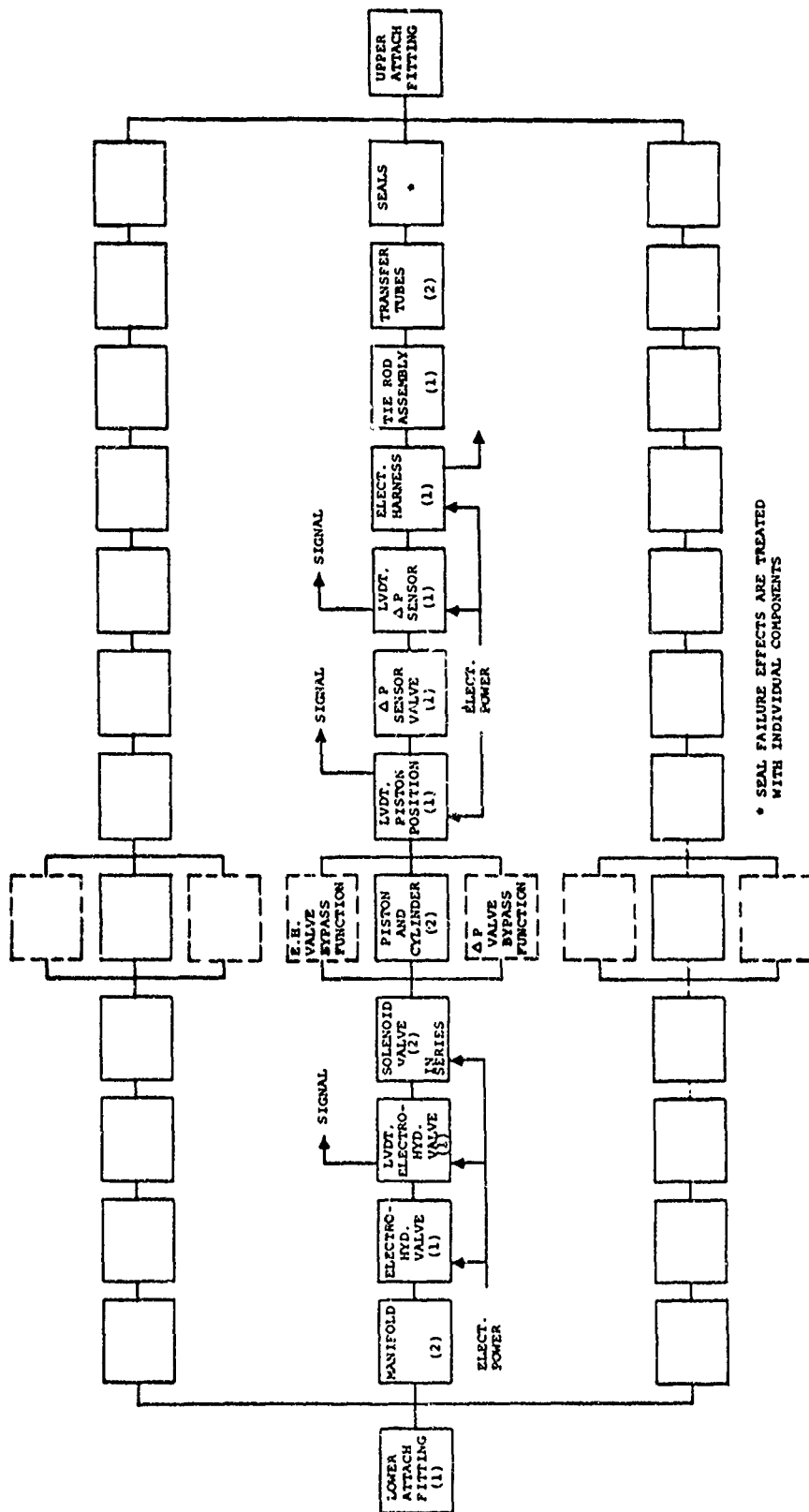

* SEAL FAILURE EFFECTS ARE TREATED WITH INDIVIDUAL COMPONENTS

Figure 71. Block Diagram of Doubly Redundant Berteau Washplate Drive Actuator, Part No. 228850.

Three failure-monitoring signals from each channel are provided for use by the DELS control unit. The three sources of these signals are one Linear Variable Differential Transducer (LVDT) monitoring actuator channel piston position, one LVDT monitoring the electrohydraulic servovalve second-stage spool position, and one LVDT monitoring the ΔP /bypass-valve operation.

Mechanical attachment of all three channels (ram force) is accomplished with a single (common) tie point at the swashplate and at structure.

FAILURE MODE EFFECTS AND CRITICALITY ANALYSES

The failure mode effects analysis and the criticality analysis are presented on separate worksheets.

The various possible failure modes of each component are identified (see Table XXXVI).

Those components having critical failure modes resulting in hazard classification of III and IV are analyzed relative to criticality.

Analysis Assumptions

1. All electrical inputs from aircraft systems are received at the SDA interface in a normal manner.
2. The hydraulic fluid supply from aircraft systems I, II, and III are received at the SDA interface in a normal manner.

FMECA Definitions

Channel

A separate, conventional, force output, electrohydraulic actuator section consisting of 2 parallel piston/cylinder arrangements, 2 separate manifold assemblies, 2 intermanifold transfer tubes, 2 solenoid control valves in series, 1 electrohydraulic servovalve, 1 ΔP /bypass valve, 1 LVDT for piston position, 1 LVDT for servovalve spool position, and 1 LVDT for ΔP /sensor bypass-valve monitoring.

Active Stage of Operation

That period of time when a channel is actually controlling the actuator output.

TABLE XXXVI. FAILURE MODE EFFECTS ANALYSIS

IDENTITY AND NOMENCLATURE	STAGE OF OPER.	FUNCTION	FAILURE MODE	FAILURE EFFECT ON:			FAILURE DETECTION METHOD	CORRECTIVE ACTION	REMARKS	HAZARD CLASS
				COMPONENT OR LRU	COMPONENT OR LRU SYSTEM	OTHER SYSTEMS AND TOTAL AIRCRAFT				
22851-1/22861-1 22852-1/22862-1 22853-1/22863-1 MANIFOLD ASSY. CHANNLES I, II AND III (1 REQ'D OF EACH MANIFOLD, TOTAL OF 9)	ACTIVE	PROVIDES METHOD OF DIRECTING FLUID TO ASSOCIATED COMPONENTS AND FUNCTIONS AS PRIMARY STRUCTURAL SUPPORT FOR COMPONENT MOUNTING.	EXTERNAL LEAKAGE (MINOR)	ABILITY TO TRANSFER AND DIRECT FLUID IS DEGRADED	NONE	VISUAL ON GROUND	NONE	MAINTENANCE MALFUNCTION	I	
			EXTERNAL LEAKAGE (MAJOR)	LOSS OF ONE OF THREE ACTUATOR CHANNELS THRU LOSS OF HYD. FLUID	LOSS OF ONE DEGREE OF REDUNDANCY FOR SWASH-PLATE POSITION CONTROL.	VISUAL COCKPIT INDICATION AND VISUAL ON GROUND	AUTOMATIC CHANNEL SHUTDOWN WITH ACTIVATION OF "ON LINE" CHANNEL	MISSION ABORT. FLUID DEPLETION RESULTS IN LOSS OF COMMON CHANNEL AT ALL FOUR CONTROL POSITIONS	II	
			INTERNAL LEAKAGE (MINOR) PRESS TO RETURN	DEGRADATION OF CHANNEL PERFORMANCE	NONE	NONE	MAINTENANCE MALFUNCTION	I		
			INTERNAL LEAKAGE (MAJOR) PRESS TO RETURN	LOSS OF ONE OF THREE ACTUATOR CHANNELS THRU LOSS OF HYDRAULIC PRESSURE	LOSS OF ONE DEGREE OF REDUNDANCY FOR SWASH-PLATE POSITION CONTROL.	VISUAL COCKPIT INDICATION	AUTOMATIC CHANNEL SHUTDOWN WITH ACTIVATION OF "ON LINE" CHANNEL	MISSION ABORT	II	
			CLOGGED PASSAGE	ABILITY TO TRANSFER FLUID IS LOST	NO EFFECT ON AIRCRAFT	VISUAL COCKPIT INDICATION	AUTOMATIC CHANNEL SHUTDOWN WITH ACTIVATION OF "ON LINE" CHANNEL	MISSION ABORT. POTENTIAL FOR LOSS OF COMMON CHANNEL AT ALL FOUR CONTROL POSITIONS IF CLOG IS LOCATED IN CRITICAL POSITION	II	

TABLE XXXVI - Continued

IDENTITY AND NOMENCLATURE	STAGE OF OPER.	FUNCTION	FAILURE MODE	FAILURE EFFECT ON:			FAILURE DETECTION METHOD	CORRECTIVE ACTION	REMARKS	HAZARD CLASS
				COMPONENT OR LRU	COMPONENT OR LRU SYSTEM	OTHER SYSTEMS AND TOTAL AIRCRAFT				
MANIFOLD ASSY, CHANNELS I, II AND III (CONTINUED)	ACTIVE		STRUCTURAL FAILURE	LOSS OF LOAD CARRYING AND FLUID RETENTION CAPABILITY	POTENTIAL LOSS OF COMPONENTS THRU LOSS OF SUPPORT, LOSS OF HYD. FLUID	LOSS OF ONE DEGREE OF REDUNDANCY FOR SWASH-PLATE POSITION CONTROL. NO EFFECT ON AIRCRAFT	VISUAL COCKPIT INDICATION AND VISUAL ON GROUND	AUTO-MATIC CHANNEL SHUTDOWN WITH ACTIVATION OF "ON LINE" CHANNEL	MISSION ABORT, FLUID DEPLETION RESULTS IN LOSS OF COMMON CHANNEL AT ALL FOUR CONTROL POSITIONS	II
				ABILITY TO TRANSFER AND DIRECT FLUID IS DEGRADED	MINOR LOSS OF HYDRAULIC FLUID.	NONE	VISUAL ON GROUND	NONE	MAINTENANCE MALFUNCTION	I
	INTERNAL LEAKAGE (MINOR) PRESS TO RETURN	EXTERNAL LEAKAGE (MAJOR)	LOSS OF ONE "ON LINE" CHANNELS THRU LOSS OF HYD. FLUID. NO EFFECT ON ACTIVE CHANNEL	LOSS OF ONE DEGREE OF REDUNDANCY FOR SWASH-PLATE POSITION CONTROL. NO EFFECT ON AIRCRAFT	VISUAL COCKPIT INDICATION AND VISUAL ON GROUND	AUTO-MATIC CHANNEL SHUTDOWN	MISSION ABORT, FLUID DEPLETION RESULTS IN LOSS OF COMMON CHANNEL AT ALL FOUR CONTROL POSITIONS	II		
			NONE	NONE	NONE	NONE	MAINTENANCE MALFUNCTION	I		

TABLE XXXVI - Continued

IDENTITY AND NOMENCLATURE	STAGE OF OPER.	FUNCTION	FAILURE MODE	FAILURE EFFECT ON-		OTHER SYSTEMS AND TOTAL AIRCRAFT	FAILURE DETECTION METHOD	CORRECTIVE ACTION	REMARKS	HAZARD CLASS
				COMPONENT OR LRU	COMPONENT OR LRU SYSTEM					
MANIFOLD ASSY, CHANNELS I, II AND III (CONTINUED)	ON LINE		INTERNAL LEAKAGE (MAJOR) PRESS TO RETURN	ABILITY TO TRANSFER AND DIRECT FLUID IS DEGRADED	LOSS OF ONE OF TWO "ON LINE" CHANNELS THRU LOSS OF HYD. PRESSURE NO EFFECT ON ACTIVE CHANNEL	LOSS OF ONE DEGREE OF REDUNDANCY FOR SWASH-PLATE POSITION CONTROL, NO EFFECT ON AIRCRAFT	VISUAL COCKPIT INDICATION	AUTOMATIC CHANNEL SHUT-DOWN	MISSION ABORT	II
			CLOGGED PASSAGE	ABILITY TO TRANSFER FLUID IS LOST	NO EFFECT ON ACTIVE CHANNEL				MISSION ABORT, POTENTIAL FOR LOSS OF COMMON CHANNEL AT ALL FOUR CONTROL POSITIONS IF CLOG IS LOCATED IN CRITICAL POSITION	II
			STRUCTURAL FAILURE	LOSS OF LOAD CARRYING AND FLUID RETENTION CAPABILITY	POTENTIAL LOSS OF COMPONENTS THRU LOSS OF SUPPORT, LOSS OF HYD. FLUID, NO EFFECT ON ACTIVE CHANNEL	VISUAL COCKPIT INDICATION AND VISUAL ON GROUND		MISSION ABORT, FLUID DEPLETION RESULTS IN LOSS OF COMMON CHANNEL AT ALL FOUR CONTROL POSITIONS	II	

TABLE XXXVI - Continued

IDENTITY AND NOMENCLATURE	STAGE OF OPER.	FUNCTION	FAILURE MODE	FAILURE EFFECT ON:			FAILURE DETECTION METHOD	CORRECTIVE ACTION	REMARKS	HAZARD CLASS
				COMPONENT OR LEU	COMPONENT OR LRU SYSTEM	OTHER SYSTEMS AND TOTAL AIRCRAFT				
228044-101 228845-1 FITTINGS, ACTUATOR, UPPER AND LOWER ATTACH (1 REQ'D OF EACH)	ALL STAGES	PROVIDES PRIMARY ATTACH POINTS FOR ACTUATOR TO STRUCTURE AND SWASHPLATE	OPEN LOAD PATH (FRACTURE)	LOSS OF CAPABILITY TO TRANSMIT RAM FORCE FROM THREE CHANNELS	LOSS OF ONE SWASHPLATE POSITION CONTROL	LOSS OF FLIGHT CONTROLS, LOSS OF AIRCRAFT	PILOT SENSES	NONE	FLIGHT SAFETY LOSS	IV
			CRACKS	DEGRADATION OF FUNCTION	POTENTIAL FOR PROGRESSION TO OPEN LOAD PATH	POTENTIAL LOSS OF FLIGHT CONTROLS WITH LOSS OF AIRCRAFT	VISUAL ON GROUND		MISSION REPORT	III
			BINDING		INTRODUCTION OF ADDITIONAL LOADS TO CONTROL SYSTEM	DEGRADATION OF CONTROL CAPABILITY, NO EFFECT ON AIRCRAFT	DETECTABLE DURING SCHEDULED MAINTENANCE		MAINTENANCE MALFUNCTION	I

TABLE XXXVI - Continued

IDENTITY AND NOMENCLATURE	STAGE OF OPER.	FUNCTION	FAILURE MODE	FAILURE EFFECT ON:				FAILURE DETECTION METHOD	CORRECTIVE ACTION	REMARKS	HAZARD CLASS
				COMPONENT OR LRU	COMPONENT OR LRU SYSTEM	OTHER SYSTEMS AND AIRCRAFT TOTAL AIRCRAFT	FAILURE DETECTION METHOD				
228841-1, -3, -5 228842-1 PISTON AND CYLINDER ACTUATOR PEYONS ARE CONNECTED TO ROD END ADAPTOR 228844-101 (2 REQ'D OF EACH PISTON AND CYLINDER PER CHANNEL)	ACTIVE	CONVERTS HYDRAULIC FLUID PRESSURE TO RAM FORCE	EXTERNAL LEAKAGE (MINOR)- PAST CYLINDER SEALS OR ROD EXCLUDER RING	DEGRADATION OF FUNCTION	MINOR LOSS OF HYDRAULIC FLUID	NONE	VISUAL ON GROUND	NONE	MAINTENANCE MALFUNCTION	I	
			EXTERNAL LEAKAGE (MAJOR)- PAST CYLINDER STATIC SEALS OR ROD EXCLUDER RING	LOSS OF FLUID PRESSURE TO RAM FORCE. CONVERSION CAPABILITY	LOSS OF ONE OF THREE ACTUATOR CHANNELS, THRU LOSS OF HYD. FLUID	LOSS OF ONE DEGREE OF REDUNDANCY FOR SWASH-PLATE POSITION CONTROL, NO EFFECT ON AIRCRAFT	VISUAL COCKPIT INDICATION AND VISUAL ON GROUND	AUTOMATIC SHUTDOWN WITH ACTIVATION OF "ON LINE" CHANNEL	MISSION ABORT. FLUID DEPLETION RESULTS IN LOSS OF CHANNEL AT ALL FOUR CONTROL POSITIONS	II	
			INTERNAL LEAKAGE (MINOR)-PAST PISTON SEAL	DEGRADATION OF FUNCTION	NONE	NONE	NONE	NONE	MAINTENANCE MALFUNCTION	I	
			INTERNAL LEAKAGE (MAJOR)-PAST PISTON SEAL	LOSS OF FLUID PRESSURE TO RAM FORCE. CONVERSION CAPABILITY	LOSS OF ONE OF THREE ACTUATOR CHANNELS THRU LOSS OF PRESSURE	LOSS OF ONE DEGREE OF REDUNDANCY FOR SWASH-PLATE POSITION CONTROL. NO EFFECT ON AIRCRAFT	VISUAL COCKPIT INDICATION	AUTOMATIC SHUTDOWN WITH ACTIVATION OF "ON LINE" CHANNEL	MISSION ABORT	II	
			JAMMED PISTON TO CYLINDER		LOSS OF ONE SWASHPLATE POSITION CONTROL IF JAM CANNOT BE RELEASED	POTENTIAL LOSS OF FLIGHT CONTROLS WITH LOSS OF AIRCRAFT	PILOT SENSES	NONE	FLIGHT SAFETY LOSS	IV	

TABLE XXXVI - Continued

IDENTITY AND NOMENCLATURE	STAGE OF OPER.	FUNCTION	FAILURE MODE	FAILURE EFFECT ON:			FAILURE DETECTION METHOD	CORRECTIVE ACTION	REMARKS	HAZARD CLASS
				COMPONENT OR LRU	COMPONENT OR LRU SYSTEM	OTHER SYSTEMS AND TOTAL AIRCRAFT				
PISTON/CYLINDER ACTUATOR (CONTINUED)			BINDING-PISTON TO CYLINDER OR GLAND	DEGRADATION OF FUNCTION	INTRODUCTION OF INCREASED FRICTION LOADS TO SYSTEM	DEGRADATION OF CONTROL CAPABILITY. NO EFFECT ON AIRCRAFT	DETECTABLE DURING SCHEDULED MAINTENANCE	NONE	MAINTENANCE MALFUNCTION	I
			OPEN LOAD PATH (PISTON ROD FRACTURE)	LOSS OF "FLUID PRESSURE TO RAM FORCE" CONVERSION CAPABILITY	LOSS OF ONE OF THREE ACTUATOR CHANNELS THRU LOSS OF FORCE LOAD PATH	LOSS OF ONE DEGREE OF REDUNDANCY FOR SWASH-PLATE POSITION CONTROL. NO EFFECT ON AIRCRAFT	VISUAL COCKPIT INDICATION	AUTOMATIC CHANNEL SHUTDOWN WITH ACTIVATION OF "ON LINE" CHANNEL	MISSION ABORT	II
	ON LINE	DURING ON LINE MODE, CHANNEL HAS NO LOAD CARRYING CAPABILITY	EXTERNAL LEAKAGE (MINOR)-PAST CYLINDER STATIC SEALS OR ROD EXCLUDER RING	EVENTUAL DEGRADATION OF FUNCTION	MINOR LOSS OF HYDRAULIC FLUID	NONE	VISUAL ON GROUND	NONE	MAINTENANCE MALFUNCTION	I
			EXTERNAL LEAKAGE (MAJOR)-PAST CYLINDER STATIC SEALS OR ROD EXCLUDER RING	LOSS OF "FLUID PRESSURE TO RAM FORCE" CONVERSION CAPABILITY	LOSS OF ONE OF TWO "ON-LINE" CHANNELS THRU LOSS OF HYD. FLUID. NO EFFECT ON ACTIVE CHANNEL	LOSS OF ONE DEGREE OF REDUNDANCY FOR SWASH-PLATE POSITION CONTROL. NO EFFECT ON AIRCRAFT	VISUAL COCKPIT INDICATION AND VISUAL ON GROUND	AUTOMATIC CHANNEL SHUTDOWN	MISSION ABORT. FLUID DEPLETION RESULTS IN LOSS OF COMMON CHANNEL AT ALL FOUR CONTROL POSITIONS	II
			INTERNAL LEAKAGE (MINOR)-PAST PISTON SEAL	DEGRADATION OF FUNCTION	NONE	NONE	NONE	NONE	MAINTENANCE MALFUNCTION	I

On-Line Stage of Operation

That period of time when a channel is engaged electrically and hydraulically, but is incapable of carrying any load.

Minor Leakage

That amount of leakage over and above component specification allowable leakage but component function is not lost; the result is degraded component performance.

Major Leakage

That amount of leakage over and above component specification allowable leakage from which component function is lost.

Criticality Analysis Reliability Data Source

The following data sources were used to determine failure rates. These sources were supplemented with good engineering judgment:

1. Berteau experience with similar equipment in use on military flight hardware (P-3, C-5A, and F-4).
2. Berteau experience with similar equipment in use on commercial flight hardware, plus airline component removal data (707, 727, 737, 747, DC-8, DC-9, DC-10, L-1011, and Gulfstream II).
3. MIL-HDBK-217A, Reliability Stress and Failure Rate Data for Electronic Equipment.

Analysis Summary

Failure Mode Effects Analysis (Table XXXVI)

Significant findings of the failure mode effects analysis may be summarized as follows:

1. An open load path at either actuator attachment fitting or a jammed piston will result in loss of aircraft (flight safety, Class IV).
2. A cracked actuator attachment fitting results in a mission abort, Class III.
3. Major external leakage of a channel component, a clogged passage, or structural failure of components resulting in major leakage will result in eventual system fluid depletion with loss of one common channel

TABLE XXXVII. CRITICALITY ANALYSIS

REF. STEP NO.	ITEM IDENTIFICATION		CRITICAL FAILURES				CRITICALITY EVALUATION						
	NOMENCLATURE	PART NUMBER	COMPONENT / SYSTEM FUNCTION	FAILURE MODE	STAGE OF OPERATION	FAILURE EFFECTS	RELIABILITY DATA SOURCE	PROBABILITY OF FAILURE EFFECTS β	FAILURE MODE RATIO α	FAILURE RATE $\lambda, 10^{-6}$	OPERATING TIME t	CRITICAL MODE CONTRIBUTION $(\beta \alpha t^{-1} 10^6)$	COMPONENT CRITICALITY NUM BER $\sum_{i=1}^n (\beta \alpha t^{-1} 10^6)$
	FITTERS, ACTUATOR, UPPER AND LOWER (1 EACH REQUIRED PER ACTUATOR)	228844-101 228845-1	PROVIDES PRIMARY ATTACH POINTS FOR ACTUATOR TO STRUCTURE AND SWASHPLATE	OPEN LOAD PATH (FRACTURE) CRACKS	ALL STAGES	(ACTUAL) LOSS OF AIRCRAFT (POSSIBLE) POTENTIAL LOSS OF AIRCRAFT	REFER TO PARA. 3.3	1.00	0.10	.001	2.00	200.0	220.0
	PISTON AND CYLINDER, ACTUATOR (3 REQ'D EACH PER CHANNEL)	278841-1, -3, -5 228842-1	CONVERTS HYDRAULIC FLUID PRESSURE TO RAM FORCE	JAMMED, PISTON TO CYLINDER	ALL STAGES	(POSSIBLE) POTENTIAL LOSS OF AIRCRAFT		.01	.01	.44	2.00	88.0	88.0

*WHEREIN BREAKOUT FORCE EXCEEDS SINGLE SYSTEM STALL FORCE CAPABILITY

at each swashplate control position (mission abort Class II).

4. All other failure modes identified are classified as I or II and require mission abort or maintenance action.

Criticality Analysis (Table XXXVII)

Criticality ranking of the several components exhibiting Class III and IV effects follows, with the most critical listed first.

1. Actuator attachment fitting experiencing cracks or open-load-path modes.
2. Piston/cylinder combination in a jam mode.

APPENDIX VII
DEVELOPMENT OF MATHEMATICAL MODELS

RELATIONSHIP OF B₁₀ LIFE TO HAZARD FUNCTION

A computer program has been developed to calculate hazard rate as a function of B₁₀ and β. This program is primarily for application when developing modal hazard functions for bearings.

A complete listing and documentation of this program are contained in the Program Documentation Volume of this report.

A derivation of the equation for hazard function used in this program is contained in the following paragraph:

$$\begin{aligned}\text{Reliability} = R &= e^{-(\text{TIME}/\theta)^\beta} \\ \ln R &= -\ln (t/\theta)^\beta \\ -\ln R &= (t/\theta)^\beta \\ \ln (-\ln R) &= \ln ((t/\theta)^\beta) = \beta \ln (t/\theta) \\ \frac{\ln (-\ln R)}{\beta} &= \ln (t/\theta)\end{aligned}$$

Let R equal 0.90, which means that \bar{R} (the cumulative probability of failure) is equal to 0.10.

By definition, the time at which \bar{R} equals 0.10 is the component B₁₀ life.

$$\text{Then, } \frac{\ln (-\ln(0.90))}{\beta} = \ln (B_{10}/\theta)$$

$$\frac{\ln(-(-0.10536))}{\beta} = \ln (B_{10}/\theta)$$

$$\frac{-2.25}{\beta} = \ln B_{10} - \ln \theta$$

$$\frac{2.25}{\beta} = \ln \theta - \ln B_{10}$$

$$\frac{2.25}{\beta} + \ln B_{10} = \ln \theta$$

$$e^{2.25/\beta + \ln B_{10}} = e^{\ln \theta}$$

$$e^{2.25/\beta} \cdot e^{\ln B_{10}} = e^{\ln \theta}$$

$$e^{2.25/\beta} \cdot B_{10} = \theta$$

Thus the hazard rate can be expressed as,

$$H(t) = \frac{\beta}{\theta^\beta} t^{\beta-1} = \frac{\beta}{B_{10}^\beta} \cdot e^{-2.25} \cdot t^{\beta-1}$$

which reduces to

$$H(t) = \frac{0.105399^\beta}{B_{10}^\beta} \cdot t^{\beta-1}$$

This is the equation for hazard rate employed in this program.

RELATIONSHIP OF B_{10} TO MTBF

Regardless of the distribution ($f(t)$) of component time to failure, the expected time to failure or mean time between failures (MTBF) can be calculated using the equation

$$MTBF = \int_{-\infty}^{\infty} t \cdot f(t) dt$$

For the Weibull distribution,

$$F(t) = \beta/\theta \left(\frac{t}{\theta}\right)^{\beta-1} e^{-(t/\theta)^\beta} dt \quad \text{when } 0 \leq t < \infty$$

$$F(t) = 0 \quad \text{elsewhere}$$

Thus for the Weibull,

$$MTBF = \int_0^{\infty} t \cdot \frac{\beta}{\theta} \left(\frac{t}{\theta}\right)^{\beta-1} e^{-(t/\theta)^\beta} dt \quad (12)$$

To integrate the right side of this equality,

$$\text{let } W = (t/\theta)^\beta$$

Then
$$t = \theta \cdot w^{\frac{1}{\beta}} \quad (13)$$

and
$$dw = \left(\frac{\beta}{\theta}\right) t^{\beta-1} dt \quad (14)$$

Substitution of equations 13 and 14 into equation 12 yields

$$MTBF = \theta \int_0^{\infty} w^{\frac{1}{\beta}} e^{-w} dw \quad (15)$$

where the integrand is a form of the gamma function whose values are readily available in standard mathematical tables.

Thus, the final result can be expressed as

$$MTBF = \theta \cdot \Gamma \left(\frac{1}{\beta} + 1\right) \quad (16)$$

Thus, $MTBF = e^{2.25/\beta} \cdot B_{10} \cdot \Gamma \left(\frac{1}{\beta} + 1\right)$

Although the above derivation and resulting equation 16 are theoretically correct, a word of caution regarding their application is in order.

The gamma function solution to equation 15 requires that the distribution of time to failures be infinite. Thus if a component has a retirement life, TBO, or some maximum intended life cycle (all of which will be called TBO), the utilization of equation 16 is not theoretically correct.

The use of equation 16 where the distribution of times to failure is finite will yield the following:

1. Overestimates of MTBF for β values greater than 1.
2. Underestimates of MTBF for β values less than 1.
3. No error for β values equal to 1.

The amount of bias incurred for β values not equal to 1 is a function of the relationship between θ and TBO.

For β values greater than 1, if TBO is large in comparison to θ , very little error will be encountered through use of equation 16. As a working rule, TBO values of at least 6 times θ will result in an acceptable error in MTBF.

For β values less than 1, TBO should be at least 10 times θ in order to use equation 16 with acceptable accuracy.

A program has been written to solve equation 16. Complete documentation of this program is contained in the Program Documentation Volume of this report. This program is intended for use only in those cases where acceptable accuracy can be expected due to the θ and TBO values of the component.

For those cases where the gamma function solution will not yield acceptable accuracy, the following approximation of MTBF can be employed:

$$MTBF = \frac{\left(\int_0^{TBO} t \cdot f(t) dt \right) + (1 - \bar{R}(TBO))(TBO)}{\bar{R}(TBO)} \quad (17)$$

where for the Weibull distribution

$$\bar{R}(TBO) = 1 - e^{-(TBO/\theta)^\beta}$$

The equation 17 for a Weibull distribution becomes

$$MTBF = \left(\int_0^{TBO} t \cdot \frac{B}{\theta} \cdot \left(\frac{t}{\theta}\right)^{\beta-1} \cdot e^{-\left(\frac{t}{\theta}\right)^\beta} dt \right) / \left(1 - e^{-(TBO/\theta)^\beta} \right) + \frac{e^{-(TBO/\theta)^\beta}}{(1 - e^{-(TBO/\theta)^\beta})^\beta} (TBO) \quad (18)$$

Equation 18 for β values not equal to 1 cannot be solved directly; thus, a numerical integration program is employed for the solution of equation 18. This is the same program used to solve equation 12. The only point to remember is that in using the program the resulting MTBF must be modified to handle the hours on unfailed components.

COMBINATION OF MODAL HAZARD FUNCTIONS INTO AN ASSEMBLY HAZARD FUNCTION

A FORTRAN program has been written to combine modal hazard functions into an assembly hazard function. Complete documentation of this program is contained in the Program Documentation Volume of this report.

The mathematical model that provides the basis for this computer program is developed in the following paragraphs.

As defined earlier, the hazard function can be expressed as

$$H(t) = \frac{f(t)}{F(t)}$$

where $f(t)$ = the probability density function
and $F(t)$ = cumulative probability of failure.

For a Weibull distribution,

$$f(t) = \frac{\beta}{\theta} \left(\frac{t}{\theta}\right)^{\beta-1} \cdot e^{-\left(\frac{t}{\theta}\right)^\beta}$$

$$F(t) = 1 - e^{-\left(\frac{t}{\theta}\right)^\beta}$$

It should be noted here that another notation previously used in this report for cumulative probability of failure is

$$\bar{R}(t) = 1 - e^{-\left(\frac{t}{\theta}\right)^\beta} = 1 - R(t)$$

where $\bar{R}(t)$ is equal to unreliability and $R(t)$ is equal to reliability.

For a transmission composed of M components each having j_i failure modes such that

$$K = \sum_{i=1}^M j_i$$

the probability that the transmission will operate successfully to time t is the same as the probability that all parts of the transmission will operate successfully to time t .

Thus, to calculate the reliability of the transmission it is necessary to consider the reliability of each of the components of the transmission.

With the assumption that the failure modes of each part can be described by a Weibull distribution of the form

$$R_{i,L} = e^{-\left(\frac{t}{\theta_{i,L}}\right)^{\beta_{i,L}}}$$

where $R_{i,L}$ is the reliability of the i^{th} component for the L^{th}

failure mode of that component, and that all parts of the transmission are nonredundant, then the reliability of the transmission $R_X(t)$ can be described as

$$R_X(t) = \prod_{i=1}^M \prod_{L=1}^{J_i} R_{i,L}(t)$$

Thus,

$$R_X(t) = \prod_{i=1}^M \prod_{L=1}^{J_i} e^{-\left(\frac{t}{\theta_{i,L}}\right)^{\beta_{i,L}}}$$

or

$$R_X(t) = e^{-\sum_{i=1}^M \sum_{L=1}^{J_i} \left(\frac{t}{\theta_{i,L}}\right)^{\beta_{i,L}}}$$

Similarly, the joint probability density function $f_X(t)$, the probability density function for failure of any transmission component in any mode, can be demonstrated to be of the form

$$f_X(t) = \sum_{i=1}^n \sum_{L=1}^{J_i} \frac{\beta_{i,L}}{\theta_{i,L}} \left(\frac{t}{\theta_{i,L}}\right)^{\beta_{i,L}-1} \cdot e^{-\left(\frac{t}{\theta_{i,L}}\right)^{\beta_{i,L}}}$$

Thus, the hazard function of the assembly $H_X(t)$ can be evaluated using the equation

$$H_X(t) = \frac{F_X(t)}{1 - R_X(t)}$$

This is the equation used in the computer program which constructs the assembly hazard functions.

APPENDIX VIII
DATA REDUCTION

INTRODUCTION

The purpose of this section is to explain why historical transmission failure data has been collected and how it can be used, and to present the tables which comprise the reduced data.

SUMMARY

The development of hazard functions from field or test data facilitates the transmission failure mode analyses intrinsic to the determination of on-condition potential. In the case of existing hardware, the decision of whether or not to go on-condition is less difficult due to the existence of failure data and becomes increasingly simpler as the amount of reliability data on that gearbox increases.

Unfortunately, one rarely has at his disposal occurrence rates and hazard functions for transmission failure modes during the design stage. The designer must then rely on the past performance of similar components, or use generic failure rates (for example, bearing failure rates). For this reason failure data was analyzed on the following transmissions:

1. CH-47 forward, part no. 114D1200
2. CH-47 aft, part no. 114D2200
3. CH-47 combining, part no. 114D5200
4. CH-47 engine, part no. 114D6200
5. CH-46 forward, part no. A07D1202
6. CH-46 aft, part no. A02D2013
7. CH-46 mix box, part no. 107D2004
8. H-3 main, part no. S6135-20600
9. UH-1 main, part no. 204-040-009

The analysis of this data consists of generic failure mode distributions, failure mode distributions unique to certain aircraft and certain transmissions, and the limits on the β parameter of the hazard function for CH-47C transmission

failure modes. This section provides the maximum representation of available data to serve as a basis for failure mode analyses on new designs.

APPLICATION OF THE DATA

The primary function of the data presented here is to provide a basis for construction of an assembly hazard function when historical data from the assembly in question does not exist.

There are two situations in which one can construct a hazard function using the techniques associated with the Weibull distribution:

1. The case of an operational transmission with a field experience record.
2. The case of a transmission without operational data, but similar to another transmission which the contractor has developed for which there is data.

Two other situations which must be handled differently and which use the data in this appendix are:

1. The case of a transmission being designed, which has no data base existing, but which is similar to one of the nine transmissions whose data is presented here.
2. The case of a transmission being designed, which has no base existing, is not similar to any of the nine transmissions whose data is presented here, but is composed of parts for which generic failure data is present in this appendix.

Hazard functions for these two cases should be constructed following this procedure:

1. Determine the percentage of failures traditionally caused by the mode being considered. To illustrate the procedure, the pitting and spalling of bearings is used as an example. This has historically caused 15.55 percent of transmission failures.
2. Convert this percentage to a failure rate, based on the total transmission assembly requirement. In our example, if the assembly requirement were for a 1,500-hour MTBF, then the failure rate for bearings would be $\frac{1,500}{0.1555}$ or 1 failure per 9,646 hours.

3. Multiply this figure by the number of bearings in the transmission design. If there were 10, then the failure rate would be 1 failure per 96,460 hours.
4. Determine the β parameter expected for bearings. In this case, a β of 1.2 is expected.
5. Calculate the θ parameter, based on β and MTBF. You now have the hazard function for pitting/spalling bearings, for the transmission being designed.
6. Repeat steps 1 through 5 for the rest of the expected failure modes in the transmission design, developing hazard functions for all modes.
7. Calculate a total assembly hazard function from the modal hazard functions.

At this point other analyses are done to determine the cost-effectiveness or establish the optimum TBO of the newly designed transmission. The above procedure shows how to use the data presented in this section. Having calculated the hazard functions, one then decides if β is unacceptably high and/or θ is unacceptably low, leaving the options of redesign, testing, or installing appropriate diagnostic systems.

HELICOPTER TRANSMISSION FAILURE DATA

The failure data presented here was compiled from four sources: the CH-46 and CH-47 data consists of transmission overhaul reports; the CH-3 data was derived from report SER 50547, STUDY OF HELICOPTER TRANSMISSION SYSTEMS DEVELOPMENT TESTING, Final Report, dated 5 June 1968; the UH-1 data was reduced from USAAVLABS Technical Report 70-66, MODE OF FAILURE INVESTIGATIONS OF HELICOPTER TRANSMISSIONS, dated January 1971. The compilation consists of six tables:

Table XXXVIII - This is based on data from all nine transmissions and presents percentages of failures occurring by modes. It is a summary of Table XXXIX.

Table XXXIX - This table shows the failure mode distribution of transmissions by aircraft type. The CH-47 modes have been grouped to be compatible with the others to facilitate comparison. For this reason, the categories high time, manufacturing errors, and other not included.

Table XL - Table XL consists of the CH-47 failure mode distribution by type of transmission. This data is summarized on Table XXXIX.

Table XLI - This table comprises the number of failures and the percentage by component class for each transmission in the CH-47.

Table XLII - This is composed of the CH-46 failure mode distribution by type of transmission. The table is summarized in Table XXXIX.

Table XLIII - This table presents the β parameters by failure mode by component class for the CH-47C transmissions. The minimum β represents the lowest calculated, the maximum β is the highest calculated, and the expected β shows the average of all calculated.

It should be noted that the percentages identified in Tables XXXVIII through XLII do not represent the percentage or rate at which these modes generate unscheduled removal. Rather, they are representative of the manner in which failures are distributed over various modes, some or all of which compete to cause an unscheduled removal. Thus, in using this data, it is necessary that the failure-warning and inspection system unique to a given design be evaluated to determine which (if any) modes would be virtually or partially undetectable. The existence of undetectable failures would necessitate modification of the percentages shown in Tables XXXVIII through XLII to modify the percentages into cause-of-removal rates.

TABLE XXXVIII. GENERIC FAILURE MODE DISTRIBUTION

	Pitted/Spalled	Debris/Corrosion	Flaking	Tracking	Fracture	Cavitation	Seized	Prettling	Wear	Spline Wear	Broken	Chipped	Interference	Scuffing	Cracked	Leaking	Bent	Total
Bearings	15.55	21.50	1.52	0.92	0.48	0.17	0.176	1.86	1.92	0	0.42	0.10	0	0.53	0.01	0	0.72	45.876
Gears	4.39	5.72	0.005	0.18	5.54	0	0	0.44	3.07	0.48	0.25	0.66	0.17	2.17	0.25	0	0.01	23.335
Lube System	0.01	0.11	0.005	0.05	0	0	0.11	0.01	0.30	0	1.23	0.48	0	0.08	0.14	0.52	0.20	3.245
Retention and Mounting Hardware	0.59	0.5°	0.028	0.32	0.16	0	0.002	0.20	6.00	0	2.93	1.53	0	0.39	0.87	0	1.71	15.310
Nonrotating Structure	0.15	1.81	0.002	0.09	0	0	0	0.002	1.60	0	0.335	0.19	0	0.02	0.81	0	0.03	5.039
Shafts	0.107	0.49	0.54	0.028	0.17	0	0	0.348	1.10	0.17	0.005	0.10	0	0.068	0.77	0	0.03	3.926
Clutches	0.003	0.33	0	0.002	0	0	0.002	0	1.50	0.48	0.79	0	0	0.002	0.15	0	0.01	3.269
Totals	20.80	30.54	2.10	1.59	6.35	0.17	0.29	2.86	15.49	1.13	5.96	3.06	0.17	3.26	3.00	0.52	2.71	100.00

NOTE: All values are expressed in percent.

TABLE XXIX. FAILURE MODE DISTRIBUTION BY COMPONENT CLASS*

	Fitted/Spalled	Debris/Corrosion	Flaking	Tracking	Fracture	Cavitation	St. red	Fretting	Wear	Spline Wear	Broken	Chipped	Interference	Scuffing	Cracked	Leaking	Bent
Bearings	35.87 8.30	6.30 4.38	38.61 31.20	5.13 5.46	1.71 0.26	0.588 0	0.588 0	3.357 2.65	0.588 1.40	0	0	0	0	0	0	0	0
Gears	3.4 1.60	9.02 1.53	9.17 10.00	0 1.13	0 0.02	0 0	0 0	0 1.56	2.413 7.10	1.71 1.72	0.588 0	1.71 0	0.314 0	5.98 0	0.524 0	0	0
Lube System	0 0.0	0 0.37	0 0.10	0 0.28	0 0.02	0 0	0 0.35	0 0.03	0 0.00	0 1.37	0 0	0 1.50	0 0.21	0 0	0 0.28	0 0.51	0 0.14
Retention and Mounting Hardware	0 0.0	0 2.10	0 0.50	0 1.54	0 0.09	0 0	0 0.01	0 0.70	0.588 5.00	1.573 14.68	0 0	0 4.60	0 0.83	0 0	0 1.38	0 3.06	0 4.70
Nonrotating Structure	0 0.53	0 0.90	5.14 0.39	0 0.01	0 0.31	0 0	0 0	0 0.01	0 4.90	0 1.05	0 0	0 0.60	0 0.08	0 0	0 0.07	0 0.11	0 0.1
Shafts	0 0.28	0.105 1.00	0.439 0.33	0 1.90	0 0.10	0 0	0 0	0.588 0.30	0 2.50	0 1.55	0 0	0 0.30	0 0.07	0 0	0 0.24	0 0.15	0 0.1
Clutches	0 0.01	0 0.10	1.04 0.05	0 0	0 0.01	0 0	0 0.01	0 0	1.71 1.0	0.734 1.94	0 0	0 0.419	0 0	0 0	0 0.01	0 0.02	0 0.02

H-3 H-1
H-46 H-47

LEGEND

* CH-47 modes grouped to conform to other gearboxes; high-time, manufacturing error, and other not included.

NOTE: All values are expressed in percent.

TABLE XL. CH-47 FAILURE MODE DISTRIBUTION BY COMPONENT CLASS

	Spalled	Brinelled	Corroded	Dented	Elongated	Fretted	Coated	Bent	Cracked	Chipped	Distorted	Dis-colored	Mutlated							
Bearings	1.03 2.65	0.99 0.17	0.11 6.53	4.50 3.26	1.54 3.34	0.75 3.06	0.88 2.03	- -	0.27 0.20	0.77 0.30	1.35 0.40	1.21 0.42	0.51 -	0.11 -	0.43 0.20	0.44 0.12	- -	0.11 0.02	0.11 0.03	
Gears	0.03 0.02	- 0.48	- 0.03	0.19 0.66	0.55 1.21	0.83 0.26	0.33 0.27	- 0.05	2.31 2.34	1.10 1.79	0.47 0.11	0.63 0.63	0.02 -	- -	0.77 0.48	0.03 0.02	0.09 -	0.51 -	- 0.06	
Lube System	- -	- -	- -	0.11 0.34	0.22 0.15	0.03 0.05	0.44 -	- -	0.07 -	0.11 0.03	0.31 0.11	0.33 0.03	0.07 0.17	0.33 0.12	0.19 0.17	0.99 0.97	0.11 0.05	0.27 0.28	0.11 0.18	1.32 0.33
Retention and Mounting Hardware	- 0.20	0.66 0.03	0.91 1.58	1.43 0.63	0.11 0.46	2.31 0.12	0.03 0.14	1.43 0.06	0.15 1.06	0.88 0.42	0.63 1.44	2.20 0.69	1.65 0.24	3.63 3.19	2.47 3.23	3.63 3.19	0.07 0.46	0.27 0.27	1.87 0.11	1.32 0.85
Nonrotating Structure	- -	- -	0.23 0.17	- 0.79	0.03 0.07	0.11 -	- -	- -	0.03 -	- -	0.31 0.02	0.11 0.18	0.11 -	0.03 0.03	- 0.02	0.07 0.33	- -	- -	- -	0.02 0.02
Shafts	0.07 -	- -	0.35 0.26	1.32 0.03	- 0.02	0.11 0.03	- 0.03	- -	0.07 0.88	0.15 0.11	0.19 0.18	0.11 0.03	- -	- -	0.19 0.11	0.11 0.18	- -	- -	- -	- -
Clutches	- -	- -	0.11 -	- -	- -	- -	- -	- -	0.03 -	0.03 -	0.07 -	0.07 -	0.03 -	0.03 -	0.03 -	0.06 -	- -	- -	- -	- -

NOTE: All values are expressed in percent. LEGEND

E	C
F	A

E = Engine transmission
 C = Combining transmission
 F = Forward transmission
 A = Aft transmission

TABLE XL - Continued

	Nicked	Part Missing	Pulled	Stripped	Worn	Scored	Torn	Frosted	Seized	Scuffed	Impressions	Smeared	Sheared
Bearings	0.31 0.55	0.03 0.11	-	-	1.91 0.77	1.55 0.44	-	-	-	0.11	-	0.35 0.22	-
	0.49 0.12	0.26 0.21	-	-	7.16 4.47	1.41 1.45	-	0.75 0.09	0.08 0.06	0.23 0.51	0.30	0.31 0.15	0.03
Gears	0.07 0.11	-	-	-	0.23	0.19 0.22	0.03	0.19 0.33	-	0.79 1.76	0.35	-	-
	0.17 0.57	-	0.03	0.03	1.87 2.95	0.05 0.66	0.06	0.15	-	0.02 1.27	0.02 0.09	0.06	-
Lube System	0.39 0.44	0.23 2.20	-	0.55	1.03 2.97	0.15 1.21	0.03 0.44	-	0.03 1.10	0.15 0.22	-	0.11 0.03	-
	0.08 0.03	0.40 0.39	-	0.02 0.03	1.96 0.36	0.17 0.09	0.05	-	0.17 0.69	-	-	0.02	0.03
Retention and Mounting Hardware	0.43 0.99	0.23 0.99	-	0.33	9.21 9.35	0.71 0.77	0.99	-	-	0.27 0.22	-	0.11 0.07 0.33	-
	0.83 0.27	0.11 0.15	0.08	0.43 0.06	14.79 16.60	1.76 1.27	0.63 0.18	0.05	0.02	0.11	0.05 0.36	0.02 0.03	-
Nonrotating Structure	0.11	-	-	-	0.63 0.88	-	-	-	-	-	0.51	-	-
	0.05 0.09	0.05 0.09	0.03	0.02 0.15	0.98 0.79	0.24	-	-	-	-	0.09	0.02	-
Shafts	0.03 0.11	-	-	-	4.03 1.87	0.47	0.03	0.07	-	0.11 0.33	-	7.74	0.03
	0.05 0.12	-	-	-	0.31 0.48	0.02 0.18	-	-	-	-	-	-	-
Clutches	-	0.19	-	-	7.14	0.07	0.03	-	-	0.03	-	-	-
	-	-	-	-	-	0.57	-	-	-	-	-	-	-

NOTE: All values are expressed in percent. LEGEND E = Engine transmission, C = Combining transmission, F = Forward transmission, A = Aft transmission

TABLE XL - Continued

	Pickup	Broken	Separated	Rough	Fitted	Wear-Step	Scratched	Frayed	Grooved	Loose	Mfg Error	Other							
Bearings	0.03	1.21	0.03	0.11	0.19	0.33	1.87	0.66	-	-	0.07	0.22	0.59	0.66					
	0.17	0.21	0.31	0.03	1.35	0.88	4.16	1.73	0.03	1.84	0.36	0.02	1.38	2.03					
Gears	-	-	0.03	-	0.39	1.21	-	0.03	0.11	-	-	-	0.71	-					
	0.02	-	0.02	0.06	0.02	-	1.84	1.64	0.21	0.14	0.24	-	0.02	0.03	0.02	0.24			
Lube System	-	0.19	1.43	-	0.11	-	0.77	0.15	0.22	-	-	0.44	-	0.35	6.05				
	0.31	-	0.76	-	0.03	0.80	0.06	0.02	-	-	0.02	0.03	-	0.03	2.16	1.70			
Retention and Mounting Hardware	-	3.03	3.08	9.26	1.32	-	0.55	2.75	0.75	0.55	-	0.22	-	0.07	0.33	1.55	0.33	2.29	8.25
	0.02	-	1.01	0.72	0.63	1.06	-	3.72	1.18	1.82	0.21	0.23	-	0.17	0.03	0.05	0.24	0.52	3.34
Nonrotating Structure	-	0.27	-	-	0.11	0.22	1.63	0.33	-	-	-	1.22	-	-	-	-	-	0.03	-
	-	0.05	0.03	-	0.28	1.18	-	-	-	-	-	-	-	-	-	-	-	-	-
Shafts	0.03	-	-	-	0.23	0.99	0.47	0.11	-	-	0.33	-	0.11	0.03	-	0.03	0.11	-	-
	-	-	-	-	0.28	0.09	-	0.03	0.05	-	-	-	-	-	-	-	-	0.02	-
Clutches	-	1.39	-	-	0.03	-	-	-	-	-	-	-	-	-	-	-	-	0.03	-
	-	-	0.69	-	-	0.03	-	-	-	-	0.03	-	-	-	0.03	-	-	-	-

NOTE. All values are expressed in percent.

LEGEND

E = Engine transmission
 C = Combining transmission
 F = Forward transmission
 A = Aft transmission

TABLE XLI. CH-47 FAILURE DISTRIBUTION BY COMPONENT CLASS AND TRANSMISSION TYPE

	Engine Transmission		Combining Transmission		Forward Transmission		Aft Transmission		Totals	
	Qty	Pct	Qty	Pct	Qty	Pct	Qty	Pct	Qty	Pct
Bearings	422	16.83	123	13.53	1,504	43.46	1,309	39.81	3,358	33.03
Gears	143	5.70	59	6.49	280	8.09	446	13.56	928	9.13
Lube System	147	5.86	208	22.88	276	7.97	202	6.14	833	8.19
Retention and Mounting Hardware	1,127	44.97	444	48.84	1,294	37.39	1,072	32.57	3,937	38.73
Nonrotating Structure	77	3.07	18	1.98	62	1.79	133	4.04	290	2.85
Shafts	358	14.28	59	6.49	44	1.27	66	2.00	527	5.18
Clutches	232	9.25	-	-	-	-	59	1.79	291	2.86
	2,506	99.26	911	100.21	3,460	99.97	3,287	99.91	10,164	99.97

TABLE XLII. CH-46 FAILURE MODE DISTRIBUTION BY COMPONENT CLASS

	Spalled/Chipped			Worn			Corroded			Broken			Bent		
	Fwd	Aft	Mix	Fwd	Aft	Mix	Fwd	Aft	Mix	Fwd	Aft	Mix	Fwd	Aft	Mix
Bearings	9.2	8.0	7.8	0.0	3.8	1.6	52.6	31.3	9.6	0.0	1.1	2.9	1.3	3.8	1.6
Gears	0.0	0.8	4.2	1.3	11.1	8.8	3.9	12.2	13.9	0.0	0.4	0.0	0.0	0.0	0.0
Lube System	0.0	0.8	3.7	0.0	0.0	0.0	0.0	0.4	0.0	0.0	7.9	0.4	0.8	0.0	0.8
Retention and Mounting Hardware	5.3	0.8	7.6	0.0	7.2	7.7	0.0	0.4	1.2	2.6	0.0	3.7	2.6	3.8	7.8
Nonrotating Structure	0.0	1.5	0.4	9.2	0.0	5.5	0.0	1.5	1.2	1.3	1.1	0.8	0.0	0.0	0.4
Shafts	0.0	0.4	0.4	0.0	7.6	0.0	2.6	0.4	0.0	0.0	0.0	0.0	0.0	0.4	0.0
Clutches	0.0	0.0	0.0	0.0	0.0	3.1	0.0	0.0	0.2	0.0	0.0	5.5	0.0	0.0	0.0

NOTE: All values are expressed in percent.

TABLE XLIII. LIMITS ON β FOR VARIOUS FAILURE MODES
ON CH-47C TRANSMISSIONS

Component Class	Failure Mode	Minimum		Expected		Maximum	
		Samp	Mod	Samp	Mod	Samp	Mod
Bearings	All modes	0.6	0.3	0.8	0.5	1.0	0.7
	Spalled, pitted	0.9	0.6	1.2	0.9	1.5	1.3
	Scuffed, scored, frosted	0.6	0.4	1.0	0.7	1.2	0.9
	Fretted, worn	0.4	0.2	0.7	0.4	2.6	2.6
	Gouged, dented	0.4	0.2	0.9	0.6	1.5	1.2
Gears	All modes	0.8	0.6	0.9	0.7	1.3	1.0
	Spalled, pitted	0.8	0.5	1.4	1.1	2.2	2.0
	Cracked	0.4	0.2	1.0	0.7	2.0	1.8
	Scuffed, scored, frosted	0.7	0.4	1.1	0.8	1.6	1.2
	Fretted, worn	0.8	0.4	1.2	1.0	2.1	1.9
	Gouged, dented	0.7	0.4	0.9	0.6	2.0	1.8
Lube System	All modes	0.9	0.6	1.1	0.8	1.2	1.0
	Worn	0.7	0.4	1.6	1.5	2.7	3.0
	Scuffed, scored, frosted	0.8	0.5	1.2	0.9	1.5	1.2
	Gouged, dented	0.7	0.4	0.8	0.5	1.0	0.6
	Cracked, broken	1.0	0.6	1.1	0.8	1.3	1.0
Retention and Mounting Hardware	All modes	0.6	0.4	1.1	0.7	1.2	0.9
	Cracked, broken	0.5	0.3	0.9	0.6	1.2	0.9
	Pitted, spalled	0.8	0.5	1.0	0.7	1.6	1.3
	Worn	1.0	0.7	1.1	0.9	1.5	1.3
	Gouged, dented	0.7	0.4	0.8	0.5	0.9	0.6
	Scuffed, scored, frosted	0.6	0.3	0.9	0.7	1.3	1.0
Nonrotating Structure	All modes	0.8	0.5	0.9	0.6	1.8	1.5
	Pitted, spalled	1.0	0.7	1.8	1.6	2.2	2.0
	Worn	0.7	0.4	1.0	0.8	1.6	1.3
	Gouged, dented	0.4	0.2	0.5	0.3	0.6	0.3
	Cracked	0.8	0.4	1.0	0.7	1.8	1.4
	Scuffed, scored	0.8	0.4	0.8	0.4	0.8	0.4
Shafts	All modes	0.5	0.3	0.9	0.6	0.9	0.7
	Scuffed, scored	0.5	0.2	0.9	0.6	0.9	0.6
	Pitted, spalled	0.8	0.4	1.4	1.1	2.4	2.3
	Worn	0.5	0.2	0.9	0.6	1.0	0.7
	Cracked	0.4	0.2	1.0	0.7	1.4	1.1
	Gouged, dented	0.3	0.1	1.0	0.7	1.6	1.2
Clutches*	All modes	0.8	0.5	1.0	0.7	1.0	0.8
	Worn	0.9	0.5	0.9	0.7	0.9	0.7
	Cracked, broken	1.0	0.7	1.0	0.7	1.1	0.8

* Clutch data based on 2 gearboxes

LEGEND

Samp = Sample
Mod = Modified to total fleet value

APPENDIX IX
DEVELOPMENT OF ELEMENTAL HAZARD FUNCTIONS

The purpose of this section is to provide hazard function plots on all CH-47 transmission parts for which sufficient data was available (Figures 72 through 78).

Source of the data was Boeing Vertol overhaul records. The β and θ parameters were calculated by the method of least squares on transformed data; the hazard rate was then calculated for specific points in time using the equation for hazard function. This was done for each transmission, for various transmission parts and modes of failure, and the results were plotted. Summaries by transmission of all failures of certain parts are also presented here.

These plots represent sample hazard functions; that is, they have been calculated based on observed data and should be modified into fleet hazard functions with the equation developed in Appendix V before they are used.

The modification of the β parameter of these sample estimates into fleet estimates is portrayed in Table XLIII of Appendix VIII, which summarizes the limits on β by transmission part for various failure modes.

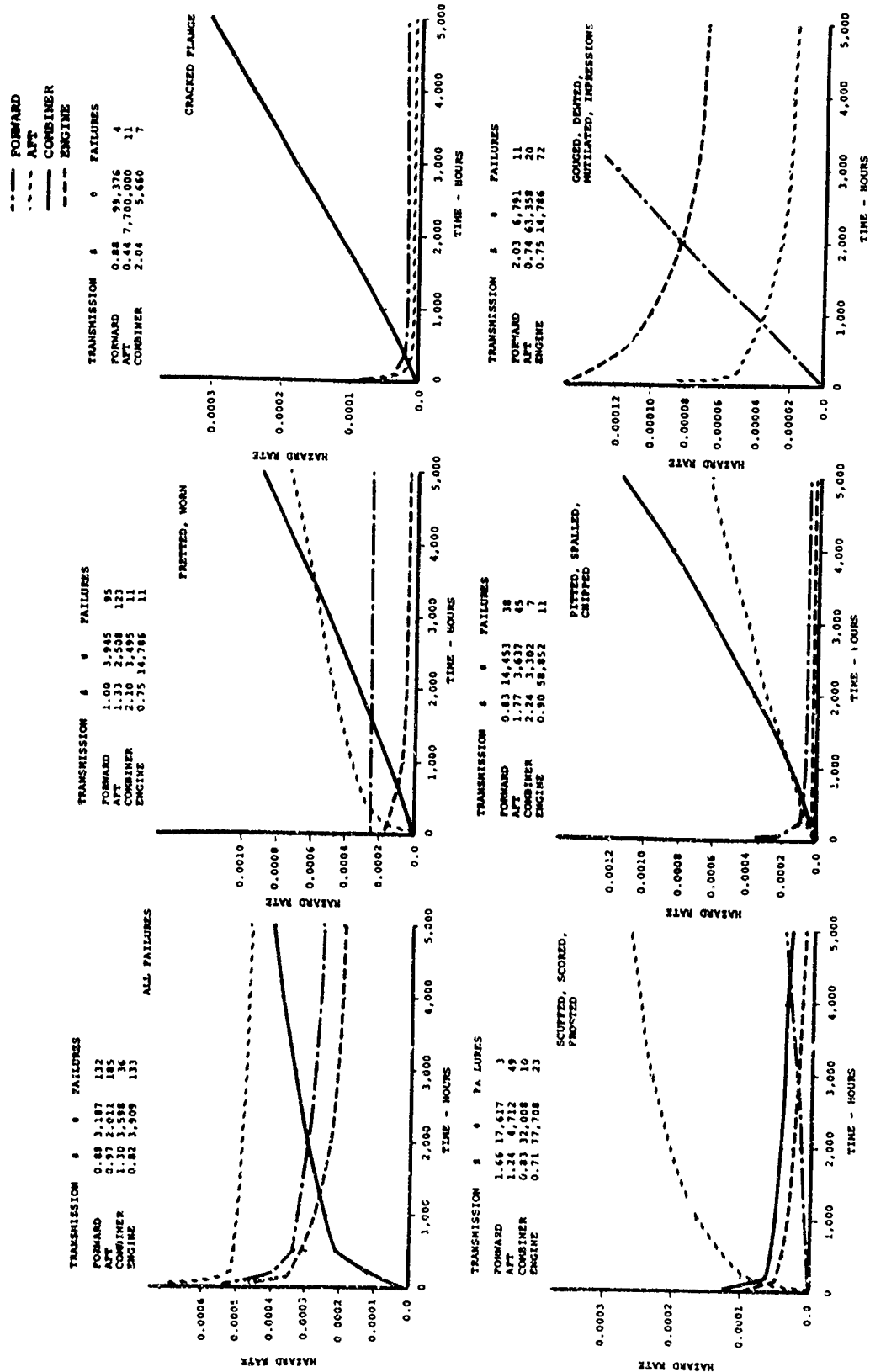

Figure 73. Hazard Function Plots for Transmission Gears.

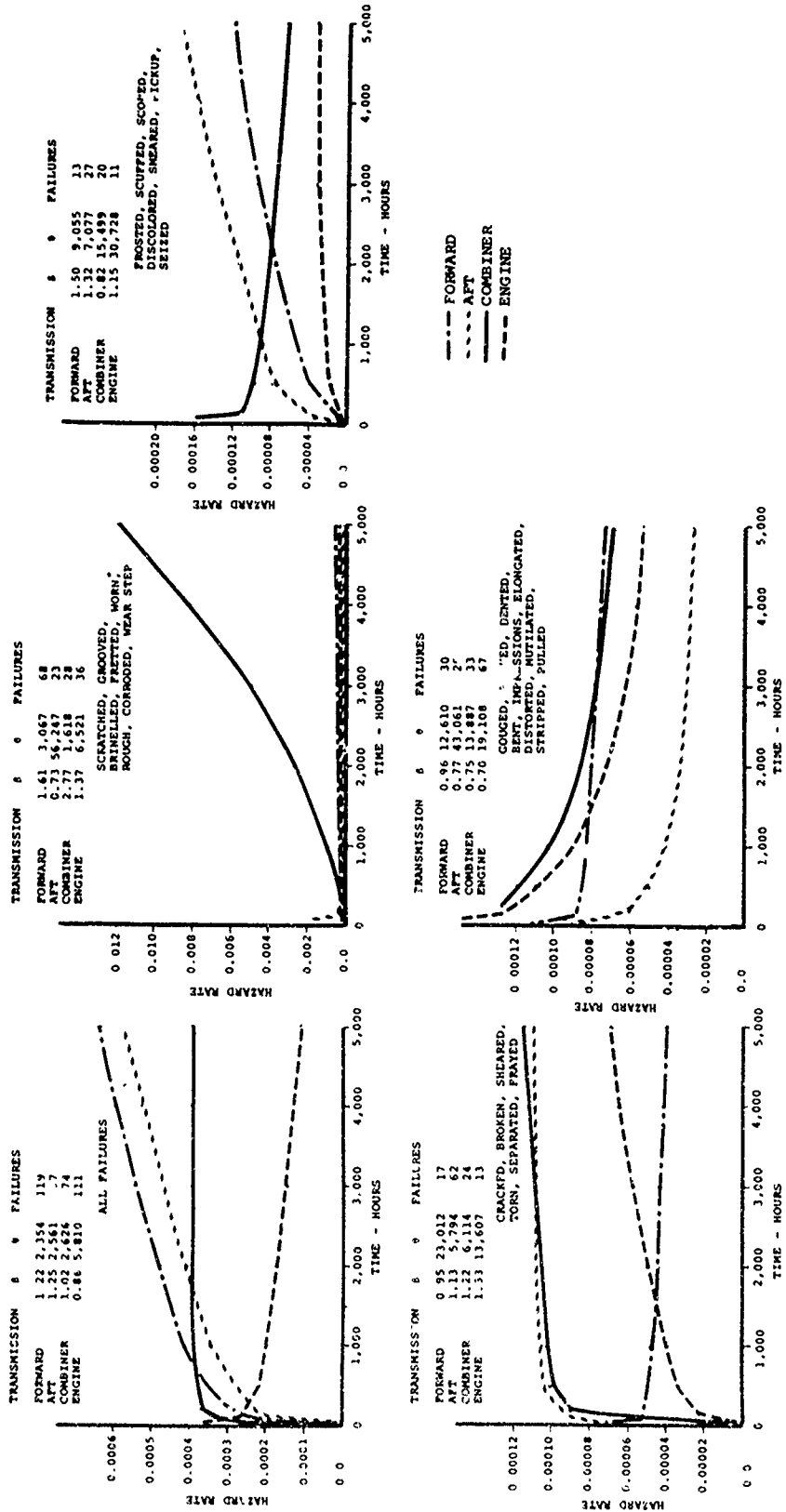

Figure 74. Hazard Function Plots for Transmission Lubrication Systems.

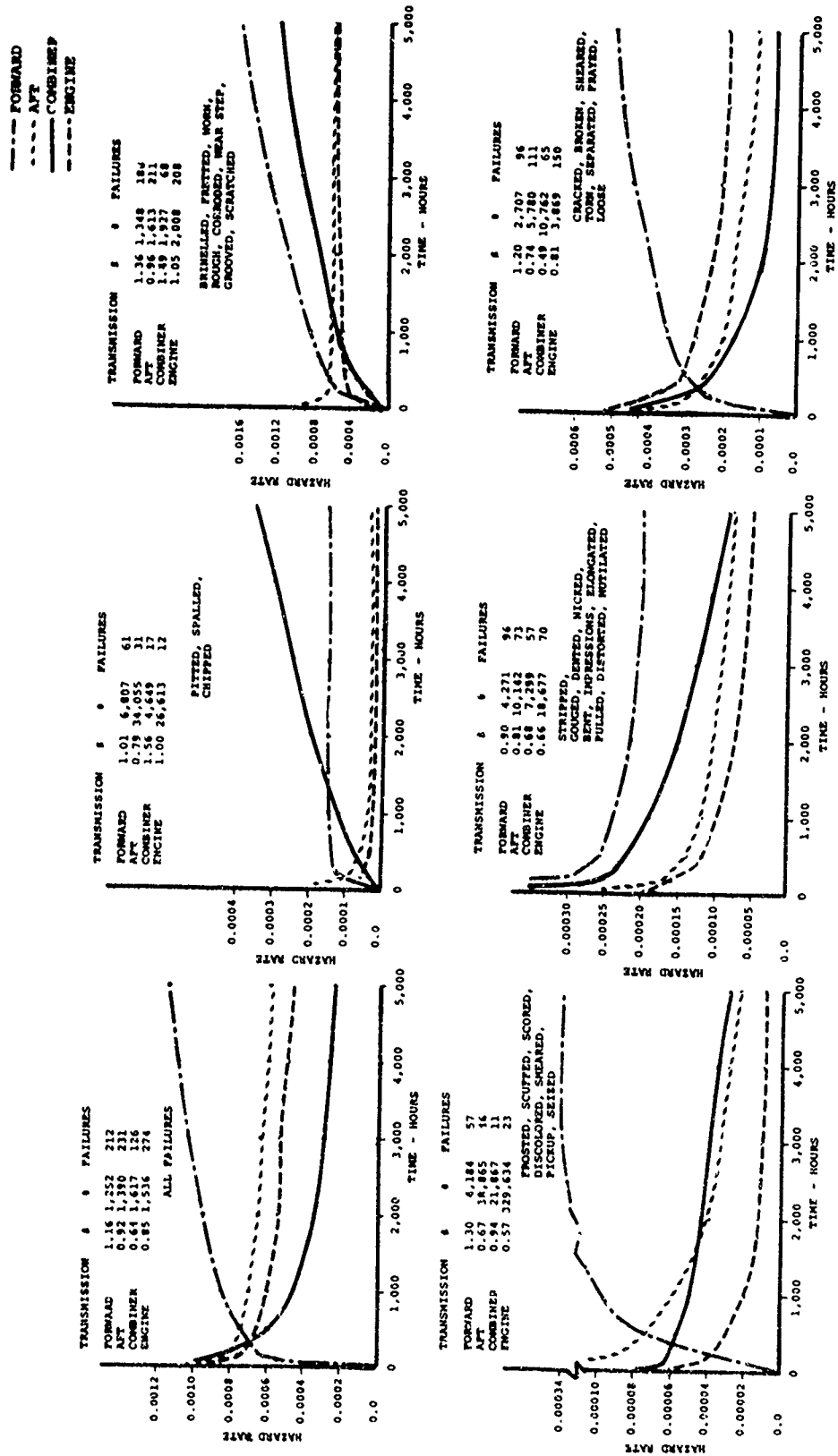

Figure 75. Hazard Function Plots for Transmission Retention and Mounting Hardware.

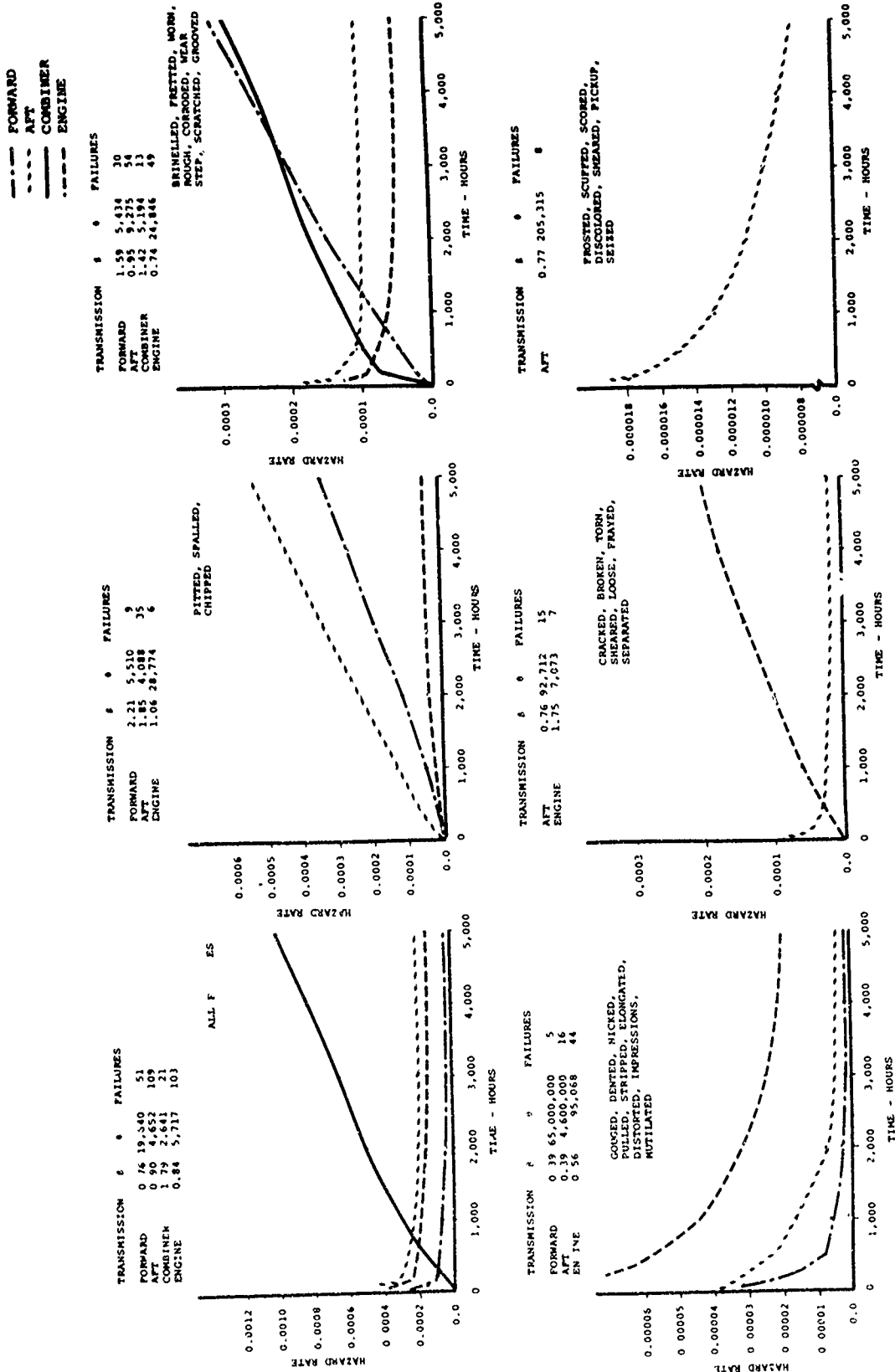

Figure 76. Hazard Function Plots for Transmission Nonrotating Structures.

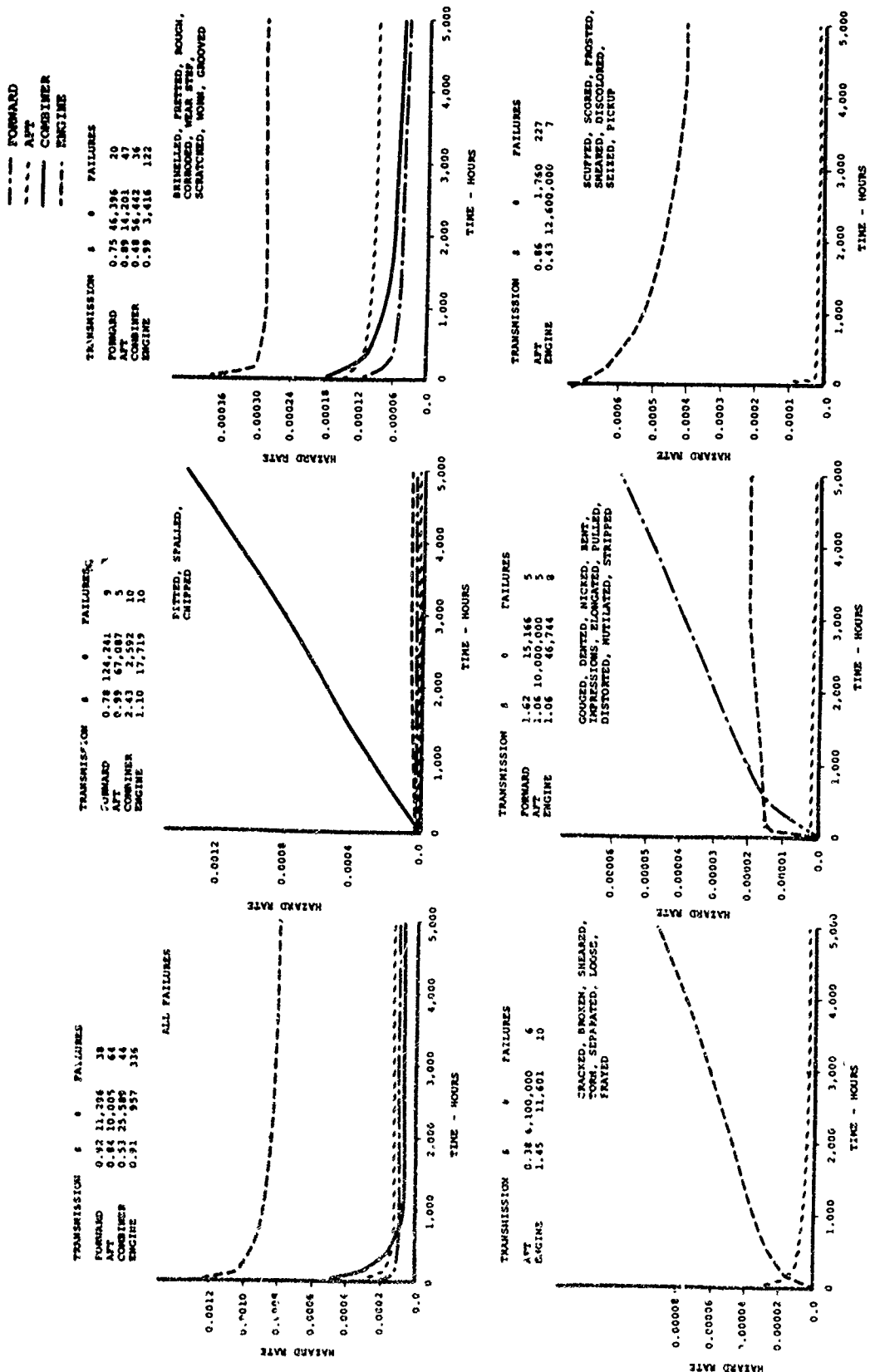

Figure 77. Hazard Function Plots for Transmission Shafting.

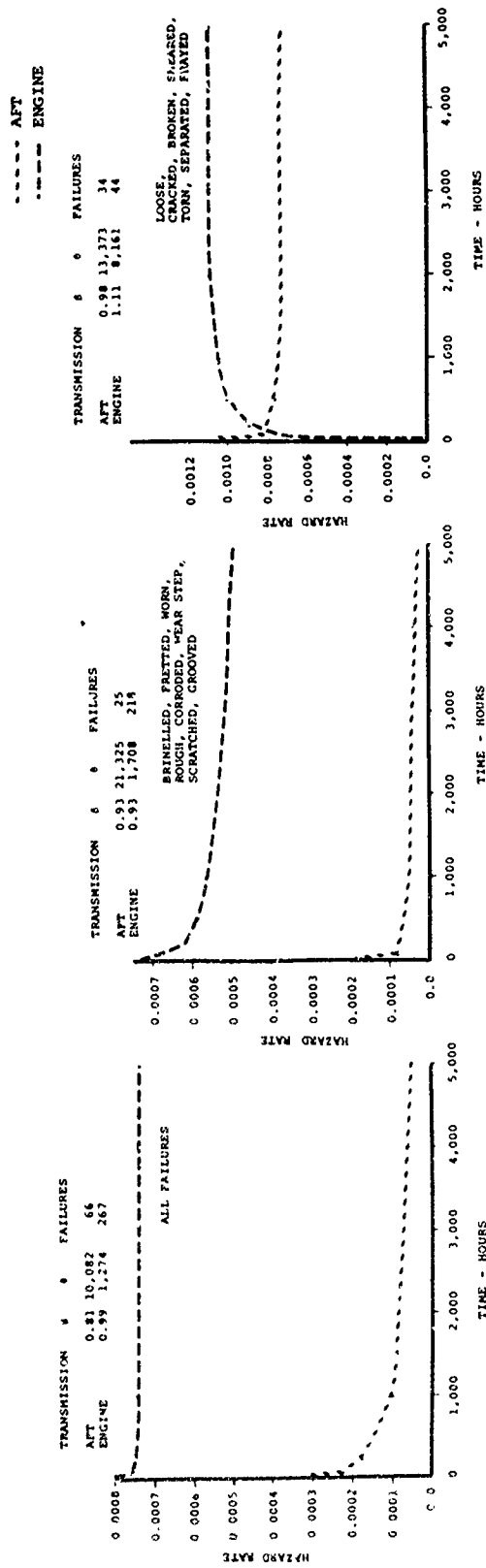

Figure 78. Hazard Function Plots for Transmission Clutches.