

AD-782 911

USER MANUAL FOR THE ACQUISITION AND
EVALUATION OF OPERATIONAL BLAST
NOISE DATA

B. Homans, et al

Army Construction Engineering Research
Laboratory
Champaign, Illinois

June 1974

DISTRIBUTED BY:

NTIS

National Technical Information Service
U. S. DEPARTMENT OF COMMERCE
5285 Port Royal Road, Springfield Va. 22151

DISCLAIMER NOTICE

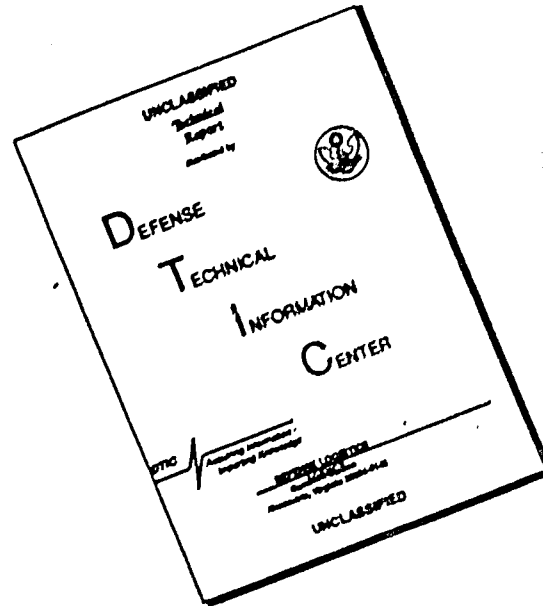

THIS DOCUMENT IS BEST QUALITY AVAILABLE. THE COPY FURNISHED TO DTIC CONTAINED A SIGNIFICANT NUMBER OF PAGES WHICH DO NOT REPRODUCE LEGIBLY.

construction
engineering
research
laboratory

TECHNICAL REPORT E-42

June 1974

Prediction and Reduction of the Noise Impact
Within and Adjacent to Army Facilities

AD 782911

USER MANUAL FOR THE ACQUISITION AND EVALUATION
OF OPERATIONAL BLAST NOISE DATA

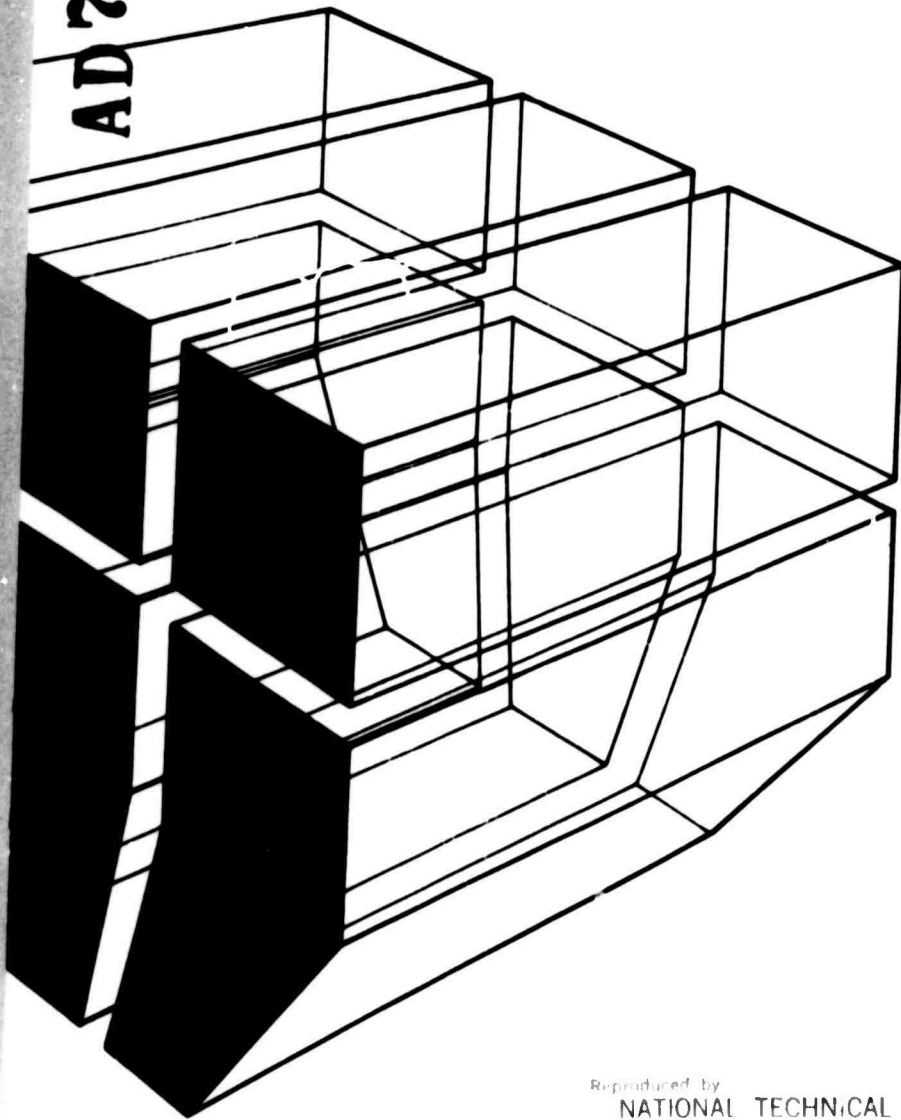

by
B. Homans
J. McBryan
P. Schomer

DDC
RECORDED
JUL 29 1974
RECEIVED
B

UWU
GERL

Reproduced by
NATIONAL TECHNICAL
INFORMATION SERVICE
U. S. Department of Commerce
Springfield VA 22151

Approved for public release; distribution unlimited.

The contents of this report are not to be used for advertising, publication, or promotional purposes. Citation of trade names does not constitute an official indorsement or approval of the use of such commercial products. The findings of this report are not to be construed as an official Department of the Army position, unless so designated by other authorized documents.

ACCESSION for		
NTIS	White Section	<input checked="" type="checkbox"/>
DIC	Buff Section	<input type="checkbox"/>
UNCLASSIFIED		<input type="checkbox"/>
SECTION		
BY		
DISTRIBUTION AVAILABILITY CODE		
Dist.	Avail. and/or	SPECIAL
A		

**DESTROY THIS REPORT WHEN IT IS NO LONGER NEEDED
DO NOT RETURN IT TO THE ORIGINATOR**

UNCLASSIFIED

AD-782911

SECURITY CLASSIFICATION OF THIS PAGE (When Data Entered)

REPORT DOCUMENTATION PAGE		READ INSTRUCTIONS BEFORE COMPLETING FORM
1. REPORT NUMBER CERL-TR-E-42	2. GOVT ACCESSION NO.	3. RECIPIENT'S CATALOG NUMBER
4. TITLE (and Subtitle) USER MANUAL FOR THE ACQUISITION AND EVALUATION OF OPERATIONAL BLAST NOISE DATA		5. TYPE OF REPORT & PERIOD COVERED FINAL REPORT
7. AUTHOR(s) B. Homans J. McBryan P. Schomer		6. CONTRACT OR GRANT NUMBER(s)
9. PERFORMING ORGANIZATION NAME AND ADDRESS CONSTRUCTION ENGINEERING RESEARCH LABORATORY P.O. BOX 4005		10. PROGRAM ELEMENT, PROJECT, TASK AREA & WORK UNIT NUMBERS 4A162121A896-06-001
11. CONTROLLING OFFICE NAME AND ADDRESS		12. REPORT DATE June 1974
14. MONITORING AGENCY NAME & ADDRESS (if different from Controlling Office)		13. NUMBER OF PAGES 140
		15. SECURITY CLASS. (of this report) Unclassified
		16. DECLASSIFICATION/DOWNGRADING SCHEDULE
16. DISTRIBUTION STATEMENT (of this Report) Approved for public release; distribution unlimited.		
17. DISTRIBUTION STATEMENT (of the abstract entered in Block 20, if different from Report)		
18. SUPPLEMENTARY NOTES		
19. KEY WORDS (Continue on reverse side if necessary and identify by block number) blast noise noise contours noise data		
20. ABSTRACT (Continue on reverse side if necessary and identify by block number) This report presents the means for acquiring operational blast noise information and evaluating the resulting contours. Forms introduced and explained to facilitate the compilation of data include the Target Data Sheet, Firing Point Data Sheet, and Attachment Sheet. Overlays to be constructed in order to evaluate the contours consist of generalized land-use and population density map overlays. The means is given to interpret the contours according to currently accepted classification systems.		

Reproduced by
NATIONAL TECHNICAL
INFORMATION SERVICE
U S Department of Commerce
Springfield VA 22151

DD FORM 1473

EDITION OF 1 NOV 65 IS OBSOLETE

UNCLASSIFIED

SECURITY CLASSIFICATION OF THIS PAGE (When Data Entered)

FOREWORD

This research was conducted for the Directorate of Military Construction, Office of the Chief of Engineers, under Project 4A162121A896, "Environmental Quality for Army Construction," Task 06, "Noise Pollution Control," Work Unit 001, "Prediction and Reduction of the Noise Impact Within and Adjacent to Army Facilities." Frank Beck was OCE Technical Monitor.

Dr. L. R. Shaffer is Director of CERL.

CONTENTS

DD FORM 1473	1
FOREWORD	3
LIST OF TABLES AND FIGURES	5
1 BACKGROUND	11
2 PURPOSE	11
3 SCOPE.....	11
4 APPROACH	14
5 DISCUSSION	14
APPENDIX A: Completing Data Sheets	17
APPENDIX B: Interpretation of Data	125
APPENDIX C: Guidelines for Submission of Data	137
DISTRIBUTION	

TABLES

Number	Page
1 Noise Exposure Forecast Ratings for Various Land-Use Descriptors	11
A1 Table of Metric Grid Coordinates	25
A2 Table of Metric Grid Coordinates	33
A3 Weapon Codes	38
A4 Maximum Charge Codes for a Small Charge of TNT	38
A5 Maximum Charge Codes for a Large Charge of TNT	38
A6 Weapon Codes	70
A7 Maximum Charge Code Used for a Small Charge of TNT	70
A8 Maximum Charge Code Used for a Large Charge of TNT	70
A9 Table of Metric Grid Coordinates	72
A10 Weapon Codes	81
A11 Table of Metric Grid Coordinates	81
A12 Maximum Charge Codes for a Small Charge of TNT	82
A13 Maximum Charge Codes for a Large Charge of TNT	82
B1 Classifications Reflecting Predominant Land-Use	125
B2 Noise Exposure Ratings for Various Land-Use Classifications (Three-Category Rating)	127

FIGURES

Number		Page
1	Military Base Generalized Present or Predicted Land-Use Map with NEF Contours	12
2	Military Base Areas with Incompatible Land Use	13
A1	Ft. Leonard Wood Illustrating a Base with Less Than 25 Targets	18
A2	Ft. Sill Illustrating a Base with More Than 25 Targets	19
A3	Target Identification with Few Targets	20
A4	Target Data Sheet Containing Identification Numbers	20
A5	Grouping Targets on a Map	21
A6	Grouping Targets on a Map	22
A7	Target Data Sheet Containing Identification Numbers	23
A8	Coordinates Read from a Map	23
A9	X Coordinate Read from a Map	24
A10	Y Coordinate Read from a Map	24
A11	Target Data Sheet Containing Coordinates	26
A12	Target Data Sheet Containing Coordinates	26
A13	Map Illustrating Target Grouping	27
A14	Target Data Sheet Containing Coordinates	28
A15	Completed Target Data Sheet	28
A16	Firing Point Data Sheet	29
A17	Map Illustrating Demolition Sites	30
A18	Range Safety Card for Firing Point 115	31
A19	Firing Point Data Sheet Containing Coordinates	32
A20	Coordinates Read from a Map	33
A21	Firing Point Data Sheet Containing Coordinates	34

FIGURES (cont'd).

Number		Page
A22	Firing Point Data Sheet Containing Coordinates	35
A23	Range Safety Card for Firing Point 115	36
A24	Firing Point Data Sheet Showing Weapon Type	37
A25	Range Safety Card Indicating Charge Range	39
A26	Firing Point Data Sheet Containing Charge Range for Non-TNT Weapons	40
A27	Firing Point Data Sheet Containing Charge Range for Non-TNT Weapons	41
A28	Firing Point Data Sheet Containing Charge Range for a Small Charge of TNT	42
A29	Firing Point Data Sheet Containing Charge Range for a Large Charge of TNT	43
A30	Range Control Log	44
A31	Range Control Log for Fire Occurring Entirely During the Day	46
A32	Firing Point Data Sheet for Fire Occurring Entirely During the Day	47
A33	Range Control Log for Fire Occurring Entirely During the Night	48
A34	Firing Point Data Sheet for Fire Occurring Entirely During the Night	49
A35	Range Control Log for Fire Overlapping Between Day and Night	50
A36	Firing Point Data Sheet Indicating Overlapping Fire	51
A37	Firing Point Data Sheet Showing the Target Identification Number	53
A38	Range Safety Card Indicating Range and Direction	54
A39	Map with Protractor Overlay	55
A40	Map with Direction Limits	55
A41	Map with Direction Limits and Ranges	56
A42	Map Showing Truncated "Pie Slice"	56
A43	Firing Point Data Sheet with Target Identification Number	57

FIGURES (cont'd.)

Number		Page
A44	Range Safety Card with Direction Limits and Ranges Marked	58
A45	Map with Protractor Overlay	59
A46	Map Illustrating Direction Limits and Ranges	59
A47	Range Control Log Showing Actual Time and Rounds Fired	60
A48	Firing Point Data Sheet with Number of Rounds Entered	62
A49	Firing Point Data Sheet with Weapon and Charge Range Copied	63
A50	Firing Point Data Sheet Showing Division of Target Groups	64
A51	Firing Point Data Sheet with Height Above Ground Entered	65
A52	Completed Firing Point Data Sheet	66
A53	Attachment Sheet	67
A54	Map Illustrating Ungrouped Targets	73
A55	Target Data Sheet Containing Identification Numbers	74
A56	Map Showing Targets Ready for Grouping	75
A57	Map with Targets Grouped	76
A58	Target Data Sheet Containing Identification Numbers	77
A59	Map Explaining Coordinate Reading	77
A60	Target Data Sheet Containing Identification and Coordinates	78
A61	Target Data Sheet Displaying Coordinates	78
A62	Map with Center of Target Groups Indicated	79
A63	Target Data Sheet Showing Coordinates	80
A64	Range Safety Card	83
A65	Range Safety Card	84
A66	Range Safety Card	85
A67	Range Safety Card	86

FIGURES (cont'd.)

Number		Page
A68	Range Control Log	87
A69	Firing Point Data Sheet with Identification Numbers Entered	88
A70	Range Safety Card Showing Coordinates	89
A71	Firing Point Data Sheet Showing Coordinates	90
A72	Map with Coordinates Indicated	91
A73	Firing Point Data Sheet Showing Coordinates	91
A74	Firing Point Data Sheet Showing Coordinates	92
A75	Range Safety Card with Weapons Indicated	93
A76	Range Safety Card with Weapons Indicated	94
A77	Range Safety Card with Weapons Indicated	95
A78	Range Safety Card with Weapons Indicated	96
A79	Firing Point Data Sheet	97
A80	Range Safety Card Showing Charge Range	98
A81	Range Safety Card Showing Charge Range	99
A82	Range Safety Card Showing Charge Range	100
A83	Range Safety Card Showing Charge Range	101
A84	Firing Point Data Sheet Displaying Charge Range	102
A85	Range Safety Card Indicating Firing Entirely During the Day	103
A86	Range Control Log Showing Number of Rounds	104
A87	Firing Point Data Sheet	105
A88	Range Safety Card Indicating Fire During the Night	106
A89	Firing Point Data Sheet Showing Fire Entirely During the Night	107
A90	Range Safety Card Indicating Fire Split During the Day and Night	108
A91	Range Safety Card Indicating Fire Split During the Day and Night	109

FIGURES (cont'd.)

Number		Page
A92	Firing Point Data Sheet Indicating Number of Rounds Per Day and Night	111
A93	Range Safety Card Indicating Direction Limits and Ranges	112
A94	Range Safety Card Indicating Direction Limits and Ranges	113
A95	Range Safety Card Indicating Direction Limits and Ranges	114
A96	Range Safety Card Indicating Direction Limits and Ranges	115
A97	Map with Direction Limits and Ranges Marked	116
A98	Map with Direction Limits and Ranges Drawn	117
A99	Map with Direction Limits and Ranges Drawn	118
A100	Map with Direction Limits and Ranges Drawn	119
A101	Firing Point Data Sheet Showing Target Identification	120
A102	Firing Point Data Sheet with Information Copied	121
A103	Firing Point Data Sheet with Rounds Divided	122
A104	Firing Point Data Sheet with Rounds Divided	123
A105	Attachment Sheet	124
B1	Base and Plan Map With NEF Contours	130
B2	Double Inversion Condition	131
B3	NEF Contour for 50% Inversion Condition	132
B4	NEF Contour for 5% Inversion Condition	133
B5	Day-Only Fire	134
B6	Firing During Non-Inversion Daylight Hours	135
C1	Target Data Sheet Showing Coordinates	139
C2	Firing Point Data Sheet with Rounds Divided	140
C3	Attachment Sheet	141

1 BACKGROUND

Noise as it impacts on man is increasingly recognized as a major source of annoyance. Currently, work is underway internationally to assess the effects of noise on man and to discover the means to eliminate and attenuate noise. For many years, desirable levels of noise in offices and commercial establishments have been known, and recently standards have been established to protect workers in industrial areas. Current studies of the effects of noise clearly show that people repeatedly exposed to high noise levels exhibit increased irritability and discomfort, severe nervous tension, loss of ability to concentrate, impaired aptitude to perform even simple tasks, and loss of sleep.¹

Once built, military facilities flourish and attract people who build homes nearby and later complain about the noise. Experience shows that complaints and legal damage suits relating to noise do exist and that at some bases this results in the reduction of training programs because of the noise they produce.

Prediction methodology, when coupled with land-use maps, identifies present and future areas of incompatible land-use pertaining to noise sensitivity. Given the operations, types of weapons and their charges and locations, and frequency and time of operations, this methodology predicts population reactions in the environs of a base. The percentage of people annoyed, the percentage willing to take group or legal action, and the percentage reduction in property values all as a function of the affluence of the neighborhood can also be predicted. Changes in operations and different weapons and locations are reflected in altered impact predictions for the base environs. The prediction methodology has been computerized to facilitate generation of noise predictions.



The result of prediction methodology is equal noisiness contours. These contours can be drawn to a

¹T. J. Shultz, *Noise Assessment Guidelines Technical Background*, Report No. TE/NA 172 (Department of Housing and Urban Development, 1972), pp 81-87.

distance scale compatible with a map of the base and its surroundings and can be used as an overlay to graphically show the noise impact of base operations.

Figure 1 depicts the boundary of a military base. Also superimposed on this figure are generalized land-use areas (describing zones as related to activities performed with regard to noise sensitivity) and, as listed in Table 1, NEF equal annoyance contours. This overlay process identifies areas of incompatible land use. Figure 2 graphically displays for this example the areas of land which are thus incompatible.

Table 1
Noise Exposure Forecast Ratings for Various
Land-Use Descriptors

NEF		Land-Use Descriptors
Below 30		Class A Zone
30-40		Class B Zone
Above 40		Class C Zone

2 PURPOSE

This report presents the means for base facility engineering personnel to gather necessary operational information in a suitable format so that it can be readily keypunched and a computer prediction made of the noise impact resulting from blast operations. In addition, the typical and generally accepted means for evaluation of noise impact contours, including the explanation of a generalized land-use map, are described.

3 SCOPE

This preliminary report presents information necessary for gathering operational data for the prediction of noise impact of artillery, demolition, and other blast operations and for evaluating the resulting noise impact contours thus produced. Contours

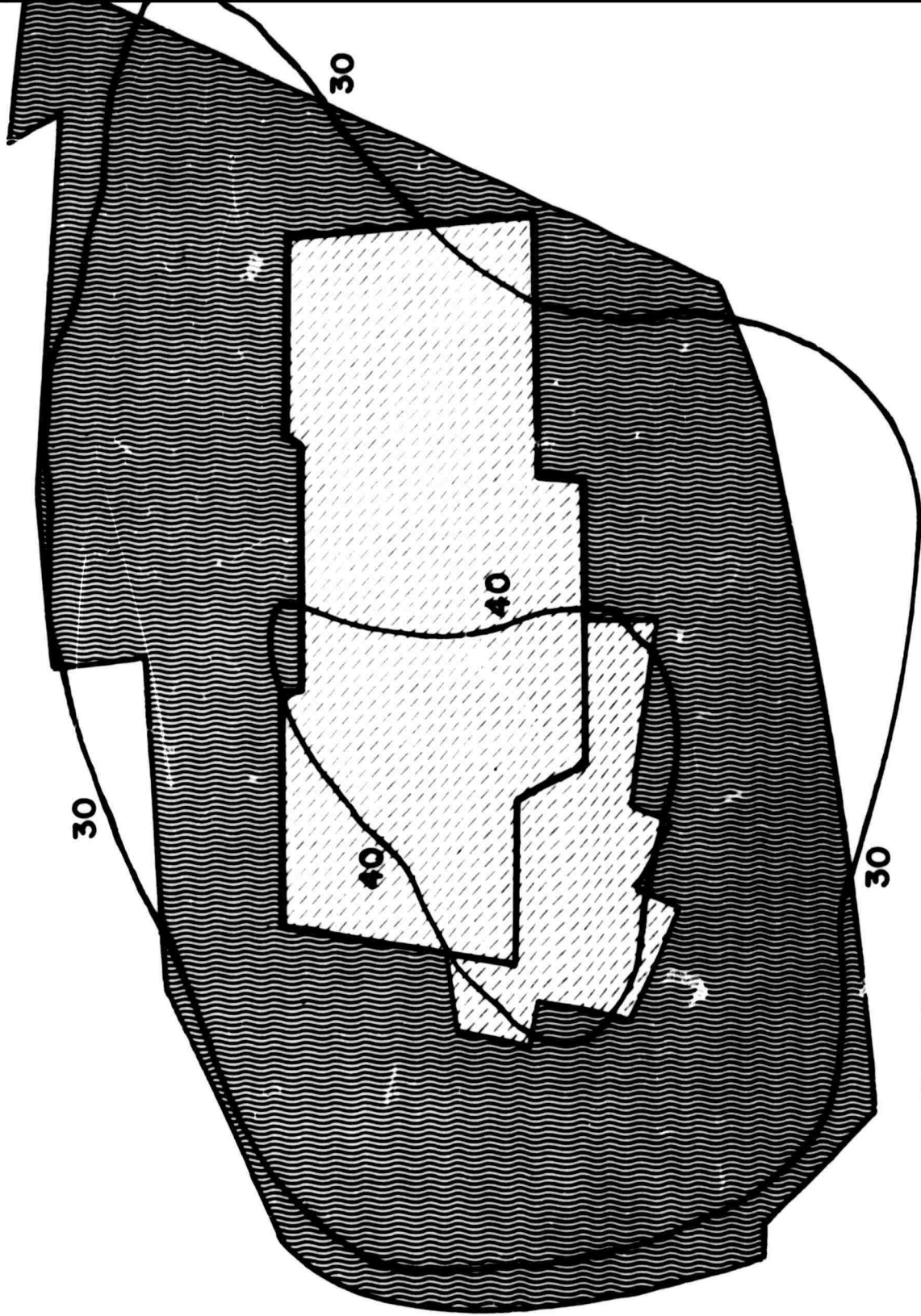

Figure 1. Military base generalized present or predicted land use map with NEF contours.

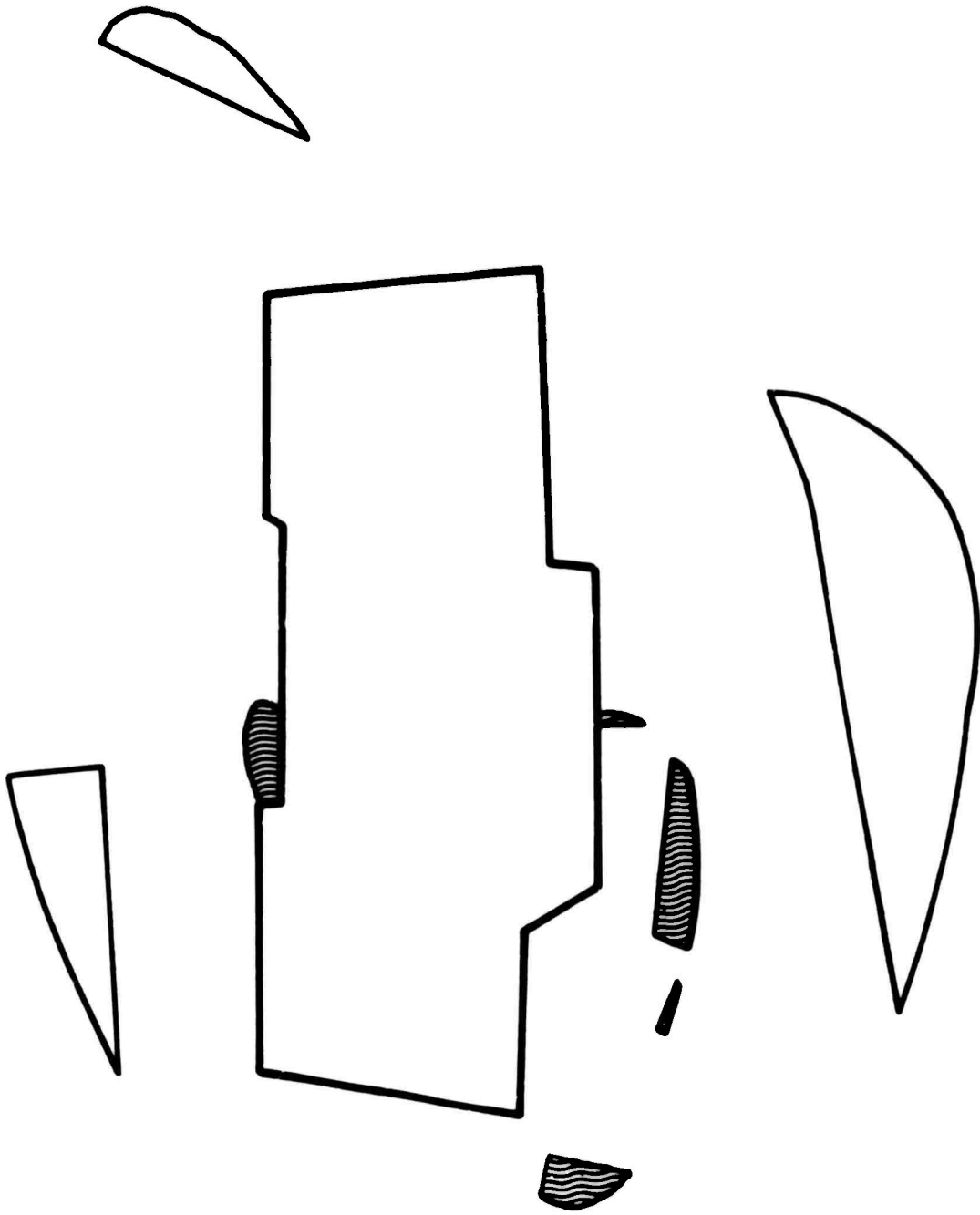

Figure 2. Military base areas with incompatible land use.

will be generated initially at the U.S. Army Construction Engineering Research Laboratory, ATTN: Acoustics Section, Box 4005, Champaign, Illinois 61820.

4 APPROACH

Data is gathered by using existing sources of information such as base commander, base facilities engineer, director of post training, a map of the base, a base publication ("List of Metric Grid Coordinates of Control Points, Reference Points, Station Markers, Firing Points, Dugouts and Targets") or a technical manual ("Artillery Ammunition" TM9-1300-203, Range Safety Cards and Range Control Logs).

Raw data that has been gathered from the above sources must be converted into a form suitable for submission to a computer. The process of completing data sheets is described which puts the raw data into an easily keypunched form. Once the data sheets have been interpreted by computer, equal annoyance contours, the end result of computer calculations, have to be evaluated for the base. Typical and generally accepted means of evaluation are thus presented.

5 DISCUSSION

To predict annoyance levels, a series of calculations must be made by computer. Appendix A presents guidelines for completion of two types of data sheets. One of these is the Target Data Sheet which will be examined first because it is the easier to complete.

The Target Data Sheet requires information concerning the location of targets on the military base. When the total number of targets is less than 25, the identification number for each target is entered on the Target Data Sheet. However, when the number of targets exceeds 25, they are grouped into target areas and assigned a unique number. This grouping of targets greatly reduces the work necessary to fill out a Target Data Sheet, without any loss of accuracy when interpreted.

The Firing Point Data Sheet, though more diffi-

cult to complete, provides more information about firing point locations and their associated targets, weapon types, number of rounds, and type of ammunition. Information on coordinates, weapon types, charge range, and target identification is most easily obtained from the Range Safety Card. Other sources of information include a map of the base and the Table of Metric Grid Coordinates. When completing the number of rounds for day and night, however, the Range Control Log is the source of information easiest to use. Charge range, projectile flag, and height above or depth below ground all require consultation of the weapon type in order to proceed.

The attachment sheet, in Appendix A, supplies information about artillery, ammunition, operation and inversion conditions, the base, and the person filling out the data sheets. Along with the requested information, the base is to forward two maps to the US Army Construction Engineering Research Laboratory, ATTN: Acoustics Section, Box 4005, Champaign, Illinois 61820. The first of the two maps to be forwarded is a Reservation Base and Plan Map. This map shows the entire military facility with some surrounding areas. The second map to be sent will show areas adjacent to the military facility within a 10 to 15 mile radius. It will be determined at the time of contour plotting if noise conditions warrant the generation of a set of contours to the scale of the adjacent area (10-15 mile radius) map. All maps will be returned unharmed with the contour overlays.

The computer contouring program accepts coordinates for firing and target points in meters (preferred) or feet. Degrees, minutes, and seconds could possibly be used on special request. Standard metric coordinates are the best choice. The contours, once generated, can be plotted in either meters or feet and drawn to the scale of the community map. Special items such as "blow-ups" of a portion of the contours are also possible such as in cantonment areas.

Based on firing and target point coordinates, which may be positive and negative, the computer chooses zero coordinate to be the center of the source and prints the coordinates of this source and locates it on the resulting contours.

Annex A1 summarizes instructions for com-

pleting both the Target and Firing Point Data Sheets which are explained in detail in Appendix A. The annex provides concise directions without lengthy explanations or examples. Numerous references, however, are made to the examples in Appendix A. Annex A2 offers several examples which show how to complete both the Target Data Sheet and the Firing Point Data Sheet.

Appendix B includes a detailed description on

interpretation of contours and a section dealing with noise mitigation techniques.

Appendix C presents guidelines for the submission of data.

Telephone and letter questions are expected during the implementation of this preliminary data gathering and analysis operation and should be addressed to CERL.

COMPLETING DATA SHEETS

1 TARGET DATA SHEET

Column 1, End of Target Data Flag. This column will be discussed at the end of this section after all items have been completed on the Target Data Sheet.

Columns 2-5, Target Identification. When the total number of targets is less than 25, the identification number for each target is entered onto the Target Data Sheet. However, when the number of targets exceeds 25, they are grouped into target areas and each target area is assigned a unique number. Figure A1 compares a base with a small number of targets and Figure A2 compares a base with a large number of targets.

Less Than 25 Targets. With this small number, the target identification number is copied directly from a map of the area or from the Table of Metric Grid Coordinates from the zone considered and entered into Columns 2-5. Figure A3 illustrates a map with eight targets and one firing point. Figure A4 shows what the Target Data Sheet should look like when all the target identification numbers are copied from Figure A3 onto the Target Data Sheet.

More Than 25 Targets. With a large number of targets, circles are drawn to group the target points into clusters. This procedure involves drawing a $\frac{1}{2}$, 1, or $1\frac{1}{2}$ kilometer-radius circle around most of the points in a target area that are clustered together. Naturally, a $1\frac{1}{2}$ kilometer circle makes identification easiest, but there is one pitfall.

If a major population center (city, town, or village) or base housing (Bachelor Entisted Quarters, Bachelor Officers Quarters or Family Housing) is near, the radius of a circle must not exceed $\frac{1}{2}$ of the distance between the population area and the center of the circle. More circles of a smaller radius are to be drawn instead of just one, $1\frac{1}{2}$ kilometer circle. A number less than 100 is arbitrarily assigned to each group. This identification number must be unique since it will be used later to identify a particular group.

Figure A5 illustrates the grouping of target points when they are close to a housing section. Note that two circles, each of 1 kilometer radius, are drawn. In Figure A6 the lower grouping of targets is near the housing area so several circles are drawn. The upper circle in Figure A6 was totally removed from any population center and was drawn to the largest size possible.

In Figure A7 the identification column for the Target Data Sheet has been completed for Figures A5 and A6. Great care must be exercised to make certain that only one target corresponds to a given target identification number.

Columns 7-12, X Coordinate.

Columns 13-18, Y Coordinate.

Targets Not Grouped. This information is obtained either from a map or from the Table of Metric Grid Coordinates. Enter the X coordinate in columns 7-12 and the Y coordinate in columns 13-18.

1. The map is easiest to use if one is familiar with the area. Coordinates are given to the nearest 100 meters.

Example: Consult Figure A8 to read the X and Y coordinates of target point 747. It can be seen that the X coordinate of 747 is between 25 and 26. Twenty-five and 26 are the large numbers running from left to right found at the bottom and in the body of the map. Notice from the circled X and Y coordinates at the lower left-hand corner of the example that the large numbers are in units of 1000 meters.

From estimation or by using a plastic grid overlay calibrated to the map scale, read a digit for the 100's place as in Figure A9. This digit is 5 since point 747 is $\frac{5}{10}$ of the way across the grid. In this case the X coordinate entered in the Target Data Sheet is 25500.

The Y coordinate is read similarly. Notice that the point 747 is between the Y coordinates of 35 and 36. By estimation or measurement the next digit is 9 since the point is $\frac{9}{10}$ of the way up the grid as shown in Figure A10. The Y coordinate entered in the Target Data Sheet is 35900. The Target Data Sheet

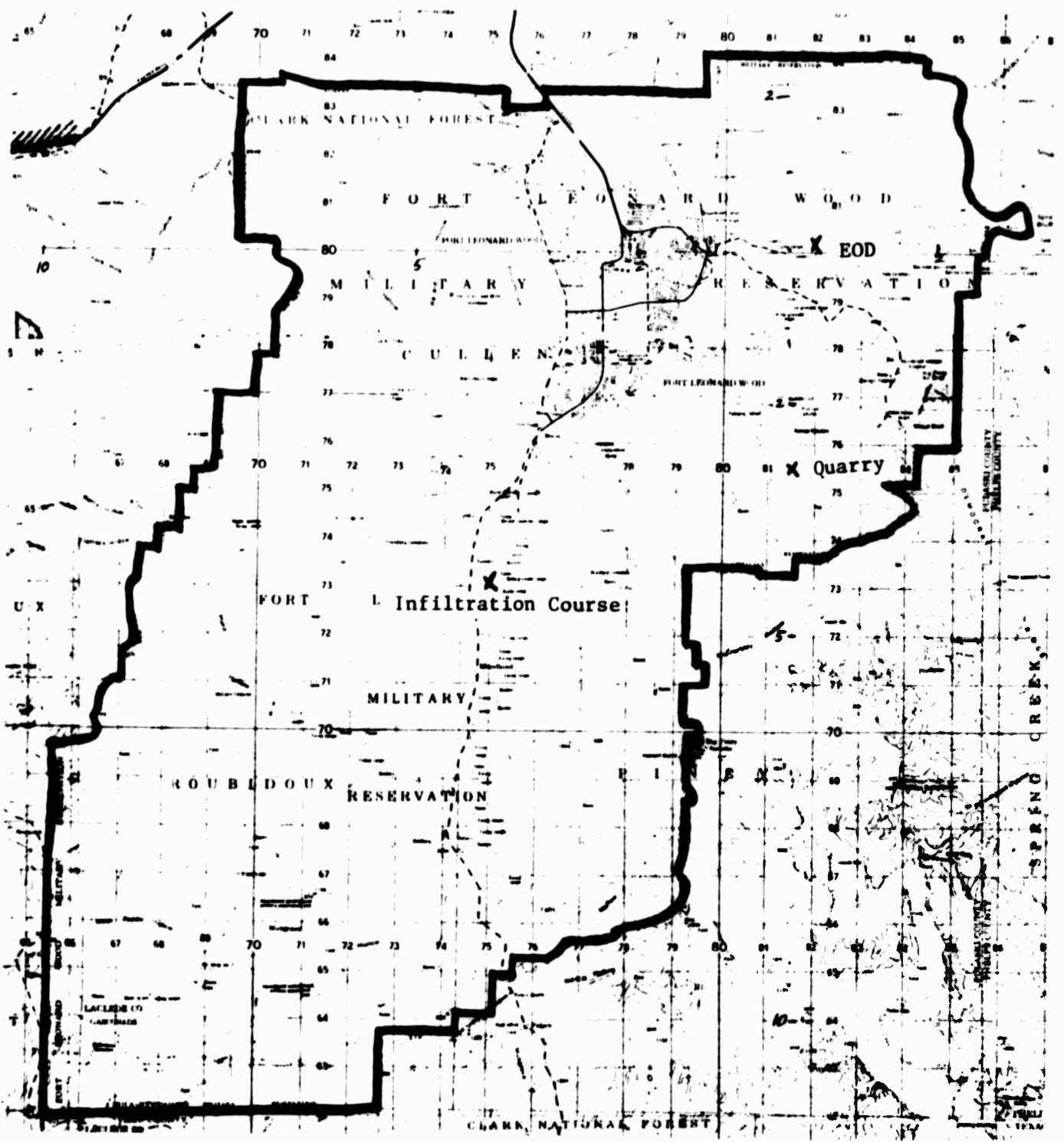

Figure A1. Ft. Leonard Wood illustrating a base with less than 25 targets.

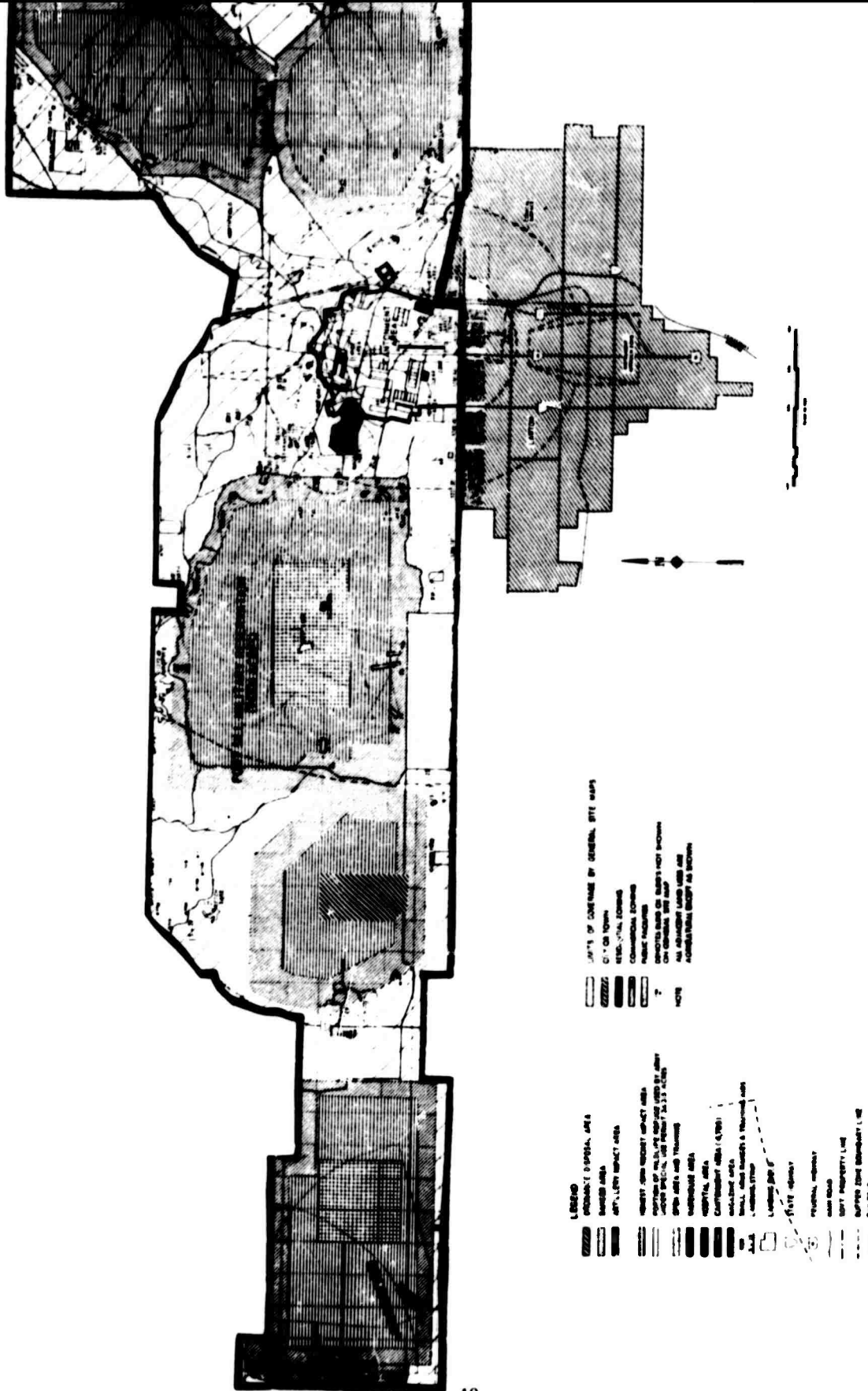

Figure A2. Ft. Sill illustrating a base with more than 25 targets.

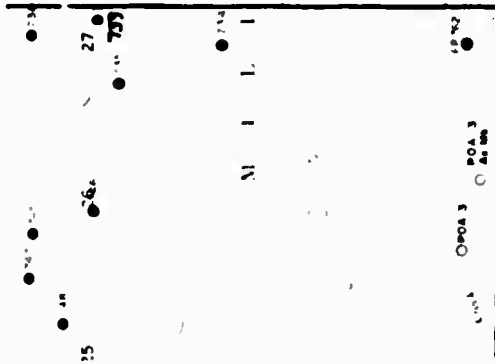

Figure A3. Target identification with few targets.

1	2	3	4	5	6	7	8	9	10	11	12	13	14	15	16	17	18
			7	4	8												
			7	4	7												
			7	4	5												
			7	4	6												
			7	3	5												
			7	3	6												
			7	3	3												
			7	3	4												

Figure A4. Target data sheet containing identification numbers.

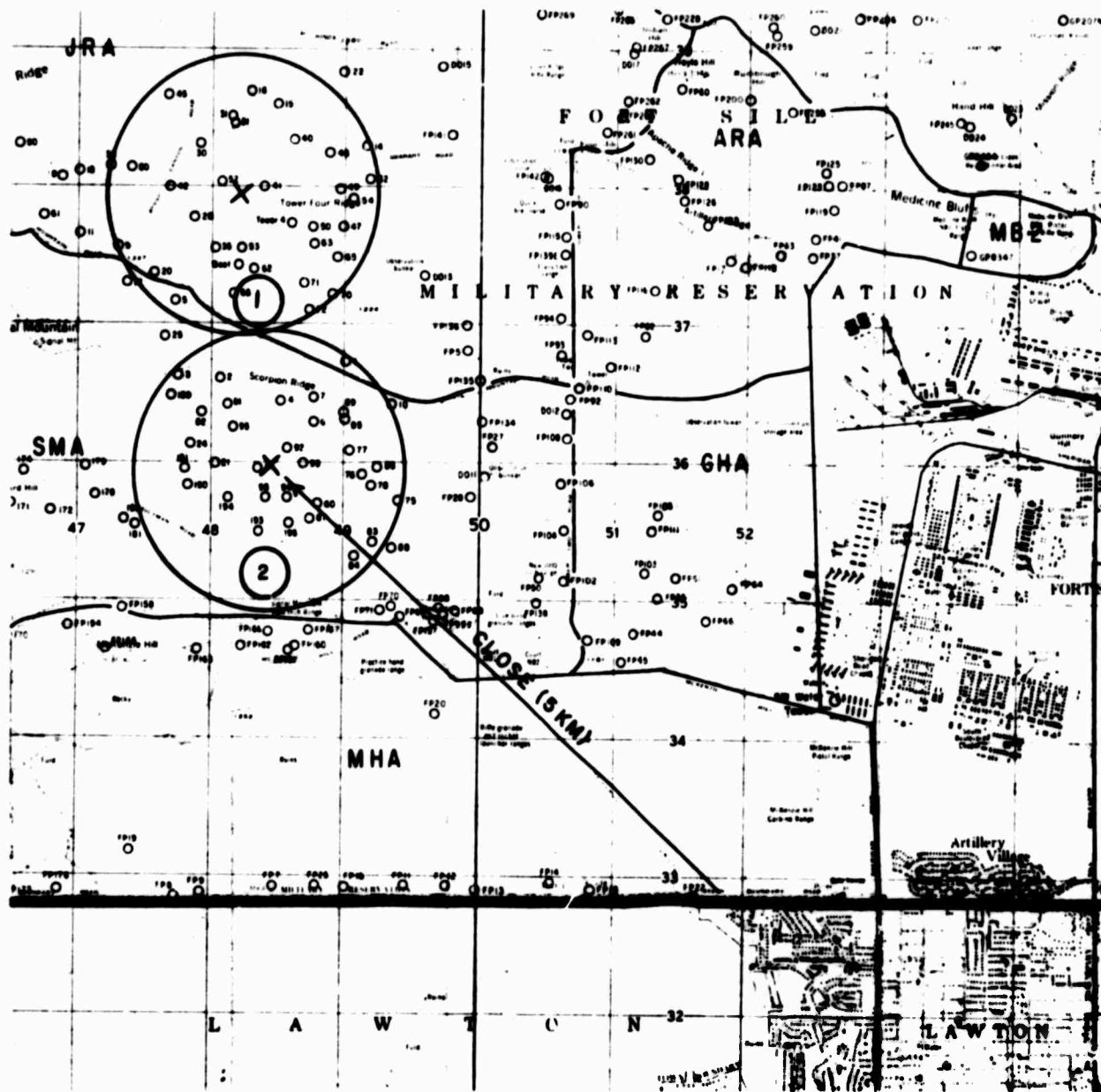

Figure A5. Grouping targets on a map.

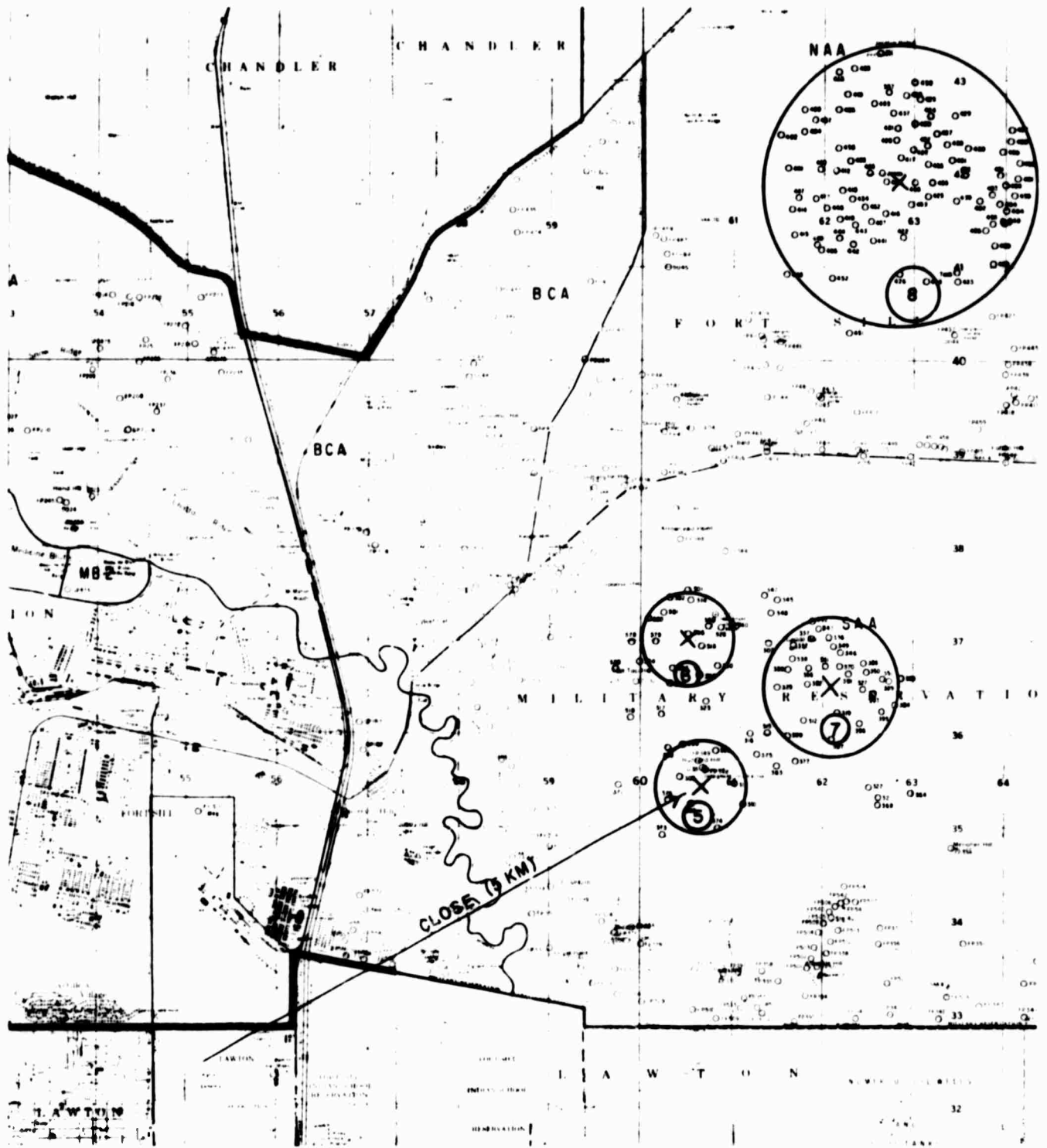

Figure A6. Grouping targets on a map.

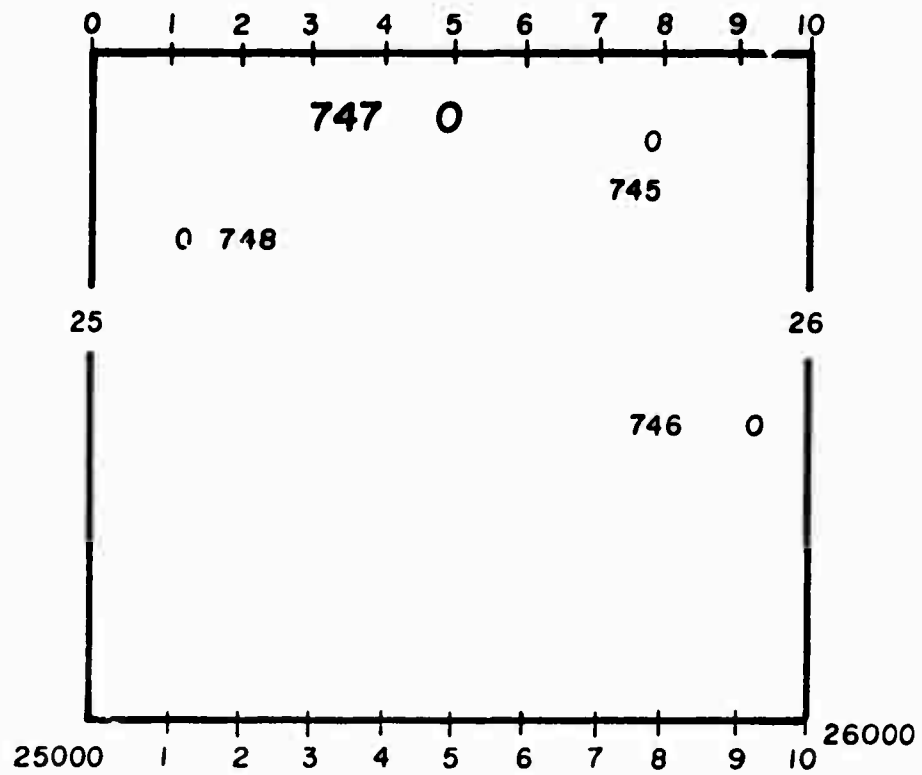

Figure A9. X coordinate read from a map.

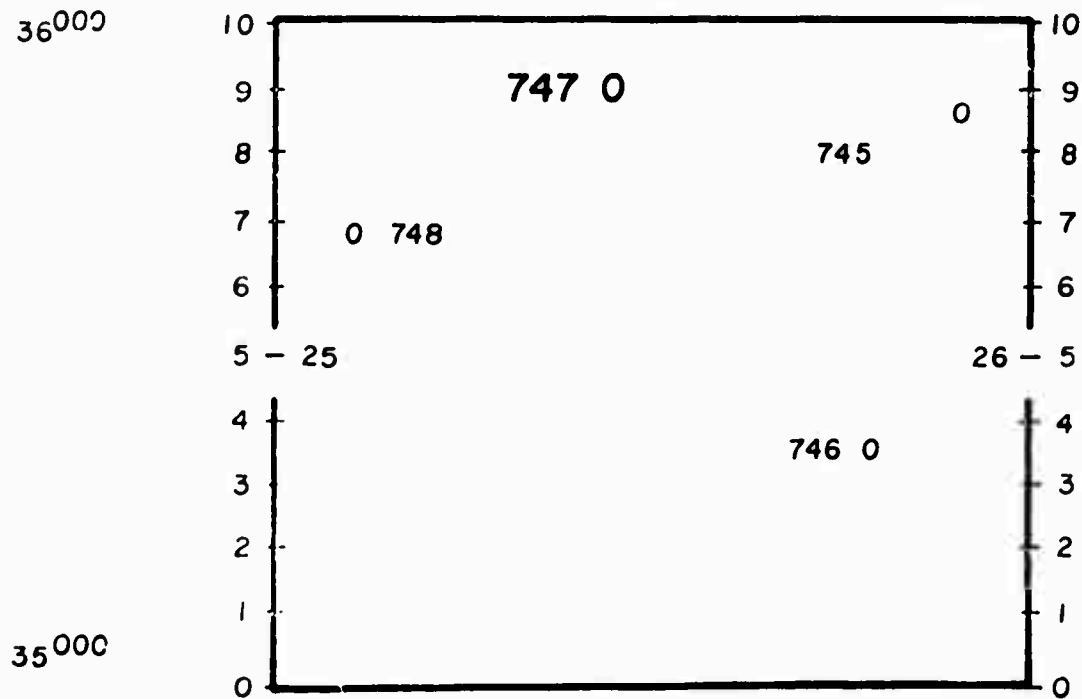

Figure A10. Y coordinate read from a map.

filled out as read from the map is indicated in Figure A11.

2. The Table of Metric Grid Coordinates is used if one is unfamiliar with the location of the target. Values in this list are stated to the nearest meter and no rounding is required. When reading from the Table of Metric Grid Coordinates shown in Table A1, the first 5 digits correspond to the Y coordinate. The Target Data Sheet is completed in Figure A12 from the Table of Metric Grid Coordinates.

Table A1
Table of Metric Grid Coordinates

Tgt no	Grid reference	Alt (meters)	Location	Description
745	25782 35849	445	POA	Yellow car body
746	25937 35476	440	POA	Orange car body
747	25499 35895	438	POA	Orange car body
748	25215 35666	433	POA	White car body
749	25086 36496	443	POA	Yellow car body

Targets Grouped. After the targets have been grouped and circles drawn, the coordinates are read directly from the map. The location of the target area is the center of the circle. A review of map reading was discussed in the example under subsection one and illustrated in Figures A8, A9, and A10. Figure A13 is an example of how to read coordinates from a map with 1 kilometer circles. The X and Y coordinates are completed in the Target Data Sheet in Figure A14.

Column 1, End of Target Data Flag. After filling out the Target Data Sheets for all the targets, place an asterisk in Column 1 of the last entry on the Target Data Sheet. This tells the computer that there are no more Target Data entries to follow. Figure A15 shows a Target Data Sheet with an asterisk after the final entry.

2 FIRING POINT DATA SHEET

When completing this form, one sheet is used for each Firing Point. The Firing Point Data Sheet is to be completed in pencil because some decisions have to be made which necessitate erasing. Work can be made easier if the Range Safety Cards are arranged in chronological and numerical order. Figure A16 is an illustration of a Firing Point Data Sheet with the columns filled.

Column 1, End of Source Data Flag. This column will be discussed at the end of this section after all items have been completed on the Firing Point Data Sheet.

The Box Above:

Columns 2-5, Firing Point Identification. To begin, the identification number of firing points is read directly from the Range Safety Card or from the Range Control Log. Unlike target points, firing points are not grouped into circles. However, if a firing point has a direction letter following the identification number, this letter is entered into the box above Column 6.

Demolition sites are not usually numbered on the map, so one must create an unused number and assign it to demolition sites in order to avoid confusion. As an example, Figure A17 shows several demolition sites. These have been arbitrarily labelled with unused numbers.

The Box Above:

Columns 7-12, X Coordinate.

Columns 13-18, Y Coordinate. Information for these columns is obtained from the Range Safety Card, Map, or from the Table of Metric Grid Coordinates.

Range Safety Card. Of the three references cited above, this card is the easiest to read and therefore should be used if possible. Referring to Figure A18, the first 4-digit number after "firing point" (5064 in this case) is used as the X-coordinate. Add a zero to the end so the number becomes 50640. Enter this 5-digit number in Columns 7-12. In like fashion for the Y-coordinate, the second 4-digit number after "firing point" (3771 in this case) becomes 37710 after adding a zero and is written in the Firing Point Target Sheet. Figure A19 shows how these two coordinate fields should look when completed.

Map. Coordinates may be read from the map if desired or if the Range Safety Card is incomplete. An example of how to read a location from a map was given in the previous section and in Figures A8, A9, and A10. For Firing Point 115, considered here in Figure A20, the X and Y coordinates are read

1	2	3	4	5	6	7	8	9	10	11	12	13	14	15	16	17	18
			740				26800					37200					
			741				26500					37200					
			742				26000					37200					
			743				25900					36500					
			744				26200					36100					
			745				25800					35800					
			746				25900					35500					
			747				25500					35900					
			748				25200					35700					
			749				25100					36500					

Figure A11. Target Data Sheet containing coordinates.

1	2	3	4	5	6	7	8	9	10	11	12	13	14	15	16	17	18
			740				26837					37234					
			741				26498					37197					
			742				26047					37243					
			743				25896					36508					
			744				26178					36111					
			745				25782					35849					
			746				25937					35476					
			747				25499					35895					
			748				25215					35666					
			749				25086					36496					

Figure A12. Target Data Sheet containing coordinates.

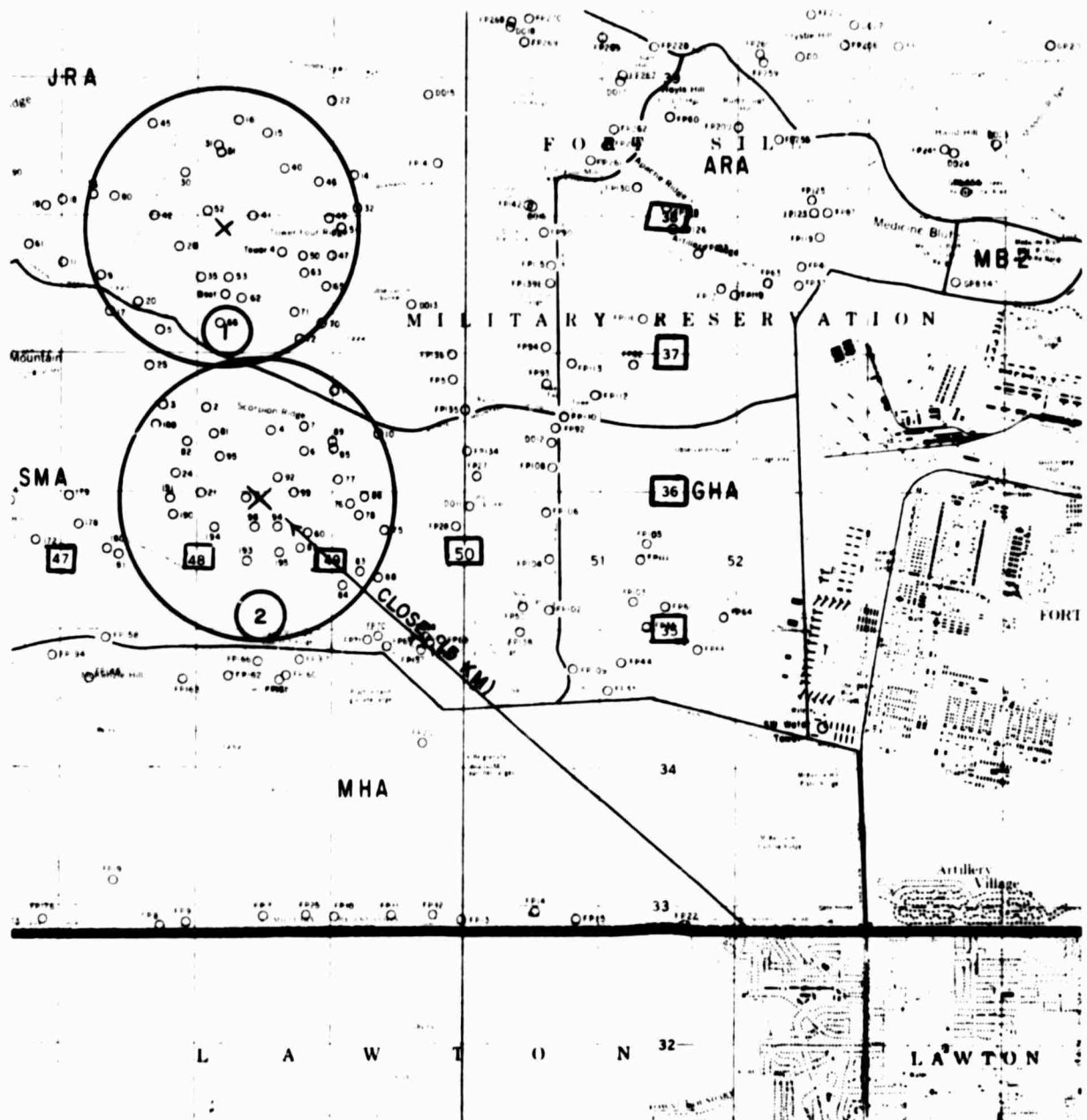

Figure A13. Map illustrating target grouping.

1	2	3	4	5	6	7	8	9	10	11	12	13	14	15	16	17	18
				1		48300					37900						
				2		48500					36000						

Figure A14. Target Data Sheet containing coordinates.

1	2	3	4	5	6	7	8	9	10	11	12	13	14	15	16	17	18
				1		48300					37900						
				2		48500					36000						

Figure A15 Completed Target Data Sheet.

End of Source Flag
Firing Point Identification
X - Coordinate
Y - Coordinate
Weapon Type
Number of Rounds per Day
Number of Rounds per Night
Minimum Charge
Maximum Charge
Target Identification
Projectile Flag
Height Above (+) or Below Ground (-)

1	2	3	4	5	6	7	8	9	10	11	12	13	14	15	16	17	18	19	20	21	22	23	24	25	26	27	28	29	30	31	32	33	34	35	36	37	38	39	40	41		

Figure A16. Firing Point Data Sheet.

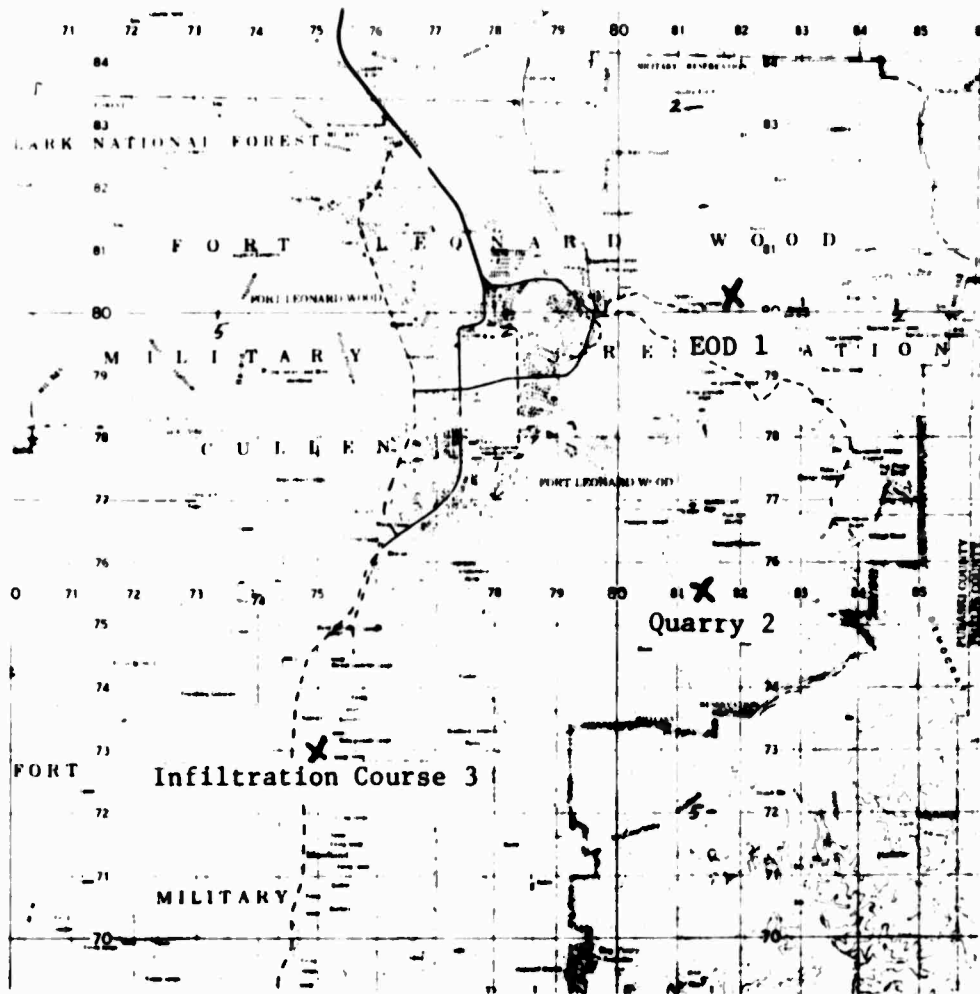

Figure A17. Map illustrating demolition sites.

RANGE SAFETY CARD

UNIT/STR: _____ ATC _____ DATE-TIME GP: 0830-1630 Fri 13 Apr 73

FIRING POINT: 115 (5064 3771) AREA: JRA SMA JRA

WEAPON: 8"H AMMUNITION: SH HE M57 FZM557 M564 M520

TYPE OF FIRE: High & Low Angle _____

DIRECTION LIMITS: (Ref GN): LEFT 4920 MILS, RIGHT 5100 MILS

LOW ANGLE PD MINIMUM RANGE 1800 METERS, MINIMUM CHARGE 1

FUZE TI, VT & HI ANGLE MINIMUM RANGE 2100 METERS, MINIMUM CHARGE 1

MAXIMUM RANGE TO IMPACT 5500 METERS, MAXIMUM CHARGE 5

SPECIAL INSTRUCTIONS: Apply +5.5 seconds to Time of Flight corresponding to Range 1500 to establish Minimum Time for Fuze VT.

See reverse side for special instructions as appropriate to authorized weapons, fuzes, and projectiles.

Figure A18. Range Safety Card for firing point 115.

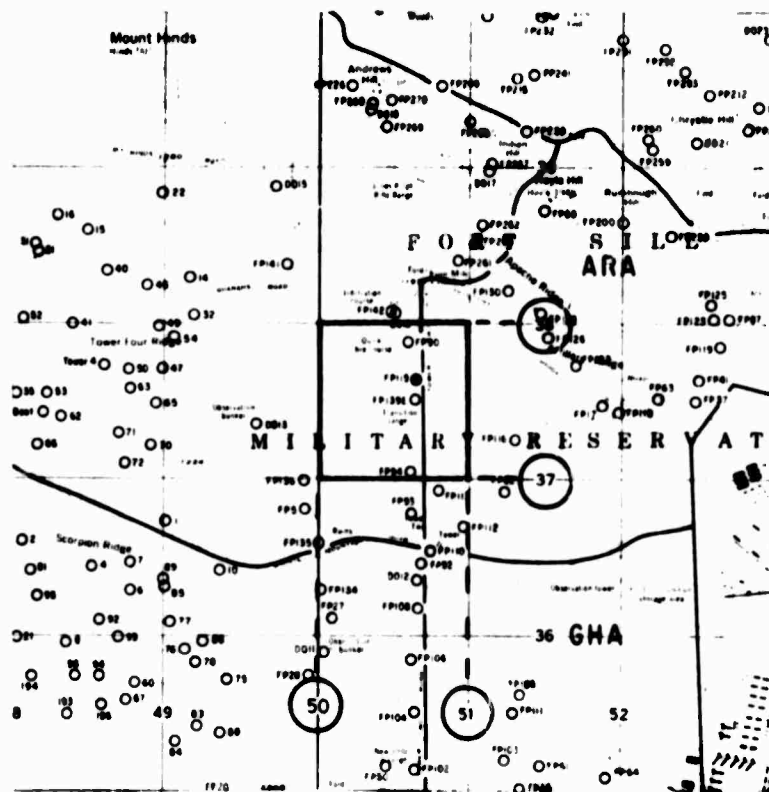

Figure A20. Coordinates read from a map.

from the map and entered in the appropriate columns. Figure A21 shows how this is accomplished when reading coordinates from a map.

Table of Metric Grid Coordinates. If desired, coordinates may be found in this table but they have to be rounded to the nearest meter in order to be consistent with the data sheet. From Table A2 the X-coordinate for Firing Point 115 is 550646.8. Round this number to 550649 and enter the last 5 digits (50649) into the Firing Point Data Sheet. The completed Firing Point Data Sheet entry is shown in Figure A22 for both the X and Y coordinates.

Table A2
Table of Metric Grid Coordinates

Station	Coordinates	Azimuth (mils) Altitude (meters)
FP 112	(550967.6 - 836772.3)	376
FP 113	(550810.3 - 837006.5)	372
FP 115	(550646.8 - 837717.2)	369
FP 115 N	(550622.2 - 837781.1)	368
FP 115 S	(550646.8 - 837647.3)	369

In some cases it is necessary to use all six digits because the base is on a division of major zones. That is, if the X coordinate of one firing point is 590747, and another firing point is 600747, then all six digits are used.

Columns 19-20, Weapon Type. Once the weapon type is known, a code is entered in these columns. To find the weapon type, the Range Safety Card is used. As can be seen from Figure A23, the weapon type for Firing Point 115 is an 8 inch H. The weapon should be double-checked with the Range Control Log to minimize any error since one firing point can have two types of weapons on any one day.

After the weapon is known, consult Table A3 below and enter the 1 or 2-digit code in Columns 19-20. Note: If the weapon is not listed in Table A3, assign the next code number (5, 6, 7, 8, or 9) to the weapon and include this information on the attachment sheet explained at the end of this chapter (see Figure A53). Figure A24 shows how to enter the codes into the Firing Point Data Sheet.

RANGE SAFETY CARD

UNIT/STR: ATC DATE-TIME GP: 0830-1630 Fri 13 Apr 73

FIRING POINT: 115 (5064 3771) AREA: JRA SMA JRA

WEAPON: 8"H AMMUNITION: SH HE M57 FZM557 M564 M520

TYPE OF FIRE: High & Low Angle

DIRECTION LIMITS: (Ref GN): LEFT 4920 MILS, RIGHT 5100 MILS

LOW ANGLE PD MINIMUM RANGE 1800 METERS, MINIMUM CHARGE 1

FUZE TI, VT & HI ANGLE MINIMUM RANGE 2100 METERS, MINIMUM CHARGE 1

MAXIMUM RANGE TO IMPACT 5500 METERS, MAXIMUM CHARGE 5

SPECIAL INSTRUCTIONS: Apply +5.5 seconds to Time of Flight corresponding to Range 1500 to establish Minimum Time for Fuze VT.

See reverse side for special instructions as appropriate to authorized weapons, fuzes, and projectiles.

Figure A23. Range Safety Card for firing point 115.

1	115		50647					37717					19	20	21	22	23	24	25	26	27	28	29	30	31	32	33	34	35	36	37	38	39	40	41																				
																			3																																				

Figure A24. Firing Point Data Sheet showing weapon type.

Table A3
Weapon Codes

Weapon	Code
105mm H	1
155mm H	2
8 in. H	3
175mm G	4
	5
	6
	7
	8
	9
Small Charge TNT (0.25-90 lbs.)	10
Large Charge TNT (110-500 lbs.)	11

Charge Range:

Columns 29-30, Minimum Charge.

Columns 31-32, Maximum Charge. Consult Columns 19-20 on the Firing Point Data Sheet:

a. If the weapon type code in Columns 19-20 was 1-9 follow either part 1 or 2 below.

b. If the weapon type in Columns 19-20 was 10, follow part 3 below.

c. If the weapon type in Columns 19-20 was 11, follow part 4 below.

1. Non-TNT Weapons (Codes 1-4) Range Safety Card. Refer to the Range Safety Card and enter the 1-digit number after "Minimum Charge" in Columns 29-30 and the number after "Maximum Charge" in Columns 31-32.

In Figure A25 the Minimum Charge is 1, which is entered in Columns 29-30 in the Firing Point Data Sheet. From Figure A25 the Maximum Charge is 5, which goes in Columns 31-32. The completed Firing Point Data Sheet for this example is displayed in Figure A26.

2. Non-TNT Weapons (Code 1-4) Charge Known. If the Range Safety Card is incomplete or if the typical charge is known, put zeros in Columns 29-30 and enter the charge in Columns 31-32. Figure A27 shows the Firing Point Data Sheet when the typical charge is known to be 5.

3. Small Charge TNT (Code 10). For a small charge of TNT (0.25-90 lbs), put zeros in Columns 29-30 and consult Table A4 below to fill in Columns 31-32. Figure A28 shows the completed Firing Point Data Sheet for a 10 lb charge.

Table A4
Maximum Charge Codes for a Small Charge of TNT

Weight of TNT lbs	Maximum Charge Code
0.25	1
1.00	2
5.00	3
10.00	4
15.00	5
25.00	6
35.00	7
50.00	8
70.00	9
90.00	10

4. Large Charge TNT (Code 11). For a large charge of TNT (110-500 lbs) place zeros in Columns 29-30 and consult Table A5 below to fill in Columns 31-32 as shown in Figure A29 for a 200 lb charge.

Table A5
Maximum Charge Codes for a Large Charge of TNT

Weight of TNT lbs	Maximum Charge Code
110	1
140	2
170	3
200	4
240	5
280	6
330	7
380	8
440	9
500	10

Note: The remaining columns on the Firing Point Data Sheet must be completed in pencil since some adjustments may have to be made after beginning.

Columns 21-24, Number of Rounds Per Day.

Columns 25-28, Number of Rounds Per Night. By definition, day occurs between 0700 and 2200 hours while night is between 2200 and 0700 hours. The Range Control Log along with the Range Safety Card are the main sources of information for this subsection.

From the Range Control Log in Figure A30 under "Actual Time (In/Out)" it can be seen that this

RANGE SAFETY CARD

UNIT/STR: ATC DATE-TIME GP: 0830-1630 Fri 13 Apr 73
FIRING POINT: 115 (5064 3771) AREA: JRA SVA JRA
WEAPON: 8"H AMMUNITION: SH HE M57 FZM557 M564 M520
TYPE OF FIRE: High & Low Angle _____
DIRECTION LIMITS. (Ref GN): LEFT: 4920 MILS, RIGHT: 5100 MILS
LO'W ANGLE PD MINIMUM RANGE: 1800 METERS, MINIMUM CHARGE 1
FUZE TI, VT & H: ANGLE MINIMUM RANGE: 2100 METERS, MINIMUM CHARGE 1
MAXIMUM RANGE TO IMPACT: 5500 METERS, MAXIMUM CHARGE 5
SPECIAL INSTRUCTIONS. Apply +5.5 seconds to Time of Flight corresponding to
Range 1500 to establish Minimum Time for Fuze VT.

See reverse side for special instructions as appropriate to authorized weapons, fuzes, and projectiles.

Figure A25. Range Safety Card indicating charge range.

115					50647							37717						19	20	21	22	23	24	25	26	27	28	29	30	31	32	33	34	35	36	37	38	39	40	41			
																3												00	5														

Figure A27. Firing Point Data Sheet containing charge range for non TNT weapons.

115		50647					37717					19	20	21	22	23	24	25	26	27	28	29	30	31	32	33	34	35	36	37	38	39	40	41			
													1	0									0	0	4												

Figure A28. Firing Point Data Sheet containing charge range for a small charge of TNT.

RANGE		FIRING ORDER NO.		RANGE CONTROL LOG										DATE		RANGE				
WEST		813		SCHEDULED TIME		FIRING POINT/GRID		OPR & PHONE LOCATION		OIC		ACTUAL TIME		CHECKFIRE		NUMBER ROUNDS FIRED		WEAPON		
PROBLEM		UNIT		IN		OUT		OIC		OIC		IN		IMPOSED		PERSONS FIRED		WEAPON		
CED 742		2/18		0800		1300		7		PFC Madden		CAP S. Sney		0500		1300		53		8" M

Figure A30. Range Control Log.

column gives the time duration during which fire occurred. Find the correct row under "Firing Point Grid" in the Range Control Log for the firing point under consideration and use these directions:

a. If fire occurred entirely during the day (0700-2200 hours) proceed to 1 below.

b. If fire occurred entirely during the night (2200-0700 hours) choose option 2 below.

c. If fire overlapped between day and night or night and day, proceed to 3 below.

1. Fire Occurring Entirely During Day. If no overlapping occurred between day and night, simply enter the number of rounds fired from the Range Control Log in Columns 21-24. Place zeros in Columns 25-28 since no fire occurred during the night. An example of a typical Range Control Log is shown in Figure A31 indicating the firing point, actual time firing occurred, and rounds fired. Figure A32 shows the completed Firing Point Data Sheet.

2. Fire Occurring Entirely During Night. If no overlapping occurred between night and day, enter the number of rounds fired from the Range Control Log in Columns 25-28. Place zeros in Columns 21-24 since no fire occurred during the day. Figure A33 shows a Range Control Log for fire entirely during the night. Figure A34 is an example of the completed Firing Point Data Sheet.

3. Fire Overlapping Between Day and Night. Computation is required if firing is continuous between day and night. This allows one to split the total rounds fired proportionately between the hours of firing that occurred during the day and night. When the total number of rounds is divided, the number of rounds per day is entered in Columns 21-24 and the number per night in Columns 25-28 of the Firing Point Data Sheet. Note that the numbers in Columns 21-24 and those in Columns 25-28 should add to equal the total rounds fired as originally read from the Range Control Log.

From the Range Control Log in Figure A35 it is seen that the "Actual Time" is split between day and night. When this occurs, the following steps are adhered to:

1. Find the number of hours during the day (0700-2200 hours) that firing occurs. Round this number to the nearest $\frac{1}{2}$ hour if necessary.

Example:

Actual Time	1100 hours - 0700 (start of day) =
In / Out	4 hours of firing during the
0500 1100	day

2. Find the number of hours in the night (2200-0700) that firing occurs. Round this number to the nearest $\frac{1}{2}$ hour if necessary.

Example:

Actual Time	0700 (start of day) - 0500 hours =
In / Out	2 hours of firing during the
0500 1100	night

3. Total the number of hours in which firing occurred during the day and night from above.

Example:

4 hours (day) + 2 hours (night) = 6 hours (total)

4. Make fractions for day and night hours. To do this for the day, make a fraction of the number of hours in the day that firing occurs over the total hours (i.e.) Part 1/Part 3 from above. Similarly, for the night hours, make a fraction of the number of hours in the night that firing occurs over the total hours, i.e. Part 2/Part 3 from above.

Example:

$$\frac{4 \text{ hours (day)}}{6 \text{ hours (total)}} = \frac{2}{3} \text{ (day fraction)}$$

$$\frac{2 \text{ hours (night)}}{6 \text{ hours (total)}} = \frac{1}{3} \text{ (night fraction)}$$

5. Multiply the day fraction times the total number of rounds fired from the Range Control Log, round to a whole number and enter in Columns 21-24 of the Firing Point Data Sheet. Multiply the night fraction times the number of rounds fired, round to a whole number and enter in Columns 25-28 as shown in Figure A36.

RANGE		FIRING ORDER NR		RANGE CONTROL LOG										DATE		RANGE								
North		32		SCHEDULED TIME		ACTUAL TIME		CHECKFIRE		OIC		OPR & PHONE LOCATION		FIRING POINT/GRID		UNIT		NUMBER PERSONS FIRED		ROUNDS FIRED		WEAPON		
PROBLEM		UNIT		IN		OUT		IN		OUT		IMPOSED TIME		CHECKFIRE TIME		LIFTED TIME		NAME		NAME		NAME		
SPC		2/18		1300	1900			1300	1830												50	49		105
SPC		2/18		2200	0200			2200	0200			CPT Carson	PVT Griffin	721							48	76		105
SPC		2/18		0400	1100			0600	1000			CPT Carson	PVT Williams	721							74	83		8
SPC		2/18		2000	0130			2000	0100			CPT Carson	PVT Coppins	721							16	94		105

Figure A31. Range Control Log for fire occurring entirely during the day.

RANGE		FIRING ORDER NR		RANGE CONTROL LOG										DATE		RANGE					
West		813		SCHEDULED TIME		ACTUAL TIME		OIC		OPR & PHONE LOCATION		FIRING POINT/GRID		UNIT		NUMBER PERSONS FIRED		ROUNDS FIRED		WEAPON	
PROBLEM		UNIT		IN		OUT		IMPOSED TIME		NAME		TIME		NAME		NAME		TIME		NAME	
LTD		212		C8302400		2200		2330		CPT Smith		434		70		20		105			

Figure A33. Range Control Log for fire occurring entirely during the night.

RANGE CONTROL LOG		FIRING ORDER NR		SCHEDULED TIME		FIRING POINT/GRID		OPR & PHONE LOCATION		OIC		ACTUAL TIME		CHECKS		DATE		RANGE	
PROBLEM	UNIT	IN	OUT	IN	OUT	IN	OUT	IN	OUT	IMPOSED TIME	LIFTED TIME	NUMBER PERSONS	ROUNDS FIRED	WEAPON	13 Apr 73				
GED 742	2/18	0500	1200			057E		PVT Kechn		SPT Blackman		80	85	105					

Figure A35. Range Control Log for fire overlapping between day and night.

Example:

$$\frac{2}{3} (\text{day fraction}) \times 85 \text{ rounds} = 56.66 = 57 \text{ rounds per day}$$

$$\frac{1}{3} (\text{night fraction}) \times 85 \text{ rounds} = 28.33 = 28 \text{ rounds per night}$$

To check the arithmetic, 57 rounds per day + 28 rounds per night = 85 total rounds.

Columns 33-35, Target Identification. Three cases will be examined to complete the Target Identification Columns. Case a. is the simplest of the three and is used when the targets are not grouped. If the targets are grouped, cases b. and c. are to be examined. Case b. describes the procedure to interpret "Direction Limits" and "Range Limits" from the Range Safety Card. Case c. is more complex and describes how to divide the number of rounds per day and night based upon the ratio of included areas between two target groups when necessary.

a. Targets Not Grouped. When a small number of targets (less than 25) is utilized on a base, the target for each firing point is usually known. If it is not known, a form such as the "Firing Gun Sheet" may have to be used. If the target for each firing point still cannot be found, use the method described in b. below. See Figure A37 for an example of a completed Firing Point Data Sheet.

b. Targets Grouped (simple case). When targets have been grouped into circles, the following method will be observed. To complete these columns the Range Safety Card and map must be used. One reads from the Range Safety Card, the "Direction Limits" (both left and right), the "Low Angle Point Detonating Minimum Range," and the "Maximum Range to Impact." A Range Safety Card is shown in Figure A38 with these items marked. The information realized from the Range Safety Card is plotted on the map with the assistance of a protractor calibrated in mils and a scale calibrated to the map scale.

Figure A39 shows Firing Point 115 over which a protractor has been placed. It can be seen that with

the left and right direction limits at 4920 and 5100 mils respectively, a "pie slice" cuts through Target Group 8. The minimum and maximum ranges further establish that Target Group 8 is the target for Firing Point 115.

The procedure for identifying the target for Firing Point 115 is as follows. Lay a protractor calibrated in mils over the firing point. Approximate the direction limits (left and right) on the map (4920 and 5100 mils in this case). Remove the protractor and use a straight edge to lightly draw two lines from the firing point to the 4920 mark and from the firing point to 5100 as is shown in Figure A40. Next use a rule or similar device calibrated to the map (a measuring device can be constructed from the scale at the bottom of the map). Lay the scale along either line previously drawn by placing the 0 end over the firing point. Make marks on the map when 1800 and 3500 meters occur as is shown in Figure A41.

Remove all protractors and scales from the map and inspect the truncated "pie slice" to see if the target group lies within the minimum and maximum range (see Figure A42). If all (or a greater portion) of a target group is within the truncated "pie slice," enter the identification number of the target group in Columns 33-34 as shown in Figure A43. If the truncated "pie slice" overlaps two target areas (one-half of the "slice" in one area and one-half in the other) more work is required.

c. Targets Grouped (complex case). This case is used when two or more target groups are included within a truncated "pie slice." Figure A44 shows the Range Safety Card for Firing Point 7 with direction limits and ranges marked. Figure A45 is a map of the firing area of Firing Point 7 with a protractor overlay. Referring to Figure A46, all necessary information has been marked on the map. As can be readily seen from the shading, Target Group 8 lies within one half of the truncated "pie slice" and Target Group 9 lies in the other half. The Range Control Log in Figure A47 has been provided for reference.

When target groups are divided in this way, new lines must be created on the Firing Point Data Sheet. The Firing Point Data Sheet for Firing Point 7 is shown partially completed in Figure A48. Items filled in include Firing Point Identification, X and Y

RANGE SAFETY CARD

UNIT/STR ATC DATE-TIME GP: 0830-1630 Fri 13 Apr 73
FIRING POINT: 115 (5064 3771) AREA: JRA SMA JRA
WEAPON: 8"H AMMUNITION: SH HE M57 FZM557 M564 M520
TYPE OF FIRE: High & Low Angle
DIRECTION LIMITS: (Ref GN): LEFT 4920 5100 MILS, RIGHT 5100 MILS
LOW ANGLE PD MINIMUM RANGE 1800 METERS, MINIMUM CHARGE 1
FUZE TI, VT & HI ANGLE MINIMUM RANGE 2100 METERS, MINIMUM CHARGE 1
MAXIMUM RANGE TO IMPACT 3500 METERS, MAXIMUM CHARGE 5

SPECIAL INSTRUCTIONS: Apply +5.5 seconds to Time of Flight corresponding to Range 1500 to establish Minimum Time for Fuze VT.

See reverse side for special instructions as appropriate to authorized weapons, fuzes, and projectiles.

2

Figure A38. Range Safety Card indicating range and direction.

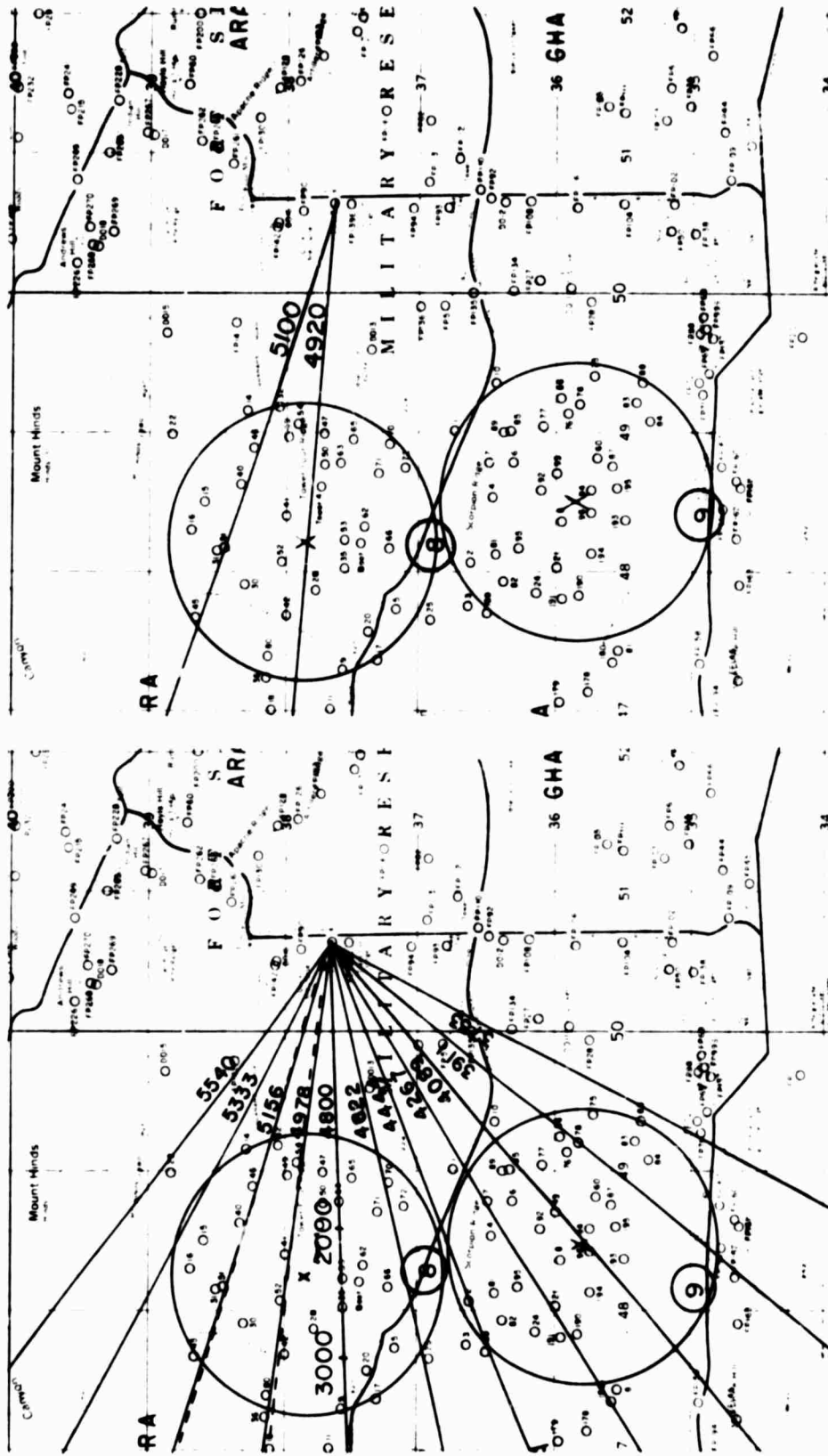

Figure A39. Map with protractor overlay.

Figure A40. Map with direction limits.

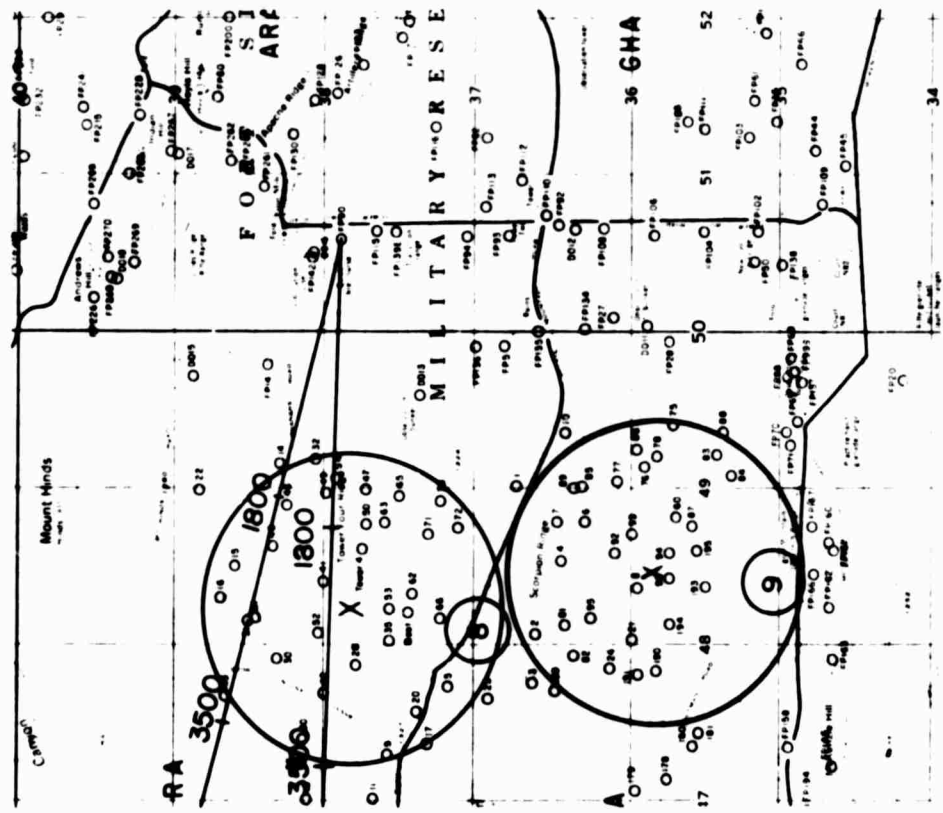
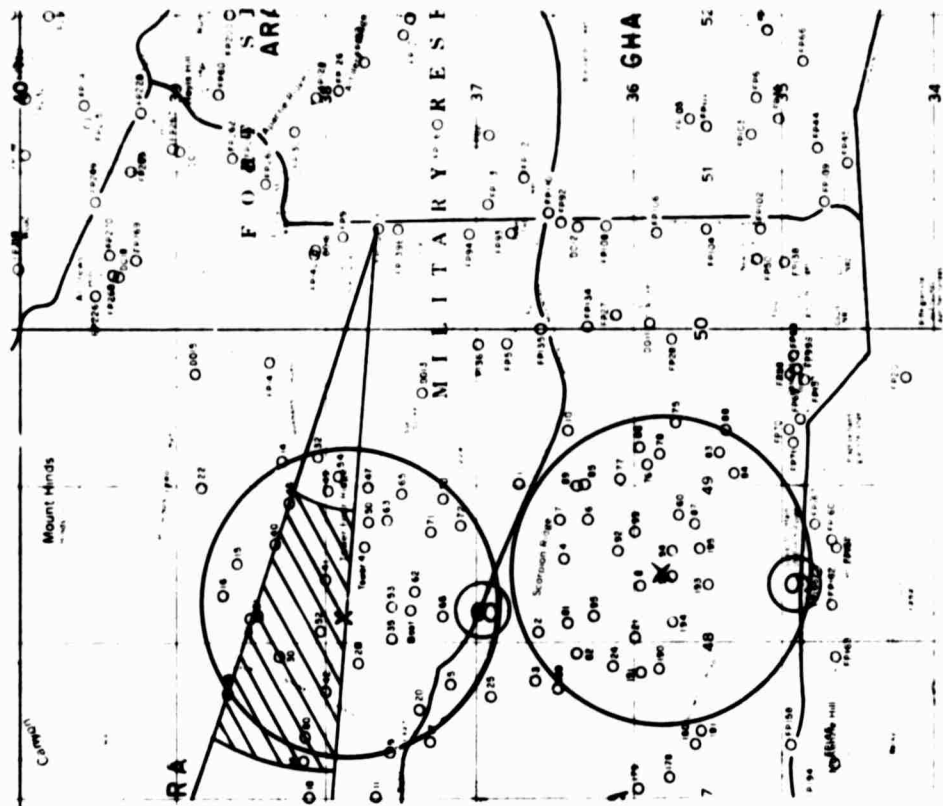

Figure A42. Map showing truncated "pie slice."

Figure A41. Map with direction limits and ranges.

RANGE SAFETY CARD

UNIT /STR: 2/18th DATE-TIME GP: 0500 - 1300 Wed 2 May 73

FIRING POINT: 7 AREA: MBA SMA JRA

WEAPON: 8"H AMMUNITION: SH HE M57 FZM564 M520 M514

TYPE OF FIRE: High & Low Angle

DIRECTION LIMITS: (Ref GN): LEFT 6222 MILS, RIGHT 0179 MILS

LOW ANGLE PD MINIMUM RANGE 3200 METERS, MINIMUM CHARGE 1

FUZE TI, VT & HI ANGLE MINIMUM RANGE 3500 METERS, MINIMUM CHARGE 1

MAXIMUM RANGE TO IMPACT 5000 METERS, MAXIMUM CHARGE 4

SPECIAL INSTRUCTIONS: Apply +5.5 seconds to Time of Flight corresponding to Range 1500 to establish Minimum Time for Fuze VT.

See reverse side for special instructions as appropriate to authorized weapons, fuzes, and projectiles.

Figure A44. Range Safety Card with direction limits and ranges marked.

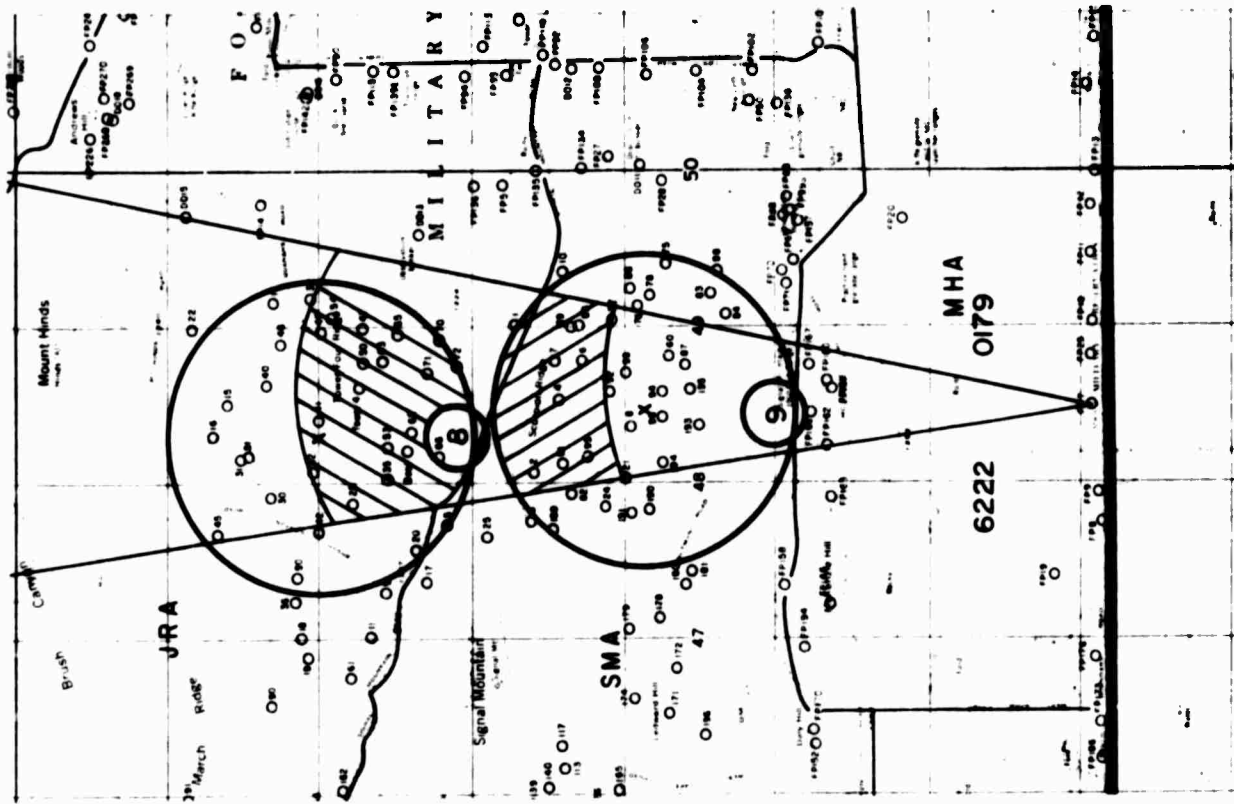

Figure A.46. Map illustrating direction limits and ranges.

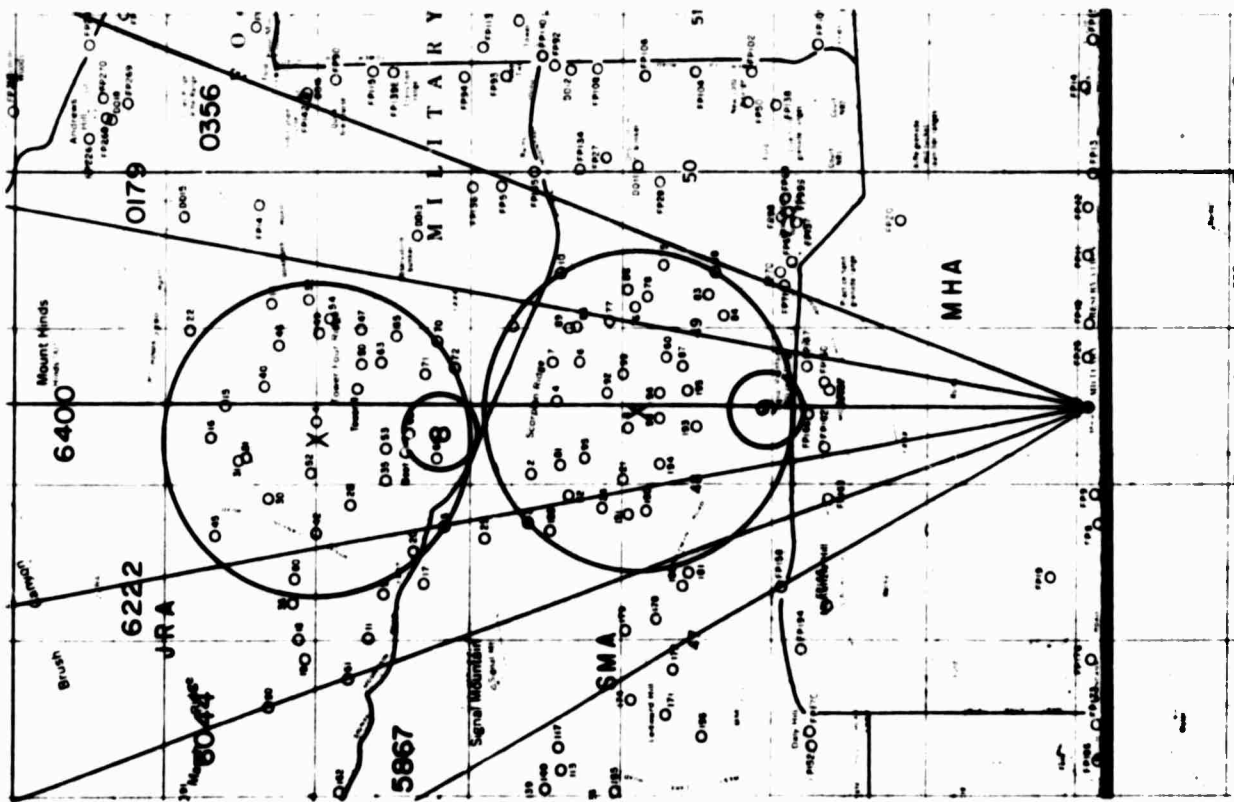

Figure A.45. Map with protractor overlay.

RANGE		FIRING ORDER NR		RANGE CONTROL LOG										DATE	RANGE
West		813												2 May 73	
PROBLEM	UNIT	SCHEDULED TIME		FIRING POINT/GRID	OPR & PHONE LOCATION	OIC	ACTUAL TIME		CHECKERE IMPOSED TIME NAME	LIFTED TIME/NAME	NUMBER PERSONS	ROUNDS FIRED	WEAPON		
		IN	OUT				IN	OUT							
GED 742	2/18	0800	1300	7	Pfc Mandtke	CPT S. Sney	0900	1300			53	40	8" H		

Figure A47. Range Control Log showing actual time and rounds fired.

coordinates, weapon type, charge range, and number of rounds per day and night.

As a review, to fill in the number of rounds per day and number per night, look at the Range Control Log shown in Figure A47. Under "Actual Time (In and Out)," it is seen that firing occurred between 0500 and 1300. Since day starts at 0700 this is 2 hours in the night and 6 in the day or $\frac{1}{4}$ in the night and $\frac{3}{4}$ in the day. The "Rounds Fired" (40) from the Range Control Log has been divided, 10 for the night and 30 for the day as shown in the Firing Point Data Sheet in Figure A48.

From the map in Figure A46 the rounds are also divided between Target Groups 8 and 9. The first step in filling out the Firing Point Data Sheet is to copy the weapon type and charge range to the line below as in Figure A49.

Next, identify each line by putting the target identification number in Columns 33-35. The first line is for target 8 and the second for target 9. Erase the 30 rounds per day in Columns 21-24 of Figure A48 and replace the 30 with a 15 for both targets 8 and 9. This is done because one-half the rounds in the day went to target 8 and one-half to 9. The number of rounds per night is done in the same fashion and is shown in Figure A50. Note how the Firing Point Data Sheet of Figure A50 differs from the initially incorrect one in Figure A48.

Column 36, Projectile Flag. Enter a 1 into Column 36 if blanks were fired or if the weapon code in Columns 19-20 was 10 or 11 (small or large charges of TNT). If neither blanks nor TNT were fired, leave Column 36 blank.

Columns 37-41, Height Above (+) or Depth Below (-) Ground. Enter a 0 into Columns 37-41 if the weapon code in Columns 19-20 was anything but 10 or 11. If TNT (Weapon Codes 10 or 11) was detonated above ground, enter the height in feet preceded by a plus sign into Columns 37-41. If TNT was buried enter the depth in feet preceded by a minus sign (see Figure A51).

Column 1, End of Source Data Flag. After all items have been entered into the Firing Point Data Sheet, an asterisk is placed as shown in Figure A52.

This terminates the information to be entered

into the Firing Point Data Sheet. Another sheet, however, must be completed in addition to the Target and Firing Point Data Sheets. This information includes whether locations are in feet or meters; overall percentage of illumination rounds; percentage of time fuses; percentage of proximity fuses; map scale size needed for the NEF Contour Overlay; weapon type vs. code numbers that have been added; and the name of the person preparing the work and information about the base.

Locations are typically specified in meters as has been the case in this report. By viewing a Range Safety Card, it is evident which method is employed at the base. It is also important to note that the method of specifying locations will also correspond to the contour maps which will be generated.

The overall percentage of illumination rounds is typically 4 percent, the overall percentage of time fuses is typically 15 percent and proximity fuses are around 5 percent. These percentages can be obtained from the Ammunition Supply Point or the Gunnery Department at the base.

The scale of the map for which contours are to be generated must be indicated. The standard scale map is 1:250,000, but contours can be adjusted to fit any map size if specified.

The additional weapon types and the corresponding codes assigned are listed. An example of the additional sheet is contained in Figure A53.

Inversion and operating conditions and the time for which data is to be gathered are explained in Appendix C.

Prediction of the noise impact of a military facility is made possible through extensive computer routines. The result of these calculations is equal noisiness contours which are plotted to a distance scale compatible with a map of the base. A description of the information necessary to initiate this program has been supplied in sections dealing with completion of the Target Data Sheet, Firing Point Data Sheet, and Attachment Sheet.

Once contours have been plotted, much more work still has to be done at the base. Appendix B indicates the procedures to be followed to predict annoyance levels from the contours.

		7		48484									32979																													
1	2	3	4	5	6	7	8	9	10	11	12	13	14	15	16	17	18	19	20	21	22	23	24	25	26	27	28	29	30	31	32	33	34	35	36	37	38	39	40	41		
																		3			15			5	1	4			8													
																		3			15			5	1	4			9													

Figure A50. Firing Point Data Sheet showing division of target groups.

		7		48484								32979																													
1	2	3	4	5	6	7	8	9	10	11	12	13	14	15	16	17	18	19	20	21	22	23	24	25	26	27	28	29	30	31	32	33	34	35	36	37	38	39	40	41	
																		3			15				5		1		4			8									
																		3			15				5		1		4			9									

Figure A52. Completed Firing Point Data Sheet.

Name of Base _____

Name of Person Preparing Work _____

Title _____

Office _____ Phone _____

Signature: _____

Approving Supervisor's Signature _____ Date _____

Special Information:

1. Is this for an additional contour? _____
2. Hours during the day that firing occurs (or is predicted to occur) or percent of inversions _____
3. Night only firing option (see Appendix C) _____

For response to 2 and 3, see Appendix C. No response is necessary for the "normal" conditions.

4. Time Period Data was Taken _____

General Information:

Locations Specified (feet or meters) _____

Overall Percentage of Illumination Rounds _____

Percentage of Time Fuses _____

Percentage of Proximity Fuses _____

Weapon _____ Code 5

Weapon _____ Code 6

Weapon _____ Code 7

Weapon _____ Code 8

Weapon _____ Code 9

Figure A53. Attachment Sheet.

ANNEX A1

1 ABBREVIATED DIRECTIONS FOR COMPLETING TARGET DATA SHEET

Column 1, End of Target Data Flag. Place an asterisk (*) in Column 1 of the last entry on the last Target Data Sheet.

Columns 2-6, Target Identification.

Less Than 25 Targets. Copy the target identification number from the map (Figure A3) and enter in the Data sheet (Figure A4).

More Than 25 Targets. Group targets into the largest circle possible, namely circles of radius $\frac{1}{2}$, 1, or $1\frac{1}{2}$ kilometers. The radius of a circle must not exceed $\frac{1}{2}$ of the distance between a population area and the center of the circle (Figures A5 and A6). Draw smaller circles if necessary. Create a unique number for each circle, write it on the map, and enter it on the data sheet (Figure A7).

Columns 7-12, X Coordinate.

Columns 13-18, Y Coordinate.

Targets Not Grouped.

1. The map is easiest to use to read coordinates of target points (Figures A8, A9, and A10). Enter 5-digit numbers for both the X and Y coordinates in the data sheet (Figure A11).

2. If using the Table of Metric Grid Coordinates, the first 5-digits under "grid reference" are the X coordinate and the last 5 are the Y (Table A1). Enter the X and Y coordinates directly into the data sheet (Figure A12).

Targets Grouped. Use the center of each circle as the location of the Target area (Figure A13). Enter 5-digit coordinates from the map for each circle group in the data sheet (Figure A14) (see Figures A8, A9, A10, and A11).

2 ABBREVIATED DIRECTIONS FOR COMPLETING FIRING POINT DATA SHEET

Column 1, End of Source Data Flag. Place an asterisk (*) in Column 1 of the last entry for each source.

The Box Above:

Columns 2-5, Firing Point Identification. Read from either the Range Safety Card or the Range Control Log and copy directly into the box above Columns 2-5. If a firing point has a direction letter following the identification number, place this letter above Column 6. Create an unused number for any demolition sites. Only one firing point identification number is used on a Firing Point Data Sheet but the sheet can be used for the full duration of gathering data. For additional sheets, cross out the boxes at the top of each continuation sheet.

The Box Above:

Columns 7-12, X Coordinate.

Columns 13-18, Y Coordinate. Obtain information from the Range Safety Card, map or Table of Metric Grid Coordinates.

Range Safety Card (Figure A18). The first 4-digit number after "Firing Point" is the X coordinate, and the second 4-digit number is the Y. Make these 5-digit numbers by placing a zero to the right of the units place (Figure A19).

Map (see Figures A8, A9, A10, and A11).

Table of Metric Grid Coordinates. Round to the nearest meter and enter the last 5-digits. If there is ever any repetition or confusion, 6-digits should be entered.

Columns 19-20, Weapon Type. Consult Range Safety Card and double-check with Range Control Log since a firing point can have more than one type of weapon per day. Read weapon code from Table

A6 and enter code in the Firing Point Data Sheet. Note: If weapon is not listed in Table A6, assign the next unused Code Number to the weapon and include this information in the Attachment Sheet (Figure A53).

Table A6
Weapon Codes

Weapon	Code
105mm H	1
155mm H	2
8in H	3
155mm G	4
	5
	6
	7
	8
	9
Small Charge TNT (40-75-90 lbs)	10
Large Charge TNT (110-800 lbs)	11

Charge Range:

Columns 29-30, Minimum Charge.

Columns 31-32, Maximum Charge.

a. If weapon code in Columns 19-20 was 1-9 follow either parts 1 or 2 below:

b. If weapon code was 10, follow part 3 below.

c. If weapon code was 11, follow part 4 below.

1. *Weapon Code (1-9) From Range Safety Card (Figure A25).* Enter the 1-digit number after "Minimum Charge" in Columns 29-30, the number after "Maximum Charge" in Columns 31-32 (see Figure A26).

2. *Weapon Code (1-9) - Charge Known.* If a typical charge is known enter zeros in Columns 29-30 and put the charge in Columns 31-32.

3. *Small Charge TNT (Code 10).* Put zeros in Columns 29-30 and enter a 1 or 2-digit code from Table A7 in Columns 31-32.

4. *Large Charge TNT (Code 11)* Put zeros in Columns 29-30 and enter the 1 or 2-digit code from Table A8 in Columns 31-32.

Table A7
Maximum Charge Code Used for a Small Charge of TNT

Weight of TNT lbs	Maximum Charge Code
0-35	1
1-00	2
5-00	3
10-00	4
15-00	5
25-00	6
35-00	7
50-00	8
70-00	9
90-00	10

Table A8

Maximum Charge Code Used for a Large Charge of TNT

Weight of TNT lbs	Maximum Charge Code
110	1
140	2
170	3
200	4
240	5
290	6
340	7
380	8
440	9
500	10

Columns 21-34, Number of Rounds Per Day.

Columns 25-28, Number of Rounds Per Night.

Fire Occurring Entirely During Day. If fire occurs between 0700 and 2000 hours, obtain the number of rounds fired from the Range Control Log (Figure A31) and enter in Columns 21-24 of the Firing Point Data Sheet (Figure A32). Put zeros in Columns 25-28.

Fire Occurring Entirely During Night. If fire occurs between 2200 and 0700 hours, obtain the number of rounds fired from the Range Control Log (Figure A31) and enter in Columns 25-28 of the Firing Point Data Sheet (Figure A34). Put zeros in Columns 21-24.

Fire Overlapping Between Day and Night. Split the total rounds fired proportionately between the rounds fired during the day in Columns 21-24 and

rounds fired during the night in Columns 25-28 (see Figures A35 and A36).

Columns 33-35, Target Identification.

Targets Not Grouped. On a base with a small number of targets, the target for each firing point is usually known or can be obtained easily (Figure A37).

Targets Grouped (simple case). From the Range Safety Card read the "Direction Limits," "Low Angle Point Detonating Range" and "Maximum Range to Impact" (Figure A38). Lay a protractor over the map and draw a "pie-shaped" section from the direction limits. Use a ruler calibrated to the map to truncate the "pie slice" for the range (Figures A39, A40, A41, and A42). If the truncated "pie slice" covers only one target area, enter the target group identification number in Columns 33-35. If the truncated "pie slice" covers more than one target group, consult the next subsection.

Targets Grouped (complex case). If the truncated "pie slice" covers two or more target areas (Figures A45 and A46) divide the number of rounds based on the ratio of included areas. Create a new line in the Firing Point Data Sheet and transfer the weapon type and charge range to the line below. Identify each row by the correct target identification number

entered in Columns 33-35. Divide the number of rounds per day and night according to the ratio of included areas of target groups and enter these for each target number (Figures A49 and A50).

Column 36, Projectile Flag. Enter a 1 into Column 36 if blanks were fired or if the weapon code in Columns 19-20 was 10 or 11 (small or large charges of TNT). If neither blanks nor TNT was fired, leave Column 36 blank.

Column 37-41, Height Above (+) or Depth Below (-) Ground. Enter a 0 in Columns 37-41 if the weapon code in Columns 19-20 was anything but 10 or 11. If TNT (Weapon Codes 10 or 11) was detonated above ground, enter the height in feet preceded by a plus sign into Columns 37-41. If TNT was buried enter the depth in feet preceded by a minus sign.

On an additional sheet the following entries are to be included: whether locations are in feet or meters; overall percentage of illumination rounds; percentage of time fuses; percentage of proximity fuses; assignment of unused code numbers to additional weapon types used at the base; inversion and operational conditions (see Appendix C); time period data was taken; name of person preparing work and information about the base.

1 EXAMPLES USED TO COMPLETE TARGET DATA SHEET

Columns 2-5, Target Identification.

Less Than 25 Targets. Copy the target identification number directly from map (Figure A54) and enter it onto the Target Data Sheet (Figure A55).

More Than 25 Targets. Group targets into a $\frac{1}{2}$, 1 or $1\frac{1}{2}$ kilometer radius circle. If a population center is near, the radius of the circle must not exceed $\frac{1}{2}$ of the distance between the population center and the center of the circle. Figure A56 shows several targets ready for grouping. Figure A57 shows the same targets after circles have been drawn. The city of Lawton is within 5 kilometers of the lower clusters of targets; consequently, two circles of $\frac{1}{2}$ kilometer radius and one of $\frac{3}{4}$ kilometer radius were drawn. The grouping with a $1\frac{1}{2}$ kilometer circle is far enough away from any population center so that it could be drawn to full size as evidenced in Figure A57. Create unique identification numbers, write them on the map and enter them in Columns 2-5 as shown in Figure A58.

Columns 7-12, X Coordinate.

Columns 13-18, Y Coordinate.

Targets Not Grouped.

1. Coordinates read from the map. The kilometer's place is copied from the coordinate numbers (running vertically and horizontally on the map), the hundred's place is estimated, and two zeros are added to the end so that a 5-digit number is entered in the Target Data Sheet.

As an example, the kilometer's place for the X-coordinate of Target Point 150 in Figure A59 is 43. Estimate the hundred's place as 8 and add two zeros to the end. The X-coordinate entered is 43800. Similarly, the Y-coordinate is 35700. The Target Data Sheet in Figure A60 shows the identification numbers and coordinates for the targets in Figure A59.

2. Coordinates read from Table of Metric Grid Coordinates. The first 5-digits under "Grid Reference" correspond to the X-coordinate and the last 5 correspond to the Y. Specifically, the coordinates for Target Point 157 are 44278 and 35815 as read from Table A9. The coordinates are entered in the Target Data Sheet as shown in Figure A61.

Table A9

Table of Metric Grid Coordinates

Tgt no	Grid Reference	Alt (meters)	Location	Description
687	44270 36453	487	WMHA	Red car body
689	43782 36151	421	WMHA	White car body
691	43608 35854	410	WMHA	White junk
699	43632 36685	464	WMHA	Red car body
701	30538 34657	405	OCA	Yellow car body
103	44519 35956	415	SMA-WMHA	Yellow junk
150	43844 35690	409	SMA-WMHA	White car body
154	43959 35412	402	SMA-WMHA	White car body
155	44046 35573	409	SMA-WMHA	Yellow car body
156	44031 35813	414	SMA-WMHA	White junk
157	44278 35815	412	SMA-WMHA	Red car body
160	44111 35944	417	SMA-WMHA	Yellow car body
118	45172 35744	402	SMA-WMHA	Yellow car body
124	45779 35577	400	SMA-WMHA	Yellow car body

Targets Grouped. If the targets have been grouped, simply read the coordinates for the target circles directly from the map. Remember to take the location of the target area as the center of the circles. A map with the centers of the circles indicated is shown in Figure A62 and the completed Target Data Sheet is displayed in Figure A63.

Column 1, End of Target Data Flag. When all targets have been entered onto the Target Data Sheets, place an asterisk in Column 1 of the last entry on the last Target Data Sheet. Include no more entries on the Target Data Sheets.

2 EXAMPLES USED TO COMPLETE FIRING POINT DATA SHEET

This example indicates how to complete the Firing Point Data Sheet. The material will be presented here by corresponding columns on the Firing Point Data Sheet. Remember to include only one firing point identification number for each Firing Point Data Sheet.

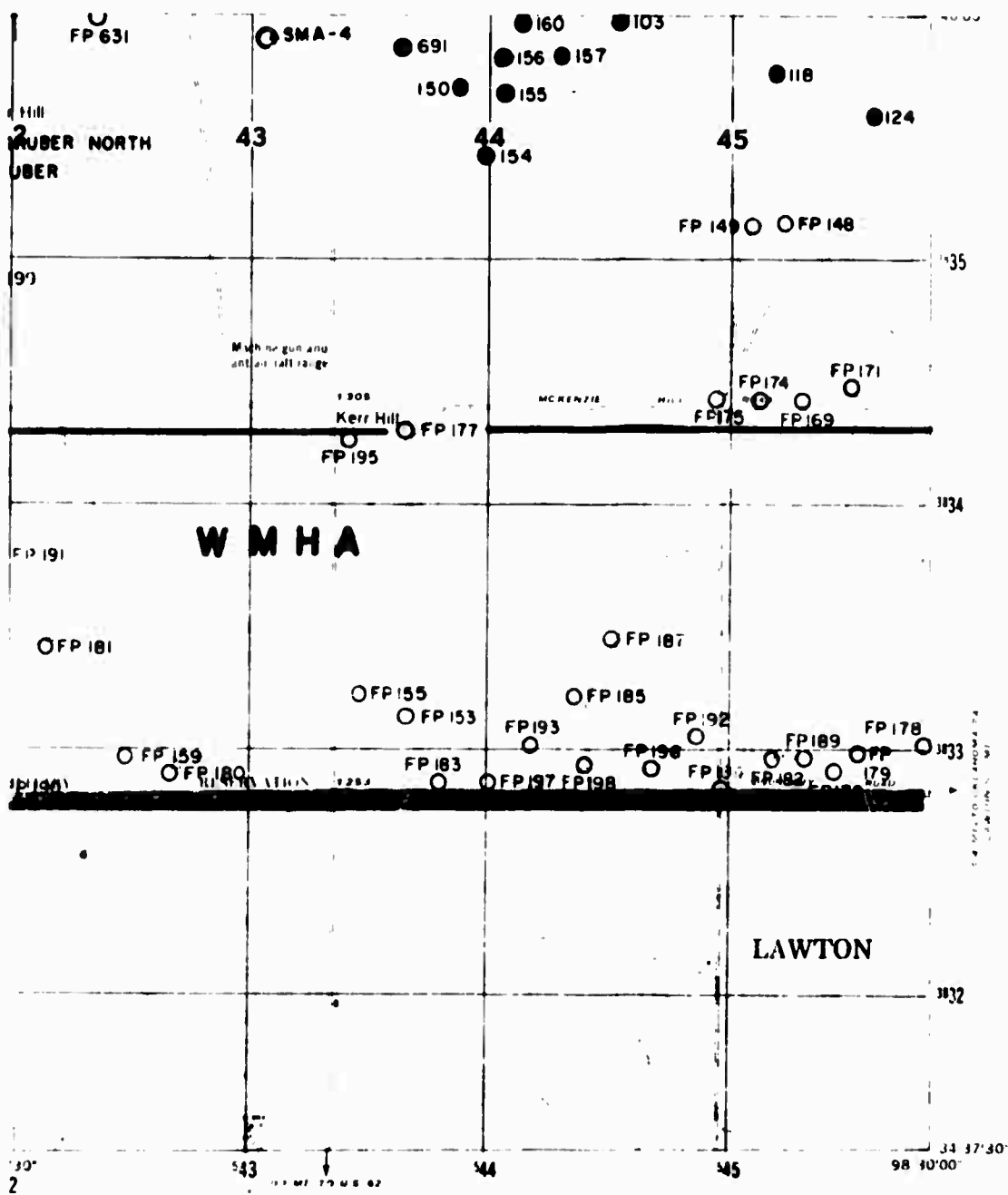

Figure A54. Map illustrating ungrouped targets.

1	2	3	4	5	6	7	8	9	10	11	12	13	14	15	16	17	18
	6	9	1														
	1	5	0														
	1	5	4														
	1	5	5														
	1	5	6														
	1	6	0														
	1	5	7														
	1	0	3														
	1	1	8														
	1	2	4														

Figure A55. Target Data Sheet containing identification numbers.

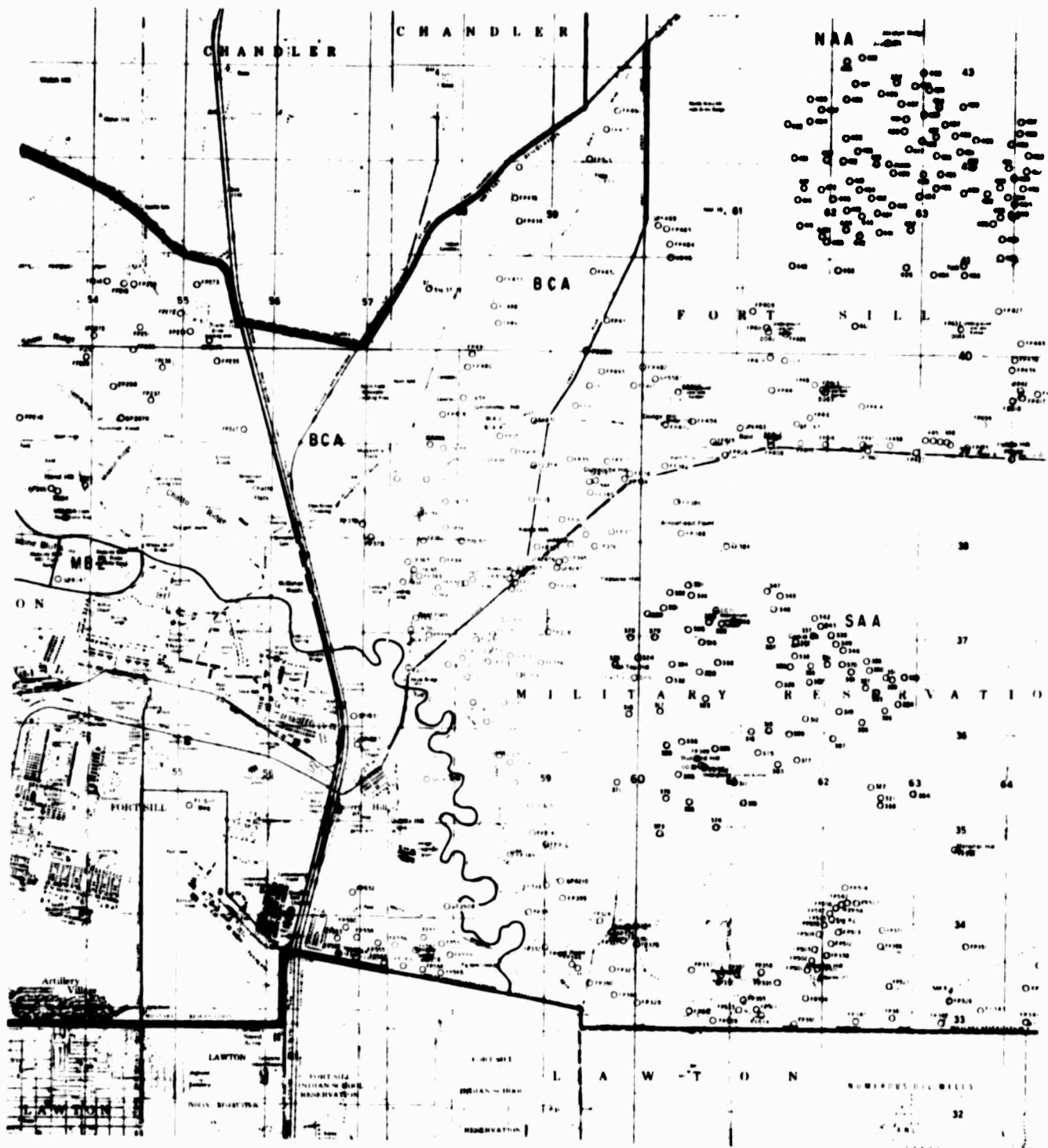

Figure A56. Map showing targets ready for grouping.

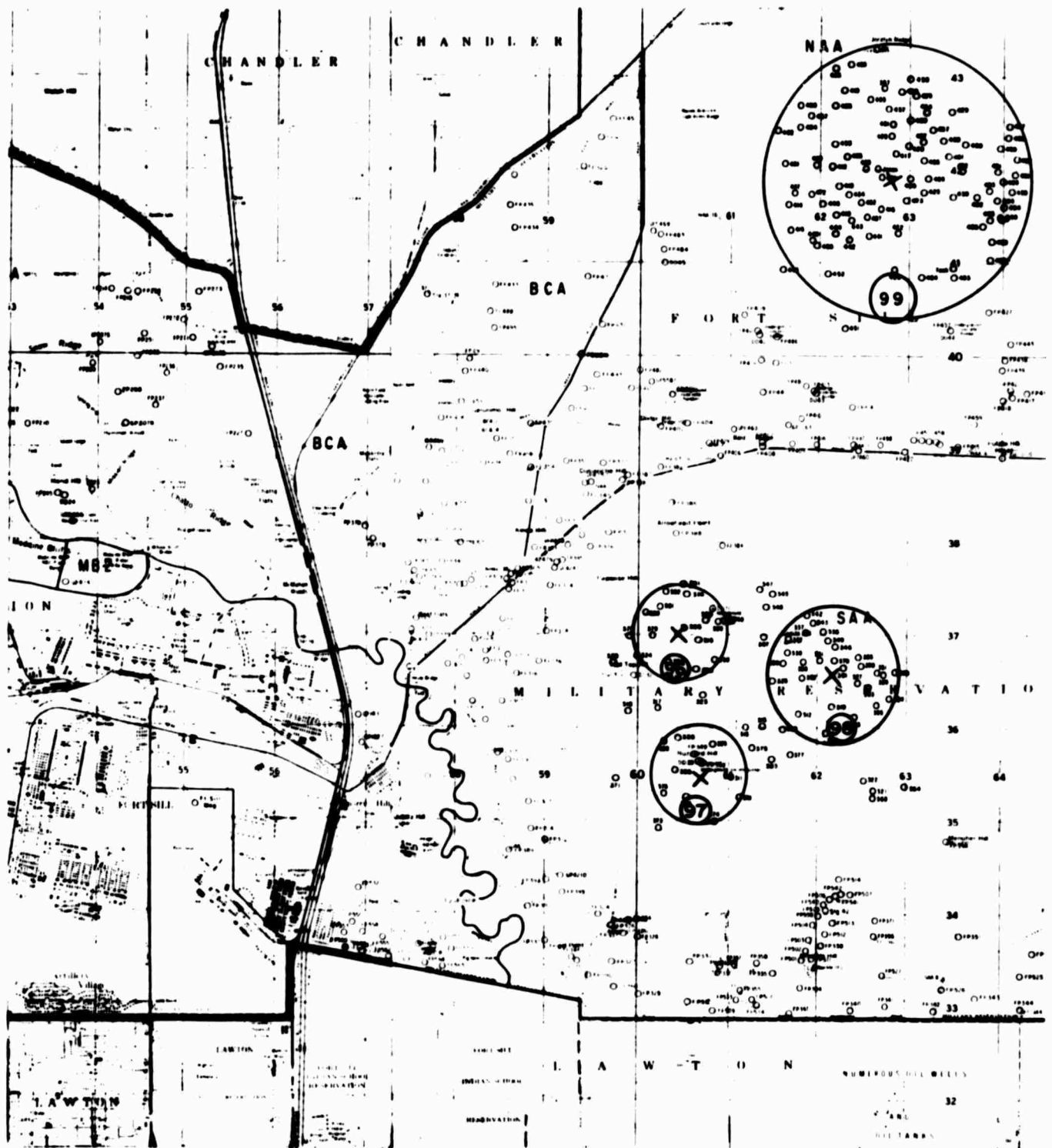

Figure A57. Map with targets grouped.

1	2	3	4	5	6	7	8	9	10	11	12	13	14	15	16	17	18
		691					43600					35900					
		150					43800					35700					
		154					44000					35400					
		155					44000					35600					
		156					44000					35800					
		160					44100					35900					
		157					44300					35800					
		103					44500					36000					
		118					45200					35700					
		124					45600					35600					

Figure A60. Target Data Sheet containing identification and coordinates.

1	2	3	4	5	6	7	8	9	10	11	12	13	14	15	16	17	18
		691					43608					35854					
		150					43844					35690					
		154					43959					35412					
		155					44046					35573					
		156					44031					35813					
		160					44111					35944					
		157					44278					35815					
		103					44519					35916					
		118					45172					35744					
		124					45579					35577					

Figure A61. Target Data Sheet displaying coordinates.

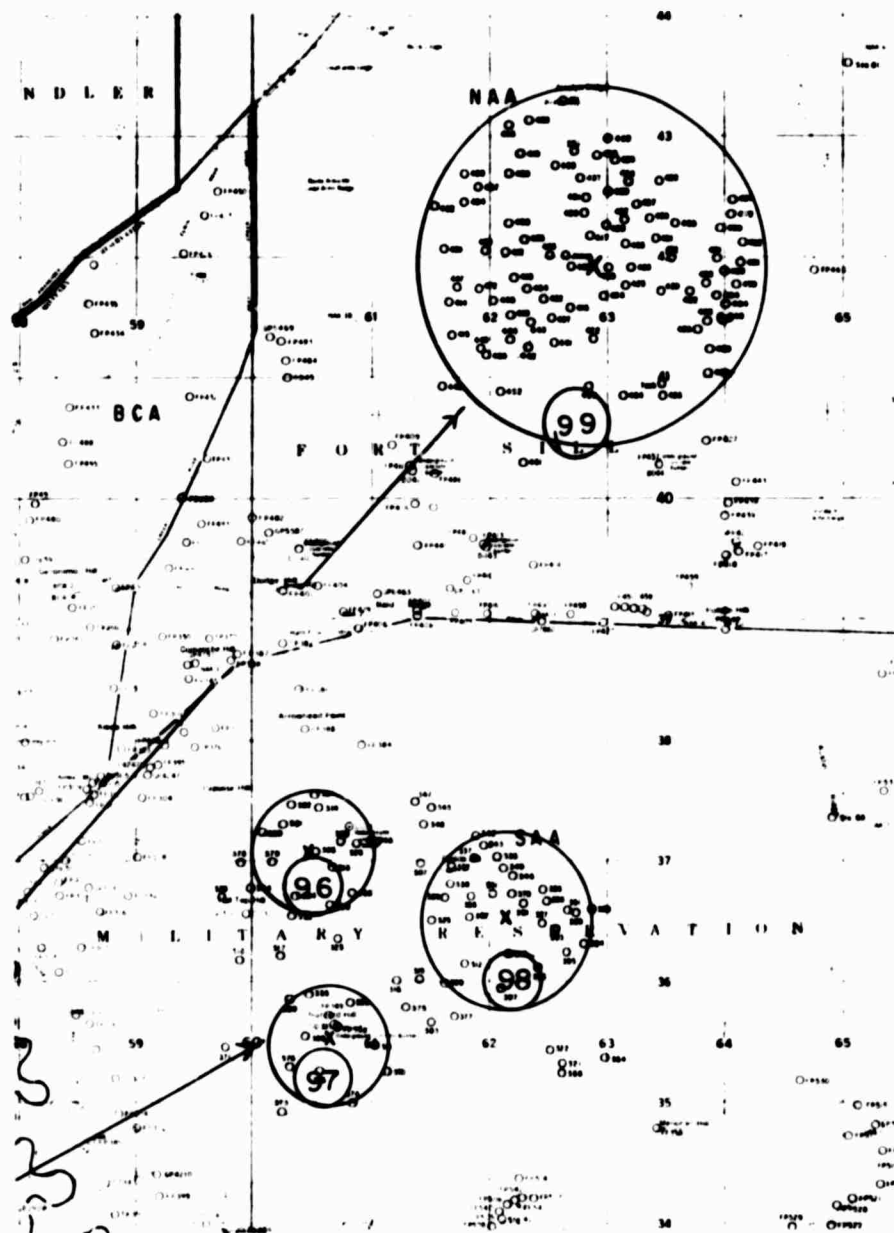

Figure A62. Map with center of target groups indicated.

1	2	3	4	5	6	7	8	9	10	11	12	13	14	15	16	17	18
			96				6	0	4	0			3	6	9	0	0
			97				6	0	5	0			3	5	5	0	0
			98				6	2	1	0			3	6	7	0	0
			99				6	2	9	0			4	2	0	0	0
*																	

Figure A63. Target Data Sheet showing coordinates.

The Box Above:

Columns 2-5, Firing Point Identification. This identification number is read from the Range Safety Card shown in Figures A64, A65, A66, and A67 or from the Range Control Log displayed in Figure A68. All of the firing points in Figures A64-67 collectively require one entry of 721 on the Firing Point Data Sheet as shown in Figure A69.

The Box Above:

Columns 7-12, X Coordinate.

Columns 13-18, Y Coordinate.

Range Safety Card. From Figure A70, the first 4-digit number following "Firing Point" is the X coordinate. Add a zero to the end and enter 32010. Likewise, the second 4-digit number indicated in Figure A70 is the Y Coordinate and is entered as 34250. The Firing Point Data Sheet is shown with these entries in Figure A71.

Map. Coordinates can be read from the map in Figure A72 if desired. The X Coordinate is 320. Add 2 zeros to the end of this number and enter on the Firing Point Data Sheet (Figure A73). Similarly, add 2 zeros to 343 and enter this number in the block for the Y Coordinate.

Table of Metric Grid Coordinates. From Table A11, the X coordinate is the first number listed for Firing Point 721. Round this number to 531978 and enter 31978 after deleting the first digit. The Y coordinate is entered as 34251 as shown in Figure A74.

Columns 19-20, Weapon Type. Consult the Range Safety Cards as shown in Figures A75, A76, A77, and A78 to find the weapon types used. Table A10 lists the codes to enter for weapons. A line is used for each Range Safety Card when filling in weapon types as shown in Figure A79.

Charge Range:

Columns 29-30, Minimum Charge.

Columns 31-32, Maximum Charge. Use the ap-

Table A10
Weapon Codes

Weapon	Code
105mm H	1
155mm H	2
8 in. H	3
175mm G	4
	5
	6
	7
	8
	9
Small Charge TNT (0.25-90 lbs)	10
Large Charge TNT (110-500 lbs)	11

Table A11
Table of Metric Grid Coordinates

Station	Coordinates	Azimuth (mils) Altitude (meters)
FP 719 S	(533106.9 - 834501.5)	394
FP 720	(531366.4 - 837346.3)	407
FP 721	(531977.8 - 834251.1)	386
FP 721 E	(532319.5 - 834094.8)	386
FP 721 S	(531855.3 - 833749.7)	390

plicable section below by first noting the Weapon Codes.

Non-TNT Weapons (Codes 1-9 from Columns 19-20). After referring to the Range Safety Cards in Figures A80, A81, A82, and A83 enter the 1-digit number after "Minimum Charge" and "Maximum Charge" in the respective columns as shown in Figure A84.

Non-TNT Weapons (Codes 1-9). If the typical charge is known, put zeros in Columns 29-30 and enter the charge in Columns 31-32.

Small Charge TNT (Code 10). For a 0.25-90 lb charge of TNT enter zeros in Columns 29-30 and fill Columns 31-32 with the code from Table A12.

Large Charge TNT (Code 11). For a 110-500 lb charge of TNT enter zeros in Columns 29-30 and fill Columns 31-32 with the code from Table A13.

Columns 21-24, Number Rounds per Day.

Columns 25-28, Number Rounds per Night.

Table A12

Maximum Charge Codes for a Small Charge of TNT

Weight of TNT lbs	Maximum Charge Code
0.25	1
1.00	2
5.00	3
10.00	4
15.00	5
25.00	6
35.00	7
50.00	8
70.00	9
90.00	10

Firing Entirely During Day. The Range Safety Card in Figure A85 shows fire occurring between 0700 and 2200 hours. From the Range Control Log in Figure A86, enter the number of rounds (49) in Columns 21-24. Put zeros in Columns 25-28 as shown in Figure A87.

Firing Entirely During Night. The Range Safety Card in Figure A88 indicates fire occurring between 2200 and 0700 hours. From the Range Control Log in Figure A86, enter the number of rounds (76) in Columns 25-28. Put zeros in Columns 21-24 as shown in Figure A89.

Fire Overlapping Between Day and Night. Split the number of rounds proportionately between the day and night. The Range Safety Cards in Figures A90 and A91 will be used as examples.

a. Find the number of hours in the day (0700-2200 hours) that fire occurs and round to nearest 1/2 hour.

Actual Time
In / Out

Figure A90:0600 - 1100 1000 hrs - 0700 hrs (start of day) = 3 hrs fired during day

Figure A91:2000 - 0100 2200 hrs (end of day) - 2000 hrs = 2 hrs fired during day

b. Find the number of hours in the night (2200-

Table A13

Maximum Charge Codes for a Large Charge of TNT

Weight of TNT lbs	Maximum Charge Code
110	1
140	2
170	3
200	4
240	5
290	6
340	7
380	8
440	9
500	10

0700 hours) that fire occurs and round to the nearest 1/2 hour.

Actual Time
In / Out

Figure A90:0600 - 1000 0700 hrs (start of day) - 0600 hrs = 1 hr fired during night

Figure A91:2000 - 0100 2400 hrs (midnight) - 2200 hrs (end of day) = 2 hrs + 0100 hrs - 0000 hrs (midnight) = 1 hr

2 hrs + 1 hr = 3 hours
(total) fired during night

c. Total the number of hours in which firing occurred during the day and night from above.

Figure A90: 3 hours (day) + 1 hour (night) = 4 hours (total)

Figure A91: 2 hours (day) + 3 hours (night) = 5 hours (total)

d. Make fractions for the day and night hours. The day fraction is Part 1/Part 3 and the night fraction is Part 2/Part 3.

Figure A90: 3 (day)/4 (total) = 3/4 (day fraction)
1 (night)/4 (total) = 1/4 (night fraction)

Figure A91: 2 (day)/5 (total) = 2/5 (day fraction)
3 (night)/5 (total) = 3/5 (night fraction)

RANGE SAFETY CARD

UPDT STR 2/18th DATE-TIME GP 1300-1830 Wed 2 May 73
FIRING POINT 721 (3198 3425) AREA CA SMA JRA
WEAPON 105 AMMUNITION SIL HE M57 FZM564 M520 M514
TYPE OF FIRE High & Low Angle
DIRECTION LIMITS (Ref GN) LEFT 4978 MILS, RIGHT 5330 MILS
LOW ANGLE PD MINIMUM RANGE 2000 METERS, MINIMUM CHARGE 2
FUZE TI, VT & HI ANGLE MINIMUM RANGE 3000 METERS, MINIMUM CHARGE 2
MAXIMUM RANGE TO IMPACT 3500 METERS, MAXIMUM CHARGE 6
SPECIAL INSTRUCTIONS Apply +5 seconds to Time of Flight corresponding to
Range 3000 to establish Minimum Time for Fuze VT.

See reverse side for special instructions as appropriate to authorized weapons, fuzes, and projectiles.

Figure A64. Range Safety Card.

RANGE SAFETY CARD

UNIT STR 2/18th DATE-TIME GP: 2200-0200 Wed 2 May 73
FIRING POINT 721 AREA: QCA SMA JRA
WEAPON: 105 AMMUNITION: SH HE M57 FZM564 M520 M514
TYPE OF FIRE: High & Low Angle _____
DIRECTION LIMITS: (Ref GN): LEFT 4978 MILS, RIGHT 5330 MILS
LOW ANGLE PD MINIMUM RANGE 3500 METERS, MINIMUM CHARGE 2
FUZE TI, VT & HI ANGLE MINIMUM RANGE 4000 METERS, MINIMUM CHARGE 2
MAXIMUM RANGE TO IMPACT 5000 METERS, MAXIMUM CHARGE 6

SPECIAL INSTRUCTIONS: Apply +5.5 seconds to Time of Flight corresponding to
Range 3000 to establish Minimum Time for Fuze VT.

See reverse side for special instructions as appropriate to authorized weapons, fuzes, and projectiles.

Figure A65. Range Safety Card.

RANGE SAFETY CARD

UNIT/STR: 2/18th DATE-TIME GP: 0600-1000 Wed 2 May 73
FIRING POINT: 721 (3198 3425) AREA: QCA SMA JRA
WEAPON: 8" AMMUNITION: SH HE M57 FZM564 M520 M514
TYPE OF FIRE: High & Low Angle
DIRECTION LIMITS: (Ref GN): LEFT 4800 MILS, RIGHT 5156 MILS
LOW ANGLE PD MINIMUM RANGE 3500 METERS, MINIMUM CHARGE 1
FUZE TI, VT & HI ANGLE MINIMUM RANGE 4000 METERS, MINIMUM CHARGE 1
MAXIMUM RANGE TO IMPACT 5000 METERS, MAXIMUM CHARGE 4

SPECIAL INSTRUCTIONS: Apply +5.5 seconds to Time of Flight corresponding to
Range 3000 to establish Minimum Time for Fuze VT.
See reverse side for special instructions as appropriate to authorized weapons, fuzes, and projectiles.

Figure A66. Range Safety Card.

RANGE SAFETY CARD

UNIT STG. 2/18th DATE-TIME GP. 2000-0100 Wed 2 May 73
FIRING POINT 721 (3232 3409) AREA QCA SMA JRA
WEAPON: 105 AMMUNITION: SH HE M57 FZM564 M520 M514
TYPE OF FIRE: High & Low Angle _____
DIRECTION LIMITS. (Ref GNI): LEFT _____ MILS, RIGHT 5156 _____ MILS
LOW ANGLE PD MINIMUM RANGE _____ METERS, MINIMUM CHARGE 2
FUZE TI, VT & HI ANGLE MINIMUM RANGE 4000 _____ METERS, MINIMUM CHARGE 2
MAXIMUM RANGE TO IMPACT _____ METERS, MAXIMUM CHARGE 6

SPECIAL INSTRUCTIONS: Apply +5.5 seconds to Time of Flight corresponding to
Range 3000 _____ to establish Minimum Time for Fuze VT.

See reverse side for special instructions as appropriate to authorized weapons, fuzes, and projectiles.

Figure A67. Range Safety Card.

RANGE		FIRING ORDER NR		RANGE CONTROL LOG										DATE		RANGE
North		32												2 May 73		
PROBLEM	UNIT	SCHEDULED TIME		FIRING POINT/GRID	OPR & PHONE LOCATION	OIC	ACTUAL TIME		CHECKFIRE		NUMBER PERSONS FIRED	WEAPON				
		IN	OUT				IN	OUT	IMPOSED TIME	LIFTED TIME/NAME						
SPC	2/18	1900	1900	721	SPT Griffin	SPT Carlson	1900	1930			50	105				
SPC	2/18	2200	0200	721	SPT Williams	SPT Carlson	2200	0200			48	105				
SPC	2/18	0600	1100	721	SPT Coppins	SPT Carlson	0600	1000			74	8				
SPC	2/18	2000	0130	721	SPT Jones	SPT Carlson	2000	0100			16	105				

Figure A66. Range Control Log.

RANGE SAFETY CARD

UNIT/STR: 2/18th DATE-TIME GP: 1300-1800 Wed 2 May 73
FIRING POINT: 721 (3201 3425) AREA: OCA SMA JRA
WEAPON: 105 AMMUNITION: SH HE M57 FZM564 M520 M514
TYPE OF FIRE: High & Low Angle
DIRECTION LIMITS: (Ref GN): LEFT 4978 MILS, RIGHT 5330 MILS
LOW ANGLE PD MINIMUM RANGE 2000 METERS, MINIMUM CHARGE 2
FUZE TI, VT & HI ANGLE MINIMUM RANGE 3000 METERS, MINIMUM CHARGE 2
MAXIMUM RANGE TO IMPACT 3500 METERS, MAXIMUM CHARGE 6

SPECIAL INSTRUCTIONS: Apply +5.5 seconds to Time of Flight corresponding to
Range 3000 to establish Minimum Time for Fuze VT.

See reverse side for special instructions as appropriate to authorized weapons, fuzes, and projectiles.

Figure A70. Range Safety Card showing coordinates.

RANGE SAFETY CARD

UNIT/STR: 2/18th DATE-TIME GP: 1300-1830 Wed 2 May 73

FIRING POINT: 721 (3198 3425) AREA: QCA SMA JRA

WEAPON: 105 AMMUNITION: SH HE M57 FZM564 M520 M514

TYPE OF FIRE: High & Low Angle

DIRECTION LIMITS: (Ref GN): LEFT 4978 MILS, RIGHT 5330 MILS

LOW ANGLE PD MINIMUM RANGE 2000 METERS, MINIMUM CHARGE 2

FUZE TI, VT & HI ANGLE MINIMUM RANGE 3000 METERS, MINIMUM CHARGE 2

MAXIMUM RANGE TO IMPACT 3500 METERS, MAXIMUM CHARGE 6

SPECIAL INSTRUCTIONS: Apply +5.5 seconds to Time of Flight corresponding to Range 3000 to establish Minimum Time for Fuze VT.

See reverse side for special instructions as appropriate to authorized weapons, fuzes, and projectiles.

Figure A75. Range Safety Card with weapons indicated.

RANGE SAFETY CARD

UNIT/STR: 2/18th DATE-TIME GP: 2200-0200 Wed 2 May 73
FIRING POINT: 721 AREA: QCA SMA JRA
WEAPON: 105 AMMUNITION: SH HE M57 FZM564 M520 M514
TYPE OF FIRE: High & Low Angle _____
DIRECTION LIMITS: (Ref GN): LEFT 4978 MILS, RIGHT 5330 MILS
LOW ANGLE PD MINIMUM RANGE 3500 METERS, MINIMUM CHARGE 2
FUZE TI, VT & HI ANGLE MINIMUM RANGE 4000 METERS, MINIMUM CHARGE 2
MAXIMUM RANGE TO IMPACT 5000 METERS, MAXIMUM CHARGE 6

SPECIAL INSTRUCTIONS: Apply +5.5 seconds to Time of Flight corresponding to
Range 3000 to establish Minimum Time for Fuze VT.

See reverse side for special instructions as appropriate to authorized weapons, fuzes, and projectiles.

Figure A76. Range Safety Card with weapons indicated.

RANGE SAFETY CARD

UNIT/STR: 2/18th DATE-TIME GP: 0600-1000 Wed 2 May 73
FIRING POINT: 721 (3198 3425) AREA: QCA SVA JRA
WEAPON: 8" AMMUNITION: SH HE M57 FZM564 M520 M514
TYPE OF FIRE: High & Low Angle _____
DIRECTION LIMITS: (Ref GN): LEFT 4800 MILS, RIGHT 5156 MILS
LOW ANGLE PD MINIMUM RANGE 3500 METERS, MINIMUM CHARGE 1
FUZE TI, VT & HI ANGLE MINIMUM RANGE 4000 METERS, MINIMUM CHARGE 1
MAXIMUM RANGE TO IMPACT 5000 METERS, MAXIMUM CHARGE 4

SPECIAL INSTRUCTIONS: Apply +5.5 seconds to Time of Flight corresponding to
Range 3000 to establish Minimum Time for Fuze VT.

See reverse side for special instructions as appropriate to authorized weapons, fuzes, and projectiles.

Figure A77. Range Safety Card with weapons indicated.

RANGE SAFETY CARD

UNIT/STR: 2/18th DATE-TIME GP: 2000-0100 Wed 2 May 73
FIRING POINT: 721 (3232 3409) AREA: QCA SMA JRA
WEAPON: 105 AMMUNITION: SH HE M57 FZM564 M520 M514
TYPE OF FIRE: High & Low Angle _____
DIRECTION LIMITS: (Ref G-I): LEFT _____ MILS, RIGHT 5156 MILS
LOW ANGLE PD MINIMUM RANGE 3500 METERS, MINIMUM CHARGE 2
FUZE TI, VT & HI ANGLE MINIMUM RANGE 4000 METERS, MINIMUM CHARGE 2
MAXIMUM RANGE TO IMPACT 6000 METERS, MAXIMUM CHARGE 6

SPECIAL INSTRUCTIONS: Apply ± 5.5 seconds to Time of Flight corresponding to
Range 3000 to establish Minimum Time for Fuze VT.
See reverse side for special instructions as appropriate to authorized weapons, fuzes, and projectiles.

Figure A78. Range Safety Card with weapons indicated.

RANGE SAFETY CARD

UNIT/STR: 2/18th DATE-TIME GP: 1300-1830 Wed 2 May 73
FIRING POINT: 721 (3198 3425) AREA: QCA SMA JRA
WEAPON: 105 AMMUNITION: SH HE M57 FZM564 M520 M514
TYPE OF FIRE: High & Low Angle _____
DIRECTION LIMITS: (Ref GN): LEFT 4978 MILS, RIGHT 5330 MILS
LOW ANGLE PD MINIMUM RANGE 2000 METERS, MINIMUM CHARGE 2
FUZE TI, VT & HI ANGLE MINIMUM RANGE 3000 METERS, MINIMUM CHARGE 2
MAXIMUM RANGE TO IMPACT 3500 METERS, MAXIMUM CHARGE 6

SPECIAL INSTRUCTIONS: Apply +5.5 seconds to Time of Flight corresponding to
Range 3000 to establish Minimum Time for Fuze VT.
See reverse side for special instructions as appropriate to authorized weapons, fuzes, and projectiles.

Figure A80. Range Safety Card showing charge range.

RANGE SAFETY CARD

UNIT/STR: 2/18th DATE-TIME GP: 2200-0200 Wed 2 May 73
FIRING POINT: 721 AREA: QCA SMA JRA
WEAPON: 105 AMMUNITION: SH HE M57 FZM564 M520 M514
TYPE OF FIRE: High & Low Angle _____
DIRECTION LIMITS: (Ref GN): LEFT 4978 MILS, RIGHT 5330 MILS
LOW ANGLE PD MINIMUM RANGE 3500 METERS, MINIMUM CHARGE 2
FUZE T1, VT & HI ANGLE MINIMUM RANGE 4000 METERS, MINIMUM CHARGE 2
MAXIMUM RANGE TO IMPACT 5000 METERS, MAXIMUM CHARGE 6

SPECIAL INSTRUCTIONS: Apply +5.5 seconds to Time of Flight corresponding to
Range 3000 to establish Minimum Time for Fuze VT.
See reverse side for special instructions as appropriate to authorized weapons, fuzes, and projectiles.

Figure AB1. Range Safety Card showing charge range.

RANGE SAFETY CARD

UNIT/STR: 2/18th DATE/TIME GP: 0600-1000 Wed 2 May 73
FIRING POINT: 721 (3198 3425) AREA: QCA SMA JRA
WEAPON: 8" AMMUNITION: SH HE M57 FZM564 M520 M514
TYPE OF FIRE: High & Low Angle
DIRECTION LIMITS: (Ref GN): LEFT 4800 MILS, RIGHT 5156 MILS
LOW ANGLE PD MINIMUM RANGE 3500 METERS, MINIMUM CHARGE 1
FUZE TI, VT & HI ANGLE MINIMUM RANGE 4000 METERS, MINIMUM CHARGE 1
MAXIMUM RANGE TO IMPACT 5000 METERS, MAXIMUM CHARGE 4

SPECIAL INSTRUCTIONS: Apply +5.5 seconds to Time of Flight corresponding to
Range 3000 to establish Minimum Time for Fuze VT.

See reverse side for special instructions as appropriate to authorized weapons, fuzes, and projectiles.

Figure A82. Range Safety Card showing charge range.

RANGE SAFETY CARD

UNIT/STR: 2/18th DATE-TIME GP: 2000-0100 Wed 2 May 73
FIRING POINT: 721 (3232 3409) AREA: QCA SMA JRA
WEAPON: 105 AMMUNITION: SH HE M57 FZM564 M520 M514
TYPE OF FIRE: High & Low Angle
DIRECTION LIMITS: (Ref GNI): LEFT 4800 MILS, RIGHT 5156 MILS
LOW ANGLE PD MINIMUM RANGE 3500 METERS, MINIMUM CHARGE 2
FUZE TI, VT & HI ANGLE MINIMUM RANGE 4000 METERS, MINIMUM CHARGE 2
MAXIMUM RANGE TO IMPACT 6000 METERS, MAXIMUM CHARGE 6

SPECIAL INSTRUCTIONS: Apply +5.5 seconds to Time of Flight corresponding to
Range 3000 to establish Minimum Time for Fuze VT.

See reverse side for special instructions as appropriate to authorized weapons, fuzes, and projectiles.

Figure A83. Range Safety Card showing charge range.

RANGE SAFETY CARD

UNIT/STR. 2/18th DATE-TIME GP. 1300-1830 Wed 2 May 73
FIRING POINT: 721 (3198 3425) AREA: QCA SMA JRA
WEAPON: 105 AMMUNITION: SH HE M57 FZM564 M520 M514
TYPE OF FIRE: High & Low Angle
DIRECTION LIMITS: (Ref GNI): LEFT 4978 MILS, RIGHT 5330 MILS
LOW ANGLE PD MINIMUM RANGE 2000 METERS, MINIMUM CHARGE 2
FUZE TI, VT & HI ANGLE MINIMUM RANGE 3000 METERS, MINIMUM CHARGE 2
MAXIMUM RANGE TO IMPACT 3500 METERS, MAXIMUM CHARGE 6

SPECIAL INSTRUCTIONS: Apply +5.5 seconds to Time of Flight corresponding to
Range 11,600 to establish Minimum Time for Fuze VT.

See reverse side for special instructions as appropriate to authorized weapons, fuzes, and projectiles.

Figure A65. Range Safety Card indicating firing entirely during the day.

RANGE North	FIRING ORDER NBR 32	RANGE CONTROL LOG										DATE 24 Aug 73	RANGE				
		PROBLEM	UNIT	SCHEDULED TIME		FIRING POINT/GRID	OPR & PHONE LOCATION	OIC	ACTUAL TIME		CHECKERS			NUMBER PERSONS	ROUNDS FIRED	WEAPON	
				IN	OUT				IN	OUT	IMPOSED TIME	NAME	TIME	NAME			
SPC	2/18		1300	1700	721	Pvt Griffin	Carson		1300	1700					50	49	105
SPC	2/18		2000	2200	721	Pvt Williams	Carson		2000	2200					41	76	105
SPC	2/18		2600	1100	721	Pvt Williams	Carson		2600	1100					74	83	8
SPC	2/18		2000	0130	721	Pvt Jones	Carson		2000	0130					16	94	105

Figure A86. Range Control Log showing number of rounds.

RANGE SAFETY CARD

UNIT/STR: 2/18th DATE-TIME GP: 2200-0200 Wed 2 May 73
FIRING POINT: 721 AREA: QCA SMA JRA
WEAPON: 105 AMMUNITION: SH HE M57 FZM564 M520 M514
TYPE OF FIRE: High & Low Angle
DIRECTION LIMITS: (Ref GN): LEFT 4978 MILS, RIGHT 5330 MILS
LOW ANGLE PD MINIMUM RANGE 3500 METERS, MINIMUM CHARGE 2
FUZE TI, VT & HI ANGLE MINIMUM RANGE 4000 METERS, MINIMUM CHARGE 2
MAXIMUM RANGE TO IMPACT 5000 METERS, MAXIMUM CHARGE 6

SPECIAL INSTRUCTIONS: Apply +5.5 seconds to Time of Flight corresponding to
Range 11,600 to establish Minimum Time for Fuze VT.
See reverse side for special instructions as appropriate to authorized weapons, fuzes, and projectiles.

Figure A88. Range Safety Card indicating fire during the night.

721						31978						34251																																		
1	2	3	4	5	6	7	8	9	10	11	12	13	14	15	16	17	18	19	20	21	22	23	24	25	26	27	28	29	30	31	32	33	34	35	36	37	38	39	40	41						
																		1			49						00		2		6															
																		1			00						76		2		6															
																		3											1		4															
																		1											2		6															

Figure A89. Firing Point Data Sheet showing fire entirely during the night.

RANGE SAFETY CARD

UNIT/STR: 2/18th DATE-TIME GP: 0600-1000 Wed 2 May 73
FIRING POINT: 721 (3198 3425) AREA: QCA SMA JRA
WEAPON: 8" AMMUNITION: SH HE M57 FZM564 M520 M514
TYPE OF FIRE: High & Low Angle
DIRECTION LIMITS: (Ref GN): LEFT 4800 MILS, RIGHT 5156 MILS
LOW ANGLE PD MINIMUM RANGE 3500 METERS, MINIMUM CHARGE 1
FUZE TI, VT & HI ANGLE MINIMUM RANGE 4000 METERS, MINIMUM CHARGE 1
MAXIMUM RANGE TO IMPACT 5000 METERS, MAXIMUM CHARGE 4

SPECIAL INSTRUCTIONS: Apply +5.5 seconds to Time of Flight corresponding to
Range 11,600 to establish Minimum. Time for Fuze VT.

See reverse side for special instructions as appropriate to authorized weapons, fuzes, and projectiles.

Figure A90. Range Safety Card indicating fire split during the day and night.

RANGE SAFETY CARD

UNIT/STR: 2/18th DATE-TIME GP: 2000-0100 Wed 2 May 73
FIRING POINT: 721 (3232 3409) AREA: QCA SMA JRA
WEAPON: 105 AMMUNITION: SH HE M57 FZM564 M520 M514
TYPE OF FIRE: High & Low Angle _____
DIRECTION LIMITS: (Ref GN): LEFT 4800 MILS, RIGHT 5156 MILS
LOW ANGLE PD MINIMUM RANGE 3500 METERS, MINIMUM CHARGE 2
FUZE TI, VT & HI ANGLE MINIMUM RANGE 4000 METERS, MINIMUM CHARGE 2
MAXIMUM RANGE TO IMPACT 6000 METERS, MAXIMUM CHARGE 6

SPECIAL INSTRUCTIONS: Apply +5.5 seconds to Time of Flight corresponding to
Range 11,600 to establish Minimum Time for Fuze VT.
See reverse side for special instructions as appropriate to authorized weapons, fuzes, and projectiles.

Figure A91. Range Safety Card indicating fire split during the day and night.

c. Multiply the day and night fractions respectively times the number of rounds found in the Range Control Log, round to a whole number, and enter in the correct columns as shown in Figure A92.

Figure A90: $\frac{3}{4} \times 83$ rounds = 62.25 = 62 rounds/day
 $\frac{1}{4} \times 83$ rounds = 20.75 = 21 rounds/night.

Figure A91: $\frac{2}{3} \times 94$ rounds = 37.60 = 38 rounds/day
 $\frac{1}{3} \times 94$ rounds = 56.40 = 56 rounds/night.

Columns 33-35, Target Identification.

Targets Not Grouped. With a small number of targets, it is usually known where every round went. If not, consult the next subsection.

Targets Grouped. When targets have been grouped, it is necessary to consult the correct Range Safety Card to read the "Direction Limits (both left and right)," "Low Angle Point Detonating Minimum Range" and the "Maximum Range to Impact."

A protractor is placed on the map and the "Direction Limits" are drawn so that "pie slices" are formed. Next, a rule calibrated to the scale of the map is used to mark the minimum and maximum ranges. After the ranges have been marked, a "truncated pie slice" is formed and the following directions are adhered to: If the "truncated pie slice" covers only one target group, go to 1 below. On the other hand, if the "truncated pie slice" covers two target groups, part 2 below is followed.

1. Targets grouped (simple cases). Consult the Range Safety Card in Figure A93 and read the "Direction Limits" (left and right) as they are marked. Pay particular attention also to the "Low Angle Point Detonating Minimum Range" and the "Maximum Range to Impact."

Lay a protractor over the map, mark the direction limits and draw "pie slices" as has been done in Figure A97. Use a rule calibrated to the scale of the map and mark the minimum and maximum range as read from the Range Safety Card. As can be seen from Figure A97, a truncated "pie slice" is thus

formed out of the pie slice. Since Target Group 18 falls entirely within the truncated "pie slice," this identification number is entered on the Firing Point Data Sheet as shown in Figure A101.

2. Targets grouped (complex case). If after drawing "pie slices" from the direction limits and truncated "pie slices" from the ranges, two or more target groups fall within a truncated "pie slice," number of rounds must be divided as to the ratio of included areas.

Figures A94, A95, and A96 are Range Safety Cards on which the direction limits have been marked. Figures A98, A99 and A100 are maps with direction limits and ranges drawn in. From Figures A98 and A99 it can be seen that one-half of the rounds go to target area 15 and the other half go to target 16. From Figure A100 it is seen that one-third go to target 15 and two-thirds to target 16.

Erasing must now be done on a new Firing Point Data Sheet used. Copy the information from weapon type and charge range directly below the latter three original entries so that the Firing Point Data Sheet appear: as shown in Figure A102.

From Figures A98 and A99, since one-half of the rounds go to target 15 and half to 16, the number of rounds per day and night must also be divided in this manner. Figure A103 shows how the rounds are divided. Compare Figure A103 with Figures A101 and A102.

From Figure A100, the ratios are one-third and two-thirds for targets 15 and 16. Take one-third of 38 rounds for the day and one-third of 56 rounds for the night. Enter these new day and night rounds for target 15. Do similarly for target 16. See Figure A104 for the completed Firing Point Data Sheet.

Column 1, End of Source Data Flag. After all entries have been completed on the Firing Point Data Sheet, an asterisk is placed in Column 1 after the last entry as shown in Figure A104.

On an additional sheet items are entered as they pertain to the base. A typical attachment sheet is shown in Figure A105.

721					31978					34251																																	
1	2	3	4	5	6	7	8	9	10	11	12	13	14	15	16	17	18	19	20	21	22	23	24	25	26	27	28	29	30	31	32	33	34	35	36	37	38	39	40	41			
																		1			49				00			2		6													
																		1			00				76			2		6													
																		3			62				21			1		4													
																		1			38				56			2		6													

Figure A92. Firing Point Data Sheet indicating number of rounds per day and night.

RANGE SAFETY CARD

UNIT/STR: 2/18th DATE-TIME GP: 1300-1830 Wed 2 May 73
FIRING POINT: 721 (3198 3425) AREA: OCA SMA JRA
WEAPON: 105 AMMUNITION: SIL HE M57 FZM564 M520 M514

TYPE OF FIRE: High & Low Angle

DIRECTION LIMITS: (Ref GNI): LEFT 4978 5330 MILS, RIGHT 5330 MILS
LOW ANGLE PD MINIMUM RANGE 2000 METERS, MINIMUM CHARGE 2
FUZE TI, VT & HI ANGLE MINIMUM RANGE 3000 METERS, MINIMUM CHARGE 2
MAXIMUM RANGE TO IMPACT 3500 METERS, MAXIMUM CHARGE 6

SPECIAL INSTRUCTIONS: Apply ± 5.5 seconds to Time of Flight corresponding to
Range 3000 to establish Minimum Time for Fuze VT.

See reverse side for special instructions as appropriate to authorized weapons, fuzes, and projectiles.

Figure A93. Range Safety Card indicating direction limits and ranges.

RANGE SAFETY CARD

UNIT/STR: 2/18E1 DATE-TIME GP: 2200-0200 Wed 2 May 73

FIRING POINT: 721 AREA: QCA SMA JRA

WEAPON: 105 AMMUNITION: SH HE M57 FZM564 M520 M514

TYPE OF FIRE: High & Low Angle

DIRECTION LIMITS: (Ref GN): LEFT 4978 MILS, RIGHT 5330 MILS

LOW ANGLE PD MINIMUM RANGE 3500 METERS, MINIMUM CHARGE 2

FUZE TI, VT & HI ANGLE MINIMUM RANGE 4000 METERS, MINIMUM CHARGE 2

MAXIMUM RANGE TO IMPACT 5000 METERS, MAXIMUM CHARGE 6

SPECIAL INSTRUCTIONS: Apply +5.5 seconds to Time of Flight corresponding to
Range 3000 to establish Minimum Time for Fuze VT.

See reverse side for special instructions as appropriate to authorized weapons, fuzes, and projectiles.

Figure A94. Range Safety Card indicating direction limits and ranges.

RANGE SAFETY CARD

UNIT/STR: 2/18cb DATE-TIME GP: 0600-1000 Wed 2 May 73

FIRING POINT: 721 (3198 3425) AREA: QCA SMA JRA

WEAPON: 8" AMMUNITION: SH HE M57 FZM564 M520 M514

TYPE OF FIRE: High & Low Angle

DIRECTION LIMITS: (Ref GN): LEFT 4800 MILS, RIGHT 5156 MILS

LOW ANGLE PD MINIMUM RANGE 3500 METERS, MINIMUM CHARGE 1

FUZE TI, VT & HI ANGLE MINIMUM RANGE 4000 METERS, MINIMUM CHARGE 1

MAXIMUM RANGE TO IMPACT 5000 METERS, MAXIMUM CHARGE 4

SPECIAL INSTRUCTIONS: Apply +5.5 seconds to Time of Flight corresponding to
Range 3000 to establish Minimum Time for Fuze VT,

See reverse side for special instructions as appropriate to authorized weapons, fuzes, and projectiles.

Figure A95. Range Safety Card indicating direction limits and ranges.

RANGE SAFETY CARD:

UNIT/STR: 2/18th DATE/TIME GP: 2000-0100 Wed 2 May 73

FIRING POINT: 721 (3198 3425) AREA: QCA SMA JRA

WEAPON: 105 AMMUNITION: SH HE M57 FZM564 M520 M514

TYPE OF FIRE: High & Low Angle

DIRECTION LIMITS: (Ref GNI): LEFT 4800 MILS, RIGHT 5156 MILS

LOW ANGLE PD MINIMUM RANGE 3500 METERS, MINIMUM CHARGE 2

FUZE TI, VT & HI ANGLE MINIMUM RANGE 4000 METERS, MINIMUM CHARGE 2

MAXIMUM RANGE TO IMPACT 6000 METERS, MAXIMUM CHARGE 6

SPECIAL INSTRUCTIONS: Apply +5.5 seconds to Time of Flight corresponding to
Range 3000 to establish Minimum Time for Fuze VT.

See reverse side for special instructions as appropriate to authorized weapons, fuzes, and projectiles.

Figure A96. Range Safety Card indicating direction limits and ranges.

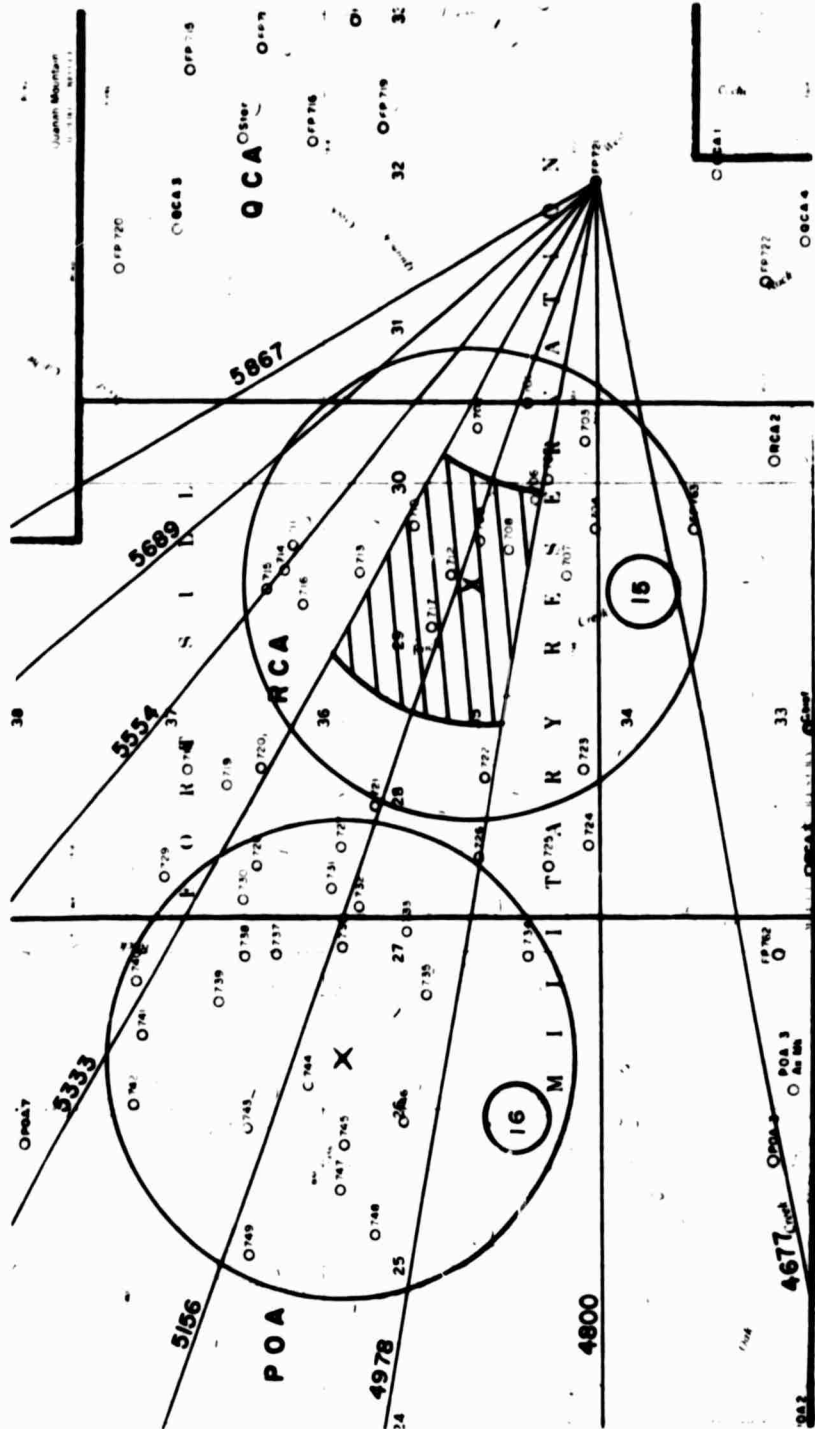

Figure A97. Map with direction limits and ranges marked.

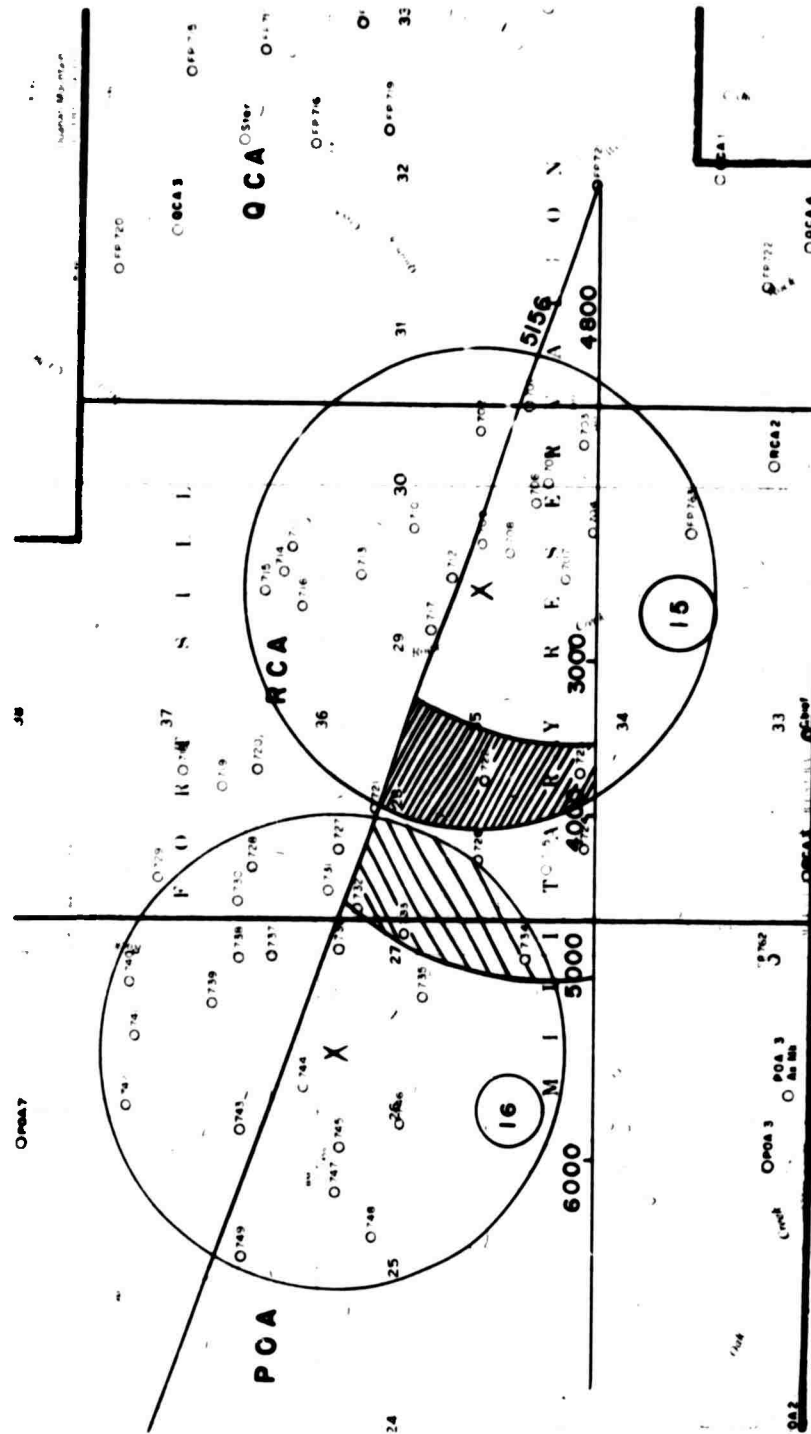

Figure A99. Map with direction limits and ranges drawn.

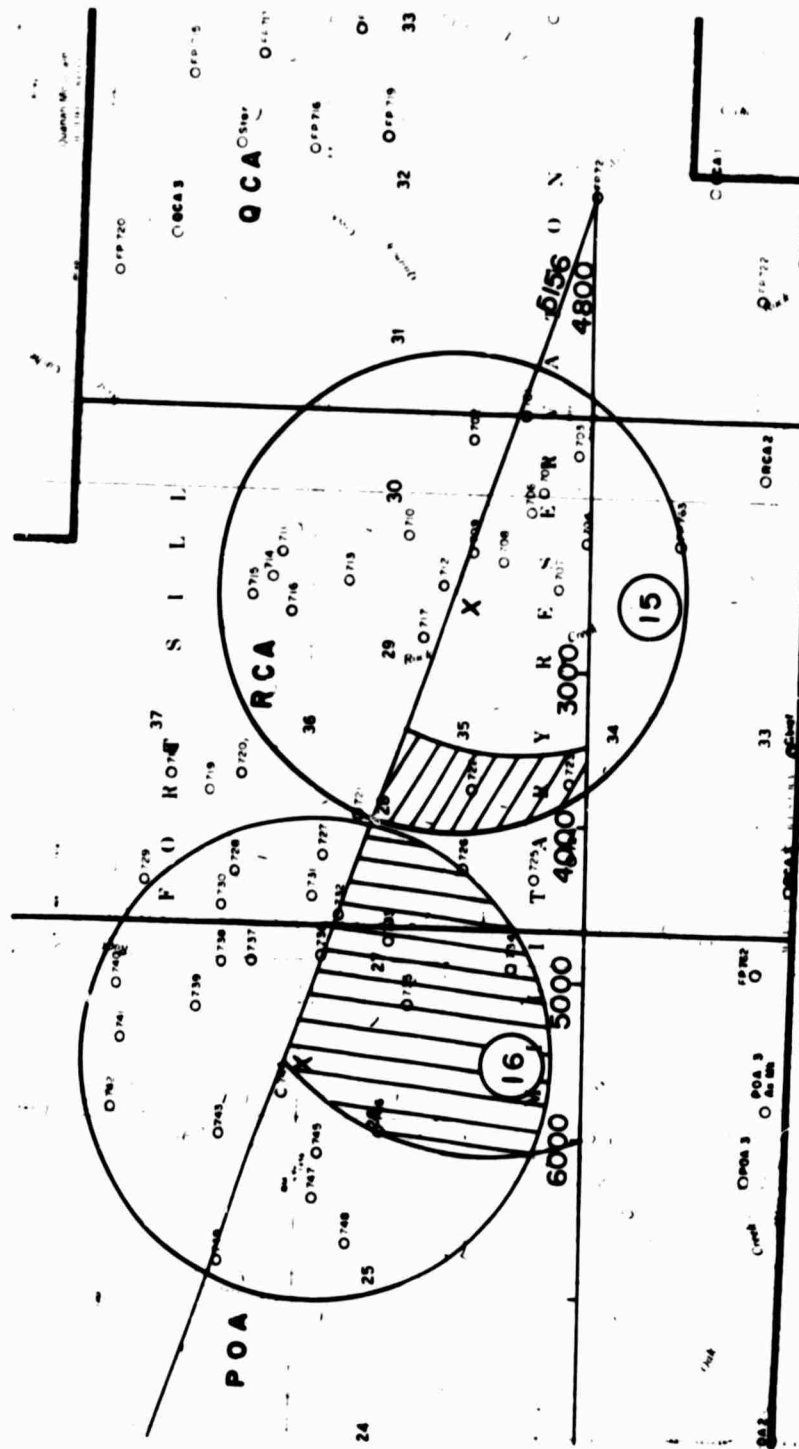

Figure A100. Map with direction limits and ranges drawn.

721					31978					34251					18	19	20	21	22	23	24	25	26	27	28	29	30	31	32	33	34	35	36	37	38	39	40	41																
																		1			4	9								0	0										2	6	1	5										
																		1																							2	6	1	5										
																		1																							2	6	1	6										
																		3																							1	4	1	5										
																		3																							1	4	1	6										
																		1																							2	6	1	5										
																		1																							2	6	1	6										

Figure A102. Firing Point Data Sheet with information copied.

			721				31978				34251																																																
1	2	3	4	5	6	7	8	9	10	11	12	13	14	15	16	17	18	19	20	21	22	23	24	25	26	27	28	29	30	31	32	33	34	35	36	37	38	39	40	41																			
																			1			49																																					
																			1			00																																					
																			1			00																																					
																			3			31																																					
																			3			31																																					
																			1																																								
																			1																																								

Figure A103. Firing Point Data Sheet with rounds divided.

721						31978						34251																														
1	2	3	4	5	6	7	8	9	10	11	12	13	14	15	16	17	18	19	20	21	22	23	24	25	26	27	28	29	30	31	32	33	34	35	36	37	38	39	40	41		
																		1			49				00			2	6	15											0	
																		1			00				38			2	6	15												0
																		1			00				38			2	6	16												0
																		3			31				10			1	4	15											0	
																		3			31				11			1	4	16											0	
																		1			12				18			2	6	15											0	
																		1			26				38			2	6	16											0	
																		*																								

Figure A104. Firing Point Data Sheet with rounds divided.

Name of Base _____

Name of Person Preparing Work _____

Title _____

Office _____ Phone _____

Signature: _____

Approving Supervisor's Signature _____ Date _____

Special Information:

1. Is this for an additional contour? _____
2. Hours during the day that firing occurs (or is predicted to occur) or percent of inversions _____
3. Night only firing option (see Appendix C) _____

For response to 2 and 3, see Appendix C. No response is necessary for the "normal" conditions.

4. Time Period Data was Taken _____

General Information:

Locations Specified (feet or meters) meters

Overall Percentage of Illumination Rounds 4%

Percentage of Time Fuses 15%

Percentage of Proximity Fuses 5%

Weapon 155 G Code 5

Weapon _____ Code 6

Weapon _____ Code 7

Weapon _____ Code 8

Weapon _____ Code 9

Figure A105. Attachment Sheet.

APPENDIX B: INTERPRETATION OF DATA

1 BASE MAP

This section describes land-use overlay maps by establishing land-use classifications. Figure B1 is a Reservation Map (described in AR-210-20) showing generalized land-use categories. On this map is superimposed a Noise Exposure Forecast (NEF) Contour overlay. It should be noted that this hypothetical example is a Reservation Map of Fort Sill, but in no way represents the noise impact of Fort Sill. The areas falling within the NEF 40 contour are those where noise from blasting and artillery would be most unacceptable. Complaints and threats of legal action from residents inside the NEF 40 contour would be the most vigorous. The areas between the NEF 30 and 40 contours are termed "Discretionally Acceptable" although some complaints are to be expected from residents and legal action may occur. The areas outside the NEF 30 contour are "Normally Acceptable."²

Referring to Figure B1, one can immediately identify the areas of impact. It can be seen that the NEF 40 contour includes a residential area in the northern part of the city of Lawton. This is the small shaded area shown. If the facility finds that it has extensive impact, then it may be desirable to construct special land-use and population density maps.

Land-Use Classifications. The intent when choosing land-use classifications is to identify the major or predominant land-use. That is, if there is an area that has several land-uses (residential and commercial), the use selected is the one that predominates. Of course, near a downtown area this tends to be commercial and in other locations it may be residential.

Activities which are particularly sensitive to noise should be considered; these may be termed high-sensitivity uses. This type of study therefore attempts to isolate areas of speech interference (where it is undesirable to have high outside noise levels and where loud noises decrease the livability of loca-

²*Land-Use Planning With Respect to Aircraft Noise*, Technical Manual 5-365 (1964), p 12

tions). The generalized classifications shown in Table B1 reflect predominant land usage by noise sensitivity groupings.

Table B1
Classifications Reflecting Predominant Land-Use

Classification	Description
1. Residential	Dwelling Units
2. General Commercial/Office	All Retail Business
3. Neighborhood Commercial/Office	Convenience shopping, offices, churches
4. Light Manufacturing	Low Inherent Noise Level (e.g., electronic assembly)
5. Heavy Manufacturing	High Inherent Noise Level (e.g., metal stamping)
6. High-Use Open Space	Recreational Open Space (e.g., parks, playgrounds, public sport centers)
7. Moderate-Use Open Space	Urban Services Open Space (e.g., cemeteries, airports, refuse disposal areas)
8. Low-Use Open Space	Agricultural - Conservation Open Space (e.g., farms, ecological research areas)
9. Noise Sensitive Land-Uses	Hospitals, Schools & Nursing Homes

Numbers preceding the following paragraphs refer to numbers in Tables B1 and B2.

1. Residential. This classification includes all types of dwelling units including single family residences, apartment buildings, and mobile homes.

2,3. Commercial. Two subclassifications are used: general and neighborhood. General commercial is defined as operations or businesses conducted primarily inside large buildings or occupying several acres of land and serving an areawide population. Examples would be large shopping centers, central business districts, and locations along frontage roads of interstate routes where there are many business concerns. Neighborhood commercial is generally categorized as small-scale, neighborhood-oriented businesses using smaller acreages. Such businesses are located away from major commercial centers where the surroundings have a general residential, agricultural, or open-space character.

4,5. Manufacturing. As with commercial, two subcategories are selected: light manufacturing and heavy manufacturing. The point of differentiation is

the inherent "normal" intensity of noise of the manufacturing activity. Therefore, light manufacturing would include such things as electronic assembly operations and industrial research facilities where the overall level of intrinsic noise is low. Heavy manufacturing would include milling, food processing, and metal stamping plants, where the normal noise levels are consistently high, and are not as sensitive to outside noise.

6.7.8. Open Space. Three subclassifications are selected for open space, based on the level of use. Low-use open space consists of farms, nonrecreational water bodies, floodplains, and similar uses. Moderate-use open space consists of land located in or close to a city, village, or town, and involving an intermittent use (church or cemetery) or performing a low-density public function (refuse sewage disposal or service as a buffer between incompatible land uses). High-use open space is descriptive of intensive land usage such as that for parks, playgrounds, recreational day programs, pools, or public sport centers (tennis courts, softball diamonds, intramural fields) or major recreational water bodies during high-use periods.

9. Noise Sensitive. These activities are particularly sensitive to noise and include hospitals, public schools, classrooms, theaters, nursing homes, rest homes, funeral homes, universities, junior colleges, mink farms, and chicken farms.

2 NOISE EXPOSURE AND COMMUNITY RESPONSE

Studies have shown that excessive noise causes physiological changes, including temporary and permanent hearing loss, cardiovascular effects, adrenocortical effects, gastric effects, and possibly brain damage; and may cause a variety of psychological effects including irritability, fatigue, and depression resulting from loss of sleep and the problems of adjustment to hearing loss. Of equal importance, although in some ways more difficult to assess, is the fact that noise is a major source of annoyance, materially affecting the quality of the environment and those subjected to it.³

³T. J. Shultz, *Noise Assessment Guidelines Technical Background*. Report No. TE/NA 172 (Department of Housing and Urban Development, 1972), pp 81-87.

Individual responses to noise are studied in the laboratory. Usually, these studies involve judgments of individual noise events in controlled environments. Such studies have been helpful in isolating some of the factors contributing to noise annoyance including intensity level and spectral characteristics of the noise; duration of the noise event; presence of impulses; abruptness of onset or cessation of the noise event; degree of harshness or roughness; degree of intermittency in loudness, pitch, or rhythm; information content; and degree of interference with activity.

Community annoyance by noise is studied through social surveys which reveal other variables important in eliciting annoyance. Contouring programs and computer methods, while effectively predicting annoyance for a great number of bases, still cannot predict precisely community response for an individual military base. Instead, personal factors contributing to a person's reaction to noise must be considered. These include:

1. Fear associated with activities of noise sources such as fear of crashes in the case of aircraft noise or accidental shelling in the case of blast noise.
2. Socio-economic status and educational level.
3. The extent to which residents of a community believe that they are being treated fairly.
4. Attitude of the community residents regarding the contribution of the activities.
5. The extent to which residents of the community believe the noise source could be controlled.⁴

As part of the process of developing the NEF, a method has been developed of interpreting noise exposure due to blasts and artillery expressed as NEF values, in terms of probable impact on land-uses. These assessments of land-use compatibility are based on accumulated case history experiences of noise complaints, speech interference criteria, subjective judgment tests of noise acceptability and relative "noisiness," need for freedom from noise intru-

⁴*Public Health and Welfare Criteria for Noise*, 550/9-73-002 (U.S. Environmental Protection Agency, 1973), pp 3.1-3.4.

sions, and typical noise insulation provided by common types of building construction.

The land-use interpretations can be related to predicted community response, particularly for residential uses. Three categories of community response prediction in noise-impacted areas are: (A) some noise complaints may occur, and noise may occasionally interfere with some activities; (B) in developed areas, individuals may complain, perhaps vigorously, and group action is possible; (C) in developed areas, repeated vigorous complaints and concerted group action might be expected. These categories are used in determining the extent and severity of land use base operation incompatibility.⁵

The Department of Housing and Urban Development (HUD) uses a four-category system to predict community response with regard to residential uses: (1) clearly acceptable, if the site lies well outside the NEF-30 contours; (2) normally acceptable, if the site lies outside the NEF-30 contours; (3) normally unacceptable, if the site lies between the NEF-30 and 40 contours; and (4) clearly unacceptable, if the site lies within the NEF-40 contours.⁶

The two most significant NEF contours for this study are NEF-30 and NEF-40, the lower number indicating a less severe exposure. The classifications reflecting prominent land-usage from Table B1 have been grouped to correspond with the two contours being used and appear in Table B2.

The Class A category identified in Table B2 includes all land identified by *Standard Land Use Coding Manual* (SLUCM) Codes 110 through 190, 651, 674, 681 through 683, 691, 711, 762, and 921. The Class B land-use category includes all land identified by SLUCM Codes 397, 471 through 479, 511 through 599, 611 through 649, 652 through 673, 675, 692, 712 through 761, 767 through 790, 811 through 819, 822, and 831 through 849. The Class C category includes SLUCM Codes 211 through 299, 311 through 396, 399, 411 (except 4111), 412 (except

4121), 421 (except 4219), 422 (except 4229), 441, 449, 460, 481 through 499, 821, and 851 through 890.⁷

For this study three categories normally provide sufficient detail.

Table B2
Noise Exposure Ratings for Various Land-Use Classifications
(Three-Category Rating)

Classification	NEF Rating
A. Residential (1) Neighborhood Commercial* (3) Noise Sensitive (9)	Outside NEF-30 Contour
B. General Commercial (2) High-Use Open Space (6) Moderate-Use Open Space (7) Light Industrial (4)	Between NEF-30 and 40 Contours
C. Heavy Industrial (5) Low-Use Open Space (8)	Inside NEF-40 Contour

*Neighborhood Commercial is not in itself a noise-sensitive operation, but this class is usually located within a residential area.

More contours, such as the NEF-25, 35, and 45 contours, may be supplied to reflect a more accurate assessment of land uses. Contours of 30, 35, 40 and 45 may be given to more finely divide the categories.

To evaluate noise exposure around a particular military base the correct NEF Contour Map is superimposed upon the base map. By referring to Table B2 one can readily see if any incompatibilities exist. For a base with small artillery operations and a town or population center far away, it is probable that no conflicts of sensitive operations with less sensitive ratings exist. As an example, classifications B and C from Table B2 are permissible if occurring outside the NEF-30 contour, but classifications A and B are not acceptable inside the NEF-40 contours. Referring to Figure B1 it can be seen that a housing area inside the NEF-40 contour is not permissible and is, in fact, an impacted area.

If conflicts (such as the latter) do occur, the next step usually is to consider the Population Density

⁵*Land Use Planning With Respect to Aircraft Noise*, Technical Manual 5-365 (1964), p. 12.

⁶E. J. Shultz, *Noise Assessment Guidelines Technical Background*, Report No. 1E-NA-172 (Department of Housing and Urban Development, 1972), pp. 142, 150.

⁷*Control for Noise from Stationary Sources*, III-Q Document No. 11-2 (State of Illinois Institute for Environmental Quality, 1972), pp. 11-12.

Maps for Day and Night. It is entirely possible that a Class B area such as General Commercial may lie inside an area with sparse population density. Usually, it will be obvious if the population distribution is dense enough to warrant a conflict. It should be remembered that the NEF contour overlay is an accumulated average of day and night artillery operations on the base and it may well be that a large nighttime activity does not affect a commercial area or a school, etc.

Prediction of blast and artillery noise around a military base is facilitated by the use of a computer-generated NEF overlay map. This overlay, in conjunction with base maps will indicate areas receiving noise exposure at levels which can be expected to create concerted adverse public reaction. This method of prediction reflects the best available information about noise and speech interference, and other physical and psychological factors.

3 NOISE MITIGATION TECHNIQUES

Local meteorological conditions, the time of day of operations, and community relations play paramount roles in the noise profile around a military installation. This section contains useful information about sound propagation through the atmosphere and community relations as they apply to noise impact mitigation.

Sound Propagation Through the Atmosphere. In practice, the speed of sound varies with direction and altitude, primarily due to wind and temperature changes. The net result is that the atmosphere sometimes acts as a lens, diverting waves travelling away from the ground and focusing them at a distant point on the ground. This focus occurs when the variation of the speed of sound with altitude undergoes an inversion; that is, the velocity decreases with altitude near the ground and then increases at greater altitudes. Of concern in this study is a double inversion, in which the velocity of sound decreases with altitude near the ground, increases as one goes higher, and then decreases again at still greater altitudes (see Figure B2). This phenomenon usually occurs only during the night and early morning hours. Figure B2 also illustrates the focusing and ducting of the sound waves. These focuses can appear in the range from 2 to 40 miles from the

source. In an area where focusing occurs, blast noise is extremely loud and annoying.

Basically, meteorological conditions can be expressed as the percentage of time that an inversion is present. This "inversion condition" takes into account the effects of temperature and wind. For most areas of the United States, the inversion condition is 50%; this value will be used when plotting contours if none other is specified.

Adjustments to Blasting Operations. If incompatible land use areas are anticipated prior to the receipt of NEF Equal Annoyance Contours, there are several alternatives that may be taken. These choices logically include specification of an adjustment to the operational blasting conditions to improve the highest quality of land use for the residential noise-sensitive activities in communities adjacent to the installation.

The most dramatic adjustment that can be made is to curtail blasting during the time when inversions occur, namely during the night and early morning hours. Figure B3 is an NEF Contour for a 50% inversion condition (firing done 24 hours daily). Figure B4 represents a 5% condition for firing only during noninversion daylight hours.

Curtailing fire during the night and early morning hours affords about a 13 dB reduction for previously incompatible land-use areas. In other terms, a 13 dB noise reduction reduces the impact area by a factor of 20. This is an extensive amount of land area that becomes usable by eliminating firing during these hours.

As a comparison, Figure B5 displays the effect of day-only fire. This set of contours does, however, include the temperature inversion present during early morning daylight hours and the reduction in noise is not as great. Figure B6 presents the NEF contours for a theoretical military base for which firing was scheduled during non-inversion daylight hours.

An alternative to eliminating blasting during a part of a 24-hour day is to reduce operations. If firing were maintained over a 24-hour period but cut by 50%, the reduction at the affected residential

areas would be only 1.8 dB (a barely audible difference). The reduction in impact on the previously affected community areas now found to be compatible would be 10-15%, compared to a factor of 200, or a 2000% reduction when eliminating firing during the night and early morning hours.

Community Relations. Good relations with area residents are extremely important in mitigating community response to blast noise. For example, if residents have a favorable attitude toward the base, the amount that complaints can be reduced is equivalent to 5-10 units of NEF contour reduction. This reduction in contour size is equivalent to an increase of 4-10 times the blasting while having the same community response. It is therefore easy to see that having a positive relationship with community residents and leaders can reduce annoyance complaints and threats of legal action.

Many things can be done to achieve good community relations; the following suggestions are in no way to be considered complete. One way to promote a positive attitude is to make speakers available to community organizations to acquaint members with blasting operations on the base. Along with an explanation of the purpose of operations, an effort should be made to convince members that the base is concerned about noise problems and the associated complaints and, most important, that the base is currently involved in noise mitigation methods.

Before speaking to area residents about noise mitigation techniques, it is helpful to understand why people are complaining. One of the primary motivations for complaints in blasting situations has been found to be fear. Many respondents, when questioned, have indicated concern about damage to their houses. If structural damage occurs, of course

the residents have valid complaints; however, if only rattling and shaking are involved, the tactful approach is to suggest that shaking and rattling do not cause damage to dwellings. Residents may also express other types of fears, such as that physical harm will come to their children from being awakened at night. Frankly, a great amount of tact is required at this point. Base personnel should advise respondents that mitigation methods are currently being employed at the base.

Above all, the important thing is to maintain good relations with area residents when speaking to organizations and when handling complaints.

REFERENCES

- Control of Noise from Stationary Sources*, IIEQ Document No. TF-2 (State of Illinois Institute for Environmental Quality, 1972), pp 11-12.
- Land-Use Planning With Respect to Aircraft Noise*, Technical Manual 5-365 (Bolt, Beranek and Newman, Inc., 1964), p 12.
- Public Health and Welfare Criteria for Noise*, 550/9-73-002 (U.S. Environmental Protection Agency, 1973), pp 31-34.
- Shultz, T. J., *Noise Assessment Guidelines Technical Background*, Report No. TE/NA 172 (Department of Housing and Urban Development, 1972), pp 81-87, 142, 150.
- Standard Land-Use Coding Manual*, Urban Renewal Administration, Housing and Home Finance Agency and Bureau of Public Roads (Department of Commerce, 1965).

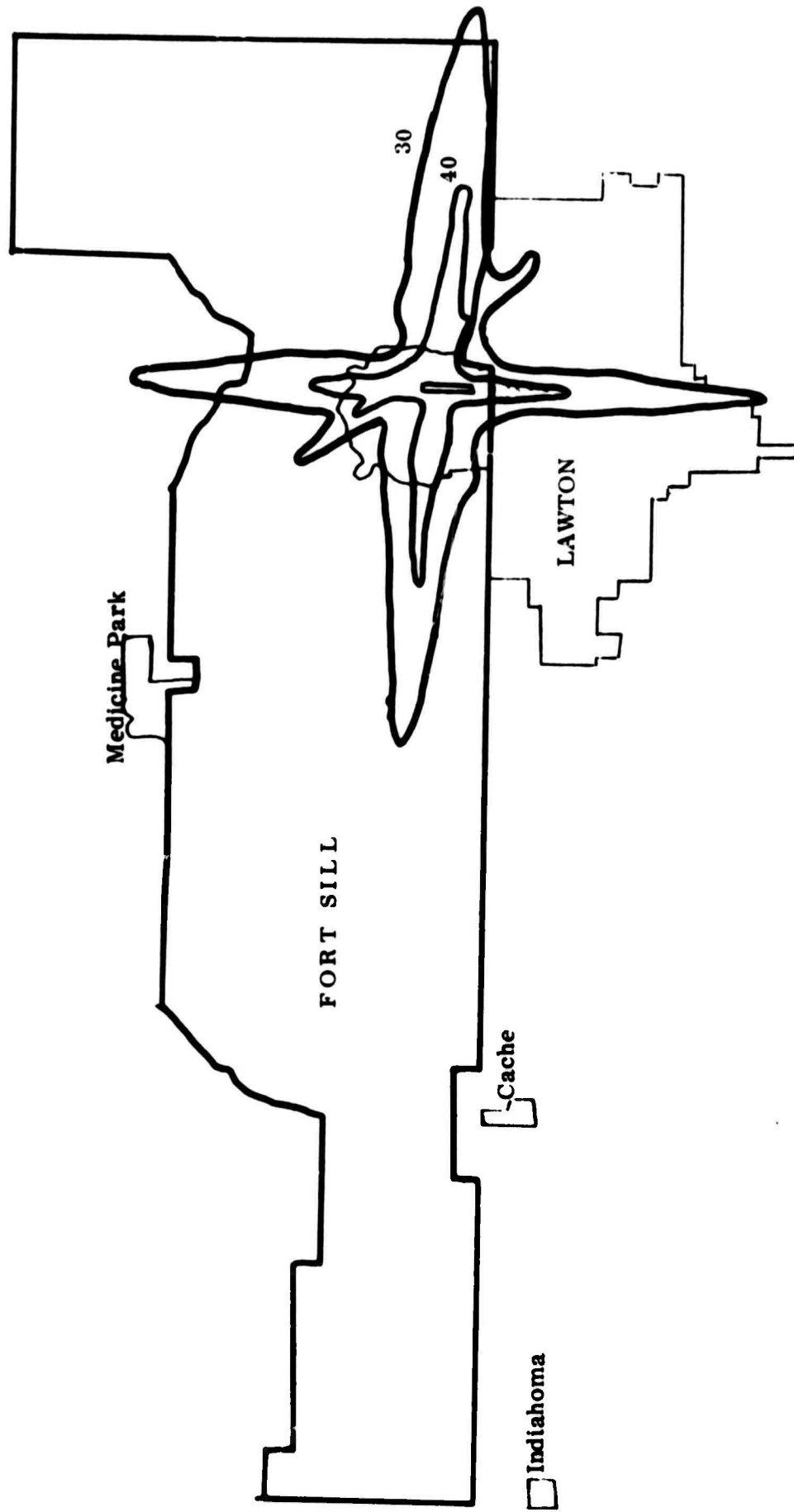

Figure B1. Base and plan map with NEF contours.

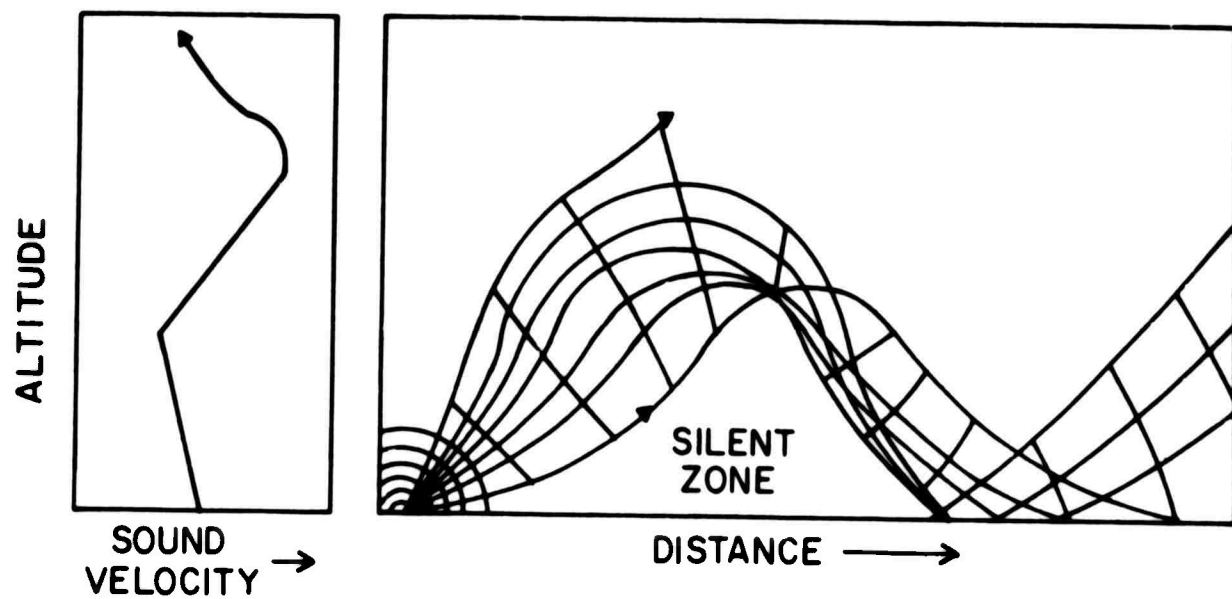

Figure B2. Double inversion condition.

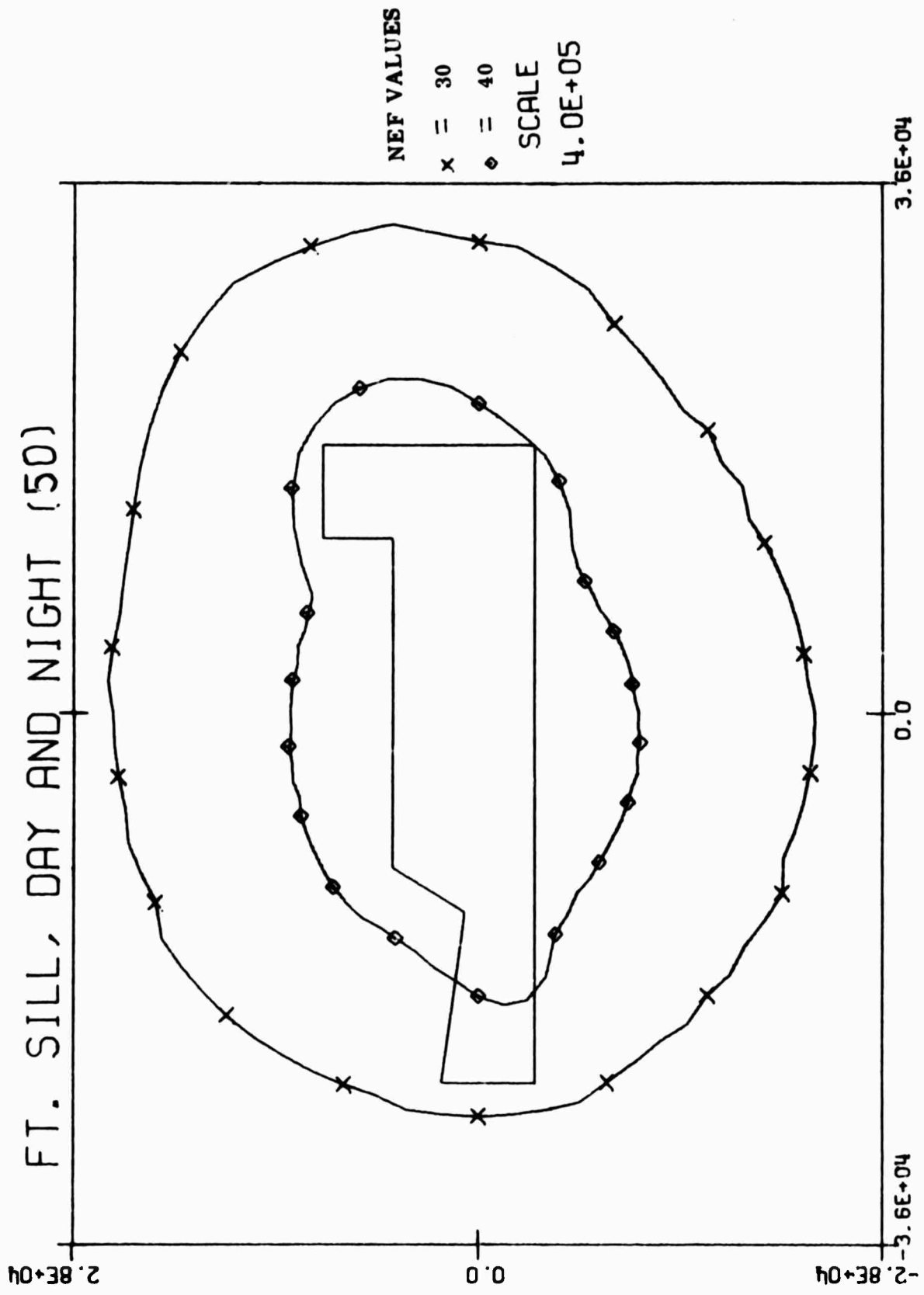

Figure B3. NEF contour for 50% inversion condition.

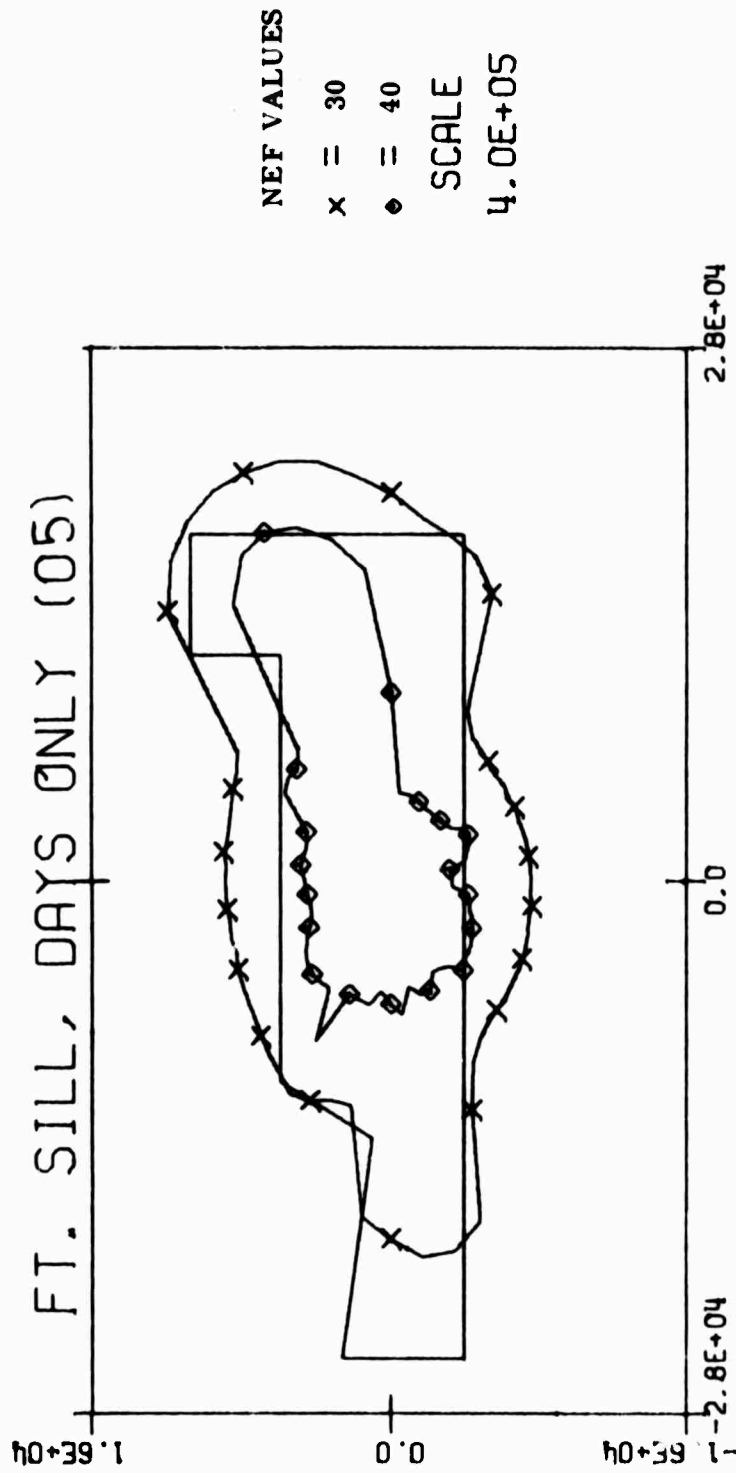

Figure B4. NEF contour for 5% inversion condition.

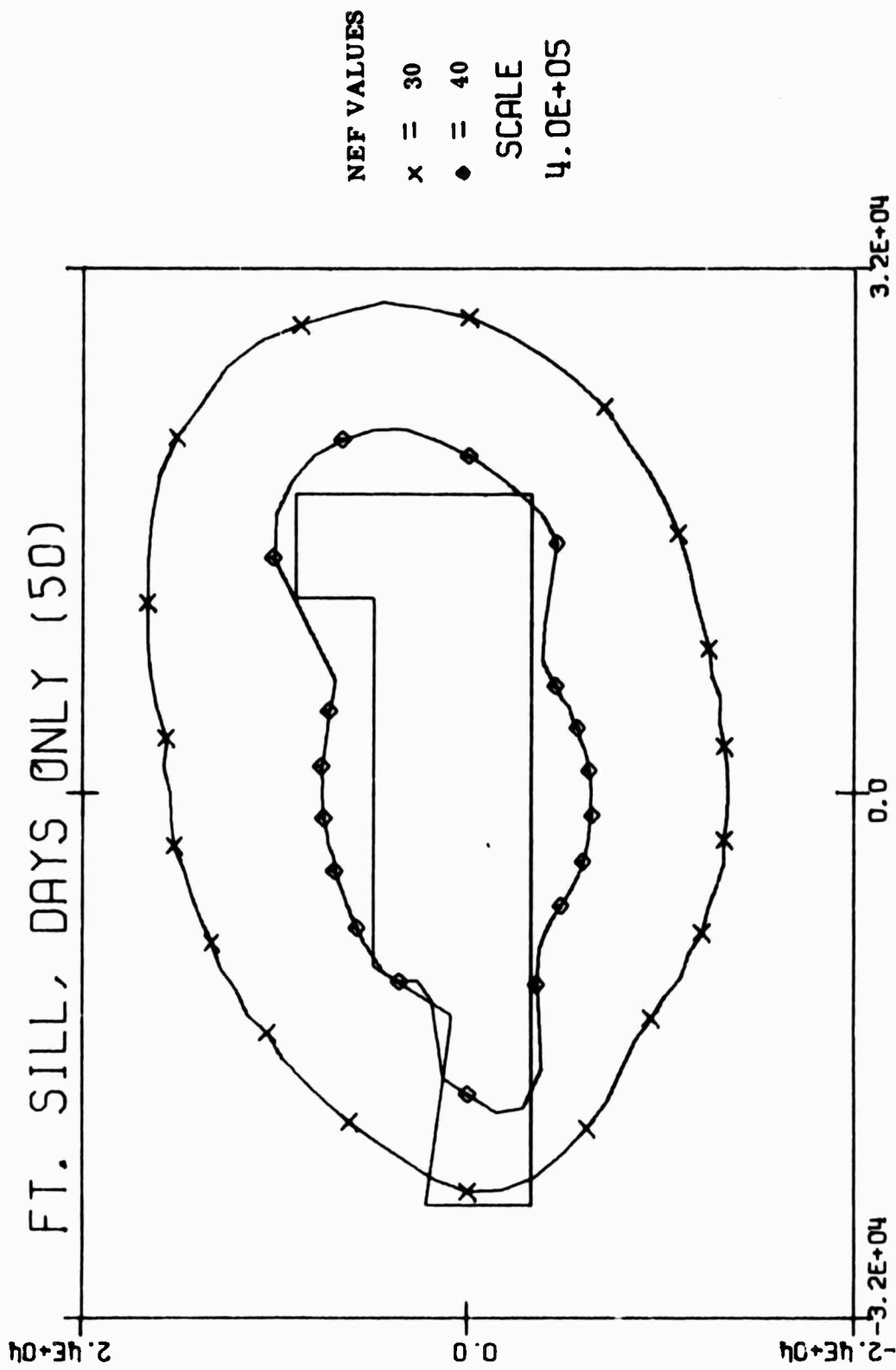

Figure B5. Day-only fire.

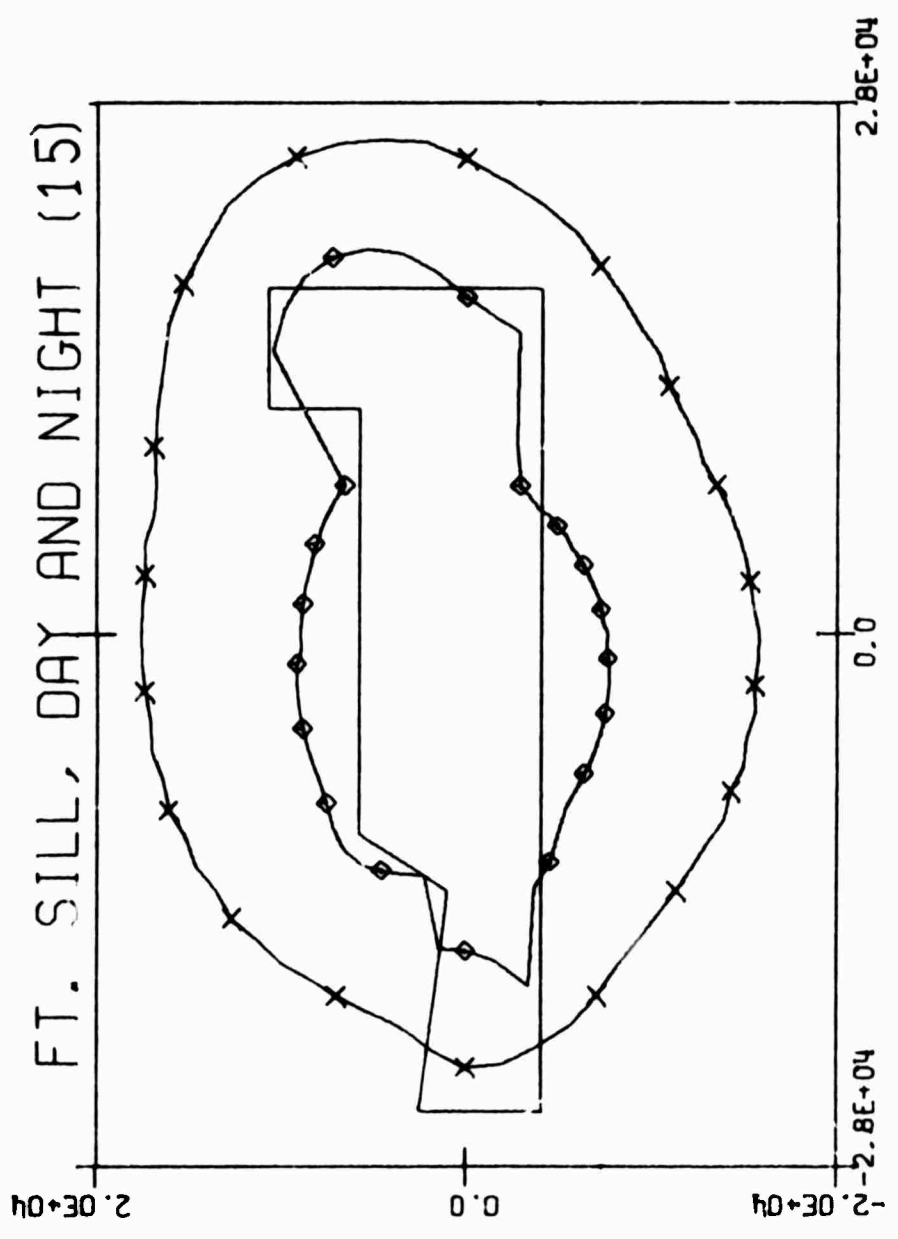

Figure 86. Firing during non-inversion daylight hours.

APPENDIX C:

GUIDELINES FOR SUBMISSION OF DATA

This appendix explains how to submit information to CERL when requesting NEF Equal Annoyance Contours. Subjects discussed include the ordering of contours, specific options available, materials the base will receive, the cost of this service, and the person to contact if difficulties arise.

A. General

Each set of NEF Contours is a generalized overlay plotted to the scale of the base maps. These contours depict "equal annoyance levels" and are in a form which can be thought of as a "footprint" of the noise impact. They are actually a composite based upon the average or typical total daily operations of the military facility.

B. Ordering of Contours; Materials to Be Submitted

The facility ordering NEF Equal Annoyance Contours must complete and furnish two types of data sheets and the attachment form as described in Appendix A of this report. In addition, the military base must also send CERL two maps. These materials include the following:

1. Target Data Forms containing the information concerning the location of targets on the military base (Figure C1).

2. Firing Point Data Forms containing the information about firing point locations and their associated targets, weapon types, number of rounds, and types of ammunition (Figure C2).

3. An Attachment Sheet (Figure C3) specifying information covered in both the forms above. This information includes:

a. Study preparation. This section of the Attachment Sheet must be completed in its entirety including name of base, person preparing forms, etc.

b. Whether or not this form is for an original or an additional contour.

c. Inversion condition. This percentage for the base will be specified if operations are controlled or if this is for an optional hypothetical condition (i.e., no firing during a percentage of inversion conditions). Thus, a base would specify 0 percent if they never fired during inversions. Further explanation is given in Specific Options below.

d. Day/night operating conditions. This optional condition specifies the day only or day and night that hypothetical firing would occur. Details are presented in Specific Options.

e. Time period data was taken. A minimum of one month of data will be required to complete the Target and Firing Point Data Sheets. If there is a large variation in operations, up to four months of data on activity may have to be considered at the time that the data sheets are being completed. (A large variation is a 40 percent or more change in operations during different parts of the year.) For example, if there is an extremely large variation in firing patterns between halves of the year, two representative months will be needed to fill out the data sheets. If there is a large variation between quarters, CERL should be consulted before work is initiated.

f. Locations specified. This is the method employed at the particular base for describing the locations of firing and target points. Locations may be specified in feet or meters only.

g. Overall percentage of illumination rounds—typically 4 percent.

h. Overall percentage of time fuses—typically 15 percent.

i. Overall percentage of proximity fuses—typically 5 percent.

j. Additional weapon types with assigned codes. These are used for any weapons not listed in Table A3. The corresponding code is for use in the Firing Point Data Sheet.

4. The Reservation Map, described in AR-210-20, must be supplied when ordering contours. The

Contour Map Overlay produced by computer will fit the scale of this map.

5. A map showing areas within a 10- to 15-mile radius of the installation must be supplied. Contours may or may not be produced for this map depending upon the noise impact upon the base. All maps will be returned unharmed.

C. Specific Options

Two options are currently available. One is the Inversion Condition and the other is the Operation Condition. As discussed in Appendix B, inversion conditions significantly affect the propagation of sound through the atmosphere. Specifications of either or both of these options will result in an additional set of contours generated at extra cost to the military facility.

1. Inversion Condition: The inversion condition is the percentage of time that an inversion is present during a 24-hour day. For most locations in the United States, this condition is 50 percent. If this condition differs from 50 percent for the military base, a different condition will be completed by CERL from National Weather Service Records. No additional charge will be added for this primary inversion condition.

Since a temperature inversion is most likely to occur in the period between two hours after sunset and two hours after sunrise, firing performed during noninversion hours reflects a reduced noise impact.

If a base operates on a reduced schedule of hours, this will impact the percentage of inversions. Thus, the base must inform CERL of the actual hours of firing. This information should be written on the attachment sheet (Figure C3) in the area concerned with percent of inversions.

As an option, a base may request an additional contour depicting the effect of eliminating firing during some or all the hours during which inversions occur. A request for an additional contour requires an additional attachment sheet (Figure C3) and the requester should write "Supplemental Contour" at the top of the sheet.

2. Day and Night Firing (0700 to 2200 and 2100 to 0700, respectively) is important for the noise impact. A penalty is assessed for night firing. If a base already fires only during the day, this is evident in its submitted data. As an option, a base may request an additional contour depicting the effect of eliminating night firing. A request for an additional contour requires an additional attachment sheet (Figure C3) and the requester should write "supplemental contour" at the top of the sheet.

D. Materials the Base Will Receive

Following receipt of completed data from the base as described in B above, evaluation and contour generation can be expected in five weeks. The base will receive a set of NEF Equal Annoyance Contours plotted to the scale of the Reservation Map.

If there is a significant noise impact, another set of contours will be plotted to the scale of the larger area map that was supplied by the facility. Any additional contours showing desired inversion and operating conditions that were requested by the military base will be included as will the two maps that were originally supplied.

E. Cost

The cost of this service will vary depending upon the complexity of operations at the installation, but a median value of \$800 can be anticipated for a base with fairly extensive blast operations.*

F. Difficulties Encountered

Communication, both by telephone and letter, is invited and encouraged during the time the base is completing data sheets. If it is found that there is a noise impact upon the military installation, assistance may be requested in the preparation of land-use and population density maps. Written correspondence may be addressed to the Construction Engineering Research Laboratory (CERL), P.O. Box 4005, Champaign, IL 61820 or to the Office of the Chief of Engineers, Washington, D.C. 20314.

*This is a March 1974 price estimate which may be adjusted due to inflation.

1	2	3	4	5	6	7	8	9	10	11	12	13	14	15	16	17	18
		96				6	0	4	0			3	6	9	0		
		97				6	0	5	0			3	5	5	0		
		98				6	2	1	0			3	6	7	0		
		99				6	2	9	0			4	2	0	0		
*																	

Figure C1. Target Data Sheet showing coordinates.

721					31978					34251																																	
1	2	3	4	5	6	7	8	9	10	11	12	13	14	15	16	17	18	19	20	21	22	23	24	25	26	27	28	29	30	31	32	33	34	35	36	37	38	39	40	41			
																		1			49			00	2	6	15																0
																		1			00			38	2	6	15																0
																		1			00			38	2	6	16																0
																		3			31			10	1	4	15																0
																		3			31			11	1	4	16																0
																		1			12			18	2	6	15																0
																		1			26			38	2	6	16																0
																		*																									

Figure C2. Firing Point Data Sheet with rounds divided.

Name of Base _____

Name of Person Preparing Work _____

Title _____

Office _____ Phone _____

Signature: _____

Approving Supervisor's Signature _____ Date _____

Special Information:

1. Is this for an additional contour? _____
2. Hours during the day that firing occurs (or is predicted to occur) or percent of inversions _____
3. Night only firing option (see Appendix C) _____

For response to 2 and 3, see Appendix C. No response is necessary for the "normal" conditions.

4. Time Period Data was Taken _____

General Information:

Locations Specified (feet or meters) _____

Overall Percentage of Illumination Rounds _____

Percentage of Time Fuses _____

Percentage of Proximity Fuses _____

Weapon _____ Code 5

Weapon _____ Code 6

Weapon _____ Code 7

Weapon _____ Code 8

Weapon _____ Code 9

Figure C3. Attachment Sheet.