

UNCLASSIFIED

AD NUMBER

AD818303

LIMITATION CHANGES

TO:

Approved for public release; distribution is unlimited.

FROM:

Distribution authorized to U.S. Gov't. agencies and their contractors; Critical Technology; JUL 1967. Other requests shall be referred to Air Force Technical Applications Center, Washington, DC. This document contains export-controlled technical data.

AUTHORITY

usaf ltr, 25 jan 1972

THIS PAGE IS UNCLASSIFIED

TR 67-42

AD818303

TECHNICAL REPORT NO. 67-42

OPERATION OF
THE TONTO FOREST SEISMOLOGICAL OBSERVATORY
Quarterly Report No. 2, Project VT/7702
1 April through 30 June 1967

DDC
RECEIVED
AUG 11 1967
A



GEOTECH

A TELEDYNE COMPANY

TECHNICAL REPORT NO. 67-42

OPERATION OF THE
TONTO FOREST SEISMOLOGICAL OBSERVATORY
Quarterly Report No. 2, Project VT/7702
April through 30 June 1967

Sponsored by

Advanced Research Projects Agency
Nuclear Test Detection Office
ARPA Order No 624

STATEMENT #2 UNCLASSIFIED

This document is subject to special export controls and each transmittal to foreign governments or foreign nationals may be made only with prior approval of

AE TAC
Wash, D.C.

GEOTECH
A Teledyne Company
3401 Shiloh Road
Garland, Texas

21 July 1967

IDENTIFICATION

AFTAC Project No:	VELA T/7702
Project Title:	Operation of TFSO
ARPA Order No:	624
ARPA Program Code No:	
Name of Contractor:	Teledyne Industries Incorporated Geotech Division Garland, Texas
Date of Contract:	1 January 1967
Amount of Contract:	\$1,090,300
Contract Number:	AF 33(657)-67-C-0091
Contract Expiration Date:	31 December 1967
Program Manager:	B. B. Leichter, BR1-2561

CONTENTS

	<u>Page</u>
ABSTRACT	
1. INTRODUCTION	1
1.1 Authority	1
1.2 History	1
2. OPERATION OF TFSO	1
2.1 General	1
2.2 Standard seismograph operating parameters	3
2.3 Data channel assignments	3
2.4 Completion and shipment of data	3
2.5 Quality control	6
2.5.1 Quality control of 16-millimeter film seismograms	6
2.5.2 Quality control of magnetic-tape seismograms	6
2.6 Security inspection	7
2.7 Emergency power generator	7
2.8 Test equipment calibrations	7
3. EVALUATE DATA AND DETERMINE OPTIMUM OPERATIONAL CHARACTERISTICS	8
3.1 Modifications to TFSO instrumentation	8
3.1.1 TFSO long-period response change	8
3.1.2 Deletion of elements from the 31-element array	8
3.1.3 Broad-band systems	8
3.2 Testing of TFSO instrumentation	8
3.2.1 Long-period surface vault	8
4. ANALYZE DATA	8
4.1 Daily reports to the Coast and Geodetic Survey	8
4.2 Daily analysis for multistation earthquake bulletin	11
4.3 Routine noise survey	11
5. PROVIDE OBSERVATORY FACILITIES AND ASSISTANCE TO OTHER ORGANIZATIONS	11
5.1 Astrodata Data Acquisition System (ASDAS)	11
5.2 Recordings for the California Institute of Technology	12
5.3 Telemetry to Massachusetts Institute of Technology	12
5.4 Astrogeological Department of USGS	12
5.5 LRSM signal study	12
5.6 Visitors	12
5.6.1 Visits by school groups	12
5.6.2 Teledyne visitors	12
5.6.3 Visit by the program manager	13

CONTENTS, Continued

	<u>Page</u>
6. RESEARCH PROGRAMS	13
6.1 Tests of the performance of long-period seismometers in an evacuated spherical chamber	13
6.2 Cominunications system	19
6.3 Evaluation of short-period seismograph with a solid- state amplifier	19
6.4 Evaluation of long-period seismograph with a solid- state amplifier	26
6.5 Design and install a short-period array	26
6.5.1 Land permitting	26
6.5.2 Archeological control	29
6.5.3 Site selection	29
6.5.4 Material received	29
6.5.5 Site and road construction	29
6.5.6 Cable installation	29
6.5.7 Modification of array seismometers	33
6.6 Design and install a long-period array	33
6.6.1 Long-period noise study	33
6.6.2 Data transmission	36

APPENDIX - Statement of work

ILLUSTRATIONS

<u>Figure</u>		<u>Page</u>
1	Location of TFSO	2
2	Normalized response characteristics of standard seismographs at TFSO	5
3	Typical response of TFSO three-component long-period system as modified on 18 January 1967	9
4	Tonto Forest Seismological Observatory vault locations, 30 June 1967	10
5	Ocean bottom sphere in place on the long-period pier at TFSO. The sphere has been sealed and evacuated	14
6	TFSO experimental long-period seismogram illustrating the similarity in the response of the test seismographs (E52LP and E45LP) and the corresponding control seismographs (E57LP and E54LP) during an atmospherically calm period: the door to the long-period pier room was sealed. (X10 enlargement of 16 mm film)	15
7	TFSO experimental long-period seismogram illustrating the similarity in the response of the test seismographs (E52LP and E45LP) and the corresponding control seismographs (E57LP and E54LP) during an atmospherically calm period; the door to the long-period pier room was sealed. (X10 enlargement of 16 mm film)	16
8	TFSO experimental long-period seismogram illustrating the similarity in the response of the test seismographs (E52LP and E45LP) and the corresponding control seismographs (E57LP and E54LP) while the wind was gusting to about 36 mph; the door to the long-period pier room was sealed. (X10 enlargement of 16 mm film)	17
9	TFSO experimental long-period seismogram illustrating the similarity in the response of the test seismographs (E52LP and E45LP) and the corresponding control seismographs (E57LP and E54LP) while the wind was blowing at about 20 mph; the door to the long-period pier room was sealed. (X10 enlargement of 16 mm film)	18

ILLUSTRATIONS, Continued

<u>Figure</u>		<u>Page</u>
10	Simplified block diagram of the short-period system with a solid-state amplifier (Z55SS) being tested at TFSO	20
11	Frequency responses for the Z55SS seismograph using a solid-state amplifier, and the Z74 seismograph using a phototube amplifier	21
12	TFSO short-period seismogram illustrating the similarity in the response of the Z55SS and Z74 seismographs to an arrival from a teleseismic event (epicenter unknown). (X10 enlargement of 16-millimeter film)	22
13	TFSO short-period seismogram illustrating the similarity in the response of the Z55SS and Z74 seismographs to an arrival from a teleseismic event (epicenter unknown). (X10 enlargement of 16-millimeter film)	23
14	Spectral relations of low level seismic background and system noise of the Z74 seismograph	24
15	Spectral relations of low level seismic background and system noise of the Z55SS seismograph	25
16	Simplified block diagram of the long-period system with a solid-state amplifier (Z102LP) being tested at TFSO	27
17	Frequency response for the long-period seismograph utilizing the Model 28450-02 amplifier	28
18	Plan for the 37-element array at TFSO showing the five main array segments	30
19	Plan of the 37-element array showing the locations of the sites, cable trails, and cable trail construction stakes	31
20	Road building in area of Z9 showing terrain typical of the lower brush country at TFSO	32
21	Road building in area of Z9 showing terrain typical of the lower brush country at TFSO	32

ILLUSTRATIONS, Continued

<u>Figure</u>		<u>Page</u>
22	Average phase response for portable LRSM long-period systems	34
23	Typical long-period response of the LRSM portable long-period system	35

TABLES

<u>Table</u>		<u>Page</u>
1	Operating parameters and tolerances of seismographs at TFSO	4
2	Number of earthquakes reported to the C&GS by TFSO between 1 April and 30 June 1967	11

ABSTRACT

This is a report of the work accomplished on Project VT/7702 from 1 April through 30 June 1967. Project VT/7702 includes the operation, evaluation, improvement, and expansion of the Tonto Forest Seismological Observatory (TFSO) located near Payson, Arizona. It also includes special research and test functions carried out at TFSO and research and development tasks performed by the Garland, Texas, staff using TFSO data.

OPERATION OF THE TONGO FOREST SEISMOLOGICAL OBSERVATORY

1. INTRODUCTION

1.1 AUTHORITY

The research described in this report was supported by the Advanced Research Projects Agency, Nuclear Test Detection Office, and was monitored by the Air Force Technical Applications Center (AFTAC) under Contract AF 33(657)-67-C-0091. The contract is dated 1 January 1967; the Statement of Work for Project VT/7702 is included as the appendix to this report.

1.2 HISTORY

The Tonto Forest Seismological Observatory (TFSO) was constructed by the United States Corps of Engineers in 1963. TFSO was designed to record seismic events and to be used as a laboratory for testing, comparing, and evaluating advanced seismograph equipment and seismometric recording techniques. The instrumentation was assembled, installed, and operated until 30 April 1965 by the Earth Sciences Division of Tele-dyne Industries under Contract AF 33(657)-7747. In March 1964, the Long-Range Seismic Measurements (LRSM) Program provided eight mobile seismic recording vans to extend the existing instrument arrays at TFSO. On 1 May 1965, Geotech assumed the responsibility for operating TFSO. The LRSM vans were phased out of the TFSO operation on 3 October 1965. On 1 January 1967, Contract AF 33(657)-67-C-0091 was awarded to Geotech for the operation and expansion of the Tonto Forest Seismological Observatory. The location of TFSO is shown in figure 1.

2. OPERATION OF TFSO

2.1 GENERAL

Data are recorded at TFSO on a 24-hour-a-day basis. The observatory is manned continuously. A full complement of personnel is on duty 8 hours a day, 5 days a week; at other times, a reduced operating crew is on duty.

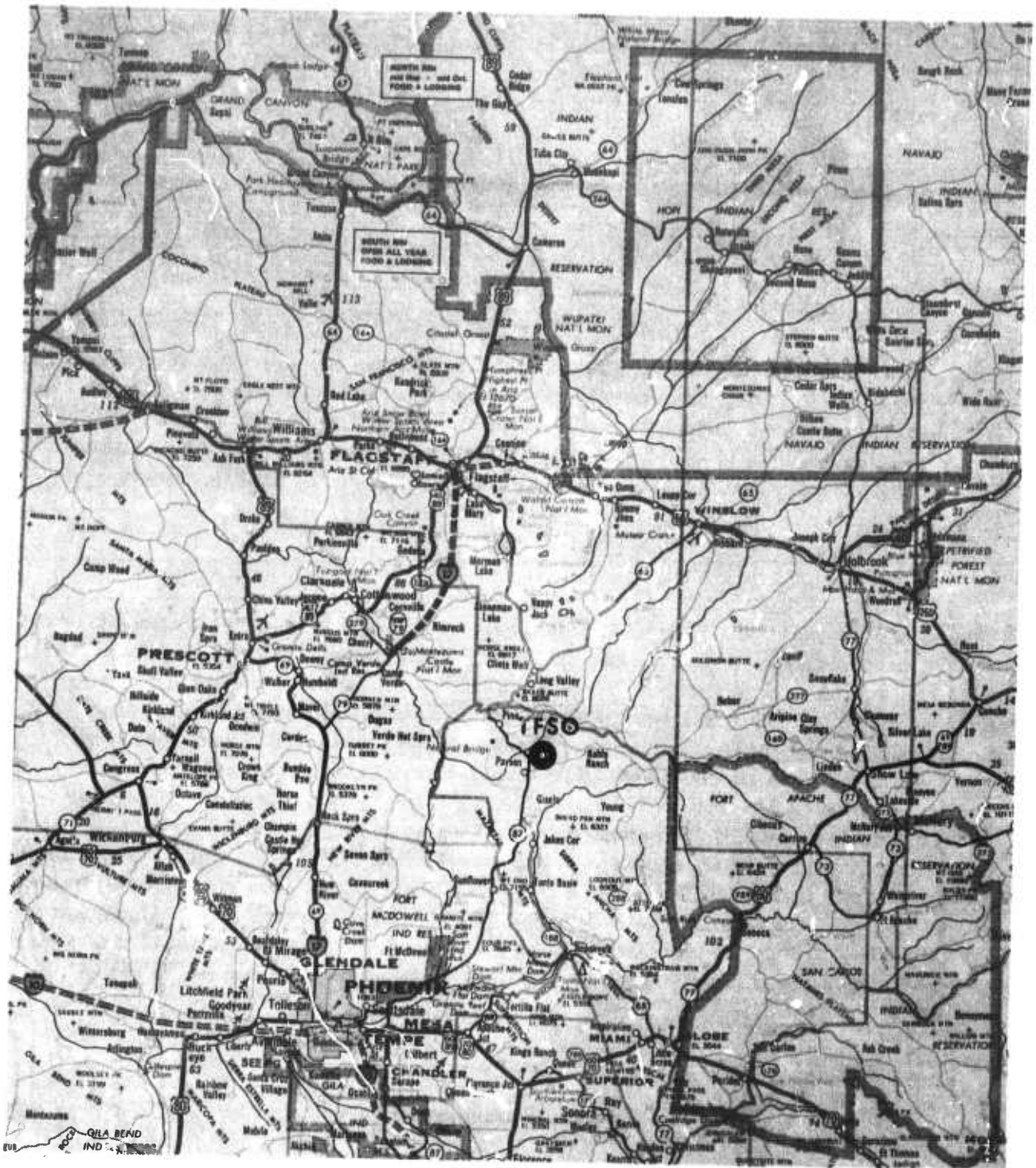

Figure 1. Location of TFSO

G 650

2.2 STANDARD SEISMOGRAPH OPERATING PARAMETERS

The operating parameters and tolerances for the TFSO standard seismographs are shown in table 1. Frequency response tests are made routinely, and parameters are checked and reset to maintain the specified tolerances.

Normalized response characteristics of TFSO standard seismographs are shown in figure 2. During portions of this reporting period, the response of the TFSO long-period seismograph system was changed to conform to the response of the LRSM portable long-period seismograph systems used for the long-period noise survey which is discussed in section 7.6.

In addition to these standard seismographs, two filtered summation seismographs are recorded. A UED filter with a high-cut frequency at 1.75 cps and a slope of 24 dB per octave and a low-cut frequency at 0.7 cps with a slope of 24 dB per octave is used to record the Σ TF seismograms on 16-millimeter film (Data Trunks 1 and 7) and on magnetic tape (Data Trunks 2 and 5). A Krohn-Hite filter with the high-cut frequency set at 3.0 cps with a slope of 24 dB per octave and the low-cut frequency set at 1.0 cps with a slope of 24 dB per octave is used to record the Σ TFK seismograms on 16-millimeter film (Data Trunk 1). On 28 April, the high-cut frequency of the Krohn-Hite filter was changed to 2.0 cps and was operated at this setting for the remainder of the reporting period.

2.3 DATA CHANNEL ASSIGNMENTS

Each data format recorded at TFSO is assigned a data group number. When a data format is changed, a new data group number is assigned. Several data format change notices reporting changes in channel assignments and data group number assignments were submitted to the Project Officer and to frequent users of TFSO data during this reporting period.

2.4 COMPLETION AND SHIPMENT OF DATA

The magnetic-tape seismograms are shipped from TFSO each week. Three of the magnetic-tape recorders are used to record data for the AFTAC/VELA Seismological Center (VSC), and three magnetic-tape recorders are used to provide data to universities. When data from all three magnetic-tape units are not required by the universities, the observatory notifies VSC.

Film records from ten Develocorders are routinely shipped to data users. The film and magnetic-tape operation logs and calibration logs are copied and shipped with the seismograms. Copies of selected Develocorder data are sent

Table 1. Operating parameters and tolerances of seismographs at TFSO

Seismograph			Operating parameters and tolerances					Filter settings		
System	Comp	Type	Model	T _s	λ _s	T _B	λ _B	δ ₂	Bandpass at 3 dB cutoff (sec)	Cutoff rate at SP side (dB/oct)
SP	Z	Johnson-Matheson	6480	1.25±2%	0.54 ±5%	0.33 ±5%	0.65 ±5%	0.0117	0.1 - 100	12
SP	H	Johnson-Matheson	7515	1.25±2%	0.54 ±5%	0.33 ±5%	0.65 ±5%	0.0117	0.1 - 100	12
SP	Z	Benioff	1051	1.0 ±2%	1.0 ±5%	0.2 ±5%	1.0 ±5%	0.0104	0.1 - 100	12
SP	H	Benioff	1101	1.0 ±2%	1.0 ±5%	0.2 ±5%	1.0 ±5%	0.0104	0.1 - 100	12
SP	Z	UA Benioff	1051	1.0 ±2%	1.0 ±5%	0.75	1.0 ±5%	0.0245		
SP	H	UA Benioff	1101	1.0 ±2%	1.0 ±5%	0.75	1.0 ±5%	0.0245		
IB	Z	Melton	10012	2.25±5%	0.65 ±5%	0.64 ±5%	1.2 ±5%	0.0006	0.05 - 100	18
IB	H	Lehner-Griffin	SH-216	2.25±5%	0.65 ±5%	0.64 ±5%	1.2 ±5%	0.0004	0.05 - 100	18
BB	Z	Press-Ewing	SV-232	12.0 ±5%	0.425 ±10%	0.64 ±5%	9.0 ±10%	0.00027	0.05 - 100	18
BB	H	Press-Ewing	SH-242	12.0 ±5%	0.425 ±10%	0.64 ±5%	9.0 ±10%	0.00027	0.05 - 100	18
LP ^a	Z	Geotech	7505A	20.0 ±5%	0.74 ±10%	110.0 ±10%	0.83 ±10%	0.66	25 - 100 ^η	12
LP ^a	H	Geotech	8700C	20.0 ±5%	0.74 ±10%	110.0 ±10%	0.83 ±10%	0.66	20 - 200 ^{aa}	12
									25 - 1000	12
									20 - 200 ^{aa}	12

KEY

- Z Vertical component
- H Horizontal component
- SP Short period
- IB Intermediate band
- BB Broad band
- LP Long period
- UA Unamplified (i. e., earth powered)
- T_s Seismometer free period (sec)
- T_B Galvanometer free period (sec)
- λ_s Seismometer damping constant
- λ_B Galvanometer damping constant
- δ₂ Coupling coefficient

^aTemporarily deactivated on 18 January

^{aa}With a 6-second notch filter

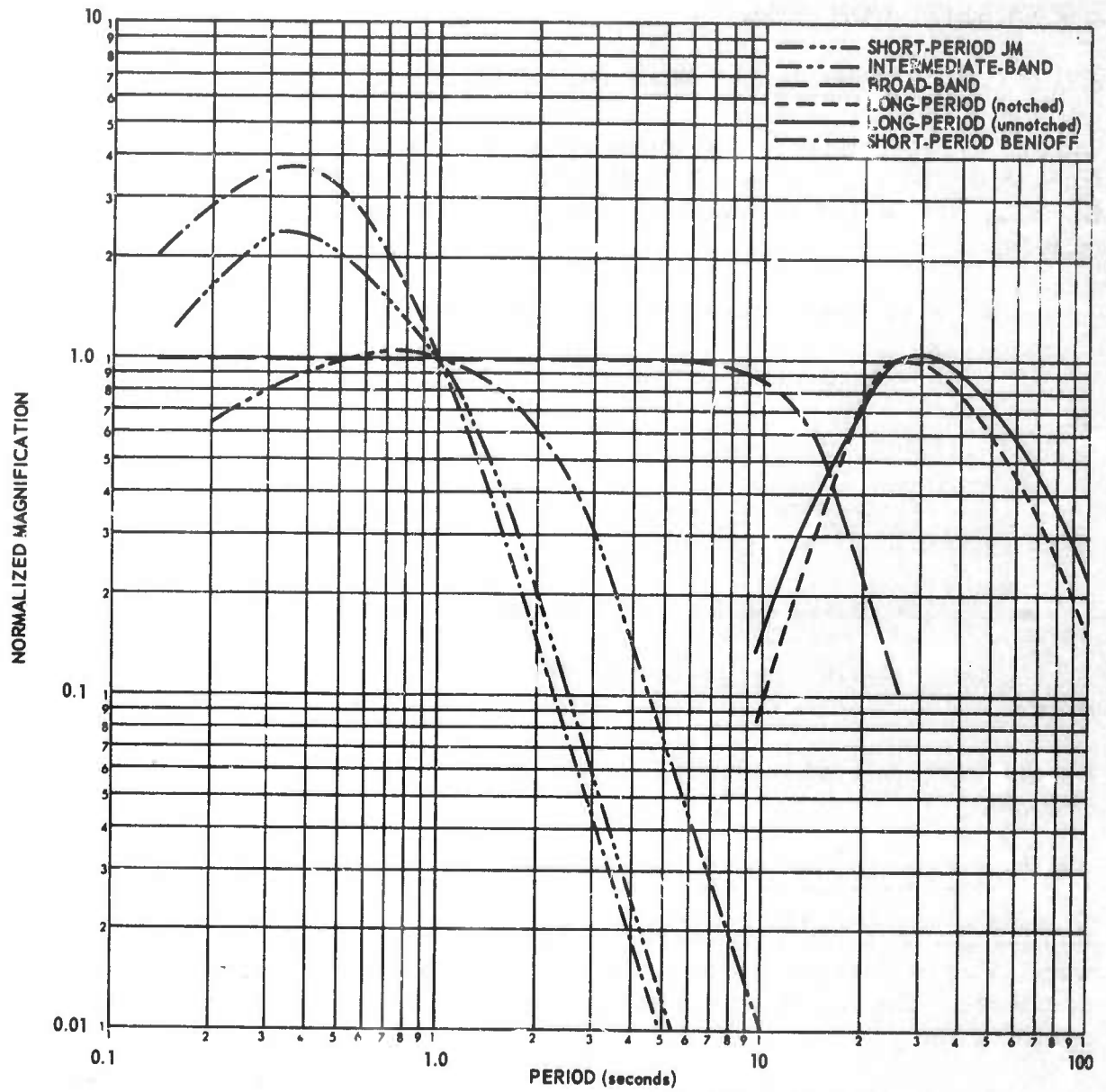

Figure 2. Normalized response characteristics of standard seismographs at TFSO

to Geotech regularly and to other data users on special request. The shipments of 16-millimeter film seismograms routinely sent to the Seismic Data Laboratory (SDL) repository are complete through April 1967.

2.5 QUALITY CONTROL

2.5.1 Quality Control of 16-Millimeter Film Seismograms

Quality-control checks of randomly selected 16-millimeter film seismograms from Data Trunks 1, 2, and 8, and the associated operation logs are made in Garland. Items that are routinely checked by the quality control analyst include:

- a. Film boxes - neatness and completeness of box markings;
- b. Develocorder logs - completeness, accuracy, and legibility of logs;
- c. Film;
 - (1) Quality of the overall appearance of the record (for example, trace spacing and trace intensity);
 - (2) Quality of film processing;
- d. Analysis - completeness, legibility, and accuracy of the analysis sheets.

Results of these evaluations are sent to the observatory for their review and comment.

2.5.2 Quality Control of Magnetic-Tape Seismograms

Routine quality control checks of randomly selected magnetic-tape seismograms were made in Garland and at TFSO to assure that recordings met specified standards. The following are among the items that were checked by the quality control group:

- a. Tape and box labeling;
- b. Accuracy, completeness, and neatness of logs;
- c. Adequate documentation of logs by voice comments on tape where applicable;

- d. Seismograph polarity;
- e. Level of calibration signals;
- f. Relative phase shift between array seismographs;
- g. Level of the microseismic background noise;
- h. Level of the system noise;
- i. PTA dc balance;
- j. Oscillator alignment;
- k. Quality of the recorded WWV signal where applicable;
- l. Time-pulse carrier;
- m. Binary coded digital time marks.

2.6 SECURITY INSPECTION

Mr. Ray Posage, Industrial Security Inspector from Phoenix, Arizona, made a routine security inspection of the observatory on 7 April 1967. All security procedures were found to be in order.

2.7 EMERGENCY POWER GENERATOR

The emergency power generator was operated for several hours each month during this reporting period. Most of the operating time was for maintenance purposes; however, a few hours of operation were necessary because of commercial power fluctuations.

2.8 TEST EQUIPMENT CALIBRATIONS

The annual test equipment calibration which was started during March at TFSO was completed during April 1967.

3. EVALUATE DATA AND DETERMINE OPTIMUM OPERATIONAL CHARACTERISTICS

3.1 MODIFICATIONS TO TFSO INSTRUMENTATION

3.1.1 TFSO Long-Period Response Change

The TFSO long-period seismograph systems had been operated with the frequency response shown in figure 3 since early in the year. On 18 April 1967, the long-period seismograph response was changed back to the standard response (figure 2).

3.1.2 Deletion of Elements from the 31-Element Array

On 22 April 1967, operation of 11 of the remaining 19 elements of the original 31-element array was discontinued. The field cables from these elements have been retrieved and tested, and the seismometers are currently being modified and checked in preparation for their installation in the 37-element array. Figure 4 shows the locations of the systems currently being operated.

3.1.3 Broad-Band Systems

On 19 April 1967, operation of the TFSO broad-band systems was suspended. This action was necessary to make available pier space on which to install the ocean bottom sphere for the long-period seismograph tests (see section 6.1) during May 1967.

3.2 TESTING OF TFSO INSTRUMENTATION

3.2.1 Long-Period Surface Vault

Operation of a horizontal long-period system in an experimental surface vault was discontinued on 19 April 1967. The horizontal long-period seismometer was required for installation in the ocean bottom sphere.

4. ANALYZE DATA

4.1 DAILY REPORTS TO THE COAST AND GEODETIC SURVEY

TFSO reports the time of arrival, period, and peak amplitude of events recorded at TFSO to the Director of the Coast and Geodetic Survey (C&GS)

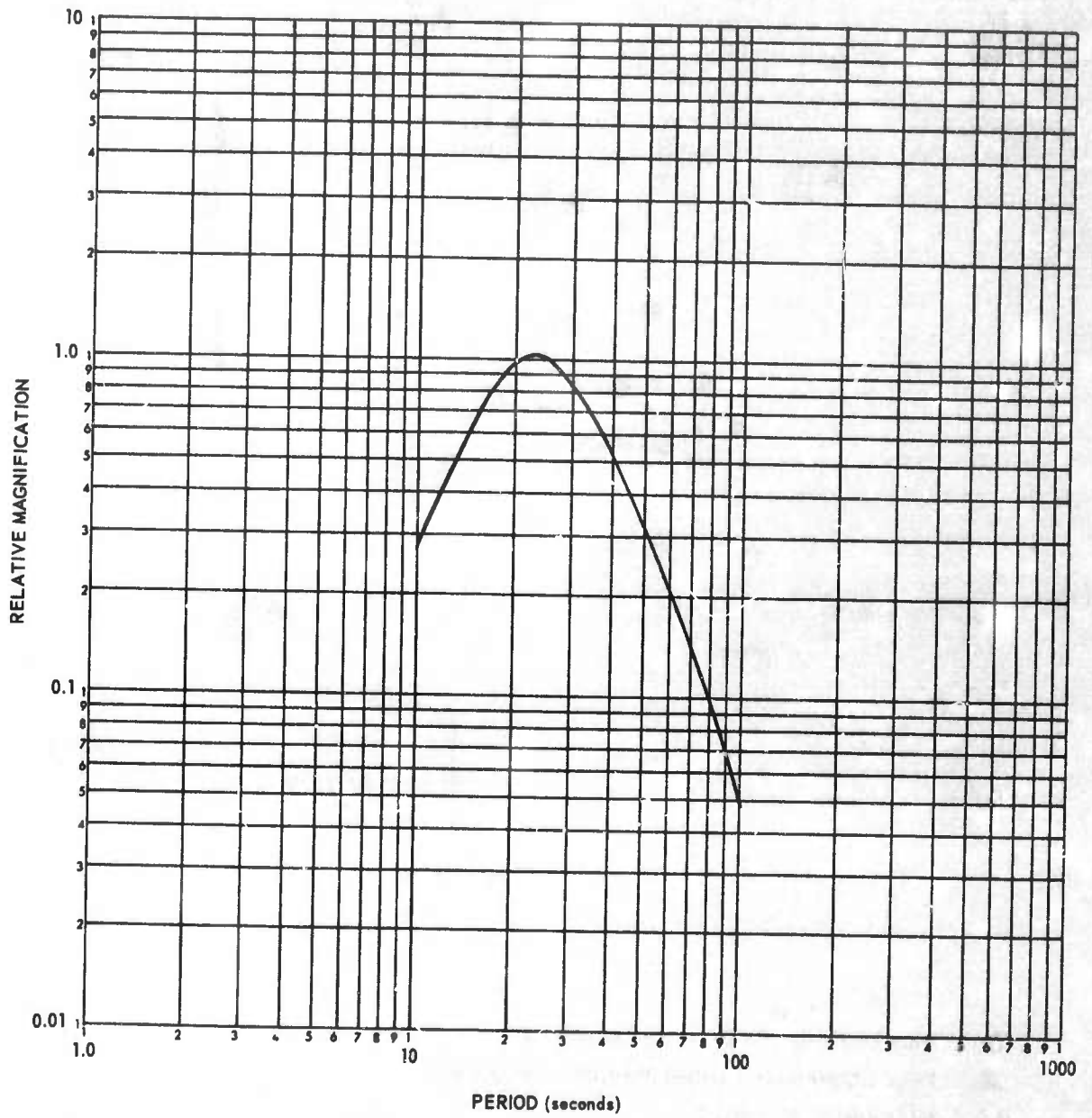
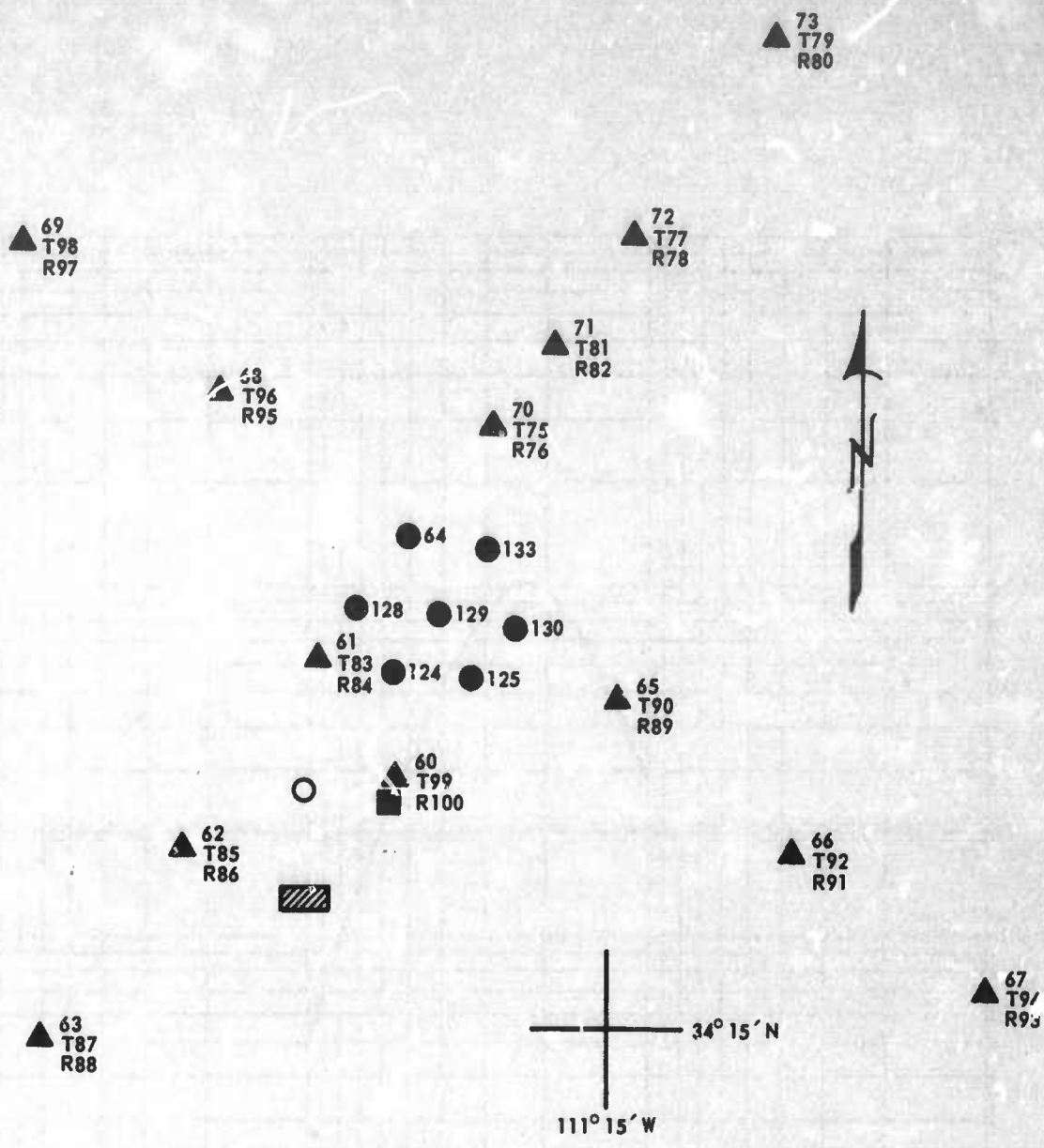

Figure 3. Typical response of TFSO three-component long-period system as modified on 18 January 1967



- SHORT-PERIOD VERTICAL SEISMOGRAPH
- ▲ THREE COMPONENT SHORT-PERIOD SEISMOGRAPH
- EXPERIMENTAL VAULT
- LONG-PERIOD VAULT
- ▨ CENTRAL RECORDING BUILDING

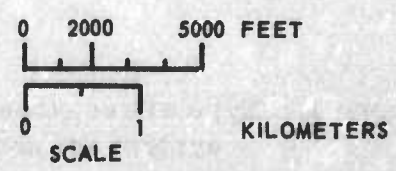

Figure 4. Tonto Forest Seismological Observatory vault locations, 30 June 1967

G 2918

in Washington, D. C., daily. The number of events reported by TFSO during each month of the reporting period is shown in table 2 by type. Lists of hypocenters located by the C&GS for these months are incomplete.

Table 2. Number of earthquakes reported to the C&GS by TFSO between 1 April and 30 June 1967

<u>April 1967</u>					<u>May 1967</u>				
<u>L</u>	<u>N</u>	<u>R</u>	<u>T</u>	<u>Total</u>	<u>L</u>	<u>N</u>	<u>R</u>	<u>T</u>	<u>Total</u>
15	142	24	1251	1432	32	188	44	1078	1342
<u>June 1967</u>									

4.2 DAILY ANALYSIS FOR MULTISTATION EARTHQUAKE BULLETIN

Data from TFSO are combined with data from CPSO, BMSO, UBSO, and WMSO and published in a monthly multistation earthquake bulletin. The bulletins for December 1966 through March 1967 were published during this reporting period. Raw data for March, April, and May 1967 were transcribed onto digital magnetic-tape and sent to SDL for processing. Key punching of the June raw data is about 20 percent complete.

4.3 ROUTINE NOISE SURVEY

Measurements of ambient noise in the 0.4- to 1.4-second period range are made from the 16-millimeter film, short-period seismograms, daily, at TFSO. Data are processed in Garland, and monthly cumulative probability curves of trace amplitude and ground displacement as recorded on the Z60, ΣT , and ΣTF seismograms are published. Curves for the months of February through May 1967 were sent to the Project Officer during this reporting period.

5. PROVIDE OBSERVATORY FACILITIES AND ASSISTANCE TO OTHER ORGANIZATIONS

5.1 ASTRODATA DATA ACQUISITION SYSTEM (ASDAS)

No problems were encountered with the Astrodata system during this reporting period. The equipment was operated for approximately 50 hours during which 34 digital seismograms were recorded.

5.2 RECORDINGS FOR THE CALIFORNIA INSTITUTE OF TECHNOLOGY

All 16-millimeter film seismograms recorded under Data Group 7211 were sent to the California Institute of Technology (Cal Tech), weekly, except for data requested by VSC.

5.3 TELEMETRY TO MASSACHUSETTS INSTITUTE OF TECHNOLOGY

Telemetry of seven seismograph channels to Lincoln Labs, Massachusetts Institute of Technology (MIT), continued throughout this reporting period. MIT is notified in advance when the seismographs are attenuated for special tests.

5.4 ASTROGEOLOGICAL DEPARTMENT OF USGS

TFSO has continued to support Dr. Harold Krivoy of the Astrogeological Department of the United States Geological Survey (USGS) in Flagstaff, Arizona. Dr. Krivoy receives copies of the daily station message routinely, and prints of events of special interest are sent to him on request.

5.5 LRSM SIGNAL STUDY

Effective, 8 April 1967, copies of the TFSO daily TWX message to the C&Gs were mailed to the LRSM Group in Garland, Texas. Also, from 1 through 23 May 1967, information consisting of basic measurements taken from large teleseismic events was reported by telephone.

5.6 VISITORS

5.6.1 Visits by School Groups

Arizona State University students and instructors visited TFSO on 14, 21, and 28 April 1967. Approximately 210 visitors were given tours of the observatory and brief lectures on seismology.

5.6.2 Teledyne Visitors

Mr. George Walker, head buyer for Geotech, visited the station during April 1967 to interview contractors interested in submitting bids for site preparation and road construction for the 37-element short-period array, and to receive bids. Mr. O. D. Starkey visited TFSO during May 1967 to install and check the solid-state long-period amplifier now being evaluated.

5. 6. 3 Visit by the Program Manager

Mr. B. B. Leichter, Geotech Program Manager, and Mr. M. E. Robinson, Program Engineer, visited TFSO during May 1967. The status of current work was reviewed and future work of Project VT/7702 was planned, especially the expansion of the short-period array.

6. RESEARCH PROGRAMS

6.1 TESTS OF THE PERFORMANCE OF LONG-PERIOD SEISMOMETERS IN AN EVACUATED SPHERICAL CHAMBER

To determine the operational characteristics of long-period seismometers in evacuated environments, we obtained a spherical chamber used to house the Texas Instruments (TI) ocean bottom seismograph on a loan basis under Project VT/5055.

We postulated that an environment evacuated to a pressure of about one thousandth of an atmosphere would eliminate or greatly reduce the effects from several potential sources of nonseismic noise. The effects caused by pressure changes (for example, mass buoyancy forces and piston-type forces exerted on the boom assembly) and those caused by air convection currents acting on the seismometer case were expected to be substantially reduced. Because the heat conduction through the air is greatly reduced, the temperature of the instruments is expected to be considerably more stable than that of similar instruments operated in conventional environments, allowing quieter operation of the seismographs.

We anticipated that the attenuation of the noise produced by these mechanisms would allow a more detailed study of any remaining nonseismic noise, afford a better opportunity to isolate specific sources of this noise, and to study the effects of controlled noise generators (for example, differential heating of the seismometer and earth-tilt).

The spherical housing and a vacuum system were sent to TFSO during early April, and a mobile hoist was modified to handle the sphere within the long-period vault and pier room. During May, the sphere was assembled on the pier, a horizontal long-period seismometer was checked out and installed inside the sphere, oriented east-west, and the sphere was sealed and evacuated (see figure 5). Shortly thereafter, lightning damaged a portion of the remote mass-positioning equipment, necessitating opening of the sphere to repair the damage. The sphere was again sealed and evacuated to approximately 1/1000 of an atmosphere.

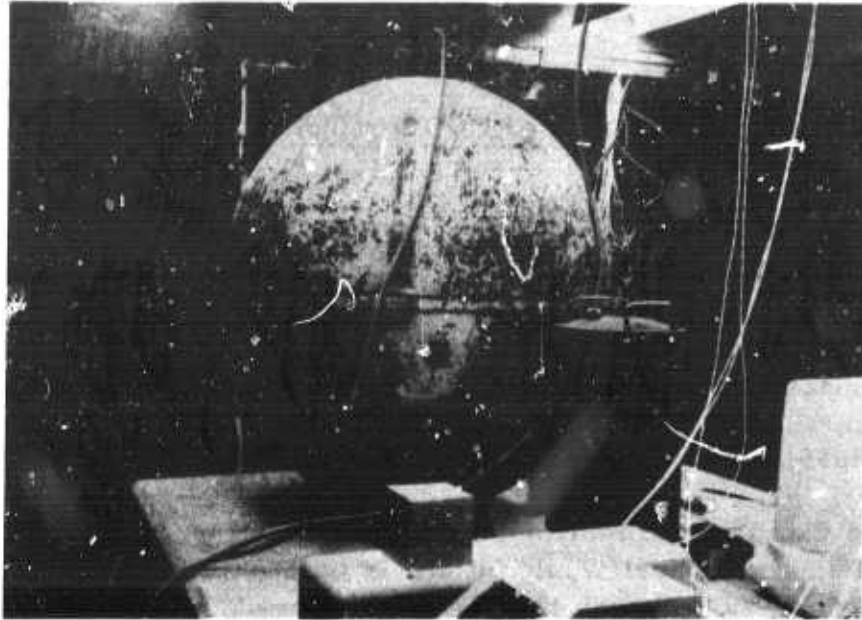

Figure 5. Ocean bottom sphere in place on the long-period pier at TFSO. The sphere has been sealed and evacuated

G 2919

The seismograms produced by the seismometer in the sphere were designated E57LP and were recorded on the experimental long-period Develocorder adjacent to the E52LP seismograms which were produced by the standard, east-west long-period horizontal seismometer installed on the same pier with the sphere. All of the seismograms made to date have been made with the vault sealed and have shown a marked similarity between E57LP and E52LP (see figures 6 through 9). A detailed examination of all data recorded on 16 and 17 June revealed no difference in the seismograms, except for minor variations expected because of slight differences in magnification and seismograph frequency and phase responses.

Because the test and control seismometers were operated in greatly different environments, and because the seismograms produced by the test and control seismographs were essentially identical, we conclude that no noise caused by

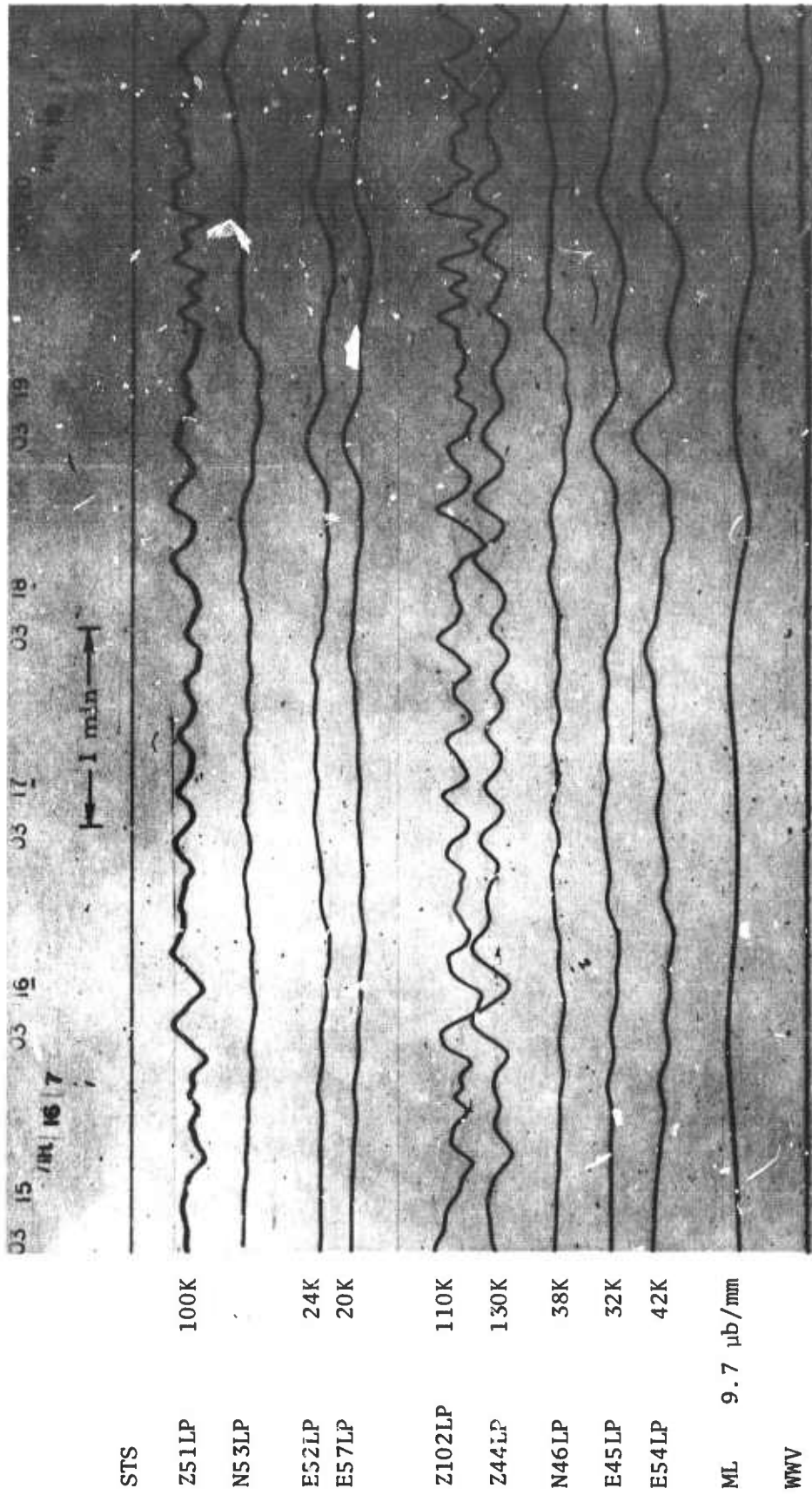
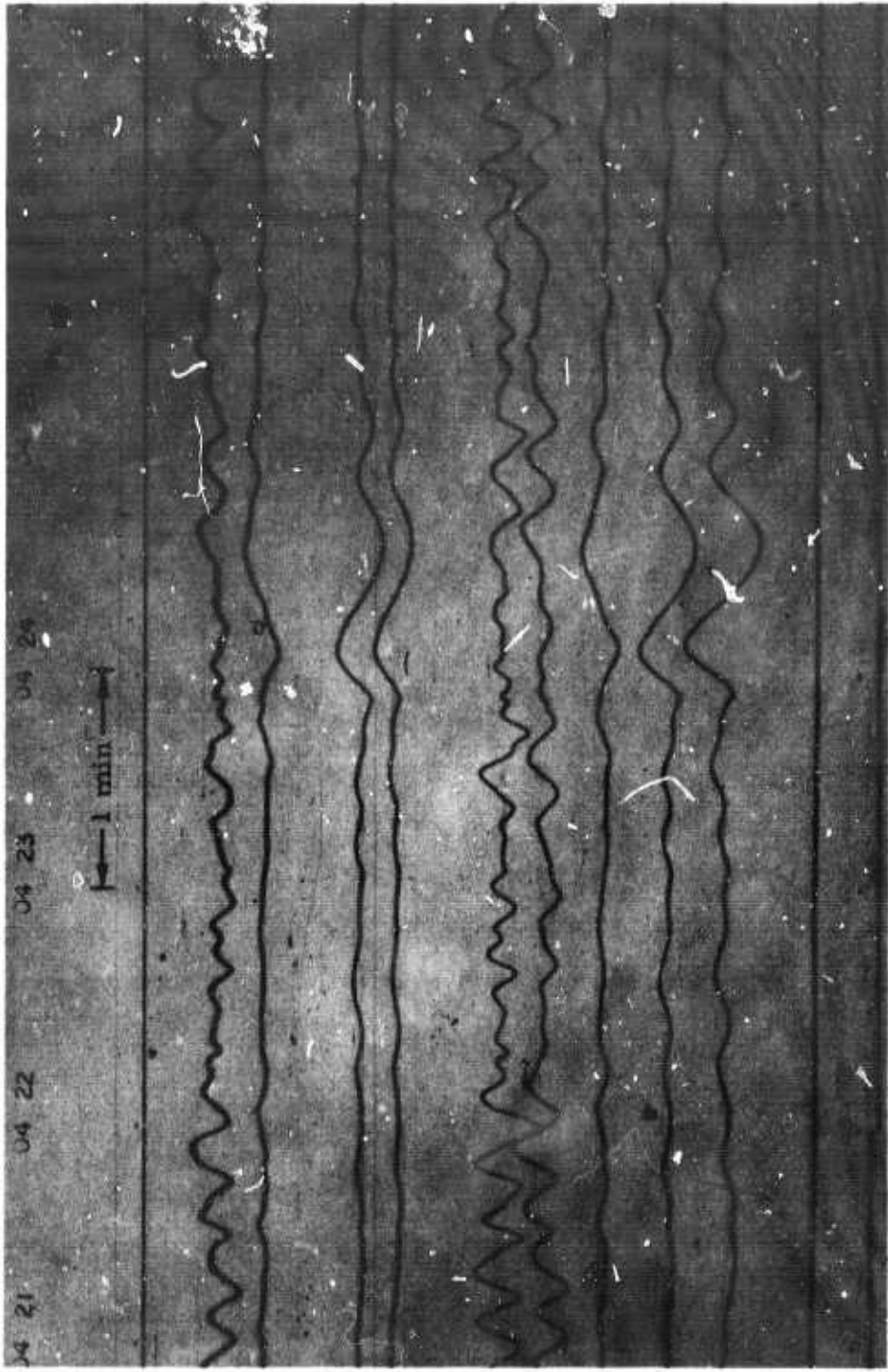

Figure 6. TFSO experimental long-period seismogram illustrating the similarity in the response of the test seismographs (E52LP and E45LP) and the corresponding control seismographs (E57LP and E54LP) during an atmospherically calm period; the door to the long-period pier room was sealed. (X10 enlargement of 16 mm film)

TFSO
 16 June 1967
 Run 167
 DT LP Exp



STS
 Z51LP 100K
 N53LP 29K
 E52LP 24K
 E57LP 20K
 Z102LP 110K
 Z44LP 130K
 N46LP 38K
 E45LP 32K
 E54LP 42K
 ML 9.7 $\mu\text{b}/\text{mm}$
 WWV

Figure 7. TFSO experimental long-period seismogram illustrating the similarity in the response of the test seismographs (E52LP and E45LP) and the corresponding control seismographs (E57LP and E54LP) during an atmospherically calm period; the door to the long-period pier room was sealed. (X10 enlargement of 16 mm film)

TFSO
 16 June 1967
 Run 167
 DT LP Exp

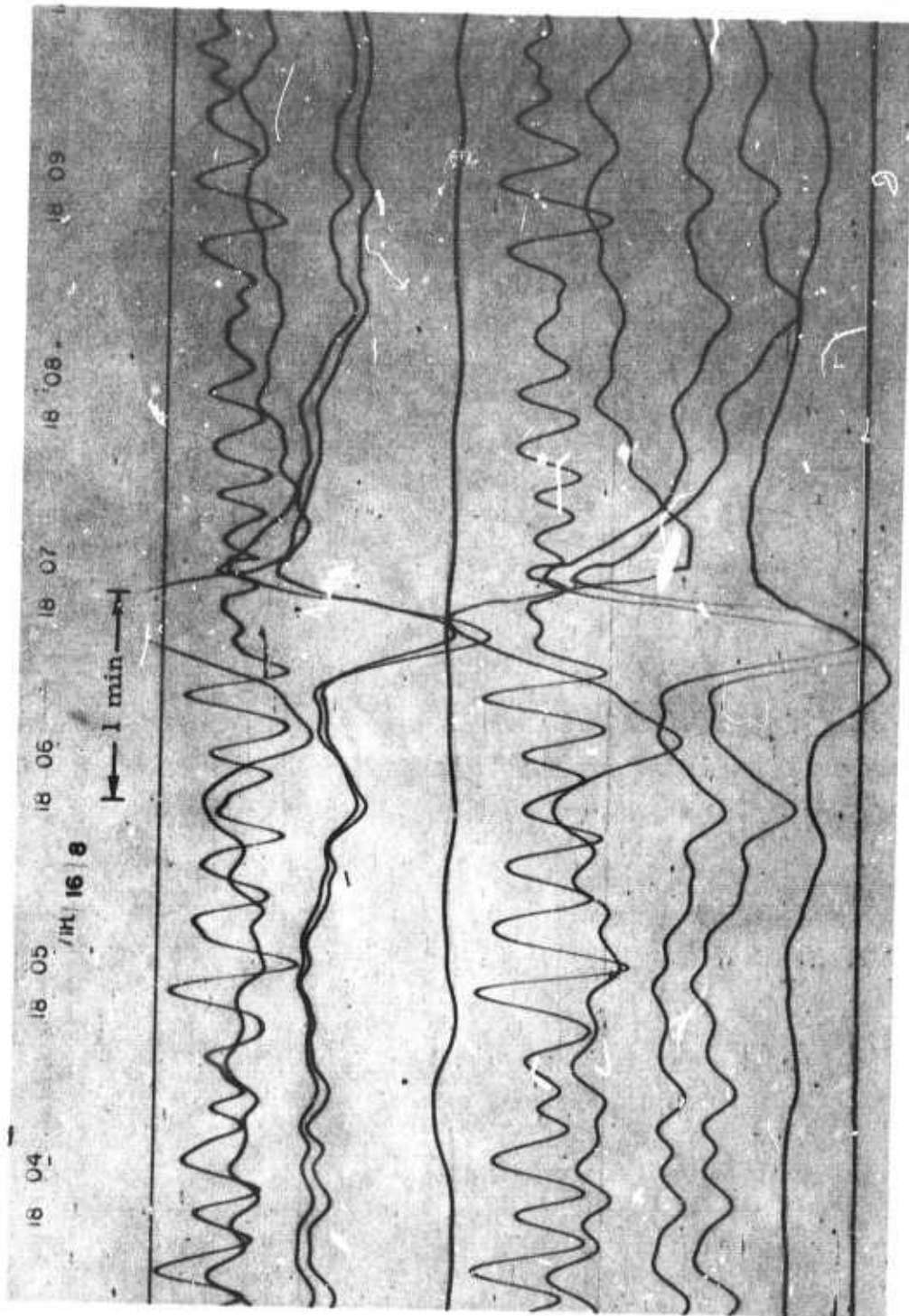

STS
 Z51LP 100K
 N53LP 28K
 E52LP 24K
 E57LP 18K

 Z102LP Inop
 Z44LP 110K
 N46LP 38K
 E45LP 33K
 E54LP 48K
 ML 9.7 $\mu\text{b}/\text{mm}$
 WMV

Figure 8. TFSO experimental long-period seismogram illustrating the similarity in the response of the test seismographs (E52LP and E45LP) and the corresponding control seismographs (E57LP and E54LP) while the wind was gusting to about 36 mph; the door to the long-period pier room was sealed. (X10 enlargement of 16 mm film)

TFSO
 17 June 1967
 RPN 168
 DT LP Exp

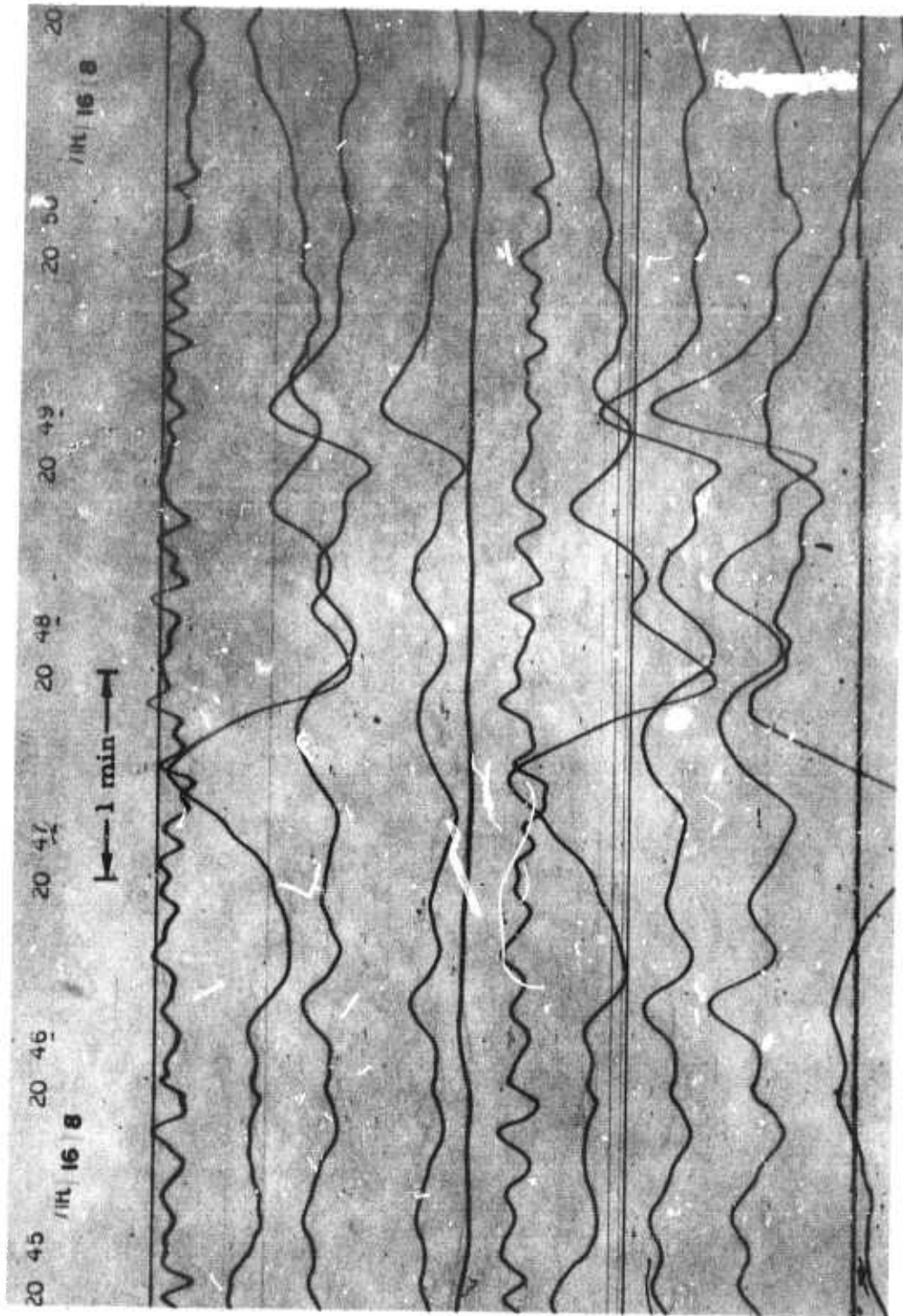

STS
 Z511LP 100K
 N53LP 28K
 E52LP 24K
 E57LP 18K
 Z102LP Inop
 Z44LP 110K
 N46LP 38K
 E45LP 33K
 E54LP 48K
 ML 9.7 μ b/mm
 WWV

Figure 9. TFSO experimental long-period seismogram illustrating the similarity in the response of the test seismographs (E52LP and E45LP) and the corresponding control seismographs (E57LP and E54LP) while the wind was blowing at about 20 mph; the door to the long-period pier room was sealed.
 (X10 enlargement of 16 mm film)

TFSO
 17 June 1967
 RPN 168
 DT LP Exp

air motion due to pressure changes and/or convection or noise caused by temperature instabilities within the instruments was present on either of the seismograms.

Near the end of the reporting period, the marine door to the long-period pier room was opened to facilitate comparisons of the operation of seismometers in sealed and unsealed environments. To date, no data are available from this phase of the tests. We plan to complete this phase of the tests during July and to begin other controlled environmental tests. When tests of the operation of the test seismometer in the pier room are complete, we will move the sphere out of the vault and install it on the surface adjacent to a near-surface tank vault so that operations of seismometers in these environments can be compared.

6.2 COMMUNICATIONS SYSTEM

TFSO received a communications license for the mobile radio system from the Federal Communications Commission on 1 May. Installation and checkout of the radios was accomplished on 4 and 5 May. The communications system has proven to be very satisfactory; to date we have been able to communicate with TFSO from all points checked within 30 miles of the observatory.

6.3 EVALUATION OF SHORT-PERIOD SEISMOGRAPH WITH A SOLID-STATE AMPLIFIER

In April 1967, a short-period seismograph employing a Geotech Solid-State Amplifier, Model 25220-03, and a Model 6480 JM seismometer with a special high-impedance coil were installed at TFSO, adjacent to a standard short-period seismograph, for evaluation.

This system was similar to the short-period solid-state seismograph tested at TFSO in December 1966 (see TR 67-13) except that this system uses wide-band FM data transmission. A block diagram of the system is shown in figure 10.

Frequency responses of the short-period solid-state seismograph (Z55SS) and the standard TFSO control seismograph (Z74) are shown in figure 11. Visual analysis of the film seismograms indicates that the performance of the two systems is essentially identical (see figures 12 and 13).

Digital samples of seismic background and system noise from the Z55SS and Z74 seismographs were recorded on the Astrodata digital data acquisition system. The digital magnetic tapes were processed on the CDC 3100 computer in Gariand to calculate the power spectral estimates presented in figure 14 and 15. In each figure, curve A corresponds to the seismic background during

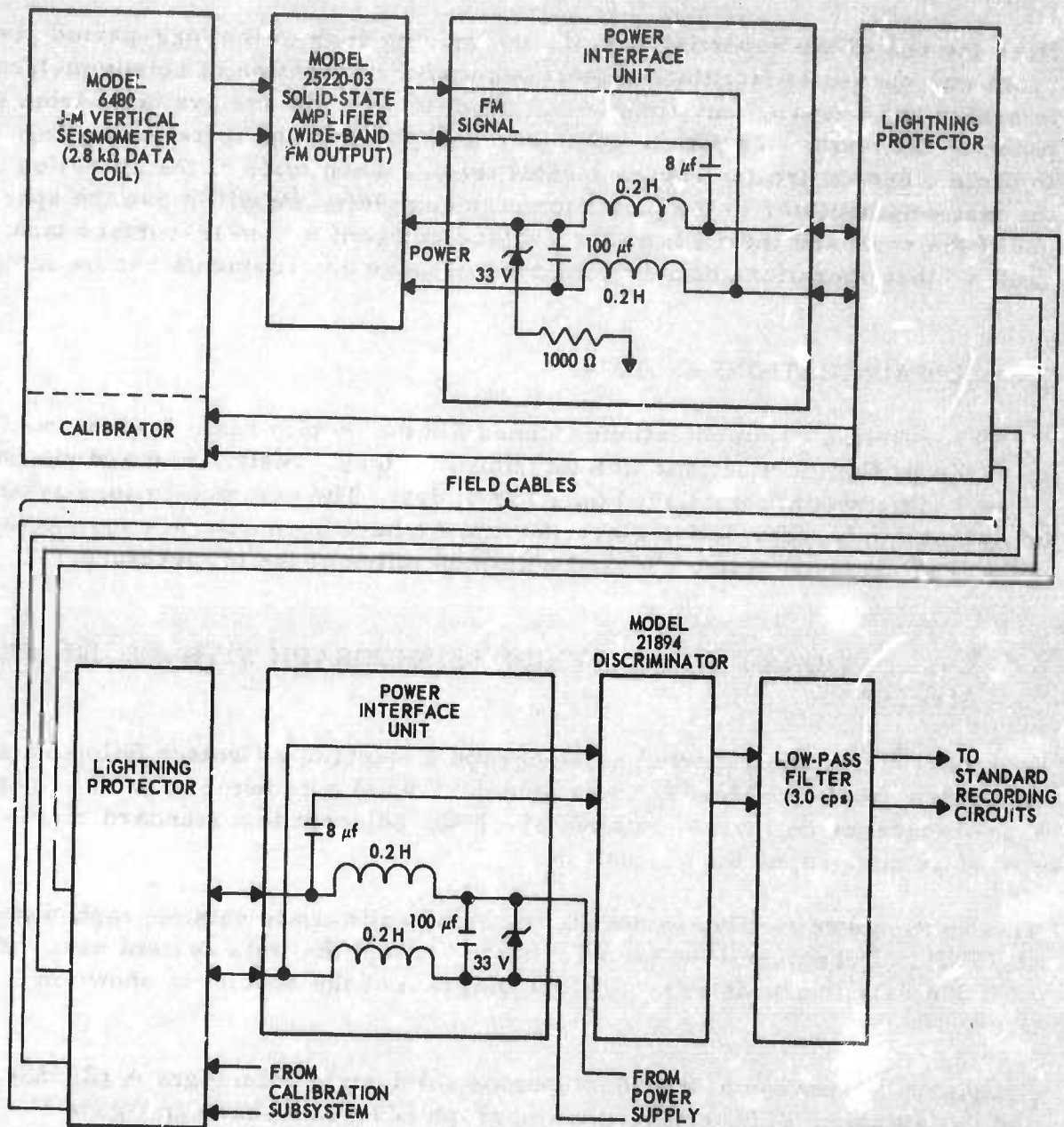

Figure 10. Simplified block diagram of the short-period system with a solid-state amplifier (Z55SS) being tested at TFSO

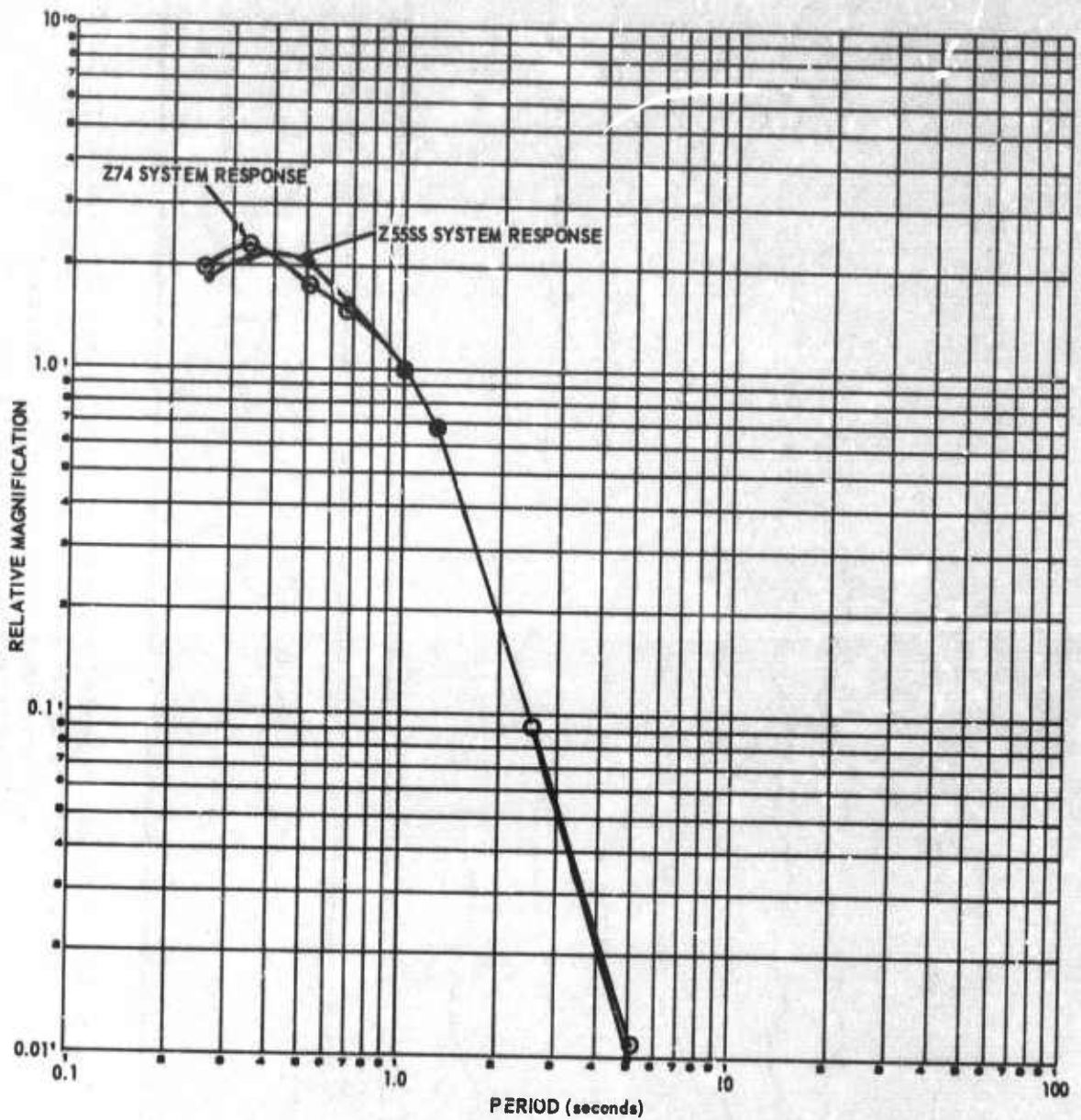

Figure 11. Frequency responses for the Z55SS seismograph using a solid-state amplifier, and the Z74 seismograph using a phototube amplifier

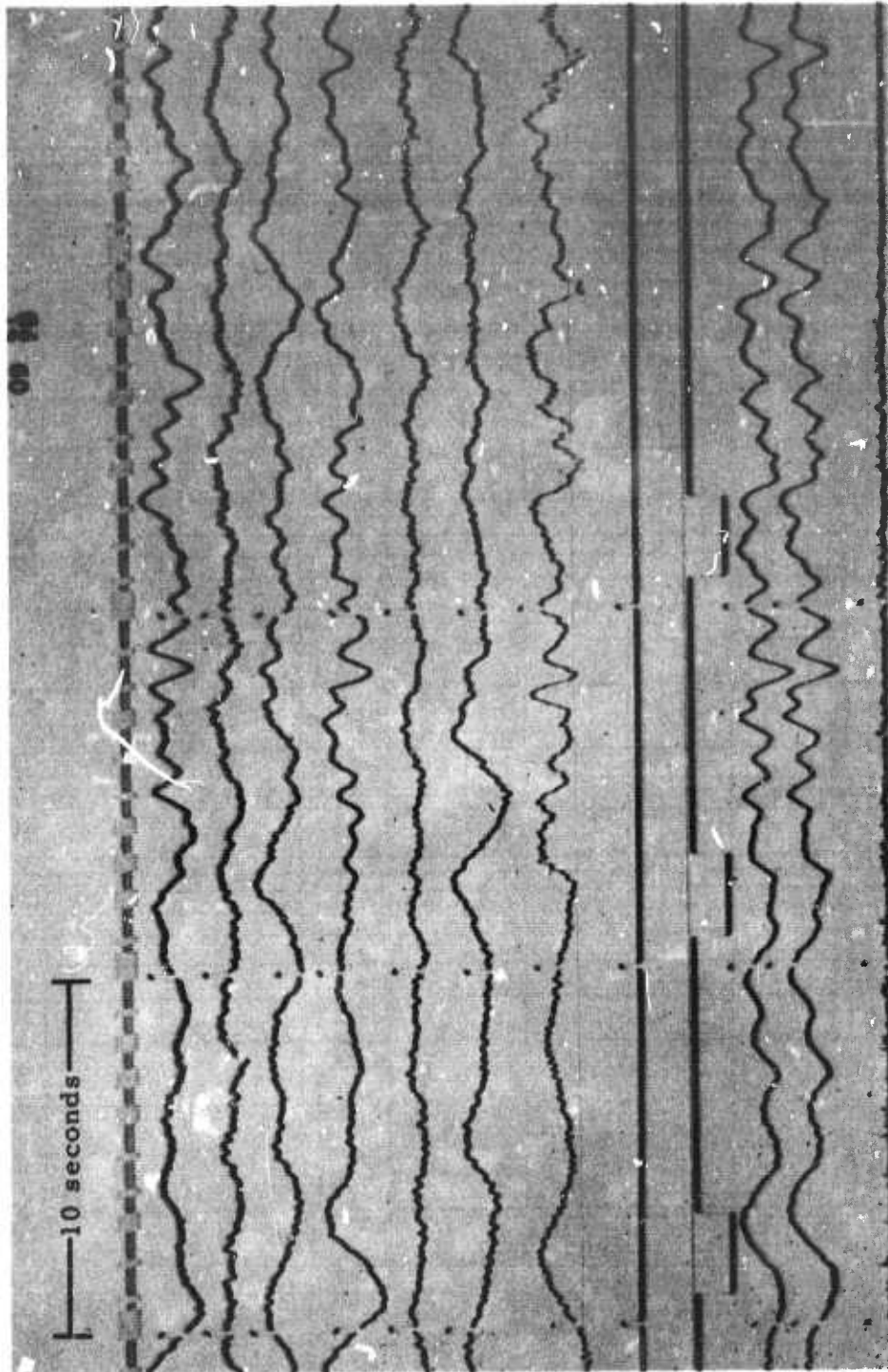

Figure 12. TFSO short-period seismogram illustrating the similarity in the response of the Z55SS and Z74 seismographs to an arrival from a teleseismic event (epicenter unknown).
(X10 enlargement of 16-millimeter film)

Z73	1000K
R80	1040K
T79	960K
Z70	1040K
R76	960K
T75	1040K
Z63	1000K
MS	
WI	
Z55SS	1000K
Z74	1080K
WWV	

TFSO
26 May 1967
Run 146
Data Group 7215

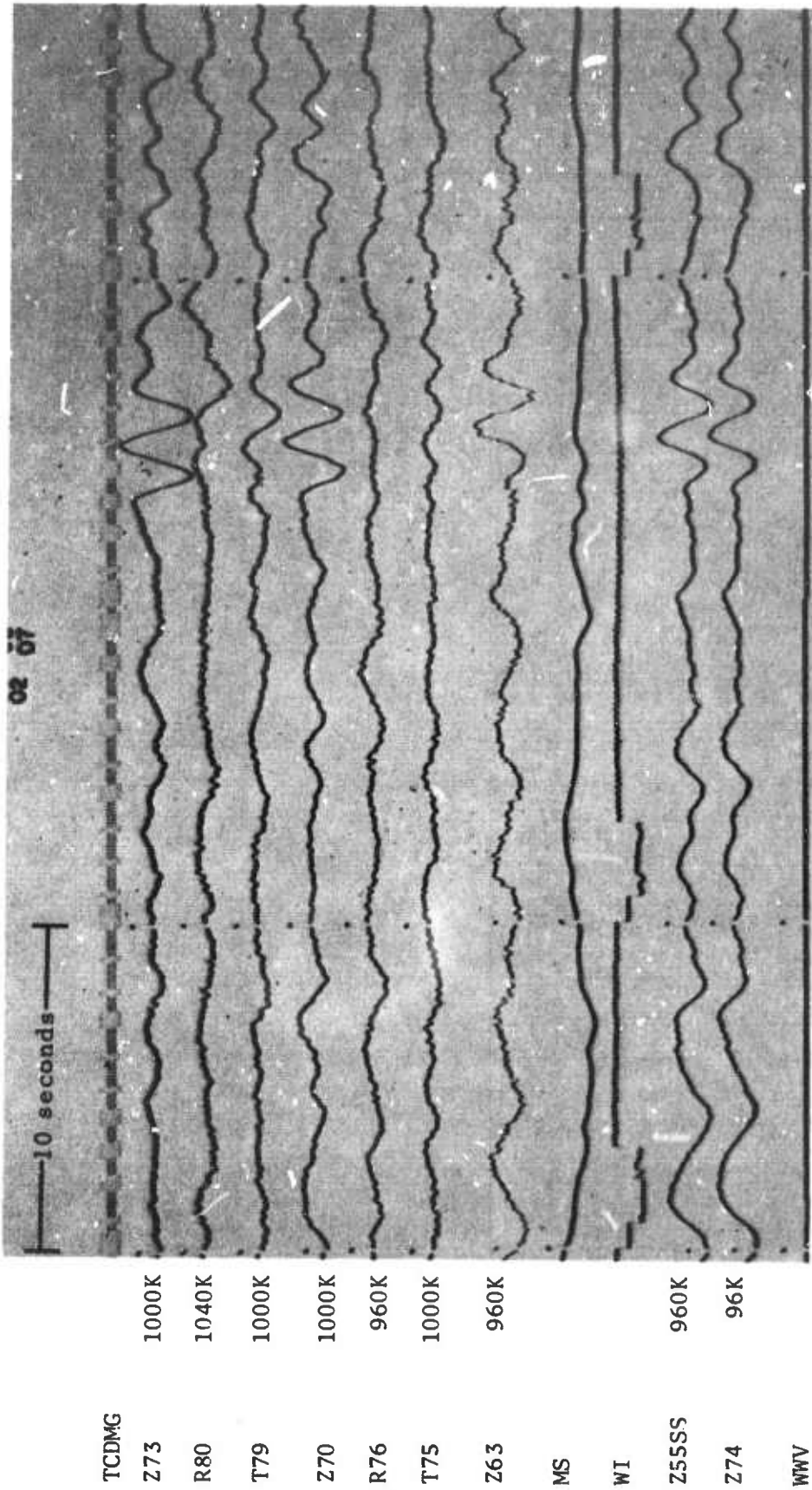

Figure 13. TFSO short-period seismogram illustrating the similarity in the response of the Z55SS and Z74 seismographs to an arrival from a teleseismic event (epicenter unknown). (X10 enlargement of 16-millimeter film)

TFSO
27 May 1967
Run 147
Data Group 7215

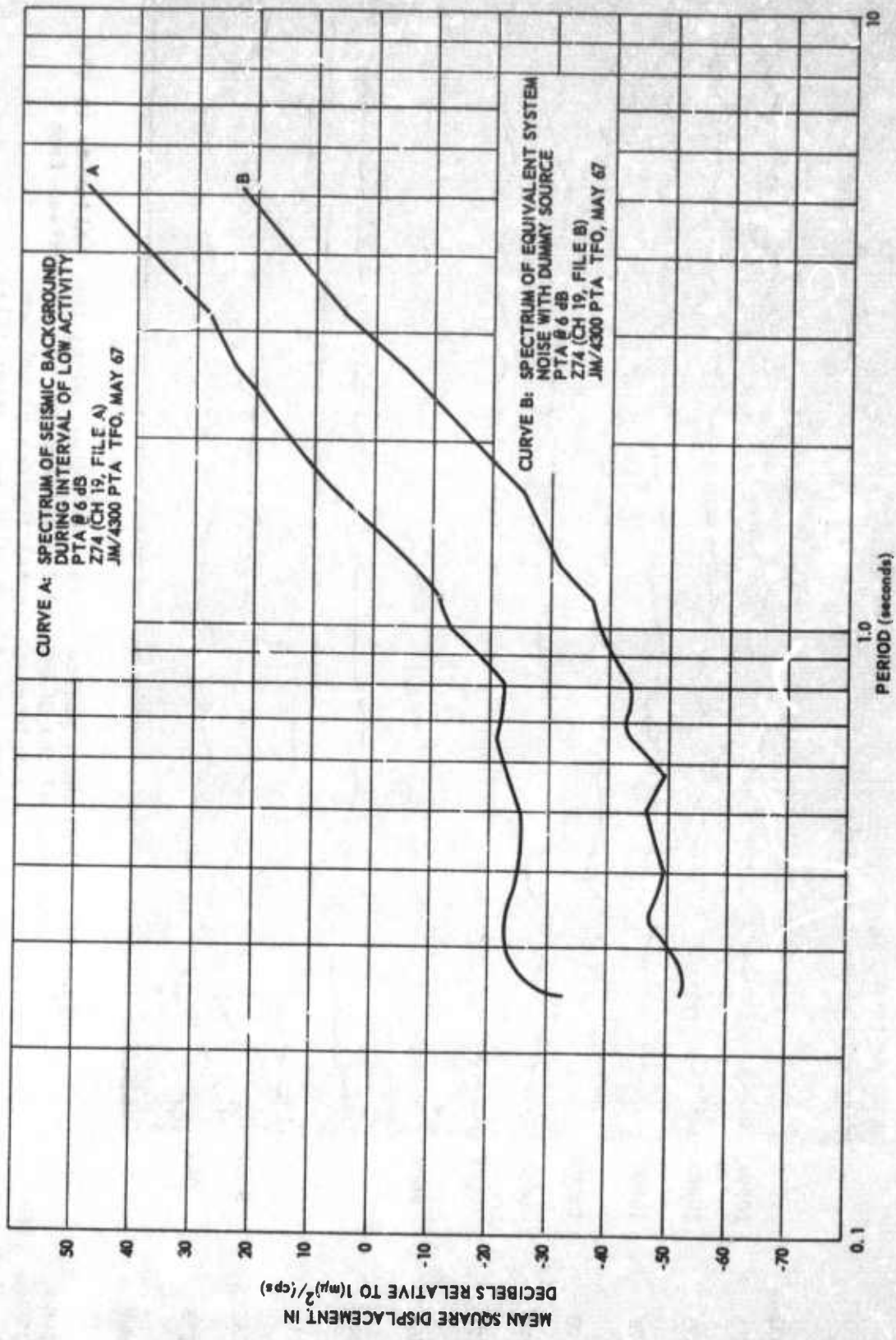

Figure 14. Spectral relations of low level seismic background and system noise of the Z74 seismograph

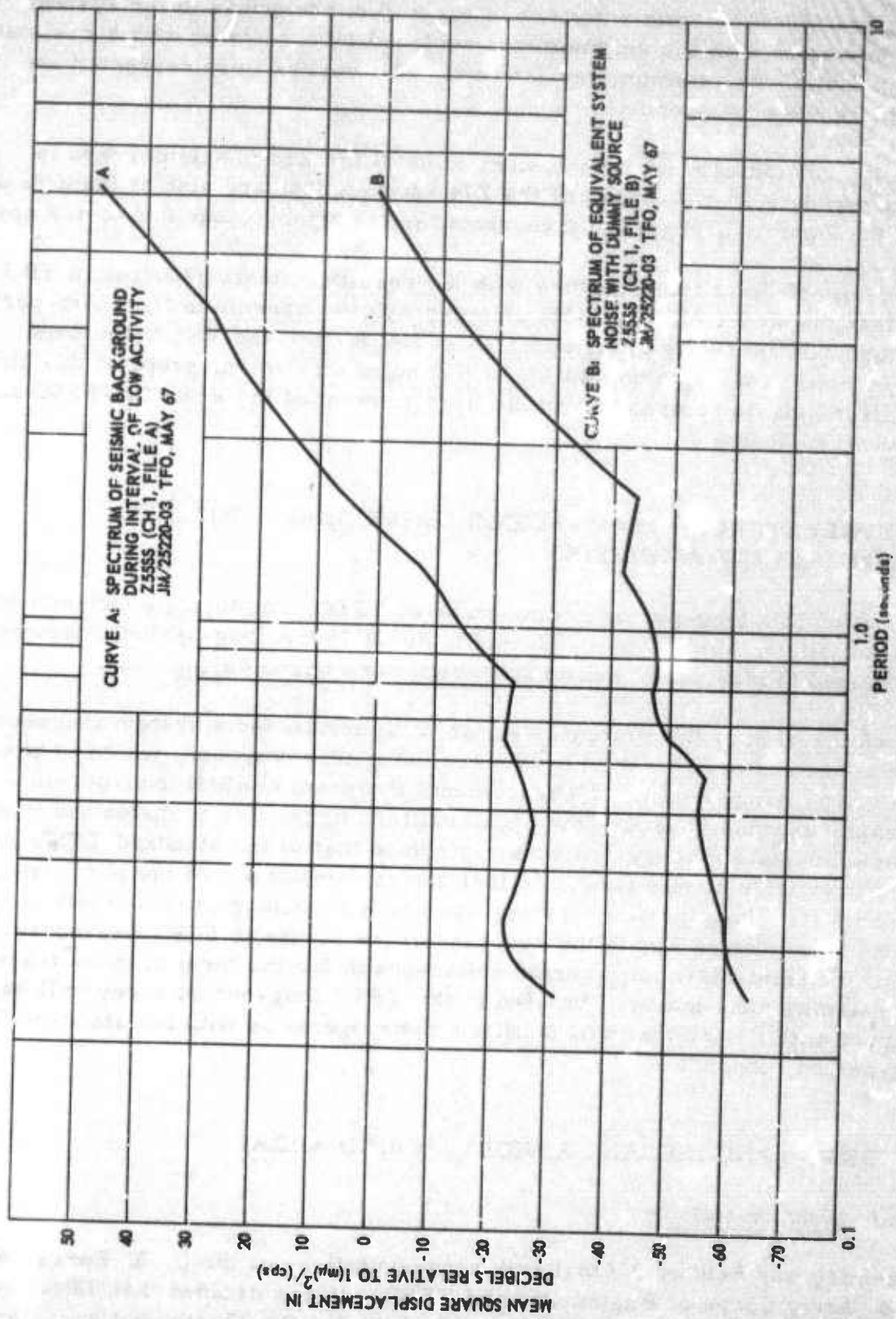

Figure 15. Spectral relations of low level seismic background and system noise of the Z55SS seismograph

an interval of low seismic activity and curve B corresponds to the system electronic noise with the seismometer replaced by a resistor with a resistance equal to that of the seismometer data coil. All curves were corrected for system frequency response.

These figures indicate that the system noise of the 755SS seismograph is approximately 6 dB below that of the Z74 seismograph and also at least 22 dB below the seismic background throughout the frequency range 0.2 to 4.0 cps.

The results of these tests coupled with the results of tests reported in TR 67-13 show that the Model 25220-03-JM seismograph is superior to the short-period seismographs currently being operated at LASA or at the VELA-Uniform observatories. We plan no additional testing of this seismograph at this time and will install its components in the first element of the expanded TFSO short-period array during July.

6.4 EVALUATION OF LONG-PERIOD SEISMOGRAPH WITH A SOLID-STATE AMPLIFIER

Installation of a long-period seismograph at TFSO, employing a Geotech Solid-State Amplifier, Model 28450-02, and a Model 7505A long-period seismometer, was started in May, and preliminary tests were begun during June.

A block diagram of the system is shown in figure 16 and a system frequency response is shown in figure 17. We are using this response, which is based on the Long Range Seismic Measurements Program (LRSM) long-period seismograph response, because the special filters necessary to match the response of the solid-state long-period seismograph to that of the standard TFSO systems are not available at this time. So that direct comparison of the performance of the solid-state long-period seismograph and a PTA long-period seismograph is possible, we plan to match the response of the standard TFSO seismograph to that of the solid-state long-period seismograph for the term of these tests. The seismographs that will be used in the TFSO long-period array will be equipped with filters that will facilitate their operation with the standard TFSO long-period response.

6.5 DESIGN AND INSTALL A SHORT-PERIOD ARRAY

6.5.1 Land Permitting

A meeting was held on 3 April with representatives of the U. S. Forest Service, U. S. Army Corps of Engineers, and TFSO. It was decided that TFSO would furnish copies of maps showing current plans for the 37-element array and that the Corps of Engineers would furnish an application for a Special Use Permit.

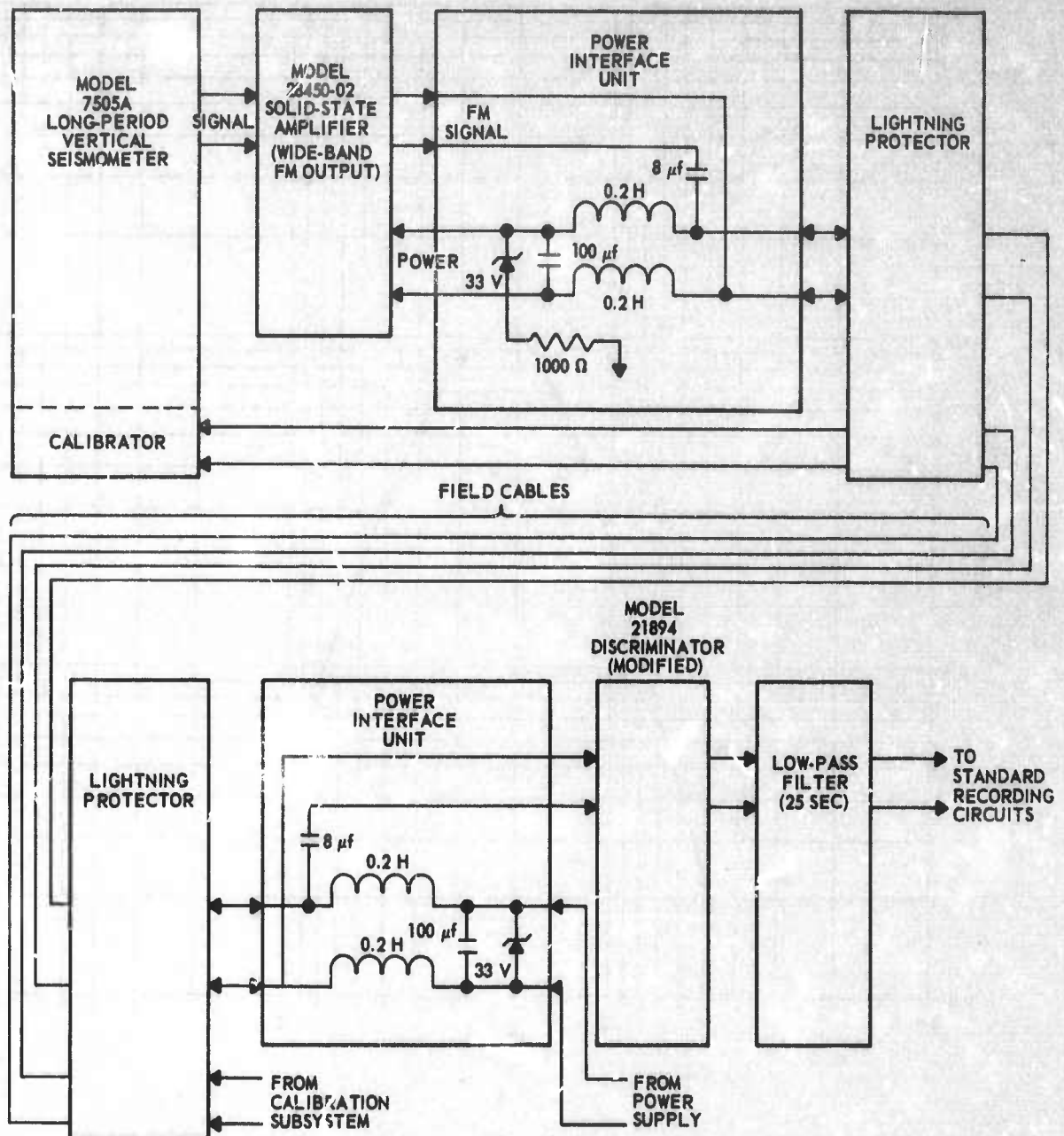

Figure 16. Simplified block diagram of the long-period system with a solid-state amplifier (Z102LP) being tested at TFSO

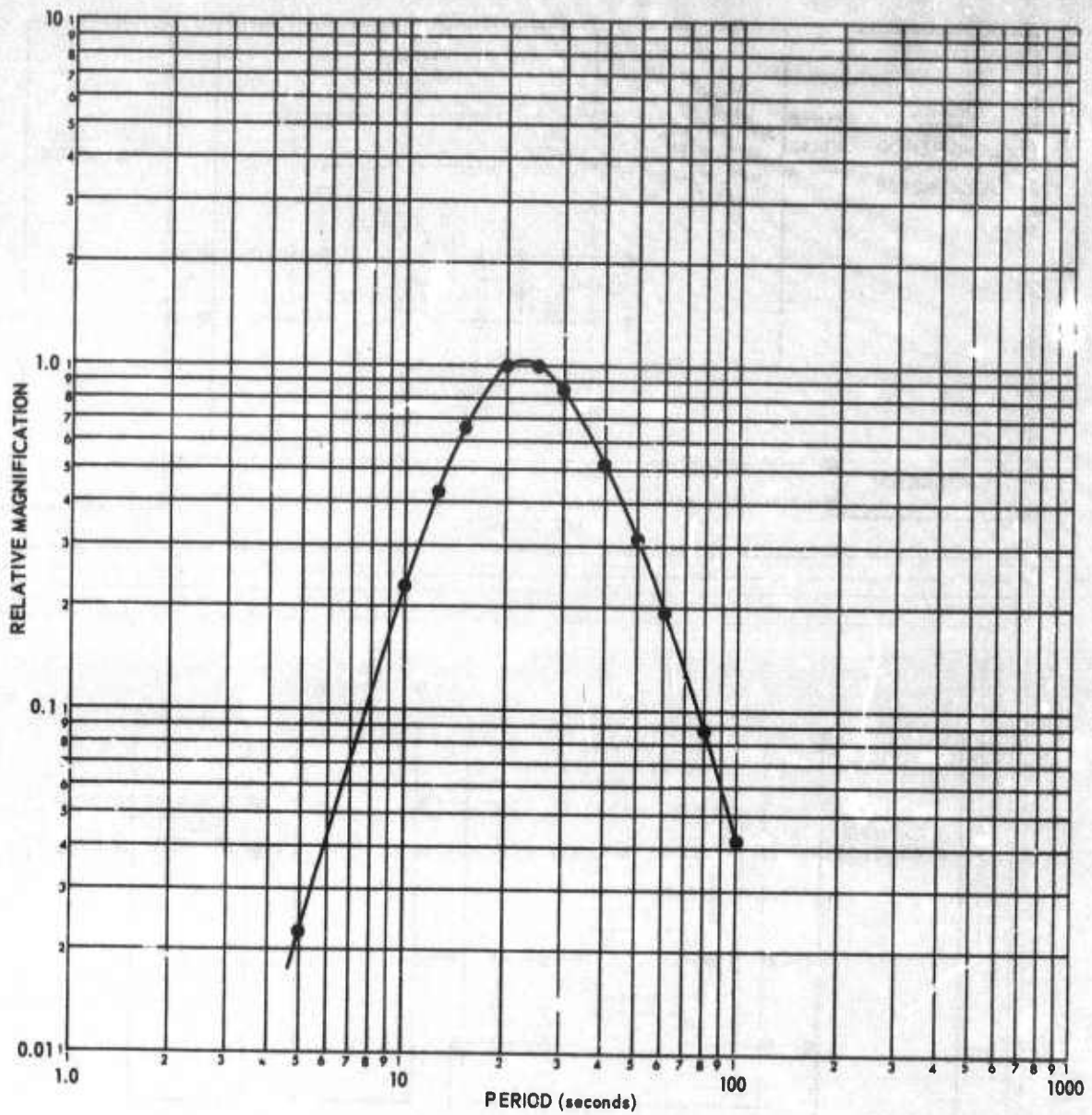

Figure 17. Frequency response for the long-period seismograph utilizing the Model 28450-02 amplifier

The maps were supplied on 12 April. Verbal authorization to proceed with the construction was given by the Forest Service on 15 May and a signed copy of Amendment No. 4 to the TFSO Memorandum of Agreement No. LA-1412, was received on 5 June.

6.5.2 Archeological Control

Archeological inspection of the expanded array area was started on 14 June under the direction of Mr. Roger Kelley, Associate Professor of Archeology, Arizona Northern University. Clearance has been given for all sites and cable trails within segments V and I plus sites Z4, Z12, Z25, Z28, and Z29, in segment II. Several indian ruins have been encountered requiring slight re-routing of cables in the vicinity of Z12 (see figure 18).

6.5.3 Site Selection

Sites selected and trails flagged during this reporting period included Z3, Z4, Z5, Z8, Z9, Z10, Z11, Z12, Z19, Z23, Z24, Z25, Z26, Z27, Z28, Z29, Z30, Z31, and Z32. Figure 19 shows the array orientation and the vault location, cable trail location, and cable trail status at the end of the reporting period.

6.5.4 Material Received

All spiral-four cable for the array has been received and all steel vaults are on hand. Steel culvert sections, 4 by 5 feet, have been ordered for use as retaining walls, and shipment of these is scheduled to start in late June. All miscellaneous hardware, messenger cable, posts, grounding rods, hock sealent, etc., is either on hand or has been ordered.

6.5.5 Site and Road Construction

Magini Construction Company of Phoenix, Arizona, was awarded the site and road construction contract. Work was started on 23 May; figures 20 and 21 show cable trail construction in the vicinity of Z9. To date, all access and cable trails within segment I and segment V have been completed plus access roads and cable trails for sites Z9, Z10, and Z3. Actual site preparation will begin on or about 5 July. Progress has been somewhat slower than anticipated due to stringent Forest Service regulations regarding drainage, gradients, and brush and tree disposal.

6.5.6 Cable Installation

Cable installation along the northwest and northeast legs of the present linear array are essentially complete. Cable for 11 systems has been installed from the end of the northwest linear leg to the junction with Z19, also between Z21 and Z19 junction and from Z37 and Z20 south to the control road. Z1 cabling is complete.

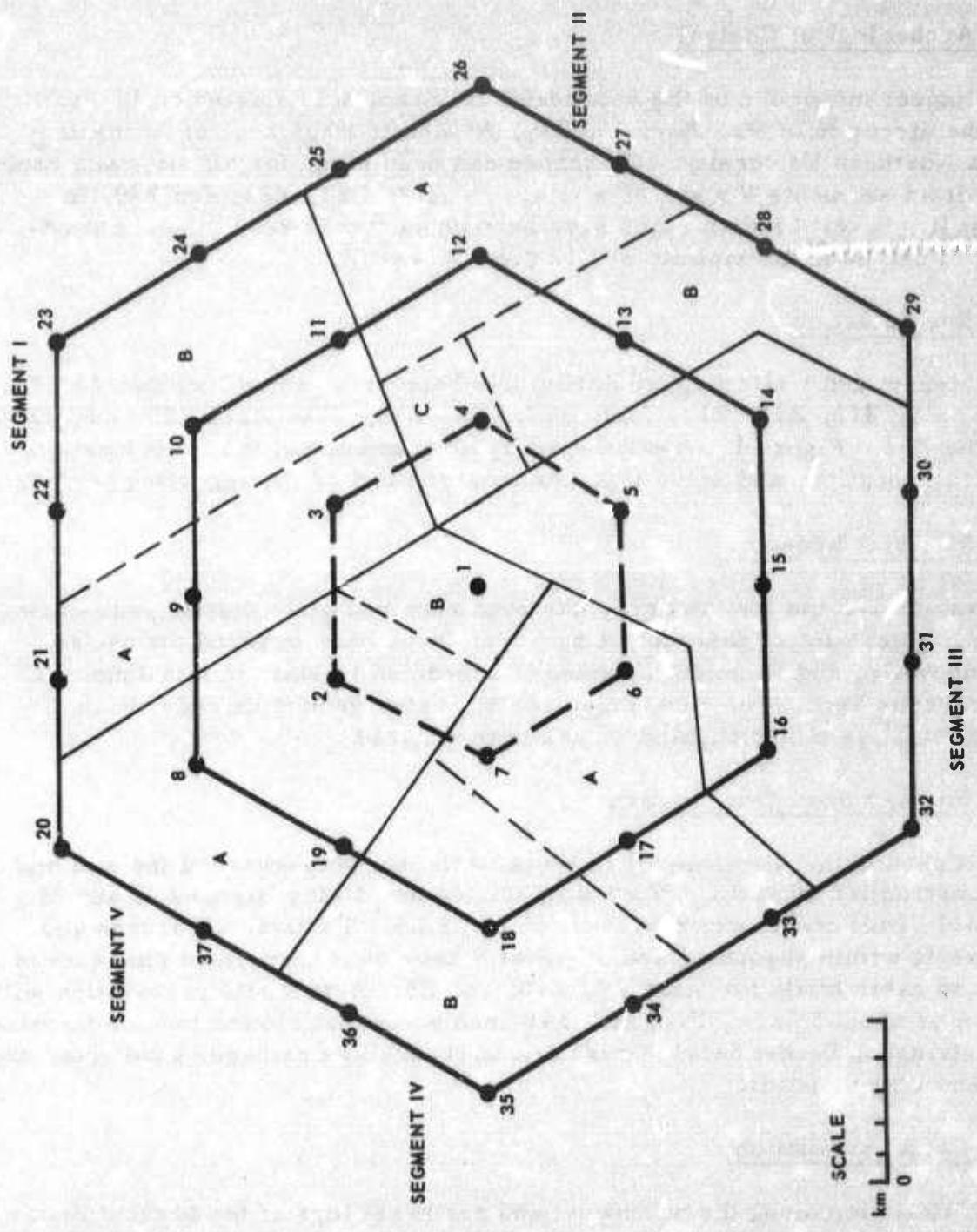

Figure 18. Plan for the 37-element array at TFSO showing the five main array segments

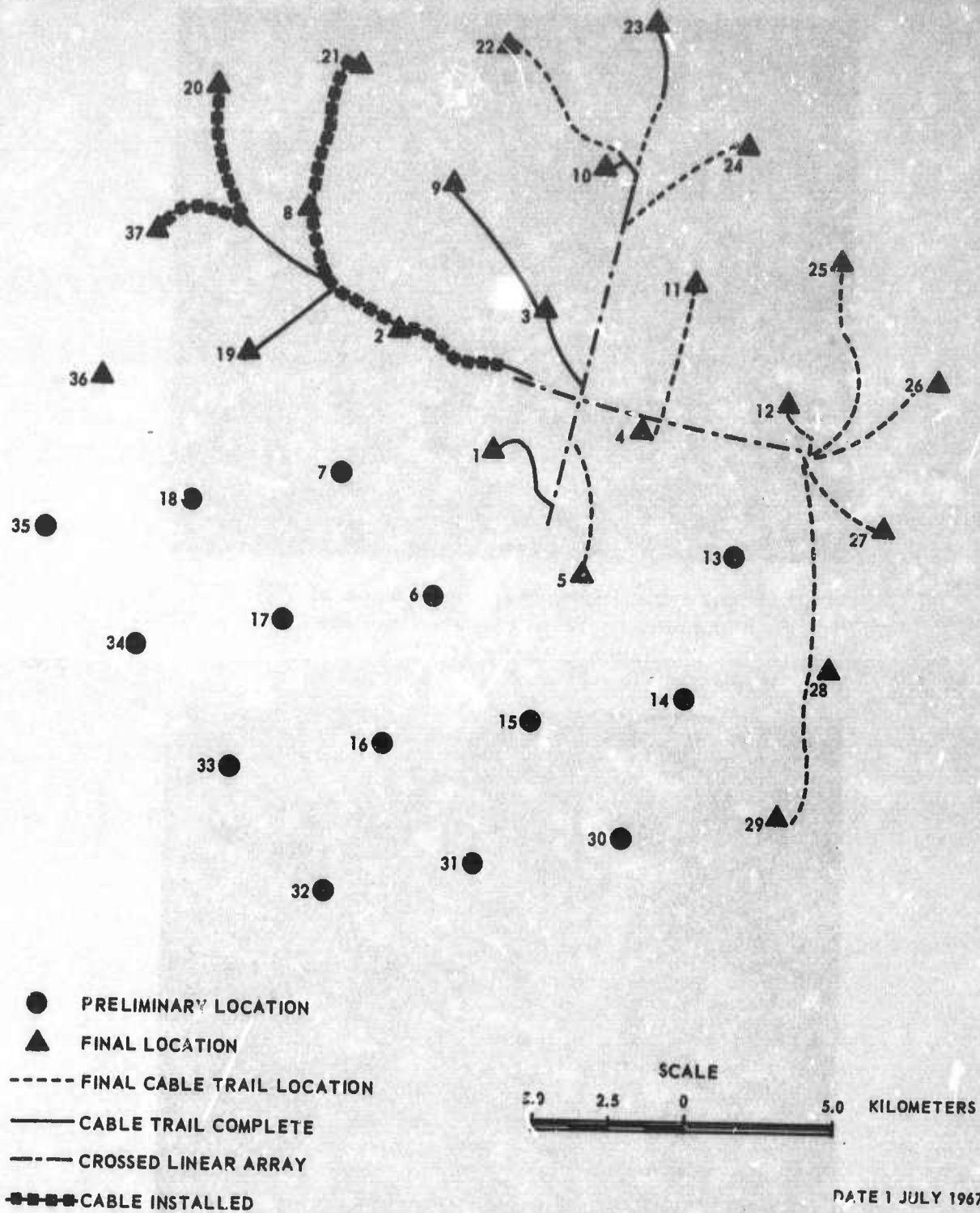

Figure 19. Plan of the 37-element array showing the locations of the sites, cable trails, and cable trail construction status

G 2796



Figure 20. Road building in area of Z9
showing terrain typical of the lower
brush country at TFSO

G 2926



Figure 21. Road building in area of Z9
showing terrain typical of the lower
brush country at TFSO

G 2927

6.5.7 Modification of Array Seismometers

High-impedance coils are presently being installed in JM vertical seismometers to be used in the new 37-element array; to date, 32 have been installed. After the coils are installed, the calibrator motor constant and the mass position of each seismometer is adjusted.

6.6 DESIGN AND INSTALL A LONG-PERIOD ARRAY

6.6.1 Long-Period Noise Study

The five LRSM portable systems assigned to gather data for the LP noise study discontinued operations on 6 April 1967. All data were shipped to Garland, Texas, for transcription onto 35-millimeter film. The sites have been restored, and inspection of the restored areas by the U. S. Forest Service is pending. The average phase response and frequency response for the long-period systems used to collect the noise data are shown in figures 22 and 23, respectively.

Four, 40-minute, long-period vertical noise-data samples were carefully selected by an experienced analyst for digitizing. The samples selected were free of obvious nonseismic noise and earthquake signals. The four data samples were filtered and then digitized at a rate of 2 samples per second.

Power spectra were computed for each station; these spectra possess the following general characteristics:

1. The noise power occurs in two frequency bands, 0.04 to 0.082 cps and 0.11 to 0.165 cps.
2. The power spectra may be space stationary, but variations in spectral level cause some doubt.
3. The spectra are not time stationary.

Coherence functions were computed for all possible pairs of stations. These functions exhibited the following general properties:

1. The noise in the frequency band 0.04 to 0.082 cps shows high coherence for small station separations and decreases with increasing distance between stations.
2. The peak coherence usually occurs near the same frequency as the spectral peak in the frequency band 0.04 to 0.082 cps.
3. The coherence functions are not time or space stationary.

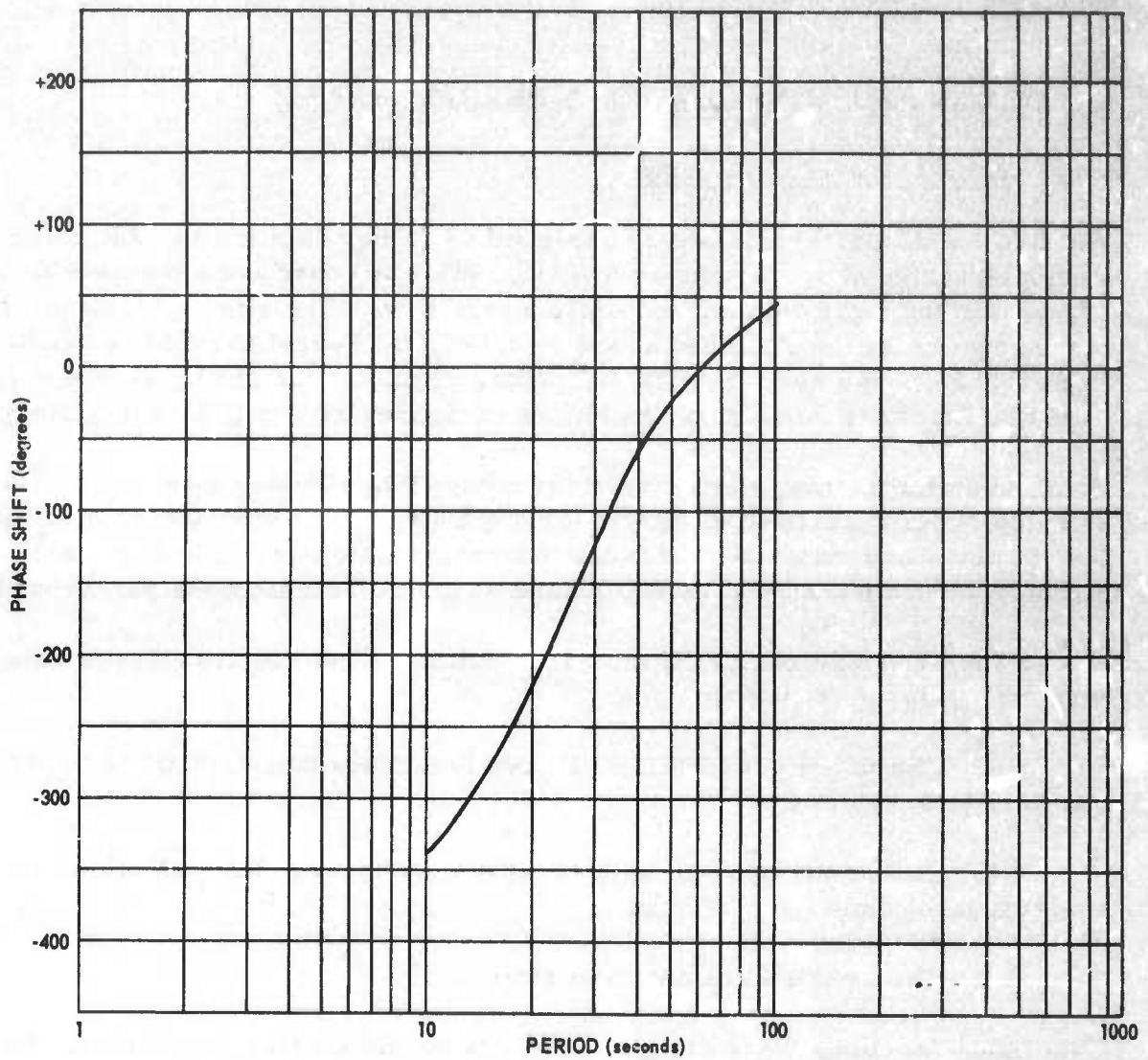

Figure 22. Average phase response for portable LRSM long-period systems

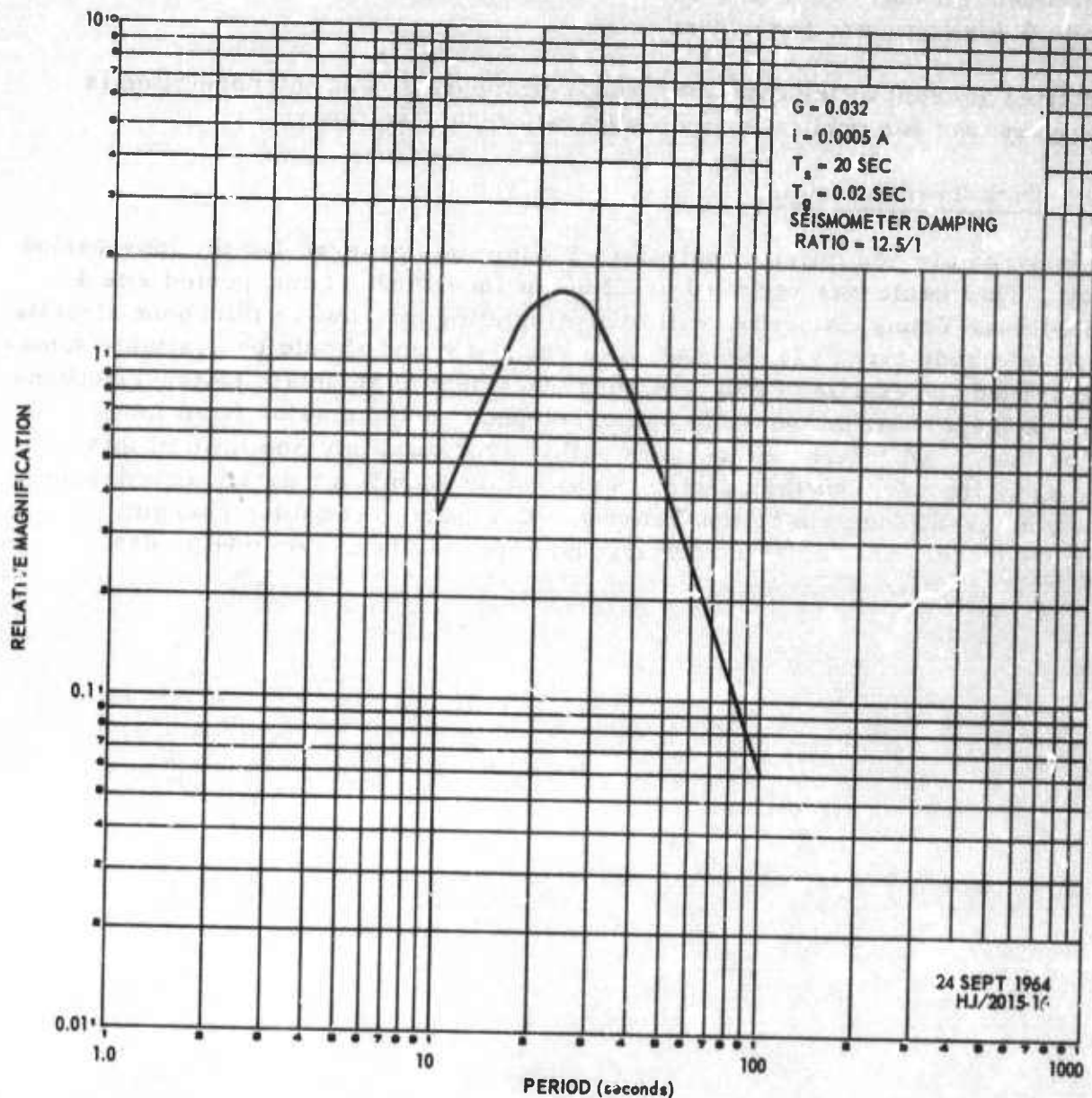

Figure 23. Typical long-period response of the LRSM portable long-period system

Phase velocity measurements were made for selected frequencies. Relative time delays between stations were measured from phase angles from the cross power spectra. Standard tripartite methods were then used to determine azimuth of propagation and phase velocity. The results indicate that noise in the frequency range 0.050 to 0.063 cps have phase velocities on the order of 3.35 to 3.6 kilometers per second.

A detailed account of the data selections, processing, and interpretation is being prepared for publication as a separate technical report.

6.6.2 Data Transmission

One hundred and ten miles of spiral-four cable was ordered for the long-period array. This cable was received at TFSO in June 1967. Long-period site 4 located near Young, Arizona, will utilize existing microwave telephone circuits. A special grade circuit (4-A), has been requested and should be available sometime around the middle of July. A query was sent to Mountain States Telephone Company regarding the possible use of telephone transmission from long-period site 3. A telephone line runs within approximately one mile of this proposed site now, but the carrier is not stable enough for data transmission. We have asked Mountain States Telephone Company to consider changing carriers on this particular circuit leg; no reply has been received to date.

APPENDIX TO TECHNICAL REPORT NO. 67-42

STATEMENT OF WORK

STATEMENT OF WORK TO BE DONE
(AFTAC Project Authorization No. VELA T/7702/s/ASD) (32)

Tasks:

a. Operation:

(1) Continue operation of the Tonto Forest Seismological Observatory (TFSO), normally recording data continuously.

(2) Evaluate the seismic data to determine optimum operational characteristics and make changes in the operating parameters as may be required to provide the most effective observatory possible. Addition and modification of instrumentation are within the scope of work. However, such instrument modifications and additions, data evaluation, and major parameter changes are subject to the prior approval of the AFTAC project officer.

(3) Conduct routine daily analysis of seismic data at the observatory and transmit daily seismic reports to the Environmental Science Services Administration, Coast and Geodetic Survey, Wash DC using the established report format and detailed instructions.

(4) Record the results of daily analysis on magnetic tape in a format compatible with the automated bulletin program used by the Seismic Data Laboratory (SDL) in their preparation of the seismological bulletin of the VELA-UNIFORM seismological observatories. The format should be established by coordination with SDL through the AFTAC project officer. The schedule of routine shipments of these prepared magnetic tapes to SDL will be established by the AFTAC project officer.

(5) Establish quality control procedures and conduct quality control, as necessary, to assure the recording of high quality data on both magnetic tape and film. Past experience indicates that a quality control review of one magnetic tape per magnetic tape recorder at the observatory during each week is satisfactory unless quality control tolerances have been exceeded and the necessity of additional quality control arises. Quality control of magnetic tape should include, but need not necessarily be limited to, the following items:

- (a) Completeness and accuracy of operation logs.
- (b) Accuracy of observatory measurements of system noise and equivalent ground motion.
- (c) Quality and completeness of voice comments.
- (d) Examination of all calibrations to assure that clipping does not occur.
- (e) Determination of relative phase shift on all array seismographs.

REPRODUCTION

- (f) Measurement of DC unbalance.
- (g) Presence and accuracy of tape calibration and alignment.
- (h) Check of uncompensated noise on each channel.
- (i) Check of uncompensated signal-to-noise of channel 7.
- (j) Check of general strength and quality of timing data derived from National Bureau of Standards Station WWV.
- (k) Check of time pulse modulated 60 cps on channel 14 for adequate signal level and for presence of time pulses.
- (l) Check of synchronization of digital time encoder with WWV.

(6) Provide observatory facilities, accompanying technical assistance by observatory personnel, and seismological data to requesting organizations and individuals after approval by the AFTAC project officer.

(7) Maintain, repair, protect, and preserve the facilities of TFSO in good physical condition in accordance with sound industrial practice.

b. Instrument Evaluation: On approval by the AFTAC project officer, evaluate the performance characteristics of experimental or off-the-shelf equipment offering potential improvement in the performance of observatory seismograph systems. Operation and test of such instrumentation under field conditions should normally be preceded by laboratory test and evaluation.

c. Special Investigations:

(1) Conduct research investigations as approved or requested by the AFTAC project officer to obtain fundamental information which will lead to improvements in the detection capability of TFSO. These programs should take advantage of geological, meteorological, and seismological conditions of the observatory. The following special studies should be accomplished:

(a) Design and install an array of approximately 37 short-period vertical seismographs. This array should be about 30 kilometers in diameter. The equipment and detector sites of existing arrays should be used to the extent possible in the design of the extended array.

(b) Design and install a 7 to 10 element array of long-period seismographs. This array should be approximately 30 kilometers in diameter.

(c) Evaluate the beam-steering capabilities of both arrays.

(2) Research might pursue investigations in, but is not necessarily limited to, the following areas of interest: microseismic noise, signal characteristics, data presentation, detection threshold, and array design (surface and shallow borehole).

(3) Prior to commencing any research investigation, AFTAC approval of the proposed investigation and of a comprehensive program outline of the intended research must be obtained.

3

REPRODUCTION

UNCLASSIFIED
Security Classification

DOCUMENT CONTROL DATA - R&D

(Security classification of title, body of abstract and indexing annotation must be entered when the overall report is classified)

1. ORIGINATING ACTIVITY (Corporate author) Teledyne Industries Incorporated Geotech Division, 3401 Shiloh Road Garland, Texas		2a. REPORT SECURITY CLASSIFICATION Unclassified	
		2b. GROUP	
3. REPORT TITLE Operation of the Tonto Forest Seismological Observatory Quarterly Report No. 2, Project VT/7702 1 April through 30 June 1967			
4. DESCRIPTIVE NOTES (Type of report and inclusive dates) Quarterly Report No. 2, Project VT/7702, 1 April through 30 June 1967			
5. AUTHOR(S) (Last name, first name, initial) Geotech Staff			
6. REPORT DATE 21 July 1967		7a. TOTAL NO. OF PAGES 50	7b. NO. OF REFS None
8a. CONTRACT OR GRANT NO. AF 33(657)-67-C-0091		9a. ORIGINATOR'S REPORT NUMBER(S) TR 67-42	
b. PROJECT NO. VELA T/7702			
c. ARPA Order No. 624		9b. OTHER REPORT NO(S) (Any other numbers that may be assigned this report)	
d. ARPA Code No.			
10. AVAILABILITY/LIMITATION NOTICES This document is subject to special export controls and each transmittal to foreign governments or foreign nationals may be made only with prior approval of the Chief of AFTAC			
11. SUPPLEMENTARY NOTES		12. SPONSORING MILITARY ACTIVITY Advanced Research Projects Agency Nuclear Test Detection Office Washington, D. C.	
13. ABSTRACT This is a report of the work accomplished on Project VT/7702 from 1 April through 30 June 1967. Project VT/7702 includes the operation, evaluation, improvement, and expansion of the Tonto Forest Seismological Observatory (TFSO) located near Payson, Arizona. It also includes special research and test functions carried out at TFSO and research and development tasks performed by the Garland, Texas, staff using TFSO data.			

DD FORM 1473
1 JAN 64

UNCLASSIFIED
Security Classification

14. KEY WORDS	LINK A		LINK B		LINK C	
	ROLE	WT	ROLE	WT	ROLE	WT
Seismograph operating parameters Long-period seismograph tests Solid-state amplifier tests Short-period array installation Long-period noise study						

INSTRUCTIONS

1. **ORIGINATING ACTIVITY:** Enter the name and address of the contractor, subcontractor, grantee, Department of Defense activity or other organization (*corporate author*) issuing the report.

2a. **REPORT SECURITY CLASSIFICATION:** Enter the overall security classification of the report. Indicate whether "Restricted Data" is included. Marking is to be in accordance with appropriate security regulations.

2b. **GROUP:** Automatic downgrading is specified in DoD Directive 5200.10 and Armed Forces Industrial Manual. Enter the group number. Also, when applicable, show that optional markings have been used for Group 3 and Group 4 as authorized.

3. **REPORT TITLE:** Enter the complete report title in all capital letters. Titles in all cases should be unclassified. If a meaningful title cannot be selected without classification, show title classification in all capitals in parentheses immediately following the title.

4. **DESCRIPTIVE NOTES:** If appropriate, enter the type of report, e.g., interim, progress, summary, annual, or final. Give the inclusive dates when a specific reporting period is covered.

5. **AUTHOR(S):** Enter the name(s) of author(s) as shown on or in the report. Enter last name, first name, middle initial. If military, show rank and branch of service. The name of the principal author is an absolute minimum requirement.

6. **REPORT DATE:** Enter the date of the report as day, month, year; or month, year. If more than one date appears on the report, use date of publication.

7a. **TOTAL NUMBER OF PAGES:** The total page count should follow normal pagination procedures, i.e., enter the number of pages containing information.

7b. **NUMBER OF REFERENCES:** Enter the total number of references cited in the report.

8a. **CONTRACT OR GRANT NUMBER:** If appropriate, enter the applicable number of the contract or grant under which the report was written.

8b, 8c, & 8d. **PROJECT NUMBER:** Enter the appropriate military department identification, such as project number, subproject number, system numbers, task number, etc.

9a. **ORIGINATOR'S REPORT NUMBER(S):** Enter the official report number by which the document will be identified and controlled by the originating activity. This number must be unique to this report.

9b. **OTHER REPORT NUMBER(S):** If the report has been assigned any other report numbers (*either by the originator or by the sponsor*), also enter this number(s).

10. **AVAILABILITY/LIMITATION NOTICES:** Enter any limitations on further dissemination of the report, other than those

imposed by security classification, using standard statements such as:

- (1) "Qualified requesters may obtain copies of this report from DDC."
- (2) "Foreign announcement and dissemination of this report by DDC is not authorized."
- (3) "U. S. Government agencies may obtain copies of this report directly from DDC. Other qualified DDC users shall request through _____."
- (4) "U. S. military agencies may obtain copies of this report directly from DDC. Other qualified users shall request through _____."
- (5) "All distribution of this report is controlled. Qualified DDC users shall request through _____."

If the report has been furnished to the Office of Technical Services, Department of Commerce, for sale to the public, indicate this fact and enter the price, if known.

11. **SUPPLEMENTARY NOTES:** Use for additional explanatory notes.

12. **SPONSORING MILITARY ACTIVITY:** Enter the name of the departmental project office or laboratory sponsoring (*paying for*) the research and development. Include address.

13. **ABSTRACT:** Enter an abstract giving a brief and factual summary of the document indicative of the report, even though it may also appear elsewhere in the body of the technical report. If additional space is required, a continuation sheet shall be attached.

It is highly desirable that the abstract of classified reports be unclassified. Each paragraph of the abstract shall end with an indication of the military security classification of the information in the paragraph, represented as (TS), (S), (C), or (U).

There is no limitation on the length of the abstract. However, the suggested length is from 150 to 225 words.

14. **KEY WORDS:** Key words are technically meaningful terms or short phrases that characterize a report and may be used as index entries for cataloging the report. Key words must be selected so that no security classification is required. Identifiers, such as equipment model designation, trade name, military project code name, geographic location, may be used as key words but will be followed by an indication of technical content. The assignment of links, rules, and weights is optional.