

UNCLASSIFIED

AD NUMBER: AD0830221

LIMITATION CHANGES

TO:

Approved for public release; distribution is unlimited.

FROM:

Distribution authorized to U.S. Gov't. agencies and their contractors; Administrative/Operational Use; .5 Jan 1959. Other requests shall be referred to Space and Missile Command, Los Angeles AFB, CA

AUTHORITY

SAMSO ltr 28 Feb 1972

COPY NO. 3  
REPORT NO. AZP-076

AD830221

RECEIVED

JAN 9 '59

ASTRONAUTICS  
TECHNICAL  
LIBRARY

This document is subject  
to export controls and  
is not to be released  
abroad without the  
prior approval of:  
Hq. SAMS0, LA., Ca. 90045  
Attn: SMSD

STUDY FOR ATLAS SPACE VEHICLE CAPABILITIES

CONVAIR ASTRONAUTICS

*Handwritten initials/signature*

APR 18 1968

*Handwritten signature*

49

AGENCY USE ONLY  
OFFICE OF THE DIRECTOR  
CENTRAL INTELLIGENCE AGENCY  
WASHINGTON, D.C. 20505

X

CLASSIFICATION  
CONTROL

X

SECURITY NOTICE

This document contains information affecting the national defense of the United States within the meaning of the Espionage Laws, Title 18 U.S.C., Sections 793 and 794. Its transmission or the revelation of its contents in any manner to an unauthorized person is prohibited by law.

ASTRO-ENGINEERING  
DISTRIBUTION CENTER

LOG A- 3638

COPY NO. 23

**UNCLASSIFIED**

STUDY FOR ATLAS CLUSTER SPACE VEHICLE CAPABILITIES

Report No. AZP-076

RECEIVED

JAN 9 '59

ASTRONAUTICS  
TECHNICAL  
LIBRARY

This document is subject  
to copyright laws and  
control regulations  
concerning export  
rights and  
usage only  
with the approval of:  
Headquarters, USAF, 90045  
Attn: SMSD

Prepared by

CONVAIR / ASTRONAUTICS

Convair Division of General Dynamics Corporation

**WS 107A (ATLAS) CLASSIFICATION CHANGED TO:**

San Diego, California

5 January 1959

**UNCLASSIFIED**

**AUTHORIZED BY: AIR FORCE LETTER**

**SAN BERNARDINO AIR MATERIEL AREA (SBAMA)**

**DATED 17 NOVEMBER 1965**

**UNCLASSIFIED**

RECLASSIFIED BY: *RJ Cook*  
DEPT. 130-1 DATE 12-13-65

Contents

List of Illustrations	v
Introduction	vii
Summary	ix
1. Discussion	1
1.1 Basic Considerations	1
1.2 General Description of Configurations	2
1.3 Tank Units	5
1.4 Structures	5
1.5 Propulsion Systems	8
1.6 Auxiliary Systems	9
1.7 Guidance and Control	10
1.8 Performance	11
1.9 Selection of Optimum Configuration	14
1.10 Missions	17
1.11 Growth Potential	18
2. Configuration Descriptions	
2.1 Configuration I	19
2.2 Configuration II	22
2.3 Configuration III	28
2.4 Configuration IV	33
2.5 Configuration V	39

Illustrations

1. Clustered Atlas/Centaur multistage vehicle	xi
2. Configurations	3
3. Structural data	7
4. Payload vs. orbital altitude	12
5. Payload capabilities	13
6. Atlas cluster, Configuration I	20
7. Atlas cluster, Configuration II	24
8. Atlas cluster, Configuration III (perspective)	29
9. Atlas cluster, Configuration III	30
10. Atlas cluster, Configurations IV and V	35

Tables

I. Configuration characteristics	4
II. Mission performance summary	15
III. Configuration changes required in Atlas E and Centaur	16
IV. Weight summary, Configuration I	23
V. Weight summary, Configuration II	27
VI. Weight summary, Configuration III	34
VII. Weight summary, Configuration IV	37
VIII. Weight summary, Configuration V	38

~~SECRET~~

## INTRODUCTION

The imminent space weapon system and space exploration programs necessitate the development of rocket-powered vehicles with capabilities greatly exceeding those of vehicles now available. Pending development of much larger vehicle structures and power plants, a wide variety of missions can be performed by clustering existing vehicles and assembling them into a larger multistage vehicle with 1 to 1.5 million pounds of thrust.

This study was made to evaluate the various configurations which could be assembled using clustered Atlas missiles as the booster. For the configurations which appeared most promising, a performance analysis was completed.

The "ground rules" established for this study included the following:

1. The vehicle booster was to be assembled by clustering Atlas Series E missiles with minimum change.
2. The vehicle upper stages were to consist of basic Atlas and Centaur units and/or clusters of same. Use of shortened Atlas tank in the upper stages to reduce the gross weight of the vehicle was permitted. (The Centaur is a liquid oxygen, liquid hydrogen upper-stage vehicle, with a gross weight of 30,000 lb., being developed by Convair-Astronautics.)
3. Performance analysis was to be based on payload capability for terrestrial orbiting missions with emphasis placed on the nominally 24-hr. orbit and the 306.6-n. mi. altitude orbit.
4. The rocket engines used were to be either existing engines, engines under development or advanced versions of these. For the latter, minimum modification only was to be assumed.

~~SECRET~~

~~SECRET~~

#### SUMMARY

A wide variety of space missions can be conducted by large multistage vehicles assembled by clustering existing vehicles. This study was completed to determine the most feasible vehicle which could be provided in the immediate future using clustered Atlas missiles as the booster.

Five basic configurations are evolved, evaluated and compared. Comparisons are made on the basis of payload capability, use of existing Atlas hardware, availability and reliability. No attempt is made to derive area costs, and cost comparisons are considered only where the relative values are obvious.

The configuration selected is comprised of three Atlases for the booster, three Centaurs for the second stage and a single Centaur for the third stage. Fig. 1 illustrates this vehicle. It has the capability of placing an 11,200-lb. payload in a 24-hr. circular equatorial orbit launched from Cape Canaveral or a 35,000-lb. payload in a 306.6-n. mi. polar orbit. With the third stage removed, it has the capability of placing a 30,600-lb. winged entry vehicle in a 100-n. mi. polar orbit. This vehicle utilizes existing hardware with minimum change. For the tanks, the skin gages are increased slightly and tie structures are provided. The engines either exist or are under development for other programs.

The growth potential of the vehicle is examined. By modifying the booster stage and inserting another high-energy stage between the existing first and second stages, it is possible to increase the payload substantially.

~~SECRET~~

---

~~SECRET~~

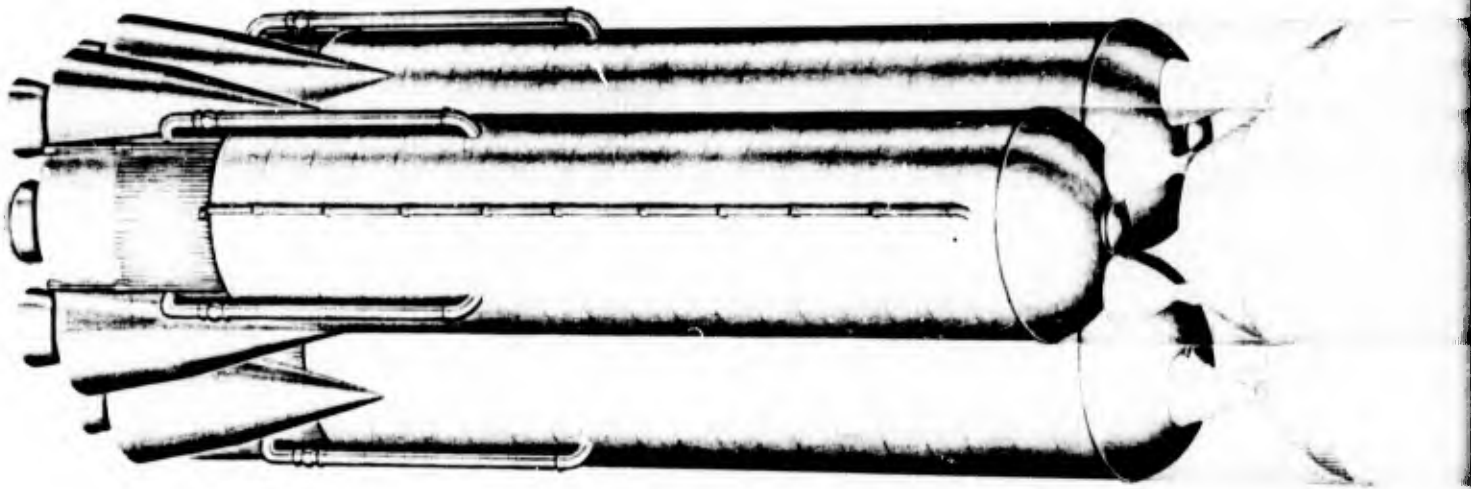

Fig. 1. Clustered Atlas/Centaur multistage vehicle

A.

~~SECRET~~



**B.**

~~SECRET~~

## 1/DISCUSSION

### 1.1 BASIC CONSIDERATIONS

1.1.1 SINGLE VS. MULTIPLE-UNIT TANKS -- A comparison between a single-unit tank and multiple-unit tanks reveals that, for the immediate future, the clustered tank arrangement offers the best approach. A single-unit tank with the same total volume and same cross-sectional area as a cluster of three Atlas tanks was considered. The single unit offers a weight saving, for the tank structure only, of approximately 13-1/2% and a 7% saving in over-all tank length. The single-unit construction is also somewhat more attractive when the adapter between stages is considered. For the same gross weight of the upper stages and payload, the adapter for the multiple unit configuration is heavier and presents more manufacturing problems.

Other considerations, however, tend to favor the multiple-unit construction. Sloshing in pitch and yaw would be a greater problem with a single tank since increasing the tank diameter decreases the sloshing frequency and thereby decreases the margin of stability. This can be corrected by the use of suitable baffles, but such a measure decreases the weight advantage indicated above.

For overland transportation, the size of a vehicle is limited to an outside diameter of about 10 ft. This necessitates marine transportation of single-unit tanks. Multiple-unit tanks can be shipped via overland transportation and assembled at the launch site.

Manufacturing costs should be appreciably lower for a design incorporating tanks with the basic dimensions of the Atlas missile because existing tooling and manufacturing facilities can be used. For a comparable single tank, the diameter would be on the order of 17 ft, and new fabrication tooling and handling facilities would have to be provided.

1.1.2 NUMBER OF TANK UNITS - In considering the number of units to be assembled in a clustered booster for missions in the immediate future, it became evident that either three or four Atlas tank structures should be utilized. For two structures, the adapter structures would be too unbalanced; for five or more structures, the vehicle becomes too complex and the adapters too cumbersome. The selection of the three or the four-unit cluster should be made on the basis of payload capability and reliability of the configurations.

To minimize the adapter weights, the upper stage should be a cluster of the same number of units as the booster stage or a single unit.

~~SECRET~~

~~SECRET~~

1.1.3 NUMBER OF STAGES -- The number of stages for the vehicles is limited by: (1) the requirement to use standard tank structures with the exception of a shortened version of the Atlas tank in the second stage, and (2) consideration of the primary missions, which are limited to terrestrial orbits with a period of 24 hr. or less.

1.1.4 MULTIPLE FIRING CAPABILITY -- To accommodate a wide variety of missions, multiple firing capability of the last stage is required. For minimum energy transfers into circular orbits, elliptical transfer orbits are utilized. At least two firings are required for high-altitude orbits. To achieve any desired longitude position in a 24-hr. orbit, three firings may be required. In addition to the coast period in the elliptical transfer orbit, a coast period in a low-altitude parking orbit must be provided.

1.1.5 JETTISONING OF BOOSTER ENGINES -- Both the Atlas used in WS 107 and the modified version to be used as a booster for a single Centaur upper stage utilize a booster stage followed by a sustainer solo firing. For the clustered versions with higher upper stage gross weights, the gain realized by jettisoning the booster engines becomes insignificant and all engines on the lower stage are fired for full duration. This nonjettisoning of the boosters increases the first-stage burnout acceleration. For at least one case it requires an increase in tank pressures and skin gage but results in improved reliability for the over-all system.

1.1.6 BOOSTER RECOVERY -- It is considered impractical to spend any weight in heat shielding of the booster to protect it during high-speed re-entry into the atmosphere. For the over-all vehicle configuration used as a typical example in Configuration IV, velocity at the end of the first stage exceeds 11,000 ft. per sec. A re-entry velocity of 11,000 fps will result in excess heating of the empty booster structure. Consequently, it is not deemed possible to effect recovery of the booster under these conditions.

## 1.2 GENERAL DESCRIPTION OF CONFIGURATIONS

The configurations which evolved from a general study of the many possibilities are shown in Fig. 2. The characteristics of these configurations are indicated in Table I.

Since the three-unit cluster is simpler and inherently more reliable than the four-unit cluster, the former was taken as the basic arrangement. For comparison purposes, Configuration V, which is a four-unit cluster of Configuration IV, was evaluated.

~~SECRET~~

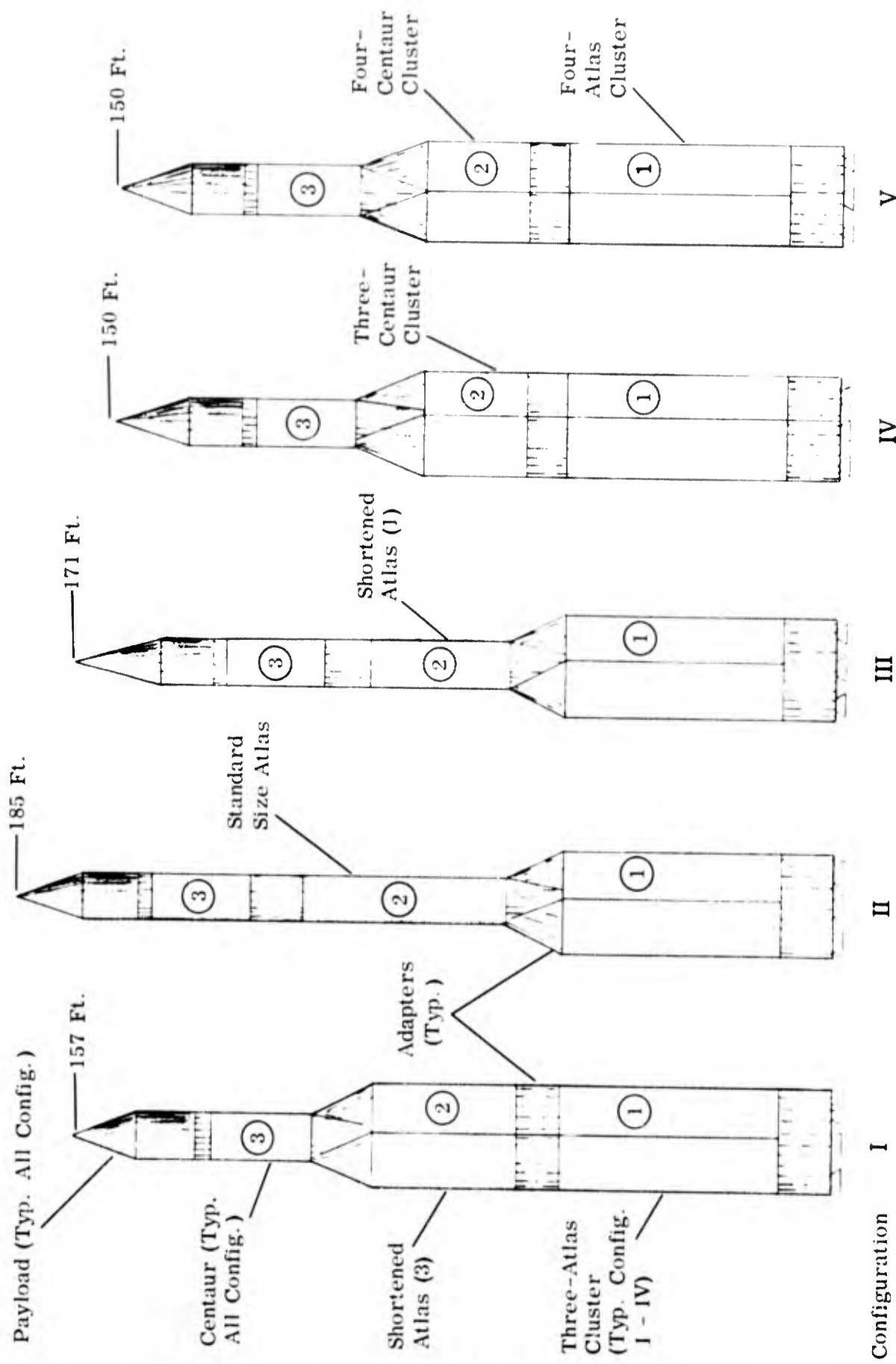

Fig. 2. Configurations

~~SECRET~~

Table I. Configuration characteristics

CHARACTERISTICS	CONFIGURATION				
	I	II	III	IV	V
LAUNCH WEIGHT, LB. (10,000-lb. payload)	1,247,154	1,089,450	1,012,449	914,344	1,206,230
1st STAGE WEIGHT, LB.	793,958	793,958	793,958	789,554	1,052,709
Wp/Ws*	.94	.94	.94	.943	.945
Engine no. / thrust	9-188K	9-165K	6-188K   3-57K	6-165K   3-57K	8-165K   4-57K
Engine area ratio	8	8	8   25	8   25	8   25
Total thrust, lb.	1,692K (SL)	1,485K (SL)	1,299K (SL)	1,161K (SL)	1,548K (SL)
T/W initial	1.36	1.36	1.28	1.28	1.28
T/W final	3.90	5.00	5.65	8.04	8.45
Propellants	LO <sub>2</sub> + RP -1	LO <sub>2</sub> + RP -1	LO <sub>2</sub> + RP -1	LO <sub>2</sub> + RP -1	LO <sub>2</sub> + RP -1
Propellant expendable weight	746,658	746,658	746,658	746,658	995,544
Specific impulse, sec.	257 (SL)	253 (SL)	257 (SL)   217 (SL)	253 (SL)   217 (SL)	253 (SL)   217 (SL)
2nd STAGE WEIGHT, LB.	414,705	257,001	180,000	86,299	115,030
Wp / Ws	.928	.948	.932	.903	.903
Engine no. / thrust	3-200K	2-200K	2-200K	6-15K	8-15K
Engine area ratio	25	25	25	40	40
Total thrust, lb.	600K (alt.)	400K (alt.)	400K (alt.)	90K (alt.)	120K (alt.)
T/W initial	1.32	1.35	1.84	.72	.78
T/W final	8.8	7.8	7.9	1.93	2.43
Propellants	LO <sub>2</sub> + RP -1	LO <sub>2</sub> + RP -1	LO <sub>2</sub> + RP -1	LO <sub>2</sub> + H <sub>2</sub>	LO <sub>2</sub> + H <sub>2</sub>
Propellant expendable weight	384,675	243,901	167,550	78,000	104,000
Specific impulse, sec.	312 (alt.)	312 (alt.)	312 (alt.)	412 (alt.)	412 (alt.)
3rd STAGE WEIGHT, LB.	28,491	28,491	28,491	28,491	28,491
Wp / Ws	.92	.92	.92	.92	.92
Engine no. / thrust	2-20K	2-20K	2-20K	2-15K	2-15K
Engine area ratio	40	40	40	40	40
Total thrust, lb.	40K (alt.)	40K (alt.)	40K (alt.)	30K (alt.)	30K (alt.)
T/W initial	1.04	1.04	1.04	.78	.78
T/W final	3.26	3.26	3.26	2.45	2.45
Propellants	LO <sub>2</sub> + H <sub>2</sub>	LO <sub>2</sub> + H <sub>2</sub>	LO <sub>2</sub> + H <sub>2</sub>	LO <sub>2</sub> + H <sub>2</sub>	LO <sub>2</sub> + H <sub>2</sub>
Propellant expendable weight	26,000	26,000	26,000	26,000	26,000
Specific impulse, sec.	412 (alt.)	412 (alt.)	412 (alt.)	412 (alt.)	412 (alt.)

\* W<sub>p</sub> = propellant weight W<sub>s</sub> = stage weight

~~SECRET~~

All the configurations are basically three-stage vehicles. The performance data, which is included in another section of this report, indicates the increase in capability achieved by using three stages instead of two. For winged entry vehicles, however, the bending moments necessitate the use of a short vehicle and the third stage would be eliminated.

1.3 TANK UNITS

1.3.1 ATLAS TANKS -- The boosters for all configurations and the second stage for Configuration II utilize "standard" Atlas tanks. These tanks are basically the same as those on the operational Atlas and are identical to the tanks being fabricated for the Centaur Atlas except for skin gage changes. The weights of tanked propellants are nominally the same, but the forward conical section of the operational Atlas liquid oxygen tank is replaced with a shorter cylindrical section, maintaining the tanks at a nominal diameter of 10 ft.

The second stages for Configurations I and III utilize shortened Atlas tanks, which have the same diameter as the "standard" Atlas but are shorter. Three tanks are clustered in Configuration I; a single tank is used in Configuration III.

1.3.2 CENTAUR TANKS -- The Centaur stages use standard Centaur tanks with restart capability for the third stages. For both the cluster and single tank arrangements in the second stage, the inner tanks and associated plumbing can be removed, since only one firing is required.

1.4 STRUCTURES

1.4.1 TANK STRUCTURE -- The design philosophy successfully utilized in the Atlas has been followed in all configurations. The individual tanks are constructed from thin, fully monocoque, pressure-stabilized skins. The material used in these skins is Type 301, extra hard, corrosion-resistant steel, having the following properties at room temperature:

Ultimate tensile strength	=	200,000 psi
Tensile yield strength	=	160,000 psi
Minimum elongation in 2 in.	=	2%

The principle connections between the individual tanks in the clustered configurations occur at the adapters and at the first-stage thrust structures. The upper stages have no structural ties between the tanks except at these points. In the longer first stage, the present bulkhead at Atlas station 1133 is duplicated at the top of the LO<sub>2</sub> tank, where the

~~SECRET~~

second-stage adapter mates, and again at a point midway between the top and bottom. Lateral shear connections between these bulkheads provide the only tie between the pressurized tanks. The thrust structure and the adapters provide end fixity for tank bending. The center connection stiffens the cluster and raises the bending frequency of the individual tanks, thereby easing the control problems.

The tanks thus are free to expand or contract radially with no tank interaction. Unequal longitudinal length changes due to pressure or heating cause load interaction only at the heavier unpressurized adapters or thrust structure and do not endanger the tanks.

1. 4. 2 TANK PRESSURES AND SKIN GAGES -- The tank gas pressures required to maintain the rigidity of the structures and the accompanying skin gages are shown in Fig. 3. All pressures shown are for ultimate loads with a safety factor of 1.25.

It has been assumed that the flight condition requiring the maximum pressure occurs at the time of maximum vehicle acceleration, when the bending moment is small. The condition of maximum aerodynamic disturbance may provide critical bending moments in the designs with a high slenderness ratio if the upper payload should consist of a winged vehicle. This problem is overcome in Configurations I, IV and V by removing the third stage for this type payload. The condition may persist, however, in Configurations II and III even after removal of the third stage. This aspect cannot be fully defined until the payload shape is evolved.

1. 4. 3 THRUST STRUCTURE -- The Atlas thrust structure is conventional aluminum alloy plate, stringer construction. The thrust structures of Configurations IV and V require minor modifications to support the higher gross weight of the vehicle while supported on the launcher. Configurations I, II and III require modifications to accommodate the higher thrust of the larger engines as well as the higher gross weight of the vehicle. The thrust structures are clustered in a manner similar to the tanks. A shear tie at a point connecting the thrust barrel center lines redistributes engine thrust variations or unequal launcher reactions between each unit. A connection between the heavy frames at Atlas station 1206 and the internal structure at the bottom of the tank provides a strong tension/compression tie between units.

1. 4. 4 ADAPTERS -- The adapters are designed to introduce axial loads uniformly around the periphery of the tanks, eliminating load concentration over local areas. The adapters connecting the clustered stages together are individual cylinders, matching tank contour, connected in a manner similar to the thrust structure. The basic adapter cylinder required for Configurations IV and V is being prepared for Centaur. Where a clustered configuration mates with a

~~SECRET~~

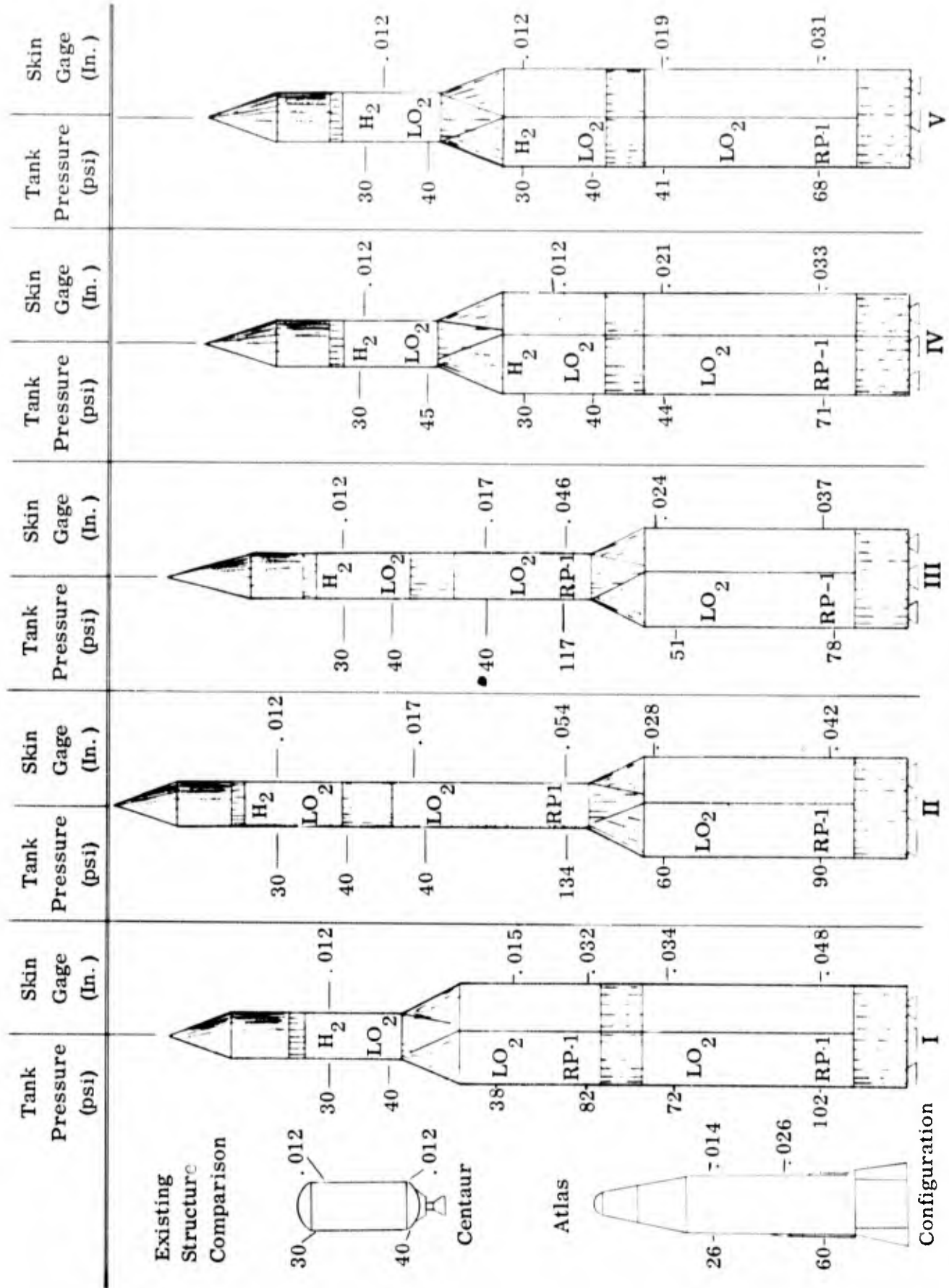

Fig. 3. Structural data.

~~SECRET~~

single tank, the adapter is made of individual conical-shaped sections. The lower part of these structures is circular and seats on the flange at the top of the tank. The contour fails from a circle to an arc at the top, which is attached to the flange at the bottom of the upper stage by jettison fittings. The individual cones are tied together with a longitudinal shear tie and are prevented from spreading apart by the internal tank structure and intertank tie at the top and bottom. By means of the inner and outer skins of each cone, an axial load at the top may be transferred into the entire lower tank circumference. This allows the tank to remain a thin shell without the necessity for axial stiffening.

Because of the relatively cool temperatures on the cylindrical adapters, they may be constructed from magnesium or fiberglass honeycomb. The higher temperatures on the conical adapters will require insulation or construction from steel similar to the Atlas nose cone adapter.

#### 1.5 PROPULSION SYSTEMS

The engines used in these vehicles have been developed, are under development or are modified versions of engines now being developed. In general, the thrust ratings of the engines are determined on the basis of thrust-to-weight ratio for the assumed stages and a 10,000-lb. payload.

1.5.1 BOOSTER ENGINES -- For the clustered Atlas boosters, combinations of booster engines and of booster and sustainer engines as indicated in Table I are used. For the booster engines, the 165K version of the Rocketdyne MA-3 booster engine, now under development for the Series E Atlas, and the 188K Rocketdyne H-1 engine, being developed for the ABMA booster vehicle, are assumed. The current 57K Rocketdyne S-4 engine is utilized where it is possible to retain the sustainer engine. Configurations IV and V utilize essentially unchanged the propulsion systems being designed for the Atlas E missile. The other configurations require replacement of boosters and/or sustainers to achieve the necessary thrust-to-weight ratio at launch. Where the sustainer engine is replaced with a booster engine, the propellant systems from the tanks to the engines would have to be modified to accommodate the much greater flow to the replacement engine.

1.5.2 SECOND-STAGE ENGINES -- Selection of rocket engines for the second stages is predicated on the tank configuration assumed. For both the standard and shortened Atlas tank configurations, an altitude version of the Atlas 165K booster is utilized. This engine uses liquid oxygen and RP-1 propellants at a nominal mixture ratio of 2.25:1. For improved altitude specific impulse and thrust, the existing 8:1 expansion ratio nozzle is replaced with one 25:1.

~~SECRET~~

~~SECRET~~

For the Centaur configuration second stages, the engines used are the Pratt and Whitney RL engines now being developed.

1.5.3 THIRD-STAGE ENGINES -- The third stages for all configurations will consist of a single Centaur vehicle with two standard Pratt and Whitney RL 10 engines. These engines, now being developed, have a chamber pressure of 300 psia, an expansion ratio of 40:1 and a nominal thrust rating of 15K at a specific impulse of 412 lb./lb./sec. Liquid oxygen and liquid hydrogen are burned at a mixture ratio of 5:1.

1.5.4 PROPELLANT UTILIZATION -- It may be possible to operate the Atlas stages as calibrated systems. If desirable, however, propellant residual could be reduced to a minimum by adapting the propellant utilization system which has been developed for the Atlas. This system is designed to sense the masses of propellants in the tanks and correct for errors by varying fuel flow to the sustainer engine. Since both booster and sustainer engines will be fired for the full duration of the booster stage, varying flow to the sustainer only probably would not provide adequate control. (The 57K Atlas sustainer engine is used as a booster engine only in this application.) Provisions could be made to control propellant utilization with the booster engines as well as the sustainer engines. When the sustainer engine is replaced, control of propellant utilization could be provided by the replacement engines or a combination of engines.

Propellant utilization in the Centaur stages will be controlled through a feedback system or a calibrated system, depending upon the system adopted for the current Centaur program.

#### 1.6 AUXILIARY SYSTEMS

1.6.1 AUXILIARY POWER SUPPLY -- The auxiliary power supplies can be eliminated from the Atlas units since electrical and hydraulic power are required only during firing of both booster and sustainer engines. The autopilot for the booster section requires approximately 200 watts of power. This and the other minor electrical requirements can be supplied by a battery system in the booster stage. The hydraulic requirements for gimbaling the engines could be supplied by hydraulic pumps mounted on the engine turbopump drive pads.

For the second and third stages, electrical power for the guidance, autopilot and other requirements will be provided by a battery system installed above the tanks of the upper stage. Hydraulic power for the gimbaling actuators will be supplied from individual engine hydraulic pumps similar to the installation described for the booster Atlas engines.

~~SECRET~~

~~SECRET~~

1. 6. 2 PRESSURIZATION -- As indicated in Fig. 3, the tank pressure requirements for the boosters on all configurations and for the Atlas second stages are significantly greater than the existing Atlas requirements. In the case of Configuration IV booster, the helium requirements for each unit are approximately twice the requirements for the operational Atlas. This necessitates an increase in the number of storage bottles provided and modifications to the turbine exhaust heat exchangers supplied with the rocket engines.

Since the tank pressures in the Centaur units are dictated by the rocket engine NPSH requirements, no additional pressurization capability is required in these stages.

1. 6. 3 ATTITUDE CONTROL -- An attitude control system will be required during the coast phases of the trajectory. Since the first and second stages are expended during the initial powered phase, attitude control is required on the third stage only. The attitude control system being designed for the Centaur appears to be adequate for this function. It includes four 50-lb. chambers for major pitch and yaw corrections prior to start and immediately after shutdown. Six 1- and 2-lb. chambers are provided for roll corrections and for pitch and yaw corrections during coast phases. These chambers are supplied with concentrated hydrogen peroxide. The propellant systems will remain essentially unchanged except that greater H<sub>2</sub>O<sub>2</sub> storage capacity may be required in view of the larger payload.

The attitude control systems can be eliminated where the Centaur is incorporated in the second stage.

1. 6. 4 VERNIERS -- Since multiple engine firing is provided on all first and second stages, the vernier engine systems on the Atlas units can be eliminated. Velocity vernier corrections are provided on the third stage only, by the use of two of the 50-lb. H<sub>2</sub>O<sub>2</sub> attitude control chambers installed on Centaur.

#### 1. 7 GUIDANCE AND CONTROL

1. 7. 1 POWERED PHASE -- The large vehicles evaluated in this study use a split guidance and control system. An all-inertial guidance system with an autopilot is installed on the Centaur third stage (second stage for the two-stage version); a separate programmed autopilot is installed on the booster.

The programmed autopilot controls the vehicle during vertical ascent and pitchover. After first staging, the guidance loop for the upper stages is closed. Any deviation from a nominal trajectory is then corrected first through control of the second-stage engines and, after second staging, through control of the third-stage engines.

~~SECRET~~

~~SECRET~~

1.7.2 COAST PHASE -- Parking orbits and transfer ellipses will be selected to insure burnout of the second stage prior to a coast period. During coast phases, the attitude of the third stage and payload is sensed by the autopilot, and control signals are initiated to the attitude control thrust chambers. The vehicle is rotated immediately at the beginning of the coast phase so that the thrust section faces the sun. This orientation will substantially reduce solar heating of the propellants, minimizing boiloff and increase in vapor pressure of the propellants.

During the coast phase, the inertial platform maintains the reference axes. The motion of the vehicle is constrained to stay within the limits of freedom of the platform. This constraint could be eliminated by utilizing an all-attitude platform (one with unlimited gimbal freedom about all three axes).

At the end of the coast period, the vehicle is reoriented so that its attitude is again in the direction of the velocity vector. Thrust is applied to continue the trajectory.

## 1.8 PERFORMANCE

1.8.1 PERFORMANCE ANALYSIS -- An analysis of the performance characteristics of the various configurations has been carried out using the IBM 704 computer. Payloads were assumed to be launched into a 100-n. mi. circular parking orbit, and the equations of motion were numerically integrated to ascertain the weight which can be placed in such an orbit.

The first stage is fired vertically for 15 seconds, rolled to the proper tilt azimuth and then tilted into a gravity turn, maintaining zero angle of attack. This minimizes aerodynamic bending moments on the vehicle. The later stages are programmed to have constant vehicle axis tilt rates with respect to time. These tilt rates (four) are chosen to provide circular velocity and zero flight path angle at the predetermined parking orbit altitude. To achieve higher orbit altitudes, the payloads were assumed to be transferred from the parking orbit along Hohmann transfer ellipses with tangential firings at perigee and apogee.

1.8.2 CAPABILITIES -- Payload is shown versus circular orbital altitude for a nonrotating earth in Fig. 4. In addition to the basic configurations, IV is shown with and without the upper Centaur stage.

Fig. 5 illustrates the payload capabilities of the various configurations for the 306.6-n. mi. and the nominally 24-hr. orbits. As anticipated, the four-unit cluster has the greatest capability. The corresponding three-unit cluster, Configuration IV, however, can place in orbit a payload 77% as great.

~~SECRET~~

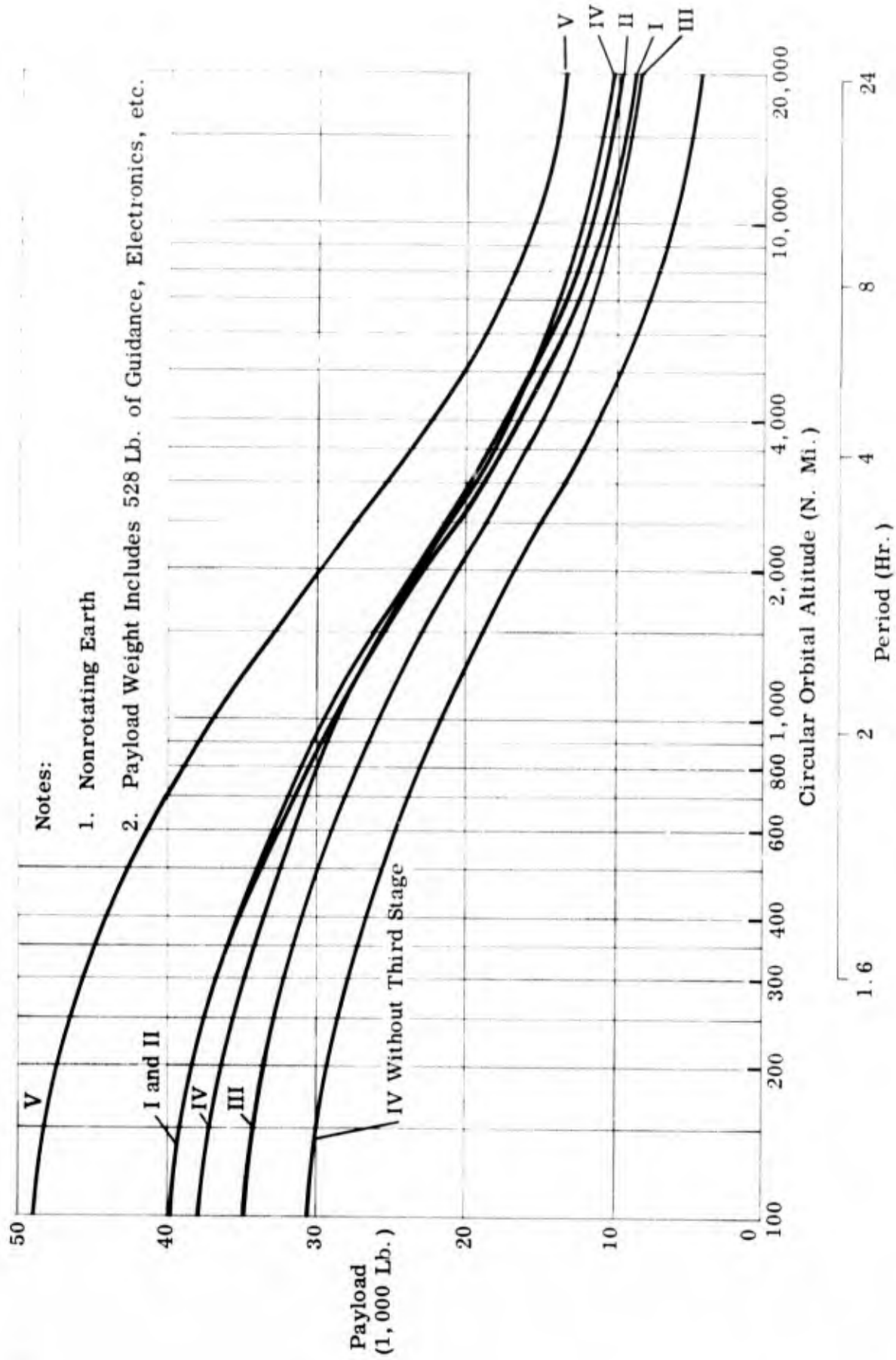

Fig. 4. Payload vs. orbital altitude

SECRET

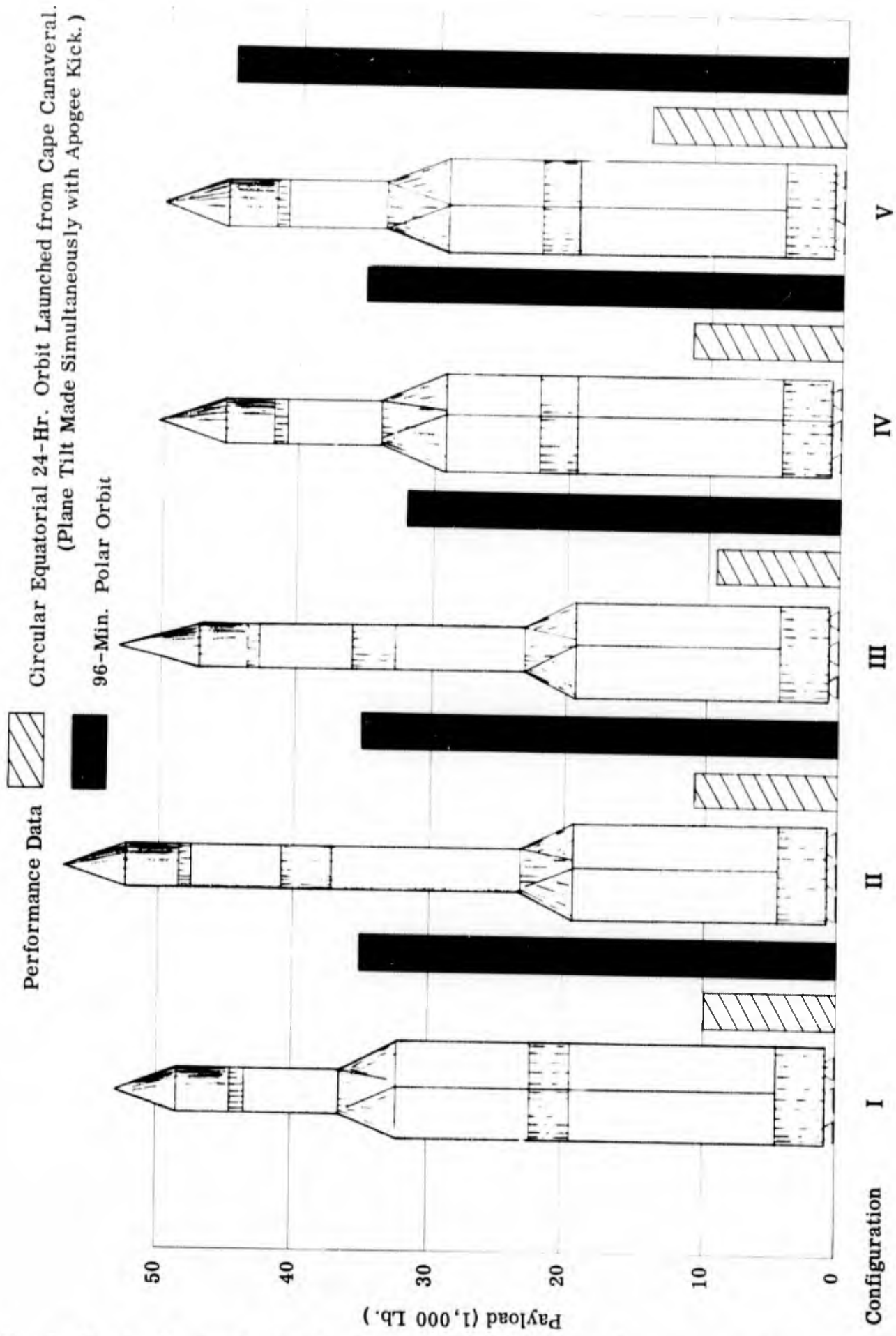

Fig. 5. Payload capabilities

SECRET

~~SECRET~~

A summary of the mission performance is shown in Table II for various types of 24-hr. orbits, a 96-min. polar orbit, a lunar soft landing and a typical Mars or Venus probe. The various lunar and interplanetary missions noted in Table II are based upon velocity requirements for specific hyperbolic trajectories previously calculated by Convair-Astronautics and should be considered as representative values only.

#### 1.9 SELECTION OF OPTIMUM CONFIGURATION

1.9.1 BASIS -- An analysis of the various designs was made to select a configuration for application to immediate space weapon system and space exploration programs. In addition to performance of the vehicle, use of existing hardware, availability, relative costs and reliability were considered.

1.9.2 SELECTION -- Configuration IV, which incorporates three clustered Atlases for the booster, three clustered Centaurs for the second stage, and one Centaur for the third stage, is recommended.

1.9.3 COMPARISON -- Configuration IV has the capability of placing an 11,200-lb. payload in a nominally 24-hr. orbit from Cape Canaveral or a 35,000-lb. payload in a 306.6-n. mi. polar orbit as indicated in Table II. As the two-stage booster vehicle for a winged entry vehicle, it can place 30,600-lb. in a 100-n. mi. polar orbit. Configurations I, II and III have slightly less capability for the 24-hr. orbit. Configuration V has a significantly greater capability, but other considerations tend to offset this advantage.

Table III summarizes and compares the changes which must be effected to modify existing Atlas E missile and Centaur hardware for the various designs. Configurations IV and V require the least changes. In the booster stage, all configurations require pressurization and tank skin gage changes. Configurations IV and V have a significant advantage in that no engine changes are required. This permits retention of the basic propellant systems and other systems associated with the rocket engines. The tank structures in the second stage of all configurations require only minor modifications. The engines and associated systems for Configurations I, II and III, however, require significant changes, while this hardware on Configurations IV and V is the same as that now being developed on the Centaur. For all configurations, no major change is anticipated for the third stage.

The number of engines required for the second stage on Configuration IV and V tend to detract from the reliability of these configurations. The 15K version of this engine, however, is currently being developed and it is anticipated that its reliability will be well established prior to its use on this vehicle. The three-cluster configuration offers some reliability advantage over the four-cluster.

~~SECRET~~

Table II. Mission performance summary

CONFIGURATION	I	II	III	IV	IV-A	V
First stage	3 Atlas					4 Atlas
Second stage	3 SH Atlas	Atlas	SH Atlas	3 Centaur		4 Centaur
Third stage	Centaur					Centaur
Takeoff thrust (in millions of pounds)	1.692	1.485	1.299	1.161	1.161	1.548
PAYLOADS						
	-- Pounds --					
Circular equatorial 24-hr. orbit, launched from equator	10,900	11,600	10,300	12,200	6,100	15,500
Circular equatorial 24-hr. orbit, launched from Cape Canaveral	10,000	10,700	9,400	11,200	5,200	14,500
Elliptic equatorial 24-hr. orbit, launched from equator (perigee at 300 n. mi; apogee at 38,500 n. mi.)	13,700	14,500	12,600	14,800	8,700	18,800
96-min. polar orbit	36,700	36,800	32,100	35,000	28,000	45,600
Mars or Venus probe	9,800	10,500	9,300	11,200	5,000	14,300
Lunar soft landing	4,600	5,000	4,300	5,500		7,200

Notes: IV-A is Configuration IV with only first and second stages.

Payload weights include 528 lb. of guidance, electronics, etc.

Table III. Configuration changes required in Atlas E and Centaur

		CONFIGURATION				
		II	III	IV	V	
First-stage tank	Forward end, skin gages, aft structure, cluster ties, propellant lines, equipment pods					
Booster engine	165K to 188K thrust	No change	165K to 188K thrust	No change	No change	
Sustainer engine	Replaced with 188K	Replaced with 165K	No change	No change	No change	
Forward adapter	New	New	New	Same as for Centaur	Same as for Centaur	
Pressurization	Increase	Increase	Increase	Increase	Increase	
Second-stage tank	Shortened, skin gage, aft structure, cluster ties, engine changes etc.			No change	No change	
Engine	Area ratio 8:1 to 25:1; remove sustainer	Area ratio 8:1 to 25:1; remove sustainer	Area ratio 8:1 to 25:1; remove sustainer	No change	No change	
Altitude start capability	Add	Add	Add	Available	Available	
Pressurization	Increase	Increase	Increase	No change	No change	
Adapter						
Third-stage tank			New			
Engine			No change			
Restart capabilities			No change			
Pressurization			Available			
Adapter + payload			No change			
			New			

~~SECRET~~

The requirements to place winged entry vehicles into low-altitude orbits is also considered in selecting the design. By removing the third stage of Configurations I, IV and V, short, high-performance vehicles are obtained which have high resistance to large bending moments.

From the above comparison, Configurations IV and V appear the most feasible. The three-unit clustered vehicle costs less and is more reliable, the four-cluster vehicle has the greater payload capability. Since the payload of Configuration IV is considered adequate for the missions in the immediate future, cost and reliability considerations are dominant; thus Configuration IV is selected.

#### 1.10 MISSIONS

1.10.1 GENERAL -- The missions to which the selected vehicle could be assigned have been examined briefly. The greatest political, psychological and perhaps military missions are those involving extension of the capabilities of manned space flight, culminating in a manned lunar landing. That is, of course, beyond immediate technological capability, and must be arrived at progressively. This study, however, shows that significant steps in that direction can be made by utilization of this vehicle's capabilities. Further, even cursory analysis shows this vehicle is capable of numerous additional tasks, including such missions as reconnaissance and communication satellites, establishment of a manned space station, and space and lunar probes.

1.10.2 EARTH ORBITAL MISSIONS -- Immediate uses for orbital vehicles of this type would be for reconnaissance missions. An especially urgent requirement is for a sophisticated early warning satellite, with the capability for detection, identification, track and impact prediction of ballistic missile or space vehicle launchings. Additional requirements exist for high-resolution photo reconnaissance, with film recovery, for targeting and general intelligence.

Establishment of a 24-hr. orbiting vehicle which remains relatively fixed with respect to the earth's surface would have considerable utility as a communications relay station. The high payload capabilities of this vehicle (11,200 lb. in a 24-hr. orbit) would provide a correspondingly high traffic handling capability.

The ability of this vehicle to place large payloads of up to 35,000 lb. into a 306.6-n. mi. orbit immediately suggests that for the first time it is possible to consider the establishment of a manned space station. Several of these vehicles would rendezvous at orbital altitude for assembly into a substantial station. The primary purpose of such a station would be the extensive scientific and technological research required to establish and exploit the future mission

~~SECRET~~

~~SECRET~~

capabilities of orbital systems. Such future missions would include highly sophisticated reconnaissance systems, missile launching strike stations, and anti-space weapons defense stations.

1.10.3 **TERRESTRIAL MISSIONS** -- The use of this vehicle as a booster for hypersonic glider appears to be the most attractive possibility in this class of missions. The proposed vehicle has the capability of boosting a 30,600-lb. glider to orbital velocity at 100-n. mi., thereby providing a vehicle with global range. Such a booster is applicable not only to the current Dynasoar programs, but to future programs for the development of hypersonic gliders, whether they be further applied to reconnaissance, strike logistics, orbital recovery, or other tasks.

1.10.4 **LUNAR AND INTERPLANETARY MISSIONS** -- As a prelude to actual manned landings and return, extensive scientific lunar research can be accomplished with this vehicle. This phase of lunar exploration would be carried out with unmanned, automatic scientific stations soft-landed in the lunar surface. This vehicle configuration can soft-land an instrumentation package of approximately 5,500 lb.

Instrumentation payloads for space and planetary probes are also well within the capabilities of this vehicle. A payload of approximately 4,000 lb. can be put into orbit around Mars; about 3,000 lb. can be carried for Venus orbital missions.

### 1.11 **GROWTH POTENTIAL**

After development of the recommended configuration, additional capability can be provided by appropriate modifications to the basic vehicle. By providing nine 188K booster engines as replacements for the current engines and increasing the tank skin gage, the gross weight of the upper stages can be increased significantly. The increase would permit insertion of a new second stage utilizing clustered Atlas tanks with hydrogen and oxygen as propellants between the existing first and second stages. With this configuration, it is estimated that the payload for a 24-hr. orbit could be increased to about 24,000 lb.

~~SECRET~~

**SECRET**

## 2/CONFIGURATION DESCRIPTIONS

### 2.1 CONFIGURATION I (Fig. 6)

2.1.1 GENERAL DESCRIPTION -- This arrangement consists of three stages plus a payload. It has a gross weight of approximately 1,246,000 lb. (see detail weight breakdown).

The first stage is a cluster of three standard Atlas E missiles modified for clustering and increased upper-stage weight. The second stage is a cluster of three shortened Atlas tanks, providing a short, rigid structure and a large quantity of propellant. Liquid oxygen and RP-1 propellants are used in both stages. Modifications required in the E missile to achieve these stage configurations are discussed in detail in the following section.

The third stage is a high-energy Centaur unit under development which employs LO<sub>2</sub> and hydrogen as propellants. This Centaur unit will be used as designed.

### 2.1.2 FIRST-STAGE CHANGES REQUIRED IN ATLAS E FOR ACCOMMODATION OF UPPER STAGES AND CLUSTERING

Tank -- Nose cone and forward adapter are eliminated. Conical 10° tapered end of LO<sub>2</sub> tank is replaced with a cylindrical section of 10-ft. diameter, and an upper bulkhead of the same contour as the center bulkhead. The same equivalent volume is maintained. Addition of an adapter with 10-ft. diameter is required to support the upper stages.

Upper-Stage Support at First-Stage Burnout -- Increase in tank pressure from 26 psi to 72 psi for the LO<sub>2</sub> tank and 60 psi to 102 psi for the fuel tank results in increase in material thickness for cylindrical skins and bulkheads, but gage thickness increase does not change Atlas tooling. Pressure increase also causes an increase in the number of pressurization bottles. Modification of the Atlas pressure regulators is necessary.

Engines -- To maintain satisfactory initial thrust-to-weight ratio, nine booster engines of 188,000 lb. (SL) thrust each must be utilized. This requires replacement of the existing 165,000-lb. thrust booster engines and the mounting of another 188,000-lb. booster in place of the 57,000-lb. sustainer.

**SECRET**

- Stage ① 3-Tank Standard Atlas Cluster  
9-188K Thrust Boosters (SL)
- Stage ② 3-Tank Shortened Atlas Cluster  
3-200K Thrust Engines (Altitude)
- Stage ③ 1 Centaur  
2-15K Thrust Engines (Altitude)

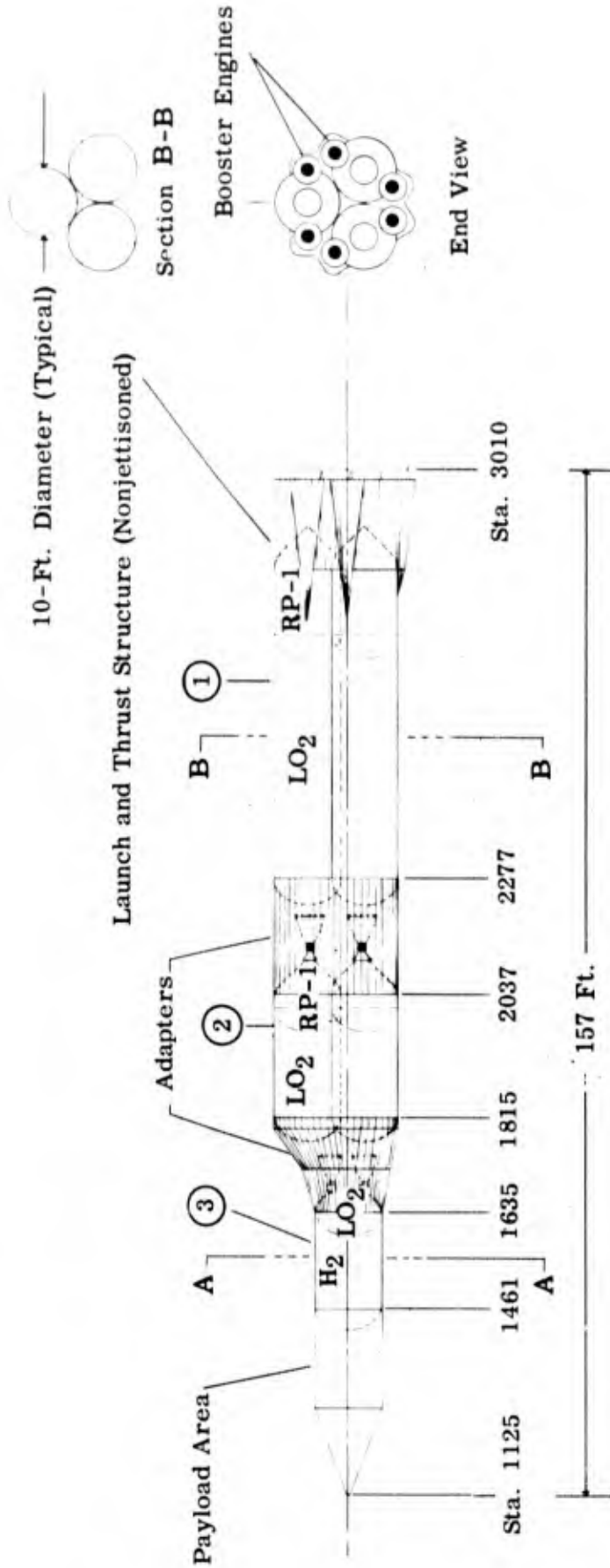
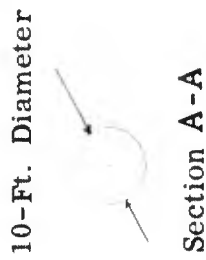

Fig. 6. Atlas cluster, Configuration I

~~SECRET~~

Clustering Attachment -- Frames and webs are added at mid-point of LO<sub>2</sub> and fuel tanks and at forward end of LO<sub>2</sub> tank. Tension/compression ties are provided between tanks at these frames. Shear and tension ties are provided in aft structure.

System Change -- Propellant tank interconnects are added at top and bottom of each tank for LO<sub>2</sub> and fuel equalization. Propellant line sizes are revised for the new engines (200K was 165K).

Removals -- Guidance, autopilot, APS, verniers and fairings and equipment pods are removed. They are items not necessary for the first stage of a multistage vehicle. The vehicle is controlled by equipment located on the upper stages.

Changes Due to the Large Engine Thrust and Increased Gross Weight -- The large booster engines and increased gross weight require substantial increase in the strength of the aft structure. The same typical construction is maintained. The large center engine requires additional stiffening of the aft bulkhead and strengthening of the mounting cone on the aft bulkhead.

2.1.3 SECOND STAGE -- This stage consists of three shortened, clustered Atlas tanks utilizing LO<sub>2</sub>/RP-1. Total stage weight is nominally 415,000 lb., or about 138,000 lb. per tank. This permits increased weight over the standard Atlas and provides a vehicle of larger diameter suitable for carrying upper stages and winged vehicles.

Changes required from Atlas E:

Tank length must be revised, due to the reduced propellant weight (and volume): existing Atlas tooling will accommodate these short tanks.

Pressures in the tank increase over that used by Atlas, due to increased axial loads at first-stage burnout.

Required clustering will be accomplished in the same manner as for the Atlas booster (see Section 2.1.2).

Propellant tank interconnects are required at the top and bottom of LO<sub>2</sub> and fuel tanks for propellant equalization.

The engines are Atlas booster engines modified for altitude start and altitude operation with a 25:1 expansion ratio. Only one engine per tank is used, mounted on the cone of the aft bulkhead in place of the sustainer. Considerable

~~SECRET~~

~~SECRET~~

modification will be required in this area. The propellant lines are of a size suitable for the large engine and would be routed differently from Atlas due to engine relocation, size, etc. The pump is mounted on the engine or aft cone of tank to permit jet-rising of the adapter structure at first-stage burnout.

The large thrust of the engine as compared to the existing sustainer requires stiffening of a major portion of the aft bulkhead by extending Atlas-type aft bulkhead stiffening members.

A new, heavy first-to-second stage adapter is required, and a structure similar to existing adapter design is anticipated. The geometry of this adapter (three barrels) is simple.

2.1.4 THIRD STAGE -- A single-unit Centaur high-energy stage under development at Convair-Astronautics is used as a third stage without change.

## 2.2 CONFIGURATION II (Fig. 7)

2.2.1 GENERAL DESCRIPTION -- This vehicle has three separate powered stages plus a payload. Takeoff weight is approximately 1,089,000 lb. The first two stages use LO<sub>2</sub> and RP-1 as propellants; the third stage uses LO<sub>2</sub> and hydrogen.

First-stage structure consists of three Atlas E missiles, modified for assembly in a cluster and increased upper-stage weight. The second stage is a standard E missile modified for attachment to the first stage and increased weight upper stages. Modifications and changes required in the missile to achieve these stage configurations are discussed in detail in Section 2.2.2.

The third stage of Configuration II is a Centaur high-energy stage now under development which will be used as designed with no modifications required.

### 2.2.2 FIRST-STAGE CHANGES REQUIRED IN ATLAS E FOR ACCOMMODATION OF UPPER STAGES AND CLUSTERING

Tank -- Nose cone and forward adapter are eliminated. Conical 10° tapered end of LO<sub>2</sub> tank is replaced with a cylindrical section having 10-ft. diameter, and an upper bulkhead of the same contour as the center bulkhead. The same equivalent volume is maintained. Addition of an adapter to the top of the cluster to support the second-stage is required.

~~SECRET~~

Table IV. Weight summary, Configuration I

	1st Stage	2nd	3rd
		--- Pounds ---	
Booster section	18,204	14,204	778
Adapter	1,800	1,800	
Tank structure	10,517	2,702	
Jettison equipment	60	60	
Heat shields and insulation	187	20	
Propulsion group	5,145	3,660	895
Electronic controls	47	47	
Hydraulics	400	357	41
Pneumatics	708	708	141
Pneumatic controls	213	213	
Electrical	75	50	50
Ground pneumatics	30		
Fill and drain	255	120	
Purge system	30		
Range safety	14	14	2,491 (inert weight)
Interconnect structure	750	750	10,000 * (payload)
Residuals	8,865	5,325	374
Jettison	47,300	30,030	12,491
Expendable propellants	746,658	384,675	26,000
Gross weight	793,958	414,705	38,491
Total gross weight	1,247,154		

\* Includes 528 lb. of guidance, electronics, etc.

**SECRET**

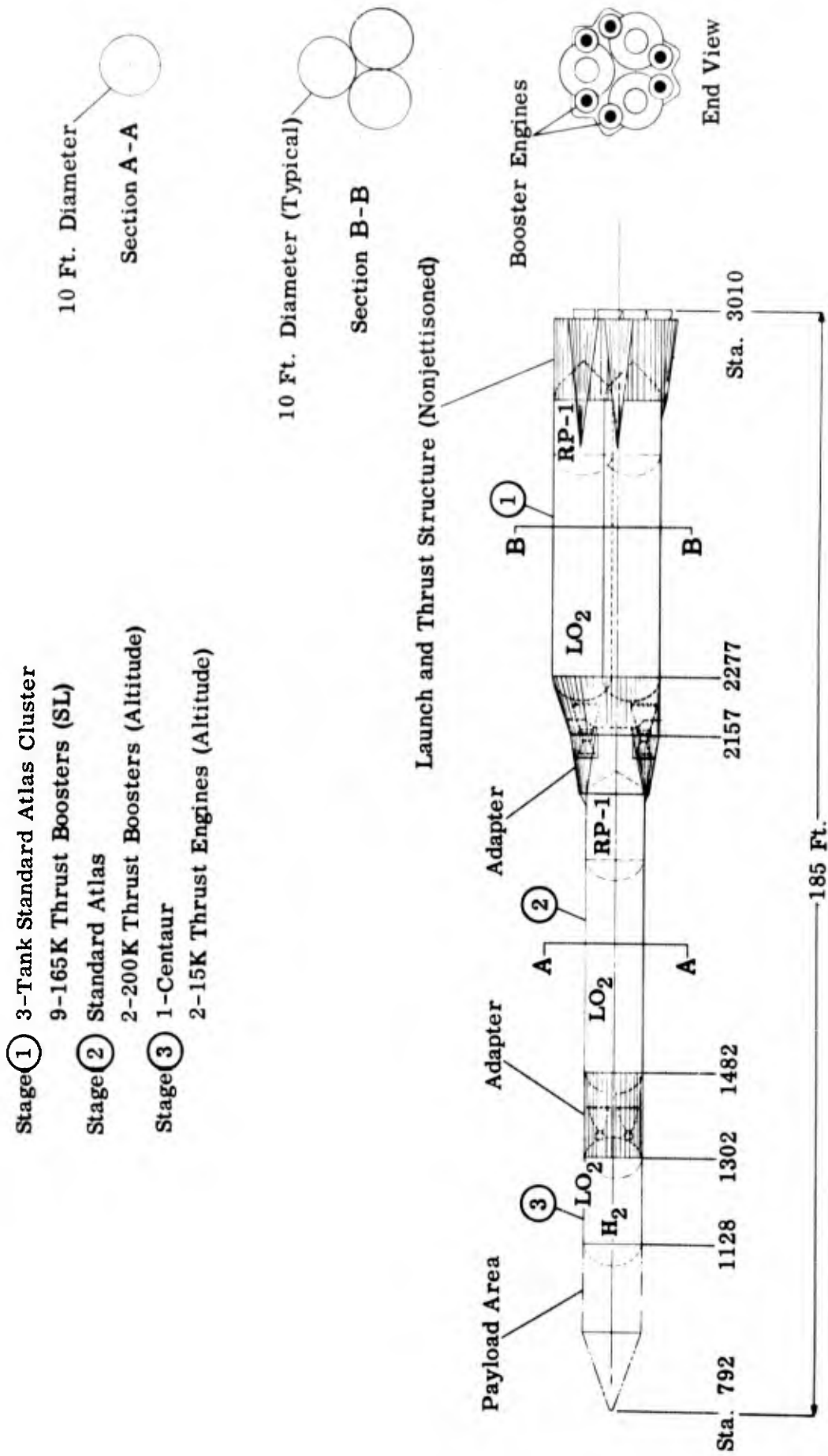

Fig. 7. Atlas cluster, Configuration II

**SECRET**

~~SECRET~~

Upper-Stage Support at First-Stage Burnout -- An increase in tank pressure from 26 psi to 60 psi for the LO<sub>2</sub> tank and from 60 psi to 90 psi for the fuel tank results in a material gage increase for cylindrical skins and bulkheads. This can be handled with existing Atlas tooling. The number of pressurization bottles is increased. Modification of Atlas pressure regulators is required.

Engines -- The sustainer engine is replaced with a 165K booster engine. Existing 165K boosters are retained.

Clustering Attachment -- Frame is added at top of tank, plus tension/compression ties. Frame and web are added to interior of tanks at the center bulkhead, with tension/compression attachments then being made between each tank. Tension and shear ties are added in aft structure.

System Changes -- Propellant tank interconnects are added at top and bottom of each tank for LO<sub>2</sub> and fuel equalization. Propellant line sizes are increased for larger thrust engines.

Removal -- Guidance, autopilot, APS, verniers and fairings, and equipment pods are removed, as items not necessary for a multistage vehicle first stage. Missile is controlled by equipment located in the upper stages.

Changes Due to Large Engine Thrust and Increased Gross Weight -- The large booster engines and increased gross weight require substantial increases in strength of the aft structure. Atlas-type construction is maintained. The large center engine necessitates additional stiffening of the aft bulkhead and mounting cone.

2.2.3 SECOND STAGE -- The second stage is an Atlas E, modified for altitude operation and high "second-stage" accelerations while carrying an upper stage and payload.

The Atlas E is designed for an initial acceleration of 1.34 to 1.5 g, with fully loaded propellant tanks and a 3,500-lb payload. As a second stage in Configuration II, the vehicle is required to withstand an acceleration at first-stage burnout of 5 g with full propellant tanks. Since the vehicle is pressure-stabilized, the propellant tank gas pressure must be increased sufficiently to maintain a tension condition in the tank skins under the new load. The LO<sub>2</sub> tank pressure is determined by the weight of the third stage plus payload, and the burnout acceleration. The fuel tank pressure is determined by all propellant and structure forward of the fuel tank.

~~SECRET~~

**SECRET**

Changes Required from Atlas E:

Accommodation for upper stage requires replacement of the nose cone, adapter, and forward 10° conical section of LO<sub>2</sub> tank with a cylindrical section of 10-ft. diameter and an upper bulkhead of the same contour as the center bulkhead. The same equivalent volume is maintained. Addition of an adapter with 10-ft. diameter to support the upper stage plus payload is necessary.

The imposed loads at first-stage burnout require gas pressures of 40 psi in the LO<sub>2</sub> tank and 134 psi in the fuel tank. This increased pressure results in skin gage and bulkhead gage changes, but increased gages can be readily handled on Atlas tooling without fixture changes.

The Atlas aft structure is designed for supporting the fully loaded vehicle (265,000-lb.) under a 1.25 g condition. This structure, therefore, must be increased in its load-carrying ability to withstand the 5g x 1.25 condition with a nominally 295,000-lb. stage weight imposed on it at first-stage burnout.

The first-to-second-stage adapter requires a new heavy structure due to the need for increased load-carrying capability, as well as the requirement of transferring the load from the single Atlas to the three-clustered Atlas booster.

The requirements for the tank pressurization during first stage dictate pressure increases during this phase. High pressures are not required, however, during the second stage, and this permits a reduction of operating pressures to those presently being used in the Atlas (LO<sub>2</sub>: 26 psi, fuel: 60 psi). Thus, the number of pressurization bottles will not change, but high initial pressure must be provided.

Engines for the second stage are limited to the present two Atlas boosters with an increased area ratio bell (25:1) to provide satisfactory altitude specific impulse. Due to the increased thrust of the booster engines at altitude (165K to 200K), the sustainer can be removed. This provides an initial thrust/weight of 1.35 and a final T/W of 7.8. The engine requires development of altitude start capability.

The guidance, autopilot and power supply for the second and third stages are carried on the upper stage. Therefore, the pods and contained equipment are removed from the second stage, as are verniers and vernier fairings.

**SECRET**

Table V. Weight summary, Configuration II

	1st Stage	2nd	3rd
		-- Pounds --	
Booster section	18,204	6,268	
Adapter	1,800	600	
Tank structure	10,517	2,800	778
Jettison equipment	60		
Heat shields and insulation	187		
Propulsion group	5,145		895
Electronic controls	47	47	
Hydraulics	400	119	41
Pneumatics	708	246	141
Pneumatic controls	213	71	
Electrical	75	75	50
Ground pneumatics	30	10	
Fill and drain	255	85	
Purge system	30	10	
Range safety	14	14	
Interconnect structure	750		2,491 (inert weight)
Residuals	8,865	2,755	10,000 * (payload)
Jettison	47,300	13,100	374
Expendable propellants	746,658	243,901	12,491
Gross weight	793,958	257,001	26,000
Total gross weight	1,089,450		38,491

\* Includes 528 lb. of guidance, electronics, etc.

**SECRET**

2. 2. 4 **THIRD STAGE** -- A single-unit Centaur high-energy stage under development at Convair-Astronautics is used as a third stage without change.

### 2. 3 **CONFIGURATION III** (Fig. 8 and 9)

2. 3. 1 **GENERAL DESCRIPTION** -- This is a three-stage vehicle, plus payload. It has a takeoff weight of approximately 1, 012, 000 lb. LO<sub>2</sub> and RP-1 propellants are used in the first and second stages; LO<sub>2</sub> and hydrogen propellants are used in the third.

The first stage consists of a cluster of three Atlas E missiles modified for clustering and increased upper-stage weight. The second stage is an Atlas E shortened by reduced propellant requirements and modified as described in Section 2. 3. 2. The third stage is a high-energy Centaur unit under development at Convair. It is used in this application without change.

### 2. 3. 2 **FIRST-STAGE CHANGES REQUIRED IN ATLAS E FOR ACCOMMODATION OF UPPER STAGES AND CLUSTERING.**

Tank -- Nose cone and forward adapter are eliminated. The conical 10° tapered end of LO<sub>2</sub> tank is replaced with a cylindrical section having a 10-ft. diameter, and an upper bulkhead of the same contour as the center bulkhead. Volume is maintained to existing value. Addition of an adapter to the top of the cluster (first stage) is required to support the second-stage Atlas.

Upper-Stage Support at First-Stage Burnout -- An increase in tank pressure is required (to support the axial load) from 26 psi to 51 psi in the LO<sub>2</sub> tank and from 60 psi to 78 psi in the fuel tank. Resulting material increase for skins and bulkheads can be handled with existing Atlas tooling. An increase in pressure bottles is required for the increased pressurization. Modification of the Atlas pressure regulators is also required.

Engines -- To maintain a satisfactory initial thrust-to-weight ratio, the booster engines are updated from 165K to 188K each at sea level. The sustainer is maintained at 57K thrust (SL).

Clustering Attachment -- Frames and webs are added at mid-point of LO<sub>2</sub> and fuel tank and top of LO<sub>2</sub> tank. At these points tension/compression ties are provided between tanks. (This frame and web assembly is the same as that used at station 1133 on Atlas.) Shear and tension ties are provided in aft structure.

**SECRET**

---

~~SECRET~~

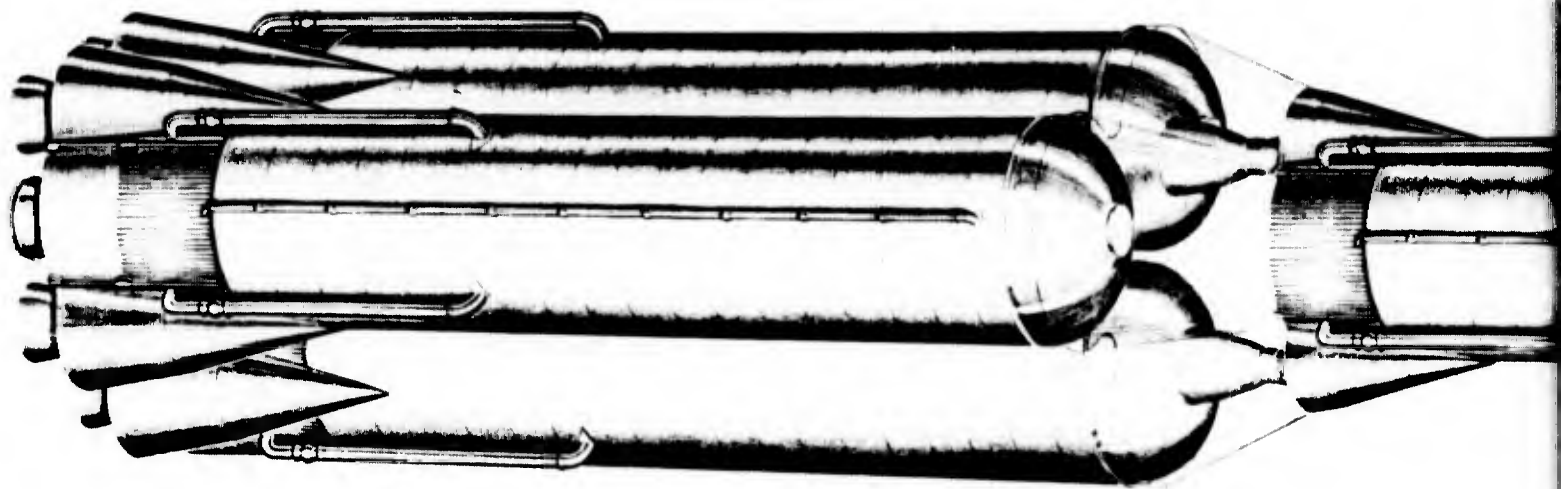
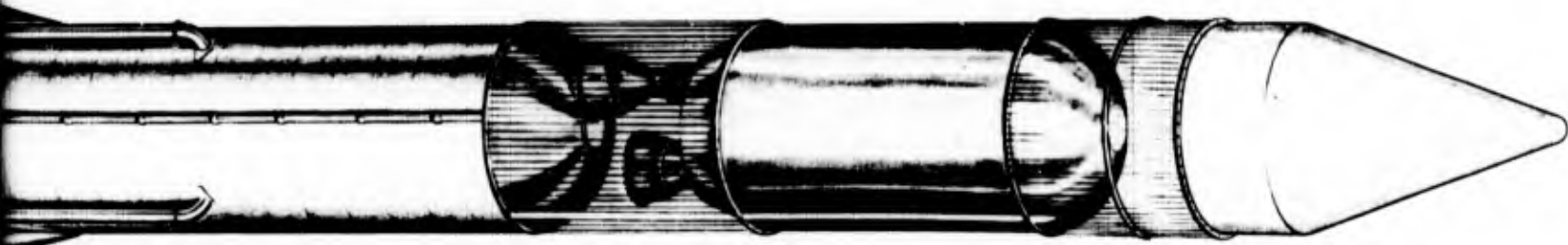

Fig. 8. Atlas cluster, Configuration III (perspective)

**A.**

~~SECRET~~



B.

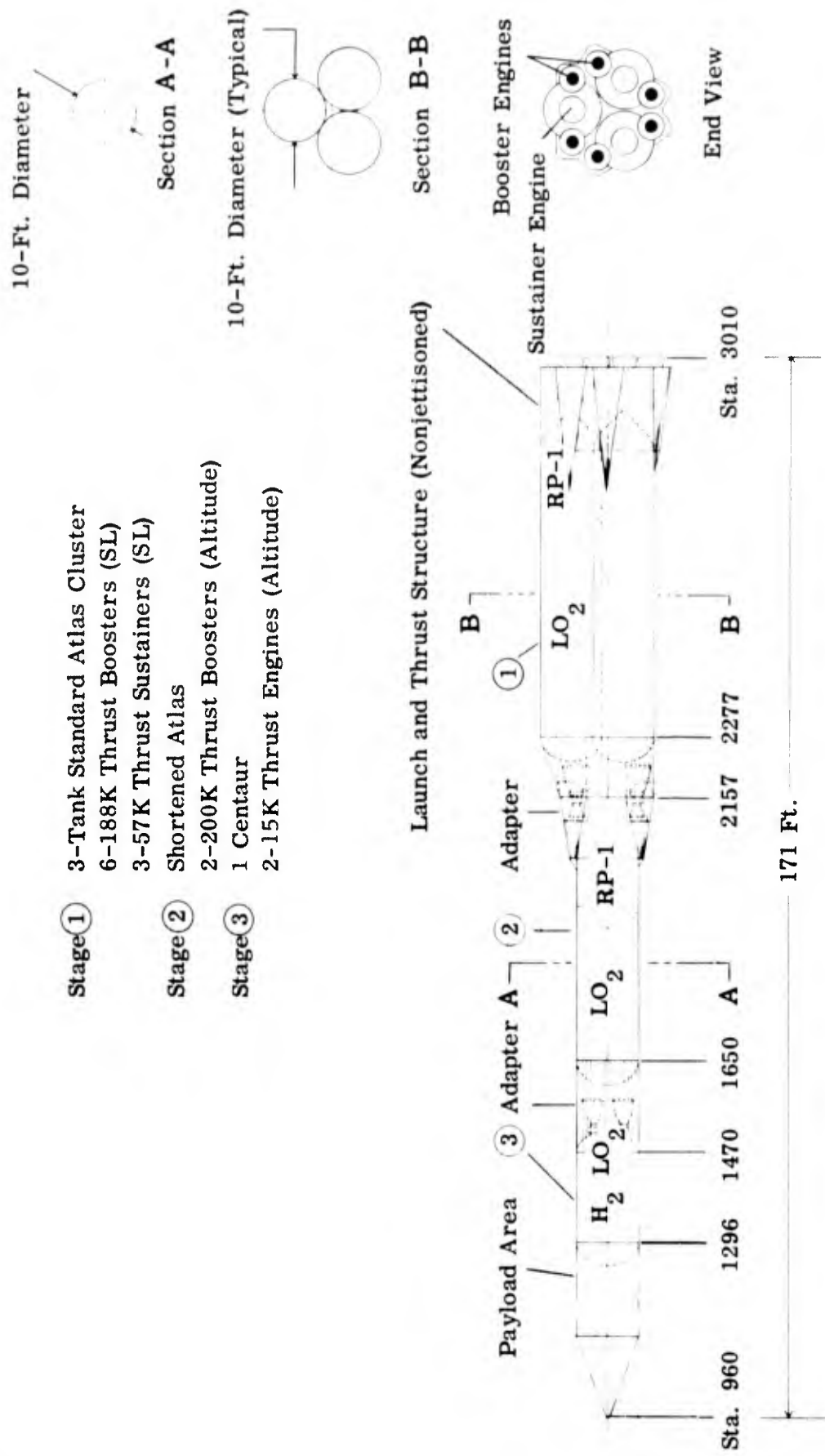

Fig. 9. Atlas cluster, Configuration III

~~SECRET~~

System Changes -- Propellant tank interconnects are added at top and bottom of each tank for LO<sub>2</sub> and fuel equalization. Propellant line sizes are increased.

Removal -- Guidance, autopilot, APS, verniers and fairings, and equipment pods are removed. For this application they would be located on the upper stage.

Changes due to increased engine thrust and gross weight -- The large booster engines and increased gross weight require substantial increases in strength of the aft structure. The same typical construction will be used as on the present Atlas.

2.3.3 SECOND STAGE -- The second stage is an Atlas E missile modified for altitude operation and higher accelerations while carrying an upper stage plus payload. In addition, the propellant volume (and weight) requirements are reduced for this stage; thus, the tank volume (and length) has been reduced accordingly.

The Atlas E is designed for an initial acceleration of 1.34 g with fully loaded propellant tanks and a 3,500-lb. payload. As a second stage in Configuration III the structure is required to withstand an acceleration at first-stage burnout of 5.65 g with full propellant tanks (reduced propellant weight, however). Since the vehicle is pressure-stabilized, the propellant tank pressure must be increased sufficiently to maintain a tension condition in the tank skins under the new load. The LO<sub>2</sub> tank pressure is determined by the weight of the third stage and payload. The fuel tank pressure is determined by all propellant and structure forward of the fuel tank.

#### Changes Required from Atlas E:

Accommodation for upper stage requires replacement of the nose cone, adapter and forward conical 10° section, plus removal of a section of the propellant tank to adjust for lower propellant volume requirements.

The imposed loads at first-stage burnout require gas pressures of 40 psi in the LO<sub>2</sub> tank and 93 psi in the fuel tank. Pressure increases result in skin gage increases noted in Fig. 3, but the thicker skins can be handled with existing tooling.

The Atlas aft launch structure is designed only to support the increased axial load imposed on it as a second-stage unit. The new axial load would be produced by the first-stage burnout acceleration of 5.65 g and the gross weight of the second and third stages plus payload (218,000 lb.)

~~SECRET~~

The first-to-second-stage adapter is a new, complicated heavy adapter due to the high axial loads involved and the complicated geometry required to adapt from a three-tank booster to the aft end of the Atlas launch structure.

Requirements for the pressurization during first stage are high, as noted earlier. The high pressures are not required during the second stage and permit reduction of operating pressures to those presently being used in the Atlas (LO<sub>2</sub>: 26 psi and fuel: 60 psi). Thus, existing pressurization bottles will suffice with provisions being made for high initial tank pressures during first stage.

The engines for the second stage are limited to the present two Atlas 165K (SL) boosters with an increase in area ratio (25:1) to provide satisfactory altitude specific impulse and increased thrust of 200K. Due to the increased thrust of the booster engines at altitude (165K to 200K), the sustainer engines are removed to maintain reasonable thrust-to-weight ratios in the second-stage system. These booster engines are required to have altitude start capabilities; this will be a new development item.

It is assumed that the guidance package is located in the upper third stage and payload. Therefore, all equipment pods are removed, as are verniers and associated equipment.

2.3.4 THIRD STAGE -- A Centaur unit under development at Convair-Astronautics will be used without change.

2.4 CONFIGURATION IV (Fig. 10)

2.4.1 GENERAL DESCRIPTION -- This arrangement consists of three powered stages plus a payload. Launch weight is approximately 914,000 lb. LO<sub>2</sub> and RP-1 are used as propellants in the first stage. LO<sub>2</sub> and hydrogen in the second and third stages.

The first stage is a cluster of three Atlas E missiles modified for clustering and increased upper stage weight. The second and third stages are formed with Centaur units being developed at Convair-Astronautics.

2.4.2 FIRST-STAGE CHANGES REQUIRED IN ATLAS E FOR ACCOMMODATION OF UPPER STAGES AND CLUSTERING

Tank -- Nose cone and forward adapter are eliminated. The conical end of the LO<sub>2</sub> tank is replaced with a cylindrical section of 10-ft. diameter, and an upper bulkhead of the same contour as the center bulkhead. The same equivalent volume is maintained.

SECRET

Table VI. Weight summary, Configuration III

	1st stage	2nd	3rd
	-- Pounds --		
Booster section	18,204	6,068	
Adapter	1,800	600	
Tank structure	10,517	2,090	778
Jettison equipment	60	20	
Heat shields and insulation	187		
Propulsion group	5,145	1,255	895
Electronic controls	47	47	
Hydraulics	400	119	41
Pneumatics	708	236	141
Pneumatic controls	213	71	
Electrical	75	50	50
Ground pneumatics	30	10	
Fill and drain	255	85	
Purge system	30	10	
Range safety	14	14	
Interconnect structure	750		
Residuals	8,865	1,775	2,491 (inert weight)
Jettison	43,700	12,450	10,000 * (payload)
Expendable propellants	746,658	167,550	374
Gross weight	793,958	180,000	12,491
			26,000
			38,491
Total gross weight	1,012,449		

\* Includes 528 lb. of guidance, electronics, etc.

SECRET

Stage ① 3 or 4-Tank Standard Atlas Cluster (See Section B-B)

165K Booster and 57K Sustainer (SL)

Stage ② 3 or 4-Centaur Cluster (See Section B-B)

15K Thrust Engines (Altitude)

Stage ③ 1 Centaur

2-15K Thrust Engines (Altitude)

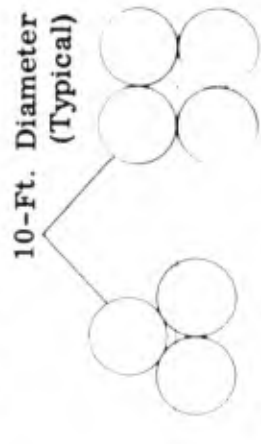

Section B-B Configuration IV  
Section B-B Configuration V

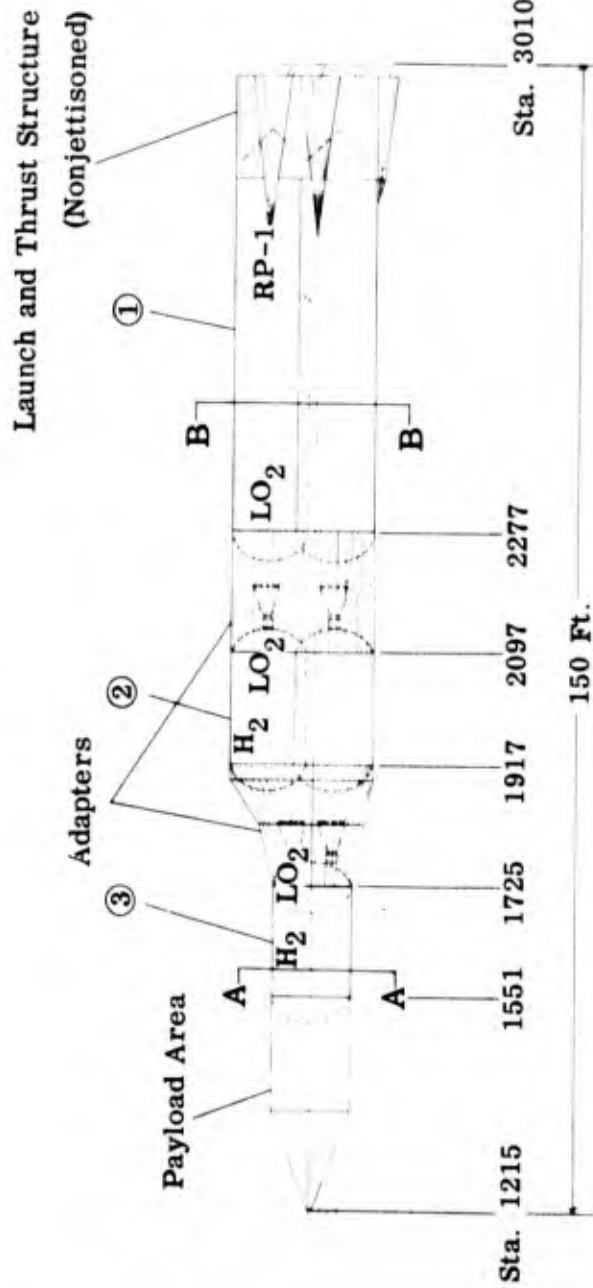
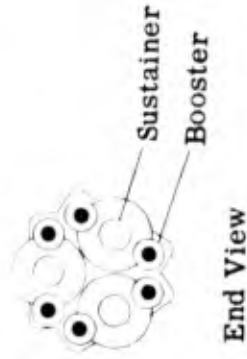

Fig. 10. Atlas cluster, Configurations IV and V

~~SECRET~~

Support of the Upper Stages at First-Stage Burnout Condition -- An increase in tank pressure is required from 26 psi to 44 psi for the LO<sub>2</sub> tank and 60 psi to 71 psi for the fuel tank, with resulting increase in material thickness for both cylindrical skins and bulkheads. This increase in material gages is accommodated by existing Atlas tooling. An increase in the number of pressurization bottles is required. Modification of the Atlas pressure regulators is required.

Engines -- To maintain a satisfactory initial thrust-to-weight ratio, the booster engine thrust will be set at 165,000-lb. The MA-3 engine booster engines being developed for the Atlas E missiles are being designed and tested for this thrust rating.

Clustering Attachment -- Frame and web are added at mid-point of LO<sub>2</sub> and fuel tank and top of LO<sub>2</sub> tank. At these points, tension/compression ties are provided between tanks. (This frame and web assembly is the same as that used at station 1133 on Atlas.) Shear and tension ties are provided in aft structure.

System Changes -- Propellant tank interconnects are added at top and bottom of each tank for LO<sub>2</sub> and fuel equalization.

Removals -- Guidance, autopilot, APS, verniers, vernier fairings, and pods are removed. These items are not necessary for the first stage of a multistage vehicle, the vehicle being controlled by equipment located on the upper stages.

Changes Required Due to Increased Gross Weight -- The aft structure must be strengthened to support the additional gross weight. Structure will be maintained as now existing on Atlas.

2.4.3 SECOND STAGE -- This stage is a cluster of three Centaur vehicles utilizing O<sub>2</sub>/H<sub>2</sub> as propellants. The basic vehicles are unchanged except for elimination of the internal propellant tanks normally used for restart. Clustering is accomplished in the same manner as that proposed for the Atlas booster (first stage).

The first-stage adapter is the same as that for the present Atlas-Centaur combination except for clustering attachment and number of tanks. The forward adapter for the third stage is a new adapter transferring load from the third-stage Centaur to the clustered second stage (three barrel).

The engines are Centaur engines (being designed by Pratt & Whitney). This permits a satisfactory initial T/W of .72.

~~SECRET~~

~~SECRET~~

Table VII. Weight summary, Configuration IV

1st Stage	(Lb.)	2nd (3 Centaurs)	(Lb.)	3rd (1 Centaur)	(Lb.)
Booster section	18,204	Adapter and tie structure	1,348	Structure	778
Adapter (1 to 2)	1,800	Structure	2,484	Propulsion	895
Tank structure	8,136	Propulsion	2,685	Pressurization	141
Jettison equipment	60	Pressurization	423	Hydraulics	41
Heat shield, low-drag fairing and insulation	187	Hydraulics	123	Electrical	50
		Electrical	114	Residuals	374
		Residuals	1,122	Inert weight	2,491
Propulsion group (sust.)	3,765	Burnout weight (less 3rd stage)	8,299	Payload (assumed)	10,000*
Electronic controls	47	Expendable propellants	78,000	Burnout	12,491
Hydraulics	357	Gross weight (2nd stage only)	86,299	Expendable propellant	26,000
Pneumatics	708			Gross weight (3rd stage only)	38,491
Pneumatics controls	213				
Electrical	75				
Ground pneumatics	30				
Fill and drain fittings	255				
Purge system	30				
Range safety	14				
Interconnect structure	750				
Residuals	8,265				
Jettison weight	42,896				
Propellant expendables	746,658				
Gross weight (1st stage only)	789,554				
Total gross weight	914,344				

\*Includes 528 lb. of guidance, electronics, etc.

~~SECRET~~

~~SECRET~~

Table VIII. Weight summary, Configuration V

1st Stage	(Lb.)	2nd (3 Centaurs)	(Lb.)	3rd (1 Centaur)	(Lb.)
Booster section	24,272	Adapter and tie structure	1,800	Structure	778
Adapter (1 to 2)	2,400	Structure	3,312	Propulsion	895
Tank structure	10,848	Propulsion	3,580	Pressurization	141
Jettison equipment	80	Pressurization	564	Hydraulics	41
Heat shield, low-drag fairing		Hydraulics	164	Electrical	50
and insulation	265	Electrical	114	Residuals	374
		Residuals	1,496	Inert weight	2,491
Propulsion group (sust.)	5,020	Burnout weight (less 3rd stage)	11,030	Payload (assumed)	10,000*
Electronic controls	47	Expendable propellants	104,000	Burnout	12,491
Hydraulics	476	Gross weight (2nd stage only)	115,030	Expendable propellant	26,000
Pneumatics	944			Gross weight (3rd stage only)	38,491
Pneumatics controls	284				
Electrical	75				
Ground pneumatics	40				
Fill and drain fittings	340				
Purge system	40				
Range safety	14				
Interconnect structure	1,000				
Residuals	11,020				
Jettison weight	57,165				
Propellant expendables	995,544				
Gross weight (1st stage only)	1,052,709				
Total gross weight	1,206,230				

\*Includes 528 lb. of guidance, electronics, etc.

~~SECRET~~

~~SECRET~~

2.4.4 THIRD STAGE -- One Centaur unit is used without change.

#### 2.5 CONFIGURATION V (Fig. 10)

2.5.1 GENERAL DESCRIPTION -- This vehicle has three stages with a payload added to the third stage. It has a launch weight of approximately 1,206,000-lb. LO<sub>2</sub> and RP-1 are first-stage propellants; LO<sub>2</sub> and hydrogen are second- and third-stage propellants.

The first stage consists of a cluster of four Atlas E missiles modified for clustering and increased upper stage weight. The second stage is a cluster of four Centaur units, with minor modifications. The third stage is a single Centaur unit.

2.5.2 FIRST, SECOND AND THIRD STAGES -- These stages are identical with those described for Configuration IV in Section 2.4, except for the following:

1. The addition of one Atlas to the first stage, making a total cluster of four units.
2. The addition of one Centaur unit to the second stage, also making a total of four units.

~~SECRET~~

SECURITY NOTICE

This document contains information affecting the national defense of the United States within the meaning of the Espionage Laws, Title 18 U.S.C., Sections 793 and 794. Its transmission or the revelation of its contents in any manner to an unauthorized person is prohibited by law.