

UNCLASSIFIED

AD NUMBER

AD842572

LIMITATION CHANGES

TO:

Approved for public release; distribution is unlimited.

FROM:

Distribution authorized to U.S. Gov't. agencies and their contractors; Critical Technology; OCT 1968. Other requests shall be referred to Air Force Technical Application Center, Washington, DC 20333. This document contains export-controlled technical data.

AUTHORITY

usaf ltr, 25 jan 1972

THIS PAGE IS UNCLASSIFIED

1 OF 2

AD

842572



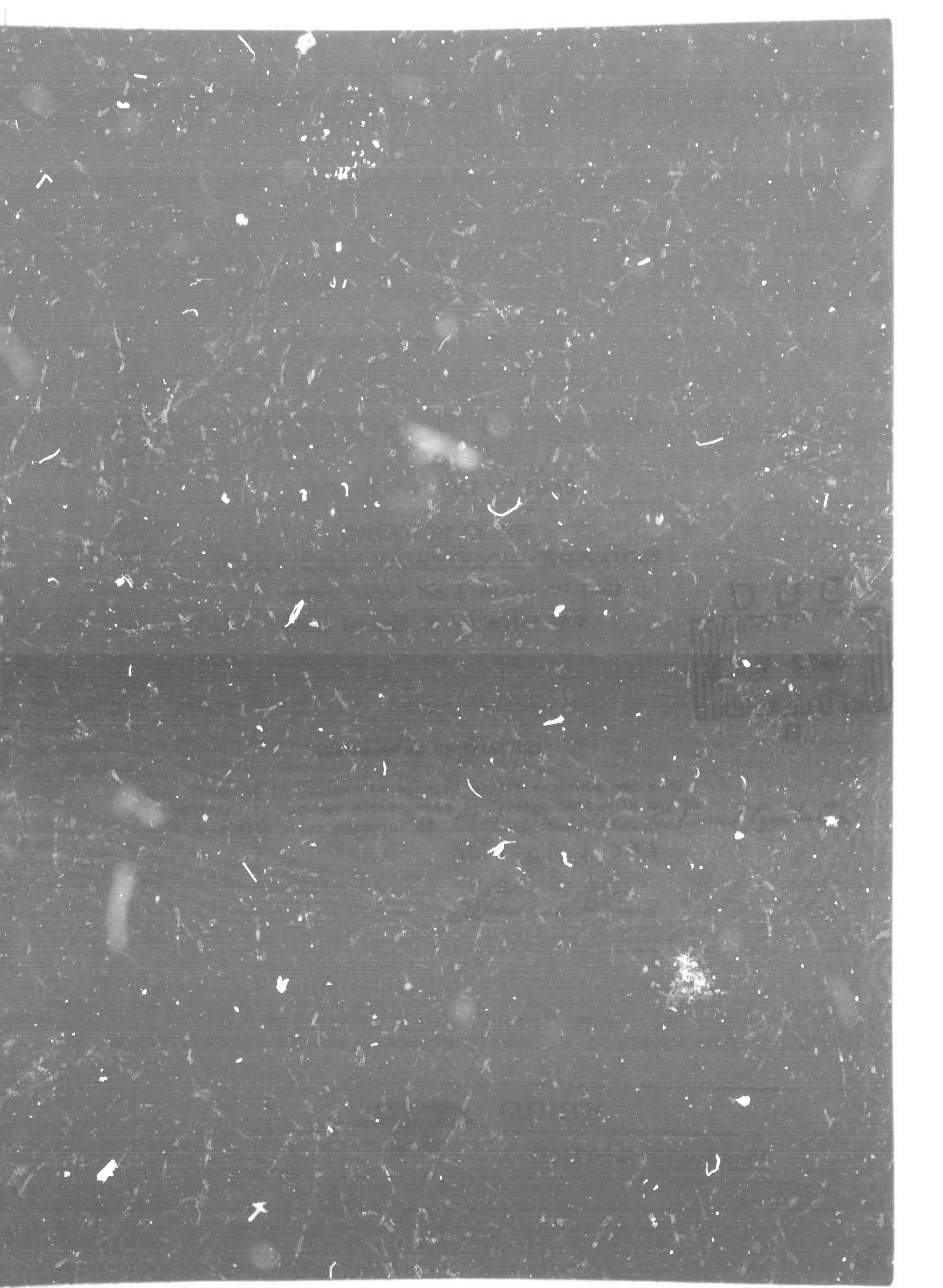

TECHNICAL REPORT NO. 68-46

OPERATION OF THE  
TONTO FOREST SEISMOLOGICAL OBSERVATORY  
Quarterly Report No. 3, Project VT/8702  
1 July through 30 September 1968

Sponsored by

Advanced Research Projects Agency  
Nuclear Test Detection Office  
ARPA Order No. 624

GEOTECH  
A Teledyne Company  
3401 Shiloh Road  
Garland, Texas

15 October 1968

IDENTIFICATION

AFTAC Project No:	VELA T/8702
Project Title:	Operation of TFSO
ARPA Order No:	624
ARPA Program Code No:	8F10
Name of Contractor:	Teledyne Industries, Incorporated Geotech Division Garland, Texas
Date of Contract:	1 January 1968
Amount of Contract:	\$493,500
Contract Number:	AF 33657-68-C-0766
Contract Expiration Date:	31 December 1968
Program Manager:	B. B. Leichter, BR1-2561, ext. 222

## CONTENTS

	<u>Page</u>
ABSTRACT	
1. INTRODUCTION	1
1.1 Authority	1
1.2 History	1
2. OPERATION OF TFSO	1
2.1 General	1
2.2 Standard seismograph operating parameters	1
2.3 Data channel assignments	2
2.4 Completion and shipment of data	2
2.5 Quality control	2
2.5.1 Quality control of 16-millimeter film seismograms	2
2.5.2 Quality control of magnetic-tape seismograms	6
2.5.3 Quality control of Astrodata digital magnetic seismograms	7
2.6 Security inspection	7
2.7 Defense Contract Administration visit	7
2.8 Property utilization survey	7
2.9 Emergency power generator	7
3. EVALUATE DATA AND DETERMINE OPTIMUM OPERATIONAL CHARACTERISTICS	8
3.1 Short-period array systems modifications	8
3.1.1 AEI lightning protectors	8
3.1.2 Improved grounding	10
3.1.3 Spike noise elimination	11
3.1.4 Solid-state amplifier	22
3.1.5 Cable hock sealing	22
3.2 Astrodata system	30
3.2.1 Overload circuit modification	30
3.2.2 Miscellaneous repairs	30
3.3 Long-period array	30
4. ANALYZE DATA	33
4.1 Daily reports to the Coast and Geodetic Survey (C&GS)	33
4.2 Multistation earthquake bulletin	33
4.3 Routine noise survey	37
5. PROVIDE OBSERVATORY FACILITIES AND ASSISTANCE TO OTHER ORGANIZATIONS	37
5.1 Telemetry to Massachusetts Institute of Technology	37
5.2 Astrogeological Department of the U. S. Geological Survey	37

CONTENTS, Continued

	<u>Page</u>
5.3 The University of Utah	37
5.4 Visitors	37
5.4.1 Visits by school and professional groups	37
5.4.2 Teledyne visitors	38
5.4.3 Visits by VELA Seismological Center personnel	38
6. RESEARCH PROGRAMS	38
6.1 Evaluation of a high-frequency seismograph	38
6.2 Multichannel filter processor (MCF)	38
6.3 Evaluation of the short-period array beamforming capabilities	39
 APPENDIX 1 - Statement of work to be done	
 APPENDIX 2 - Results of tests of firing times of AEI lightning protectors	
 APPENDIX 3 - Test plan for TFSO spike-noise reduction study	

## ILLUSTRATIONS

<u>Figure</u>		<u>Page</u>
1	Location of TFSO	2
2	Normalized response characteristics of standard seismographs at TFSO	4
3	AEI test circuit	9
4	TFSO short-period seismogram exhibiting typical spike noise before circuit modifications. (X10 enlargement of 16-millimeter film)	12
5	TFSO short-period seismogram exhibiting typical spike noise before circuit modifications. (X10 enlargement of 16-millimeter film)	13
6	TFSO short-period seismogram exhibiting typical spike noise before circuit modifications. (X10 enlargement of 16-millimeter film)	14
7	TFSO short-period seismogram showing effect of typical spike noise upon beam-steered data traces. (X10 enlargement of 16-millimeter film)	15
8	TFSO short-period seismogram exhibiting typical spike noise before circuit modifications. (X10 enlargement of 16-millimeter film)	16
9	TFSO short-period seismogram exhibiting typical spike noise before circuit modifications. (X10 enlargement of 16-millimeter film)	17
10	TFSO short-period seismogram exhibiting typical spike noise before circuit modifications. (X10 enlargement of 16-millimeter film)	18
11	TFSO short-period seismogram showing effect of typical spike noise beam-steered data traces. (X10 enlargement of 16-millimeter film)	19
12	TFSO short-period seismogram exhibiting typical spike noise. (X10 enlargement of 16-millimeter film)	23

ILLUSTRATIONS, Continued

<u>Figure</u>		<u>Page</u>
13	TFSO short-period seismogram exhibiting typical spike noise. Note absence of spikes on Z19, Z22, and Z24, the modified channels under test.(X10 enlargement of 16-millimeter film)	24
14	TFSO short-period seismogram exhibiting typical noise. Note absence of spikes on Z34, the modified channel, under test. (X10 enlargement of 16-millimeter film)	25
15	Short-period circuit modification for sites power from central recording building	26
16	Short-period modification for sites powered by thermoelectric generator or commercial power	27
17	Typical hock seal using heat-shrinkable tubing and tape	29
18	Circuit installed at LP sites to protect line driver cards in FM data circuit from lightning-induced potentials	31
19	Circuit installed at LP2, LP3, and LP4 to protect power supply against lightning-induced potentials	32
20	Distribution of Coast and Geodetic Survey located epicenters in the northern hemisphere for February, March, and April 1968	35
21	Distribution of Coast and Geodetic Survey located epicenters in the southern hemisphere for February, March, and April 1968	36

TABLES

<u>Table</u>		<u>Page</u>
1	Operating parameters and tolerances of standard seismographs at TFSO	3
2	Events reported to the C&GS by TFSO during July, August, and September 1968	33
3	Percentage of hypocenters reported in the C&GS "Earthquake Data Report" for which TFSO data were used	34

## ABSTRACT

This is a report of the work accomplished on Project VT/8702 from 1 July through 30 September 1968. Project VT/8702 includes the operation, evaluation, and improvement of the Tonto Forest Seismological Observatory (TFSO) located near Payson, Arizona. It also includes special research and test functions carried out at TFSO and research and development tasks performed by the Garland, Texas, staff using TFSO data.

# OPERATION OF THE TONTO FOREST SEISMOLOGICAL OBSERVATORY

## 1. INTRODUCTION

### 1.1 AUTHORITY

The research described in this report was supported by the Advanced Research Projects Agency, Nuclear Test Detection Office, and was monitored by the Air Force Technical Applications Center (AFTAC) under Contract AF 33657-68-C-0766. The effective date of the contract is 1 January 1968; the statement of work for Project VT/8702 is included as appendix 1 to this report.

### 1.2 HISTORY

The Tonto Forest Seismological Observatory (TFSO) was constructed by the United States Corps of Engineers in 1963. TFSO was designed to record seismic events and to be used as a laboratory for testing, comparing, and evaluating advanced seismograph equipment and seismometric recording techniques. The instrumentation was assembled, installed, and operated until 30 April 1965 by the Earth Sciences Division of Teledyne Industries under Contract AF 33(657)-7747. On 1 May 1965, Geotech assumed the responsibility for operating TFSO. The location of TFSO is shown in figure 1.

## 2. OPERATION OF TFSO

### 2.1 GENERAL

Data are recorded at TFSO on a 24-hour-a-day basis. The observatory is manned continuously. A full complement of personnel is on duty eight hours a day, five days a week; at other times, a reduced operating crew is on duty.

### 2.2 STANDARD SEISMOGRAPH OPERATING PARAMETERS

The operating parameters and tolerances for the TFSO standard seismographs are shown in table 1. Frequency response tests are made routinely, and parameters are checked and reset to maintain the specified tolerances.

Normalized response characteristics of TFSO standard seismographs are shown in figure 2. In addition to these standard seismographs, two filtered

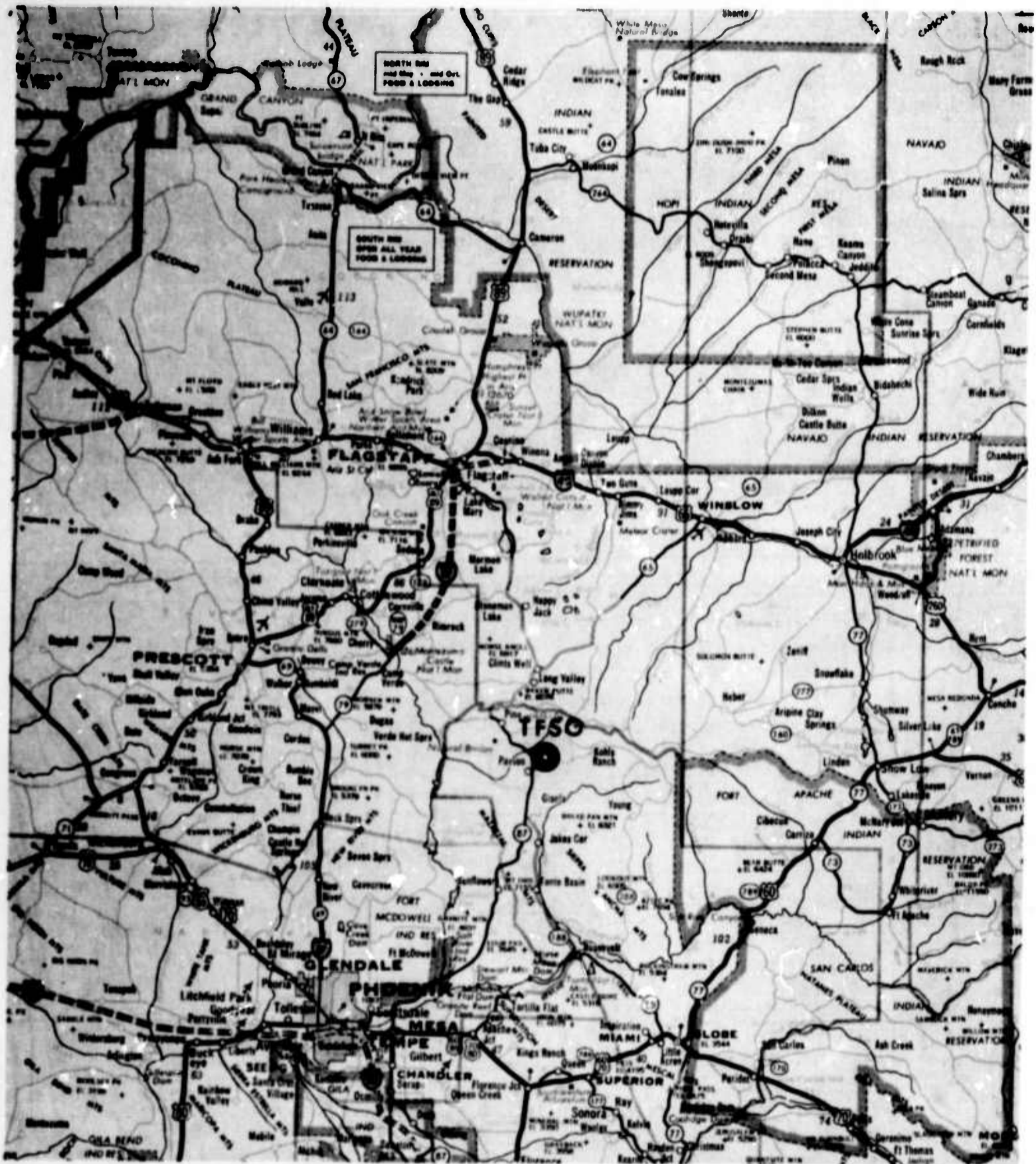

Figure 1. Location of TFSO

G 650

Table 1. Operating parameters and tolerances of standard seismographs at TFSO

System	Seismograph			Operating parameters and tolerances					Filter settings	
	Comp	Type	Model	Ts	λs	Tg	λg	δ <sup>2</sup>	Bandpass at 3 dB cutoff (sec)	Cutoff rate at SP side (dB/oct)
SP <sup>a</sup>	Z	Johnson-Matheson	6480	1.25 ±2%	0.54 ±5%	---	---	0.0000	0.3 - 10	6
SP <sup>b</sup>	Z	Johnson-Matheson	6480	1.25 ±2%	0.54 ±5%	0.33 ±5%	0.65 ±5%	0.0117	0.1 - 100	12
SP <sup>b</sup>	H	Johnson-Matheson	7515	1.25 ±2%	0.54 ±5%	0.33 ±5%	0.65 ±5%	0.0117	0.1 - 100	12
SP	Z	Benioff	1051	1.0 ±2%	1.0 ±5%	0.2 ±5%	1.0 ±5%	0.0104	0.1 - 100	12
SP	H	Benioff	1101	1.0 ±2%	1.0 ±5%	0.2 ±5%	1.0 ±5%	0.0104	0.1 - 100	12
SP	Z	UA Benioff	1051	1.0 ±2%	1.0 ±5%	0.75	1.0 ±5%	0.0245	---	---
SP	H	UA Benioff	1101	1.0 ±2%	1.0 ±5%	0.75	1.0 ±5%	0.0245	---	---
SP	H	Wood-Anderson	TS 220	0.8	0.78	---	---	---	---	---
IB <sup>c</sup>	Z	Melton	10012	2.25 ±9%	0.65 ±5%	0.64 ±5%	1.2 ±5%	0.0006	0.05 - 100	18
IB <sup>c</sup>	H	Lehner-Griffith	SH-216	2.25 ±9%	0.65 ±5%	0.64 ±5%	1.2 ±5%	0.0004	0.05 - 100	18
LP	Z	Geotech	7505A	20.0 ±5%	0.77	---	---	0.00	80 - 300	6
LP	H	Geotech	8700C	20.0 ±5%	0.77	---	---	0.00	80 - 300	6

KEY

SP Short period  
 IB Intermediate band  
 LP Long period  
 UA Unamplified (i.e., earth powered)

Ts Seismometer free period (sec)  
 Tg Galvanometer free period (sec)  
 λs Seismometer damping constant  
 λg Galvanometer damping constant  
 δ<sup>2</sup> Coupling coefficient

<sup>a</sup> 37-element hexagonal array

<sup>b</sup> Linear array and 3 comp

<sup>c</sup> Discontinued after 25 June

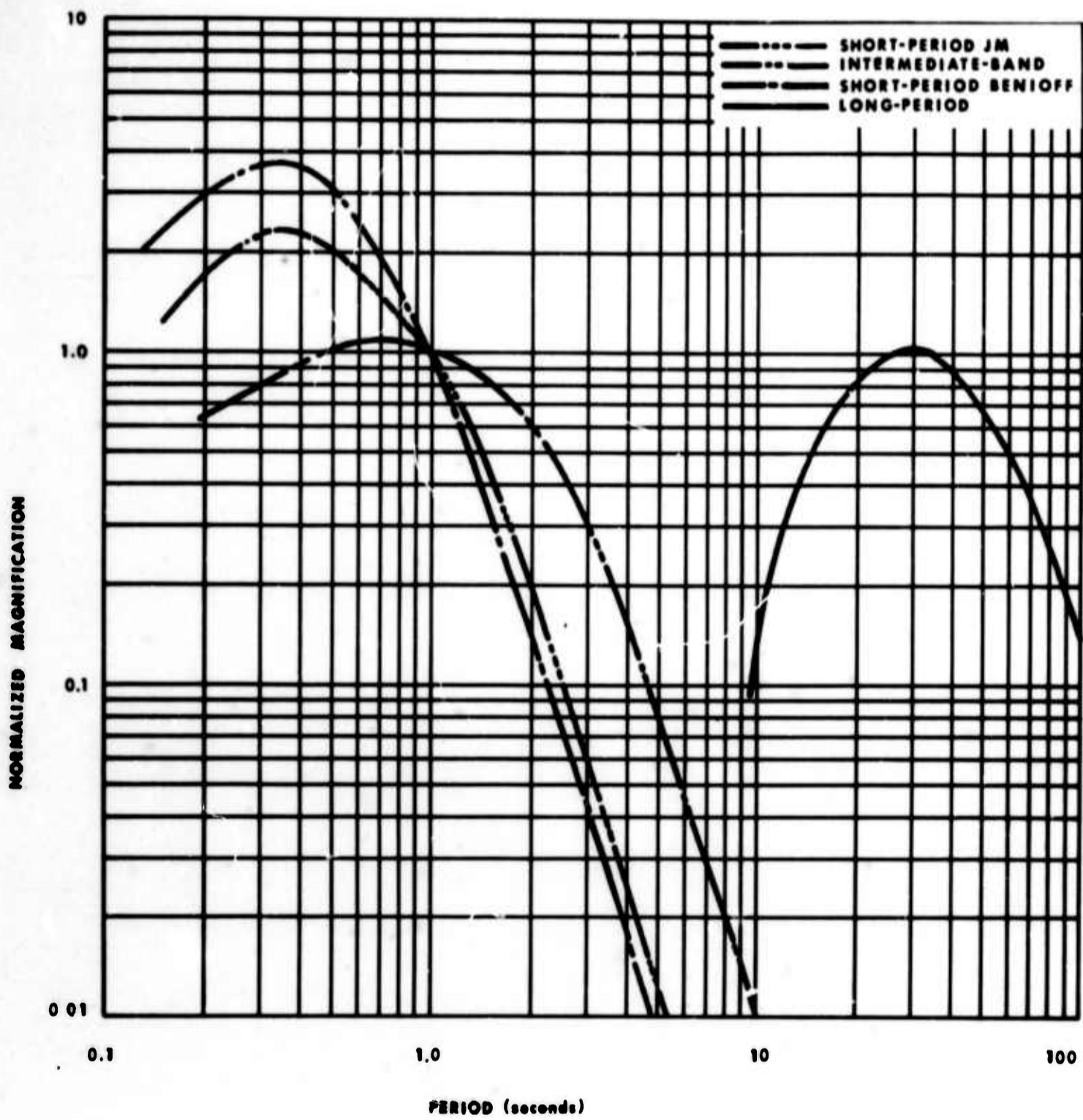

Figure 2. Normalized response characteristics of standard seismographs at TFSO

summation seismographs are recorded. The  $\Sigma$ TF seismograph is filtered by a UED filter with a high-cut frequency of 1.75 cps and a slope of 12 dB per octave. The  $\Sigma$ TFK seismograph utilizes a Krohn-Hite filter; the high-cut frequency is set at 2.0 cps with a slope of 24 dB per octave, and the low-cut frequency is set at 1.0 cps with a slope of 24 dB per octave. Both filtered seismographs are recorded on 16-millimeter film on data trunk 1.

The intermediate band system was deactivated on 25 June 1968 in order to provide recording space for the high-frequency seismograph system.

### 2.3 DATA CHANNEL ASSIGNMENTS

Each data format recorded at TFSO is assigned a data group number. When a data format is changed, a new data group number is assigned. Several data format change notices reporting changes in channel assignments were submitted to the Project Officer and to frequent users of TFSO data during this reporting period.

### 2.4 COMPLETION AND SHIPMENT OF DATA

The magnetic-tape seismograms are shipped from TFSO each week. Six magnetic-tape recorders are used to record data for the AFTAC/VELA Seismological Center (VSC).

Film seismograms from twelve Develocorders are routinely shipped to data users. The film and magnetic-tape operation logs and calibration logs are copied and shipped with the seismograms. Copies of selected film seismogram data are sent to the Geotech Program Manager regularly and to other data users on special request. The shipments of 16-millimeter film seismograms routinely sent to the Seismic Data Laboratory (SDL) repository are complete through July 1968, except for selected seismograms being held for use in conjunction with special investigations or instrument tests that are in progress.

### 2.5 QUALITY CONTROL

#### 2.5.1 Quality Control of 16-Millimeter Film Seismograms

Quality control checks of randomly-selected 16-millimeter film seismograms from data trunks 1, 2, and 8, and the associated operation logs were made in Garland. Items that are routinely checked by the quality control analyst include:

- a. Film boxes - neatness and completeness of box markings;
- b. Develocorder logs - completeness, accuracy, and legibility of logs;

c. Film:

1) Quality of the overall appearance of the record (for example, trace spacing and trace intensity);

2) Quality of film processing;

d. Analysis - completeness, legibility, and accuracy of the analysis sheets.

Results of these evaluations are sent to the observatory for their review and comment.

2.5.2 Quality Control of Magnetic-Tape Seismograms

Routine quality control checks of randomly-selected magnetic-tape seismograms were made in Garland and at TFSO to assure that recordings met specified standards. The following are among the items that were checked by the quality control group:

- a. Tape and box labeling;
- b. Accuracy, completeness, and neatness of logs;
- c. Adequate documentation of logs by voice comments on tape where applicable;
- d. Seismograph polarity;
- e. Level of calibration signals;
- f. Relative phase shift between array seismographs;
- g. Level of the microseismic background noise;
- h. Level of the system noise;
- i. PTA dc balance;
- j. Oscillator alignment;
- k. Quality of the recorded WWV signal where applicable;
- l. Time-pulse carrier;
- m. Binary coded digital time marks.

### 2.5.3 Quality Control of Astrodata Digital Magnetic Seismograms

Quality control checks of Astrodata tape were initiated during June. At present, one tape per day is checked for the following items:

- a. Neatness and accuracy of the associated logs;
- b. Parity errors;
- c. Recording level of each channel;
- d. Fidelity of reproduction;
- e. Presence of header record and correct record length.

### 2.6 SECURITY INSPECTION

Mr. M. Craig, Industrial Security Inspector from Phoenix, Arizona, made a routine security inspection of the observatory on 24 September. All items checked were found to be in order.

### 2.7 DEFENSE CONTRACT ADMINISTRATION VISIT

Mr. C. P. Fink, Phoenix office of the Los Angeles Defense Contract Administration Service Region (DCASR), and Mr. H. Clinkert, Small Business Administration, visited TFSO on 19 July 1968. Their visit was in compliance with a facilities visit regulation.

### 2.8 PROPERTY UTILIZATION SURVEY

Mr. D. Peebles and Mr. E. Friedman visited TFSO on 7 August for the purpose of conducting a utilization survey of industrial plant equipment. Both men were from the Phoenix office of the DCASR, Los Angeles.

### 2.9 EMERGENCY POWER GENERATOR

The emergency power generator was operated 92.1 hours during the reporting period. Approximately 68 percent of the emergency power operation was required because of activity that resulted in commercial power fluctuations and outages.

### 3. EVALUATE DATA AND DETERMINE OPTIMUM OPERATIONAL CHARACTERISTICS

#### 3.1 SHORT-PERIOD ARRAY SYSTEMS MODIFICATIONS

##### 3.1.1 AEI Lightning Protectors

Due to the many equipment failures at TFSO during the electrical storms of June and July 1968, a detailed study of the lightning protection system was conducted. The AEI lightning protectors were studied first, because preliminary tests performed under another contract had indicated that their performance did not necessarily meet manufacturer's specifications. These specifications indicated that the protectors should operate in less than 1 microsecond, but test results had indicated that their times often exceeded 100 microseconds. In addition, many units which exhibited long initial operate times showed short operate times on repeat tests performed soon thereafter. However, these same units, after being allowed to remain idle (unoperated) for a day or two, again had long operate times on their first tests and had short operate times on repeat tests conducted shortly thereafter.

When the manufacturer of this protector was contacted, he indicated an awareness of this problem. He stated that initial operate time had been shortened by modifying the procedure for introducing radioactive material into the protector. All protectors manufactured after 1 January 1967, should have short operation times regardless of how long they had remained idle.

On the basis of this information, a plan was set up to test AEI protectors at TFSO and to replace all defective units. One hundred new protectors were purchased. These were tested by applying a charged 16 microfarad capacitor to the protector unit and measuring the time delay before the protector operated. With the equipment available for these tests, the time resolution was 2 microseconds.

Figure 3 shows the test circuit used. The results of testing the 100 new protectors received from the manufacturer are shown in table 1 of appendix 2. On the basis of these tests it was decided to accept any protector that operated within 10 microseconds. Three of the new protectors failed to meet this requirement and were returned to the manufacturer.

The tested and selected new units were shipped to TFSO and were used to replace the protectors at the field end of the circuits of the long-period seismographs. The replaced units were returned to the Dallas office for testing. Of the 33 protectors that were checked, 17 (51.5 percent) failed to meet the 10 microsecond operate time requirement. Three would not fire

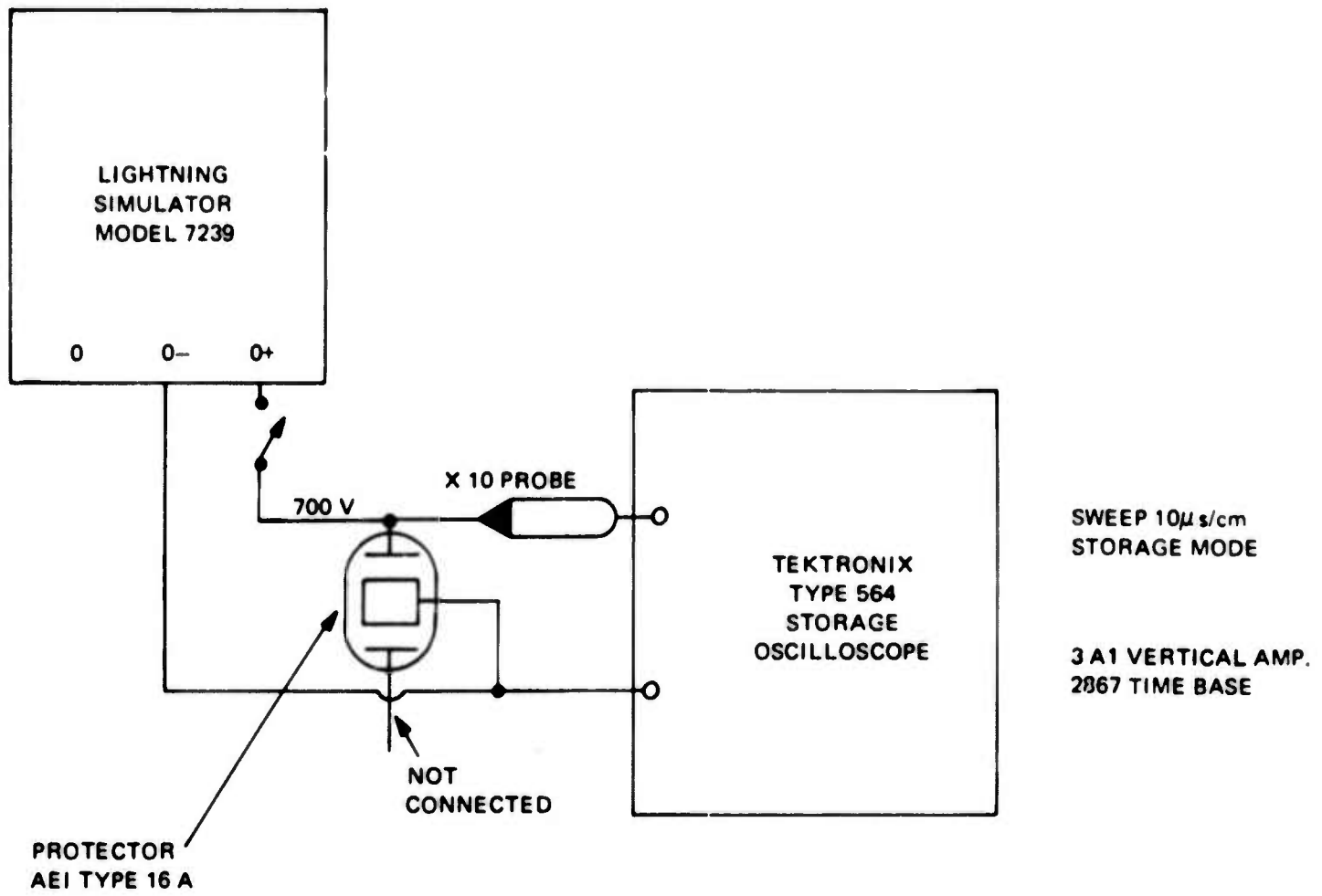

Figure 3. AEI test circuit

at 700 volts, the standard voltage for these tests, requiring 1000 or more volts to operate. The results of these tests are presented in table 2 of appendix 2.

Another 100 protectors were purchased to replace those in the field circuits of the 37-element short-period array. When these new units were tested, 17 were found to be unacceptable and were returned to the manufacturer. Results of these tests are presented in table 3 of appendix 2.

Table 5 of appendix 2 shows the results of tests of protectors which were received as replacement units for those rejected from the 200 units purchased. Note that 9 (24 percent) of the 38 units tested are unacceptable.

Since installation of the new AEI protectors, along with new grounding techniques (covered in section 3.1.2), the array has been exposed to several lightning storms without damage to the vault equipment. The most severe test took place at site Z8, where the spiral-4 cable was hit by lightning approximately 200 yards from the vault. The spiral-4 cable was destroyed, but no equipment was damaged.

On the basis of this study and the test results, we recommend that all AEI protectors in service at TFSO be replaced once per year with units that have passed a standard performance test. It is recommended that an acceptable protector be defined as one which will operate (break down into an arc discharge) in 10 microseconds or less after a 16 microfarad capacitor charged to 700 volts has been connected to one end and the center electrodes of the protector.

### 3.1.2 Improved Grounding

In August, as part of the overall effort directed toward reducing the damage suffered during lightning storms, the grounding system used at the remote short-period sites was reviewed and its effectiveness was evaluated. At the several sites visited, it was found that the resistance of the ground conductor connecting the tank vault to the ground rod was more than 5 ohms. Resistance between the center (ground) electrode of the AEI protector and the ground rod also was usually more than 5 ohms. In some instances it was over 1000 ohms. Ground connections between some instruments within the vault itself used a variety of wires, some rather small for this service.

Although these relatively high equipment-to-ground resistances apparently have not affected the performance of the short-period array with respect to signal characteristics, they quite likely have reduced the effectiveness of the lightning protection circuits. Accordingly, a program was undertaken to connect all components at each short-period site to each other and to ground through low resistance conductors. Number 4 copper wire was used to connect

the tank vault and the culvert to the ground rod. Connection to the tank vault was made by bolting the No. 4 cable terminating lug to the lip of the tank. This permits removal of the tank lid without interfering with the ground connection. All surfaces that mate with ground wire terminating lugs were cleaned of paint and corrosion, and star lock washers were used to insure good electrical connections. Sizes of wires connecting components within the tank vault were increased and fastened to points that will insure good ground connections. The No. 10 wire connecting the ground rod to the vault terminal box (to which spiral-4 shields are terminated) was retained, but its box termination was reworked to insure a good connection.

The grounding at all 37 short-period array sites was reworked during this reporting period.

There are no data available to show specific improvements in performance resulting from this modification, but we believe that the better grounding has contributed to the increased overall effectiveness of the lightning protection system by providing a low impedance path through which lightning-induced potentials can be returned to earth.

### 3.1.3 Spike Noise Elimination

Although there has been no reoccurrence of the extremely high amplitude spike noise that was observed on the short-period traces from late-May to 10 June 1968, smaller amplitude spikes have been observed. In general, the incidence of these spikes has fallen into three categories: First, spikes that occur during thunderstorms and appear to be related to lightning discharges. Second, spikes that occur during intervals when there is cloud cover over the array - when there is no obvious electrical storm in the area. Third, spikes occur at random each day - the incidence of these spikes is very small during the daylight hours and increases during the nighttime hours, peaking near midnight or 1 a.m. local time.

Figures 4 through 11 show short-period seismograms that exhibit typical spike noise.

A series of tests were conducted and work was done to determine the causes of the spike noise and to devise circuit modifications which would eliminate this noise from data recordings. The test plan for this work is reproduced in appendix 3 to this report. Work was first undertaken with Z19 circuits. The following is a detailed record of the work done.

1. The first test was run with a signal generator feeding the input to short-period discriminator (Z19). This test was performed to attempt to isolate the source of spikes as either internal or external to the central recording building (CRB). The test indicated that the spiking was occurring external to the CRB due to the absence of spikes.

18:47:00  
 |-----|  
 10 seconds

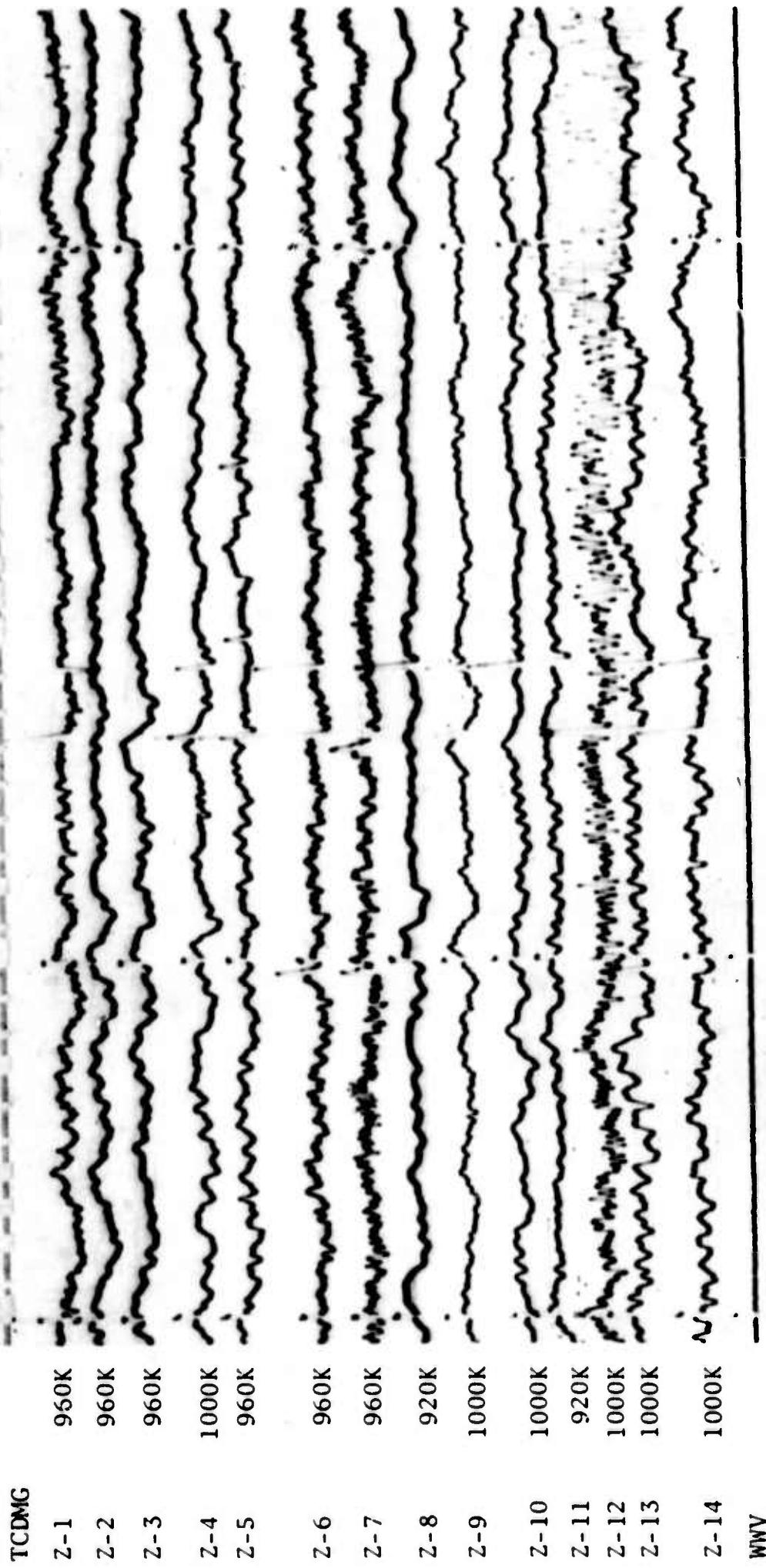

TFSO  
 Run-155  
 3 June-68  
 Data Group 7240

Figure 4. TFSO short-period seismogram exhibiting typical spike noises before circuit modifications. (X10 enlargement of 16-millimeter film)

18:47:00

10 Seconds

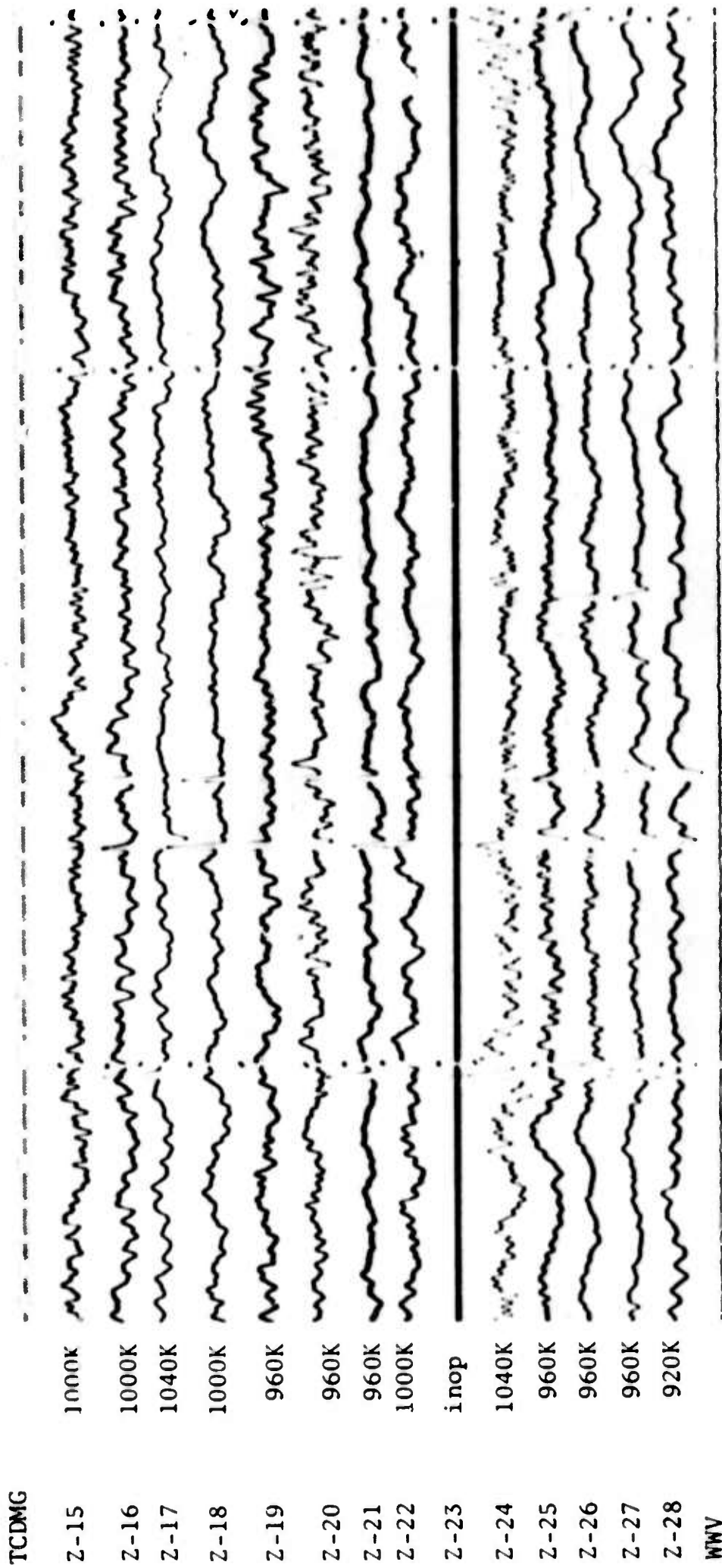

TFSO  
Run-155  
3 June-68  
Data Group 7242

Figure 5. TFSO short-period seismogram exhibiting typical spike noise before circuit modifications. (X10 enlargement of 16 millimeter film)

18:47:00.7

10 Seconds

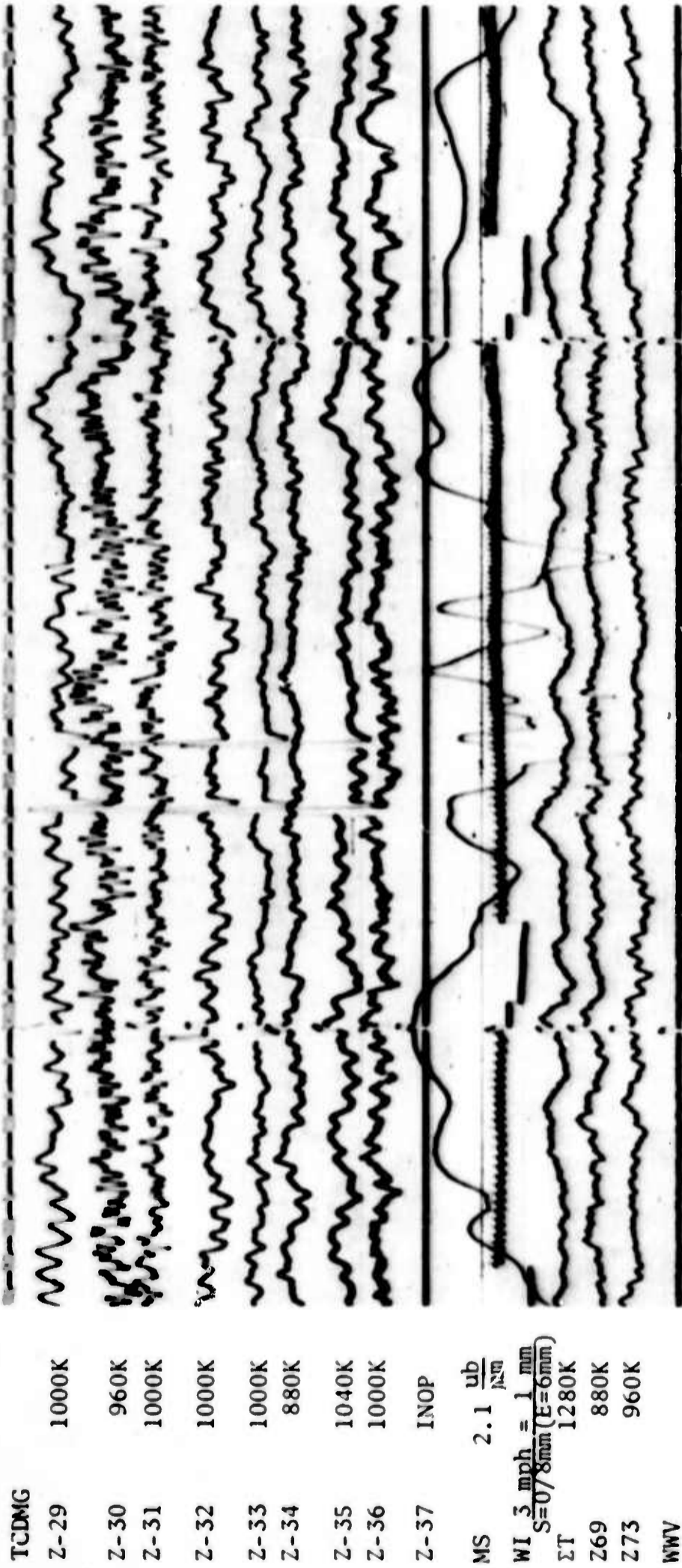

Figure 6. TFSO short-period seismogram exhibiting typical spike noise before circuit modifications. (X10 enlargement of 16 millimeter film)

TFSO  
Run-155  
3 June-68  
Data Group 7263

18:47:00

10 seconds

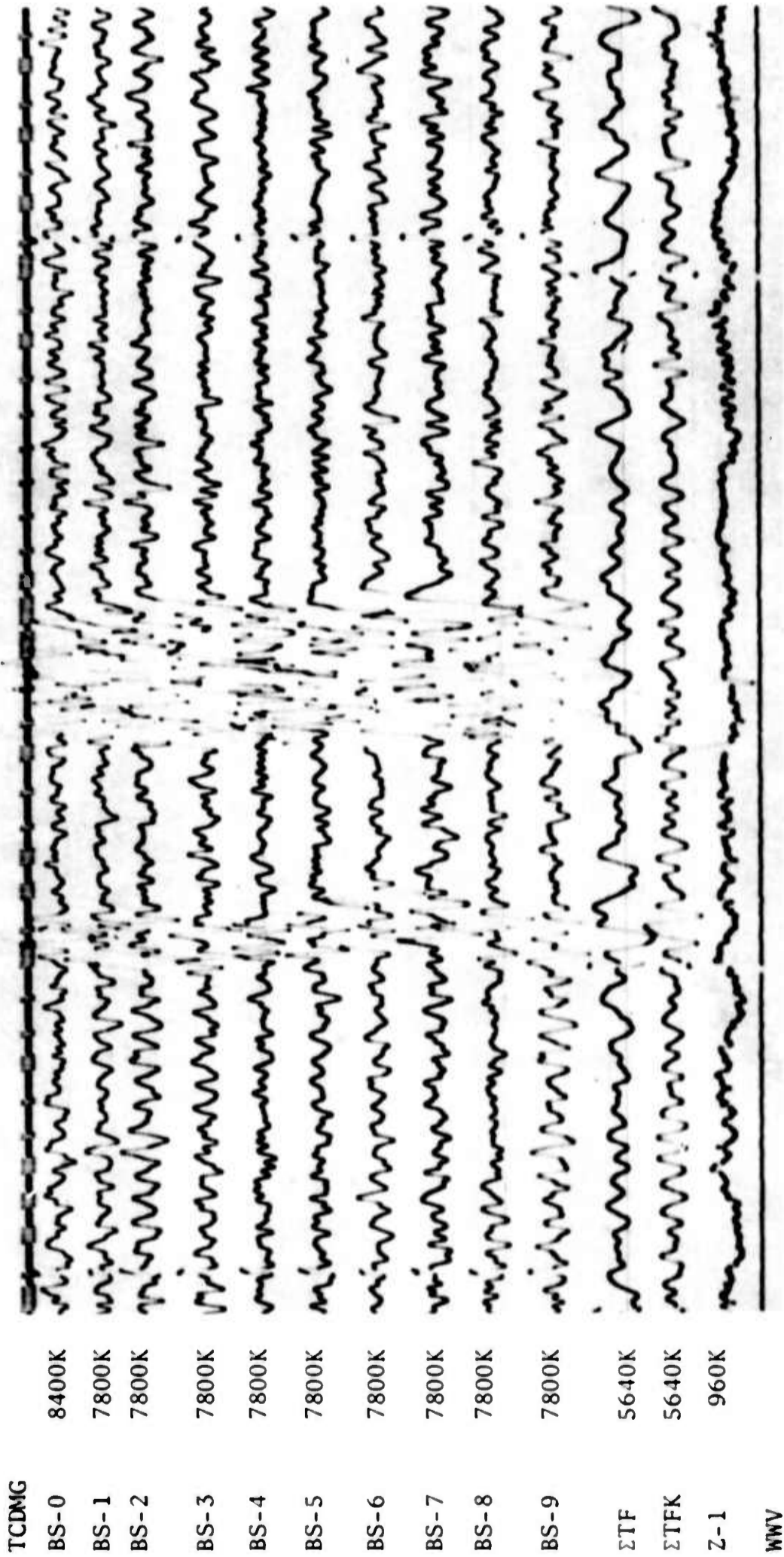
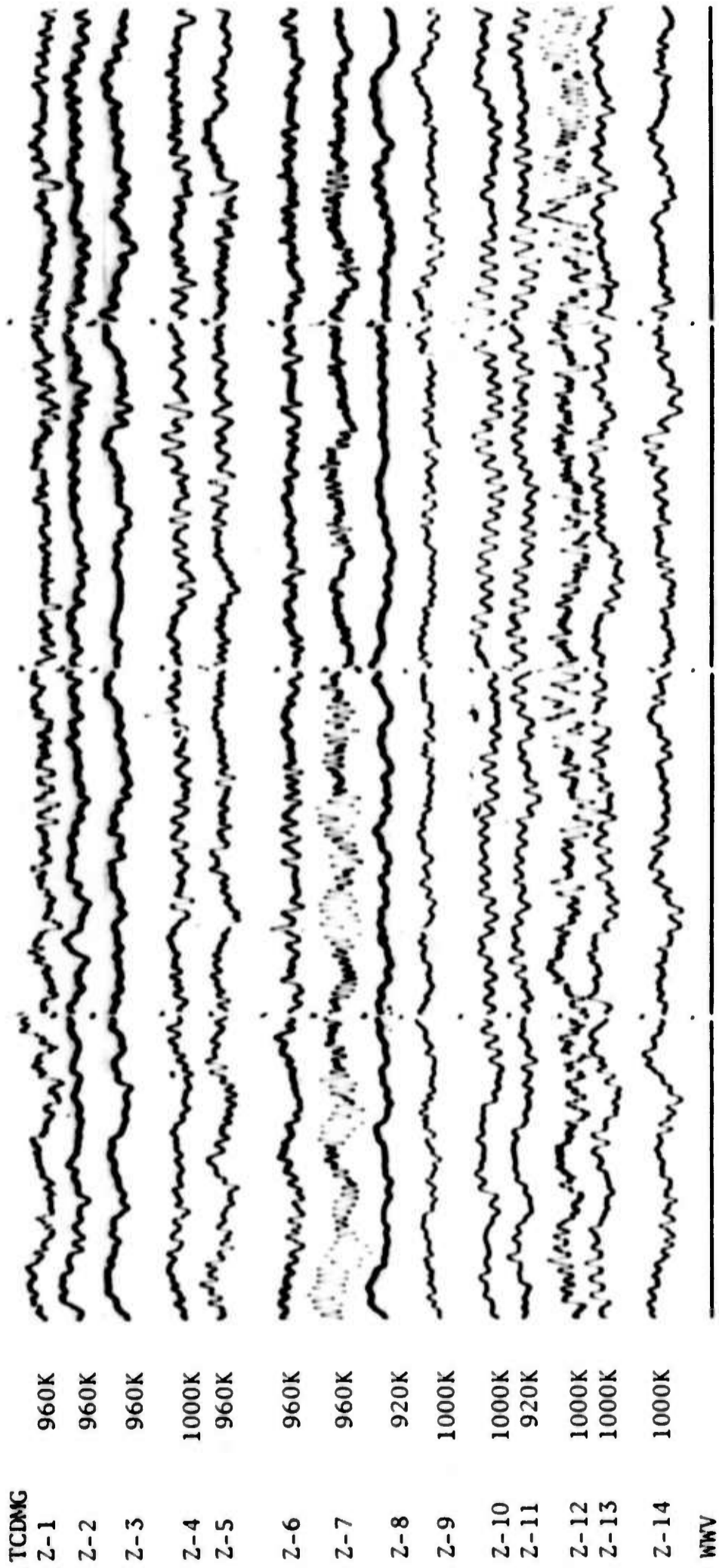

Figure 7. TFSO short period seismogram showing effect of typical spike noise upon beam steered data traces. (X10 enlargement of 16 millimeter film)

TFSO  
Run-155  
3 June -68  
Data Group 7264

19:56:30

10 Seconds



TFSO  
Run-155  
3 June-68  
Data Group 7240

Figure 8. TFSO short-period seismogram exhibiting typical spike noise before circuit modifications. (X10 enlargement of 16 millimeter film)

19:56:30

10 seconds

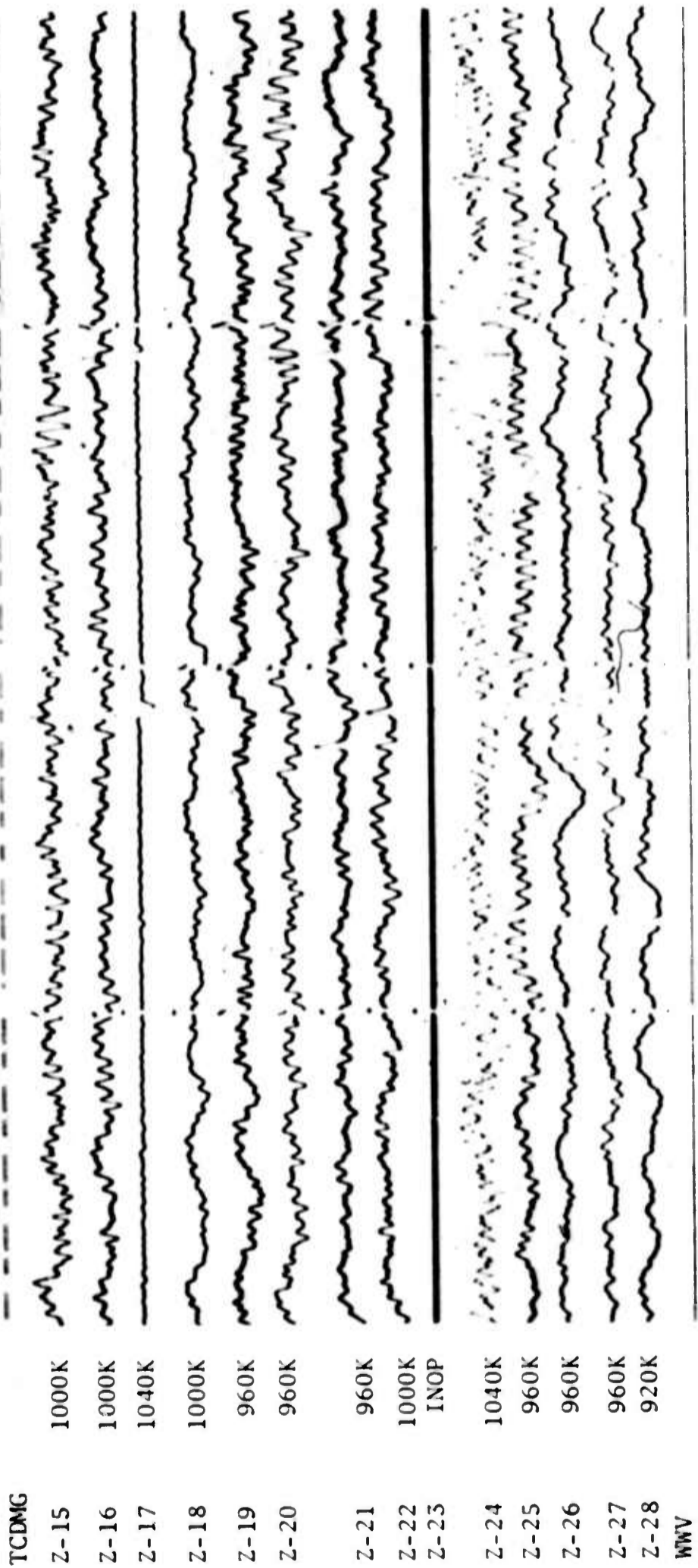

TFSO  
Run-155  
3 June-68  
Data Group 7242

Figure 9. TFSO short-period seismogram exhibiting typical spike noise before circuit modifications. (X10 enlargement of 16 millimeter film)



19:56:30

10 seconds

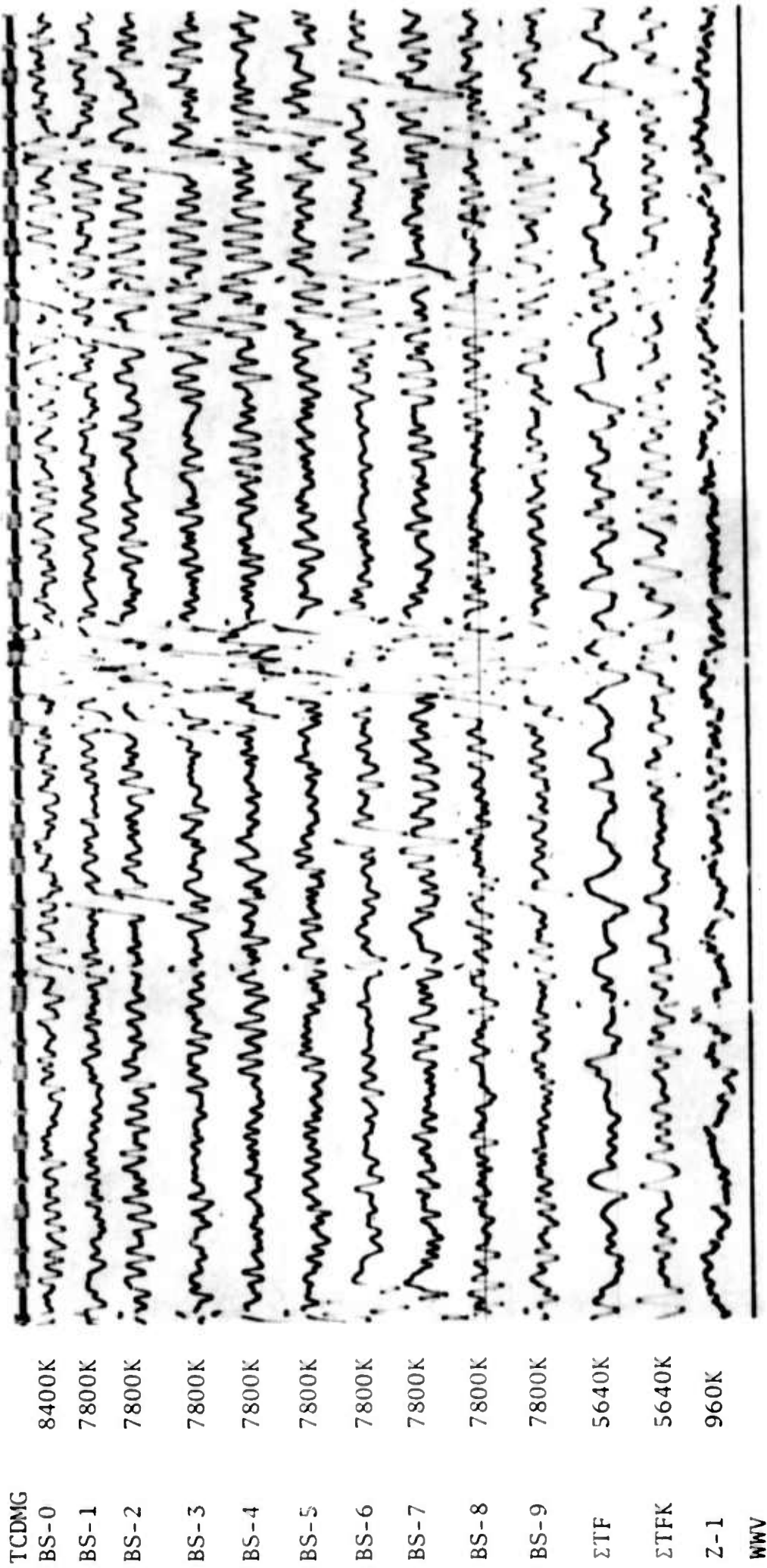

Figure 11. TFSO short-period seismogram showing effect of typical spike noise upon beam-steered data traces. (X10 enlargement of 16 millimeter film)

TFSO  
Run-155  
3 June-68  
Data Group 7264

2. Secondly, attempts were made to induce spikes into the lines by discharging a magnet charger between two ground rods placed near the cables. Also, the charger was discharged into spiral-4 cable running parallel to the data lines. All attempts to induce spikes were unsuccessful.

3. After abandoning efforts to induce spikes, the dc power was removed from the Z19 data line and all vault equipment disconnected from the circuit. A 1550 cps carrier frequency was then applied to the line by connecting a Wavetek Model 111B signal generator directly to the spiral-4 transmission line. No spikes were observed.

4. A 3 kohm dummy load resistor was installed across the amplifier input in place of the Johnson-Matheson (JM) seismometer. The remainder of the circuit operated in the normal configuration with all gain controls at the normal operate settings. (This statement applies for all tests performed.) Many spikes were observed on the test record. These spikes are more frequent at night, reaching a peak at approximately 0700-0900Z.

5. The grounding at Z19 was improved by installing new AEI protectors and connecting the tank vault, culvert, and ground rod together using a No. 4 stranded copper cable. Also, the amplifier case, seismometer case, and the AEI center point were connected to the tank using No. 14 stranded wire. The 100 kohm resistor, which was used on the negative power connection to the Model 25220 amplifier, was removed to eliminate the path to ground as a possible spike source. (It was necessary, however, to retain the 0.5 microfarad capacitor to prevent the voltage-controlled oscillator (VCO) frequency from being "pulled" by the amplifier power-converter frequency.) The 100 kohm resistors installed in the Vault Isolation Filter, Model 19275 as "static drains" were also removed. Finally, the  $\pm 10$  Vdc common, pin G of J102; the output ground, pin F of J102; and pin C of J102 were tied directly to the tank vault to assure a good ground connection. The amplifier input dummy load test was then repeated. Spikes were observed.

6. A long-term test with the Wavetek generator connected to the spiral-4 line and dc power removed was then repeated. No spikes were observed.

7. The amplifier output was disconnected at the vault, and the Wavetek generator was used to apply a carrier frequency in the FM input jacks on the isolation filter. An 820 ohm, 3 watt, wirewound resistor was substituted for the amplifier dc load at the isolation filter. Dc power was applied to the line at the CRB. Spikes were observed.

8. The Wavetek generator was coupled through a 2.0 microfarad capacitor to the vault end of the transmission line. An 820 ohm resistor was used to terminate the line at the vault end. Dc power was applied to the line at the CRB. Spikes were observed.

9. The Wavetek generator was connected to the isolation filter at the CRB and loaded with a 4 kohm resistance. There was no connection to any field lines. Dc power was applied to the circuit. No spikes were observed.

10. A 50 kohm leakage path on the transmission line of Z19 was traced to a badly corroded terminal strip in splice box 132. This was eliminated and a normal data connection was run overnight to check for spikes. Spikes were observed.

11. A considerable buildup in spike frequency was observed on the latter part of the previous test. At this time it was noted that a storm front was evident to the southeast of the array at an estimated distance of 35-40 miles. We disconnected the ground connection from the shield of the spiral-4 at the CRB. Spiking was still present.

12. The storm front moved in over the array overnight, bringing light rain. The spike noise increased.

13. The next morning dc power was applied to Z19 on one spiral-4 pair and the FM data were fed over the other pair. No spikes were observed.

14. At this time it was concluded that spike elimination was in some way dependent upon the separation of dc power and FM carrier. To confirm this, Z24 was modified to the same configuration as Z19. No spikes were observed.

15. Z22 was next modified to basically conform with Z19. (This site is powered by the Lambda power supply that also provides power for LP2.) It was used as another test circuit to observe the absence of spiking when the dc power and FM data are separated.

16. Since the FM data from Z24 were transmitted over the calibration pair, an attempt was made to transmit both the calibration signal and FM data over the same pair. A 1.0 cps calibration signal was applied and appeared normal at the CRB. A check of the motor constant was then made to establish the accuracy of the calibration. Dc pulses were applied directly to the seismometer at the vault and from the CRB to check for discrepancies that might be caused by interaction between the calibration and data circuits. Motor constants determined by both methods agreed closely, verifying that calibration and data signals could be transmitted over the same cable without reducing calibration accuracies.

17. To further confirm the validity of the circuit modifications, Z34 was modified. (This site is powered by the thermoelectric generator that powers LP7.) No spikes were observed after its rework.

The four modified sites were operated routinely for several weeks to confirm that a significant reduction in spike noise would be realized at sites that had been modified. Figures 12, 13, and 14 show typical recordings made during this period. Note that the modified channels Z19, Z22, Z24, and Z34 are free from spikes while other channels were noisy. An examination of all of the recordings for this time period revealed that Z19 recorded no spikes at all, and that Z22, Z24, and Z34 recorded an occasional small amplitude spike.

On the basis of these test results, it was concluded that spike noise could be eliminated or greatly reduced if:

1. dc power and FM were transmitted over separate cable pairs, and
2. all leakage paths from signal, power and calibration circuits were eliminated or minimized.

Therefore, modification of the remaining 33 systems was started on 23 September. At the end of the month, 78 percent of the array had been modified. Figures 15 and 16 show the circuit modifications which are being made. The motor constant of each short-period seismometer also is being checked immediately after modification.

#### 3.1.4 Solid-State Amplifier

One of the reasons the short-period system is susceptible to interference from electromagnetic radiation like that produced by lightning is that a relatively low amplitude of FM carrier is transmitted from each remote site to the CRB. To reduce this susceptibility, all amplifiers in the system are being modified to increase the output carrier levels from about 1.8 volts to 2.9 volts. This is done by changing one resistor and should improve signal-to-noise discrimination in the transmission system by approximately 4 dB.

The amplifiers are being modified as they are brought into the CRB for maintenance. To date, 50 percent of the amplifiers have been modified.

#### 3.1.5 Cable Hock Sealing

It has been observed that the leakage resistance between conductors and also from conductor to shield in TFSO spiral-4 cables will vary with weather conditions. In general, during rainy conditions leakage resistance assumes relatively low values, and during extended periods of dry, clear-sky conditions, the leakage resistance assumes higher values. This indicates that moisture can bridge the insulation that normally would separate the cable conductors and shield and thereby lower the normal insulation resistance.

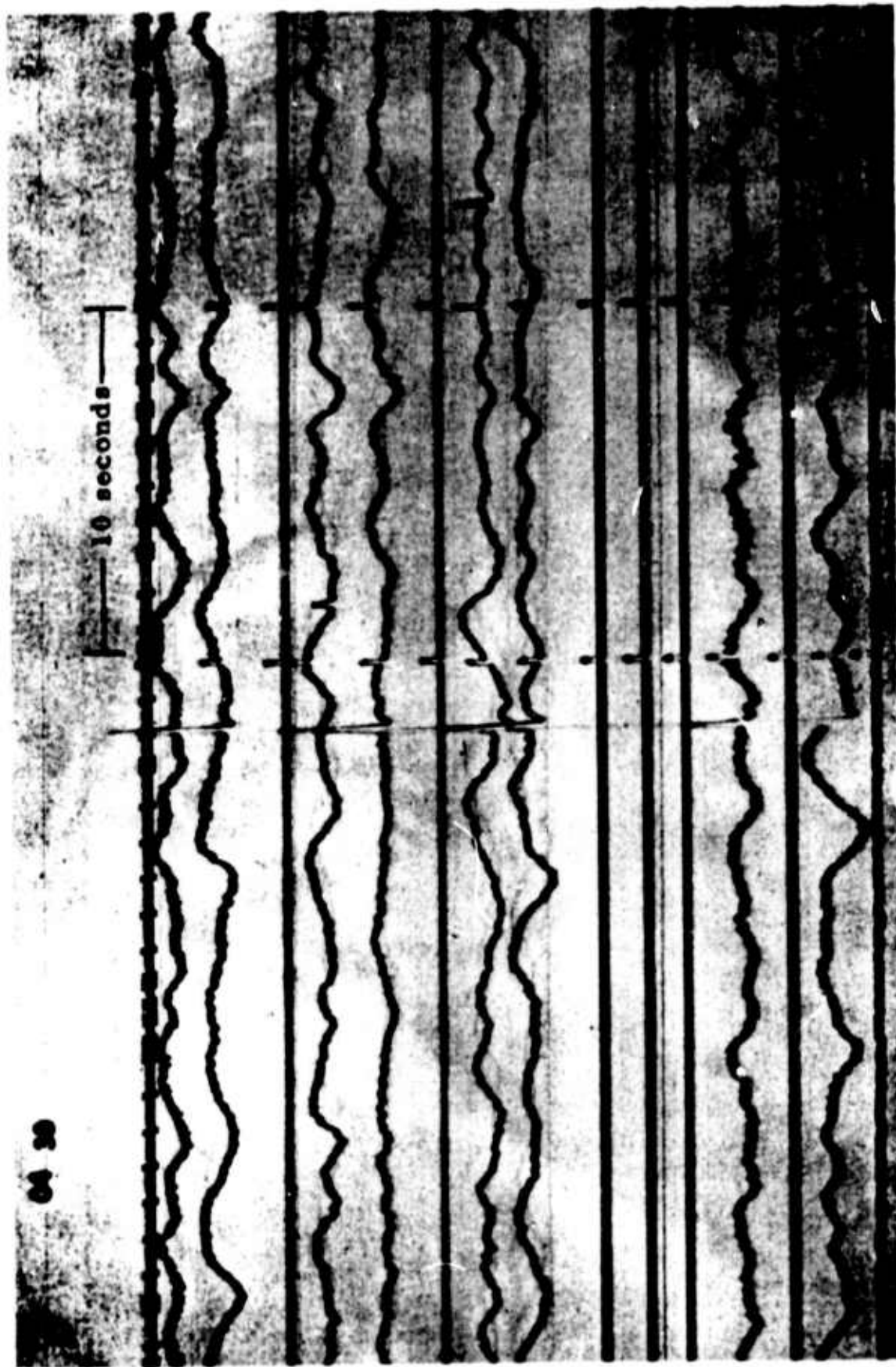

TCDMG  
 Z1 UNK  
 Z2 960K  
  
 Z3 INOP  
 Z4 1000K  
 Z5 1200K  
 Z6 INOP  
 Z7 1000K  
 Z8 1000K  
  
 Z9 INOP  
 Z10 INOP  
 Z11 INOP  
 Z12 1000K  
 Z13 INOP  
 Z14 UNK  
 WWV

TFSO  
 24 Aug 68  
 RPN 237  
 DT 8  
 Figure 12. TFSO short-period seismogram exhibiting typical spike noise.  
 (X10 enlargement of 16-millimeter film)

TCDMG  
 Z15 1040K  
 Z16 INOP  
 Z17 INOP  
 Z18 1040K  
 Z19 UNK  
 Z20 920K  
 Z21 INOP  
 Z22 1000K  
 Z23 INOP  
 Z24 1000K  
 Z25 1000K  
 Z26 1120K  
 Z27 1120K  
 Z28 INOP  
 WWV

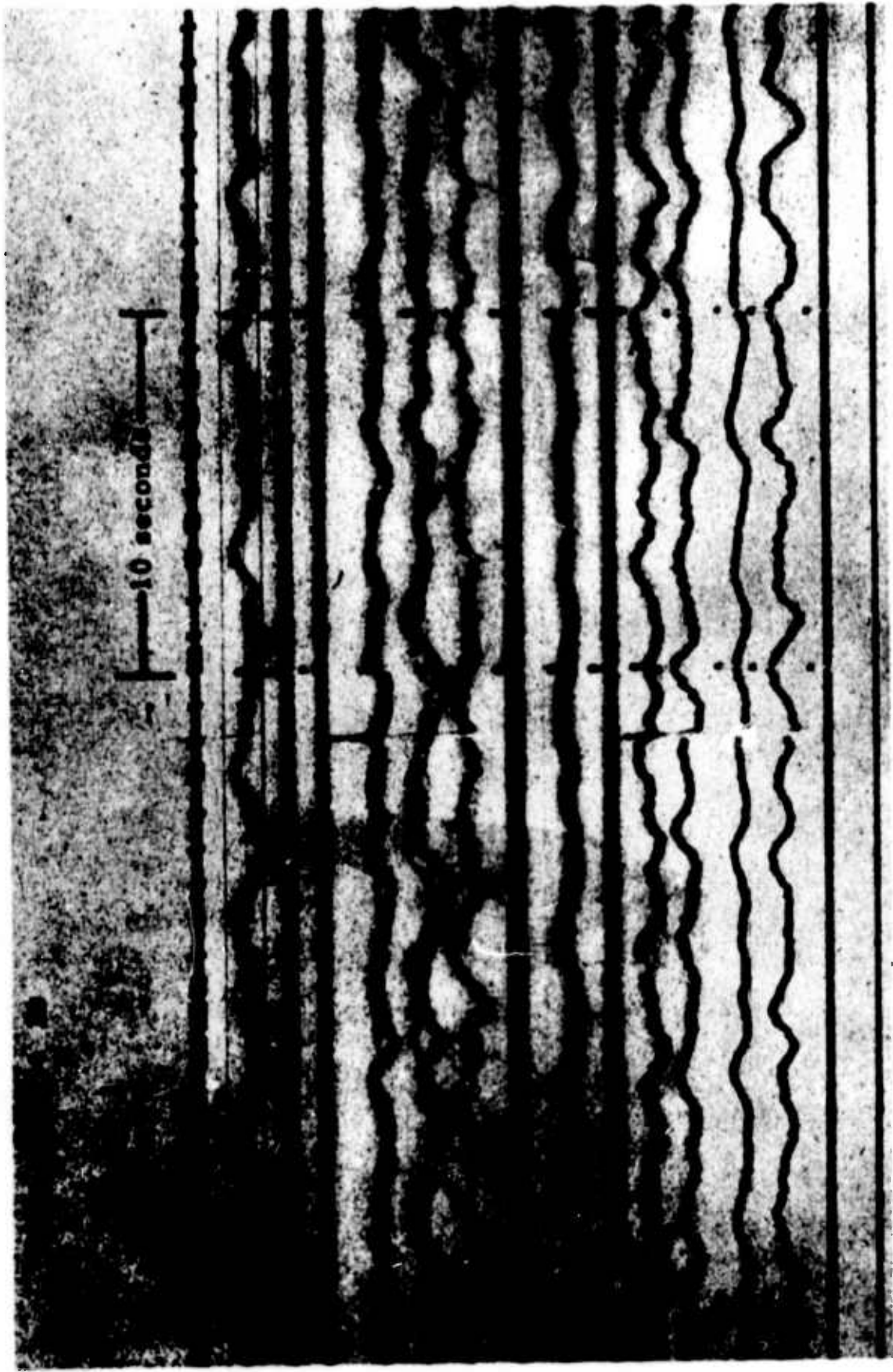

TFSO  
 24 Aug 68  
 RPN 237  
 DT5

Figure 13. TFSO short-period seismogram exhibiting typical spike noise. Note absence of spikes on Z19, Z22, and Z24, the modified channels under test (X10 enlargement of 16-millimeter film)

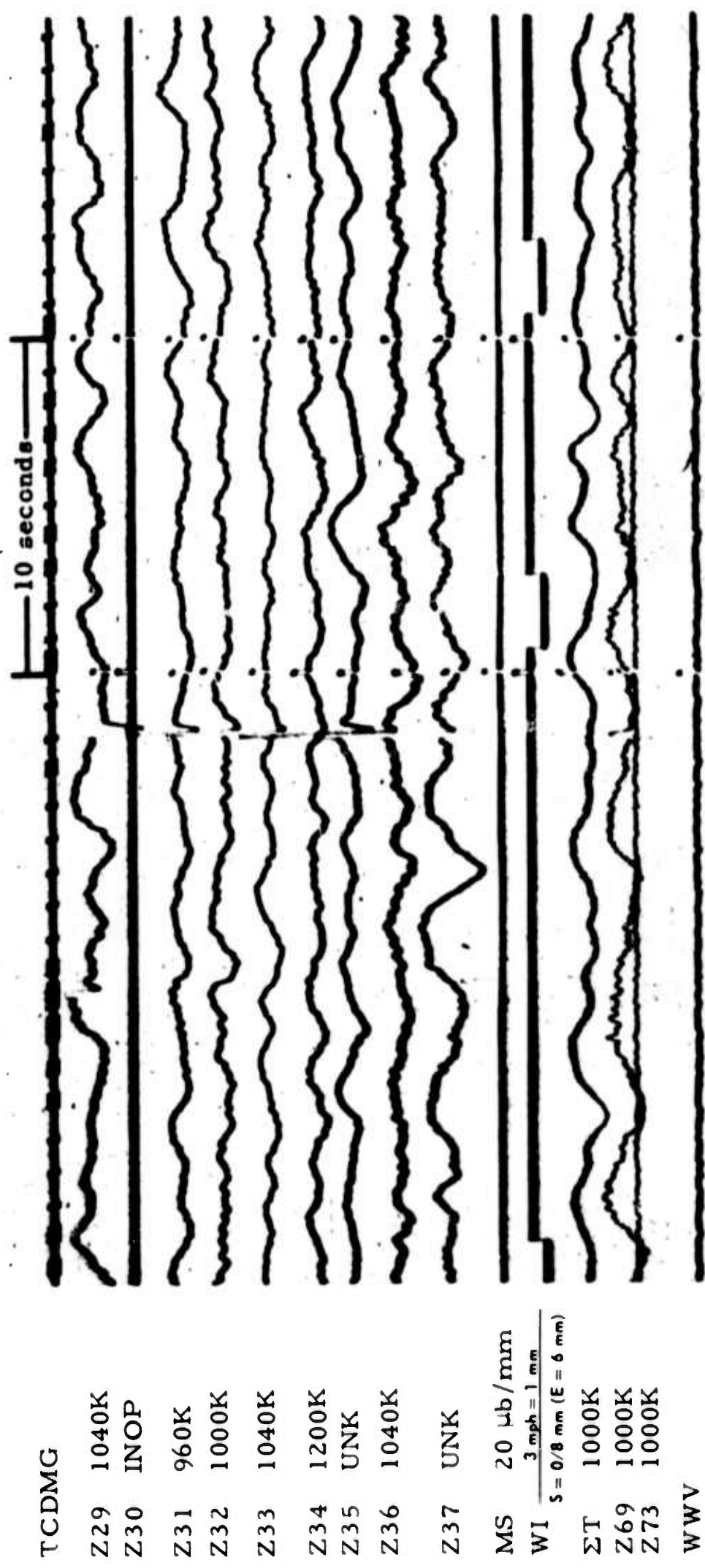

Figure 14. TFSO short-period seismogram exhibiting typical spike noise.  
 Note absence of spikes on Z34, the modified channel, under test.  
 (X10 enlargement of 16-millimeter film)

TFSO  
 24 Aug 68  
 RPN 237  
 DT 3



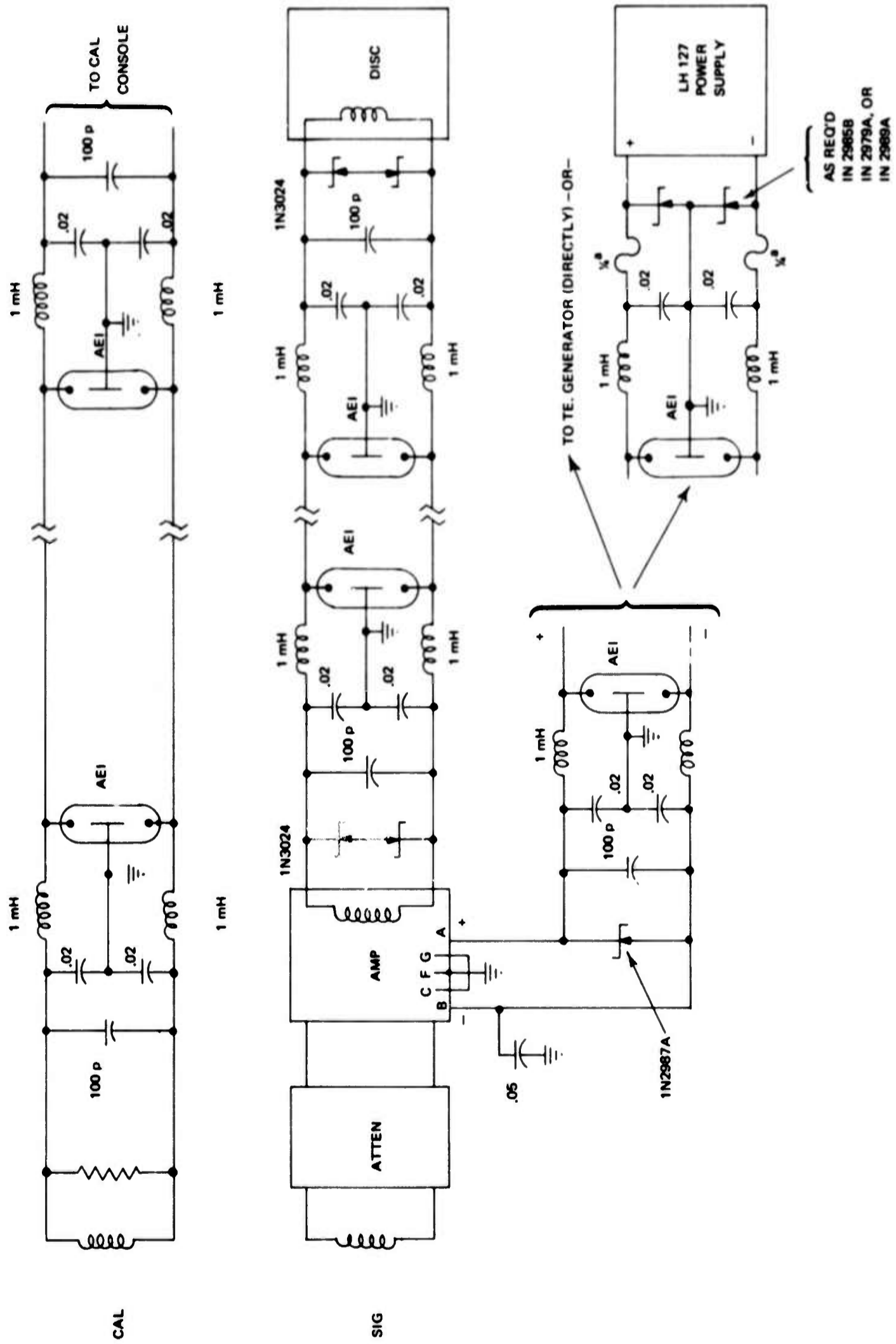

Figure 16. Short-period modification for sites powered by thermoelectric generator or commercial power

G 4396

Furthermore, it has been observed that after an electrical storm the spaces between contacts in some cable hocks have been blackened - apparently by arcing between contacts. The blackening appears to represent a thin burned (carbonized) surface on the plastic hock insulation and is a conductive medium. This, of course, gives the cable conductors a measurable, low value of leakage resistance which interferes with the proper operation of the circuits connected to that cable. It appears reasonable to assume that a hock will be more easily arced over and carbonized during a storm if moisture bridges the contacts and lowers the leakage resistance.

For these reasons it is important that moisture be excluded from the cable proper and the hocks. To accomplish this for all TFSO cables, a program of hock sealing was undertaken. During September, materials were ordered and plans were made to accomplish the following:

1. Open and inspect each hock;
2. Clean moisture, carbon and dirt from inside hock;
3. Place heat-shrinkable tubing over line;
4. Apply thin coating of DC-4 Silicone to inside of hock;
5. Assemble hock;
6. Move heat-shrinkable tubing to cover hock;
7. Apply heat and shrink tightly;
8. Wrap joints (2) between cable and hock with heat-shrinkable tape and apply heat to shrink. An example of a sealed hock is shown in figure 17.

The tubing used for this job will have an original diameter of 3 inches and a shrink ratio of 3 to 1. The hock diameter is 2 inches. This combination will insure a tight fit after shrinking. The tubing is coated on the inside with a relatively soft sealing material that will fill all spaces and provide a moisture-tight seal.

All lines are presently being tested and unsatisfactory sections are being replaced. Upon receipt of all materials, which are expected in early October of this year, sealing work will be started.

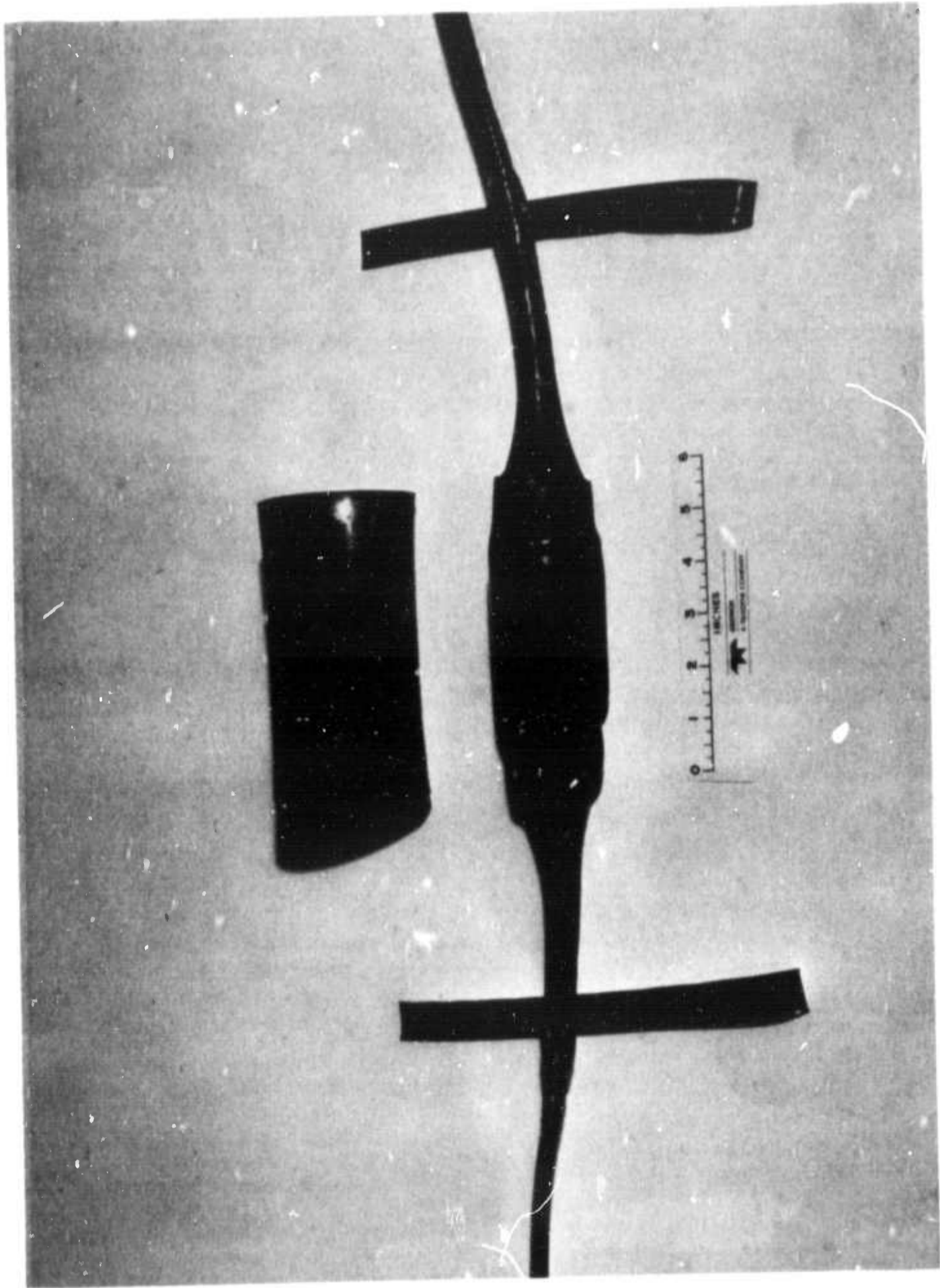

Figure 17. Typical hock seal using heat shrinkable tubing and tape

G 4397

## 3.2 ASTRODATA SYSTEM

### 3.2.1 Overload Circuit Modification

The overvoltage reset circuit was modified to reduce the reset-hold time to less than 50 milliseconds. This was done to prevent the saturation of the system amplifiers which occurs when the reset signal is greater than one sample in duration. The shorter reset-hold time will allow only one overloaded sample to be converted before the overvoltage shut-off is reactivated, eliminating data dropouts from subsequently sampled channels.

### 3.2.2 Miscellaneous Repairs

Both Datamec transports required replacement of photo-sense lamps. The tape-feed reel-motor of tape transport 2 shorted out and damaged the control circuits; the motor was replaced and the control circuits repaired. The vacuum motor on transport 2 also failed and was replaced.

## 3.3 LONG-PERIOD ARRAY

During August, new AEI lightning protectors were installed in all long-period circuits at the vaults. These protectors were quality-control inspected by the Garland, Texas, group before installation. The replaced AEI protectors were returned to Garland for evaluation.

During September, diodes were installed across the multiplexed data output in the Hoffman boxes at each long-period site. This modification is to protect the transistors on the line driver cards. Figure 18 shows a schematic of these modifications.

Lightning protection of the Lambda power supplies at LP2, LP3, and LP4 consisting of an AEI protector and a 2-ampere fuse in one side of the commercial power line was completed. This modification will protect the input circuits of the power supply. Modifications to the Lambda power supplies at LP2, LP3, LP4, and LP5 were installed for Lambda output circuit protection. This modification involved placing two Zener diodes in series across a network of fuses, AEI protectors, chokes, and capacitors in such a manner as to prevent lightning damage to the output circuits. Figure 19 shows a schematic of these modifications.

Early in October we expect to initiate a program to improve the operational performance of the long-period systems.

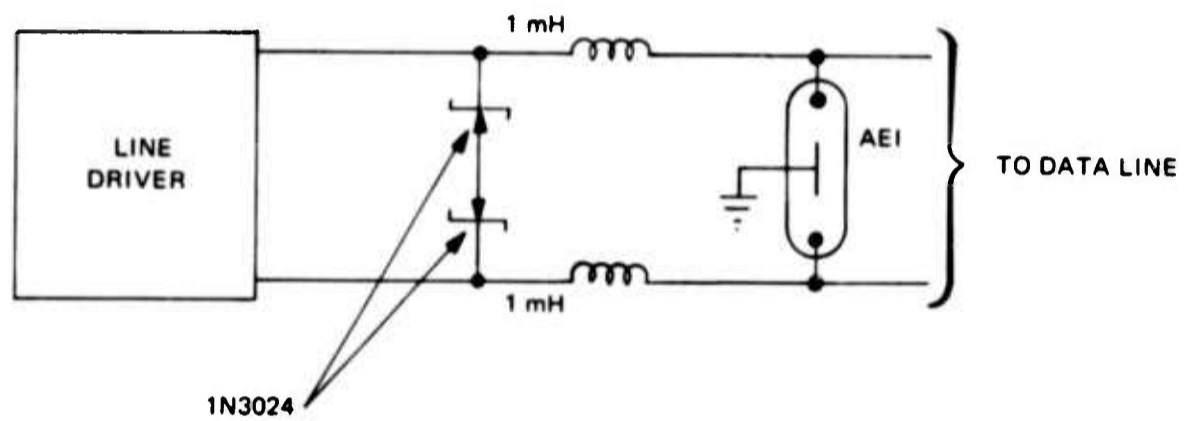

Figure 18. Circuit installed at LP sites to protect line driver cards in FM data circuit from lightning induced potentials

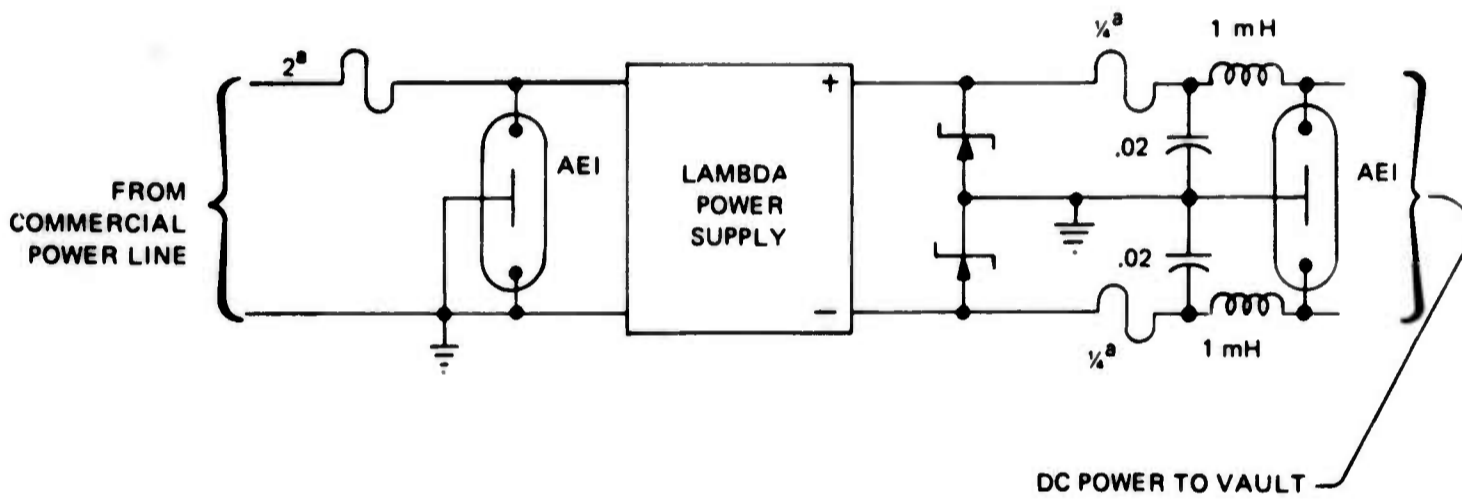

Figure 19. Circuit installed at LP2, LP3 and LP4 to protect power supply against lightning induced potential

#### 4. ANALYZE DATA

##### 4.1 DAILY REPORTS TO THE COAST AND GEODETIC SURVEY (C&GS)

The arrival time, period, and peak amplitude of events recorded at TFSO are reported daily to the Director of the Environmental Science Services Administration's Coast and Geodetic Survey in Washington, D. C. The number of events reported by TFSO during each month of the reporting period is shown in table 2, by type.

Table 2. Events reported to the C&GS by TFSO during  
July, August, and September 1968

<u>Month</u>	<u>Local</u>	<u>Near Regional</u>	<u>Regional</u>	<u>Teleseisms</u>	<u>Total</u>
July	4	74	38	1022	1138
August	4	83	10	1170	1267
September	4	86	10	1361	1470

The number of events reported by C&GS in their "Earthquake Data Report" for March and April 1968, are given in table 3. Also shown in table 3, by month, are the percentages of the C&GS hypocenters in which TFSO data were used to establish the location; the percentages of the C&GS hypocenters from which TFSO recorded a P or PKP arrival, based on associated data; and the percentages of the C&GS hypocenters from which TFSO recorded a P, PKP, or later phase, based on updated ABP associated data. Figures 20 and 21 show the world-wide distribution of the C&GS-located epicenters for February, March, and April 1968. The three types of symbols used to show the epicentral locations represent the detection, by TFSO, of a P or PKP phase; the detection of an event in which the first recorded arrival was not P or PKP; and no detection by TFSO.

##### 4.2 MULTISTATION EARTHQUAKE BULLETIN

Data from TFSO are combined with data from UBSO and WMSO and published in a monthly multistation earthquake bulletin. The bulletins for January, February, and March 1968 were published during this reporting period. The ABP outputs for April and May were received from the Seismic Data Laboratory on 5 September, respectively. The April bulletin is scheduled for distribution about 5 October, and the May bulletin is scheduled for distribution about 20 October.

Table 3. Percentage of hypocenters reported in the C&GS "Earthquake Data Report" for which TFSO data were used

<u>Month</u>	<u>No. events reported by TFSO</u>	<u>No. C&amp;GS hypocenters</u>	<u>Percent of C&amp;GS hypocenters for which the C&amp;GS listed a TFSO P or PKP arrival</u>	<u>Percent of C&amp;GS hypocenters for which TFSO recorded a P or PKP phase, based on associated data</u>	<u>Percent of C&amp;GS hypocenters for which TFSO recorded a P, PKP, or later phase, based on updated associated data</u>
March	980	342	51.5	62.9	69.3
April	1475	350	54.0	63.5	69.3

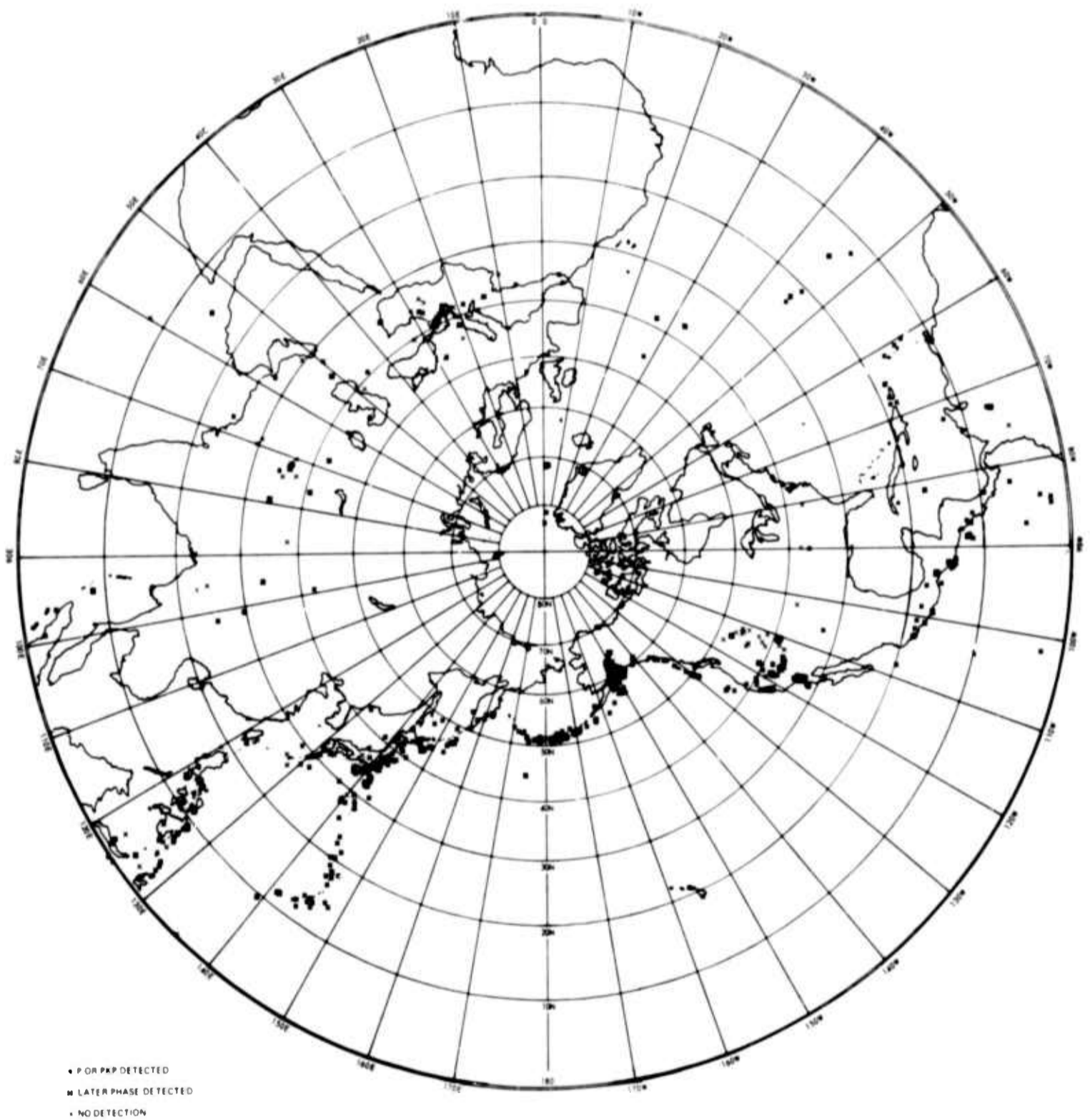

Figure 20. Distribution of Coast and Geodetic Survey located epicenters in the northern hemisphere for February, March, and April 1968  
G 3179

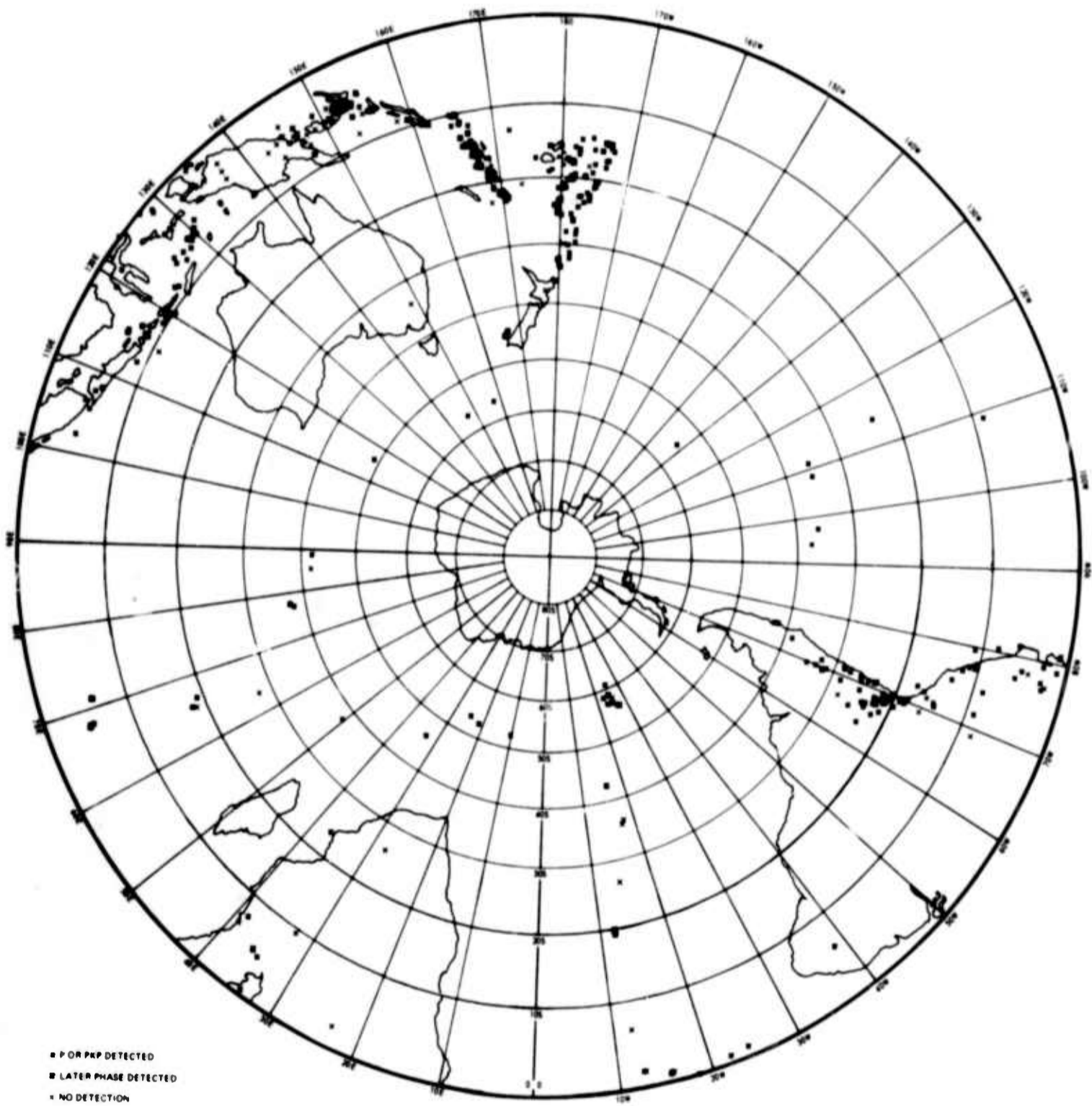

Figure 21. Distribution of Coast and Geodetic Survey located epicenters in the southern hemisphere for February, March, and April 1968

G 3180

#### 4.3 ROUTINE NOISE SURVEY

Measurements of ambient noise in the 0.4-1.4 second period range are made daily from the short-period 16-millimeter film seismograms. Data are processed in Garland, and monthly cumulative probability curves of trace amplitude and ground displacement as recorded on the Z60,  $\Sigma T$ , and  $\Sigma TF$  seismograms are published. Curves for the months of June, July, and August 1968 were sent to the Project Officer during this reporting period.

### 5. PROVIDE OBSERVATORY FACILITIES AND ASSISTANCE TO OTHER ORGANIZATIONS

#### 5.1 TELEMETRY TO MASSACHUSETTS INSTITUTE OF TECHNOLOGY

Telemetry of seven seismograph channels to Lincoln Laboratory, Massachusetts Institute of Technology (MIT), continued throughout this reporting period. MIT is notified, in advance when possible, if the seismographs are to be attenuated for special tests.

#### 5.2 ASTROGEOLOGICAL DEPARTMENT OF THE U. S. GEOLOGICAL SURVEY

TFSO has continued to support Dr. Harold Krivoy of the Astrogeological Department of the United States Geological Survey (USGS) in Flagstaff, Arizona. Dr. Krivoy receives copies of the daily station message and all Helicorder records not needed by the observatory on a regular basis.

#### 5.3 THE UNIVERSITY OF UTAH

TFSO has continued to support Dr. Kenneth Cook, University of Utah. Copies of the daily station message are sent to him routinely.

#### 5.4 VISITORS

##### 5.4.1 Visits by School and Professional Groups

Arizona State University students and instructors visited TFSO on 5 July, 12 July, and 2 August. Approximately 138 visitors were given tours of the observatory and brief lectures on seismology. Approximately 45 members of the National Science Foundation, Arizona State University summer school, visited the observatory on 20 July.

#### 5.4.2 Teledyne Visitors

Mr. Dean Rabenstein, Seismic Data Laboratory, was a visitor on 16 July. Messrs. B. B. Leichter, Geotech program Manager, and M. G. Gudzin, program Engineer, were at TFSO from 31 July through 3 August. Mr. S. Montoya and Mr. J. R. Herrage, Geotech, were at TFSO from 14 through 24 August, and Mr. M. G. Gudzin was at TFSO from 21 through 24 August to conduct tests of circuits designed to improve the operation of the 37-element array seismographs.

#### 5.4.3 Visits by VELA Seismological Center Personnel

Major C. Lam visited TFSO on 29 and 30 August, and Major C. Schuster visited on 16 and 17 September.

### 6. RESEARCH PROGRAMS

#### 6.1 EVALUATION OF A HIGH-FREQUENCY SEISMOGRAPH

The high-frequency seismograph system became operational on 2 July 1968. On 3 July, a lightning storm burned out the Ithaco amplifier. A new amplifier was obtained and installed with additional lightning protection circuits on 7 August. Two problems existed at that time. The system exhibited a high noise level and tended to drift, and the calibration circuit was inoperative. The noise was reduced by replacing the P65AU amplifiers in the filter system and by increasing the system gain ahead of the filter at the P2 amplifier. Insertion of a capacitor in the circuit removed the system drift. It will be necessary to remove the seismometer from the well to repair the calibration circuit. This will be accomplished no later than 4 October. Data have been recorded from this system since early August at an approximate magnification of 23,000 K at 8 cps. The determination of the magnification was based on a comparison of the noise level to the level when the calibration system was operating.

#### 6.2 MULTICHANNEL FILTER PROCESSOR (MCF)

In general, the MCF operated routinely throughout the reporting period. The MCF was inoperative for 86 hours, all but 1 hour of which occurred when the unit was turned off during severe electrical storms. One hour of data was lost because of a malfunction of the processor. There were periods in August and September when the full effectiveness of the beams was not attained because a large number of short-period channels were inoperative. Large numbers of channels were inoperative during parts of

August and September due to lightning damage and array modifications, respectively.

On 9 July the MCF beam outputs BS1, BS2, BS3, and BS5 were changed at the request of the Project Officer. The beam format is as follows:

<u>Channel</u>	<u>Azimuth (degrees)</u>	<u>Distance (degrees)</u>
BS0	353.8	97.
BS1	313.2	69.7
BS2	315.9	64.7
BS3	345.6	104.7
BS4	4.2	72.
BS5	209.3	61.8
BS6	129.7	27.
BS7	137.5	67.
BS8	29.1	61.
BS9	311.1	51.

A Flexowriter was furnished to Project VT/8702 during July by the Government from surplus stock at Vandenberg Air Force Base. After minor repairs to the unit, it was placed in service as a tape reader-printer and tape punch increasing the station capability for preparing programs for the MCF.

### 6.3 EVALUATION OF THE SHORT-PERIOD ARRAY BEAMFORMING CAPABILITIES

This study has been completed, and the report is in the final stages of preparation. We expect to submit the report to the Project Officer in early October.

APPENDIX 1 TO TECHNICAL REPORT NO. 68-46

STATEMENT OF WORK TO BE DONE

TR 68-46

STATEMENT OF WORK TO BE DONE

(AFTAC Project Authorization No. VELA T/8702/S/ASD) (32)

Tasks:

## a. Operation:

(1) Continue operation of the Tonto Forest Seismological Observatory (TFSO), normally recording data continuously.

(2) Evaluate the seismic data to determine optimum operational characteristics and make changes in the operating parameters as may be required to provide the most effective observatory possible. Addition and modification of instrument are within the scope of work. However, such instrument modifications and additions, data evaluation, and major parameter changes are subject to the prior approval of the AFTAC project officer.

(3) Conduct routine daily analysis of seismic data at the observatory and transmit daily seismic teletype reports to the Coast and Geodetic Survey, Environmental Science Services Administration, Washington Science Center, Rockville, Maryland, using the established report format and detailed instructions.

(4) Record the results of daily analysis on magnetic tape in a format compatible with the automated bulletin program used by the Seismic Data Laboratory (SDL) in their preparation of the seismological bulletin of the VELA-UNIFORM seismological observatories. The format should be established by coordination with SDL through the AFTAC project officer. The schedule of routine shipments of these prepared magnetic tapes to SDL will be established by the AFTAC project officer.

(5) Establish quality control procedures and conduct quality control, as necessary, to assure the recording of high quality data on both magnetic tape and film. Past experience indicates that a quality control review of one magnetic tape per magnetic tape recorder at the observatory during each week is satisfactory unless quality control tolerances have been exceeded and the necessity of additional quality control arises. Quality control of magnetic tape should include, but need not necessarily be limited to, the following items:

- (a) Completeness and accuracy of operation logs.
- (b) Accuracy of observatory measurements of system noise and equivalent ground motion.
- (c) Quality and completeness of voice comments.
- (d) Examination of all calibrations to assure that clipping does not occur.

REPRODUCTION

(e) Determination of relative phase shift on all array seismographs.

(f) Measurement of DC unbalance.

(g) Presence and accuracy of tape calibration and alignment.

(h) Check of uncompensated noise on each channel.

(i) Check of uncompensated signal-to-noise of channel 7.

(j) Check of general strength and quality of timing data derived from National Bureau of Standards Station WWV.

(k) Check of time pulse modulated 60 cps on channel 14 for adequate signal level and for presence of time pulses.

(l) Check of synchronization of digital time encoder with WWV.

(6) Provide observatory facilities, accompanying technical assistance by observatory personnel, and seismological data to requesting organizations and individuals after approval by the AFTAC project officer.

(7) Maintain, repair, protect, and preserve the facilities of TFSO in good physical condition in accordance with sound industrial practice.

b. Instrument Evaluation: On approval by the AFTAC project officer, evaluate the performance characteristics of experimental or off-the-shelf equipment offering potential improvement in the performance of observatory seismograph systems. Operation and test of such instrumentation under field conditions should normally be preceded by laboratory test and evaluation.

c. Special Investigations:

(1) Conduct research investigations as approved or requested by the AFTAC project officer to obtain fundamental information which will lead to improvements in the detection capability of TFSO. These programs should take advantage of geological, meteorological, and seismological conditions of the observatory. The following special studies should be accomplished:

(a) Evaluate the beam-steering capabilities of the 30-kilometer long- and short-period vertical seismometer arrays.

(b) Determine the detection capabilities of the 30-kilometer long- and short-period vertical seismometer arrays.

(c) Study the properties of the noise field with the new arrays.

d) Determine the reliability of instrumentation in the new arrays.

(2) Research might pursue investigations in, but is not necessarily limited to, the following areas of interest: microseismic noise, signal characteristics, data presentation, detection threshold, and array design (surface and shallow borehole).

(3) Prior to commencing any research investigation, AFTAC approval of the proposed investigation and of a comprehensive program outline of the intended research must be obtained.

APPENDIX 2 to TECHNICAL REPORT NO. 68-46

RESULTS OF TESTS OF FIRING TIMES OF AEI  
LIGHTNING PROTECTORS

Table 1. Results of tests of new lightning protectors purchased for use in the long-period array at TFSO

Protector Serial No.	Operate time (microseconds)		Protector Serial No.	Operate time (microseconds)	
	Test 1	Test 2		Test 1	Test 2
K302/10	2	2	K302/35	2	2
* K302/23	2	11	K302/20	2	2
K302/7	2	2	K302/30	2	2
K302/3	2	2	K302/6	2	2
K302/49	2	2	K302/47	2	2
K302/5	2	2	K302/8	2	2
K302/52	2	2	K302/44	2	2
K302/11	2	2	K302/46	2	2
K302/1	2	2	K302/38	2	2
K309/45	2	2	K302/40	2	2
K309/27	2	2	K302/43	2	2
K309/28	2	2	K302/48	2	2
K309/47	2	2	K302/42	2	2
K309/46	2	2	K302/45	2	2
K309/29	2	2	K302/25	2	2
K309/32	2	2	* K302/39	>100	2(3 times)
K309/49	2	2	K320/57	2	2
K309/25	2	2	K320/53	2	2
K309/18	2	2	K320/39	2	2
K309/21	2	2	K320/58	2	2
K309/20	2	2	K320/43	2	2
K316/54	2	2	K320/54	2	2
K316/1	2	2	K320/52	2	2
K316/7	2	2	K320/51	2	2
K316/12	2	2	K320/3	2	2
K316/11	2	2	K320/8	2	2
K316/2	2	2	K320/6	2	2
K302/55	2	2	K320/4	2	2
K302/50	2	2	K309/12	2	2
K302/59	2	2	K309/23	2	2
K302/19	2	2	K309/35	2	2
K302/28	2	2	K309/33	2	2
* K302/27	10	16	K309/13	2	2
K302/31	2	2	K309/3	2	2
K302/36	2	2	K309/6	2	2
K302/26	2	2	K309/39	2	2
K302/32	2	2	K309/59	2	2
K302/35	2	2	K309/48	2	2
K302/34	2	2	K309/42	2	2
K302/37	2	2	K309/26	2	2

\* Rejected

Table 1. (Continued)

<u>Protector Serial No.</u>	<u>Operate time (microseconds)</u>	
	<u>Test 1</u>	<u>Test 2</u>
K309/43	2	2
K309/31	2	2
K309/47	2	2
K309/44	2	2
K309/36	2	2
K309/34	2	2
K316/56	2	2
K316/29	2	2
K316/50	2	2
K316/57	2	2
K316/30	2	2
K316/58	2	2
K316/34	2	2
K309/22	2	2
K309/37	2	2
K309/17	2	2
K309/19	2	2
K309/2	2	2
K309/24	2	2
K309/54	2	2

Table 2. Results of tests of lightning protectors removed from the field end of the long-period array circuits at TFSO

Circuit removed from	Protector serial No.	Operate time (microseconds)					
		Test #	1	2	3	4	5
<u>LP1</u>							
*Vault data	G160/33	>100	2	20			
Vault power	G136/43	2	2	2	8	2	
Vault cal.	G160/34	2	2	2	2		
*Crs. data	G656/42	2	2	23	2		
Crs. cal.	G69/57	2	2	2	2		
<u>LP2</u>							
Power supply	C167/9	2	2	2	2		
*Telephone ckt.	C157/33	2	500	>100	2		
*Vault cal.	G160/57	2	>100	2	>100		
*Vault data	G134/41	No	No	2	No		
*Vault power	G160/55	No	2	2	2	2	No
<u>LP3</u>							
Vault power	G160/41	2	2	2	2	2	
*Vault data	G134/44	>100	2	>100			
Power supply	C151/27	Scope did not trigger		2	2	2	2
Vault cal.	G160/36	2	3	2	2		
*Telephone ckt.	C167/14	3	35	2	2		
<u>LP4</u>							
*Telephone data	C243/39	No	No				Fired @ 1100 V.
*Telephone cal.	E778/18	>100	2				
Power supply	C208/18	2	2	2	2		
Vault data	G160/51	2	2	2	2		
Vault cal.	G160/52	2	2	2	2		
Vault power	G160/42	2	2	2	2	2	2
<u>LP5</u>							
*	B604/55	No	2				
	G160/54	2	2	2	2		
* Not recorded	G134/42	No	No				Fired @ 1000V.
	H656/20	2	2	2	29		
*	G9/8	No	No			1200 V	No
*	C243/42	37	37				

\* Rejected

Table 2. (Continued)

<u>Circuit removed from</u>	<u>Protector serial No.</u>	<u>Operate time (microseconds)</u>						
		<u>Test #</u>	<u>1</u>	<u>2</u>	<u>3</u>	<u>4</u>	<u>5</u>	<u>6</u>
<u>LP6</u>								
*	G110/40		No	No	No			
* Not recorded	G160/34		2	2	3	22		
	G150/39		2	2	2	2		
<u>LP7</u>								
	G179/2		2	2	2	2		
Not recorded	G160/37		2	2	2	2		
	G160/35		2	2	2	2	2	2

---

\* Rejected

Table 3. Results of tests of lightning protectors purchased for use in the short-period array circuits at TFSO

Protector serial No.	Operate time (microseconds)					
	Test #1	2	3	4	5	6
K366/43	2	2				
K366/5	2	2				
K366/27	2	2				
K366/22	2	2				
K366/3	2	2				
K366/9	2	2				
K366/2	2	2				
K366/15	2	2				
* K366/51	25	22	2	2		
K366/8	2	2	3	2		
* K366/6	10	2	2			
K366/60	2	2				
K366/12	4	3	2			
* K357/1	98	2	2	2		
* K357/47	76	24	89	>100	86	100
K357/15	2	2	2			
K357/23	2	4	2			
K357/37	2	2				
K357/16	2	?				
K357/44	2	2				
K357/31	2	2				
K357/18	2	2				
K357/6	2	2				
* K357/24	>100	12	14			
K357/36	2	2				
K310/25	2	2				
K310/31	2	8	2			
K310/55	2	2				
K366/42	2	2				
K366/14	2	2				
K366/17	2	2				
* K366/34	No	>100	2	2		
K366/19	2	2				
K366/59	2	2				
K366/28	2	2				
* K366/7	9	12	4	25	2	
K366/34	2	2				
* K366/18	14	2	2			
K366/29	2	7	2	2		
K366/58	2	2				
K366/45	2	2				

\* Rejected

Table 3. (Continued)

<u>Protector serial No.</u>	<u>Operate time (microseconds)</u>						
	<u>Test #</u>	<u>1</u>	<u>2</u>	<u>3</u>	<u>4</u>	<u>5</u>	<u>6</u>
K357/49		8	2				
K357/3		2	2				
K357/39		2	2				
K357/51		2	2				
* K357/26		>100	2	2			
* K357/17		83	2	11			
K357/35		2	2				
K357/50		2	2				
K357/48		2	2				
* K357/33		45	2	2			
K357/14		2	2				
K357/28		2	2				
K310/57		2	2				
K310/60		2	2				
K310/46		2	2				
K310/52		2	2				
K310/41		2	3				
* K310/37		>100	2	2			
* K310/29		2	2	11	2		
K310/42		2	2				
K310/40		2	2	2			
* K310/27		>100	2	2			
K310/36		2	2				
K310/7		2	2				
K310/48		2	2				
K310/9		2	8	2			
K310/13		2	2	3			
K310/56		2	2				
K310/45		2	2				
K310/47		2	2				
K310/59		2	2				
K310/43		2	2				
K310/53		2	2				
K310/50		2	2				
* K310/58		2	>100	2	2		
K310/54		2	2				
K310/24		2	2				
K310/1		2	5	4	2		
* K310/11		2	>100	2	2		
K310/4		3	2				
K310/34		2	2				
* K310/12							Did not fire
K310/35		2	2				

\*Rejected

Table 3. (Continued)

<u>Protector serial No.</u>	<u>Operate time (microseconds)</u>						
	<u>Test #</u>	<u>1</u>	<u>2</u>	<u>3</u>	<u>4</u>	<u>5</u>	<u>6</u>
K310/20		2	2				
K310/17		2	2				
K310/15		2	2				
K310/19		2	2				
K310/14		2	2				
K310/22		2	2				
K310/16		2	2				
K310/18		2	2				
K310/23		2	2				
K310/2		2	2				
K310/49		2	2				
K310/32		2	3				
K310/26		2	2				
K310/30		2	5				
K310/39		2	3				

Table 4. Results of tests of lightning protectors removed from the 37-element short-period array at TFSO

Circuit removed from	Protector serial No.	Operate time (microseconds)					
		Test #	1	2	3	4	5
* Z1 data	G27/40		No	No	>100	@ 1100 volts	
* Z1 cal	G27/42		2	56	2	2	
* Z2 data	F178/27		4	99			
* Z2 cal	F469/28		No	80			
* Z3 data	E669/17		No	No	No	No	<2 @ 1600 volts
* Z3 cal	E669/22		>100	2			
* Z4 data	G123/10		2	16	2		
* Z4 cal	G464/23		No	No	<2	@ 1400 volts	
* Z5 data	G9/36		No	No	<2	@ 1100 volts	
* Z5 cal	E778/32		No	No	<2	@ 1100 volts	
* Z6 data	E669/14		No	No	<2	@ 1100 volts	
Z6 cal	E669/60		2	2	2	2	
* Z7 data	G9/11		2	2	2	20	
* Z7 cal	G9/15		No	<2	@ 1100 volts		
* Z8 data	E669/16		No	>100	@ 1100 volts		
* Z8 cal	F660/6		>100	>100			
* Z11 data	G9/38		>100	>100			
* Z11 cal	G9/37		No	2	@ 1100 volts		
* Z12 data	F440/55		60	86			
Z12 cal	F440/56		2	2	3	2	
* Z13 data	F446/13		No	No	>100	@ 1400 volts	
* Z13 cal	G8/6		No	>100	@ 1100 volts		
* Z14 data	K778/2		No	2	@ 1100 volts		
Z14 cal	F660/51		2	2	2	2	
* Z15 data	G669/7		No	No	No	No	@ 1600 volts
* Z15 cal	G669/35		2	15	2	36	
* Z16 data	B728/31		>100	11			
* Z16 cal	E669/20		No	No	2	@ 1100 volts	
* Z17 data	F446/12		No	No	31	@ 1100 volts	
Z17 cal	E778/11		2	2	2	2	
Z18 data	E669/26		2	2	2	2	
* Z18 cal	E664/41		No	2	2	6	82
Z21 data	E669/66		2	2	2	2	
Z21 cal	E669/46		No	No	No	>100	@ 1100 volts
* Z22 data	E669/18		>100	>100			
* Z22 cal	F440/2		No	No	2	18	
* Z22 Power	C167/15		>100	16			
* Z23 data	E440/3		No	No	No	No	Fired @ 1200 volts
* Z23 cal	E440/11		No	No	No	No	Fired @ 1200 volts
Z24 data	E464/44		2	2	2	2	
* Z24 cal	E228/33		35	7	37	41	
* Z25 data	G9/7		>100	4	2		

\* Rejected

Table 4. (Continued)

Circuit removed from	Protector serial No.	Operate time (microseconds)				
		Test #	<u>1</u>	<u>2</u>	<u>3</u>	<u>4</u>
Z25 cal	G9/10	2		Will not trigger scope		
Z26 data	G9/12	2	2	2	2	
* Z26 cal	G9/14	2	20	2	2	
* Z27 data	E669/25	No	No	2 @ 1100 volts		
* Z27 cal	E669/40	>100	23	29	40	
* Z28 data	E660/23	2	2	22	59	
* Z28 cal	E778/38	17	18	2		
* Z29 data	F464/26	No	4	@ 1100 volts		
* Z29 cal	F464/24	No	No	No	No	arced air gaps @ 1400 volts
* Z30 data	G9/35	No	2	Fired @ 800 volts 2nd try		
* Z30 cal	G9/34	2	3	2	23	
* Z31 data	E669/27	>100	24	7	10	
* Z31 cal	F641/98	>100	5	4	48	
* Z32 data	G9/33	No	>100	Fired @ 1200 volts 2nd try		
* Z32 cal	G9/32	>100	2	2	2	
* Z33 data	E669/57	No	>100	Fired @ 1200 volts 2nd try		
* Z33 cal	F464/50	12	10	34	6	
* Z34 data	G9/26	2	13	2	2	
Z34 cal	G9/49	2	2	2	2	
* Z35 data	E664/5	No	>100	Fired @ 1200 volts		
* Z35 cal	E669/58	No	>100	Fired @ 800 volts		
* Z36 data	G9/31	No	2	Fired @ 1200 volts 2nd try		
* Z36 cal	G9/30	>100	36	12	12	
Z37 data	F464/30	2	2	2	2	
* Z37 cal	F464/29	>100	>100			

\* Rejected

Table 5. Results of tests on lightning protectors received as replacements for previously rejected lightning protectors

Protector serial No.	Operate time (microseconds)					
	Test #	1	2	3	4	5
K352/36		2	2	2	2	
K352/42		2	2	2	2	
* K352/11		22	4	2		
K352/38		2	2	2	2	
* K352/31		>100	2	3	4	2
K352/46		2	2	2	2	
* K352/39		14	2	10	10	
K352/24		2	2	2	2	
K352/13		2	2	2	2	
* K352/6		2	2	12	6	2
K352/47		2	2	2	2	
K352/14		2	2	2	2	
K352/27		2	2	2	2	
K352/45		2	2	2	2	
K352/56		2	2	2	2	
K352/55		2	2	2	2	
* K352/51		2	2	12	>100	
K352/29		2	2	2	2	
K352/54		2	2	2	2	
K352/60		2	2	2	2	
K368/41		2	2	2	2	
K368/24		2	3	2	2	
K368/44		2	2	2	3	
K368/50		2	2	2	2	
* K368/1		12	12	2	>100	2
* K368/39		2	72	66	93	
K368/45		2	2	2	2	
K368/58		2	2	2	2	
K368/15		2	2	2	2	
K368/16		2	2	2	2	
K368/18		2	2	2	2	
K368/3		2	2	2	2	
* K368/33		12	28	2	2	
K386/44		2	2	2	2	
K386/33		2	2	2	2	
K386/39		2	2	2	2	
K386/10		2	2	2	2	
* K386/31		2	2	22	24	33

\* Rejected

APPENDIX 3 TO TECHNICAL REPORT NO. 68-46

TEST PLAN FOR TFSO SPIKE-NOISE  
REDUCTION STUDY

## TEST PLAN

13 August 1968

TO: S. Montoya / J. R. Herrage  
FROM: M. G. Gudzin  
PROJECT: TFSO Spike Noise Reduction  
CHARGE TO: WO 1250-2-2

### OBJECTIVES:

An objectionable amount of "spike noise" appears on the data recorded at TFSO. This must be reduced to make the data usable in the data processing programs that have been devised.

The objectives of your work will be to improve the quality of the data produced by TFSO.

The test procedures outlined below will be undertaken at TFSO.

All test equipment required to accomplish this work should be available at TFSO.

### TEST PROCEDURES:

1. Prepare cable run
  - 1.1 Check cable leakage
    - Between conductors
    - Between conductors and ground
  - 1.2 Inspect all hocks
    - Clean carbon and oxide as required
    - Seal hocks
  - 1.3 Inspect entire cable length
    - Tape all holes or breaks in outer sheath
  - 1.4 Replace defective sections of cable

REPRODUCTION

2. Prepare remote ground

- 2.1 Measure resistances from equipment to ground rod before and after working on this site.
- 2.2 Use adequate size wire
  - #4 from tank to culvert to ground rod
  - #12 from seismometer case to instrument common
  - #12 from other instruments to common
  - #12 from AEI's to common
  - #12 or larger from common to ground rod
- 2.3 Follow wiring concepts set forth for HF seismograph.
- 2.4 Use appropriate lugs for wire size. Solder or use appropriate crimp tool.
- 2.5 Use lock washers under all lugs.

3. Prepare vault wiring

- 3.1 Make sure all connections are properly made -- either soldered or using correct lugs and crimped correctly. Replace all suspicious connections.
- 3.2 Inspect all connectors for proper workmanship and cleanliness. Has a corrosive solder flux been used?

4. Prepare CRB site as in (2) and (3).

5. Record test data on separate Helicorder as well as on observatory Develocorder. This will give continuous quick-look comparative data that may be retained for duration of tests. Suggest 24 hrs/sheet be recorded.

6. Set up standard spike noise generator using RFL magnet charger discharging into two ground rods.

Can this be done?

How far apart must the rods be?

Can they be located so that all cables have approximately the same amplitude spike induced?

Use the final spike generator setup chosen as a standard.

Is the noise from this generator affected by:

humidity?

rainfall?

temperature?

REPRODUCTION

7. Progressively eliminate possible points at which spikes may be entering system.
  - 7.1 Drive discriminator with telemetry oscillator (HP200T)
    - a. At CRB (no Spiral-4)
      - With 10 volts p-p
      - With 50 mv p-p
    - b. Through cable from vault.
  - 7.2 Drive discriminator with VCO (with amplifier input terminated with matching resistance).
  - 7.3 Connect seismometer to amplifier.
  - 7.4 Disconnect calibration coil from seismometer.
8. Try various ground connections to solid state amplifier.
  - a. Standard circuit
  - b. Tie pins C, G, and F of J102 all to the vault instrument ground
9. Measure amplitude of spikes seen on signal cable terminated in 560 ohms at each end:
  - a. Between conductors
  - b. From conductor to ground

What difference does cable length make?

10. Try increasing transmitted carrier amplitude using additional, higher-power line driver. Suggest this be run off batteries.

REPRODUCTION

Unclassified

Security Classification

DOCUMENT CONTROL DATA - R & D

(Security classification of title, body of abstract and indexing annotation must be entered when the overall report is classified)

1. ORIGINATING ACTIVITY (Corporate author) <b>Geotech, A Teledyne Company</b> <b>3401 Shiloh Road</b> <b>Garland, Texas</b>		2a. REPORT SECURITY CLASSIFICATION <b>Unclassified</b>	
		2b. GROUP	
3. REPORT TITLE <b>Operation of the Tonto Forest Seismological Observatory</b> <b>Quarterly Report No. 3, Project VT/8702, 1 July through 30 September 1968</b>			
4. DESCRIPTIVE NOTES (Type of report and inclusive dates)			
5. AUTHOR(S) (First name, middle initial, last name) <b>Geotech Staff</b>			
6. REPORT DATE <b>15 October 1968</b>		7a. TOTAL NO. OF PAGES <b>68</b>	7b. NO. OF REFS
8a. CONTRACT OR GRANT NO. <b>AF 33657-68-C-0766</b>		9a. ORIGINATOR'S REPORT NUMBER(S) <b>TR 68-46</b>	
8b. PROJECT NO. <b>VELA T/8702</b>		9b. OTHER REPORT NO(S) (Any other numbers that may be assigned this report)	
8c. ARPA Order No. <b>624</b>			
8d. ARPA Program Code No. <b>6F10</b>			
10. DISTRIBUTION STATEMENT <b>This document is subject to special export controls and each transmittal to a foreign national may be made only with prior approval of the Chief of AFTAC.</b>			
11. SUPPLEMENTARY NOTES		12. SPONSORING MILITARY ACTIVITY <b>Advanced Research Projects Agency</b> <b>Nuclear Test Detection Office</b> <b>Washington, D. C.</b>	
13. ABSTRACT <p><i>Handwritten: This is</i></p> <b>This is a report of the work accomplished on Project VT/8702 from 1 July through 30 September. Project VT/8702 includes the operation, evaluation, and improvement of the Tonto Forest Seismological Observatory (TFSO) located near Payson, Arizona. It also includes special research and test functions carried out at TFSO and research and development tasks performed by the Garland, Texas, staff using TFSO data.</b>			

KEY WORDS	LINK A		LINK B		LINK C	
	ROLE	WT	ROLE	WT	ROLE	WT
Long-Period Array Short-Period Array Seismograph Operating Parameters Beam-Steering Evaluation High-Frequency Seismograph Multichannel Filter						