

UNCLASSIFIED

AD NUMBER: AD0850630

LIMITATION CHANGES

TO:

Approved for public release; distribution is unlimited.

FROM:

Distribution authorized to U.S. Gov't. only;  
Administrative/Operational Use; 01 NOV 1968. Other requests shall be  
referred to Naval Civil Engineering Laboratory, Port Hueneme, CA 93401.

AUTHORITY

USNCEL ltr dtd 10 DEC 1969.

7

AD850630



**CR 69.008**

NAVAL CIVIL ENGINEERING LABORATORY  
Port Hueneme, California

FERRO CEMENT PANELS  
VOLUME I

Experimental Evaluation  
and Protective Potential

November 1968

An Investigation Conducted by  
**T. Y. LIN AND ASSOCIATES**  
Consulting Engineers  
Van Nuys, California

N62399-68-C-0040

DDC  
 RECEIVED  
 APR 22 1969  
 RECEIVED  
 C

Each transmittal of this document outside the agencies  
of the U. S. Government must have prior approval of  
the Naval Civil Engineering Laboratory

*Port Hueneme, Calif 93041*

**BLANK PAGE**

ACCESSION for		
CFSTI	WHITE SECTION	<input type="checkbox"/>
DDC	BUFF SECTION	<input checked="" type="checkbox"/>
UNANNOUNCED		<input type="checkbox"/>
JUSTIFICATION		
BY		
DISTRIBUTION/AVAILABILITY CODES		
DIST.	AVAIL. and/or	SPECIAL
3		

FINAL REPORT — VOLUME I

Contract N62399-68-C-0040

Report No. CR 69.008

FERRO CEMENT PANELS

November 1968

by

**T. Y. LIN AND ASSOCIATES**

Consulting Engineers

Van Nuys, California

**FOREWORD**

The results of this investigation are contained in two volumes. Volume I contains evaluations of an experimental series to determine the protective potential of ferro cement. Volume II provides recommendations for military protective uses and installation of ferro cement panels in the building of revetments, bunkers, "concrete sky" aircraft cover, and fenders around bridge piers.

Each transmittal of this document outside the agencies of the U.S. Government must have prior approval of the Naval Civil Engineering Laboratory, Port Hueneme, California 93041.

## Introduction

The United States Naval Civil Engineering Laboratory at Port Hueneme, California, engaged the firm of T. Y. Lin and Associates to design and conduct a series of experiments to provide visual evidence of the protective capabilities of ferro cement panels against military forward area demolitions, shell fragments and infantry aimed-fire weapons. In view of the nature of the problems and the time available, it was specified that results be judged by visual examination without instrumentation.

Ferro cement is a composite material consisting of closely packed layers of steel mesh with interstices filled with sand-cement mortar. Ferro cement panels have very high capacities for energy absorption and resistance to penetration. Ferro cement is distinguished from reinforced concrete by its uniform distribution, close spacing and high ratio of reinforcement. Panels of ferro cement are much more ductile than reinforced concrete panels and, consequently, they absorb more energy before failure. They do not fracture in large pieces in the manner of reinforced concrete.

The requirements which, primarily, provided the impetus for this effort are:

- (1) Protection of bridge substructures from demolition by underwater swimmers.
- (2) Protection of parked aircraft from shell fragments by revetments and "concrete sky."
- (3) Facilitated bunker construction for protection against shell bursts and infantry aimed weapons fire.

The program was comprised of three series of experiments. In the first series, varied design parameters and panel arrangements were tried under rifle and pistol fire. These experiments were conducted in their entirety by T. Y. Lin and Associates.

In the second series, panels of selected design were subjected to surface blast charges; hand-placed, primer-detonated shells and grenades; and infantry aimed fire weapons. These experiments were conducted at the U. S. Marine Corps Base, Camp Pendleton, California. Detonations and firing were accomplished by U. S. Marines. The provision, placement and supporting of the panels and bridge pier simulator and evaluation and recording of results were accomplished by T. Y. Lin and Associates.

The operations in the third series of experiments, all underwater demolitions, were performed by the San Clemente Island facility of the U. S. Naval Undersea Warfare Center.

The design and control of mortar proportioning, casting of the panels and all other operational support by T. Y. Lin and Associates were performed under sub-contract by the Construction Research and Development Corporation of Van Nuys, California.

The design and programming of experiments, which was a contract responsibility of T. Y. Lin and Associates and subject to N.C.E.L. approval, was largely accomplished as a joint effort of the project managers of the two contract parties. Mr. Owen Olsen, Research Civil Engineer, Structures Division was the Project Manager for N.C.E.L.. Colonel Ray Adams, U.S.A. (Ret.), civil engineer and Senior Project Manager, Special Projects Group, was the Project Manager for T. Y. Lin and Associates and writer of this report.

Tests to determine, primarily, the ductility and static energy absorbing capacity of the panels were performed by N.C.E.L.. The tests were designed and supervised and the results were analyzed by T. Y. Lin and Associates. Supervision was accomplished by Mr. W. E. Gates, Manager of Special Projects and Mr. B. M. Mehta, analyst in the Special Projects group. Mr. Mehta assisted in the presentation of test results.

Mr. Herbert C. Wade, Project Engineer and Mr. John J. Fogarty, Engineering Technician, U.S. Naval Undersea Warfare Center, provided valuable information and advice relative to underwater explosions. U. S. Marines on the staff of the Commanding General, U. S. Marine Corps Base, Camp Pendleton supplied helpful first

hand information relative to Viet Cong bridge demolition techniques, gained during their service in South Vietnam.

In a report which depends largely on photographs for the communication of results, it seems desirable to limit the typewritten information interspersed with photographs to that necessary for them to be viewed informatively, thus relieving the reader of the annoyance of page flipping as much as possible. With this thought in mind, the writer will present the background information about the design of experiments, the casting of panels and the method of conducting the experiments for the entire series before presenting results. All pertinent parameters of the panels and the experiments will be repeated, in brief format, in association with the photographs in the presentation of results in Chapter 4.

An abstract of the report of the experiments and conclusions precedes the full report.

The recommended use and installation of the panels is presented in Volume II.

## ABSTRACT

A series of practical experiments was conducted in order to judge the effectiveness of ferro cement panels for use in building revetments, bunkers and "concrete sky" aircraft cover and fenders around bridge piers to protect them from demolition by underwater blast charges. Ferro cement consists of closely packed steel mesh reinforcing with its interstices filled with sand-cement mortar.

Two panel designs were selected by exposing panels of differing thicknesses, mortar mixes and types and amounts of reinforcing to Caliber .30-06 rifle and caliber .45 pistol fire. Portland Type III and Fast Fix I cements were tried. A 1:2.5 cement to sand mortar mix was selected and ordinary expanded metal lath was chosen for the reinforcement.

Panels  $41\frac{1}{2} \times 41\frac{1}{2} \times 2$ " were exposed to surface demolition charges up to 20 pounds of TNT to obtain lower bound results for guidance in the design of underwater experiments. Panels of this size in different arrangements, numbers in tandem and standoff distances from a simulated bridge pier were exposed under 11 feet to 16 feet of water to TNT charges up to 20 pounds.

Panels  $27\frac{1}{2} \times 27\frac{1}{2} \times 1$ " were exposed to the blast and fragmentation of the M26 hand grenade, 81mm and 4.2 inch mortar shells, 105mm Howitzer shell and to 66mm and 3.5 inch rockets, HEAT. This ordnance was statically detonated by replacing the fuze with a wad of composition C4, primed, and time-fuzed.

The M16 rifle and the M79 cartridge grenade launcher were fired on  $27\frac{1}{2} \times 27\frac{1}{2} \times 1$ " panels.

Panels  $41\frac{1}{2} \times 41\frac{1}{2} \times 2$ ", placed horizontally 6 feet apart were exposed to the bursts of 81mm mortar and 105mm Howitzer shells statically detonated midway between them.

The experiments demonstrated that two 1-inch panels separated by an air space of 6" or more will stop the fragments of 81mm mortar shells bursting 3 feet away, 4.2 inch mortar and 105mm Howitzer shells bursting 5 feet away, contact bursts of grenades, hand, M26 and cartridge, M79, and fire of the M16 rifle. They are ineffective against HEAT rockets and shell bursts between panels. Minor damage to the pier simulator from a 20 lb. TNT charge on a 2-inch panel 6 feet away with two intervening panels demonstrated the effectiveness of the enforced 6 ft. standoff. The panel at 6 ft. was destroyed and the intervening panels were damaged.

## VOLUME I

### Experimental Evaluation and Protective Potential of Ferro Cement Panels

#### Table of Contents

	<u>Page</u>
Introduction	i
Abstract	iv
Table of Contents	v
List of Tables	x

#### Chapter 1

##### THE DESIGN OF THE EXPERIMENTS

1-1	General	1-1
1-2	Basic Considerations and Concepts	1-1
	1-2.1 Capabilities and Limitations of Passive Defensive Measures	1-1
	1-2.2 Broad Concept of the Use of Ferro-Cement Protective Panels	1-1
	1-2.3 Concept of the Experiments	1-2
	1-2.4 Phases and Objectives	1-2
	1-2.5 Static Load-Deflection Tests	1-3
1-3	Design of Experiments for the Selection of Panel Design Parameters	1-3
	1-3.1 The Problem of Parameter Selection	1-3
	1-3.2 Program of Parametric Experiments	1-4
1-4	Design of Surface Blast, Shell and Grenade and Aimed Weapons Experiments	1-5
	1-4.1 Demolition Charges	1-5
	1-4.2 Fragmenting Projectiles and Grenades	1-8
	1-4.3 Penetrating Projectiles	1-9
	1-4.4 Exposure of Panels to the Blast Charges and Ordnance Items	1-10
	1-4.5 Program of Surface Blast, Shell and Grenade, and Aimed Weapons Experiments	1-10
	1-4.6 Program of Underwater Blast Experiments	1-11

#### Chapter 2

##### CASTING AND CURING OF PANELS

2-1	General	2-1
-----	---------	-----

	<u>Page</u>
2-2 Casting and Curing of Panels for the Parametric Experiments	2-2
2-2.1 The Casting Operation	2-2
2-2.2 Curing of the Panels	2-3
2-2.3 Control Specimens and Strengths	2-3
2-3 Casting and Curing of Panels for the Field Service Experiments and the Laboratory Tests	2-5
2-3.1 Reinforcement	2-5
2-3.2 The Multi-Panel Forms	2-6
2-3.3 The Casting Operation	2-6
2-3.4 Curing of the Panels	2-8
2-3.5 Control Specimens and Strengths	2-9
2-4 The Two Casting Methods in Retrospect	2-10
2-4.1 One-at-a-time Panel Casting for the Parametric Experiments	2-10
2-4.2 Multi-Panel Casting for the Field Experiments and Laboratory Tests	2-11
2-4.3 Lessons Learned From the Experience	2-11

### Chapter 3

#### METHODS USED TO SUPPORT PANELS AND EXPOSE THEM TO DEMOLITION CHARGES AND ORDNANCE ITEMS

3-1 General	3-1
3-2 Methods in the Five Series of Experiments	3-1
3-2.1 The Parametric Experiments	3-1
3-2.2 Static Detonations on Horizontal Panels	3-4
3-2.3 Fragmentation Experiments	3-7
3-2.4 Rifle and Cartridge Grenade	3-7
3-2.5 Underwater Blast Experiments	3-10

### Chapter 4

#### EXPERIMENTAL RESULTS AND CONCLUSIONS

4-1 General	4-1
4-2 Parametric Experiments	4-2
4-2.1 Experiments 1 & 2 (Mortar Mix)	4-2
4-2.2 Experiment 3 (Panel Thickness)	4-6
4-2.3 Experiment 4 (Reinforcement Type)	4-15
4-2.4 Experiment 5 (Conventional Reinf. & Mesh Orientation)	4-40

	<u>Page</u>
4-2.5 Experiments 7 & 8 (Fast Fix Cement & Incident Angle of Fire)	4-46
4-3 Surface Blast Experiments	4-60
4-3.1 Panel Design	4-60
4-3.2 Two-Pound Charge at Six Foot Stand Off (2 Panels at 12" Spacing)	4-60
4-3.3 Four-Pound Charge at Six Foot Stand Off (2 Panels at 12" Spacing)	4-62
4-3.4 Eight-Pound Charge at Six Foot Stand Off (3 Panels at 12" Spacing)	4-64
4-3.5 Twenty-Pound Charge at Six Foot Stand Off (3 Panels at 12" Spacing)	4-66
4-3.6 Eight-Pound Charge at Four Foot Stand Off (2 Panels at 24" Spacing)	4-68
4-3.7 Twenty-Pound Charge at Four Foot Stand Off (2 Panels at 24" Spacing)	4-70
4-4 Experiments with Fragmenting Projectiles and Grenade, M26	4-72
4-4.1 Panel Design	4-72
4-4.2 Shell, Mortar, 81mm at Three Foot, Six Foot and Twelve Foot Stand Offs	4-72
4-4.3 Shell, Howitzer, 105mm	4-76
4-4.4 Shell, Mortar, 4.2 Inch	4-84
4-4.5 Delay Fuzed Shell, Mortar, 81mm, Between Panels (At 6' Spacing)	4-90
4-4.6 Delay Fuzed Shell Comparable to the Shell Howitzer, 105mm (At 6' Spacing)	4-92
4-4.7 Grenade, Hand, M26	4-94
4-4.8 Evaluation of Results of the Fragmenting Weapons	4-96
4-5 Shaped Charge Experiments	4-97
4-5.1 General	4-97
4-5.2 Results of the 66mm Rocket, HEAT, Detonation	4-98
4-5.3 Results of the 3.5 Inch Rocket, HEAT, Detonation	4-100
4-6 Live Fire Experiments	4-102
4-6.1 General	4-102
4-6.2 Slow Fire with Rifle, M16	4-102
4-6.3 Grenade, Cartridge, M79	4-110
4-6.4 Evaluation of Panel Resistance to the Rifle M16, and the Grenade, Cartridge, M79	4-112

	<u>Page</u>
4-7 Underwater Blast Experiments	4-112
4-7.1 General	4-112
4-7.2 The First Experiment (2 lbs. TNT)	4-113
4-7.3 The Second Experiment (2 lbs. TNT)	4-116
4-7.4 The Third Experiment (2 lbs. TNT)	4-120
4-7.5 The Fourth Experiment (4 lbs. TNT)	4-123
4-7.6 The Fifth Experiment (8 lbs. TNT)	4-125
4-7.7 The Sixth Experiment (8 lbs. TNT)	4-128
4-7.8 The Seventh Experiment (20 lbs. TNT)	4-130
4-7.9 The Eighth Experiment (20 lbs. TNT)	4-132
4-7.10 The Ninth Experiment (20 lbs. TNT)	4-134
4-7.11 The Tenth Experiment (20 lbs. TNT)	4-138
4-7.12 Evaluation of Results	4-141
4-7.13 Conclusions Relative to the Protection of Piers from Underwater Blast Charges	4-145
4-8 Conclusions	4-146
4-8.1 Effectiveness in Protection of Bridge Piers	4-146
4-8.2 Effectiveness in Revetments	4-146
4-8.3 Effectiveness in Concrete Sky	4-146
4-8.4 Effectiveness in Bunkers	4-147
4-8.5 Multiple Panels in Tandem vis a vis Single Thick Panels	4-147
4-8.6 Alternate Reinforcements	4-148
4-8.7 Cements	4-148
4-8.8 Considerations Relative to the Military Worth of Ferro-Cement Panels	4-149

#### Appendix A

##### CHARACTERISTICS OF FLEXURE AND SHEAR BEHAVIOR OF FERRO-CEMENT PANELS UNDER STATIC LOADING

A-1. General	A-1
A-2. The Test Program	A-1
A-3. The Loading Method	A-2
A-4. Conduct of the Tests	A-3
A-5. Results of the Tests	A-3
A-6. Conclusions	A-21

Page

Appendix B

REFERENCE AND BIBLIOGRAPHY

Reference

B-1

Bibliography

B-1

## LIST OF TABLES

	<u>Page</u>
1-1 Program of Parametric Experiments with Small Arms Fire	1-5
1-2 Details Supplementary to Table 1-1	1-6
1-3 Representative U. S. Military Forward Area Explosives	1-7
1-4 Program of Surface Blast Experiments	1-10
1-5 Program of Underwater Blast Experiments	1-12
2-1 Types and Amount of Reinforcement	2-2
2-2 Cylinder Strengths, Parametric Experiments	2-4
2-3 Densities and Cylinder Strengths Field Experiments and Laboratory Tests	2-9
3-1 Oceanographic Environment, Wilson Cove	3-10
A-1 Panel Reinforcements	A-1
A-2 Summary of Flexural Test Data	A-6
A-3 Summary of Punching Shear Test Data	A-14

## Chapter 1

### THE DESIGN OF THE EXPERIMENTS

#### Section 1-1

##### General

This section presents basic considerations and concepts bearing on the design of experiments, the concept of the experiments and the design of each of the three phases of the series of experiments.

#### Section 1-2

##### Basic Considerations and Concepts

###### 1-2.1 Capabilities and Limitations of Passive Defensive Measures

A military defensive measure which does not depend on the delivery of weapons fire or, more effectively, on fire and maneuver is a passive measure. Protective devices are in this category. They are most effective as an adjunct to fire and maneuver. Used alone, they have a fixed ceiling of effectiveness and offer no impediment to the enemy's effort to break through their effective ceiling. Nevertheless, by increasing the effort required, they may reduce the frequency of successful attack against protected facilities. A significant increase in the effort required to accomplish successful demolitions may make the enemy's security of such attacks by stealth more difficult. It is seldom possible to provide a non-destructible protective device, but if the device affords protection in the process of being destroyed and is readily replaceable, it may have significant military value.

###### 1-2.2 Broad Concept of the Use of Ferro-Cement Protective Panels

Effective precast panels will facilitate the construction and post-attack repair of bridge pier fenders, parked aircraft protection and bunkers. The stand-off distance imposed on the underwater placement of demolition charges is the main defensive feature of pier

fenders which a swimmer cannot penetrate readily with cutting tools. The necessary distance may be reduced by the energy absorption and shock wave impedance of intermediate panels. Revetments probably cannot be made proof against very close shell bursts, but consideration of the probable error and the decline in blast energy and fragmentation density with distances from the burst indicates that they will materially reduce the amount of aircraft damage. The same reasoning applies to the reduction of personnel casualties.

Panels would, most likely, be cast in quantity at base facilities and transported to locations where needed. In pier fender construction, where hoisting equipment would be required in building the supporting structures, larger and thicker panels could be used than in revetments and overhead cover where the panels may have to be man-handled.

### 1-2.3 Concept of the Experiments

It was conceived that the experiments should be in the nature of field tests in which the panels would be exposed to pertinent weapons and demolition charges and their resistance would be evaluated by visual examination of damage. The visual evidence would be recorded by photographing the damaged areas. It was decided that the panel design parameters would be selected, one parameter at a time, by comparing the responses of panels of differing parametric values to weapons fire which would reveal significant characteristics of the damage. The rifle, caliber .30-06 was selected as the weapon to be used throughout the selection of panel design. Match grade ammunition was selected with 2640 fps muzzle velocity and 2680 foot-pounds of kinetic energy. It was decided also to fire the pistol, caliber .45, semi-automatic in the early experiments because it is a much lower velocity weapon (860 fps), but to continue it only if it proved to be significant. The kinetic energy of the pistol bullet (390 ft.lbs.) is far below that of the rifle bullet.

### 1-2.4 Phases and Objectives

The entire series of experiments was found to be logically subdivisible into the following three principle phases:

- (a) The parametric experiments, in which the objective was to design the panels.
- (b) The exposure of panels of selected design to surface (not underwater) blast charges, shell and hand grenade bursts, high explosive anti-tank rockets, the launcher-projected M79 grenade and the M16 rifle. The objectives were to field test the panels for protection of bridge piers at the lower bound of severity environment, and for use in revetments and overhead cover.
- (c) The exposure of the panels to underwater blast charges in water depths between ten and twenty feet to field test them for protection of bridge piers at the most likely upper bound of severity environment to be encountered in rivers.

#### 1-2.5 Static Load-Deflection Tests

It was considered advisable to conduct static load-deflection tests on panels with varied reinforcement in order to gain information likely to be useful in the interpretation of the field test experiments. Description of the tests and results are presented in Appendix A.

### Section 1-3

#### Design of Experiments for the Selection of Panel Design Parameters

##### 1-3.1 The Problem of Parameter Selection

Consideration of possible coupling between the influence of parametric values on the resistance of the panels gave rise to a question about the validity of selecting each parameter independently of the others. This type of selection may not reveal the ultimate combination of parameters. On the other hand, with what was considered to be the minimum number of discrete values of each parameter there are 72 parametric combinations. It was not feasible to perform this number of parametric experiments in the time it was deemed prudent

to allocate. Statistical methods based on random sampling are reliable only where results may be quantized. The difference between a good combination of design parameters and the ultimate combination is not likely to influence conclusions about the protective worth of the panels in a theater of combat operations.

### 1-3.2 Program of Parametric Experiments

Reference is made to Tables 1-1 and 1-2, in which the parametric values, sequence of selection and other details of the parametric experiments are presented. The size of all panels is 24"x24".

Mortar mixes at about the upper and lower bounds and mid-range were chosen for trial. Panels of 2-inch thickness were considered to be near the upper bound of practicality for the handling required from the casting plant to destination in a protective structure. Thickness of 1/2" was certain to be at or below the lower bound of effectiveness. Two thicknesses were chosen between these bounds. Moving on to reinforcement, high carbon steel wire cloth is a brittle, high-strength reinforcement ( $f_u=260$  ksi;  $f_y=234$  ksi). Hardware cloth and expanded metal lath are both ductile materials in the lower part of the range of mild carbon steel. Both are readily available materials. Expanded metal lath is delivered in 8-foot sheets stacked in a wooden frame, which makes it convenient for shipping and handling. Hardware cloth is rolled and requires straightening to make it lie flat in panel casting forms. It costs over twice the price of expanded metal lath. In view of the performance of 1/2" mesh wire cloth in Experiments 1, 2 and 3, wire cloth and hardware cloth of 1/4" mesh and expanded metal lath were chosen for purposes of reinforcement selection in Experiment 4. Opportunity to vary the reinforcement ratio was not available. With reinforcement stacked layer on layer from form bottom to screed line, the ratio of expanded metal was near the lower end of the ferro-cement range and the ratio of wire cloth was below the upper end.

Fiber-glass window screen, barely embedded in the two surfaces, was introduced in Experiment 4 in order to observe its effectiveness in retaining spalls. A 1-inch panel, conventionally reinforced with 1 layer of 2"x10g. welded wire fabric at its mid-plane was introduced in Experiment 5 in order to compare the character of its response with that of ferro-cement. The randomness of mesh distribution was varied in Experiment 6 by varying

Table 1-1 PROGRAM OF PARAMETRIC EXPERIMENTS WITH SMALL ARMS FIRE

Exp. No.	Mortar Mix	Panels in Tandem		Type	Reinforcement			Cement Type	Control Cylinder		Incident Angle of Fire	Weapon
		No.	Thickness		Spacing	Layers	% By Voi.		Orientation	Strength Psi		
1 & 2	(1:3.75) (1:2.50) (1:1.00)	1	1"	-		9	9.70	90°	( 3540 ( 6360 ( 11000	5) 5) 5)	90°	P&R
3	1:2.50 1:2.00	(2 (2 (1 (2	1 1/2" 1 1/2" 2" 1 1/2"	12" 2", 6.5", 12" - 2", 6.5", 12"	1/2"WC 1/2"WC 1/2"WC 1/2"WC 1/2"WC	5 15 22 18	10.78) 10.78) 11.85) 7.64	90° 90° 90°	4610 (Prototype Panel)	5 -	90° 90° 90°	P&R P&R
4	1:2.50	2 & 3	1"	2" & 3.5"	(1/2"WC (1/2"HC ( EM	9 13 8	5.95) 7.16) 5.14)	90°	4530	5	90°	R
5	1:2.50	3	1"	3.5"	2"x10G WWF	1	1.43	90°	6440	9	90°	R
6	1:2.50	3	1"	3.5"	EM	8	5.14	45°	4240	4	90°	R
7	1:2.50	3	1"	3.5"	EM	3	5.79	90°	4090	5	90°	R
8	1:2.50	( 1 ( 2 ( 2 ( 2&3 ( 3	1" 1" 1" 1" 1"	- 3.5") 3.5") 3.5") 3.5")	EM	9	5.79	90°	5300	7	33° 27° 42° 57° 49.5°	R

\*Where two or more panels were in tandem, the back panel simulated a protected object and those in front of it were the protective panels.

Explanation of Symbols

Type of Reinforcement:	Orientation of Reinforcement to produce randomness of overlay:	Type of Cement:	Weapon:
WC - High Carbon Steel Wire Cloth	90° - Alternated 0° and 90°	PIII - Portland	P - Pistol 45 Cal.
HC - Hardware Cloth	45° - Alternated 0°, 45°, 90° and 135°	FFI - Fast Fix, Type I	R - Rifle.30-06 Cal.
EM - Expanded Metal Lath, diamond pattern 1/2"x1/4"			at 100 yds.
WWF - Welded Wire Fabric			

Table 1-2 DETAILS SUPPLEMENTARY TO TABLE 1-1

Experiments 1 and 2, Combined						
Varied Parameter: Mortar Mix				Constant: 1" Panel Thickness		
Panel No.	Mark	No. of Rounds	Mortar Mix	Layers Reinf.	Water-Cement Ratio	
1	4L11H2	3R, 2P	1:3.75	9 ½"WC	0.75	
2	4L11H2	9P	1:3.75	"	0.75	
3	4M11H2	3R, 2P	1:2.50	"	0.60	
5	4H11H2	3R, 4P	1:1.00	"	0.60	

Experiment 3						
Varied Parameter: Thickness				Constant: Mortar Mix 1:2.5		
Panel No.	Spacing	Mark	No. of Rounds	Thickness	Layers of Reinf.	
8	-	8M13H2	6R	2"	22 ½"WC	
7	2", 6.5", 12"	6M12H2	6R	1-1/2"	15 ½"WC	
9	12"	2M12H2	6P	1/2"	5 ½"WC	
A	2", 6.5", 12"	6M9L2	5R	1-1/2"	Prototype	18 ½"HC

Experiment 4						
Varied Parameter: Type of Reinforcement and Fiber-Glass Screen at Surfaces						
Panel No.	Spacing	Mark	No. of Rounds	Reinforcement	Layers Reinf.	Fiber-Glass Screen at Surfaces
41	2", 3.5"	41-WC-PS	2R	1/4" Wire Cloth	9	Yes
42	"	42-WC-O	4R	1/4" Wire Cloth	9	No
43	"	43-HC-PS	2R	1/4" Hdw. Cloth	13	Yes
44	"	44-HC-O	4R	1/4" Hdw. Cloth	13	No
45	"	45-EM-PS	3R	Exp. Metal Lath	8	Yes
46	"	46-EM-O	4R	Exp. Metal Lath	8	No

Experiments 5 and 6, Combined						
Varied Parameter: Conventional Reinforcement vis-a-vis Ferro-Cement and Orientation of Mesh.						
Panel No.	Spacing	Mark	No. of Rounds	Reinforcement Concept	Layers Reinf.	Orientation of Mesh
51	3.5"	52-WF-PC)	4R	Conventional	1 2"WWF	90°
52	"	51-WF-PC)		Conventional	1 2"WWF	90°
61	"	61-EM-PC)	5R	Ferro-Cement	8 EM	45°
62	"	62-EM-PC)		Ferro-Cement	8 EM	45°

Experiments 7 and 8, Combined						
Varied Parameter: Fast Fix I Cement and Angle of Incidence of Fire						
Set-Up No.	Spacing	Mark	No. of Rounds	Type of Cement	Angle of Incidence	
1	3.5"	71-FF)	2R	Fast Fix I	87°	
2	"	71-FF)		Fast Fix I	87°	
3	"	81-PC-1	1R	Portland III	33°	
4	"	81-PC-2	1R	Portland III	27°	
5	"	81-PC-3	1R	Portland III	42°	
6	"	81-PC-4&5	2R	Portland III	57°	
7	"	81-PC-6	6R	Portland III	49°30'	

Note: Angles marked on panels in photographs are 30°, 45°, 60° and 52°30'. These angles have been corrected for 3° ascent of line of sight from firing point to the panel. Panel numbers marked on panels were for identification from casting to firing. Cards bearing panel marks were photographed with panels to identify photographs.

the orientation of layers as explained in the footnotes of Table 1-1.

Two panels of Fast Fix I cement were tried in Experiment 7. In Experiment 8, the incident angle of the line of sight was varied. The angle between the line of sight and the tangent to the trajectory of a caliber .30-06 bullet at 100 yards is about 5 seconds. The supporting frames, which were spirit-leveled, could be adjusted to 90°, 75°, 60°, 45° and 30° and, by expedient means, at 52½°. The line of sight was found by transit measurement to ascend 3° from the bench rest to the panel. In set-up No. 3, the support was reversed in order to ground the expected ricochet, which did not occur. The support was then restored to its original orientation.

#### Section 1-4

#### Design of Surface Blast, Shell and Grenade and Aimed Weapons Experiments

##### 1-4.1 Demolition Charges

The range of U. S. Military forward area demolition charges is well represented by the explosives listed with their detonating velocities in Table 1-3.

---

Table 1-3 REPRESENTATIVE U.S. MILITARY  
FORWARD AREA EXPLOSIVES

<u>Designation</u>	<u>Detonating Velocity</u>
TNT	23000 fps
Composition, C3	25018 fps
Composition, C4	26379 fps

---

Our concern is with the explosives used by an enemy, therefore we cannot fix upon a particular one. Several U. S. Marines who recently returned from South Vietnam stated in interviews that the Viet Cong use "whatever they can get hold of," supposedly by capture or pilfering. TNT was chosen for the experiments because it is best known generally and has become a standard of measure.

#### 1-4.2 Fragmenting Projectiles and Grenades

- a. Explosive shell weapons most likely to be encountered in close country with natural concealment and difficult terrain are mortars, of which the U. S. 81mm and 4.2-inch mortars are representative. The shell, mortar, 81mm is tear drop shaped with tail fins to give it stability in flight. It contains approximately 2 lbs. of TNT and the casing bursts into small sharp fragments. The shell, mortar, 4.2-inch is cylindrical from the base plate to the bourillet. It is rotationally stabilized by a rotating band which is expanded by propellant pressure to engage the lands of the rifled barrel. It contains approximately 8.5 lbs. of TNT and creates a very damaging pattern of fragmentation. The containment of explosive in a strong steel shell magnifies its effectiveness. The explosive solid is converted to gas by the time the casing bursts, so that the rise time is almost instantaneous. Mortars are always fired at quadrant elevations above  $45^{\circ}$ , normally  $60^{\circ}$  to  $80^{\circ}$ . The kinetic energy of the shell is virtually all converted to potential energy at the peak of the trajectory. The fall from the peak is nearly vertical and the shell reaches terminal velocity when the air drag equilibrates its weight.
- b. The shell, Howitzer, 105mm was included among the fragmenting projectiles to provide diversity of characteristics of the more destructive weapons used in the experiments. It contains approximately 4 lbs. of TNT. Although this is less than one-half the bursting charge of the 4.2-inch mortar, the thicker wall of the 105mm shell compensates, in part, for the lesser charge and produces very destructive fragmentation.

- c. The grenade, M26 is a hand-thrown weapon carrying a small bursting charge which projects a deadly spray of fragments due to the gridded scribing of the containment shell. Unlike the hand grenade familiar to World War veterans, the M26 has a smooth outer surface; the scribing is internal. It is an individual-carried weapon which may be expected almost anywhere in close combat and in surprise raids.

#### 1-4.3 Penetrating Projectiles

This term is used herein to classify bullets and shaped charge projectiles which inflict damage primarily by penetration.

- a. Antitank rockets employ shaped charges, each augmented by one steel pellet, to penetrate tank armor. The Rocket, 66mm, HEAT and the Rocket, 3.5 inch, HEAT are representative of current antitank rockets employed in South Vietnam, according to U. S. Marine returnees with whom these weapons were discussed. They were selected for the experiments.
- b. The rifle, M16, currently employed by U.S. forces in South Vietnam, is representative of enemy rifles encountered and was selected.
- c. The cartridge grenade, 40mm, M79, is a shaped charge, impact fuze grenade, in the configuration of a blunt nosed bullet, seated in a cartridge with a low velocity propellant charge. It is fired from a smooth-bore launcher which is quite similar to a sawed-off, single barrel shotgun. Its velocity in flight is low enough that it is visible and the trajectory is arched. It has considerable side blast as well as penetrating effect.

1-4.4 Exposure of Panels to the Blast Charges and Ordnance Items

Two basic methods were selected. The blast charges, mortar and artillery shells, antitank rockets and hand grenade, M26, were hand placed and detonated by a small charge of Composition, C4, primed and actuated by a powder train fuze cut to allow six minutes of time-delay. Ordnance items were supported in the position relative to the panels they would be expected to have at the instant of burst if live-fired, except that flat-base shells were positioned base down for stability in the fragmentation experiments where fragmentation from the cylinder wall was most significant. The rifle, M16 and the cartridge grenade, M79, were live fired.

1-4.5 Program of Surface Blast, Shell and Grenade, and Aimed Weapons Experiments

In the surface blast experiments, varied numbers of panels were positioned in tandem at varied distances from a bridge pier simulator and the blast charges were placed on the most remote panel. The distance from the pier simulator to the charge is termed, "the stand off distance." The pier simulator consisted of 13 solid concrete blocks, 5½"x12"x6'-0", interfaced on the 12" faces and bolted tightly together by means of six 1-inch diameter threaded rods to form an assembled slab 6'x6'x1' which lay flat on the ground. Further information of experimental methods is presented in Chapter 3. The selected program of surface blast experiments is presented in Table 1-4.

---

Table 1-4 PROGRAM OF SURFACE BLAST EXPERIMENTS

<u>Charge,</u> <u>lbs. TNT</u>	<u>Stand Off</u> <u>Distance</u>	<u>Number of</u> <u>Panels</u>	<u>Spacing</u>
2	6'	2	12"
4	6'	2	12"
8	6'	3	12"
20	6'	3	12"
8	4'	2	24"
20	4'	2	24"

---

#### 1-4.6 Program of Underwater Blast Experiments

The underwater blast experiments were conducted about 75 yards offshore of San Clemente Island, California, in the Pacific Ocean in varying depths of water from 16 feet to 21 feet, as affected by tide. The pier simulator consisting of four mooring buoy anchors of concrete, each about 4'x4'x2.5' arranged to provide an assembly about 8' in height and width and 2.5' in thickness. Varied two, three and four panel arrangements and conditions of support were exposed to charges ranging from 2 lbs. to 20 lbs. of TNT.

The charge position, on the central axis of the panels and pier simulator was 5 feet above the ocean bottom, at 11 feet to 16 feet below the water surface. The program of the experiments is shown in Table 1-5. The water depths were determined by daily soundings and corrected for tide variation between the time of sounding and time of detonation. Panel supports described as 2-edge are as nearly so as rolled steel shape and welding tolerances permitted. Those described, "sling suspended", have wire strands looped through holes drilled in the upper corners and each looped over a horizontal pipe support. Panels thus supported were free to swing. The top edges of the panels were approximately 5" below the pipe supports. Where two panels are tabulated at the same distance from the pier they were as nearly inter-faced as the suspension permitted and the distance was to the panel toward the charge.

Table 1-5 PROGRAM OF UNDERWATER BLAST EXPERIMENTS

<u>Shot No.</u>	<u>Date Aug. 68</u>	<u>Charge Wt. TNT</u>	<u>Charge Depth</u>	<u>Panel Arrangement No. &amp; Ft. From Pier</u>
1	23	2 lbs.	14.0'	1 @ 10.0' 1 @ 9.0' 1 @ 8.0'
2	24	2 lbs.	12.0'	1 @ 7.0' 1 @ 6.0' 1 @ 5.0'
3	24	2 lbs.	11.0'	1 @ 4.0' 1 @ 3.0' 1 @ 2.0'
4	25	4 lbs.	15.8'	1 @ 15.5' 2 @ 10.5' 1 @ 1.5'
5	25	8 lbs.	12.5'	2 @ 15.5' 1 @ 10.5' 1 @ 1.5'
6	25	8 lbs.	12.3'	1 @ 15.0' 1 @ 1.5'
7	25	20 lbs.	12.3'	Same as No. 4
8	26	20 lbs.	15.0'	1 @ 9.5' 2 @ 6.5' 1 @ 1.5'
9	26	20 lbs.	16.2'	1 @ 9.5' 1 @ 6.5' 1 @ 1.5'
10	26	20 lbs.	12.8'	1 @ 6.5' 1 @ 3.5' 1 @ 0.5'

Shots No.1-3 : 2-edge Support  
Shots No.4-10: Sling Suspended

## Chapter 2

### CASTING AND CURING OF PANELS

#### Section 2-1

##### General

The parametric experiments were conducted on five firing days on the rifle range on the following dates in 1968: (1) June 3, (2) June 10, (3) June 17, (4) June 28, and (5) July 8.

Panels for each firing day were cast in a casting run for the particular firing, consequently the number of panels cast in one run varied from three to seven. For such small numbers, the panels were cast in one-panel forms with equipment used in connection with cement laboratory tests. This equipment had been used extensively and was well proven. Twenty-seven panels were cast in a 36 day period.

One hundred and thirteen panels were cast for the experiments at Camp Pendleton and San Clemente Island and the laboratory tests at N.C.E.L.. In order to consolidate the trucking of panels to Camp Pendleton and shipment to San Clemente Island, a casting method with a greater output rate was chosen. In the absence of experience in volume casting of ferro cement, by the contractor or reported by others, this effort was, in fact, an experiment, although it was not planned as such. Some delay was encountered at the outset and thereafter 113 panels were cast during the period July 25 to August 2. Quality of the product was below that desired and valuable lessons were learned.

Both panel casting methods will be presented in retrospect and the lessons learned will be presented.

## Section 2-2

### Casting and Curing of Panels for the Parametric Experiments

#### 2-2.1 The Casting Operation

The wire mesh reinforcement layers were cut to size by means of a carborundum disc on a table saw. The layers were positioned in a wooden jig to form a stack of thickness equal to the panel thickness. The numbers of layers are shown in Table 2-1. The stacked layers were tied with tie wire so that the stack could be transferred to the form without disturbance.

Table 2-1 TYPES AND AMOUNT OF REINFORCEMENT

<u>Panel Thickness</u>	<u>Reinforcement</u>	<u>Number of Layers</u>
½"	½" Wire Cloth	5(1)
1"	½" Wire Cloth	9(1)
1½"	½" Wire Cloth	15(1)
1½"	½" Hardware Cloth	18
2"	½" Wire Cloth	22(1)
1"	¾" Wire Cloth	9
1"	¾" Hardware Cloth	13
1"	Exp. Metal Lath	8(2)
1"	Exp. Metal Lath	9(3)
1"	2" Welded Wire Fabric	1

Notes: (1) Reason for non-proportionality was not ascertained.

(2) Through Parametric Experiment 6.

(3) Beyond Parametric Experiment 6.

Single panel forms of 3/4" plywood with 2" (nominal) x panel thickness side forms, nailed in position, were placed on the 1/2" steel bed of the vibrating table. The steel bed was supported on four 4 1/2" coil springs which rested on the 3" channel frame of the assembly. The springs and bed were retained laterally by 3/4" diameter vertical steel rods welded to the frame and extending up through the coil springs and 3/16" oversize holes in the bed. An air driven external vibrator was bolted to the bed.

Mortar was mixed in a 1/2 sack paddle mixer and discharged into a wheelbarrow from which it was placed in the forms with a hand scoop. The form containing the vibrated and screeded panel was placed aside for trowel finishing at the proper stage of setting.

#### 2-2.2 Curing of the Panels

Panels for Experiments 1 and 2 were placed under water maintained at 70 degrees F. as soon as they could be stripped, where they remained for approximately 30 hours. Thereafter, they were in the atmosphere within a heated building at an average temperature of about 75 degrees F. until they were taken to the rifle range. Portland cement, Type III, is a high early strength cement. Panels for Experiments 3 through 8 were cured 30 hours in a vapor saturated atmosphere within an insulated enclosure at 120 degrees F. and in the prevailing outside temperature of 57 to 85 degrees until taken to the range.

The age of the panels in the parametric experiments when exposed to fire is shown in Table 2-2.

#### 2-2.3 Control Specimens and Strengths

Cylinders, 3"x6", were moulded of each casting and given the same cure as the panels. The strengths are shown in Table 2-2.

Table 2-2 CYLINDER STRENGTHS, PARAMETRIC EXPERIMENTS

Exp. No.	Age At Exp.	W. C. Ratio	Cylinder Strengths (psi)				
			4-Day	5-Day	7-Day	9-Day	28-Day
1(a)	5 days	0.45	-	11000	-	-	-
1(b)	5 days	0.75	-	3540	-	-	-
2(c)	5 days	0.60	-	6360	-	-	-
3	5 days	0.69	-	4610	4710	-	6010
4	5 days	0.70	-	4530	5350	-	6010
5(d)	9 days	0.60	-	-	5700	6440	7920
6	4 days	0.75	4240	-	4310	-	5560
7(e)	5 days	0.29	-	4090	-	-	7510
8	7 days	0.75	-	-	5300	5330	-

Notes: Mortar Mixes: (a)-1:1.0; (b)-1:3.75; (c)-1:2.5;  
All others - 1:2.5

Comparison Panels: (d) Conventionally reinforced  
with 1 layer of wire fabric.

(e) Fast Fix I Cement

## Section 2-3

### Casting and Curing of Panels for the Field Service Experiments and the Laboratory Tests

#### 2-3.1 Reinforcement

Expanded metal lath, as tried in the parametric experiments was selected for all panels with the exception of one each of  $\frac{1}{4}$ " hardware cloth and 2"x10g wire cloth for the laboratory tests. It was decided that the size of the 2" panels for TNT blast experiments should be approximately  $3\frac{1}{2}$  ft. x  $3\frac{1}{2}$  ft.. Expanded metal lath is manufactured in 27" sheets, normally 8' in length. A decision was made to provide the necessary width by abutting 27" sheets and  $13\frac{1}{2}$ " (nominal) pieces cut from 27" sheets, rotating the recognized line of flexural weakness around the panel in successive layers. Two 27"x $40\frac{1}{2}$ " pieces cut from a 27"x96" sheet leave a 15"x27" piece. It was decided to use 6 layers of reinforcement from the panel surfaces inward, with filler stacks of 6 narrow pieces of the waste lath between them. When lath was delivered after some 10 days of lead time, it was found to be in sheets  $27\frac{1}{2}$ "x $97\frac{1}{2}$ ". Nine sheets produced 12 pieces  $27\frac{1}{2}$ "x $41\frac{1}{4}$ ", 12 pieces  $13\frac{3}{4}$ "x $41\frac{1}{4}$ " and 6 stacks of 6 pieces each,  $27\frac{1}{2}$ "x $3\frac{3}{4}$ ", enough for one panel. The 6 stacks were arranged in four rows at about 6" centers and one on either side opposite the ends of the four. The 2" panels were cast  $41\frac{1}{2}$ "x $41\frac{1}{2}$ ". For the laboratory specimens with less than 9 layers of expanded metal lath, small square stacks of lath were used to separate the two layers of reinforcement toward the panel surfaces.

For the  $27\frac{1}{2}$ "x $27\frac{1}{2}$ " panels, the  $27\frac{1}{2}$ "x $97\frac{1}{2}$ " sheets were cut to 4 -  $27\frac{1}{2}$ "x $24\frac{1}{4}$ " pieces which were stacked, 9 to a panel with the long directions alternated at 90 degrees. A photograph of the reinforcement cutting operation is shown in Figure 2-1. All reinforcement stacks were securely wire tied.



Figure 2-1  
Cutting of Reinforcement

### 2-3.2 The Multi-Panel Forms

The vibrating table used in the parametric tests would not accommodate the  $41\frac{1}{2}'' \times 41\frac{1}{2}'' \times 2''$  panel forms, consequently form beds had to be fabricated. It was decided that multi-panel beds would be used. The beds each formed 8 -  $41\frac{1}{2}'' \times 41\frac{1}{2}''$  panels or 12 -  $27\frac{1}{2}'' \times 27\frac{1}{2}''$  panels. These beds are shown in Figures 2-2 and 2-3. Four turbo-vibrators were affixed to the form bed in use (Fig. 2-4).

### 2-3.3 The Casting Operation

All panels were cast of 1:2.5 mortar with water cement ratios of 0.8, for 8 -  $41\frac{1}{2}'' \times 41\frac{1}{2}'' \times 2''$  panels cast July 25, 1968 and 0.75 for all others. Mortar was mixed in a one sack paddle type mortar mixer (Fig. 2-5) and placed in the forms from a wheelbarrow. Difficulty was encountered in gaining adequate vibration of the mortar. The form bed supports were stiffer than those of the vibrating table used in casting panels for the parametric tests. The turbo-vibrators appeared to have higher frequency than the rotating ball external vibrator attached to the vibrating table. The high frequency,



Figure 2-2 Multi-Panel Form Bed,  
41½"x41½"x2" Panel Forms



Figure 2-3 Multi-Panel Form Bed,  
27½"x27½"x1" Panel Forms



Figure 2-4 Turbo-Vibrators  
Attached to Form Bed



Figure 2-5 Paddle Type  
Mortar Mixer

short amplitude vibration of the beds did not vibrate the reinforcement stacks sufficiently. The stacks tended to float while the beds vibrated beneath them. The mortar was slow in flowing down through the layers of reinforcement, resulting in longer vibration time for each panel. It was, of course, not possible to vibrate one panel without vibrating others previously placed. Vibration at the end where casting was begun could be decreased by stopping one or two vibrators toward that end, but the earlier placed panels were, nevertheless, being over-vibrated.

In some panels free water came to the surface. Completion of casting in time to use ranges at Camp Pendleton precluded a change in the casting method.

#### 2-3.4 Curing of the Panels

After finishing, the panels were covered and exposed overnight to a warm, vapor saturated atmosphere. On the following morning the covers were removed and the panels allowed to harden and gain enough strength to be stripped. They were then submerged in a saturated lime solution for a period of 3 to 4 days. Ordinary playground plastic wading pools were used for tanks (Fig. 2-6).



Figure 2-6 Panels Curing in Saturated Lime Solution

2-3.5 Control Specimens and Strengths

Cylinders were picked up by the testing laboratory, given standard laboratory curing and tested at 7 days and 28 days. The cylinder strengths and densities are shown in Table 2-3.

Table 2-3 DENSITIES AND CYLINDER STRENGTHS  
FIELD EXPERIMENTS AND LABORATORY TESTS

<u>Date Cast</u>	<u>Panel Size</u>	<u>Number Cast</u>	<u>Density lbs/ft<sup>3</sup></u>	<u>Cyl. Str. (psi)</u>	
				<u>7-day</u>	<u>28-day</u>
7-25	4 1/2" x 4 1/2" x 2"	8	127 <sup>(a)</sup> 118	2160 <sup>(a)</sup> 2890	3180 <sup>(a)</sup> 4420
7-27	" 27 1/2" x 27 1/2" x 1"	8 12	133	3750	5250
7-29	4 1/2" x 4 1/2" x 2" 27 1/2" x 27 1/2" x 1"	8 12	123	3380	4240
7-30	4 1/2" x 4 1/2" x 2" 27 1/2" x 27 1/2" x 1"	3 12	128	2730 <sup>(b)</sup>	4640
7-31	27 1/2" x 27 1/2" x 1"	12	132	3860	5280
8-1	4 1/2" x 4 1/2" x 2" 27 1/2" x 27 1/2" x 1"	8 12	129	3510	4780
8-2	4 1/2" x 4 1/2" x 2" 24" x 24" x 1"	7 <sup>(c)</sup> 11 <u>113</u>	131	3320	4130

Notes: (a) 6"x12" Cylinder; All others 3"x6"  
(b) Cylinder had one bad end.  
(c) Laboratory Panels

## Section 2-4

### The Two Casting Methods in Retrospect

#### 2-4.1 One-at-a-time Panel Casting for the Parametric Experiments

The very important advantage of this casting method is the opportunity it provides for giving each panel the amount of vibration required to produce a dense panel, free of air pockets or bubbles on the under side, with no other panel being over-vibrated. The reinforcement layers were a close fit within the side forms. It is believed that this contributed a great deal to the vibration of the reinforcement stack, which is the main contributor to the downward flow and lateral spread of the mortar.

An observation relative to mixing is peculiar to sand-cement mortar. A  $\frac{1}{2}$  sack drum mixer was first tried. The mix, without coarse aggregate, tended to ball and roll and mortar dropped from the fins in one mass without much internal agitation. The trial batches were rejected and a paddle type mixer was used. When the paddles on this type of mixer have become quite worn, a layer of mortar adheres to the surface of the hopper and is difficult to discharge. It will, most likely not be well mixed and should preferably not be discharged, except for the possibility that it builds up and some of it may enter later batches after it has attained its initial set.

Carborundum discs mounted on the arbor of a table saw provide a fairly fast means of cutting wire mesh or expanded metal. The insertion of tie wires through a stack of  $\frac{1}{4}$ " mesh or expanded metal is a tedious operation. Hardware cloth was cut toward one side of the mesh openings and stacked so the openings did not line up, in order to gain a random distribution of wires through the panel. Expanded metal layered with the axial directions of the rhombuses alternated at 90 degrees offers few straight through paths for tie wires.

#### 2-4.2 Multi-Panel Casting for the Field Experiments and Laboratory Tests

The advantage of one-at-a-time panel casting was stated in Paragraph 2-4.1. The converse of that statement was found to be true of multi-panel casting. Difficulties with vibration associated with the stiffness of the form bed mounts could be overcome with spring mounting, but no reason is seen, in retrospect, for using multi-panel form beds. The panels were, in fact, cast one at a time in the multi-panel form beds. The tendency of the reinforcement stacks not to vibrate with the forms was due, in part, to their not fitting snugly within the form sides. The beds, fabricated of 8" channels, were covered with 16 gauge steel sheet. Steel sheet may not be absolutely flat. Leakage at the junction of the form sides and the steel sheet was overcome only by taping, which becomes troublesome when forms are used repetitively.

#### 2-4.3 Lessons Learned From the Experience

Panel forms should be independent of each other and panels should be cast and vibrated singly. One single-panel, vibrating form bed may be considered the unit of measure of the size of a continuous casting plant. The facilities and personnel for cutting reinforcement, layering and tying it in stacks and placing the stacks in forms at the casting rate are part of the unit. The facilities and personnel, downstream from the unit, engaged in finishing, initial curing and stripping are part of the unit. An efficiently laid out, well equipped unit with trained personnel should cast about 12 panels per hour. Where Type I Portland cement is used, in warm climates, batches may be sized for thirty-five minutes of casting. In this time about 3 cu. ft. net, of mortar would be cast, per unit, in 27"x27"x1" panels and about 19 cu. ft. net, in 48"x48"x2" panels. One mixer should serve several units and mortar transported to the units should be discharged into hoppers from which it would be admitted into the forms.

Mortar sand should pass a No. 8 screen. Number 4 is the absolute maximum size and it will make consolidation of the mortar difficult. The sand must be washed to remove fines because fines would occupy space between sand grains that must be occupied by cement. Slump is not a reliable control to use with mortar. The water-cement ratio should be the lowest with which good consolidation of mortar and elimination of honeycomb is obtained by vibration of the form bed.

The passage of mortar through the layers of reinforcement is affected by the type of reinforcement. Expanded metal lath presents more resistance than hardware cloth.

Relatively low frequency vibration (3000 rpm) of comparatively large amplitude is most effective for initial compaction; higher frequency (5000 rpm) of less amplitude will better accomplish the detailed particle adjustments necessary for final consolidation without harmful agitation of the compacted mortar.

The form bed should have freedom to move about  $\frac{1}{4}$ " laterally but need not have lateral springs. Vertical coil springs supporting the bed must have enough stiffness to support the entire load with at least  $\frac{1}{8}$ " clear distance between coils, which should expand to at least  $\frac{3}{8}$ " with no load on the form bed. Such springs, 3" or more in length, will respond well to any external vibration in the lower range of frequencies (3000 to 5000 rpm). An air driven, circulating ball type external vibrator, securely bolted to the form bed was found to be effective. The vertical motion of the form bed is more effective than the horizontal motion because all of it is imparted to the stack of reinforcement layers. The stack loses much of the horizontal motion by sliding on the bottom of the form.

Time spent in the design and fabrication of an efficient plant will be quickly regained in production of panels and continue to pay dividends in quality of panels as well as continued high production rate. Forms must be rugged. Nails or wood screws are ineffective connectors of wood or steel to plywood and screw connected friction joints of wood to steel are ineffective. Hinged side forms would facilitate stripping and re-assembling forms.

An untried suggestion is offered for the tying of reinforcement stacks. A heavier wire hooked at one end might be inserted through the stack, bent over on the other end with long nose pliers and snubbed down by two or three light blows with a hammer. This would require only one passage of the wire through the stack, whereas two are required with lighter wire. A table saw with a carborundum disc is a good tool for cutting mesh. Tough leather work gloves are essential in handling cut mesh, which has very sharp wire ends.

## Chapter 3

### METHODS USED TO SUPPORT PANELS AND EXPOSE THEM TO DEMOLITION CHARGES AND ORDNANCE ITEMS

#### Section 3-1

##### General

Parametric experiments involved comparisons between experiments, necessitating effort to minimize extraneous variables. Field experiments were independent of each other. Service production and installation of panels may readily equal the conditions in the field experiments.

#### Section 3-2

##### Methods in the Five Series of Experiments

##### 3-2.1 The Parametric Experiments

- a. Firing in the parametric experiments was conducted on the Angeles Shooting Club heavy caliber rifle range in the Los Angeles area. This range is equipped primarily for bench rest shooting. The firing line has overhead weather cover and is asphalt paved. The bench rests are very rigid and generously supplied with sand filled shot bags to enable the rifleman to fashion a rest for his piece to suit his taste. The 100 yard target position is defined by an anchored slotted base for paper target supports. The line of fire in our experiments was found to ascend at an angle of 3 degrees with the horizontal.

- b. The panel supports (Figure 3-1) were fabricated by a finish carpenter of straight grained Douglas Fir. Spacers used between multiple panels in tandem were in picture frame configuration, with rabbeted joints at the corners. Retaining frames with rabbeted corner joints were drawn against the front of the panel and spacer assembly by torquing the nuts on threaded rods through the frames and the main body of the supports. All four-edge contact surfaces were brought as near to a plane as finish carpentry tools would produce. The rear braces of the supports were bored for adjustment of the panels at angles with the horizontal of 90 degrees, 75 degrees, 60 degrees, 45 degrees and 30 degrees. (Figure 3-2) The supports were spirit-leveled fore and aft and sideward and each of the two skids was sand-bagged at its extremities. (Near the end of the experiments, a  $\frac{1}{2}$ " panel, precariously balanced on its lower edge with no other support, was exposed to two rounds of cal. .30-06 fire and one of cal. .280, near its upper edge without disturbing its balance.)
- c. Caliber .30-06 rifle fire was delivered by a U. S. Rifle, model 1917, which has the Enfield bolt action. The bore was in excellent condition. The ammunition was match grade with muzzle velocity of 2640 feet per second and bullet weight of 173 grains (0.395 oz. av.). Caliber .45 pistol fire at 10 yards was delivered by the U. S. Pistol, Cal. .45, semi-automatic. The bullet has a muzzle velocity of 860 feet per second and weighs 230 grains (0.525 oz. av.).
- d. Beginning with the third experiment (Table 1-1), where two or more panels were used in tandem the rear panel was a back up panel, which gave an indication of the damage, if any, which would be done to a protected object by bullet fragments or spall. Frequently the back up panel was of different design than that of the protective panels. Similarity was not necessary since the visual evidence provided by the back up panel was limited to surface damage.



Figure 3-1 Panel Support and Spacers,  
Parametric Experiments

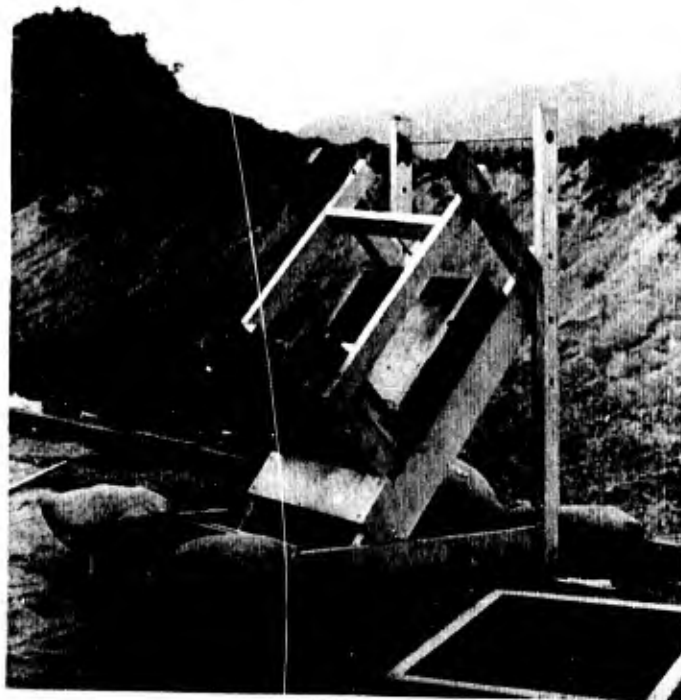

Figure 3-2 Panel Support at  
Oblique Angle of Incidence

### 3-2.2 Static Detonations on Horizontal Panels

- a. It was anticipated that any support used in these experiments would be severely damaged. Cribbing was chosen because a partially disarrayed crib may be quickly restored and destroyed cribbing may be replaced without carpentry. (Figures 3-3 and 3-4). Eight-by-eight cribbing was used from the ground to the lower panel and six-by-six's were used where necessary to space the panels at the desired distance. Rigidity and four-edge support were provided by the use of wedges and wedge shingles. Figure 3-5 shows the use of fill cribs and wedges to complete the four-edge support. The TNT charge was placed in the center of the top panel. (Figure 3-6).
- b. Since it was anticipated that panels in the path of blast charges would be destroyed, but would provide protection of piers by enforcing stand off, it was necessary to provide simulation of a bridge pier. A composite concrete slab, 6'x6'x1', was placed on the ground and the crib was erected around it. (Figure 3-7). The slab was composed of 13 segments, each 6'x1'x5½", snugly interfaced by the drawing up of nuts on six 1" diameter threaded rods which ran through the assembly. Each segment was reinforced with two 3/8" diameter bars. The ground surface was prepared with hand tools. The soil was dessicated adobe so it is unlikely that uniform bedding of the slab was achieved.
- c. Cribbing was also used to support panels in the delayed fuze experiments where mortar and artillery shells were detonated midway between two panels. The shell in each case was supported on a 1x8 inserted through the cribbing (Figure 3-8).

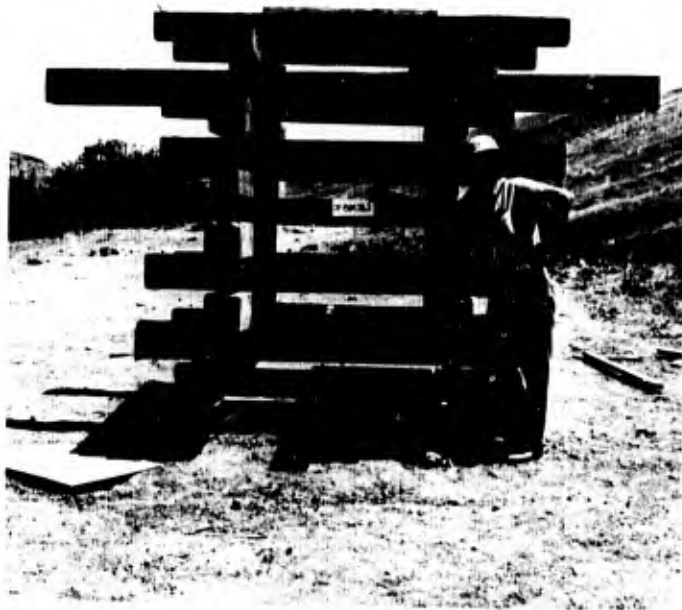

Figure 3-3 Crib Panel Support,  
Surface Blast Experiments



Figure 3-4 Crib Panel Support,  
Surface Blast Experiments



Figure 3-5 Fill Cribs and Wedges  
to Provide Four Edge Support



Figure 3-6 Placement of  
Surface Blast Charge



Figure 3-7 Composite Slab,  
Pier Simulator

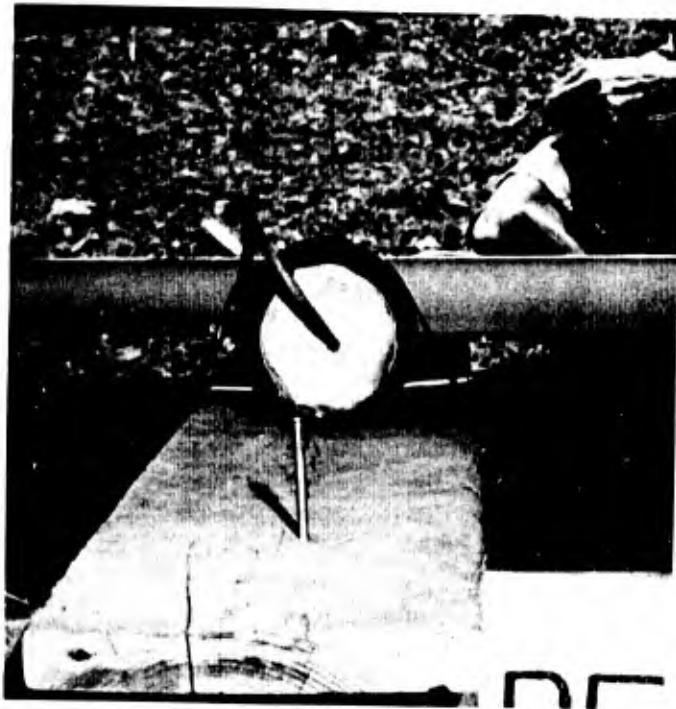

Figure 3-8 Shell Placement in  
Delay Fuze Experiments

- d. Panels exposed to antitank rockets and hand grenades were supported on cribbing. Anti-tank rockets were placed, nose down, on the top panel and supported in the vertical position by expendable supports made of styrofoam. The placement of the 66mm rocket is shown in Figure 3-9 and the 3.5 inch rocket, in Figure 3-10.

The hand grenade, M26, was placed on the top panel with its axis of symmetry vertical, fuze well up, as shown in Figure 3-11.

### 3-2.3 Fragmentation Experiments

In these experiments, with the shells placed vertically, three stand offs were tried with each detonation. Three panels in tandem, placed vertically at 6½" spacing, were supported at two stand off positions in supports which were used in the parametric experiments and, at the third stand off, in supports composed of two sills, laid across two pieces of cribbing, with pairs of 2x4's, edge interfaced, nailed in vertical position to the sills. The panels rested on the sills and occupied spaces between pairs of 2x4's, thus being spaced at 7". The assembly was securely braced, fore and aft and sideward and the 2x4 verticals were drawn snug against the panels by means of wedges. Supports were set at three stand off positions around the pier simulator which had been used in the blast experiments and blocking was placed on the simulator to support the shell, base down, at panel height. The third stand off position provided only 2-edge support. Views of the three position arrangement are shown in Figures 3-12 and 3-13 and views of the placement of shells in Figures 3-14 and 3-15.

### 3-2.4 Rifle and Cartridge Grenade

The supports and spacers used in the parametric experiments and again in the fragmentation experiments were repaired and used in the experiments with the rifle, M16 and the grenade, cartridge, M79. Extensive repair work was required and less effort was devoted to uniformity of four edge support, since it had been learned that little reaction from such weapons would reach the supports, due to the inertia of the panels.



Figure 3-9

Placement of Rocket, 66mm, HEAT

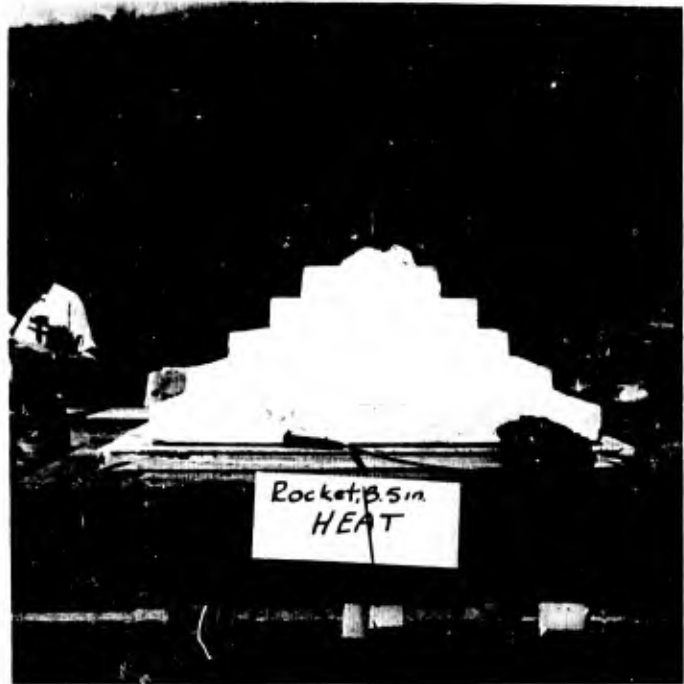

Figure 3-10

Placement of Rocket, 3.5 inch HEAT



Figure 3-11

Placement of Grenade,  
Hand, M26



Figure 3-12

Three Stand Off Position Arrangement,  
Fragmentation Experiments



Figure 3-13

Three Stand Off Position  
Arrangement, Fragmentation Experiments



Figure 3-14

Placement of Shell,  
Fragmentation Experiments



Figure 3-15

Placement of Shell,  
Fragmentation Experiments

Live fire was delivered with the grenade launcher at a range of about 70 yards. The panels were small targets for the launcher at this range and six shots were required in order to score four hits. Seventy yards is about the minimum safe range and even at that range, the firer wore a steel helmet and a flak vest. There was evidence that some small, nearly spent fragments reached the firing line. Slow fire with the rifle, M16, was delivered from about 70 yards. After the panels proved to be small targets for full automatic fire at this range, the firer moved in to 10 yards, unhooked the tail of the sling so it trailed on the ground and placed his foot on it to restrain climb of the piece. By this method he was able to place 35 rounds of automatic fire in an area of about 20 square inches.

### 3-2.5 Underwater Blast Experiments

The underwater blast experiments were conducted in Wilson Cove, San Clemente Island, California. Water depths are shown in Table 1-5.

The oceanographic environment is given in Table 3-1.

---

Table 3-1 OCEANOGRAPHIC ENVIRONMENT, WILSON COVE

---

Location:	118° 33'22" W. 33° 00'21" N.
Salinity:	33.63 to 33.67%
Temperature:	
Surface	66.2° F.
6 Meters	62.6° F.
Currents:	
Velocity	0.1 knot Av.
Direction	Varied

---

A structural steel framework was fabricated from the most adaptable structural steel available on the island to secure the pier simulator and provide 4-edge simple support for the panels placed in varied numbers and at varied spacing and distances from the pier simulator.

The pier simulator was assembled of four mooring buoy anchor blocks of concrete, approximately 4'x4'x2.5', weighing 6000 lbs. each. The four 4'x2.5' (approx.) faces were slightly tapered. A recess in the larger square face, visible in several photographs, usually elicits curiosity. Its purpose was to receive the lifting eye cast in the opposite surface so the anchors would stack flat. The recess was cast by means of the simple expedient of placing a pottery planter upside down on the form bottom.

The anchor blocks were stacked, two wide and two high, alternated so the battered surfaces would interface, to form a pier simulator, approximately 8'x8'x2.5'. The top surfaces of the lower two blocks were buttered with Embico ready mixed grout before the upper blocks were placed. This grout contains iron filings to prevent shrinkage. Grout was worked into the vertical joints as well as possible. Wooden wedges were driven between the anchor blocks and structural steel members to secure the blocks and a tie-down channel across the top of the blocks increased the pressure of the upper blocks on the lower ones.

Three views of the supporting frame work are shown in Figures 3-16, 3-17, and 3-18.



Figure 3-16 Structural Steel Support Frame  
For Panels and Pier Simulator

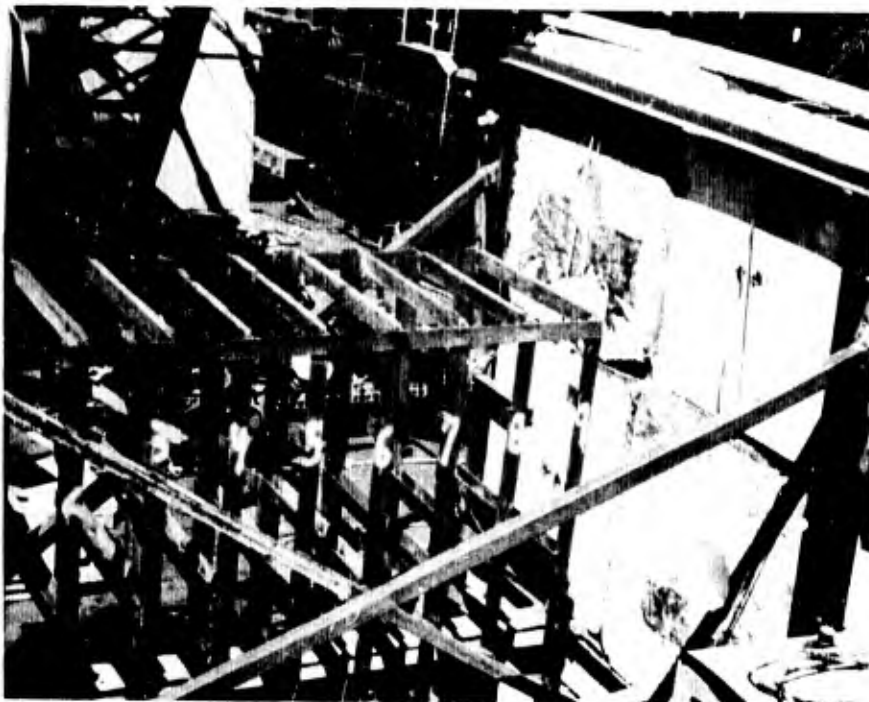

Figure 3-17 Front View of Support Frame  
With Pier Simulator Installed

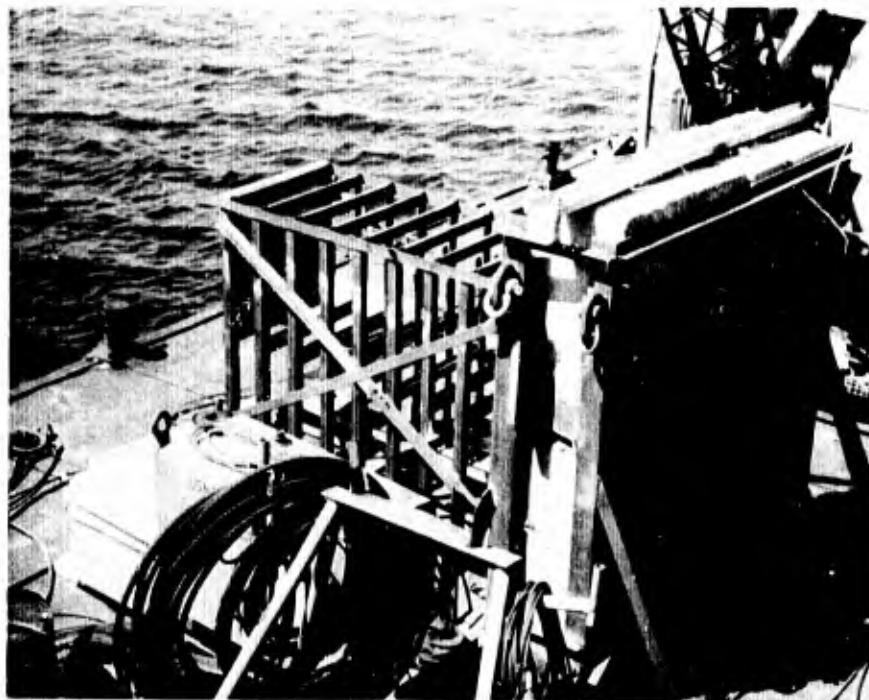

Figure 3-18 Rear View of Support Frame  
With Pier Simulator Installed

Complete 4-edge support of panels was not achieved, due to tolerances in rolled shapes and in welding without secure jigs. The panel edges were secured to the vertical supports with C-clamps in the first three experiments. Furthermore, the horizontal edge supports broke loose at the welds when the charges were detonated. The vertical edge supports securing panels in each shot were bent and twisted by the blast and bubble collapse to such extent that none were re-usable. After one progression toward the pier of panel settings with 2 lb. charges, two pipe rails were installed from which the panels were suspended, free to swing, by means of 1/4" steel wire cable, passed through 7/16" diameter holes drilled near the upper corners of the panels, and looped over the rails. The pipe rails required repair after each shot and replacement before the experiments were finished.

The panels were placed in the frame on the deck of a Diesel powered derrick barge and the TNT charge was affixed on the outer panel. The frame, containing panels and pier simulator was then hoisted, swung beyond the rail and lowered to the ocean bottom. Divers then trailed out the electric line with the primer attached and inserted the primer. The barge then backed off a safe distance and the charge was detonated. The divers made the underwater inspections and affixed slings and lines for the retrieval of broken and destroyed panels. The frame was hoisted back on deck after each shot for inspection of the pier simulator and of panels which remained secured or were lodged in the frame.



Figure 3-19 Plume From Underwater Demolition Charge

## Chapter 4

### EXPERIMENTAL RESULTS AND CONCLUSIONS

#### Section 4-1

##### General

The visual evidence of the response of panels to several ordnance items and surface and underwater blast charges is presented by means of photographs, which constitute the primary report of results. The information which accompanies the photographs, intended to facilitate their informative examination, is arranged in format to keep it on pages facing the photographs. The figures in this chapter are designated with the section sub-heading number, followed by two digits, which represent their sequence therein. Thus, for example, Figure 4-2.103 is the third figure in sub-section 4-2.1. Since titles are given on facing pages, only the figure numbers are shown beneath the photographs.

## Section 4-2

### Parametric Experiments

#### 4-2.1 Experiments 1 and 2 (Various Mortar Mixes, 1" Panels)

These experiments, programmed separately in view of the possibility that Experiment 2 would not be required, were conducted together for the purpose of deciding between three mortar mixes, 1:1.00, 1:2.50, and 1:3.75 cement to sand (Tables 1-1 and 1-2, Chapter 1).

##### Lean Mix 1:3.75

Three rifle rounds, followed by two pistol rounds were fired on Panel No. 1 (1:3.75 mix) and nine pistol rounds were fired on Panel No. 2 (1:3.75 mix). An area on the back surface of Panel No. 2 was seriously honeycombed in casting. Three rifle and two pistol rounds were fired on Panel No. 3 and three rifle and four pistol rounds on Panel No. 5, at ranges of 100 yards for the rifle and ten yards for the pistol. Panel No. 4, badly honeycombed, was not used.

Results are presented in the following figures:

Figure 4-2.101 Three Rifle Hits, Front  
Face, Panel No. 1 (1:3.75)

Figure 4-2.102 Back Face, Panel No. 1

Figure 4-2.103 Two Pistol Hits Added to  
Front Face, Panel No. 1

Figure 4-2.104 Nine Pistol Hits, Front  
Face, Panel No. 2

One penetration and one deep lodgement in the mesh, of pistol rounds, occurred in the honeycombed area where there was only  $\frac{1}{2}$ " of good cement. The honeycombed area permitted gradual evaluation of pistol fire from complete stoppage to full penetration of the bullet.

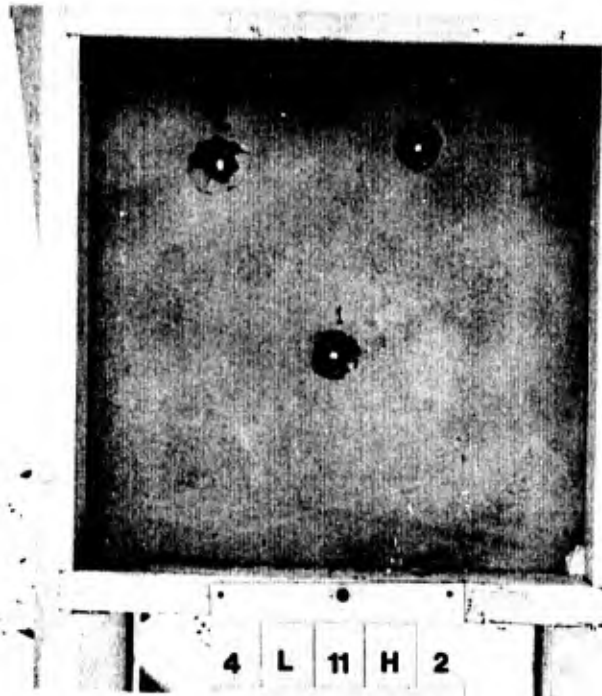

Figure 4-2.101



Figure 4-2.102

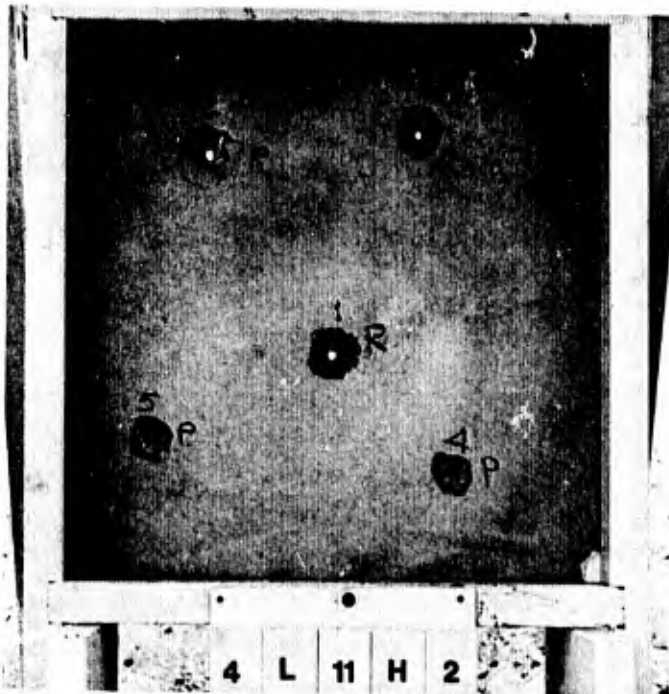

Figure 4-2.103

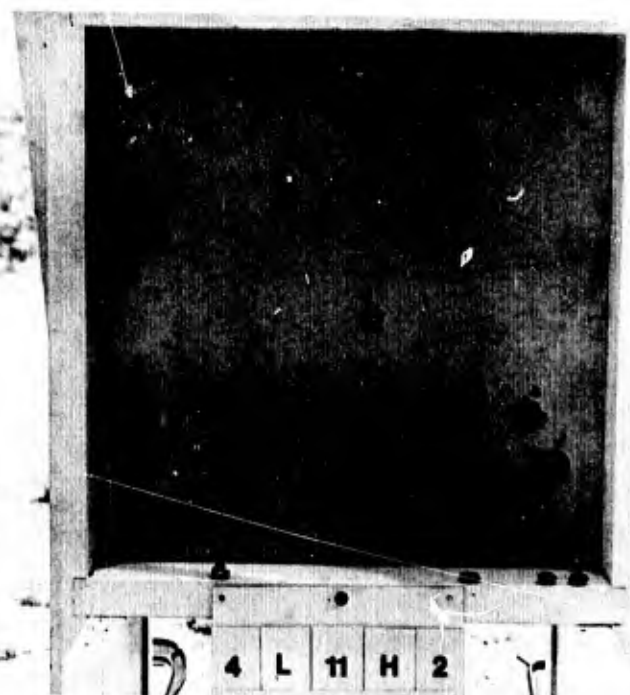

Figure 4-2.104

Figure 4-2.105 shows the lodgement of the pistol bullet in the mesh of Panel No. 2

Medium Mix 1:2.5

Figure 4-2.106 and Figure 4-2.107 show the front and back faces respectively, of Panel No. 3 (1:2.5) after exposure to three rifle rounds and two pistol rounds

Rich Mix 1:1.0

Figure 4-2.108 and Figure 4-2.109 show the front and back faces, respectively of Panel No. 5, after exposure to three rifle and four pistol rounds.

All pistol bullets rebounded 7 to 9 yards, deformed to a mushroom shape, with the exception of the honeycombed area on the back of Panel No. 2.

All rifle bullets penetrated the panels. The wire cloth was dished outward where rifle bullets exited and, in some cases, wires were severed and curled backward. The evidence of comparative damage was confined to spalling. Pronounced difference was not observed, but the panels of 1:2.5 mix revealed discernable improvement in comparison to those of 1:3.75 mix. No difference could be detected between the panels of 1:2.5 and 1:1.0 mix. Casting of the 1:1.0 mortar had been somewhat troublesome, particularly the elimination of bubbles where entrained air accumulated. In the light of these considerations, the 1:2.5 mortar mix was selected.



Figure 4-2.105

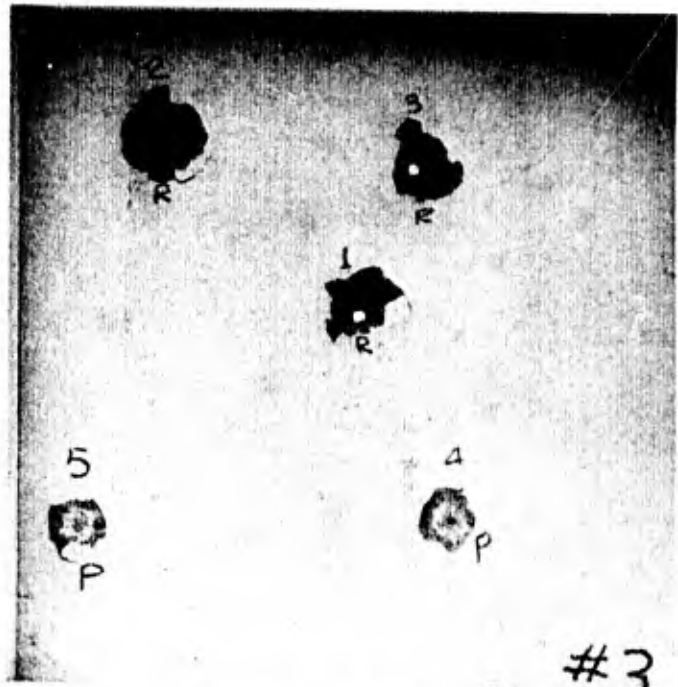

Figure 4-2.106



Figure 4-2.107

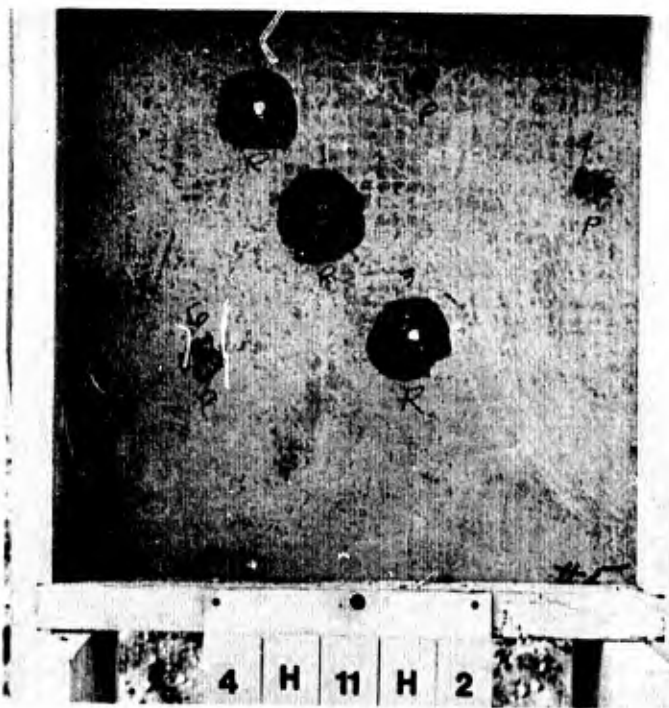

Figure 4-2.108

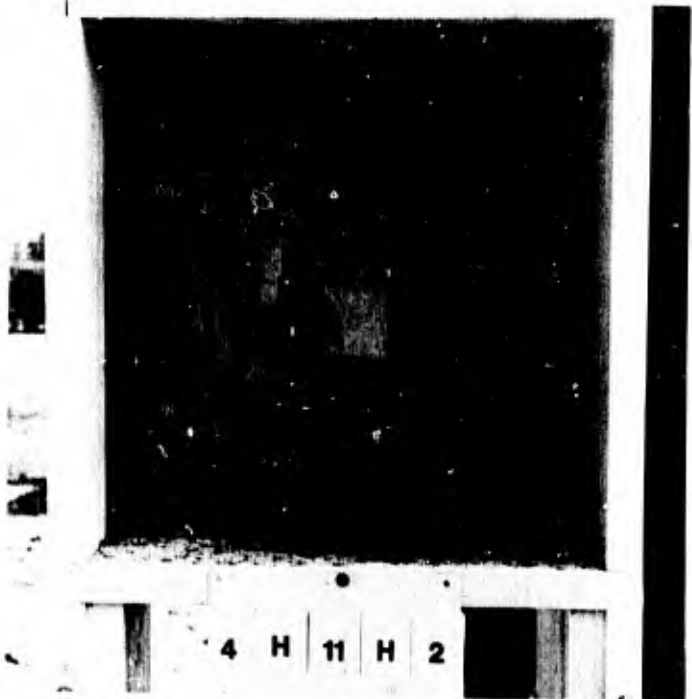

Figure 4-2.109

#### 4-2.2 Experiment 3 (Various Thicknesses of Panels)

This experiment was conducted in order to select one or more panel thicknesses. Evidence of the response of  $\frac{1}{2}$ ",  $1\frac{1}{2}$ " and 2" panels was obtained in addition to evidence already obtained of the response of 1" panels.

##### 2-inch Panels

Figure 4-2.201 and Figure 4-2.202 show the front and back faces, respectively, of the 2" panels after exposure to two rifle rounds.

Figure 4-2.203 and Figure 4-2.204 reveal the added effect of four additional rifle rounds on the front and back faces, respectively.

The encircling crack patterns on the front surface are believed to be the boundaries of the areas over which front face spalling force was exerted by elastic rebound of the wire cloth. The crack pattern has a radius of about  $2\frac{1}{4}$ " and the area from which spalls have been ejected has a radius of about  $1\frac{1}{2}$ ". A bullet lodged in the mesh at the back face is indicated in Fig. 4-2.202. The first round hit at the intersection of two wires and severed wires in the first two layers (Fig. 4-2.201). The second round entered through the mesh pattern and only one wire was severed. The first two rounds created a spalled area on the back face approximately 6"x14" in size (Fig. 4-2.202). Four of the rounds penetrated the panel (Fig. 4-2.204) and two were lodged in the wire cloth, one at  $1\frac{3}{4}$ " penetration and the other at  $2\frac{1}{8}$ " in bulged wire cloth. Bright pieces of stripped copper jackets and finely divided lead from the bullet core were found in the debris back of the panel (Fig. 4-2.204). The photographs of the front face (Figures 4-2.201 and 4-2.203) reveal two concentric spall patterns. The inner pattern indicates the radial shear caused by the penetrated bullet. The outer ring appears to be a surface severance caused by the elastic rebound of the mesh.

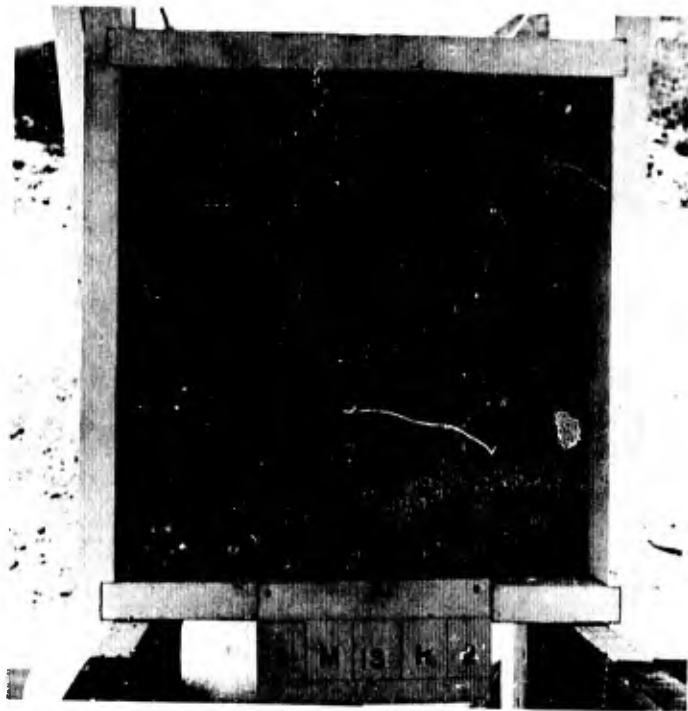
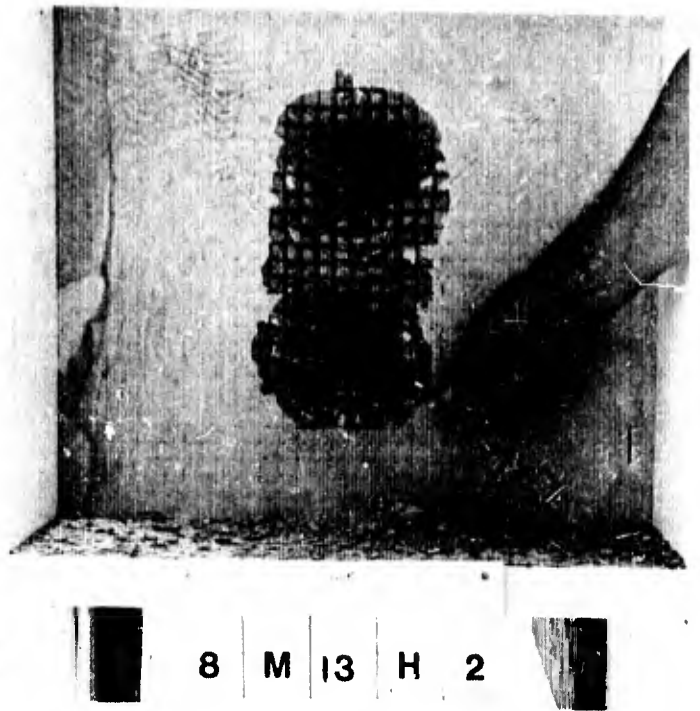
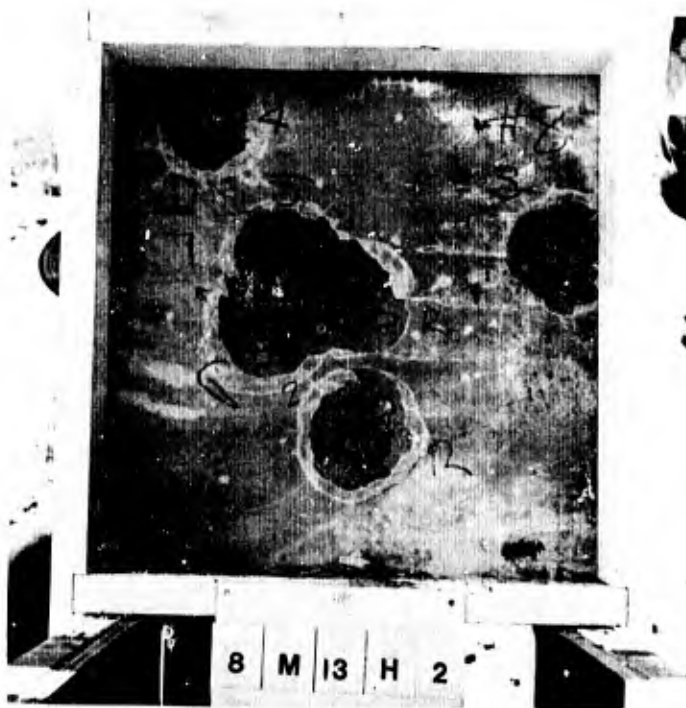

Figure 4-2.201



8 M 13 H 2

Figure 4-2.202



8 M 13 H 2

Figure 4-2.203

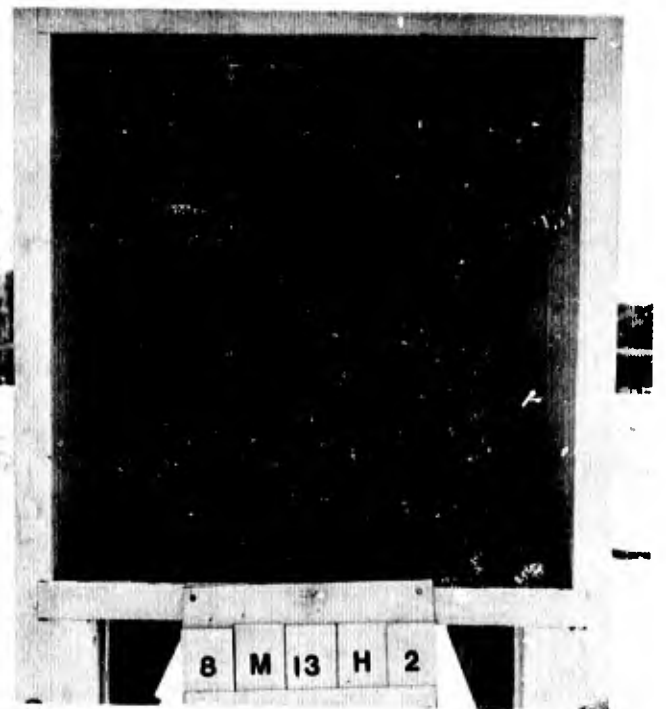

8 M 13 H 2

Figure 4-2.204

### 1 1/2 inch Panels

Six rifle rounds were fired on the 1½" panel with a back up panel. The clear spacing was varied, two rounds at 12", two at 1-7/8" and two at 6½", in that order.

Figure 4-2.205 Front Face, 1½" Panel shows the order in which the rounds were fired. The round numbers are above the hit in each case.

Figure 4-2.206 Back Face, 1½" Panel reveals the wire severance and spalling on the back face after five rounds were fired.

Figure 4-2.207 Front Faces of 1½" Panel and Back Up Panel (left) reveals the character of the spalled areas in sharp relief which exaggerates their depth.

It may also be noted that the severance of one wire in the front mesh layer of the 1½" panel occurred from rounds 1, 2 and 6 and no severance occurred from rounds 3, 4 and 5. The spalling on the front face of the back up panel is indicative of the residual energy after penetration of the 1½" panel. The first round caused no spall on the back up panel at 12" spacing. The fourth round, at 1-7/8" spacing almost penetrated the back up panel. A large piece of the bullet, lodged near the back surface, was pushed on through by means of a small stick with the exertion of very little force. It is not valid to attribute this difference in penetration entirely to panel spacing in view of the randomness of wire positions relative to the bullet path. All other rounds failed to penetrate the back panel.

Figure 4-2.208 Back Faces of the 1½" Panel and the Back Up Panel (left) reveal the back face spalling and mesh dishing on the 1½" panel and the spalling on the back face of the back up panel. Pronounced spalling was caused by rounds 2, 4, 5, and 6; two small spalls and two hairline cracks by round 3.

Debris found between the panels, consisting mainly of granulated cement, contained pieces of the copper jackets and traces of virtually powdered lead from the bullet core.



6 M 12 H 2

Figure 4-2.205

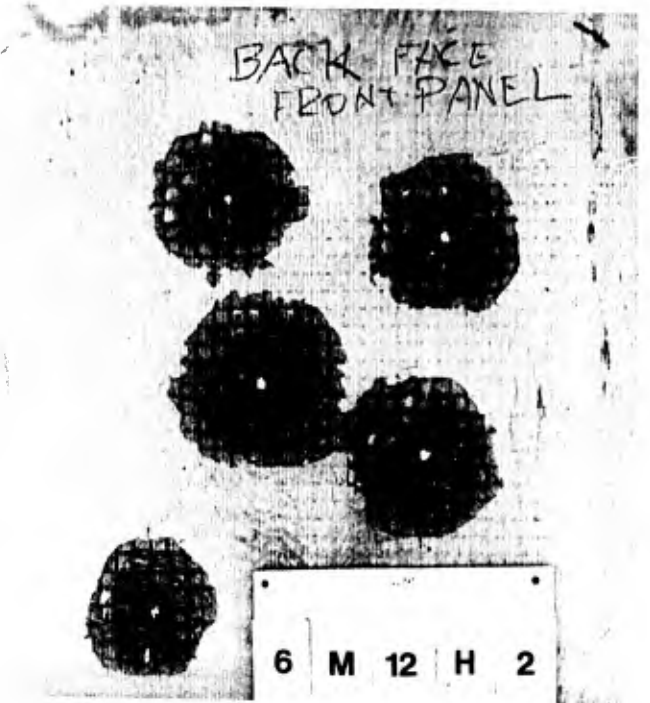

6 M 12 H 2

Figure 4-2.206

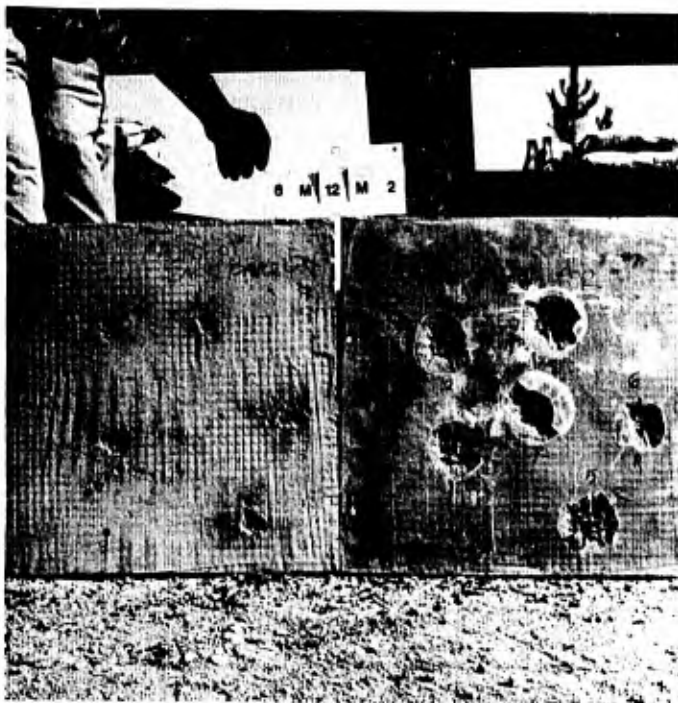

Figure 4-2.207

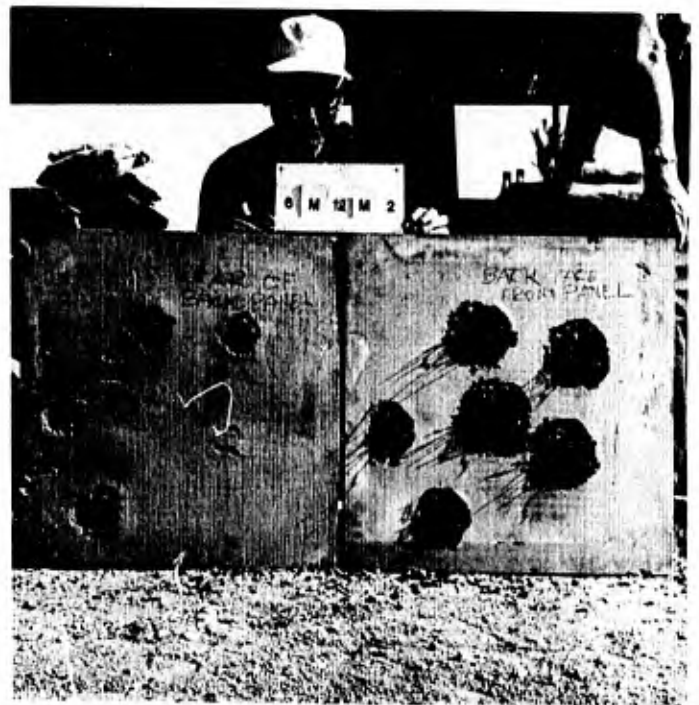

Figure 4-2.208

### 1/2-inch Panels

Six pistol rounds at 10 yards were fired on the  $\frac{1}{2}$ " panel, with a back up panel during the firing of the last four rounds.

Figure 4-2.209 and Figure 4-2.210 are photographs of the front and back faces, respectively, of the  $\frac{1}{2}$ " panel.

Figure 4-2.211 is the Front Face of the Back Up Panel

Figure 4-2.212 shows the mushrooming of pistol bullets.

Hits 1 and 4 are about 1" apart. Light shows through hits 3 and 5 but only one severed wire can be found in 5 and none in 3. The mesh opening is not expanded. Only round 4 severed wires on the back face of the  $\frac{1}{2}$ " panel. Pieces of bullet jackets and flaky pieces of lead were found in the debris back of the  $\frac{1}{2}$ " panel. The spalls on the front face of the  $\frac{1}{2}$ " panel show no evidence of the radial expansive force which would be exerted by a drill-like penetration. The spalls and mesh dishing on the back face are indicative of the exertion of considerable force. The back up panel reveals only the impact marks of rounds 4 and 5 and discoloration for which only lead dust was available to produce the dark color.

When this evidence is coupled with the facts that the pistol bullet is a heavy bullet with low velocity and that the  $\frac{1}{2}$ " panel has a lower period of vibration than the thicker panels, it leads to postulation that the holes that were made through the panel were not pure penetrations; that cement was fractured by the shock wave and ejected by terminal severance and elastic rebound of mesh and that bullet fragments, created on impact, passed through the panel intermingled with cement fragments.

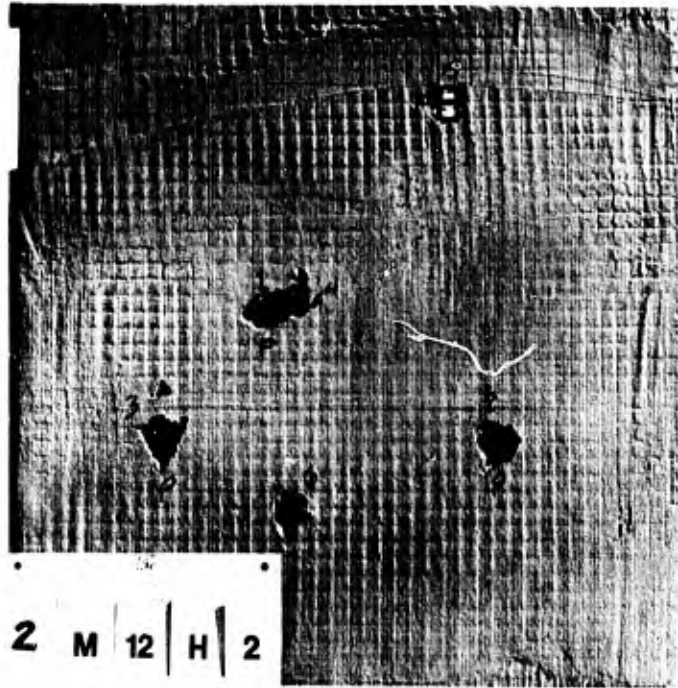

Figure 4-2.209



Figure 4-2.210

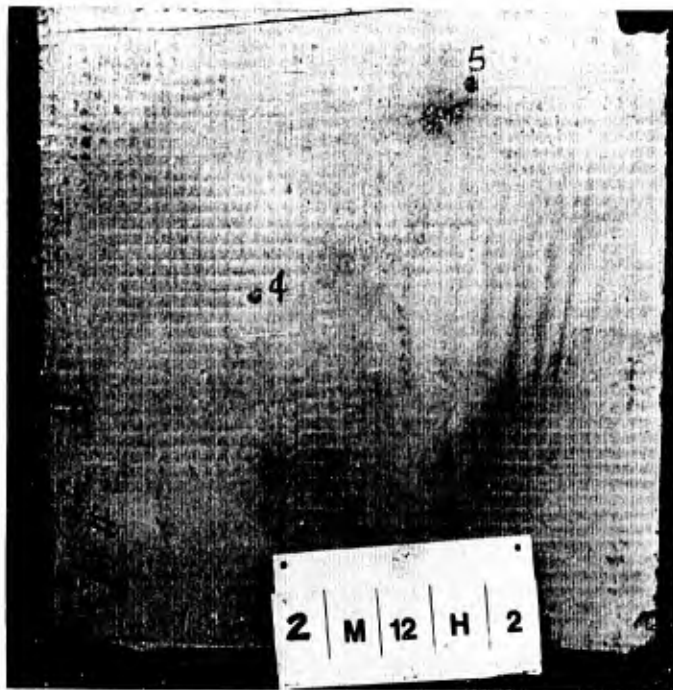

Figure 4-2.211

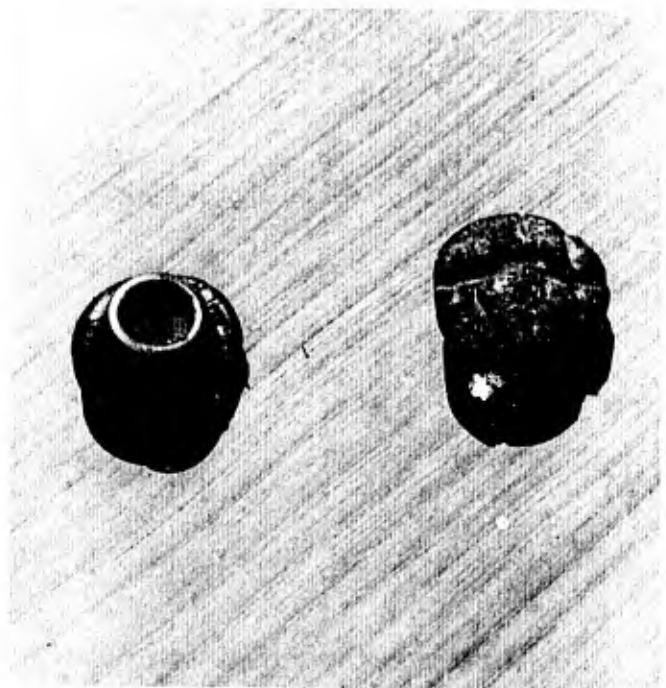

Figure 4-2.212

### 1 1/2 inch Prototype Panel

Prior to casting the panels designed for the experiments, a prototype panel was cast to test the casting operation. It was a 24"x24"x1 1/2" panel, of Type III, 1:2.0 cement mortar reinforced with 10 layers of ordinary, over-the-counter, 1/2" mesh hardware cloth, providing 7.64%, by volume, of reinforcement. It had received thermal vapor and water bath curing followed by over 30 days, sheltered at an average temperature of about 80 degrees.

Five rifle rounds were fired on this prototype panel with the back up panel at 12" for round 1, 1-7/8" for rounds 2 and 3, and 6 1/2" for rounds 4 and 5. The results were not considered in the selection of panel thickness because of the difference in other parameters, but they revealed useful information about ductile reinforcement, which was considered in Experiment 4.

Figure 4-2.213 is a photograph of the Front Faces of the Prototype Panel and the Back Up Panel

Figure 4-2.214 is a photograph of the Back Faces

The prototype panel is on the right in both figures.

There was remarkably less front face spalling on the prototype panel reinforced with 1/2" mesh hardware cloth, than on the 1 1/2" panel (p.4-8) which was reinforced with 1/2" mesh wire cloth. The spalling that occurred appeared to have been produced by the radial expansive force exerted by the penetrating bullet; there was very little evidence of elastic rebound. There was some less spalling on the back face, where numerous wires were severed, and absence of the outer ring of incipient spalling that was revealed by the wire cloth reinforced panels. The dishing of the hardware cloth was shaped like a puncture through soft sheet metal whereas the dishing of wire cloth was in the form of a bulge. There was a noticeable difference in the character of the bullet hole. It was more nearly cylindrical in the prototype panel and had more appearance of having been formed by compactive radial crushing of cement. Comparison of the back up panel with the one used back of the wire cloth reinforced panel revealed no significant indication of difference in the residual kinetic energy of the bullet.



Figure 4-2.213

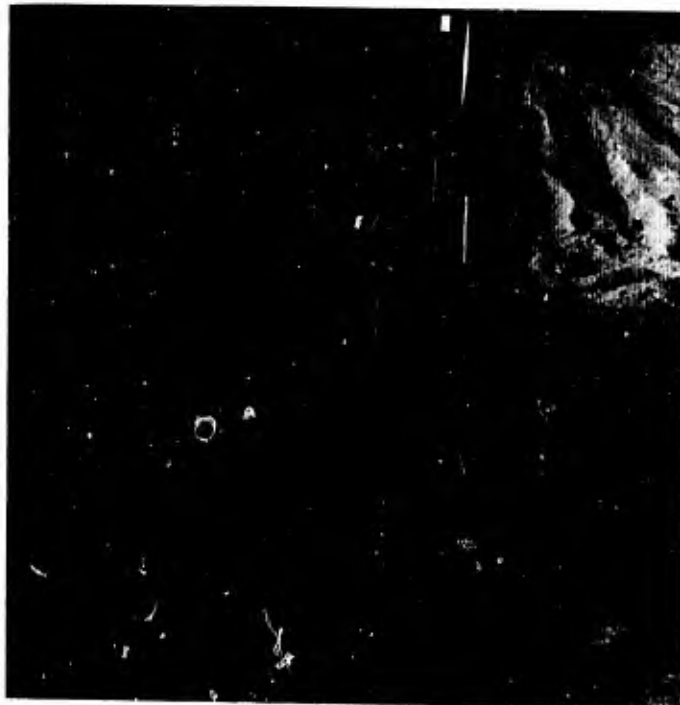

Figure 4-2.214

Conclusions are based on the visual evidence revealed by the  $\frac{1}{2}$ " ,  $1\frac{1}{2}$ " and 2" panels cast for the experiment and the 1" panel of 1:2.5 mix cast for Experiment 2. The  $\frac{1}{2}$ " panel was obviously inadequate. The 2" panel was penetrated by four of six rounds and was extensively spalled on the back face. It would afford, at the best, no more than marginal protection from shell fragments. Two panels in tandem would be required for reliable protection. Although all rounds penetrated the  $1\frac{1}{2}$ " panel, none penetrated the back up panel, which was 1" thick. A calculated risk, of having to extend the experiment, was taken. It was forecasted that two 1" panels in tandem would afford adequate protection against shell fragments and infantry weapons other than antitank rockets.

It was felt that panels for bridge pier fenders should be of larger dimension, in the order of 4'x4'. For protection against damage by floating logs in high water as well as for additional energy absorption, pier fender panels should be 2" thick. A panel thickness of 1" was selected for the balance of the parametric tests.

#### 4-2.3 Experiment 4 (Various Types of Reinforcement)

The purpose of experiment 4 was to select the type of reinforcement. Wire cloth of  $\frac{1}{4}$ " mesh was used, instead of  $\frac{1}{2}$ ", to place more wires in the path of bullets. The other two reinforcements were  $\frac{1}{4}$ " mesh hardware cloth and expanded metal lath (Table 1-1). Fiber glass window screen was barely embedded at the surfaces of three panels to observe its spall retaining capability.

#### Panel arrangements for Type of reinforcement mesh being tested

<u>1/4" Wire Cloth</u>	<u>1/4" Hdwe Cloth</u>	<u>EM Lath</u>
*41*d4	*43*d3	*45*d4
42 d4	44 d3	46 d4
*41*D42D3	*43*D44D3	*45*D46D4
42D*41*D3	44D*43*D3	46D*45*D4

in which, direction of fire is from left to right.

\*indicates fiber glass screen near both faces

d " interface panel spacing of 1 7/8"

D " interface panel spacing of 3 1/2"

Panels 41 - 46 contain reinforcement mesh being tested.

Panels 3 and 4 are back up panels from previous tests.

1/4" WIRE CLOTH

Results with 4 arrangements of Panels No. 41 and No. 42, wire cloth reinforced are depicted in the figures that follow. Only Panel No. 41 contained fiber glass screen.

Arrangement 42d4

- Figure 4-2.301 Front Face, Panel No. 42  
as Front Panel
- Figure 4-2.302 Back Face, Panel No. 42  
as Front Panel
- Figure 4-2.303 Front Face, 1" Back Up Panel,  
1-7/8" Back of Panel No. 42
- Figure 4-2.304 Back Face, 1" Back Up Panel,  
1-7/8" Back of Panel No. 42

Arrangement \*41\*d4

- Figure 4-2.305 Front Face, Panel No. 41  
as Front Panel
- Figure 4-2.306 Back Face, Panel No. 41  
as Front Panel

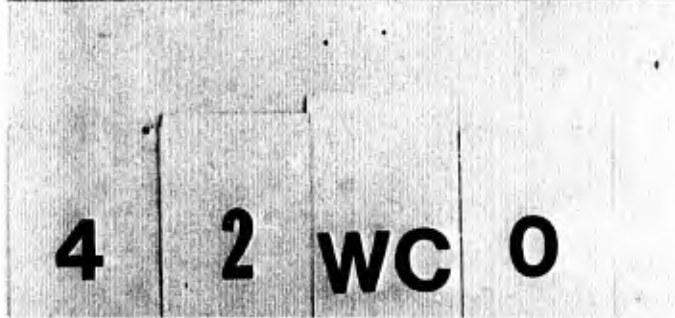

Figure 4-2.301

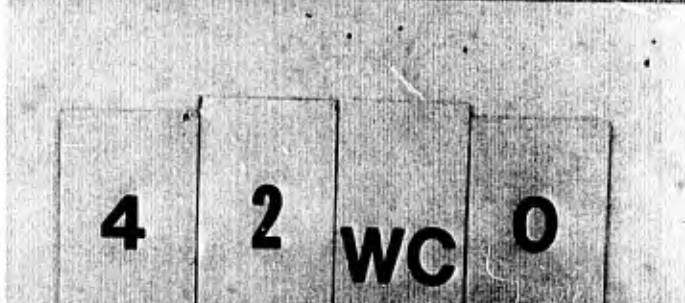
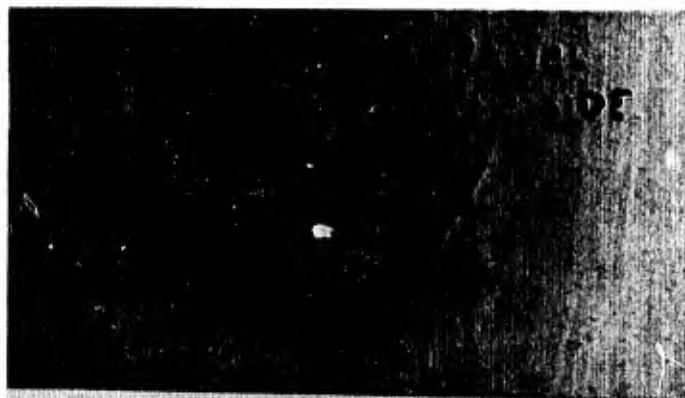
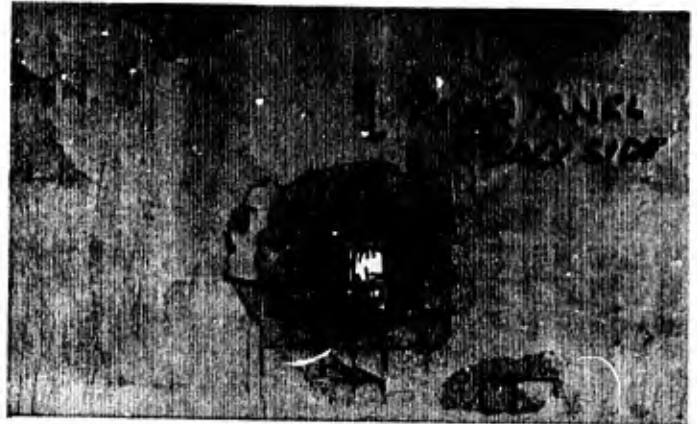

Figure 4-2.302



4 2 WC 0

Figure 4-2.303



4 2 WC 0

Figure 4-2.304

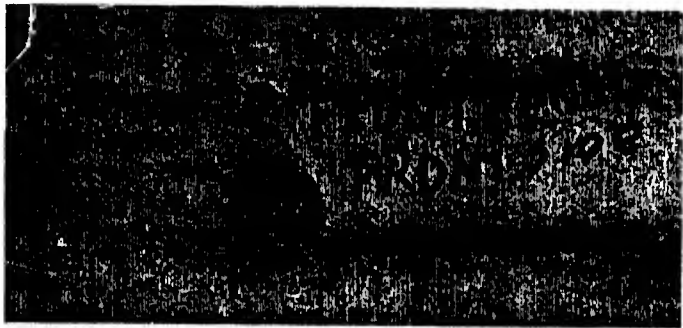

4 1 WC PS

Figure 4-2.305



4 1 WC PS

Figure 4-2.306

Figure 4-2.307 Front Face, 1" Back Up Panel,  
1-7/8" Back of Panel No. 41

Figures 4-2.301 and 4-2.305 reveal the effect of the fiber glass screen on front face spalling in the front panel; Figures 4-2.302 and 4-2.306 reveal the effect on back face spalling.

Arrangement \*41\*D42D3

Figure 4-2.308 Front Face, Panel No. 42, as Intermediate Panel, 3½" Back of Panel No.41

Figure 4-2.309 Back Face, Panel No. 42, as Intermediate Panel, 3½" Back of Panel No.41

Figure 4-2.310 Bullet Path Through Panels No. 41 and No. 42 to Back Up Panel

Dust fines from Panel No. 42 adhered to the back up panel. The dark fines are lead from the bullet core.

Arrangement 42D\*41\*D3

Figure 4-2.311 Round 4 on Front Face, Panel No. 42 as Front Panel

Figure 4-2.312 Round 4 on Rear Face, Panel No. 42 as Front Panel

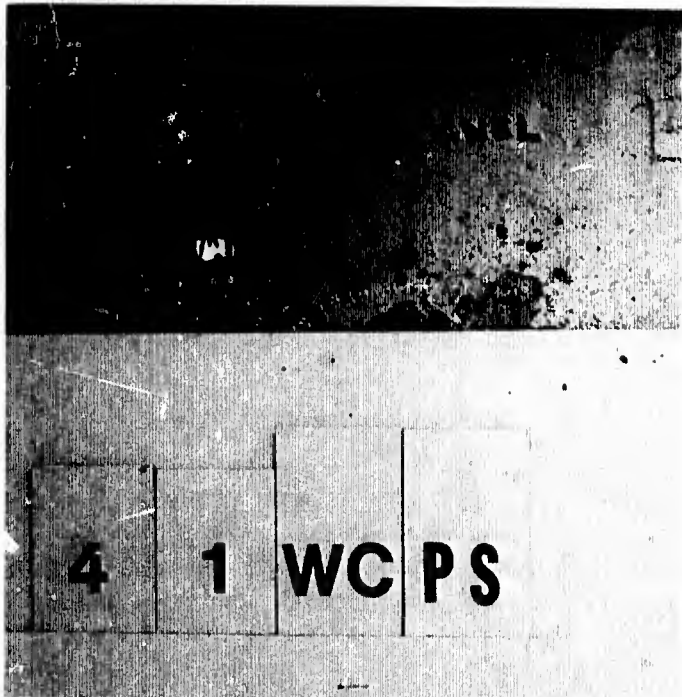

Figure 4-2.307

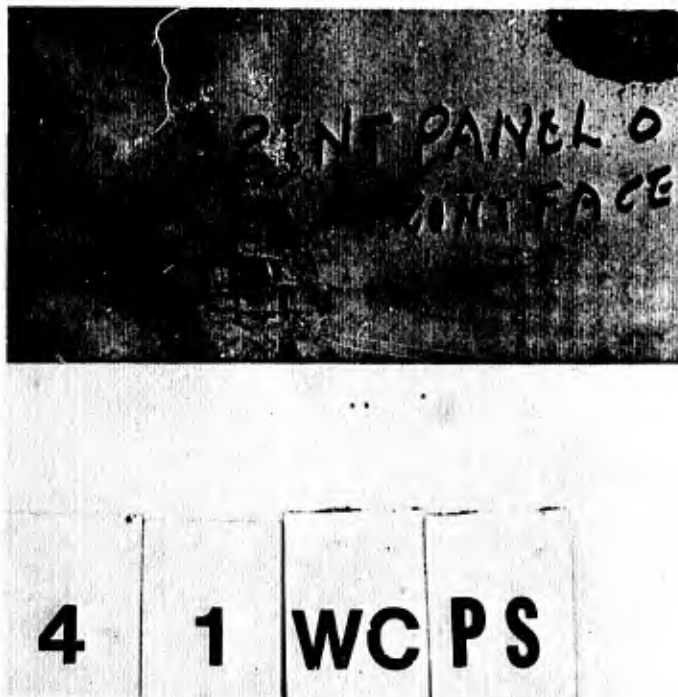

Figure 4-2.308



Figure 4-2.309



Figure 4-2.310

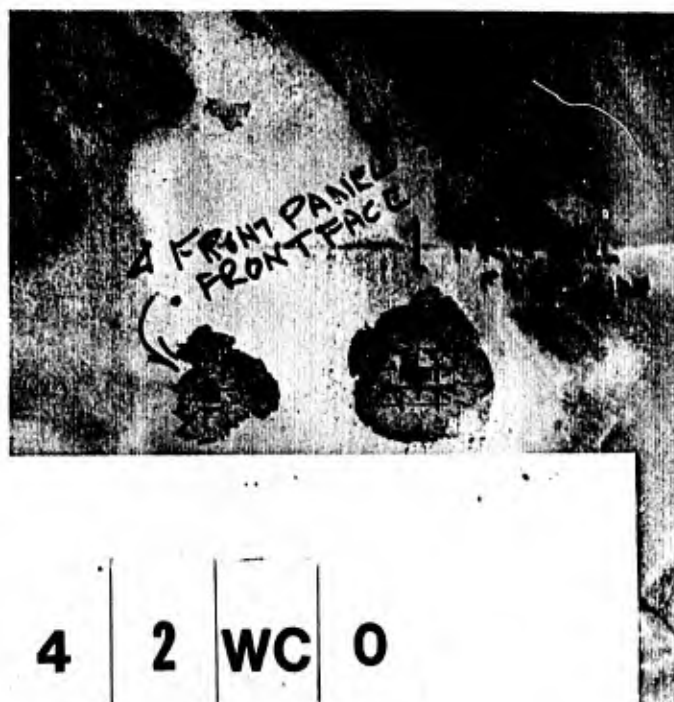

Figure 4-2.311

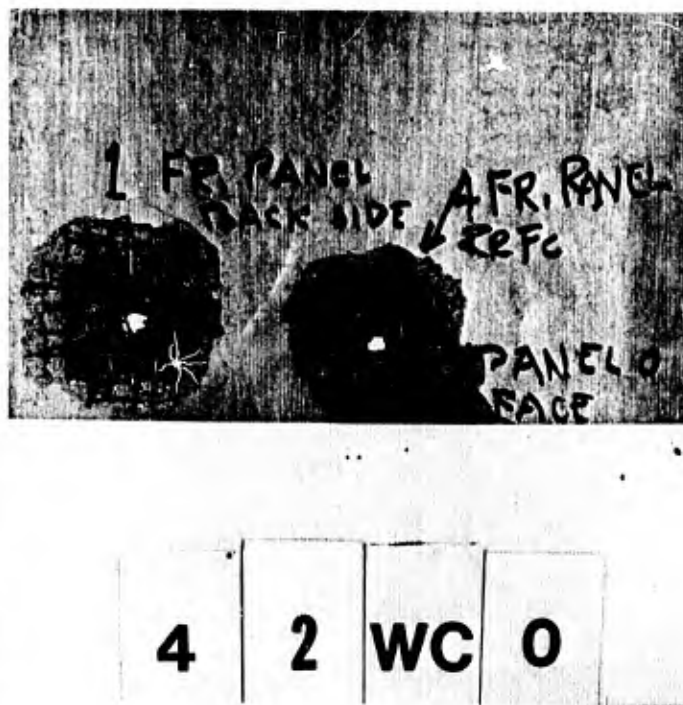

Figure 4-2.312

Figure 4-2.313 Front Face, Panel No.41 as Intermediate Panel, 3½" Back of Panel No.42

Figure 4-2.314 Back Face, Panel No.41 as Intermediate Panel, 3½" Back of Panel No.42 (Mutilated Bullet Jacket on Card)

Figure 4-2.315 Bullet Path through Panels No.42 and No.41 to Back Up Panel

When either Panel No.41 or Panel No.42 were backed up by a 1" Panel, reinforced with ½" mesh wire cloth, at a clear distance of 1-7/8" both panels were penetrated. When Panel No.41 was backed up by Panel No.42 at 3½" clear distance, the bullet lodged in Panel No.42, bulged the mesh on the rear face and caused extensive rear face spalling. No damage was done to the back up panel, 3½" back of Panel No.42. When Panel No.42 was backed up by Panel No.41 at a clear distance of 3½", both panels were penetrated. A back up panel 3½" back of Panel No.41 was undamaged. The mutilated copper jacket of the bullet was found lying on the lower member of the spacer. In both arrangements with a back up panel, the dust fines which adhered to it were darkened by the inclusion of lead dust fines from the core of the bullet. These observations and the total absence of damage to the back up panel demonstrate that the bullet was destroyed in the process of penetrating two panels. The performance of a bullet with a hard steel core is not known. The Cal. .30-06 bullet has a lead core. Parametric selection is primarily for shell fragments, which are hard. Fragments will lose more energy during penetration than would hard bullets, however, because their shape is irregular.

Fiber glass screen tended to funnel the ejection of back face spalls without decreasing the amount of spalling significantly. It reduced front face spalling from a varying diameter of 2" to 3" to a variation from 1" to 2".

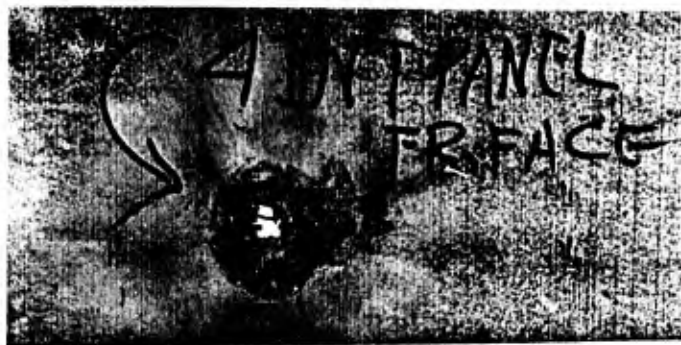

4	2	WC	0
---	---	----	---

Figure 4-2.313

4	2	WC	0
---	---	----	---

Figure 4-2.314



4	2	WC	0
---	---	----	---

Figure 4-2.315

1/4" HARDWARE CLOTH

Arrangement \*43\*d3

Panels No.43 and No.44, hardware cloth reinforced, were exposed to 1 round in each of four arrangements which were the same as the arrangements of Panels No.41 and No. 42. Results are shown in the figures which follow:

Figure 4-2.316 Front Face, Panel No.43 as Front Panel

Figure 4-2.317 Back Face, Panel No.43 as Front Panel

Figure 4-2.318 Front Face, 1" Back Up Panel, 1-7/8" Back of Panel No.43

Figure 4-2.319 Back Face, 1" Back Up Panel, 1-7/8" Back of Panel No.43

Figure 4-2.320 Profile of Fiber Glass Screen, Back Face, Panel No.43 as Front Panel

Arrangement \*43\*D44D3

Figure 4-2.321 Second Round, Front Face, Panel No. 43 as Front Panel

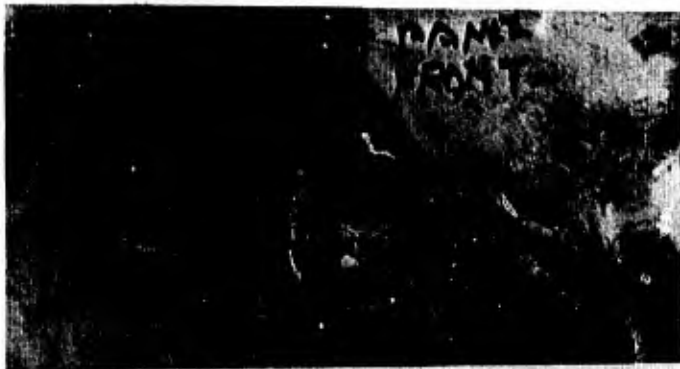

4 | 3 | HC | PS

4 | 3 | HC | PS

Figure 4-2.316

Figure 4-2.317

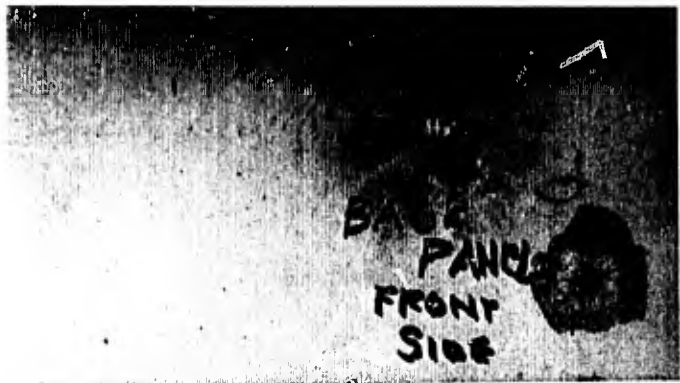

4 | 3 | HC | PS

Figure 4-2.318



4 | 3 | HC | PS

Figure 4-2.319

4 | 3 | HC | PS



Figure 4-2.320

4 | 3 | HC | PS



Figure 4-2.321

Figure 4-2.322 Second Round, Back Face,  
Panel No.43 as Front Panel

Figure 4-2.323 Front Face, Panel No.44,  
3½" Back of Panel No.43

Figure 4-2.324 Back Face, Panel No.44,  
3½" Back of Panel No.43

Figure 4-2.325 Front Face, Back Up Panel,  
3½" Back of Panel No.44

Figure 4-2.326 Front Face Profiles along  
path of bullet through  
Panels No.43 and No.44 to  
the Back Up Panel

Figure 4-2.327 Back Face Profiles along  
bullet path as in  
Fig. 4-2.326

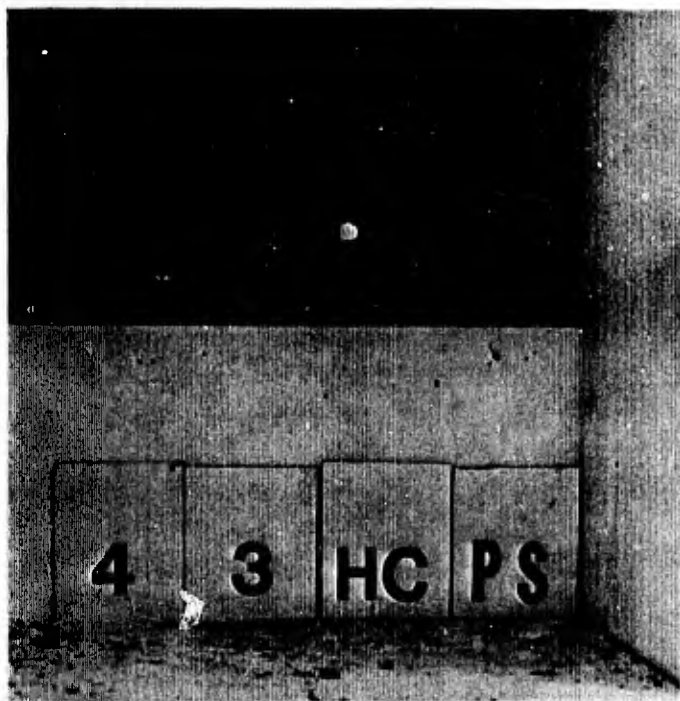

Figure 4-2.322

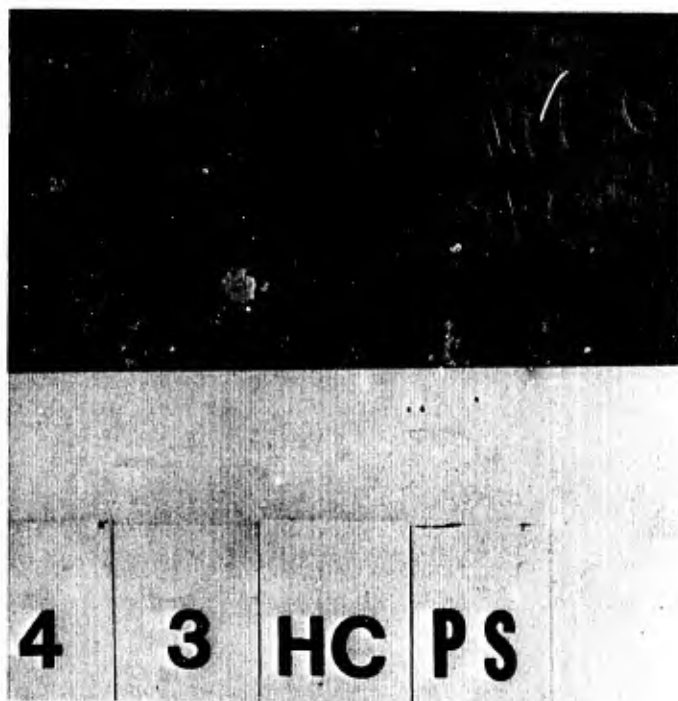
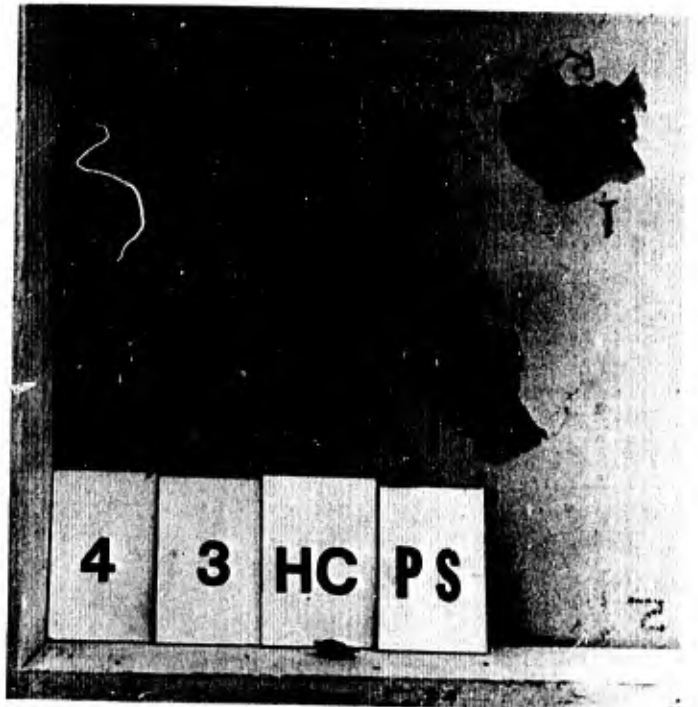

Figure 4-2.323



4 3 HC PS

Figure 4-2.324



4 3 HC PS

Figure 4-2.325

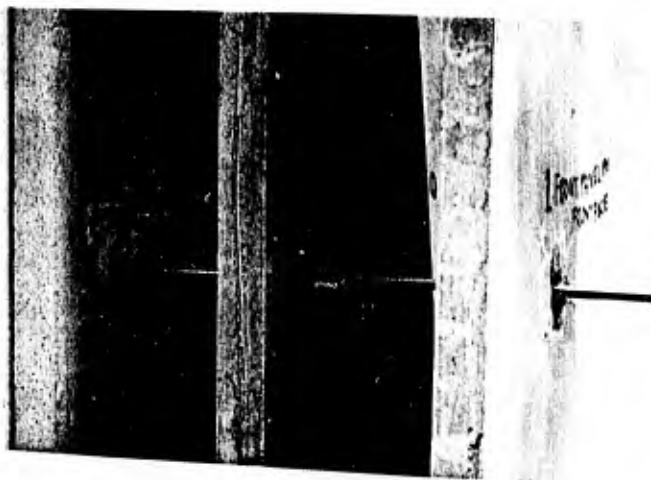

4 3 HC PS

Figure 4-2.326

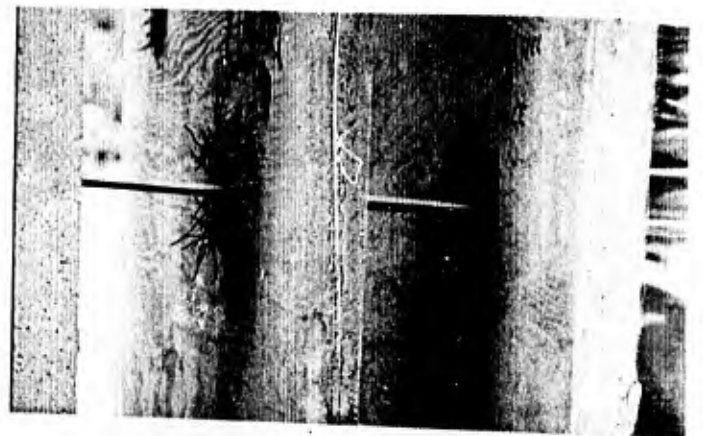

4 3 HC PS

Figure 4-2.327

Arrangement 44d3

The preceding arrangements were repeated with Panel No.44 in front and Panel No.43 as the intermediate panel, with the results shown in the following figures:

- Figure 4-2.328 Front Face, Panel No.44 as Front Panel
- Figure 4-2.329 Back Face, Panel No.44, as Front Panel
- Figure 4-2.330 Front Face, 1" Back Up Panel, Back of Panel No.44
- Figure 4-2.331 Back Face, 1" Back Up Panel, Back of Panel No.44 (Left Hit)

Arrangement 44D\*43\*D3

- Figure 4-2.332 Second Round, Front Face, Panel No.44 as Front Panel
- Figure 4-2.333 Second Round, Back Face Panel No.44 as Front Panel

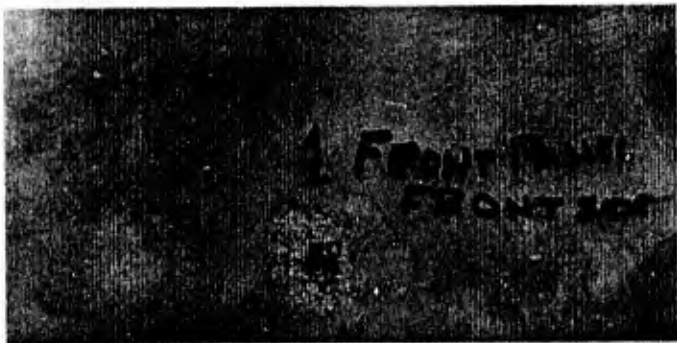

4 4 HC 0

4 4 HC 0

Figure 4-2.328

Figure 4-2.329



4 4 HC 0



Figure 4-2.330

Figure 4-2.331

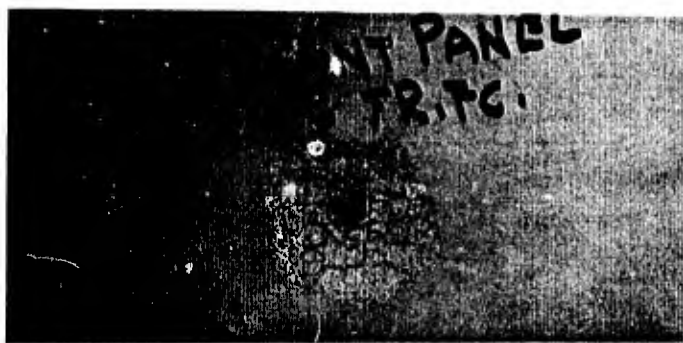

4 4 HC 0

4 4 HC 0

Figure 4-2.332

Figure 4-2.333

- Figure 4-2.334 Front Face, Panel No.43,  
3½" Back of Panel No.44
- Figure 4-2.335 Back Face, Panel No.43,  
3½" Back of Panel No.44
- Figure 4-2.336 Front Face of Back Up Panel,  
3½" Back of Panel No.43
- Figure 4-2.337 Profiles along the Bullet  
Path

#### FIBER GLASS SCREEN EFFECTS

The observations pertaining to the effect of fiber glass screen on spalling and to the destruction of bullets in penetrating two panels were the same as those made of the panels reinforced with wire cloth. There was little difference in the evidence of impact on the back up panel. If any, the difference favored the panels reinforced with hardware cloth. The visual evidence of less diameter of spalling, attributable to the ductility of the reinforcement was similar to the evidence observed in the response of the 1½", hardware cloth reinforced, prototype panel which was exposed to rifle fire in Experiment 3. Wire cloth and hardware cloth are both residually deformed, hence they passed through the elastic range and returned the elastic energy in rebounding. The lower yield reinforcement had less elastic energy to return; it dissipated a larger portion of the total energy in the plastic range. More wires were severed in the ductile reinforcement, fully utilizing the energy absorbing capability of the reinforcement and keeping the work done on the panel more closely confined to the path of the bullet. It appeared that this would be advantageous under exposure to multiple penetration by the fragments from a shell burst.

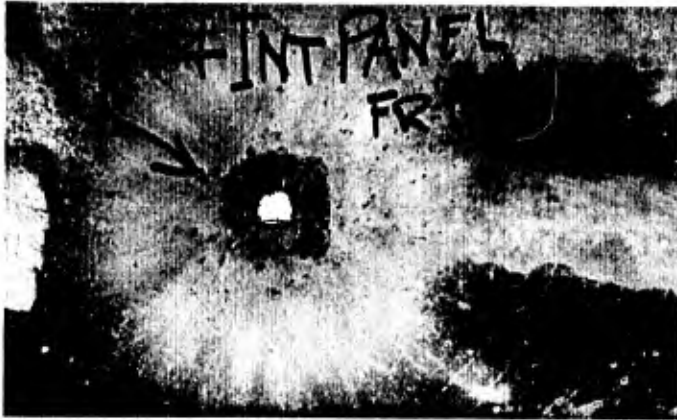

4 | 4 | HC | 0

Figure 4-2.334

4 | 4 | HC | 0

Figure 4-2.335

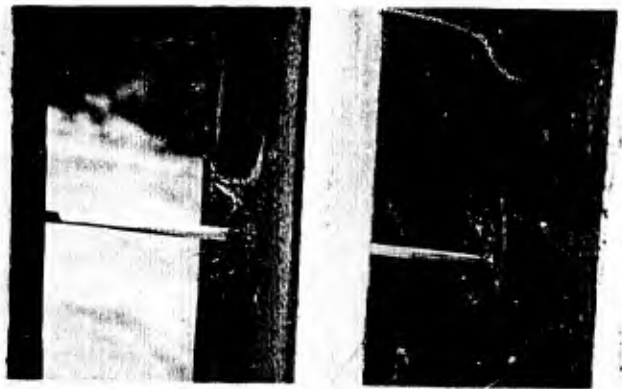

4 | 4 | HC | 0

Figure 4-2.336

4 | 4 | HC | 0

Figure 4-2.337

EXPANDED METAL LATH

Arrangement \*45\*d4

Panel No.45, reinforced with expanded metal lath and with fiber glass screen at the surfaces, was placed 1-7/8" in front of a 1", wire cloth reinforced panel and exposed to two rifle rounds, with results as shown in the following figures:

- Figure 4-2.338 Rounds 1 and 2, Front Face, Front Panel
- Figure 4-2.339 Rounds 1 and 2, Back Face, Front Panel
- Figure 4-2.340 Round 1, Front Face, Back Up Panel
- Figure 4-2.341 Round 1, Back Face, Back Up Panel
- Figure 4-2.342 Round 2, Back Face, Back Up Panel
- Figure 4-2.343 Round 2, Back Face, Back Up Panel

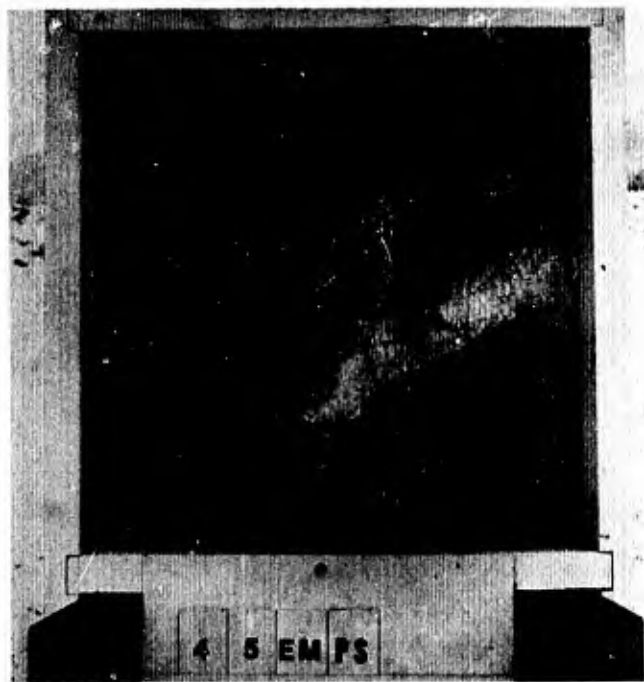

Figure 4-2.338

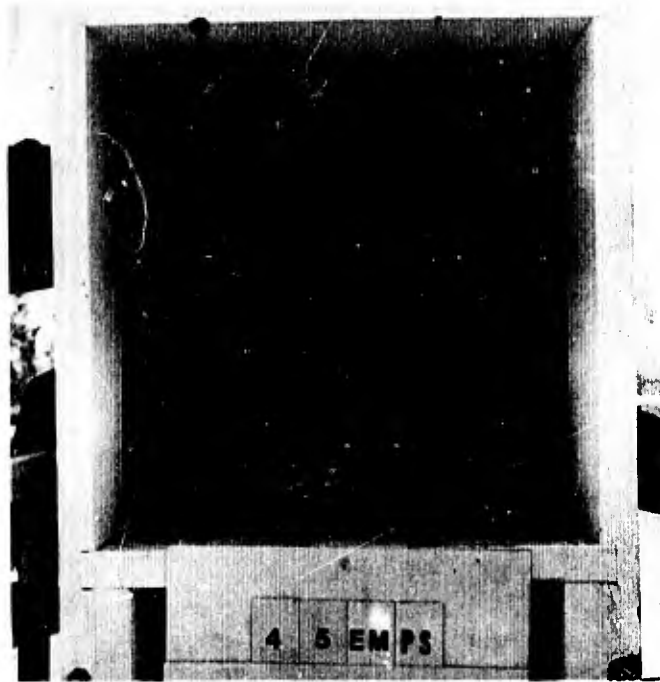

Figure 4-2.339



4 | 5 | EM | PS

Figure 4-2.340



4 | 5 | EM | PS

Figure 4-2.341

4 | 5 | EM | PS



Figure 4-2.342

4 | 5 | EM | PS



Figure 4-2.343

Arrangement \*45\*D46D4

Panel No.45, Panel No.46 (without fiber glass screen) and a 1" wire cloth reinforced back up panel were then placed in tandem, in that order, at 3½" clear spacing and exposed to round 3, with results as shown in the following figures:

Figure 4-2.344 Front Face, Front Panel No.45

Figure 4-2.345 Back Face, Front Panel No.45

Figure 4-2.346 Front Face, Intermediate Panel No.46

Figure 4-2.347 Back Face, Intermediate Panel No.46

Figure 4-2.348 Front Face, Back Up Panel (Marked No. 3)

Figure 4-2.349 Back Face, Back Up Panel (Marked No. 3)



Figure 4-2.344

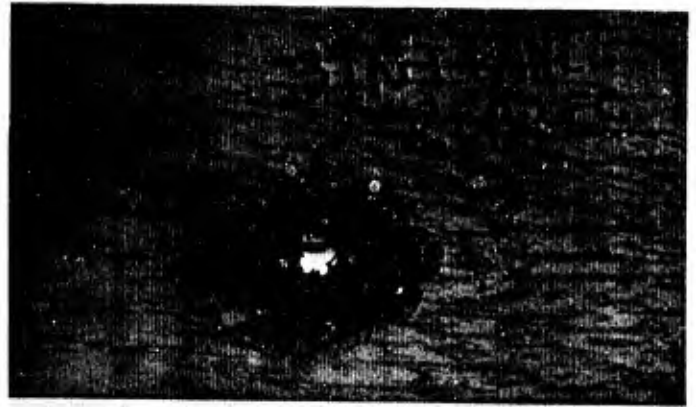

Figure 4-2.345



4 5 EM PS

Figure 4-2.346



4 5 EM PS

Figure 4-2.347

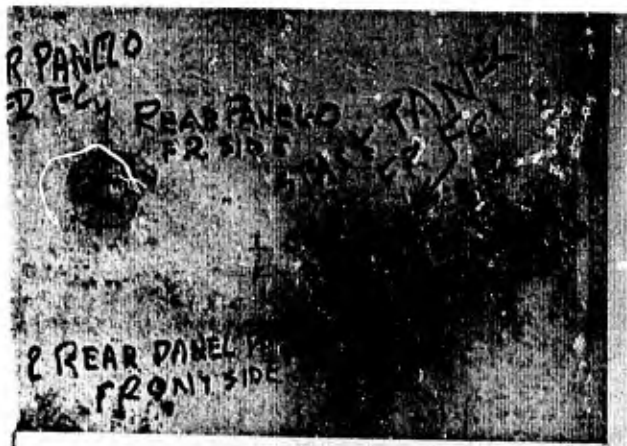

4 5 EM PS

Figure 4-2.348

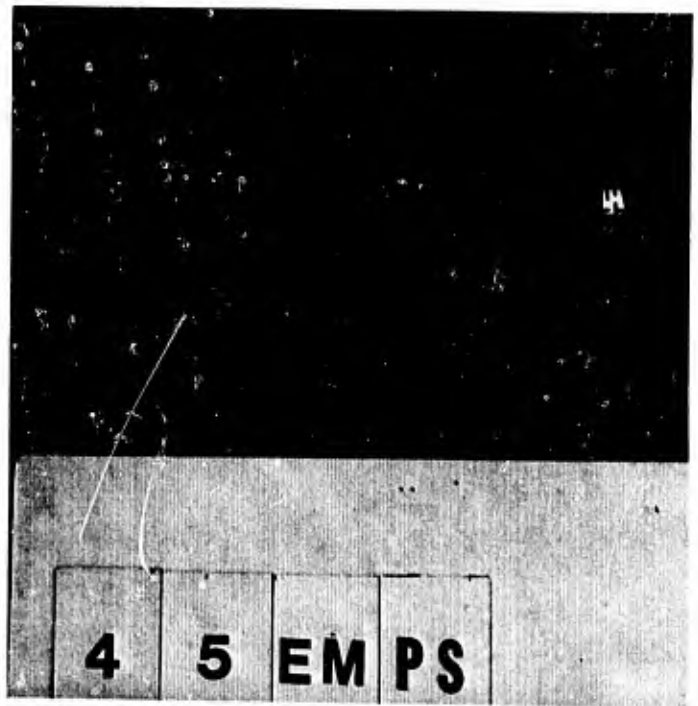

4 5 EM PS

Figure 4-2.349

Figure 4-2.350 Front Face, Profiles along  
Bullet Path

Figure 4-2.351 Back Face, Profiles along  
Bullet Path

Arrangement 46d4

One round was fired on Panel No. 46 placed 1-7/8"  
in front of a 1", wire cloth reinforced back up panel  
with results shown in the following figures:

Figure 4-2.352 Front Face, Panel No.46

Figure 4-2.353 Back Face, Panel No.46

Figure 4-2.354 Front Face, Back Up Panel

Figure 4-2.355 Back Face, Back Up Panel



Figure 4-2.350



Figure 4-2.351

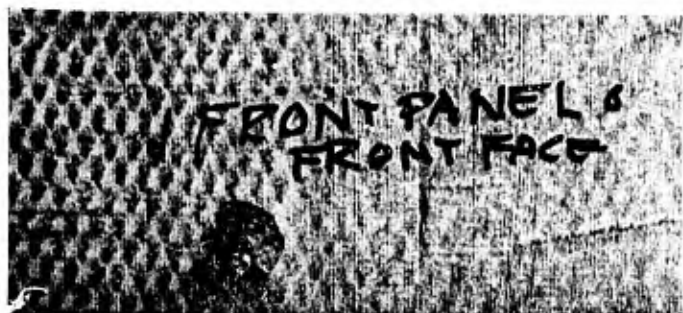

Figure 4-2.352



Figure 4-2.353

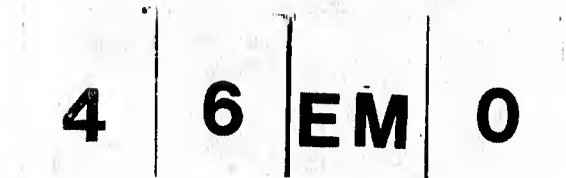

Figure 4-2.354

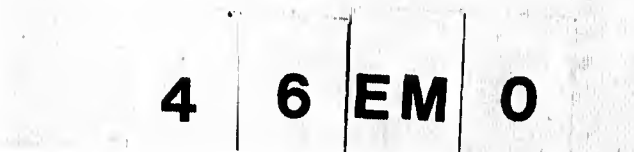
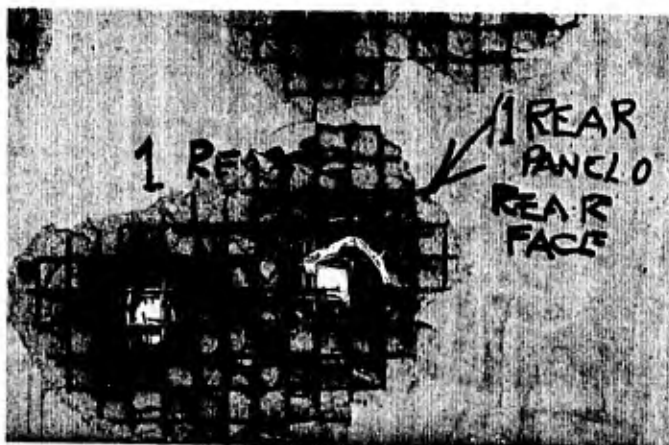

Figure 4-2.355

Arrangement 46D\*45\*D4

Panel No.46, Panel No.45 and a 1" wire cloth reinforced panel were placed in tandem, in that order, at 3½" clear spacing and exposed to round 4, with results as shown in the following figures:

Figure 4-2.356 Front Face, Front Panel No.46

Figure 4-2.357 Rear Face, Front Panel No.46

Figure 4-2.358 Front Face, Intermediate Panel No.45

Figure 4-2.359 Rear Face, Intermediate Panel No.45

Figure 4-2.360 Front Face, Back Up Panel

Figure 4-2.361 Front Face Profiles along the Bullet Path

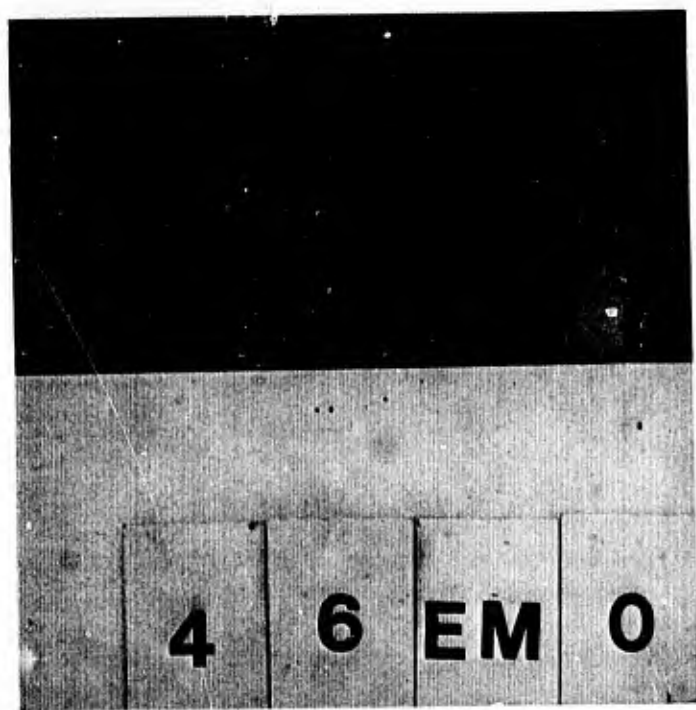

Figure 4-2.356

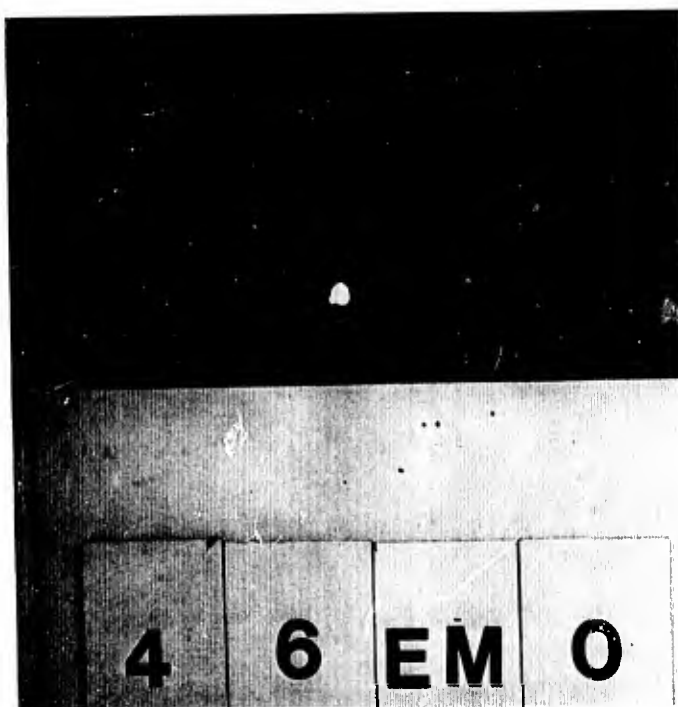

Figure 4-2.357



4 | 6 | EM | 0

Figure 4-2.358



4 | 6 | EM | 0

Figure 4-2.359



4 | 6 | EM | 0

Figure 4-2.360

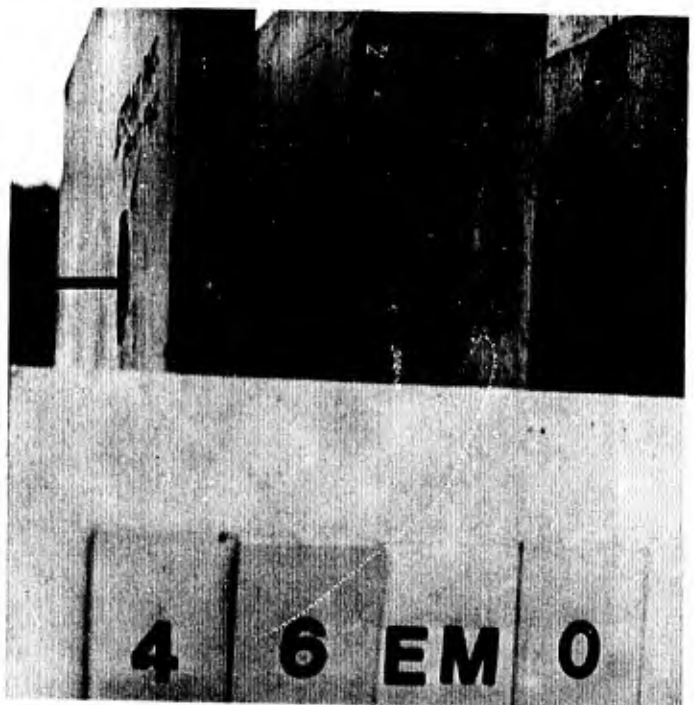

4 | 6 | EM | 0

Figure 4-2.361

Figure 4-2.362 Rear Face Profiles  
along the Bullet  
Path

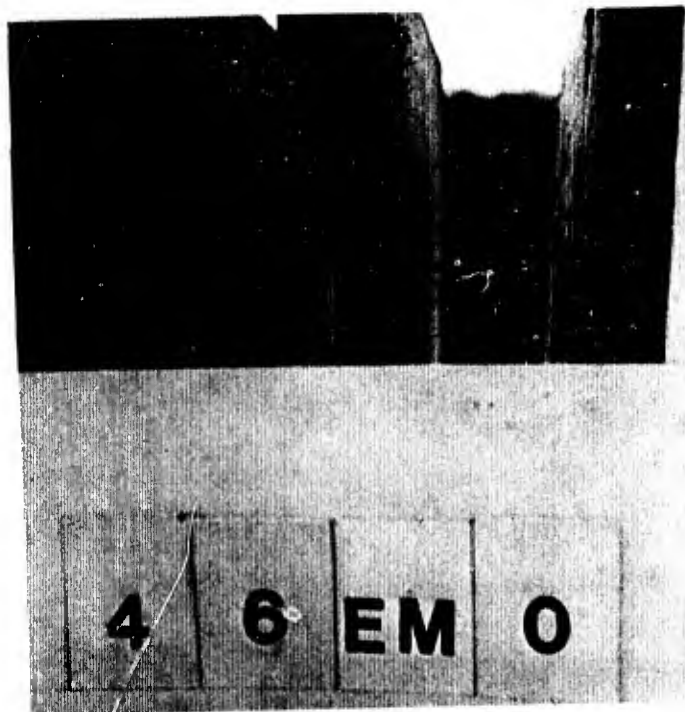

Figure 4-2.362

The selection of the type of reinforcing took into account the 1" panels in preceding experiments which were reinforced with  $\frac{1}{2}$ " wire cloth. Not much difference was apparent in the results obtained with  $\frac{1}{2}$ " and  $\frac{3}{4}$ " mesh in the wire cloth reinforcement. With  $\frac{3}{4}$ " mesh there was slightly less spalling, more broken wires and fewer wires pushed aside by penetrating bullets in both the first and second panels in tandem. Panels reinforced with hardware cloth or expanded metal lath, both ductile reinforcements, showed less front face spalling than those reinforced with the high strength, brittle wire cloth. The character of the bullet hole formation with ductile reinforcement differs from that with wire cloth. With ductile reinforcement, the hole appears to have been formed by

punching shear, crushing of cement in the path of the bullet, and expulsion and outward radial packing of crushed cement. Holes in wire cloth reinforced panels appear to have been formed by small fragmentation and expulsion of cement and breaking or bypassing a path through a maze of wire. All wires of ductile reinforcement which crossed the bullet path were severed. Panels with ductile reinforcement are expected to be more durable under exposure to multiple penetration by shell fragments because damage due to a penetration is expected to be more closely confined to the path of the fragment.



U. S. Pistol, Cal. .45,  
Semi-Automatic

## CONVENTIONAL REINFORCEMENT

### 4-2.4 Experiment 5 and 6, Combined

The purpose of Experiment 5 was to compare the response of a conventionally reinforced panel with that of the ferro-cement panels. The experiment was conducted in conjunction with Experiment 6 which provided a comparison of 45 degree variation of the orientation of successive reinforcement layers with the 90 degree orientation used in preceding experiments.

The 1" panels for Experiment 5 had 1 layer of 2"x10g wire fabric at the mid-plane of the panel. The results of three rifle rounds on two such panels and a 1", wire-cloth reinforced back up panel, in tandem at 3½" spacing are shown in the following figures:

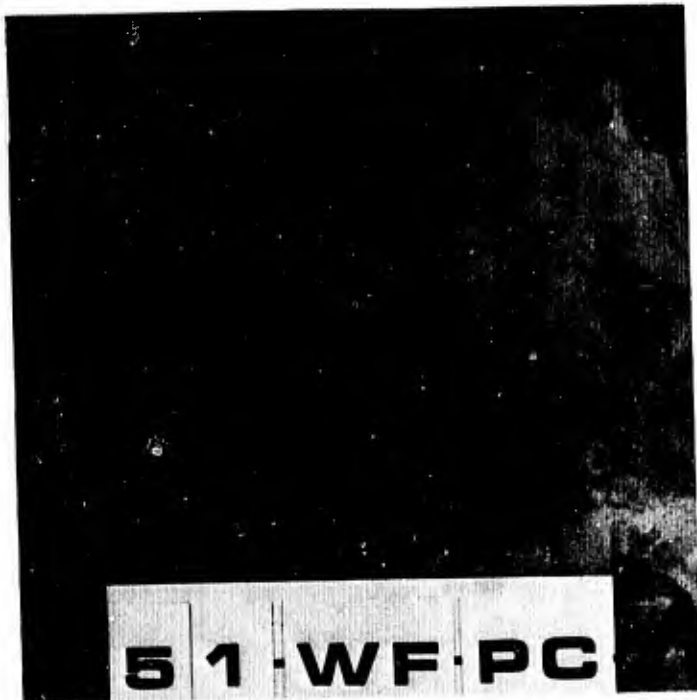

Figure 4-2.401

- Figure 4-2.401 Front Face, Front Panel
- Figure 4-2.402 Back Face, Front Panel
- Figure 4-2.403 Front Face, Intermediate Panel
- Figure 4-2.404 Back Face, Intermediate Panel
- Figure 4-2.405 Front Face, Back Up Panel,  
Hits Encircled

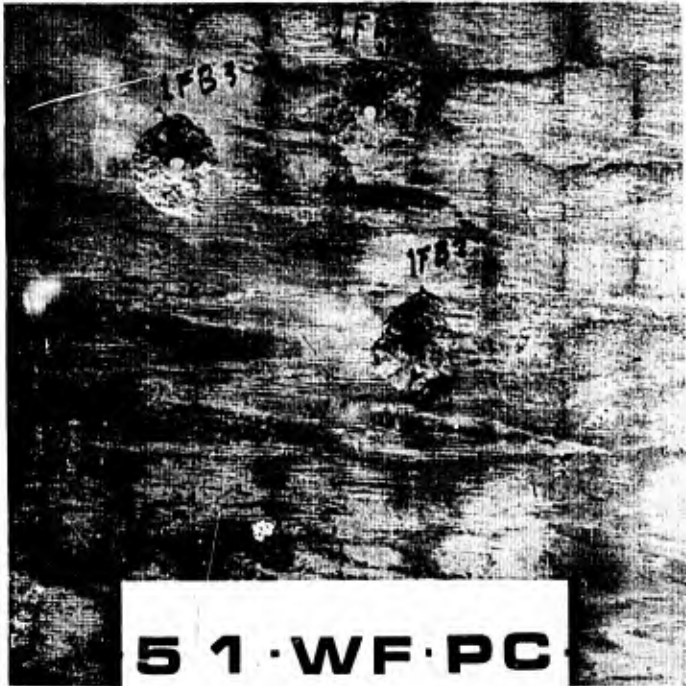

Figure 4-2.402

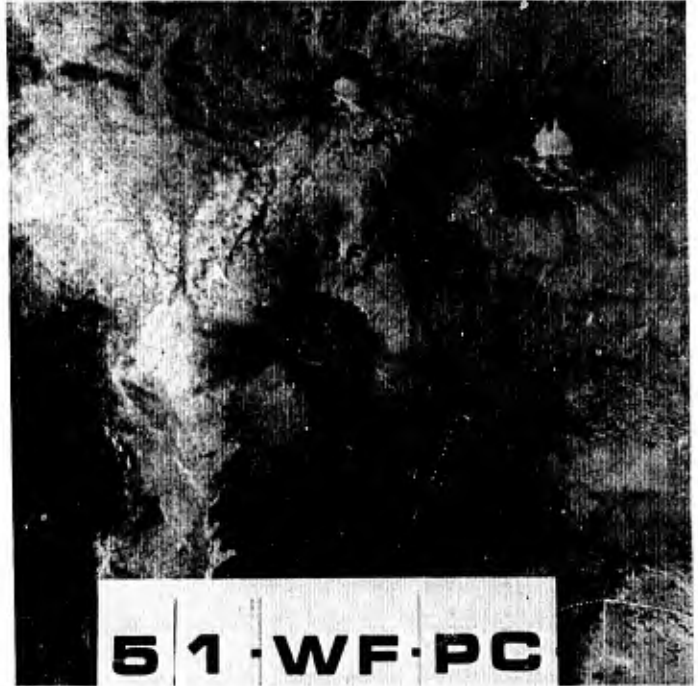

Figure 4-2.403



Figure 4-2.404

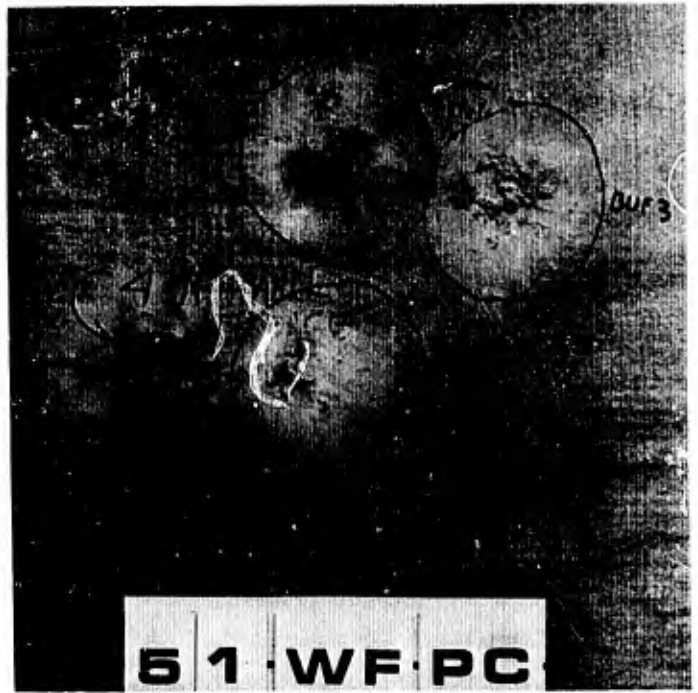

Figure 4-2.405

### CONVENTIONAL REINFORCEMENT

The panels were each reversed and a fourth round was fired with no perceptible change in results. The following two views of the intermediate panel are characteristic of the penetrations of the conventionally reinforced panel:

Figure 4-2.406 Front Face, Intermediate Panel

Figure 4-2.407 Back Face, Intermediate Panel

Penetrations were in the approximate form of two cones, truncated at the plane of the wire fabric, which is also the mid-plane of the panel. The spalls were much larger than those from the ferro-cement panels which were exposed to the same fire and the spalling had more of the character of brittle fracture. This might be expected in the absence of distributed reinforcement.

The resistance to penetration by rifle fire provided by the conventionally reinforced panel appeared to equal that provided by the ferro-cement panels. This is evidenced by the following figure:

Figure 4-2.408 Front Face, Back Up Panel

The evidence of effect on the back up panel is limited to the adhesion of cement and lead dust fines. There is question, however, about the comparative durability of the conventionally reinforced panel under exposure to the multiple penetrations of fragments from a shell burst. The embedment of conventional wire mesh reinforcement required to bond the wires adequately reduces the effective depth and obviously detracts from the flexural strength, as does also the absence of compressive reinforcement. Further consideration of these matters is left to the drawing of conclusions from the series of experiments and the characteristics of panel behavior in shear and flexure under static loading in the laboratory tests.



Figure 4-2.406



Figure 4-2.407

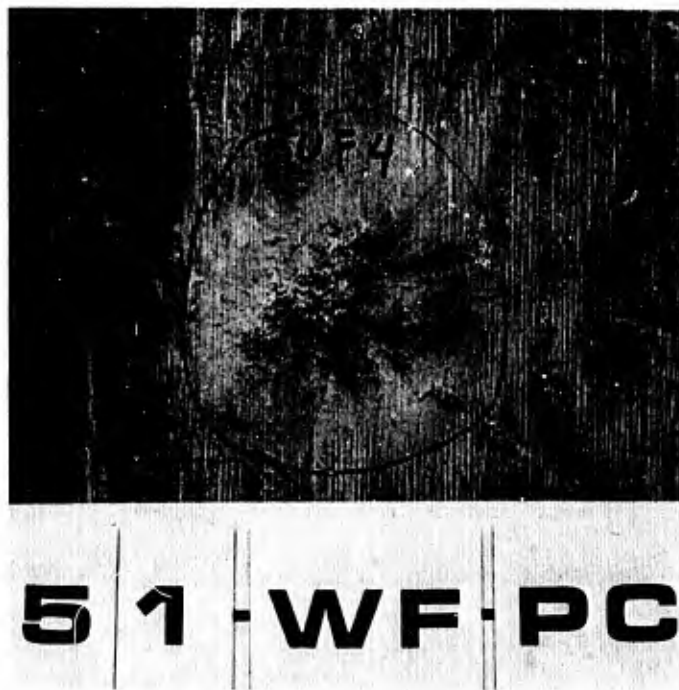

Figure 4-2.408

### MESH ORIENTATION

In Experiment 6, with panels having 45 degree variation in the orientation of reinforcement layers, two such panels and a 1" wire cloth reinforced back up panel were placed in tandem at 3½" spacing and exposed to three rifle rounds. The panels were then each reversed and three more rounds were fired.

Characteristic results are shown in the following figures:

Figure 4-2.409 Round 1, Front Face, Front Panel (Right) and Round 5, Back Face (Left)

Figure 4-2.410 Round 1, Back Face, Front Panel (Left) and Round 5, Front Face (Right)

Figure 4-2.411 Round 1, Front Face, Intermediate Panel

Figure 4-2.412 Round 1, Back Face, Intermediate Panel

Figure 4-2.413 Round 2, Back Face of Back Up Panel (Right) and Round 4, Front Face of Back Up Panel (Left)

Figure 4-2.414 Round 2, Front Face of Back Up Panel (Marked BUF2)

Back face spalling of the back up panels occurred with all rounds fired and the first layer of wire mesh was barely exposed on the front face at the point of impact of Rounds 2 and 3.



Figure 4-2.409

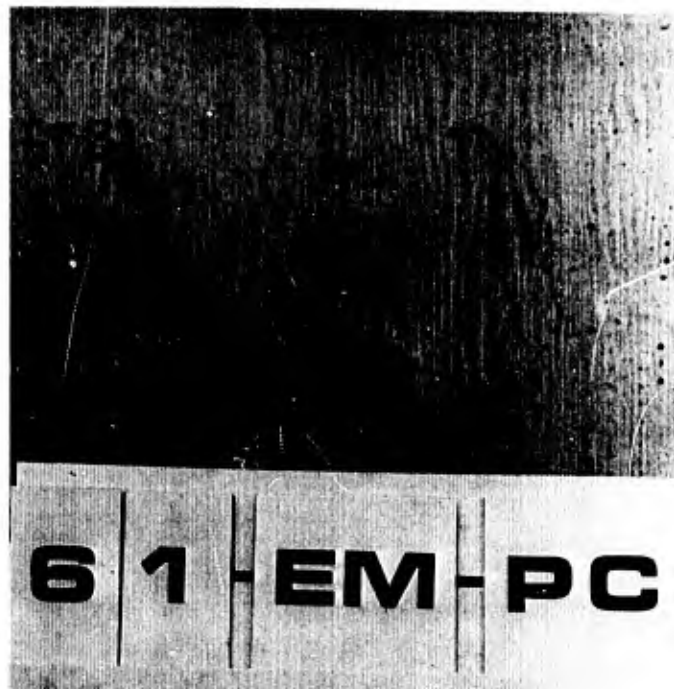

Figure 4-2.410



6 | 1 | -EM-PC

Figure 4-2.411



6 | 1 | -EM-PC

Figure 4-2.412

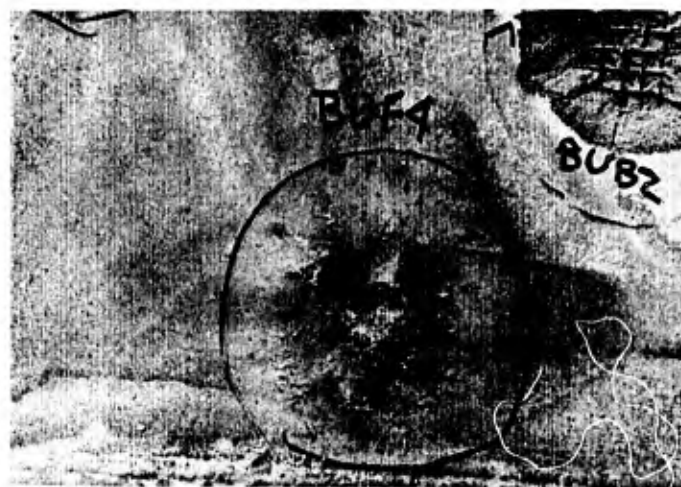

6 | 1 | -EM-PC

Figure 4-2.413

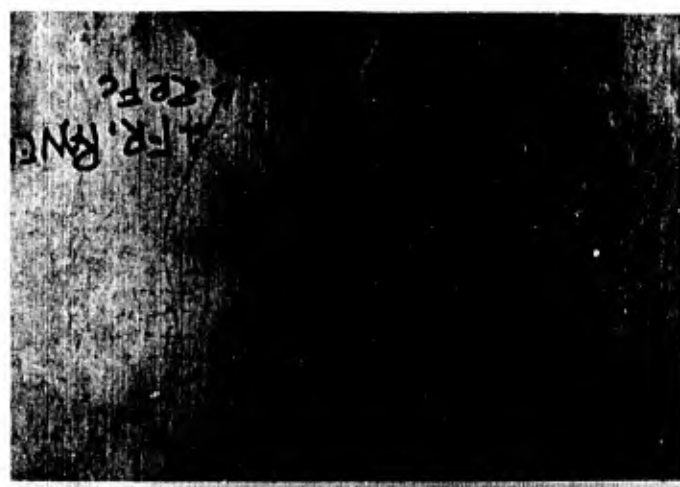

6 | 1 | -EM-PC

Figure 4-2.414

The back face spalling of the back up panel is indicative of more residual energy after penetration of two panels than was indicated with 90 degree orientation of reinforcement. Dust fine powdered lead in the adhesion to the front face of the back up panel is evidence that the bullet core was pulverized and the impact on the front face was that of a jet stream of pulverized cement and lead. There appeared to be more of this material adhering to the panel face than adhered in the experiments with the mesh oriented at 90 degrees. The diameters and depths of spall areas on the front and intermediate panels were compared with those without fiber glass screen in Experiment 4 and no consistent difference was found. These measurements have a random variation between rounds in one panel.

It was discovered during the experiment that the reinforcement on the screeded side of the panels was embedded about 3/16". Subsequent trial with two layers of expanded metal lath revealed that the rhombuses can nest slightly when one layer is oriented at 45 degrees with the other. It is believed that the embedment was an accumulation of nesting that occurred during vibration. This embedment may have reduced the resistance of the panels to some degree, believed to be small. It is safe to say that no improvement in response may be gained by orienting successive layers at 45 degrees.

#### 4-2.5 Experiments 7 and 8, Combined

The purpose of Experiment 7 was to compare the response of panels made of Fast Fix I cement with those made of Portland cement Type III. Experiment 8 was a trial of several angles of incidence with panels of Portland cement Type III. The two experiments were conducted in one day of firing on the rifle range.

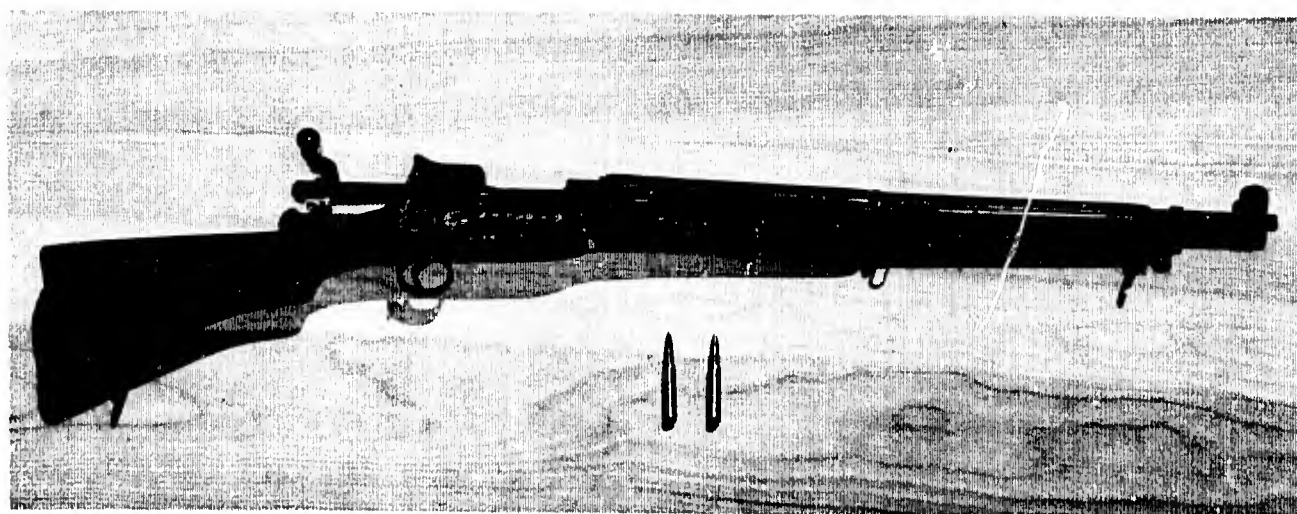

U. S. Rifle, M1917, Cal. .30-'06  
(Enfield Action)

FAST FIX CEMENT



In Experiment 7, two Fast Fix I panels and a 2" Portland Cement back up panel were placed in tandem at 3½" clear spacing and exposed to two rifle rounds. The results are shown in the following figures:

Figure 4-2.501 Front Face, Front Panel

Figure 4-2.502 Back Face, Front Panel

Figure 4-2.503 Front Face, Intermediate Panel

Figure 4-2.504 Back Face, Intermediate Panel

Figure 4-2.505 Front Face, Back Up Panel

Figure 4-2.501

The response of the panels did not indicate any difference in the protective capability of Fast Fix I and Portland cement panels.

Both rounds made neat holes in the front panel with little front face spalling and moderate spalling on the back face. Holes in the second panel were larger and jagged and there was considerable back face spalling. The evidence of impact on the back up panel was the same as observed with two Portland cement panels in front.

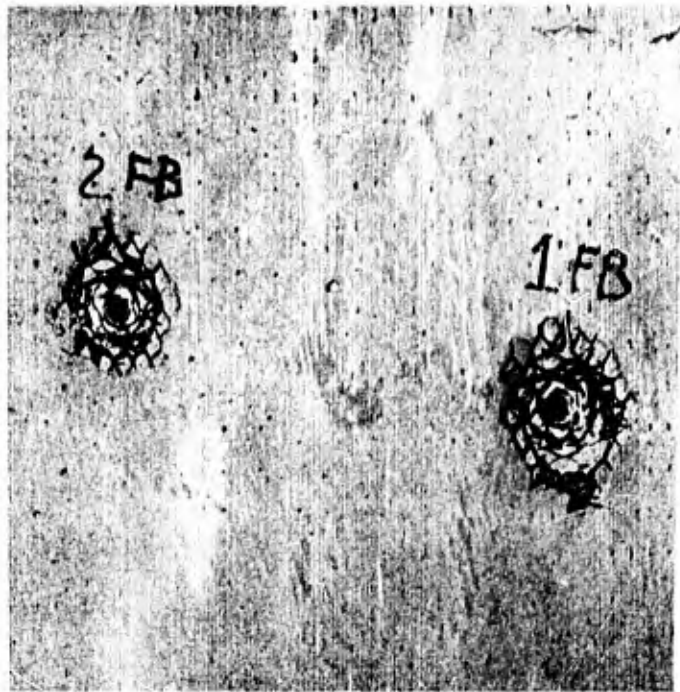

Figure 4-2.502

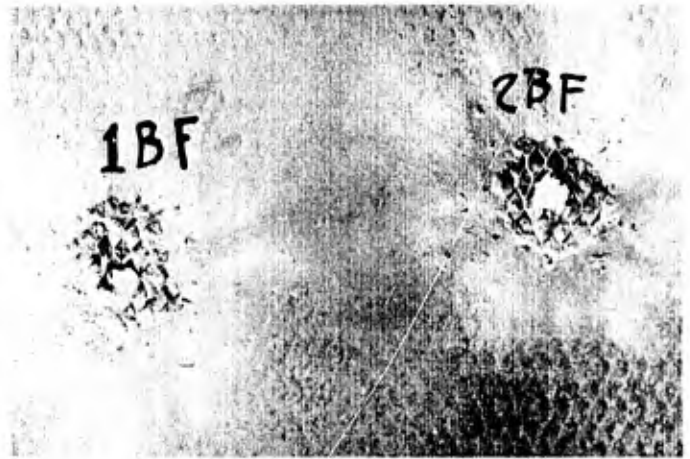

Figure 4-2.503

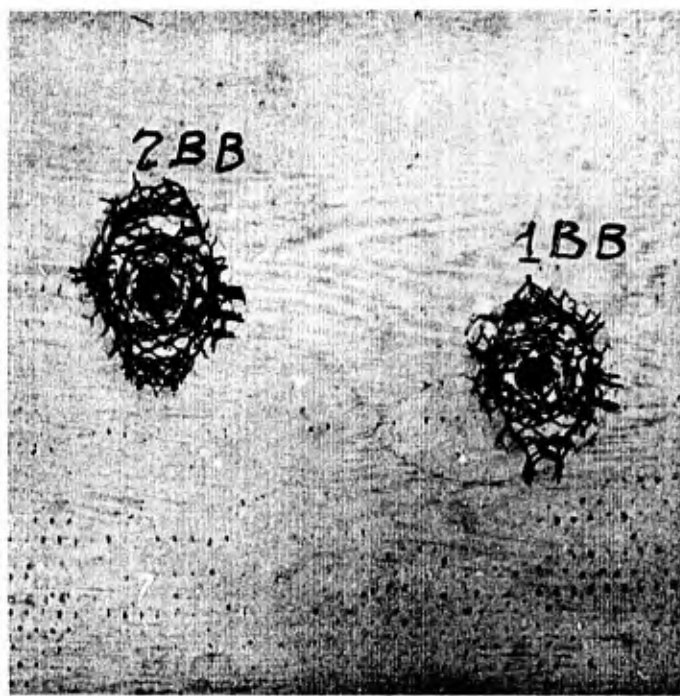

Figure 4-2.504

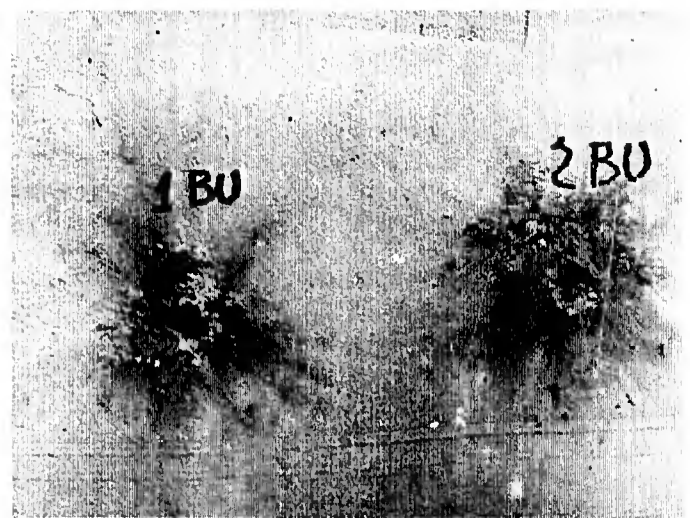

Figure 4-2.505



33° ANGLE OF INCIDENCE

The results in Experiment 8 of one rifle round on a 1" Portland cement panel tilted forward at an incident angle of 33 degrees is shown in the following figures;

Figure 4-2.506 Front Face, Line of Fire View

Figure 4-2.507 Front Face View Normal to Panel

Figure 4-2.508 Back Face View Normal to Panel

Figure 4-2.509 Path of Bullet, Front Face

Figure 4-2.510 Path of Bullet, Rear Face

Fragments of most of the bullet were found in debris on the lower edge support

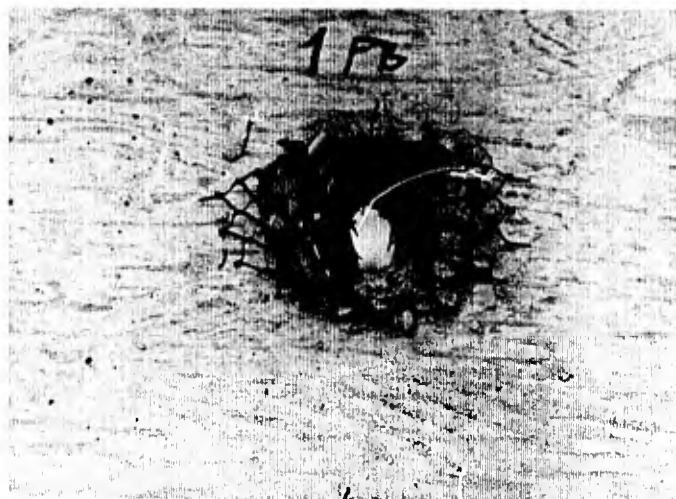

Figure 4-2.506



**8-1-PC-1**

Figure 4-2.507



**8-1-PC-1**

Figure 4-2.508



**8-1-PC-1**

**8-1-PC-1**



Figure 4-2.509



Figure 4-2.510

27° ANGLE OF INCIDENCE

The results of one rifle round on two 1" panels at 3½" clear spacing without a back up panel, tilted rearward at an incident angle of 27 degrees are shown in the following figures;

- Figure 4-2.511 Front Face, Front Panel, Line of Fire View
- Figure 4-2.512 Front Face, Front Panel, in Profile
- Figure 4-2.513 Back Face, Front Panel
- Figure 4-2.514 Back Face, Front Panel, in Profile
- Figure 4-2.515 Back Face, Front Panel, Line of Fire View
- Figure 4-2.516 Impact Area on Undamaged Rear Panel (circled)



Figure 4-2.511



Figure 4-2.512

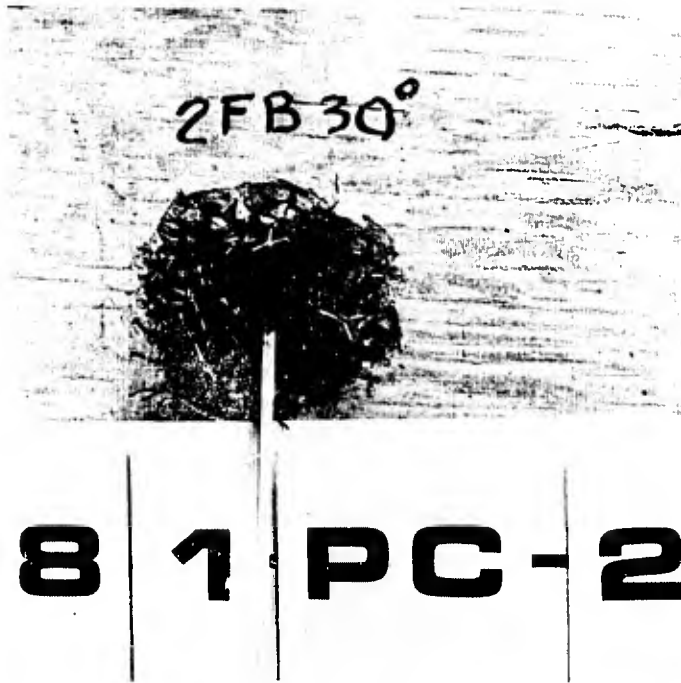

Figure 4-2.513

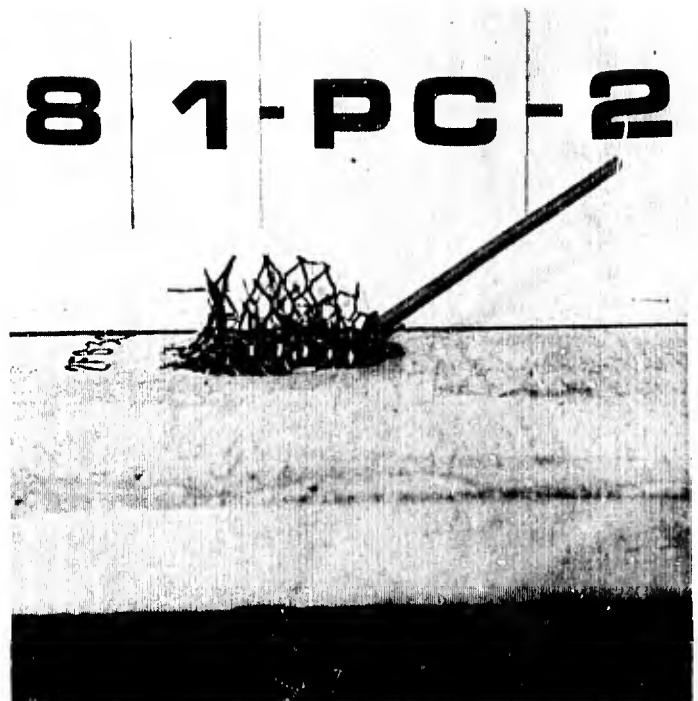

Figure 4-2.514



Figure 4-2.515

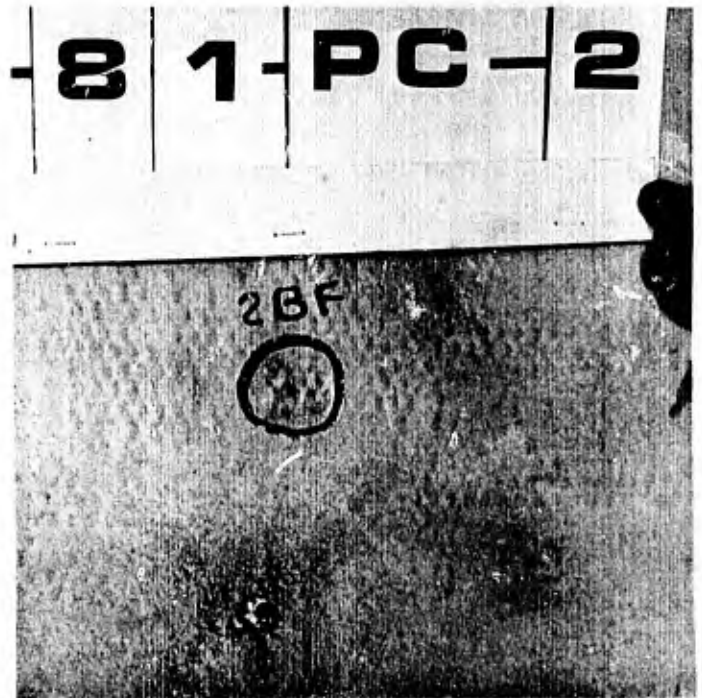

Figure 4-2.516

42° ANGLE OF INCIDENCE

The incident angle was next set at 42 degrees with two 1" panels in tandem at 3½" clear spacing without back up panel.

Results are shown in the following figures;

Figure 4-2.517 Front Face, Front Panel

Figure 4-2.518 Back Face, Front Panel

Figure 4-2.519 Profile of Front Face, Front Panel

Figure 4-2.520 Profile of Back Face, Front Panel

Figure 4-2.521 Slight Damage to Front Face, Rear Panel

The back face of the rear panel showed no evidence of the impact on the front face.



Figure 4-2.517

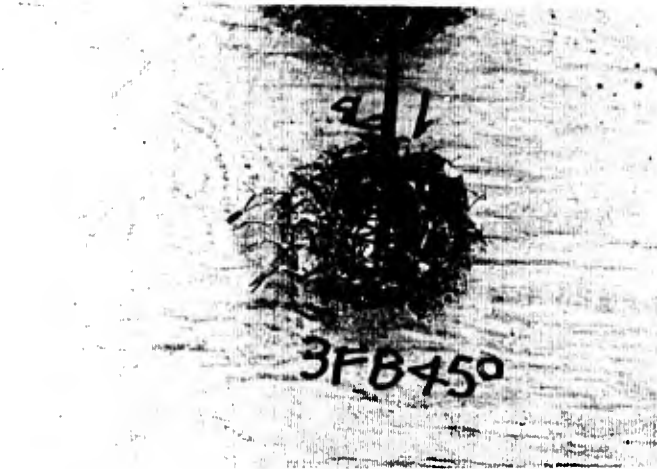

**8 1-PC-3-**

Figure 4-2.518

**8 1-PC 3**

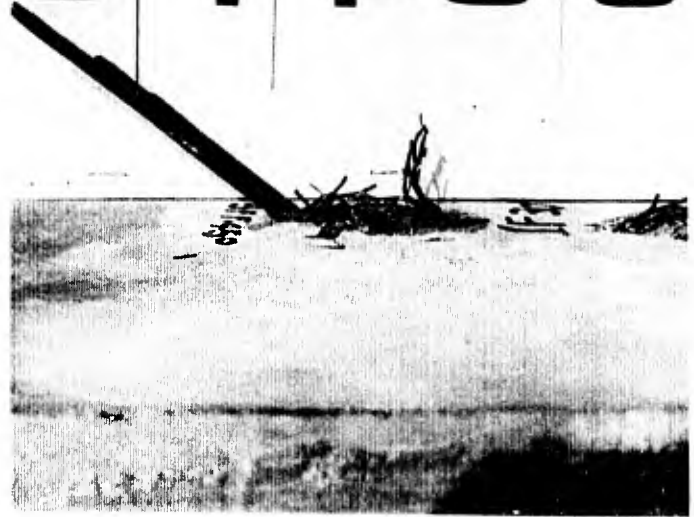

Figure 4-2.519

**8 1-PC-3**

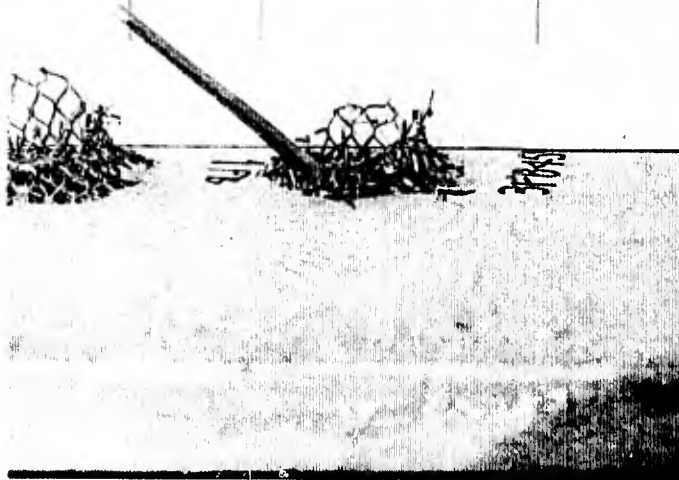

Figure 4-2.520



**8 1-PC-3**

Figure 4-2.521

57° ANGLE OF INCIDENCE

Two 1" panels and a back up panel at 3½" clear spacing were exposed to one rifle round at an incident angle of 57 degrees. For the first time in Experiment 8, the intermediate panel was penetrated.

Results are shown in the following figures:

Figure 4-2.522 Front Face, Front Panel

Figure 4-2.523 Back Face, Front Panel

Figure 4-2.524 Front Face, Back Panel

Figure 4-2.525 Back Face, Back Panel

Figure 4-2.526 Back Face, Back Panel,  
in Profile

There was no damage to the back up panel.



Figure 4-2.522

4FB60°



**8 | 1-PC-4**

Figure 4-2.523

4BF 60°



**8 | 1-PC-4**

Figure 4-2.524

4BB60°



**8 | 1-PC-4**

Figure 4-2.525

**8 · 1-PC-4**

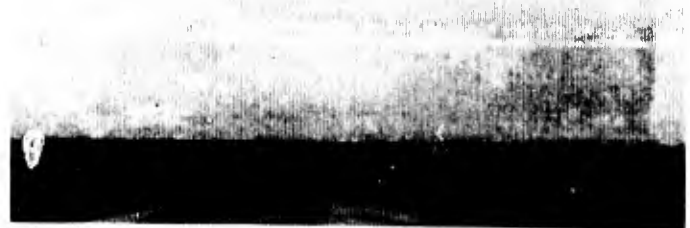

Figure 4-2.526

#### 49.5° ANGLE OF INCIDENCE

The 57 degree and 42 degree results bracketed rear panel penetration; the same panel arrangement was repeated at 49½ degrees. Earlier rounds had been fired on the panel; a clear area was chosen but for some reason, 8 rounds were wild and penetrated damaged areas of the rear panel. The range manager, an experienced rifleman suggested that a tiny particle of jacket copper may have become seized in the lands of the bore. Rounds 9, 10 and 11 hit in a clear area and provide valid results. Results are shown in the following figures:

Figure 4-2.527 Front Face, Front Panel

Figure 4-2.528 Back Face, Front Panel

Figure 4-2.529 Front Face, Rear Panel

Figure 4-2.530 Back Face, Rear Panel

The results appear to support a conclusion that penetration of two 1" panels by caliber .30-06 bullets may be expected at incident angles of 50 degrees or larger; not at lesser incident angles. Ricochets may not be expected at angles of 27 degrees or greater. Lesser incident angles were not tried on the rifle range but were tried later with the M16 rifle. (Par.4-6.2).

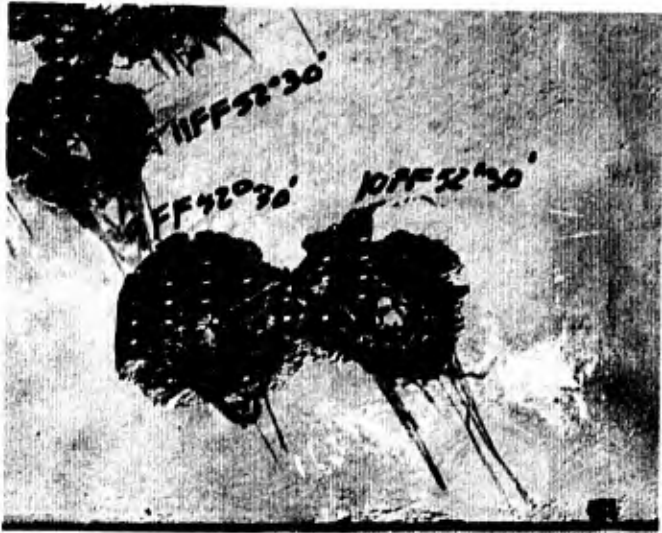

- 8 | 1 | PC | 6 | - 8 | 1 | PC | 6 | -

Figure 4-2.527

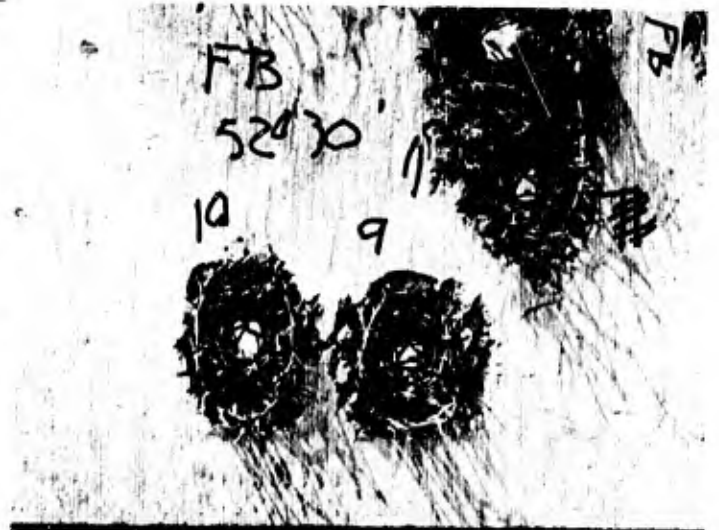

- 8 | 1 | PC | 6 | -

Figure 4-2.528

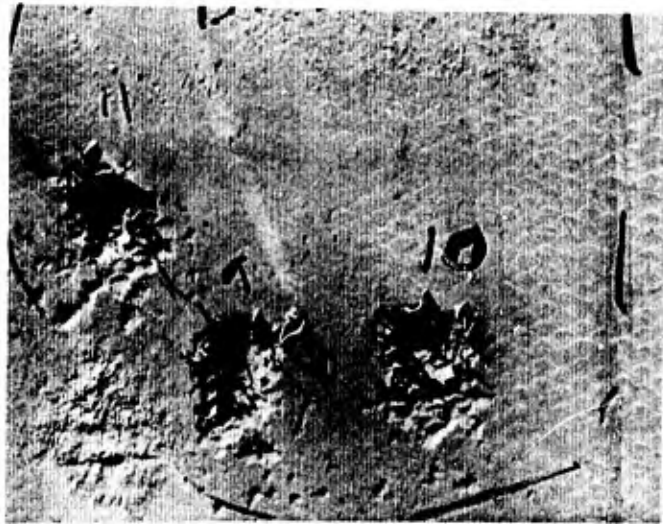

- 8 | 1 | PC | 6 | - 8 | 1 | PC | 6 | -

Figure 4-2.529

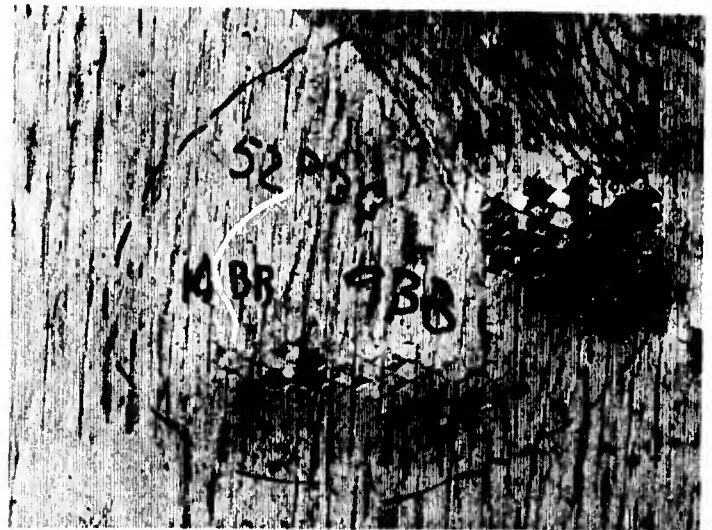

- 8 | 1 | PC | 6 | -

Figure 4-2.530

## Section 4-3

### Surface Blast Experiments

#### 4-3.1 Panel Design

Panels were 3'-5½"x3'-5½"x2", nominal, reinforced from each surface inward with six interfaced layers of expanded metal lath. The six-layer stacks were separated by 6 six-layer spacer stacks, 27"x4", nominal. The nominal thickness of panels overran from 1/8" to 1/4" due to deficiencies in the forms and reinforcement on the screed side was embedded from 1/4" to 3/8". Panels were placed with the screed side upward for all experiments except the two pound charge.

#### 4-3.2 Two-Pound Charge at Six Foot Stand Off

Two panels cast on July 25, 1968, form side up, at 5 feet and 6 feet, respectively from the pier simulator, were exposed to 2 lbs. of TNT on the top panel, on August 6, 1968.

Results are depicted in the following figures:

Figure 4-3.201 Top Surface of the Upper Panel

Figure 4-3.202 Side View of the Upper Panel

Figure 4-3.203 Lower Surface of the Lower Panel

Figure 4-3.204 Side View of Lower Surface  
of Lower Panel

The upper surface of the lower panel was undamaged. Apparently the fracturing on the lower surface was terminal spall produced by the shock wave through the panel. The large flakes into which it fractured were probably due to the unintended embedment of reinforcement. A small rise at the corners of the lower panel indicated the start of flexural yield.

The hole in the top panel measured approximately 9"x6" and four layers of the top reinforcement were peeled back. The hole was about 10" in diameter at the lower surface with spalling extending out radially to a distance of about 1½" from the edge of the hole.



Figure 4-3.201

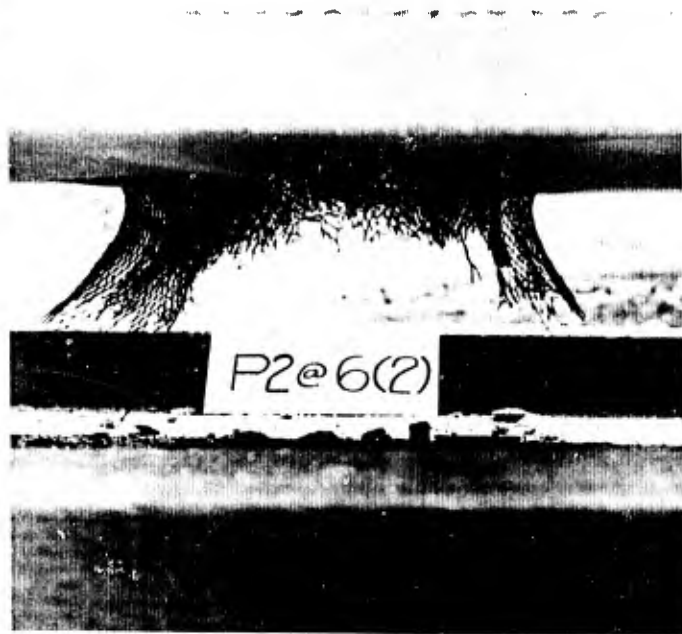

Figure 4-3.202



Figure 4-3.203



Figure 4-3.204

### 4-3.3 Four-Pound Charge at Six Foot Stand Off

Two panels, cast on July 25, 1968, screed side up, at 5 ft. and 6 ft., respectively, from the pier simulator were exposed to 4 lbs. of TNT on the top panel on August 6, 1968.

Results are depicted in the following figures:

Figure 4-3.301 Top Surface of the Upper Panel

Figure 4-3.302 East Side View of the Two Panels

Figure 4-3.303 West Side View of the Two Panels

Figure 4-3.304 Lower Surface View of the Two Panels in Place

Figure 4-3.305 Upper Surface of the Lower Panel

Figure 4-3.306 View Through Cribbing of Debris on Pier Simulator

The pier simulator remained undamaged. The top panel damage was mainly punching shear with small flexural yield. The lower panel was destroyed by punching shear and flexure. More energy appeared to be absorbed by the lower panel.



Figure 4-3.301



Figure 4-3.302



Figure 4-3.303



Figure 4-3.304



Figure 4-3.305

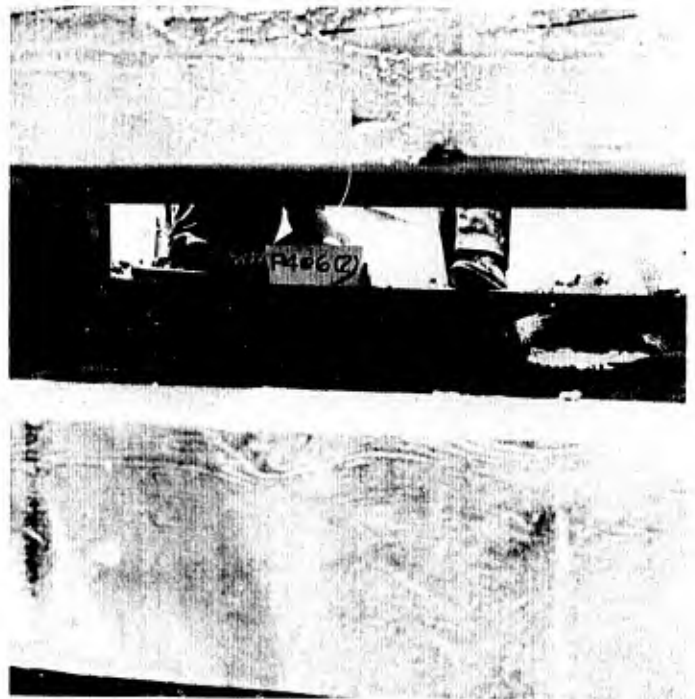

Figure 4-3.306

4-3.4 Eight-Pound Charge at  
Six Foot Stand Off

Three panels, cast July 25, 1968, screed side up, at 6 ft., 5 ft., and 4 ft., respectively, from the pier simulator, were exposed to 8 lbs. of TNT on the top panel, on August 6, 1968. Results are depicted in the following figures:



Figure 4-3.401

Figure 4-3.401 View Down Through Three Panels

Figure 4-3.402 Side View of Three Panels

Figure 4-3.403 Lower Surface of Top Panel

Figure 4-3.404 Upper and Lower Surfaces, Respectively, of Second Panel

Figure 4-3.406 Upper and Lower Surfaces, Respectively, of Third Panel

No damage was done to pier simulator. The most energy appeared to be absorbed in the second panel.

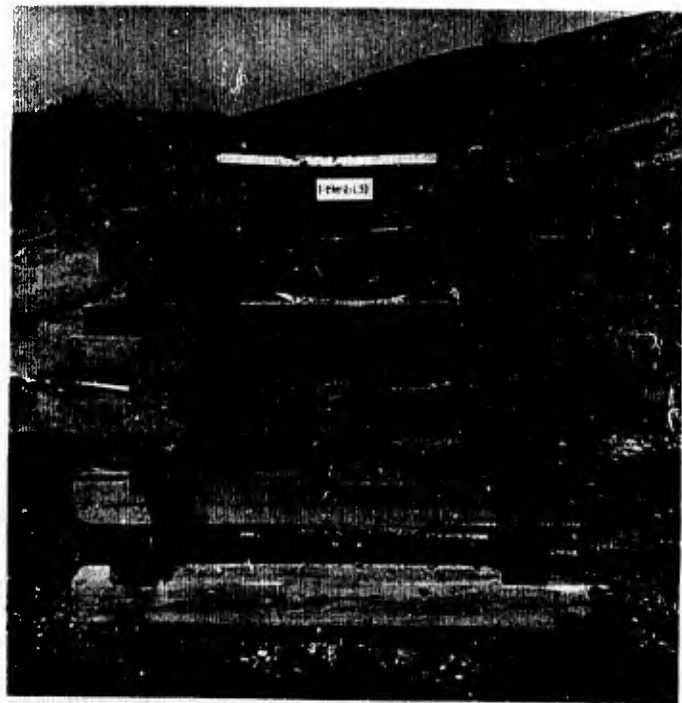

Figure 4-3.402

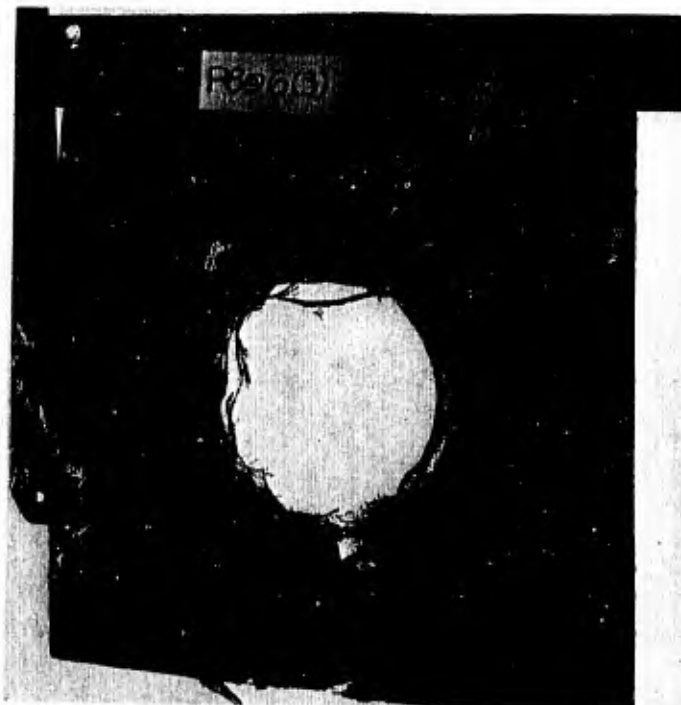

Figure 4-3.403



Figure 4-3.404



Figure 4-3.405



Figure 4-3.406



Figure 4-3.407

#### 4-3.5 Twenty-Pound Charge at Six Foot Stand Off

Three panels, cast July 29, 1968, screed side up, at 6 ft., 5 ft., and 4 ft., respectively, from the pier simulator, were exposed to 20 lbs. of TNT on the top panel, on August 7, 1968. Results are depicted in the following figures:

- Figure 4-3.501 Disarrayed Crib; Broken Panels Piled on Pier Simulator
- Figure 4-3.502 Criboing Removed to Reveal Broken Panels
- Figure 4-3.503 Re-assembled Panel Remains in the Order, Top, Intermediate, and Lower, from the Viewer's Right
- Figure 4-3.504 Residual Deflection in Pier Simulator

Residual deflection of the pier simulator, evidence of lower surface cracking, first appeared in this experiment. The amount was straight-edged on the two diagonals and on the 5½" segment with most deflection. The average of the three measurements was 1-1/16". Interface slippage occurred on both faces of this segment and appeared to have occurred at one interface removed on either side. Friction due to the tension in the torqued threaded rods had to be overcome for interface slippage to occur.

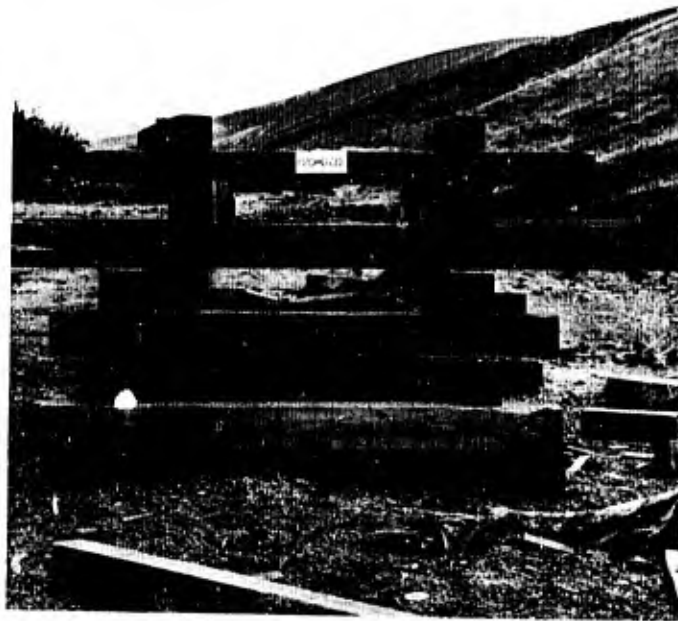

Figure 4-3.501



Figure 4-3.502

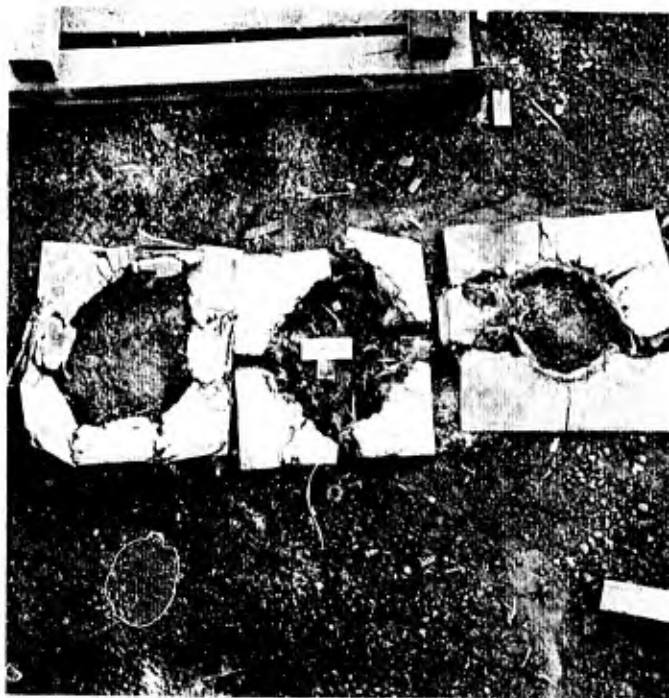

Figure 4-3.503

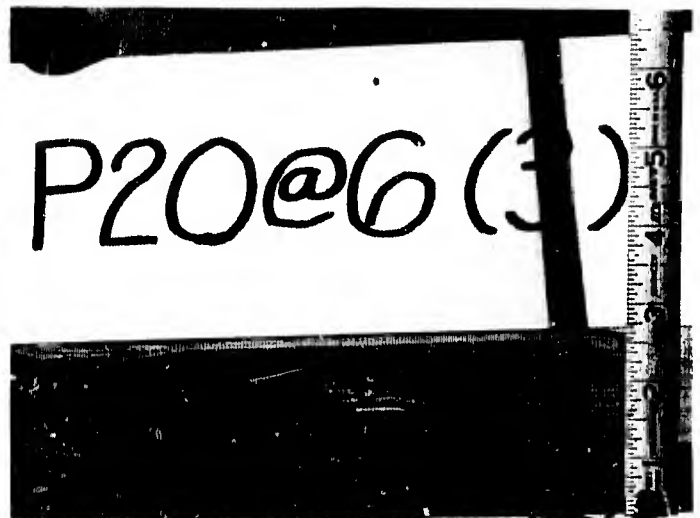

Figure 4-3.504

#### 4-3.6 Eight-Pound Charge at Four Foot Stand Off

Two panels, cast July 29, 1968, screed side up, at 4 ft. and 2 ft., respectively, from the pier simulator were exposed to 8 lbs. of TNT on the top panel, on August 7, 1968. Results are depicted in the following figures:

Figure 4-3.601 Top Surface of the Upper Panel

Figure 4-3.602 Underside of the Upper Panel

Figure 4-3.603 Broken Lower Panel Lying on the Pier Simulator

Figure 4-3.604 Underside of Re-assembled Lower Panel

The hole in the top panel is about 16 inches in diameter. Three to four layers of expanded metal are peeled back on the upper surface. The panel is dished downward. Flexural cracking occurred normal to the edges where the distance from the hole to the edge is least. The panel was rotated and displaced somewhat and one fill crib was dislodged, indicating that the panel may have lifted. The mesh on the underside was flared outward more than on the earlier 8 lb. shot with 12 inches between panels.

The second panel revealed closely spaced fracture cracks fanning out radially from the hole in the center. The panel is deeply dished and there is pronounced curvature with no evidence of flexure cracks.

The pier simulator was straight-edged and the residual deflection was found to be  $1-1/16$ ", which was the same as measured after the preceding 20 lb. shot.



Figure 4-3.601



Figure 4-3.602

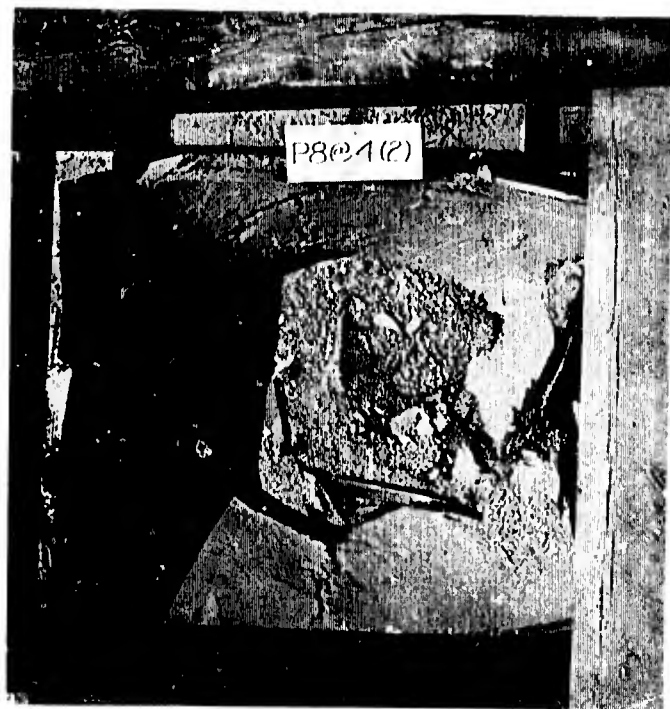

Figure 4-3.603



Figure 4-3.604

#### 4-3.7 Twenty-Pound Charge at Four Foot Stand Off

Two panels, cast July 29, 1968, screed side up, at 4 ft. and 2 ft., respectively, from the pier simulator, were exposed to 20 lbs. of TNT on the top panel on August 7, 1968. Results are depicted in the following figures:

Figure 4-3.701 Remains of Crib and Panels

Figure 4-3.702 Straight-edge Across Pier Simulator

Figure 4-3.703 Maximum Residual Deflection of Pier Simulator

Figure 4-3.704 Underside of Pier Simulator

The quite complete destruction of the panels left nothing significant to examine or to photograph. The maximum residual deflection of  $1-1/16$ " measured after the preceding 20 lb. shot was in the sixth segment from the viewer's left in Figure 4-3.702. It increased to  $1-1/8$ ", but the residual deflection in the eighth segment from the left was scaled at  $1-11/16$ " after the second 20 lb. shot. (Fig. 4-3.703). The pier simulator was tilted up to permit the lower surface to be photographed. This photograph is reproduced in Figure 4-3.704. Six cracked segments are discernable.

#### 4-3.8 Evaluation of the Surface Blast Results

The cracking and residual deflection that occurred in the pier simulator when it was exposed to the blast and driven debris from a 20 pound charge do not necessarily indicate that the shaft of a pier or column of a bent would be destroyed. The simulator, composed as it was, of segments that could be readily lifted and set in place at Camp Pendleton, differed considerably from a shaft or column as to its properties. Nevertheless, it may be accepted as a guide to a conclusion that a six foot stand off is marginal for surface blast from a 20 pound charge.

While it is not factually revealed that the panels afford protection by means other than enforcing stand off, there are indications that the energy absorbed is significant. The damage done to the intermediate panel by an eight pound charge was greater than that done to the lower panel. Instances of pronounced bending curvature accompanied by closely spaced hair cracks was indicative of the ductility of the panels.

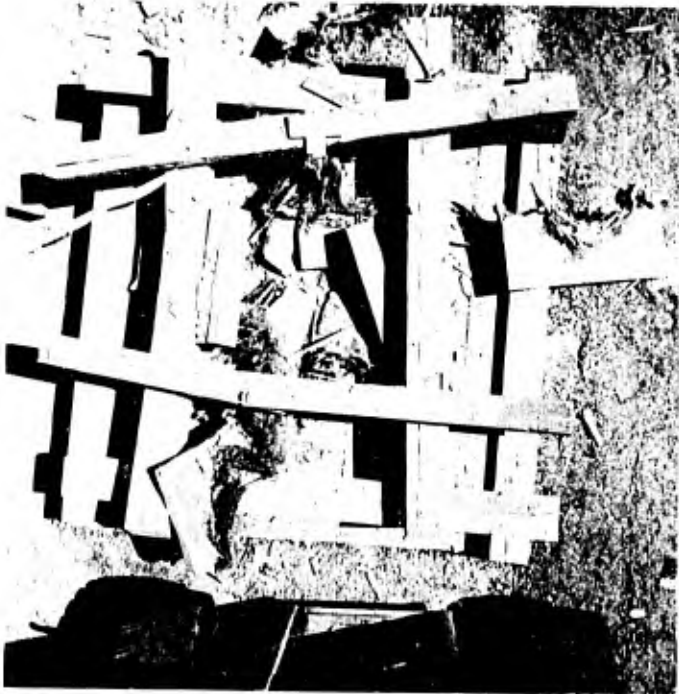

Figure 4-3.701

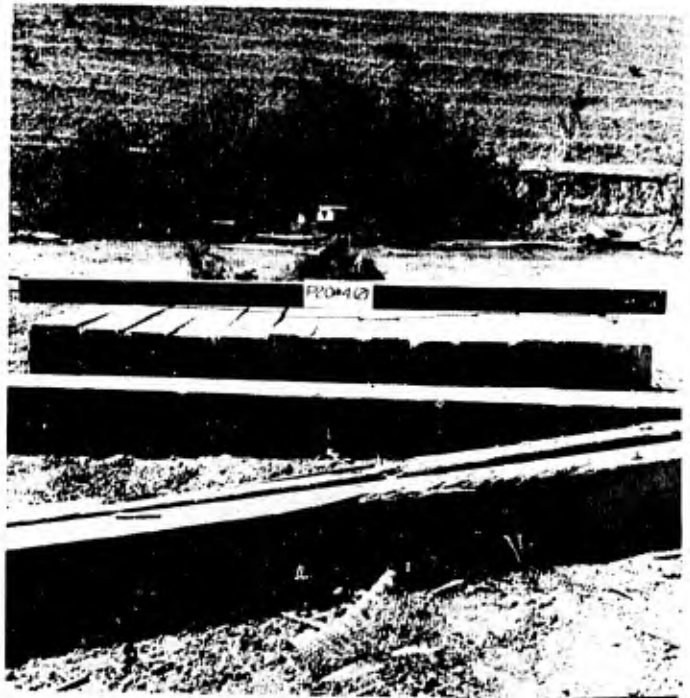

Figure 4-3.702



Figure 4-3.703

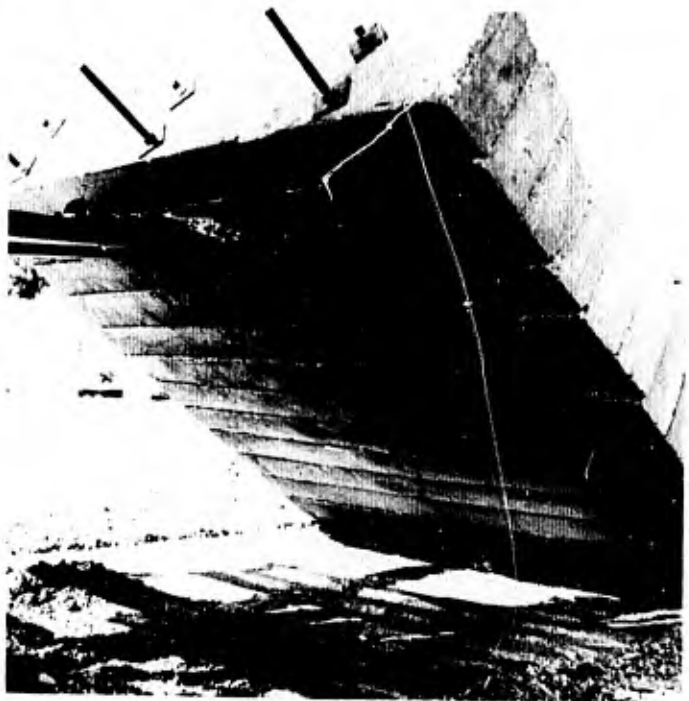

Figure 4-3.704

## Section 4-4

### Experiments with Fragmenting Projectiles and Grenade, M26

#### 4-4.1 Panel Design

Panels exposed to all ordnance items except delay fuzed shells were 2'-3½" x 2'-3½" x 1", nominal, reinforced with 9 layers of expanded metal lath. The layers were 2'-3½" x 2'-0", stacked with the direction of the lesser dimension alternated. Panels exposed to delay fuzed shells were of the same design as those exposed to surface blast. (Paragraph 4-3.1)

#### 4-4.2 Shell, Mortar, 81mm at Three Foot, Six Foot and Twelve Foot Stand Offs

Two sets of three panels each, at 6½" clear spacing were at 3 foot and 6 foot stand offs in supports originally used on the rifle range and one set of three panels at 7" clear spacing were at 12 foot stand off in the support built at the site. The shell was vertical at panel height, vanes down. Panels were cast on July 29 and 30, 1968 and exposed on August 8, 1968. Results at three foot stand off are depicted in the following figures:

Figure 4-4.201 Front Face of the Front Panel in Place

Figure 4-4.202 Rear Face of the Front Panel

Figure 4-4.203 Profile of the Front Panel, Rear Face on the Left

Figure 4-4.204 Front Face of the Intermediate Panel with Wire Probe through the only Penetration

Figure 4-4.205 Rear Face of the Intermediate Panel

There was neither damage nor marks of any kind on the rear panel. The support was moved backward 19".



Figure 4-4.201



Figure 4-4.202



Figure 4-4.203



Figure 4-4.204



Figure 4-4.205

81mm Mortar at 6'

Results at six foot stand off are depicted in the following figures:

Figure 4-4.206 Front Panel In Place

Figure 4-4.207 Rear Face of Front Panel

Figure 4-4.208 Profile of Rear Face of Front Panel

Figure 4-4.209 Front Face of Intermediate Panel

The intermediate panel was not penetrated. Seven small surface spalls barely revealed the outer layer of reinforcement without disturbing it. The rough surfaced mounds are dust adhesions from the front panel. The support was moved backward 3".



Figure 4-4.206

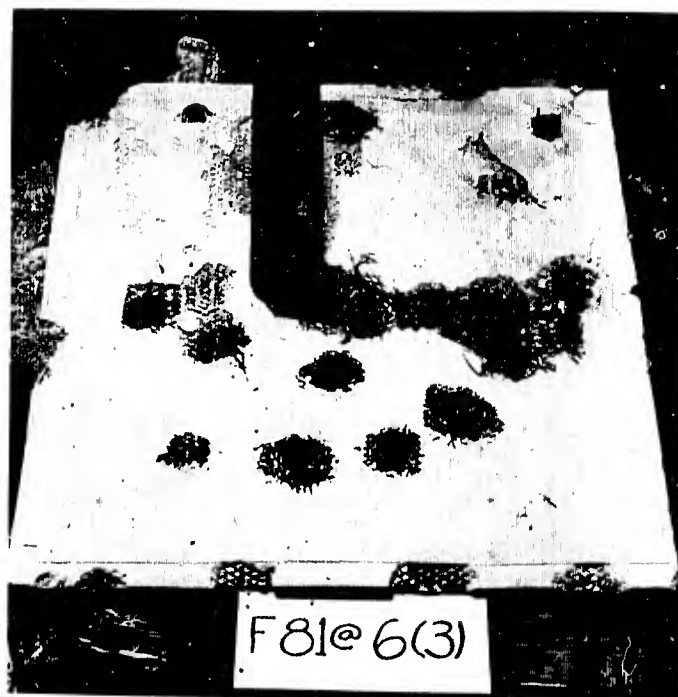

Figure 4-4.207



Figure 4-4.208



Figure 4-4.209

### 81mm Mortar at 12'

The results at twelve foot stand off are depicted in the following figures:

- Figure 4-4.210 Front Panel in Place
- Figure 4-4.211 Rear Face of Front Panel
- Figure 4-4.212 Profile of Front Face of Front Panel
- Figure 4-4.213 Profile of Rear Face of Front Panel

Damage to the intermediate panel was limited to one shallow surface spall on the front face which revealed four of the diamond shaped patterns of the undisturbed expanded metal.

Comparison of the results at the three stand offs reveals the pronounced decline in the kinetic energy of fragments during 12 feet of flight from the burst and equally pronounced decrease in the density of the fragment pattern. The support was not displaced.

### 4-4.3 Shell, Howitzer, 105mm

Two sets of three panels each, at 6½" clear spacing, at 5 foot and 20 foot stand offs, respectively, and one set of three panels at 7" clear spacing, at 10 foot stand off were exposed to the 105mm shell on August 8, 1968. The panels were cast July 29 and 30, 1968.



Figure 4-4.210



Figure 4-4.211



Figure 4-4.212



Figure 4-4.213

105mm Howitzer at 5'

Results at five foot stand off are depicted in the following figures:

- Figure 4-4.301 Front Panel in Place
- Figure 4-4.302 Rear Face of Front Panel
- Figure 4-4.303 Intermediate Panel in Place
- Figure 4-4.304 Rear Face of Intermediate Panel
- Figure 4-4.305 Rear Panel in Place with Lodged Fragment Indicated
- Figure 4-4.306 Rear Face of Rear Panel

Damage to the rear panel was limited to embedment of one large fragment and one deep indentation near the lower edge. Both caused rear face spall without rupture of metal. The support was moved backward 2'-11".

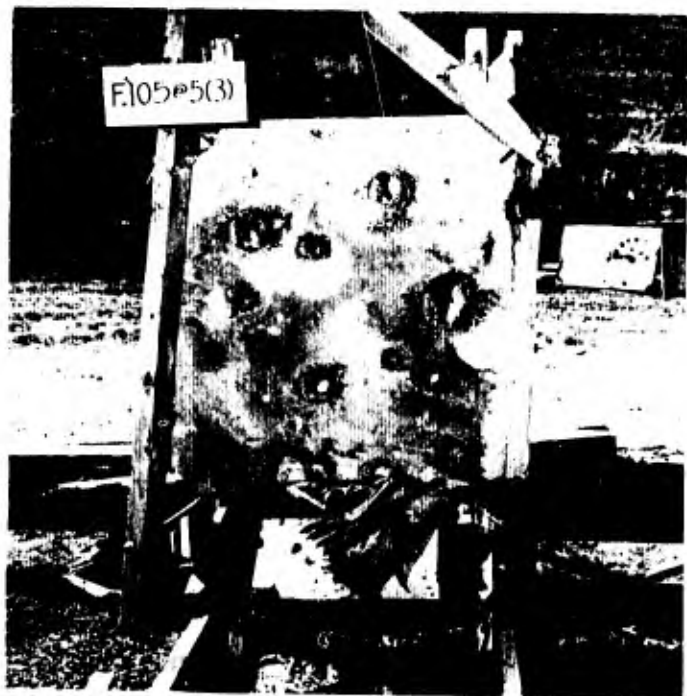

Figure 4-4.301

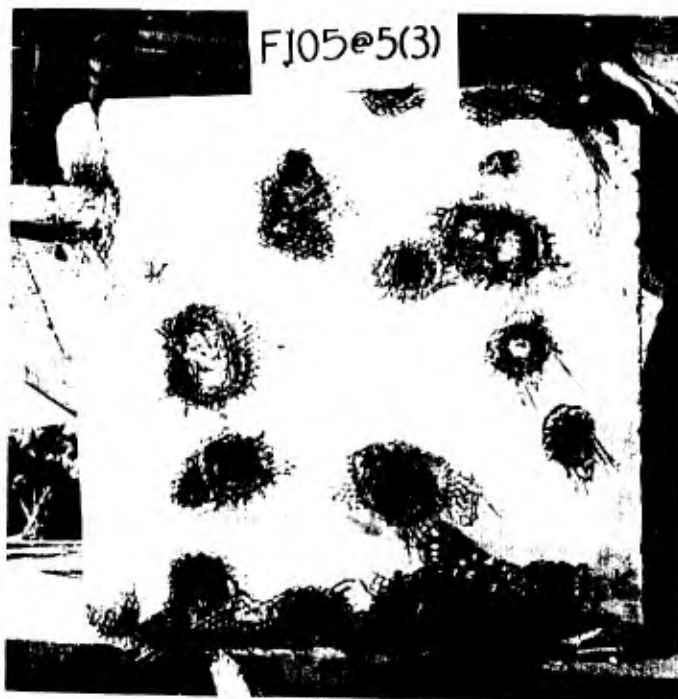

Figure 4-4.302



Figure 4-4.303

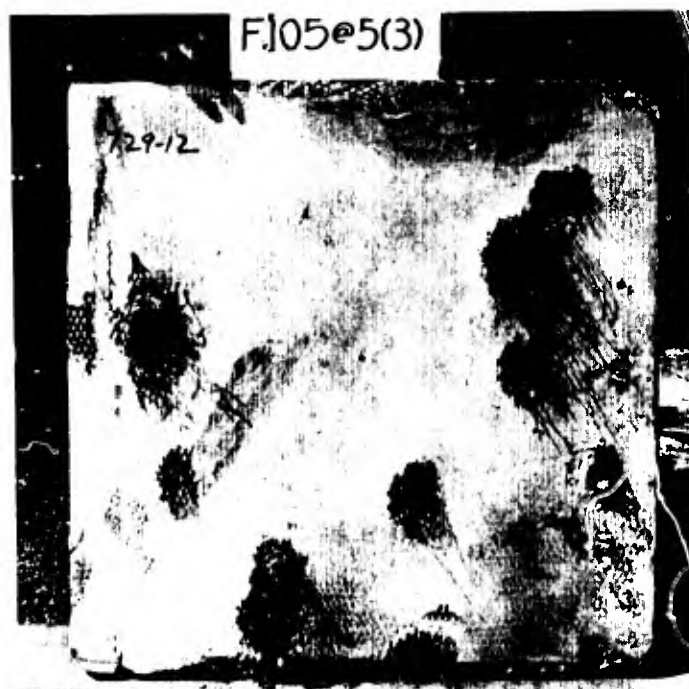

Figure 4-4.304

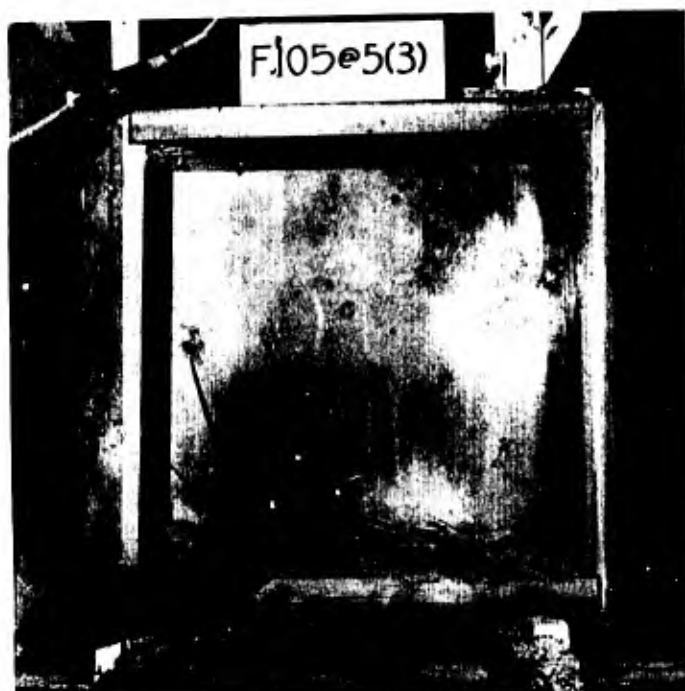

Figure 4-4.305

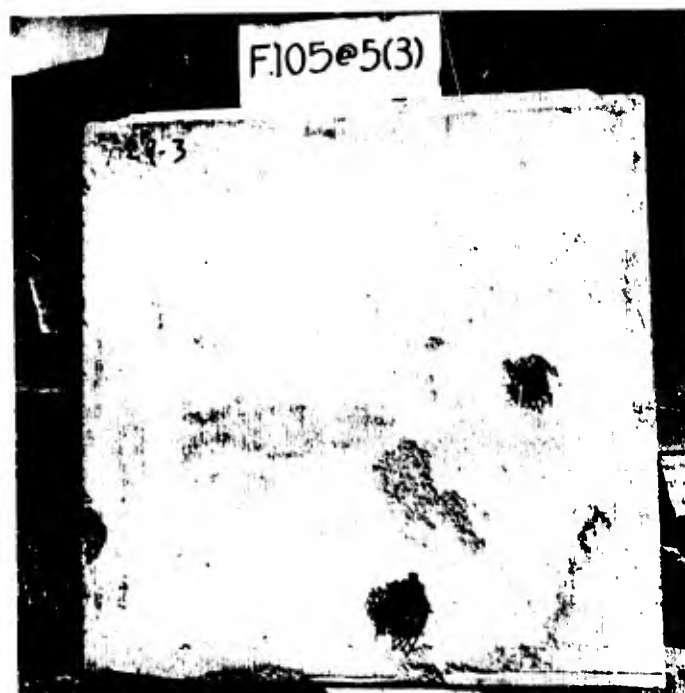

Figure 4-4.306

105mm Howitzer at 10'

Results at ten foot stand off are depicted in the following figures:

Figure 4-4.307 Front Panel in Place

Figure 4-4.308 Rear Face of Front Panel

Figure 4-4.309 Intermediate Panel in Place

Figure 4-4.310 Rear Face of Intermediate Panel

There was one penetration of the intermediate panel, one embedment creating slight spall on the back face and one hit that cut a large notch in the edge of the panel. The rear panel was undamaged. This indicated that the penetration of the intermediate panel extracted virtually all of the energy of the fragment. The support was pushed backward 11" and considerably damaged. (Fig. 4-4.307)



Figure 4-4.307



Figure 4-4.308



Figure 4-4.309



Figure 4-4.310

105mm Howitzer at 20'

Results at twenty foot stand off are depicted in the following figures:

- Figure 4-4.311 Front Panel in Place
- Figure 4-4.312 Rear Face of Front Panel
- Figure 4-4.313 Front Face of Intermediate Panel
- Figure 4-4.314 Rear Face of Intermediate Panel
- Figure 4-4.315 Spall Caused by Impact on Front Face of Rear Panel (Lower Left)
- Figure 4-4.316 Spall and Blister on Back Face of Rear Panel

The penetration of the intermediate panel was made by a large fragment. The support was not displaced.



Figure 4-4.311



Figure 4-4.312

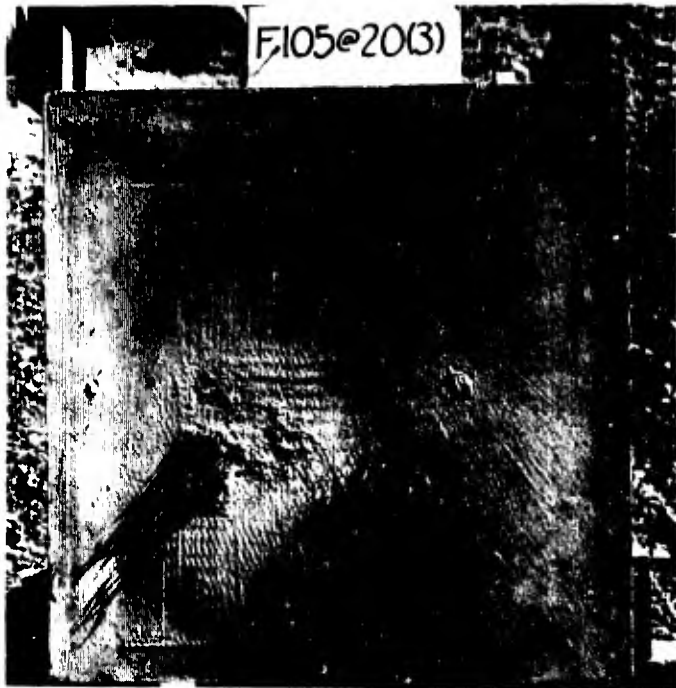

Figure 4-4.313

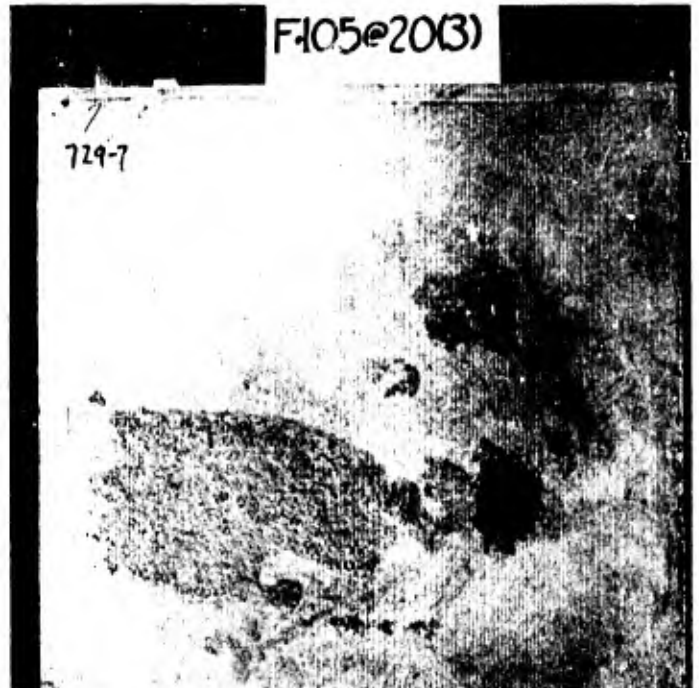

Figure 4-4.314



Figure 4-4.315



Figure 4-4.316

4-4.4 Shell, Mortar, 4.2 Inch

Panel arrangements as described in Paragraph 4-4.2 were exposed to the 4.2 inch mortar shell on August 9. Panels were cast on July 27 and 29, 1968. Results at five foot stand off are depicted in the following figures:

- Figure 4-4.401 Condition After the Shell Burst
- Figure 4-4.402 Front Face of Front Panel
- Figure 4-4.403 Back Face of Front Panel
- Figure 4-4.404 Front Face of Intermediate Panel
- Figure 4-4.405 Back Face of Intermediate Panel
- Figure 4-4.406 Embedment in Rear Panel of only Penetration of Intermediate Panel



Figure 4-4.401



Figure 4-4.402



Figure 4-4.403



Figure 4-4.404



Figure 4-4.405



Figure 4-4.406

4.2" Mortar at 10'

Results at ten foot stand off are depicted in the following figures:

Figure 4-4.407 Front Panel in Place

Figure 4-4.408 Back Face of Front Panel

Figure 4-4.409 Front Face of Intermediate Panel

Figure 4-4.410 Back Face of Intermediate Panel

No damage was done to the back panel. There was an adhesion of dust about  $1\frac{1}{4}$ " in diameter behind the single penetration of the intermediate panel. The decline in panel damage from front to rear is note-worthy. It is apparent in Figure 4-4.407 that the large fragment, or cluster of fragments that did extensive damage at the lower edge of the front panel was diverted downward so it merely nicked the edge of the intermediate panel.



Figure 4-4.407



Figure 4-4.408



Figure 4-4.409

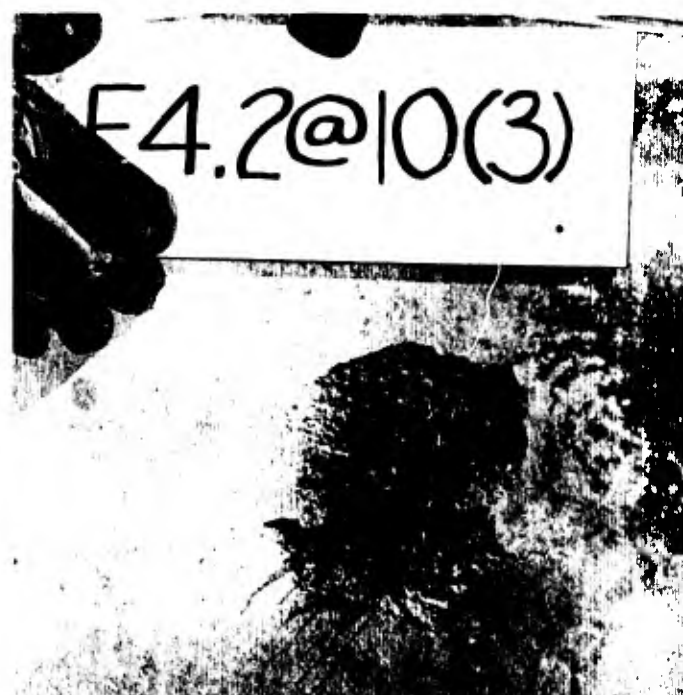

Figure 4-4.410

4.2" Mortar at 20'

Results at twenty foot stand off are depicted in the following figures:

Figure 4-4.411 Front Panel in Place

Figure 4-4.412 Rear Face of Front Panel

Figure 4-4.413 Front Face of Intermediate Panel

Figure 4-4.414 Rear Face of Intermediate Panel

The single penetration of the intermediate panel did not even mark the rear panel.

Figure 4-4.415 shows an assortment of retrieved fragments.

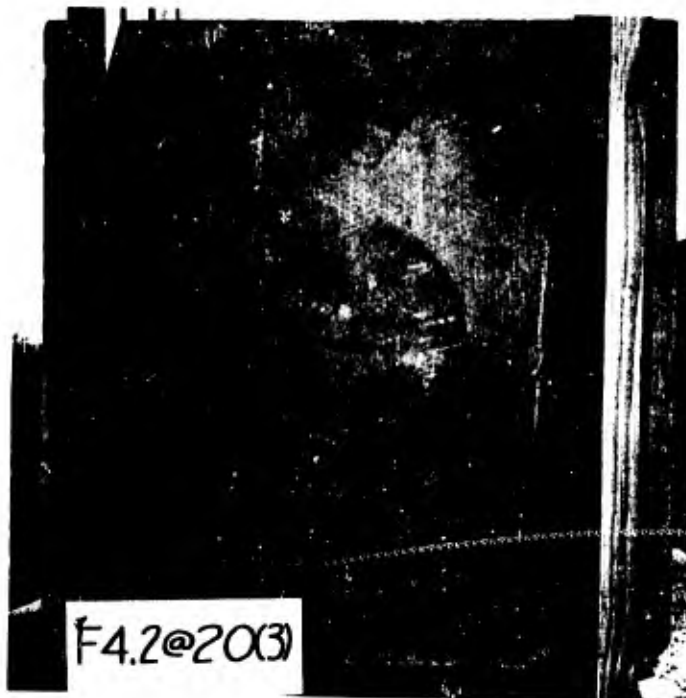

Figure 4-4.411

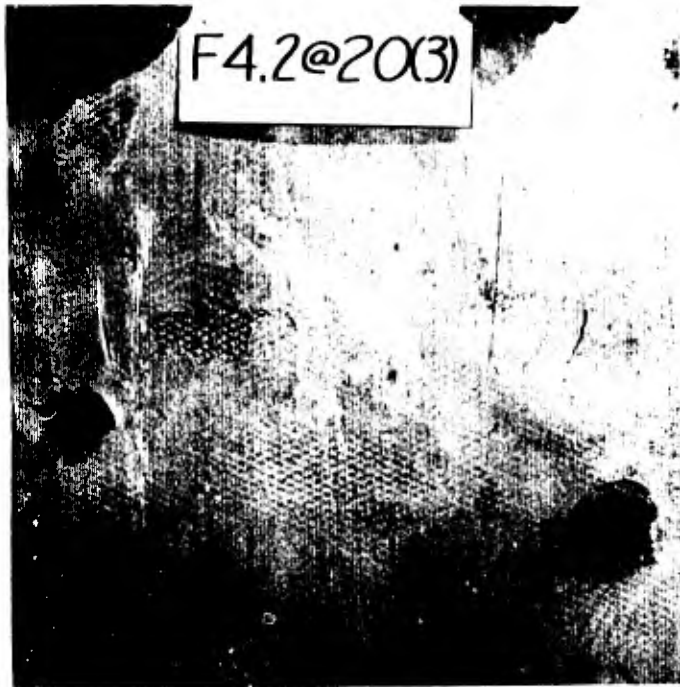

Figure 4-4.412

F4.2@20(3)



Figure 4-4.413

F4.2@20(3)



Figure 4-4.414



Figure 4-4.415

#### 4-4.5 Delay Fuzed Shell, Mortar, 81mm, Between Panels

Penetration of the top layer of two-layer overhead cover, followed by a burst between layers, was simulated by statically detonating an 81mm mortar shell on August 8, 1968, in horizontal position midway between two 3'-5½"x3'-5½"x2" panels placed 6 feet apart.

Results are depicted in the following figures:

Figure 4-4.501 Partly Demolished Cribbing

Figure 4-4.502 Position of Panels After Burst

Figure 4-4.503 Upper Panel Turned to Reveal Lower Surface

Figure 4-4.504 Upper Surface of Lower Panel in Position After Burst (Debris Removed)

Figure 4-4.505 Lower Surface of Lower Panel

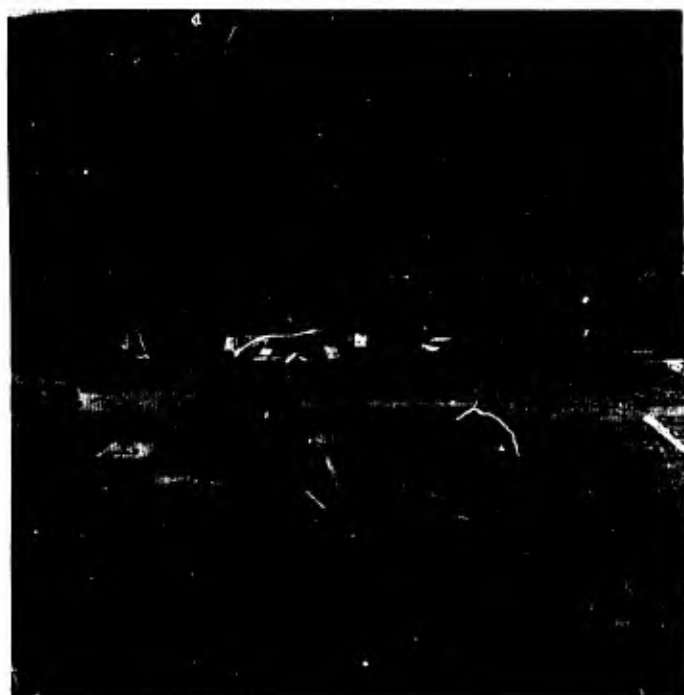

Eight penetrations were identifiable in the lower panel and others may be concealed by the flexural and shear failure. The upper panel, which was free to rise, has a dense pattern of indentations on the lower surface and nine spalled areas with bulged mesh on the upper side. There were three blister-like bulges where the cement adhered to the mesh. The flexural break is near the junction of 27½" and 13-¾" mesh layers. (These junctions were distributed around the panel.)

Figure 4-4.501



Figure 4-4.502



Figure 4-4.503



Figure 4-4.504



Figure 4-4.505

4-4.6 Delay Fuzed Shell Comparable to the Shell, Howitzer, 105mm

The 105mm shell was used as a measure of damage potential because there seemed to be little doubt that the 4.2 inch mortar shell would so far exceed the upper bound that no useful information would be gained. The panel and shell arrangement was the same as that used for the 81mm shell (Paragraph 4-4.5). The shell was detonated on August 8, 1968.

Results are depicted in the following figures:

Figure 4-4.601 Overall View of Disarrayed Cribbing

Figure 4-4.602 Bird's-eye View of the Wreckage

Figure 4-4.603 Piece of Upper Panel Found, Upper Side Down, 20 Feet From the Crib

Figure 4-4.604 Another Piece of Upper Panel Found 25 Feet from the Crib in the Opposite Direction

Figure 4-4.605 Bottom Panel Lying on the Ground as it was Found

Figure 4-4.606 Upper Surface of the Larger Piece of Upper Panel

Evaluation is substantially limited to a description of the destruction as complete.

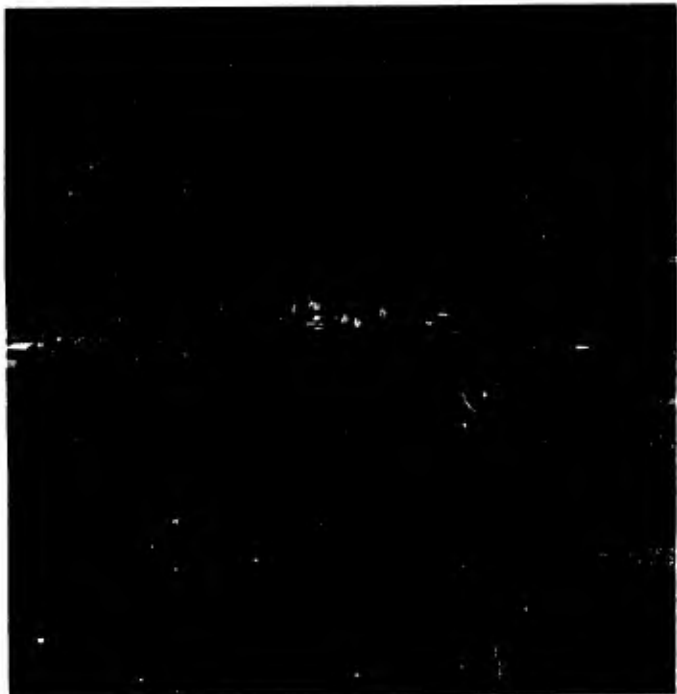

Figure 4-4.601



Figure 4-4.602



Figure 4-4.603



Figure 4-4.604



Figure 4-4.605



Figure 4-4.606

#### 4-4.7 Grenade, Hand, M26

The grenade was detonated, August 13, 1968, on the uppermost panel of three panels, 1" thick, in horizontal position, spaced 12 inches apart. The axis of symmetry of the grenade was vertical with the fuze well up and charged with Composition, C4.

Results are depicted in the following figures:

Figure 4-4.701 Upper Surface of the Upper Panel

Figure 4-4.702 Lower Surface of the Upper Panel

The rather neat hole sheared through the top panel measured about 5" in diameter to the edge of the expanded metal and 8" to 9" across, measured to the limits of the spalled area. The panel was dished downward by means of rather uniform curvature with no evidence of flexural failure in the form of cracking on either surface. The permanent deflection, straight-edged on the diagonals, was 7/16" to 1/2", measured at the edge of the cement around the hole. The deflection, straight-edged along one edge of the panel was 1/4".

The top surface revealed an interesting pattern of small spalls, or gouges, in concentric circles. There was evidence of the uniformity of fragmentation of the grenade wall and the precision with which fragments travelled on lines perpendicular to the curved wall of the grenade, both results which are due to the internal waffle-gridding of the wall. The pattern of radial blast marks on the upper surface is also notable for its uniformity.

The pronounced outward flaring of expanded metal on the lower surface is believed to be evidence of lateral component of blast, which may have been induced by reflection from the intermediate panel. It is recognized that the flaring may be due, in part, to the inertia of the expanded metal.

The only visible damage to the intermediate panel was some pock-marking of the surface and a small amount of dish shaped permanent deflection, which was straight-edged on the diagonals and measured at about  $3/16$  inch. One shallow surface mark was about  $1 \times 3/4$ " and there was a blister area about 1" in diameter opposite it on the lower surface.

The lower panel was undamaged.



Figure 4-4.701



Figure 4-4.702

#### 4-4.8 Evaluation of Results of the Fragmenting Weapons

Under all conditions tried in the experiments with the exception of shell bursts between panels, the panels revealed evidence of significant potential for use in protection against fragments.

Damage to rear panels was limited to the embedment of one large fragment and one deep indentation under exposure to the Shell, Howitzer, 105mm at 5 foot stand off, and one embedment under exposure to the Shell, Mortar, 4.2 inch at 5 foot stand off. Damage to the rear panel is a guide in estimating the damage to protected surfaces screened by a two-panel revetment or overhead cover. The rear panel was only 7 inches away from the intermediate panel. Pronounced spacial attenuation of the kinetic energy of fragments, caused by air drag, was demonstrated by the decrease in intermediate panel damage by fragments encountered by the panels at 6, 10, 12 and 20 foot stand offs.

A revetment will have bands of weakness where panels meet if the edges are abutted. This could be avoided by overlapping the edges with the acceptance of some added work in replacing damaged panels. Unquestionably, repeated bursts at 5 foot or 6 foot stand off from the same panels will destroy three 1" panels. The probability of this occurrence is rather small.

It is concluded that well constructed two-panel revetments will very materially reduce the probability of materiel damage and personnel casualties from 81mm mortar shells that burst at 3 foot stand off or more and 4.2 inch mortar and 105mm Howitzer shells that burst at 5 foot stand off or more. The probability of bursts at lesser stand offs will depend on the probable error of the weapons and, with the Howitzer and other artillery weapons, the height of protected materiel and revetment and orientation of the revetment relative to the direction of fire.

The panels in overhead cover show little potential against delay fuzed projectiles which penetrate the top layer and burst between layers. The degree of venting as a result of cribbing used as supports in these tests was about 50%. The probability of such an occurrence is not known but felt not to be great. Hits with time-fuzed high angle Howitzer fire may drive the nose cone through two layers of panels. This eventuality was not tried because the fuze had to be removed for static detonation.

The downward velocity of the nose cone and bourillet fragments is increased by the terminal velocity of the shell. The terminal velocity of mortar shells is a rather small percentagewise increase. If the nose cone penetrates two layers, it is likely to remain in one piece as a single projectile. The stopping of bourillet fragments should materially reduce casualties and damage. It is concluded that overhead cover of two 1-inch panels will afford protection against time-fuzed bursts approximately equal to that afforded by revetments against low time-fuzed bursts or contact ground bursts.

## Section 4-5

### Shaped Charge Experiments

#### 4-5.1 General

Panels 2'-3½"x2'-3½"x1", cast July 31 and August 1, 1968, reinforced with 9 layers of expanded metal lath were used in these experiments, which were conducted on August 13, 1968. In both experiments, three panels at 12 inch spacing were placed in horizontal position with the lower panel 2 feet above the ground. The rocket, placed nose down on the center of the top panel, was held in vertical position by an expendable styrofoam support.

4-5.2 Results of the 66mm Rocket, HEAT, Detonation

Results are depicted in the following figures:

Figure 4-5.201 Bird's-eye View of Top Panel in Place

Figure 4-5.202 Side View of Top Panel in Place

Figure 4-5.203 Top Surface of Intermediate Panel

Figure 4-5.204 Bottom Surface of Intermediate Panel

Figure 4-5.205 Top Surface of Lower Panel

Figure 4-5.206 Bottom Surface of Lower Panel

The penetration of three panels with little evidence of energy loss rejects the panels for protection against shaped charges. Unexpected results of interest are the elongated hole in the top panel and the severing, by flexural failure, of an outside strip about  $1\frac{1}{2}$ " in width. Observed unsymmetrical splitting of the shell case indicated sideward blast, which elongated the hole. Pressure over the entire panel exerted negative moment. The reinforcement near the outer edge was reduced by the 24" width of alternate layers (p.2-5).

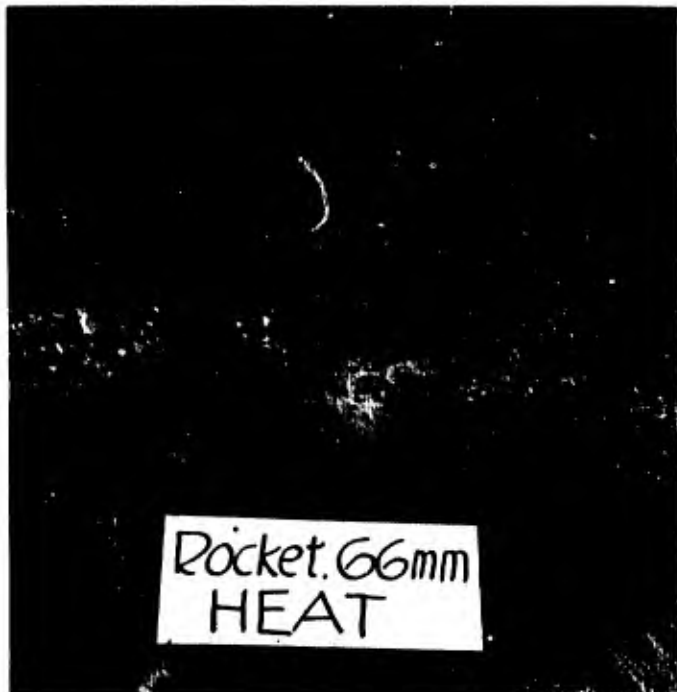

Figure 4-5.201



Figure 4-5.202



Figure 4-5.203



Figure 4-5.204



Figure 4-5.205



Figure 4-5.206

4-5.3 Results of the 3.5 inch Rocket, HEAT, Detonation

Results are depicted in the following figures:



Figure 4-5.301

Figure 4-5.301 Top Surface of Upper Panel

Figure 4-5.302 Bottom Surface of Upper Panel

Figure 4-5.303 Top Surface of Intermediate Panel

Figure 4-5.304 Bottom Surface of Intermediate Panel

Figure 4-5.305 Top Surface of Lower Panel

Figure 4-5.306 Bottom Surface of Lower Panel

Figure 4-5.307 Hole Drilled 3' into Ground

Ineffectiveness against this shaped charge is demonstrated. Severance of edge strip of upper panel is for reasons explained in Par. 4-5.2.



Figure 4-5.302

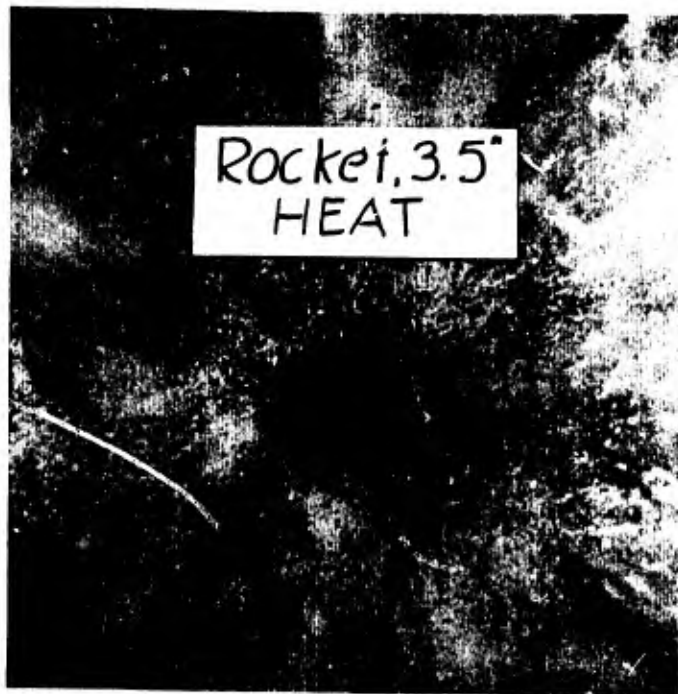

Figure 4-5.303



Figure 4-5.304



Figure 4-5.305

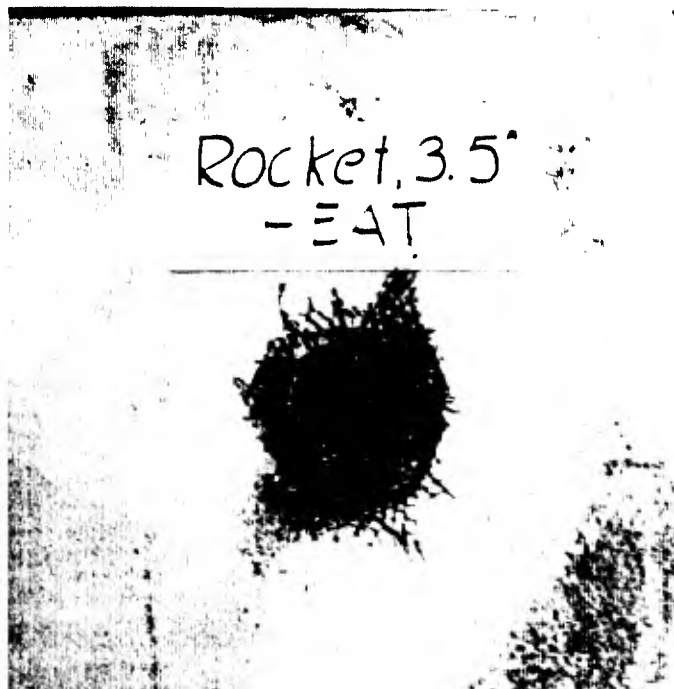

Figure 4-5.306



Figure 4-5.307

## Section 4-6

### Live Fire Experiments

#### 4-6.1 General

Panels, 2'-3½"x2'-3½"x1", cast July 31 and August 1 and 2, 1968, were exposed to live fire from the rifle and the grenade launcher on August 14, 1968. Fire was delivered from about 70 yards, with the exception of a burst of automatic fire from the rifle at about 10 yards. Several panel arrangements were tried, in some of which two panels were interfaced. Panel arrangements are described by notation explained by the following examples:

$P3\frac{1}{2}P3\frac{1}{2}P$  - 3 panels at 3½" spacing

$P3\frac{1}{2}PP3\frac{1}{2}P$  - 1 panel, 3½" space, 2 panels interfaced, 3½" space, 1 panel

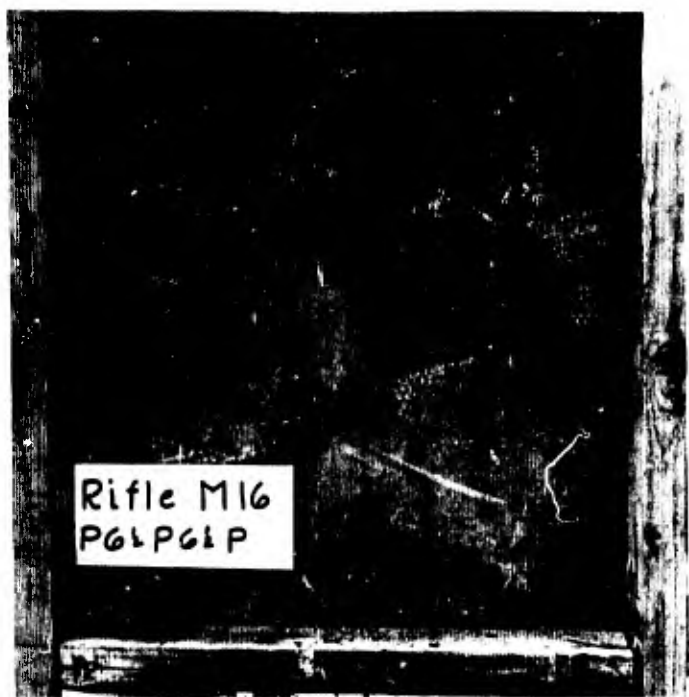

Figure 4-6.201

#### 4-6.2 Slow Fire with Rifle, M16

- Figure 4-6.201 Front Face, First Panel,  $P6\frac{1}{2}P6\frac{1}{2}P$ , is characteristic of all initial bullet entries.
- Figure 4-6.202 Rear Face, First Panel,  $P3\frac{1}{2}P3\frac{1}{2}P$ , is characteristic of single first panel bullet exits.
- Figure 4-6.203 Rear Face, First Panel,  $PP6\frac{1}{2}P$ , reveals ring of surface shear and prevention, by the interfaced second panel of spalling and mesh rupture in the concentric area.
- Figure 4-6.204 Front Face, Second Panel,  $P3\frac{1}{2}P3\frac{1}{2}P$ , is characteristic of bullet entries into a single second panel.
- Figure 4-6.205 Front Face, Second Panel,  $PP6\frac{1}{2}P$ , reveals the prevention of spalling by the interfaced first panel.



Figure 4-6.202



Figure 4-6.203



Figure 4-6.204

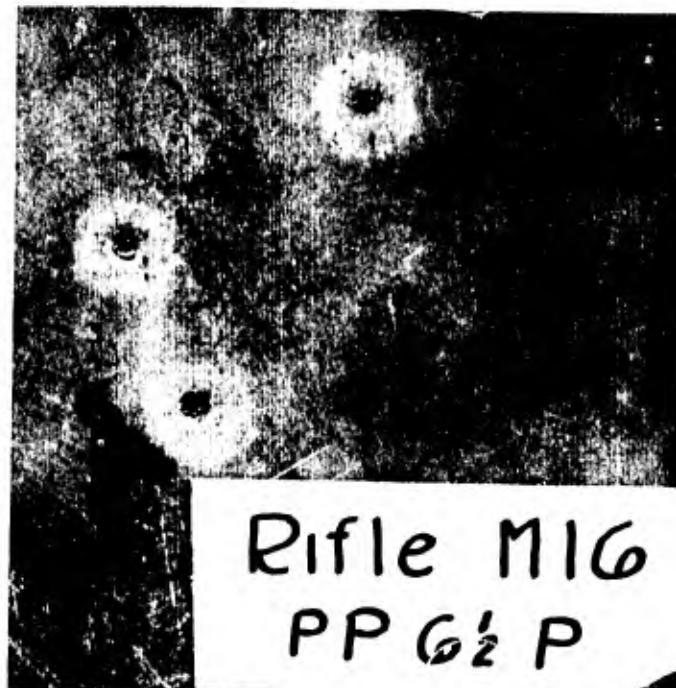

Figure 4-6.205

Slow Fire with Rifle M-16 (continued)

- Figure 4-6.206 Back Face, Second Panel, PP6½P, reveals the spalling and, behind the lower hit, the rupture of mesh, which is indicative of shock propagation. The bullets did not penetrate. Apparently, they were fragmented and lodged in the cement. Front face indentations were about ¼".
- Figure 4-6.207 Back Face, Second Panel, P3½P3½P, two spalled areas in the rear face and one, barely discernable, incipient spall. Four rounds were fired (Fig. 4-6.204); none penetrated.
- Figure 4-6.208 Front Face, Second Panel, P6½P6½P, reveals three indentations with a small amount of spalling.
- Figure 4-6.209 Rear Face, Second Panel, P6½P6½P, reveals one bulged area with virtually no spall out of the three hits revealed by Fig. 4-6.208.

No second panels were penetrated in the M16 Rifle slow fire experiments. Figures 4-6.206, 4-6.207 and 4-6.209 provide a comparison, in the ascending order of apparent energy absorption of the panel arrangements PP6½P, P3½P3½P and P6½P6½P. The 6½" spacing was indicated to be the most defensive of the first and second panel arrangements mentioned above. Increase in spacing above 3½" appeared to have more effect on the M16 bullet than it had on the .30-06 bullet in the parametric experiments.



Figure 4-6.206

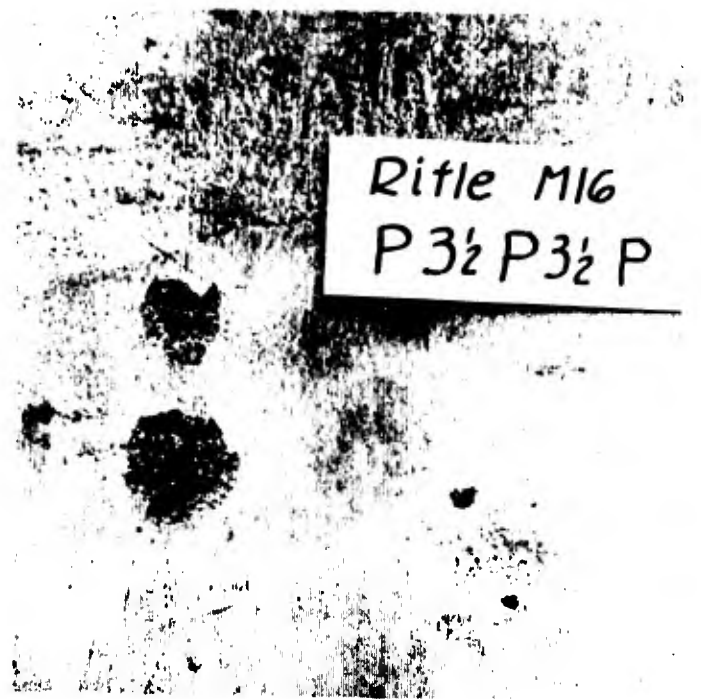

Figure 4-6.207

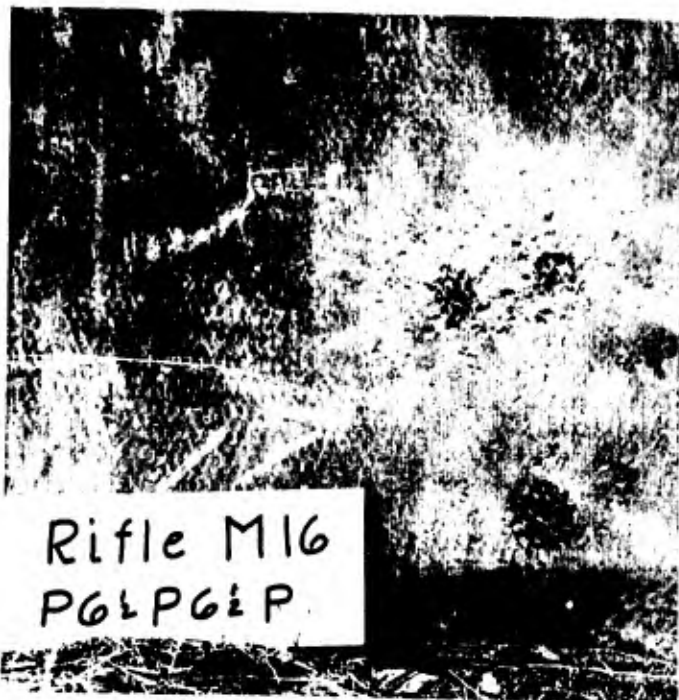

Figure 4-6.208



Figure 4-6.209

Slow Fire with Rifle M16 (continued)

- Figure 4-6.210 Rear Face, Second Panel, P13P, reveals no improvement over the rear face of the second panel in Fig. 4-6.209.
- Figure 4-6.211 Front Face, Second Panel, P3½PP3½P, reveals one pronounced indentation and one scarred surface. On the rear face of this panel there was very shallow spalling, 1" to 1½" in diameter, and no bulging. Second panel effectiveness appeared to be improved by the back up of the third panel. The pronounced difference in front face damage between the two hits can be attributed only to randomness in the performance of a bullet after passing through one panel.
- Figure 4-6.212 Rear Face, Front Panel, P6½P6½P, is an unusually revealing photograph of the details of first panel penetration by the M16 bullet.

Automatic Bursts with M16 Rifle

- Figure 4-6.213 Rear Face of First Panel, P3½P3½P, reveals the effect of automatic fire. One hundred rounds fired at about 10 yards were all low; approximately half of them were misses and the hits were all at the lower edge, many through the lower 2x4 of the retaining frame. Twenty rounds were then fired into the center of the panel at a range of about 5 yards. The second panel was not penetrated.

Thirty-five additional rounds of automatic fire at 5 yards were then delivered to an area of about 20 square inches about 1/3 of the panel height up from the lower edge (Fig. 4-6.213).



Figure 4-6.210



Figure 4-6.211

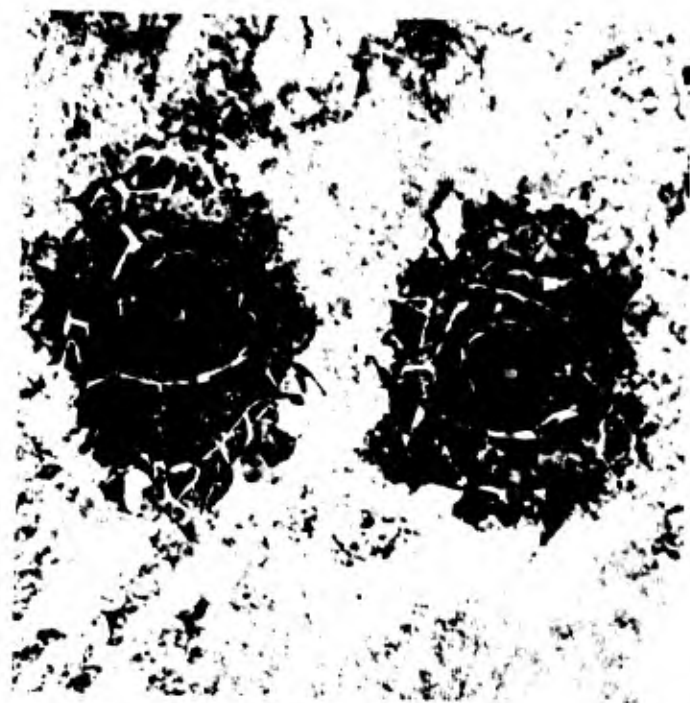

Figure 4-6.212



Figure 4-6.213



Figure 4-6.214

Figure 4-6.214 Rear Face, Second Panel  
and

Figure 4-6.215 Rear Face, Third Panel,  
reveal the decline in the  
amount of penetration  
achieved through succes-  
sive panels.

Angle Fire with Rifle M16

The remainder of the M16 rifle firing was at varied incident angles to observe the effects, in general, of oblique incident angles and, particularly, to find the largest incident angle at which ricochets could be expected.

Figure 4-6.216 Front Face, First Panel, P3½P, reveals the enlarged hole and ruptured metal on the front face at an incident angle of thirty-nine degrees. There was no damage or marking on the rear panel.

Figure 4-6.217 Front Face of Single Panel, reveals five ricochets obtained on a panel set at an angle of fifteen degrees with the horizontal. Fire was delivered from about 50 to 5 yards.

Figure 4-6.218 Rear Face of Single Panel, reveals the bulging and spalling on the back face, caused by ricochets of the rounds fired in the standing and kneeling positions. From the depth gouged out of the front face of the panel (Fig. 4-6.217) and the occurrence of back face spall as a result of only the kneeling and offhand (standing) fire (Fig. 4-6.218), the maximum incident angle for ricochets is estimated to be 20° with the M16 rifle. The panel was tilted backward. The offhand round was fired at 50 yards with about a 3° downhill ground slope; kneeling and prone rounds at 5 yards with no ground slope. The incident angles of fire were about 20° offhand and kneeling and 15° prone.

Rifle M16  
 P3½ P3½ P Auto Burst



Figure 4-6.215



Figure 4-6.216

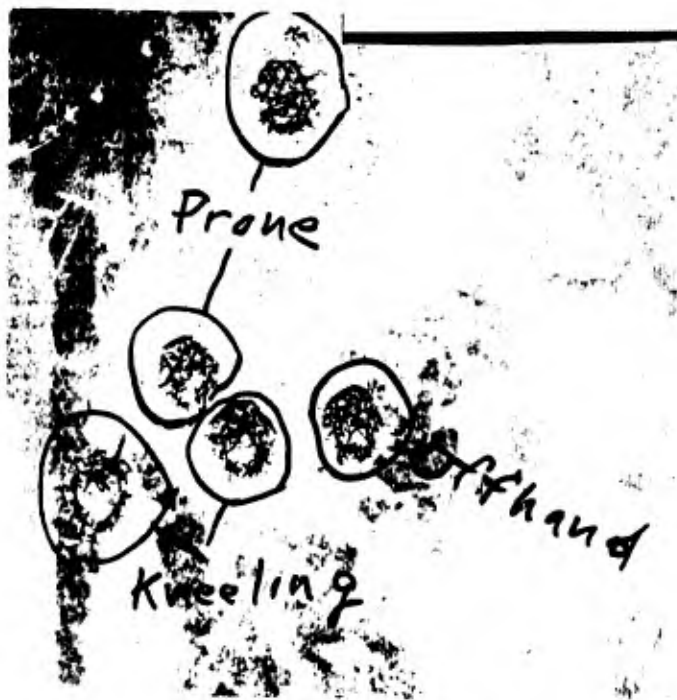

Figure 4-6.217



Figure 4-6.218

### 4-6.3 Grenade, Cartridge, M79

This grenade was launched on panel arrangements,  $P6\frac{1}{2}P6\frac{1}{2}P$ ,  $P3\frac{1}{2}P3\frac{1}{2}P$ ,  $PP3\frac{1}{2}P$  and  $PP$ . One first panel was penetrated. Extensive spalling and rupture of metal occurred on the back faces of single first panels. Back up by an interfaced panel reduced this damage to slight spall. The back up panel was permanently dished and was spalled on the back face.

Results are depicted in the following figures:

Figure 4-6.301 Front Face, First Panel,  $PP3\frac{1}{2}P$  (one valid hit)

Figure 4-6.302 Front Face, First Panel,  $PP$  (similar to hand grenade)

Figure 4-6.303 Back Face, First Panel,  $P6\frac{1}{2}P6\frac{1}{2}P$

Figure 4-6.304 Back Face, First Panel,  $PP$

Figure 4-6.305 Front Face, Back Panel,  $PP$

Figure 4-6.306 Rear Face, Back Panel,  $PP$



Figure 4-6.301

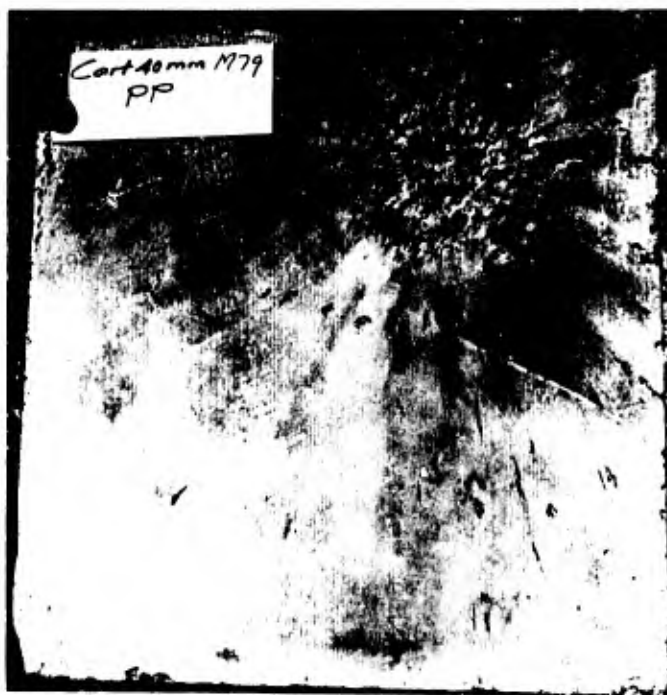

Figure 4-6.302

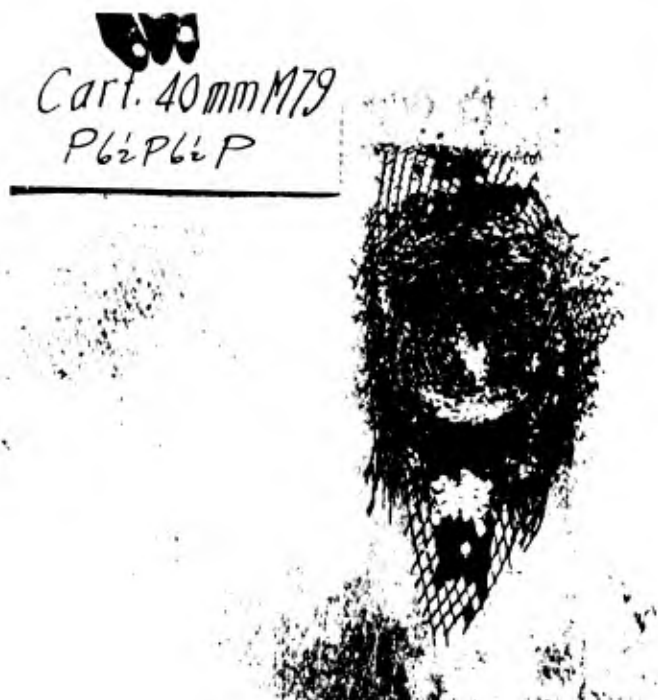

Figure 4-6.303



Figure 4-6.304

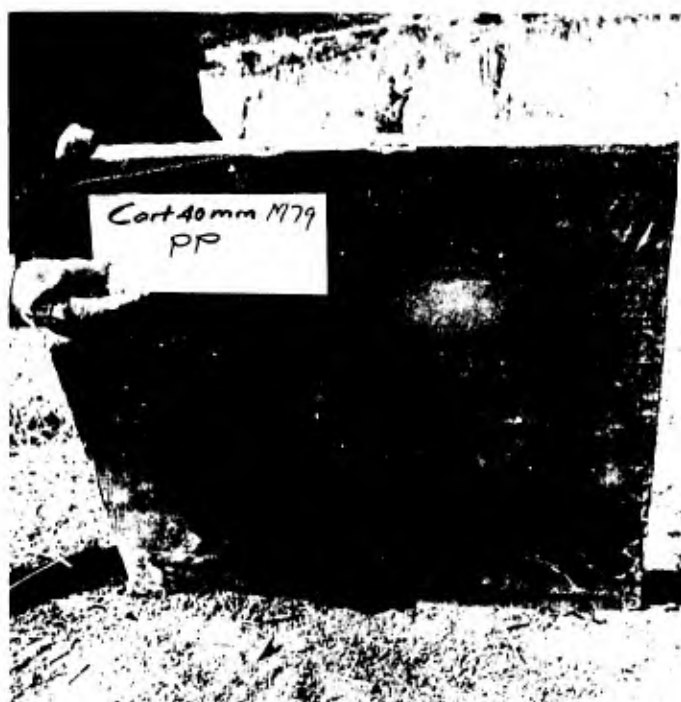

Figure 4-6.305



Figure 4-6.306

#### 4-6.4 Evaluation of Panel Resistance to the Rifle M16, and the Grenade, Cartridge, M79

Two 1" panels in any arrangement will provide reliable protection from the fire of either of these two weapons. In an emergency situation when panels are available but have not been installed, one panel thickness should minimize casualties and greatly reduce the severity of those wounds which are inflicted. The wounding agents would be cement spalls and bullet fragments of relatively low kinetic energy.

### Section 4-7

#### Underwater Blast Experiments

##### 4-7.1 General (See also page 1-11)

Panels for the ten underwater blast experiments were  $41\frac{1}{2} \times 41\frac{1}{2} \times 2$ " (nominal). The casting and finishing tolerance in panel thickness was  $+3/16$ " and all of the thicknesses overran. Panels were reinforced with 6 layers of expanded metal lath, stacked layer on layer from the form bottom upward, surmounted by six-layer strips of expanded metal spacers, on which were laid a six-layer stack of expanded metal intended to reach the screeded surface. The layers in the reinforcing stacks had the major axes of the rhombic pattern alternated 90 degrees in orientation, but the strips, of course, could not be alternated in the spacer stacks. Some of the interfaced spacer strips nested during vibration of the forms. As a result the total thickness of reinforcing and spacer stacks underran within a tolerance of  $-1/8$ ". As a general rule, embedment of reinforcement at the screeded surfaces of from  $1/8$ " to  $1/4$ " was observed in the damaged panels.

The necessary width of expanded metal lath was made up by abutting the edges of  $27\frac{1}{2}$ " widths and  $13-3/4$ " (nominal) widths produced by splitting  $27\frac{1}{2}$ " widths with a carborundum disc. Abutted edges of layers in six-layer stacks were alternated around the four sides of the stacks. The relative positioning of the two stacks in the forms was random. Thus, lines of reinforcing deficiency in the total reinforcing, through the third points of panel width, could amount to  $1/6$ ,  $1/4$  or  $1/3$

of two reinforcement stacks, with expectancies of occurrence, respectively, of 25%, 50% and 25%.

The 7-day and 28-day strengths of cylinders of each day's cast are shown in Table 2-3 (p.2-9). Casting dates were marked on panels with waterproof marking ink when they were stripped. Some of the markings faded, or were inadvertently covered by the color coating applied before panels were mounted for blast exposure in order to identify pieces retrieved from the ocean bottom. Casting dates that could be read during the experiments are given in the report of each experiment which follows. All unidentified panels were cast during the five day period, July 29 - August 2, 1968. A consolidation of the main parameters of each experiment is shown in Table 1-5 (p.1-12). These parameters are repeated in the report of each experiment, which follows. Panels were C-clamped at their midsides to the vertical edge supports in the first three experiments. The oceanographic environment is shown in Table 3-1 (p.3-10).

The photographs of experimental results are numbered according to the paragraph to which they pertain, e.g., Figure 4-7.202 is the second photograph in Paragraph 4-7.2.

#### 4-7.2 The First Experiment

##### (a) Parameters

Date and time: August 23, 1968; 1648 PST.

Charge and depth: 2 lbs. TNT at 14.0 ft.

Panel arrangement: 1 each at 10.0 ft., 9.0 ft. and 8.0 ft. from the pier simulator.

Casting dates: 10.0 ft. and 9.0 ft., August 2, 8.0 ft., mark lost.

##### (b) Damage to Frame

Top and bottom edge supports were broken loose at the welds. Vertical edge support angles were twisted and bent and welds to diagonal braces were broken. Bar flat struts at tops of vertical angles were buckled back of the panel at 8 ft. Top edge support at 7 ft. from pier simulator was bent slightly.

Failure of the top and bottom edge supports allowed the panels to bend in flexure on the vertical side supports and move backward.

(c) Damage to Panels

The first panel on which charge was placed was blasted into several pieces and scattered on the ocean bottom. Most of the pieces were retrieved.

A hole about 21" in diameter was blasted through the center of the panel and complete severance occurred on vertical and horizontal hinge lines running through the third points of panel width.

The second panel was completely dislodged from the support. Vertical and horizontal hinge lines formed at about the third points.

Concentric crack rings, approximately centered on the panel and extending to the edges may be seen in Figure 4-7.201.

The third panel failed in flexure, but was not severed, on a vertical hinge line about 4" from its center. The deflection was about  $\frac{1}{2}$ ". This panel revealed concentric crack rings similar to those on the second panel except that they were centered somewhat below the center of the panel.

(d) Damage to Pier Simulator

Some small dislodgement was indicated by cracked grout between the anchor blocks. Some of the wood wedges were dislodged. There was no damage to the blocks. (Figures 4-7.202 and 4-7.203) The divers reported that one block had been moved back about 2".

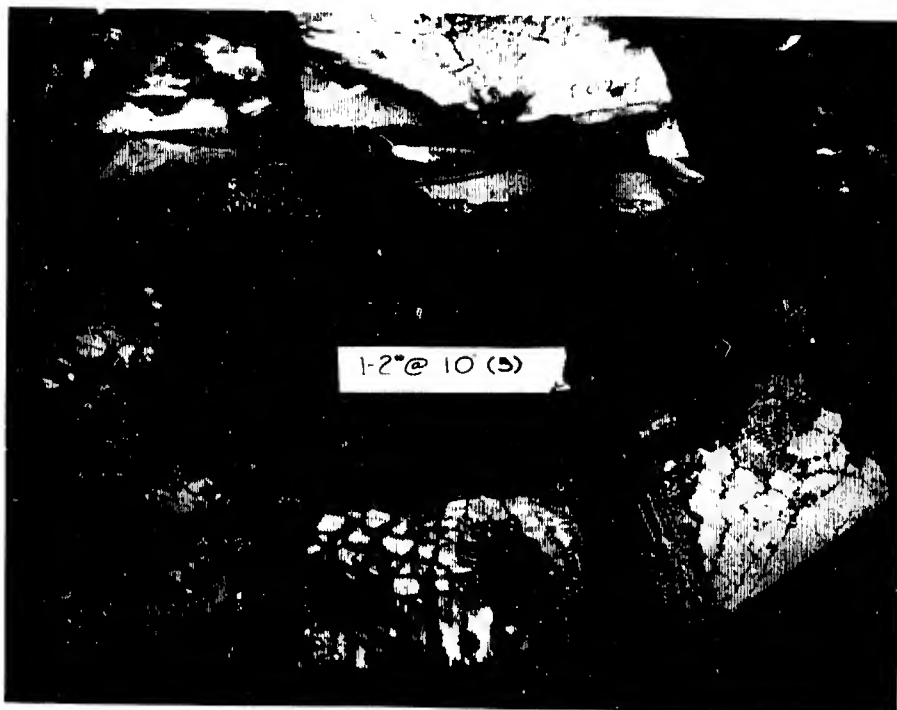

Figure 4-7.201 Front and Intermediate  
Panel Reassembled



Figure 4-7.202 Front of Pier Simulator

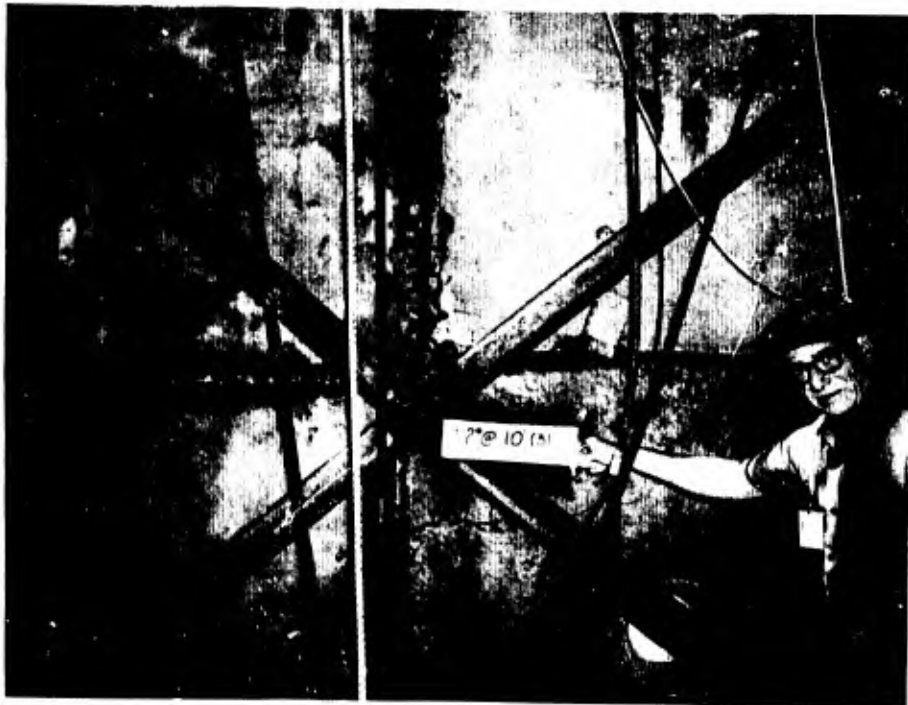

Figure 4-7.203 Back of Pier Simulator

#### 4-7.3 The Second Experiment

##### (a) Parameters

Date and time: August 24, 1968; 1410 PST

Charge and depth: 2 lbs. TNT at 12 ft.

Panel arrangement: 1 each at 7 ft., 6 ft.,  
and 5 ft. from pier  
simulator.

Date cast: 7 ft., August 2; 6 ft., mark lost.  
5 ft., August 1.

##### (b) Damage to Frame

The damage was the same in all respects as in the first experiment but located 3 ft. nearer the pier simulator (Figure 4-7.301).



Figure 4-7.301 Support and Panels  
as Hoisted Aboard

(c) Damage to Panels

All three panels were destroyed and mostly lodged in frame. Some pieces were retrieved from the ocean bottom (Figure 4-7.302).

The panels revealed more damage than those in the first experiment with randomness of fracture lines rather than the defined hinge lines of the first and second panels of the first experiment (Figures 4-7.303, 4-7.304, and 4-7.305).

(d) Damage to Pier Simulator

The right lower anchor block was displaced approximately 2" (Figure 4-7.306).

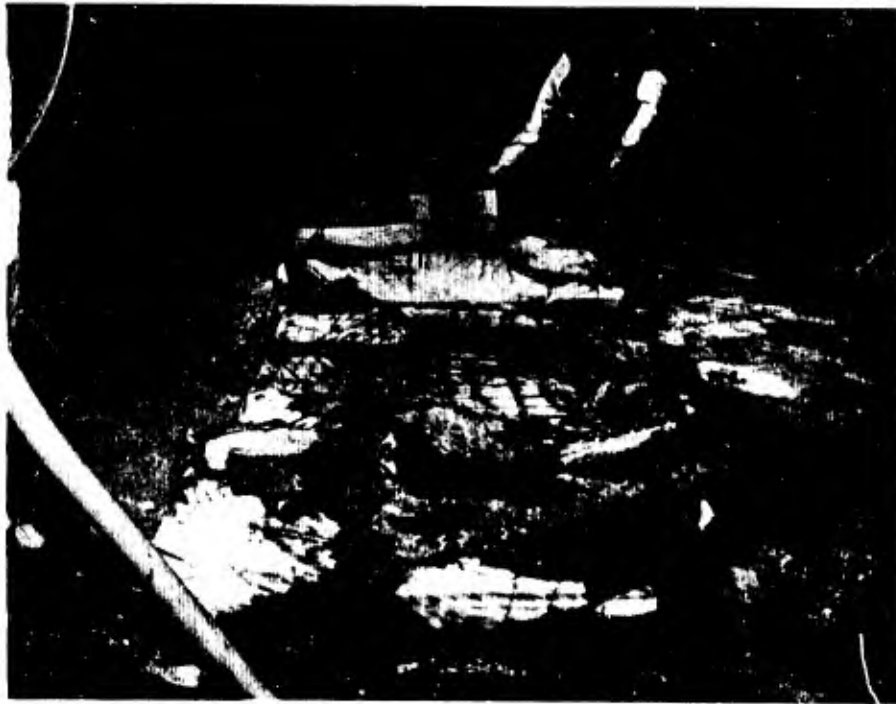

Figure 4-7.302 Panels Reassembled



Figure 4-7.303 Front Panel Reassembled



Figure 4-7.304 Intermediate Panel  
Reassembled



Figure 4-7.305 Rear Panel Reassembled



Figure 4-7.306 Displacement of Anchor Block

#### 4-7.4 The Third Experiment

##### (a) Parameters

Date and time: August 24, 1968; 1530 PST.

Charge and depth: 2 lbs. TNT at 11 ft.

Panel arrangement: 1 each at 4 ft., 3 ft.,  
and 2 ft.

Casting dates: 4 ft. and 3 ft., August 1,  
2 ft., mark lost.

##### (b) Damage to Frame

The upper edge supports were broken loose at the welds and the vertical edge support angles were bent inward from 6" to 12" at the tops. (Figure 4-7.401)



Figure 4-7.401 Frame as Hoisted Aboard

(c) Damage to Panels

The first and second panels were broken up on vertical and horizontal lines at the third points. The third panel failed on one vertical and one horizontal hinge line which extended from an edge to their junction, beyond which a corner Y formed in the characteristic manner of flat slabs on 4-edge support. (Figure 4-7.402)

(d) Damage to Pier Simulator

Upper and lower anchor blocks were separated about 1" and lower blocks appeared to have separated more at the top than at the bottom. (Figures 4-7.403 and 4-7.404)



Figure 4-7.402 Panels Reassembled



Figure 4-7.403 Separation of Upper Blocks

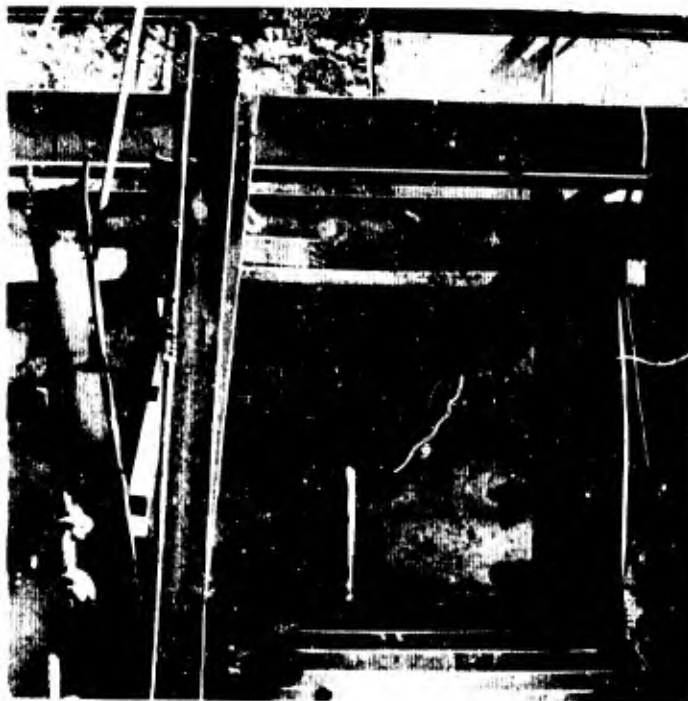

Figure 4-7.404 Separation of Lower Blocks

#### 4-7.5 The Fourth Experiment

##### (a) Parameters

Date and time: August 25, 1968; 1055 PST.

Charge and depth: 4 lbs. TNT at 15.8 ft.

Panel arrangement: 1 at 15.5 ft., 2 at 10.5 ft.,  
in contact, and 1 at 1.5 ft.

Panels were suspended at top edges from  
pipe rails (Figure 4-7.501).

Casting dates: 15.5 ft., July 29; 10.5 ft., Au-  
gust 2 & 1; 1.5 ft., August 1.

##### (b) Damage to Frame

Pipe rails installed just prior to this experiment  
were slightly damaged.



Figure 4-7.501 Free Swinging Panel Suspension

(c) Damage to Panels

A large hole was blasted in the center of the first panel and the rim was severed into four pieces. The two top pieces, still on the lifting sling were thrown back into the structural frame. The divers retrieved the other pieces from the ocean bottom, forward of their installed position. (Figure 4-7.502)

The two panels at 10.5 ft. had snapped their 1/4" diameter steel wire strand suspenders and were tossed clear of the supports. They were retrieved from the ocean bottom. Damage was limited to slight chipping at the corners, from impacting the support frame during blast.

The panel 1.5 ft. from the pier simulator remained in place, undamaged.

(d) Damage to Pier Simulator: None



Figure 4-7.502 First Panel Reassembled

#### 4-7.6 The Fifth Experiment

(a) Parameters

Date and time: August 25, 1968; 1250 PST

Charge and depth: 8 lbs. TNT at 12.5 ft.

Panel arrangement: 2 at 15.5 ft. in contact,  
1 at 10.5 ft. and 1 at  
1.5 ft., free swinging  
from pipe rails.

Casting dates: First panel, July 29;  
second, Aug. 2; third, Aug. 1

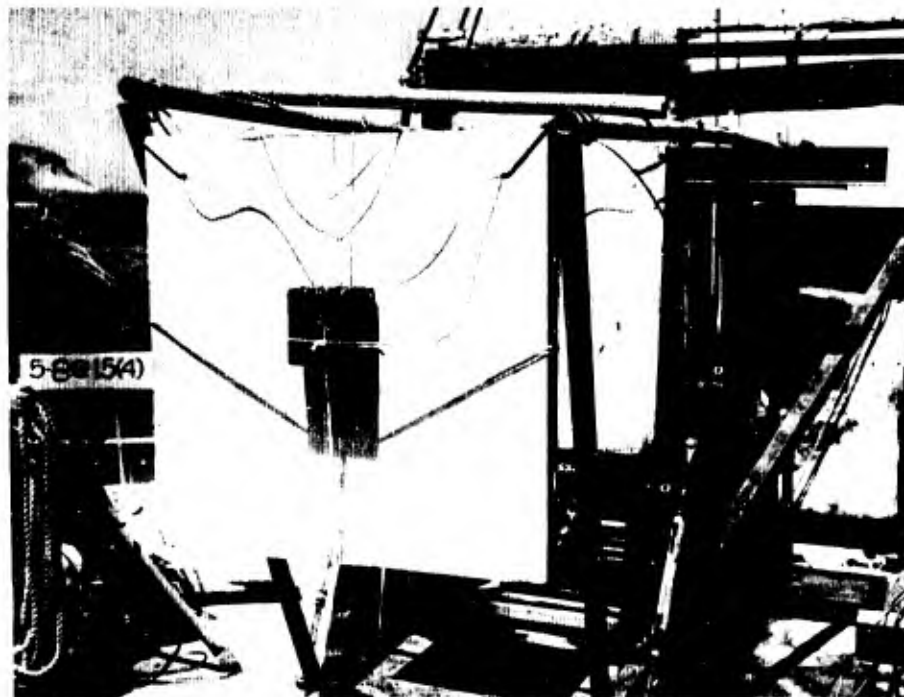

Figure 4-7.601 Assembly Ready to Place in Water

(b) Damage to Supports

Both ends of both pipe struts were broken loose at welds. (Figure 4-7.602)

(c) Damage to Panels

All of the two front panels were retrieved from the ocean bottom except two corner pieces of the rearward one of the two panels, which were suspended from the pipe rails. The intermediate panel was retrieved from the ocean bottom with damage limited to one broken lower corner and a small broken out area near the diagonally opposite corner, neither of which was caused by the suspenders. The breaks appeared to have resulted from collision. This panel was found on the ocean bottom 15 feet to the left and forward of its installed position.

The two forward panels and the intermediate panel, reassembled on deck in the order in which installed, are shown in Figure 4-7.603. Fourth panel remained undamaged.

(d) Damage to Pier Simulator: None



Figure 4-7.602 Supports Being Repaired



Figure 4-7.603 First Three Panels Reassembled in Installed Order

#### 4-7.7 The Sixth Experiment

##### (a) Parameters

Date and time: August 25, 1968; 1540 PST.

Charge and depth: 8 lbs. TNT at 12.3 ft.

Panel arrangement: 1 at 15.5 ft. and 1 at  
1.5 ft. from pier  
simulator.

Casting dates: Front panel, August 2,  
rear panel, mark lost.

(Figure 4-7.701)

##### (b) Damage to Supports

The rail supporting strut was broken loose at the welds at both ends and the pipe rail was bent.

##### (c) Damage to Panels

The panel at 15.0 ft. was broken up in much the same pattern as the panels carrying the charge in the preceding experiments. (Figure 4-7.702) Divers reported more scatter of pieces laterally.

##### (d) Damage to Pier Simulator

The anchor blocks were not damaged. The timber wedging of the lower right block was dislodged and the block was moved backward about two inches.

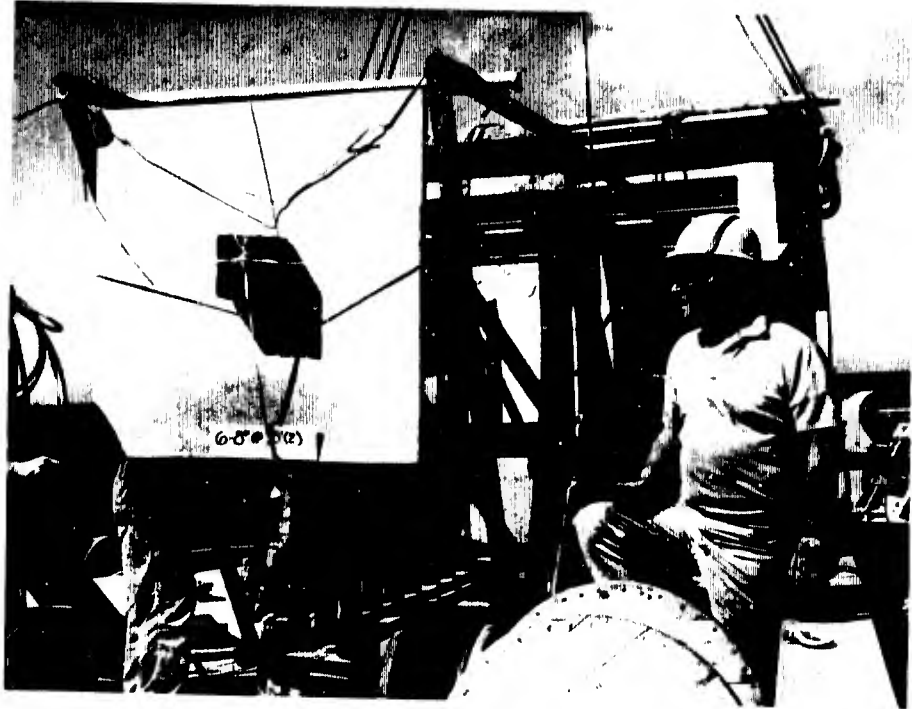

Figure 4-7.701 Assembly Ready to be  
Placed Underwater



Figure 4-7.702 Retrieved Parts of  
Front Panel Reassembled

#### 4-7.8 The Seventh Experiment

##### (a) Parameters

Date and time: August 25, 1968; 1613 PST.

Charge and depth: 20 lbs. TNT at 12.3 ft.

Panel arrangement: 1 at 15.5 ft., 2 in contact  
at 10.5 ft. and 1 at 1.5 ft.  
from pier simulator.

Casting dates: Panel at 15.0 ft., July 30; third  
panel, July 29; others, mark lost.

(Figure 4-7.801)

##### (b) Ocean Bottom Cratering

The divers reported that a crater, 3 ft. deep and  
8 ft. in diameter was formed in the ocean bottom.

##### (c) Damage to Supports

One pipe rail and its supporting strut was broken  
loose at the welds and the other pipe rail was bent  
severely.

##### (d) Damage to Panels

The front panel was completely destroyed. The two  
intermediate panels snapped their suspenders and were  
retrieved from the ocean bottom, undamaged. They were  
approximately upright and buried about 2 ft. in sand in  
the middle of the crater. This leads to an hypothesis  
that sand to a depth of about 5 ft. was tossed upward  
and about 2 ft. of it dropped back with the panels.

The rear panel remained in place with only some  
material broken away at the edge near a lower corner.  
(Figure 4-7.802)

##### (e) Damage to Pier Simulator

The lower right anchor block, which had been moved  
backward by an earlier shot and had come to rest against  
a piece of I-beam installed as a back up for wedges, was  
returned to its original position.

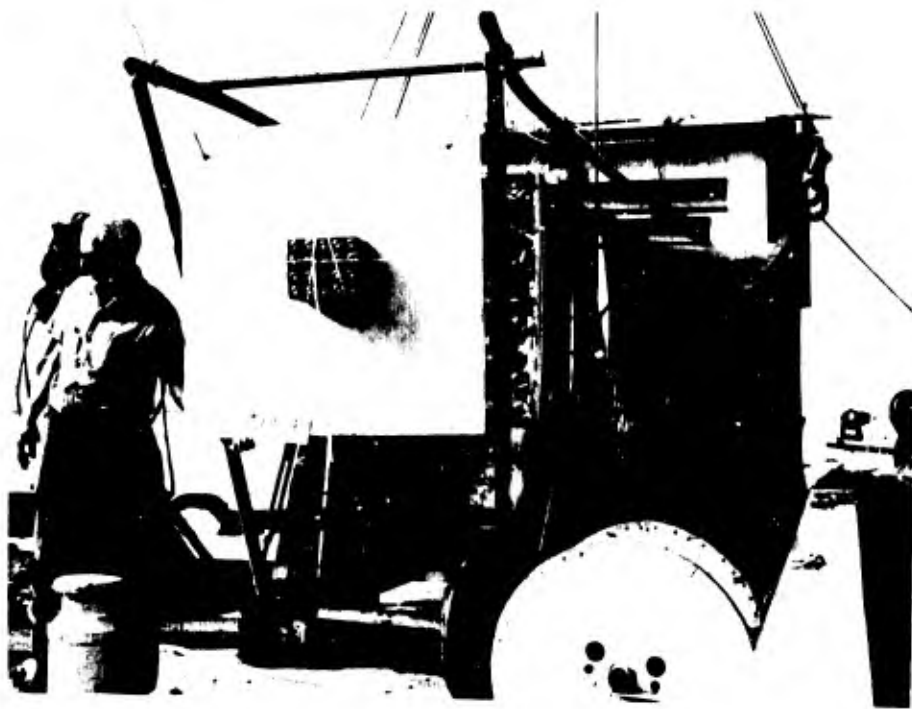

Figure 4-7.801 Assembly Ready to be  
Placed Underwater

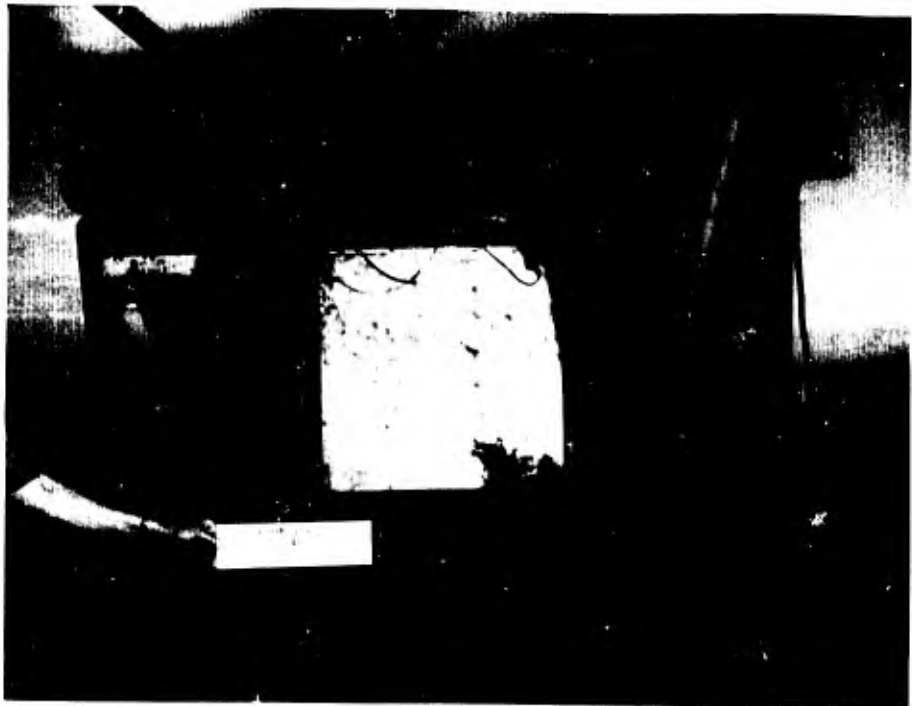

Figure 4-7.802 Damage to Rear Panel

#### 4-7.9 The Eighth Experiment

##### (a) Parameters

Date and time: August 26, 1968; 0823 PST.

Charge and depth: 20 lbs. TNT at 15.0 ft.

Panel arrangement: 1 at 9.5 ft., 2 in contact  
at 6.5 ft. and 1 at 1.5 ft.  
from pier simulator.

Casting dates: Third panel, July 29;  
others, marks lost.

(Figure 4-7.901)

##### (b) Ocean Bottom Cratering

A crater 4 ft. in diameter and 2 ft. deep was reported by the divers.

##### (c) Damage to Support Frame

The front base shoes were broken and warped (Figure 4-7.902).

##### (d) Damage to Panels

The front panel was completely destroyed. The upper right corners of both intermediate panels were both broken through the cement and hinged forward about the mesh. Lesser damage occurred at other corners. (Figure 4-7.903) They were dislodged by snapping of the suspenders and appeared to have slammed against some part of the support.

The back panel was undamaged.

##### (e) Damage to Pier Simulator

The lower left anchor block was rotated back about 2" at the center of the assembly. The lower right block was rotated back about 1".

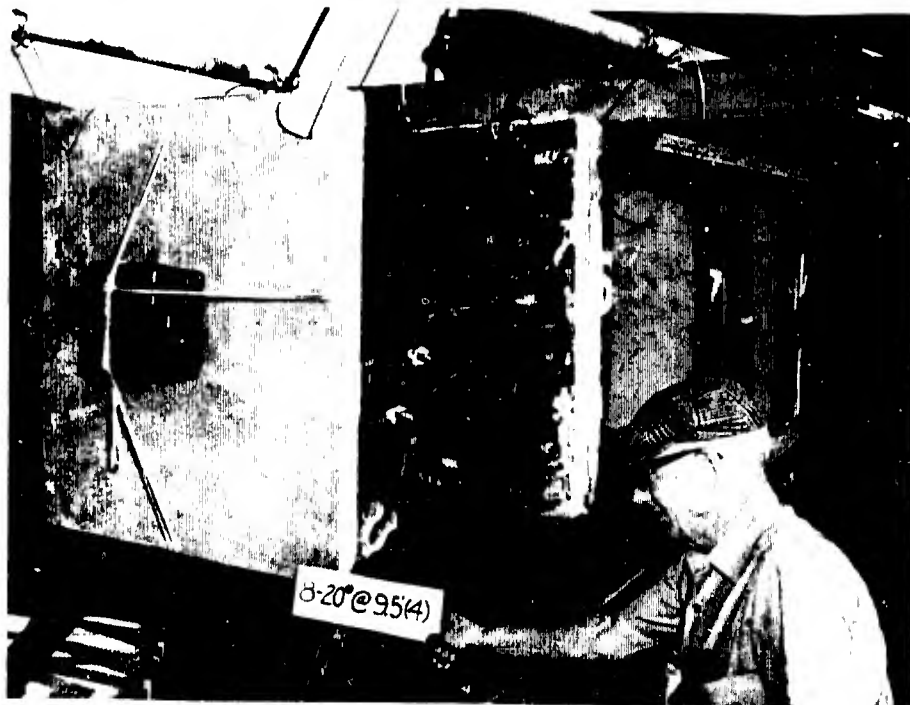

Figure 4-7.901 Assembly Ready to be  
Placed Underwater



Figure 4-7.902 Further Damage to  
Support Frame



Figure 4-7.903 Damage to the Two Intermediate Panels

#### 4-7.10 The Ninth Experiment

##### (a) Parameters

Date and time: August 26, 1968; 1013 PST

Charge and depth: 20 lbs. TNT at 16.2 ft.

Panel arrangement: 1 at 9.5 ft., 1 at 6.5 ft.  
and 1 at 1.5 ft. from the  
pier simulator.

Casting dates: Marks lost.

(Figure 4-7.1001)

##### (b) Ocean Bottom Cratering

The divers reported that a crater 2 ft. deep and 5 ft. in diameter was formed in the ocean bottom.

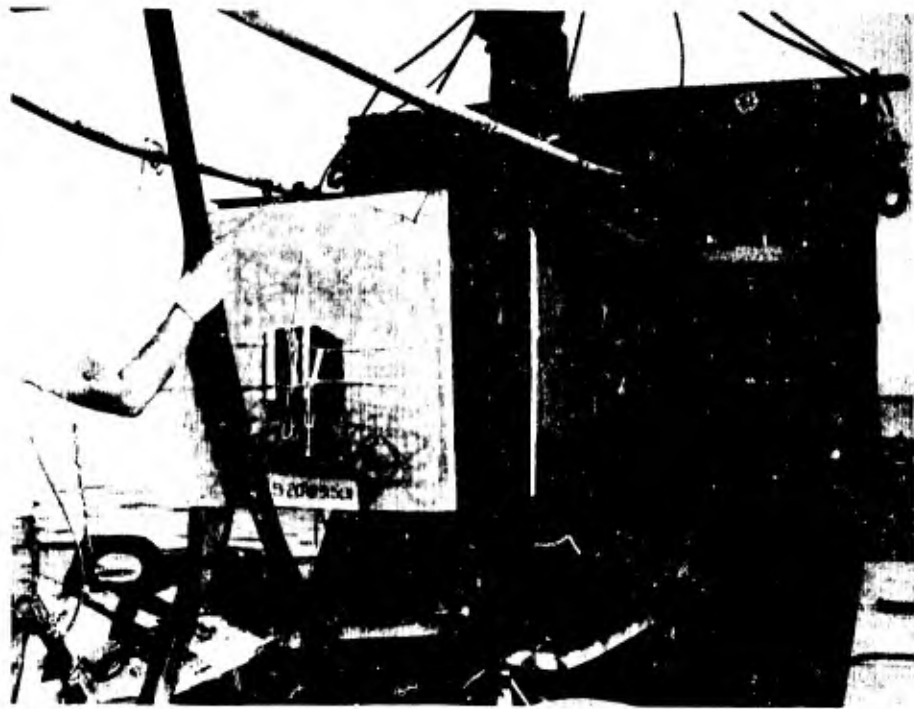

Figure 4-7.1001 Assembly Ready to be Placed Underwater

(c) Damage to Supports

The pipe rails and remaining part of the original support frame were completely bent out of shape and almost entirely broken loose from the pier simulator frame. The wreckage was cut entirely free and pipe rails for the tenth and last experiment were welded to the pier simulator frame. (Figure 4-7.1002)

(d) Damage to Panels

The divers reported that the front panel was blasted into pieces of less than 1 ft. in largest dimension, which were scattered about on the ocean bottom.

The intermediate panel snapped its wire strand suspenders and was suspended by its lifting sling, which was looped over one of the original edge support angles. It revealed only a flexural crack across the panel and slight damage near two corners (Figure 4-7.1003).

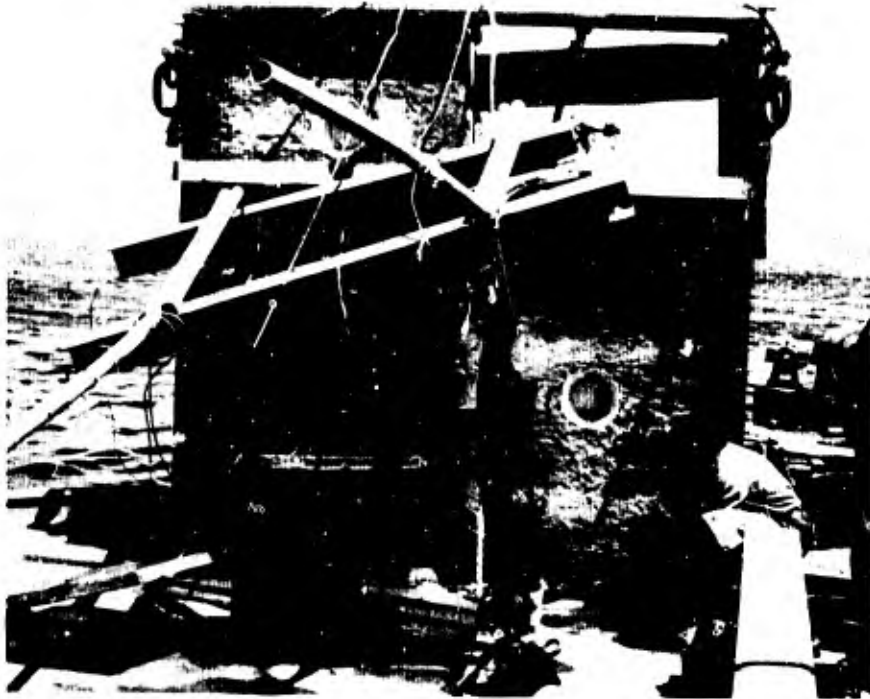

Figure 4-7.1002 Completely Wrecked  
Support Frame



Figure 4-7.1003 Damage to the  
Intermediate Panel

The back panel was freed by the breaks in the pipe rail welds and was retrieved from the ocean bottom undamaged.

(e) Damage to the Pier Simulator

The lower right anchor block shifted toward the blast about 4" and the lower left block shifted toward it about 1". (Figure 4-7.1004) The blocks returned to about the position of the seventh experiment.



Figure 4-7.1004 Shifting of Blocks in Pier Simulator

#### 4-7.11 The Tenth Experiment

##### (a) Parameters

Date and time: August 26, 1968; 1253 PST.

Charge and depth: 20 lbs. TNT at 12.8 ft.

Panel arrangement: 1 at 6.5 ft., 1 at 3.5 ft.  
and 1 at 0.5 ft. from the  
pier simulator.

Casting dates: Marks lost.

(Figure 4-7.1101)

##### (b) Damage to Supports

The pipe rails and struts were broken loose at the welds.

The pier simulator in its support frame overturned in the direction toward the placement of the charge and was found lying on the panels.

##### (c) Damage to the Panels

The front panel was completely destroyed.

There were random cracks in the intermediate panels but no hinge lines. The back panel developed a vertical hinge line at about the third point of its width. It is not known how much, if any, of the damage was done by the pier simulator when it overturned on the panels. The two intermediate panels and the back panel were photographed on deck after retrieval. (Figure 4-7.1102)

##### (d) Damage to Pier Simulator

For the first time, anchor blocks were cracked.

The upper blocks revealed cracks about mid-height through the recesses cast in the larger faces. These are visible in Figures 4-7.1103 and 4-7.1104. These cracks were observed to continue around the outer corners of the blocks to where the edges of the blocks were obscured by the steel supports. A crack was not observed on the opposite faces of either block.

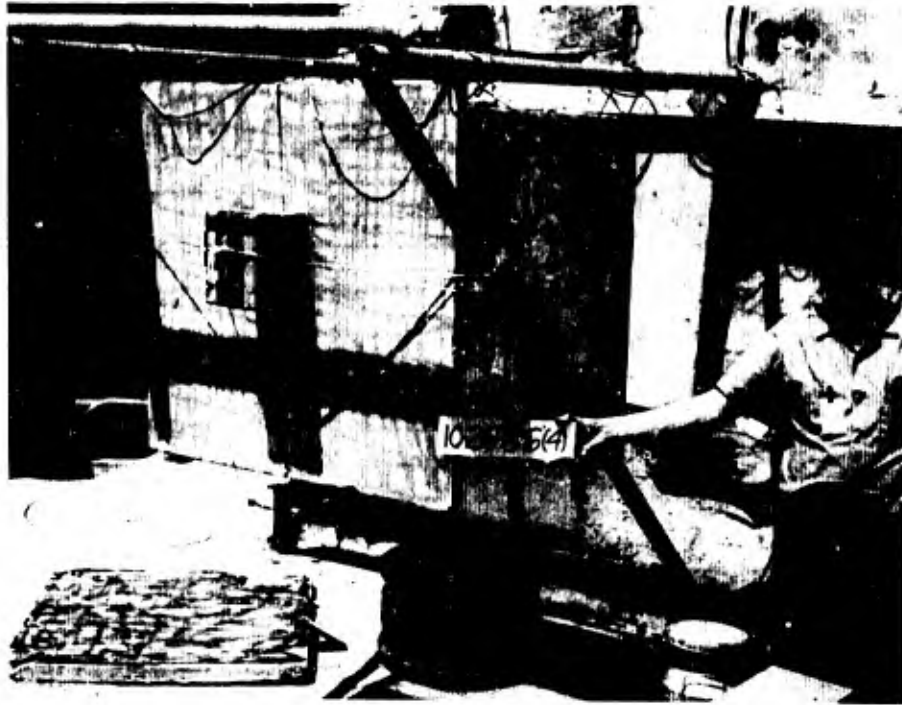

Figure 4-7.1101 Assembly Ready to be  
Placed Underwater



Figure 4-7.1102 Retrieved Intermediate  
Panels and Back Panel

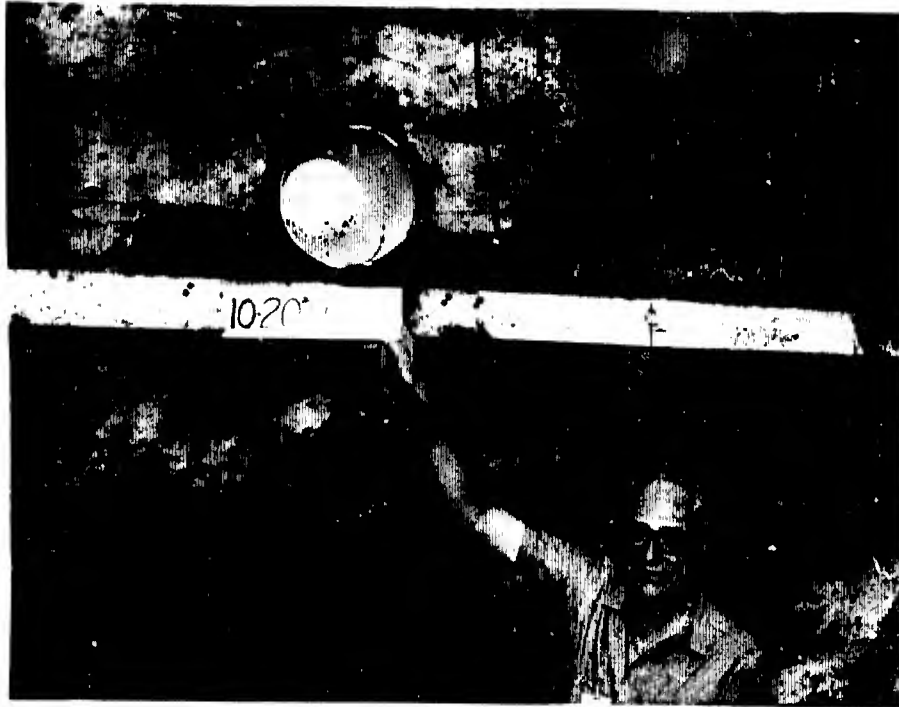

Figure 4-7.1103 Crack Across Front Face  
of Upper Left Anchor Block



Figure 4-7.1104 Crack Across Back Face  
of Upper Right Anchor Block

#### 4-7.12 Evaluation of Results

It is useless to seek a practicable pier fender material that will resist the blast of the demolition charge placed on its surface. According to Cole<sup>1</sup> the pressure in the product gasses is in the order of 50,000 atmospheres and the temperature is in the order of 3000° C. Cole continues, stating, "The first cause of disturbance to the water in an explosion is the arrival of the pressure wave in the reacting explosive at the water boundary. Immediately upon its arrival, this pressure, which is of the order of  $2 \times 10^6$  lb./in.<sup>2</sup> for TNT, begins to be relieved by an intense pressure wave and outward movement of the water." The pressure growth from 50,000 atmospheres to  $2 \times 10^6$  lb./in.<sup>2</sup> is noted. It is believed that the clue to an explanation of the growth is in Cole's preceding statement, "A reaction occurring in this way (detonation) develops a very narrow boundary between material in its initial (solid) and the products (gaseous) state at high temperatures and pressures. This clearly defined rapidly advancing discontinuity is known as a 'detonation wave', and travels at several thousand meters a second." (The paranthetical remarks are the writer's). Cole is describing the detonation phenomenon within the volume occupied by the explosive in its solid state. The water, or the panel, as the case may be, is exposed, not only to the 50,000 atmospheres of internal pressure, but also to the kinetic energy of the gaseous mass at a wave velocity of several thousand meters a second. Water or panel, since both are elastic, receives this energy as strain energy. Cole discusses the outward radial propagation of the shock wave in the water. He states, "As compared to waves of infinitesimal amplitude, this shock wave has the following characteristics:

- (i) The velocity of propagation near the charge is several times the limiting value of about 5,000 ft./sec., this value being approached quite rapidly as the wave advances outward and the pressure falls to 'accoustic' values.
- (ii) The pressure level in the spherical wave falls off more rapidly with distance than the inverse first power law predicted for small amplitudes, but eventually approaches this behavior in the limit of large distances.

(iii) The profile of the wave broadens gradually as the wave spreads out. This spreading effect is most marked in the region of high pressures near the charge."

Cole illustrates this spacial attenuation by a drawing showing the pressure distribution around a 300 lb. TNT charge at three times after completion of detonation. The parameters in the drawing are pressure and the radius at each of the three times. The pressures and radii are:

34,000 lb/in<sup>2</sup> at 5 ft., 2,200 lb/in<sup>2</sup> at 50 ft.  
and 160 lb/in<sup>2</sup> at 500 ft.

The following pressures around a 20 lb. TNT charge were estimated by an Engineering Technician at the U.S. Naval Undersea Warfare Center who has researched this subject extensively: 4,500 lb/in<sup>2</sup> at 10 ft., 8,500 lb/in<sup>2</sup> at 6 ft. and 18,000 lb/in<sup>2</sup> at 3 ft. In considering the resistance of a large mass, such as a pier shaft, to these pressures, one must think of inertia. The pressure wave has a step front and pronounced concave upward curvature over the duration, which is very short, indeed. The impact of the step front at a radius in the order of 6 feet would produce a high frequency low amplitude shock wave across the pier shaft which would probably crack it, but not produce significant relative movement of the interfaces along the crack.

A cracked pier shaft, however, may be vulnerable to a follow-on phenomenon known as "bubble collapse". In water of usual river depths, the bubble formed by the expanding gas will grow and vent at the surface before it rises appreciably. Where the standoff from the pier is less than the depth of the charge the pier will become a "wall" of the bubble which, for that reason, abandons its spherical shape in further growth. The venting of gas when the bubble grows to the surface leaves an unstable, concave wall of water on the side opposite the pier, which immediately collapses into a large volume, high velocity jet stream. This stream will strike the pier with great force, believed to be sufficient to completely dislodge the shaft above the crack made by the shock wave, from the part of the shaft below the crack. This hypothesis is illustrated in Figure 4-7.1201, as to the idea, without attempting to illustrate the details. A charge of 20 lbs. or more, placed as indicated, should crater the shaft to some depth and, produce a more random cracking pattern than shown.

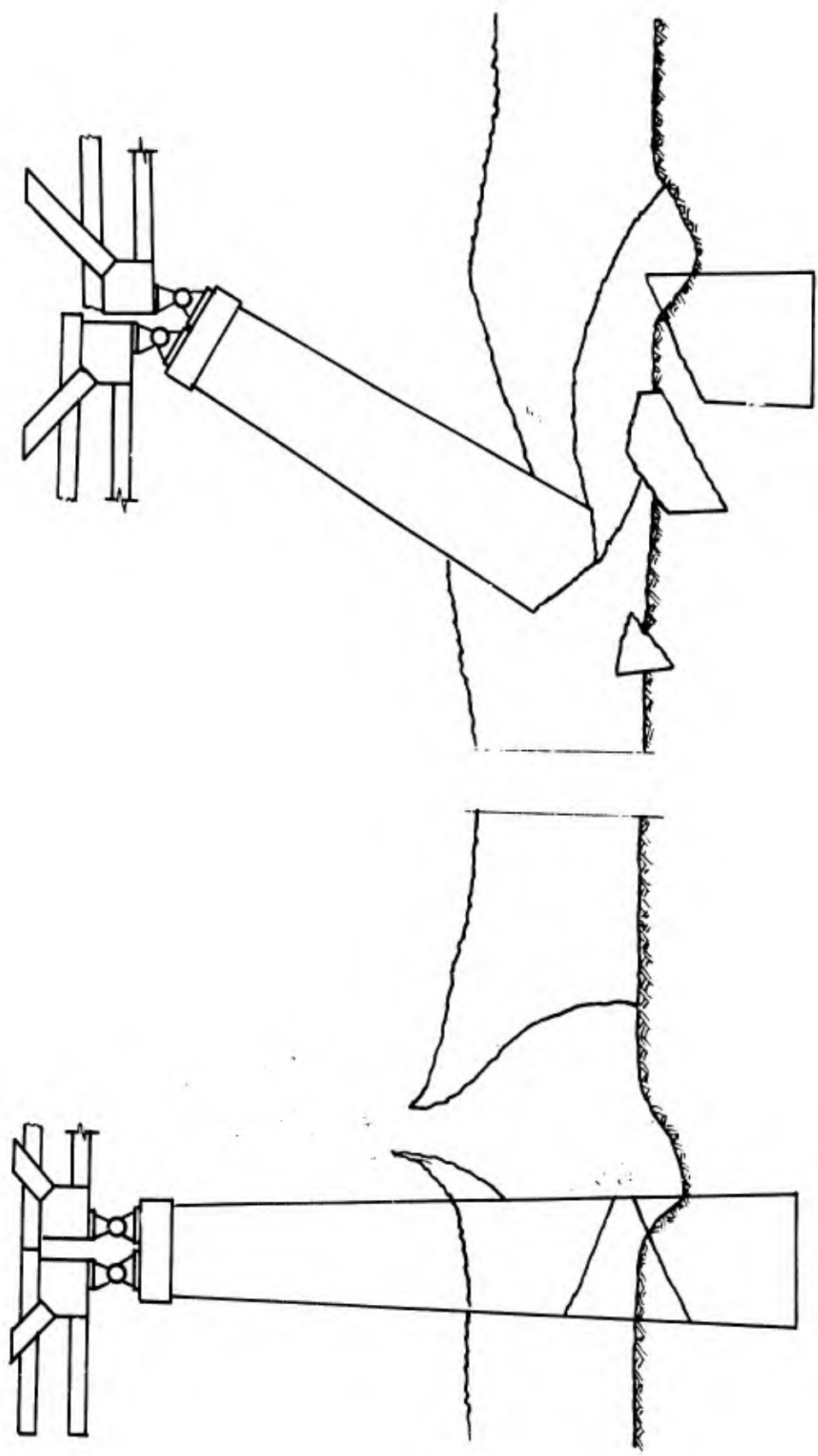

Figure 4-7.1201 Hypothetical Demolition Failure Mode of a Bridge Pier

The results of the experiments quite conclusively demonstrate the protection to be gained by enforcing a standoff for charge placement. A question arises as to the worth of a second wall of panels inside the outer wall of the fender, aside from preventing the second swimmer on a two-man team from swimming through the hole in the outer wall and placing a second charge against the pier shaft. He could trail a line to assist him in finding the exit in murky water after he pulled the ignitor pin.

The experiments revealed that a second panel free to swing, three feet or more from the first panel, will not be significantly damaged, but a completely supported panel will be destroyed. This raises a second question relative to the comparative protection given the pier by the two conditions of support.

A rough idea, at least, of the energy expended in destroying a panel may be obtained from the results of static loading tests reported in Appendix A. Reference is made to Figures A-3, A-6 and A-7 of Appendix. Figures A-6 and A-7 indicate that the ultimate deflected shape of panel 4-1-4EM might be approximated by a curved surface which is parabolic in all directions. The average deflection of the assumed surface is  $\frac{4}{9}$  its center deflection. It is also assumed that this deflected shape was constant throughout the loading of the panel. The area under the curve 4-1-4EM, out to virtual destruction at a deflection of 3.25", is 93 psi-in. With the assumptions made, the calculated value of work performed by the loading is 1116 ft. lb/ft<sup>2</sup>. This will now be transformed from the 22½"x22½"x1" tested panel to a 47"x47"x2" panel, approximately the portion within 4-edge supports of a 4'x4' panel, 2" thick.

With the assumed parabolic deflected shape the moment is constant throughout the panel and the energy per square foot absorbed by panels of the same material properties is approximately proportional to their thicknesses. The 4'x4'x2" panels will absorb twice the energy per square foot absorbed by the tested 22½"x22½"x1" panels if their material properties are the same. This amounts to 2230 ft.lb/ft<sup>2</sup>. With assistance provided at the U. S. Naval Undersea Warfare Center, the blast energy of a 20 lb. TNT charge is estimated to be 60,000 ft. lb/ft<sup>2</sup> at 3 ft. from the charge and 16,000 ft.lb/ft<sup>2</sup> at 6 ft. The outer panel, on which the charge is placed, will absorb an extremely small percent of the concentrated energy. A second panel 3 ft. away will absorb only about 3.7% of the

energy. If it is 6 ft. away it will absorb about 13.9% of the energy reaching it and presumably reduce the energy reaching the pier by this amount, if the panels have 4-edge support. From 1 to 4 of the inner panels would be destroyed, depending on the positioning of the charge. A panel which is installed so it is free to swing will not accept a significant amount of strain energy. What it will do by interposing a medium which has a different shock wave velocity than water, and by deflecting water movement and creating turbulence is not known. It appears, however, that the order of magnitude of energy reduction is not as significant as other matters to be considered relative to the construction and maintenance of pier fenders.

#### 4-7.13 Conclusions Relative to the Protection of Piers from Underwater Blast Charges

The protective capability of a pier fender constructed of ferro cement panels is due almost entirely to its denial of access for placement of the charge on the pier surface.

One to four precast panels of any design in the exposed surface of a fender will be destroyed by a charge equivalent to 20 lbs. of TNT placed on the surface.

The value of a second, inner surface of panels is mainly to prevent access to the pier by the follow-on swimmer in a two-man demolition team.

Panels of the inner surface within a practicable distance from the outer surface will be destroyed unless they are free to swing, in which event their suspension must be stronger than the 1/4" steel wire cables used in the experiments. At a distance of 3 ft. from the outer surface, free swinging panels of the inner surface are likely to be cracked and permanently deflected in the order of 1" but the mesh will not be severed and they will continue to deny access to the pier. Two, inter-faced, free swinging, inner panels will not suffer significant damage.

## Section 4-8

### Conclusions

#### 4-8.1 Effectiveness in Protection of Bridge Piers

A fender of ferro cement panels around a bridge pier at a distance of 6 feet from the pier will protect the pier from a demolition charge equivalent to 20 lbs. of TNT by limiting its proximity to the pier to the 6 foot standoff. The energy absorbed by two peripheries of panels is not significant in the energy order of magnitude of charges of such size placed underwater. From one to four panels in the outer periphery will be destroyed. Panels in the inner periphery will be destroyed unless they are free to swing about their top edges.

#### 4-8.2 Effectiveness in Revetments

Two arrays of 1" ferro cement panels separated by a clear distance of 6" or more will stop almost all fragments from 81mm mortar shells which burst 3 feet or more from the revetment. The limiting distance for 4.2 in. mortar and 105mm Howitzer shells is 5 ft. The occasional fragment which penetrates the second panel will have expended virtually all of its energy and will not damage aircraft or other material or inflict wounds more serious than a skin break. Damaged panels should be replaced as promptly as the situation will permit because the fragments from repeated bursts near the same panel will finally chew through both panels.

A revetment as described will stop hand grenade fragments and will not be penetrated by the M79 cartridge grenade. It will stop all fire of the M16 rifle except well held point blank full automatic fire, which should be preventable by other means available to the defenders. Pellets from antitank rockets will penetrate any feasible number of panels in tandem and damage whatever they hit.

#### 4-8.3 Effectiveness in Concrete Sky

Two arrays of 1" panels, separated by a clear distance of 6" or more in overhead cover for aircraft, built according to the concrete sky concept, will provide protection from fragments equivalent to that which revetments

will provide, with one possible exception. It is believed that the fuze housing of a shell may penetrate both panels with enough residual energy to damage an airplane. This would be a more likely occurrence with an artillery shell, where the terminal velocity adds significantly to the velocity after burst.

#### 4-8.4 Effectiveness in Bunkers

Since bunkers are essentially revetted inclosures roofed with overhead cover, the conclusions relative to revetments and concrete sky apply, collectively, to bunkers. The feasibility of constructing bunkers with ferro cement panels will depend upon the freedom to deliver panels provided by the situation and the freedom of troops to expose themselves in the process of placing the panels.

#### 4-8.5 Multiple Panels in Tandem vis a vis Single Thick Panels

Multiple panels in tandem with 6" or more of separation are more effective than a single panel with their collective thickness. The separation interrupts the shock wave. If a shock wave is to exist in the next panel it has to be initially generated by the fragment or bullet, which expends energy in doing it. The shock wave phenomenon is, in essence, the momentary storage of energy in strain of a thin filament followed immediately by the transfer of energy to the next filament by means of elastic rebound. This will continue all the way through a panel, with energy loss due only to deviation of the material from perfect elasticity. When the last filament receives energy with no neighbor on the other side, it is accelerated and spalls, due to its inertia. The spalling uses most of the energy in separating material, in which process it is converted to heat and dissipated. The bullet or fragment has to start the process anew when it strikes the next panel. It is probable that the jet stream of granulated cement reaches the next panel just ahead of the bullet or fragment, which loses velocity in puncturing its way through the first panel and overcoming friction. Energy delivered to the impacted cushion of cement granules is partly converted to heat by inter-granular friction and dissipated. Part of this explanation is hypothetical, but the result was observed in the parametric experiments.

#### 4-8.6 Alternate Reinforcements

It was found in the parametric experiments that the reinforcement should be a mild carbon steel, which is ductile, and no difference in results was observed between 1/4" hardware cloth and expanded metal lath, even though a higher steel ratio can be attained with hardware cloth. Only expanded metal lath was used in the field experiments. Results obtained with fragmenting weapons were as predicted with results in the parametric experiments.

It was found that conventional reinforced concrete panels were brittle as compared to ferro cement panels.

For protection against underwater demolitions, the enforcement of standoff is the significant capability of fenders, however, reinforced concrete thin panels would lack the toughness required to withstand transportation over rough roads, erection in fenders and the general abuse of a fender by a river.

In the static load test, 1/4" hardware cloth reinforcement exhibited greater strength in flexure and shear than expanded metal lath. The static load condition differs very much, however, from high velocity loading by fragments, bullets and blast forces. Study of results in the parametric and field experiments lead to a conclusion that any closely spaced, ductile mesh reinforcement, even small mesh chicken wire, will afford about the same protection.

The important characteristic of reinforcing material is the ease of procuring it, in quantity, in the width in which panels are to be cast. The widths should not be built out by abutting the edges of mesh layers. Nearly all of the hinge lines and severances in the underwater tests occurred where layers had been abutted because expanded metal lath could not be purchased in small quantities in the widths of the panels.

#### 4-8.7 Cements

Panels were cast of Type III Portland cement. Type III was used to gain high early strength in order to avoid prolonging the experiments. In service, 28 days will most likely pass between casting and use, in which event Type I Portland cement will produce results equal to Type III. A panel of Fast Fix I was tried and the results were not observed to differ from those obtained with Type III Portland cement. Fast Fix I sets so fast that it must be mixed,

placed and vibrated rapidly in order to cease disturbance of it before it starts to set. Without coarse aggregate to help agitate it, the mortar tends to ball and roll in the mixer. It is an excellent cement for rapid repair of airfield pavements, but it is not recommended for ferro cement panels.

#### 4-8.8 Considerations Relative to the Military Worth of Ferro Cement Panels

This subject should be considered in two parts:  
(a) The panels vis a vis other materials for the same protective installations; (b) The protective installations built of any applicable material.

The return to be gained from the expenditure of manpower, materials and equipment-hours is the consideration next in importance to the reliability of the panels. Use of the panels, instead of earth, sand bags, empty oil drums and the like, introduces manufacture at base facilities and transport to places when used. Construction of revetments and bunkers of precast panels requires less effort than construction with locally available expedient materials. Thus, there evolves a trade-off to be considered.

Precast panels of some kind appear to be the only feasible material for "concrete sky" in situations which require such protection.

Construction of fenders around bridge piers, bents and the wet surface of abutments for any purpose is a large, costly undertaking, particularly for existing bridges where the superstructures eliminate head room for cranes. The proven design concepts are eliminated where the purpose is blast protection. For this purpose, the protective skin must be assembled of replaceable panels of some material in order that the protection may be maintained. Ferro cement panels will require no more effort in construction and maintenance than panels of other suitable materials. Thus, the consideration, for each bridge, is narrowed to comparing the expenditure of effort to the military value of the bridge. Where the risk of considering probabilities may be taken, the probability of enemy attempt to destroy the bridge, the probability that the fenders will protect it, the probability of increased charges and the certainty of the expenditure if the decision is to build the fenders, all must be taken into account.

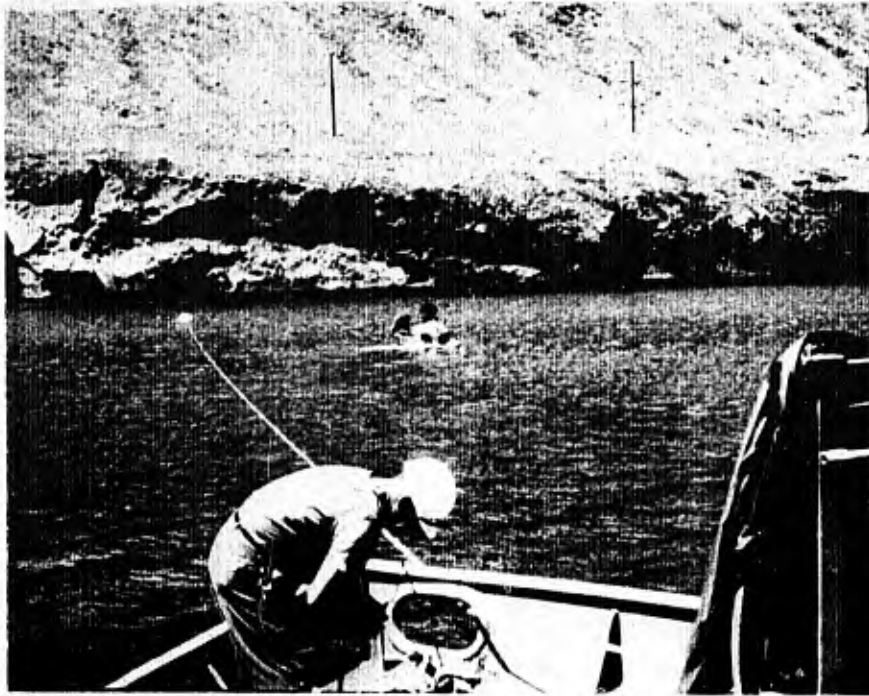

Final Preparation for Detonation  
of Underwater Charge

## Appendix A

### CHARACTERISTICS OF FLEXURE AND SHEAR BEHAVIOR OF FERRO CEMENT PANELS UNDER STATIC LOADING

#### A-1. General

Ferro cement panels with varied reinforcement and one panel conventionally reinforced with one layer of 2"x10g. wire fabric at its mid-plane were statically loaded to failure in the testing laboratory of the Naval Civil Engineering Laboratories. Uniform loading was applied to produce the flexural failure mode. The load to produce the punching shear mode of failure was applied to a 1½" or 2" diameter circle at the center of the panel.

The purpose of the test was to obtain information relative to the ductility of the panels under static loading and the energy required to produce failure.

#### A-2. The Test Program

All panels were cast of 1:2.5 mortar with a water-cement ratio of 0.75. All were 1.1" in thickness. The panel reinforcements are shown in Table A-1.

Table A-1 PANEL REINFORCEMENTS

<u>Type</u>	<u>Location and Number of Layers</u>			<u>Percent by Vol.</u>
	<u>Screed Surf. Downward</u>	<u>Mid-Plane of Panel</u>	<u>Form Surf. Upward</u>	
Exp.Met.	1	0	1	1.17
" "	2	0	2	2.34
" "	3	0	3	3.51
" "	4	0	4	4.68
" "	4	1	4	5.26
¾"Hdwe.Cloth	7	1	7	7.51
2"x10g W.Fabr.	0	1	0	1.30

The percent by volume of expanded metal and hardware cloth is calculated by means of the equation

$$P_v = \frac{nw}{4.083t} \quad \text{A-1}$$

where  $n$  = the number of layers,

$w$  = the weight in lbs/ft<sup>2</sup> of one layer,

$t$  = the thickness of the panel,

and by means of the following equation for the 2"x2" wire fabric

$$P_v = \frac{D^2 \pi}{4t} \quad \text{A-2}$$

where  $D$  = the diameter of the steel wire.

### A-3. The Loading Method

Uniform loading to produce a flexural failure mode was applied through a truck size inner tube containing sufficient water to completely fill a welded loading box of 3/4" steel plate into which it was crowded. To further insure uniformity of load, a 1/4" sheet of gum rubber lay between the inner tube and the top surface of the panel. The panels were supported at four edges on a 1 1/2"x1 1/2" steel bar which was hydrostoned to the slab. The bar rested on a 1 1/2" diameter steel rod which rested on a 3"x3" steel block bearing on the bed of the loading structure. The dial gage was mounted at the center of the panel between its lower surface and the bed of the loading frame. The load was applied by means of a hand operated hydraulic jack, with pressure gage, between the top surface of the loading box and the reaction beam at the top of the loading frame.

The loading to produce a punching shear failure mode was applied to the loading pin by a testing machine which recorded the loads and deflections by means of two dial gages, one to measure pin movement and one to measure panel deflection near the pin edge. The difference is the approximate penetration.

A schematic drawing of the apparatus for application of uniform load is shown in Figure A-1 and loading arrangement for both is shown in Figure A-2.

#### A-4. Conduct of the Tests

Small specimens were sawed from the 24"x24" panels for test under loading for punching shear. Panels with two layers and four layers of expanded metal lath reinforcement failed in flexure, even when supported two ways at 8" span and loaded by means of a 1½" diameter pin. Panels with six layers and eight layers of expanded metal lath and with fifteen layers of hardware cloth failed in shear when thus supported and loaded.

In panels with less than nine layers of expanded metal lath, fills were inserted between the two reinforcement stacks to keep the outer layers at the panel surfaces. These fills were layers of expanded metal, cut about 4"x4". The number of layers in a fill was the difference between the number of reinforcement layers and the nine layers required to fill the panel. The fills were to be placed at the center and near the corners of the panel. It was disturbing to find that the saw cuts revealed several fills quite out of position. Cut specimens for the shear tests were selected to minimize the probability of there being a fill in the shear area.

#### A-5. Results of the Tests

A summary of the data obtained with loading to produce the flexural mode of failure is tabulated in Table A-2.

The yield strength of welded wire fabric is 65,000 psi. Yield strengths of the wire in hardware cloth and of the cold rolled carbon steel sheets which are expanded into lath are not quoted; information that has been gained indicates that 30,000 ksi is a fair average.

The data in Table A-2 is based on the response of the panels until the ultimate load is reached, where collapse is initiated. This provides a valid evaluation of their structural response. The panels continue to absorb blast energy, however, until the load drops to zero. The energy absorption to destruction is indicated by the areas under the curves in Figure A-3 (p.A-8).

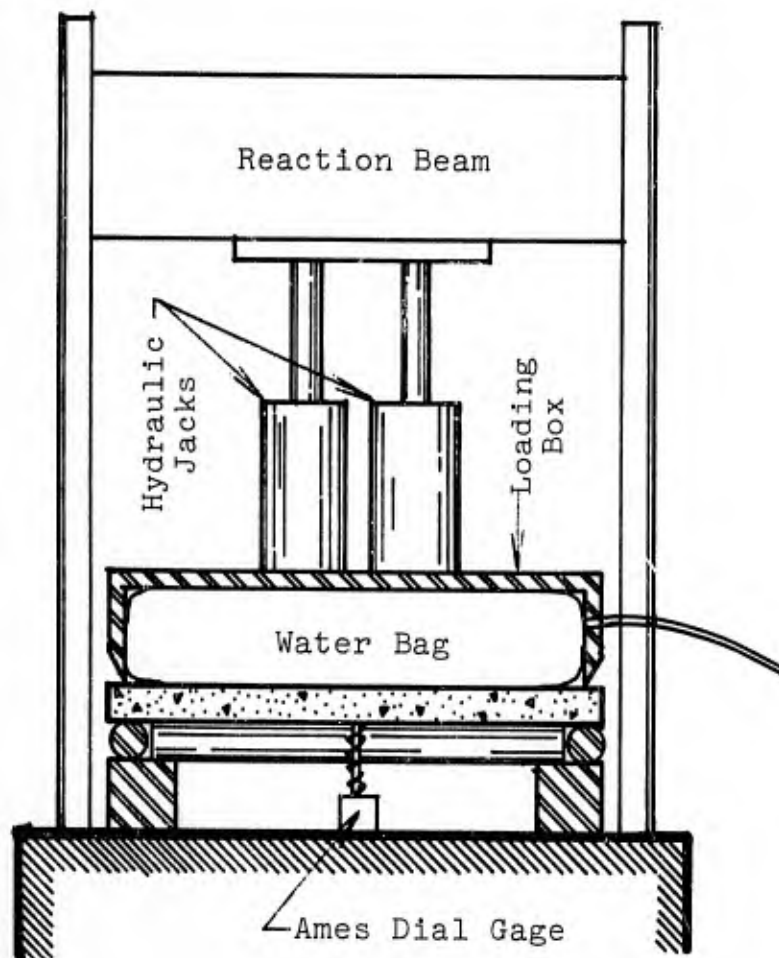
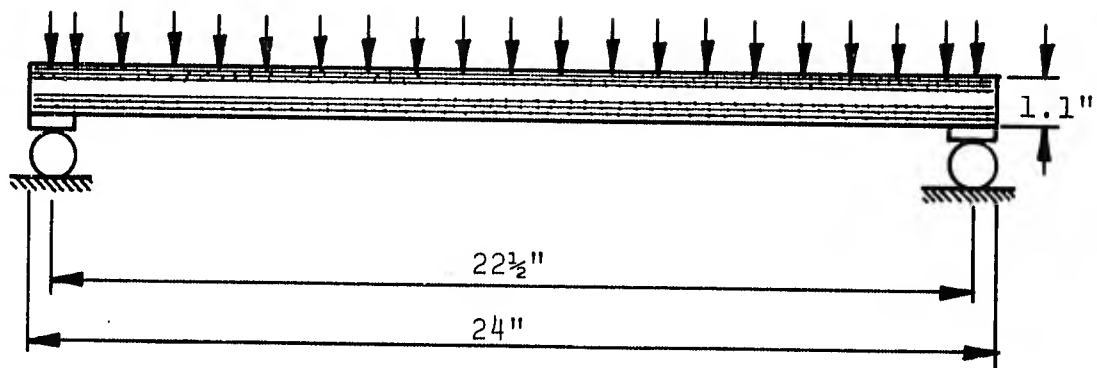
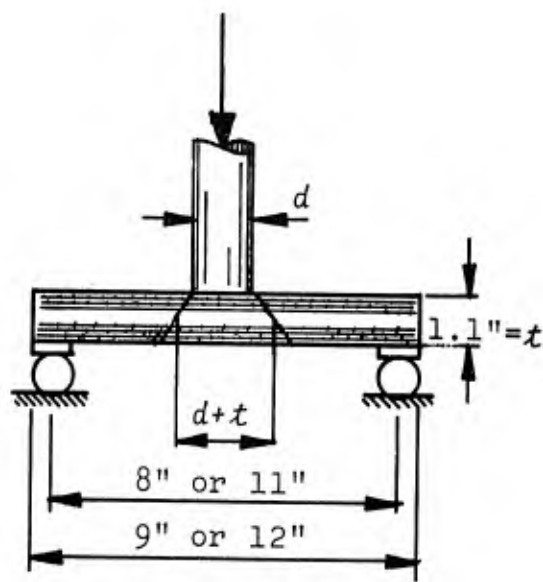

Figure A-1 SCHEME OF THE UNIFORM  
LOADING APPARATUS



Flexural Loading



Punching Shear Loading

Figure A-2 PANEL LOADING ARRANGEMENTS

Table A-2 SUMMARY OF FLEXURAL TEST DATA

Slab Designation	Age (Days)	Cyl. Str. (psi)	% Reinf. by Vol.	Ultimate Load (psi)	Defl. at Collapse (ins.)	Strain Energy Indicator** (psi-ins.)	Ult. Hinge-line Moment (in.lbs./in.)
1-0-1EM	18	3870	1.17	9.0	0.15	0.80	189.8
2-0-2EM	14	3730	2.34	13.2	0.80	9.13	278.4
3-0-3EM	17	3840	3.51	30.7	1.17	25.75	647.6
4-0-4EM	17	3840	4.68	33.5	2.00	48.50	706.6
4-1-4EM	39	6300*	5.26	36.0	2.05	47.54	760.0
7-1-7HC	19	3900	7.51	55.0	1.05	32.03	1160.0
0-1-0WF	18	3870	1.30	23.0	0.80	12.70	485.0

Notes: Slab Designation: Number, arrangement and type of reinforcement layers. Cylinder strengths interpolated by means of straight line semi-log plot of 7 day and 28 day strengths.

\*Bad 28 day cylinder. Gain assumed at same ratio as other panels.

\*\*Strain energy indicator is the area under load-deflection curve to yield point. Valid for comparison, assuming that all panels had about the same history of deflected shape. (Slab 4-1-4EM area measured to first peak.) Ultimate hinge-line moment calculated by equation,  $m = wl^2/24$

Values in the column headed, "Strain Energy Indicator," provide a reasonable basis for comparing the energy absorption of the several panels. The true value of strain energy is the amount of work performed by the uniform load, which may be expressed by the following equation:

$$U = \int_{(x,y,z)} w(x,y,z) dx dy dz \quad A-3$$

The right hand term expresses an integration of the load-deflection history over the loaded area of the panel. The strain energy indicator may be expressed by the equation:

$$E_u = \int_{y'} w(y') dy' \quad A-4$$

where  $y'$  is measured at the center of the panel. It is to be noted that  $U \neq AE_u$ , because  $y$  is variant with  $(x,z)$ . The effect of deflection on resistance of the several panels in flexure is plotted in Figure A-3. The series of discontinuities beginning at  $y'=2.0$ ins. is attributed to the pressure variations between the jacks and the water bag in following the collapse of the panel. The rapidly applied load is not considered to be representative of the static resistance of the panel. The ultimate strength is considered to be at the first peak.

The effect of the reinforcement ratio on the resistance, deflection and strain energy indicator at the ultimate strength is plotted in Figure A-4.

The compression faces of all panels except 4-1-4EM are shown in Figure A-5; the tension faces in Figure A-6. The compression face of panel 4-1-4EM is shown in Figure A-7 and a profile view of the tension face in Figure A-8.

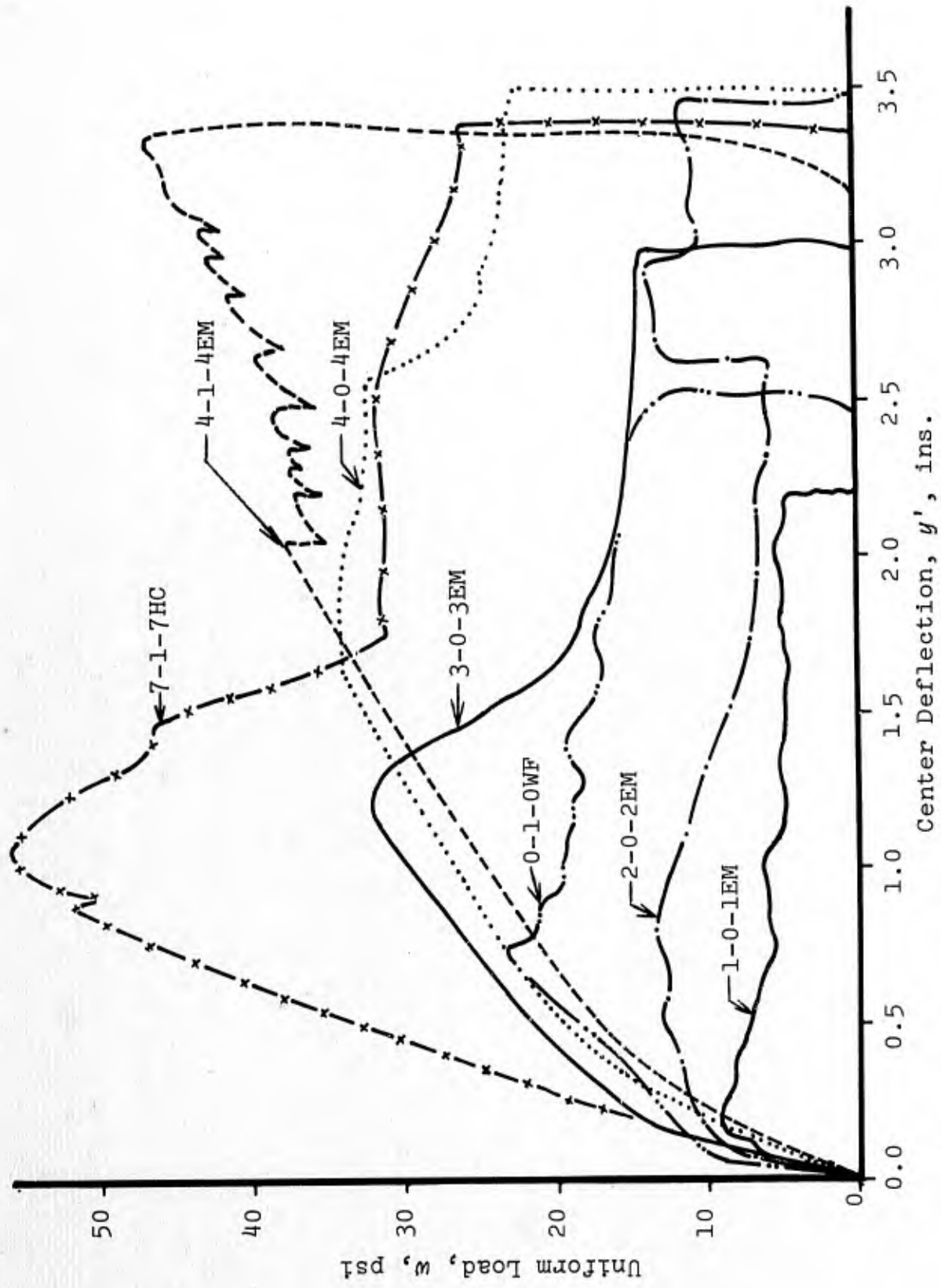

Figure A-3 EFFECT OF DEFLECTION ON RESISTANCE TO UNIFORM LOAD

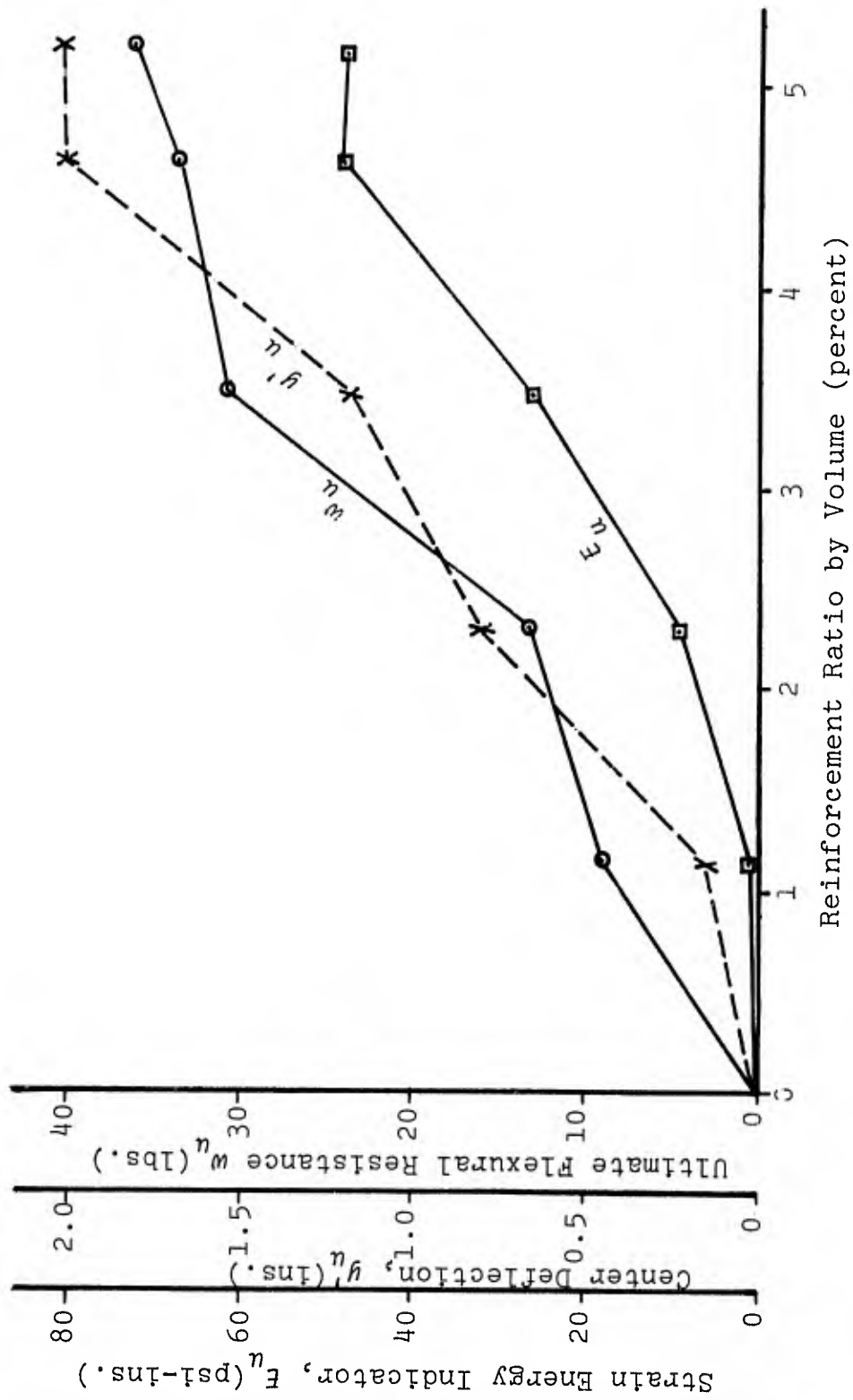

Figure A-4 EFFECT OF REINFORCEMENT RATIO ON PANEL RESPONSE

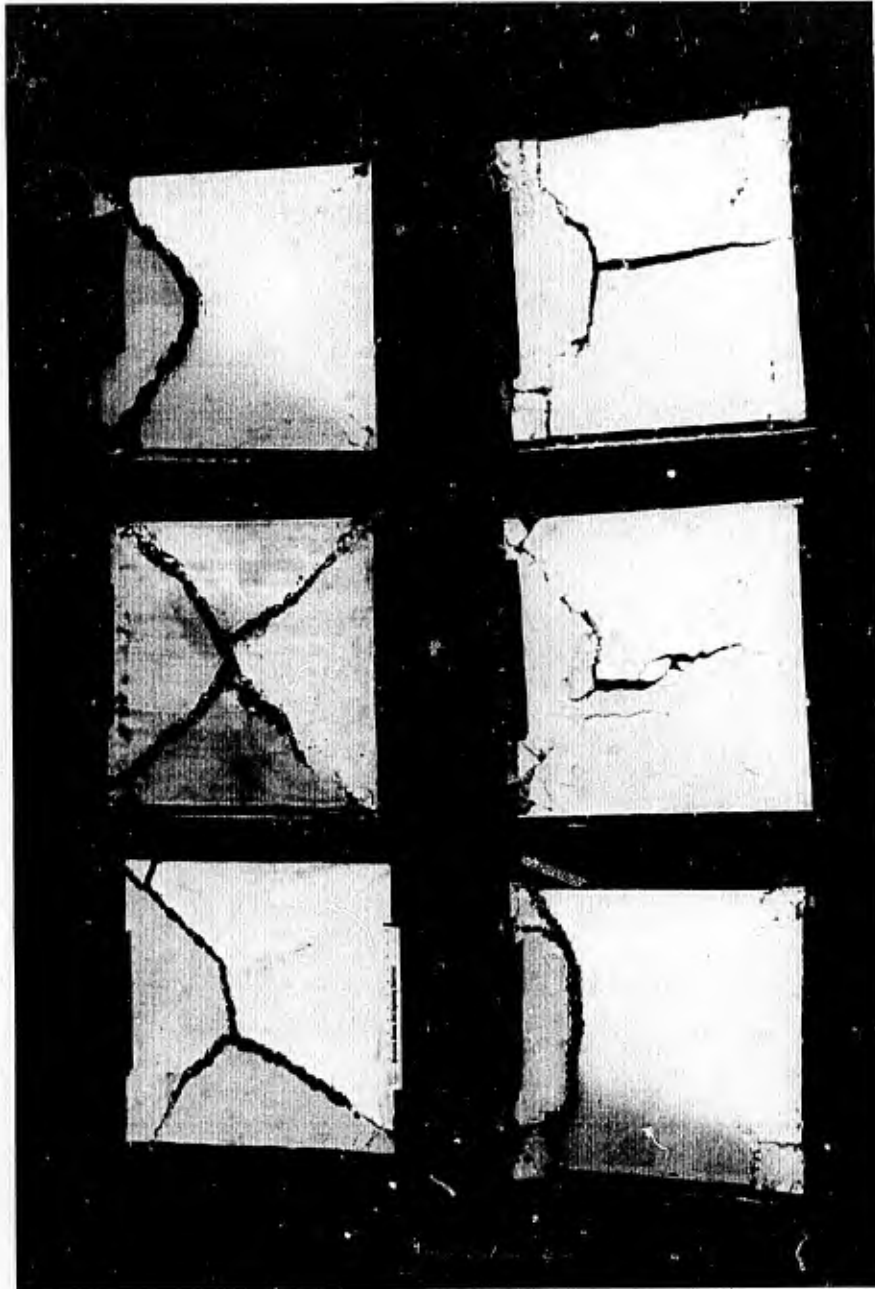

Figure A-5 COMPRESSION FACES OF PANELS, AS LABELLED,  
AFTER FLEXURAL FAILURE

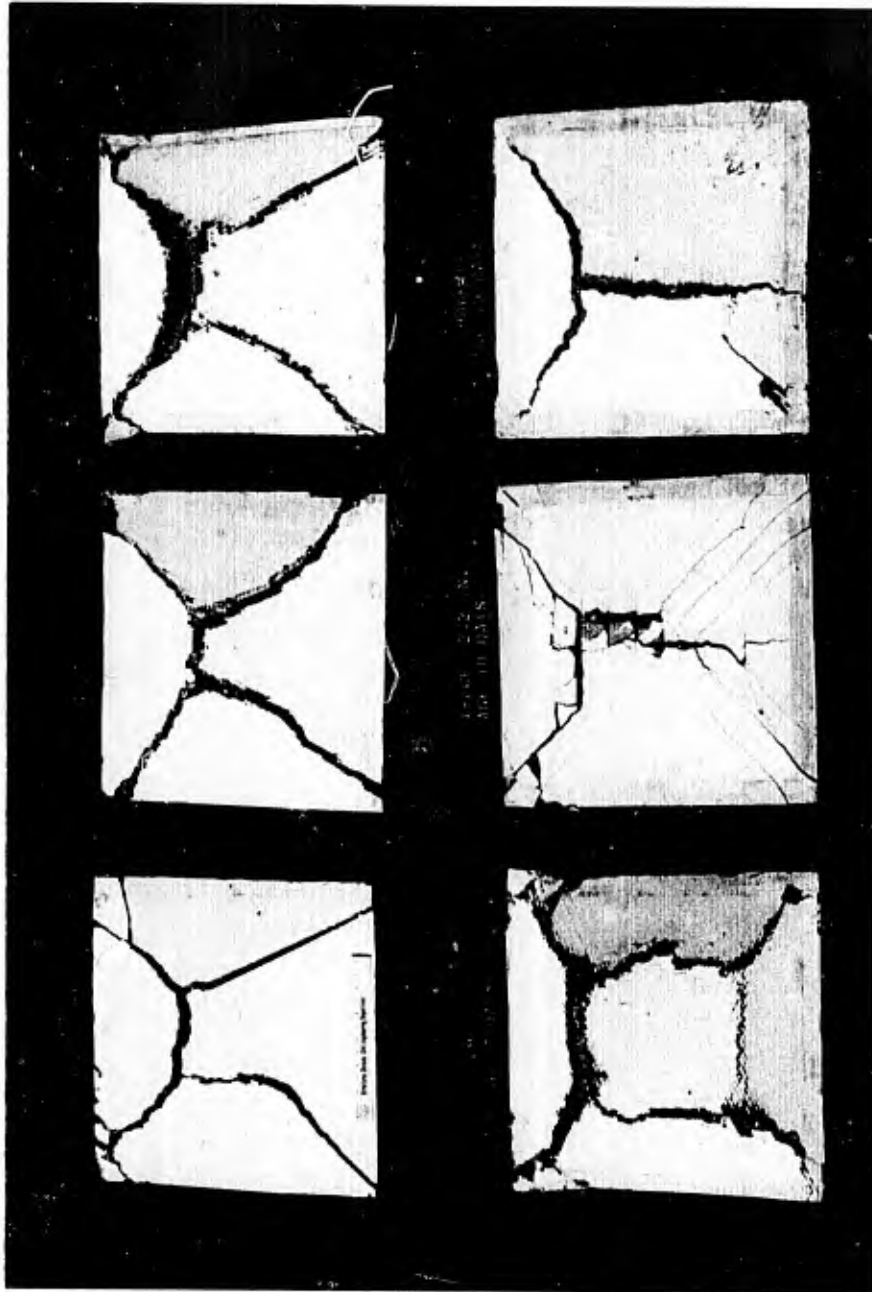

Figure A-6 TENSION FACES OF PANELS, AS LABELLED,  
AFTER FLEXURAL FAILURE

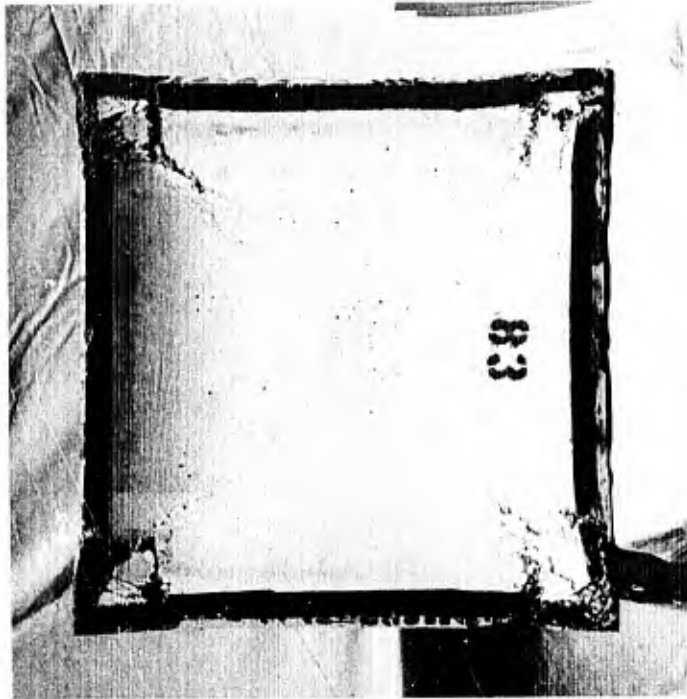

Figure A-7 COMPRESSION FACE OF PANEL 4-1-4EM  
AFTER FLEXURAL FAILURE

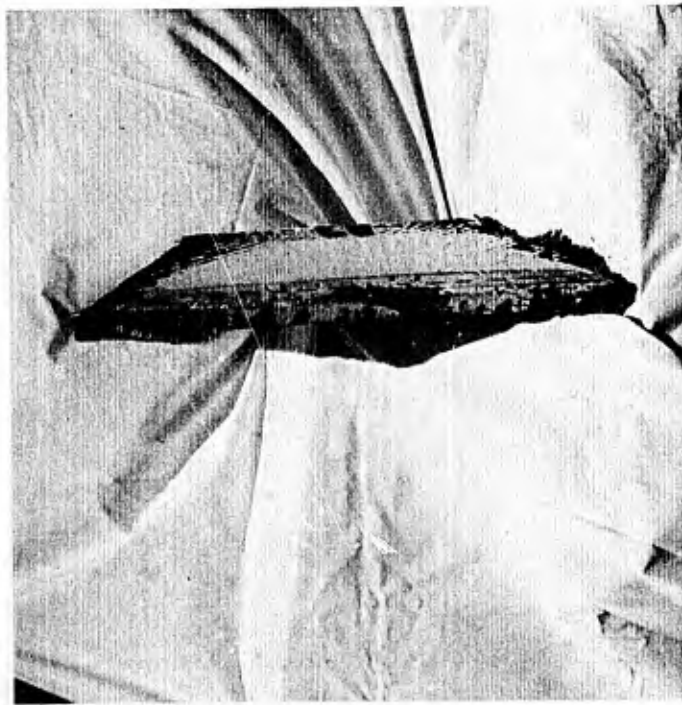

Figure A-8 TENSION FACE OF PANEL 4-1-4EM  
AFTER FLEXURAL FAILURE

A summary of the data obtained with loading to produce a punching shear mode of failure is contained in Table A-3. It will be noted that the theoretical flexural resistance is tabulated and the ratio of the shear resistance to the theoretical flexural resistance is used to determine the failure mode theoretically.

Hinge-line theory, used in calculating the theoretical flexural capacity, is an idealization which is close enough to reality to be a completely valid tool for use in ultimate strength design. It is doubted that it provides a reliable prediction of the mode of failure of ferro cement panels where the ratio  $V_u/P_u$  lies between 0.9 and 1.1. In this band, however, it is believed there is a reasonable expectancy that failed panels will reveal evidence of both modes, usually with one predominating somewhat over the other. The progress of failure in one mode is likely to lessen resistance to failure in the other mode, particularly in ferro cement panels with ductile reinforcement.

The relation between the penetration of the panels by the loading pin and the applied load shown is in Figure A-9, relative to the 9" square panels supported at a span of 8"x8" and, in Figure A-10 relative to the 12"x12" panels 2-0-2EM supported at a span of 11"x11". The greater load capacity exhibited by Panel No. 1 in Figure A-10 was not a result to be expected since this was the 21 day old panel with about 2% less strength than Panel No. 3 as well as Panel No. 2, which was also loaded with a 2" diameter pin.

Reproduced photographs of the loaded and opposite faces of the panels tested with 8"x8" supports are shown in Figures A-11 and A-12 and, of those tested with 11"x11" supports, in Figures A-13 and A-14. The back faces of the panels reinforced with expanded metal lath reveal bulging over a large area on the face opposite to the load and those with 1-0-1 and 2-0-2 arrangements of reinforcement are radially cracked and spalled on this face. Only the panel marked, 2-2EM2-2", in Figure A-13, reveals indication of flexural distress on the front face. The reinforcement layers at and toward the unloaded face have separated from those deeper in the panel. The panel which is fully reinforced with hardware cloth, marked, 15HDWE1.5" in Figure A-12 does not reveal a similar response. The shear cone is about 1½" in diameter on the loaded face and about 3¼" on the opposite face.

Table A-3 SUMMARY OF PUNCHING SHEAR TEST DATA

Slab	Span (in.)	Pin Dia. (in.)	Shear Area (in <sup>2</sup> )	Age (Days)	Cyl. Str. $f'_c$ (psi)	% Reinf. by Vol.	Ult. Ld. $V_u$ (lbs.)	Shear Resistance $v_u$ (psi)	$\frac{v_u}{\sqrt{f'_c}}$	Theoretical Flex. Resistance $P_u$ (lbs.)	$\frac{V_u}{P_u}$	Theoretical Failure Mode
1-0-1EM	8x8	1.5	8.98	27	4110	1.17	1670	186	2.90	1735	0.962	Shear-Flexure
2-0-2EM	8x8	1.5	8.98	26	4090	2.34	2640	294	4.60	2530	1.043	Shear-Flexure
2-0-2EM2	11x11	2	10.71	24	4040	2.34	2220	207	3.25	2520	0.883	Shear-Flexure
2-0-2EM3	11x11	1.5	8.98	24	4040	2.34	2200	245	3.85	2425	0.907	Shear-Flexure
2-0-2EM1	11x11	2	10.71	21	3960	2.34	2750	257	4.08	2510	1.095	Shear-Flexure
3-0-3EM	8x8	1.5	8.98	27	4110	3.51	2900	323	5.04	5900	0.492	Shear
4-0-4EM	8x8	1.5	8.98	27	4110	4.68	3310	369	5.75	6450	0.513	Shear
7-1-7HC	8x8	1.5	8.98	27	4110	7.51	5700	635	9.90	10600	0.537	Shear

Notes: The thickness of all panels was 1.1".

Shear area is calculated as the area of a 45° cone, truncated at the loading pin.

The theoretical flexural capacity was calculated according to hinge-line theory with the load uniformly distributed over the contact area of the loading pin.

Cylinder strengths were interpolated by means of a straight line plot on semi-log paper of 7 day and 28 day test results.

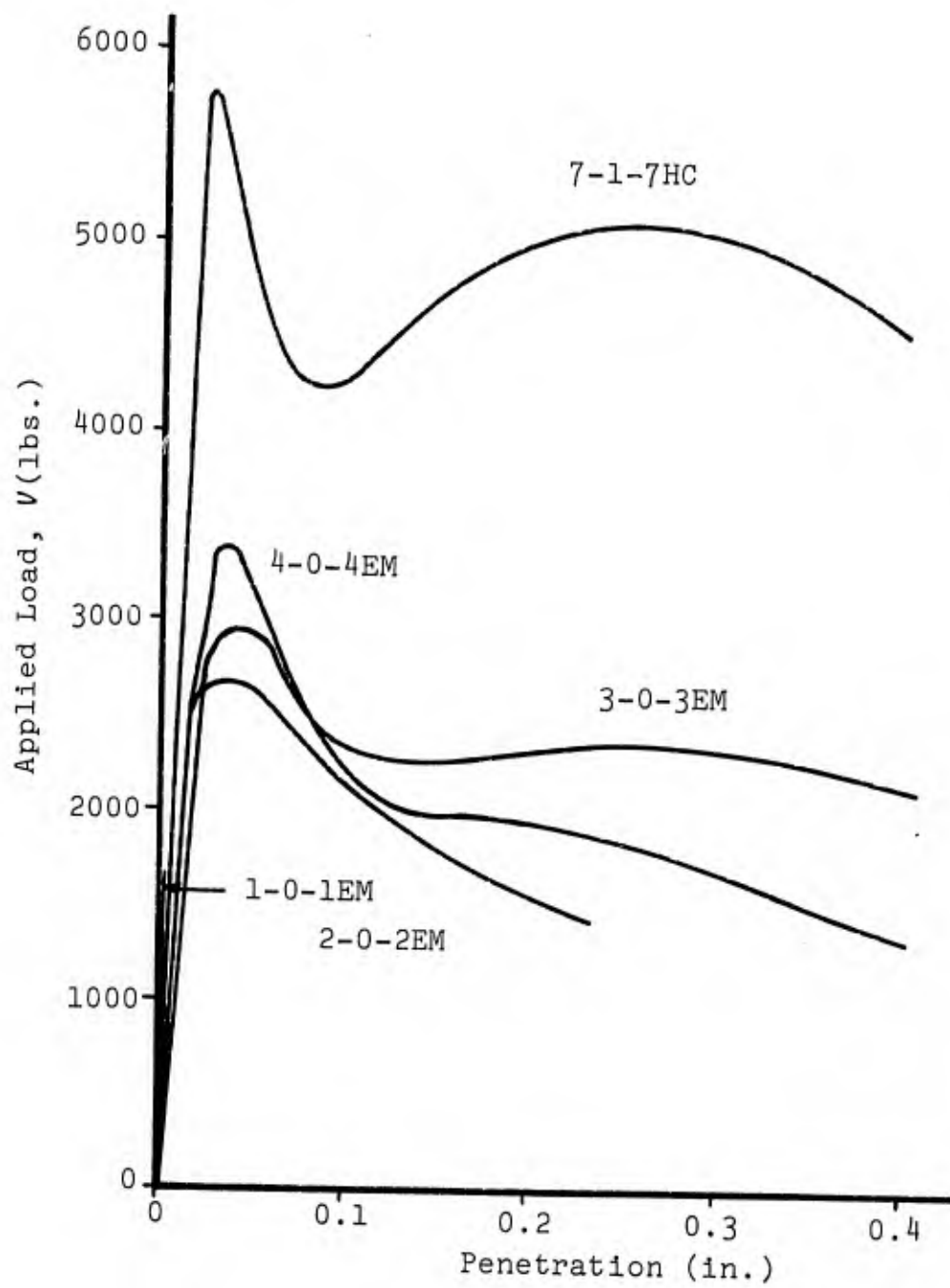

Figure A-9 LOAD-PENETRATION RELATION  
9"x9" PANELS

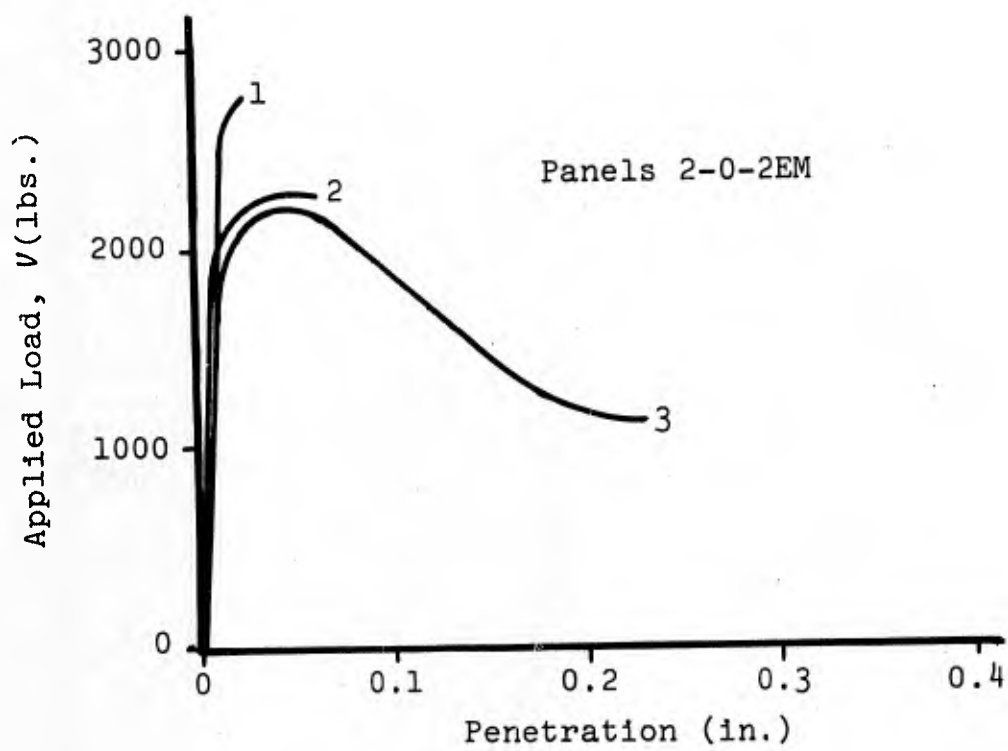

Figure A-10 LOAD-PENETRATION RELATION  
12"x12" PANELS

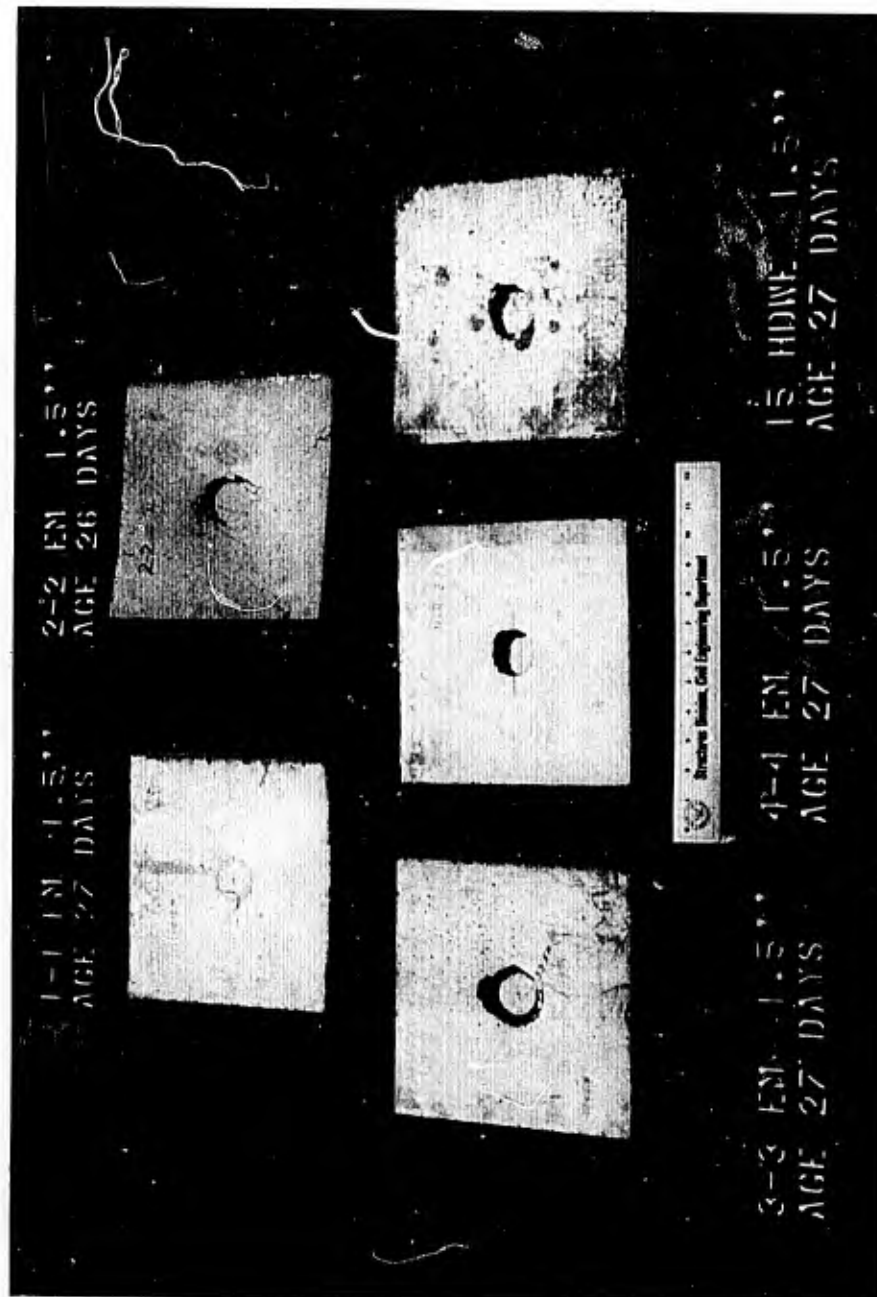

Figure A-11 PIN CONTACT FACES OF 9"x9" PANELS, AS LABELLED, AFTER LOADING TO FAILURE IN PUNCHING SHEAR

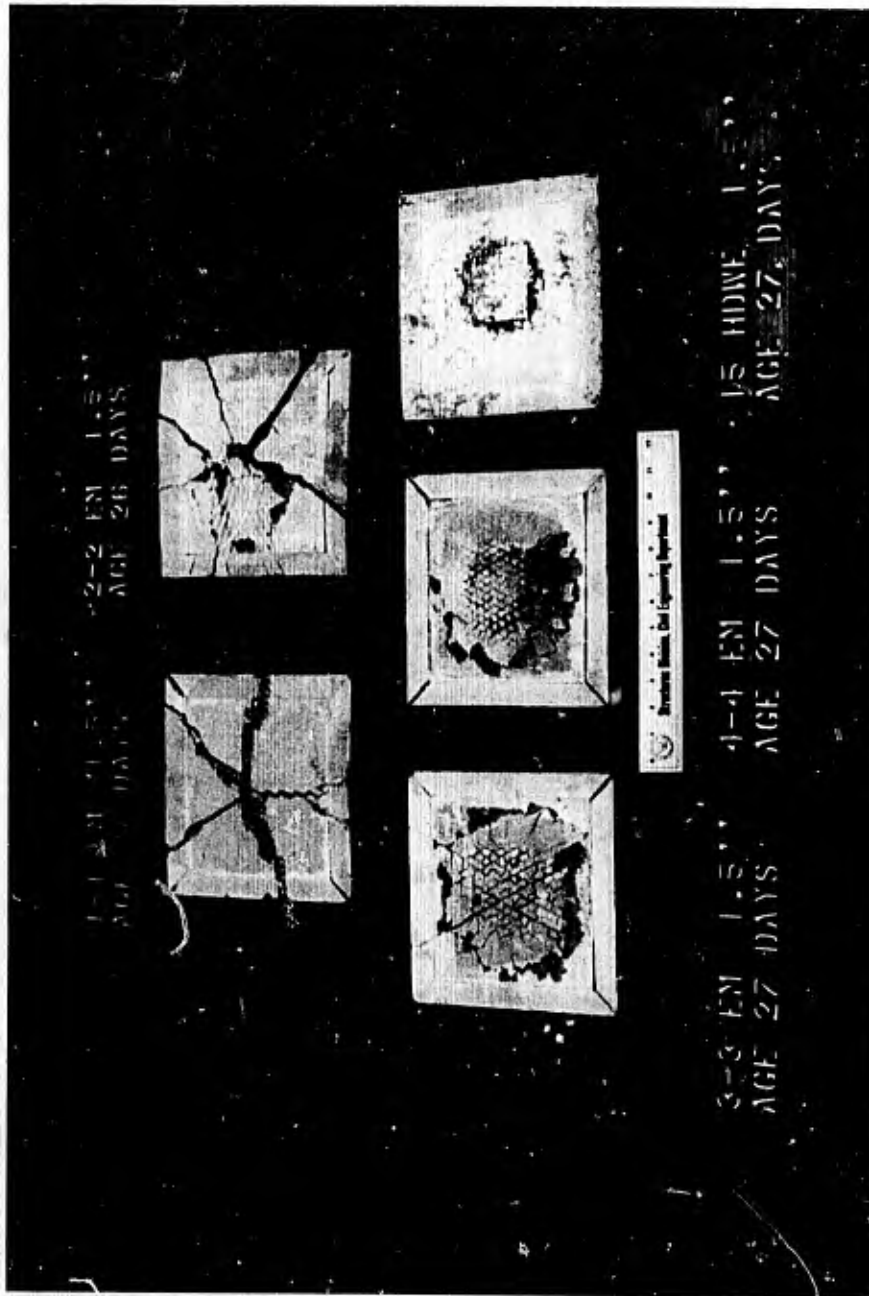

Figure A-12 FACES OPPOSITE TO PIN CONTACT OF 9"x9" PANELS, AS LABELLED, AFTER LOADING TO FAILURE IN PUNCHING SHEAR

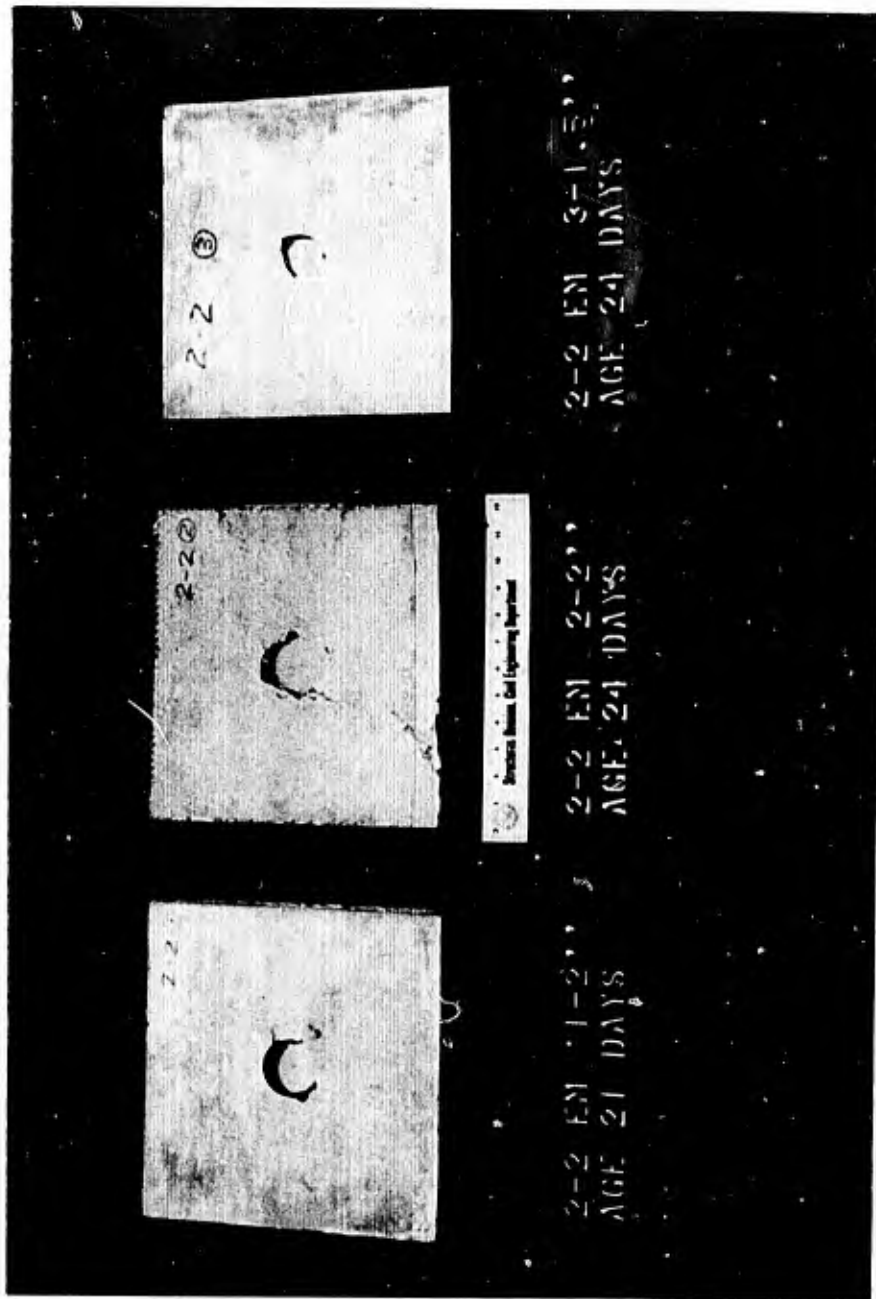

Figure A-13 PIN CONTACT FACES OF 12"x12" PANELS, AS LABELLED, AFTER LOADING TO FAILURE IN PUNCHING SHEAR

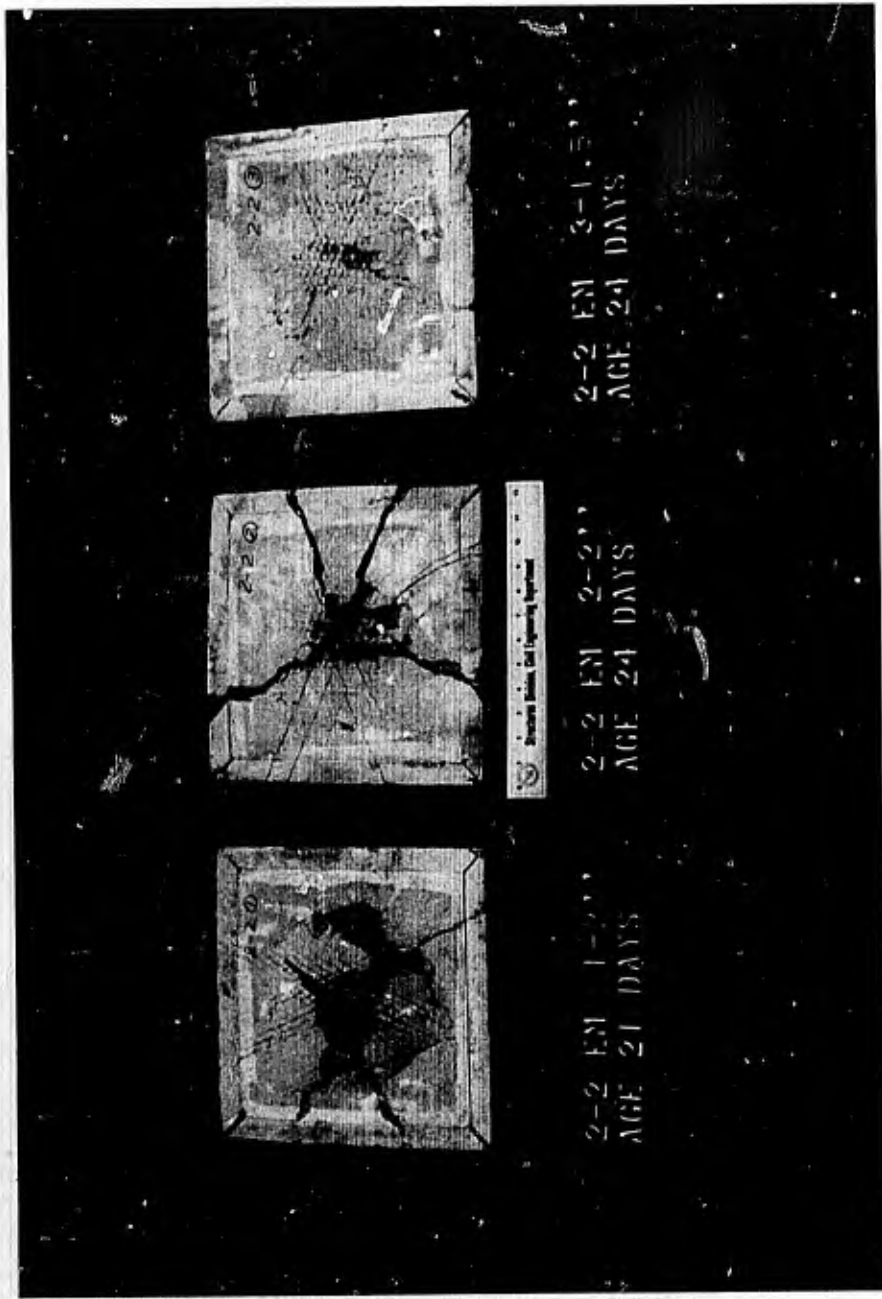

Figure A-14 FACES OPPOSITE TO PIN CONTACT OF 12"x12" PANELS, AS LABELLED, AFTER LOADING TO FAILURE IN PUNCHING SHEAR

This is very close to the theoretical 45 degree truncated cone. The sides of the rhombuses in expanded metal lath are strips  $1/64$ " x  $1/16$ " and the axial overall dimensions of the rhombic pattern are  $3/8$ " x  $5/8$ ". The sides of the rhombuses are canted at about 45 degrees. Expanded metal lath interposes many small separation planes in the cement. The steel volume in hardware cloth is in the efficient cylindrical configuration of wire and interposes less separation of cement. The failure modes characterized as shear-flexure in Table A-3 are more likely to be a combination of shear and this unique flexure-like response of panels reinforced with expanded metal lath. The flexure-like response probably occurred to some extent in the panels to which the shear mode is attributed in Table A-3.

The load-penetration curve (Fig. A-9) of the hardware cloth reinforced panel, 7-1-7HC, undergoes a pronounced rise from a penetration of 0.1" to 0.25", following an initial drop. The curves for the expanded metal lath reveal a decline in load drop with penetration following the initial drop, but only panel 3-0-3EM rises, slightly. The initial drop is due to punching shear failure of the cement and the portion of the curves beyond the initial drop is believed to reflect the membrane resistance of the reinforcement. The surface of the shear cone, substantially, is the boundary of dished hardware cloth; the boundary of dished expanded metal lath at the surface opposite the loading pin has a varying diameter of from 5" to 6". Penetration dished the hardware cloth at lesser radii of curvature than that of the expanded metal lath and, hence, imparted greater strain to the hardware cloth.

#### A-6. Conclusions

The energy expended in destroying panel 7-1-7HC in punching shear appears to be approximately twice that expended in destroying panel 3-0-3EM. Less energy was expended on 4-0-4EM than on 3-0-3EM. The energy expended in destroying panel 7-1-7HC in flexure is indicated to be not much more than was expended on 4-1-4EM. The concrete strength of 4-1-4EM, however, was 60% greater than 7-1-7HC. It is concluded from these observations that with a particular concrete strength, the energy absorption of ferrocement panels is dependent on the reinforcement ratio, as would be expected. Since about 50% greater ratio can be obtained with hardware cloth, greater energy absorption may be expected of hardware cloth reinforced panels in flexure than may be expected of those reinforced with expanded metal lath.

The energy expended in destroying panel 7-1-7HC in punching shear was over twice that expended in destroying panel 3-0-3EM, which accepted more energy than panel 4-0-4EM.

It appears that hardware cloth has two advantages over expanded metal lath; it provides a higher steel ratio and it performs more predictably and efficiently in punching shear. Some anomalies in the shear tests may have resulted, however, from out-of-place spacers referred to on page A-3.

The energy expended in destroying the conventionally reinforced 0-1-0WF panel was not greatly in excess of that expended in destroying panel 2-0-2EM, due to the much greater ductility of panel 2-0-2EM. The load jump in panel 2-0-2EM beyond 2.5" of deflection is not understood. The steel ratio of panel 2-0-2EM was twice that of panel 0-1-0WF but the yield stress of expanded metal is less than one-half that of wire fabric.

The advantages of ferro-cement panels over reinforced concrete panels are:

- 1) Higher ultimate strength.
- 2) Greater ductility (energy absorption between the ultimate strength and complete failure).
- 3) Greater durability under exposure to shell fragments or automatic weapons fire due to less spalling.
- 4) Decreased spall hazard to personnel due to reduced size of spalls.

Discussion of the two materials in terms of these properties is contained in the following paragraphs.

Ferro-cement has protective properties not possessed by reinforced concrete, even if the latter be over reinforced. Concrete is over reinforced when its compressive strength does not develop yield stress in the reinforcement. Ferro-cement is distinguished from reinforced concrete by the distribution of its reinforcement, consisting of many layers with small mesh size. This feature causes ferro-cement to respond like an homogenous material, such as steel.

The properties of ferro-cement are predominantly those of the reinforcement. The function of the cement is primarily to hold the reinforcement in place and accomplish the force transfer between layers necessary for the panels to resist bending. Yield occurs first in the reinforcement layers at the panel surfaces, at the ultimate strength of the panel. Beyond the ultimate strength, reinforcement yield progresses inwardly, layer after layer. This would continue until the rupture stress was reached in the outer layers if the cement continued to perform its function completely. Progressive failure occurs in the cement, but it appears that entrapped, partially failed cement continues to perform its function at a reduced and progressively declining rate. The interaction of cement and reinforcement beyond the ultimate strength of the panel appears to be too complex for specific definition, but the fact remains that the panels have pronounced ductility. This is the property to absorb a large amount of energy while undergoing large deflection beyond the ultimate strength. This property is most important in protective panels. The ultimate strength and ductility of ferro-cement cannot be equaled in reinforced concrete panels in thickness under consideration for protective uses. Where the forces in the reinforcement are concentrated in larger, more widely spaced wires, the provision of the necessary bond strength between the concrete and the wires requires embedment of the reinforcement,  $2\frac{1}{2}$  to 3 times the wire diameter. In panels 1" to 2" in thickness, embedment is a significant decrease in effective depth.

For the ductility of the reinforcement to be exploited, a concrete panel must be under reinforced considerably, so that the concrete can develop the complete yield of the steel. (Compressive reinforcement as sometimes used in reinforced concrete would not be effective in panels 2" or less in thickness.) The ultimate strength of the panel would be considerably less than a ferro-cement panel of the same thickness. If the amount of reinforcement were increased to gain more ultimate strength, ductility would be reduced sharply because the inelastic behavior of concrete in compression does not provide ductility comparable to that of mild steel.

It was found during the parametric experiments (p.4-42) that spalls from reinforced concrete panels, resulting from the impact of Cal. .30-06 rifle bullets, were much larger than from ferro-cement panels and approximately equal in number. Reduction of the size of spalls will contribute to the durability of panels exposed to fragments from bursting shells or to automatic fire, as well as reducing the hazard to personnel of the spalls.

Appendix B

REFERENCE AND BIBLIOGRAPHY

Reference:

1. Cole, Robert H., *Underwater Explosions*, Princeton University Press, 1948.

Bibliography:

Griffith, Nancy H., *Round the World Open House on the Ferro-Cement Awahnee*, Boating (Mag.) October, 1968.

Gardner, John, *Wide Interest Shown in Ferro-Cement Boats*, National Fisherman (Mag.) September, 1968.

*Seattle Designer Writes on Ferro-Cement, and Aussies Outline Boatbuilding in Ferro-Cement*, National Fisherman (Mag.) October, 1967.

Gardner, John, *To Sea in a Stone*, The Skipper (Mag.) December, 1967.

Rath, Dick, *Two Florida Boatmen Build a Big Beamy Charter Boat of Ferro-Cement, Acquire a Batch of New Skills Along the Way*, Boating (Mag.) July, 1968.

Collen, L.D.G. and Kirwan, R.W., *The Mechanical Properties of Ferro-Cement*, Civil Engineering and Public Works Review, December, 1958.

Collen, L.D.G., *Some Experiments in Design and Construction with Ferro-Cement*, The Institution of Civil Engineers of Ireland, Vol. 86, p. 40, January, 1960.

Byrne, J. G. and Wright, W., *An Investigation of Ferro-Cement, Using Expanded Metal*, Concrete and Construction Engineering, December, 1961.

James, T. L., *A New Boat Building Material*,  
Ship and Boatbuilder International, April, 1967.

Evans, G. M., *The Cement Boat That has Circled  
the World*, Rudder (Mag.) June, 1968.

Department of the Army, *Demolition Materials*,  
TM9-1375-200, January, 1964.

Department of the Army, *Explosives and Demoli-  
tions*, FM 5-25, May, 1967.

Sullivan, B. R. and Bombish, A.A., U. S. Army  
Waterways Experiment Station, Corps of Engineers,  
Vicksburg, Miss., *Blast Attenuation Studies in  
Dividing Wall Protective Construction*, Misc.  
Paper No. 6-840, Defense Documentation Center,  
September, 1966.

Unclassified

Security Classification

DOCUMENT CONTROL DATA - R & D		
<i>(Security classification of title, body of abstract and indexing annotation must be entered when the overall report is classified)</i>		
1. ORIGINATING ACTIVITY (Corporate author) T. Y. Lin and Associates 14656 Oxnard Street Van Nuys, California 91401		2a. REPORT SECURITY CLASSIFICATION Unclassified
		2b. GROUP
3. REPORT TITLE FERRO CEMENT PANELS - VOLUME I Experimental Evaluation and Protective Potential		
4. DESCRIPTIVE NOTES (Type of report and inclusive dates) Final Report 22 May 1968 - 30 Oct 1968		
5. AUTHOR(S) (First name, middle initial, last name) Adams, Ray		
6. REPORT DATE November 1968	7a. TOTAL NO. OF PAGES 217	7b. NO. OF REFS 1
8a. CONTRACT OR GRANT NO. N62399-68-C-0040	9a. ORIGINATOR'S REPORT NUMBER(S) #68224	
b. PROJECT NO. 51-005	9b. OTHER REPORT NO(S) (Any other numbers that may be assigned this report) CR 69.008	
c.		
d.		
10. DISTRIBUTION STATEMENT Each transmittal of this document outside the agencies of the U. S. Government must have prior approval of the Naval Civil Engineering Laboratory		
11. SUPPLEMENTARY NOTES	12. SPONSORING MILITARY ACTIVITY Naval Civil Engineering Laboratory Port Hueneme, California 93041	
13. ABSTRACT A series of practical experiments was conducted in order to judge the effectiveness of ferro cement panels in building revetments, bunkers, "concrete sky" aircraft cover and fenders around bridge piers for protection against underwater demolition charges. Ferro cement consists of sand-cement mortar filled with closely woven steel mesh reinforcing.  Panels of varied design were exposed to rifle and pistol fire and 4 1/2"x4 1/2"x2" and 27 1/2"x27 1/2"x1" panels of 1:2.5 (cement to sand) mortar and expanded metal lath reinforcement were selected for ensuing experiments. Two-inch panels were exposed to surface and underwater demolition charges up to 20 lbs. of TNT, the latter in different arrangements and stand off distances from a simulated bridge pier under 11' to 16' of water. One-inch panels were exposed to the M26 hand grenade, M79 cartridge grenade, M16 rifle, 81mm and 4.2 in. mortar shells, 105mm Howitzer shell and to 66mm and 3.5 in. rockets, HEAT.  Two 1" panels in tandem 6 1/2" apart are effective against the rifle and grenades, and the shells bursting 5' or more away, but ineffective against the HEAT rockets. A fender of 2" panels at 6' stand off will provide bridge pier protection against 20 lb. charges, due to the stand off. One to four panels will be destroyed, necessitating an inner enclosure to deny access to the pier.		

DD FORM 1473 (PAGE 1)

1 NOV 65  
S/N 0101-807-6801

Unclassified

Security Classification

14. KEY WORDS	LINK A		LINK B		LINK C	
	ROLE	WT	ROLE	WT	ROLE	WT
Armor						
Blast						
Bridge						
Bunker						
Casting						
Concrete Sky						
Cover						
Defensive						
Demolition						
Fenders						
Ferro Cement						
Forms						
Fortifications						
Fragmentation						
Overhead						
Panels						
Penetration						
Pier						
Pill-boxes						
Protection						
Protective						
Resistance						
Revetments						
Shield						
Strength of materials						
Underwater						
Vibration						
Weapons						