

FILE COPY

ESD ACCESSION LIST

NTTI Call No. 83344

Copy No. 1 of 2 cys. /

Technical Note

1975-33

Measurements of ELF  
Noise Processing

A. S. Griffiths

2 September 1975

Prepared for the Department of the Navy  
under Electronic Systems Division Contract F19628-76-C-0002 by

**Lincoln Laboratory**

MASSACHUSETTS INSTITUTE OF TECHNOLOGY

LEXINGTON, MASSACHUSETTS



Approved for public release; distribution unlimited.

ADA016477

The work reported in this document was performed at Lincoln Laboratory, a center for research operated by Massachusetts Institute of Technology. The work was sponsored by the Department of the Navy under Air Force Contract F19628-76-C-0002.

This report may be reproduced to satisfy needs of U.S. Government agencies.

This technical report has been reviewed and is approved for publication.

FOR THE COMMANDER

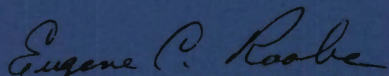

Eugene C. Raabe, Lt. Col., USAF  
Chief, ESD Lincoln Laboratory Project Office

MASSACHUSETTS INSTITUTE OF TECHNOLOGY  
LINCOLN LABORATORY

MEASUREMENTS OF ELF NOISE PROCESSING

*A. S. GRIFFITHS*  
*Consultant*  
*Group 66*

TECHNICAL NOTE 1975-33

2 SEPTEMBER 1975

Approved for public release; distribution unlimited.

LEXINGTON

MASSACHUSETTS

## ABSTRACT

This report describes non-linear processing experiments with ELF noise recorded in Norway, Saipan, and Greece. Effective noise levels, an important measure of performance for a non-linear receiver, were computed using sine-wave signals in the 42-48 Hz and 72-78 Hz bands. Although results were not optimum due to fixed (as opposed to adaptive) clip levels, notch filter effects and local sine-wave interference, they do show diurnal variations and do provide a significant increase in the available data in this frequency range.

## SUMMARY

This reports describes non-linear processing experiments with ELF noise recorded in Norway, Saipan, and Greece. The purpose of the experiments was to measure "effective noise levels,"\* an important measure of the performance of a non-linear processing receiver. The experiments used simulated sine wave signals in the 42-48 Hz and 72-78 Hz bands. The Norway data (approximately 600 hours) was recorded during six periods of various length from January 1969 to September 1973. The Saipan and Greece data (approximately 300 and 200 hours, respectively) was recorded in May 1972, coincident with one of the Norway recording periods. The results were obtained using a fixed (as opposed to adaptive) clipper and may therefore be suboptimum.

Emphasis was placed on examining highest effective noise levels which determine the minimum required signal energy received for an ELF communications system which must operate under worst case conditions.

The highest levels ( $-130 \text{ dBH}_0$ ) were observed in the 42-48 Hz band in Norway; however, significant degradation in the simulated receiver may be attributed to the proximity of the 50 Hz notch filter and local interference. The highest Norway levels in the 72-78 Hz band were about  $-137 \text{ dBH}_0$ . While the data base for these experiments was too small to measure seasonal variations, diurnal

---

\* The effective noise level is defined in Ref. 9 as

$$N_{\text{eff}}(\text{dBH}_0) = 10 \log_{10} (2 H_s^2 T / \text{SNR})$$

where

$H_s$  = injected signal strength (amp/m)

$H_0$  = reference H-field usually taken as 1 amp/meter

T = matched filter integration time (sec)

SNR = (mean<sup>2</sup>/variance) at the matched filter output.

variations of 4-10 dB were observed (with the higher levels during the day). The highest levels in Saipan were about -136 and -137 dBH<sub>0</sub>, respectively, in the 45-48 Hz and 72-78 Hz bands. The highest levels observed in Greece in the 72-78 Hz band were about -134 dBH<sub>0</sub>.

## Measurements of ELF Noise Processing

### I. INTRODUCTION

These experiments were part of Lincoln Laboratory's analysis and design of long range ELF communications sponsored by the Department of the Navy.<sup>1</sup> Long range communication in the ELF band is possible due to the relatively low attenuation rate of the atmosphere. Similarly the relatively low attenuation rate in sea water allows penetration to submerged submarine antennas. The dominant source of noise in this band is attributed to radiation induced by lightning.\* Local noise characteristics are affected not only by nearby storms, which produce large spikes, but also distant storms which generate background noise with occasional spikes. Since there is a worldwide variation in thunderstorm activity there is a corresponding variation in ELF noise characteristics.

An important aspect of ELF noise is its distinctly non-gaussian character. Waveforms recorded throughout the world display frequent spikes. Analysis of amplitude distributions similarly shows significant departures from normal distributions.<sup>2</sup> While linear receivers are optimum in a gaussian environment, more sophisticated techniques are required to optimize receiver performance in a non-gaussian environment.<sup>3,4,5,6,7,8</sup> However, extensive simulations with digital recordings of ELF noise indicated that a relatively simple clipper provides significant improvements compared to linear processing and that more sophisticated techniques which were examined yielded no further improvement.<sup>9</sup>

Initial digital recordings were wideband, had a wide dynamic range, and

---

\* Antenna noise is also a factor.

were relatively short (30 mins/tape).<sup>10</sup> A series of analog recordings were made for propagation measurements<sup>11,12,13</sup> and also to provide a data base for further receiver simulations. In estimating receiver performance under worst case conditions a very large data base is required. While these analog recordings are still not sufficient to base precise predictions of worst case performance, they represent a major increase over the digital recordings.

## II. PROCEDURE

Concurrent with propagation measurements, ELF noise with an injected sine wave signal was recorded for analysis of effective noise levels. During one 15-day period in May 1972 simultaneous recordings were made in Norway, Greece and Saipan. In addition, similar recordings were made in Norway during October-November 1971, January 1972, September 1972 and July 1973. The recording periods ranged from 5 to 24 days; typically two tapes each 6 to 12 hours long were recorded each day and subsequently analyzed.

The injected sine wave, which was used for calibration of the propagation tests, was varied in frequency from 42 to 48 Hz and from 72 to 78 Hz. The injected signal level was designed to be high enough to provide reasonable measures of signal-to-noise ratios over periods comparable to system message lengths and to be low enough to reflect receiver performance.\* In the higher frequency band the injected signal was approximately  $-140 \text{ dBH}_0$  and in the lower band it was approximately  $-135 \text{ dBH}_0$ .

---

\* With non-linear processing, the signal-to-noise ratio is approximately proportional to the signal strength for small signals.

As shown by Fig. 1 three channels of signal plus noise were clipped and recorded in the field. The results described in subsequent sections are based primarily on data from tape recorder channel 2, which was proportional to the time derivative of the H-field over the 3-130 Hz range. The clip level on this channel was set at approximately -123 dBH at 75 Hz in both the Saipan and Norway equipment and at approximately -129 dBH at 75 Hz in the Greece equipment. Waveforms on this channel show definite clipping, but particularly in Saipan and Norway the clip levels may have been set too high.

As shown by Fig. 2, three channels were processed in parallel in the laboratory. The injected signal and the reference signal used for matched filtering were recorded in the field and played back through identical filters. Fluctuations in tape recorder speeds thus introduced identical phase shifts in both signal and reference. Using a hybrid of analog equipment and a small computer (Varian 620/L), effective noise levels were calculated and displayed. Since the software was relatively straightforward (involving no digital filters) the processing could be done at 32 times real time.\* The longest tapes of 12 hours could thus be processed in about 22 minutes each, excluding setup time. In all the simulations, message lengths of 13 minutes were used. The matched filter integration time was typically 1-2 seconds. The effective noise levels (and simulation parameters) were written on magnetic tape for subsequent plotting and analysis. Results were also printed on the teletype console, plotted on the CRT and copies on a hard-copy device while the analog tapes were rewound.

---

\* By bandpass filtering the data before sampling, a sample rate less than the Nyquist rate was possible without aliasing. In fact, the higher band (2304-2496 Hz after the x32 playback speedup factor) was centered 480 Hz above the sample rate of 1920 Hz while the lower band (1344-1536 after playback) was centered 480 Hz below the sample rate.

In addition to the noise processing, spectral analysis of most tapes was performed using the same equipment. A Varian 620i computer was programmed using FFT subroutines to provide the spectrum averaged over the tape, noise power variations as a function of time, and also to plot a segment of the time waveform. Using a x32 playback factor this processing took about 22 minutes for a 12-hour tape.

Figure 3 illustrates the spectral analysis processing procedure. The A/D converter was driven by a 250-Hz clock derived from the recorded clock signal of 1000 Hz. For a given channel, a buffer of 512 samples was filled (requiring 64 milliseconds of real time corresponding to 2.048 seconds of tape time). The power spectrum was computed using an FFT, buffered and combined with previous spectra for subsequent averaging (requiring an estimated 1.1 seconds of real time or 35.2 seconds of tape time). Power estimates were obtained by summing spectral values over selected bands (e.g., 40-45 Hz and 75-80 Hz). This process was then repeated for the next two data channels. At the end of the input tape, the averaged spectra and the temporal power samples were converted to dB, and written on an output scratch tape for subsequent plotting. Also written were two seconds of waveforms. As shown in Table 1, the analysis band was 0-125 Hz with 0.49 Hz frequency resolution. Spectral samples were taken at about two-minute intervals on each channel, yielding 12 hours x 30 samples per hour = 360 samples per channel.

TABLE 1  
SPECTRAL ANALYSIS PARAMETERS

| <u>Variables</u>        | <u>On Input Tape</u>         | <u>With x32 Playback</u> |
|-------------------------|------------------------------|--------------------------|
| Sample Rate             | 250 Hz                       | 8000 Hz                  |
| FFT Length              | 512 samples<br>2.048 seconds | 512 samples<br>64 msec   |
| Frequency Resolution    | 0.4883 Hz                    | 15.62 Hz                 |
| Analyzing Band          | 0 - 125 Hz                   | 0 - 4000 Hz              |
| Degrees of Freedom      | 720                          | 720                      |
| Processing Time per FFT | ≈ 35 seconds                 | ≈ 1.1 seconds            |
| No. of Channels         | 3                            | 3                        |
| Time Between FFT's      | ≈ 2 minutes                  | ≈ 3.3 seconds            |

### Results

Table 2 summarizes the data derived from Norway, Saipan and Greece. Recordings were made in Norway on five occasions. The highest levels were observed in the 42 - 48 Hz range in the Fall of 1971 and the summer of 1973. In both Norway and Greece there was noticeable power line interference at 50 Hz, which may have degraded the results particularly in the lower band. At each site, in both bands significant diurnal variations were observed. Following is a summary of each set of measurements.

TABLE 2  
SUMMARY OF EFFECTIVE NOISE LEVELS (dBH<sub>o</sub>)

| <u>Recording Site</u> | <u>Recording Period</u> |      | <u>Hours of data Analyzed</u> | <u>42-48 Hz</u> |               |            | <u>72-76 Hz</u> |               |            |
|-----------------------|-------------------------|------|-------------------------------|-----------------|---------------|------------|-----------------|---------------|------------|
|                       |                         |      |                               | <u>High</u>     | <u>Medium</u> | <u>Low</u> | <u>High</u>     | <u>Median</u> | <u>Low</u> |
| Norway                | October-November        | 1971 | 252                           | -132            | -137          | -140       | -137            | -145          | -150       |
| Norway                | January                 | 1972 | 54                            | -               | -             | -          | -143            | -148          | -152       |
| Norway                | May                     | 1972 | 214                           | -               | -             | -          | -137            | -142          | -149       |
| Norway                | September               | 1972 | 46                            | -               | -             | -          | -138            | -143          | -148       |
| Norway                | July                    | 1973 | 40                            | -130            | -133          | -134       | -139            | -141          | -145       |
| Saipan                | May                     | 1972 | 320                           | -138            | -141          | -146       | -137            | -143          | -149       |
| Greece                | May                     | 1972 | 214                           | -               | -             | -          | -134            | -142          | -149       |

Norway: October - November 1971

Over a 22-day period, 44 analog tape recordings were made. Each day two 8-hour tapes were recorded from about 2000 to 0400 and from 1000 to 1800 GMT. During the first 12 days the injected signal was in the 72 to 78 Hz range. During the last 10 days the injected signal was in the 42 to 48 Hz range. Three channels, using the two different clip levels and two different front-end filters, were recorded in addition to the narrow-band channel, time code, calibration signal and reference signal.

From a sample of 12 tapes with signals at 42 and 46 Hz representing about 100 hours of data over a 6-day period effective noise levels were derived and are summarized by Table 3. Sinusoidal interference was observed at 16 Hz and at 42 Hz. This interference, particularly at 16 Hz, was unusually high and quite

possibly increased effective noise levels. Despite the possible degradation due to the notch filter, the 46 Hz data was about 2 dB lower than the 42 Hz data presumably due to the interference near 42 Hz. Because of possible degradation effects, this data may not be representative. Analysis of these degradation effects is presented in Appendix A.

TABLE 3  
EFFECTIVE NOISE LEVELS MEASURED AT 42 AND 46 Hz  
FROM NORWAY, FALL 1971

| Tape No. | Start Date | Day/Night * | Injected Signal Frequency (Hz) | Effective Noise Level (dB <sub>0</sub> ) |        |        |
|----------|------------|-------------|--------------------------------|--|--------|--------|
|          |            |             |                                | Low                                      | Median | High   |
| 33       | Oct. 28    | Night       | 42                             | -136.1                                   | -134.8 | -133.3 |
| 34       | 29         | Day         | 42                             | -136.3                                   | -134.3 | -131.7 |
| 35       | 29         | Night       | 42                             | -126.0                                   | -134.5 | -133.2 |
| 36       | 30         | Day         | 42                             | -134.8                                   | -133.8 | -132.8 |
| 37       | 30         | Night       | 46                             | -140.4                                   | -138.5 | -132.3 |
| 38       | 31         | Day         | 46                             | -138.2                                   | -137.0 | -135.2 |
| 39       | 31         | Night       | 46                             | -139.4                                   | -138.2 | -136.1 |
| 40       | Nov. 1     | Day         | 46                             | -138.4                                   | -137.0 | -135.2 |
| 41       | 1          | Night       | 42                             | -138.3                                   | -136.9 | -135.2 |
| 42       | 2          | Day         | 42                             | -138.0                                   | -136.6 | -134.7 |
| 43       | 2          | Night       | 42                             | -139.6                                   | -138.2 | -137.4 |
| 44       | 3          | Day         | 42                             | -136.7                                   | -134.8 | -133.3 |

\* Recording times were 1000 to 1800 GMT during the day and 2000 to 0400 GMT at night.

Figure 4 is a plot of effective noise levels observed in the 72-76 Hz band over the 12-day period from October 12 to October 24, 1971. Figures 5 through 9 show the same data on an expanded scale. As shown by these figures, two 7-hour segments were processed for each day. Over this period (representing 48 hours of data) the median was about  $-145 \text{ dBH}_0$  and the extremes were  $-136.7$  and  $-150.0 \text{ dBH}_0$ .

Table 4 shows a frequency distribution of the effective noise levels for each 7-hour segment (32 - 13-minute messages) as well for the entire period. The highest levels were concentrated over brief periods. The afternoons of October 13 and 15 produced 26 of the 27 observations over  $-140 \text{ dBH}_0$ . Diurnal variations are apparent; variations greater than 10 dB were observed on October 13 and 15. Figure 9 shows the average effective noise level variation as a function of time of day. The peak at about 1300 GMT is about 5 dB higher than the minimum at about 0300. These diurnal variations could not be related to changing levels in local man-made interference; spectral measurements over a 7-hour period on October 15 (see for example, Figs. 10 and 11) remained virtually constant while the effective levels dropped 7 dB from about noon to 1600 GMT.

#### Norway: January 1972

Over a 6-day period in January 1972, about 54 hours of ELF data with an injected 76 Hz signal were recorded and subsequently processed. The effective noise levels ranging from  $-143$  to  $-152 \text{ dBH}_0$ , shown by Fig. 12 are considerably lower than other Norway results. Consequently, they do not directly affect minimum transmitter power requirements, but their deviation from previous observations suggests seasonal fluctuations which should be considered in

TABLE 4

FREQUENCY DISTRIBUTION OF EFFECTIVE NOISE LEVELS FROM NORWAY, FALL 1971 (768 OBSERVATIONS)

| Tape October | Frequency (Hz) | Effective Noise Levels (dBH <sub>0</sub> ) |      |      |      |      |      |      |      |      |      |      |      |      | Total |      |      |
|--------------|----------------|--|------|------|------|------|------|------|------|------|------|------|------|------|-------|------|------|
|              |                | -150                                       | -149 | -148 | -147 | -146 | -145 | -144 | -143 | -142 | -141 | -140 | -139 | -138 |       | -137 | -136 |
| 1301         | 12-13          |  |      | 6    | 7    | 7    | 3    | 4    | 2    | 2    | 1    |      |      |      |       |      | 32   |
| 1302         | 13             |  |      |      |      |      |      |      | 1    |      | 5    | 10   | 10   | 4    | 1     | 1    | 32   |
| 1303         | 13-14          |  |      | 6    | 13   | 7    | 1    | 2    | 3    |      |      |      |      |      |       |      | 32   |
| 1304         | 14             |  |      |      |      |      | 2    | 13   | 10   | 7    |      |      |      |      |       |      | 32   |
| 1305         | 14-15          |  |      |      | 1    | 3    | 3    | 9    | 8    | 8    |      |      |      |      |       |      | 32   |
| 1306         | 15             |  |      |      |      |      |      | 1    | 5    | 10   | 2    | 4    | 5    | 2    | 1     | 2    | 32   |
| 1307         | 15-16          |  |      |      |      |      |      | 3    | 6    | 10   | 9    | 3    |      |      |       |      | 32   |
| 1308         | 16             |  |      |      |      |      |      |      | 2    | 15   | 4    | 5    | 4    | 2    |       |      | 32   |
| 1309         | 16-17          |  |      |      |      |      |      |      | 1    | 16   | 12   | 3    |      |      |       |      | 32   |
| 1310         | 17             |  |      |      |      |      |      |      | 1    | 5    | 6    | 4    | 8    | 2    |       |      | 32   |
| 1311         | 17-18          |  |      |      |      |      |      |      | 6    | 11   | 15   |      |      |      |       |      | 32   |
| 1312         | 18             |  |      |      |      |      |      |      |      |      |      |      |      |      |       |      | 32   |
| 1313         | 18-19          |  |      |      |      |      |      |      | 1    | 8    | 9    | 8    | 5    | 1    |       |      | 32   |
| 1314         | 19             |  |      |      |      |      |      |      | 2    | 0    | 9    | 9    | 12   |      |       |      | 32   |
| 1315         | 19-20          |  |      |      |      |      |      |      |      | 5    | 11   | 5    | 10   |      |       |      | 32   |
| 1316         | 20             |  |      |      |      |      |      |      |      | 8    | 8    | 5    | 15   | 4    |       |      | 32   |
| 1317         | 20-21          |  |      |      |      |      |      |      | 2    | 10   | 3    | 4    | 5    | 8    |       |      | 32   |
| 1318         | 21             |  |      |      |      |      |      |      |      |      | 8    | 5    | 8    | 7    | 3     | 1    | 32   |
| 1319         | 21-22          |  |      |      |      |      |      |      | 11   | 6    | 4    | 5    | 1    |      |       |      | 32   |
| 1320         | 22             |  |      |      |      |      |      |      |      |      |      |      | 12   | 13   | 6     | 1    | 32   |
| 1321         | 22-23          |  |      |      |      |      |      |      | 8    | 17   | 7    |      |      |      |       |      | 32   |
| 1322         | 23             |  |      |      |      |      |      |      |      |      | 4    | 11   | 6    | 11   |       |      | 32   |
| 1323         | 23-24          |  |      |      |      |      |      |      | 10   | 7    | 7    | 4    | 3    | 1    |       |      | 32   |
| 1324         | 24             |  |      |      |      |      |      |      |      |      | 4    | 15   | 6    | 6    | 1     |      | 32   |
| Total        |                |  |      | 13   | 46   | 78   | 85   | 102  | 111  | 136  | 98   | 41   | 31   | 16   | 6     | 2    | 768  |
| %            |                |  |      | 1.7  | 6.0  | 10.2 | 11.1 | 13.3 | 14.5 | 17.7 | 12.8 | 5.3  | 4.0  | 2.1  | 0.8   | 0.3  | 0.4  |
| cum %        |                |  |      | 1.7  | 7.7  | 17.9 | 29.0 | 42.3 | 56.8 | 74.5 | 87.3 | 92.6 | 96.4 | 98.7 | 99.5  | 99.9 | 100  |

estimating system performance.

As shown by Fig. 12, five recordings each 8-12 hours were analyzed. The first two (January 3 and 4, shown in detail by Figs. 13 and 14) were recorded during the day. On both days there was a rise of about 4 dB from late morning to mid-afternoon. The last three (January 5-8, shown in detail by Figs. 15, 16, and 17) were recorded from late evening (2200 GMT) to the next morning (about 0900 GMT). All three of these recordings showed a 4-6 dB drop from late evening to very early morning followed by a rise to mid-morning. Although these are not continuous 24-hour recordings, they do suggest diurnal variations of 6-8 dB with a minimum in very early morning and a maximum in the afternoon or evening.

Spectral analysis was performed to note prominent man-made interference and to determine whether variations in effective noise level could be related to variations in spectra. The "soft" limiter channel which had very little clipping (see Fig. 18) was used for spectral analysis while the "hard limiter" channel (Fig. 19) was used to compute effective noise levels.

Comparison of spectra taken at 30-minute intervals over a 12-hour period showed very little variation. For example, Figs. 20 and 21 are spectra taken at 1100 GMT and 1900 GMT on January 4. Over this period the effective noise level rose 2 dB. When these spectra (and others) are superimposed nearly identical levels of sine wave interference are seen at about 16, 42, 63, 84 and 105 Hz. The consistency of this interference is most clearly shown by a spectrum averaged over several hours using the hard limiter channels, for example, Fig. 22; these lines and a smaller one at 125 Hz are evident from this spectrum which also shows the signal energy at 76 Hz.

Norway: May 1972

Over a 15-day period in May 1972, simultaneous ELF recordings were made in Saipan, Greece and Norway. As was observed from the Fall 1971 recordings, the lower band data from Norway and Greece was apparently degraded by local interference and by the effects of the 50 Hz notch filter. Analysis of these effects is presented in Appendix B. Figure 23 shows the frequency distribution for the higher band data recorded nearly continuously from May 1 to May 10. Table 5 shows the distribution of effective noise levels for each of the tapes. The odd numbered tapes were recorded from 0630 to 1800 GMT and the even numbered tapes from 1830 to 0600. Consistent with other observations, diurnal variations of about 8 dB were apparent. Figures 24, 25, and 26 show the effective noise levels on the three noisiest days. With the exception of Fig. 24 which showed an unexpected peak around midnight (possibly due to local interference), the highest levels were observed in the late afternoon (odd numbered tapes).

Norway: July 1973

From July 15 to July 18 recordings were made with injected signals at 76 Hz and 46 Hz. As shown by Fig. 27, the 76 Hz levels were significantly lower than 46 Hz levels except during a brief period on July 16 when there was very strong local interference. As with the Fall 1971 and May 1972 data, the high levels at 46 Hz may be attributed to the proximity of the 50 Hz notch filter.

Saipan: May 1972

In May 1972 simultaneous recordings were made in Saipan, Norway (previously described) and Greece. There were recorded and subsequently analyzed about 215 hours in the 72-78 Hz band and about 110 hours in the 42-48 Hz band.

TABLE 5

EFFECTIVE NOISE LEVELS IN NORWAY, May 1972 (987 OBSERVATIONS OVER 13-MINUTE INTERVALS)

Effective Noise Levels (dBH)

| Tape  | Date<br>(May) | Frequency<br>(Hz) | Effective Noise Levels (dBH) |      |      |      |      |      |      |      |      |      |      |      |      |      |   |  |  |
|-------|---------------|-------------------|------------------------------|------|------|------|------|------|------|------|------|------|------|------|------|------|---|--|--|
|       |               |                   | -136                         | -137 | -138 | -139 | -140 | -141 | -142 | -143 | -144 | -145 | -146 | -147 | -148 | -149 |   |  |  |
| 1001  | 1             | 76                |                              |      |      |      |      |      | 8    | 12   | 22   | 8    |      |      |      |      |   |  |  |
| 1002  | 1             | 76                |                              |      |      |      | 2    | 12   | 23   | 9    | 2    |      |      |      |      |      |   |  |  |
| 1003  | 2             | 76                |                              |      |      |      | 1    | 13   | 22   | 10   | 4    |      |      |      |      |      |   |  |  |
| 1004  | 2             | 76                |                              |      | 3    | 10   | 4    | 14   | 5    | 2    | 5    | 6    | 1    |      |      |      |   |  |  |
| 1005  | 3             | 72                |                              |      |      |      | 9    | 32   | 9    |      |      |      |      |      |      |      |   |  |  |
| 1006  | 3             | 72                |                              |      |      |      |      | 3    | 15   | 9    | 2    | 14   | 6    |      |      |      |   |  |  |
| 1007  | 4             | 72                |                              |      |      |      |      | 1    | 27   | 20   | 2    |      |      |      |      |      |   |  |  |
| 1008  | 4             | 72                |                              |      |      |      |      |      | 3    | 6    | 7    | 6    | 3    | 15   | 7    | 3    |   |  |  |
| 1009  | 5             | 78                |                              |      |      |      |      |      | 2    | 9    | 14   | 12   | 1    |      |      |      |   |  |  |
| 1010  | 5             | 78                |                              |      |      |      |      |      |      | 1    | 14   | 14   | 4    | 3    | 2    | 7    | 5 |  |  |
| 1011  | 6             | 78                |                              |      |      |      | 1    | 4    | 14   | 8    | 5    | 13   | 5    |      |      |      |   |  |  |
| 1012  | 6             | 78                |                              |      |      |      | 1    | 6    | 14   | 10   | 6    | 12   | 1    |      |      |      |   |  |  |
| 1013  | 7             | 72                |                              |      |      |      | 7    | 23   | 9    | 9    | 2    |      |      |      |      |      |   |  |  |
| 1014  | 7             | 72                |                              |      |      |      |      |      | 3    | 19   | 10   | 3    | 3    | 11   | 1    |      |   |  |  |
| 1015  | 8             | 72                |                              |      |      |      |      |      | 5    | 15   | 8    | 6    | 8    |      |      |      |   |  |  |
| 1016  | 8             | 72                |                              |      |      |      |      |      | 6    | 7    | 9    | 7    | 4    | 7    | 8    | 2    | 2 |  |  |
| 1017  | 9             | 78                |                              |      |      |      |      |      |      |      | 12   | 10   | 6    | 18   | 4    |      |   |  |  |
| 1018  | 9             | 78                |                              |      |      |      |      |      |      | 1    | 13   | 24   | 12   |      |      |      |   |  |  |
| 1019  | 10            | 78                |                              |      |      |      | 12   | 19   | 18   | 1    |      |      |      |      |      |      |   |  |  |
| 1020  | 10            | 78                |                              |      |      |      |      |      | 6    | 23   | 7    | 11   | 2    | 1    |      |      |   |  |  |
| Total |               |                   |                              |      | 3    | 17   | 53   | 138  | 230  | 202  | 124  | 100  | 65   | 31   | 16   | 8    |   |  |  |
| %     |               |                   |                              |      | .3   | 1.7  | 5.4  | 14.0 | 23.3 | 20.5 | 12.6 | 10.1 | 6.6  | 3.1  | 1.6  | 0.8  |   |  |  |
| Cum % |               |                   |                              |      | 0.3  | 2.0  | 7.4  | 21.4 | 44.7 | 65.1 | 77.7 | 87.8 | 94.4 | 97.6 | 99.2 | 100  |   |  |  |

Figures 28, 29, and 30 are typical spectra from the three data channels. In contrast to the Norway and Greece equipment, the notch filter was centered at 60 Hz, although no interference at this frequency is apparent. Interference at about 35-37 Hz was observed on all spectra. The signal energy visible on these figures at 72 Hz is the injected signal. The 60 Hz notch appears deeper and the sine waves slightly less prominent in Fig. 28 due to the higher clip level on this channel. The difference in clip levels is shown by typical waveforms, Figs. 31, 32, and 33. Energy around 7 Hz is apparent from the spectra and from the waveform shown by Fig. 31.

Effective noise levels from channel 2, proportional to  $dH/dt$ , are summarized by Figs. 34 and 35 and by Tables 6 and 7. In the high band less than one percent of the observations exceeded  $-137.5 \text{ dBH}_0$  and none exceeded  $-137 \text{ dBH}_0$ . In the low band less than two percent exceeded  $-139 \text{ dBH}_0$  and none exceeded  $-138 \text{ dBH}_0$ .

As seen from Table 6, May 4 (Tape 3007), May 7 (Tape 3013), and May 10 (Tape 3019) stand out as the noisiest days in the 72-78 Hz band. Figures 36, 37, and 38 show the effective noise level variations on those three days. In each case the peak is around 0700 - 1100 GMT, followed by a gradual decline, reaching a minimum around 0100 - 0500 GMT.

As shown by Table 7 the highest levels in the low frequency band were on May 11 and 12. Figures 39 to 42 show the four highest level days. The daily minima were typically around 0100 - 0500 GMT (like the high-frequency band). The maxima were not sharp and were not consistently at the same time.

TABLE 6  
EFFECTIVE NOISE LEVELS IN SAIPAN (500 OBSERVATIONS OVER 13-MINUTE INTERVALS)

| Tape  | Date (May) | Frequency (Hz) | Effective Noise Levels (dBH) |      |      |      |      |      |      |      |      |      |      |      |      |      |   |  |
|-------|------------|----------------|------------------------------|------|------|------|------|------|------|------|------|------|------|------|------|------|---|--|
|       |            |                | -136                         | -137 | -138 | -139 | -140 | -141 | -142 | -143 | -144 | -145 |      |      |      |      |   |  |
| 3001  | 1          | 76             |                              |      | 1    | 4    | 12   | 4    | 10   | 8    | 10   | 1    | 1    |      |      |      |   |  |
| 3002  | 1          | 76             |                              |      |      |      |      |      |      |      | 5    | 7    | 29   | 9    |      |      |   |  |
| 3003  | 2          | 76             |                              |      |      | 2    | 12   | 20   | 13   | 3    |      |      |      |      |      |      |   |  |
| 3004  | 2          | 76             |                              |      |      |      |      |      | 2    | 4    | 12   | 18   | 11   | 1    |      |      |   |  |
| 3005  | 3          | 72             |                              |      |      | 1    | 9    | 17   | 10   | 10   | 1    |      |      |      |      |      |   |  |
| 3006  | 3          | 72             |                              |      |      |      |      |      |      |      | 6    | 11   | 9    | 3    | 6    | 15   |   |  |
| 3007  | 4          | 72             |                              |      | 10   | 6    | 5    | 5    | 18   | 7    |      |      |      |      |      |      |   |  |
| 3008  | 4          | 72             |                              |      |      |      |      |      |      |      |      | 4    | 7    | 6    | 1    | 32   |   |  |
| 3009  | 5          | 78             |                              |      |      |      |      | 2    | 7    | 9    | 9    | 18   | 6    |      |      |      |   |  |
| 3010  | 5          | 78             |                              |      |      |      |      |      |      |      |      | 7    | 18   | 18   | 9    |      |   |  |
| 3011  | 6          | 78             |                              |      |      |      | 2    | 2    | 12   | 23   | 8    | 3    |      |      |      |      |   |  |
| 3012  | 6          | 78             |                              |      |      |      |      |      | 4    | 10   | 5    | 8    | 3    | 2    | 2    | 16   |   |  |
| 3013  | 7          | 72             |                              |      |      | 1    | 9    | 16   | 15   | 2    | 4    | 1    |      |      |      |      |   |  |
| 3014  | 7          | 72             |                              |      |      |      |      |      |      | 11   | 7    | 11   | 6    | 8    | 5    | 2    |   |  |
| 3015  | 8          | 72             |                              |      |      |      |      |      | 6    | 21   | 17   | 6    |      |      |      |      |   |  |
| 3016  | 8          | 72             |                              |      |      |      |      |      |      |      |      | 2    | 11   | 6    | 13   | 8    | 9 |  |
| 3017  | 9          | 78             |                              |      |      |      |      |      | 2    | 11   | 10   | 12   | 13   | 2    |      |      |   |  |
| 3018  | 9          | 78             |                              |      |      |      |      |      |      |      | 7    | 17   | 21   | 4    |      |      |   |  |
| 3019  | 10         | 78             |                              |      | 2    | 9    | 8    | 11   | 15   | 5    |      |      |      |      |      |      |   |  |
| 3020  | 10         | 78             |                              |      |      |      |      |      |      | 7    | 18   | 15   | 5    | 7    |      |      |   |  |
| Total |            |                |                              |      | 14   | 31   | 64   | 84   | 125  | 128  | 109  | 144  | 124  | 71   | 31   | 75   |   |  |
| %     |            |                |                              |      | 1.4  | 3.1  | 6.4  | 8.4  | 12.5 | 12.8 | 10.9 | 14.4 | 12.4 | 7.1  | 3.1  | 7.5  |   |  |
| Cum % |            |                |                              |      | 1.4  | 4.5  | 10.9 | 19.3 | 31.8 | 44.6 | 55.5 | 69.9 | 82.3 | 89.4 | 92.5 | 100. |   |  |

TABLE 7

EFFECTIVE NOISE LEVELS IN SAIPAN (500 OBSERVATIONS OVER 13-MINUTE INTERVALS)

Effective Noise Levels (dBH)

| Tape  | Date (May) | Frequency (Hz) | -137 | -138 | -139 | -140 | -141 | -142 | -143 | -144 | -145 | -146 | -147 | -148 | -149 |
|-------|------------|----------------|------|------|------|------|------|------|------|------|------|------|------|------|------|
| 3021  | 11         | 46             |      | 4    | 27   | 18   | 1    |      |      |      |      |      |      |      |      |
| 3022  | 11         | 46             |      |      | 2    | 5    | 14   | 7    | 10   | 9    | 3    |      |      |      |      |
| 3023  | 12         | 42             |      | 4    | 8    | 14   | 16   | 2    | 6    |      |      |      |      |      |      |
| 3024  | 12         | 42             |      |      |      | 2    | 9    | 15   | 10   | 11   | 3    |      |      |      |      |
| 3025  | 13         | 48             |      |      | 5    | 19   | 19   | 6    | 1    |      |      |      |      |      |      |
| 3026  | 13         | 48             |      |      |      | 6    | 12   | 10   | 5    | 12   | 5    |      |      |      |      |
| 3027  | 14         | 42             |      |      | 8    | 17   | 16   | 3    | 6    |      |      |      |      |      |      |
| 3028  | 14         | 42             |      |      |      | 2    | 20   | 19   | 9    |      |      |      |      |      |      |
| 3029  | 15         | 48             |      |      |      | 3    | 19   | 23   | 5    |      |      |      |      |      |      |
| 3030  | 15         | 48             |      |      | 1    | 19   | 15   | 14   | 1    |      |      |      |      |      |      |
| Total |            |                |      | 8    | 51   | 105  | 141  | 99   | 53   | 32   | 11   |      |      |      |      |
| %     |            |                |      | 1.6  | 10.2 | 21.  | 28.2 | 19.8 | 10.6 | 6.4  | 2.2  |      |      |      |      |
| cum % |            |                |      | 1.6  | 11.8 | 32.8 | 6.1  | 80.8 | 91.4 | 97.8 | 100  |      |      |      |      |

Greece: May 1972

Like the Norway data, the data in the low frequency band from Greece was corrupted by interference and the effects of the 50 Hz notch. Typical spectra (Fig. 43) showed interference around 30, 35, and 100 Hz. Power line interference was apparent in the 50 Hz notch.

To determine the effects of sinusoidal interference, experiments with different integration times were done. Effective noise levels attributed to random noise are not a function of integration time due to the normalization to a 1 Hz bandwidth. The effect of nearby sine wave interference, however, is a function of the match filter spectral window and hence the integration time. The effect of interference is shown by Fig. 44 which shows that 2 dB lower effective noise levels were obtained by lengthening the integration time and hence reducing the matched filter bandwidth.

Analysis of the higher frequency data from Greece was less affected by the interference and notch filtering. Results are summarized in Fig. 45, which shows about one percent of the observations exceeding  $-135 \text{ dBH}_0$ . Table 8 shows that most of the higher levels were concentrated on three tapes recorded on May 3, 7, and 10, which are also shown by Figs. 46, 47, and 48. As in Saipan, diurnal variations of 10 dB or more are apparent with peaks around 1300 - 1700 GMT and minima around 0300 - 0600 GMT.

TABLE 8

EFFECTIVE NOISE LEVELS IN GREECE (979 OBSERVATIONS OVER 13-MINUTE INTERVALS)

Effective Noise Levels (dBH)

| Date<br>Tape (May) | Frequency<br>(Hz) | -134 | -135 | -136 | -137 | -138 | -139 | -140 | -141  | -142  | -143  | -144  | -145 | -146 | -147 | -148 | -149 |
|--------------------|-------------------|------|------|------|------|------|------|------|-------|-------|-------|-------|------|------|------|------|------|
| 2001 1             | 76                |      |      |      |      |      | 3    | 15   | 16    | 11    | 5     |       |      |      |      |      |      |
| 2002 1             | 76                |      |      |      |      |      |      |      |       |       | 11    | 25    | 12   | 2    |      |      |      |
| 2003 2             | 76                |      |      |      | 10   |      | 9    | 10   | 3     | 1     | 3     | 3     | 7    | 4    |      |      |      |
| 2004 2             | 76                |      |      |      |      |      | 1    | 1    | 10    | 23    | 11    | 6     |      |      |      |      |      |
| 2005 3             | 72                |      | 7    |      | 7    |      | 3    | 2    | 2     | 7     | 6     |       |      |      |      |      |      |
| 2006 3             | 72                |      |      |      |      |      | 1    | 4    | 17    | 7     | 3     | 5     | 13   |      |      |      |      |
| 2007 4             | 72                |      |      |      |      | 5    | 6    | 6    | 11    | 2     | 8     | 8     | 3    |      |      |      |      |
| 2008 4             | 72                |      |      |      |      |      | 1    | 10   | 15    | 8     | 0     | 5     | 1    | 6    | 3    | 1    |      |
| 2009 5             | 78                |      |      |      |      |      | 3    | 6    | 8     | 4     | 1     | 4     | 6    | 6    | 9    | 2    |      |
| 2010 5             | 78                |      |      |      |      |      |      |      | 1     | 1     | 0     | 1     | 6    | 20   | 2    | 4    | 15   |
| 2011 6             | 78                |      |      |      | 5    |      | 4    | 2    | 4     | 1     | 3     | 1     | 3    | 5    | 10   | 5    |      |
| 2012 6             | 78                |      |      |      |      |      |      |      | 2     | 11    | 13    | 6     | 4    | 12   | 2    |      |      |
| 2013 7             | 72                |      | 3    | 9    | 7    | 7    | 2    | 3    | 3     | 3     | 3     | 4     | 7    |      |      |      |      |
| 2014 7             | 72                |      |      |      |      |      |      |      | 2     | 3     | 21    | 8     | 1    | 1    | 3    | 8    | 3    |
| 2015 8             | 72                |      |      |      | 3    | 7    | 6    | 3    | 4     | 2     | 4     | 2     | 1    | 1    | 10   | 5    |      |
| 2016 8             | 72                |      |      |      |      |      |      |      | 9     | 9     | 5     | 9     | 5    | 13   | 7    | 1    |      |
| 2017 9             | 78                |      |      |      |      |      | 1    | 8    | 9     | 6     | 2     | 2     | 3    | 3    | 11   | 5    |      |
| 2018 9             | 78                |      |      |      |      |      |      | 1    | 4     | 7     | 12    | 5     |      |      |      |      |      |
| 2019 10            | 78                |      | 1    | 7    | 10   | 2    | 6    | 2    | 4     | 3     | 3     | 9     | 3    |      |      |      |      |
| 2020 10            | 78                |      |      |      |      |      |      |      | 1     | 5     | 11    | 17    | 0    | 7    | 8    |      |      |
| Total              |                   | 11   | 23   | 32   | 48   | 44   | 44   | 64   | 111   | 121   | 133   | 115   | 79   | 75   | 68   | 36   | 19   |
| %                  |                   | 1.12 | 2.35 | 3.27 | 4.90 | 4.49 | 4.49 | 6.54 | 11.34 | 12.36 | 13.57 | 11.75 | 8.09 | 7.66 | 6.94 | 3.68 | 1.94 |
| cum %              |                   | 1.1  | 3.5  | 6.7  | 11.6 | 16.1 | 22.7 | 34.0 | 46.4  | 60.0  | 71.7  | 79.8  | 87.5 | 94.4 | 98.1 | 100  |      |

## ACKNOWLEDGMENT

Principal contributors to the work reported here, in addition to the author, were Dale McNeill who provided much of the software, Ogden Nackoney who developed the hardware, and Mark Saklad who did much of the programming.

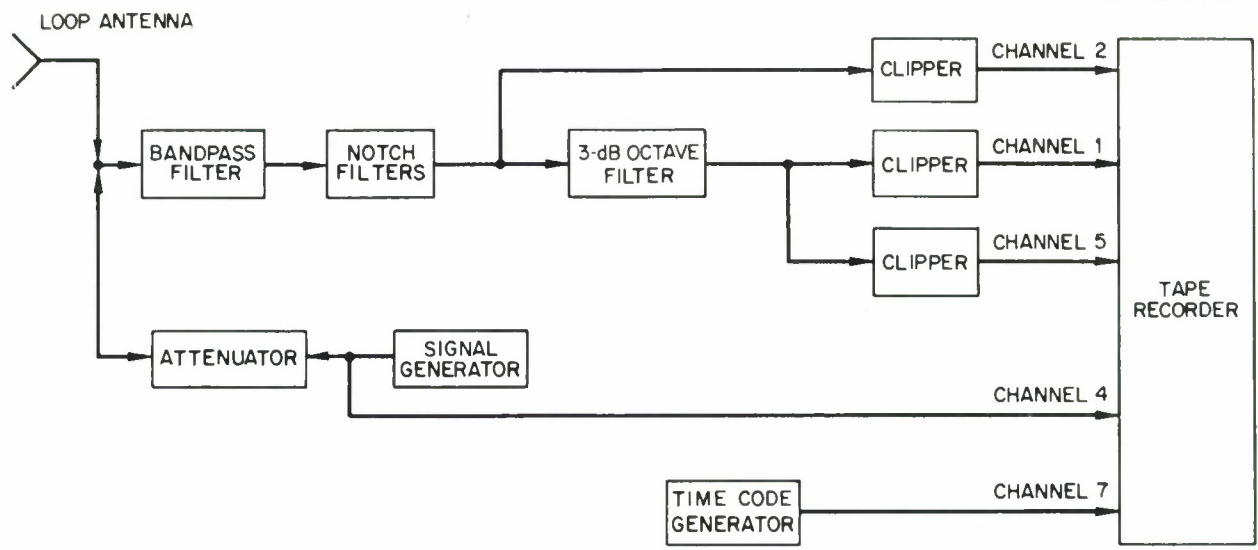

Fig. 1. Simplified block diagram of recording equipment.

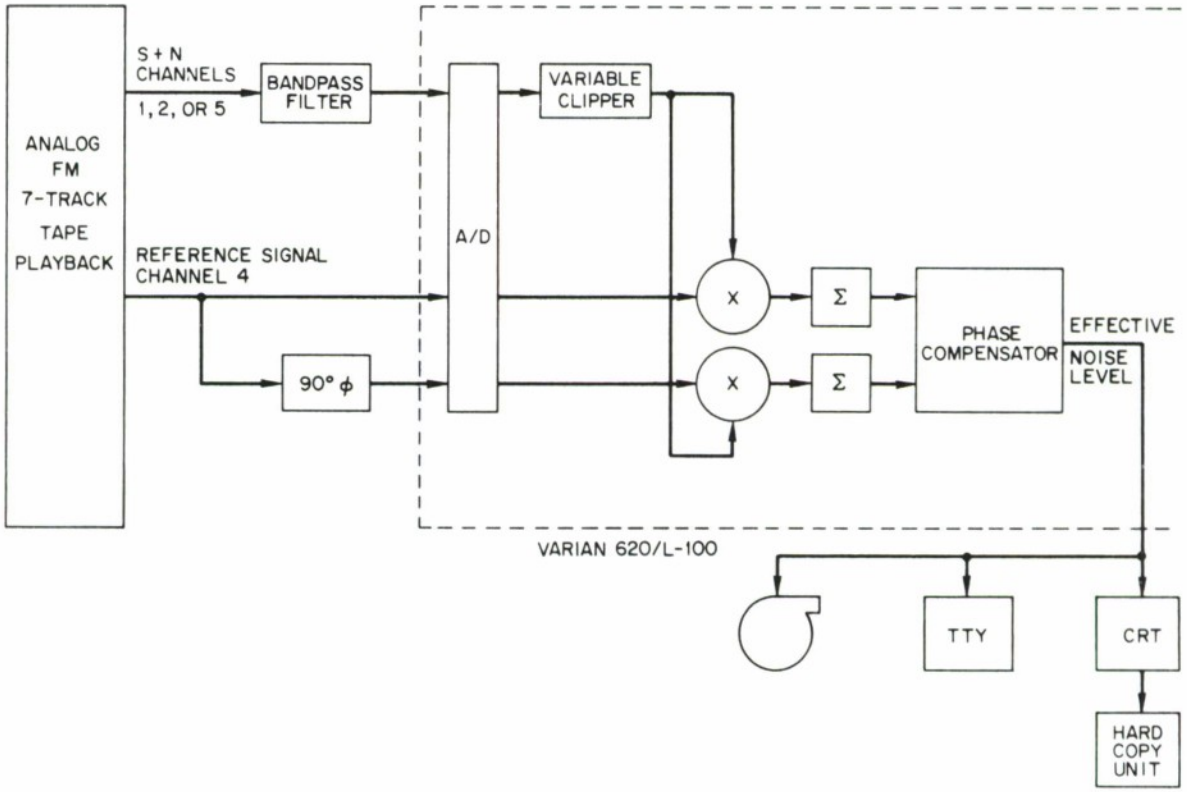

Fig. 2. Simplified block diagram of noise processor.

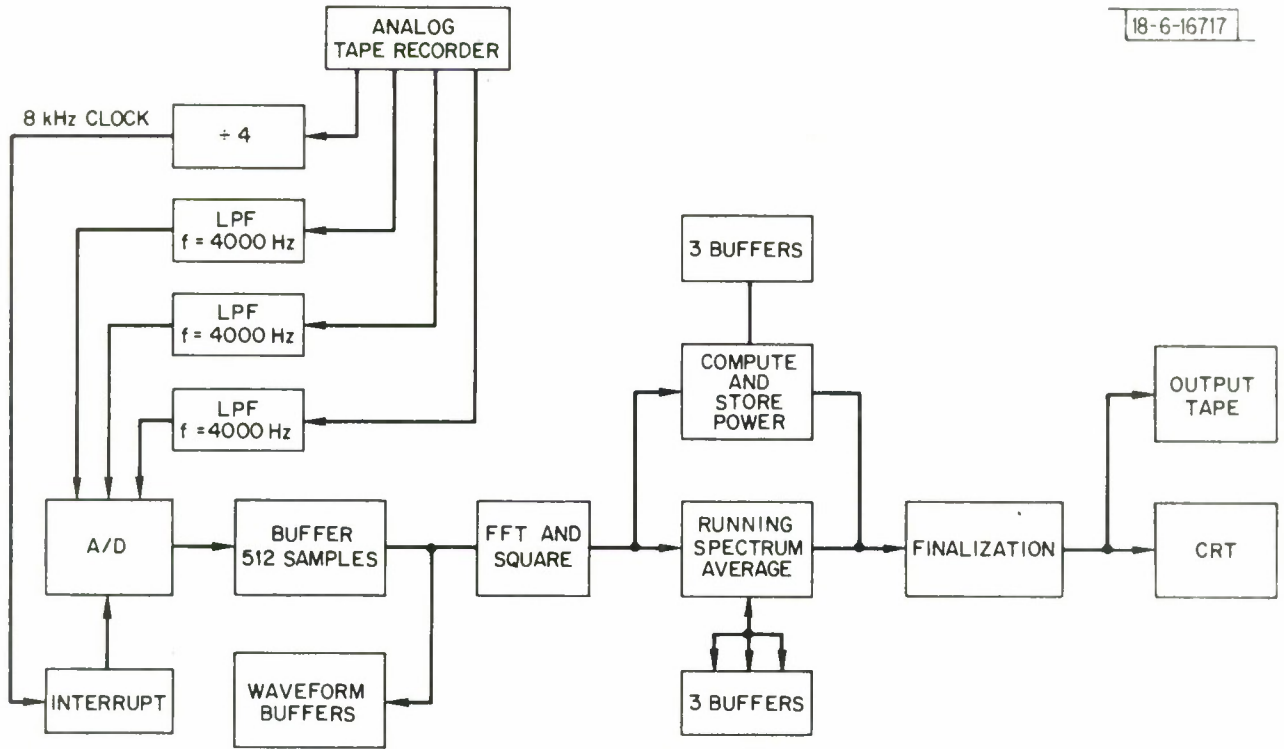

Fig. 3. Simplified flow chart of spectral analysis.

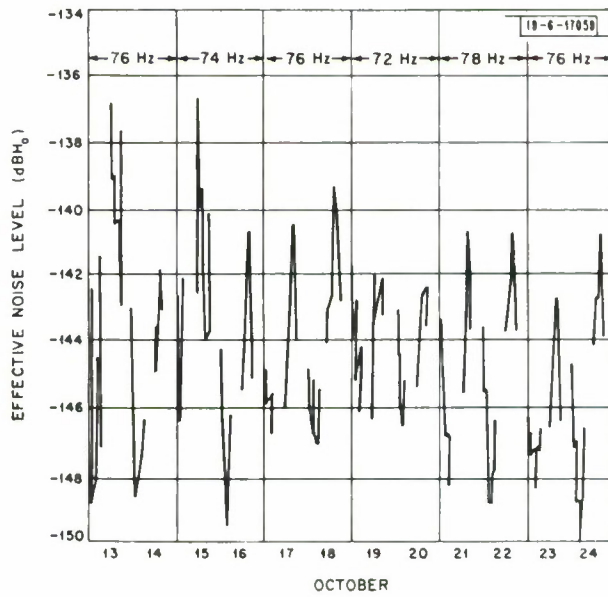

Fig. 4. Effective noise levels at 72-78 Hz recorded in Norway, October 13-24, 1971.

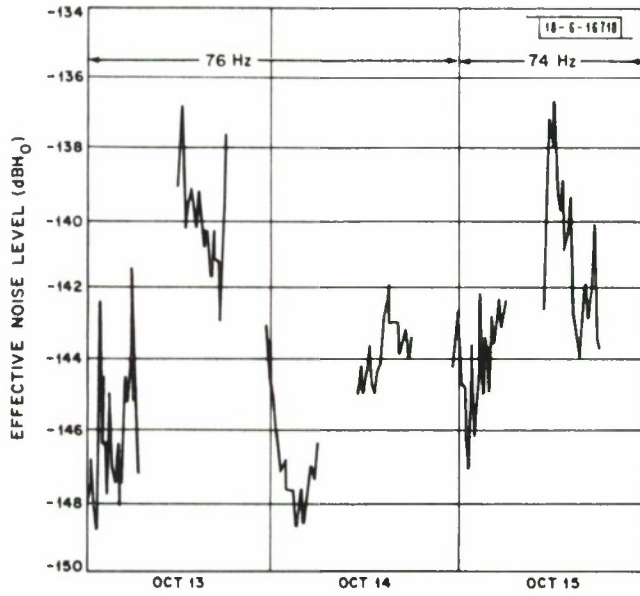

Fig. 5. Effective noise levels from Norway, October 13-15, 1971.

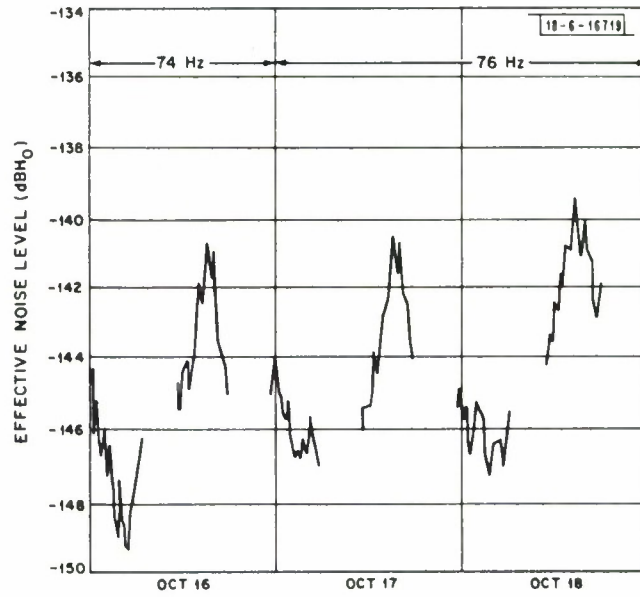

Fig. 6. Effective noise levels from Norway, October 16-18, 1971.

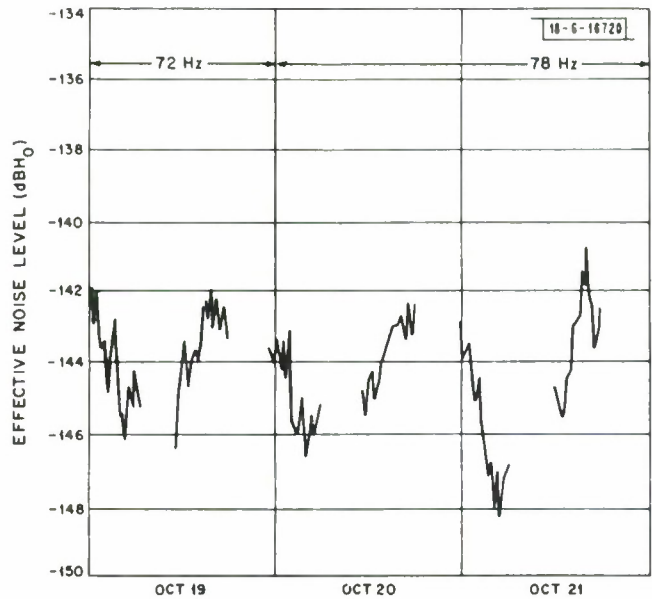

Fig. 7. Effective noise levels from Norway, October 19-21, 1961.

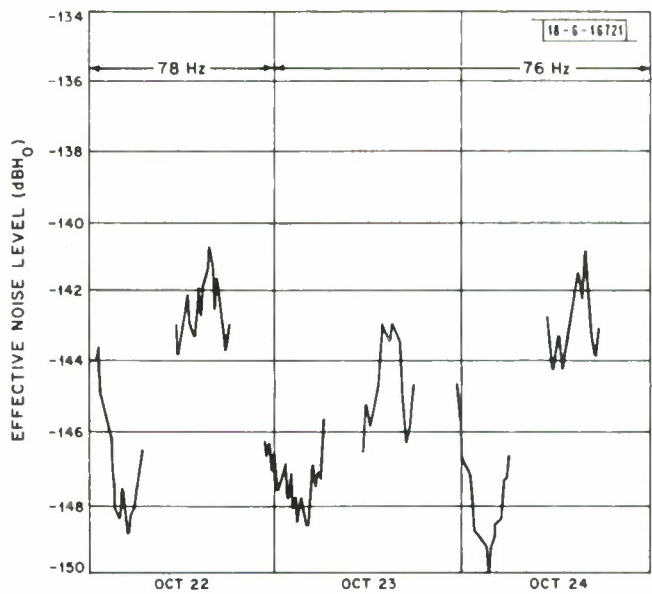

Fig. 8. Effective noise levels from Norway, October 22-24, 1971.

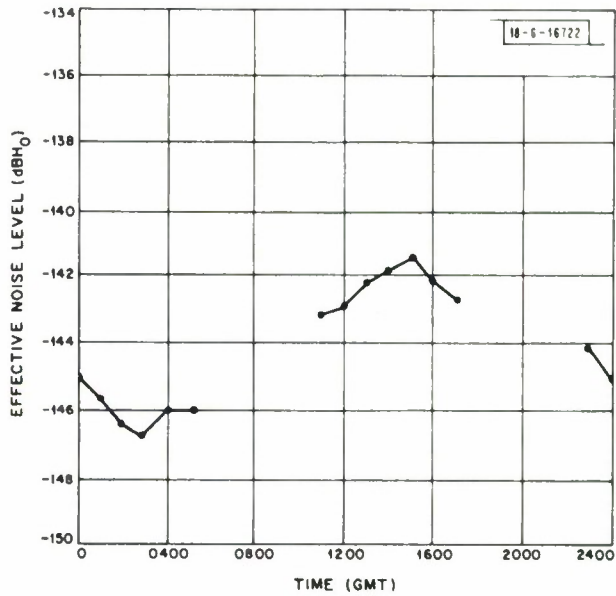

Fig. 9. Average diurnal variation in effective noise level recorded in Norway, Fall 1971, 72-78 Hz.

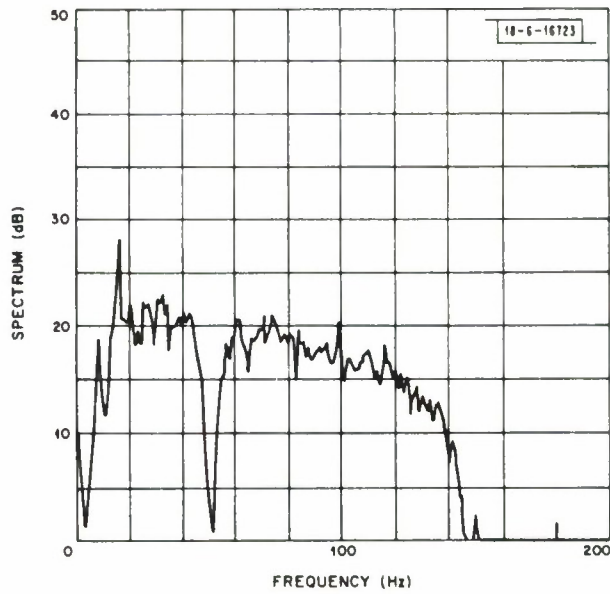

Fig. 10. ELF spectrum recorded in Norway, 1200-1220 GMT, October 15, 1971.

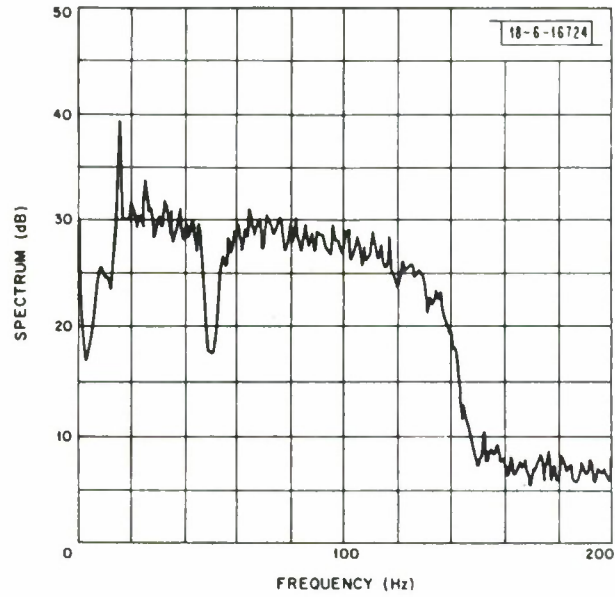

Fig. 11. ELF spectrum recorded in Norway, 1600-1620 GMT, October 15, 1971.

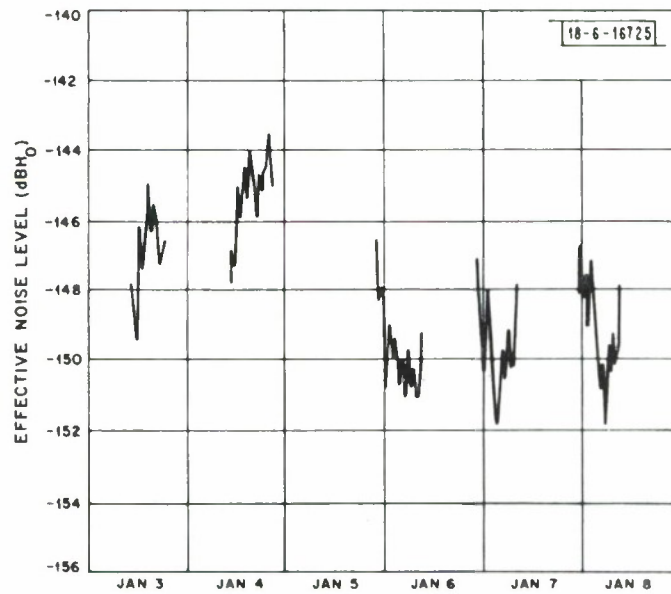

Fig. 12. Effective noise levels at 76 Hz recorded in Norway January 2, 1972.

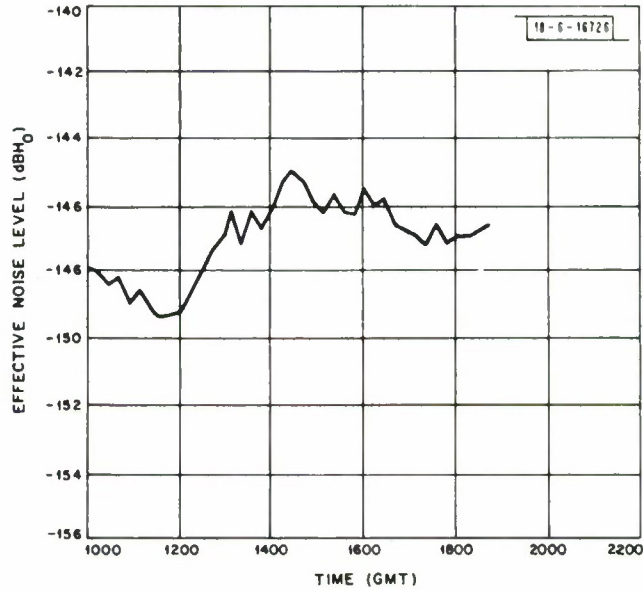

Fig. 13. Effective noise levels at 76 Hz recorded in Norway, January 3, 1972.

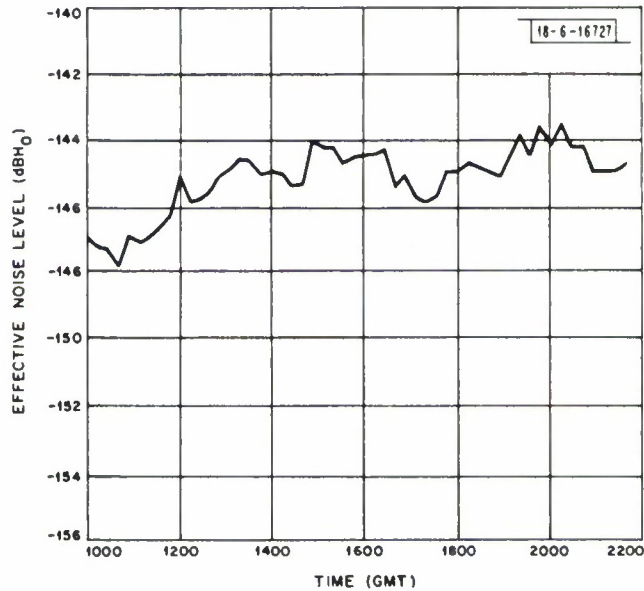

Fig. 14. Effective noise levels at 76 Hz recorded in Norway, January 4, 1972.

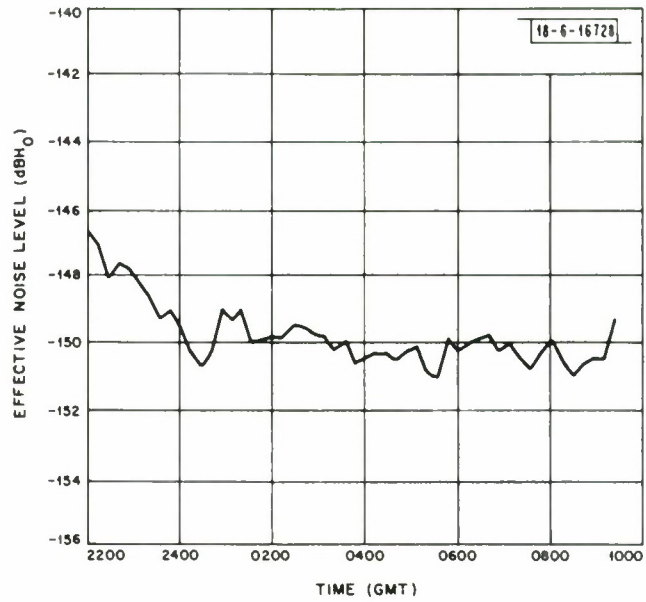

Fig. 15. Effective noise levels at 76 Hz recorded in Norway, January 5-6, 1972.

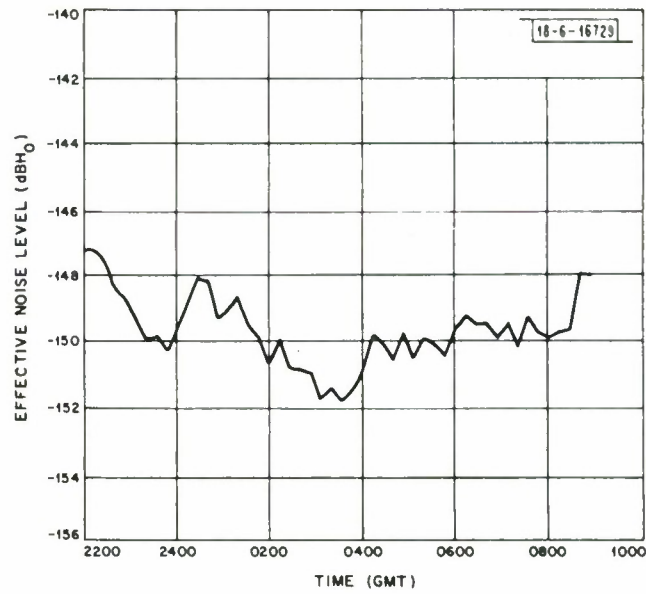

Fig. 16. Effective noise levels at 76 Hz recorded in Norway, January 6-7, 1972.

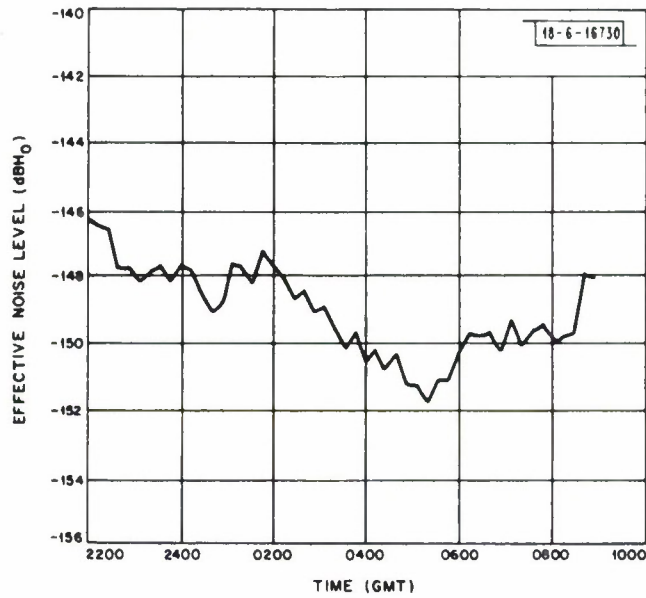

Fig. 17. Effective noise levels at 76 Hz recorded in Norway, January 7-8, 1972.

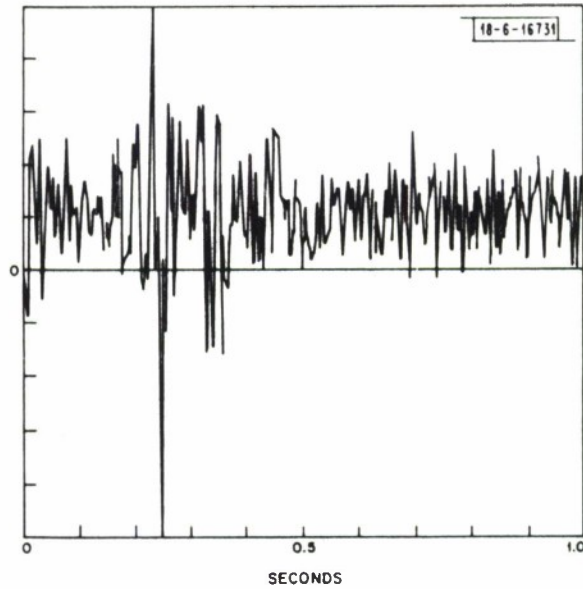

Fig. 18. Typical waveform from "soft" limiter channel, Norway, January 1972.

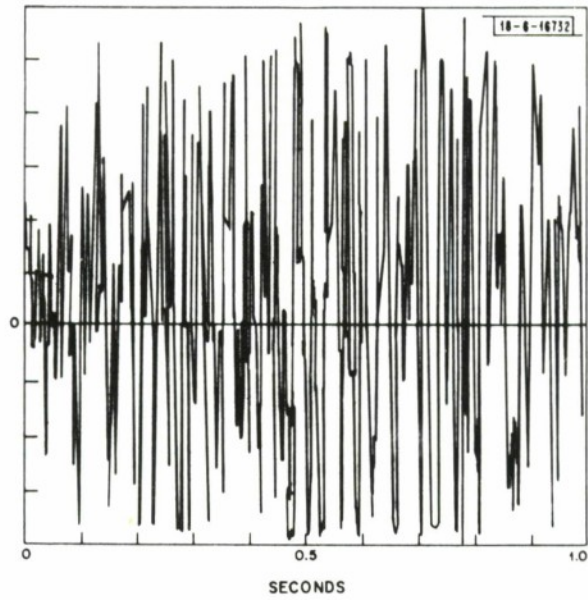

Fig. 19. Typical waveform, from "hard" limiter channel, Norway, January 1972.

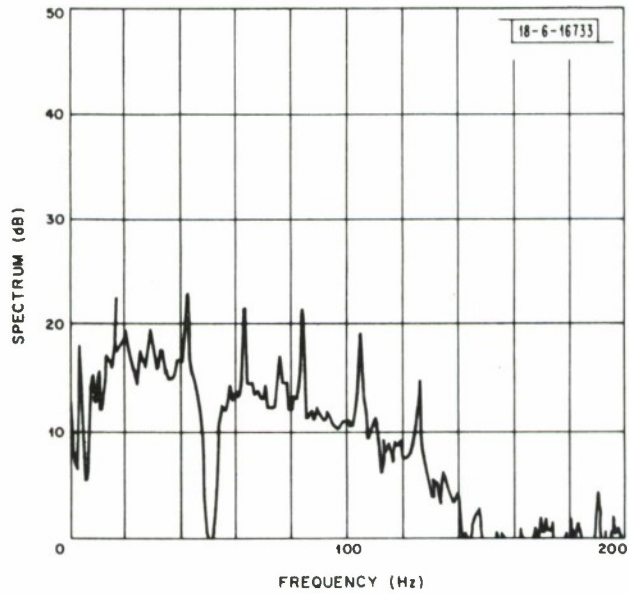

Fig. 20. ELF spectrum recorded in Norway, 1100-1120 GMT, January 4, 1972.

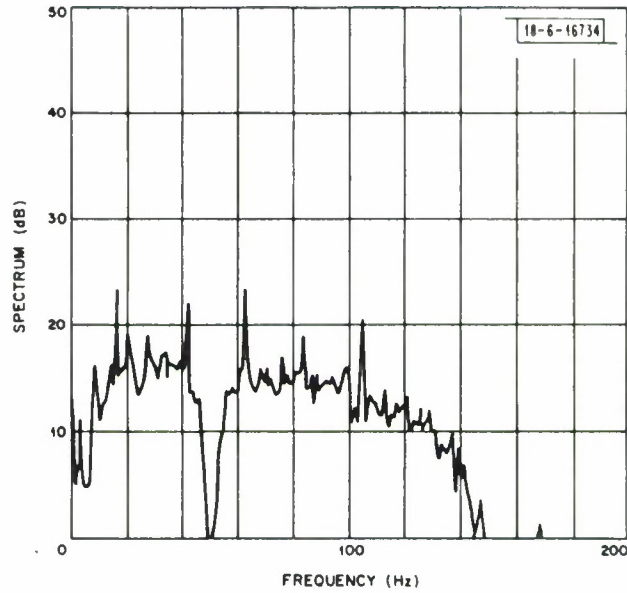

Fig. 21. ELF spectrum recorded in Norway, 1900-1920 GMT, January 4, 1972.

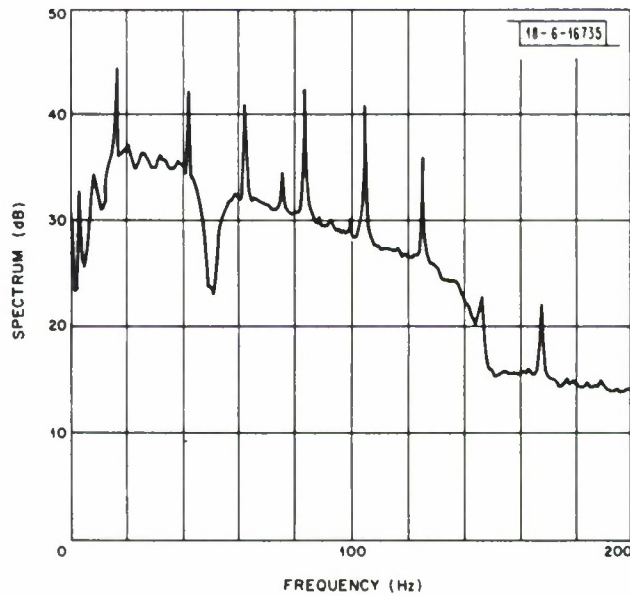

Fig. 22. ELF spectrum from "hard" limiter channel recorded in Norway, 1000-1800 GMT, January 4, 1972.

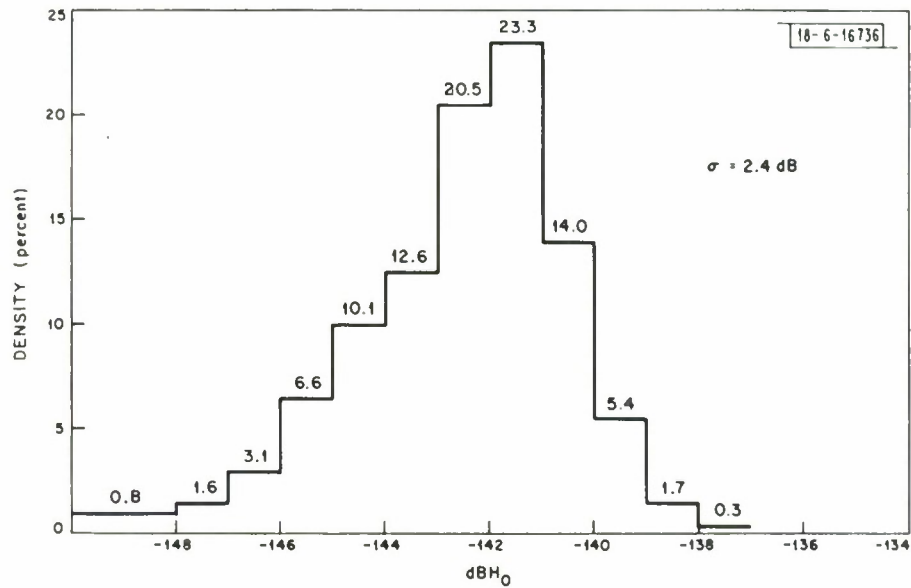

Fig. 23. Distribution of effective noise levels for Norway data in the 72-76 Hz band (10 days in May 1972).

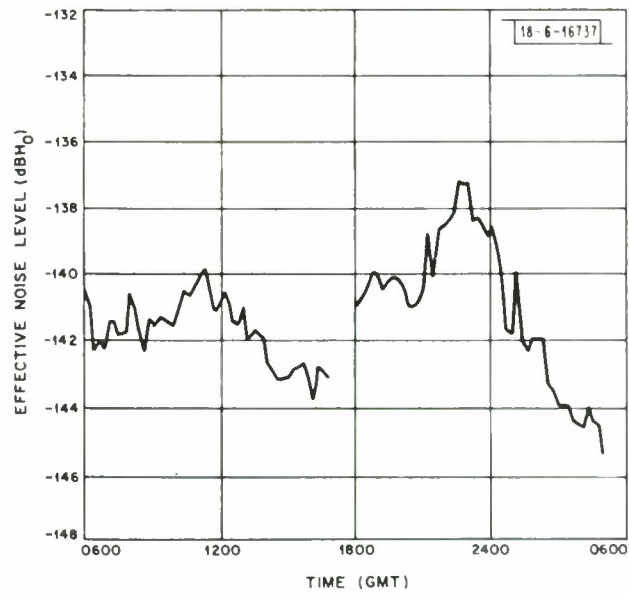

Fig. 24. Effective noise levels at 76 Hz recorded in Norway, May 2-3, 1972 (tapes 1003-1004).

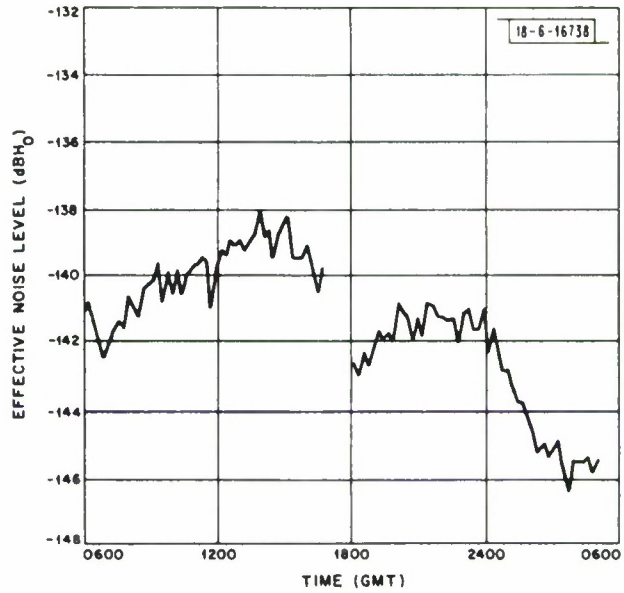

Fig. 25. Effective noise levels at 72 Hz recorded in Norway, May 7-8, 1972 (tapes 1013-1014).

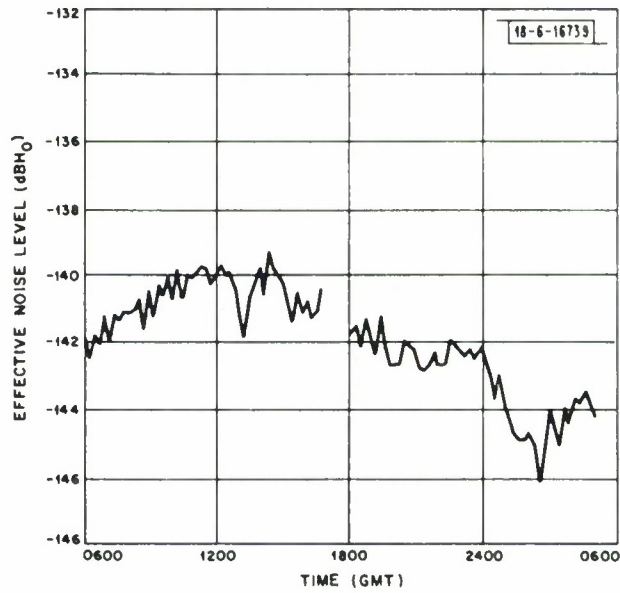

Fig. 26. Effective noise levels at 78 Hz recorded in Norway, May 10-11, 1972 (tapes 1019-1020).

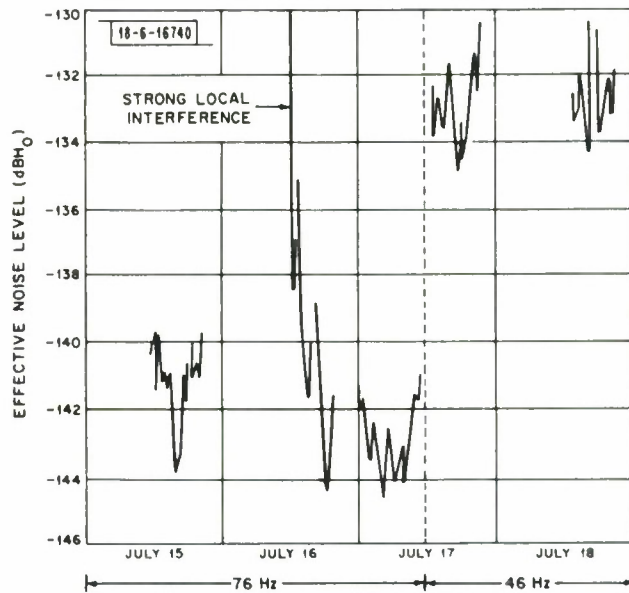

Fig. 27. Effective noise levels recorded in Norway, July 1973.

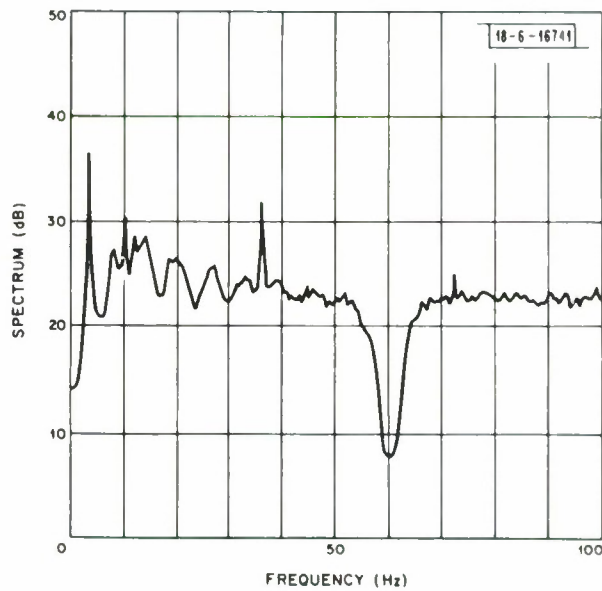

Fig. 28. ELF spectrum recorded in Saipan, 0600-0900 GMT, May 3, 1972 (tape 3005, channel 1, 3 dB/octave, soft limiter).

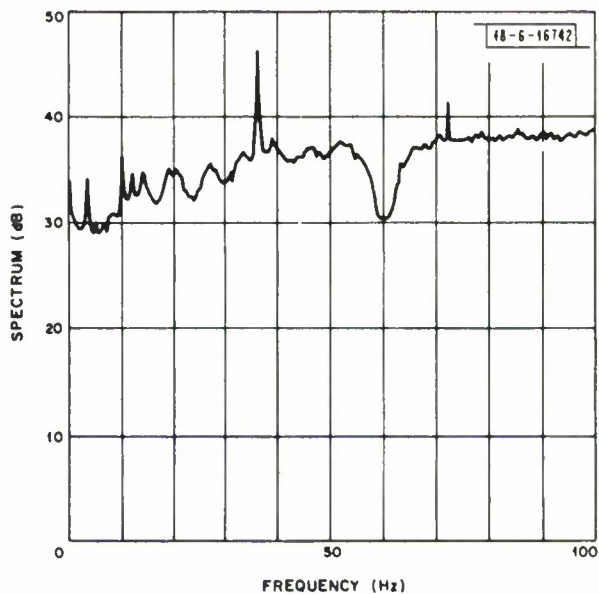

Fig. 29. ELF spectrum recorded in Saipan, 0600-0900 GMT, May 3, 1972 (tape 3005, channel 2, dH/dt, hard limiter).

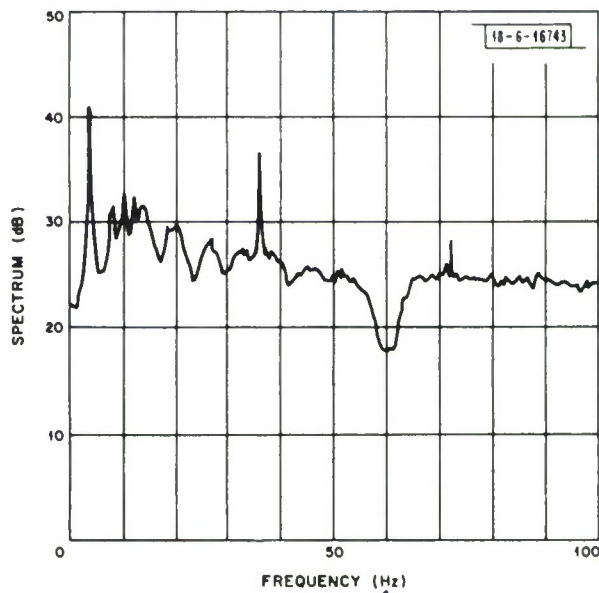

Fig. 30. ELF spectrum recorded in Saipan, 0600-0900 GMT, May 3, 1972 (tape 3005, channel 5, 3 dB/octave, hard limiter).

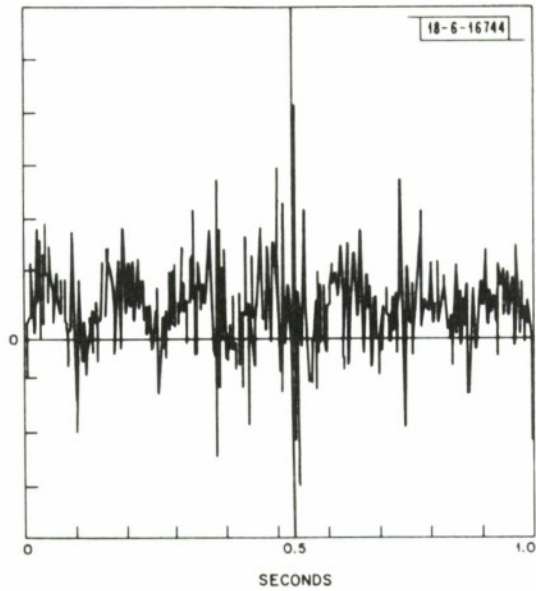

Fig. 31. Typical waveform recorded in Saipan, May 3, 1972 (tape 3005, channel 1, 3 dB/octave, soft limiter).

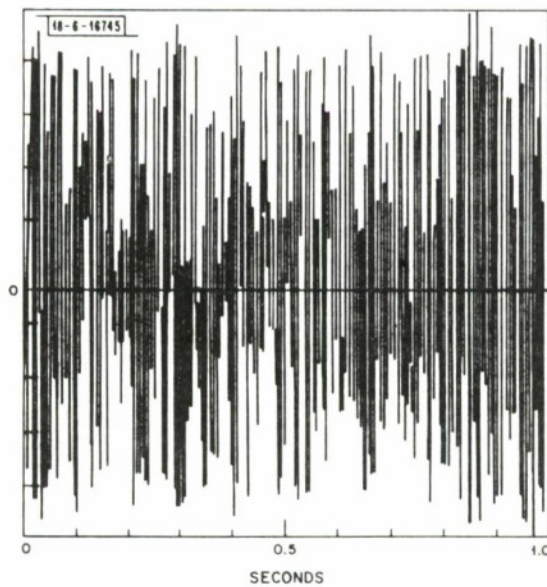

Fig. 32. Typical waveform recorded in Saipan, May 3, 1972 (tape 3005, channel 2, dH/dt, hard limiter).

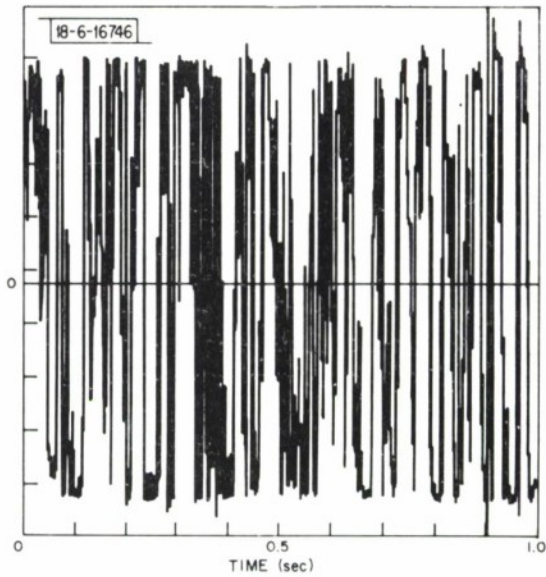

Fig. 33. Typical waveform recorded in Saipan, May 3, 1972 (tape 3005, channel 5, 3 dB/octave, hard limiter).

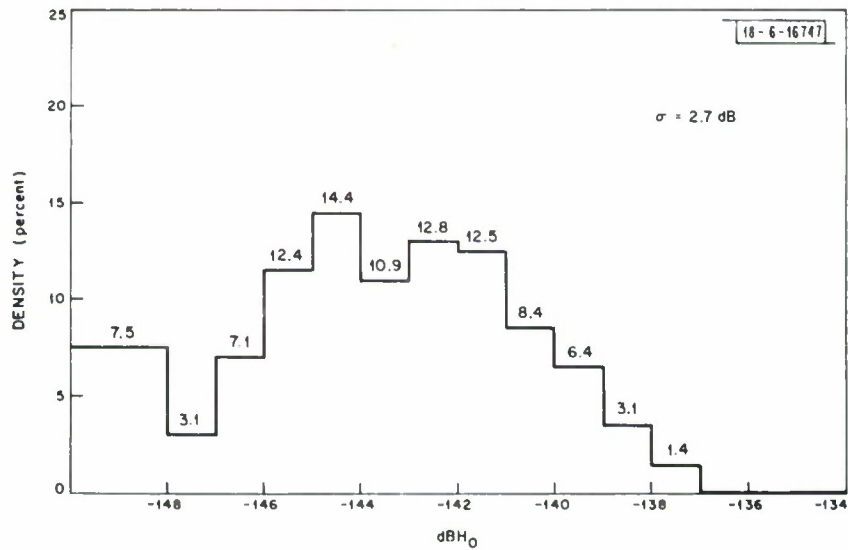

Fig. 34. Distribution of effective noise levels for Saipan data in the 72-76 Hz band (10 days in May 1972).

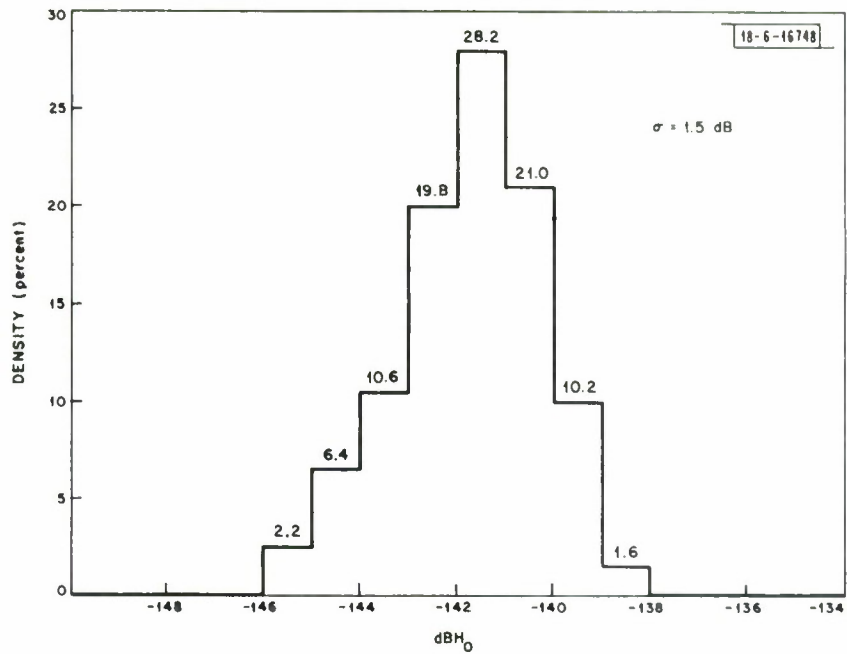

Fig. 35. Distribution of effective noise levels for Saipan data in the 42-48 Hz band (5 days in May 1972).

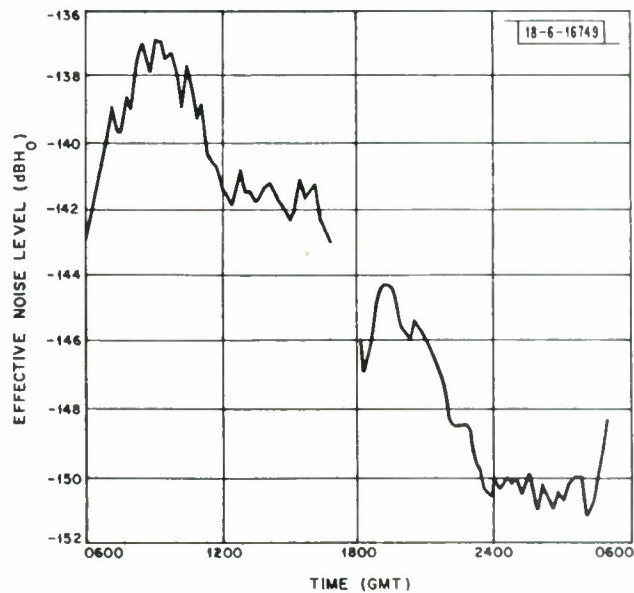

Fig. 36. Effective noise levels at 72 Hz recorded in Saipan, May 4-5, 1972 (tapes 3007-3008).

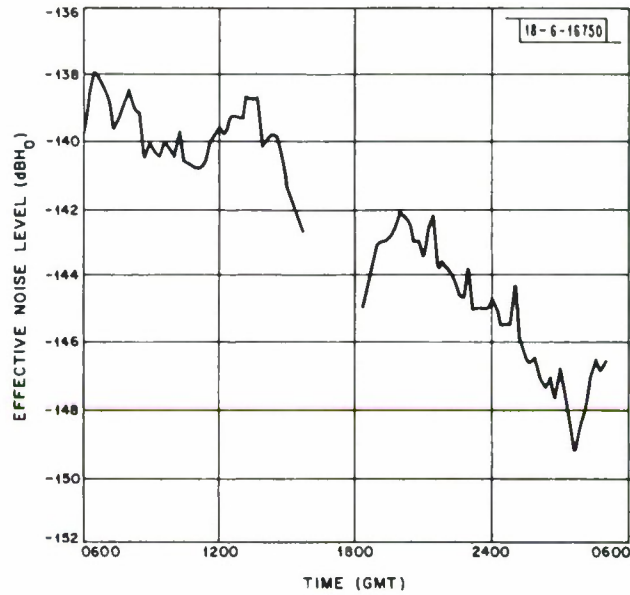

Fig. 37. Effective noise levels at 72 Hz recorded in Saipan, May 7-8, 1972 (tapes 3013-3014).

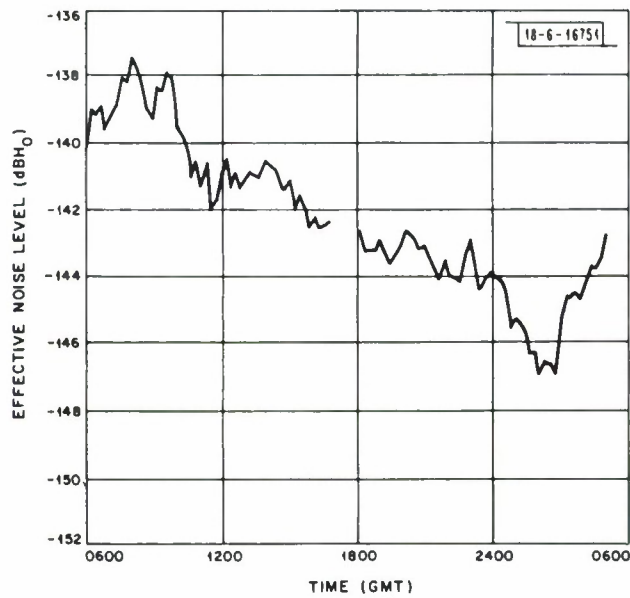

Fig. 38. Effective noise levels at 78 Hz recorded in Saipan, May 10-11, 1972 (tapes 3019-3020).

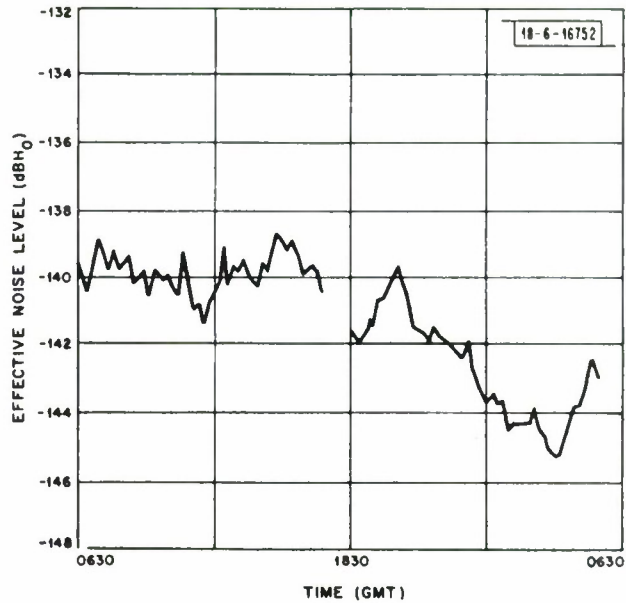

Fig. 39. Effective noise levels at 46 Hz recorded in Saipan, May 11-12, 1972 (tapes 3021-3022).

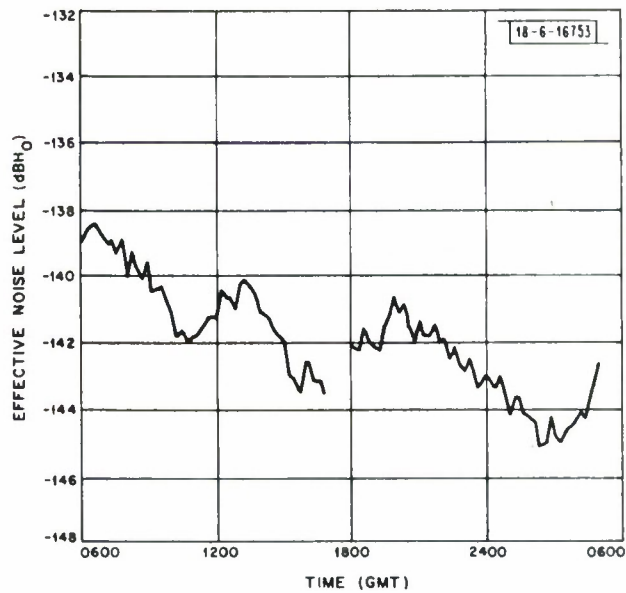

Fig. 40. Effective noise levels at 42 Hz recorded in Saipan, May 12-13, 1972 (tapes 3023-3024).

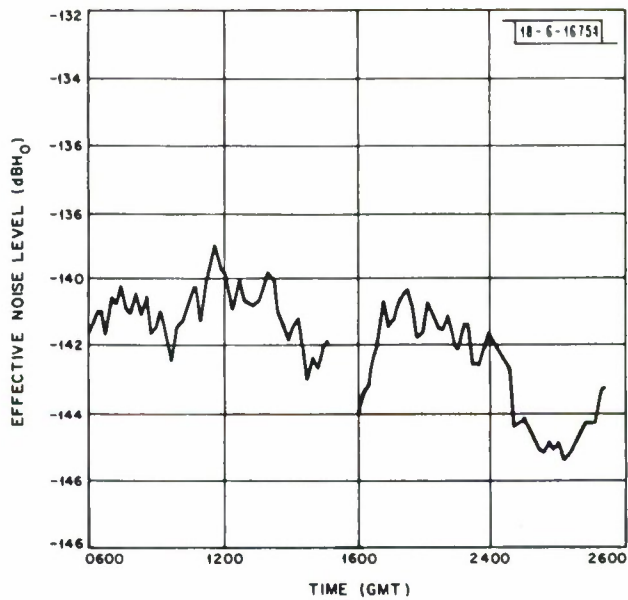

Fig. 41. Effective noise levels at 48 Hz recorded in Saipan, May 13-14, 1972 (tapes 3025-3026).

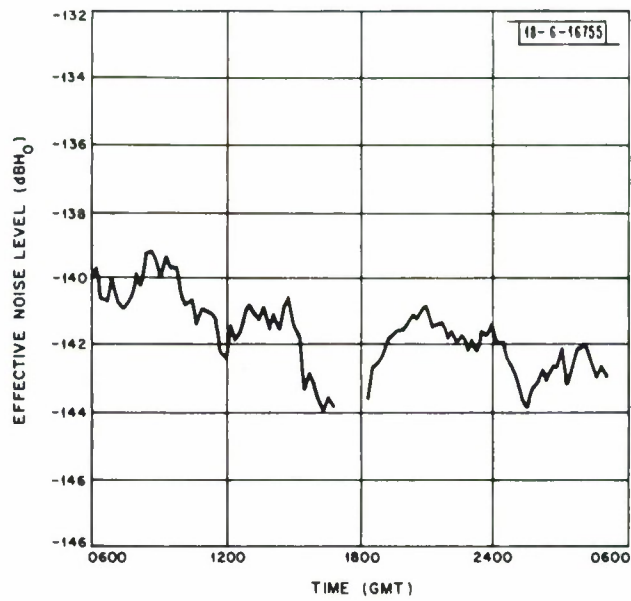

Fig. 42. Effective noise levels at 42 Hz recorded in Saipan, May 14-15, 1972 (tapes 3027-3028).

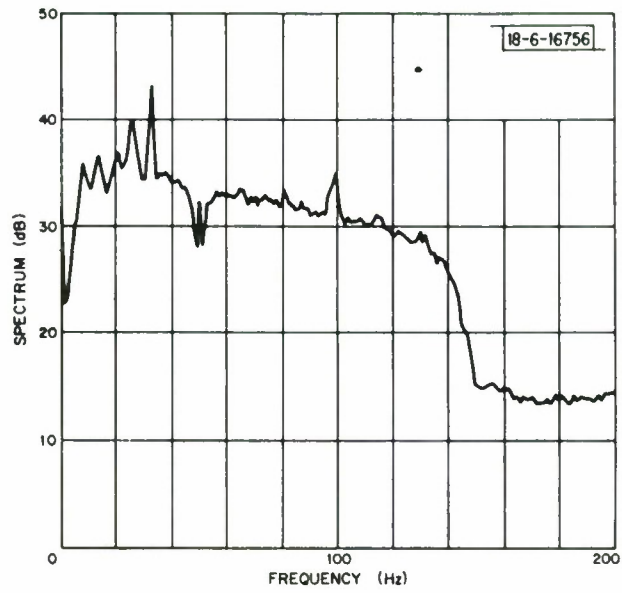

Fig. 43. ELF spectrum recorded in Greece, May 3, 1972 (tape 2025).

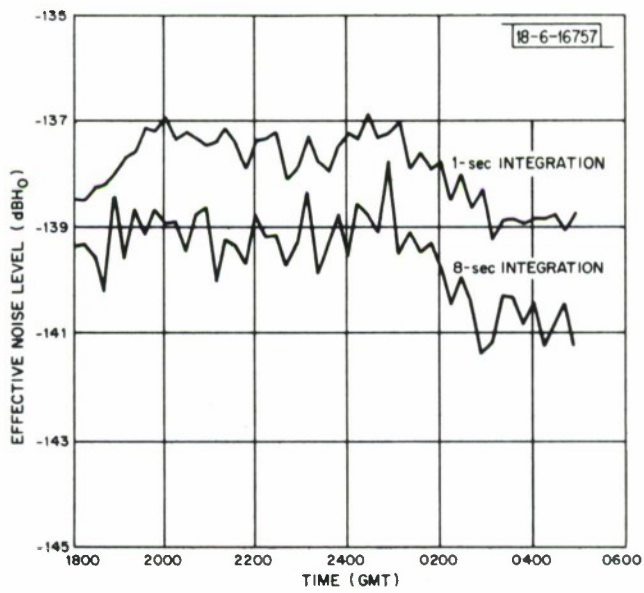

Fig. 44. Effective noise levels at 42 Hz recorded in Greece, May 15, 1972 (tape 2028).

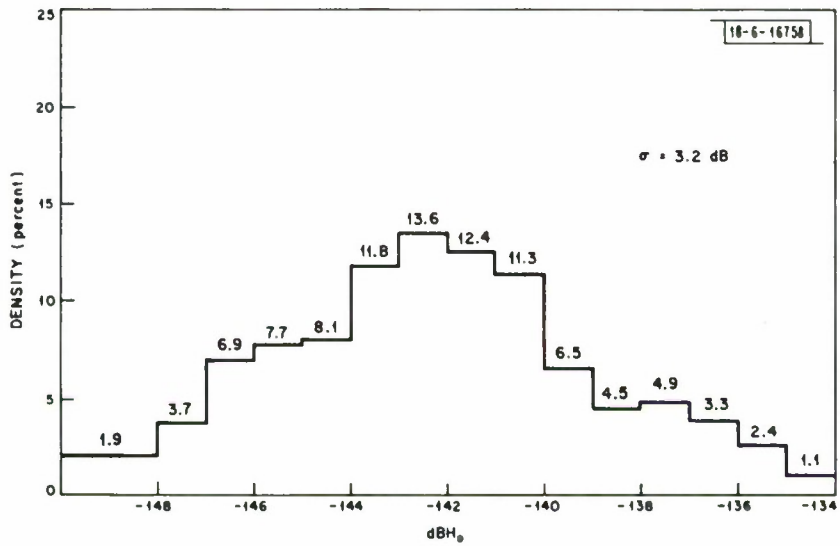

Fig. 45. Distribution of effective noise levels for Greece data in the 72-76 Hz band (10 days in May 1972).

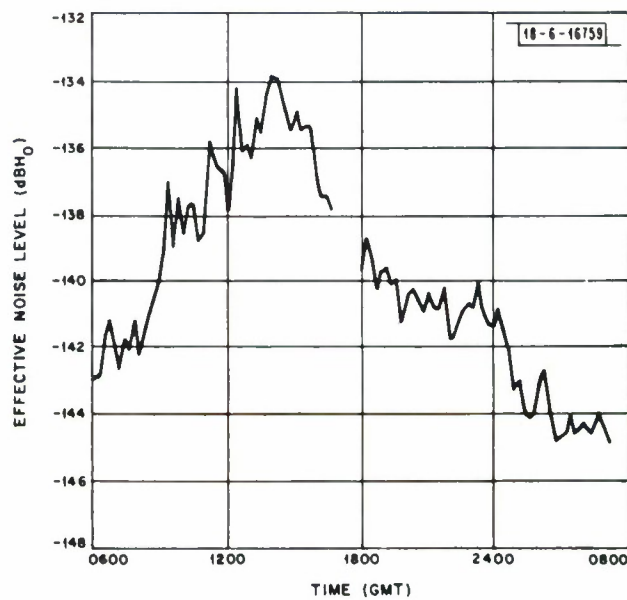

Fig. 46. Effective noise levels at 72 Hz recorded in Greece, May 3-4, 1872 (tapes 2005-2006).

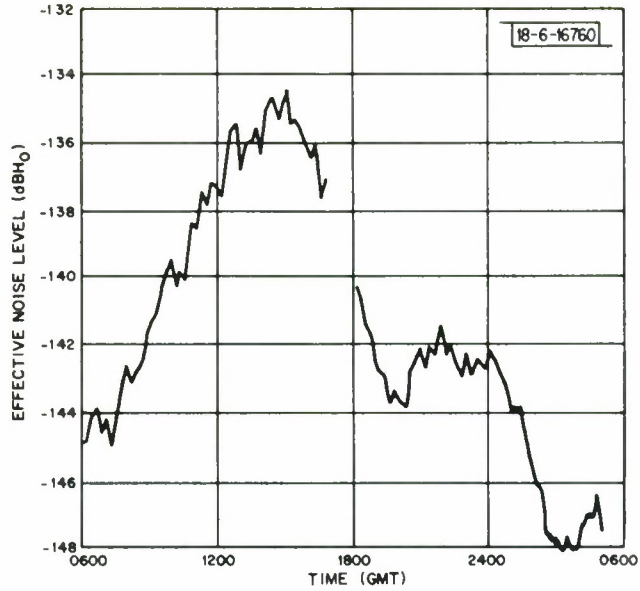

Fig. 47. Effective noise levels at 72 Hz recorded in Greece, May 7-8, 1972 (tapes 2013-2014).

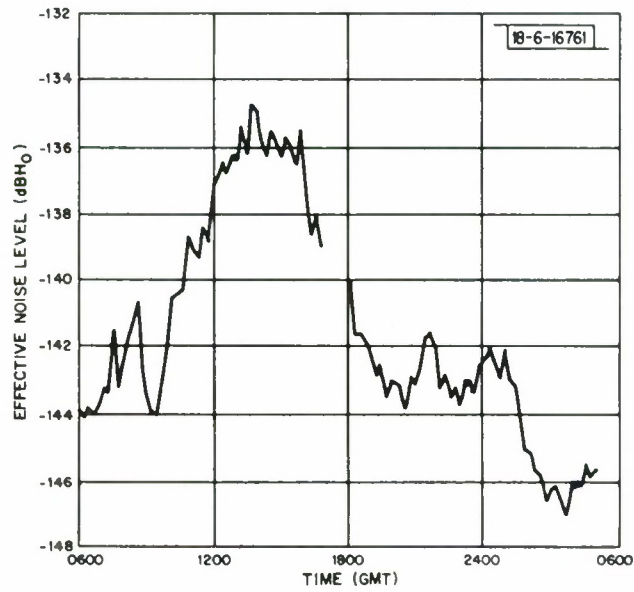

Fig. 48. Effective noise levels at 72 Hz recorded in Greece, May 10-11, 1972 (tapes 2019-2020).

## REFERENCES

1. A. L. Bernstein et al., "Long Range Communications at Extremely Low Frequencies," Proc. IEEE 62, 292-312 (March 1974).
2. J. E. Evans, "Preliminary Analysis of ELF Noise," Technical Note 1969-18, Lincoln Laboratory, M.I.T. (26 March 1969), DDC AD-691814.
3. H. F. Hartley, "Wideband Technique for Improving FSK Reception in Atmospheric Noise," Proc. Nat. Electronics Conf. 24, 528-532 (1968).
4. D. L. Snyder, "Optimal Binary Detection in Known Signals in a Non-Gaussian Noise Resembling VLF Atmospheric Noise," WESCON Tech. Papers, pt. 4, WESCON, Los Angeles, Calif., Session 6, Paper 4 (1968).
5. V. R. Algazi and R. M. Lerner, "Binary Detection in White Non-Gaussian Noise," Lincoln Laboratory, M.I.T. (Unpublished Group 65 report).
6. O. Ye. Antonov, "Optimum Detection of Signals in Non-Gaussian Noise," RadioEng. Electron. Phys., 12, 541-548 (1967).
7. S. S. Rappaport and L. Kurz, "An Optimal Nonlinear Detector for Digital Data Transmission Through Non-Gaussian Channels," IEEE Trans. Commun. Tech. COM-14, 266-274 (1966).
8. J. E. Evans, "Probability Density Function Estimation (with Applications to Receiver Design for Reception in Non-Gaussian Noise)," Technical Note 1969-47, Lincoln Laboratory, M.I.T. (29 August 1969), DDC AD-694552.
9. A. S. Griffiths, "ELF Noise Processing," Technical Report 490, Lincoln Laboratory, M.I.T. (13 January 1972), DDC AD-739907.
10. J. E. Evans, D. K. Willim, and J. R. Brown, "Description of the Lincoln Laboratory Wideband ELF Noise Recording Systems," Technical Note 1972-19, Lincoln Laboratory, M.I.T. (14 April 1972), DDC AD-743006.
11. D. P. White and D. K. Willim, "ELF Propagation Study (Phase II - Fall 1971)," Technical Note 1972-1, Lincoln Laboratory, M.I.T. (15 February 1972), DDC AD-739871.
12. D. P. White, "ELF Propagation Measurements (Phase III - Fall 1971)," Technical Note 1972-21, Lincoln Laboratory, M.I.T. (31 July 1972), DDC AD-747779.
13. D. P. White, "ELF Propagation Measurements at Norway, Saipan, and Greece (Phase IV - Spring 1972)," Technical Note 1972-37, Lincoln Laboratory, M.I.T. (7 December 1972), DDC AD-753685.

## APPENDIX A

### Analysis of Interference Effects on 42-46 Hz Data Recorded in the Fall of 1971 in Norway

Examination of the Norway data recorded in the Fall of 1971 indicated intermittent man-made interference which probably significantly increased the effective noise levels in the 42-46 Hz band. High levels of 16 Hz interference were observed on several occasions.

Figures A-1 and A-2 illustrate spectra taken from these Fall 1971 tapes, using 1/2 Hz resolution averaging 200 blocks over three-hour periods using tape recorder channel 1, the "soft limiter" channel. As shown by Fig. A-3, the clip level is exceeded a very small fraction of time on this channel. On all tapes analyzed on the preliminary spectral analysis there was significant interference at about 16 Hz, 10-15 dB above the background. There was also interference at about 42 Hz (2 to 10 dB above the background) at about 63 Hz (1-7 dB above the background) and at about 84 Hz (2-8 dB above the background). These spectra also show the relatively wide notch at 50 Hz without any visible 50 Hz interference.

Figure A-4 shows a plot of a typical waveform from the "hard limiter" channel after bandpass filtering. Figures A-5 through A-10 are effective noise level plots in the 42-46 Hz range from this channel. As consistently observed in the Norway data, diurnal variations were apparent with a definite upward trend in the late afternoon; in five of the six afternoons examined there was a rise of 3-4 dB from 1200-1700 GMT. Over a 24-hour period there was a 3-6 dB variation.

Figures A-7 and A-8 are effective noise levels measured at 46 Hz, while

Figs. A-5, A-6, A-9, and A-10 are 42 Hz data. The notch centered at 50 Hz could be expected to degrade the 46 Hz results. Interference near 42 Hz could degrade the effective noise levels at this frequency. There were no dramatic differences between the 42 Hz and 46 Hz data, although the 46 Hz tapes had slightly lower levels (by 2 dB on the average).

Figure A-7 shows a rapid drop in effective noise level from a very high level, about  $-132 \text{ dBH}_0$  to a low value of about  $-140 \text{ dBH}_0$  over a 4-hour period in the middle of the night. Because such a drop had never been seen on previous Norway recordings, particularly at night, the high levels were attributed to local interference. To confirm this assumption further spectral analysis was conducted on this Tape (37) and on Tapes 34 and 40 which showed short-term variations.

Figures A-11 and A-12 are spectra taken at 2030 and 2130 GMT of Tape 37 when the effective noise level was rapidly dropping, as shown by Fig. A-7. These spectra show unusually high levels of 16 Hz interference, 20 dB above the background compared to previous observations when it was 10-15 dB above the background. No other spectral lines are outstanding; Fig. A-11 shows some energy at about 46 Hz which was the signal frequency. Both Figs. A-11 and A-12 indicate energy at 42 Hz. From the early drop in effective noise level, one might expect noticeably more interference on the earlier spectrum. However, Fig. A-9 indicates that the drop may not have been monotonic. Starting at 2030 GMT, successive spectra every 30 minutes showed the level at 16 Hz to vary: 6, 5, 7, -2, 3, -2, 0, 0, 0, -2 dB with respect to one digital unit. Figures A-13 and A-14 are later spectra in this tape when the effective noise level was low. The 16 Hz is still prominent, but about 5 dB lower than the earlier

spectra. While the variations in 16 Hz interference do not closely track the variations in effective noise level, there is sufficient correlation to suspect that the effective noise level variation on this tape is not due to natural effects. Examination of sample waveforms, Figs. A-15, A-16, and A-17 indicate that the 16 Hz interference dominates the background but that its amplitude fluctuates.

On October 29 and November 1, (Tapes 34 and 40) there was a 3-4 dB rise in effective noise level during the afternoon (Figs. A-5 and A-8). Spectral analysis of October 29 data showed a fairly consistent decrease in 16 Hz interference as the effective noise level increased. For example, Fig. A-18 shows a level of -1 dB at 0100 GMT when the effective noise level was -136 dBH while Fig. A-19 shows a level of -7 dB at 1400 GMT when the effective noise level had risen to -132.5 dBH. Sample waveforms, Figs. A-20, A-21, and A-22 again indicated that the 16 Hz interference level was varying although the different scales exaggerate this effect. Like the October 29 results, analysis of November 1 data did not show dramatic correlation between interference levels and effective noise levels. While there was a fairly steady rise in effective noise level from about 1100 GMT, -138 dBH to about 1630 GMT, -135 dBH during this period, the only noticeable interference was 16 Hz (Fig. A-22, for example) which fluctuated from -3 to -7 dB with a general downward trend.

In summary the nighttime variations in effective noise level may be due to man-made interference at 16 Hz while the afternoon variations as previously observed are probably due to variations in the ELF background.

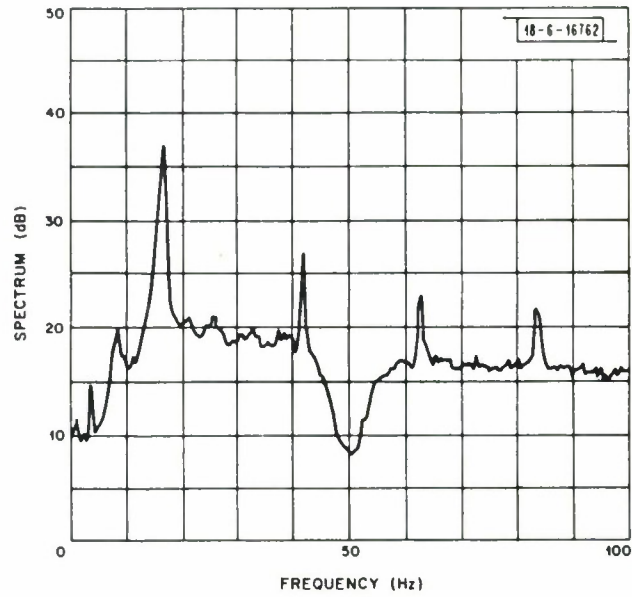

Fig. A-1. ELF spectrum recorded in Norway, 0100-0400 GMT, November 2, 1971 (tape 41).

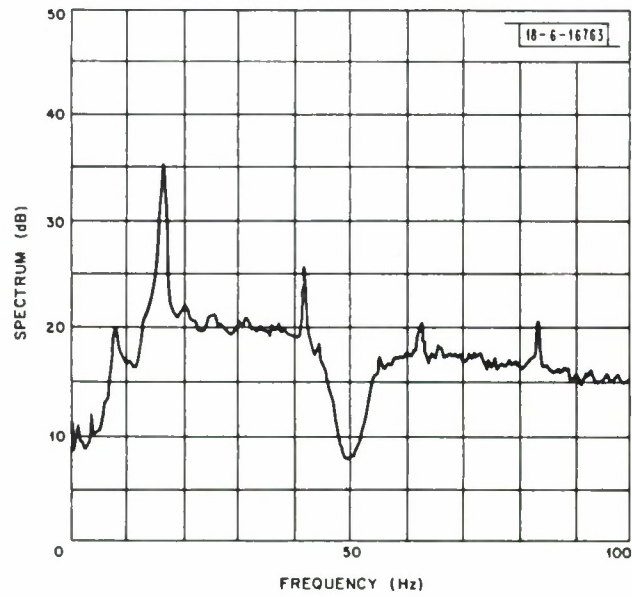

Fig. A-2. ELF spectrum recorded in Norway, 1000-1300 GMT, November 2, 1971 (tape 42).

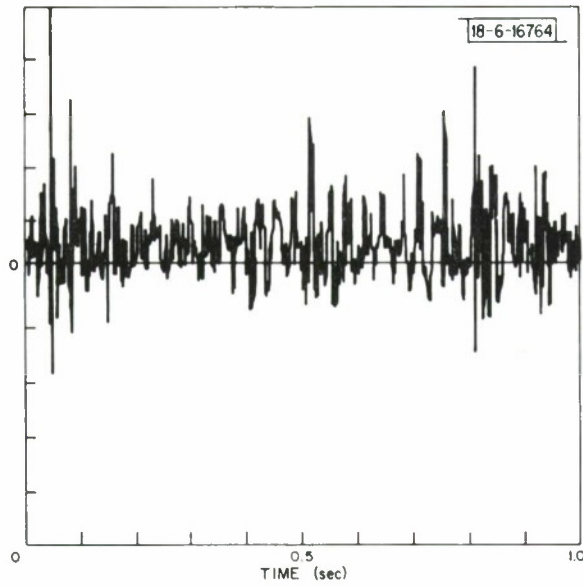

Fig. A-3. Typical waveform recorded in Norway, Fall 1971 (tape 41, channel 1, 3 dB/octave, soft limiter).

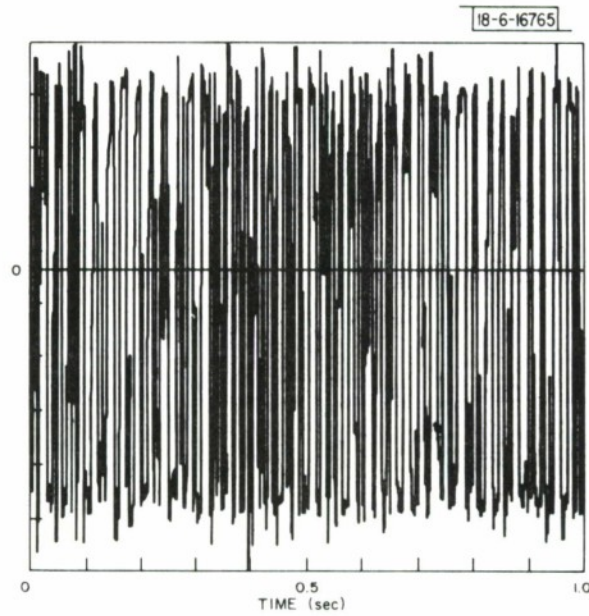

Fig. A-4. Typical waveform recorded in Norway, Fall 1971 (tape 41, channel 5, 3 dB/octave, hard limiter).

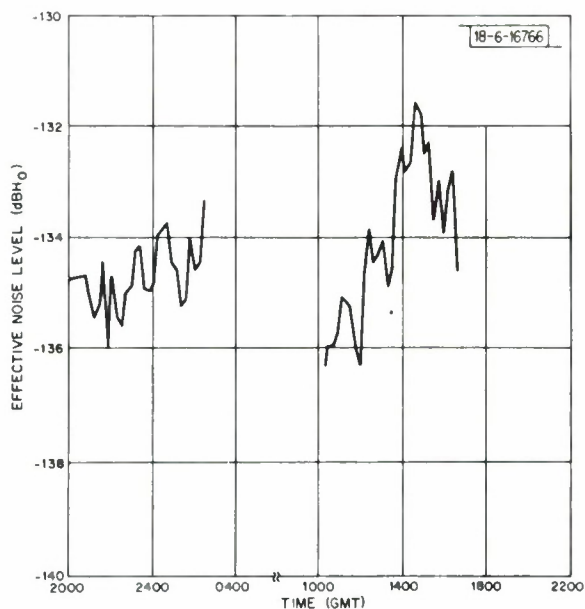

Fig. A-5. Effective noise levels at 42 Hz recorded in Norway, October 28-29, 1971 (tapes 33-34).

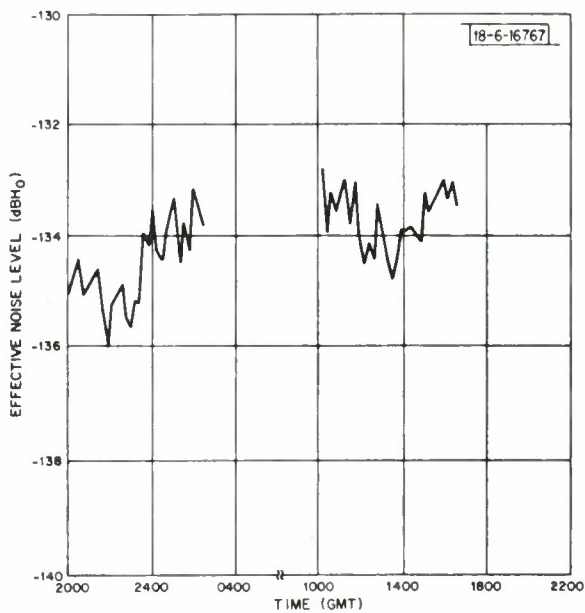

Fig. A-6. Effective noise levels at 42 Hz recorded in Norway, October 29-30, 1971 (tapes 35-36).

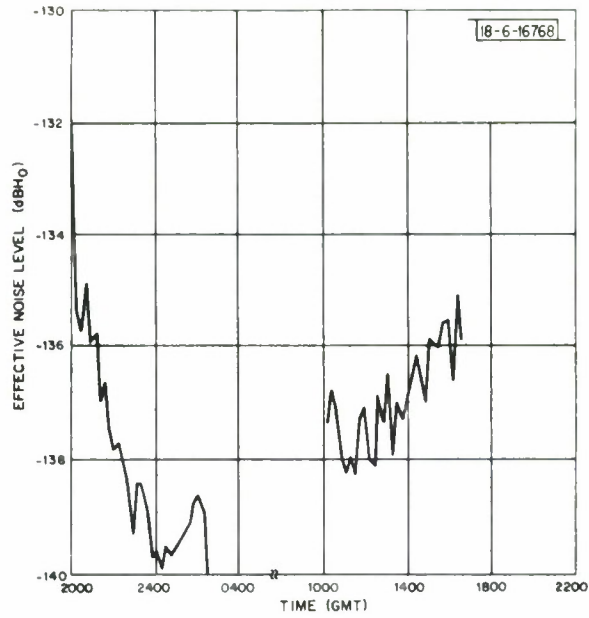

Fig. A-7. Effective noise levels at 46 Hz recorded in Norway, October 30-31, 1971 (tapes 37-38).

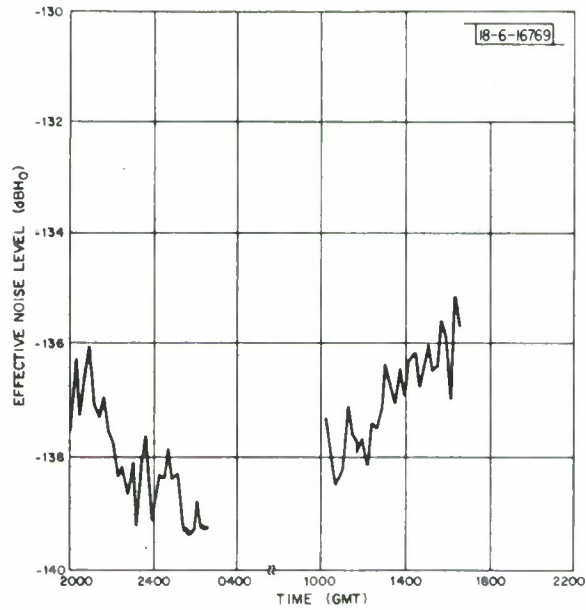

Fig. A-8. Effective noise levels at 46 Hz recorded in Norway, October 31-November 1, 1971 (tapes 39-40).

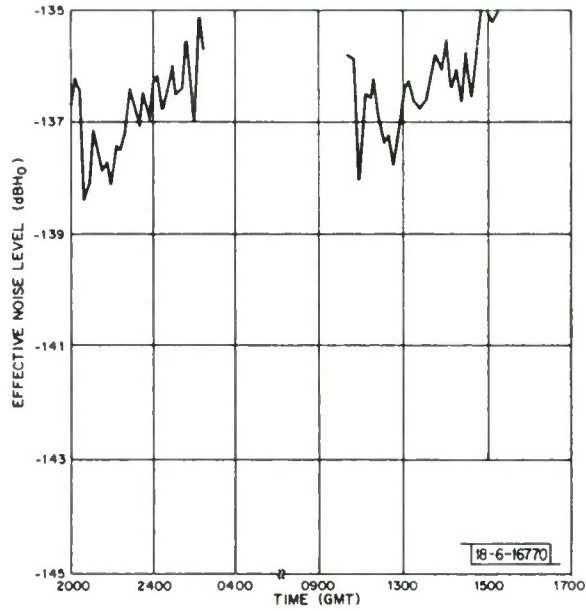

Fig. A-9. Effective noise levels at 42 Hz recorded in Norway, November 1-2, 1971 (tapes 41-42).

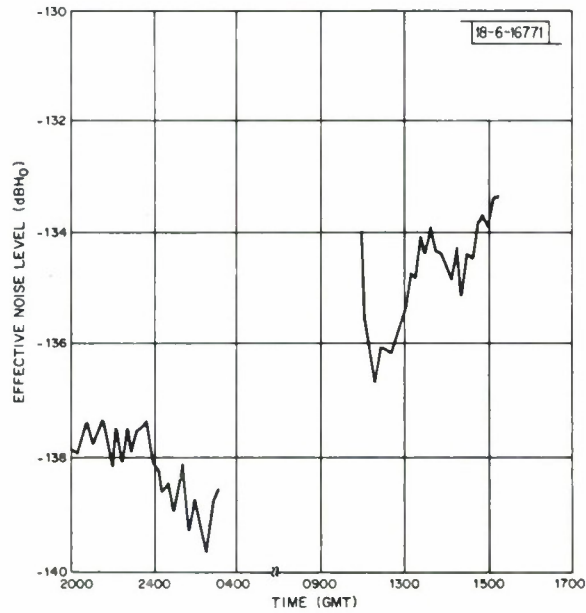

Fig. A-10. Effective noise levels at 42 Hz recorded in Norway, November 2-3, 1971 (tapes 43-44).

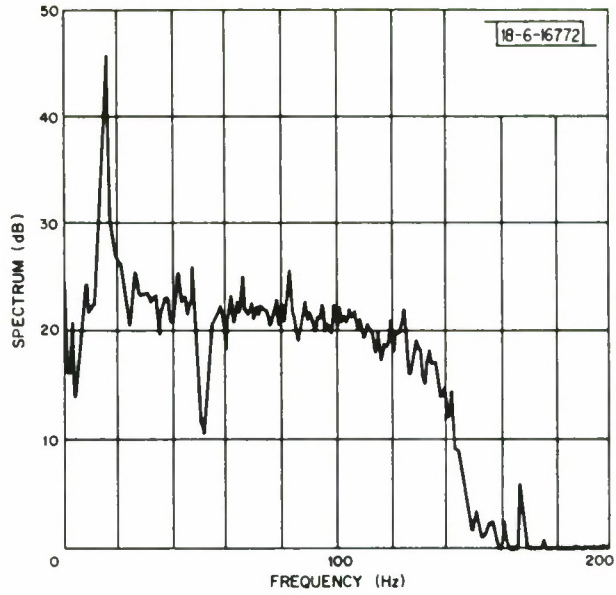

Fig. A-11. ELF spectrum recorded in Norway, 2030-2051 GMT, October 30, 1971.

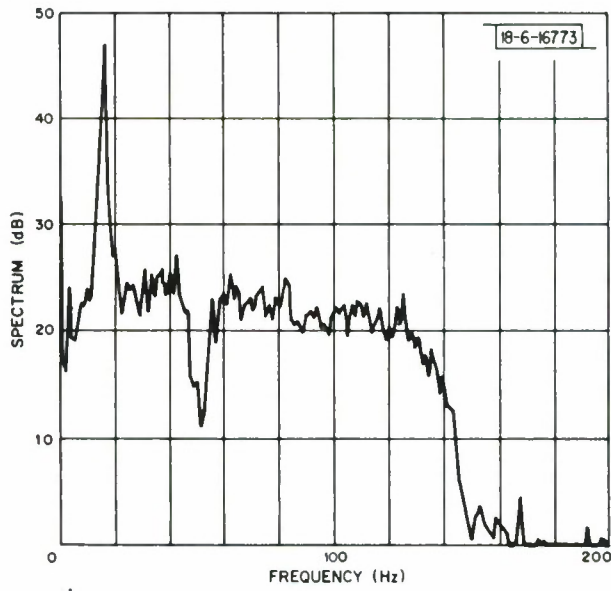

Fig. A-12. ELF spectrum recorded in Norway, 2130-2151 GMT, October 30, 1971.

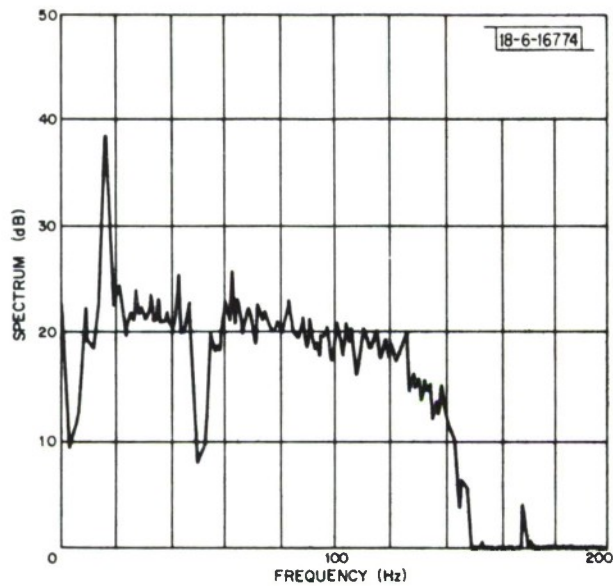

Fig. A-13. ELF spectrum recorded in Norway, 2300-2331 GMT, October 30, 1971.

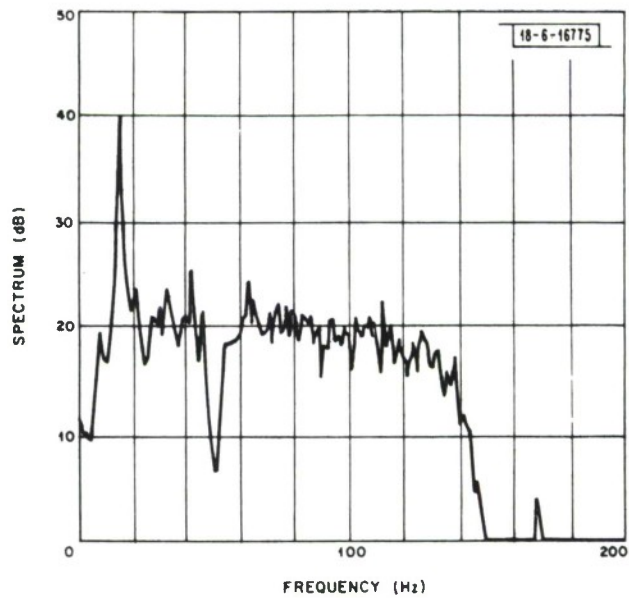

Fig. A-14. ELF spectrum recorded in Norway, 2400-0021 GMT, October 30, 1971 (tape 37).

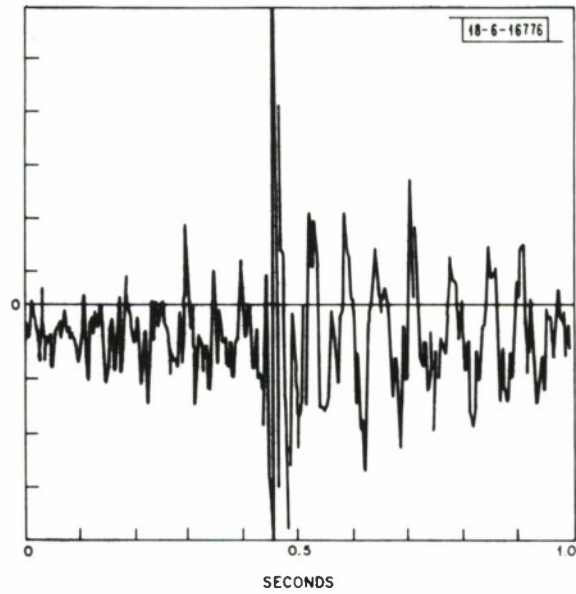

Fig. A-15. Typical waveform recorded in Norway, 2230 GMT, October 30, 1971 (tape 37).

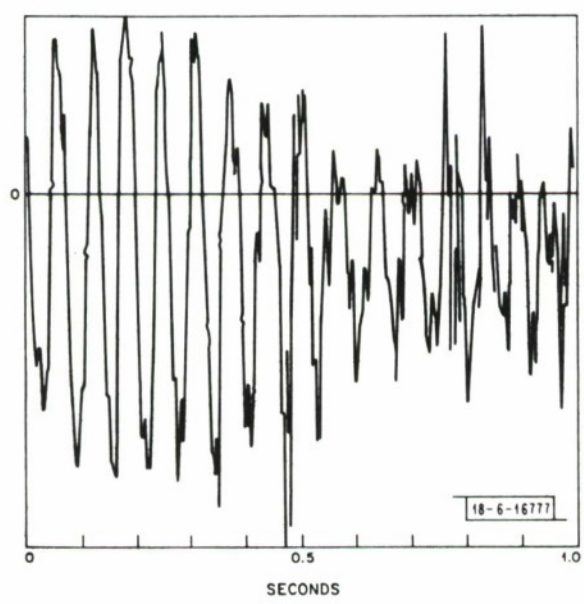

Fig. A-16. Typical waveform recorded in Norway, 2230 GMT, October 30, 1971 (tape 37).

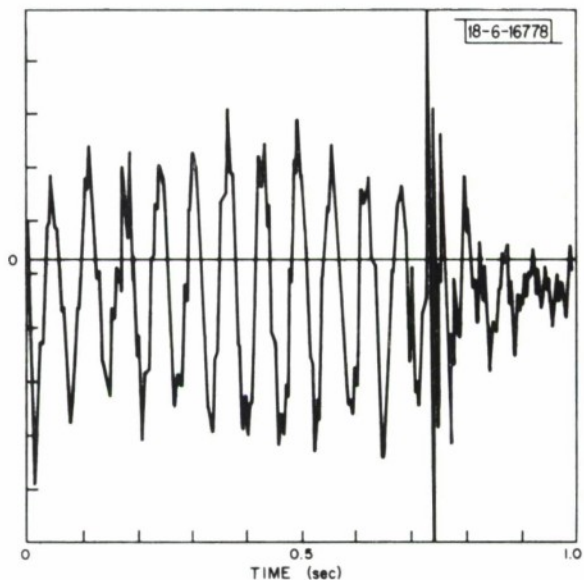

Fig. A-17. Typical waveform recorded in Norway, 2330 GMT, October 30, 1971 (tape 37).

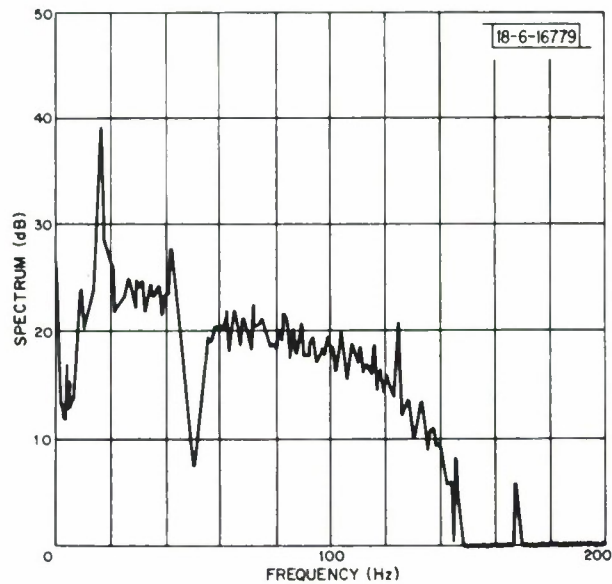

Fig. A-18. ELF spectrum recorded in Norway, 1000-1021 GMT, October 29, 1971 (tape 34).

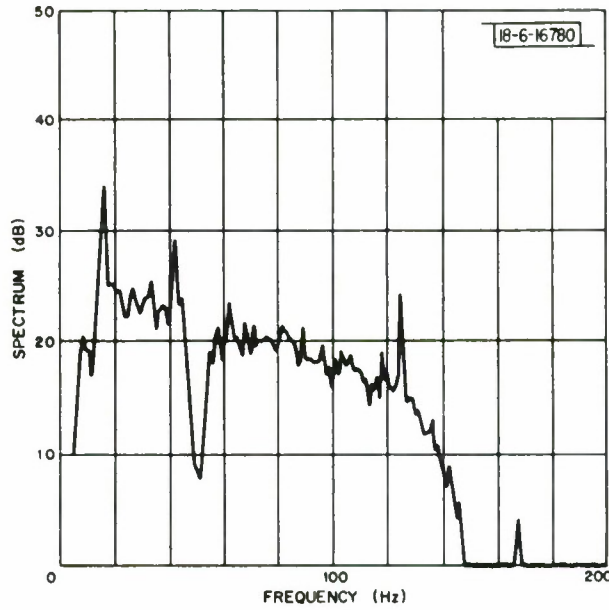

Fig. A-19. ELF spectrum recorded in Norway, 1400-1421 GMT, October 29, 1971 (tape 34).

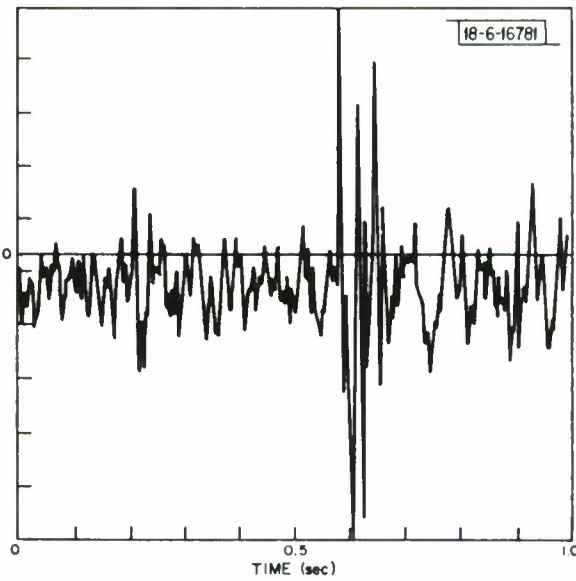

Fig. A-20. Waveform recorded in Norway, 1300 GMT, October 29, 1971 (tape 34).

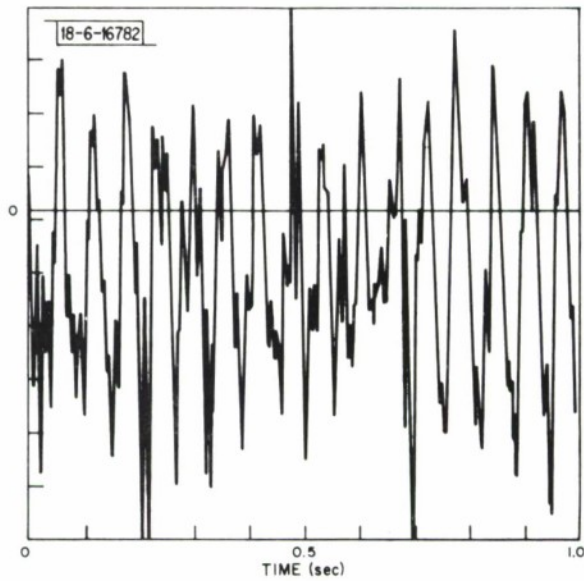

Fig. A-21. Waveform recorded in Norway, 1400 GMT, October 29, 1971 (tape 34).

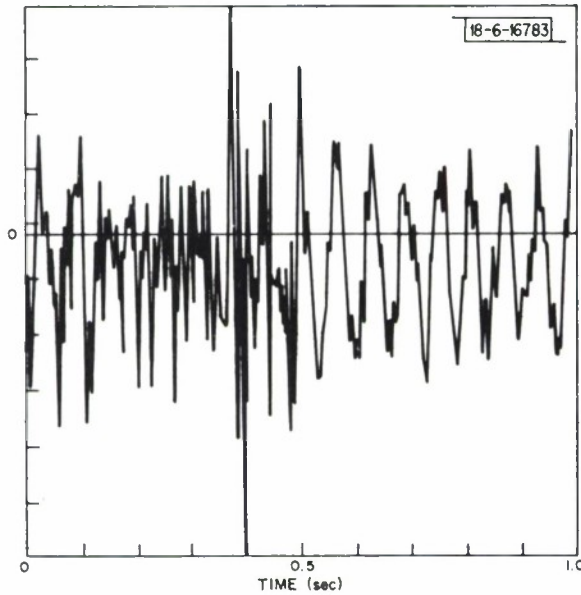

Fig. A-22. Waveform recorded in Norway, 1500 GMT, October 29, 1971 (tape 34).

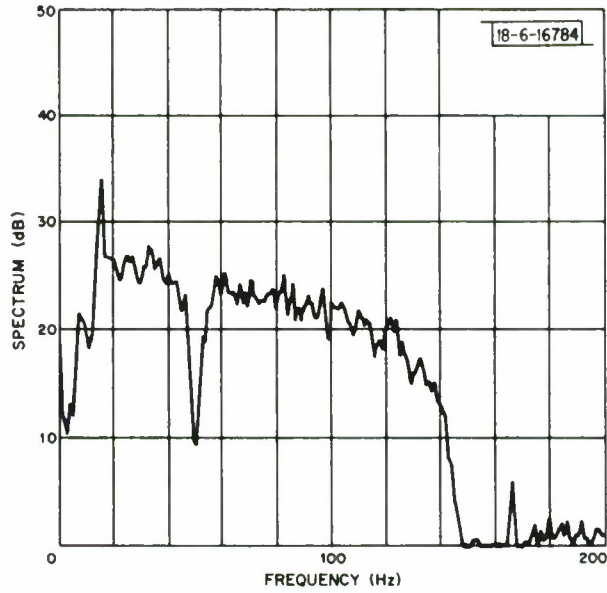

Fig. A-23. ELF spectrum recorded in Norway, 1500-1521 GMT, November 1, 1971 (tape 40).

## APPENDIX B

### Analysis of 42-48 Hz Data Recorded in Norway and Greece, May 1972

From May 11 to May 15, the injected signal was varied from 42 to 48 Hz. Laboratory calculation of effective noise levels yielded results which were unexpectedly high. Subsequent analysis indicated that the high levels may be attributed to degradation due to the notch filter and due to local interference.

Figure B-1 is a spectrum of Norway Tape 1025, which had an injected signal at 48 Hz (not apparent in plot) and which had very, very high effective noise levels ( $-136$  to  $-131$  dBH<sub>0</sub>). Five features are apparent from this plot:

- (1) Extraordinary interference occurred around 42 Hz and various harmonics.
- (2) The 50 Hz notch is broad enough to seriously degrade a 48 Hz signal.
- (3) No 50 Hz is apparent although one might expect to see a line in the notch.
- (4) No 150 Hz is apparent, although interference is very prominent around 165 Hz.
- (5) Unlike Fall 1971 data, 16 Hz interference is not apparent.

Figure B-2 is a spectrum of Norway Tape 1028 which had a 42 Hz signal and comparatively low effective noise levels ( $-139$  to  $-135$  dBH<sub>0</sub>). In contrast to Fig. B-1, the interference at 42 Hz and harmonics is virtually absent — the energy at 42 Hz is probably signal. Interference at 16 Hz is apparent. The 50 Hz notch appears deeper than from Tape 1025, suggesting the first tape had clippings and associated spectral smearing. Still no 50 Hz or 150 Hz is apparent but there is a suggestion of interference at 165 Hz. The notch filter which attenuates the 50 Hz power lines by about 50 dB also attenuated the

injected signal: 10 dB at 48 Hz, 5 dB at 46 Hz and 3 dB at 42 Hz. In a linear system with a narrowband signal, this signal attenuation would have little effect since the noise in the matched filter band would be similarly attenuated. In a non-linear system, however, out-of-band noise is folded into the signal band. With non-gaussian noise, it is difficult to analyze quantitatively the fold-over effects.

In order to determine if the high effective noise levels were due to sine wave interference near the signal frequency, simulation experiments, varying the matched filter integration times (ranging from 1 to 16 seconds) were performed on two tapes. If degradation had occurred due to sine wave interference close to the signal frequency (not capture effects), longer integration times (i.e., narrow matched filter bandwidths) would reduce this effect. The two Norway tapes showed no noticeable improvement with increased integration times.

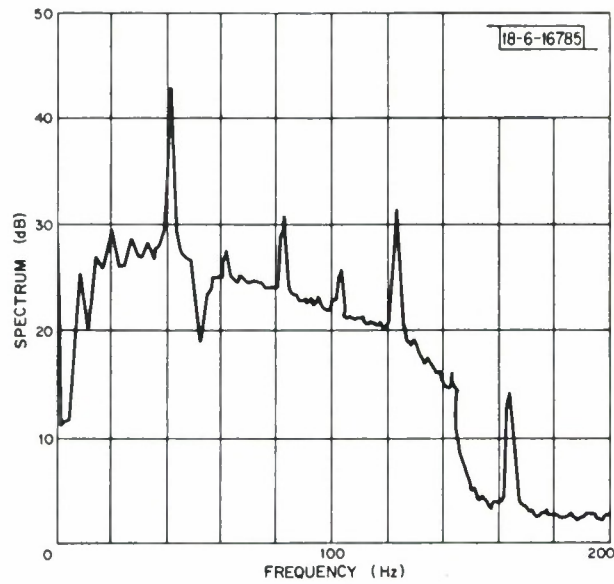

Fig. B-1. ELF spectrum recorded in Norway, 0900-1400 GMT, May 13, 1972 (tape 1025).

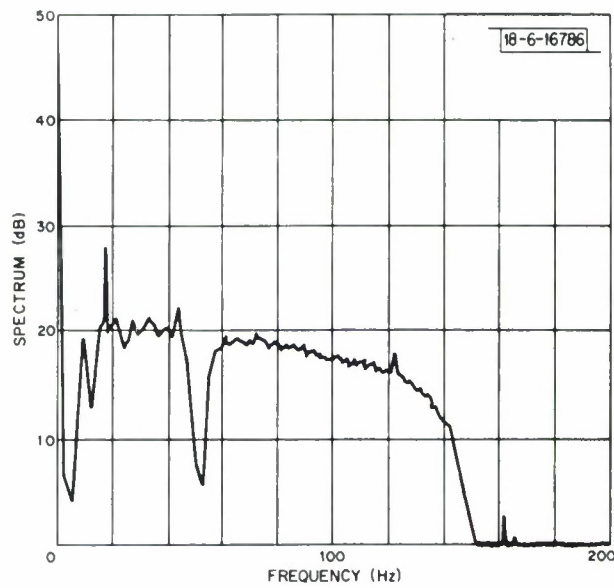

Fig. B-2. ELF spectrum recorded in Norway, 1800-2300 GMT, May 14, 1972 (tape 1028).

External Distribution List

Chief of Naval Operations (OP-941P)  
Department of the Navy  
Washington, D.C. 20350

Chief of Naval Operations  
Dr. R. E. Conley (OP-94H)  
Department of the Navy  
Washington, D.C. 20350

Chief of Naval Research (Code 418)  
Attn: Dr. T. P. Quinn  
800 North Quincy Street  
Arlington, VA 22217

Computer Sciences Corp. (10 copies)  
Systems Division  
Attn: Mr. D. Blumberg  
6565 Arlington Blvd.  
Falls Church, VA 22046

Director  
Defense Communications Agency  
Code 960  
Washington, D.C. 20305

IIT Research Institute  
Attn: Mr. A. Valentino, Div. E  
10 W. 35th Street  
Chicago, Illinois 60616

Naval Civil Engineering Laboratory  
Attn: Mr. J. R. Allgood  
Port Hueneme, CA 93043

Naval Electronics Laboratory Center  
Attn: Mr. R. O. Eastman  
271 Catalina Blvd.  
San Diego, CA 92152

Naval Electronic Systems Command  
Attn: PME-117, Captain W. C. Cobb  
Department of the Navy  
Washington, D.C. 20360

Naval Electronic Systems Command  
Attn: PME-117T, Mr. J. E. DonCarlos  
Department of the Navy  
Washington, D.C. 20360

Naval Electronic Systems Command  
Attn: PME-117-21, Captain J. Galloway  
Department of the Navy  
Washington, D.C. 20360

Naval Electronic Systems Command  
Attn: PME-117-21A, Dr. B. Kruger  
Department of the Navy  
Washington, D.C. 20360

Naval Electronic Systems Command  
Attn: PME-117-22  
Department of the Navy  
Washington, D.C. 20360

Naval Electronic Systems Command  
Attn: PME-117-23  
Department of the Navy  
Washington, D.C. 20360

Naval Electronic Systems Command  
Attn: PME-117-24, Mr. Leroy S. Woznak  
Department of the Navy  
Washington, D.C. 20360

Naval Facilities Engineering Command  
Attn: Mr. G. Hall (Code 054B)  
Washington, D.C. 20390

Naval Intelligence Support Center  
4301 Suitland Road  
Washington, D.C. 20390

Naval Research Laboratory  
Attn: Mr. R. LaFonde  
4555 Overlook Avenue, S.W.  
Washington, D.C. 20390

Naval Research Laboratory  
Attn: Dr. John M. Goodman, Code 7950  
4555 Overlook Avenue, S. W.  
Washington, D.C. 20390

Naval Research Laboratory  
Mr. Charles J. Stillings  
Code 5437  
Washington, D.C. 20375

New London Laboratory (3 copies)  
Naval Underwater Systems Center  
Attn: Mr. J. Merrill  
New London, Conn. 06320

The Defense Documentation Center  
Attn: DDC-TCA  
Cameron Station, Bldg. 5  
Alexandria, VA 22314

Naval Telecommunication Division  
Attn: Dr. N. McAllister, OP941T  
Department of the Navy  
4401 Mass Avenue  
Washington, D.C. 20350

Naval Electronic Systems Command  
Attn: Mr. W. F. Larson, PME-117-24  
Department of the Navy  
Washington, D.C. 20360

Mr. George L. Downs, Manager (3 copies)  
Strategic Systems, Electronic Systems Group  
GRE Sylvania  
189 B Street  
Needham Heights, Mass. 02194

Mr. S. M. Hergert, Attn: W31  
Director, National Security Agency  
Ft. George G. Meade, Maryland 20755

