



Calhoun: The NPS Institutional Archive
DSpace Repository

Theses and Dissertations

Thesis and Dissertation Collection

1976

Consideration of the carrier-based tactical support center design

Farris, Christy Lee

<http://hdl.handle.net/10945/17709>

Downloaded from NPS Archive: Calhoun



Calhoun is a project of the Dudley Knox Library at NPS, furthering the precepts and goals of open government and government transparency. All information contained herein has been approved for release by the NPS Public Affairs Officer.

Dudley Knox Library / Naval Postgraduate School
411 Dyer Road / 1 University Circle
Monterey, California USA 93943

<http://www.nps.edu/library>

CONSIDERATION OF THE CARRIER-BASED
TACTICAL SUPPORT CENTER DESIGN

Christy Lee Farris

UNIVERSITY LIBRARY
MARIE POSTGRADUATE SCHOOL
MONTEREY, CALIFORNIA 93940

NAVAL POSTGRADUATE SCHOOL
Monterey, California



THESIS

CONSIDERATION OF THE CARRIER-BASED
TACTICAL SUPPORT CENTER DESIGN

by

Christy Lee Farris
Neil John Gaffney

March 1976

Thesis Advisor:

Douglas E. Neil

Approved for public release; distribution unlimited.

T 173106

REPORT DOCUMENTATION PAGE

READ INSTRUCTIONS
BEFORE COMPLETING FORM

1. REPORT NUMBER		2. GOVT ACCESSION NO.	3. RECIPIENT'S CATALOG NUMBER
4. TITLE (and Subtitle) Consideration of the Carrier-Based Tactical Support Center Design		5. TYPE OF REPORT & PERIOD COVERED Master's Thesis March 1976	
7. AUTHOR(s) Christy Lee Farris Neil John Gaffney		6. PERFORMING ORG. REPORT NUMBER	
9. PERFORMING ORGANIZATION NAME AND ADDRESS Naval Postgraduate School Monterey, California 93940		8. CONTRACT OR GRANT NUMBER(s)	
11. CONTROLLING OFFICE NAME AND ADDRESS Naval Postgraduate School Monterey, California 93940		10. PROGRAM ELEMENT, PROJECT, TASK AREA & WORK UNIT NUMBERS	
14. MONITORING AGENCY NAME & ADDRESS (if different from Controlling Office) Naval Postgraduate School Monterey, California 93940		12. REPORT DATE March 1976	
		13. NUMBER OF PAGES 134	
		15. SECURITY CLASS. (of this report) Unclassified	
		15a. DECLASSIFICATION/DOWNGRADING SCHEDULE	
16. DISTRIBUTION STATEMENT (of this Report) Approved for public release; distribution unlimited.			
17. DISTRIBUTION STATEMENT (of the abstract entered in Block 20, if different from Report)			
18. SUPPLEMENTARY NOTES Travel funding and publishing costs were provided by CV/TSC Project Office, NADC Warminster, Pa.			
19. KEY WORDS (Continue on reverse side if necessary and identify by block number)			
20. ABSTRACT (Continue on reverse side if necessary and identify by block number) This joint thesis analyzes the carrier-based Tactical Support Center (CV-TSC) design from a human factors engineering view-point. Beginning with the ASW threat to the carrier force under the CV concept, a definition of the mission of the CV/TSC is presented. System functions are identified and developed into man-machine relationships of the CV/TSC. A comprehensive, albeit general, description of TSC components is included as part of the			

20. Abstract (Continued)

system analysis. Man's role, functions and tasks in the CV/TSC are identified and form the basis for alternatives to the current TSC display/control console.

Consideration of the Carrier-Based
Tactical Support Center Design

by

Christy Lee Farris
Lieutenant, United States Navy
B.A., University of Wyoming, 1968
and

Neil John Gaffney
Lieutenant, United States Navy
B.A., Marquette University, 1967

Submitted in partial fulfillment of the
requirements for the degree of

MASTER OF SCIENCE IN SYSTEMS TECHNOLOGY

from the

NAVAL POSTGRADUATE SCHOOL
March 1976

ABSTRACT

This joint thesis analyzes the carrier-based Tactical Support Center (CV-TSC) design from a human factors engineering viewpoint. Beginning with the ASW threat to the carrier force under the CV concept, a definition of the mission of the CV/TSC is presented. System functions are identified and developed into man-machine relationships of the CV/TSC. A comprehensive, albeit general, description of TSC components is included as part of the system analysis. Man's role, functions and tasks in the CV/TSC are identified and form the basis for alternatives to the current TSC display/control console.

TABLE OF CONTENTS

I.	INTRODUCTION -----	14
A.	HISTORY/BACKGROUND -----	14
1.	The Threat -----	14
2.	To Meet the Threat -----	17
3.	CV/TSC Specifications -----	20
B.	CV/TSC MISSION REQUIREMENTS -----	22
1.	Role of the CV/TSC -----	22
2.	Mission -----	23
3.	Requirements -----	25
4.	Functions and Tasks -----	25
a.	Preflight -----	26
b.	Inflight -----	27
c.	Postflight -----	28
II.	SYSTEM DESCRIPTION -----	29
A.	WATCH STATIONS -----	29
1.	Tacco Station -----	30
2.	Watch Officer's Station -----	31
3.	Brief/Debrief Stations -----	32
4.	ADP Station -----	33
B.	CONSOLE DESIGN -----	33
1.	General -----	33
2.	Dimensions -----	35

C.	DISPLAY UNITS -----	35
1.	Tactical Display -----	35
a.	Format -----	37
b.	Performance -----	40
2.	Tabular Display -----	41
a.	Format -----	41
b.	Performance -----	43
D.	CONTROLS -----	45
1.	Manual Entry Panel -----	45
a.	Projection Readout Switches -----	48
b.	Category II - VI Switches -----	51
c.	Category VII Switches -----	51
2.	Tabular Keyboard -----	52
a.	Categories 1, 2 and 3 -----	52
b.	Categories 4 and 5 -----	56
E.	COMMUNICATIONS -----	56
1.	Audio Switching Matrix (ASM) -----	56
2.	Internal Communication System -----	57
a.	NTDS -----	58
b.	Dial Up -----	58
c.	MC Circuits -----	59
3.	Radio -----	59
4.	Other External Communications -----	62
F.	WATCH STATION INTERFACES -----	62

III.	MAN AS A SYSTEM COMPONENT -----	65
	A. CLOSED-LOOP SYSTEM -----	67
	B. FUNCTION ALLOCATION WITHIN THE TSC -----	69
	C. MAN AS AN ELEMENT -----	71
	1. Model -----	71
	2. Noise in the Model -----	73
	a. Environmental Stress -----	74
	b. Training/Education -----	75
	c. Overloads -----	76
	D. DISPLAY FUNCTIONS -----	78
	1. Tabular Display -----	78
	2. Tactical Display -----	79
	3. Controls -----	79
	E. MAN'S LIMITATIONS AND CAPABILITIES -----	80
	1. Sensors -----	80
	a. Visual -----	80
	(1) Brightness Sensitivity -----	81
	(2) Brightness Discrimination -----	81
	(3) Visual Acuity -----	81
	(4) Target Size -----	83
	(5) Other Considerations -----	83
	b. Aural -----	83
	(1) Threshold Detection and Intensity -----	84

(2) Speech -----	85
2. Effectors -----	85
a. Language Skills -----	85
b. Physiology (Motor Skills) -----	86
IV. ALTERNATIVES AND CONCLUSIONS -----	87
A. DISPLAYS -----	89
1. Visual -----	89
a. Formats -----	89
b. Conclusions -----	90
2. Aural -----	92
a. Alerts -----	92
b. Conclusions -----	92
B. CONSOLES -----	93
1. Tabular Keyboard -----	94
a. Category 1 (Keyboard) -----	94
b. Category 3, Editing and Error Correction -----	94
c. Category 5, Switches -----	95
d. Category 4, Switches -----	96
e. Duplicated Functions -----	96
f. Category 2, Numerics and Data Entry -----	97
2. Tabular Keyboard Alternatives and Summary -----	99
a. Category 1 -----	99

b.	Category 2 -----	99
c.	Category 3 -----	99
d.	Category 4 -----	99
e.	Category 5 -----	99
f.	ON/OFF LINE STATUS INDICATORS and Power Switches -----	101
g.	General -----	101
3.	Manual Entry Panel -----	102
a.	Category VI - Communication -----	102
b.	Category I - PRO Matrix -----	102
c.	Category V - Track Inhibits/Display Controls -----	104
(1)	Track Inhibits -----	104
(2)	Display Controls -----	105
d.	Category III - Display Controls -----	105
(1)	General -----	105
(2)	Scale Controls and "Center On" Switches -----	105
e.	Force Stick -----	107
f.	General -----	107
4.	Manual Entry Panel Alternatives Summary -	108
a.	Category VI - Communications -----	108
b.	Category I - PRO Matrix -----	110
c.	General -----	110
C.	ANTHROPOMETRIC CONSIDERATIONS -----	111
1.	The Seated Operator -----	112

2.	Grasping Reach (Functional Reach) -----	117
3.	Conclusions -----	119
D.	WATCH OFFICER'S STATION -----	119
1.	Single Panel -----	119
2.	Communications -----	121
3.	Watch Officer's Station Alternative Summary -----	123
E.	SUMMARY -----	128
	LIST OF REFERENCES -----	132
	INITIAL DISTRIBUTION LIST -----	134

ACKNOWLEDGEMENTS

This research effort would not have been possible without the encouragement and support of Commander Frank B. Osgood, TSC Project Officer (of NADC, Warminster, Pa.) who indicated the need for such a study, approved the necessary funding and advocated an independent analysis of the CV/TSC design. Commander Osgood made available to us all members of his staff, all reference documents at his disposal and literally gave us "free reign" to conduct this study in the manner we felt appropriate.

Extensive interviews and considerable time was granted to us by Mr. Tom Massey, Assistant Project Manager, Mr. Phil Sapovits, Project Engineer, and Mr. Vince LaFranchi, Training Officer. Each individual exerted special effort on our behalf and provided us with documents, pictures, and background materials which otherwise would have been unobtainable. These individuals seem to set the mood of those associated with the CV-TSC Project - enthusiasm for providing the fleet with the best possible product. Interaction with these individuals was enlightening, both in their desire for operationally-oriented opinion and their eagerness to help us construct something of value. As operationally-oriented

Naval Officers lacking exposure to Research and Development Groups, we found our association with the CV/TSC Project Office to be most gratifying.

In lieu of royalties, we also extend our gratitude to Mr. Peter Guerrini, a former VP pilot and Carrier CIC Officer, now associated with SEMCOR of Moorestown, New Jersey. As the instructor of officers assigned to TSC's, Mr. Guerrini was able to provide extensive, definitive information on the TSC. As a minimum, he saved us numerous hours of researching essentially incorrect published materials by notating erroneous or out-of-date areas. Considering the dynamics of change within the TSC system due to alterations of software and functional requirements, his help was nothing less than essential. We feel much of the system description is a result of his inputs; those areas which may not exactly portray the TSC system are a result of our own misunderstanding of portions of the enormous amount of data which we attempted to condense and not due to Mr. Guerrini.

The merit of this thesis is directly due to the encouragement and help given us by Drs. Doug E. Neil and Lou Waldeisen, professors of the Naval Postgraduate School. Their basic courses in Human Engineering provided us with a "new look" toward the subject and caused within us an

appreciation for the complexity of man versus complexity of machines. It is also to Dr. Neil's credit that this thesis research was allowed to proceed in the manner we felt most appropriate, providing valuable guidance as we made various difficulties known. His teaching techniques and encouragement makes him an "educator" in the highest sense and has gained for him the respect of operationally-oriented students who have a tendency to regard the scientific community with some distrust.

As noted in Chapter IV, we attempted to utilize Military Standards of Human Engineering in the analysis. In areas felt to be important to a logical analysis, the documents were found lacking. Information on human engineering considerations of the CV/TSC was found to be non-existent, implying that no such considerations were attempted (or, at least, published). This thesis, then, is viewed by us as only scratching the surface. It was necessary to define limits due to constraints of time and access to the equipment.

Special thanks is extended to Jane Farris who, in addition to her motherly duties, found time to type reference cards and rough drafts at our convenience rather than hers. She is, indeed, a Navy wife.

I. INTRODUCTION

A. HISTORY/BACKGROUND

1. The Threat

The Soviet submarine force is the largest in the world. In the past 15 to 20 years the Soviets have built many classes of sophisticated nuclear-powered submarines, each class being an improvement over earlier designs. Soviet literature informs us of a continuing effort in scientific research and technological development to enhance their submarine force capabilities. It follows that future Soviet submarines will benefit from those efforts and become faster, quieter, and deeper-diving than they are now. For those engaged in the search for submarines, such improvements cause much consternation.

In the past, Soviet submarines appear to have been targeted against the Continental United States, U.S. Naval Surface Forces (primarily the carrier strike forces) and the U.S. Submarine Forces (with probable emphasis on Polaris). The Soviet Submarine Force, backbone of the Soviet Navy, poses a three-pronged threat to Western forces, complementing torpedoes and ballistic missiles with a guided cruise missile capability. Of the threefold threat - against

the continental United States, surface forces, and submarines - the second is most relevant to this paper. Soviet Naval construction priorities have shown that they have perceived the strike carrier as a dominant threat since the end of World War II. For example, during the 50's, "The first distinct anti-carrier force was programmed to repulse the CVA in its then role of delivering nuclear attacks against the homeland." Ref. (1). Foxtrot and November class submarines were authorized in the mid-50's and were operational by 1957-59. "The projected anti-carrier weapon for the N and F submarine classes was the nuclear-tipped torpedo." Ref. (2).

Russians began development of a cruise missile capability and began testing in 1955-56. Within four years cruise missiles were available to their fleet giving the Echo class submarine an over-the-horizon capability. While a launch required the submarine to surface, the effective range of the missiles allowed sufficient standoff distances for the submarine to remain well clear of the protective screen of the carrier task force.

During the 1960's, the Soviet defense posture changed from a defense of the homeland to that of a blue-water, aggressive Navy. Soviet strategists noted the downgrading of the carrier in its strategic strike role.

"...they see the carrier as a growing threat to their submarine and surface fleet out-of-area operations and to the effective pursuit of their political policies in many areas of the world." Ref. (2).

In the late 60's two new Soviet submarines appeared; the Charlie and Victor. Both classes are nuclear powered and provide a quick reactionary weapon against carriers in a strike position. The torpedo-attack Victor class and the short-ranged cruise missile Charlie class are much faster and quieter than previous classes. Further, the Charlie possesses the capability to submerge launch the cruise missile. We can conclude from these trends in Soviet submarine construction that the carrier and its strike force remain a prime target for Soviet submarines.

Not only does a single submarine pose a significant threat to the carrier but the likelihood of attack from more than one submarine (possibly in conjunction with surface ships) is high and poses an even greater threat. Throughout many of the articles written by Admiral of the Fleet of the Soviet Union, S. G. Gorshkov, there are statements like the following one taken from Morshoy Sbornik, November 2, 1972 as reprinted by Naval Institute Proceedings, January 1974:

"The hallmark of Naval forces is their high degree of maneuverability, and ability to concentrate secretly and to form powerful groupings which are of surprise to the enemy." (Emphasis our own.) Ref. (1).

A critical threat to the carrier, then, is from "powerful groupings" of deep-running, fast, quiet submarines equipped to fire both nuclear and conventional weapons from short or long ranges.

2. To Meet the Threat

To meet the threat, we must be able to locate and track enemy submarines at close, medium, and long ranges from the carrier. We must have the flexibility to handle multiple contacts in a hostile environment. To aid the traditional destroyer screen, extend coverage area, and provide fast responses to the threat previously described, airborne antisubmarine warfare (ASW) platforms have been introduced. Airborne coverage may be provided by landbased P3C aircraft or carrier-based S3A aircraft and SH3 helicopters. Although the P3 is used for long-range coverage, the S3A for medium ranges (out to about 300 miles) and the SH3 for close support, this paper deals only with the carrier-based air platforms. However, the need for an operational interface with distant support units is an obvious requirement.

Most of "The CV carriers which will support sea-based air ASW weapons systems are not equipped nor manned for the tactical support of the new generation of weapons systems now in development. These new weapons systems with computer integrated avionics acquire tactical sensor data in quantities and formats never before experienced in the fleet. A modern means to provide timely preflight information, in-flight support, and post-flight analysis and evaluation of ASW missions, must be developed and implemented to ensure the best utilization of these new weapons systems." Ref. (3)

Also required is a means by which selected tactical information may be relayed to the ship's Combat Information Center (CIC) and Tactical Flag. Therefore, we need a system that can (1) provide a preflight briefing and a post-flight debriefing, (2) provide communications for inflight support, (3) real-time processing, (4) faster than real-time post-flight analysis of sensor data for evaluation and (5) integration with other shipboard tactical presentations. The tactical support center aboard the carriers provides a computer link with land-based patrol aircraft, but as mentioned before is secondary to this thesis.

The carrier-based tactical support center (CV/TSC) "gives the Navy a highly advanced mission brief and debrief

capability that matches our newest airborne ASW weapons systems. The CV/TSC gives us both real-time and delayed analysis of ASW data from the aircraft - before, during, and after flight..." Ref. (5).

Optimal space allocation aboard a carrier requires streamlining of weapons and support systems. Similar requirements are usually not as stringent at land-based installations as for example, in the VP/TSC. However, the "CV/TSC gives the fleet an up-to-the-second high data rate capability compatible with the most advanced airborne weapon systems. It has a fast and flexible display capability, making possible rapid target detection, classification, evaluation and decision making - something our manual ASCAC's can't do." Ref. (4). Aboard the carrier this capability occupies only 1000 square feet.

The primary function of the CV/TSC is to provide sensor processing and multi-source, multi-sensor correlation information. "The CV/TSC is not intended to duplicate other command functions aboard the CV." Ref. (3).

The fact that the TSC is designed to carry out its primary function without duplicating shipboard functions may be attributed to the space limitations and the fact that the TSC and its associated ASW aircraft are part of a

complex organization aboard the CV. It is not intended to be the command center aboard the ship.

3. CV/TSC Specifications

The general specifications are promulgated in ref. (3). They are included to provide an appreciation for the CV/TSC capabilities.

(1) "Timely exchange of tactical and sensor information with on-scene, enroute or in-area aircraft (VP, VS,HS) when permitted by EMCON is essential." This can be done with all three types of aircraft on a tactical level with VP and HS on a sensor level, however, the S3A aircraft launched from the carrier is not equipped for real-time sensor monitoring by the TSC. This means the TSC's processing advantage can only be gained in post-flight evaluation of the S3 data and then passed to the on-scene aircraft.

(2) "Rapid and thorough briefing of flight crews prior to launch with the most current and accurate flight, tactical and target information is required, including pre-flight insertion tape preparation." In briefings, information may be passed on to the crew quickly, hard copies of messages and other required information are provided to crew members and efficient updating at aircraft computers is accomplished.

(3) "Expeditious debriefing and analysis following a mission, to provide evaluated information to command levels as well as to aircraft on-station or scheduled for departure, is an important specification." During the debrief a second look at all possible contacts is made by replaying the mission tape. The display subsystem provides amplified projections and instantaneous reconstruction of the mission on the 4 x 4 foot screen. The crew can discuss their actions, look at the situation in an "instant-replay" format and, with a qualified observer, critically analyze contact classifications.

(4) "Adequate internal shipboard communications capability is required with tactical command and control centers to provide analysis reporting and display of contact information on a real-time basis." Information may be relayed to the ship's CIC, the Flag plot and the Intelligence plot. Again this information may come from processing of acoustic information after completion of S3 flights, relaying in real-time information that may be up to six hours old.

(5) "The TSC should degrade gracefully under conditions of ultimate stress or overload. The capability to recoup, especially following an equipment failure, and to provide for alternate modes during such failure is required."

B. CV/TSC MISSION REQUIREMENTS

1. Role of the CV/TSC

The CV/TSC was designed in response to the latest generation of ASW weapons systems - notably the S3A. The large quantities of sensor data which the S3A collects, as well as tactical histories of entire flights, made the manual ASCAC facilities obsolete. The presence of an automated digital system, such as the S3, requires a support system capable of digital preflight preparation, inflight support and post-flight analysis. Each phase requires appropriate communications interfaces with higher command and other support systems.

The following definitions from Dr. Kenyon B. Degreen's System Psychology, Ref. (5), are adhered to in this treatment.

"Mission: A statement of what the system is to do to solve a given problem and when and where.

Requirement: A statement of an obligation the system must fulfill to effect the system mission. They further delineate the mission.

Function: A general means or action by which the system fulfills its requirements. They are the first hows of the system."

2. Mission

As defined for the purposes of this thesis, the mission of the CV/TSC is to provide CV oriented ASW support to the ASW commander and to support modern carrier-based ASW platforms assigned to him to counter the threat to the CV as described.

This definition of the CV/TSC's mission implies a duality of roles - support to the ASW Commander and support to the ASW platforms. While the latter is, in fact, merely an extension of the former; it is necessary to distinguish between the two types of support which the TSC provides, since they are interwoven within TSC functions but differ significantly in tasks.

Support to the ASW platforms is of a direct nature, i.e. information exchanges occur on a one-to-one basis without intermediaries (the major exception is discussed under the inflight function). Conversely, information exchange with the ASW commander is seldom one to one. Rather, information is routed through intermediaries as it progresses up the chain of command. Plate (1) depicts the TSC mission and its relationship to functions and tasks as defined in this paper. Viewing the TSC system as a black box, the output is seen to be filtered information routed to higher authority via the chain of command.

MISSION

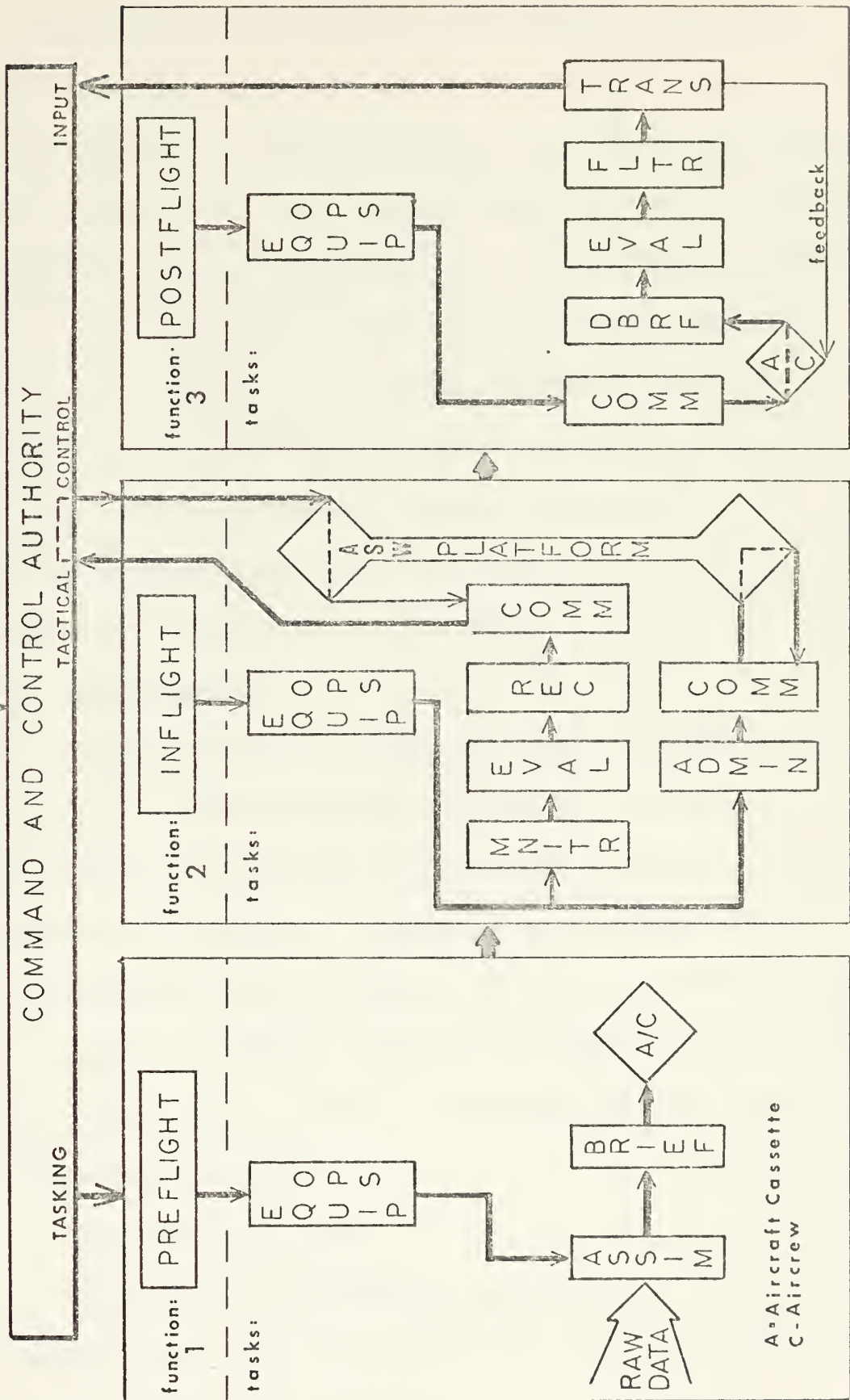

PLATE (1) MISSION, FUNCTIONS & TASKS OF THE TSC

Specifying the mission in this manner alleviates problems which may exist concerning the CV/TSC's role in the chain of command. It implies the TSC is a part of a complex command structure with the role of receiving and disbursing intelligently "filtered" information. The filtered information, as an output from the TSC, goes to higher authority where it is combined with information from other sources in order that command-level decisions are made. The TSC, then, is an advisory/support system in conjunction with several others and should not be construed to be in the command/control business as is the CIC.

3. Requirements

Fulfillment of its roles requires a digital system with a high data flow rate which interfaces with other support systems, ASW aircraft and higher authority. Requirements also include a capability to provide data in formats compatible with aircraft avionics, aircrew personnel, and the chain of command. Further, the TSC must be able to rapidly process acoustic data in conjunction with the sensor's associated position.

4. Functions and Tasks

Clearly, the outstanding requirement of the TSC is information flow consistent with technically advanced platforms and sensors. By interpreting system requirements as

information flow, general functions which the system must perform to fulfill its mission can be defined.

In its role of direct support to airborne ASW platforms, the CV/TSC has three major functions distinguished by the aircraft's phase of operation and various communications requirements. Each function has associated tasks comprised of a set of operations or a sequence of procedures. (Tasks will be the basis of system analysis in a later section.) See plate (1).

a. Preflight

The preflight support or mission-planning function occurs in response to tasking by higher authority. Information flow, after tasking, is basically twofold - raw data from other support systems is input to the TSC, while a formatted summary provided to the crew in a brief is the output. To accomplish the preflight function the human must perform the following tasks:

1. General housekeeping - normal equipment operations to include on/off control, display adjustments, button pushing and environmental control.

2. Assimilation - the set of operations required of the operator to gather raw data from other support units (Operations, Intelligence, Metro, etc.) and transcribe

that data into a form compatible with the aircraft avionics and aircrew.

3. Communication - those actions by the operator necessary to transmit the condensed information to the flight crew and aircraft system.

b. Inflight

During inflight phases information flow is more complex. The TSC is required to communicate with higher authority, other support systems and the aircraft. The following tasks are included in the inflight support functions:

1. General housekeeping - as previously defined.

2. Communication - with higher authority, the ASW platform and other support systems as necessary.

3. Monitoring - those actions required of the operator to fulfill tactical support requirements.

4. Administration - those actions required to maintain asset inventories.

5. Evaluation - actions required to provide a comparison of real-time tactical information with available intelligence in order to reach conclusions regarding the tactical situation.

6. Recommendation - actions resulting from evaluation of tactical data which are forwarded to the aircraft and/or higher authority.

c. Postflight

Postflight functions include information transfer between aircrew and TSC and the preflight Data Insertion Tape and the TSC.

Further communication with other support systems may be necessary prior to transmitting relevant data to higher authority. The following tasks are included in the postflight function:

1. General housekeeping
2. Communication - aircrew and TSC personnel, TSC and aircraft digital tape, TSC and other support systems.
3. Debrief - those actions required to effect an appreciation for the events which occurred during a flight.
4. Evaluation - as previously defined.
5. Filter - those actions required to condense tactical information to a form most usable by higher authority. (Implies that selected information is compiled in a summary format.)
6. Transmit - actions required to forward filtered information to higher authority.

II. SYSTEM DESCRIPTION

Although it is intended to confine analysis to the TSC's Watch Officer Station, a description of the complete system is presented to develop various hardware interfaces and place the operator's role in perspective. It should be noted that five of the six stations are identical with the exception of communications inserts. Station VI, the Automated Data Processing console, is mentioned only briefly.

The thrust of this paper is discussion of the man-machine interfaces rather than a treatment of software problems or limitations. Therefore, software is addressed only when other options do not exist.

A. WATCH STATIONS

For this treatment, two general types of information flow have been identified within the TSC system - tactical and administrative. Administrative information is defined as data within the system which is stored or presented as a listing or in an "inventory" form. It is seldom output to higher authority except in special circumstances and is associated with tabular displays which are discussed in part D of this chapter. Tactical information is comprised of the remaining information within the system and is

associated with the tactical display discussed in part C of this chapter. Identifying the two types of information is relevant since the stations and their operation may be categorized by information type and TSC function as described in I.B.4. Also, as watch officer duties are considered, it is useful to distinguish his tasks by the type of information he is processing.

1. Tacco Station

Stations I and II are Tactical Coordinator (TACCO) stations. They are adjoined with Acoustic Analysis (ACAN) Stations which are used to process acoustic information. See plate (2). (ACAN stations are not addressed in this paper.) Tacco stations are assumed to perform all tasks associated with the Inflight function. In addition, during Postflight functions they may perform the tasks of Communications, Evaluation, and Filtration.

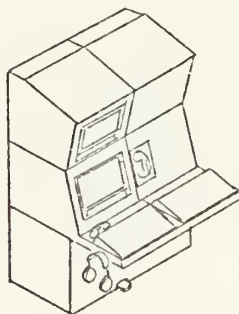

Plate (2) Tacco Console, Stations I, II

Manual Entry Panels and Tabular Keyboards of the Tacco stations are identical to those of the Watch Officer.

Communications provided to these stations support inflight requirements and include covered and uncovered transceiver capability. Internal communication (ICS) capability is identical with the other stations.

2. Watch Officer's Station

The Watch Officer's Station is designated as station III. See plate (3). It can operate to support all three CV/TSC functions previously identified. Primary tasks associated with the watch officer's station include Assimilation in Mission Planning, Evaluation, Recommendation, Communication and Administration during Inflight stages, and Filtration and Transmission during Postflight stages. (Although station III may be required to perform any system task, only those routinely performed have been included.)

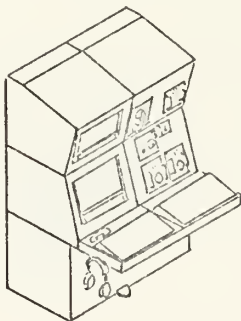

Plate (3) Watch Officer's Console, Station III

The Manual Entry Panel and Tabular Keyboard located at Station III are described in part D of this chapter.

The most unique feature of the Watch Officer's Station is the communications control installation which provides monitoring capability of all communications from TSC stations to units external to the TSC. Communications are addressed in more detail in part E of this chapter.

3. Brief/Debrief Stations

Stations IV and V are associated with the Preflight and Postflight functions and perform tasks of Briefing and Debriefing. The two stations are located in aircrew briefing spaces rather than within the TSC. See plate (4). The station is capable of processing either tactical or administrative information and is utilized for that purpose in briefs and debriefs.

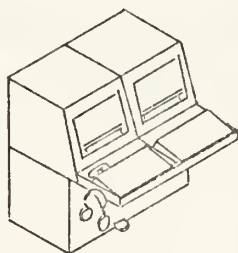

Plate (4) Brief/Debrief Console, Station IV, V

The Manual Entry Panel and Tabular Keyboard of Brief/Debrief Stations are identical to those of the Watch Officer Station and have the same capabilities.

Communications at Stations IV and V are limited to ICS within the TSC. There is no provision for any other type of transmitter/receiver.

4. ADP Station

The ADP Station, designated Station VI, provides the TSC with an independent maintenance station with which to control processing functions of the system. See plate (5).

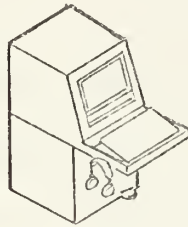

Plate (5) ADP Console, Station VI

A Tabular Keyboard is included at the station.

Communications at the ADP Console are limited to ICS.

B. CONSOLE DESIGN

1. General

Fabrication of all six stations is accomplished with the same basic components. Welded steel framework covered with steel enclosure panels form basic cabinet

units. Support for displays and "bullnose" assemblies are incorporated.

Bullnose units provide the necessary horizontal surface for the Manual Entry Panels and Tabular Keyboards and are attached to the display cabinets. Either type of bullnose (MEP or TKB) is interchangeable on any cabinet.

Two completed cabinets are joined for Stations I, II, and III, and include display units mounted vertically in one of the cabinets. Stations IV and V do not incorporate the top third of the basic cabinet and have display units mounted in the horizontal. Station VI consists of only one cabinet.

Display units and bullnose units are independent, self-contained assemblies which are fitted with slides to allow complete removal for maintenance. See plate (6).

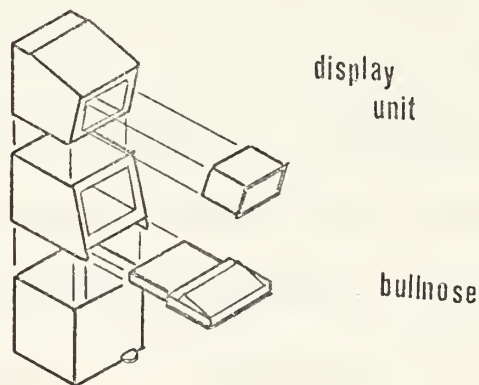

Plate (6) Display Unit and Bullnose Assembly

2. Dimensions

Plate (7) is provided to depict dimensional data obtained from Ref. (6) and photographs provided by the NADC photo lab.

C. DISPLAY UNITS

Two displays are provided at each station except the ADP station. They provide the primary visual interface between operators and machine as tactical and administrative information is processed in the system. Each display is a high resolution, dual channel 17-inch diagonal cathode ray tube.

1. Tactical Display

The Tactical Display provides (a) real-time, (b) faster than real-time and (c) stop-action (during mission replay) tactical information to the operator. Symbols, vectors and alphanumerics are utilized as coding of unit, track, sensor and position data. The display is controlled from the MEP but accepts certain inputs from the TKB other than those duplicated at both panels. A slaved circular cursor is incorporated and controlled at the MEP. Inputs to the Tactical Display are primarily derived from airborne ASW units (SH3 or Relay Pod) or S3A digital tapes although Link 11 and NTDS interfaces will be established.

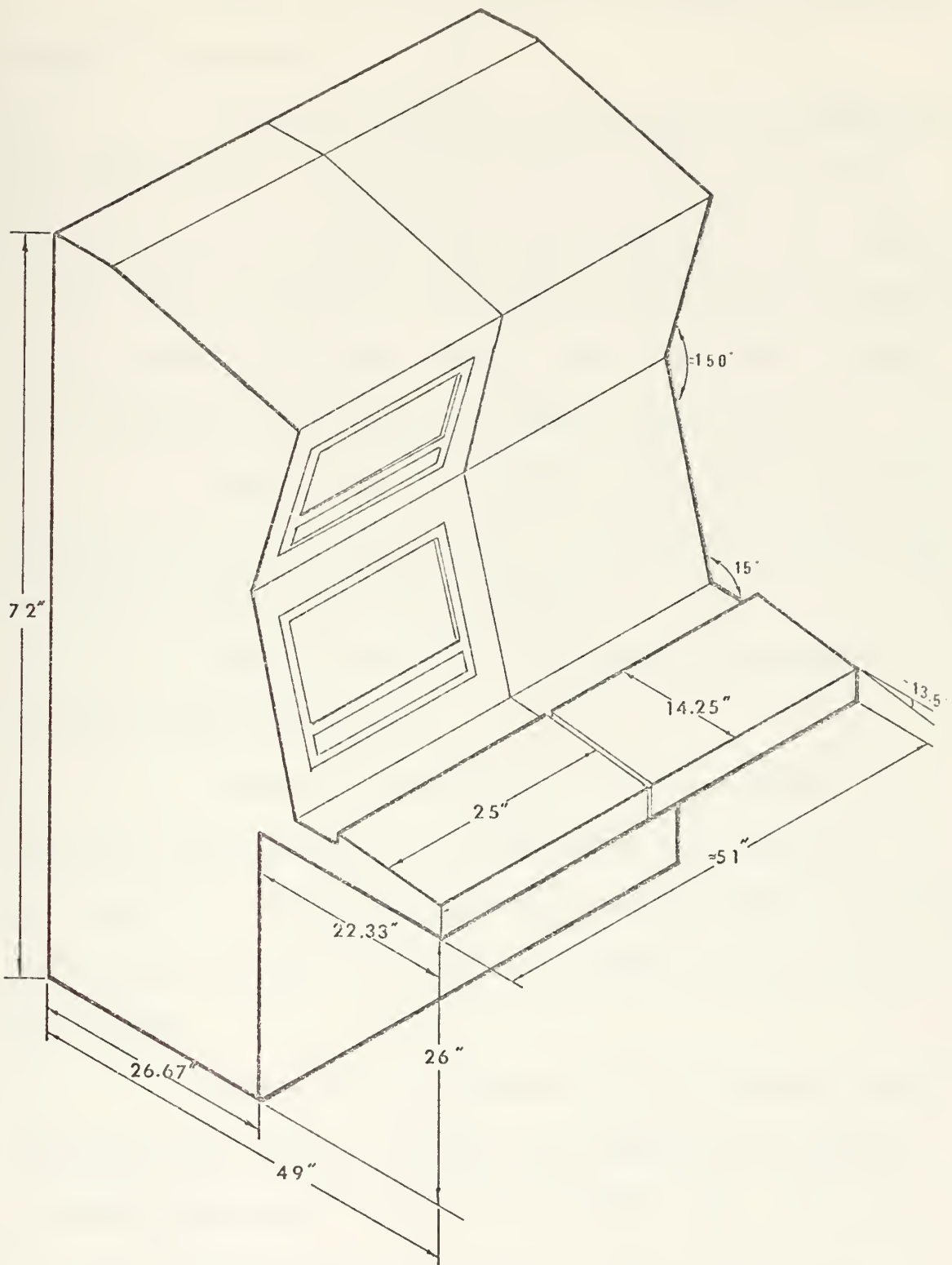

PLATE (7) CONSOLE DIMENSIONS

a. Format

Plate (8) shows the display format of Tactical Display Information.

Alerts and computer status cues are located in the upper center portion of the display and may impinge upon concurrent tactical symbology depending on the display scale. Real time in Zulu (Greenwich Mean Time) is displayed at the center left edge. Scales range from 1nm to 1024nm in multiples of two yielding eleven possible scales.

Replay rate is utilized during Mission Replay and indicates speed and direction (forward or reverse time) at which a sortie is being replayed.

Replay Time Zulu is the time corresponding to events on the replay tape.

Alerts to the display occur in response to operator entry errors or as other types of advisories to the operator. Status messages occur as the Tactical Display is altered in scale or certain other data is entered manually at the MEP.

Plate (9) is an example of the Tactical Display during an ASW mission. Notice the formatted information displayed concurrently with the tactical plot. No status or alert messages are outstanding. Scale is included as is platform course and speed. (If the display was a

REAL TIME ZULU
STATUS MESSAGE
STATUS MESSAGE
ALERT NUMBER 1
ALERT NUMBER 2
ALERT NUMBER 3
ALERT NUMBER 4
ALERT QUEUE FULL MSG

DISPLAY SCALE (1-1024)

REPLAY RATE AND DIRECTION
REPLAY TIME ZULU

PLATFORM SPEED
PLATFORM DIRECTION

PLATE(8) TACTICAL DISPLAY FORMAT

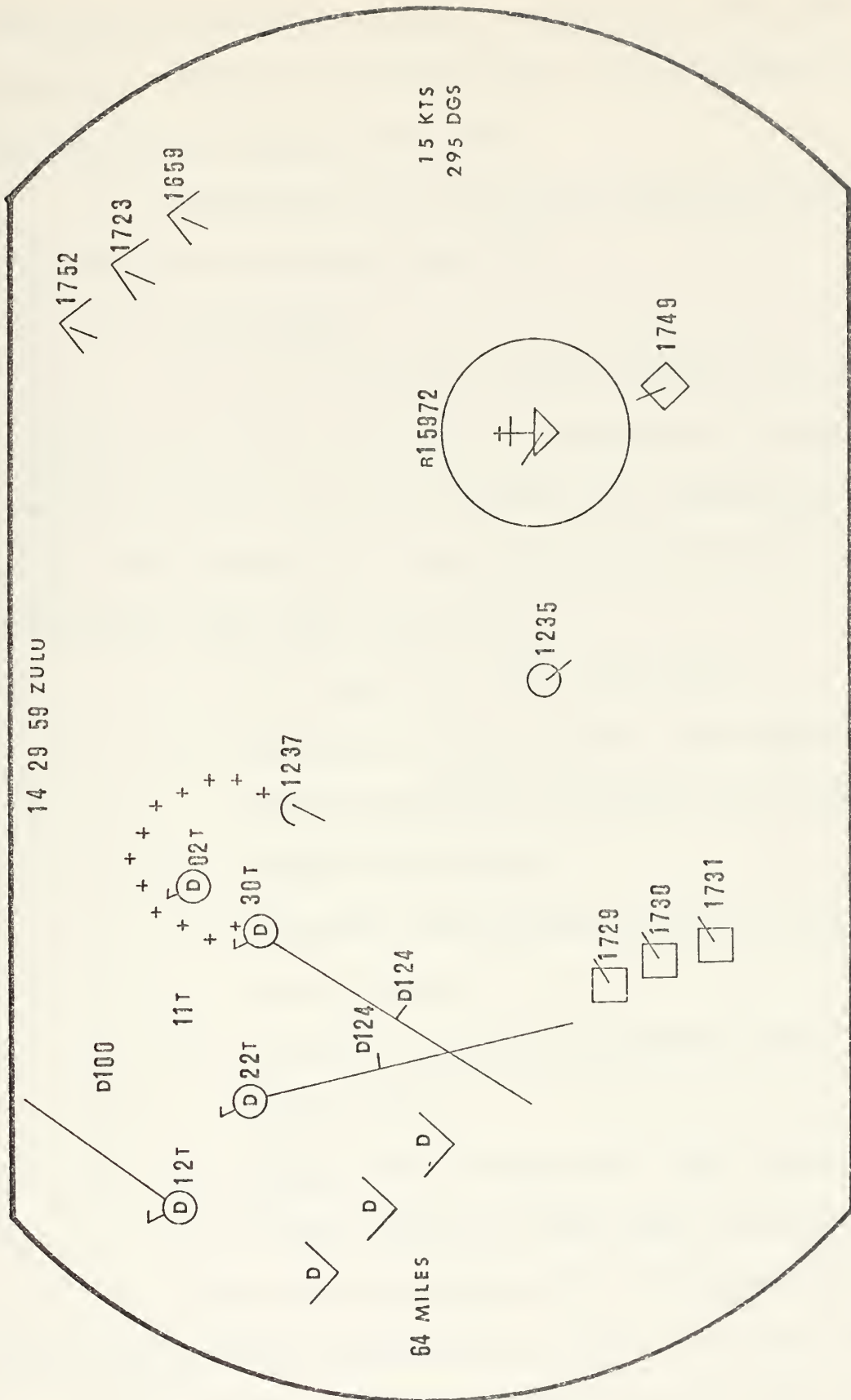

PLATE (9) TACTICAL DISPLAY DURING SORTIE

stop-action view during mission replay, Replay Rate and Direction and Replay Time Zulu would also be included on the display as shown in plate (8)).

Hardcopies of the Tactical Display can be made with appropriate actions at the MEP.

b. Performance

As part of display-related software, the field of view of the 1024 x 1024 grid is adjustable, allowing the operator to alter the size of symbols on a comprehensive basis. The following is a list of Tactical Display channel performance data taken from Ref. (7).

1. 2:1 interlace, 30-Hz frame rate.
2. Character, conic, vector, and cursor display using "on-the-fly" converters for minimum memory requirements.
3. External analog video interface accepts three sources.
4. Provides compensated composite sync for each source.
5. Eight shades of grey for video display.
6. Slave outputs for GFE large-screen projectors.

The television display has a flicker-free frame of 30 fps, position resolution of 1/1024 and brightness greater than 25 fL. Vertical blanking occurs after each

512 active horizontal scan periods. Horizontal retrace time is less than 7 microseconds.

2. Tabular Display

The Tabular Display is the primary visual interface between man and machine as Administrative or Tabular information is processed. The television displays formatted summaries and is controlled by switches at both the TKB and MEP. The only noticeable difference from the Tactical Display is in color of the presentations - the Tabular Display is in shades of green while the Tactical Display is in eight shades of grey.

a. Format

The Tabular Display provides formatted information to the operator in standardized "tableaus." An example of the most general tableau is found in Plate (10).

Alerts and status messages conform to the description given in the Tactical Display Section. Line 01 is the tableau title. Lines 02 through 60 accept data from the Tabular Keyboard. Two types of data occur on each tableau - foreground data and background data. All information entered by the operator is categorized as foreground data and can be altered from the TKB. Background data is that which acts as a cue to the operator and cannot be altered by the operator.

ALERT NO 1
ALERT NO 2
ALERT NO 3
ALERT NO 4

STATUS MSG
STATUS MSG

STATUS MSG
STATUS MSG
STATUS MSG
STATUS MSG
STATUS MSG

QUEUE FULL MSG

01 TABLEAU

02
03
04
05
06
07
08
09
10
11
12
13
14
15
16
17
18
19
20
21
22
23
24
25
26
27
28
29
30
31
32
33
34
35
36
37
38
39
40

41
42
43
44
45
46
47
48
49
50
51
52
53
54
55
56
57
58
59
60

ERROR CUE

CLEAR CUE AREA

CUE
CUE
CUE
CUE
CUE
CUE OR BACKGROUND CONTENT OF SELECTED LINE
BACKGROUND FORMAT, LEFT JUSTIFIED
CURSOR

PLATE (10) TABULAR FORMAT

Portions of the cue list located in the lower left hand corner of the display occur as tableaus are requested from the system. When the operator has correctly identified the desired tableau, he responds to those decision cues by entering appropriate letters or numerals corresponding to his preferences. Background content of the line selected for updating, in addition to a cue, may appear at the bottom left side of the display. Errors in answering decision cues result in advisory messages (e.g., format error) located directly below the twentieth line of the tableau.

Tableaus may be accessed from either the MEP or TKB as a result of certain duplicated functions. However, alphanumeric data can only be entered from the TKB as will be seen in the section on MEP and TKB. Numeric data may be entered from either panel.

b. Performance

The following is a list of Tabular Display Channel Performance characteristics taken from Ref (7):

1. 512-line-by 720-element raster display.
2. 60 Hz frame rate, no interlace.
3. Fixed format 40-row-by-80-column character display yielding 3200-character maximum plus cursor.

4. Blinkable characters on selectable basis.
5. Real-time video generation with automatic character spacing.
6. Internal edit operations on operator-entered data (foreground).
7. Background data displayed at lower intensity than foreground data.

Characters are defined in 7 x 9 element font and the display is refreshed at a 60 Hz rate. Display update, which can be performed during vertical retrace, is completed in one display period without associated flicker. Automatic character spacing is incorporated in the real-time video display. As in the Tactical Display appropriate blanking is accomplished to eliminate overlapping of signals and maximize resolution.

Hardcopies of Tabular presentations are available with appropriate actions from the MEP or TKB.

Editing of foreground data is accomplished as a function of a horizontal cursor's position controlled at the TKB. Background data cannot be altered regardless of cursor position.

D. CONTROLS

A few of the uses of the Manual Entry Panel (MEP) and Tabular Keyboard have been mentioned. MEP's and TKB's located at each station are identical. Since cost advantages exist in this type of standardization, the Watch Officer's Station is treated as though it were required to perform all tasks of the TSC. Identification of problem areas in Chapter IV are assumed to apply equally to each station unless otherwise noted.

The MEP and TKB are direct links between the operator and computer-generated displays of the processing system. Since this link is the most apparent interface between man and machine, it is discussed in detail.

1. Manual Entry Panel (MEP)

The Manual Entry Panel is primarily associated with the Tactical Display and allows the operator to influence Tactical Display information as well as communicate with other units of the display system. Functions which are duplicated on the MEP and TKB panels are identified later.

The MEP shown in Plate (11) is mounted on the self-contained Bullnose Assembly previously discussed. A communications panel is included in the upper left hand corner of each MEP. Plate (12) shows functional assignments.

MISSION COMMANDS

LAMP TEST

taco 1	AIC 1&2	trk sup	SWC	+
taco 2	AIC 3&4	CICO	ADP	point
rad1 MON	rad2 MON	rad3 MON	rad4 MON	act dial
rad1 XMIT	rad2 XMIT	rad3 XMIT	rad4 XMIT	term dial
frn air	h-u air	frn sub surf	h-u sub surf	asw plat
+	+	+	+	+
ref mark	+	clr pnt	+	clr alrt
sta id	+	clr tac plot	+	+

miss plan	brief	man dbrf	+	miss repl	enter cntct	enter data	recl sens	recl type	miss repl 2
comp contr	data link	+	disp aids	track 1	hard copy	+	data extr	amp data	track 2
ack cntct	disp tac plot	disp IOIC	disp rdr	128 nu scl	inc scl	cen on CV	chg scl	index	adv
read stat	grid coord	mark time	enter plot	cen on A/C	decr scl	cen on hook	+	sel line	retrn

desg sys

dstry pnt

PRO

mond

TRACK INHIBITS

MISSION MODES

DATA ENTRY

frn air	h-u air	frn sub surf	h-u sub surf	asw plat	miss repl	enter cntct	enter data	recl sens	recl type	miss repl 2
+	+	+	+	+	track 1	hard copy	+	data extr	amp data	track 2
ref mark	+	clr pnt	+	clr alrt	128 nu scl	inc scl	cen on CV	chg scl	index	adv
sta id	+	clr tac plot	+	+	enter plot	decr scl	cen on hook	+	sel line	retrn

1	2	3
4	5	6
7	8	9
ne	0	sw
enter		

DISPLAY CONTROL

hook ver

hook ver

PLATE (11) MANUAL ENTRY PANEL

LAMP TEST

pro

no

CATEGORY I

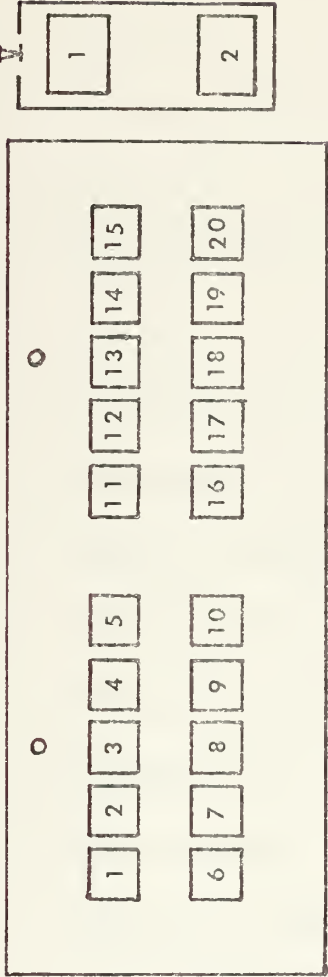

VI

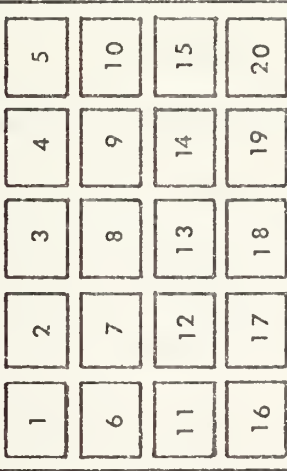

CATEGORY II

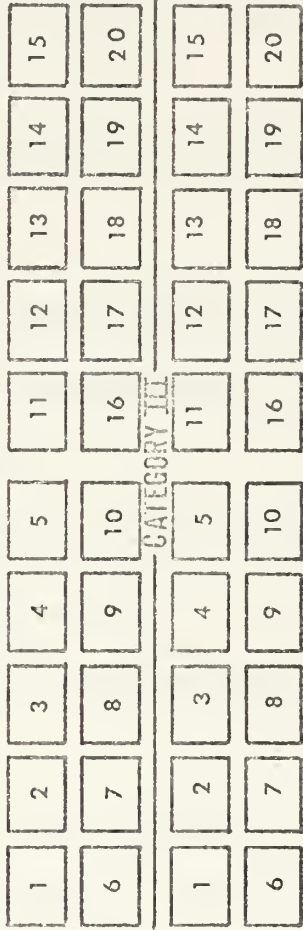

V

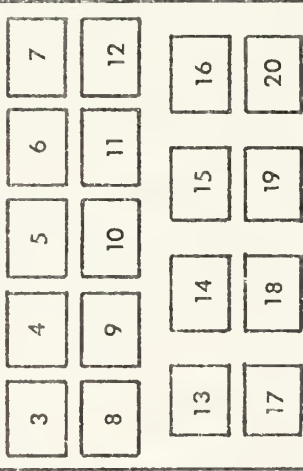

III

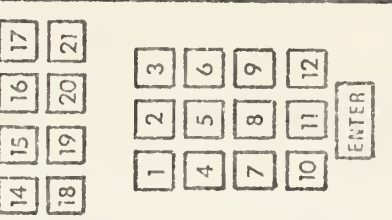

CATEGORY III



force stick

PLATE (12) FUNCTIONAL CATEGORY ASSIGNMENTS OF MANUAL ENTRY PANEL

Switches on the MEP are divided into seven functional groups listed below: Ref. (7).

Category I - 20 Projection Readout switches (matrix readout)

Category II - 20 monofunction switches (mission modes)

Category III - 20 monofunction switches (display aides)

Category IV - 2 monofunction switches (hook verify)

Category V - 18 monofunction switches (inhibits/display controls)

Category VI - 20 monofunction switches (12 blinkable, communications)

Category VII - 21 monofunction switches (numeric/data entry).

Plate (12) shows the MEP with category assignments.

a. Projection Readout Switches (PRO)

Category I switches are Projection Readout (PRO) switches and are of IEE Model 880 type. See Plate (13).

PRO switches are divided into two groups as are Category II switches. See Plate (14). Depression of a Category II switch (matrix select switch) of Group 1 causes illumination of one level of ten PRO switches also in Group 1. (Group 1 switches are numbered 1 through 10, Group 2

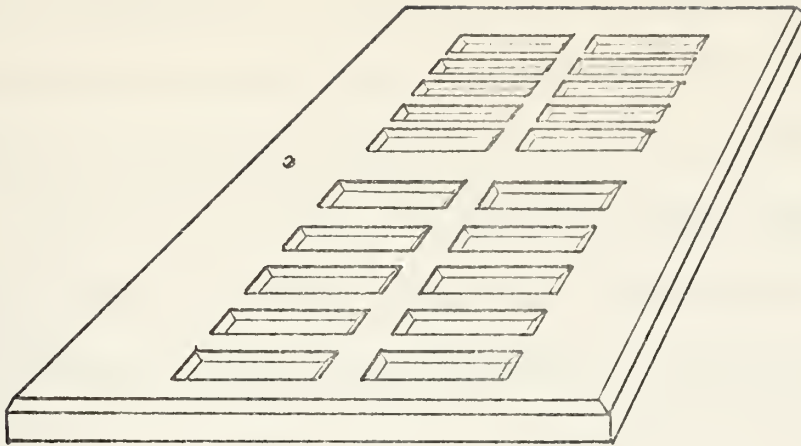

Plate (13) Category I, PRO Switches

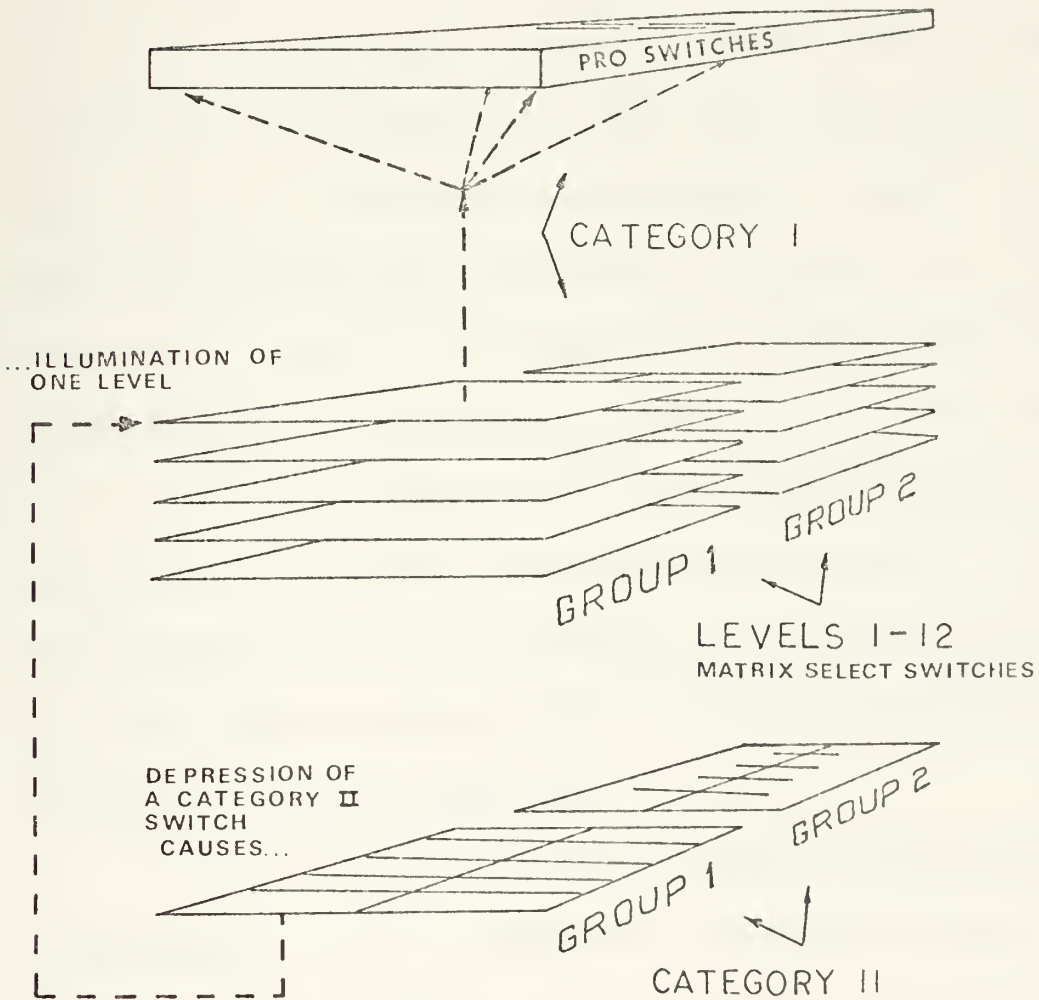

Plate (14) Groups, Categories and Levels

are 11 through 20). The PRO switches are divided into twelve levels, each level incorporating two groups. Level twelve is currently utilized as growth potential and level 11 is activated or deactivated by the PRO lights test switch. The remaining levels are controlled by Category II switches (matrix select switches). Matrix select switches of the same group are mutually exclusive, i.e., only one matrix select switch of a group illuminates a PRO level at a given time.

Since only one matrix select switch of each group can be activated at a given time, only one level of each Category I group can be activated at a given time. When one PRO level is illuminated, depression of another Category II switch of the same group extinguishes the first level and illuminates the most recently selected level.

Upon receiving the appropriate command from a matrix select switch, a corresponding Category I level is illuminated and film chip labels are projected and focused onto the switch surfaces. The viewed presentation is white letters on a grey background.

Positive indication of PRO switch depression is indicated by brief illumination of a small red light on the matrix border centered above each group. No tactile feeling of button depression can be utilized by the operator as

feedback; however, in some cases, alterations in the display can be used as positive indication of switch activation.

b. Category II - VI Switches

All switches of Categories II - VI are identical in design and spacing. Each monofunction switch extends approximately 1/8" above the panel surface and are 1/2 x 3/4 inches.

c. Category VII Switches

Category VII switches are raised from the panel surface approximately one half inch. These monofunction switches have square contact surfaces of approximately 1/2 x 1/2 inch. The ENTER key in Category VII is rectangular and is also raised 1/2 inch.

Plate (11) is a scale view of the Manual Entry Panel currently installed in a CV/TSC. A two-dimensional force stick is incorporated at the lower center position of the panel. The two buttons located on either side of the force stick and labeled HOOK VER are associated with the force stick-controlled cursor functions. The amount of pressure applied to the force stick controls the rate at which the cursor moves although five selectable force to speed ratios are available to the operator at the maintenance-test panel.

With the exception of the unique PRO switches all buttons are internally backlighted. Switch depression causes normal green illumination to momentarily change to amber indicating switch activation to the operator. All buttons on the MEP have black backgrounds with green or amber lettering - depending on switch status. Brightness is controlled with a rotary type rheostat located below the MEP.

Typical functions performed at the MEP include scale changes, clearing of display data, addition of amplifying data, and entry and removal of selected tactical data during mission planning and mission replays.

2. Tabular Keyboard (TKB)

The Tabular Keyboard provides the direct interface between the operator and Tabular Display. Use of the TKB enables the operator to change foreground data on the Tabular Display. See Plate (15).

The TKB is mounted on a bullnose assembly and, like the MEP, is a self-contained, independent unit. Switches on the TKB are separated into five functional groups for this description. See Plate (16).

a. Categories 1, 2, and 3

Categories 1 through 3 include switches similar to most electric typewriters. Keys slope forward and have

11	12	13	14	15	16	17
18	19	110	111	112	113	114

indx	adv	next	clr	send
line	ret	line	alt	msg
sel	ret	acpt	tpl	on/off
line	msg	msg	msg	line

on	line
off	line

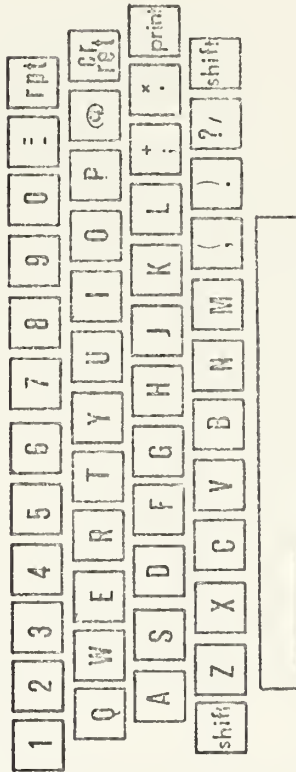

ins	line	ins	char
del	line	del	char
clr	fg		

PLATE (15) TABULAR KEYBOARD

CATEGORY 5

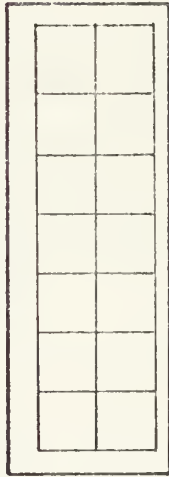

CATEGORY 4

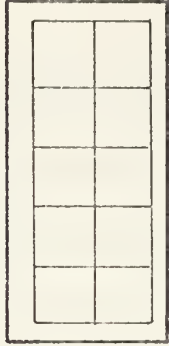

LAMP
TEST



CATEGORY 3

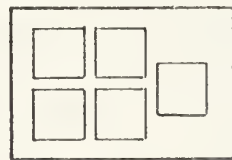

CATEGORY 1

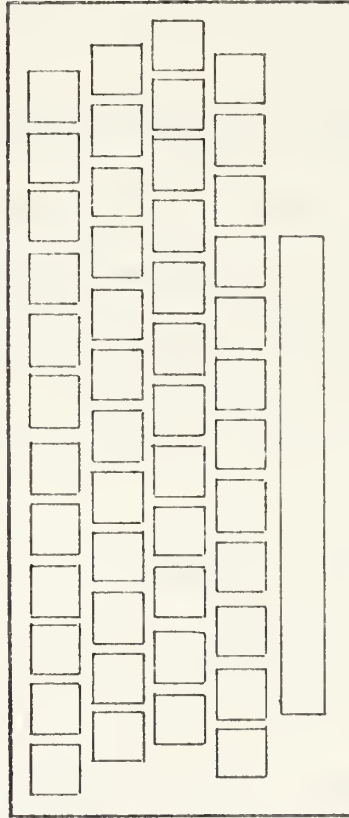

CATEGORY 2

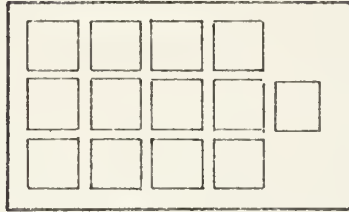

CATEGORY 3

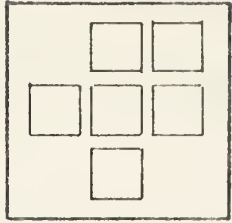

PLATE (16) FUNCTIONAL GROUPS OF THE TKB

concave surfaces. Spacing between keys is similar to standard typewriters.

Each button is etched appropriate to its function and is internally backlighted through the green translucent symbols.

The only significant difference in Category I keys and those of a typewriter is that of the upper-case symbols co-located with numerics. The upper-case symbols are utilized to code various platforms and/or events on the tactical display unit.

Category 2 keys are utilized for numeric data and include the ENTER key which may be utilized to manually enter any acceptable data into the computer and hence the display. With the exception of the bottom row of keys and the ENTER key position, Category 2 keys are in standard adding-machine format.

Category 3 keys are utilized for edit functions. Those on the left are used to insert or delete complete lines of data, a single character or clear all foreground data. Keys on the far right control cursor position indicating which line or character may be altered.

When operating alphanumeric keys, sequences of release has no effect on input since switch activation occurs on the downstroke. If one key is held down while

a second is depressed, input data from the second is entered irrespective of the first key.

An audible tone is incorporated to alert the operator when the right-hand margin of the display is being approached.

b. Categories 4 and 5

Categories 4 and 5 switches are similar to those of Category 2 on the MEP. Category 5 switches are presently assigned for expansion while switches of Category 4 are primary control keys.

E. COMMUNICATIONS

The TSC's computer-assisted communication system interfaces with less sophisticated hardware to provide the communication and transmission capabilities discussed in Chapter I. This section contains an overview of the communication system and includes the most important interfaces. It also includes brief descriptions of required procedures to effect desired communications.

1. Audio Switching Matrix (ASM)

The ASM provides the audio interface for communications within the TSC and associated subsystems. It also functions as the interface between the operator and audio equipment external to the TSC, e.g., monitors, sound-powered

phones, intercom, PA systems, radios and recorders. Additionally, the ASM links the TSC's Automatic Data Processing subsystem to the NTDS console interphone system. While the ASM may be controlled manually, it is normally controlled automatically by the AN/UYK-20 minicomputer.

The switching matrix provides up to 10 TSC operators with the capability of connecting with any of 52 possible stations. In its expanded configuration the network could provide up to 90 input circuits with any of 96 output circuits. For "push to talk" communications (Keyline) the ASM allows ten TSC operators to talk with a maximum of 30 other stations (15 NTDS, 5 Radiophone, 5 Sound-Powered Telephone, and 5 ICS). Ref. (8).

2. Internal Communications System (ICS)

ICS controls are located in the upper left-hand corner of the MEP and are blinkable, monofunction switches. See Plates (11) and (12). Switch activation routes signals through the ASM and to the Display Generator Unit providing the operator with alerts, cues or status information.

Depression of a direct access switch such as TACO 2 at Station III (Watch Officer) causes the button labeled TSC WO at Station II to blink and the cue TSC WO CALLING to appear on the display. In response, when Tacco II depresses TSC WO, the circuit is completed and a flashing alert - CALL

ACTIVE - appears on the display at each station. (Each operator has the option of using headsets or speakers with hand-held microphones or a telephone with which to communicate.) The circuit is disconnected by either station upon depression of the ACTIVE button. The alert then changes to CKT DISC. Other cues which are displayed include CLEAR CUE AREA, OPER NOT AVAIL, CALL REFUSED or CALL LIM EXC.

a. NTDS

Direct access to specified NTDS interphone system stations is provided at the TACCO stations and at the Watch Officer's station. Incoming calls from NTDS units are only received at the Watch Officer's Station due to software limitations.

b. Dial Up

Dial up capability is provided to each operator. The operator determines appropriate two-digit numbers by accessing the communications tableau which lists stations and associated numbers. Depression of ACT DIAL causes the cue ACT DIAL NN to appear on the display. (NN tells the operator two numbers are required to meet format requirements.) Entry of the two numbers opens the associated circuit. The call may be terminated by depression of TERM DIAL (also terminating any other dialed circuits at that station).

c. MC Circuits

MC circuits include the 21 MC (Captain's Command Circuit), 22 MC (Radio Room Circuit), and the 24 MC (Flag Officer's Command Circuit). MC circuits can be accessed via the dial up system, however, "...selection of an MC circuit must be done by notifying the Watch Officer since the Watch Officer must select the desired station." Ref. (8).

The ICS system also allows monitoring of radio communications and acoustic information relayed by MCJR or replayed from a cassette.

3. Radio

Tactical communication between the TSC and its operating units is provided primarily through covered or uncovered voice networks. Secure voice is provided at both Tacco Stations and at the Watch Officer's. These phones are linked into the ship's secure voice matrix and transceivers. Four frequencies, preassigned by ship's communication, may be available to the TSC and would be controlled with the buttons labeled RAD1, RAD2, RAD3, RAD4 in Plate (17).

The Tacco or Watch Officer may simultaneously monitor any number of the TSC's radio circuits by depressing the RAD MON for the desired circuits. Transmission on a

single circuit is available by merely depressing RAD (8) XMIT for the circuit desired. "The radio circuit active for transmission shall be noted in the status portion of the Tactical Display in order to keep the operator informed at all times that he is transmitting beyond the CV." Ref. (8).

TACO 1	AIC 1&3	TRK SUP	SWC	+
TACO 2	AIC 2&4	CICO	ADP	POINT
RAD 1 MON	RAD 2 MON	RAD 3 MON	RAD 4 MON	ACT DIAL
RAD 1 XMIT	RAD 2 XMIT	RAD 3 XMIT	RAD 4 XMIT	TERM DIAL

Plate (17) Watch Officer's Communications Panel

Secure UHF is available with the red phone only. Transmitting and receiving on uncovered tactical networks is accomplished with the ICS phone or the headset. A floor-mounted foot key is provided to key the selected transmitter leaving the hands free for other duties.

The stereo/monaural headset plugs into the console (below the bullnose) and is of a light weight type of construction. Selection of Channel A or Channel B on the ICS panel routes the respective channel into both earphones.

All transmission is accomplished over Channel A. Selection of A and B provides the stereo capability with Channel A in one side and Channel B in the other.

A brief summary of results due to button activation is provided below.

If an MEP button is pressed in the ICS mode or a dial up of an ICS Station is initiated - and if the ICS mode is not currently active for the TSC operator originating the call, then Radio mode is deactivated and ICS mode is activated resulting in:

(1) A check is made for the alerts, errors, etc. as previously described.

(2) The Communications Tableau of active circuits for the TSC operator is updated accordingly and displayed.

If an MEP button is pressed in a radio mode or a dial up of a radio circuit is initiated and if radio mode is not currently active for the TSC operator, then all active ICS circuits are switched to monitor-only status:

(1) If the radio communications circuit is active, then the active radio circuit is deactivated.

(2) The communications tableau of active circuits for the TSC operator is updated and displayed.

4. Other External Communications

Other means of tactical ASW communication exist.

"Many operational orders, queries for data, and status reports are formatted into standardized messages and sent using radio-teletype circuits." Ref. (8). Currently a teletype (UGC-12) is located in the TSC and can be patched through Ship's Communications and provide a monitoring capability independent of the TSC ADP system.

Future TSC models will be capable of digital exchanges via Link 11. "The essence of the Link 11 system is that a data-processing system is used to generate, format, store, and transmit vital information automatically, thus relieving an operator from having to perform this function manually." Ref. (8). At the present time, received Link 11 messages are translated into ADER (Automatic Data Extraction Routine) messages. There are 29 separate ADER messages; each one a precise bit of information. Of these, the TSC presently utilizes only nine.

F. WATCH STATION INTERFACES

The Tactical Support Center system may be divided into five subsystems - Automatic Data Processing (ADP), Display, Communications, Fast Time Analysis System, and Human Servo-mechanism. Plate (18) depicts the four subsystems of interest to this treatment.

all others. Simultaneous access of tabular data is possible as long as no operator is altering the tableau of interest.

The Tactical and Tabular DGU's, display units and other associated hardware comprise the Display Subsystem. For purposes of this paper it is sufficient to recognize that hard copies of tabular or tactical displays may include SCU data and that SCU data transmitted to the Tabular Display is background data (hence unalterable by the operator).

Communications within the TSC is the subject of the previous section. However, communication between any station is possible with appropriate selection at the MEP's.

The Acoustic Analysis subsystem relies on incoming acoustic information via MCJR/MCDR or acoustic information derived from S3 acoustic tapes. The information is then processed by the Fast Time Analysis System and displayed at the ACAN station. At any time during the process, the ACAN operator can exchange tactical and acoustic information with the Tactical Coordinator.

III. MAN AS A SYSTEM COMPONENT

One formula describing human response sets as a function of stimulæ would, theoretically, allow a concise description of a human servo-mechanism in the same manner TSC components are described in the previous chapter. Obviously, such a formula is non-existent, primarily due to the wide range of variables and nonlinearity of human responses. If a formula did exist, it would probably be possible to construct a machine which could perform the same tasks as the human.

Included in this chapter is a treatment of the operator viewed as a servo-mechanism in the TSC, relating operator functions to the mission description of Chapter I, Plate (1). Operator tasks are then treated, establishing a basis for identification of stimuli presented to the watch station operator. (Specific TSC operating procedures are not included in this paper since their description is the subject of various references published under the auspices of NADC.)

A simplistic model of the human component and some of the inherent relationships are also included in this chapter since certain sets of sensory and response data allow rough-cut solutions to many function-allocation and design problems.

Treatment of the human as a servo-mechanism is a matter-of-convenience rather than a matter-of-fact. Man is far too complex in his responses and processing abilities to realistically be defined as a servo-mechanism.

Perhaps the feature which most distinguishes man from machine is the human's ability to modify many of his characteristics to meet requirements of a vast range of situations. This is not to imply man is infinitely adaptable; the statement itself defies common knowledge. But it does allude to the difficulties facing the psychologist and human factors engineer; preferred methods of presenting information to an operator can be identified for a variety of general situations, but the "best" method of presenting information to an operator remains elusive; there may be no "best" method.

It is the goal of this chapter to relate some of the requirements placed upon an operator in the existing TSC. It is also intended to depict the operator and Watch Station as components of a man-machine system with a common mission.

The human element is described in sufficient detail for an appreciation of the complexity of designing a system within which human psychological and physiological capabilities are maximized. Specific areas have been included to provide background for the following chapter while some

topics are included which would be of use for future studies. This chapter relies heavily on Refs. (11), (12), (13) and (14).

A. CLOSED-LOOP SYSTEMS

A closed-loop system is defined as one in which the human operator alters machine operations based on system output data in order to control or stabilize that output. Such a generalized loop is pictured in Plate (19).

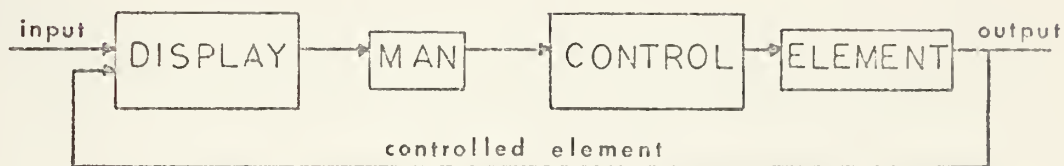

Plate (19) General Closed-Loop System

TSC watch stations, as well as most manual control and monitoring systems, can be considered as a closed-loop system. Plate (20) is a representation of a TSC station with an operator as elements of such a closed-loop system. The operator portion is more detailed than commonly found but the detail serves to amplify man's role in the TSC.

The TSC has been described as a closed-loop system since studies conducted on continuous-system control have emphasized closed-loop systems in which effects of control data are returned to the displays. It is not meant to imply that

all interactions of TSC display, operators and controls are in the category of closed-loop systems. However, many important operations in the TSC are of the closed-loop type and merit consideration from that view.

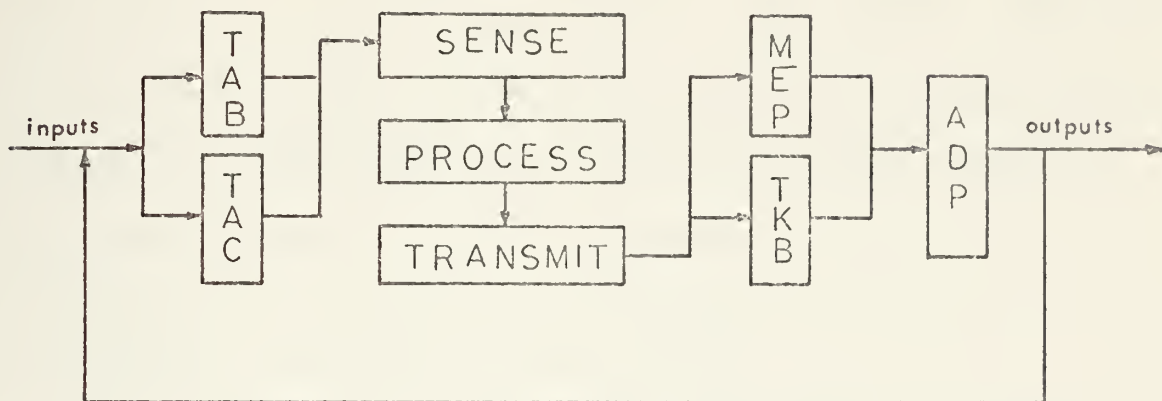

Plate (20) Watch Station as Closed-Loop System

The diagram depicts the two types of general information - tactical and administrative - which might flow through the system at a given time. In this form, however, the diagram does not adequately imply existing relationships between the operator and the control console, i.e., TKB or MEP. As man senses, perceives, processes and effects decisions from display information, he also interfaces with controls in a similar manner, i.e., the MEP and TKB are also a display (control display) and require that the operator sense, perceive, etc. before the operator alters their status.

The preceding discussion centers on the TSC operator's function as a controller. Man performs many functions in

man-machine systems including controller, monitor, evaluator and communicator. Man's role in the TSC is, however, more basic. "The primary role of a human in a complex system (the TSC qualifies) is that of an information-receiving, processing, or transmitting element." Ref. (13). Discussion of the human in these roles is provided in following sections preceded by identification of some of the more important functions assigned to the TSC operator.

B. FUNCTION ALLOCATION WITHIN THE TSC

It is necessary to distinguish functions and tasks of the system from Functions and Tasks of the operator (references to operator Functions and Tasks will be capitalized). Plate (1) of Chapter I is designed to infer system functions - (1) Preflight, (2) Inflight and (3) Postflight - and system tasks - equipment operations, assimilation, briefing, etc.

Construction of a similar type of diagram with the operator as primary subject, rather than the system, is possible by incorporating man's role - receiver, processor and transmitter - into system functions. It is then clear that, in the frame of reference of Plate (1), man's Functions are system tasks. A listing of duties or Tasks required to fulfill each Function can be developed from established operating procedures. Such a listing provides a set of

interactions indicative of sensory requirements placed upon an operator by the Watch Station configuration.

Limitations inherent in this type of analysis were previously mentioned. Identification of each task and its "apparent" associated stimuli does not imply the extent of influence exerted by other unrelated stimuli. Application of generally accepted human limitations, in conjunction with Task identification, can, however, provide reasonable approximations regarding areas of possible operator overloads. While a better method of determining overloads might be time-line analyses of operational TSC's, various constraints of this thesis made that type of approach unrealistic.

A large majority of TSC Tasks require the operator to sense visual stimuli including Control Tasks with the TKB, MEP and Monitoring Tasks associated with the Tabular or Tactical Displays. The second stimulus most frequently occurring is aural. The aural sense is, with only one exception, utilized for standard voice communications. A third sensory requirement of the operator is tactile, utilized as a positive feedback indication of switch depressions.

An operator seldom uses any sense independently, as if in a vacuum from the others. The three senses mentioned

are of primary importance to the TSC operator but are not exclusive of those omitted from this discussion.

C. MAN AS AN ELEMENT

An appreciation of man's sensory capabilities and limitations is necessary if man's contribution to a system is to be understood. A basic model of man's processing system is developed in this section to identify areas subject to variable operator performance.

1. Model

Man acts as a receiver when stimulus sets of sufficient intensity impinge upon his senses - visual, auditory, tactile, etc. Depending on factors including intelligence, education, motivation, stress and fatigue, the stimulus may be perceived and formed into a mental image for short-term storage. In processing the image, the operator often uses another important capacity - his memory, and the ability to compare what he perceives with past experiences, to recall operating rules learned during training or to coordinate what he perceives with strategies he may have formed for handling similar events. Ref. (12).

Although processing functions in man are beyond the scope of this paper, some comment is included to indicate human limitations. Storage of images in short-term memory

is often considered to be a discrete processing function of the human implying that signals (perceived stimulus formed into images are processed discretely in some type of order. Experimental data indicates man is, in fact, a discrete processor, providing theoretical basis for consideration of operators in overloaded and underloaded states.

Comparison of the perceived stimulae, stored in short-term memory, with education and strategies, accumulated in long-term memory, may have the effect of altering the operator's perception of future events. A diagram of man as a receiver, processor and transmitter is provided in Plate (21).

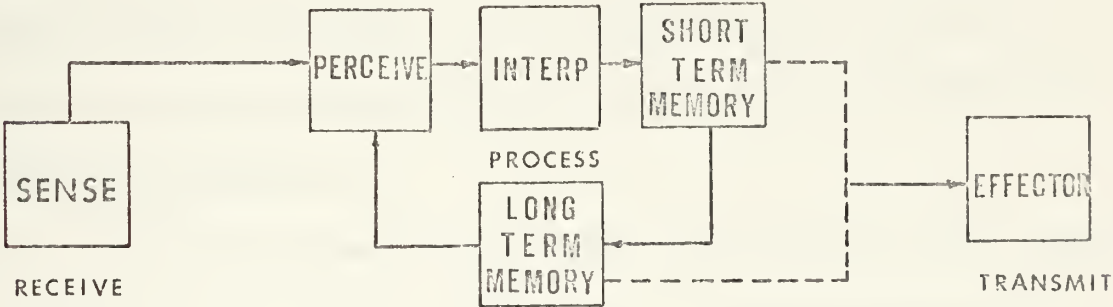

Plate (21) Man as Receiver, Processor and Transmitter

Assuming that a decision is formulated in the processing stage, the decision is effected by the human as a physiological action (motor skill) or a more general class of actions labeled language skills. Motor skills are used predominately in the TSC to alter display information from

the MEP and TKB's. Language skills are used for most communications within the TSC and for exchanges with units external to the TSC. (An ultimate goal of the TSC design seems to have been to provide a system which required virtually no verbal communications with external units. All exchanges would have been digital, i.e., computer to computer.)

2. Noise in the Model

Certain perturbations adversely affecting operator performance would be better placed in an operating procedures manual, e.g., effects of fatigue or inadequate training. They are included in this section, however, to imply that system design may cause, or at least amplify, adverse effects on operator performance; hence causing changes in system performance.

Perturbations of the model are caused by what might be termed (in a broad sense) Noise - the presence of undesirable signals concurrent with desired (pure) signals and which adversely influence any of man's receiving, processing or transmitting capabilities. Presence of Noise results in stress - a psychological or physiological imbalance requiring adaptation by the operator.

Stress on the operator over a sufficient period of time (dependent mostly on the type of stress and how it is

perceived) results in operator strain or fatigue - a physiological or psychological effect which degrades the operator's immediate (and in some cases future) capabilities. Stress may be measured but fatigue is more difficult since it is a subjective response of inadequacy to cope with conditions of a given situation. Psychological fatigue impairs cognitive processes and degrades operator performance while physical fatigue represents physical impairment. Ref. (14).

a. Environmental Stress

Generally included as environmental stresses are excesses in temperature, atmospheric contamination, noise and vibration. Environmental stresses may adversely affect performance in two ways. Sensory modalities may be reduced directly or as a causitive of psychological stress, sensory or motor performance may be indirectly modified. Ref. (13).

For example, the following list taken from Ref. (12) is a partial listing of critical temperatures at which efficiency is impaired as an operator performs certain tasks. (Levels of significance were not available.)

NAME & TYPE OF TEST	INVESTIGATOR	MAX TEMP F ^o W/NORMAL PERFORMANCE	TEMP OF STATISTICALLY SIGNIFICANT IMPAIRMENT
Typewriter Code (Scrambled letters)	Viteles	80	87
Locations (Spatial relations code)	Viteles	87.5	92
Block Coding (Problem solving)	Mackworth	83	87.5
Visual Attention (Clock test)	Mackworth	79	87.5

Extrapolation of the results of the tests is hazardous, but in light of the statistical significance of each of the last column's figure it is reasonable to assume the temperature of working spaces should be below 90 degrees Farenhiet.

But the intent is not to extrapolate experimental results which are unrelated to the TSC system. Rather, the point is that general limits can be developed if appropriate performance criteria is established and tested with an operational TSC.

b. Training/Education

Training and Education play a large role in development of the operator's long-term memory capability and establishment of stimulus-response sets. Training is

mentioned only to amplify the need for a carefully constructed training program whenever man is required to function within a complex system since overloading forces an operator to rely on "automatic" processing rather than actions which require more time and increase the overload.

c. Overloads

Overloads occur as Tasks and stresses accumulate and the operator is unable to adapt further. The stresses may be one or a combination of four general types - (1) psychological, (2) physiological, (3) task induced or, (4) social-political. (Environmental effects on operators are manifested as psychological or physiological stresses and are considered in those categories.) A measure of overloads is implied by general functions of performance versus stress. A graph is shown in Plate (22) as an inverted U.

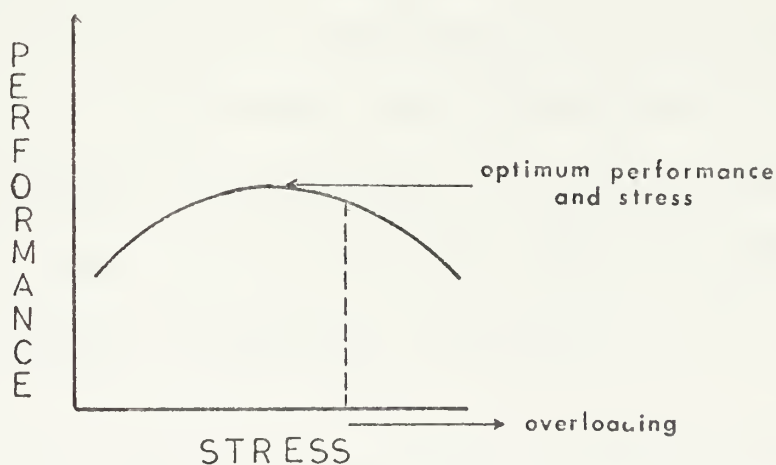

Plate (22) Performance vs Stress
Taken after Ref. (14)

The graph implies the existence of an optimum level of stress - that point where performance is maximized.

Significant to this treatment, however, is the area at the far right of the graph where performance decreases as stress increases.

If stress is due to information overload, an operator's response may be to increase his workrate and allow an increase of errors. Or, the operator may (consciously or unconsciously) act as a filter, clipping portions of incoming information. Another adaptation might be queuing in priority lists. As overloading increases, eventually the operator may choose to eliminate the overload by quitting the Task.

It is important to note that accumulation of stresses is not necessarily additive in nature. "Broadly speaking, the effects of a continuum of stresses can take the form either of summation, where performance is worse when two stresses are applied than it is when either stress is applied singly, or of interaction, where the effects on one stress appear to cancel out the effects of the other." Ref. (13).

Lacking experimental data on an operational TSC, it is worthwhile to identify areas of probable stress and eliminate them where possible. Admittedly, it is not the

best method of developing optimal performance, however, it can, as a minimum, fulfill the need between applied experimental data and the easiest alternative of inaction.

D. DISPLAY FUNCTIONS

Consideration of each display's function implies the type, amount and form of information most suitable for presentation. A single function of each display, chosen to infer the primary purpose of each of the three (Tactical, Tabular and Controls), has been selected for discussion.

1. Tabular Display

The Tabular Display serves as a primary briefing tool. As a briefing presentation, a long-term storage capability for large quantities of information is available relieving operators of a massive task of documentation and/or memorization.

Briefings presented by the TSC fulfill various needs. It is important that briefings are presented in a format which serves to key the recall both of the TSC operators who "error-check" input data and of flight crews who must use briefing data when performing their mission. The implication is clear; briefings presented by the TSC are "learning" experiences for the flight crew personnel necessitating construction of the brief, taking advantage of the human's learning process.

2. Tactical Display

The function of the Tactical Display is to depict continuous tactical situations in symbolic form. The Tactical Display and associated control tasks are the most obvious examples of the TSC as a Closed-loop system. The complexity of tactical problems and the method of presentation especially taxes the human's abilities of perception and pattern recognition in this type display. It requires the operator to interpret symbology and develop an understanding of the total tactical picture, not limited to the immediate display presentation.

The operator is not required to identify electromagnetic signals in the presence of noise, that function is assigned to others in the TSC. Rather, he is required to formulate tactics from an accumulation of past information, the current situation and strategies formed during prior experiences. Lacking the requirements of threshold signal detections, the tactical display places interpretation and decision-making demands upon the operator.

3. Controls

The MEP and TKB force the operator to make decisions regarding the manner in which other display information should be altered. The primary function of the two panels, however, centers around control functions - the physical

operator-machine interface and the relationship between displays and controls.

Relevant questions regarding the control panels include illumination, functional groupings, compatability of controls and displays and compatability of switches with human physiology.

E. MAN'S LIMITATIONS AND CAPABILITIES

An exhaustive treatment of man's limitations and capabilities is not presented in this paper since they are the subjects of numerous books, e.g., Refs. (10) and (12). Instead, only general limitations are included to delineate some of the more important areas which might be appropriate for further studies of the TSC.

1. Primary Sensors

Previous discussion included designation of the primary sensory requirements of a TSC watch station. Listed in order of the amount of information presented in the respective forms, the sensors include visual, aural and tactile.

a. Visual Sense

Some aspects of visual performance can be understood from an anatomical basis. Particularly useful is the knowledge of the density of rods and cones on the retina.

The cone system is basically necessary for detail and color vision while the rods provide for detection of small amounts of light. In general, rods require much less radiant energy to be stimulated than do cones.

(1) Brightness Sensitivity. Brightness sensitivity is a function of the amount of radiant energy and the wave length of that energy. A plot of relative sensitivity to light as a function of wave-length indicates that rods are most sensitive to wave-lengths at about 525 nanometers while cones are most sensitive at about 560 nanometers.

(Blue is 476, Green is 515 and Yellow is 582 nanometers.)

(2) Brightness Discrimination. Brightness discrimination refers to the capability of discriminating a target as a function of background luminance. As illumination increases, the capacity of the human to detect differences in the brightness of objects also increases. Similarly, as target size increases, discrimination increases.

(3) Visual Acuity. Visual acuity is one of the parameters of primary interest in a display study. Foveal acuity (central vision) increases rapidly with background luminance up to one mililambert and then levels off. At four and 30 degrees from the fovea, large objects can be discriminated at low luminance values.

Since the Watch Station operator is not required to detect and classify targets from the displays included in this paper, minimum separable acuity, also called gap resolution, is relevant. Gap resolution is defined as the smallest space the eye can detect between parts of a target. As the amount of light is increased, smaller gaps are detectable; as the amount of light increases, acuity increases.

For white targets on a black background (such as letters or numerals cut out and lighted from behind) acuity first increases with luminance up to about 10 mL and then levels off. Above 10 mL, however, acuity for white-on-black targets rapidly decreases as the white parts blur (commonly termed irradiation). Less contrast implies less acuity. It is more difficult to see black on gray than it is to see black on white.

High levels of luminance degrade visual acuity. When the eye is adapted to the luminance level of the target, visual acuity is maximized. Acuity is reduced when the target and its immediate surroundings are not as bright as the immediate background. Acuity is also slightly reduced when the surroundings are considerably darker than the target area. Refs. (12) and (13).

(4) Target Size. Reference (15) considered the effects of target size on target search and identification. The results imply that when the largest dimension of the target subtends a visual angle less than 12 minutes or arc, time to detect and identify, as well as identification errors, increase. With low contrast levels, size of the target should be increased by a factor of two or three.

Letters of the alphabet are identifiable as they subtend an angle of at least 5 minutes. Letters are discernable in most instances, partially due to the human's ability to determine context and the repetitive nature of the written language. Ref. (12).

(5) Other Considerations. The four areas listed above are far from exhaustive. Viewing distance must be considered and is implied when discussing visual angles. Angle of view (best is usually when displays are perpendicular to direct line of sight) is a necessary consideration. The total pattern of displays is also an important area of concern to operator functions as is glare, an obvious detractor, which should be eliminated wherever it occurs.

b. Auditory Capabilities

Auditory stimuli occur as differences in sound pressure levels impinge upon the eardrum. The commonly accepted frequency range discernable by the human ear is

from 20 to 20,000 Hertz. The differences in the amount of acoustic energy required for perception of sounds across the frequency range is large.

(1) Threshold Detection and Intensity. The ear is slightly more sensitive to frequencies above 1000 Hertz; the threshold of audibility (the least amount of energy which can be detected) occurs at about 5 to 10 dB lower, near 3000 Hertz. Unless an operator suffers from a hearing loss, the watch stations of TSC, with the exception of the TACCO stations, are not concerned with threshold detections in their communications systems.

Intensity and frequency, however, are important, as are the subjective characteristics of loudness and pitch. Masking becomes important when operators simultaneously monitor different channels and attempt to decipher a single conversation or when other acoustic stimuli, ambient noise or transmission noise, interfere with the perception of the desired message. Reference (16) concluded that there is more masking between tones which lie close in frequency than for those farther apart and that a low frequency tone more effectively masks a higher frequency tone than conversely.

White noise masking is relatively constant across the frequency range.

(2) Speech. The primary form of communications in the TSC is by voice rather than hardcopy or digital relays. Speech perception is a function of masking, familiarity with the message, frequency and amplitude distortion. Man's ability to perceive severely distorted speech is, to an extent, due to the repetitive nature of speech.

A signal in the presence of noise is easier to detect if the source of the noise occurs from a different direction than the signal. This effect can be obtained by use of amplitude and/or phase control in a stereo headset. The effects of masking can also be reduced if each ear is presented the same signal with masking noise acquired from a different source.

2. Effectors

a. Language Skills

Reliability of verbally communicated information is dependent upon the type of messages sent and the language used. Reference (17) concluded that longer words are more often correctly received than short words, probably due to the human's ability to reconstruct familiar words missing some syllables. A similar effect was noted with phrases and meaningful word groups where only 75% of a phrase was intelligible, it was found that over 95% of the test phrases were understood by the subjects.

b. Physiology (Motor Skills)

Data on human anthropometry is available in many sources including Ref. (12). Use of reliable anthropometric data allows system design which accounts for a wide variety of population dimensions. Uncomfortable operators may intentionally damage equipment or, as a minimum, exhibit decreased performance. Reference (18) reported technical choices of standardized anthropometric measurement methods useful to a system designer.

A second major consideration is the operator's ability to reach all controls without undue exertion or discomfort. This requires knowledge and application of seated heights (in clothing), shoulder heights, eye height, arm reach and other physiological measurements across the appropriate percentile range of the population. Other areas of concern include knowledge of the range of movement of various limbs and digits of the human body, relative muscle strength available for switch or lever depression and data on dynamic working capacity.

IV. ALTERNATIVES AND CONCLUSIONS

Manifestations of operator errors are an implicit part of the preceding discussion of operator stresses and resulting overloads. Establishment of relevant performance criteria is necessary to evaluate the significance of the various types of errors and further isolate causal factors of operator overloads. While there may be no optimal measure, the method chosen should be sensitive to input, output and the relationships between the two. The criteria should be appropriate to the type of task (as mentioned in Chapter III, human Tasks are denoted with caps) and allow comparisons between performances in various situations. Third, the measure should be sensitive to the accuracy of operator responses as related to time.

The approach of this thesis in regard to performance was twofold. First, limited functional criteria was applied to imply areas of obvious physico-physiological stress. Second, after extensive consideration was given to Tasks and information flow; and given a minimal amount of time with which to work directly with the TSC system, (the time constraint being a function of location, not of NADC cooperation) efforts were directed toward streamlining the operator's

Tasks assuming sufficient pressures exist to produce optimal performance without task-induced or system-design induced stresses.

Conclusions were drawn based on summarized information presented in this paper, subjective comments by operators, personal hands-on-experience (limited to approximately seven hours apiece) with the Watch Officer's console and information gained through extensive interviews with individuals involved in the design and implementation stages of the CV/TSC. All conclusions and alternatives were formed independent of individuals associated with the TSC and in no way reflects upon those individuals who graciously provided extensive reference materials and of more importance, their time and expertise.

As was noted, much of the information incorporated in the System Description was obtained from Ref. (7), A Proposal for the CV/TSC Display System. Although it is the most general and comprehensive discussion of the CV/TSC available, it must be recognized that it was written as a proposal and the TSC system which evolved differs from the proposal in many significant areas. If Chapter II is nothing more than a description eliminating presently inaccurate information in Ref. (7), then the system description in this thesis may be the most current, albeit general,

description of the CV/TSC, since current, comprehensive, general descriptions are unavailable.

In the absence of substantive test data supporting various technical parameters directly related to the man-machine interface (e.g., the Tactical and Tabular Displays) conclusions are of a broad, subjective nature. In contrast, the judgments and alternatives presented in relation to the MEP and TKB appear rather specific. It is not intended to portray the alternatives as the "best" method of presenting TSC control information to an operator, rather variations presented are based on some "recognized relationships" of human-factors engineering.

A. DISPLAYS

1. Visual

It is noted that performance specifications of the TKB and MEP as listed in Ref. (7) meet or exceed requirements of MIL-STD-1472A as well as recommendations of Ref. (12).

a. Formats

A requirement of the TSC identified in Chapter I was that information be provided in formats compatible with aircraft avionics and aircrew. During hands-on operation of the Watch Officer's Station, it was noted that at least

a few of the tableaus utilized for briefing (and eventually replay in the aircraft) and insertion into the S3A cassette take on dissimilar forms between the TSC and aircraft. It was also noted that frequently the full range of information listed on a tableau is not available to the aircrew, e.g., hot areas and bingo fields.

A second problem, also software related, was noticed in "cross referencing" of tableau information. Since various tableaus require data which is duplicated in another, an operator is currently forced to enter the same data more than once, thereby needlessly increasing the operator's workload. (This problem does not exist with all tableaus. However, it occurs frequently enough to enhance omissions in briefing data.)

A third example of software limitations adversely affecting operator workload is that of formats for messages to be transmitted from the TSC. The current model TSC does not include the message formatting capability originally included in the TSC design.

b. Conclusions

(1) Substantive tests should be conducted on the Tabular and Tactical Displays to ensure that they meet the minimums of criteria recommended by MIL-STD-1472A and other relevant references. (Visual acuity considerations,

brightness discrimination, gap resolution and other similar data will remain ludicrous until adequate definition and incorporation of a Seat Reference Point is accomplished as discussed in section C of this chapter.)

(2) In order to obtain maximum positive transfer to the aircrew, TSC brief formats should be of the same form and inclusive of the same information as that obtained by crew members when accessing data in the aircraft. (This also includes tactical symbology which should be equivalent for obvious reasons.)

(3) Operators should be required to enter data initially and later only as it changes. Each existing tableau should be surveyed and software altered as necessary to remove multiple-entry requirements from the operator.

(4) The output of the TSC, as identified in Chapter I, is filtered tactical information implying voice transmission or hard-message transmission of formatted information. Since the Data Extraction routine is currently unavailable in the software, an acceptable alternative would be the incorporation of formatted messages (in tabular form) required by higher authority or intelligence requirements. The desirability of providing formatted messages is based on space and workload considerations as well as the suitability of a digital system for that type of task.

2. Aural

a. Alerts

The single aural alert incorporated in the TSC was mentioned previously. Aural alerts are commonly utilized in other systems and are most effective when the message is simple, short, requires immediate action and is not referred to later.

With the exception of standard voice communications, all other information is presented to the operator visually, including feedback indications of PRO switch activation and notice of incoming ICS calls. Since during tactical evolutions the operator may fluctuate between periods of underloads and overloads, audible tonal alerts might provide a degree of stabilization by implying information of immediate urgency which could then be removed from the visual displays, e.g., ICS calls, PRO switch activation feedback, data entry and activation of cassette preflight loading.

b. Conclusions

Incorporation of tonal alerts is a valuable tool for reduction of visual stimulae. Consideration should be given to their utility in the TSC in the areas mentioned (as a minimum).

B. CONSOLES

Since the Display Units have met with favorable subjective approval they are discussed only in general terms of anthropometry. That discussion, which logically would be included at this point, is presented in the following section since the conclusions result in an alternative which includes both the TKB and MEP on one panel.

This section is restricted to consideration of the TKB and MEP as separate entities, leaving as an alternative the incorporation of two separate panels similar to the current arrangement, albeit somewhat refined.

The following excerpt from Ref. (12) is a succinct statement of the philosophy of this and the remaining sections:

The more directly the operator can attend to the task at hand, the more efficient will be his operation. Distracting machine demands, such as specific (input) formats, margins, unique spatial locations, special and unusual symbols, cumbersome correction procedures, etc. should be avoided if at all possible. If the important job of the operator is editing, or writing, or designing, or programming, etc., and a large and expensive system is being committed to facilitate his performance of that job, then it makes no sense to distract him from doing his important work by imposing machine-idiosyncratic data entry demands in order to save relatively trivial dollars in engineering or software costs. Unfortunately there are no experimental data for guidance in this area. What support there is for the general principle must be derived from an examination of 'what sells.'

1. Tabular Keyboard

a. Category I Switches

The TKB is an aesthetically appealing display due, in part, to the method of key illumination and its uncluttered, business-like appearance. The typewriter keyboard generally adheres to the standard electric typewriter stereotype and poses no significant problems for an operator with or without extensive typing experience.

b. Category 3, Editing and Error Correction

Reference (19) concluded that overlapping activities occur within the human processor during data entry tasks. In addition to maintaining an awareness of data being entered, an operator also maintains an "error watch." While error checking is not the same process as is making of correct responses, some form of response checking must take place "concurrently" with data entry activity. The study implies (a) typewriter output (display in the TSC) should provide a format such that self-detected errors are easily seen, (b) the operator should be able to rapidly insert or delete parts of a message, and (c) the format should allow rapid verification procedures.

Editing tasks in the TSC currently require the operator to remove his hands from the keyboard, locate the

cursor, reset it to the desired position from the right-hand side of the keyboard and then, from the left-hand side, enter (a) insert line, (b) insert character, (c) delete line, or (d) delete character. Incorporation of insert and delete functions into the body of the keyboard may be an alternative which would make editing less tedious.

(Insert/delete switches would still be most appropriately placed on opposite sides of the panel enabling two-handed "simultaneous" operation of each group.)

c. Category 5 Switches

Category 5 switches are, with one exception, non-functional and are incorporated for expansion. They operate in conjunction with the typewriter SHIFT key. The practicality of including those switches for expansion is recognized, however, prior activation of the SHIFT key is considered a needless motion and should be eliminated.

(Perhaps cost advantages exist by including non-assigned, non-functional switches on the keyboard. However, in order to simplify panel appearance, thereby reducing distractions to the operator, an alternative involves inclusion of internal circuitry without mounting the buttons. Granted that future utilization of those switches would be more difficult; panels would have to be removed for button installation, etc. However, lead time required for software

preparation most likely would provide sufficient lead time for any necessary panel alternations.)

d. Category 4 Switches and Status Lights

Category 4 switches perform primary control functions of the TKB including ON/OFF, INDEX, SELECT LINE, ADVANCE, RETURN, NEXT LINE, ACCEPT MESSAGE, CLEAR ALERT, SEND MESSAGE and REPLY MESSAGE.

The ON LINE and OFF LINE status indicators are located directly to the right of Category 4 switches. The two status lights are housed in enclosures identical to Category 4 and 5 switches. The status lights are immediately mistaken for switches although there is no indication that either would be required to perform switching functions.

The functional ON/OFF LINE button is switch number 4-10. It is not clear why depression of that switch to the ON position should not cause its own illumination to change (to green) as positive indication of a powered system. Absence of illumination would indicate the TKB was OFF LINE, thereby eliminating a requirement for extra status indicators. In either case, indicators should not be of the same form as switches which are incorporated for control functions.

e. Duplicated Functions

Category 4 switches labeled INDX, ADV, SEL LINE, and RET are duplications of switches III - 14, 15, and III -

19, 20. This duplication is discussed in section C of this chapter.

Duplication of numerics is noted, however, numerics of the typewriter keyboard are most easily used in conjunction with alphanumeric text and does not require repositioning of hands from the keyboard. Conversely, Category 2 switches are most frequently used when entering numerals without other text.

The remaining duplicity is a result of incorporating NEXT LINE, CR RET (carriage return) and cursor positioning controls. Each serves to move the cursor enabling entry of data on the next line. Since it is necessary to maintain the manual cursor control switches, it is recommended that the Category 4 switch labeled NEXT LINE be removed in favor of the carriage return function on the keyboard. (It is recognized that NEXT LINE is related to the next line of tableaus and CR RET is generally related to any functions of the TKB as text is being entered. It is felt, however, that software should not constrain the removal of the NEXT LINE switch.)

f. Category 2, Numerics and Data Entry

Category 2 includes 13 switches, 10 numeric, one an ENTER key and the remaining two latitude/longitude prefixes. Three areas are considered less than optimal for operator use.

Considering the physical characteristic of the human hand, i.e., the thumb on the right hand is offset from the fingers, it is obvious that, in relation to numeric entry, a human can depress the ENTER key more rapidly if it is located along the axis of the thumb. This implies that, as in standard adding machines, the entry key should be located to the left of the numerals. An operator will rapidly adapt to this arrangement, easily locating the number five key for reference and merely rotating his wrist for numeric entries (as is common with business-machine operators).

Second, inclusion of the latitude/longitude keys marked N/E, + and S/W, -, is detrimental to rapid use of the numeric data. An operator is forced to look at the group of buttons to ensure the correct number is depressed, especially zero since the underlying button is the ENTER key. It is suggested that software be altered to allow removal of the NE/SW switches in favor of requiring the operator to enter N, E, S or W from the typewriter keyboard either preceding or following latitude/longitude coordinates.

The final objection noted with Category 2 keys is the size of the ENTER button. Since it is utilized to enter all data from the TKB, its significance is sufficient to set it apart from the other buttons. Enlarging the ENTER

key, as well as the zero, and then locating each as is common in adding machines would serve two purposes. First it would fit the operator's hand with the potential for increasing his data entry rate, and second it would allow rapid, automatic referencing of key positions as discussed previously.

2. Tabular Keyboard Alternative Summary

Plate (23) depicts a Tabular Keyboard which includes points made in this section (except inclusion of Category 3 buttons in the typewriter keyboard).

Alterations to the TKB include:

a. Category 1

- (1) inclusion of backspace
- (2) relocation of PRINT
- (3) inclusion of RPT in PRINT space.

b. Category 2 - Placed into adding machine format.

c. Category 3 - no change

d. Category 4

- (1) exclusion of ON/OFF LINE SWITCH from panel surface
- (2) repositioning and regrouping of nine switches.

e. Category 5 - circuitry is assumed to be underneath the panel surface in the same location but without buttons.

COMMUNICATIONS

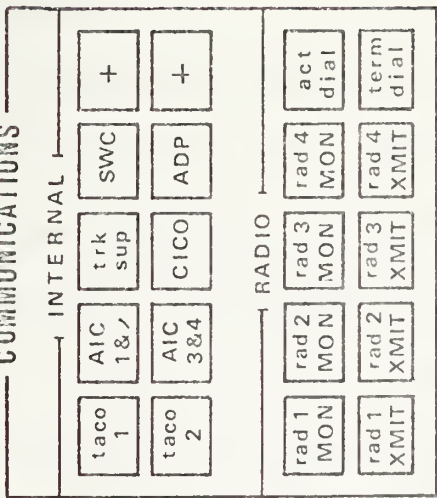

STATUS

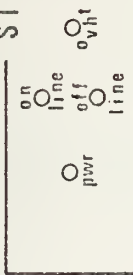

DATA ENTRY

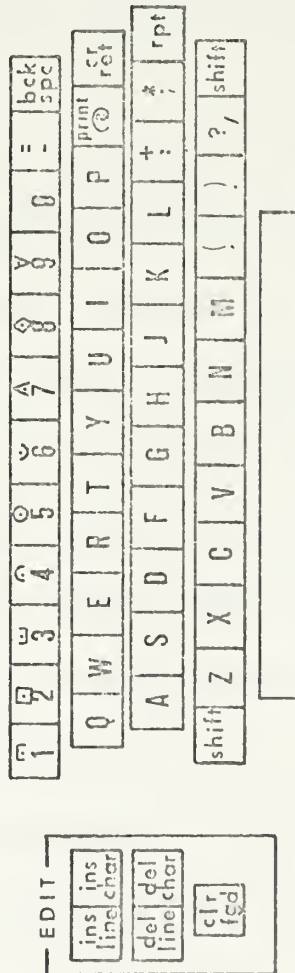
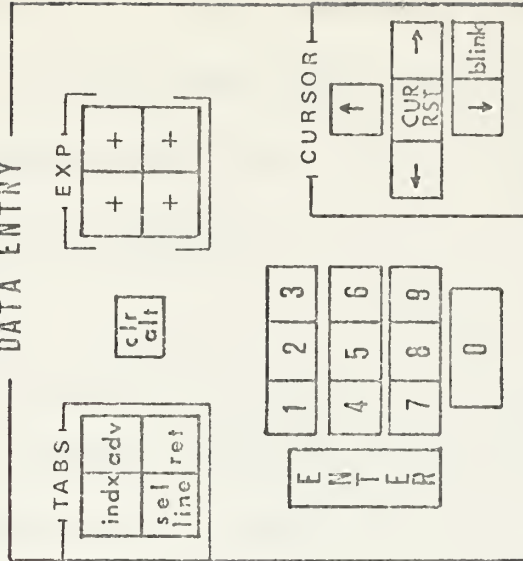

PLATE (23) ALTERNATIVE TKB

f. ON/OFF LINE status indicators and POWER switch

(1) The power switch (ON/OFF) for the alternative TKB was placed out of view, located on the underside of the bullnose. A small green bulb indicates power on.

(2) ON/OFF LINE status indicators were relocated within 30° of panel centerline.

g. General

(1) Formatted messages would be available through a standard tableau included in the tableau index.

(2) SEND MSG and REPLY MSG are functionally similar. Elimination of REPLY MSG should be accomplished with software.

(3) Advisory lights currently located in the trough behind the TKB panel (difficult to see) are incorporated within $\pm 30^{\circ}$ of the panel's centerline. The remaining switches in the trough could be located with the ON/OFF switch below the panel or, if left in the trough, covered with an access plate suitable to remove all appearance of a trough. (Any other switches which are seldom used could also be placed within the enclosed trough, e.g., ON/OFF, illumination controls, etc.)

(4) For this presentation, Category 4 switches would be of the same type as Categories 1, 2 and 3 or similar to those of the MEP.

3. Manual Entry Panel

The different types of switches, and their dimensions, are provided in Chapter II. It is relevant to note that the inclusion of raised, square Category VII switches detracts from the aesthetic appeal of the panels (while aesthetic appeal of the panel is not a prerequisite of any MIL-STD, an operator's regard toward the equipment which he must operate day after day can clearly effect performance.)

a. Category VI - Communications

Discussion of the communications panel is limited to items discussed in the first section of this chapter recommending use of tonal alerts for incoming ICS calls and a recommendation that switch VI-16, labeled POINT, be re-located within a more compatible functional group and associated with radio controls on the TKB console. (POINT is used to display the pointer symbol on the NTDS display.)

b. Category 1 - PRO Switches, MISSION MODES

Lack of tactile feedback in the PRO switches is discussed in Chapter 2. As noted, indication of switch activation occurs as a small red light (usually obscured by the operator's hand) flashes momentarily. Paragraph 5.2.2.1.19a of Ref. (20) states, appropriately, that red lights "...shall be used to alert an operator that the system or any portion of the system is inoperative, and

that a successful mission is not possible until appropriate corrective or override action is taken." Examples include indicators displaying information such as "...'no-go,' 'error,' 'failure,' 'malfunction,' etc."

Visual acuity is discussed briefly in Chapter III. It was noted in Chapter II that the projected film chips produce labels of white lettering on a grey background. Reversal of film polarity would project black letters on a white background and relieve the requirement of semi-darkness in order to adequately view the PRO switch labels. (The PRO switches exhibited the only noticeable illumination problem detected during hands-on time.)

Since only two groups of PRO levels are expected to incorporate all ten switches as functional it is recommended that a comprehensive survey be made of functional requirements elicited in response to matrix select switches. It is suggested that with careful grouping and elimination of all duplicated functions, extra levels for expansion will emerge.

Consideration should then be given to incorporation of Category II (matrix select) switches into the uppermost level of the PRO matrix. Category II functions would have to be arranged in two mutually exclusive groups of ten. Selection of a Group I switch would cause Group II

to be extinguished and illumination of the level associated with the depressed switch. In the event a switch of the illuminated level is required to provide ten additional options, then the Mission Modes of Group I would be extinguished and another level illuminated in its place.

An inherent assumption is that system-mode status is readily identifiable, either as a portion of one of the displays or as an additional display directly above the PRO matrix.

(The display would have to include nothing more than the labels of activated mode switches in a chronology implying which functions are activated and the order necessary to return the system to its original state.)

Incorporating such a display removes the requirement that an operator recall, for example, that to continue his mission planning evolution after using DISP AIDS, (a) the order required to "clean up" the Display Aids level to (b) extinguish the Display Aids level and (c) return to the Mission Planning. Currently, there is no indication of Mission Modes selections.

c. Category V - Track Inhibits/Display Controls

(1) Track Inhibits. Category V switches three through twelve are Track Inhibit Switches. The nature of their functions implies they are suitable to be incorporated in the PRO matrix. Another alternative is to provide a

single switch labeled Track Inhibit which would automatically display available inhibits in tabular form. Upon depression of SEL LINE and a two-digit entry, the tableau would be flagged for future reference and ready to accept other entries. Removal of the tableau would be caused by redepression of the TRACK INHIBIT switch.

(2) Display Controls. Functional grouping is better served through removal of CLR PNT from Category V and locating it in close proximity of POINT (Category VI) and DSTRY PT (Category V to the right of the PRO matrix.)

d. Category III - Display Controls

(1) General. MARK TIME is a functional switch (III - 8) although marked with a plus. Its function is most similar to the INDEX switch of the same category.

The function of ENTR PLT is currently undefined.

(2) Scale Controls and Center On "Reference" Switches. CHNG SCALE (III - 13) is a functional switch but is currently labeled with a plus.

Four switches are utilized to alter the tactical scale: (1) CHNG SCALE, (2) INCR SCALE, (3) DECR SCALE and (4) 128 MI SCALE. Activation of 128 MI SCALE causes immediate alteration of display scale to 128 nm. Other scale changes require a minimum of two of the remaining

three switches. (The method of entry was determined in deference to software rather than vice versa.) If four separate switches are retained (in order to perform virtually identical functions) it is recommended they be grouped in close proximity.

A proposed alternative is use of only two switches (or one dual-function switch) - INCR SCALE and DECR SCALE. Depression of INCR SCALE would display the next higher scale, in sequence, until switch release. Upon switch release, the scale displayed in the status area (as is currently done) would be automatically entered and the display altered. Appropriate delay times would have to be established giving the operator sufficient response time. Six scale cycles would be the maximum waiting period.

A second alternative is incorporation of a single SCALE switch. Activation would cause a list of available scales oriented vertically along the left side of the tactical display. Scale selection would be accomplished utilizing the hook. Upon completion of standard hook procedures, the scale would automatically change and the list would disappear.

Center-on switches labeled CEN ON CV (III-12), CEN ON A/C (III-10) and CEN ON HOOK (III-17) can be replaced by a single button - CENTER ON HOOK - which would

require the display to center on the reference upon which the hook is "dropped."

e. Force Stick

The force stick currently installed on the MEP is subject to removal and inadvertent breakage in its present location. It is suspected that most operators will have had experience with the track-ball concept from the P3 or S3 aircraft. Also, since it is difficult to determine proper positioning of a protruding force stick to eliminate accidental breakage it is recommended that a track ball replace the force stick. Use of the track ball will also allow more precise cursor positioning as the operator performs continuous tracking tasks with the hook.

f. General

Two HOOK VER switches associated with the force stick are considered excessive. It is suggested that one HOOK VER is adequate if appropriately placed.

The ICS BUSY switch associated with Category VII Data Entry switches would better serve functional groupings if placed with the Communications switches (Category VI).

Other than objection with the shapes and heights of Category VII switches, the same basic faults are seen to reoccur as in the numeric data entry keys of the TKB.

Two lights test switches of the same enclosure type as Category VII keys are located in the upper right-hand side of the panel. Similar objections to their shape and size exist.

In many cases, switch labels do not sufficiently imply function, e.g., light test switch labeled MONO, or DSTRY PNT (removes symbol from all Files and Displays) and CLR PNT (hook symbol is cleared from the display).

It was noted that most non-functional buttons are labeled with a plus sign although some functional buttons remain marked with the same symbol. In view of the cost of the entire system, it is difficult to understand why complete systems are placed in operational status with unlabeled functions.

4. Manual Entry Panel Alternative Summary

Plate (24) depicts an alternative MEP which would possess, as a minimum, all current functions of the MEP as well as an undefined amount of expansion (primarily in the PRO matrix).

Alterations to the MEP include:

a. Category VI - Communications

(1) Incorporate ICS BUSY as a communications function.

(2) Relocate POINT to a better functional group.

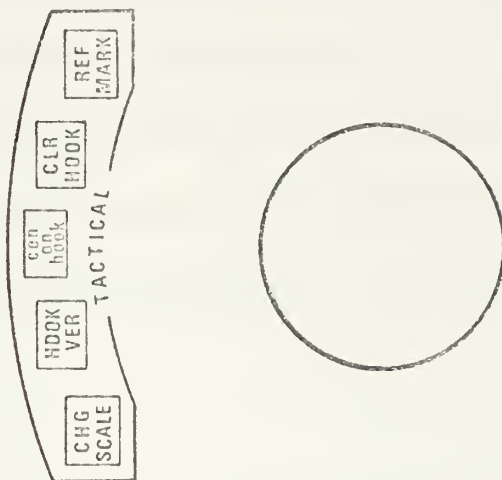
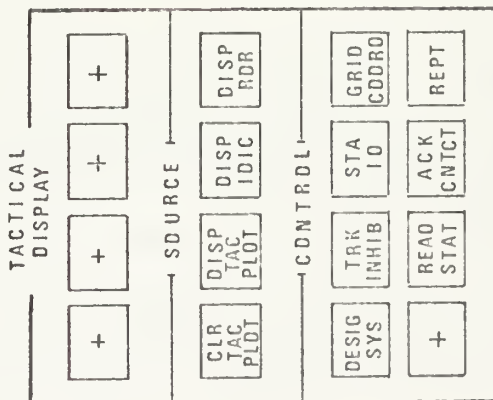
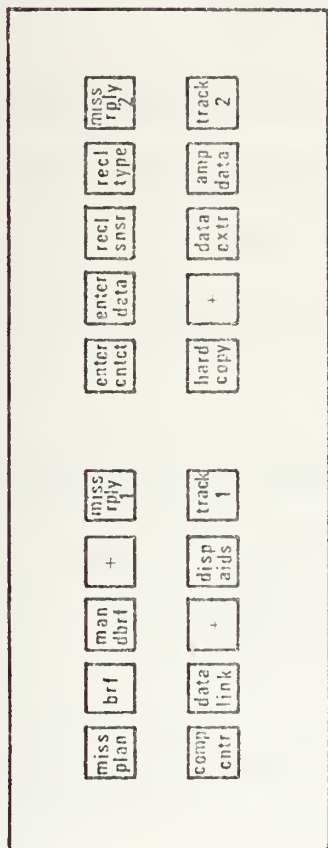
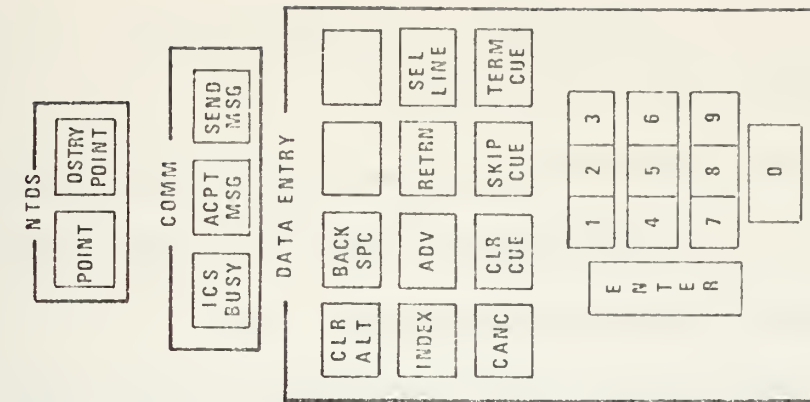

PLATE (24) ALTERNATIVE MANUAL ENTRY PANEL

b. Category I - PRO Matrix

(1) Incorporation of Category II Mission Mode switches into constantly illuminated first level through use of 24-level prism if necessary.

(2) Use of status area of display to indicate Mode and level at which the system is operating.

(3) Incorporation of a tonal alert to indicate switch activation in lieu of redesigning matrix panel for switch depression. (Elimination of red lights.)

(4) Reverse polarity of film chips and use black letters on white background vice white letters on grey.

(5) Replacement of ten TRACK INHIBIT switches with one through use of software or inclusion as one level of the PRO matrix.

c. General

(1) Functional grouping of DISPLAY CONTROLS including POINT and DSTR PNT should be identified and labeled.

(2) Utilize one switch for scale control in lieu of four.

(3) Utilize software to perform functions of Center-on switches thereby replacing CEN ON HOOK, CEN ON A/C and CEN ON CV with one switch - CENTER ON HOOK.

(4) Replace force stick with track ball and relocate track ball to middle portion of panel directly

below PRO switches with appropriate clearance in all quadrants for unobstructed operation. (Could require recessed ENTER key.)

(5) Utilize only one HOOK VER.

(6) Replace all buttons of Category VII type with those of the TKB's typewriter.

(7) Replace Lamp-Test switches with buttons similar to the rest of the MEP.

(8) Alter the design of Category VII Data Entry switches in the same manner as described for the TKB.

(9) Raise all status indicators out of the trough. Any seldom-used controls could conveniently be located inside and out of sight if the trough were enclosed.

C. SOME ANTHROPOMETRIC CONSIDERATIONS

Paragraph 3.2.2.3 (Work Environment, Crew Stations and Facilities Design) of MIL-H-46855A states that in the design of crew stations and facilities which affect human performance under a variety of situations, there are specific items which, as a minimal effort, should be addressed by system designers. Included in the list are the following two items: "(The designer should ensure) adequate physical, visual, and auditory links between men and men, and men and their equipment, including eye position in relation to display surfaces,

control and external visual areas (and ensure that) provisions for minimizing psychophysiological stresses (are incorporated)." Ref. (21).

The document references MIL-STD-1472A, Ref. (20), as final authority on human factors engineering design constraints. It is the purpose of this section to consider the TSC console from an anthropometric view, contrasting specifications of MIL-STD-1472A with the dimensions of the TSC Watch Officer Station as taken from Hughes Drawing Number 1622689-500A, CV-TSC-System Designator 5A5. (Plate (7) of Chapter II).

1. The Seated Operator

Plate (25) is a side view of the Watch Officer's Station with operators B and C positioned by different methods. "Operator A" is a "composite" of 50th percentile USN subject's dimensions extracted from 1472A and is discussed after consideration of B and C. (The 50th percentile operator was chosen as a convenience in an attempt to maintain the simplicity of the diagram.)

The position of "Operator B" is determined by striking lines perpendicular to the center of each display. The visual reference point of the operator is the point of intersection (implying that it is the point of minimum parallax) which logically should be the best viewing distance.

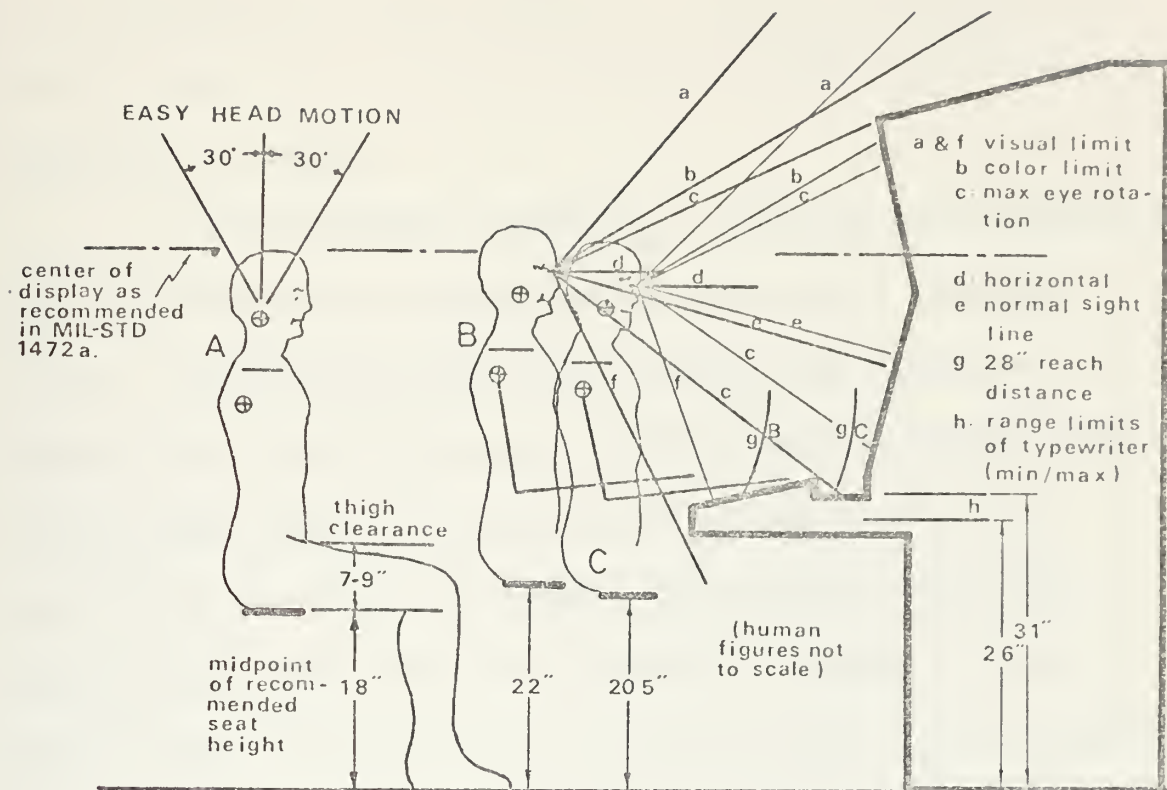

Plate (25) Side View of Stacked Console with Visual Reference Points

It can be determined from the plate that the distance along each perpendicular to the point of intersection is 36 inches. The 50th percentile USN operator would require a seat height of approximately 22 inches to place his eye at that visual reference point. (All measurements are for nude subjects. Addition of one inch to subject dimensions is adequate to allow for clothing, thereby decreasing required seat height to 21 inches.)

Visual reference angles are shown in the diagram. Operator B's normal line of vision (15° below horizontal)

is centered on the lower display. The upper display lies within normal color limits and can be viewed without excessive head motion.

It is necessary, however, to consider the operator's reach limitations as a function of the visual reference point. An effective reach of 28 inches was chosen as nominal for this discussion. It was measured in the plane of the paper forward from the axis of rotation of the operator's shoulder. As shown, the operator, with arms extended directly forward 28 inches, is unable to reach beyond the lower half of the bullnose panel. The conclusion is, that an operator, positioned to minimize display parallax, is not in an optimal position for operating system controls.

The visual reference point of Operator C was determined by establishing a point 28 inches from the center of each display. Seating height was again determined from 50th percentile USN subjects.

Visual angles are seen not to differ significantly from Operator B. Color limit is within the desired range and the normal vision line is within the upper third of the lower display. The lower limit of vision, however, has to be augmented by head rotation for viewing of the panel base.

In this position, effective reach distance of 28 inches extends into the trough at the top of the panel. While the operator is unable to reach the displays and their co-located controls it is felt to be a minor fault, since the controls are used infrequently.

The center of the console should occur 31.5 inches above the seat reference point. Ref. (20). Utilizing definitions of the MIL-STD, a center line was constructed for the console displays. It can be seen that the center-line of the console is not concurrent with the constructed line. This is not considered a significant drawback since Operator C, located at an optimal seated position, does not view either display orthogonally, nor would he if his eyes were located on the central line.

"Operator A" is a composite of 50th percentile USN subject's dimensions from Refs. (12) and (20). It is included to indicate that the TSC console has sufficient thigh clearance for that operator. Use of the 50th percentile figures is not an attempt to represent the "average" man. It is obvious a system designed to fit the 50th percentile might cause 50% of the subjects to suffer from the results. The composites indicate general areas of concern and provide a feel for some of the constraints considered.

In attempting to construct a stacked console with a seated operator from data available in MIL-STD-1472A, it was found that the MIL-STD is not sufficiently explicit. A general range of console dimensions are presented in Table VII and Figure 22 of the MIL-STD and anthropometric data is provided in its Section 5.6. However, the relationship between the console and human is inadequately portrayed.

While seat height from a standing surface is defined, as well as vertical seat adjustability, the user is forced to extrapolate data to determine the position of the Seat Reference Point (SRP) - the point at which the center line of the seat back surface and seat bottom surface intersect - and the range of horizontal adjustments necessary for the population of operators. Further, axes of rotation of the head, shoulders, hips, knees, etc. are not included, requiring a user to resort to other sources of definitions when a human factors effort is conducted in the spirit of Ref. (21).

It is not intended to condemn either the TSC design or the MIL-STD. Nor is it implied that the MIL-STD should be an all-encompassing document. It is reasonable to assume, however, that the degree of standardization desired (as implied in the MIL-STD) in human factors designs requires

a comprehensive set of definitions, alleviating the user of establishing definitions from other sources, often conflicting and irrelevant to military needs.

2. Grasping Reach (Functional Reach)

Plate (26) depicts the grasping reach of shirt-sleeved subjects extending the right arm horizontally at a constant level of 20 inches above the Seat Reference Position, i.e., seat height. Ref. (12). The study was limited to the right arm, assuming reasonable symmetry, and to a U.S. Air Force subject population. Data was adjusted so that it could be plotted from the SRP rather than the shoulder axis. It is important to note that the subject's seated position is not the same as occurs with most permanently mounted consoles (as opposed to cockpit seating or seating of other moving objects).

The effects of those limitations may have been overcome to a degree through choice of the SRP at a distance of only eight inches from the console. Since it is intended to demonstrate the undesirability of two separate control panels utilizing anthropometric data not directly related to the TSC design, an effort has been made to "weight" the data in favor of the TSC console. (For example, the SRP location would barely be sufficient for a 5th percentile operator much less one of the 95th percentile.) As the

distance from the console to the SRP increases, so does the subject's difficulty of reaching controls without excessive movement. Additionally, values of reach distances for 20 inches above the seat height are generally greater than those for 10 inches which better approximate the TSC operator's average horizontal boundaries. Even under the constraints and weighting factors, it is clear that an operator is unable to conveniently reach a significant portion of the Tabular Keyboard when seated on the center-line through the displays and Manual Entry Panel.

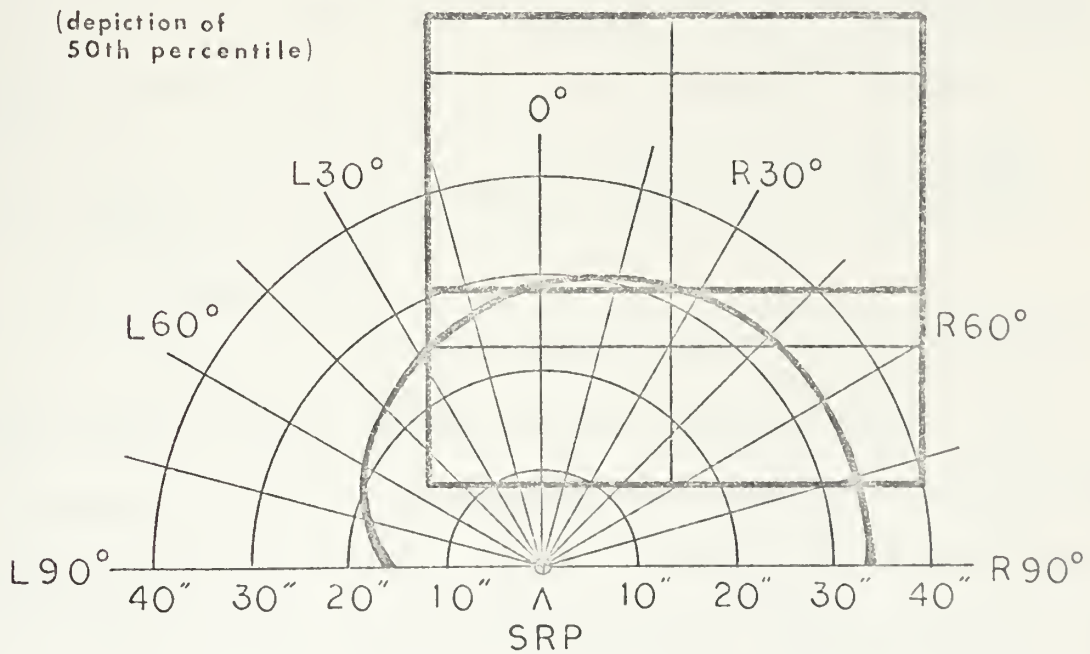

Plate (26) Grasping Reach of Seated Operator

3. Conclusions

Other basic applications of anthropometric data could be included, such as horizontal head and eye rotations required of an operator seated at the TKB and attempting to read Tabular Display presentations. However, the two subject areas included in this section are sufficient to imply that an alternative method of MEP and TKB control presentation is justified.

It is also recommended that serious consideration be given to incorporation of an appropriately mounted and adjustable seat which meets MIL-STD-1472A as a replacement for the swivel-type office chair currently utilized.

D. ALTERNATIVE TO THE CURRENT WATCH OFFICER'S STATION

1. Single Panel

Section B of this chapter presents alternatives to the TKB and MEP if maintained as separate panels. Of necessity, certain duplications are retained to provide the most flexibility at each panel. Reference (3) specifies that the TKB and MEP should be independent, separate panels, explaining perhaps, why the panels were, in fact, designed as two panels vice one.

However, even the cursory anthropometric analysis of Section C clearly implies that division of display controls

into two panels is an error. For purposes of clarity, Plate (26) only showed grasping reach of the 50th percentile operator. While the reach of the 95th percentile operator is slightly greater than that depicted, a significant portion of the TKB remains beyond reach (including data entry keys). Since reach limitations of any console design should be based on the reaching distance of the smallest operator, an even more significant portion of the TKB is unavailable to the 5th percentile operator seated in front of the CRT displays further substantiating the necessity for mounting controls on a single panel. Further, Ref. (20) states in paragraph 5.7.6.1.1, regarding panel width, than when preferred panel space requires a panel width greater than 44 inches, a wrap-around console should be provided in order to place all controls within reach of the 5th percentile operator.

Reach distance would not, however, be as critical if an operator was, in fact, able to perform all required Tasks from each respective panel without reliance on the other e.g., performance of mission planning functions requires use of both panels - all alphanumerics must be entered from the TKB while Mission Commands are executed from the MEP.

The implication is that although there are two separate physical panels, the operator control surface, if considered to be the combination of both, is in excess of 44 inches and adversely affects an operator's ability to perform his job smoothly.

Consideration of parallax in the horizontal plane was not included in the previous section since it is not realistic to assume an operator will be seated directly in front of the TKB when all display information is located in front of the MEP. For these reasons, the desirability of a single panel, in lieu of two which are not independent, is an obvious requirement to optimize operator performance.

Therefore, based on conclusions of Section C and in an effort to provide an alternative panel which (a) decreases decision and reaction times, (b) reduces the frequency of errors, (c) improves the speed and precision of control adjustment and (d) decreases training requirements and learning time, an alternative to the CV/TSC Watch Officer's Station is presented.

2. Communications

It was originally intended to consider communications in depth sufficient to reduce its complexity without degrading its capabilities. It was decided, however, that that project would exceed the scope of this thesis and

could, in its own right, form the basis of another. Conclusions derived on the basis of an analysis of limited scope are listed below.

(a) A sound-powered, open-channel ICS which does not require operator action other than depression of a transmit key would be sufficient for communications within the TSC. Two channels could be provided to allow conference calls apart from the open circuit. There would be no requirement for computer monitoring of the circuit - if an operator wishes to talk on a circuit which is in use, it is only necessary to use standard radio communication procedures to obtain the circuit.

(b) In general, the capabilities of the communication system appear excessive for the role of the TSC. If viewed to have the mission developed in this paper, its communications system would be more appropriate for a command/control installation. Therefore, it is recommended that communications requirements be studied in light of the TSC's realistic mission and functions.

(c) For this paper, communications of the MEP are not altered significantly except for location. Category VI switches are removed from the MEP and placed within the functional reach of the 5th percentile subjects. Not only is this an advantage to the operator in terms of panel

space, but it also locates the majority of communications controls within easy sight of all communications inserts of the Watch Officer's Station. Functionally, the Watch Officer would have only two separate groups - Tactical/Tabular Displays and Controls and Communications Displays and Controls.

3. Watch Officer's Station Alternatives, Summary

Essentially, those items mentioned in the MEP and TKB summaries are included in the single console station as proposed in Plates (27) and (28).

a. Category I, PRO Switches

(1) Incorporate audible tonal alert signifying switch activation.

(2) Mounting of PRO switches at 15° from horizontal to provide the best viewing angle to the operator. (This could require moving its casing aft into the trough, but would present no problem to the operator if it remained within reach distance. This assumes, of course, that equipment currently mounted in the trough would be removed and the remaining opening would be enclosed.)

b. Category II Switches would be incorporated into Category I (PRO Matrix) and would be constantly illuminated as previously discussed.

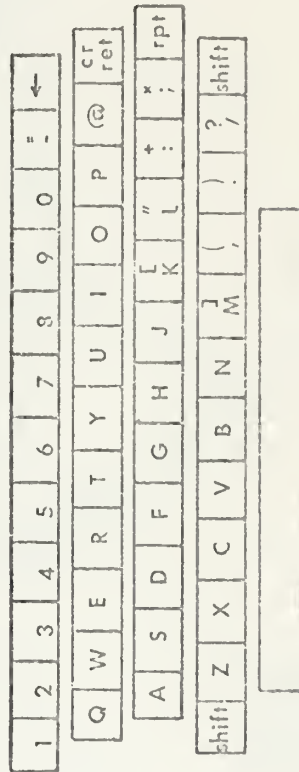
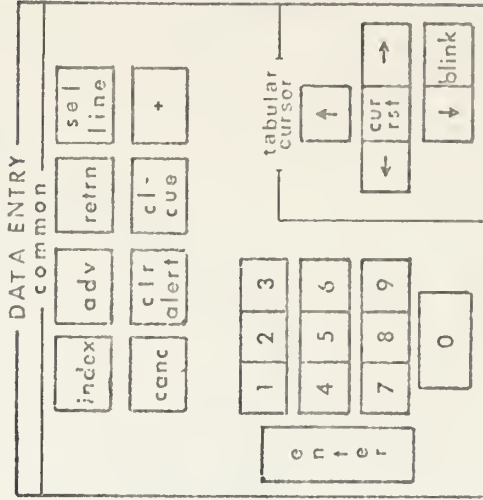
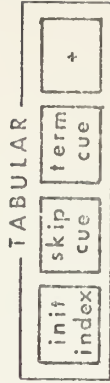
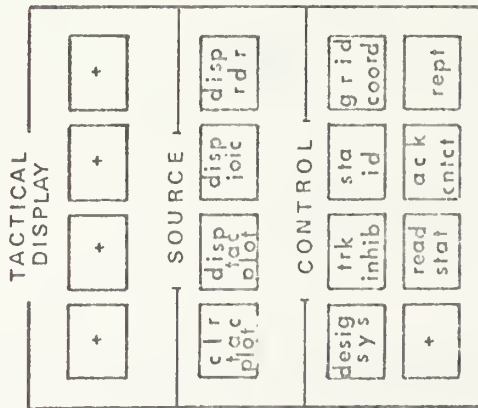
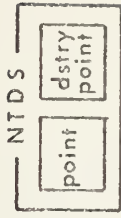
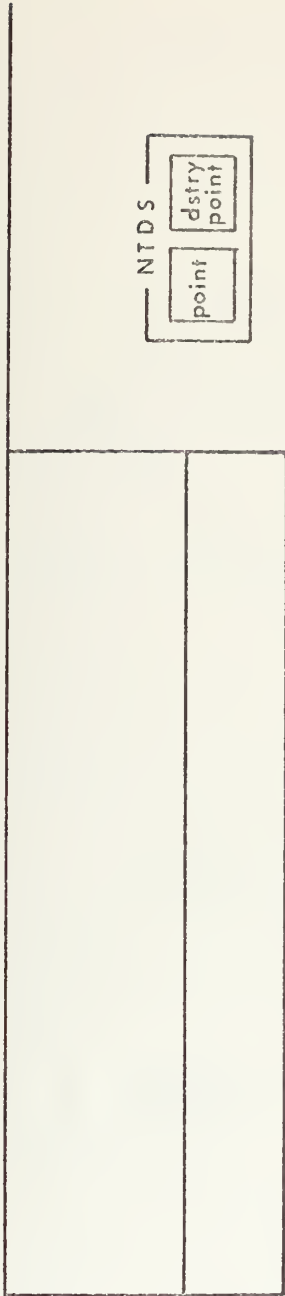

PLATE (27) ALTERNATIVE SINGLE DATA ENTRY PANEL

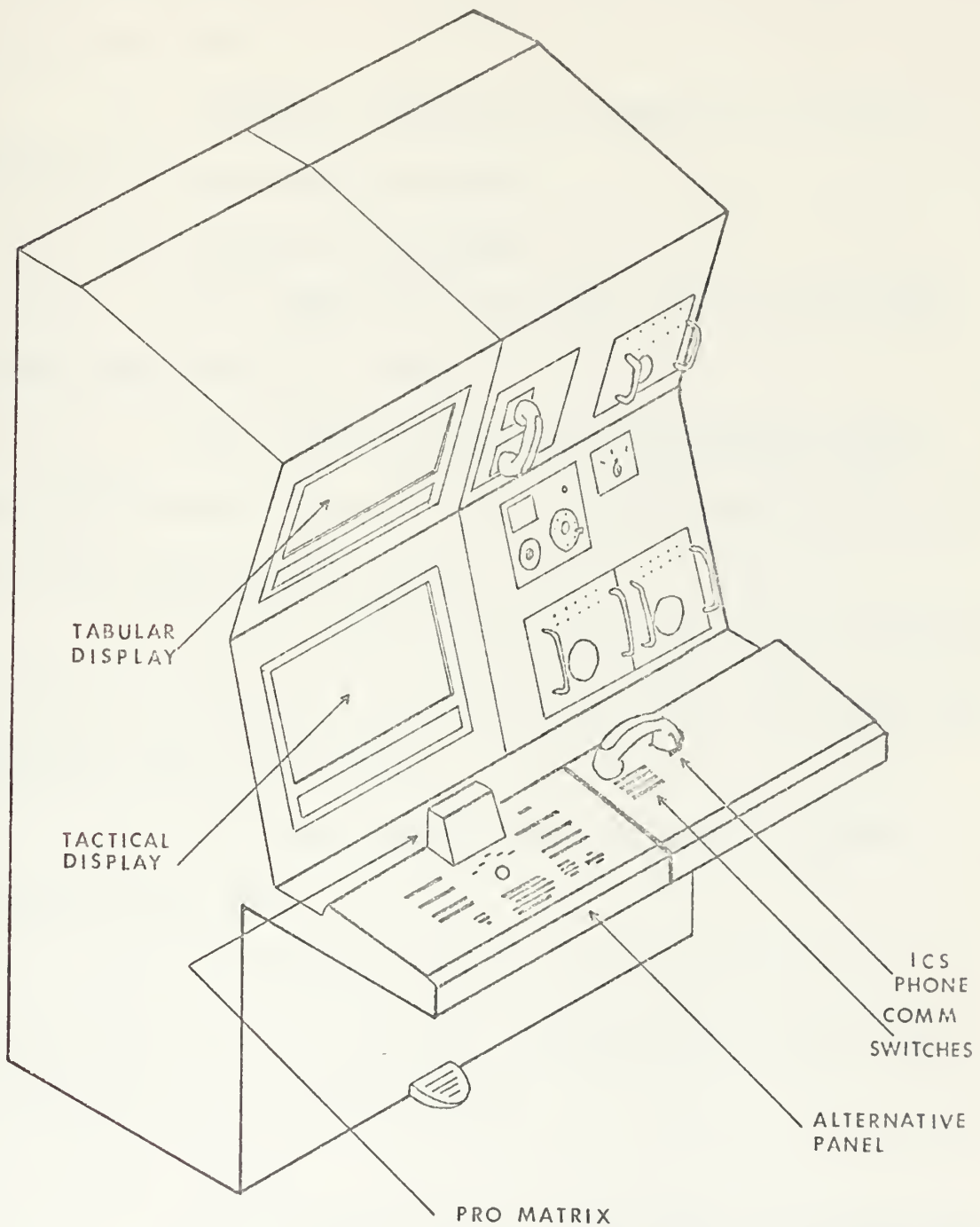

PLATE (28) ALTERNATIVE CONSOLE

c. Category IV Switches are reduced to a single switch and are located in association with the cursor control (track ball).

d. Category V Switches are reduced to a single switch as a function of software.

e. Category VI Switches

(1) POINT was removed and located with DSTRY POINT (both related to NTDS).

(2) Remaining switches were located within operator's reach but were moved to the bullnose associated with the Communications Panel.

f. Category VII Switches were essentially eliminated in favor of Category 2 switches of the TKB. All duplicated functions were eliminated.

g. Lamp Test Switches were altered to conform to buttons of the MEP.

h. Trough was enclosed, status indicators were removed as well as ICS controls. Seldom-used switches were retained in the enclosed trough.

i. General

(1) CLR FGD and the ENTER button were recessed to prevent accidental activation.

(2) PRINT was associated with the upper-case symbol @ on the typewriter.

(3) Track ball was incorporated rather than the force stick.

(4) Notes on Plate (27).

The diagram is, essentially, to scale. Buttons which are associated with the TSC MEP are slightly enlarged for lettering. Although not depicted, distances from the keys at either margin to the edge of a bullnose panel are larger than currently exist.

The minimum unobstructed distance from the center of the track ball is six inches. All hook functions are located directly above the track ball.

The PRO Matrix is assumed to be raised to 15° with the horizontal. That installation would allow a maximum of $3\frac{1}{2}$ inches depth to the MEP at it's top before utilizing the trough as extra space. Locating the PRO Matrix farther back would allow an increase in unobstructed area about the track ball.

(5) Comment.

The preceding Plates are not purported to be the only answer to console design. If that were true, a milestone would have been reached which has been sought for many years. Rather, through a logical development of mission and information flow with an awareness of the complexity of the human, it is maintained that the

alternatives presented are reasonable steps with the potential of providing a more efficient CV/TSC MAN-machine system.

E. SUMMARY

The underlying philosophy of this thesis stated in Chapter IV relates specifically to the importance of the operator in a man-machine system and the cost of utilizing him inefficiently. It is surprising that system designers continue to use man as a component without considering his performance "specs" in the same manner as those which exist for electronic components are considered. Unfortunately, many still rely on human flexibility - the ability to overcome adverse conditions and still adequately perform assigned jobs. But it can be demonstrated that, if the human engineer is included in initial design stages, the operator will be included as an integral part of the system rather than as an added apurtenance constrained to operate at minimal efficiency. Exclusion of consideration of human capabilities and limitations in design phases likely leads to compromise of human efficiency in favor of software or, frequently, hardware. With the importance of cost-effectiveness in system development, it has become essential to optimize

performance of each system component. It is doubtful that it can be achieved without optimizing the performance of the operator.

The development of this thesis started with a definition of mission, identification of system functions and tasks. Consideration of the human Function in the system and the nature of his Tasks led to a definitive list of operator requirements. It was then noted that, as a discrete processor, the human is overloaded in various areas. It has been the intent of this thesis to provide display/control alternatives which could eliminate overloads caused by control display relationships, functional groupings, unnecessary duplication of functions and anthropometric constraints.

It should be clear that major problems are directly related to software, especially in areas which overlap one another. But the software should be made to conform to human-oriented system designs, not vice versa.

The alternative designs for the MEP and TKB include the points summarized at the end of each respective presentation. They both emphasize functional grouping (and labeling) and would rely on precise, clearly defined and documented software. Each provides a minimal number of functional groups which could reduce training and operating costs

substantially. But, in the use of two panels, a primary objection remains - control/display relationship.

An operator seated at the TKB would still be forced to look approximately 60 degrees to the left when entering data. Also, as in the current design, physical limitations would again cause the operator inconvenience. Finally, in either model, current or alternative, the operator cannot use either panel to the exclusion of the other.

The final alternative (Plates (27) and (28)) eliminates those objections. The Communications controls are located within the reach of the seated operator and are more closely associated with communications hardware. Tactical and Tabular functions are delineated and marked for the operator's convenience. Functions used most frequently are located in areas which eliminate "searching time" and minimize motion.

All controls associated with the Tactical and Tabular Displays are located immediately below the displays, requiring minimal effort by the operator. Accidental activation of controls was considered and recommendations for minimizing the probability of its occurrence and its effects were discussed. Duplicated functions were eliminated, further reducing the operator's workload.

It is felt that the alterations could be significant in various areas (perhaps not in the exact physical alterations but certainly in the general areas of considerations). If considerations in this thesis were to have even 5 per cent impact in the reduction of training time then the effort and costs of this study would be repaid many times over. If, however, a similar study had been conducted with design stages (and its results incorporated) costs might have been reduced significantly more. If cost-effectiveness is a suitable Measure of Effectiveness, we can no longer afford to neglect the operator as a component in any man-machine system.

LIST OF REFERENCES

1. Gorshkov, S.G. Morshov Sbornik, "No. 2," as reprinted in Naval Institute Proceedings, January 1974.
2. Funkhouser, John T., "Soviet Carrier Strategy," Naval Institute Proceedings, December 1973.
3. Naval Air Development Center Report SDC-21-73, Specifications for CV/TSC Tactical/Tabular Display System, Revision B, 15 January 1975.
4. Introduction to CV/TSC...New Concept for Airborne ASW, Naval Air Development Center, Warminster, Pennsylvania 18974 (no other information available on reference).
5. DeGreene, Kenyon B., System Psychology, McGraw-Hill Book Co., 1970.
6. Naval Air Development Center, CV/TSC Console, Data Display, OJ-374(V) 3/SSQ-78(V), outline and mounting dimensions, provided on request by Mr. Peter Guerrini, SEMCOR, Moorestown, New Jersey 08057
7. Hughes Aircraft Company, Vol. II, Proposal for a CV/TSC System, by Ground Systems Group, Fullerton, California, 12 March 1973.
8. Naval Air Development Center Report SDC-12-72, Carrier Based TSC Functional Requirements for Communications Software, by System Analysis and Engineering Department, Warminster, Pennsylvania 18974.
9. NAVAIR 16-355A2033-1, Preliminary Technical Manual, Audio-Data Processing Switching Unit SA-2033/SYQ and Power Supply PP-7153/SYQ, 15 September 1975.
10. Murrell, K.F.H., Ergonomics: Man in His Working Environment, Chapman and Hall, 1969.
11. McCormack, Ernest J., Human Factors Engineering, 3rd Edition, McGraw-Hill Book Company.

12. Van Cott, Harold P. and Kinkade, Robert G., Ed, Human Engineering Guide to Equipment Design, (Revised Edition), sponsored by joint Army-Navy-Air Force Steering Committee, American Institutes for Research, Washington, D. C., 1972.
13. Wulfeck, J.W. and Zeitlinfrom, Psychological Principles in System Development, Ed. by Robert M. Gagne, Princeton Univ., "Human Limitations and Capabilities," Holt, Rinehart and Winston, 1962, p. 115-159.
14. Poulton, E.C., Environment and Human Efficiency, Charles C. Thomas Publishing Co., 1972.
15. Steedman, W.C. and Baker, C.A., "Target Size and Visual Recognition," Human Factors, v. 2(3), p. 120-27, 1960.
16. Licklider, J.C.R., "Basic Correlates of the Auditory Stimulus," S.S. Stevens, Ed., Handbook of Experimental Psychology, New York, John Wiley and Sons, 1961.
17. Howes, D.H., "On the Relation Between the Intelligibility and Frequency of Occurrence of English Words," Journal of the Acoustical Society of America, V. 29, p. 296, 1957.
18. Hertzberg, H.T.E., "The Conference on Standardization of Anthropometric Techniques and Terminology," American Journal of Physical Anthropometry, v. 28, p. 1-16, 1968.
19. Rabbitt, P.M.A., "Time to Detect Errors as a Function of Factors Affecting Choice - Response Time," Acta Psychologica, v. 27, p. 131-142, 1967.
20. Department of Defense Military Standard, MIL-STD-1472A, Human Engineering Design Criteria for Military Systems, Equipment and Facilities, 15 May 1970.
21. Department of Defense Military Specification MIL-H-46855, Human Engineering Requirements for Military Systems, Equipment and Facilities, 2 May 1972.
22. Chapanis, Alphonse, Man-Machine Engineering, Wadworth Publishing Co., 1965.

INITIAL DISTRIBUTION LIST

	No. Copies
1. Defense Documentation Center Cameron Station Alexandria, Virginia 22314	2
2. Library, Code 0212 Naval Postgraduate School Monterey, California 93940	2
3. Chairman, ASW Group Department of Weapons Engineering Naval Postgraduate School Monterey, California 93940	2
4. Professor D.E. Neil, Code 55NI Department of Operations Research Naval Postgraduate School Monterey, California 93940	1
5. Professor L.E. Waldeisen (CDR) Code 55WD Department of Operations Research Naval Postgraduate School Monterey, California 93940	15
6. CV-TSC Project Office, Code 50P2 Naval Air Development Center Warminster, Pennsylvania 18974	2
7. LT Christy L. Farris, USN 2115 Seymour Cheyenne, Wyoming 82001	1
8. LT Neil J. Gaffney, USN 12 Williams Street Barrington, R.I. 02890	1
9. Mr. Peter G. Guerrini SEMCOR Strawbridge Lake Office Building Moorestown, New Jersey 08057	1

thesF234

Consideration of the carrier-based tacti



3 2768 002 13388 6
DUDLEY KNOX LIBRARY