

AD-A032 636

AEROJET SOLID PROPULSION CO SACRAMENTO CALIF
FLEXIBLE CASE-GRAIN INTERACTION IN BALLISTIC WEAPON SYSTEMS. VO--ETC(U)
OCT 76 H LEEMING, K W BILLS, S W JANG F04611-72-C-0055
ASPC-1953-81-F-VOL-2 AFRPL-TR-76-57-VOL-2 NL

UNCLASSIFIED

1 OF 2
AD
A032636

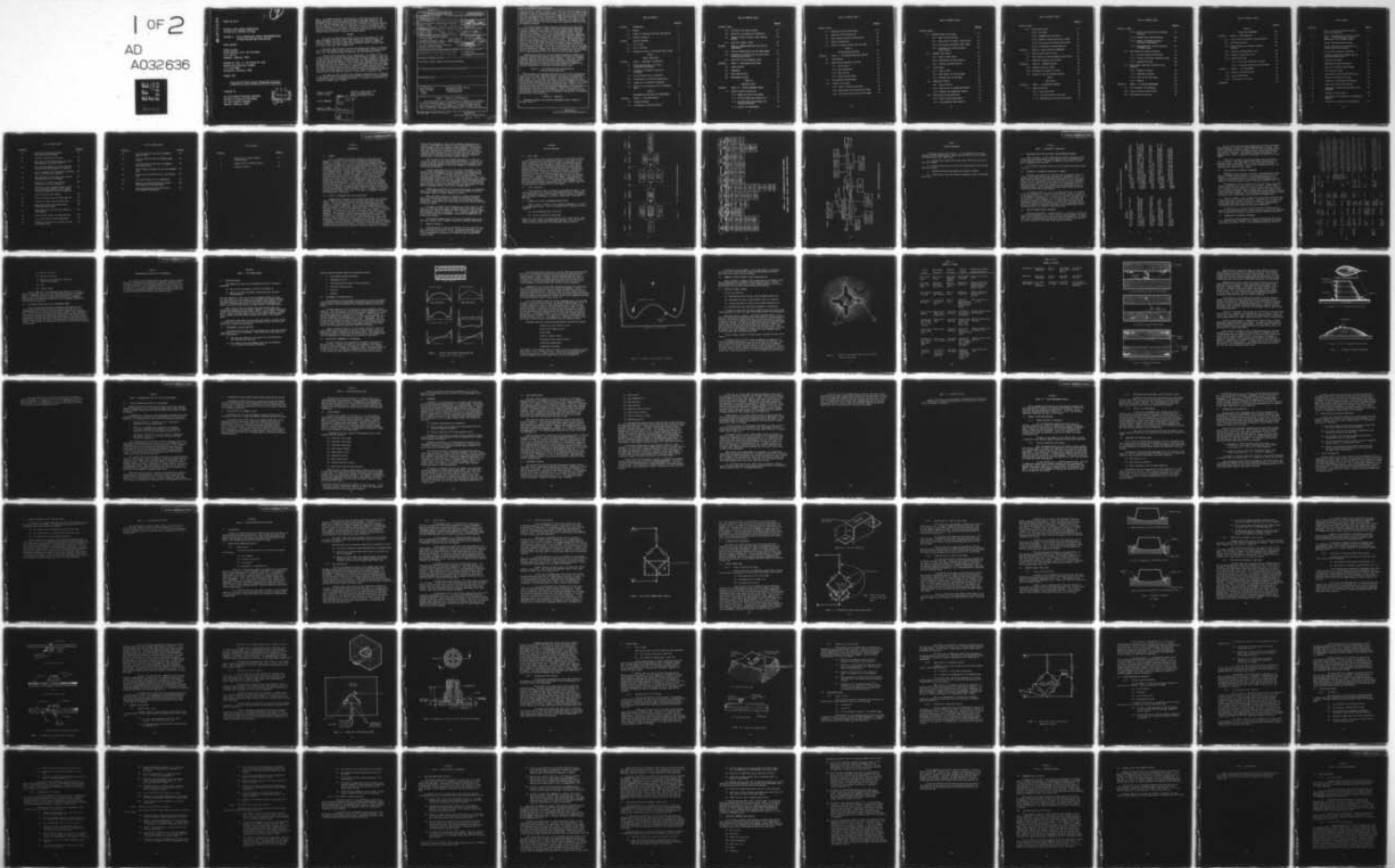

AD A 032636

J (9)

AFRPL-TR-76-57

FLEXIBLE CASE-GRAIN INTERACTION
IN BALLISTIC WEAPON SYSTEMS

VOLUME II - SOLID PROPELLANT GRAIN INSTRUMENTATION
SYSTEM DESIGN AND APPLICATION

FINAL REPORT

Harold Leeming
Harold Leeming, Ph.D. and Associates
P. O. Box 79
Redlands, California, 92373

Kenneth W. Bills, Jr. and Samuel W. Jang
Aerojet Solid Propulsion Company
P. O. Box 13400
Sacramento, California, 95813

October 1976

Approved for Public Release; Distribution Unlimited

Prepared for:

Air Force Rocket Propulsion Laboratory
Director of Science and Technology
Air Force Systems Command
Edwards, California, 93523

D D C
NOV 29 1976
RECEIVED
B

When U. S. Government drawings, specifications, or other data are used for any purpose other than a definitely related Government procurement operation, the Government thereby incurs no responsibility nor any obligation whatsoever, and the fact that the Government may have formulated, furnished, or in any way supplied the said drawings, specifications, or other data, is not to be regarded by implication or otherwise, or in any manner licensing the holder or any other person or corporation, or conveying any rights or permission to manufacture, use or sell any patented invention that may in any way be related thereto.

FOREWORD

This report was submitted by Aerojet Solid Propulsion Company, P. O. Box 13400, Sacramento, California, 95813, under Contract No. F04611-72-C-0055, Job Order No. 305910JU with the Air Force Rocket Propulsion Laboratory, Edwards, California, 93523. The report summarizes the technical efforts conducted under this contract from April 1972 to March 1976.

The efforts reported herein represent the combined activities of the Aerojet Solid Propulsion Company, Harold Leeming, Ph.D. and Associates, Konigsberg Instruments, Inc., the Texas A&M Research Foundation, and the University of Texas.

The key technical personnel on this program were: Mr. Kenneth W. Bills, Jr. of ASPC, who was the Principal Investigator on the Program; Mr. Samuel W. Jang, also of ASPC, who was the program's Principal Engineer; Dr. Harold Leeming, of HL&A, who coordinated the instrumentation of the motors and, later the acquisition of gage data during motor testing; Mr. Herman P. Briar, of ASPC, who conducted much of the gage diagnostic work; Mr. Eph Konigsberg, of KI, who supplied the stress and strain gages and supporting consultation; Dr. Scott W. Beckwith, of TAMRF, who provided an extensive study of flexible case materials and their constitutive relations; and Drs. Eric Becker and Robert Dunham, of the University of Texas, who developed an advanced computer code for the structural analysis of grains held in fiberglass cases.

This report has been reviewed by the Information Office/DOZ and is releasable to the National Technical Information Service (NTIS). At NTIS it will be available to the general public, including foreign nations. This report is unclassified and suitable for general public release.

Durwood I. Thrasher
Project Engineer

Charles E. Payne, Major, USAF
Chief, Surveillance and
Mechanical Behavior Section

FOR THE COMMANDER

Charles R. Cooke
Solid Rocket Division

ADDITION for	
WTR	White Section <input checked="" type="checkbox"/>
BCC	Buff Section <input type="checkbox"/>
UNASSIGNED	<input type="checkbox"/>
JUSTIFICATION	
BY	
DISTRIBUTION/AVAILABILITY CODES	
Dist.	AVAIL. and/or SPECIAL
A	

UNCLASSIFIED

SECURITY CLASSIFICATION OF THIS PAGE (When Data Entered)

19 REPORT DOCUMENTATION PAGE		READ INSTRUCTIONS BEFORE COMPLETING FORM	
18 1. REPORT NUMBER AFRPL-TR-76-57-Vol-2	2. GOVT ACCESSION NO.	3. RECIPIENT'S CATALOG NUMBER	
4. TITLE (and Subtitle) Flexible Case-Grain Interaction in Ballistic Weapon Systems. Volume II. Solid Propellant Grain Instrumentation		9 5. TYPE OF REPORT & PERIOD COVERED Final Report, April 1972 - March 1976	
7. AUTHOR(s) Harold Leeming, Kenneth W. Bills, Jr., Samuel W. Jang		6. PERFORMING ORG. REPORT NUMBER 1953-81-F-1	
10 System Design and Application.		8. CONTRACT OR GRANT NUMBER(s) F04611-72-C-0055	
9. PERFORMING ORGANIZATION NAME AND ADDRESS Aerojet Solid Propulsion Company P. O. Box 13400 Sacramento, California, 95813		10. PROGRAM ELEMENT, PROJECT, TASK AREA & WORK UNIT NUMBERS Job Order No. 3059/0JU	
11. CONTROLLING OFFICE NAME AND ADDRESS Air Force Rocket Propulsion Laboratory Edwards, California, 93523		12. REPORT DATE October 1976	
14. MONITORING AGENCY NAME & ADDRESS (if different from Controlling Office) 14 ASPC-1953-81-F-Vol-2		13. NUMBER OF PAGES 749	
15. SECURITY CLASS. (of this report) Unclassified		15a. DECLASSIFICATION/DOWNGRADING SCHEDULE	
16. DISTRIBUTION STATEMENT (of this Report) Approved for public release; distribution unlimited.			
17. DISTRIBUTION STATEMENT (of the abstract entered in Block 20, if different from Report)			
18. SUPPLEMENTARY NOTES			
19. KEY WORDS (Continue on reverse side if necessary and identify by block number) Solid Propellant Experimental Stress Analysis Sensors or Gages Structural Testing Stress Filament-Wound Case Strain			
20. ABSTRACT (Continue on reverse side if necessary and identify by block number) Volume I - Technical Accomplishments The original objective of this program was to establish the reliability of existing structural analysis techniques for the prediction of stresses and strains in solid propellant grains. This was to be accomplished by fully instrumenting a full-scale Minuteman III Stage III motor with the latest stress-strain instrumentation, subjecting it to various test conditions.			

UNCLASSIFIED

SECURITY CLASSIFICATION OF THIS PAGE (When Data Entered)

405 706 mt

(thermal cycling, handling, vibration, pressurization) and then comparing the experimental results with predicted values. This was to be a "closed envelope" approach in which the reduced data from the gages were to be kept secret until the final assessment phase of the program. Midway through the motor testing phase serious anomalies were detected in the gage data. This led to a suspension of the original plan and an eventual redirection and change in scope to concentrate efforts on the identification and correction of the sources of the anomalies observed.

The revised program included diagnostic evaluations to isolate error sources, a system rework to correct and/or modify questionable components, a parallel laboratory investigation of specific gage characteristics and, finally, verification of the stability of the reworked system. From the results of the diagnostic tests it was determined that the major anomalies observed could be traced to the gages-lead-wire-solder junction combinations. Use of an acid flux in soldering the stainless steel leadwires provided a potential for corrosion to occur as the junction aged. The reworked system, which included crimped spade-lug junctions in place of the leadwire solder joints, a new DAS and revised operational procedures showed a substantial improvement in system stability, exhibiting an average drift rate of 0.5% of full scale output per month. This value is consistent with that for the gages alone as quoted by the manufacturer, and converts to about 0.75 psi per month for the 150 psi gage. However, this drift is considered excessive for measurement of long term thermal stress (as required by the original program).

Laboratory evaluations of the gages addressed potential problems associated with exposed semi-conductor strain gages on the normal stress gage diaphragm, gage self-heating and hysteresis effects. These tests indicated potential transducer response differences between the calibration and the high rate pressurization situations which would require experimentally determined corrections to achieve the accuracy required to accomplish the original program goals for the high rate pressurization tests.

Volume II - Solid Propellant Grain Instrumentation System Design and Application

The experience and knowledge gained from this and similar programs were compiled in this volume, which was designed as a guide to the experimental stress analysis of solid propellant grains. The effect was divided into six major phases. The first phase is directed to the program manager and the project engineer, who must make the initial decision to conduct such an effort. The second and third phases are more elaborate versions of Phase I, but involve realistic plans for instrumenting and testing the units. Phase III is an evaluation of these plans to assure that the measurements can be obtained with the available facilities and test equipment. Phases IV and V define the extensive work required to carry out the test plans, while Phase VI includes the reduction of the test data and an assessment of the quality of the testing and the value of the results.

Volume III - Appendices

Seventeen appendices give detailed supplemental data in support of Volumes I and II.

TABLE OF CONTENTS

		<u>Page No.</u>
SECTION 1	INTRODUCTION	1
1.1	Purpose	1
1.2	Status of Transducers and Their Applications	1
1.3	Format of Volume II	2
SECTION 2	CRITICAL FUNCTIONS	3
2.1	Tier 1 Chart	3
2.2	Tier 2 Flow Chart	3
2.3	Schematic of Typical Instrumented Motor System	3
	PHASE I	
	CONCEPT EVALUATION	7
SECTION 3	PHASE I - ASSESSMENT OF OBJECTIVES	9
3.1	Preliminary Questions for Project Engineer/Program Manager	9
3.2	Statement of Fundamental Objectives of Program	9
3.3	Can the Required Data be Measured?	9
3.4	Investigation of Alternative Approaches	11
3.5	Comparison of Alternative Approaches	11
3.6	Decision to Investigate Use of Instrumented Motor	13
	PHASE II	
	INSTRUMENTATION PLAN AND TEST REQUIREMENTS	15
SECTION 4	PHASE II - TEST MOTOR DESIGN	17
4.1	Design Philosophy	17
4.2	Environmental Loading Conditions	17

TABLE OF CONTENTS (CONT.)

	<u>Page No.</u>
SECTION 4 (CONT.)	
4.3 Preliminary Test Motor Analyses	18
4.4 Definition of Parameters to be Measured	18
4.5 Summary of Types of Sensor, Their Location and Use	22
4.6 Location of Gages in Motor	22
SECTION 5 PHASE II - MANUFACTURING AND TEST FACILITY REQUIREMENTS	31
5.1 Review of Manufacturing and Test Requirements	31
5.2 Estimation of Possible Grain Failures During Processing and Testing	32
5.3 Definition of Test Parameter Limits	32
SECTION 6 PHASE II - DATA ACQUISITION SYSTEM	33
6.1 System Capacity	33
6.2 Redundancy	34
6.3 Data Sampling Rates	35
6.4 Measurement Accuracy	35
PHASE III	
FEASIBILITY STUDY	
	39
SECTION 7 PHASE III - SYSTEM REQUIREMENT REVIEW	41
7.1 Overall System Considerations	41
7.1.1 Number and Type of Instruments	41
7.1.2 Limiting Temperature Requirements	41
7.1.3 Maximum Pressure Requirements and Pressurization Rate	42
7.1.4 Special Test Requirements	42

TABLE OF CONTENTS (CONT.)

	<u>Page No.</u>
SECTION 7 (CONT.)	
7.2 Comparison with Available Gages	42
7.3 Comparison with Available DAS	43
7.4 Motor Design and Processing Constraints	44
7.5 Safety Considerations	44
7.6 Review of Probable Results from Test Motor	45
PHASE IV	
DESIGN AND QUALIFICATION	
SECTION 8 PHASE IV - SYSTEM DESIGN AND SPECIFICATION	49
8.1 System Design	49
8.2 Motor Design, Manufacture and Test	49
8.2.1 Design Details	49
8.2.2 Motor Manufacture	50
8.2.3 Motor Testing	51
8.2.4 Safety Considerations	52
8.3 Instrumentation Requirements	54
8.4 Surface Strain Gages	54
8.4.1 Types of Surface Strain Gage	54
8.4.2 Applications for Surface Strain Gages	56
8.4.3 Difficulties with Surface Strain Gages	56

TABLE OF CONTENTS (CONT.)

	<u>Page No.</u>
SECTION 8 (CONT.)	
8.5 Embedded Normal Stress Gages	57
8.5.1 Types of Gage Available	57
8.5.2 Applications for Normal Stress Sensors	59
8.5.3 Difficulties with Normal Stress Gages	59
8.5.4 Techniques for Installing Normal Stress Sensors	60
8.6 Embedded Shear Sensors	62
8.6.1 Types of Shear Sensor	62
8.6.2 Applications for Shear Sensors	63
8.6.3 Problems with Shear Sensors	66
8.7 Failure Gages	67
8.7.1 Types of Gage	67
8.7.2 Applications for Failure Gages	67
8.7.3 Problems with Failure Gages	69
8.8 Temperature Sensors	69
8.8.1 Types of Sensor	69
8.8.2 Applications for Temperature Sensors	70
8.8.3 Problems with Temperature Sensors	70
8.9 Data Acquisition System Review	72
8.9.1 Overall System Requirements	72
8.9.2 Instrumentation Power Supplies	73

TABLE OF CONTENTS (CONT.)

	<u>Page No.</u>
SECTION 8 (CONT.)	
8.10 System Specification	74
8.10.1 Test Motor	74
8.10.2 Embedded Gages and Sensors	75
8.10.3 Methods of Gage Installation in Motor	76
8.10.4 Data Acquisition System Specification	77
8.10.5 Environmental Loading Conditions	78
SECTION 9 PHASE IV - QUALIFICATION OF COMPONENTS	79
9.1 Gage and Sensor Qualification	79
9.2 Data Acquisition System Component Qualification	81
9.3 Additional Component Qualification	82
SECTION 10 PHASE IV - COMPONENT CHECKOUT	85
10.1 Component Check-out Sheets	85
10.2 Acceptance and Rejection Criteria	85
10.3 Storage of Gage and Component Records	86
PHASE V	
APPLICATION	87
SECTION 11 PHASE V - CALIBRATION TECHNIQUES	89
11.1 Gage Calibrations	89
11.1.1 Case Strain Gages	89
11.1.2 Clip-Type Surface Strain Gages	89
11.1.3 Embedded Gage Calibration Philosophy	93

TABLE OF CONTENTS (CONT.)

	<u>Page No.</u>
SECTION 11 (CONT.)	
11.1.4 Elastic and Viscoelastic Calibration Procedures	95
11.1.5 Embedded Shear Gage Calibration	104
11.1.6 Summary of Embedded Transducer Calibration Requirements	111
11.1.7 Determination of Long Term Stability of Embedded Gage	112
11.2 Data Acquisition System Calibration	117
11.2.1 Internal Calibration Approaches	117
11.2.2 Periodic Calibration Procedure for DAS	118
11.2.3 Sampling Rate Check	120
11.3 Miscellaneous Additional Calibration Data Required	121
11.3.1 Barometric Pressure	121
11.3.2 Temperature Standard	121
11.3.3 Precision DC Power Supply	121
11.3.4 Humidity	122
SECTION 12 PHASE V - TESTING AND MEASUREMENT	123
12.1 Test Procedures and Safeguards	123
12.2 Periodic Review of Data Validity	123
12.3 Data Handling and Storage	124

TABLE OF CONTENTS (CONT.)

	<u>Page No.</u>
PHASE VI	
RESULTS AND ASSESSMENTS	
	125
SECTION 13	127
PHASE VI - DATA REDUCTION	
13.1	127
13.2	128
13.3	128
13.4	128
13.5	129
13.6	129
13.6.1	129
13.6.2	131
SECTION 14	135
PHASE VI - TEST ASSESSMENT	
14.1	135
14.2	136
14.3	136
REFERENCES	139

LIST OF FIGURES

<u>Figure No.</u>		<u>Page No.</u>
1	Tier 1. Critical Functions for Use of Grain Instrumentation	4
2	Tier 2. <i>Instrumentation System for Rocket Motors - Concept Evaluation - Design - Manufacture - Test and Data Review</i>	5
3	Typical Instrumented Motor System	6
4	Typical Stress/Strain Distributions for Thermal and Pressure Loading	19
5	Typical Stress Pattern at Interface	21
6	Schematic Showing Bore Diameter and Slot Width Gage Installations	23
7	Locations for Sensors	26
8	Temperature Gradient Measurement	28
9	Gage Circuit Showing Safety Problem	53
10	Clip Type Strain Gage	55
11	Semiconductor Strain Gage Bridge Circuit	55
12	Methods of Attaching Clip Gages	58
13	Schematics of Gage Mounting Techniques	61
14	"Shear Cube" Stress/Strain Sensor	64
15	Rocketdyne's Through-the-Case Shear Stress Transducer	65
16	Sketches of Failure Gages	68
17	Gage Bridge Circuit Modified for Temperature Readings	71
18	Fixture for Clip Gage Strain Calibration	91

LIST OF FIGURES (CONT.)

<u>Figure No.</u>		<u>Page No.</u>
19	Clip Gage Calibration Data Versus Temperature and Displacement	92
20	Uniaxial Calibration Test Fixture	94
21	Gage Sensitivity Calibration Data for 25-psi Gage Embedded in an Elastic Material	97
22	Zero Load Gage Readings for 25-psi Pressure Gage Before and After Bonding to Propellant	98
23	25-psi Diaphragm Stress Transducer Calibration Data in Lockheed's STV Propellant	101
24	Time-Temperature Shift Factors $\log a_T$ Versus Temperature for 25 psi Transducer	102
25	Vertical Shift Factors $\log b_T$ Versus Temperature for 25 psi Transducer	102
26	Comparison Between Embedded and Bare 150-psi Stress Transducer Outputs at -65°F Showing Viscoelastic Behavior of Potted Transducers	103
27	Shear Calibration Test Fixture	105
28	Elastic Calibration Data for Shear Gage #31	107
29	Viscoelastic Shear Gage Calibration Data	108
30	Shear Gage Sensitivity Data Shifted by Propellant Shift Factors	108
31	Shear Gage Sensitivity Data After Vertical Shift Applied	109
32	Vertical Shift Factors for Shear Gage Data	109
33	$\log a_T$ Shift Factors Versus Temperature	110
34	Schematic of Uniaxial Test Fixture for Long Term Tension Tests	113

LIST OF FIGURES (CONT.)

<u>Figure No.</u>		<u>Page No.</u>
35	Long Term Stability Test Data on Embedded Gages at 150°F	114
36	Long Term Stability Data for Embedded Gages at 80°F	115
37	Long Term Stability Test Data for Embedded Gage Showing Drift	116
38	Typical Thermal Cooldown Test Data from Embedded Gage	130
39	Master Curve of Log Sensitivity vs Log Reduced Time	132
40	Log a_T Shift Factor Curve vs Temperature	132
41	Comparison of Shear Gage Thermal Cooldown Data Analyzed by Three Approaches	134
42	Stress Difference-to-Testing Error Ratio Versus Number of Replicates	138

LIST OF TABLES

<u>Table No.</u>		<u>Page No.</u>
1	Questions for Project Engineer/ Program Manager	10
2	Summary Chart of Available Sensors	12
3	Summary of Sensors	24

SECTION 1

INTRODUCTION

1.1 PURPOSE

This is a pedagogical instrument designed to guide the project engineer in planning his program and the experienced instrumentation engineer in carrying it out. It aims to provide the necessary guidelines and criteria to enable the project and instrumentation engineers to design a complete instrumentation system for measuring stresses, strains and temperatures within a real (live propellant) motor. To this end, questions are posed to determine precisely the purpose of the tests and the relevance of instrumented motors. Having established the basis for the testing the next questions lead to considerations of what a complete instrumentation system comprises, what available instruments can and cannot do, and how accurately the required data can be measured. This preliminary phase provides the project engineer and/or program manager with sufficient information to assess the merits of instrumenting a motor and the chances of obtaining the desired data. In this manner it is hoped to discourage ventures which are unlikely to succeed and ensure that marginal operations will only be undertaken in a full realization of their high risk of failure. Too often, in the past, instrumented motor programs have been initiated with no clear understanding of what is wanted, or why it is required, and with no estimation of the chances of success. This report is intended to preclude this possibility in the future.

1.2 STATUS OF TRANSDUCERS AND THEIR APPLICATIONS

Although these transducers were developed and brought to an advanced state of sophistication, their present accuracy levels limit their applications. They are quite satisfactory for simple measurements of stress change at a constant temperature. But, thermal stress measurements are made less accurate by gage drift, thermal gradients through the gage, and the uncertainties in the time and temperature effects of the gage calibration parameters. Both the normal and shear stress gages, when embedded in the solid propellant, are sensitive to high rates of loading and they are frequency dependent. This dependence (based on present understanding of gage-grain interaction) is expected to decrease with increasing gage stiffness. Thus, the use of gages in motors must involve careful planning with a good understanding of the characteristics of the gages and of the loads that are to be measured. Past experience has supported the view that this rate dependence is predictable purely on the basis of viscoelastic propellant behavior. However, laboratory tests of gages (see Volume I, Section 10 of this report) appear to indicate that another mechanism (possibly viscoelastic behavior of the epoxy

used to bond semiconductor gages to the transducer diaphragm) may be involved. The dilemma this created for the Flexible-Case-Grain Interaction Program is one to be avoided in future programs. The laboratory tests indicated that the calibrations of the transducers in the test motor were invalid for the high rate test; there was no way to directly recalibrate those transducers prior to the high rate test, and no firm evidence that an external calibration of other identical transducers would provide a sufficiently accurate correction factor.

The existence of rate and frequency dependencies is clear and the possible sources of the effects have been isolated. It must be left to future research programs to define the factors more accurately and to develop better gage designs or more precise methods of transducer calibration and data analysis.

The most significant use of in-situ stress measurements, in the present stage of development of stress transducers, is to determine the effective level of propellant modulus in the short term thermal loading of various grain designs. It is known that the relaxation modulus decreases with increasing strain level in the propellant (1). This strain-level dependence in the grain is seen as larger than predicted grain stresses (measured values from 2 to 6 times the predicted levels have been reported (2, 3, and 4)). Bills, et.al. (3), found that a factor of four times the measured relaxation moduli was required to fit the creep behavior of large beams, large model sections, and a 120 in. diameter grain.

Another good application of the present stress gages is the measurement of environmental loads in some kinds of motor storage and handling environments (where the thermal gradients are small).

Where the present gages are of borderline accuracy the measured data can be made more statistically relevant by replicating the gage measurements. This adds to the costs of the test, which must be weighed against the improved statistical significance of the data and the importance of the test results.

In summary, although stress transducers can serve a number of useful purposes as they now stand, several problems require still more accurate gages with more rigorous procedures for their calibration (time and temperature dependence) and use in the motors. It is strongly recommended that the Air Force pursue these developments and provide the opportunity for further motor studies.

The following document details the current procedures and, at the same time, becomes a basic reference to guide the necessary improvements.

1.3 FORMAT OF VOLUME II

Following Section 2, the section headings of this volume follow the Tier 1 flow chart (given in Section 2). The various requirements of the system are discussed in detail. It must be emphasized that all aspects of the instrumentation system must be reviewed in order to design the required system.

SECTION 2
CRITICAL FUNCTIONS

2.1 TIER 1 CHART

A Tier 1 (first level) flow chart which covers the overall aspects of motor instrumentation is presented as Figure 1. Each block in this figure represents an important aspect of motor instrumentation and the titles of these blocks are employed as section titles in the remainder of this report. Note that the design and building of a motor instrumentation system, as well as the Gage and Data Acquisition System (DAS), Calibration and Data Analysis are covered in this chart. Each phase or block of this chart is important in the overall motor instrumentation system and no aspect may be ignored without risk of failure or poor resulting data. Specific gage or DAS performance data are not included in this chart or indeed in the body of this report. The problem here is that motor instrumentation, including gages and DAS components such as amplifiers, power supplies, etc., is constantly being improved, so that the instrumentation engineer should obtain the latest available data from the manufacturers to compare with his requirements.

2.2 TIER 2 FLOW CHART

A more detailed, Tier 2, Flow Chart is presented as Figure 2. This flow chart outlines the information and problems discussed in more detail in the subsequent sections of this report. Being an outline, it should be used as an index to show where a particular problem area is discussed in the report.

2.3 SCHEMATIC OF TYPICAL INSTRUMENTED MOTOR SYSTEM

Figure 3 shows a schematic of the important components of a typical instrumented motor system. It will be observed that it comprises two basic components:

- (1) The instrumented motor itself and
- (2) the data acquisition system (DAS).

Additional items include the bridge completion units, power supply, dummy gages, reference voltages and temperature standards. Also, the DAS may include a data recording device for subsequent computer analysis.

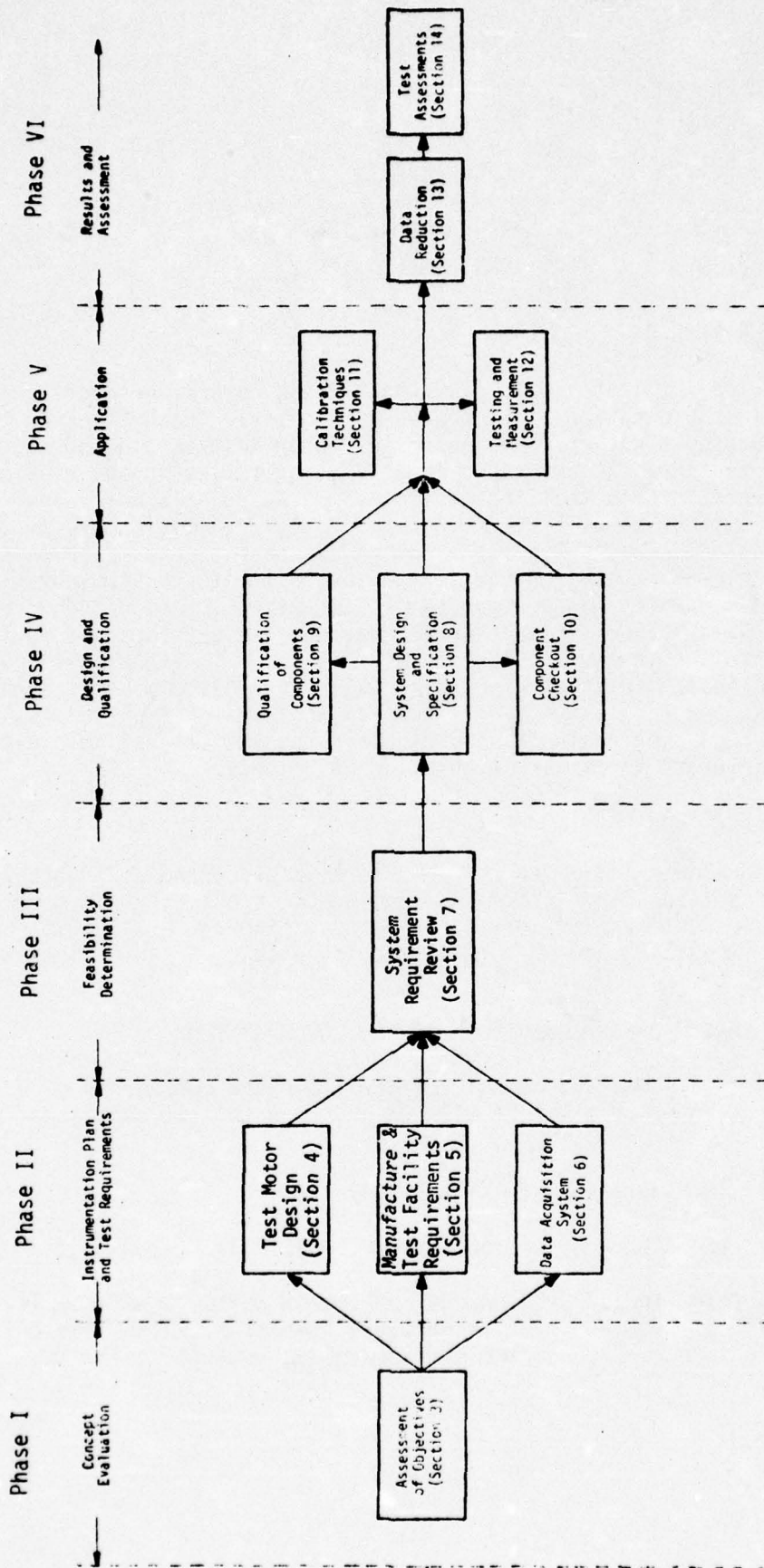

Figure 1. TIER 1. CRITICAL FUNCTIONS FOR USE OF GRAIN INSTRUMENTATION

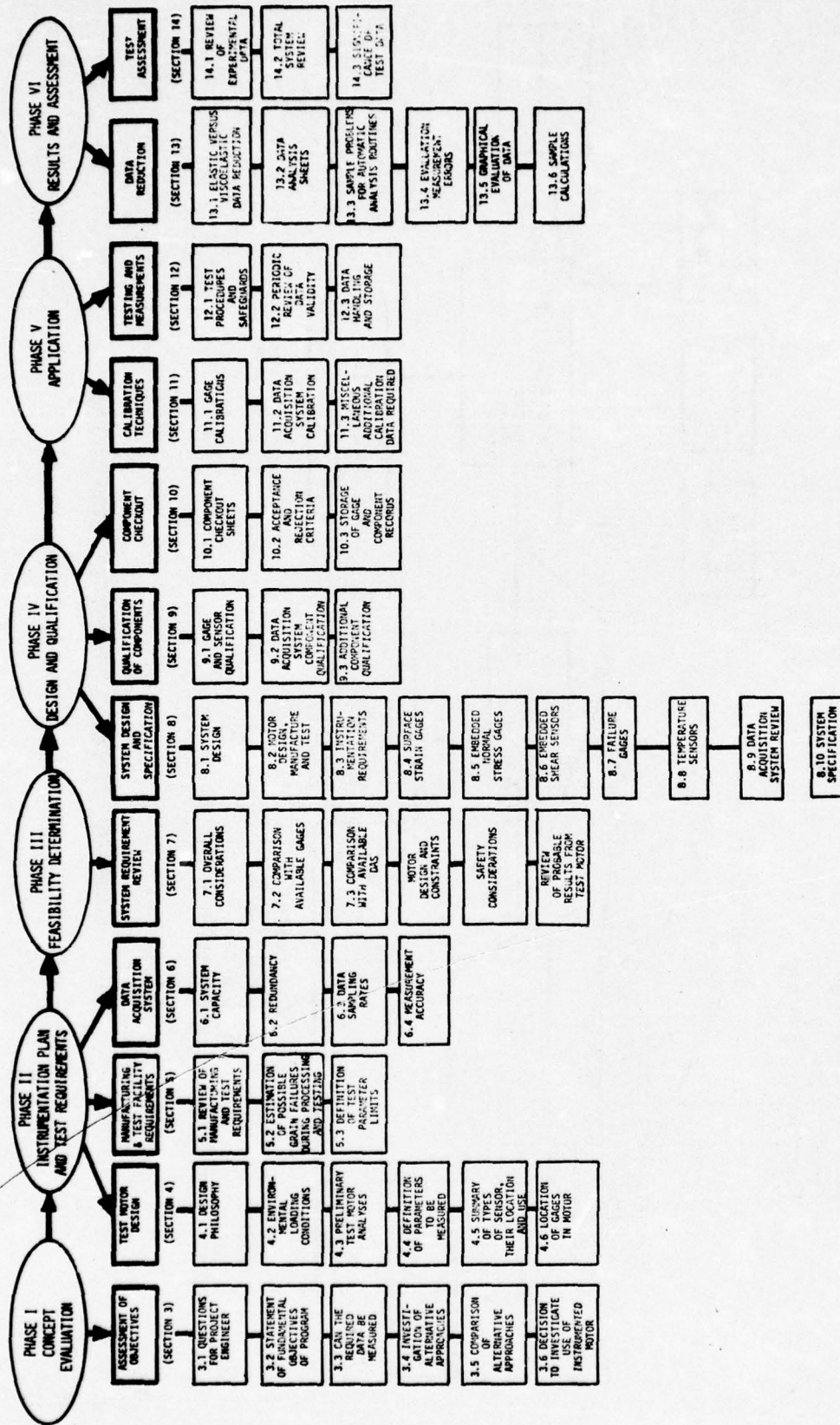

FIGURE 2. TIER 2 INSTRUMENTATION SYSTEM FOR ROCKET MOTORS - CONCEPT EVALUATION - DESIGN - MANUFACTURE - TEST AND DATA REVIEW

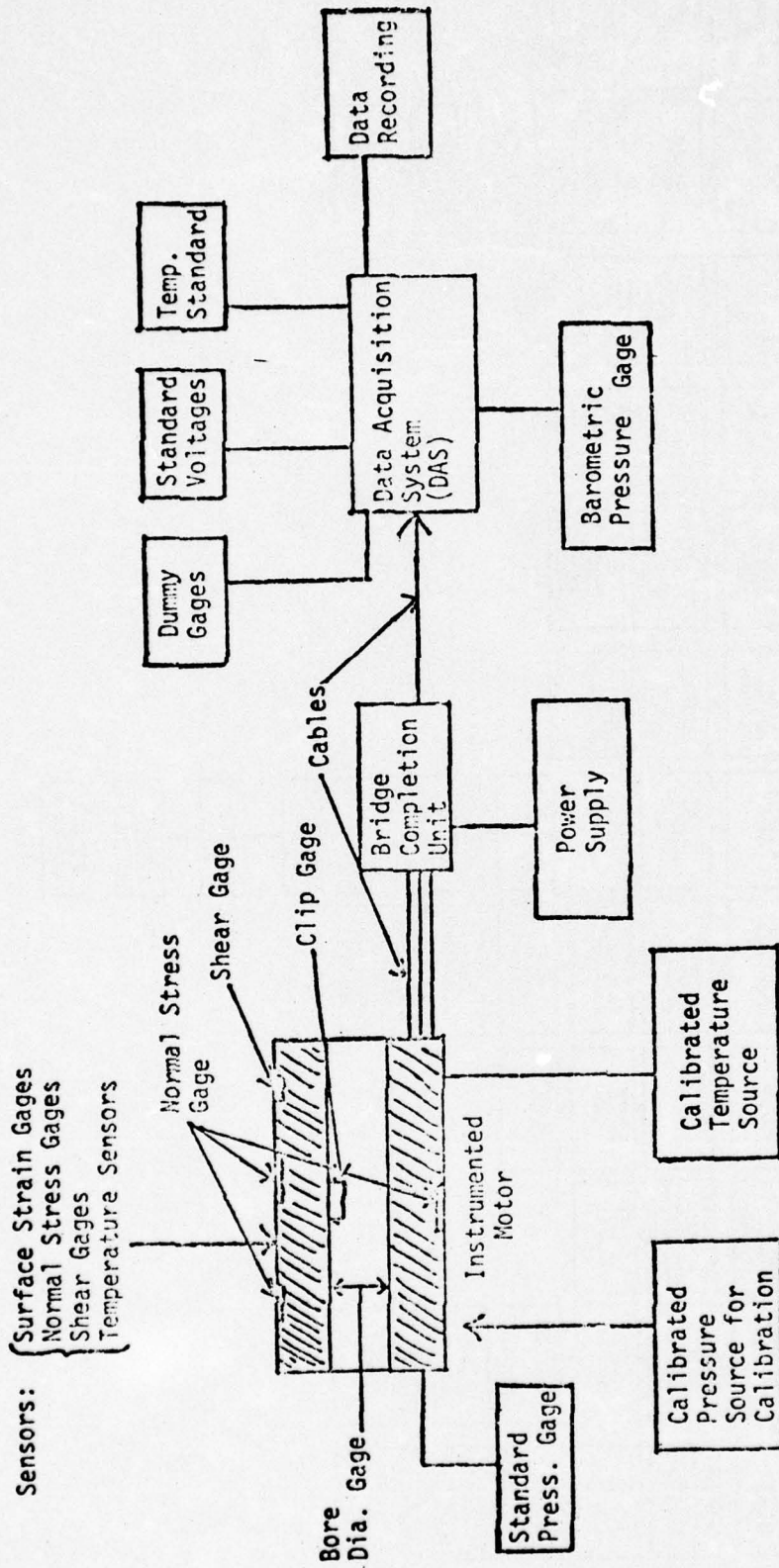

FIGURE 3. TYPICAL INSTRUMENTED MOTOR SYSTEM

PHASE I
CONCEPT EVALUATION

This phase involves only Section 3. It is addressed to the Project Engineer and the Program Manager. Before they make the decision to conduct instrumented motor tests they should:

- a. Evaluate their objectives to make certain that such evaluations are really needed.
- b. Assess the feasibility of making the measurements to the required degree of accuracy.
- c. Consider alternate experimental and analytical methods.
- d. Comparatively assess the alternate approaches versus instrumented grain tests.

SECTION 3

PHASE I - ASSESSMENT OF OBJECTIVES

3.1 PRELIMINARY QUESTIONS FOR PROJECT ENGINEER/PROGRAM MANAGER

Table 1 presents a series of questions which must be answered by the project engineer/program manager before deciding that an instrumented motor is the approach to follow. A number of comments are provided to clarify what is intended by the questions.

The following subsections amplify the basic question-and-answer theme of Table 1.

3.2 STATEMENT OF FUNDAMENTAL OBJECTIVES OF PROGRAM

Initially, the objectives of the work under consideration should be listed. These objectives may range from specific requirements such as determining the deflection and deformation characteristics of a pulse motor grain during the ignition and firing of another grain, to more intangible problems such as investigating the accuracy of a new nonlinear viscoelastic theory, or the estimation of the long term failure characteristics of an operational motor. A variety of problems may be investigated by means of instrumented motors and the fundamental program objective must be clearly stated at the initiation of the project.

In considering what is, or are, the program objectives, the question of why this information is required must be examined. Usually, a need for an instrumented motor will arise as a result of a problem or problems during the development or deployment of a solid rocket motor. In this event the why question is simply answered, i.e., to provide specific answers to the particular problems being experienced. In other cases, much more serious consideration must be given to the question of why it is necessary because, unless this question is thoroughly evaluated, an instrumented motor may be manufactured which can provide no really useful data.

3.3 CAN THE REQUIRED DATA BE MEASURED?

Having specified what is required and why it is necessary, we then ask can the data be obtained? This is not a trivial question because the answer hinges on the accuracy with which the data need to be determined. The acceptable limits of required data accuracy must first be specified and then compared with conservative estimates of the expected test data.

TABLE 1

QUESTIONS FOR PROJECT ENGINEER/PROGRAM MANAGER

<u>QUESTION</u>	<u>COMMENTS</u>
1. What is the nature of the problem to be investigated?	e.g., motor failure on long term storage, or ignition; need for improved performance in existing envelope, etc.
2. Is the use of an instrumented motor the only method of resolving the problem, or are other techniques available?	In some instances the problem may be too difficult for analysis and use of an instrumented motor may be the only viable approach. In other cases the instrumented motor may be desired only to supplement available analyses.
3. Do the available transducers have sufficient accuracy to measure what is required?	Precisely define the parameters required and the maximum acceptable error, e.g., 6 psi (thermal stress) within <u>±</u> 5% error band.
4. Will the measured motor data be sufficiently accurate to resolve analytical problems.	In many instances the instrumented motor data may not be sufficiently accurate to provide the required answer. This must be determined before the motor is built.
5. How will the measured motor data be used if they do not agree with analyses?	If the experiment has been realistically designed and allows for gage and testing errors, then the observed differences can be accepted as real.

In this context the difference between absolute stress measurement and differential, or change in, stress measurement must be noted. Under certain controlled conditions changes in stress level may be measured with fair accuracy and relative ease whereas absolute stress levels are much more difficult to measure. The problem of absolute measurements with embedded stress sensors is discussed in more detail in Section 11 of this report.

A preliminary guideline for the measurements that can be made is given in Table 2. This table summarizes the types of measurements and the gages needed to make them, plus a listing of typical accuracies observed in past test programs. Clearly, new instrumentation and/or use techniques will improve on these figures.

3.4 INVESTIGATION OF ALTERNATIVE APPROACHES

Although it may be feasible to employ an instrumented solid rocket motor to provide the required data, it may not necessarily be the best approach. A review must be made of all alternative approaches, e.g., conventional two dimensional elastic analyses, three dimensional elastic analyses, viscoelastic analyses, special laboratory simulation tests, etc.

Two dimensional elastic analysis is the simplest and most economical method of obtaining stress and strain values in grains. Unless there is strong evidence that the analytical stress and strain values are incorrect, e.g., the motor fails upon firing or storage, then this is always the preferred preliminary approach. When the conventional analyses provide incorrect values, the simplest approach is to consider more elaborate analyses or direct laboratory tests to obtain more realistic propellant property data.

There is, however, a limit to what can be achieved by analytical techniques before the cost becomes prohibitive. Therefore, if it is clear that a three dimensional, nonlinear viscoelastic analysis will be necessary to provide the relevant grain stress values, it is highly probable that an instrumented motor could provide the data more economically.

In other cases it is possible that the specific problem cannot be successfully modeled analytically, in which case the use of special laboratory tests to simulate the problem as closely as possible should be considered.

3.5 COMPARISON OF ALTERNATIVE APPROACHES

Once the alternative methods of obtaining the desired grain stress/strain data have been enumerated, their respective advantages and disadvantages must be examined. Factors to be considered include the following:

TABLE 2
SUMMARY CHART OF AVAILABLE SENSORS

TYPE OF MEASUREMENT	TYPE OF SENSOR	SENSING ELEMENT	RANGE	OUTPUT	ACCURACY	DRIFT	COMMENTS
Temperature	Thermocouples	Dissimilar metal junctions.	-300 to 500°F	± 5.5 mv	Best ± 1°F Usual ± 2°F	-----	Self generating, low output devices need high gain DC amplifier. Good stability and accuracy nonlinear output vs. temperature - second order fit required. Need reference junction and special bimetal wires and plugs.
	Thermistors	Doped Semiconductor	Between +500 and -300°F Depends on (bridge) circuit.	Depends on bridge, but commonly ± 500 mv.	± 2°F	Can be significant.	Can be high output devices but need external power source. When semiconductor material exposed to propellant significant drift may occur necessitating frequent recalibration. Non-linear output vs. temperature - third order fit required.
	Gage elements of normal or shear sensors.	Doped Semiconductor	Between +200 and -100°F	Depends on bridge, but commonly ± 250 mv.	± 2°F	Not known; but depends on stability of semiconductor material and bondline.	Simplest approach for semiconductor strain gaged devices since no additional sensor required. Provides temperature at specific gage location and therefore best calibration data for gage. Stress field interaction with temperature can be reduced to negligible proportions with proper circuit design.
Surface Strain	Resistance Wire/ Foil strain gage	Foil Strain gage	+ 2000 micro inches	Depends on bridge and power supply; but usually ± 10 mv.	+ 50 micro inches	Can be significant at higher temps. (≈ 500°F)	Stable, low output devices easily bonded to metal cases. Only real problem concerns stability of adhesive used to bond gages down under high temperature or high moisture conditions. Not suitable for low modulus materials, e.g., propellant.
	Clip Gage (Strain gaged metal element in bending.)	Semiconductor strain gages.	Not fixed; typically ± 10% strain	+ 100 mv	+ 1% strain	Not known.	Sensitive gages for use on soft materials, e.g., propellant. Problems with attaching gages to surface; using inserted pins or bonded studs. Calibration linear for small displacements but becomes nonlinear over wide displacement range.
Normal stress in propellant.	Miniature diaphragm pressure sensor.	Semiconductor strain gages.	(Varies). ± 50 psi ± 150 psi ± 450 psi	+ 100 mv to ± 150 mv full scale	Best Typical ± 1/2 psi ± 1 psi ± 1 psi ± 2-5 psi ± 4 psi ± 10 psi	Not known.	Small, sensitive sensors can provide accurate stress data with proper use. ± 150 psi sensor can resolve dynamic stresses of ± 0.5 psi. Drift due to combination of gage aging and propellant hardening can be significant (20 mv).
	Piston sensor through case wall.	Semiconductor strain gages.	(Varies) typically ± 100 psi	+ 15 mv	Best Typical ± 1 psi ± 5 psi	Not known.	Requires hole through case wall. Not very sensitive so that accuracy suffers in moderately noisy environment. Under laboratory conditions data very similar to miniature diaphragm gage data.
	Capacitance Diaphragm sensor	Capacitance of diaphragm case causing oscillator frequency change.	Varies with diaphragm thickness. Typical ± 100 psi	+ 500 Kc	Best ± 2 psi	Not known.	This device developed as a self-contained telemetry system for stress measurement in large motors.
Shear stress/strain in propellant	"Shear cube"	Semiconductor strain gages	(Varies). Typically ± 60 psi with Ruggedized Strain gages or ± 10% strain	+ 150 mv.	Best Typical ± 25% ± 100% (Depending on stress field.)	Not known.	These devices are sensitive monitors of distortion in propellant and may be calibrated in terms of shear stress or strain. Sensitivity depends markedly on propellant modulus. Accuracy influenced by stress state e.g., calibration factors for plane strain are ~ 40% higher than plane stress factors.
	Through case wall. Dual-plane shear sensors.	Semiconductor strain gages.	(Varies). Typically ± 50 psi	+ 10 mv	-----	-----	These through-case wall devices have low sensitivity but can measure two in-plane shear stress components.

- (a) Chances of success
- (b) Relative difficulty
- (c) Whether or not additional information can also be obtained
- (d) Cost
- (e) Schedule impact

Item (c) above must be an important consideration at this stage because it represents one of the main advantages of using an instrumented motor. Although the unit may be built and instrumented for a specific purpose, it is often feasible to obtain additional useful information from the motor at relatively low additional cost and without compromising the primary test objectives.

3.6 DECISION TO INVESTIGATE USE OF INSTRUMENTED MOTOR

After reviewing the alternative approaches and determining their relative merits the preliminary study may indicate that the use of an instrumented motor will provide the best chance of measuring the required data. In this case the decision must be made to perform a more comprehensive investigation into the instrumented motor concept including the test motor design and the required data acquisition system (DAS). The project engineer/program manager require additional information concerning the overall instrumented motor system and the types of test required to provide the information desired. These aspects are considered in more detail in the following sections of this report.

PHASE II

INSTRUMENTATION PLAN AND TEST REQUIREMENTS

In this phase a preliminary decision has been made to instrument the motor. Now the project engineer must consider, in general terms, the practical aspects of the test motor design (Section 4), how it will be tested (Section 5), and the methods available for data acquisition (Section 6). All of these considerations are to be made as input data to a feasibility assessment (Phase III), where the final decision will be made to continue (or discontinue) the planned testing.

SECTION 4

PHASE II - TEST MOTOR DESIGN

4.1 DESIGN PHILOSOPHY

Instrumented test motors can be designed using one of two general approaches;

- (1) they can be scale models of the full size motor, or
- (2) they can be simplified models incorporating only essential design features.

The first approach is often used for non-instrumented motors for aging or firing tests, and in such cases full-scale motors are commonly employed. The second approach is the structural test vehicle (STV) approach in that the motor is designed specifically for structural testing purposes and models a particular design aspect of primary concern to the manufacturer.

When realistic data are required from subscale motor tests the designer must consider the scale factors involved. It is usually impractical to duplicate thermal heating and cooling rates or inertia effects in subscale motors. Often a modified thermal cycle or a more severe vibration spectrum may be required to provide similar stresses and strains in the subscale grains.

When motors other than full-scale units are tested, a rigorous review of the test plan and STV design must be performed to ensure that valid data and realistic simulations are obtained.

4.2 ENVIRONMENTAL LOADING CONDITIONS

Having determined the motor design philosophy the various environmental loading conditions must be considered. These loads must be specified at an early stage because:

- (1) The types and locations of the sensors will be determined by these loading conditions and,
- (2) The sequence of the environmental tests must be determined so as to provide the maximum information.

Typical loading conditions which may be considered include:

- a. Slow thermal cooling and heating
- b. Temperature cycling
- c. Rapid pressurization (motor firing simulation)
- d. Long term storage (aging)
- e. Vibration
- f. Handling

4.3 PRELIMINARY TEST MOTOR ANALYSES

Once the design of the test motor and the details of the environmental loading conditions have been determined, preliminary analyses of the grain should be made to provide estimates of the interface and bore stresses and strains.

A separate analysis will be required for each environmental loading condition. From these analyses, and assuming a linear superposition of stress, a detailed stress and strain history can be prepared to determine the sums of the stresses and strains at key points in the grain. In this context, it should be remembered that embedded stress or strain gages monitor the sum of all the stresses and strains developed in a motor. Consequently, test conditions such as changing the motor's position from a horizontal location to a vertical location must be included. While the inertial stresses involved may well be small, they cannot be ignored without introducing significant errors into the analytically predicted stress/strain patterns.

Figure 4 presents sketches of the case-grain interfacial normal and shear stresses and the bore hoop strains for a simple circular port grain subjected to thermal cooldown and pressurization tests. These figures show the predicted regions of high stress and strain and will help determine the critical parameters to be measured and the location of the sensors.

4.4 DEFINITION OF PARAMETERS TO BE MEASURED

The most significant test parameters will depend on the purpose of the test vehicle. Usually, the motor will be designed to investigate a particular loading condition or combination of conditions, e.g., thermal cooldown to say -65°F followed by a simulated firing. The primary objective of the tests will be to measure the maximum bore (hoop) strains and the critical normal and shear interface stresses during the testing sequence.

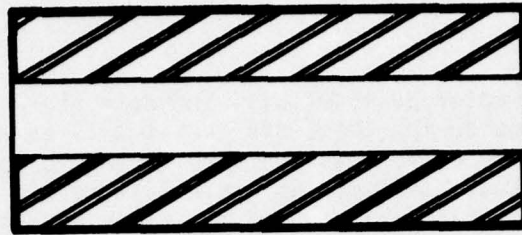

Motor Geometry

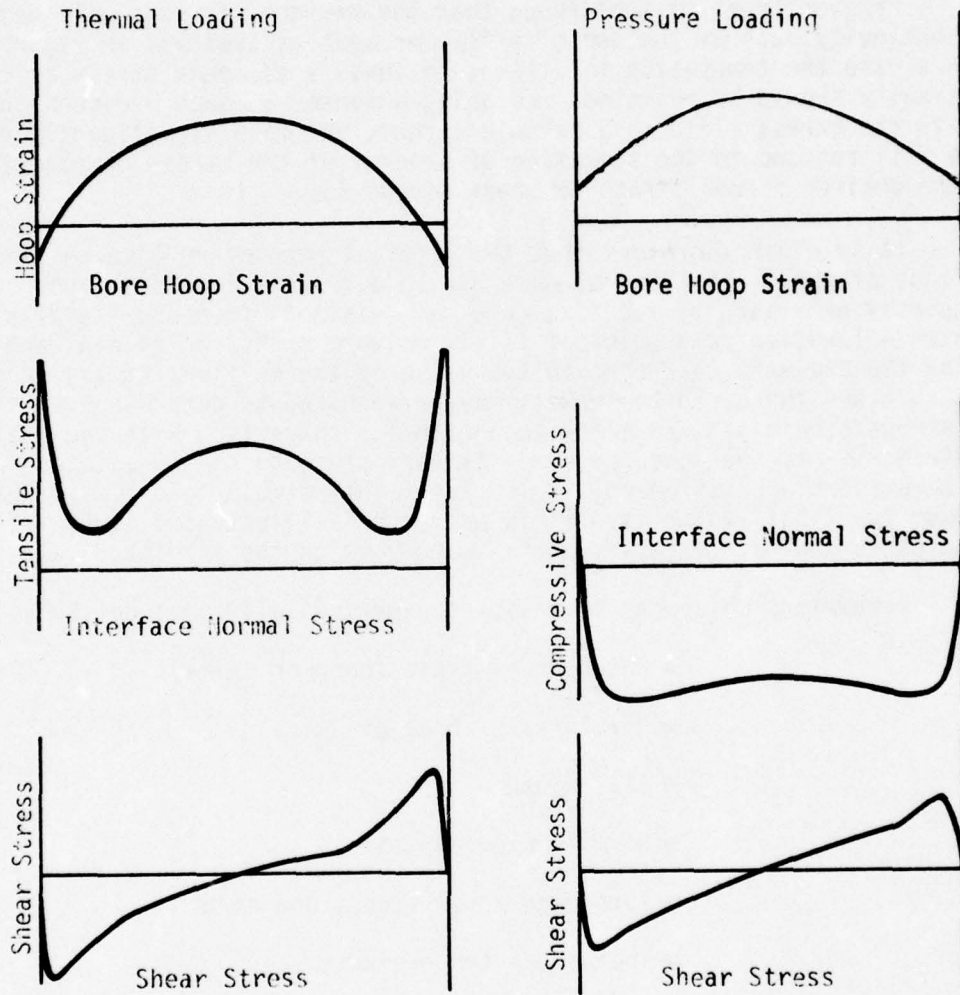

FIGURE 4. TYPICAL STRESS/STRAIN DISTRIBUTIONS FOR THERMAL AND PRESSURE LOADING

The preliminary motor analyses will indicate where the maximum stresses and strains will develop during the tests and it will be noted that these maxima may occur at quite different locations depending upon the type of loading condition imposed. Inasmuch as grain failure will result from the resulting total stresses and strains (and the times for which they act) it is necessary to review the complete motor analysis picture for the entire loading sequence to determine which are the most critical parameters.

Frequently it will be found that the maximum stresses will develop at a discontinuity such as the end of a flap or boot as sketched in Figure 4. In such a case the temptation to attempt to measure the peak stress at the discontinuity should be resisted. Locating a sensor at such a discontinuity will modify the stress field to a certain extent, but more significantly the embedded gage will respond to the summation of several of the stress components, not just to the desired normal stress or shear stress (5).

It is clear therefore that the critical parameters have to be specified in light of the limitations of what can be done with embedded gages and it is frequently necessary to locate a gage some distance from a critical stress or strain location to a point of fairly uniform stress or strain, and then employ the analysis to ascertain the value of the critical stress or strain. In such cases two or three sensors may be required to determine the shape of the stress/strain pattern along the grain for comparison with the analytical predictions. If the measured shape is very close to that predicted and only the magnitudes are different, it is then fairly simple to estimate what the maximum (critical) value is. (This approach is illustrated in Figure 5 where three gages indicate stresses approximately twice the predicted values).

Parameters which may be measured experimentally include the following:

- Motor case strain (hoop or axial)
- Bore strain (hoop or axial)
- Slot width
- Normal interface stress
- Interface shear stress and strain
- Individual temperatures
- Temperature gradients

Measurements of bore diameter and/or the width of a slot are frequently desired when a motor is to be tested to failure. These data can be obtained readily using clip strain gages. However, gages for bore strain measurement, if installed improperly, may well induce local failure in the grain (6).

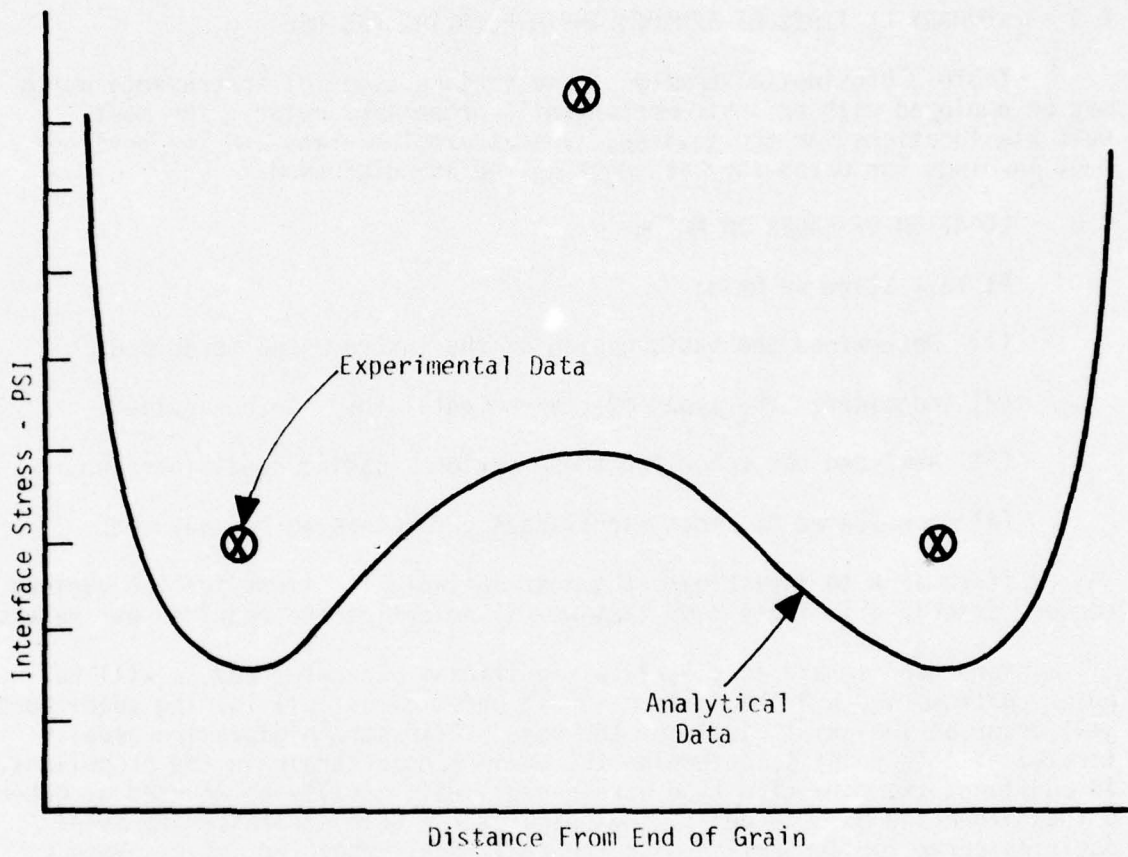

FIGURE 5. TYPICAL STRESS PATTERN AT INTERFACE

Installation of bore diameter or slot width gages as illustrated in Figure 6 will usually provide a significant measurement from which the critical bore strain can be calculated.

4.5 SUMMARY OF TYPES OF SENSOR, THEIR LOCATION AND USE

Table 3 provides a summary of the various types of instruments which may be employed with an instrumented solid propellant motor. The most suitable locations for the devices, typical problem areas and the environment loadings for which they are most suited are discussed.

4.6 LOCATION OF GAGES IN MOTOR

At this stage we have:

- (1) Determined the basic design of the instrumented motor and,
- (2) considered the types of environmental loads to be applied,
- (3) analyzed the motor for these various loading conditions and,
- (4) considered the most significant parameters to be measured.

It remains to investigate the most suitable locations for the various sensors described in Table 1 so that we may determine the required parameters.

Bore hoop strain is clearly a significant parameter and as will be observed from Figure 4 the maximum strain under almost all loading conditions will occur at the axial middle of the bore. Clip strain gages are usually located at this point to determine the maximum hoop strain in the propellant. In addition, two more clip type strain gages will usually be mounted at other points along the bore to define the shape of the bore strain versus axial position curve for comparison with the analytical predicted curve. When bore strains are to be measured to failure, the clip strain gage at the point of highest strain will frequently be replaced by a bore diameter gage to prevent the gage from initiating failure (6).

Figure 7a shows a sketch of the most useful locations for bore strain sensors.

Elastomeric surface failure gages will generally be bonded at the location of maximum hoop strain, i.e., the axial middle of the grain. Care must be taken that the physical properties of the gage, and the adhesive used to bond it to the bore are very similar to those of the propellant. Too hard a gage may cause a premature failure in the propellant or reinforce the grain locally, while too soft a gage instead may mean that the gage will bridge over a crack in the grain i.e., it will not detect the grain failure.

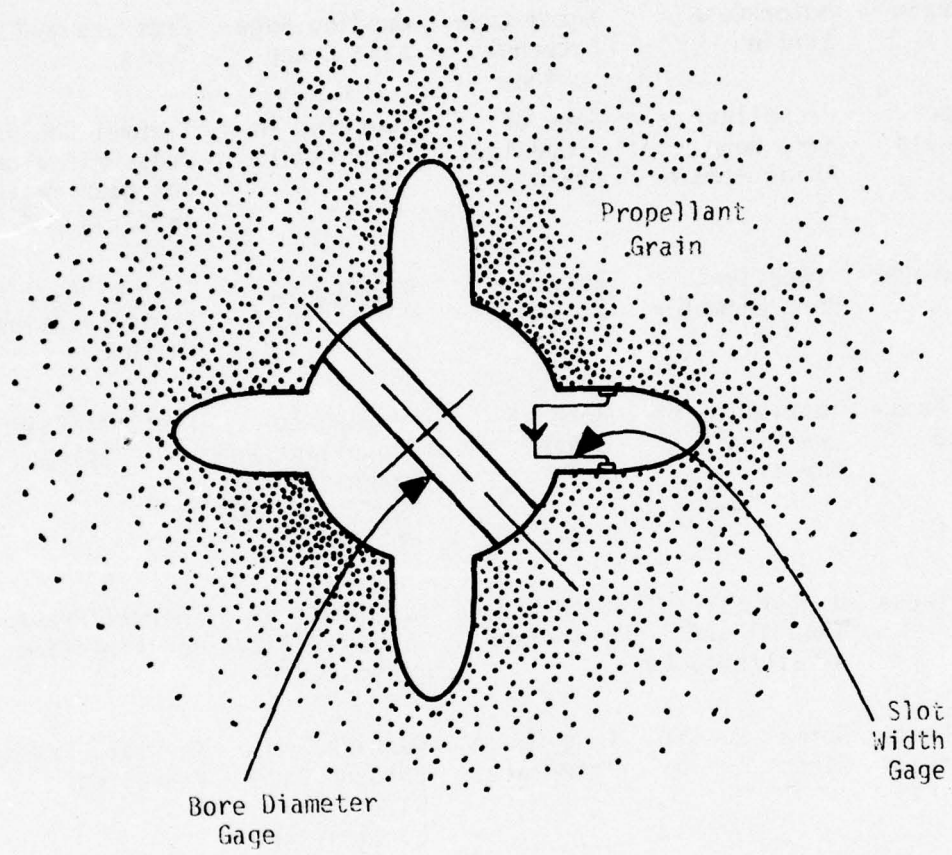

FIGURE 6. SCHEMATIC SHOWING BORE DIAMETER AND SLOT WIDTH GAGE INSTALLATIONS

TABLE 3
SUMMARY OF SENSORS

Type of Sensor	Measurement Required	Suitable Locations	Inherent Problems	Suitable Environmental Loading Conditions
Foil Strain Gages	Motor Case Strain	Motor Case External Surface	Bonding Adhesive Creep	Pressure and Firing Tests
Clip Type Bore Strain Gages	Propellant Bore Hoop Axial Strain	Bore of Propellant Grain	Mounting in Propellant	Thermal Cooling and Pressurization, but not near failure. (Refs. 3 and 4)
Bore Diameter Clip Gage	Propellant Bore Diameter	Bore of Grain	Bonding to Propellant	Thermal Cycling and pressurization to failure.
Surface Failure Gages	Initiation of Cracking at Bore	Bore of Grain	Bonding to Propellant and Matching Grain's Physical Properties	Tests to Failure and Aging.
Normal Stress Sensors	Normal Stress (Radial and Axial) (Ref. 7)	Case-Grain Interface	Calibration and Stability of Response	Thermal Pressure Tests and Vibration.
Through Case Wall Normal Stress - Piston Type	Normal Radial Stress	Case-Grain Interface	Requires hole through Case Wall. Low Sensitivity.	Thermal, Pressure and Vibration.
Shear Stress/Strain Shear Cube	Shear Stress	Case-Grain Interface	Accuracy of Data influenced by Stress Field	Thermal, Pressure and Vibration Tests.
Through Case Wall Dual-Plane Shear Gages	Shear Stress in two Planes	Case-Grain Interface	Accuracy of Data-Low Output. Requires Hole through Case Wall	Thermal, Pressure and Vibration.
Interface Failure Gages	Initiation of Failure by Cracking or Unbonding	Case-Grain Interface	Bonding to Propellant and Matching Grain's Physical Properties	Failure and Aging Tests

TABLE 3 (Cont.)

SUMMARY OF SENSORS

Thermocouple	Case/Grain Temperature	Case or Grain	Low Output; Needs Special Wiring	Any Thermal Testing.
Thermistor	Case-Grain Temperature	Case or Grain	Long Term Stability	Any Thermal Testing.
Semiconductor Gage Element	Local Gage Circuit Temperature	Location of S/C Gages	Long Term Stability	All Tests, for Interpretation of Gage Data.

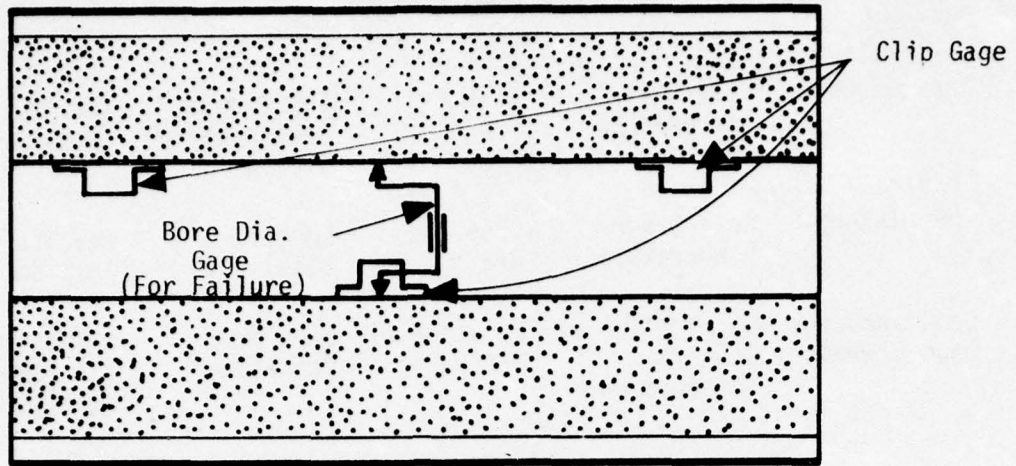

a. Sketch Showing Locations for Strain Gages

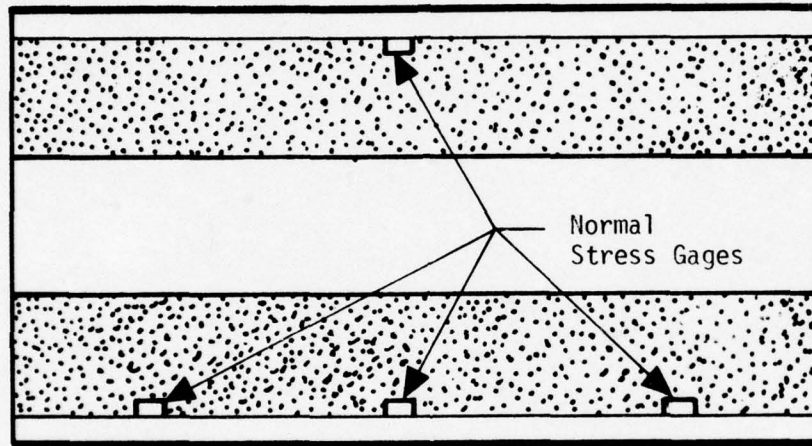

b. Location of Normal Stress Gages

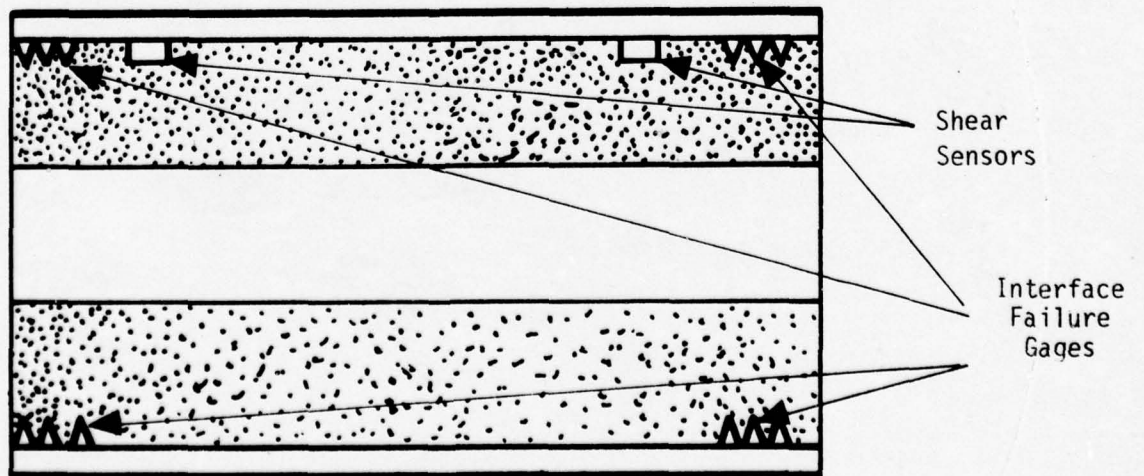

c. Location of Shear Stress Sensors and Failure Gages

FIGURE 7. LOCATIONS FOR SENSORS

Conventional foil type strain gages are often bonded to the motor case, usually at the axial middle, to measure case strain and provide an accurate boundary condition for realistic motor analyses. This is often required when flexible (fiberglass) motor cases are employed but care must be taken to ensure that the strain measured by the gage is typical of the average motor case strain when filament wound motor cases are instrumented.

Embedded normal stress sensors will usually be placed at the axial middle of the grain (Figure 7b) since a peak normal stress occurs here under most loading conditions. Furthermore the stress gradient is low at this point. Two more normal stress sensors are usually employed along the axis of the motor to define the shape of the normal stress - axial position curve. It is also good practice to make redundant measurements of the key normal stresses. This may be done by employing two gages at the middle of the grain 180° apart as shown in Figure 7b.

The measurement of the maximum shear stresses in a grain presents a problem since they are usually associated with the termination points of the grain (see Figure 4). Because the shear gage will provide an inaccurate reading in regions of rapidly changing stresses (5) it is better to locate the sensor a small distance from the end termination as shown in Figure 7c. The maximum shear stress will then have to be estimated from the gage reading and the stress analysis.

Interfacial elastomeric failure gages will be located at the anticipated failure sites i.e., adjacent to the ends of the grain, as shown in Figure 7c. As with the surface failure gages, the physical properties of the interfacial failure gages should be as close a match as possible to those of the propellant.

The use of thermocouples or thermistors for measuring grain and gage temperatures generally presents no problems. The sensor is simply bonded at the desired location with a suitable adhesive (suitable adhesive implies one that is compatible with the propellant and will not cause local stress concentrations as a harder epoxy might).

A more difficult problem is that of measuring temperature gradients throughout the grain. If precisely located sensors are required then the best approaches are those employed by LPC (in the STV and BDU programs) and by ASPC (in the Polaris program) (4,8,9). The scheme is illustrated in Figures 8a and b where it will be noted that the temperature sensors are bonded to a shaped piece of propellant (live or inert, as desired) with the lead wires routed to the case wall. The temperature block is then bonded to the case wall. The temperatures at the discrete known distances from the case wall may then be monitored during a test.

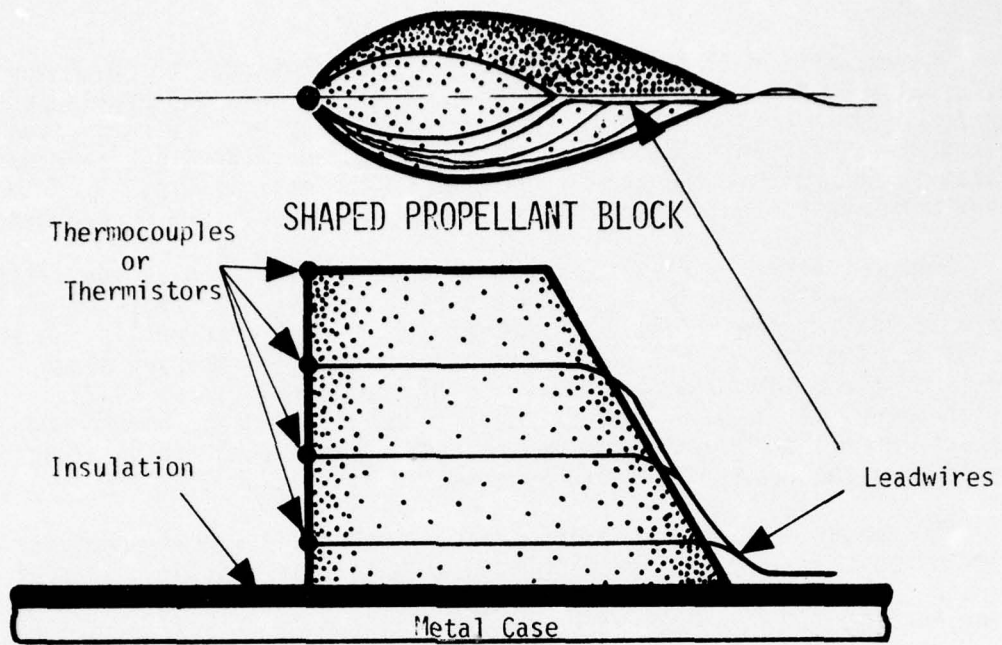

a. Schematic of LPC's Temperature Gradient Block

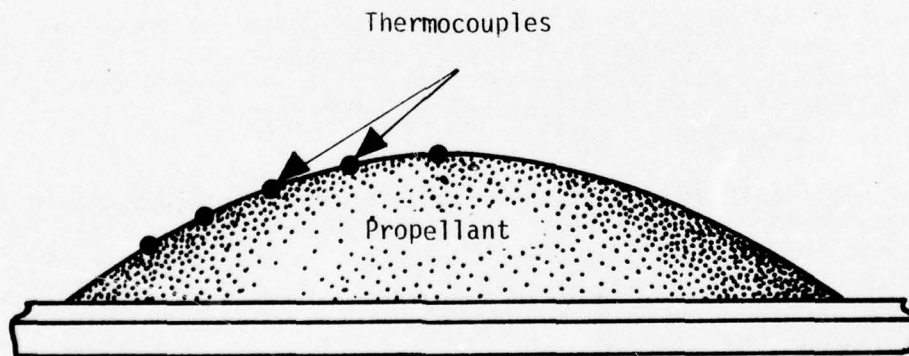

b. Schematic of ASPC's Temperature Gradient Block

FIGURE 8. TEMPERATURE GRADIENT MEASUREMENT

A precaution which must be observed in installing a temperature block of this type is to ensure that it is small enough that a significant depth of propellant is subsequently cast over it. Otherwise, the block itself may well act as a stress/strain riser and cause the grain to crack at the bore during severe thermal tests (10).

SECTION 5

PHASE II - MANUFACTURING AND TEST FACILITY REQUIREMENTS

5.1 REVIEW OF MANUFACTURING AND TEST REQUIREMENTS

Beginning with the installation of the gages in the case, (and the subsequent calibration tests), the complete planned motor history through casting, cooldown, thermal, pressure and any dynamic tests required, should be prepared.

A comprehensive listing of all the manufacturing procedures and tests planned for the motor is required so that the necessary facilities may be specified. It is important that items such as the following be detailed:

- a. Handling procedures; any handling rings, transporters, harnesses, etc., must be specified.
- b. Details of all manufacturing operations and equipment to be used, temperature and length of cure, orientation during cure, any pressure requirements during cure, etc.
- c. Location of facilities to be used, accuracy of temperature and humidity control, ease of access and space available for auxiliary apparatus.

This information must be obtained to enable any problem areas which might crop up with the manufacture and test of the instrumented motor to be investigated and eliminated prior to motor manufacture. In this context, a special provision has to be made for protecting the gage lead wires during cure and tests and for ensuring that modified casting equipment is available if required to avoid interfering with the gages and lead wires. A provision for sealing the instrumented motor must be made if a pressure casting operation is specified.

The specific tests to be performed will dictate the support apparatus required. For instance, high rate (ignition simulation) pressure tests will require a special high pressure fluid/gas source and high speed valves and control circuits. Similarly, temperature cycling or cooling of a motor requires conditioning boxes of adequate size, thermal capacity, and accuracy of temperature control. When these support facilities are not available they may have to be purchased or constructed and should be included in the total cost of the proposed instrumented motor tests.

While the use of a series of separate single-temperature chambers is feasible with an instrumented motor, because of problems associated with system component interconnection such as cables, plugs, power supplies, DAS, etc., it is preferable (and more accurate) to employ a single chamber and to change its temperature as required with the instrumented motor installed.

5.2 ESTIMATION OF POSSIBLE GRAIN FAILURES DURING PROCESSING AND TESTING

The maximum and minimum pressures, stresses and strains anticipated in the instrumented motor during the manufacture and environmental testing sequence must be determined. These estimates are of great significance from the viewpoint of avoiding unplanned motor failure due to excessive loadings or from damage accumulation.

5.3 DEFINITION OF TEST PARAMETER LIMITS

Acceptable limits for the environmental loading histories must be considered in addition to propellant property tolerances and gage accuracies.

In particular the control limits at the lowest storage and cycling temperatures must be known and so should the limits for the high rate pressurization testing. In some cases it will be necessary to perform limit analyses, using these limiting temperatures and pressurization rates, to indicate the type of variation in grain stresses and strains which could result. These data will indicate the type of accuracy required of the embedded gages and the DAS recording systems. Note that different tolerances may be specified for an embedded gage for different environmental loading conditions.

SECTION 6

PHASE II - DATA ACQUISITION SYSTEM

The data acquisition system (DAS) is an important part of an instrumented motor test program; in that the accuracy of the measured data is limited by the DAS accuracy. Consequently, the components of the DAS must be selected so as to obtain the best possible information from the gages proposed for use. Technically, the DAS presents no real problem as it can be purchased to design specifications, calibrated and standardized.

6.1 SYSTEM CAPACITY

Initially, the capacity of the DAS (i.e., the total number of data channels to be measured) must be considered. In the preliminary review of the motor design we have determined the number of locations where it is desired to install gages and we have considered briefly the problem of redundant data measurements. However, the overall DAS capacity will determine how many instruments can be monitored at any one time. This DAS capacity also limits the degree of gage redundancy which is required to add statistical significance to the data or, simply, just to give confidence in the measurements.

In considering the total number of measurements we must include readings from the following:

- (a) Individual stress gages
- (b) Individual strain gages
- (c) Individual temperatures
- (d) Power supply voltages*
- (e) Dummy bridge circuits
- (f) Barometric pressure
- (g) Motor pressure gages
- (h) Standard reference voltages
- (i) Gage circuit currents where necessary

Often the DAS is chosen to operate with a specific type of sensor. In such cases, more than one DAS would be required for some of the tests. In many cases it is convenient to separate the thermocouple measurements because of their low range output voltages. This approach is satisfactory for long term isothermal motor tests, but may not provide sufficiently accurate time-temperature correlation during thermal transient or high-rate pressurization tests.

* At present constant voltage power supplies are generally used. In the event that constant current power supplies are used, then some method for monitoring their stability would be required.

The use of capacitive type stress transducers (e.g. Hercules' sensors (11)) would necessitate a different list of measurements from that given above.

6.2 REDUNDANCY

In general, if a particular stress is of great significance then at least two independent measurements of it should be made. For example, for a grain with an axi-symmetric port, the interface stress at the axial midpoint may be measured by redundant gages located 180° apart. Almost all instrumented motors have employed redundant stress gages because of inherent errors in single stress gage data (4, 12 to 15). When making temperature measurements redundancy is not usually considered necessary, but it is good practice to install thermocouples for temperature measurement in addition to the use of other forms of temperature measurement, e.g., thermistors or use of a gage's bridge circuit. The reasons for this are:

- (1) Economic; thermocouples are inexpensive.
- (2) There is much more experience with thermocouples than with the other temperature sensors.
- (3) They are inherently stable and repeatable sensors.

Thermistors can be wired in a bridge circuit to provide a large output but their resistance characteristics can change with time necessitating frequent recalibration.

Redundant measurements are seldom employed for surface strain measurement because it is felt that if the data from a particular gage is suspect it can be easily replaced by another gage at (almost) any time in the life of the test motor.

An interesting approach to redundant test measurement uses two strain gage circuits on a single stress gage diaphragm. This dual bridge gage, although initially expensive, minimizes the wiring problems associated with redundant measurements and provides two independent measurements of the stress at a single location. Differences between readings from a dual bridge gage provide strong evidence of problems with at least one half-bridge circuit. When space is at a premium or whenever stress at a specific location is essential, the use of a dual bridge, redundant stress gage should be given consideration.

The degree of redundancy necessary for adequate test motor data should be determined for each essential measurement. This determines the minimum number of required data channels for the DAS. Then, from estimates of the stresses and strains and the sensitivities of the sensors, the anticipated range of gage output signals can be listed. This information determines the amplifier requirements of the DAS. Two other factors which must be listed at this stage are the gage excitation voltages of the sensors and the total power consumption required by all of the sensors.

6.3 DATA SAMPLING RATES

The rate of data gathering at the various points in the program must be specified in the overall test plan. Clearly, tests of a repetitive (dynamic) nature such as vibration will require special data handling and recording, e.g., magnetic or oscillographic recorders. Similarly, high speed data recording may be necessary for high rate pressurization tests although a digital system may be needed for this type of test to obtain the required accuracy. At the other end of the scale, thermal cooling and cycling tests generally require a sampling rate which is logarithmic in nature. Thus, initially, after changing the motor temperature, the sampling rate may be as often as one reading per minute and this may slow to one reading every four hours after approximately four hours of test.

When long term aging tests are performed the rate of data sampling is open to question. Data have been monitored at intervals from daily to weekly to monthly in various experimental test programs. When an automatic data gathering and recording system is employed, the complete history of a gage can be tracked much more closely. However, for a large motor subjected to closely controlled environmental conditions, e.g., a first or third stage Minuteman motor in a silo, monthly gage readings may well prove satisfactory (see Reference 16).

Motor ignition, either simulated or during an actual firing is difficult to monitor satisfactorily. Use of an analog recording technique, e.g., galvanometer recorder, will provide the data but generally with an accuracy of at best $\pm 5\%$. Digital monitoring techniques are to be preferred but in this case a very rapid sampling rate is necessary if a large number of gages are to be monitored during the ignition pressurization. As an illustration, if it is required that 50 channels of data be monitored during an ignition transient lasting 100 milliseconds then to obtain adequate definition of the transient stresses at least 10 readings of each channel are required, i.e., an individual sampling time of one every 10 milliseconds, which requires that the DAS have the capability of taking an individual measurement and storing it in its memory in (10/50) ms., i.e., 0.2 milliseconds. High speed DAS equipment employing computer control would be required to obtain this type of data sampling speed.

6.4 MEASUREMENT ACCURACY

The purpose of the testing and the environmental loadings to which the motor is to be subjected will determine the levels of temperature, stress and strain in the grain. The overall accuracy to which these quantities must be measured will be specified by the project engineer. His requirements will be in the form of statements such as: (1) normal interface stresses ranging from 5 to 25 psi to within $\pm 5\%$; and (2) bore hoop strain values from 0 to 10% with a permissible error of $\pm 1\%$. The system measurement accuracy encompasses a number of different errors including:

- (1) Gage accuracy
- (2) Gage repeatability
- (3) Gage hysteresis
- (4) Gage stability
- (5) Amplifier stability (drift)
- (6) Power supply stability
- (7) Digital voltmeter accuracy
- (8) Recording accuracy

The instrumentation engineer has to review the total system including the gage, power supply and DAS and ascertain that the total system will provide the required data accuracy. The typical output range must be known and the amplifiers and power sources will have to be selected to provide stable, accurate information with those sensors. For instance, the output of most thermocouples is in the range of ± 5 mv, from one temperature extreme to another. Consequently high gain (usually chopper stabilized) DC amplifiers are generally used for monitoring the output signals from thermocouples. Furthermore, T.C. reference junctions are frequently built into the DAS to provide an accurate reference voltage for the temperature measurement. In the case of the semiconductor stress or strain sensors employed in solid rocket motors, their output has generally been in the range of 20 to 150 mv.

To distinguish between DAS and gage stability problems a common technique is to test the DAS against dummy bridge circuits with high stability resistors. Any variations in dummy gage output are then a function of all the components downstream of the gage. Similarly, several measurements of the power supply voltage should be made together with the gage readings. It is not possible to obtain accurate gage data if the power supply exhibits significant changes in voltage with either load or line voltage.

A direct test of DAS measurement accuracy is obtained using standard voltages and measuring the variation in repeated measurement. The drift of the system may be determined using similar measurements over a prescribed period of time. The DC amplifier is probably the most drift prone component of the DAS and it may be necessary to check it during a very long term test period.

In the case of a digital DAS, the Analog-to-Digital convertor may be a source of inaccuracy especially for low level signals in the presence of large amounts of noise in the circuits. Some A to D convertors are more prone to noise effects than other types and the device must be chosen to suit the particular application. Unfortunately, high speed (successive approximation) A to D convertors necessary for rapid pressurization tests are particularly vulnerable to noise effects. Because of this fact a great deal of care should be taken when an instrumented motor is first set up, to reduce noise in the circuits to a minimum. Careful circuit screening, the use of guards and proper grounds, will eliminate most of the problem although occasionally some residual noise will remain (17).

Target figures for the whole system stability (long term and short term) and repeatability must be made and these accuracy measurements should be reviewed during the preliminary calibration tests of the motor. In considering the types of system accuracy which may be desired the following observations should be reviewed:

A $\pm 10\%$ error band is feasible when measurements of normal stress or surface strain differences are considered, i.e., the change in stress or strain when the motor is moved from one defined loading condition to another within a short time period.

The measured values of shear stress and/or strains are subject to inherently larger errors ($\pm 25\%$ at best) because of the influence of other stress/strain components on the gage sensitivity (5). An additional complexity with shear stress/strain measurement is the fact that significant shear stresses or strains only develop towards the ends of a grain or at discontinuities such as flap terminations, etc. At these locations, all the stress components are changing rapidly with distance from the discontinuity so that slight positional inaccuracy can also cause larger errors in shear stress measurement.

Where high precision measurements are required, e.g., from normal stress gages during pressurization tests to determine the deviatoric stresses, special gage calibration procedures are required in addition to a very accurate DAS. In general, the inherent error band of the DAS should be smaller than the allowable error band of the data. Note that this error band includes drift, and repeatability errors in the acquisition system.

It is fortunate that the most precise data are generally required under isothermal conditions, since constant temperature tests are undoubtedly the most accurate types of instrumented motor test.

A difficult test for instrumented motors involves long term, varying temperature tests, where combinations of propellant and gage aging and thermal drift in the gage often produce significant errors in the data (14). At this time the only method of ensuring accurate, long-term absolute stress/strain data is to employ specially selected "aged" embedded gages which have been tested under realistic stress levels for significant time periods and have demonstrated low or negligible drift and sensitivity change.

PHASE III - FEASIBILITY STUDY

Having established a preliminary motor instrumentation and test plan, it is appropriate to evaluate its feasibility from an operational viewpoint. That is the subject of Section 7.

SECTION 7

PHASE III - SYSTEM REQUIREMENT REVIEW

This assessment must be made by the instrumentation engineer who will determine the feasibility of conducting the program in terms of the facilities and test equipment available to him. In general, he will review the considerations noted in Sections 4, 5 and 6. The following subsections summarize the steps of this review.

7.1 OVERALL SYSTEM CONSIDERATIONS

7.1.1 Number and Type of Instruments

The instrumentation engineer must ensure that the selected instruments are suitable for measuring the desired parameters with the precision required over the specified environmental temperature range. He must also consider whether or not several transducers with different ranges should be employed. This will be necessary if low thermal stress values are required initially and if motor firing data are required later.

A summary of the number of the different types of sensor is required so that the total number of DAS data channels may be specified.

7.1.2 Limiting Temperature Requirements

Most instrumented motors will be tested at several temperatures and the highest and lowest test temperatures will have been specified. It is now necessary to ascertain that facilities are available to meet these requirements. This requires conditioning boxes of adequate size and thermal capacity for the new test motor. Furthermore the problem of taking the lead wires from the motor to the DAS has to be examined. The ability of the conditioning boxes to maintain the specified temperatures, within the designated error band also needs investigation.

In some instances, e.g., simulated aeroheat tests, the rates of temperature change may be extremely important and the instrumentation engineer must consider whether or not the available transducers, with their inherent limitations under thermal gradient fields, can be placed in the motor so as to make the measurements and whether the existing facilities will be suitable for the testing.

7.1.3 Maximum Pressure Requirements and Pressurization Rate

Although in most cases the pressurization test requirements will be fairly simple, such as step pressure tests to a specified maximum pressure level, in other instances, e.g., simulated motor firing tests, special facilities may be required. The instrumentation engineer must ensure that any special test facilities required are available.

7.1.4 Special Test Requirements

In this area, the engineer must consider such tests as vibration tests, centrifuge (acceleration) tests, handling tests, and firing tests which require removal of the motor to a special test facility and the mating of the motor instrumentation to the data acquisition and recording apparatus. The motor wiring and gage circuitry must be designed for transportation, and easy cable removal via multiconnector plugs and sockets mounted on the motor case or end sealing plates is usually the simplest solution. However, the location of the bridge completion units and their wiring to the active gage elements must also be carefully reviewed when these special (dynamic) tests are considered.

Data acquisition and recording for special (dynamic) tests present problems that must be investigated and resolved during the feasibility study.

7.2 COMPARISON WITH AVAILABLE GAGES

By this time the instrumentation engineer will have a reasonably good idea of what gages are required, the environmental tests to be performed and as a consequence the DAS requirements. He must now compare these requirements with the performance of available gages and with available data acquisition systems.

Considering initially the gage requirements the first question he must answer is: Are the requirements within the state-of-the-art? To answer this question he must review the requirements from three viewpoints:

- (1) Their physical size
- (2) Their overall performance
- (3) Their compatibility with the motor propellant

The physical size of the gage may be critical especially if a small subscale motor is to be made. Another aspect of the physical size of the gage system concerns the location of the Bridge Completion Units (BCUs) of the gages. If these resistors and mounting board are to be situated close to the gage then it must be determined that there is sufficient space available.

Considering item (2), it is clear that the required gage performance must be met by available instruments. Compromise may well be required at this point especially if it is concerned with the accuracy of the gage measurements. The measurement of internal stresses with embedded gages is a complex problem involving not merely the embedded gage, but the whole range of external apparatus including the power supply and the DAS. Achieving the desired accuracy level in a particular gage measurement must be examined in the light of the overall system capability.

7.3 COMPARISON WITH AVAILABLE DAS

The data acquisition requirements must initially be compared with available DAS with a view to determining if the available systems will be satisfactory. A common problem is that existing DAS do not have the number of data channels required by the new test motor. In this case, the instrumentation engineer must carefully review the requirements to see if they may be reduced to fit the available DAS without compromising the program objectives. Discussions with the project personnel will reveal whether or not compromise in this area is possible.

A more difficult area where compromise may not be possible concerns the accuracy of the existing DAS. Older systems may exhibit considerable drift or lack of precision in the digital measurement feature which may preclude the meeting of the specified accuracy limits. In such a case, the instrumentation engineer has the choice of recommending replacing the whole system or at the very least replacing the digital voltmeter (DVM) by a more precise, drift free component. As a guideline, the following minimum acceptable DVM readout errors are suggested:

- (1) Konigsberg or similar moderately high output gages, i.e., ± 100 mv full scale output, a DVM reading to one hundredth of a millivolt, i.e., ± 0.01 mv is required whereas
- (2) For the low output ± 20 mv full scale output gages, a DVM reading to one microvolt, i.e., ± 0.001 mv is required.

Instruments of the above quality are expensive, but to obtain precision data with a stiff, low output sensor, it is necessary to employ such equipment.

After reviewing the gage and DAS requirements in the above manner, the instrumentation engineer will be able to determine whether or not any available data acquisition systems will be satisfactory for the proposed project or if a total new system or partial new system is required.

An aspect of data acquisition which is frequently regarded as a refinement rather than as an essential feature is the storage of the measured data in such a format that it may subsequently be analyzed in a computer without manual transcription. Either punched cards, punched paper tape, or digital magnetic cassette are suitable and enable the gage data to be analyzed rapidly and without errors due to manual translation of the gage data into the computer or calculator. While this type of data storage cannot be regarded as an essential feature of the DAS, it will save considerable time and greatly reduce the possibility of analysis errors if a considerable volume of data is to be handled.

7.4 MOTOR DESIGN AND PROCESSING CONSTRAINTS

In general the constraints imposed by the motor design and by the processing operations involved in the manufacture of the motor, are self evident. However, there are certain universal aspects of this problem which must be considered:

- (1) The proposed gage locations must be examined to ensure that they do not interfere with casting equipment.
- (2) The casting tooling must be designed or modified to avoid interfering with the gage lead wires.
- (3) The procedures for attaching the gages and lead wires to case/insulation must be established.
- (4) The instrumented motor must be pressure sealed if hydrostatic gaseous pressure is required during cure.
- (5) Handling the instrumented motor before, during and after casting, without damaging the gages or their lead wires may require special procedures.

7.5 SAFETY CONSIDERATIONS

Whenever electrically activated sensors are to be embedded within live propellant the problem of the safety of the technique will have to be resolved. Considerable testing at ASPC during the Flexible Case-Grain Interaction program (14) showed that power levels of the order of 3 watts were necessary to ignite the Third Stage Minuteman propellant. This ignition power requirement is very much greater than is conventionally applied to the embedded gages. However, the difficulty is to ensure that under all conditions of use and abuse it is not possible to apply sufficient electrical energy through the embedded gage to ignite the grain.

7.6 REVIEW OF PROBABLE RESULTS FROM TEST MOTOR

This point in the program represents the first decision point as far as the new test motor is concerned. The program manager/project engineer and instrumentation engineer will meet to examine:

- (1) The feasibility of instrumenting and testing the motor
- (2) The probable chances of obtaining the desired data, and
- (3) The estimated cost of the complete operation.

These factors must be reviewed in some depth to determine whether or not the new test motor is a technically and economically feasible proposition. It is much better to approach this discussion with a realistic assessment of what can be done, what apparatus is available and how much it will cost to obtain the data than to discover downstream that the real chances of success are much poorer than imagined. It is also possible that several alternative decisions are possible. For instance, using existing DAS the chances of measuring the required data may well be poor but if new DAS or part thereof is purchased, the chances of success may be greatly improved. Decisions of this type will be peculiar to each and every test motor and must be resolved by the cognizant personnel knowing the levels of funding available.

PHASE IV - DESIGN AND QUALIFICATION

The instrumentation engineer assumes control of the work at this point and firmly establishes the plan that was roughed-out in Phase II. He designs the system to be used (Section 8), qualifies the instrumentation and test components (Section 9) and gives them a comprehensive evaluation (Section 10).

SECTION 8

PHASE IV - SYSTEM DESIGN AND SPECIFICATION

8.1 SYSTEM DESIGN

Following a favorable decision to proceed with the new test motor, the formal design of the total system begins. This includes the design of the test motor itself and the specifics of the gages and the Data Acquisition System. Although many of the problems have been discussed earlier in this report, this section enlarges upon the solutions to them.

8.2 MOTOR DESIGN, MANUFACTURE AND TEST

8.2.1 Design Details

The significant design details of the test motor include the following:

- (1) Grain geometry
- (2) Propellant composition
- (3) Case material
- (4) Heavyweight or lightweight case

While all of these design details are common to all rocket motors they must be viewed in a slightly different light when an instrumented test motor is under consideration. Usually the purpose of a solid propellant rocket motor is to produce a specified thrust at a given pressure for a particular length of time. The design details are chosen to meet these basic requirements. In the case of the instrumented motor, however, the basic requirement is not a rocket motor to fire but a test vehicle which is subjected to a defined environmental loading with the major objective of determining the stress, strain and temperature at key locations within the motor. The use of the embedded gages will introduce additional complexities into the motor design.

It is preferred that the test motor be either a simplified model motor (i.e. an STV) or a full-scale motor since a realistic subscale model of a full-scale motor involves difficulties in testing and in measured data interpretation.

When realistic data are required from subscale motor tests the designer must consider the scale factors involved. In general, it is impractical to duplicate thermal heating and cooling rates in subscale motors (unless significant changes in propellant composition are employed). Similarly, inertia effects cannot be duplicated precisely in subscale motor tests. However, a review of the type of data which will be obtained may often suggest a modified thermal test cycle or a more severe vibration spectrum which will provide similar, if not identical, stresses and strain at the propellant case interface and/or bore of the STV.

When motors other than simple geometry STV's or full-scale units are tested, a careful review of the test plan must be made to ensure that valid data are obtained.

Additional motor design parameters which must be considered include:

- (1) Provision for mounting bridge completion units of embedded gages.
- (2) Provision for attaching lead wires to motor so that they are not easily damaged.
- (3) Methods of sealing motor case containing gages for pressure calibration tests. This will probably require special end fittings if lead wires are contained within motor case.

8.2.2 Motor Manufacture

Initially the proposed locations of the embedded gages must be reviewed to ensure that when they are positioned in the motor within the hemisphere of propellant surrounding them (for calibration purposes) the gage-propellant piece will not interfere with any casting equipment, e.g., the mandrel. Furthermore the locations of the lead wires must be planned so that they may be routed out of the motor case without interferring with the casting tooling. In most cases, a simple modification to the existing casting tooling is usually sufficient to allow the casting operation to proceed without destroying the gage lead wires. Coordination with the motor manufacturing engineer will usually resolve any difficulties.

Another problem associated with motor manufacture concerns the attachment of the gage and lead wires to the motor case. Is the gage to be initially attached to the case wall prior to insulation and lining operations or will the gage-propellant block have to be installed on top of the normal motor insulation? This question must be answered separately for each test motor considered. Both approaches have been used in successful instrumented motor programs (8), but the most common approach has been to install the gage-propellant block on top of the motor insulation. This requires that great care must be taken during gage installation not to contaminate the surface of the motor insulation.

8.2.3 Motor Testing

As mentioned earlier it is imperative to ensure that all facilities required to perform the projected tests on the instrumented motor are available and in operating condition. For thermal tests on the instrumented motor this requires that conditioning boxes of adequate size and thermal capacity (and with proper temperature controls to maintain the required temperature limits) are available for use. Furthermore the problem of routing the lead wires from the motor to the DAS has to be examined.

In some instances, e.g., simulated aeroheat tests, the rates of temperature change may be extremely important and the engineers must consider whether or not the existing facilities will be suitable or if modified or new facilities will be required.

In most cases the pressurization test requirements will be fairly simple. Severe problems will only occur in cases where large (ballistic type) motors are to be subjected to high rate pressurization tests. Most companies will only attempt such tests if they already have the facilities to perform them properly or if such facilities exist nearby and may be leased for the tests. However, the problems of mounting the instrumented motor in the existing test hardware and the connection of the high rate pressurization pipes must be examined. At the very least, special adaptor plates or mounting fittings will be required.

Considering normal (low rate) pressurization tests, it is usual to employ high-pressure dry nitrogen gas as a pressure source. This is readily available and relatively inexpensive. One of the few causes of error with these conventional pressure tests is the measurement of the motor pressure. A motor-mounted precision (secondary standard) pressure gage is required for the precise pressure step (calibration) tests. Additionally, if the gage outputs are being recorded then an accurate recording type of pressure transducer must be employed so that a permanent record of the real motor pressure is retained with the gage data.

A problem occurs when different range stress gages are employed in a test motor. In this case, it may be necessary to install the high stress sensors first and perform the required in-situ pressure step tests up to the maximum pressure of these gages prior to installing the lower range stress sensors. The later pressure step tests can then be performed at much lower pressure levels using different pressure standards.

As mentioned earlier in this report transportation difficulties associated with dynamic tests, e.g., vibration or handling can be greatly reduced by employing motor wiring cables terminating in multiconnector sockets mounted on the motor. These sockets must be located so that they are not easily damaged during transportation or handling of the motor. Similarly, if externally mounted bridge completion units are employed on the motor then they must be mounted in a protective box and situated on the motor in such a manner that they cannot easily be damaged.

8.2.4 Safety Considerations

Several approaches are available to reduce the hazards of employing gages in live propellant motors. Early work in this area by Hercules (18) showed that if an adequate (hermetic) seal was maintained on the CEC pressure gage then no safety problems would be experienced either in Cast Double Base propellants or in the stabilized liquid nitro-glycerine itself. The gage seals and the wire insulation must be impervious to attack by the propellant ingredients.

When gages are embedded directly in live propellant a problem may exist with gages using a high voltage (28 V) power supply in a bridge circuit as shown in Figure 9. Normally if the bridge completion components are external to the motor, the embedded elements will only receive a low voltage of approximately 2.5 volts maximum. The feed resistor R_S limits the current through the bridge so that even if a short circuit develops within the motor insufficient power would be available for ignition. A break in the wiring, however, at a point such as X in Figure 9, results in 28 volts being available across the break, which in certain cases might result in propellant ignition.

The ASPC approach to a safe, live propellant instrumented motor was to embed the normal stress gages within IBT 115, an inert insulation material, and to take the lead wires out of the motor case by the shortest possible route (see Section 8.5.4). Between them these safeguards virtually eliminated the safety problem with the normal stress gages.

Another approach to motor safety is to reduce the voltage applied to the bridge. This approach was adopted by HL&A in their gages employed in AFRPL's new flight vehicle (19).

In the case of embedded shear sensors most test vehicles have employed gages made from inert propellant or insulation to reduce the hazards as much as possible (14). Some compromise with gage accuracy is involved whenever the shear gage material or the surrounding material is not the real grain propellant but in most cases this compromise in performance is willingly accepted for greatly reduced safety hazards.

In a few instrumented motor programs (4, 20) the shear gages have been manufactured from the same live propellant as the grain and the calibration fixture material has been live propellant. These all-live propellant shear gages have not proved troublesome in use probably because the low current used with the shear gages prevents local heating even with the semiconductor gage close to the live propellant. In this context, an early test at LPC during the STV program showed that a shear gage comprised of four semiconductor elements in a 1/4-inch cube of live propellant did not ignite when the gage elements were all connected in parallel and an increasing DC voltage was applied until the gages burnt

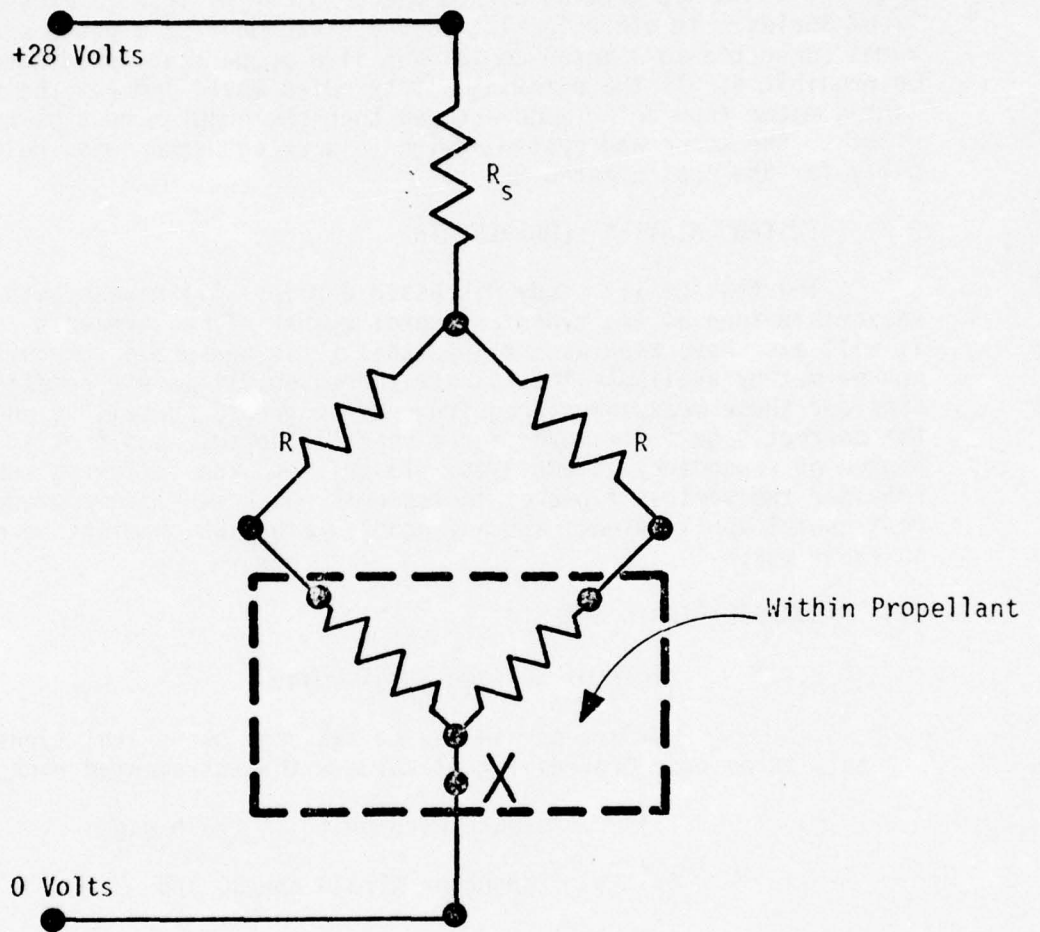

FIGURE 9. GAGE CIRCUIT SHOWING SAFETY PROBLEM

out. Even though the hazards associated with an instrumented motor may not be very great, there may still be difficulties in manufacturing the motor because of accepted and rigorously enforced safety codes. For example, it is not permissible to use a soldering iron in many propellant laboratories. In other facilities the attachment of a power source to wires connected to a motor containing live propellant would automatically be prohibited. If the existing safety rules would prevent the new instrumented motor from being manufactured then the problem must be discussed prior to the motor and system design to work out compromise rules specifically for the instrumented motor.

8.3 INSTRUMENTATION REQUIREMENTS

The feasibility study discussed earlier will have provided a reasonable idea of the types and total number of measurements required. It will also have been ascertained that these measurement requirements can be met by available instruments. However, it is now necessary to consider these measurement requirements in greater detail to ensure that the correct gage is employed for a specific purpose and that an adequate degree of redundancy is employed. To this end the following subsections consider the various types of instruments which may be employed, their most useful applications, and any problem areas which might be encountered in their use.

8.4 SURFACE STRAIN GAGES

8.4.1 Types of Surface Strain Gage

Surface strain may be measured by several types of sensor but only three have proved of real value with instrumented rocket motors.

- (1) Resistance wire or foil strain gages
- (2) Semiconductor strain gages, and
- (3) Clip type strain sensors

Types (1) and (2) are conventional devices developed primarily for the measurement of surface strains in metallic structures. Resistance wire or foil gages are very stable, relatively temperature insensitive devices with low sensitivity (a gage factor of 2 being typical). Semiconductor type strain gages are usually very small and very sensitive type sensors with a gage factor ranging from 50 to 200. They are not as stable as foil strain gages and their properties change markedly with temperature. Both the foil and semiconductor type of strain sensor work best when bonded to a high modulus material, e.g., a motor case of a rocket motor. They are not suitable for measuring the strain at the bore of a propellant grain. The clip type strain gages was developed for this purpose. This device is comprised of a thin metal sheet structure with strain gages (usually semiconductor type) mounted so as to measure the displacement of the arms of the gage, as shown in Figure 10.

Foil Semiconductor Strain Gages

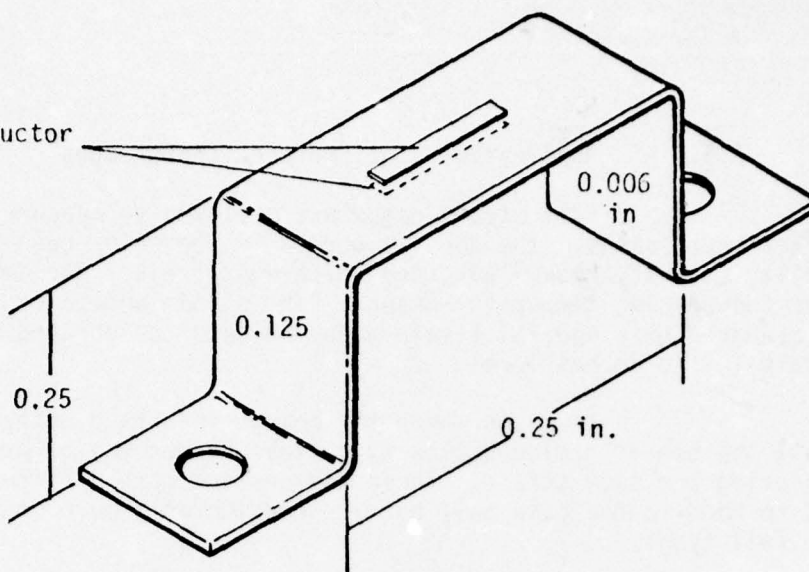

FIGURE 10. CLIP TYPE STRAIN GAGE

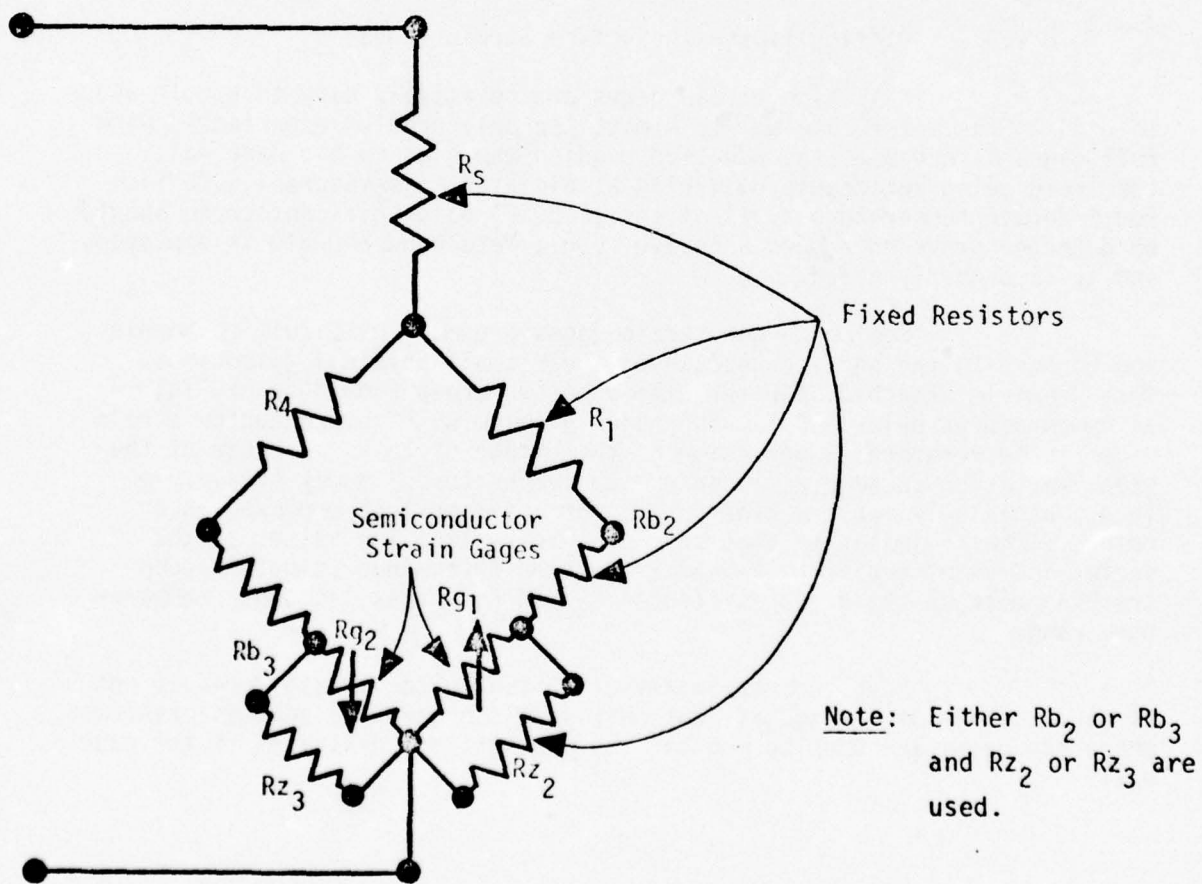

FIGURE 11. SEMICONDUCTOR STRAIN GAGE BRIDGE CIRCUIT

8.4.2 Applications for Surface Strain Gages

Foil strain gages are employed to measure the strains in rocket motor cases. The gage is bonded to the motor case with a high quality (usually epoxy) adhesive which must exhibit negligible creep over the working temperature range. The strain under load (pressure) is measured by a special strain gage indicator calibrated directly in strain (micro inches/inch).

In cases where the change in strain under load is very small the use of semiconductor type strain gages may be preferred for measuring the case strain. These devices are more difficult to handle and to bond to the case wall but are considerably more sensitive than the foil types.

The clip type strain gages were developed to monitor the strain at the surface of soft, elastomeric materials such as propellant. They may be used to measure hoop and axial strain at points along the bore of a grain or they can measure the strain at the tip of a star valley.

8.4.3 Difficulties with Surface Strain Gages

Foil type strain gages are relatively easy to handle and to bond to the motor case wall. Almost the only problem experienced with foil gages is creep of the adhesive bonding the gage to the case wall, the creep being noticeable primarily at elevated temperatures ($>200^{\circ}\text{F}$). For moderate temperature applications ($<180^{\circ}\text{F}$) no significant creep should be detected provided a good adhesive, e.g., Metalbond 600/610 is employed, and it is properly cured.

Semiconductor strain gages are more difficult to handle and to bond to the surface because of their small physical dimensions. Once properly attached, however, the adhesive creep should be negligible at temperatures below 200°F . The major problem with semiconductor strain gages is temperature compensation of the bridge circuit. Because of the great variation in gage resistance with temperature a dummy strain gage (e.g., an axially mounted gage on a motor case) must be employed in a bridge circuit similar to that shown in Figure 11. The values of the series and shunt resistors R_b and R_z must be determined to obtain good tracking between the gage resistances R_2 and R_3 across the whole temperature range.

Long term stability of semiconductor strain gages is not as good as that of foil gages, but this should present no serious problems where the gages are used to monitor the pressurization strains in the case wall.

Attaching the clip gage to the propellant is the most serious problem with these devices. Figure 12 shows three alternative methods which have been employed in various instrumented motor programs. The simplest approach shown in Figure 12a is to bond the feet of the clip gage to the propellant with an adhesive. Achieving a satisfactory bond presents a problem in that a soft elastomeric adhesive will exhibit creep and will not provide stable data, whereas a hard adhesive, e.g., an epoxy, will act as a stress riser and may cause the propellant to crack. Even if the gage can be properly bonded to the propellant surface the gage calibration will almost certainly be changed so that the measured strains will be in error.

Because of these problems which were experienced at LPC during the early stages of the STV program the second technique shown in Figure 12b was developed. The clip gage is mounted on and bonded to pins inserted in the propellant. This is a much more positive mounting technique but cannot be used on a motor to be tested near failure because the pins may precipitate grain cracking at the bore.

The third mounting technique for clip gages Figure 12c was developed by Rocketdyne and the First Stage Minuteman motor (21). With this technique the clip gage engages in the grooves machined in the pins bonded to the propellant. The clip gage is sprung in position so that it is always tight in the grooves. A special tool and technique was developed by Rocketdyne to prevent creep of the clip gages in operation and over a period of 5 years the gages have performed very well in the First Stage Minuteman motor (21).

8.5 EMBEDDED NORMAL STRESS GAGES

8.5.1 Types of Gage Available

Two basic types of embedded normal stress sensor have been employed in solid propellant rocket motors; the through-the-case wall piston type and the miniature diaphragm pressure sensor. The through-the-case sensor was developed by Rocketdyne and is a very stiff relatively insensitive device as shown in Table 2.

Several types of diaphragm sensor have been employed in rocket motors including the CEC device used by Hercules (18), the Konigsberg Instruments gages used by LPC and many other programs (12, 14) and the capacitor type telemetry sensors developed by ABL (11). Three different types of sensing element are employed in the above referenced gages.

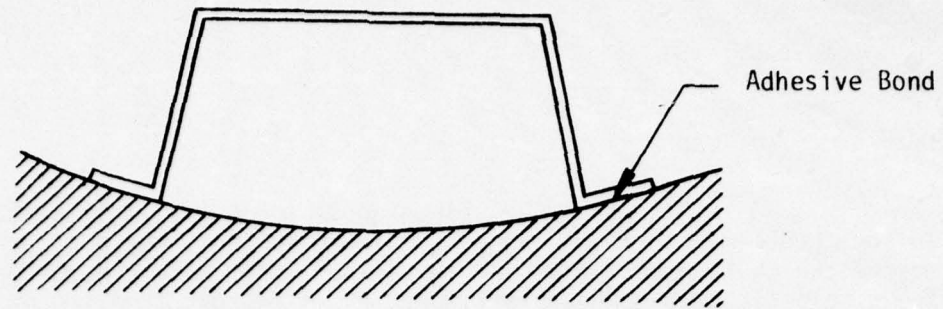

a. Adhesive Bonding of Tabs to Propellant Surface

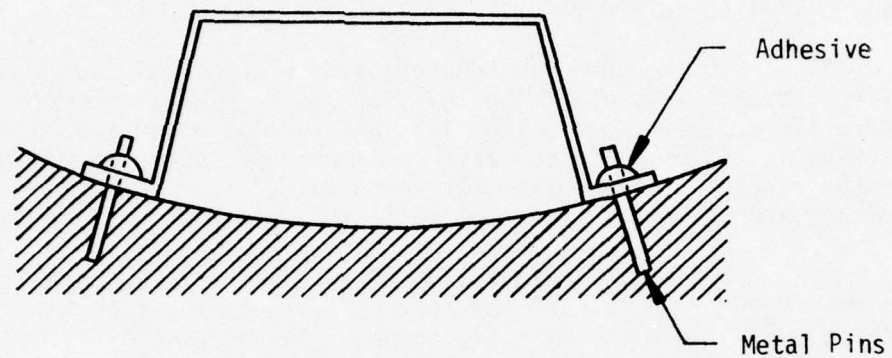

b. Using Pins Embedded in the Propellant Grain

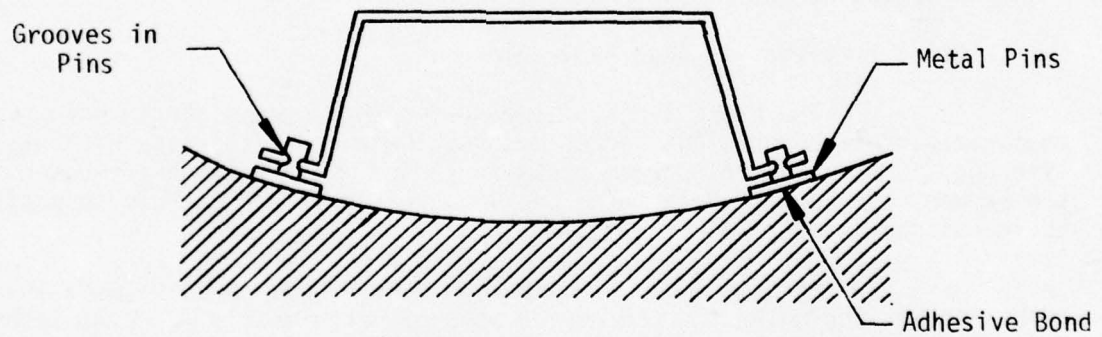

c. Adhesive Bonding of Separate Pins to Propellant Surface

FIGURE 12. METHODS OF ATTACHING
CLIP GAGES

- (1) The CEC gage employed unbonded resistance strain gage wire to monitor the deflection of the diaphragm.
- (2) The KI gages employ semiconductor strain gage elements to monitor the strain in the diaphragm, and
- (3) The ABL sensor uses the change in capacitance due to the diaphragm movement to produce a change in frequency in an electrical oscillator circuit.

8.5.2 Applications for Normal Stress Sensors

Embedded normal stress sensors are usually employed to monitor the radial stress at the propellant-insulation-case boundary. They can also be used to measure the axial strain in a motor (7).

The KI P14 series of gages is very small in size (0.31 to 0.43-inches diameter) and may be used in small test motors as well as large motors. The CEC gage is larger (0.75-inches diameter) and is thereby more difficult to use in small motors. The ABL "transensor" was designed for telemetry data from large ballistic type motors, e.g., Polaris, and is not suitable in its normal form for use in small test motors.

8.5.3 Difficulties with Normal Stress Gages

The major difficulty associated with any embedded sensor is the interaction between the gage and the propellant grain. The presence of the gage in the propellant disturbs the stress/strain field in the vicinity of the gage and simultaneously causes the gage to respond to the stresses and strains developed. These local stress field perturbations are real but of no interest to the grain analyst. He is concerned only with the stresses produced by the grain as a structure. Consequently a technique was developed by LPC during the STV program to eliminate the local stresses (caused by the gage) from consideration. By casting a hemisphere of propellant around the gage bonded to the insulation/motor case, the effects of the propellant on the gage will be simulated without the simultaneous development of the grain stresses. The radius of the hemisphere of propellant needs to be approximately five times the radius of the sensor to approximate an infinite half-space around the gage. By subjecting the gage embedded in the hemisphere of propellant to the thermal and pressure environment, the effects of the gage-grain interaction can be measured and used as zero stress conditions for analysis of the motor data obtained when the grain is cast around the embedded gages. The stresses exerted by the grain on the boundary of the hemisphere of propellant will then be detected and measured by the gage. The primary approximation involved in using this approach is that the gage calibration also applies to non-uniform stress fields.

It is further assumed in this approach that the gage-grain interaction stresses are fixed and depend only upon temperature (and perhaps the duration of the load to a minor extent). However, extended testing of instrumented motors, especially at ASPC (14), strongly suggests that the gage-grain interaction stress may change due to aging of the propellant or by long-term relaxation of the interaction stresses themselves. This will, of course, change the "zero stress" condition of the embedded gage and introduce errors into the measured stress values.

There is no real method of eliminating this effect. The best approach appears to be the use of a very stiff sensor (which minimizes gage-grain interaction effects) with a corresponding reduction in sensitivity and an increase in measurement error.

As one final precaution in the use of embedded gages, it is imperative to eliminate or minimize porosity in the materials surrounding the gage. The effective bulk modulus at low stresses can decrease from 1,000,000 psi to about 20,000 psi as the microvoid content goes from 0 to 1%.

8.5.4 Techniques for Installing Normal Stress Sensors

Two basically different approaches to installing normal stress sensors have been employed:

- (a) The through-the-case approach of Rocketdyne, and
- (b) The internal installation used by Hercules, LPC, etc.

In the through-the-case approach of Rocketdyne (Figure 13a), a probe tip which is a close tolerance fit in a hole through the case wall is attached to a sensing element rigidly mounted to the exterior case surface. The propellant or insulation bonded to the plug applies a stress which is measured by the sensing element. No parts of the gage are mounted within the motor and all lead wires and bridge completion units are external to the case.

In contrast, the diaphragm gages are usually installed by bonding to the interior surface of the motor case, or insulation, and the lead wires are taken along the interior surface of the case to a pressure tight plug at the end of the motor (Figure 13). Note that the whole gage and at least part of the gage wiring are contained completely within the propellant in this approach.

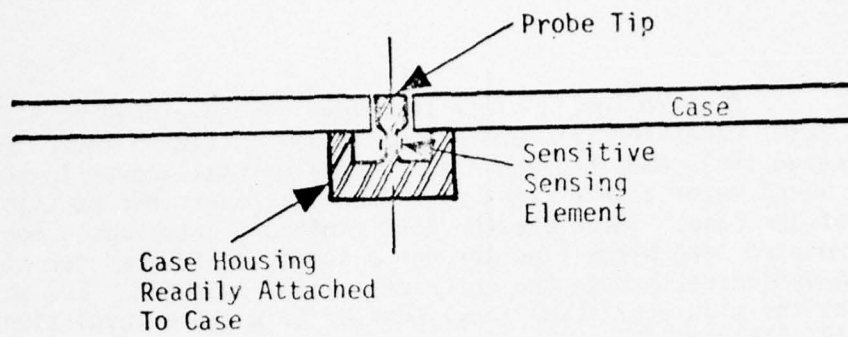

a. Through-the-Case Gage

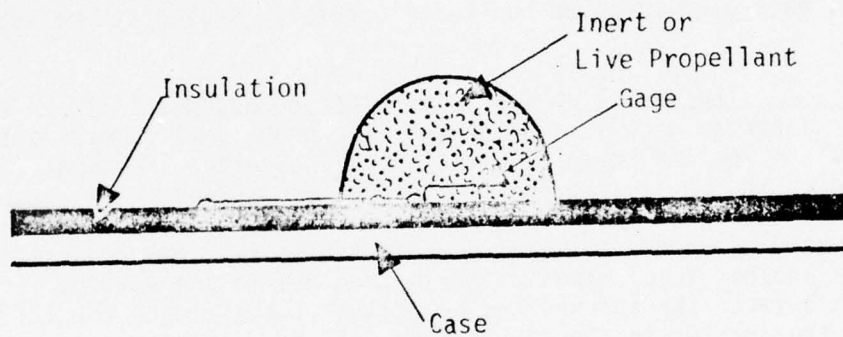

b. Internally Mounted Gage

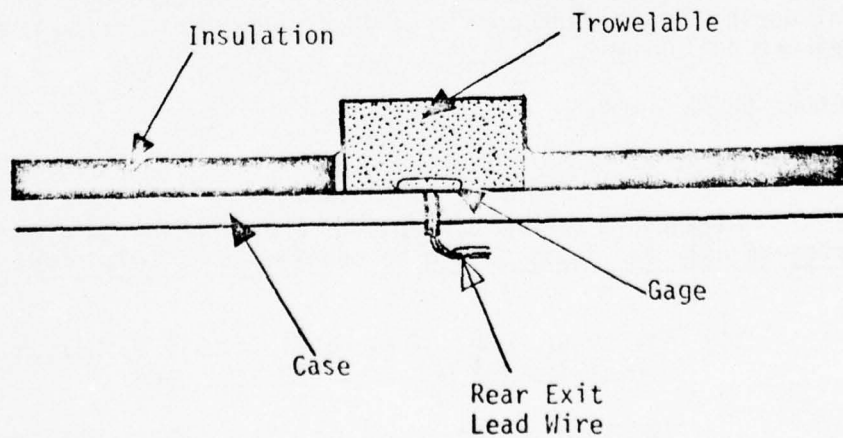

c. ASPC Through-Case Gage Mounting System

FIGURE 13. SCHEMATICS OF GAGE MOUNTING TECHNIQUES

A third installation technique was developed at ASPC for fiberglass motor cases and is shown schematically in Figure 13c. In an earlier program (22), ASPC had shown that drilling small holes through a fiberglass wound motor case did not significantly impair the structural integrity of the case. Therefore the ASPC miniature diaphragm gages used rear mounted lead wires (led through a short, small diameter steel tube) which projected through the motor case wall, as shown. The gages were cast at the middle of a small cylinder of trowelable insulation material (IBT 115) and the internal motor insulation at the gage location was machined so as to provide a good seat for the gage. The IBT "potted" gage was bonded in place with the same trowelable insulation material (IBT 115). This approach to installing gages in a motor represents a compromise between an all-internal mounting scheme and a through-the-case approach. The location of all lead wires external to the grain meant that no special pressure tight plugs were required in the motor. On the other hand, each gage location had to be carefully sealed at the lead wire exit point.

The use of an inert "potting" compound IBT 115 to encapsulate the diaphragm gage instead of the live propellant compromises the accuracy of the "potted" gage calibration. Because the inert material will not match the physical properties of the propellant in all respects, the stress at the interface between the IBT-115 and the propellant as measured by the embedded gage will consist of the required grain interface stress plus another local stress distribution due to the physical property differences between the IBT and the propellant. The closer the IBT resembles propellant the smaller the 'error' stress will be.

A problem with the externally located gages and lead wires is the possibility of their being damaged during the handling operations involved in motor casting. When (Rocketdyne) through-the-case gages are used, the actual sensitive gage and lead wires are replaced by a dummy gage element during the casting operation (and subsequent firing tests) so that they are not damaged.

8.6 EMBEDDED SHEAR SENSORS

8.6.1 Types of Shear Sensor

Although a number of types of shear sensor have been used in motor programs only two types should be considered at this time. These are:

- (1) The shear cube, developed initially by Gulton Industries for Hercules (23, 24), and
- (2) The through-the-case dual plane shear gage developed by Rocketdyne (25).

These devices are shown schematically in Figures 14 and 15.

The shear cube is a single plane sensor containing a pair of orthogonal semiconductor strain gages, mounted at 45° to the surface of the case. Improved shear cubes were developed by HL&A for the ASPC Flexible Case-Grain Interaction program by employing the Kulite "Ruggedized" semiconductor strain gages. These devices consist of semiconductor strain gages embedded in a thin layer of epoxy fiberglass. The improved sensor is able to monitor shear stress/strain up to failure at a propellant-metal interface (27).

The Rocketdyne through-the-case shear sensor is a dual plane device capable of resolving two planes of shear, e.g., τ_{rz} and $\tau_{r\theta}$ in a rocket motor. The Rocketdyne gage is very stiff and therefore not very sensitive as may be noted in Table 2.

8.6.2 Applications for Shear Sensors

All the shear sensors were developed for monitoring the shear stress or strain at the propellant-insulation-case interface. The axial shear stress τ_{rz} is usually of major concern especially towards the end of case-bonded grains. However, under dynamic test conditions the lateral shear stress $\tau_{r\theta}$ can be significant.

Shear cubes may be bonded to the insulated motor case and oriented to monitor either the τ_{rz} (fore and aft) shear component or the $\tau_{r\theta}$ transverse shear component. A single through-the-case device installed on the motor case can measure both components simultaneously.

The best application for shear sensors is in dynamic tests, e.g., vibration handling or firing, where changes in the stress or strain value due to a short-term imposed load are required. They may also be used (with reduced accuracy) for motor pressurization tests and for thermal cooling and cycling tests.

The shear cubes are generally very sensitive and will measure fractions of a psi stress with ease whereas the through-the-case devices are much less sensitive.

Pairs of orthogonally mounted shear cubes are frequently employed to measure both axial and circumferential shear stress or strain. Often, the differences in the measured data from the two gages will provide considerable insight into the validity of thermal cooldown shear stresses or pressurization shear stresses which tend to be difficult to interpret in the absence of corroborating information.

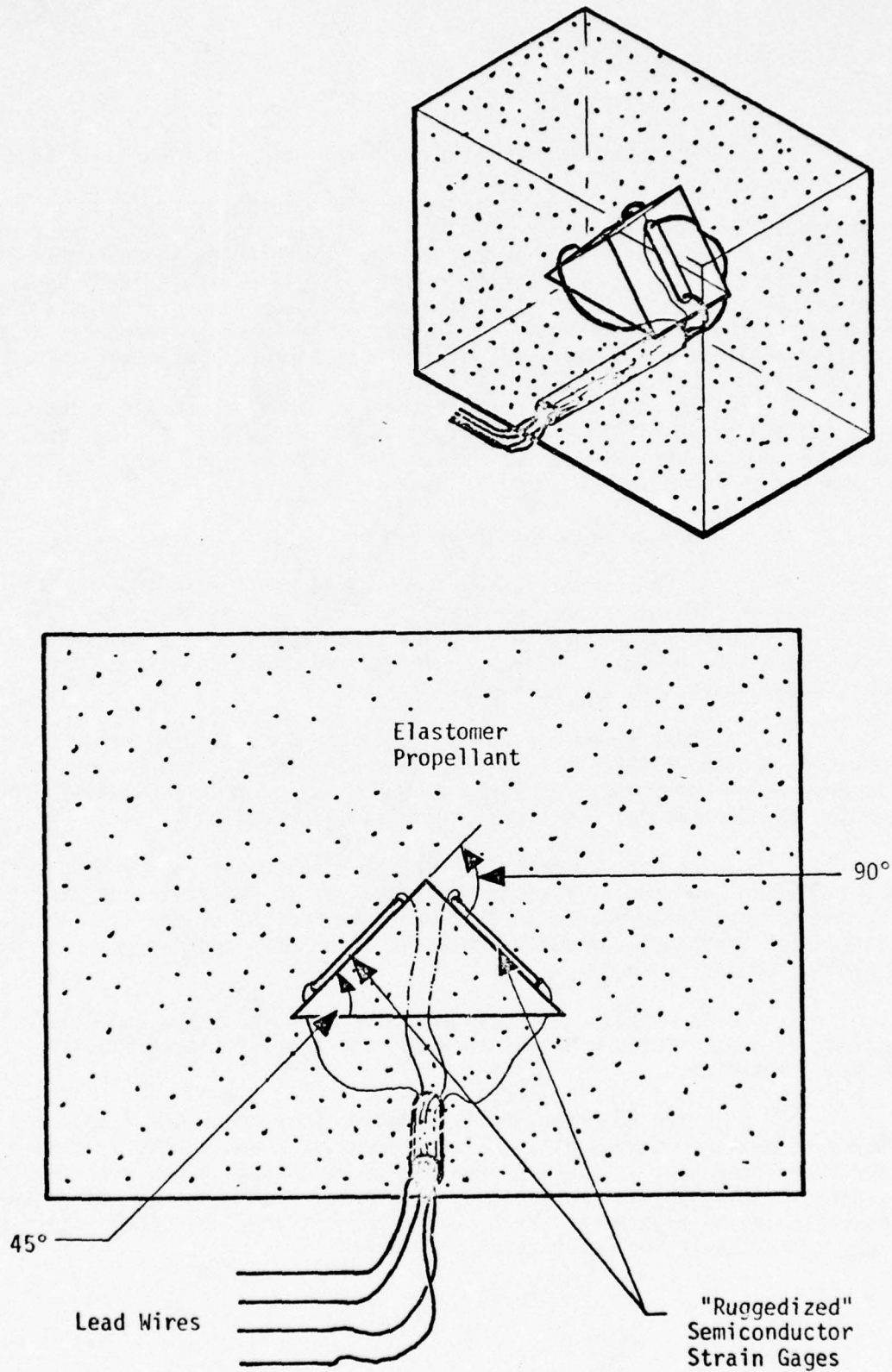

FIGURE 14. "SHEAR CUBE" STRESS/STRAIN SENSOR

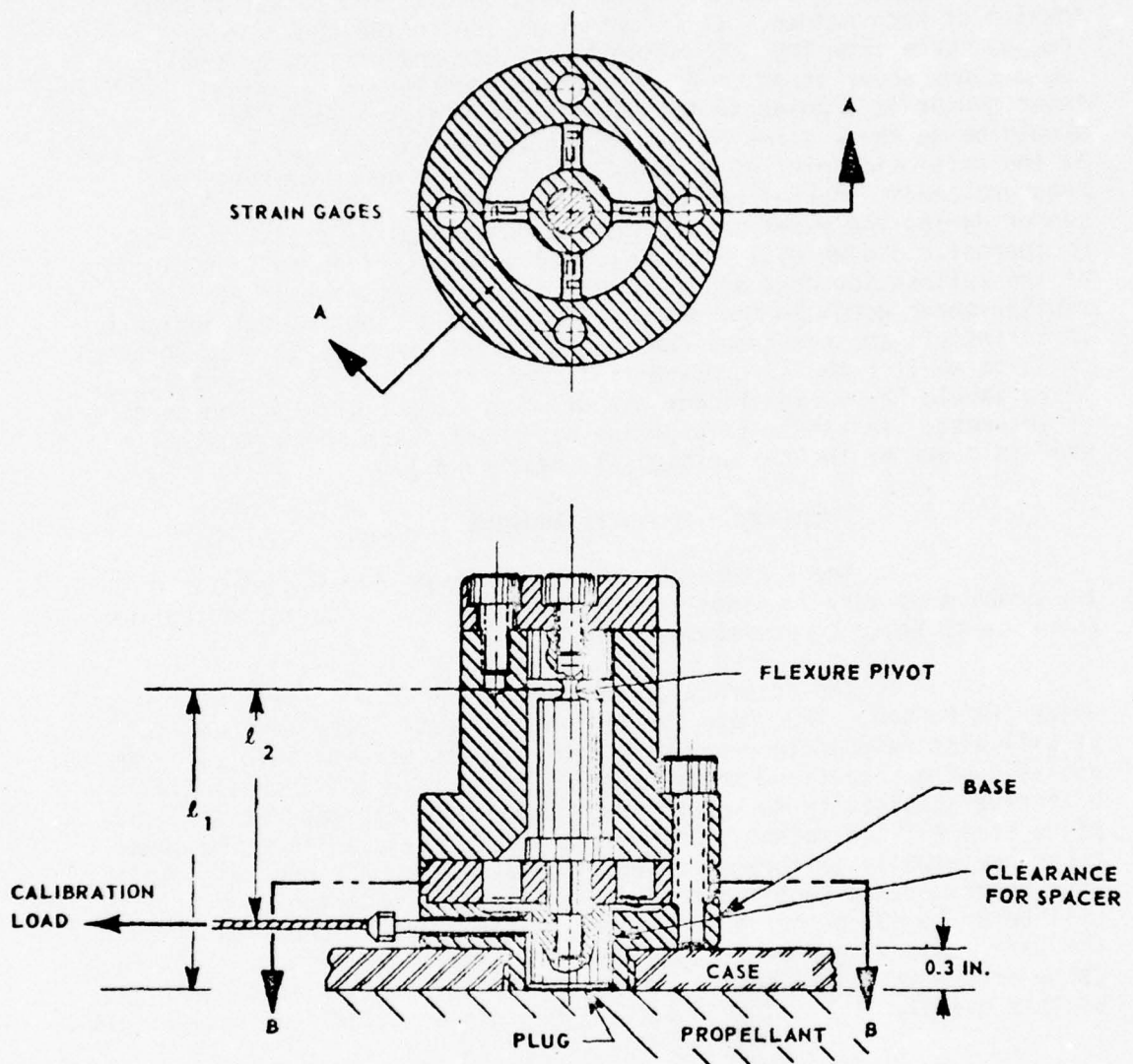

Figure 15. Rocketdyne's Through-the-Case Shear Stress Transducer

Although maximum shear stresses and strains usually occur at a discontinuity unreliable data results from shear sensors mounted at such points. It is better to locate the shear sensors some distance from the discontinuity and use analysis to determine the maximum shear stress. A recommended practice is to install one shear sensor at a point in the grain where analysis indicates there should be no shear stress under most normal environmental loads, e.g., at the axial mid-point of a circular port grain under hydrostatic pressure and/or thermal cooldown conditions. The behavior of this sensor during the experimental loading conditions of pressurization or thermal cooldown will provide useful information as to the validity of the calibration data and as to the probable accuracy of other, similar shear gages in the grain. Similarly, another useful approach is to install another shear cube at the axial midpoint of a symmetrical grain to monitor the circumferential shear stress or strain. Again, there should be no significant output under almost all loading conditions of interest. (A single through the case dual plane shear gage may be used in place of the two orthogonal shear cubes).

8.6.3 Problems with Shear Sensors

The Rocketdyne through-the-case shear gages suffer from the problem of very low sensitivity (Table 2) and a corresponding low accuracy of shear stress measurement.

The accuracy of the shear cube is also low but for a different reason. The shear cube has ample sensitivity to shear but it will also respond to other components of the stress field (5). An analysis of an idealized shear gage (7) predicts a 40% increase in effective sensitivity to shear stress when the shear gage is used in a plane strain field rather than a plane stress field. Since the shear cubes are usually calibrated under plane stress conditions this implies that under certain conditions of use in a motor the actual sensitivity will be up to 40% higher than the calibration value. Consequently, the data measured by shear cubes must be regarded as being subject to large errors ($\pm 25\%$ at best). However, in many applications shear data of this quality is still much better than can be calculated analytically.

The other major problem with shear cubes is concerned with the fact that in order to calibrate them they must be cast or bonded into a shear test fixture. After the calibration tests are complete the shear cubes must be removed from the fixture without damaging them. In some instances this can prove troublesome.

8.7 FAILURE GAGES

8.7.1 Types of Gage

Two distinct types of failure gages have been developed:

- (1) The surface failure gage, Figure 16a.
- (2) The interfacial failure gage, Figure 16b.

Surface failure gages are simple conducting elastomeric devices which become discontinuous when a crack is propagated through them. Failure gages of this type have been used by several companies (26, 27). The physical properties of the failure gage should be as close a match as possible to the propellant's physical properties for the most reliable results.

Various types of interface failure detector may be employed to determine when a crack has progressed to a specific location at an interface. These devices usually comprise an electrical circuit which becomes discontinuous when fractured. Conductive elastomeric failure gages were employed by ASPC and Thiokol (15, 26) whereas LPC employed foil strain gages embedded in propellant in their STV program (12). Neither technique is foolproof since it relies upon the grain crack propagating in a specific direction and through the failure gage. Furthermore, the introduction of the failure gage must not by itself weaken or reinforce the propellant bond line otherwise incorrect data will be obtained.

8.7.2 Applications for Failure Gages

The main application for failure gages is to determine the initiation of failure in a grain by bore cracking or by bond/propellant failure at the case/grain interface, under a specific type of loading environment. Failure gages have been used for long term storage (aging) tests of motors and for short term ignition simulation pressurization tests (28).

Surface failure gages will be attached to the propellant bore at the region of highest strain. Similarly, the interface failure gages will be located at likely failure sites, e.g., towards the end terminations of the grains. A group of failure sensors will usually be mounted fairly close to each other (axially) but spaced along the periphery of the grain to prevent interaction or possible weakening of the case-grain bond. Each failure gage will be connected to a power supply and a continuity detector so that the progression of the crack can be monitored by the sequential failure of the gages.

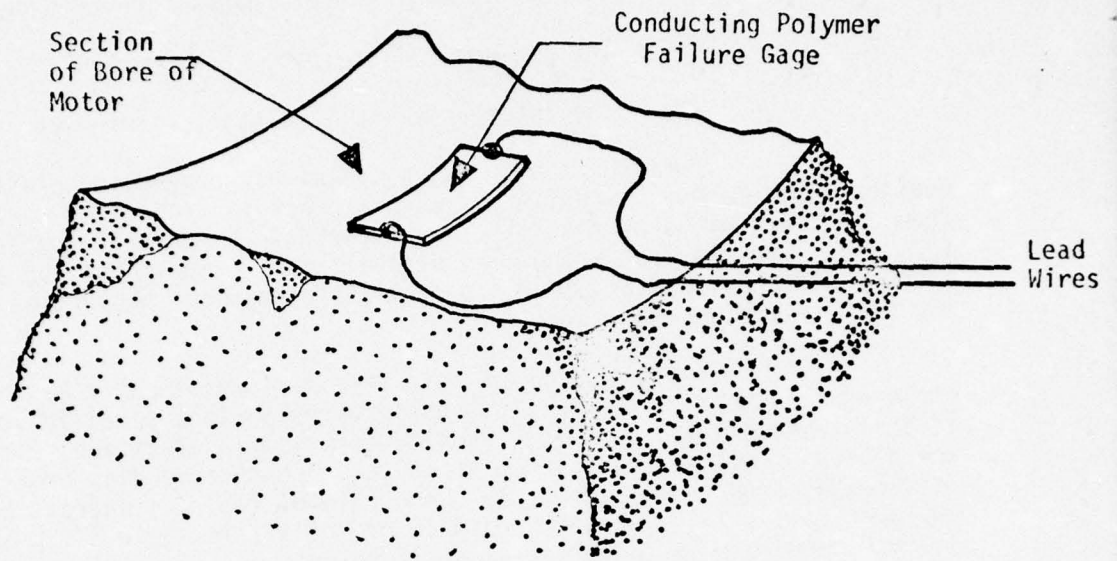

A. Surface Failure Gage

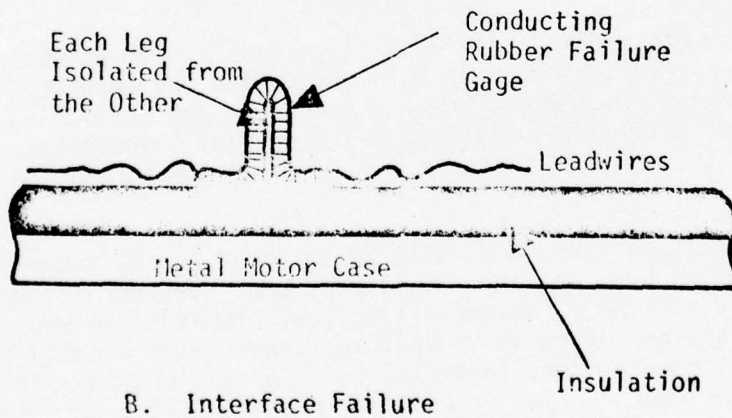

B. Interface Failure

FIGURE 16. SKETCHES OF FAILURE GAGES

8.7.3 Problems with Failure Gages

Many problems have been experienced in attempting to manufacture and use failure gages in a motor. Considering initially the failure gage manufacture, it has proved very difficult to obtain the devices commercially so that the relatively small quantities needed often have to be made by the propellant company. Typical problems experienced may be listed as follows:

- (1) Matching the conducting rubber's physical properties with those of the propellant.
- (2) Defining a suitable adhesive to bond the surface gages to the propellant or the interface gage to the insulated case wall.
- (3) Attaching the lead wires to the conducting rubber - a weakness in all failure gages.
- (4) Aging (hardening or softening) of the conducting elastomer used in the gages leading to premature failure.
- (5) Development of a satisfactory design for an interface failure gage which is delicate enough to fail with the propellant yet strong enough to withstand the casting operation.

8.8 TEMPERATURE SENSORS

8.8.1 Types of Sensor

Three different methods of monitoring the temperature at points within a solid propellant motor have been employed:

- (1) Thermocouples
- (2) Thermistors
- (3) The semiconductor elements of the embedded gages

Thermocouples are self generating devices when used with a reference junction located at a point of known temperature. The sensing element, i.e., the junction between the two types of wire is very small and provides accurate data without extensive calibration.

Thermistors are essentially temperature variable resistors and must be used in an electrical circuit, e.g., a bridge circuit connected to a power supply. The electrical bridge output is then related to the temperature by calibration.

The third type of temperature sensor takes advantage of the marked change in resistance of a semiconductor strain gage with changes in temperature to develop an output signal which can be interpreted as temperature.

8.8.2 Applications for Temperature Sensors

Temperature sensors may be used for two distinct purposes within a solid propellant motor:

- (1) To monitor critical motor temperatures
- (2) To measure the temperatures of the embedded gages.

In the second case, the actual temperature at the gage location may well be useful but the data are basically necessary for the interpretation of the gage outputs.

When a sensor is employed to monitor the temperature of a gage, it must clearly be located as close to the gage as possible. For this purpose, the use of the semiconductor strain sensing elements of the gage as a measure of temperature has a distinct advantage. By employing the circuit shown in Figure 17 the change in gage element resistance with stress is virtually eliminated at the 'temperature output' points.

The use of thermocouples or thermistors to measure temperature gradients in propellant grains was discussed in reasonable detail in Section 4.6.

8.8.3 Problems with Temperature Sensors

The most common difficulty with thermocouples concerns the requirement for special bimetal plugs, sockets and wiring at all points in the thermocouple circuit. If this necessity is appreciated and if a stable reference junction at a constant temperature is employed, then accurate temperature measurements will be obtained. Where very accurate ($\pm 1^\circ\text{F}$) measurements are essential, it may be necessary to order special batches of thermocouple wire, but in most situations the standard thermocouple output tables with standard thermocouples will provide sufficient accuracy. Furthermore, the output of the thermocouple is very stable over long time periods.

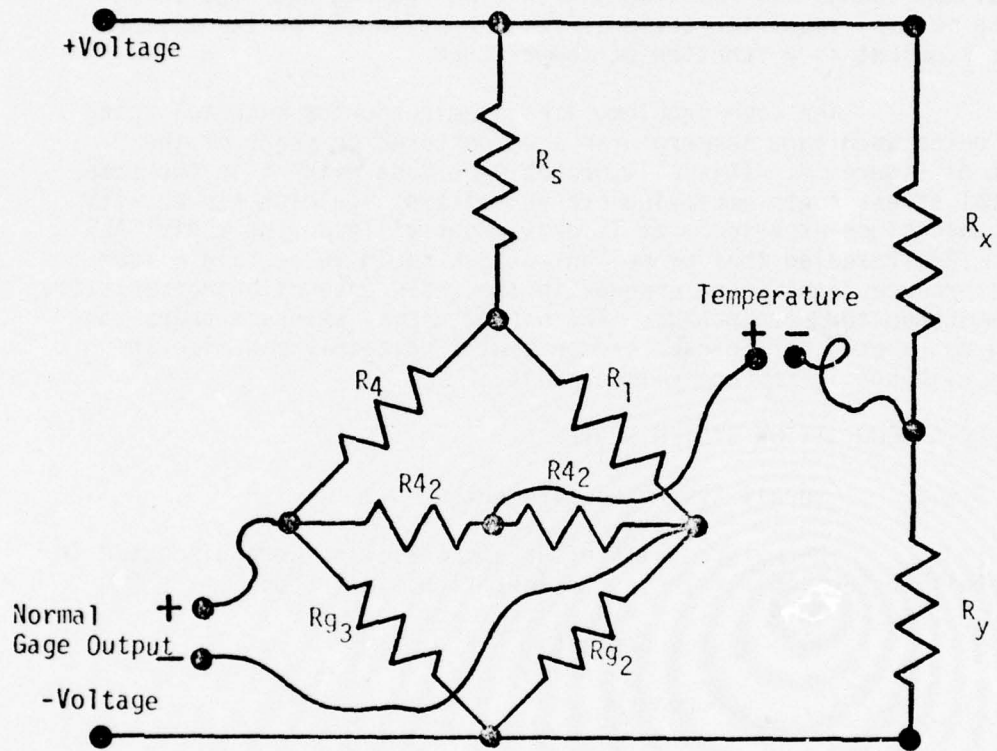

FIGURE 17. GAGE BRIDGE CIRCUIT MODIFIED FOR TEMPERATURE READINGS

The low output of thermocouples (± 5.5 mv) over the entire operating range may in some instances prove to be a problem. In field use in a noisy electrical environment the data from thermocouples may be very poor. In such cases the greater output obtainable from thermistor circuits may prove beneficial. However, the thermistor material may change its resistance with time (during extended aging tests on motors) requiring periodic recalibration of the thermistor circuit's output as a function of temperature.

The same problem, i.e., semiconductor material aging may be noted when gage temperatures are monitored by means of the circuit of Figure 17. This will probably be most evident in the case of normal stress gages employing exposed strain gage elements or with shear cubes since experience at Thiokol, Huntsville during their SALE program (29) revealed that propellant attack could in certain circumstances produce significant changes in the resistance of characteristics of a semiconductor strain gage. The use of normal stress sensors containing no exposed strain gage elements will certainly minimize the problem although it may not eliminate it.

8.9 DATA ACQUISITION SYSTEM REVIEW

8.9.1 Overall System Requirements

The main details of data acquisition were discussed in some detail in Section 6. These considerations included:

- (1) System capacity
- (2) Redundancy
- (3) Data sampling rates
- (4) Measurement accuracy

In addition to these basic considerations the following factors must be considered during the system design phase:

- (5) Is there a requirement that the DAS be portable so as to be able to follow the motor through its various tests?
- (6) Does the DAS need its own data analysis capability to determine the validity of test data as quickly as possible?

If the answer to Item 6 is yes then another series of problems arises:

- (a) The DAS must be rugged enough to withstand transportation, or
- (b) The DAS must be installed with shock absorbing mounts into a special trailer or truck which can accompany the motor.
- (c) The need for air conditioning to keep the temperature of the DAS within reasonable limits must be examined.

If in fact the DAS has to be portable or transportable so as to be able to travel with the test motor, the difficulties of maintaining system calibration and trouble-free performance become much greater than for a laboratory installed DAS.

The question of some data analysis capability in the DAS is specially valid if the unit is intended to be transportable and operated remote from any data analysis facilities. In other cases the need must be examined from the point of view of convenience and speed of operation versus additional cost. When long term tests are to be conducted and analysis may be required over weekends or holidays, then the capability to perform the more routine types of analysis as a part of the DAS is a necessity.

8.9.2 Instrumentation Power Supplies

One of the least considered aspects of motor instrumentation is the type of power supply to be used and the method of its use. For instance, the use of a simple DC power supply can be shown to generate local heat with a gage through dissipation of the electrical current through the gage resistance. Because in most instances the sensing element is a minute semiconductor gage mounted on a small metal diaphragm of low thermal capacity and surrounded by a good insulation material, e.g., liner, rubber insulation or propellant, a severe temperature gradient can be established in the vicinity of the gage. Typically, this temperature gradient takes some time to establish after the power is turned on so that the temperature variations produced can produce corresponding changes in the gage output. These output changes are, of course, especially pronounced during the time period immediately following the power switch-on, and become progressively smaller as the local temperature gradient stabilizes.

The simplest solution to this problem is to maintain power on the gages at all times. In this manner the calibration and subsequent gage measurements are performed under similar thermal dissipation conditions, which results in improved data accuracy.

The time required for the various sensors to attain equilibrium conditions (warm-up period) must be determined prior to conducting the motor tests. This is necessary because when removing the motor from one test condition to another requires disconnecting the power supply, it must be ensured that the necessary warm-up period is allowed after reconnecting the power supply, so that meaningful data are obtained.

The worst method of use is merely to switch on the power supply and then proceed to take a series of measurements over a period of several minutes. Unless such data are confirmed by taking duplicate or triplicate readings to ensure that the gage readings are stable values, then considerable doubt may exist as to the reliability of the measured data. This is especially true of gage measurements at very low temperatures where the local temperature gradients may have a very pronounced effect on the gage readings.

To overcome the local temperature gradient problem the use of a pulsed power source may be considered. The low duty cycle of the power pulse maintains the heat dissipation at negligible levels. Special demodulator apparatus is required for measurement of the output from a gage fed with a pulsed power source. The use of an AC power source might be considered as an intermediate between pulse power and a DC supply. An AC (sine wave) power supply has the advantage that the gage output can be easily monitored with readily available meters.

8.10 SYSTEM SPECIFICATION

8.10.1 Test Motor

Once the design of the test motor has been determined in detail the various components and manufacturing techniques must be specified. The motor specification must include at least the following items:

- (1) Grain geometry (with tolerance limits).
- (2) Case material, including end closures.
- (3) Insulation material composition, method of application, cure time and the liner material.
- (4) Propellant composition, cure time and temperature.
- (5) Casting technique, including any required vacuum, vibration, pressure, etc.

- (6) Method of mandrel extraction after grain cure.
- (7) Techniques for installing clip gages in bore of motor.
- (8) Location of bridge completion networks (any special boxes or fittings required, etc.).

Note that the above parameters concern essentially the motor design and manufacture. Aspects of instrumentation to be installed prior to casting must be specified separately. Similarly, the required test fixtures, testing sequence and measurements required are additional items requiring specification.

8.10.2 Embedded Gages and Sensors

The precise numbers of each type of sensor to be employed and its location in the test motor must first be specified. Note that the specific gage requirements will be determined from the estimated stresses and strains at the point of measurement, considering the entire sequence of tests to be performed on the motor from pre-casting calibration tests through temperature cycling, to failure or motor firing.

Considering first a specific, bare (unembedded) sensor, it must be specified in terms of the following:

- (1) Property to be measured, e.g., bore hoop strain, interface normal stress, etc.
- (2) Normal measurement range and overload capability, e.g., 150 psi with a 450 psi overload capability.
- (3) Power requirements, e.g., 28 v. dc or 5 v ac.
- (4) Physical size with any permissible range, e.g., diameter from 0.3 to 0.6-inches; thickness to be not greater than 0.10 inches, etc.
- (5) Type of sensing element if critical, e.g., pressure sensor using foil gages for stability or pressure sensor using semiconductor strain gages for sensitivity.
- (6) Whether single or dual bridge (redundant) gage is required.
- (7) Minimum and maximum full-scale outputs for gage, e.g., ± 100 to ± 150 mv.

- (8) Maximum permissible inaccuracy, e.g., linearity, hysteresis and repeatability to be within $\pm 1\%$ full-scale.
- (9) Maximum tolerable drift in output with time, e.g., $\pm 1\%$ full-scale output/month.
- (10) Maximum permissible change in zero load reading across operating temperature range, e.g. $\pm 5\%$ full scale from -65° to 165°F .
- (11) Allowable range of sensitivity across operating temperature range, e.g., sensitivity = 1.0 mv/psi $\pm 2\%$ from -65° to 165°F .
- (12) Type of lead wires to be used, e.g., copper.
- (13) Whether or not external (semiconductor) strain gage elements are permissible (trade-off for sensitivity).
- (14) Type of lead wire exit from gage e.g., side exit or rear exit.

8.10.3 Methods of Gage Installation in Motor

The following aspects of gage installation must be specified at this stage:

- (1) Location of gage in motor with positional tolerance limit and methods of ensuring accuracy of location.
- (2) Whether internally mounted gage is to be installed on bare case or on insulated case. If former, method of insulating or lining over gage must be specified.
- (3) Adhesive for bonding gage to case/insulation, cure time and temperature.
- (4) Type and size of material to be used for embedding normal stress gages, e.g., live or inert propellant or insulation material, 2-inches diameter.
- (5) Preparation of gage for embedment (also whether gage is to be 'pre-potted' prior to installation or not).

- (6) Precise technique for mounting gage in test motor; e.g., through-the-case (Rocketdyne approach), all internal, or with lead wire exit through case (ASPC approach).
- (7) Location of bridge completion units if adjacent to gage and method of bonding in place.
- (8) Method of holding lead wires to insulated case wall prior to casting.
- (9) Provision for special pressure tight bulkhead plugs for normal and shear gage leadwires and for thermocouple wires.
- (10) Details of methods of connecting lead wires to externally mounted bridge completion network, e.g., solder, crimping.
- (11) Methods for protecting externally routed gage lead wires.

8.10.4 Data Acquisition System Specification

Summarizing the factors discussed earlier in this report we must specify the following DAS parameters:

- (1) Total number of data channels required, including normal stress, surface strain and shear stress/strain gages, all types of temperature sensor, motor pressure gages and barometric pressure gage.
- (2) The anticipated output signals of all the sensors must be specified to enable suitable amplifiers to be obtained. The sum of the various stresses and strains from the sequential environmental loadings must be used to determine the total gage output to prevent overloading the amplifier. The amplifier specification must include input amplitude, gain required for each embedded sensor, and noise rejection levels.
- (3) The stability of the DAS must be specified. This will primarily be in terms of drift under both short and long term testing. Also included will be the inherent error in the digital voltmeter used to measure the output signals, and any drift of the zero reading with time.

- (4) The accuracy of the system DVM must be specified.
- (5) The maximum and minimum sampling rates must be specified.
- (6) The recording and data storage system must also be specified.
- (7) The number of dummy gage circuits and power supply voltage readings to be monitored with the real data must be specified, as must the details of the dummy bridge circuits.
- (8) Interconnecting components such as crimps, terminal boards, connectors, wires, must be specified.

8.10.5 Environmental Loading Conditions

The precise details of the environmental tests must be specified and the sequence which will be followed experimentally. Details of any transportation of the instrumented motor must be included together with any requirements for disconnecting power supplies or gage lead wires. A detailed wiring diagram must be prepared so that the wiring can be reconnected without problems.

Included with the environmental loading history will be the required temperatures at each step with acceptable variations. Also the details of the standard pressure gages and the pressurization system to perform the motor pressure tests must be specified.

SECTION 9

PHASE IV - QUALIFICATION OF COMPONENTS

9.1 GAGE AND SENSOR QUALIFICATION

The detailed specification prepared in Section 8 will have listed a series of requirements which any component to be employed in the test motor or DAS must meet. The purpose of the Qualification phase of the instrumentation operation is to devise test plans and inspection routines to ensure that all the components of the new test motor system, i.e., all gages, sensors, and DAS components comply with the specifications laid down.

Considering initially the bare sensors (unpotted) and gages the following aspects must be investigated during gage and sensor qualification:

- (1) Response (sensitivity) over temperature range (i.e., the gage response must comply with the sensitivity and zero load shift restrictions called out in the specifications).
- (2) Repeated loading and unloading tests must be performed to ascertain the repeatability, hysteresis, and nonlinearity inherent in the gage's response. This "accuracy" figure must be within specification limits.
- (3) Typical (or sample) gages should be placed on test to determine drift both under zero load and typical loading situations. The drift observed must be within the figure specified.
- (4) Pressurization rate response data for the gages are required for all of the rate ranges to which they will be subjected during motor testing. The testing procedures* (see Section 10 of Volume I) must be conducted within a confining liquid to minimize adiabatic heating effects.
- (5) The response of the gages to high frequency loading is expected to produce significant sensitivity changes. The gages should be calibrated* for all frequency ranges applicable to the specific motor testing.

* The precise testing procedures have not been developed and ASPC recommends AFRPL sponsorship of a study to define them.

- (6) Tests must be undertaken to verify that there will be no safety problems due to incompatibility between the embedded sensor and the embedding propellant. This will be most important where live propellant embedment is adopted.
- (7) When the bare gage has shown that it can meet the required specification limits; sample gages must be embedded in the defined material to examine the embedded gage response. Some sacrifice in performance must be anticipated but this should not be marked except at very low temperatures (-65°F).
- (8) A typical (sample) normal gage should be embedded within a shear and compression test fixture to ascertain the effects of shear on the response of the gage. This should be negligible.
- (9) A typical (sample) gage embedded in a uniaxial test fixture should be placed on extended test to ascertain the change in gage reading under constant creep loading condition. The short term drift (or creep) over a period of several hours immediately after the application of the load and the extended term (month long) drift characteristics need to be measured.

Note that the response of a normal stress gage is attenuated by both the viscoelasticity and low bulk modulus (less than 500,000 psi) of the surrounding propellant or elastomer. This impairment in performance encompasses both sensitivity (the embedded gage will show a loss in sensitivity; especially at low temperatures) and zero stress shift, where the new embedded gage 'zero stress' shift as a function of temperature will be considerably different because of interaction stresses between the gage and the embedding material.

Similarly, the performance of a shear cube stress sensor is almost impossible to predict before it is tested in a calibration fixture. Thus, the specifications quoted for the shear cubes must be applied to the gages after embedding them in the shear test fixture. In addition to the response of a shear gage to both positive and negative shear stress or strains, the influence of a normal (tensile) stress component and a hydrostatic pressure load on the shear gage's response must be ascertained. (This can be done in a scarf joint test where both normal and shear loads are simultaneously applied).

Once the qualification test plan for the gages has been prepared it is necessary to ensure that all gages are examined in accordance with the plan. When the inspection tests of the as-delivered (bare) sensors are considered, the easiest approach is to specify that this work be performed by the company quality assurance laboratory and to require them to sign-off the gage check-list sheet as being satisfactory. When it comes to the sample tests of typical gages in propellant (or other embedding material), this work should be carried out by the department using the gages as they should be most familiar with the embedment techniques and the calibration testing requirements.

Shear cubes will be tested merely for continuity in the as received (not bonded in test fixture) condition. Their calibration, sensitivity and zero shift characteristics will also have to be determined in the user laboratory after the embedment or casting procedure has been performed.

A special test plan must be prepared to ascertain the best techniques for embedding the gages, the adhesives to be used and the cure time and temperature. Experimental tests of a small number of the embedded gages are required to determine the best experimental techniques and to obtain realistic embedded gage performance figures. Simple pressure step tests on the embedded gages at the designated temperatures will probably provide the required data in the most expeditious manner. The stability of the embedded sensor under zero applied stress conditions may be monitored fairly easily but if the stability under a small applied stress is required then a leak proof pressure vessel is necessary if the load is applied by means of gaseous pressure. Alternatively, the stability tests may be performed on gages mounted in uniaxial test fixtures (19) in which case deadweights can be used to apply the small stress during the long term test.

9.2 DATA ACQUISITION SYSTEM COMPONENT QUALIFICATION

The qualification of the components of the DAS is a relatively straightforward matter concerned with ensuring that the purchased parts of the DAS, if it is being assembled by the motor manufacturer, or the complete DAS, if the system is being built elsewhere and delivered to the user, will provide the accuracy and stability specified.

To investigate the inherent stability of the DAS the gages are removed from the DAS amplifier inputs and a series of precision voltage signals from a standard voltage cell and a precision attenuator is applied to all channels. After preliminary adjustment (calibration) a large number of repeated individual voltage reading should be made so that the accuracy of the DAS measurements at typical voltage input levels may be determined. These data will provide a reasonable estimate for the measuring accuracy of the DAS.

Repeated tests over a period of hours, days and weeks are required to enable the following DAS specification parameters to be determined:

- (1) Individual channel sensitivity and repeatability error.
- (2) Total system stability both long term and short term, expressed in either $mv/hour$ or $mv/month$ drift or percentage amplifier input range drift/hour or drift/month.

- (3) The data sampling rates; mean figures and typical ranges, e.g., reading/minute or readings/hour with \pm error band.
- (4) Rejection of common mode signals applied to amplifier.
- (5) Interaction between channels when an overload signal is applied to one channel.

The standard voltages should then be replaced by dummy gage circuits connected to the DAS and powered by the specified excitation power supply. The following characteristics must then be ascertained:

- (6) Stability of power supply over a period of hours and months.
- (7) Stability of output readings from dummy gages which should be very similar to that of the power supply.
- (8) Signal to noise ratio in dummy bridge circuit.

In considering measurements from a specific gage circuit made by a properly calibrated DAS with low inherent circuit noise, the individual gage readings will have real validity. However, in order to be able to determine the measurement accuracy, at least three gage readings are essential as used by Thiokol, Wasatch on their Third Stage Minuteman program (16). If an automatic DAS is employed then a minimum of 10 readings per gage would provide more meaningful data especially if there is noise in the gage circuits.

9.3 ADDITIONAL COMPONENT QUALIFICATION

In this area we include a broad mixture of miscellaneous factors which need to be considered and which frequently will be overlooked in the structuring of an instrumented motor program. Recent AFRPL sponsored programs (14, 29) have revealed that considerable difficulties can result if factors such as those listed below are not closely specified:

- (1) BCU resistors
- (2) BCU boards
- (3) Solder and fluxes used
- (4) Crimping technique
- (5) Lugs, tags, etc.
- (6) Cables
- (7) Connectors

Considering the above items the following comments are pertinent:

- (a) The resistors employed to complete the gage bridge circuits must be precision, high stability components with low temperature sensitivity coefficients. Otherwise, spurious gage outputs are observed as the resistors change value due to temperature changes or due to aging effects.
- (b) One of the best approaches to building a bridge completion unit is to have a printed circuit board prepared with the spaces for the resistors properly identified. In this case, all that is necessary is for the special resistors which are generally supplied with the gages to be soldered in their correct places on the BCU boards and the device will be correctly wired. An important aspect of this approach is to ensure that the printed circuit board is absolutely correct and defect free.
- (c) An attractive approach where space is available is to locate the BCU in a sealed unit adjacent to the embedded sensor. Many problems with leadwires, junction corrosion, etc. are eliminated with this approach. However, the safety problem may become serious unless low voltage bridge circuits are used as in (19).
- (d) The whole bridge completion network if it is to be located external to the motor must be placed in a junction box mounted on the motor case end rings or skirts. These junction boxes must be rugged and moisture proof and maintained at the same temperature as the gages. Furthermore, the design of the BCU boxes must provide easy access to test points for bridge voltages and for power supply voltages. Additionally the box must incorporate facilities for trouble-shooting and replacement of components.
- (e) The major problem with solder and fluxes was concerned with the method of connecting the stainless steel lead wires used in the Konigsberg series of gages to the BCUs. To obtain a proper solder joint an acid flux was required. Unless the soldered joint was specially treated to prevent it, the residual acid flux would gradually corrode the joint producing potentially large changes in the signal level of the gage (see Section 9 of Volume I). While complex procedures and careful cleaning operations will allow stainless steel leadwires to be properly soldered without subsequent corrosion, ASPC determined that alternative joining techniques, such as crimping the stainless steel leadwires onto lugs provided the lowest resistance and most reliable joints. Again it is necessary to specify carefully the types of lugs to be used and the crimping tools and pressures for reliable results.

The recommended solution to the lead wire problem is to employ a material other than stainless steel. Copper is the easiest wire to use but is much weaker structurally than stainless steel and therefore more easily broken. Copper is also more susceptible to attack by corrosive elements in propellants. However, the gages employed in LPC's BDU program (8) used copper lead wires and only one of the six gages has become defective (in one half-bridge circuit) after six years of use.

It must be determined that the motor design covers the details of such seemingly trivial items as those just discussed, otherwise, the reliability of the data obtained from the new test motor will be far lower than desired.

SECTION 10

PHASE IV - COMPONENT CHECKOUT

10.1 COMPONENT CHECK-OUT SHEETS

To expedite the checkout of the gage and DAS components in accordance with the required specifications the instrumentation engineer has prepared a brief test plan to be followed during the components qualification. To avoid the possibility of misunderstandings or omissions in the checkout of the components it is strongly recommended that the qualification tests be prepared in the form of a check-out sheet. This sheet will accompany each and every item which will form a part of the new test motor, or the new DAS, and all of the qualification tests listed on the sheet must have been completed before the component is used in the motor or DAS.

While this may well seem an unnecessary complication of the whole acceptance-inspection procedure, the aim is to make absolutely certain that no component is used in the motor or DAS unless all the required tests and checks have been performed. Generally this is not a major problem with the larger components of the system but frequently an important test or check on some of the smaller, less significant aspects of the total system may be overlooked.

10.2 ACCEPTANCE AND REJECTION CRITERIA

In any component check-out sheet used to determine whether or not a specific component is acceptable, criteria must be given so that some discretion may be used in the acceptance or rejection of the system components. In many instances acceptance limits will have been prepared in the form of maximum or minimum values with an error band: as an example the gage output under full scale load may be defined as $100 \text{ mv} \pm 10\%$. Clearly, if a gage is delivered with a full scale output of 115 mv , i.e., outside the allowable upper limit, in most applications the gage would be perfectly acceptable and should not be rejected. On the other hand, if the gage had a sensitivity slightly lower than that specified, it is possible that the reduced output under certain critical test conditions might be a cause for rejecting the gage. There can be no universal criteria applicable to all test motors and all situations. Each gage and each component of the whole instrumented motor system must be examined separately to determine realistic acceptance criteria.

In this context, care must be taken to ensure that the original specification sheet for the gage or system component is not too conservative, i.e., the specification is not much tighter than is really required. If this happens then the gage or component may cost considerably more than is really necessary in attempting to meet the unnecessarily tight requirements.

10.3 STORAGE OF GAGE AND COMPONENT RECORDS

Because of the complexity of an instrumented motor system there will be a considerable volume of paperwork associated with the project. This material is important and must be stored in an orderly fashion so that the original data sheets and copies thereof are available for examination at any time. In view of the lengthy timespan of most instrumented motor tests, from one to six years for existing projects, the gage and system component records must be kept in a secure location for the duration of the motor test.

To avoid the loss of important documents during the course of the motor testing it is strongly recommended that microfiche copies of all valuable data be made during the early stages of the program. In this way, the film copies will be retained even if the originals are lost.

Whatever approach is adopted, the problem of storage of the large volumes of data generated in an instrumented motor program must be investigated.

PHASE V - APPLICATIONS

With a good engineering design and qualified instrumentation, the test engineer is now ready to calibrate the transducers (Section 11), install them in the motor and conduct the planned test measurements (Section 12).

SECTION 11

PHASE V - CALIBRATION TECHNIQUES

11.1 GAGE CALIBRATIONS

11.1.1 Case Strain Gages

Included in these devices are the conventional foil or wire strain gages used to measure the strains in the motor case and the clip-type strain gages used for monitoring the strains at the surface of a soft propellant.

Resistance strain gages are now made so accurately that it is seldom necessary to calibrate the gage itself. However, in some rare applications, variations in the thickness of the adhesive used to bond the gages in place can produce changes in response, necessitating an independent calibration of the system.

A common method of calibrating the specific gage-adhesive-substrate system is to bond two gages to a length of the substrate material and test the system in a bending test. The precise strain applied to the gages can readily be determined and, from the gage output, the effective "gage factor" for the system can be measured. The assumption is then made that this effective 'gage factor' will be repeated on the actual gages in the operational test mode.

In most practical applications, however, the gages are simply mounted on the surface to be strained, e.g., the exterior of a motor case, and the gage factor supplied by the manufacturer is employed to determine the case strain.

11.1.2 Clip-Type Surface Strain Gages

a. Thermal calibration. If the clip gage is to be used for the measurement of surface strains across a range of temperatures, then the thermal zero strain output signal from the clip gage must be determined as a function of temperature. Probably the best technique is to use a small block of Invar to which are bonded two small pins with enlarged bases. Holes drilled in the tabs of the clip gage locate on the two pins and hold the gage firmly in place. The essentially zero coefficient of linear expansion of the block of Invar maintains the feet of the clip gage at a constant distance apart across the whole range of temperature required. The gage mounted on the block is placed in a temperature-conditioning box and the temperature is set at a desired value. Sufficient time is allowed for the gage and block to attain thermal equilibrium before a reading of the gage output signal is taken. The chamber temperature is then changed to another value and, after thermal equilibrium is attained, another gage reading is taken.

AD-A032 636

AEROJET SOLID PROPULSION CO SACRAMENTO CALIF
FLEXIBLE CASE-GRAIN INTERACTION IN BALLISTIC WEAPON SYSTEMS. VO--ETC(U)
OCT 76 H LEEMING, K W BILLS, S W JANG
ASPC-1953-81-F-VOL-2 AFRPL-TR-76-57-VOL-2 F04611-72-C-0055
NL

F/G 21/9.2

UNCLASSIFIED

2 OF 2
AD
A032636

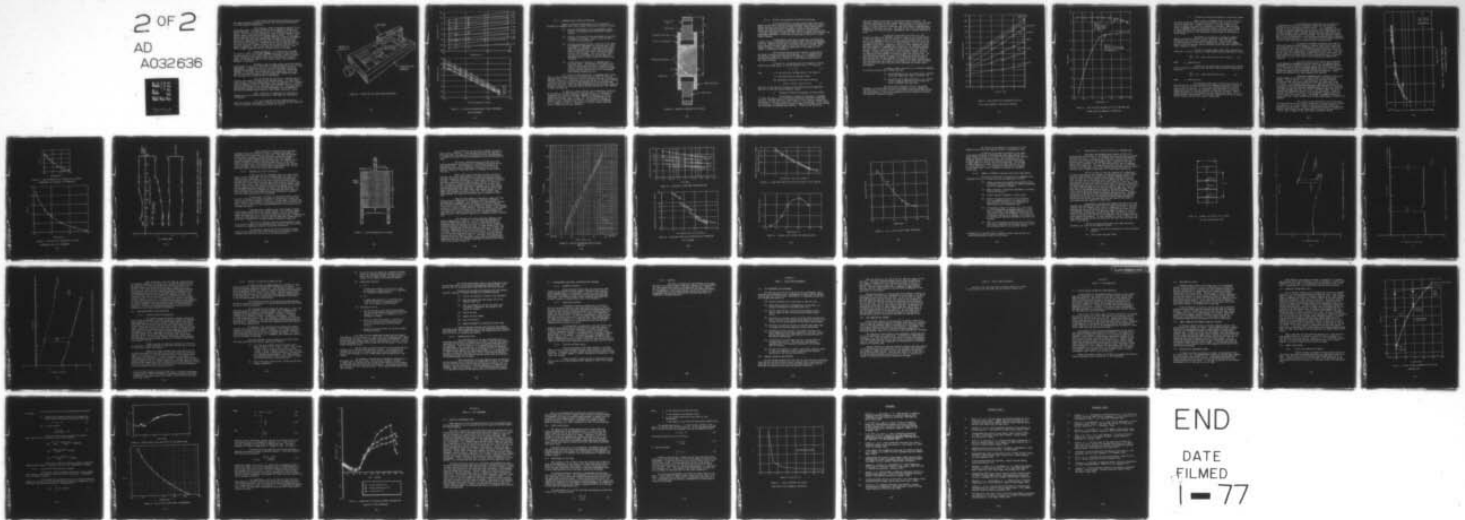

END
DATE
FILMED
1-77

In this manner the gage output readings for a fixed and known displacement between the feet of the clip gage are determined for a wide range of temperatures.

This technique, which is employed by workers in the strain gage field, is probably the most accurate method of thermal calibration available. For many applications it is unnecessary to go to this length. The clip gage may be mounted on a piece of steel instead of Invar, and the thermal zero strain gage readings taken as before. In this case, however, the steel block will be changing dimensions slightly with temperature so that the actual gage readings must be corrected for the thermal expansion or contraction of the steel block in order to determine the precise zero strain readings. Depending on the use to which the gage is to be put, this small correction factor may be ignored, especially if the change in readings is small and the gage sensitivity to strain is very high; a common situation with the clip-type surface strain gages.

b. Strain calibration. To calibrate the clip gages for strain, a small tool is used, equipped with a pair of jaws that can be moved relative to each other either by a micrometer screw or a vernier slide. The two pins are bonded to the jaws of the device, as shown in Figure 18, and the clip gage is fixed in place using a small amount of adhesive, if necessary.

Readings of the clip gage output signals for various displacements of the jaws of the device can then be made at a series of fixed temperatures. A common practice is to use the displacement device for determining the thermal zero readings as well as the strain calibration readings. In this way, the two pins have to be bonded only once to the jaws of the calibration device, and the thermal zero readings are made with the jaws set to a known relative displacement.

Once the thermal and the strain calibration data are obtained, they should be plotted as two separate graphs: (1) Gage signal versus strain, or relative displacement of the clip gage feet, for a constant value of temperature, and (2) gage signal versus temperature for a constant separation of the feet of the clip gage (see Figure 19). With these sets of data the gage readings can be quickly interpreted as strain whether the problem be isothermal pressurization or slow thermal cooling of a motor.

After calibration is completed, the clip gage is removed from the calibration fixture and is then ready for installation in the motor.

It is very important that the technique used to mount the clip gage in the motor is identical to that used in the calibration fixture, otherwise the calibration data will be invalid.

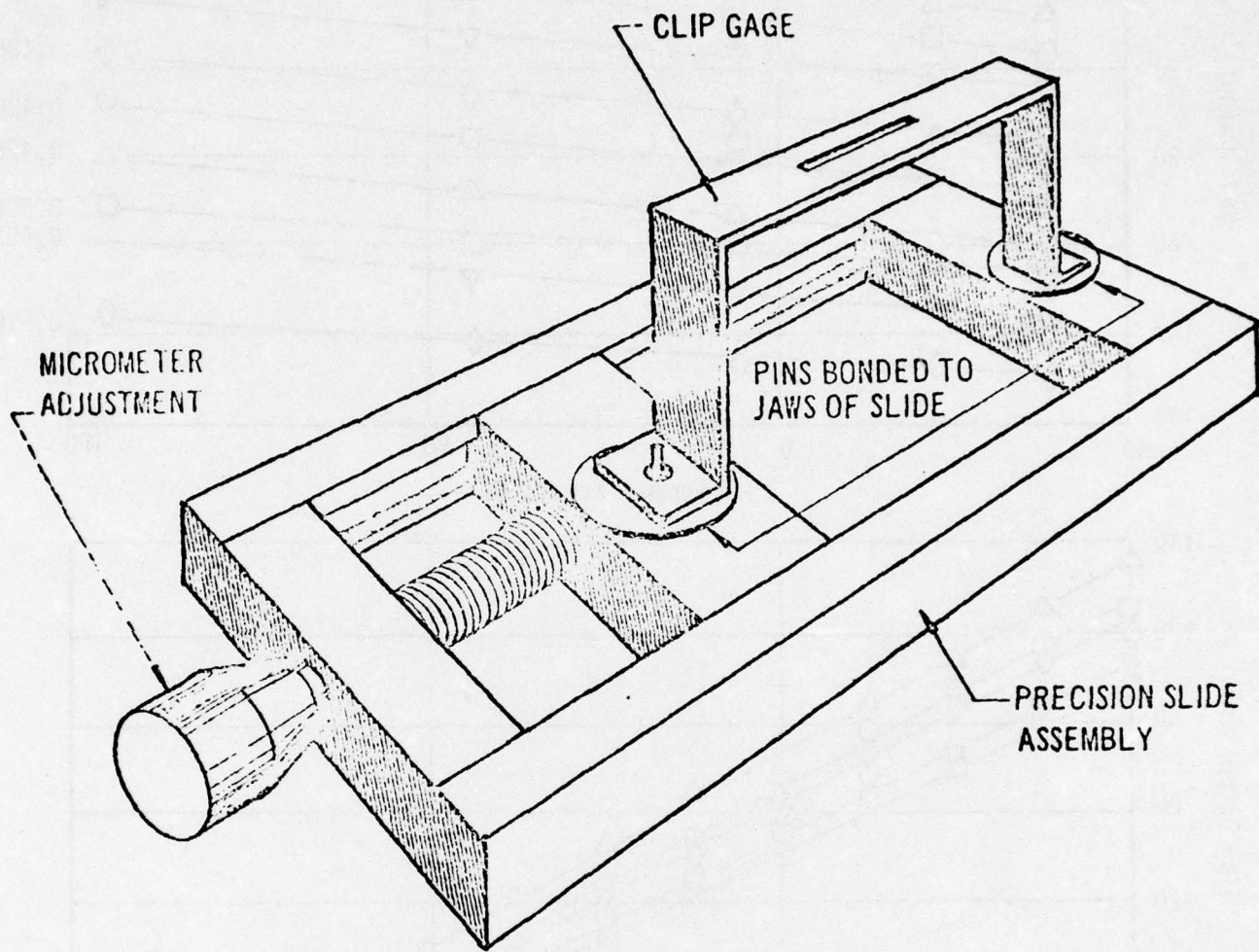

FIGURE 18. FIXTURE FOR CLIP GAGE STRAIN CALIBRATION

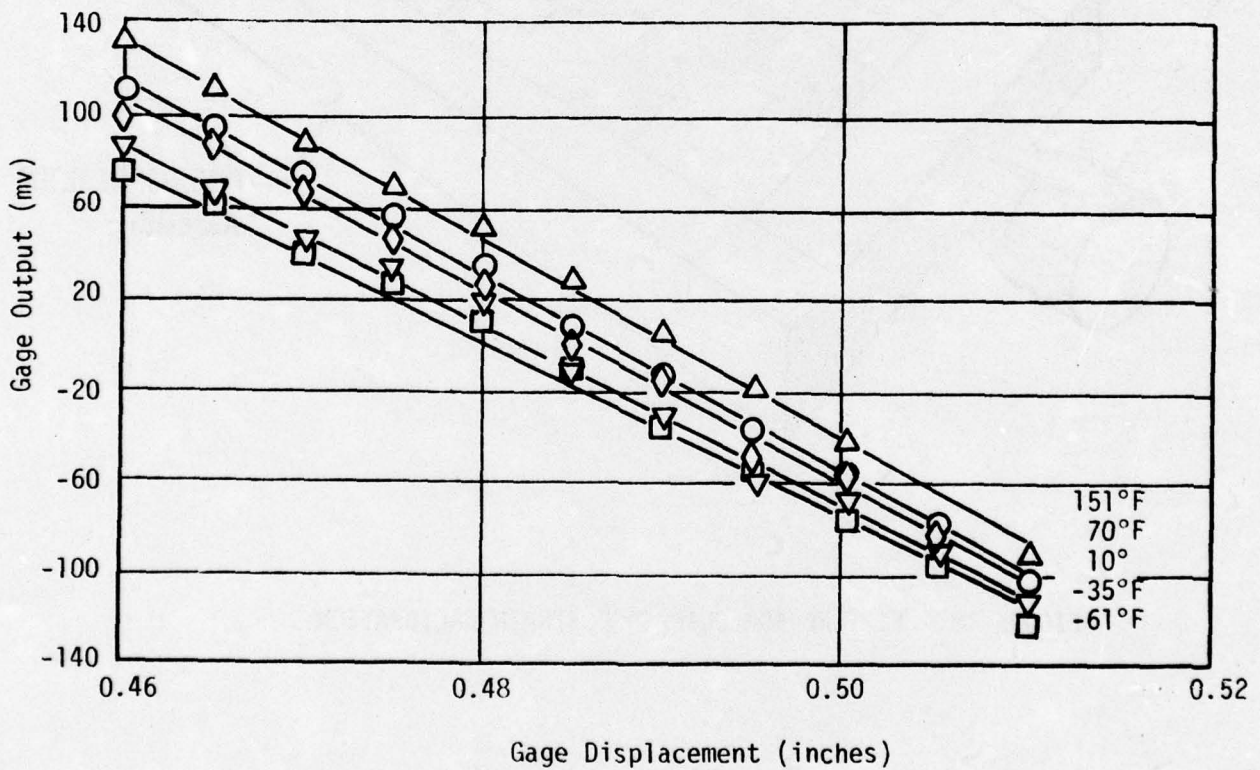
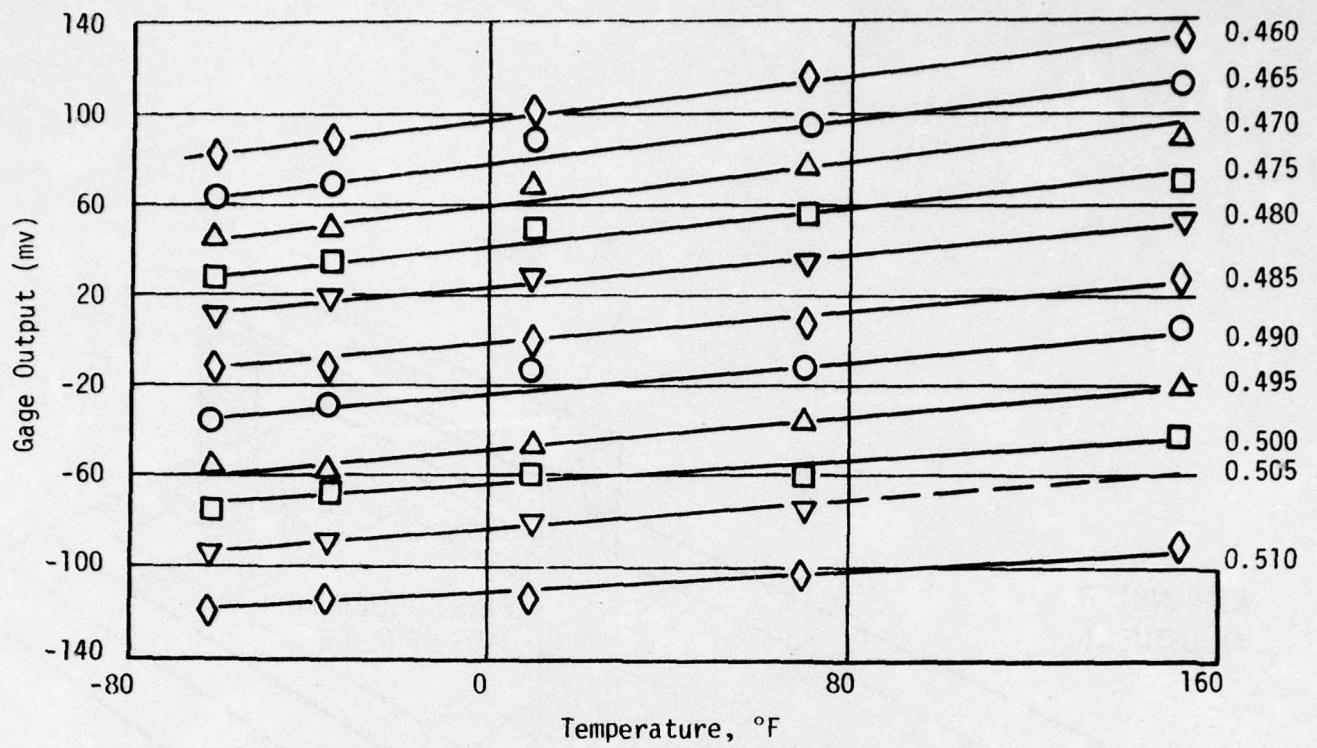

FIGURE 19. CLIP GAGE CALIBRATION DATA VERSUS TEMPERATURE
AND DISPLACEMENT

11.1.3 Embedded Gage Calibration Philosophy

There are several distinct phases in the calibration procedure for embedded normal stress sensors which may be listed as follows:

- (1) Pressure calibration of bare (not embedded) gages wired up in accordance with manufacturer's specifications.
- (2) Pressure calibration of bare gage bonded at specified locations in test motor. Again, wiring circuit is as specified by manufacturer.
- (3) Pressure calibration of gage, installed in test motor and embedded in hemisphere of live propellant, inert propellant, or insulation. Depending on the type of gage, the manufacturer's circuit may require modification to keep the 'zero stress' reading reasonably close to zero mv output. The 'zero stress' output now consists of the output of the bare gage plus superposed effects of the interaction stresses with the grain.
- (4) In-situ pressure calibration of embedded gage in propellant grain. The response of the gage at this time will depend upon the amount of pressure transmitted by the grain to the case. Typically the gage response should be about 90 to 98% of the embedded gage response without the grain.

The results of experimental tests on embedded normal stress gages at LPC confirmed the analytical predictions of Pister (5) that the diaphragm gage is less sensitive to tension or compression than to hydrostatic pressure. Typically, a stiff gage (such as the 150 psi KI P14 sensor) exhibits a sensitivity to tension which is approximately 90% of the response under hydrostatic pressure. Thus, the step calibration sensitivity values (Step (4)) obtained in motor tests should be reduced by approximately 10%, then compared to those from Step (3).

In addition to these pressure step calibrations, which will be performed on all gages employed in the test motor, it is necessary to investigate the response of the gage embedded in propellant to tension, compression and shear stress fields. This is best accomplished in the uniaxial test fixture shown in Figure 20. This fixture is designed to produce a simple, uniform stress field in the absence of the transducer and is amenable to analysis. Additionally, the test fixture should be large in comparison with the transducer.

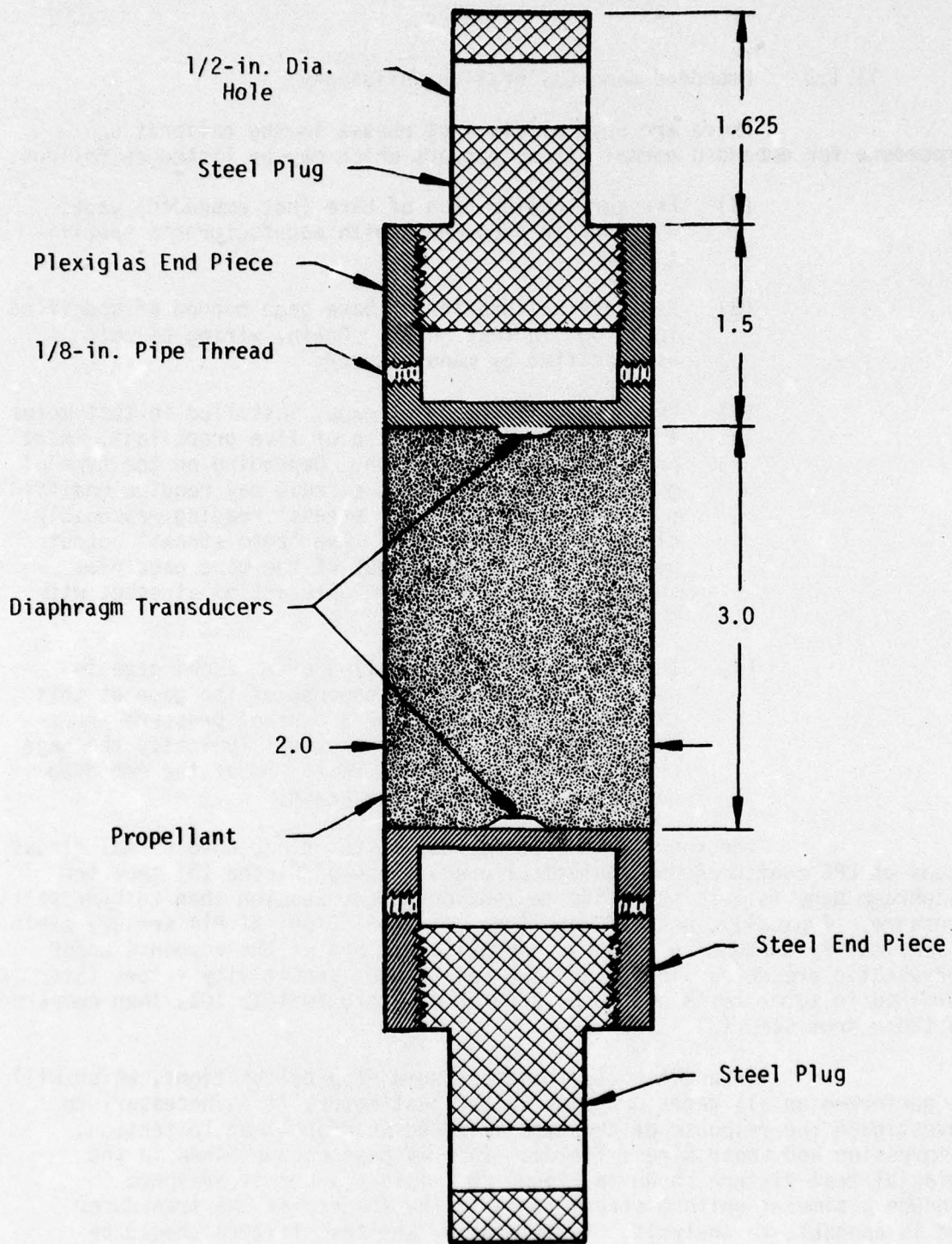

FIGURE 20. UNIAXIAL CALIBRATION TEST FIXTURE

11.1.4 Elastic and Viscoelastic Calibration Procedures

As indicated earlier, the bare normal stress gage itself appears to show time, rate and frequency dependence when these viscoelastic effects (which are not necessarily linear or, even, thermo-rheologically simple) are combined with the viscoelastic effects of the gage-grain interactions the result may be exceedingly complex to unravel analytically. It has been recommended to AFRPL (by ASPC) that they support both analytical and experimental approaches in providing accurate gage calibrations for these complex loadings.

In the meantime, some loading conditions lend themselves to nearly elastic calibrations, while others clearly require time-dependent relations. Thermal loadings with stiff gages under grain storage temperatures above 60°F are good examples of the near elastic conditions, while thermal loadings of these gages to temperatures in the range of -75°F require a viscoelastic calibration.

The following subsections give examples of both elastic and linear viscoelastic calibration techniques. It is recommended that the Appendix A, Gage-Grain Interaction and Appendix B, Transducer Calibration of Reference 30 be reviewed for a more detailed explanation of this complex subject.

In the elastic calibration work the fundamental relation between the voltage output, v , and the imposed stress, σ , is given by

$$v = a + b\sigma \quad (1)$$

where a is the zero stress voltage output of the gage, mv
 b is the sensitivity of the gage, mv/psi

The viscoelastic version of this relation becomes

$$v(t,T) = a(t,T) + \psi(t,T) \sigma(t,T) \quad (2)$$

where all of the terms are functions of the testing time and temperature and $\psi(t,T)$ is the sensitivity parameter, mv/psi.

a. Transducer Calibration Procedures in Elastic Media

If the material in which the transducer is embedded is linear and elastic, then calibration procedures follow well-established practice. The application of a step stress or strain (tension, compression, or pressure) to the test fixture will result in a step change in sensor output. The transducer is calibrated by applying incremental load steps to the specimen and noting the corresponding gage readings. Increasing and decreasing

load steps should be performed to investigate hysteresis effects. The transducer output data are then plotted against stress and the best straight line is fitted through the data points. This procedure is illustrated in Figure 21 in which pressure calibration data from a 25-psi diaphragm sensor embedded in propellant are given. The slope of the line is the sensitivity of the gage, b , at that particular temperature, and is usually expressed in mv/psi.

In addition to the sensitivity data it is also necessary to measure the embedded transducer output at zero applied stress, a , over the temperature range of interest. In many cases the zero stress data for the embedded sensor will be considerably different from those for the unpotted transducer. Curve A in Figure 22 shows a typical zero stress transducer output versus temperature signal for a well compensated sensor. When the transducer is embedded within propellant, the difference between the coefficients of thermal expansion of the sensor and of the propellant produces a stress on the gage with no external stress applied. Curve B of Figure 22 shows the thermal zero stress transducers output signal for the same sensor when embedded in propellant under zero external load. The marked difference between the sensor data without the propellant and the data obtained with the gage embedded in the propellant will be evident. The important fact is that Curve B will repeat itself during thermal excursions (assuming that the propellant aging effects are small) and, therefore, this curve must be used as the zero stress reference for thermal stress measurements.

In summary, proper calibration of a transducer embedded in an elastic material must include two steps:

- (1) A determination of the zero stress sensor response across the temperature range of interest, and
- (2) The definition of gage sensitivity, (i.e., output signal divided by applied stress) through the use of isothermal step load tests.

The sensitivity calibration test of a transducer embedded in an elastic material must be performed at several temperatures over the range of interest. Both the zero stress sensor output data and the sensitivity data as a function of temperature will be required to interpret the subsequent transducer readings.

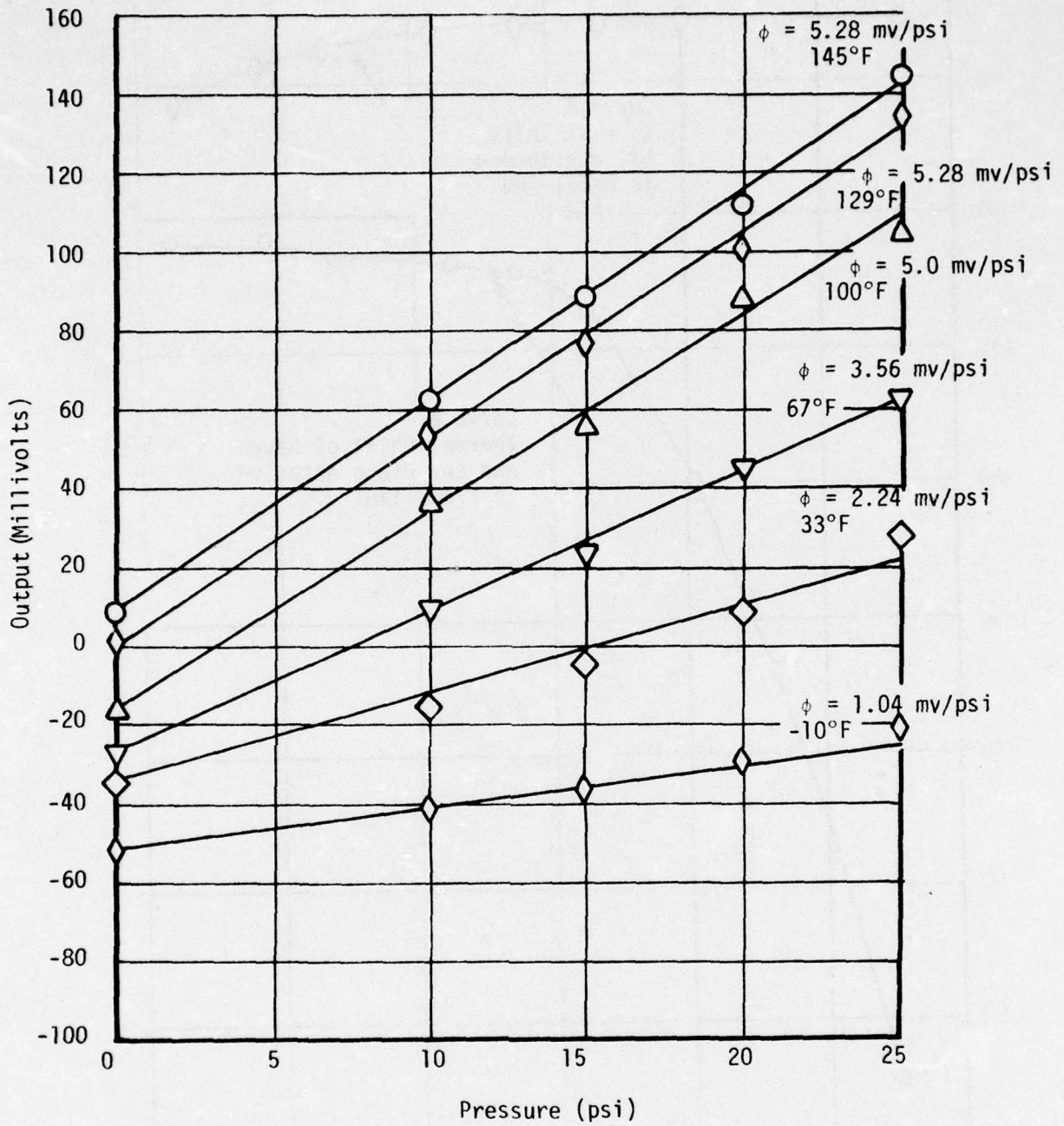

FIGURE 21. GAGE SENSITIVITY CALIBRATION DATA FOR
25 PSI GAGE EMBEDDED IN AN ELASTIC MATERIAL

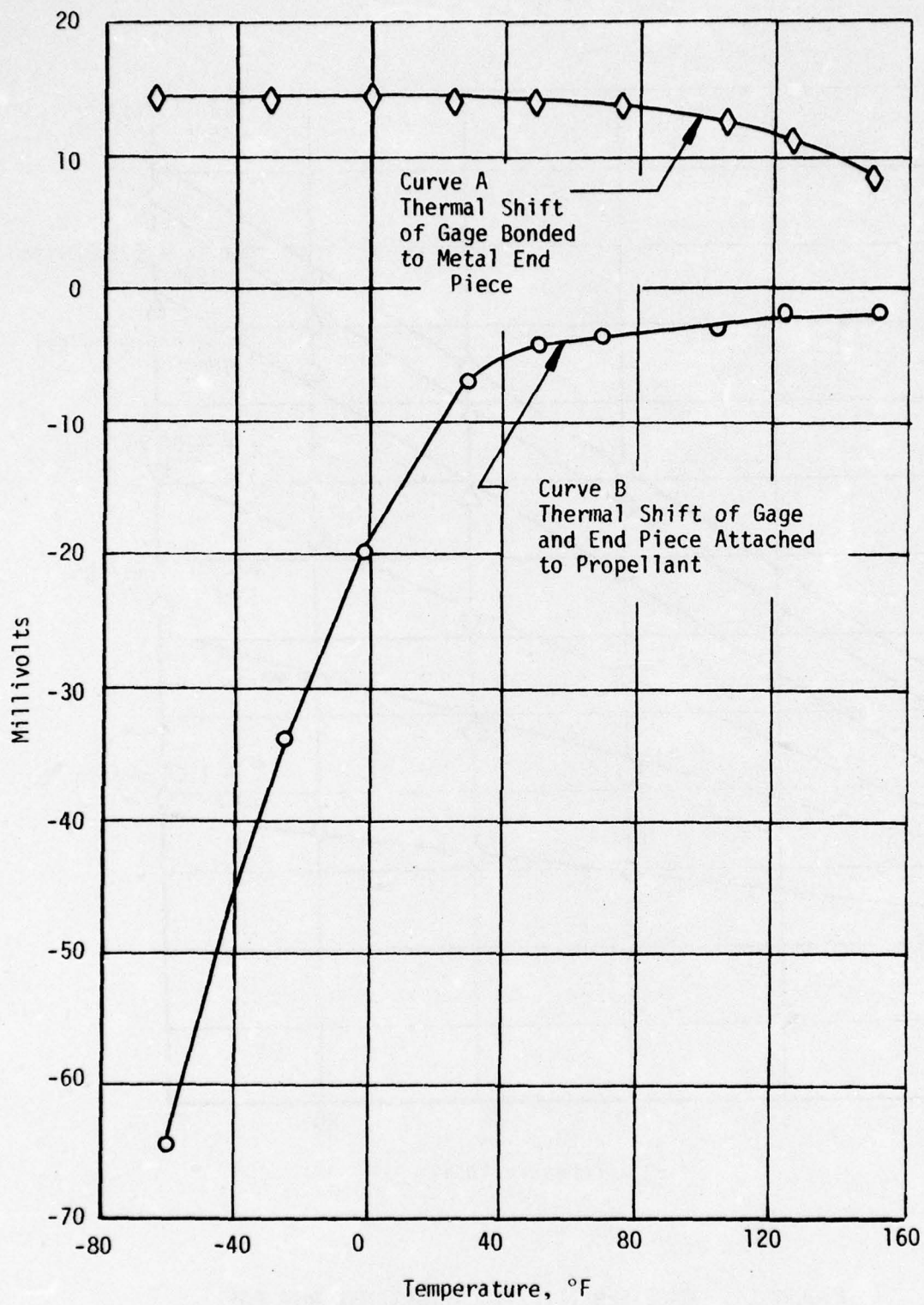

FIGURE 22. ZERO LOAD GAGE READINGS FOR 25-PSI PRESSURE GAGE BEFORE AND AFTER BONDING TO PROPELLANT

b. Transducer Calibration Procedures in Viscoelastic Media

When a sensor is embedded within an elastic material, the sensor output may be related directly either to the stress or to the strain in the material. Because the stress is uniquely related to the strain by Hooke's Law, there is no ambiguity in the data. When the same sensor is embedded within a viscoelastic material, the stress is no longer a unique function of the applied strain, so that the sensor output has to be related by analysis or by experimental testing either to the stress or to the strain.

The methods of calibrating a transducer embedded within a viscoelastic material closely follow the techniques used for determining the viscoelastic material properties. Thus, constant load or stress (creep) tests are used to determine the response of an embedded gage to stress and constant strain (relaxation) tests are used to define the gage's response to strain.

If $v(t)$ is the gage output signal under constant load conditions, a transfer function for gage sensitivity may be defined as follows:

$$\frac{v(t)}{\sigma_0} = \psi(t) = \text{gage sensitivity to stress (mv/psi)} \quad (3)$$

where σ_0 = applied stress

Similarly if the gage output is measured under constant strain (relaxation) conditions then the strain sensitivity of the gage may be defined as:

$$\frac{v(t)}{\epsilon_0} = \beta(t) = \text{gage sensitivity to strain} \quad (4)$$

where ϵ_0 = applied strain

By performing creep and/or stress relaxation tests on the uniaxial test fixtures and monitoring transducer output as a function of time, in addition to stress or strain, the transducer-propellant transfer functions may be obtained. The isothermal creep compliance or relaxation modulus data are first shifted along the log time axis to obtain a master relaxation modulus or creep compliance-versus-reduced time curve. The isothermal transfer function data $\psi(t)$, and $\beta(t)$, then may be shifted to produce master transfer function plots against reduced time.

As pointed out by Pister (31), it is impossible to separate the viscoelastic transducer calibration from the characterization of the viscoelastic material itself. It is necessary to make use of the time-temperature shift factors of the propellant material in order to properly reduce the gage sensitivity data. Consequently, it is often extremely useful to measure the material properties at the same time that the gage calibration is performed. The only additional requirement is that the deformation of the specimen be monitored during a constant-load creep calibration test, or that the stress in the specimen be monitored during a stress relaxation or constant strain calibration test.

Viscoelastic transducer calibration data from constant-load (creep) tests performed on a uniaxial test fixture containing live propellant and a 25-psi diaphragm sensor are presented in Figure 23. The sensitivity data were first translated along the log time axis by the log a_T shift factors determined for the propellant (Figure 24). Since this did not result in a smooth curve, an additional vertical shift factor log b_T was applied to the sensitivity values to obtain the curve of Figure 23. These log b_T vertical shift factors are plotted against temperature in Figure 25.

The log b_T vertical shift factors may be regarded as the temperature dependent sensitivity factors of the embedded sensor, independent of any viscoelastic effects due to the surrounding propellant. This viscoelastic calibration approach assumes that the viscoelasticity effects are entirely due to the propellant and that there is no interaction between the sensor and the propellant viscoelastic properties. Experimental data obtained so far have supported this approach.

Transducers embedded within viscoelastic media also exhibit changes in the zero stress output signal as the temperature is changed. For this reason it is also necessary to perform a thermal calibration under zero stress conditions across the temperature range of interest. In performing these tests it is important to specify the time spent at each temperature because recent data obtained at HL&A during calibration of 150-psi transducers embedded within LPC-667 inert propellant have shown evidence that the "zero stress" transducer output may not be a constant with temperature but may, in fact, be viscoelastic. Figure 26 shows the variation in a 150-psi stress transducer's response while held at -65°F under zero applied stress. The change in embedded transducer output with time is quite evident while the bare gage outputs are essentially constant.

This finding is not surprising in view of the fact that the propellant-sensor thermal interaction is caused by stresses induced by differences in the coefficients of expansion and moduli between the propellant and the sensor. Clearly if the propellant exhibits viscoelastic behavior, any thermal stresses induced will relax with time, and this will, in turn, cause a change in the "zero stress" transducer reading.

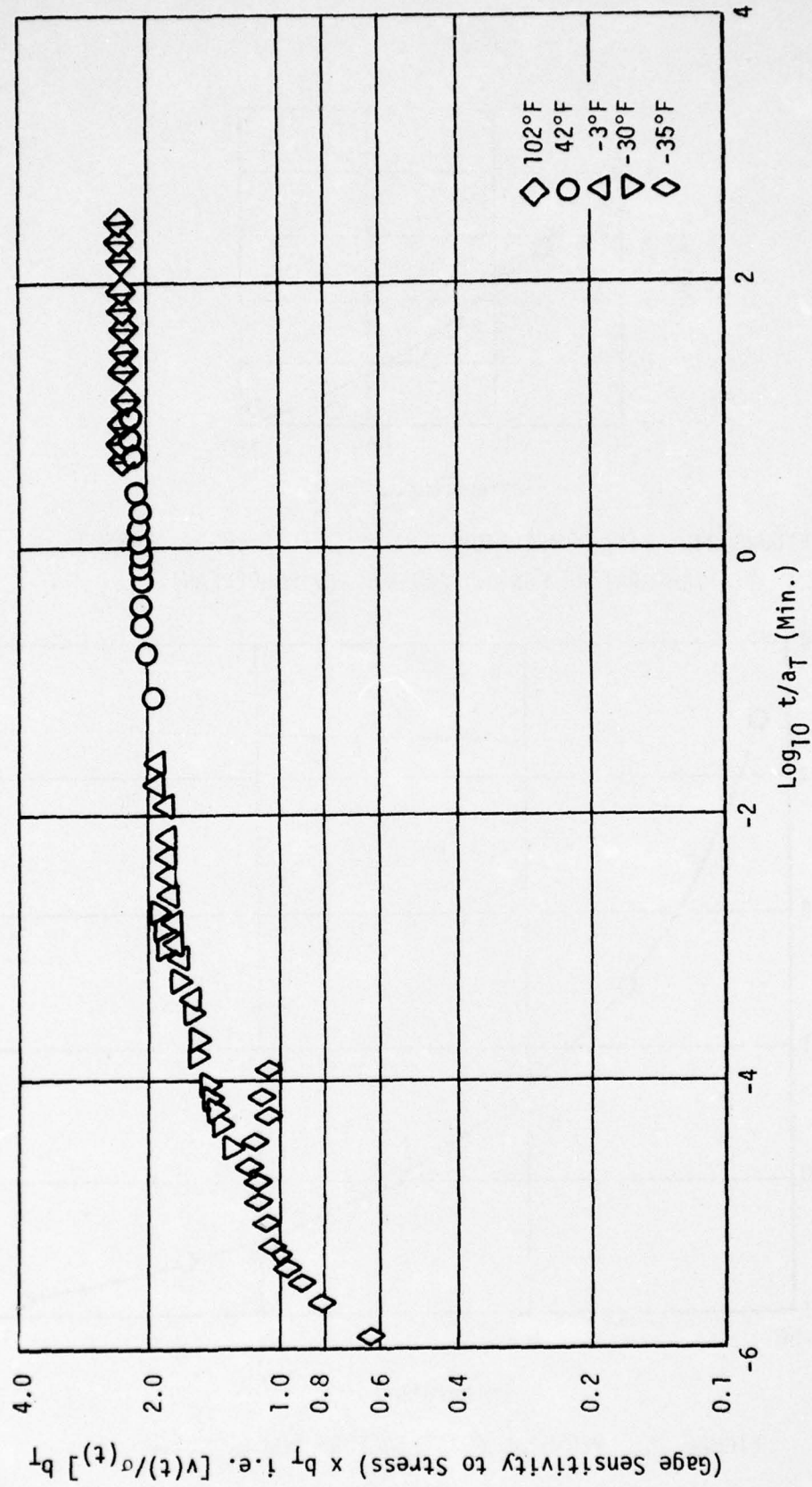

FIGURE 23. 25-PSI DIAPHRAGM STRESS TRANSDUCER CALIBRATION DATA
IN LOCKHEED'S STV PROPELLANT

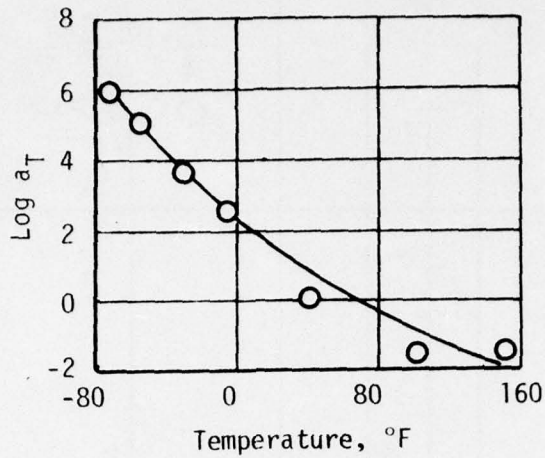

FIGURE 24. TIME-TEMPERATURE SHIFT FACTORS $\log a_T$ VERSUS TEMPERATURE FOR LOCKHEED'S STV PROPELLANT

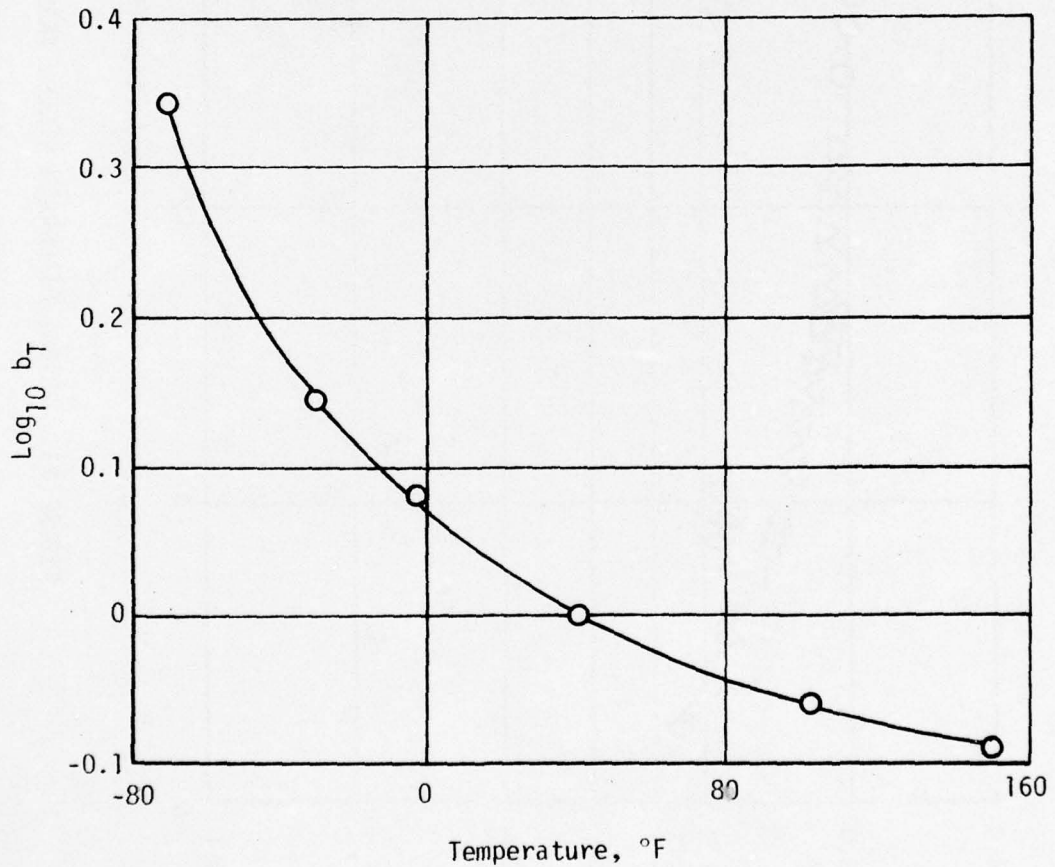

FIGURE 25. VERTICAL SHIFT FACTORS $\log b_T$ VERSUS TEMPERATURE FOR 25 PSI TRANSDUCER

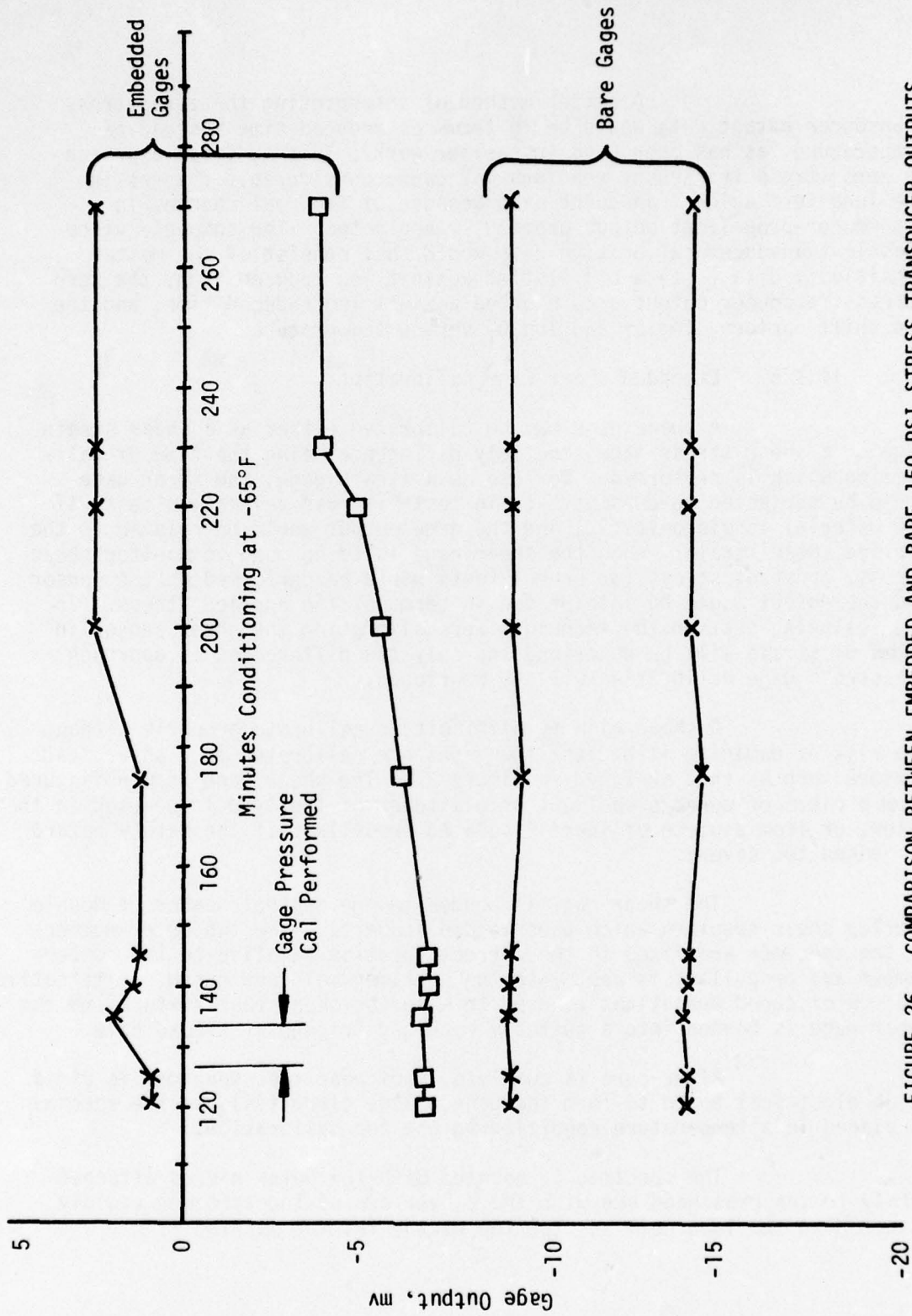

FIGURE 26. COMPARISON BETWEEN EMBEDDED AND BARE 150-PSI STRESS TRANSDUCER OUTPUTS AT -65°F SHOWING VISCOELASTIC BEHAVIOR OF POTTED TRANSDUCERS

A better method of interpreting the zero stress transducer output data would be in terms of reduced time instead of temperature, as has been used in earlier work. This modified approach to zero stress transducer readings may cause considerable changes in the long-term aging transducer data because of the real changes in transducer-propellant output previously neglected. The complete viscoelastic transducer calibration data would then consist of the master sensitivity data $[\psi(t) \times b_T]$ plotted against log reduced time, the zero stress transducer output also plotted against log reduced time, and the two shift factors, $\log a_T$ and $\log b_T$ versus temperature.

11.1.5 Embedded Shear Gage Calibration

A shear gage may be calibrated either as a shear strain gage or a shear stress gage, the only difference being the type of calibration which is performed. For use as a strain gage, the shear gage would be subjected to constant strain tests (stress relaxation tests if the material is viscoelastic) and the gage output would be related to the applied shear strain. When the shear gage is to be used to monitor shear stress, constant stress (or creep) tests would be performed on the sensor and the output would be interpreted in terms of the applied stress. In the following section the technique for calibrating the shear sensor in terms of strain will be described and only the differences in approach for stress gage calibration will be mentioned.

A shear gage is difficult to calibrate properly without the risk of damaging it because the gages are calibrated in a shear test fixture such as that sketched in Figure 27. The shear gage is manufactured from a piece of cured propellant or elastomer of the type to be used in the motor, or from a piece of inert simulated propellant if the safety hazard is judged too severe.

The shear gage is bonded to the central member of double overlap shear specimen which uses wooden supports. The two outer members of the specimen are fixed in the correct location relative to the center member and propellant is cast into the specimen mold and cured. Alternatively, a piece of cured propellant is used to make the shear test fixture and the shear gage is bonded into a suitably machined triangular shaped hole.

After cure is complete, the shear test specimen is wired to an electrical board to form the gage bridge circuit(s) and the specimen is placed in a temperature conditioning box for calibration.

The specimen is mounted with the outer pieces attached firmly to the crosshead and with the center arm of the specimen rigidly attached to the load cell and the top of the testing machine.

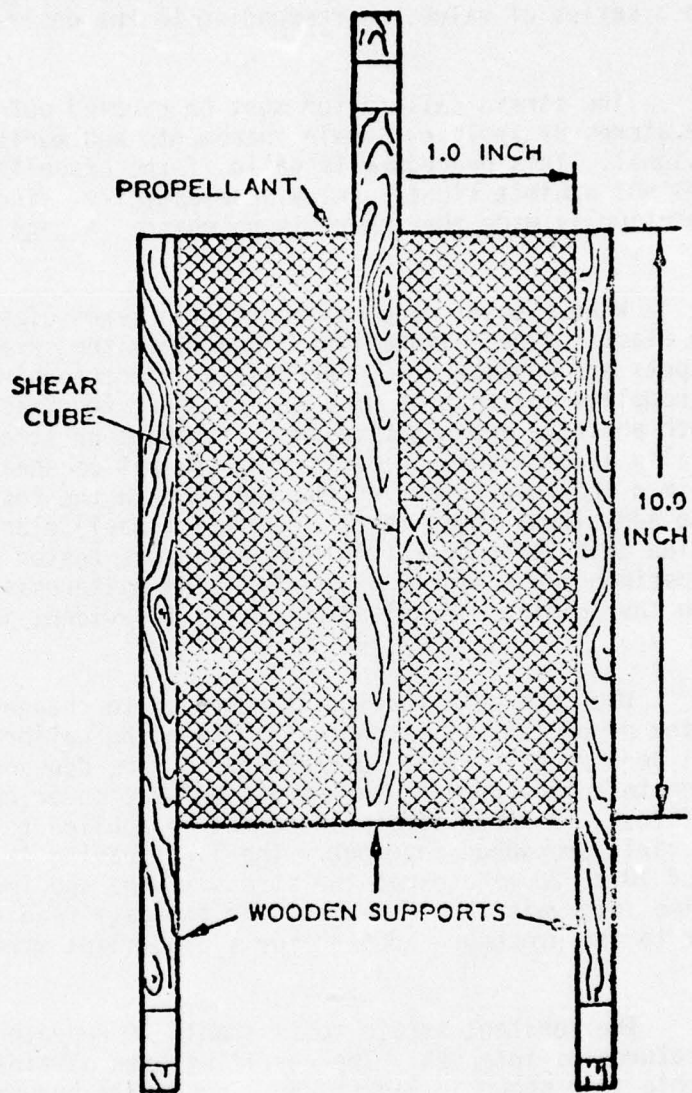

FIGURE 27. SHEAR CALIBRATION TEST FIXTURE

Two calibrations are required, a thermal calibration and a strain calibration. In the thermal calibration the specimen is held fixed under zero applied strain conditions while the temperature is changed to a series of values corresponding to the desired operating range.

The strain calibration must be carried out at the various temperatures by applying strain increments and monitoring the gage output signal. This procedure is valid if the propellant or elastomer does not exhibit significant viscoelasticity, since the implicit assumption is made that there is no change in gage reading with time.

When a shear gage calibration in terms of stress is required, the elastic type calibration is precisely the same except that gage outputs are monitored for increasing and decreasing applied stresses. A complete calibration of a shear sensor requires calibration data under both positive and negative shear stresses or strains and this is generally accomplished by performing one set of shear tests with the specimen and then inverting the specimen in the test machine and performing additional shear tests. Typical (quasi) elastic shear gage calibration data for rubber (V45) shear sensors tested in a V45 rubber test specimen are shown in Figure 28. The hysteresis loop formed between the loading and unloading curves is evident in these data.

When the gage reading is observed to change with time, showing that the propellant is viscoelastic, then the calibration procedure must be changed to that suitable for a time-dependent process. The calibration technique used is the stress relaxation or constant strain type of test. A known strain increment is applied to the specimen by means of a rapid crosshead movement. The gage reading is then recorded for a period of 10 to 20 minutes as the stress in the specimen decays. Logarithmic time intervals should be used for the gage readings in a manner similar to the procedure adopted for a propellant stress relaxation test.

The constant strain tests should be repeated at the various temperatures of interest. The resulting data obtained will probably resemble that shown in Figure 29. These data curves are translated along the log time axis using the shift factors obtained from the propellant relaxation test data. In some instances this will result in a smooth gage calibration function curve but, in others, the individual temperature curves will be displaced as shown in Figure 30. To produce a smooth master gage calibration curve, it is necessary to shift the various temperature curves in a vertical direction thereby producing the curve shown in Figure 31. The small shift factors (b_T) required to make all the temperature curves align are plotted against temperature in Figure 32, and the conventional horizontal shift factors ($\log a_T$) are given in Figure 33.

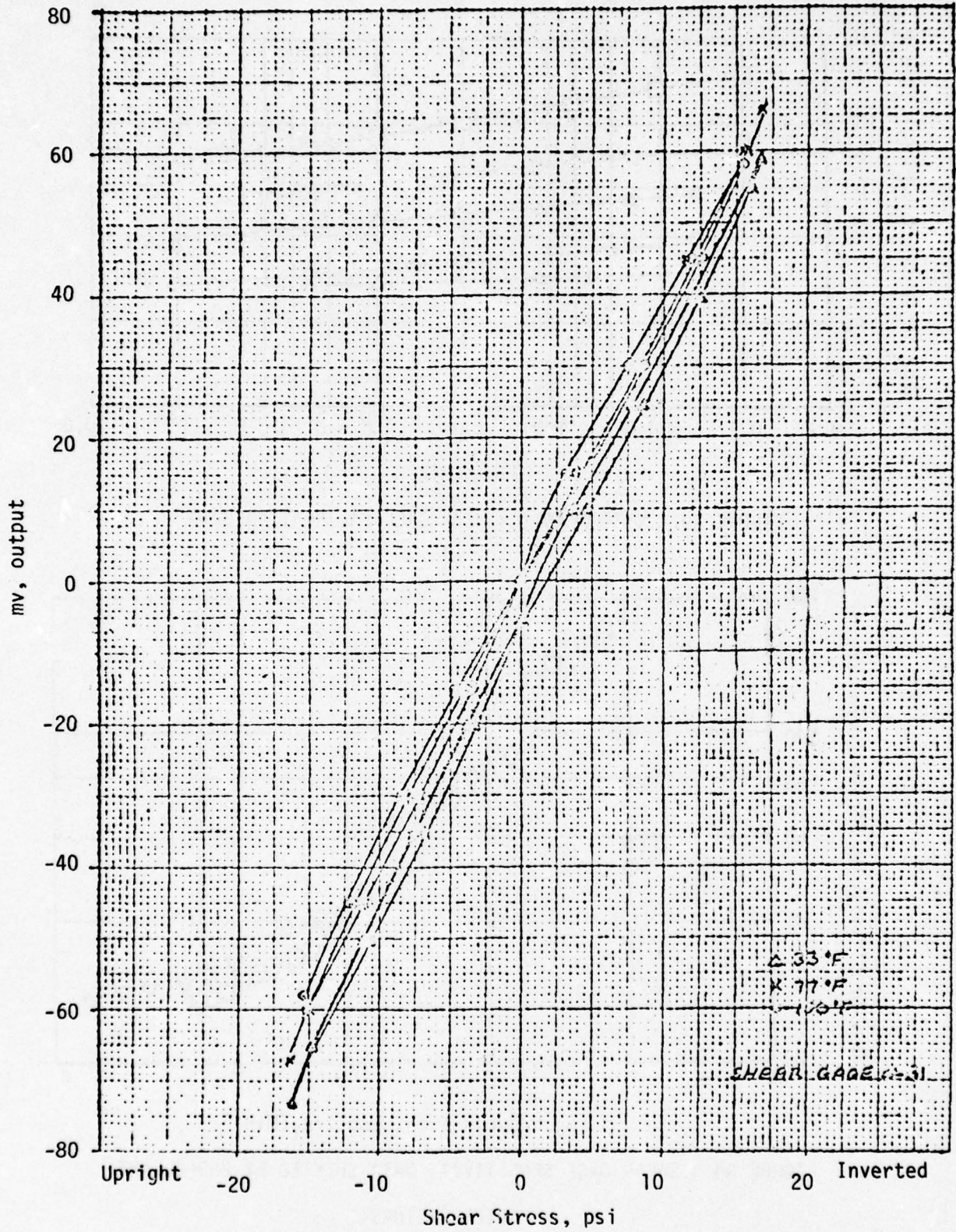

FIGURE 28. ELASTIC CALIBRATION DATA FOR SHEAR GAGE #31

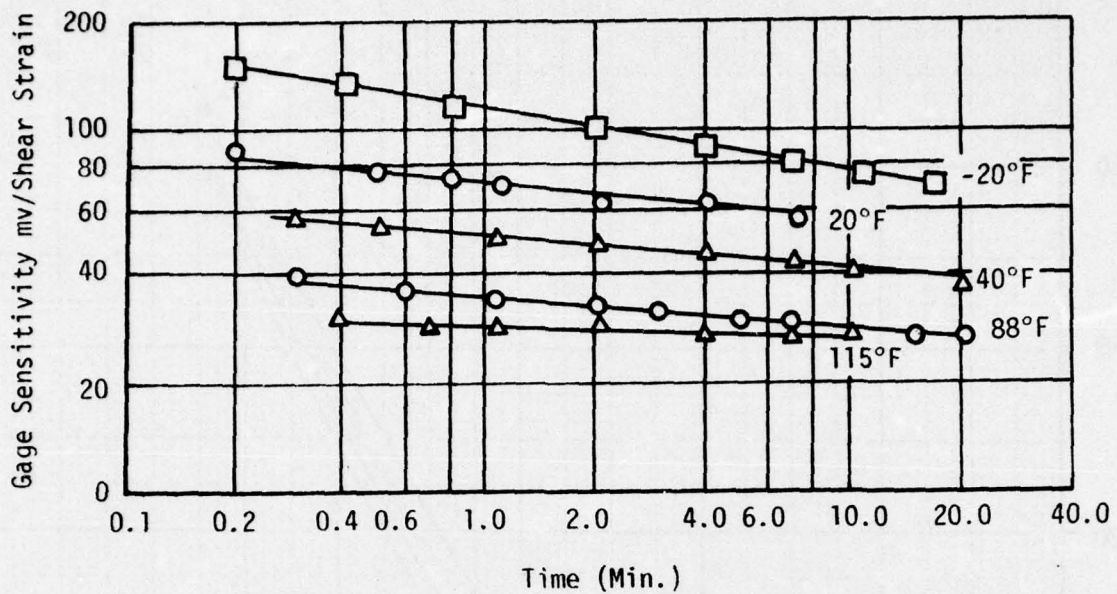

FIGURE 29. VISCOELASTIC SHEAR GAGE CALIBRATION DATA

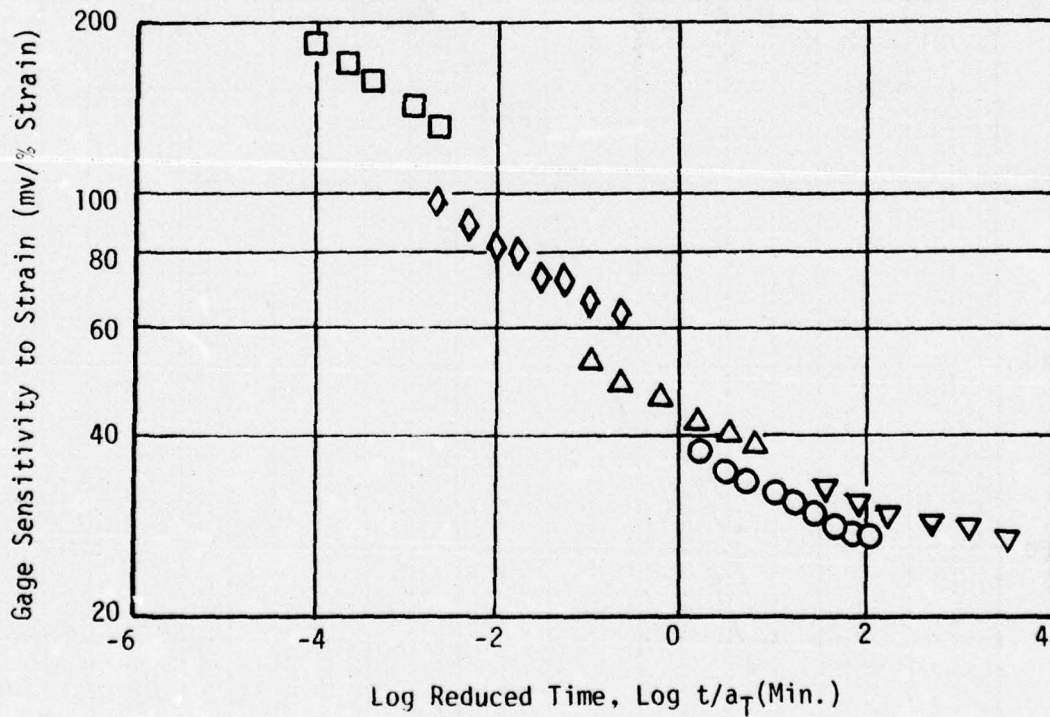

FIGURE 30. SHEAR GAGE SENSITIVITY DATA SHIFTED BY PROPELLANT SHIFT FACTORS

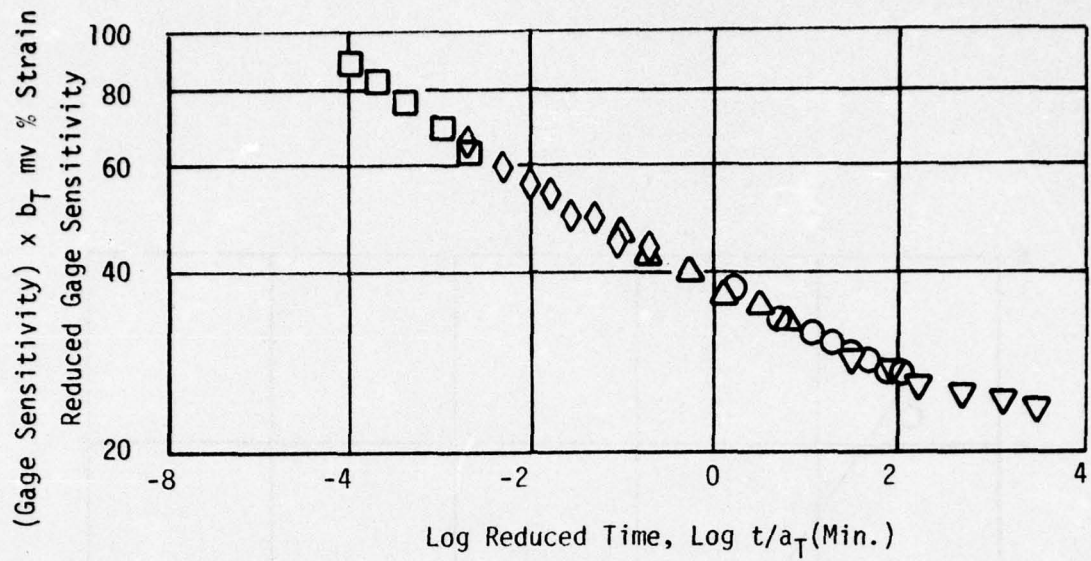

FIGURE 31. SHEAR GAGE SENSITIVITY DATA AFTER VERTICAL SHIFT APPLIED

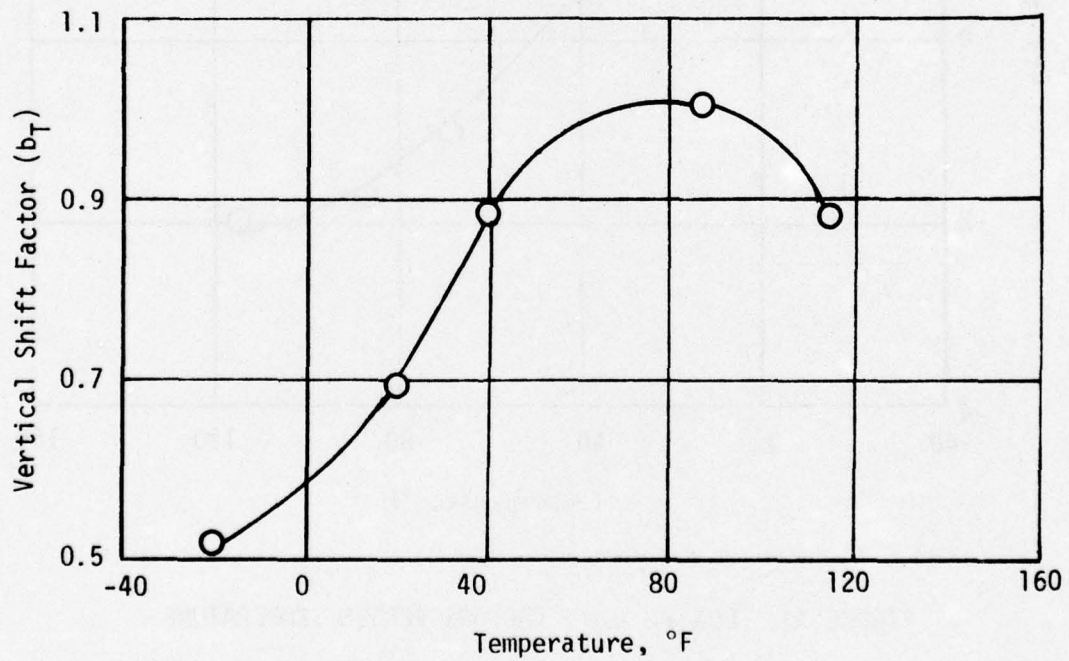

FIGURE 32. VERTICAL SHIFT FACTORS FOR SHEAR GAGE DATA

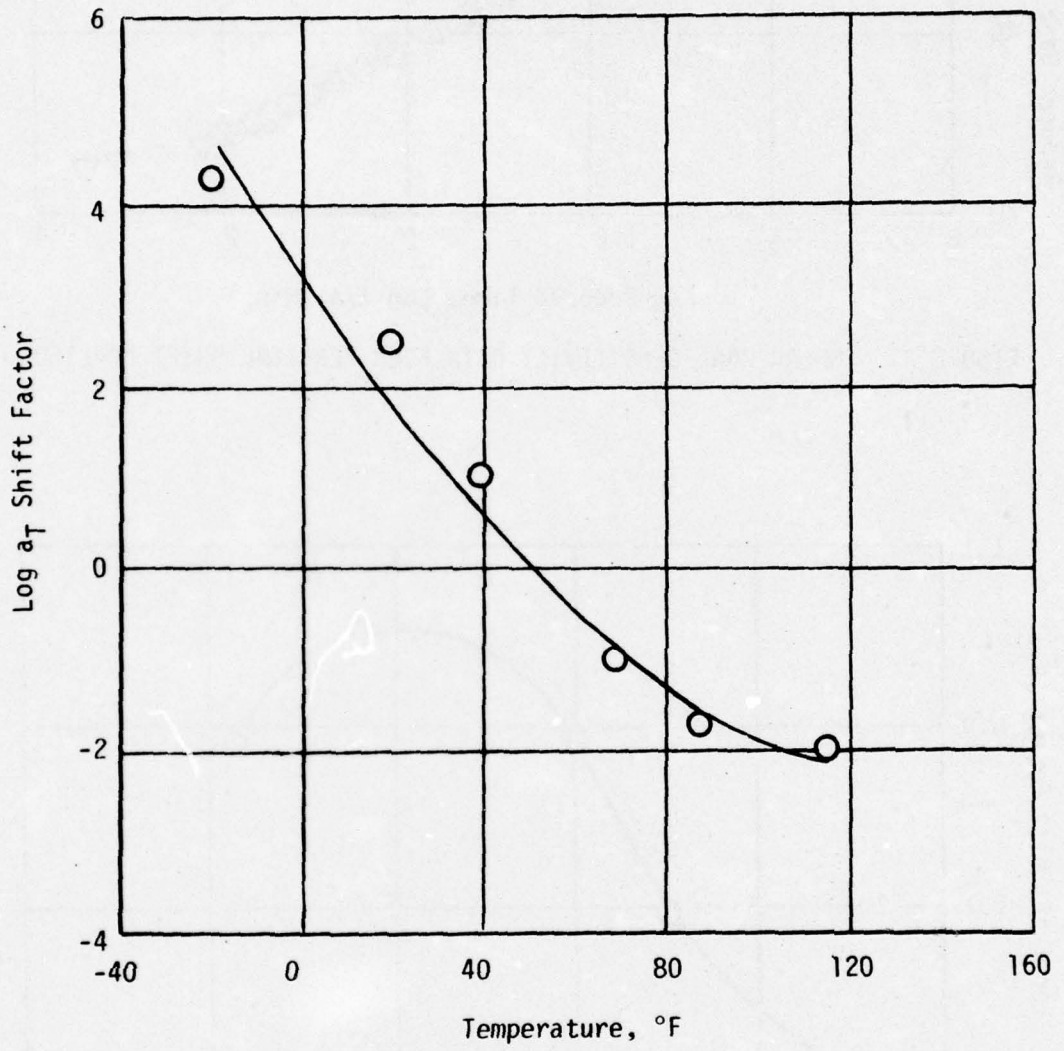

FIGURE 33. LOG a_T SHIFT FACTORS VERSUS TEMPERATURE

The vertical shift amounts to a correction for the change in sensitivity with temperature and is independent of time.

In addition to the shear calibration of the gages, it is usually necessary to determine the shear gage response to a normal stress or strain so as to permit an assessment of the inherent errors in the shear gage output data. This calibration test is performed simply by rotating the specimen and gripping the wooden or metal edges in a pair of strip biaxial-type jaws. The specimen is then strained in a normal direction and gage readings are taken as in the shear tests. If a viscoelastic calibration is required for the shear tests, it will probably be necessary for the normal strain tests.

11.1.6 Summary of Embedded Transducer Calibration Requirements

The steps in the overall calibration of an embedded stress transducer for use in a rocket motor may be summarized as follows:

- (1) Conduct pressure-step (loading and unloading) fluid calibration of bare transducers at ambient temperature and at the temperature extremes.
- (2) Embed transducer in propellant hemisphere to simulate infinite half-space.*
- (3) Install "potted" transducers in motor case.*
- (4) Perform viscoelastic pressure-step calibration tests on embedded sensors, i.e., application of step pressures, both loading and unloading, at known times, across temperature range.
- (5) If temperature range is limited, e.g., 30 to 130°F, and if the propellant (embedding material) is soft, then the response of the embedded transducer may be sufficiently linear and independent of time for the viscoelastic effects to be ignored. This remains to be determined by combined experimental and analytical programs.
- (6) These in-situ pressure calibration tests will suffice only after a comprehensive transducer evaluation has been performed using a uniaxial test fixture.

* Alternatively, bond bare gage to interior of motor case and then cast propellant hemisphere around installed gage.

11.1.7 Determination of Long Term Stability of Embedded Gage

Experience with embedded stress sensors at ASPC (14) indicated that the stability of the embedded sensor was poor during extended duration aging tests. Clearly, in any aging test, before we can measure the effects of aging on the propellant of the grain, we must know the most probable trends of aging on the embedded sensor. Because of this fact HL&A recently conducted a series of long-term stability tests on embedded normal stress gages (31). The objective of these tests was to investigate the behavior of embedded sensors over extended time periods under low tensile stresses, such as would be experienced in a rocket motor application.

The first series of tests was conducted at a temperature of 150°F using uniaxial test specimens of approximately two inches diameter and three inches length, with three normal sensors embedded therein, as shown in Figure 34. After completing conventional pressure calibration tests and step tension calibration tests at ambient and 150°F, the long-term stability test was initiated using stress levels of 6 and 9 psi. After approximately 26 days under constant load at 150°F the load was removed and the gage allowed to revert to its zero load reading. New tensile calibration tests were then performed with the results shown in Figure 35. These data show that all the embedded gages exhibited a considerable change in zero stress reading during the long term stability test and furthermore, the sensitivity of the gages changed considerably during the test. Subsequent examination of the LPC 667 inert propellant from which the test specimen was made disclosed that this inert propellant had hardened considerably during the test and this was believed to be the cause of the shifts in zero reading and the reduction in sensitivity.

Consequently, the gages were removed from the initial test specimen and re-bonded into another uniaxial test fixture and the long term stability test was repeated, this time at a temperature of 80°F. The data generated for one of the gages during this second long-term stability test are presented in Figure 36. This gage gave almost no change in its zero reading during and exhibited essentially the same sensitivity to tensile stress at the end of the test as at the beginning. Not all gages exhibited such exemplary performances. In some instances, as shown in Figure 37, the gage reading changed consistently during the test both with and without the tensile load applied.

The data presented above suggest that gage calibration parameters can occur for two separate reasons:

- (1) Changes in the material properties of the surrounding material.
- (2) Drift within the gage itself.

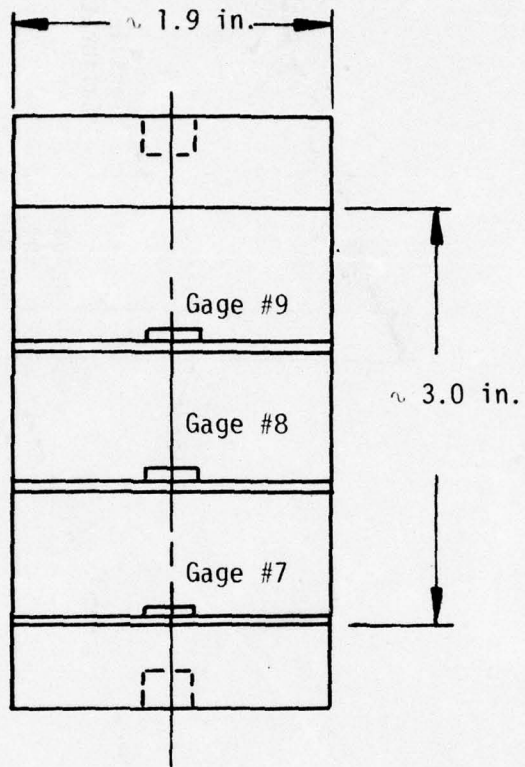

FIGURE 34. SCHEMATIC OF UNIAXIAL TEST FIXTURE
FOR LONG TERM TENSION TESTS

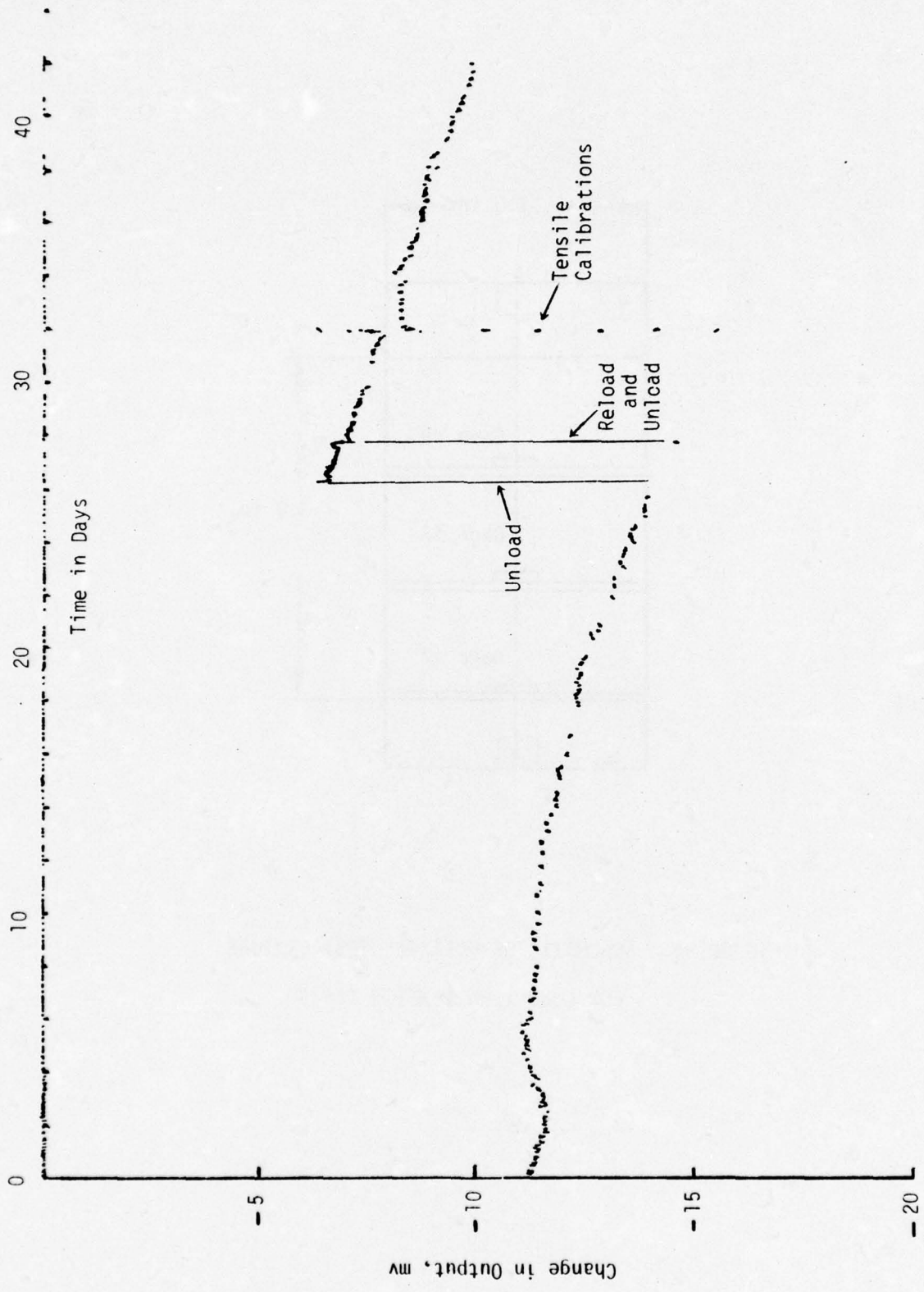

FIGURE 35. LONG TERM STABILITY TEST DATA ON EMBEDDED GAGES AT 150°F

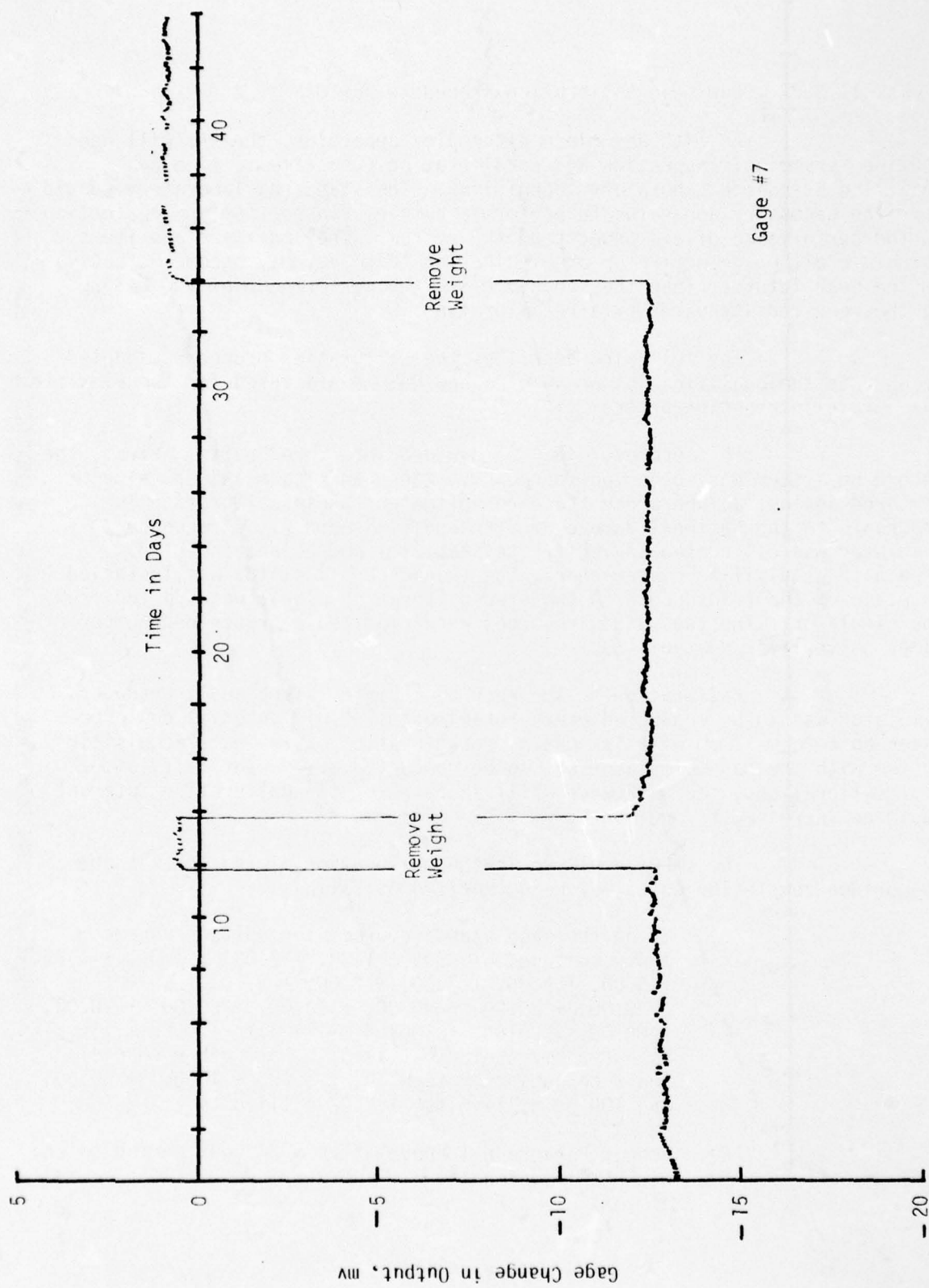

FIGURE 36. LONG TERM STABILITY DATA FOR EMBEDDED GAGES AT 80°F

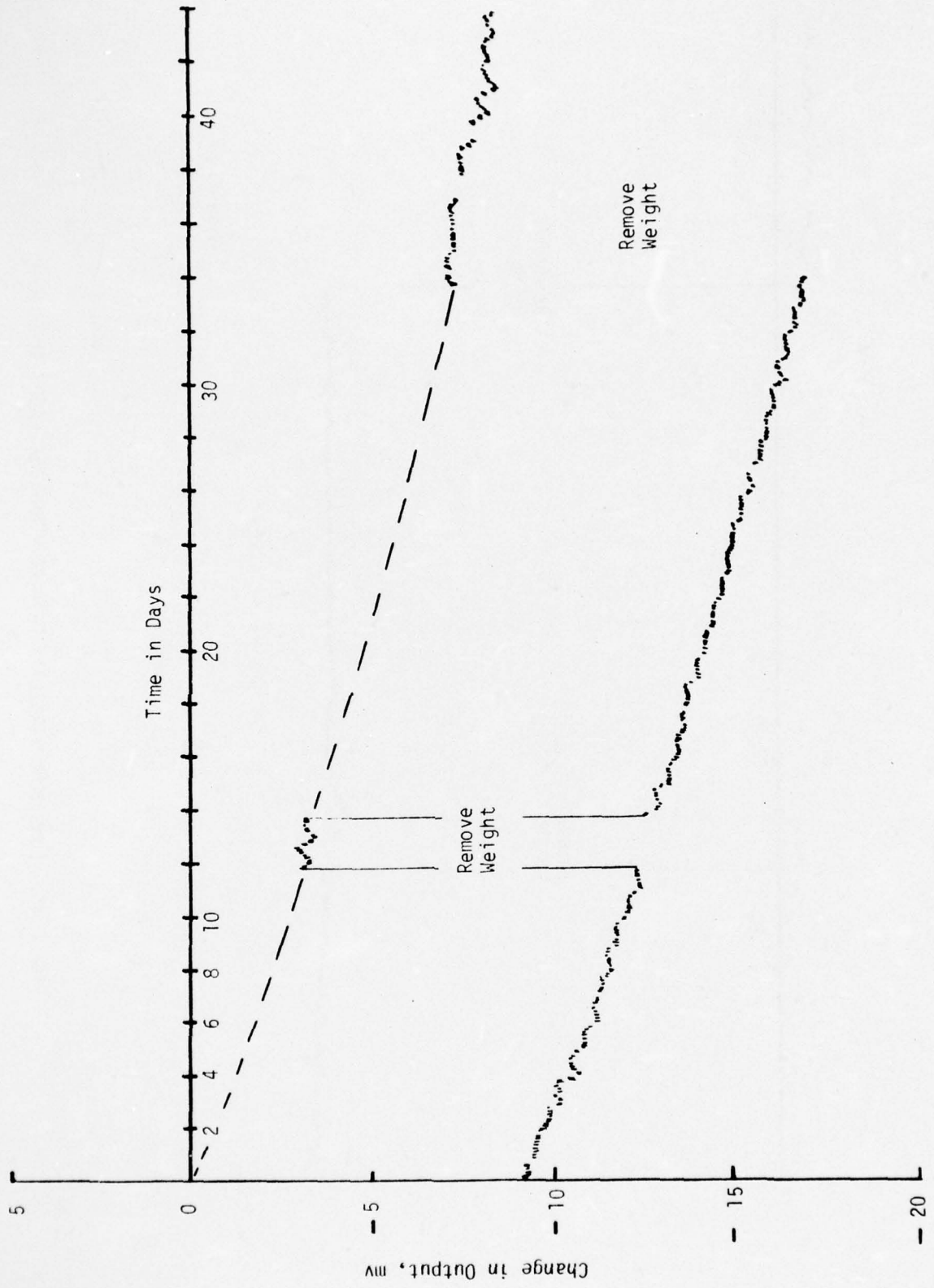

FIGURE 37. LONG TERM STABILITY TEST DATA FOR EMBEDDED GAGE SHOWING DRIFT

This instability of the bare gage was studied briefly by Konigsberg (Appendix O of Volume III). He drew the conclusion that the stability of the bare sensor must be specified in detail so that the manufacturers can design, build and test it properly prior to delivery. His review of typical epoxy bonded miniature gage stability data indicates that 1-2 micro inches/inch apparent slippage per month is experienced by the best 25% of the gages made while the best 50% will experience from 2-4 micro inches/inch slippage per month. This translates into a 150 psi gage drift or creep of 0.3 to 0.6 psi/month at best (top 25%) to 0.6 to 1-2 psi/month for the top 50% of the gages. If better stability than this is required then new types of gage employing an internally mounted Kovar beam to monitor the diaphragm displacement with anodic bonding of the semiconductor elements to the beam may be necessary.* An order of magnitude improvement in stability should be obtained with this approach when fully developed.

11.2 DATA ACQUISITION SYSTEM CALIBRATION

11.2.1 Internal Calibration Approaches

The simplest method of providing internal calibration checks on the performance of the DAS components, excluding the embedded gages themselves, is to provide a number of dummy gage circuits made from stable high precision resistors with shunt resistors which may be switched across one of their arms to provide a known change in output signal. During the testing of a motor, the validity of any data channel can be examined by disconnecting the particular gage and connecting the dummy gage in its place. The reading from the dummy gage should match the known output of that dummy gage and when the shunt resistor is switched into the circuit, the change in output signal should match the known value. Any differences between the measured output voltages with the dummy gage and the known voltages will indicate a problem with that channel of the DAS.

Another approach for internal calibration of the DAS is to incorporate a stable reference voltage within the DAS and to use this to check out a suspect data channel.

Removing the gage from the input to the DAS and short circuiting the amplifier input while measuring the output from that data channel will indicate if there has been any shift in the channel output under zero input conditions. If drift is observed, it may readily be eliminated by adjusting the zero offset control. Periodic checks of these output readings of the data channels under short circuited input conditions and with either dummy gage circuits attached or with known reference voltages applied to the channel input must be made to ensure that the performance of the DAS remains within the specified limits.

* A current AFRPL sponsored improved normal stress transducer development program (Contract F04611-75-C-0042) is attempting to develop very stable transducers using epoxy bonded strain gages. Results are not expected until late in 1977.

11.2.2 Periodic Calibration Procedure for DAS

As with any piece of complex apparatus, the DAS will need routine servicing, inspection and recalibration from time to time by qualified Standards Laboratory technicians. The standards laboratory should have the necessary apparatus to perform a complete inspection and evaluation of the performance of all aspects of the system. They must replace items which are either defective or are indicating that they may become defective in the near future. Then they should bring the performance of the DAS up to the required standards by a recalibration.

The following describes the calibration procedure adapted by ASPC in the qualification phase of a new DAS manufactured for the Flexible Case-Grain Interaction program.

This procedure may be divided into three parts. First, the recording system was subjected to known voltages and its measured value compared against a laboratory standard voltmeter, whose calibration is traceable to the National Bureau of Standards. Secondly, a transducer simulator was calibrated to verify its stability and balance. Thirdly, as a data acquisition system check, the transducer simulator was installed in place of the transducer. A two step calibration signal was applied from the simulator. The two values recorded were repeated a prescribed number of times to verify repeatability.

Calibration of the recording system alone and transducer simulator was to be conducted every three months. This interval could be extended to a maximum of 4-1/2 months. Calibration of the data acquisition system with the gage simulator was to be conducted every week. If, after four calibrations, the data were still acceptable, the calibration interval could be increased to one month.

The steps employed in the calibration of the DAS without the bridge completion units may be summarized as follows:

- (1) Using the shop standard precision voltage source apply voltages of 0.0, ± 1.00 , ± 2.00 , ± 3.00 , ± 4.00 , ± 5.00 , ± 6.00 , ± 7.00 , ± 8.00 , ± 9.00 , ± 10.00 , ± 20.00 , ± 30.00 , ± 40.00 , ± 50.00 , ± 60.00 , ± 70.00 , ± 80.00 , ± 90.00 , ± 100.00 millivolts ± 0.02 millivolts, to a randomly selected channel. All other channels shall be subjected to 0.00, ± 5.00 , ± 10.00 , ± 50.00 , and 100.00 millivolts, ± 0.02 millivolts.
- (2) Repeat Paragraph 1 above after a 24 hour period twice, without adjustments.

- (3) Cross talk shall be checked on a randomly selected channel by subjecting adjacent channels to plus and minus overscale input voltages and recording any changes to the reading of the selected channel.
- (4) Common Mode Rejection
 - a. D.C.

A common mode voltage of 10 volts D.C. shall be applied to an unbalanced input of 1,000 ohms of a randomly selected channel.
 - b. A.C.

A common mode voltage of 5 volts RMS, 60 hz shall be applied to an unbalanced input of 1,000 Ω of a randomly selected channel.
- (5) Acceptance Criteria
 - a. Zero offset must be less than 2.00 millivolts. The DAS must be capable of reproducing the input voltage to within ± 0.1 millivolt or $\pm 1.5\%$ whichever is greater.
 - b. Cross talk shall not exceed $\pm .1$ millivolt of the value read on the selected channel just prior to the application of the overscale voltages.
 - c. Common mode rejection shall be -80 db or better for both AC and DC.

To assure that the common mode voltage does not exceed 5 volts RMS AC, the AC voltage on all input lines will be measured with respect to ground when the DAS is first attached to the motor instrumentation. As a further check four dummy bridges will be limit checked to ± 0.1 mv. The DAS will be programmed to check these bridges and flag the system if any of the outputs exceed the limits.

The transducer simulator consisted of two balanced 500 ohm resistors and a 550 ohm bridge unbalance resistor. The purpose of the simulator was to serve as a stable source which could be installed in place of the transducer so that a known output could be applied to a DAS channel.

The transducer simulator was calibrated to verify that it was stable over a period of time. An excitation voltage of 10.0000, ± 0.0002 volts was applied and the voltage at the midpoint of the simulator was measured with and without the shunt resistor. Ten readings were taken each 24 hours for three consecutive days. These readings were taken at +30, +60, and +90°F.

The voltage measurements taken at each temperature could not vary more than ± 0.2 mv for any corresponding readings taken. The same was true for the measurements taken with the shunt step applied.

The whole DAS excluding the transducer was then checked using the simulator to replace the gage in the following manner:

- (1) Install the simulator in place of the transducer.
- (2) Read the voltage from each output leg to the negative input leg.
- (3) Take ten readings of the zero and shunt step. (A reading is defined as the average of 100 samples or greater).
- (4) Record all data.
- (5) Repeat for each channel.
- (6) Wait for 24 hours.
- (7) Repeat paragraphs (1) through (6) three times.

From the measured simulator data the mean and standard deviation of the samples readings both with and without the shunt resistor were determined. The standard deviation of the readings was to be smaller than ± 0.2 mv or 3%, whichever was greater.

11.2.3 Sampling Rate Check

This represents one of the more troublesome areas to investigate when the DAS is examined in the field. Only the most cursory examination of the data acquisition rates can be made without extensive test equipment. For this reason if it is suspected that the DAS is not providing data at the required rate it should be returned to Standards Laboratory with a request that the rate be checked. If it is not possible to remove the DAS from the test motor because the test is continuing and the data are required, then the actual rate of data sampling should be measured as precisely as possible so that the actual times corresponding to the measured data will be known.

When comparatively slow data sampling rates are employed, precise sampling rate is comparatively unimportant as long as it is known. The more difficult problem occurs when the very high sampling rates are employed, when the rate itself is probably employed as a reference time standard. Under such conditions, i.e., high rate pressurization tests, it is important to know the DAS sampling rate as accurately as possible.

11.3 MISCELLANEOUS ADDITIONAL CALIBRATION DATA REQUIRED

11.3.1 Barometric Pressure

Since the normal stress gages are sealed units they respond to any external pressure changes. Therefore, for accurate stress determinations it is necessary to take into account any barometric pressure changes from that which existed when the gages were calibrated. This pressure change is most important when conducting at high altitudes or transportation tests in the mountains.

11.3.2 Temperature Standard

The problem of measuring temperature of the motor with real precision should be given some attention especially during the gage calibration and during the subsequent data measurement period. Generally, small changes in temperature will not introduce significant errors into the gage readings except at the lowest test temperature conditions (-40 to -65°F). At these low temperatures it will be found that the sensitivity and/or zero load reading of many embedded gages can change significantly over a relatively small range of temperature. For this reason, therefore, it is imperative that we know the real temperature as precisely as possible.

If thermocouples are employed in the test vehicle then generally these devices used in conjunction with precision readout systems will indicate the motor temperature to within probably $\pm 3^\circ\text{F}$. To obtain temperature readings to a better accuracy than this figure would require special batches of thermocouple wire or secondary standard devices such as, for example, a platinum resistance thermometer with a digital readout system. It is strongly recommended that one of these digital thermometers be made available at the test site and that periodic checks on the conventional temperature readings be made using this device.

11.3.3 Precision DC Power Supply

Precise measurements with gages powered by a DC power supply can only be obtained when the power supply voltage is known very precisely. Furthermore the power supply must maintain the precise voltage levels for all normal changes in current loadings and fluctuations in the input line voltages.

During the ASPC Flexible Case-Grain Interaction program tests on the Third Stage Minuteman motor employed a 0.05%, 28 volt power supply.

11.3.4 Humidity

The effect of humidity on gage readings is not known and there is no strong evidence that small changes in relative humidity will cause measurable changes in embedded gage readings. However, drastic changes in relative humidity such as occur during the passage of a thunderstorm, could produce changes and for this reason it is recommended that the relative humidity be measured when tests are conducted on instrumented motors.

SECTION 12

PHASE V - TESTING AND MEASUREMENT

12.1 TEST PROCEDURES AND SAFEGUARDS

The detailed test plan will show the various environmental tests which are to be performed on the instrumented test motor and the sequence in which they will be performed. Additionally, a comprehensive test plan will include such details as:

- (1) The data sampling rate at each phase in the test plan.
- (2) Points when additional instrumentation are required, e.g., pressure transducers for pressure tests, etc.
- (3) Details about the most significant data channels during a specific phase of the test plan with anticipated output levels.
- (4) Provisions for periodic checks on the DAS drift and amplifier gains at points in the testing program where the resulting loss in data will not be detrimental to the overall test program.
- (5) Provision for periodic analysis of selected gage output data for comparison with the predicted stresses and strains.
- (6) Alternative testing routines in the event of failure of a major component of the support apparatus or the DAS. Supplementary data acquisition apparatus may be made available in the event of DAS failure.
- (7) A provision to stop the motor testing if suspect data are obtained during a test. The whole test plan should be suspended until the (suspected) problem with the measured data is resolved.
- (8) At least 10 readings of a specific gage output should be taken at each test condition so that a mean value and standard deviation for the data may be determined.

12.2 PERIODIC REVIEW OF DATA VALIDITY

We have already mentioned the fact that the test plan must incorporate provisions to stop the testing program if suspect data are generated by the gages and that periodic analysis of selected gage output data should be performed for comparison with predicted stresses and strains.

These two operations are similar but not identical aspects of the test plan. The major difference between them is that the guidelines with respect to suspect data will have been presented in the form of gage outputs in millivolts rather than in terms of grain stresses or strains. The test engineer merely has to compare his gage readings with the realistic limits defined in the test plan to determine if the gage output is satisfactory.

The periodic analysis of selected gage data, however, provides the project engineer with the basic information as to the state of the motor and program at any stage in the test plan. He will be able to compare the experimentally measured stresses and strains at key locations in the test motor with the best analytically predicted values determined prior to the test. Thus he will have a running check on the status of the program at periodic (at least weekly) intervals. By employing this approach he will be able to query doubtful gage data shortly after it is obtained and perhaps insist on a repetition of a selected phase of the test program to verify the measured data. By this means he will feel much more confident as to the real progress of the test motor program than he would if the periodic data were not provided to him.

12.3 DATA HANDLING AND STORAGE

This periodic analysis of the gage data is greatly simplified if the test data are stored on magnetic or punched paper tape, or on punched cards so that the automated analysis procedure can be performed without errors due to manual transcription of the gage data. Furthermore, once the automatic gage data analysis program has been de-bugged and is operating properly, there will be no errors in the data analysis procedure.

The simplicity of data analysis from permanently stored gage data has to be experienced to be appreciated. In addition to simple analysis procedures, e.g., the calculation of the stress or strain corresponding to a certain gage reading, the test data can be interpreted as automatic plots of stress versus time, temperature or pressure with a considerable reduction in analysis time.

Another advantage of employing automatic computer gage data analysis is the fact that the calibration data for all the gages can be stored in the computer's memory and does not have to be entered by the operator during the gage data analysis. This not only results in a great saving in time but also eliminates the possibility of error in entering the number of calibration coefficients required by the gages.

PHASE VI - RESULTS AND ASSESSMENTS

Once the tests have been made it becomes necessary to reduce the data (Section 13) and assess the test results (Section 14).

SECTION 13

PHASE VI - DATA REDUCTION

13.1 ELASTIC VERSUS VISCOELASTIC DATA REDUCTION

In the majority of instrumented motors presently in use, elastic gage calibration data are employed in the much simpler elastic data reduction equations. The reason for this fact is that generally the types of testing imposed on most of the test motors have not been particularly severe and significant viscoelastic gage behavior is not usually evident with normal stress gages except under very low temperature conditions. In keeping with the view that experimentally measured stress values to within + 10% accuracy would be acceptable, the added refinement of viscoelastic calibration would scarcely improve the real data by a significant amount.

Even in the case of shear gages for which viscoelastic calibration data were available, the elastic data analysis technique was used for reduction of the BDU flight test data (8). Comparison between viscoelastic gage data analysis and the elastic approximation disclosed no significant differences in the calculated shear stress values. Therefore in the majority of instrumented motor test programs the assumption of elastic behavior on the part of an embedded gage may be made with little error in the resulting stress/strain values.

The accuracy of the required gage measurements and the type of test being performed between them will determine if the simple elastic data analysis technique is adequate or if a viscoelastic approach is required. Rapid thermal cycling between temperature extremes is the type of test for which viscoelastic data analysis is usually required to provide an accurate value for the thermal stress. However, even under rapid thermal cooldown conditions the standard types of normal stress sensor generally provide reasonably accurate data when a simple elastic analysis is used. However, the shear gages, with their much more pronounced loss in sensitivity at low temperatures, will require a viscoelastic data reduction to achieve accurate stress or strain measurements under thermal cycling conditions.

Where viscoelastic analyses of the data are required the numerical analysis procedures given in Reference 12 are recommended.

13.2 DATA ANALYSIS SHEETS

Although manual analysis of the gage data is not recommended because of the possibility of errors in the resulting calculations, the test engineer should be provided with data tabulation sheets and detailed instructions for conducting the data reduction procedures employed with the various gages. The basic gage calibration data, in the form of two curves of zero stress output, a , versus temperature and gage sensitivity, b , versus temperature, should be kept with the data analysis sheet to facilitate a rapid check of any computer analysis data which might be suspect. In any event the ability to perform a rapid manual check of the measured stress or strain from a particular gage output reading is a valuable asset at any time.

Slight differences in stress or strain values may be obtained between the manual data reduction approach and the numerical computer analyses. These will result from the fact that the zero gage reading vs temperature plots will be approximated by a second or third order equation in the computer analysis whereas a curve with a better fit may be used in the manual analysis. In most cases, however, the differences between the two calculations will not be significant.

13.3 SAMPLE PROBLEMS FOR AUTOMATIC ANALYSIS ROUTINES

As with any complex system an automatic computer analysis code can go wrong for a variety of reasons. In the event that such a problem develops it is advantageous to have a sample analysis problem prepared (with the correct answer available) for the purpose of checking the computer code. In the case of the elastic analysis code, the computations are very simple and the most common type of problem is concerned with the analysis being performed with the zero load and sensitivity data for the wrong gage, due to an incorrect "call out" in the program. This can readily be evaluated by performing the sample calculation and comparing the computer output with the correct answer. If the two agree then any problem is in the information input to the computer and this part of the code should be examined.

13.4 EVALUATION OF MEASUREMENT ERRORS

In order to be able to estimate the errors in the measured stress and strain values it is recommended that a number of separate gage readings be taken during a short period of time. These repetitive readings will enable the mean stress/strain values to be ascertained along with the standard deviation of the values. In this way an estimate of the probable measurement error in the gage data can be made.

When automatic gage readout equipment is employed it is suggested that the mean of 10 sets of readings be used to determine a specific gage reading at a given time. This approach was used by ASPC in their later work in connection with the Flexible Case Grain Interaction program.

13.5 GRAPHICAL EVALUATION OF DATA

One of the best techniques for evaluating the validity of embedded gage data is to prepare graphs showing the measured stress values from a number of gages as a function of distance along the grain. When redundant gages are employed the similarity in their readings at any time provides additional confidence in the validity of the data. The graphs should be prepared initially using the predicted stresses and strains (with the limits also shown) and the measured data can be superposed on the analytically predicted curves. In many instances the differences between the measured and analytical data will be simply one of magnitude and the consistency of the experimental data from gage-to-gage suggests that the measured values are valid. In fact, the self-consistency of the experimental gage data is the best measure of its value. In certain instances it will be found that the majority of the experimental data agree reasonably well but one gage or group of gages shows unexpected results. In such a case the area of the motor containing these suspect gages should be examined by X-ray photographs to investigate the possibility of a local failure in the bond line or propellant. Typical of this type of data is the reading from a normal or shear stress sensor located close to the end of a grain. If the grain begins to unbond from the case wall then the gages close to the unbond will exhibit erratic and greatly changing values while the other gages remote from the unbond may not change output significantly.

When a gage that has been operating properly for a long period of time becomes erratic in its behavior, the first thing to suspect is a poor junction in the gage circuit. However, if it is found that the gage circuit is not defective then the most probable cause of this type of behavior is a grain or bond failure close to the gage.

13.6 SAMPLE CALCULATIONS

13.6.1 Elastic Data Reduction Procedure

Consider the data presented in Figure 38 which shows the zero stress curve for an embedded gage across the temperature range 30 to 130°F. With the grain cast in place the gage readings were 0.83 mv at 110°F, -3.96 mv at 70°F, and -13.11 mv at 30°F. The sensitivity of the gage remained essentially constant at -0.78 mv/psi across this temperature range.

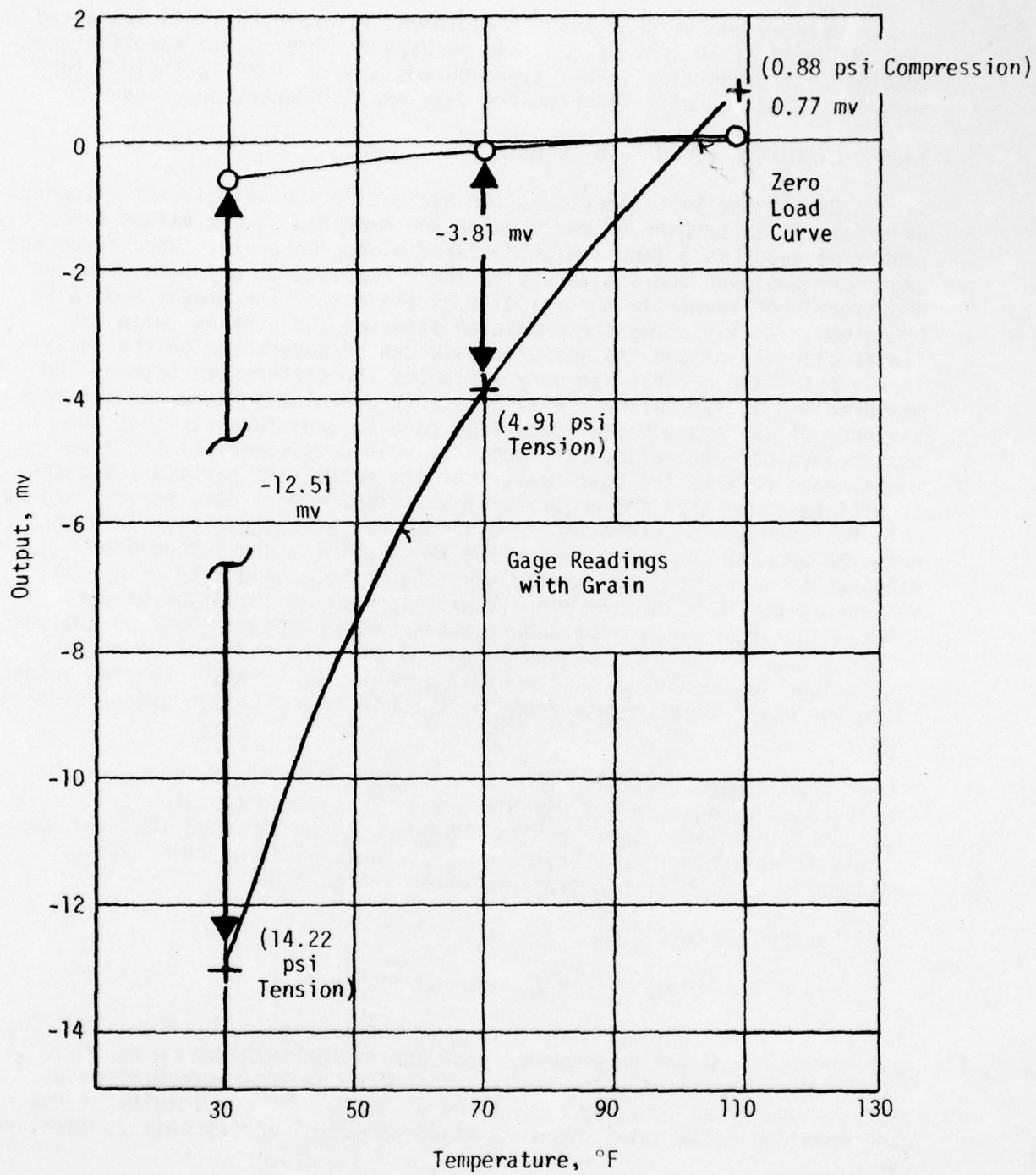

FIGURE 38. TYPICAL THERMAL COOLDOWN TEST DATA FROM EMBEDDED GAGE

as follows:

To calculate the stresses at each temperature we proceed

- (1) Determine the change in reading (mv) between the gage reading with the grain and without the grain.

$$\Delta v = v_g - v_z \quad (5)$$

- (2) From the equation

$$\sigma = \frac{v_g - v_z}{\text{Sensitivity}} = \frac{\Delta v}{b} \quad (6)$$

Note that from the sign convention for pressure gages the sensitivity to tensile stress will be negative.

$$\sigma_{110} = \frac{S_g - S_z}{\text{Sens.}} = \frac{0.83 - 0.06}{-0.88} = \underline{-0.88 \text{ psi}}$$

$$\sigma_{70} = \frac{-3.96 - (-0.15)}{-0.88} = \underline{4.31 \text{ psi}}$$

$$\sigma_{30} = \frac{-13.11 - (-0.60)}{-0.88} = \underline{14.22 \text{ psi}}$$

Note that at 110°F the stress is slightly compressive (negative) but becomes increasingly tensile as the temperature is reduced.

13.6.2 Viscoelastic Data Reduction Procedure

Consider now a shear gage whose sensitivity $\psi(t/a_T)$ changes with reduced time as shown in Figure 39, with a shift factor - temperature curve as shown in Figure 40.

Then knowing the gage reading $v(t,T)$ as a function time and temperature and the zero load gage reading as a function of temperature $v_z(T)$, the stress causing the gage reading is determined from:

$$\sigma(t) = \int_0^t \theta(\zeta - \zeta') \frac{dv'}{d\tau} d\tau \quad (7)$$

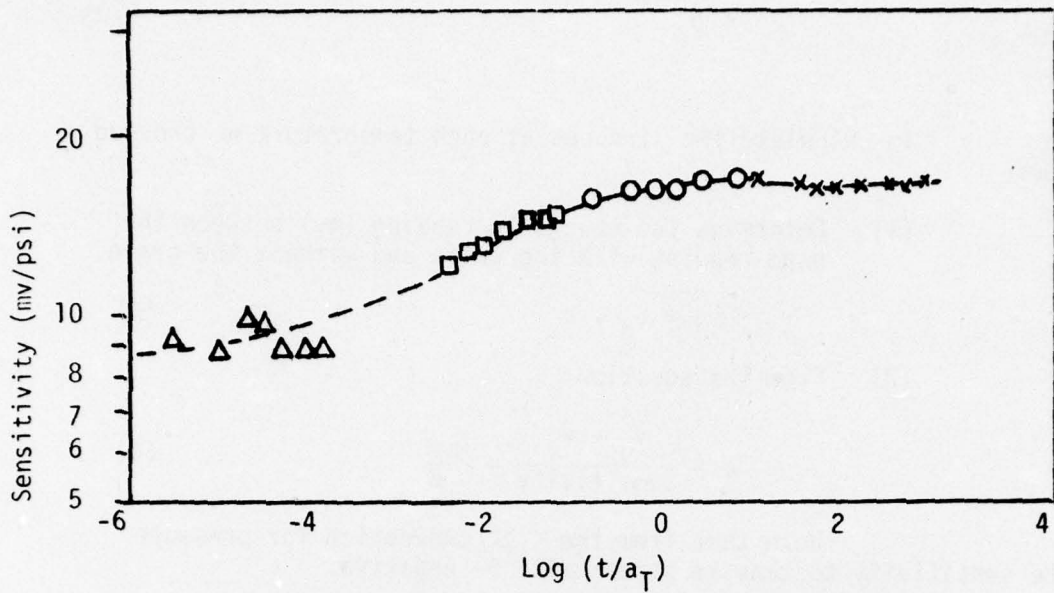

FIGURE 39. MASTER CURVE OF LOG SENSITIVITY VS LOG REDUCED TIME

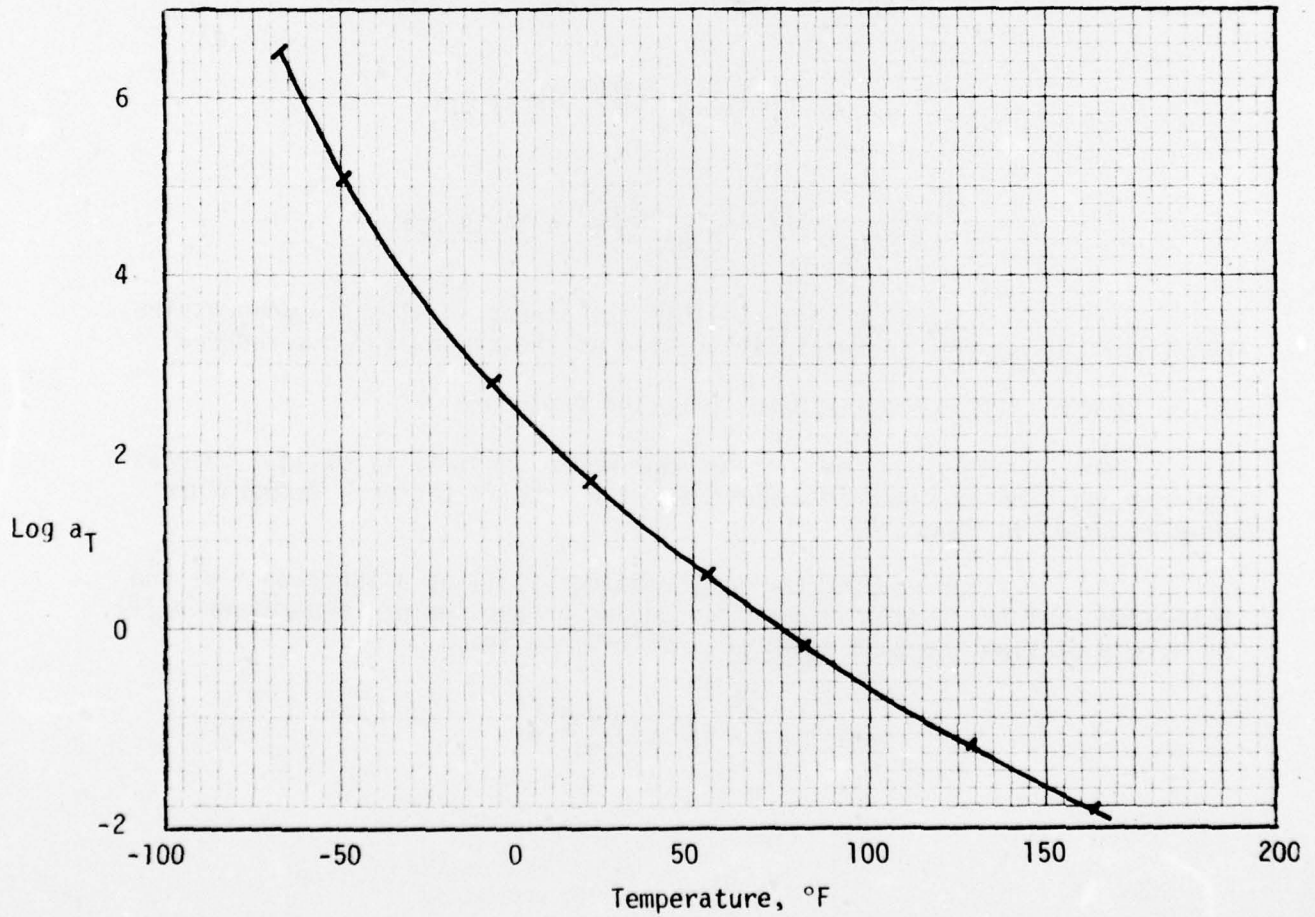

FIGURE 40. LOG a_T SHIFT FACTOR CURVE VS TEMPERATURE

where

$$v' = v(t,T) - v_z(T) \quad (8)$$

$$\theta = 1/\psi \quad (9)$$

$$\zeta = \int_0^t \frac{d\alpha}{a_T} \quad (10)$$

and

$$\zeta' = \int_0^T \frac{d\alpha}{a_T} \quad (11)$$

Solution of this convolution integral requires the fitting of the curve for θ versus (t/a_T) by a mathematical equation, e.g, a Prony series, and then a computer solution using an appropriate code. The actual solution for a specific gage output is shown as curve c in Figure 41.

Alternatively we can simplify the precise integration approach and perform a pseudo viscoelastic analysis. Using this approach the stress may be written as:

$$\sigma(t/a_T) = \frac{v(t,T) - v_z(T)}{\psi(t/a_T)} \quad (12)$$

Knowing the output signal $v(t,T)$ at a given time and temperature and the zero stress output at a specific temperature $v_z(T)$, we approximate the value of the sensitivity by the term $\psi(t/a_T)$ from the curve in Figure 39 and determine the stress $\sigma(t/a_T)$. Curve b of Figure 41 shows the same data analyzed by this pseudo viscoelastic approach and it will be noted that the stresses computed by the approach are higher than those determined by the integral calculation.

For completeness, curve a of Figure 41 shows the same data analyzed as though it were elastic and using a constant sensitivity value (that occurring at the initiation of the thermal cooldown process), i.e., approximately 17 mv/psi from Figure 39. It is interesting to observe that in this case the errors introduced by using an elastic approximation are not very large.

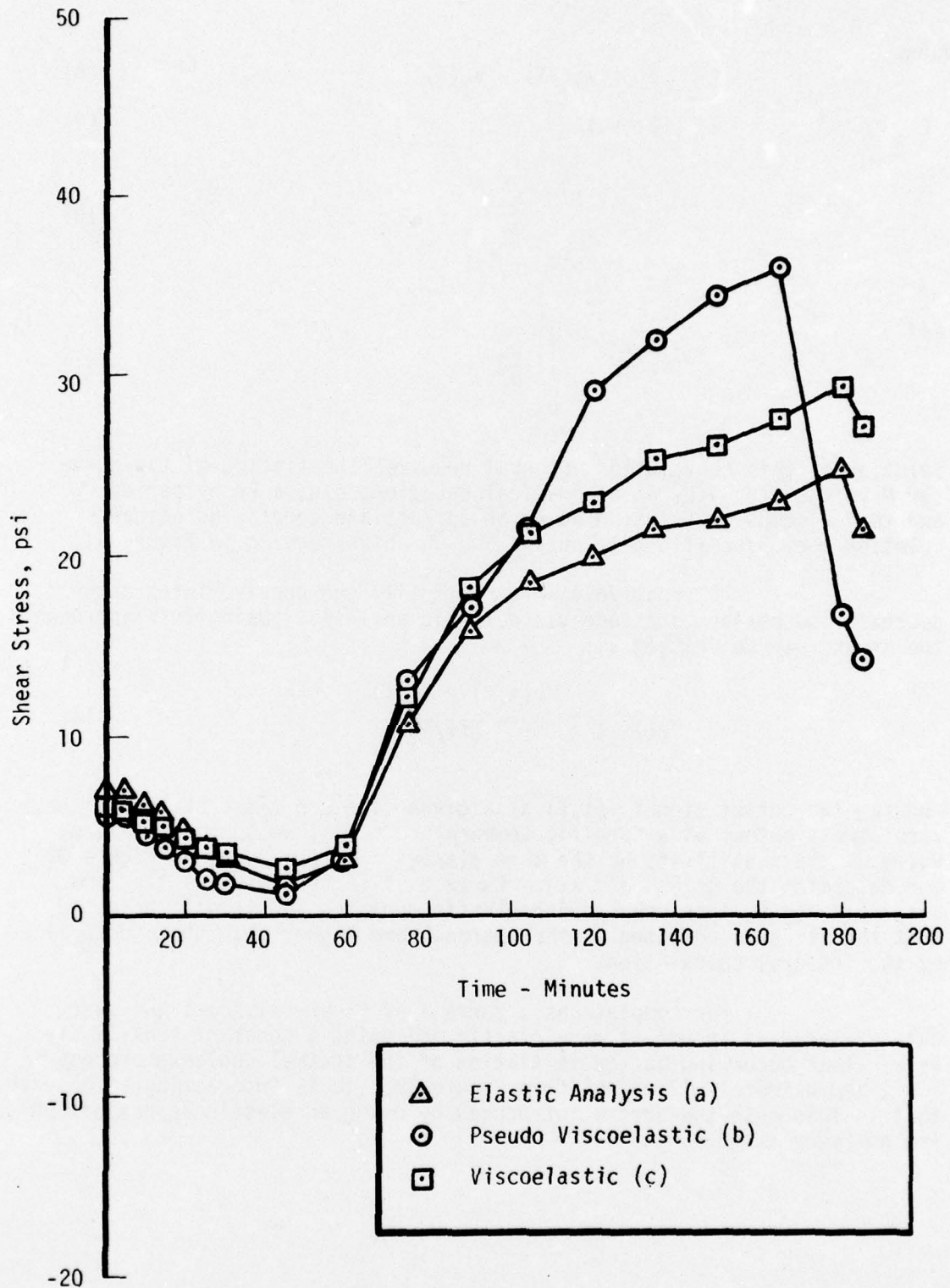

FIGURE 41. COMPARISON OF SHEAR GAGE THERMAL COOLDOWN DATA ANALYZED BY THREE APPROACHES

SECTION 14

PHASE VI - TEST ASSESSMENT

14.1 REVIEW OF EXPERIMENTAL DATA

Upon completion of the experimental testing of the instrumented motor, the data measured by the various gages during the course of the tests should be closely examined.

The plots of analytically predicted data versus the measured data will indicate the real value of the gages during the various types of test. Agreement of the majority of gage data with the analytical predictions would be the most satisfactory type of result, but it is rarely obtained. When significant differences between analysis and experiment are found the causes of the discrepancy should be sought. If the experimental gage data show good self consistency, i.e., redundant gages indicate similar values and the axial and circumferential stress and strain plots are rational, then the differences between the gage data and the analytical predictions will almost certainly be due to the material properties assumed in the analyses. Usually the gage data will indicate higher stress values at the case-grain interface than are predicted. Strain values at the bore, however, are usually in fairly good agreement with the analysis. When data of this type are obtained the problem resolves itself into determining what is the 'correct' value of Young's Modulus and the bulk modulus required in the analysis to obtain agreement with the measurements. Having calculated these 'correct' material properties the next problem is to ascertain why they were not measured in the laboratory tests.

The above discussion relates to a successful instrumented motor test in which consistent measured gage data with small inherent errors was obtained. In other cases, particularly long term tests where only small changes in stress and strain are predicted as the propellant ages, the defects in the embedded gages may become more apparent. Typically gages will operate rationally for a period of time and then become erratic or completely stop providing meaningful data. Alternatively the gages may exhibit apparently reasonable trends but are subject to erratic jumps in reading for no apparent reason. In all these cases, it must be assumed that the measured data are invalid and that the gage is defective for one reason or another. Many gages in instrumented motor programs have exhibited erratic or poor behavior of this type and their data has been disregarded. However, once having eliminated the data from clearly defective gages, the remaining data must be re-examined for consistent trends and magnitudes.

Not all instrumented motor programs are successful and not all measured gage data are valid. However, there are now a sufficient number of reasonably successful instrumented motor programs to suggest that the technique of using embedded gages is worthwhile for certain types of loading conditions. This range of conditions will expand as better gages are produced and as better techniques for their use are developed.

14.2 TOTAL SYSTEM REVIEW

The success of the program depends on many things other than simply the performance of the embedded sensors. In fact, unless the support apparatus and the DAS perform in a reliable fashion then the chances of a successful program are remote. Therefore, in the final evaluation of the instrumented motor program the behavior of all components of the system should be reviewed. Weak links in the system, i.e., components which have consistently proved troublesome during the course of the tests should be identified so that they may be eliminated from future tests.

Considering the total cost of producing, instrumenting and testing the special motor and the type of data obtained, the project engineer/program manager must then evaluate the effectiveness of the approach and answer the question as to whether or not the program was a technical and economic success.

14.3 SIGNIFICANCE OF TEST DATA

Any statement of the validity of the test results must be made in terms of the magnitudes of the stress levels being measured and the estimated error in making these measurements. Clearly, the larger stress levels are more significant with respect to any given measurement error, so test conditions which give large grain stresses are preferred.

The simplest approach to questions of measurement significance is to use the Student t-test. The recommended form of this test evaluates the significance of the difference between average measured stresses and the analytically predicted values. To keep from being restrictive, the standard deviation for the distribution (assumed normal) of the "population" comprising a hypothetical large number of test measurements is assumed to be unknown; the statistics use the "sample" standard deviation as an estimate of the population standard deviation.

The calculation of t_0 from the test data and analytical predictions requires the following relation

$$t_0 = \frac{|\sigma_A - \bar{\sigma}|}{\hat{S}/\sqrt{n}} \quad (13)$$

where: σ_A is the analytically predicted stress
 $\bar{\sigma}$ is the average of the measured stress
 \hat{S} is the standard deviation of the sample of test measurements
 n is the number of replicate test measurements (sample size)

The measured mean stress, $\bar{\sigma}$, is significantly different from σ_A when t_0 is greater than the table value of t at the selected confidence level. We will use this fact together with the following definition

$$\Delta \equiv |\sigma_A - \bar{\sigma}| \quad (14)$$

Substituting Equation (14) in (13) gives

$$t < \frac{\Delta}{\hat{S}/\sqrt{n}} \quad (15)$$

or, upon rearranging

$$\frac{\Delta}{\hat{S}} > t/\sqrt{n} \quad (16)$$

Equation (16) provides a simple ratio of the significant stress difference to the testing error in terms of the number of replicate test measurements. A plot of Δ/\hat{S} versus n is given in Figure 42 for a confidence level of 95%. The curve decreases rapidly as the number of replicates increase from 2 to 4 and Δ/\hat{S} falls to a value of 1.05 at six replicates. Thus, with six replicate measurements Δ is significant if it exceeds $1.05 \hat{S}$. This appears to be a good target criterion for both the number of replicates and for the stress difference, Δ .

The replicate measurements could come from repeat tests on the motor or from a number of gages located in the same axial plane in the motor. Considering the difficulties in reproducing large motor tests it is recommended that the testing be conducted with as many gages as financially acceptable.

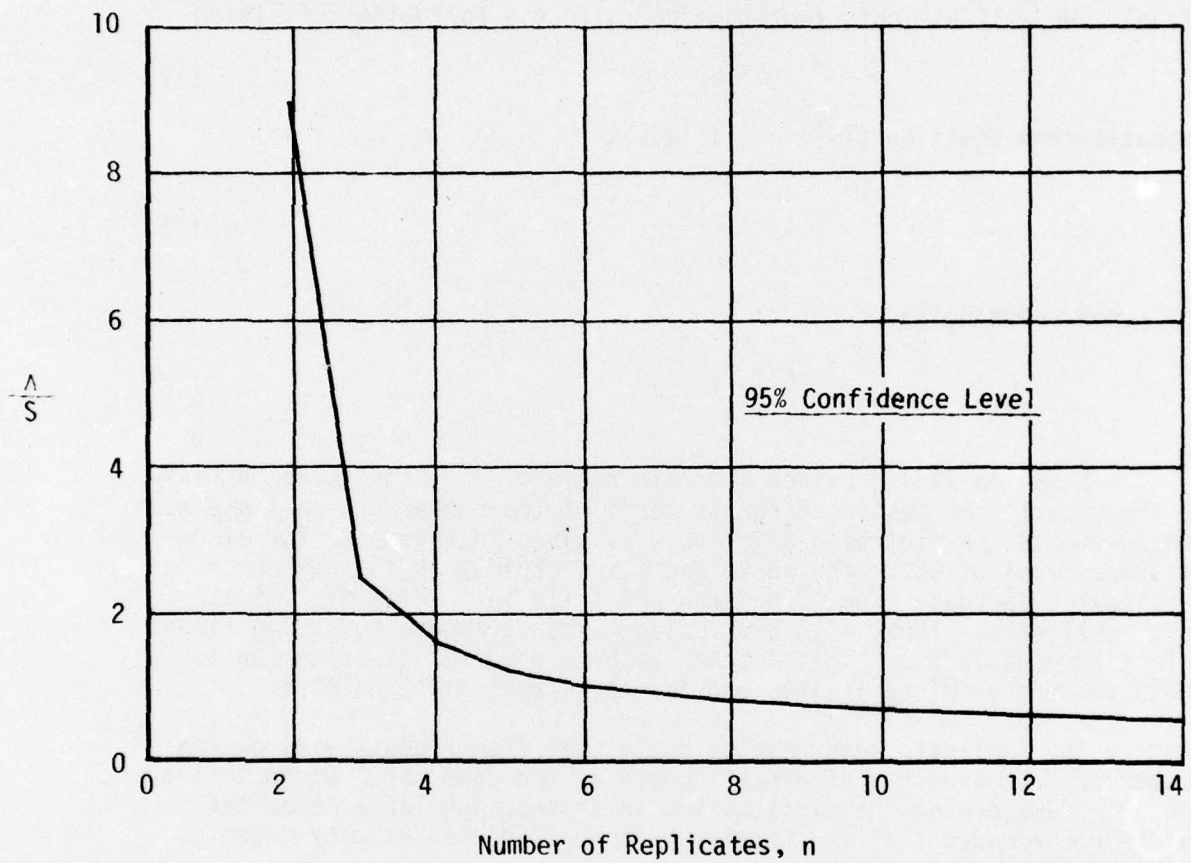

FIGURE 42. STRESS DIFFERENCE-TO-TESTING
ERROR RATIO VERSUS NUMBER OF REPLICATES

REFERENCES

1. Francis, E. C. and Carlton, C. H., "Some Aspects of Composite Propellant Nonlinear Behavior in Structural Applications*", ICRPG/AIAA 3rd Solid Propulsion Conference, AIAA Paper No. 68-519 (June 1968).
2. K. W. Bills, Jr., and R. D. Steele, "Effects of Chemical Change and Time-Dependent Response and Failure Properties on Grain Storage Life", Bulletin of the 7th Annual Meeting of the Working Group on Mechanical Behavior, ICRPG, p. 351 (November 1968).
3. K. W. Bills, Jr. and G. J. Svob, "Establishing Mechanical Properties Criteria", Bulletin of the 4th Meeting of the ICRPG Working Group on Mechanical Behavior, CPIA Publication No. 94U, Vol. I, p. 269 (October 1965).
4. Leeming, H., et al, "Solid Propellant Structural Test Vehicle, Cumulative Damage and Systems Analysis", Final Report No. AFRPL-TR-68-130 (October 1968).
5. "Final Report Solid Propellant Structural Test Vehicle Program", by H. Leeming, et al AFRPL-TR-72-29, Lockheed Propulsion Company (April 1972).
6. (Unpublished) R&D Contract Status Report, AFRPL Contract F04611-74-C-0009, "Air Launch Instrumented Vehicles Evaluation Program", Rocketdyne Division, Rockwell International Corporation.
7. Leeming, H., Briggs, W., "Development of a Three Dimensional Stress Gage for Propellant Grains", Final Report, AFRPL-TR-74-48, H. Leeming and Associates (February 1976).
8. Burton, J. D., "Project DAME - Flight and Simulation Testing of a Modified Bomb Dummy Unit", AFRPL-TR-76-60, Rocketdyne Division, Rockwell International Corporation (October 1976).
9. (Unpublished Work) Polaris A1, A2 and A3, Full Scale Motors, Aging and Surveillance Program, Aerojet Test Plan (July 1, 1962).
10. Pritts, O. R., "Aeroheat Structural Test Vehicles: Design, Instrumentation, Manufacture, and Calibration", AFRPL-TR-76-42, Thiokol Huntsville Division (June 1976).

REFERENCES (CONT.)

11. Rice, J. H., Jr., "In-Situ Sensor and Telemetry System for Solid Propellant Rocket Motors", JANNAF Operation Serviceability and Structures and Mechanical Behavior Working Groups Combined Annual Meeting, CPIA Publication 264 (May 1975).
12. Leeming, H., et al, "Solid Propellant Structural Test Vehicle and Systems Analysis", Final Report No. AFRPL-TR-70-10 (March 1970).
13. (Unpublished) R&D Contract Status Report, AFRPL Contract F04611-73-C-0026, "Space Motor Surveillance Program", Thiokol Elkton Division (July 15, 1974).
14. Bills, K. W. and Jang, S. W., "Flexible Case-Grain Interaction in Ballistic Weapon Systems", Final Report No. AFRPL-TR-76-57, Vol. 1 - Technical Accomplishments (October 1976).
15. Unpublished data, (Contract F04611-72-C-0048), "Development of HTPB Propellant for Ballistic Missiles", Thiokol Wasatch.
16. Unpublished Work (Detailed Monitoring Plan) on AFRPL Contract F04611-75-C-0007, "HTPB Ballistic Motor Service Life", Thiokol Wasatch Division (November 1974).
17. "Floating Measurements and Guarding", Hewlett Packard Company, Application Note No. 123.
18. Danziger, L., Klein, A. H., and Mosher, P. R., "Monitoring Internal Stresses in Solid Propellant Motors", Tech. Memo Report TMR-232, Naval Propellant Plant, Indian Head, Md. (October 20, 1965).
19. (Unpublished) R&D Contract Status Reports on AFRPL Contract F04611-75-C-0069, "Project DAME Tactical Instrumented Motor Simulation Testing", Rocketdyne Division, Rockwell International Corporation.
20. Mastrolia, E. J., and Michigian, H. J., "Demonstration of Ambient Temperature Cure", Final Report No. AFRPL-TR-73-68 (August 1973).
21. Jones, W. G., et al, "Surface and In-Situ Physical Properties and Instrumentation for Ballistic Missile Motor Grains", 1971, JANNAF Combined Propulsion Meeting (November 1971).
22. ASPC Report No. POL 71416, "Polaris A3 First Stage Chamber Preparation and Hydrotest for Structural Evaluation of Through-the-Forward-Head Instrumentation", Final Report (March 1971).

REFERENCES (CONT.)

23. Schwartz, D. S., "Development of Unidirectional d.c. Axial and Radial Flexible Propellant Shear Strain Transducers", Gulton Industries, Inc., Final Report to ABL P. O. No. ABL-73197 (November 1963).
24. Dicken, G. M, and Thatcher, J. H., "Shear Strain Measurement in Solid Propellant Rocket Motors", AIAA Paper No. 64-506, 1st AIAA Annual Meeting, Washington, D. C. (June/July, 1964).
25. Burton, J. D., and Noel, J. S., "Final Report, Stress State Transducer Development Program", Report No. AFRPL-TR-102 (October 1970).
26. Jang, S. W., Bills, K. W., and Leeming, H., "Flexible Case-Grain Interaction in Ballistic Weapons Systems", Special Report No. AFRPL-TR-75-7 (October 1975).
27. Daniels, A. S., "An Event Gage for the Detection of Propellant Crack Initiation", Bulletin of Combined Annual Meeting of JANNAF Operational Serviceability and Structures and Mechanical Behavior Working Groups, CPIA Publication 253 (July 1974).
28. "Minuteman III Third-Stage Motor Burnthrough Investigation", ASPC Report No. 0162-III-SE-07, Appendix E (21 December 1973).
29. Pritts, O. R., "Simulated Air Launch Environment", AFRPL-TR-74-47, Vol. I, Thiokol Huntsville Division (October 1974).
30. Leeming, H., "Techniques of Measuring Stress, Strain and Temperature in Solid Propellant Motors", AFRPL-TR-71-131 (November 1971).
31. Leeming, H., "Solid Propellant Structural Test Vehicle and Systems Analysis", Special Report, Lockheed Propulsion Company, Report No. 966-9-1 (June 1969).