

AD-A035 907

DAVID W TAYLOR NAVAL SHIP RESEARCH AND DEVELOPMENT CE--ETC F/G 1/3
AIR-CUSHION-SUPPORTED VEHICLE FAN DYNAMIC RESPONSE: A REVIEW OF--ETC(U)
JUN 76 D D MORAN

UNCLASSIFIED

SPD-695-01

NL

1 OF 2
AD-A
035 907



U.S. DEPARTMENT OF COMMERCE
National Technical Information Service

AD-A035 907

AIR-CUSHION-SUPPORTED VEHICLE FAN DYNAMIC RESPONSE
A REVIEW OF THE LITERATURE

DAVID W. TAYLOR NAVAL SHIP RESEARCH AND
DEVELOPMENT CENTER, BETHESDA, MARYLAND

JUNE 1976

ADA 035907 SPD-695-01

AIR-CUSHION-SUPPORTED VEHICLE FAN DYNAMIC RESPONSE:
A REVIEW OF THE LITERATURE

DAVID W. TAYLOR NAVAL SHIP RESEARCH AND DEVELOPMENT CENTER



Bethesda, Md. 20084

AIR-CUSHION-SUPPORTED VEHICLE FAN DYNAMIC RESPONSE:
A REVIEW OF THE LITERATURE

by
David D. Moran

DDC
RECEIVED
FEB 23 1977
RECEIVED
A

APPROVED FOR PUBLIC RELEASE: DISTRIBUTION UNLIMITED

REPRODUCED BY
NATIONAL TECHNICAL
INFORMATION SERVICE
U. S. DEPARTMENT OF COMMERCE
SPRINGFIELD, VA. 22161

JUNE 1976

SPD-695-01

ENCLOSURE (1)

MAJOR DTNSRDC ORGANIZATIONAL COMPONENTS

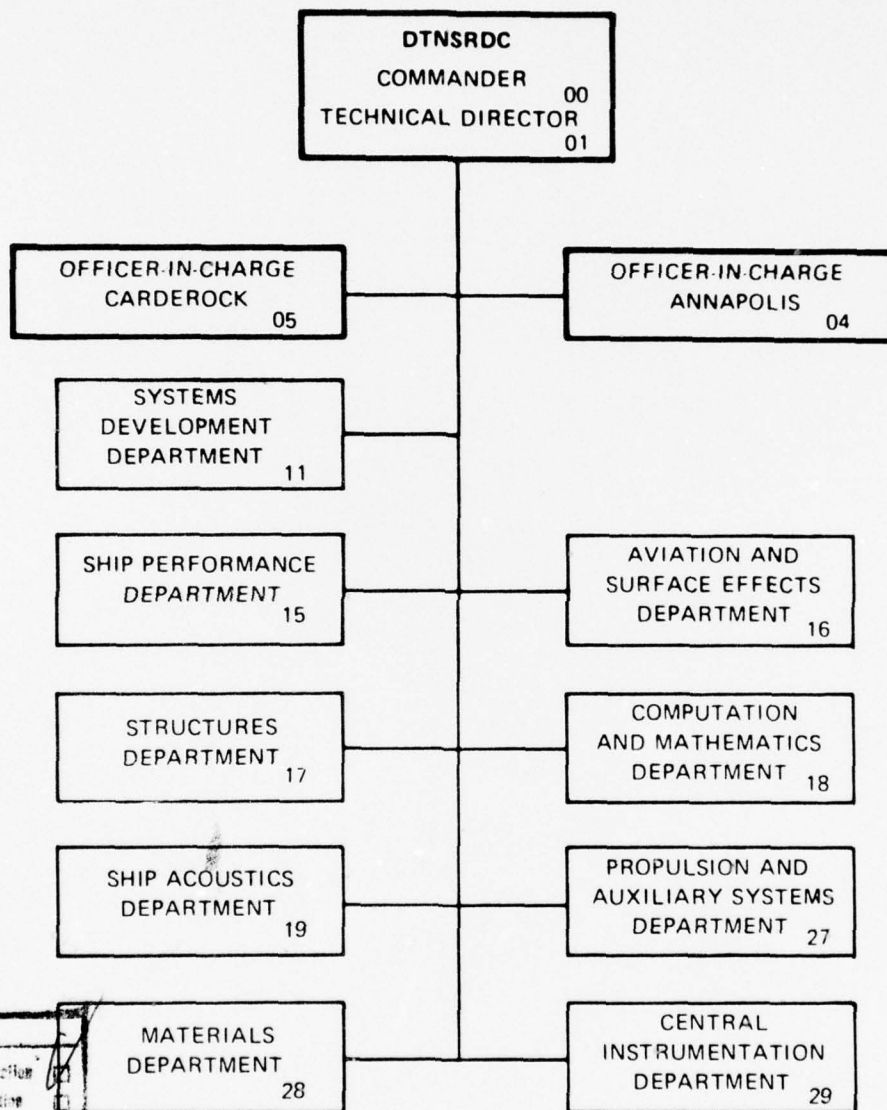

ACCESSION for	
RTIS	Water Section <input checked="" type="checkbox"/>
DDC	Buff Section <input type="checkbox"/>
UNANNOUNCED JUSTIFICATION.....	
BY.....	
DISSEMINATION AUTHORITY CODES	
DET.	AVAIL. FOR SPECIAL
A	

1 (a)

UNCLASSIFIED

SECURITY CLASSIFICATION OF THIS PAGE (When Data Entered)

REPORT DOCUMENTATION PAGE		READ INSTRUCTIONS BEFORE COMPLETING FORM
1. REPORT NUMBER SPD-695-01	2. GOVT ACCESSION NO.	3. RECIPIENT'S CATALOG NUMBER
4. TITLE (and Subtitle) Air-Cushion-Supported Vehicle Fan Dynamic Response: A Review of the Literature	5. TYPE OF REPORT & PERIOD COVERED	
	6. PERFORMING ORG. REPORT NUMBER	
7. AUTHOR(s) David D. Moran	8. CONTRACT OR GRANT NUMBER(s)	
9. PERFORMING ORGANIZATION NAME AND ADDRESS David W. Taylor Naval Ship Research and Development Center, Ship Performance Department Bethesda, Maryland 20084	10. PROGRAM ELEMENT, PROJECT, TASK AREA & WORK UNIT NUMBERS S 1417 14174 1-1180-004	
11. CONTROLLING OFFICE NAME AND ADDRESS Amphibious Assault Landing Craft Office Systems Development Department David W. Taylor Naval Ship R&D Center	12. REPORT DATE June 1976	
	13. NUMBER OF PAGES 98	
14. MONITORING AGENCY NAME & ADDRESS (if different from Controlling Office)	15. SECURITY CLASS. (of this report) UNCLASSIFIED	
	15a. DECLASSIFICATION/DOWNGRADING SCHEDULE	
16. DISTRIBUTION STATEMENT (of this Report) APPROVED FOR PUBLIC RELEASE: DISTRIBUTION UNLIMITED		
17. DISTRIBUTION STATEMENT (of the abstract entered in Block 20, if different from Report)		
18. SUPPLEMENTARY NOTES		
19. KEY WORDS (Continue on reverse side if necessary and identify by block number) ACV Lift Systems, Fan Dynamics, Pump Hysteresis		
20. ABSTRACT (Continue on reverse side if necessary and identify by block number) The mechanisms which constitute the dynamic response of air-cushion- supported vehicle lift fans subjected to unsteady excitation are summarized and examined through a review of research as reported in literature published between 1932 and 1976.		

DD FORM 1473 1 JAN 73

EDITION OF 1 NOV 65 IS OBSOLETE
S/N 0102-014-6601

UNCLASSIFIED

SECURITY CLASSIFICATION OF THIS PAGE (When Data Entered)

TABLE OF CONTENTS

	Page
ABSTRACT	1
ADMINISTRATIVE INFORMATION	1
INTRODUCTION	2
LITERATURE REVIEW.	8
SUMMARY	62
REFERENCES	64
APPENDIX	77

LIST OF FIGURES

	Page
Figure 1 - Dynamic Characteristics of an SES Lift Fan	71
Figure 2 - Dynamic Characteristic of an ACV Lift Fan.	72
Figure 3 - Pressure Coefficient as a Function of Flow Coefficient for Progressive Stall and Root- to-Tip Stall	73
Figure 4 - Maximum Lift and Moment Coefficients as a Function of Velocity Parameter	74
Figure 5 - Airfoil Lift Coefficient and Pitch Moment Variations Following a Sudden Onset of Flow.	75
Figure 6 - Temporal and Spatial Unsteady Pressure Distributions	75
Figure A1- Bidard-Jenny Calculations	88
Figure A2- Unsteady Flow Solution for Exhaust Orifice A2 and Nozzle B	89
Figure A3- The Substitute Model	90

NOTATION

\bar{b}	Slope of blower characteristic curve
C	Chord length
C_f	Frequency coefficient
dp/dq	Slope of fan characteristic or fan map
f	Frequency of forced fluctuation
G	Characteristic function, Equation (3)
\bar{g}	Slope of valve characteristic curve
m'	Suction pipe length
N	Sum of suction pipe and delivery pipe lengths
N_R	Number of blades
n	Rotational speed of impeller
n'	Delivery pipe length
p	Fan pressure
q	Fan discharge
t	Time
u	Velocity of air in pipeline
V	Free stream velocity
α	Damping coefficient determined by compressor and system characteristics
$\dot{\alpha}(s)$	Rate of change of angle of attack of airfoil evaluated at instant that dynamic stall occurs
ΔW	Variation of weight flow from initial or stall value
ΔW_s	Weight-flow increment between equilibrium points on upper and lower branches of compressor characteristic
Λ	Constant determined by compressor and system characteristics

NOTATION (Continued)

λ_R	Stagger angle of cascade
ϕ	Flow coefficient
Ω	Undamped natural frequency of compressor and receiver
ω	System constant that determines oscillation frequency

ABSTRACT

The mechanisms which constitute the dynamic response of air-cushion-supported vehicle lift fans subjected to unsteady excitation are summarized and examined through a review of research as reported in literature published between 1932 and 1976.

ADMINISTRATIVE INFORMATION

This study was sponsored by the Naval Sea Systems Command under Task Area S 1417, Task 14174 and administered by the Amphibious Assault Landing Craft Program Office, Systems Development Department, David W. Taylor Naval Ship Research and Development Center, under Work Unit Number 1-1180-004.

INTRODUCTION

The air-cushion-supported vehicle (ACV) or surface-effect ship (SES) is a new and unique concept in several respects. The system components, which constitute the ACV/SES design, function together to produce a dynamic response to sea-wave excitation requiring study and investigation different from other types of ships.

Three unique characteristics of air-cushion-supported craft precipitated their design and construction. The first is the very low or, indeed, zero, hull resistance which these craft exhibit. Sidewall type surface effect vehicles can be designed to optimize surface-piercing hull drag. The wave-making drag of the cushion pressure distribution is amenable to a degree of control and optimization. In general, the ACV/SES is capable of a greater design speed than a displacement ship.

The second characteristic of some surface-effect vehicles is an amphibious capability. The benefits of amphibious high-speed vehicles are obvious for both military and commercial uses. The British have indeed made a commercial success (Hoverloyd) of full-skirted ACV ferry operations across the English Channel. Although the amphibious nature of the craft is not required in this specific case, it does make the operations of loading and unloading easier. The United States Navy is presently constructing two prototype air-cushion vehicles which will serve as evaluation craft for ACV implementation in amphibious assault warfare.

In this application, the amphibious capabilities will be exploited fully since the craft will operate over water, overland, in surf zones and upon the decks of support ships.

The third characteristic of air-cushion ships which has been noted historically as a major reason to seriously consider ACV implementation is their seakeeping response. The ACV from its inception was expected to be a good seakeeper. An early expectation was that the vehicle would ride over the waves on its air-cushion shock absorber as if the sea were nearly flat. This expectation could not of course hold up under either dynamic analysis or actual ACV testing. The surface-effect vehicle is a dynamic system and like all dynamic systems will exhibit response which is a function of the frequency and amplitude of the excitation. The excitation is, in this case, the wave field or overland terrain over which the vehicle travels. Air-cushion-supported vehicles do have a great promise as good seakeepers, but the details of their behavior in a seaway must be known in order to make use of their benefits and minimize their disadvantages.

The dynamic response of the ACV may be examined in a number of ways. A total-system or black-box approach is the fastest, easiest, and most convenient. This technique does not, however, allow parametric analysis or performance improvement identification. Empirical analysis of the ACV produces the most reliable dynamic performance criteria on model scale, but the technique suffers from unresolved questions of scaling of dynamic performance. An alternative to the total-system approach is

interactive systems component analysis. This method allows a great flexibility in design and evaluation of ACV motions but is limited by cumulative errors produced by inaccurate mathematical models of physical systems. When the separate models are combined in a series-constructed system, the individual component errors are multiplicative. Nonetheless, this is a reasonable and attractive approach. The following presentation relates to one specific element of the system, the lift system.

The ACV lift system consists of the compressor, the plenum, the bow and stern seals, and the airflow control devices. The principal requirement of the lift system in calm water is to provide the required pressure to support the ship. The principal requirements in a seaway are to supply sufficient airflow variations at minimum pressure fluctuations, to accommodate changes in cushion volume due to the passage of waves, and to control the motions of the ship. All types of lift system fans are available from centrifugal flow to axial flow machines with or without variable geometry. Airflow can be varied and motions modified by varying the fan flow (through changes in fan speed or design), or by varying the flow through a cushion vent when using a fixed geometry fan. The dynamic response of an air cushion vehicle is determined by the total lift system response including fan characteristics, seal dynamics, and other lift system characteristics.

The lift fan is the most important feature of the system. Properly designed, the lift fan must have a proven capability of functioning under conditions of varying load. This dynamic capability is one feature of

the system which has been somewhat neglected until recently. The dynamic performance of an ACV lift fan can differ dramatically from its static performance. Examples (Durkin (1974),*Thomas (1972)) of this behavior are shown in Figures 1 and 2 which give the pressure-discharge relationships for both static and dynamic performance of axial flow fans. The performance indicated in Figure 1 was obtained from a dynamic fan-testing device which is a dynamic system itself and, therefore, the indicated behavior cannot be accepted as purely the result of the fan characteristics. The figure does show dynamic behavior which is indicative of that observed in ACV lift systems. The major point of this discussion is that the lift fan is a dynamic component and must be analysed as such in the complete system. The example shown in Figure 2 is obtained from the vertical oscillation of the ground plane under an ACV model and therefore also represents a total system response.

Another example of dramatic dynamic effects in an ACV lift system was the appearance of backflow in the lift fans of a high length-to-beam ratio surface-effect ship model (XR-5) tested in regular and irregular waves by Moran (1975) and Ricci and Moran (1976). In an experiment directed toward an examination of this specific problem it was observed that regular wave excitation produced conditions of periodic reverse flow through the lift fans. The reverse flow persisted for approximately 10 percent of the fan flow oscillation period.

The time-dependent character of the fan discharge was also measured by Moran (1976a) for a fully skirted ACV (AALC-JEFF(B)) in a study of the

*References begin on page 64 and are listed in alphabetical order by the first author's surname.

overland dynamic response to regular wave excitation. Although these data did not indicate reverse flow conditions the magnitude of discharge variations over an excitation period was significant. A similar experimental study was performed by Moran (1976b) for a surface-effect ship model in a wave field. These results also show that the dynamic performance of the lift fan for an air-cushion-supported ship cannot be neglected. It is therefore vital to the continued technological development of ACV dynamics to construct a valid mathematical model of the physical mechanism involved in the unsteady operation of lift fans.

A dynamic model for the lift system must include several mechanisms for system response hysteresis. In the fan itself, blade stall due to time-dependent changes in the angle of attack can be experienced. The most dramatic example of blade stall is associated with full flow reversal in the fan. Stall can occur over the whole impeller disk or propagate around the disk in an unsteady manner not directly related to the excitation or rotational frequencies. Flow surge is another problem that can affect the fan system, including the fan volute. This phenomenon can result from volume resonance or conditions of volume variation in the plenum or from the hydraulic surge generated by compressible flow in the lift system duct work. A third hysteresis-generating mechanism is a Coanda phenomenon resulting in nonlinear behavior of the flow under an ACV skirt. This mechanism is most evident for rigid seal (sidewall) or air-seal craft (peripheral jet ground-effect machines). Two further mechanisms that give rise to nonlinear behavior are flow separation in the fan and duct work and

deformations of the skirt and bags.

This report is concerned only with the dynamic response of the lift system of an air-cushion-supported vehicle, with concentration on the problems of stall and surge in the lift fan. The remaining mechanisms for hysteresis are touched on as they appear in the literature review. The review presented here is arranged in chronological order according to publication date. Reference to each reviewed work is made by year of publication. A list of references and other bibliographical material, arranged in alphabetical order by the first author's surname, can be found beginning on page 64. Although a diversity of themes runs through the review, the chronological arrangement was chosen to aid the reader in an appreciation of the systematic development of fan-dynamics technology. Certain themes noted in the review are not directly applicable to the ACV/SES dynamics problem (e.g., diesel supercharger surging at very high frequencies, and helicopter rotor lift dynamics) but are included in the present discussion for their importance in the developing technology base for general fluid flow devices.

LITERATURE REVIEW

In an early study of the surging phenomena in superchargers for aircraft engines, Brooke (1932) performed a series of experiments to investigate the effect of impressed flow periodicity on the magnitude of surge. For this purpose the author fitted a rotary interrupter valve to the supercharger delivery. This enabled the outlet area to be varied periodically by a definite amplitude over a range of high frequencies. The author concluded that there is no evidence of any important effect upon surging as a result of the fluctuation of flow imposed by a high frequency variation of area of the compressor outlet. Unfortunately for present applications the author was interested only in the very high frequency excitation characteristic of that corresponding to engine valve frequencies (e.g., frequencies greater than 1000 Hz). The interrupter valve was designed to produce variations of only plus or minus 11 percent from the mean flow area. Although this is also pertinent to aircraft engine design it is not applicable to the present problem.

Flow instabilities are observed in proximity to the surge point using the equipment and techniques described above, but at flows immediately beyond the region affected by the hysteresis in recovery of delivery pressure there is no observed tendency for surging to be developed by the fluctuation of flow imposed by operating the interrupter. The natural surge point is determined in the author's experiments by progressively reducing the mass flow of air by restricting (statically) the outlet from

the supercharger. The pressure at the delivery point increases as the mass flow diminishes until at the surge point the discharge pressure decreases abruptly. The magnitude and frequency of the surging phenomenon are greatly influenced by the volume of air enclosed in the pipe system between the compressor and the throttle valve. Increasing the capacity or volume of the system causes an increase in the amplitude of pressure variation and a decrease in the resonant frequency.

Bidard (1946 and 1950) produces a stability condition for hysteresis in the pressure-discharge curve for a harmonically-excited compressor. The author indicates convergent and divergent spiral regimes as a function of the slope of the characteristic curves for the compressor and the receiving tank (or valve).

Fujii (1948) has contributed a relaxation oscillation analysis for surging in centrifugal water pump systems containing a free surface. The author's analysis is not applicable to present considerations because of the inertial and damping characteristics of the gravitationally affected components of the system (i.e. the free surface). The solution is enlightening, however, in its illustration of the convergent and divergent characterizations of the relaxation solution.

In an early paper concerning the surging of axial compressors, Pearson and Bowmer (1949) have constructed analog resistance/inductance/capacitance (RLC) circuits to describe the surging behavior of multi-stage axial flow compressors. Their goal is not to explain the mechanism of surging but simply to describe the compressor output response.

The differential equation describing the analogous RLC circuit is developed by the authors and is shown to have three possible solutions described as

- (1) Critically damped, no oscillators.
- (2) Exponentially damped oscillators.
- (3) A singular solution.

In each case an exponential decay factor includes the system resistance or slope of the characteristic curve (dp/dq) which is negative for stalled conditions leading to critical divergence (solution 1) or rapidly growing oscillations (solution 2) as a system response. The authors also discuss a continuous flow model (quasi-steady in formulation) which predicts surge at points on the compressor characteristic curve at which the ratio of discharge to pressure is a constant at a fixed fluid temperature. This solution indicates that surging will occur far below the peak on the pressure-discharge characteristic curve, a result which is contrary to the experimental evidence available to the authors. The diverging flow solution predicts surge points very near the peak of the characteristic curve. The oscillatory flow solution results in surge initiation at somewhat higher discharges. The authors conclude from this discussion that there is some justification therefore to assume that the surge line on the compressor characteristic curve coincides with the peak pressure locus. They further conclude that the oscillatory instability (solution 2) is unlikely to occur in practice due to the nonlinear character of the system resistance (dp/dq) which would "in effect place a heavy damping on the oscillations" once they were initiated. Experimental observations by the authors show no

evidence of the high frequency oscillations associated with this solution, but they have observed sudden pressure changes which only gradually returned to equilibrium. This behavior is not predicted by any of the authors' models.

Despite the limitations of the analyses presented in this paper, the authors must certainly be commended for their creative approach to a problem which was rather new to the engineering profession. That commendation must also be extended to their prophetic call for an evaluation of the dynamic performance of compressors in addition to the static performance historically studied.

Jenny (1950) has presented a complete discussion of the characteristic solution for one-dimensional compressible transient flow in his milestone paper published by the Brown Boveri Review. Prior to the development of more exact theories the author's method formed the basis of all analysis of the transient characteristic of flow machinery.

A paper by Kusama, Tsuji, and Oshida (1950) describes a natural instability in a pump-pipe system. The authors ascribe the instability to the positive slope portion of the steady state pressure-rise versus flow-coefficient curve for the pump examined. They have noted that the observed instability can be controlled by closing an exit valve for their system and then opening it according to some prescribed procedure. Unfortunately the significance of this prescribed procedure is unknown. The authors have demonstrated the existence of closed counterclockwise

hysteresis loops in the pump performance characteristics for unsteady flow. They have measured the natural period of the resultant oscillations in pressure and have shown a linear increase of oscillation period with the rotational speed. The authors have also presented experimental evidence demonstrating an approximately linear increase of oscillation period with pipe length (i.e., the volume of the receiving element of the system) for fixed pump speeds. A hydraulic model of the system has produced a stability parameter with which the authors have shown experimental correlation.

The flow behavior in any rotational machinery can be examined in detail only through a careful analysis of the mechanics of flow of viscous compressible fluid in a rotational flow domain. Nemenyi and Prim (1951) have summarized the classes of nonviscous incompressible fluid flow formulated by Beltrami and Masotti and known by their names (i.e., Beltrami Flow and Masotti Flow) and have extended their techniques to an analysis of the rotational flow patterns of a perfect gas.

An investigation of stall and surge phenomena in axial-flow compressors has been performed by Huppert and Benser (1953). They have shown that single-stage stall is an unsteady phenomenon in which some sectors of the annulus operate at a much lower mass-flow rate than the remainder of the sectors, rotating about the compressor axis. Uniform flow exists at a point far upstream of the stall zone, and stream lines immediately upstream of the blades have to diverge to maintain continuity around the stall zone. As a result of this spillage of flow, the stall zone under-

goes a tangential propagation relative to the rotor, at a rate generally opposite in direction to but lower in magnitude than the rotor-blade speed.

The authors note that two categories of stall patterns have been observed. The first, a progressive stall, originates at the ends of the blade and consists of multiple stall zones extending over only a portion of the blade span. The rotor-tip angle of attack varies with flow rate much more rapidly than the root angle of attack does, and the rotor-blade tip stalls first while the rest of the blade remains unstalled. The second type of stall is a root-to-tip stall that usually consists of only one zone extending over the entire blade span. The stall angle of attack is approached nearly simultaneously over the entire blade span, and the resulting variations in flow rate are relatively uniform in intensity from root to tip. There is a sharp drop in pressure ratio at instigation of stall, in contrast to the gradual decrease in pressure ratio seen for progressive stall. The stalled zone must be completely eliminated in order to un stall the root-to-tip stage stall. Typical performance curves showing pressure coefficient as a function of flow coefficient are presented for both categories of stall in Figure 3. It can be seen that for progressive stall the number of stall zones increases with decreasing flow on the left side of the characteristic curve.

Data from multi-stage compressors are reported to show a progressive-type stall at low speeds. The flow fluctuation amplitude increases in magnitude through the first stages and then decreases to a small value in the

downstream stages. The authors present the results of a stage-stacking analysis which shows that rotating stall exists over a large portion of the compressor map at low speeds but will be instigated almost simultaneously with compressor surge at high speeds.

Multi-stage compressors with large inlet and discharge tanks frequently experience violent surge, normally with a frequency of 0.5 to 2 cycles per second. For the classical type of surge in which the compressor characteristic of pressure rise is assumed to be a continuous function of weight flow for a constant compressor speed, a solution to the differential equation of flow has been obtained in previous investigations by linearizing the compressor and discharge throttle characteristics and simplifying the external system. The resulting solution is of the form

$$\Delta W = K_1 e^{-\alpha t} \sin (\omega t + K_2) \quad (1)$$

where ΔW is the variation of weight flow from equilibrium

K_1 is a constant

α is the damping coefficient

t is time

ω is a function of the oscillation frequency

K_2 is a constant expressing the phase relation

The stability of the system is defined by α , with a positive value indicating a stable system.

The authors consider another kind of surge attributed to a limit cycle operation about the compressor stall point. The pressure-ratio, weight-flow characteristics that are discontinuous at stall result in the

hysteresis effect seen in Figure 3. The discontinuity in pressure associated with stall causes a flow-rate fluctuation if normal stability requirements are satisfied. However, stall will be relieved if the compressor flow rate becomes at least as large as the stall recovery value during the transient, and the compressor will seek equilibrium at the original point of stall on the unstalled branch of its characteristic. The solution of the linearized equations for the flow variation is

$$\Delta W = -|\Delta W_S| + \left[1 + e^{-\alpha t} (\Lambda \sin \omega t - \cos \omega t) \right] \quad (2)$$

where ΔW is the variation of weight flow from the initial or stall value

ΔW_S is the weight-flow increment between equilibrium points on the upper and lower branches of the compressor characteristic

α is the damping coefficient determined by compressor and system characteristics

t is time

Λ is a constant determined by compressor and system characteristics

ω is a system constant that determines the oscillation frequency

This type of cyclic operating condition, known as limit-cycle surge, is caused by a step change in pressure ratio due to complete compressor stall and will result in violent oscillations of flow and pressure ratio. The receiver pressure change will lag the flow change during the transient because of inertia and capacitance effects of the system. The authors report that oscillation amplitudes increase with decreasing α/Ω ratios, where Ω is the undamped natural frequency of the compressor and receiver. If the receiver and throttle have a large time constant, the damping coefficient

α will be small and the compressor will probably surge. Limit-cycle surge is more likely to occur at high compressor speeds than at low speeds because of the increased slope of the throttle curve and the narrow range of weight flows for which the two branches overlap. The classical type of surge is also encountered more frequently at high speeds.

Sears (1953) has shown that the asymmetrical flow in an axial flow compressor stage exhibits rotational flow in the wake of the rotor disk. The author has presented a steady flow analysis leading to relationships between the circumferential circulation distribution and the induced velocities in the axial flow disk.

The propagation of stall in axial-flow compressors has also been investigated in Iura and Rannie (1954). The experimental results presented by the authors cover an extensive range yielding relationships between stall frequencies and fan rotational rate, stall patterns, and the extent of stall in an axial-flow compressor.

The authors have first defined the scope of their results by differentiating between the phenomena of surge and propagating stall. Surging is defined as the phenomenon in which the net flow through the entire compressor flow disk fluctuates with time. Propagating stall is defined by the authors as a phenomenon in which the total flow rate through the annulus does not vary with time. Although the mechanisms for these two phenomena are different, the authors have

nonetheless provided an external or observational means of classifying unsteady flow effects. The two phenomena may be coupled with respect to the possibility of stall-exciting surge, or surging which involves an oscillation from one propagating-stall pattern to another.

Iura and Rannie propose the same explanation for the occurrence of propagating stall as offered by other investigators, namely that the propagating stall is explained qualitatively as a successive unstalling and stalling of blades in a cascade. When a particular blade has reached a condition of stall it manifests a high resistance to flow through the cascade and the approaching flow streamlines are distorted such that the preceding foil encounters flow at a decreased angle of attack whereas the following foil is subject to flow at a large angle of attack. Flow separation is therefore inhibited on the preceding foil and encouraged on the following fan blade. The stalled region therefore moves in the direction of the following blades and the frequency of stall rotation in a rotational fan may be expected to be less than the rotational speed of the fan. The authors have found that the stall frequency (or rotational speed) varies between 25 percent and 30 percent of the fan speed for the device tested. The ratio of stall-to-fan frequencies changes only slightly with fan discharge.

The form and frequency of stall are dependent upon the velocity of propagation of the disturbance from one blade to the next. Various authors have proposed analytic models to describe this reaction. As examples, Sears (1953) postulated a phase lag between the fluctuating lift and the mean angle of attack of the foil for a

two-dimensional cascade. In this model the number of active blades was assumed to be infinite. In a similar analytic treatment of a two-dimensional cascade containing a finite number of blades, Marble (1953) proposed a nonlinear relationship between lift and angle of attack in a manner that forced a hysteresis loop response.

As noted by Iura and Rannie, each of the aforementioned models are simplified analytical relations which approximate in different ways the known behavior of single airfoils in stall. The present authors express the opinion that a more realistic model of the unsteady cascade flow is obtained by examining the exit flow angle and the total pressure loss through the cascade. The authors have observed that the exit flow angle can be taken as a constant but the total pressure loss is grossly nonlinear. The loss in total pressure is small and nearly constant over an angle of incidence in the range of 8 to 10 degrees but rises sharply to a high value outside of this range. It is this nonlinear behavior which, the authors propose, fixes the amplitude of the stall oscillation.

Returning to the velocity of disturbance propagation, it has appeared to be intuitive that the velocity must be inversely proportional to the time required to establish a complete separated-flow region on a foil after a sudden increase in the angle of the incident flow. The phase angle between the unsteady lift response and the angle of attack of an oscillating foil is consistent with that explanation. Further, the phase angle has been found to be rather insensitive to excitation frequency. The results of compressor

experiments do not however show as good a correlation in this respect. As an example the authors note that removing every other blade in an impeller does not double the stall propagation speed as the characteristic-time model would suggest. They further note that full-stall propagation speed is insensitive to flow rate, including conditions of flow reversal. This observation would demand that the characteristic time be similarly independent of flow rate including direction of flow. This does not seem to be possible if the characteristic time is related to the boundary layer growth.

Emmons, Pearson, and Grant (1955), responding to the needs of the aircraft industry to minimize the detrimental effects of violent surge in aircraft gas turbines, demonstrated two mechanisms contributing to instabilities in flow machinery. The authors have shown that compressor surge consists of two distinct types of phenomena. First, the whole flow system consisting of intake, compressor and receiving volume may be unstable in the manner of a self-excited Helmholtz resonator. The second mechanism consists of stalling of the flow through blade groups or blade rows in the compressor. This second mechanism, which is usually assumed to be the pulsation excitation for the ultimate Helmholtz resonance, is shown to produce unique effects which may not couple with the resonance phenomena but rather act alone to produce an observable surge.

The authors have noted the variations in published surge descriptions including the fact that reported surge frequencies have sometimes varied with the speed of the compressor and in other reports

have been shown to be independent of compressor speed. Similarly, the volume of connected ducting and reservoirs has in some experiments affected the magnitude of pressure fluctuations in a surging system but in other studies had no effect. Clearly there could well exist several modes of instability and, if so, the variety of surge characteristics reported could be due to the occurrence of various combinations of phenomena in any one machine.

The initial experiments performed by the authors using a centrifugal compressor in a laboratory test stand produced two clearly defined surge regions characterized by low-frequency pulsing occurring throughout the system. These two unstable regions were for low rotational rates separated by a region of stable operation in which no low-frequency pulsing was observed in the system. In the high flow rate unstable region the pressure amplitude deviation was mild and the predominant frequency was 10.5 Hz. The lower flow rate unstable region was characterized by more violent surge, increasing in magnitude near zero system discharge and occurring at a dominant frequency of 9.5 Hz. In each case the surge frequency was independent of speed.

The authors' discussion on stall propagation constitutes a significant contribution to the explanation of surge effects in rotating machinery. This characteristic is certainly significant to an understanding of the problems encountered with air-cushion vehicle lift systems. Whenever the discharge through a compressor is modified the angle of attack of each compressor blade, either for axial flow or centrifugal flow machines, is either increased or decreased. The

Individual blades may therefore approach a stall condition. Emmons, Pearson, and Grant have shown that as the blade rows approach stall, the flow may separate on some blades or groups of blades but remain attached on others. The separated or stalled regions then follow one another around the circumference of the machine at a frequency which falls between zero and the rotational frequency of the compressor. Although this model has been previously described, the authors' explanation of the effect is so logical that it is worth quoting in its entirety.

"A qualitative explanation of this phenomenon is easy to give. Consider a cascade of airfoils operating on the verge of stall (large positive incidence angle) and suppose some transient disturbance causes one vane to stall momentarily (i.e., causes the vane boundary layer to separate on the convex side); then the flow area between that vane and the next is restricted momentarily. Since the cascade-exit pressure remains essentially constant (dependent on the mean turning through the whole blade row) the local flow must change, and, in fact, the result is a momentary choking of flow through the single blade passage. Flow ahead of the blade is diverted toward adjacent passages. The effect is to increase the angle of attack on the vane next in line in the direction of tangential component of inlet velocity and to decrease the angle of attack on the preceding vane. Thus the next vane tends to stall and the preceding vane tends to become more stable. If the adversely affected vane does stall, it in turn affects the one next to it, and in this manner stall spreads along the blade row in the direction of inlet tangential velocity. But when the stall has

propagated some distance, the incidence angle on the first vane improves, because of the flow being directed by the choking of succeeding blade passages, so that the first vane unstalls, and the unstalling process subsequently moves from blade to blade down the row. One might expect to find stall regions of a characteristic size propagating down the blade row with a velocity which depends upon the rate of formation and recovery of the separation regions.

"The quantitative formulation of the problem involves several steps. By a small disturbance analysis, the condition for the appearance of large-scale disturbances can be obtained, and this is done. Following this, another analysis is required to determine the mean row characteristics observed during stall propagation; such an analysis would treat finite disturbances and would lead to the size of the separation region as well as to the resultant mean characteristics. Such a subsequent analysis is as yet not sufficiently useful to justify the labor involved."

The authors' small disturbance analysis mentioned in the preceding quotations yields a stability criterion for cascades. The flow is shown to be stable or unstable relative to propagation according to whether the gradient of the flow-area ratio with respect to the (tangent of the) inlet angle of attack is less than or greater than, respectively, the ratio of the steady operation flow-area ratio to the (tangent of the) inlet flow angle for steady flow operation. The frequency of propagation of stall is not predicted by the authors' model, as they note in the paragraph quoted from their report.

The surge model presented by the authors is an energy flux representation for a polytropic process. The final expression obtained for the frequency of pulsation is valid for any two-mass system where the two volumes are connected by the compressor. The final conclusions presented by the authors are however not applicable to air-cushion vehicles since the mass of cushion fluid contained in the receiving volume (i.e., plenum) may vary significantly from its equilibrium value over a full excitation period. The model neglects the third surge excitation mechanism, namely the pumping of the receiving volume which occurs (most probably) at a frequency different from those associated with the instabilities studied by the authors.

Keulegan and Carpenter (1958) have published a solution for the inertial and drag coefficients of two-dimensional flat plates in oscillating (simple sinusoidal) currents. A similar solution for circular cylinders is also included in this paper. The authors present a nondimensional correlation coefficient or period parameter equal to the ratio of the product of the maximum velocity of the sinusoidal current and the period of excitation to the width of the flat plate (or diameter of the cylinder). For the plates, the drag coefficient is shown to be inversely proportional and the inertia coefficient is shown to be directly proportional to this period parameter.

Shimoyama and Ito (1958) have presented a completely experimental study of a pump connected to a large volume receiving tank through a long prismatic-supply tube. The authors reach the following conclusions as a result of their experiments:

- (1) In the surging state the air column in the pipeline vibrates in a manner resembling that of a normal mode of free vibration.
- (2) Surging amplitude is proportional to the pump revolution rate.
- (3) If the length and area of a cross-section of the pipeline are fixed, surging tends to build up according to the volume of the tank.
- (4) Surging is influenced considerably by the conditions under which energy is dissipated from the vibrating air column through the outlet opening.
- (5) The type of surging that usually occurs corresponds to the fundamental mode of free vibration. When conditions of the pipeline such as the pipeline dimensions and the position of the outlet opening have a large damping effect on the vibration of this mode, the surging that occurs is of a type corresponding to a higher mode.

Ito (1960) has written independently an encyclopedic work concerning surging in a blower. His report includes a well-developed mathematical analysis which is verified through good experimental data.

The author begins with a survey of past investigations in the field. An experimental study by Bullock, Wilcox, and Moses (1947) has indicated that surging is a phenomenon of periodic variation of pressure and velocity which occurs in the range of discharge in which the machine has a rising characteristic and that its frequency is the same throughout the pipeline. A complex dependence was found between frequency and amplitude of pressure variation and pipeline conditions.

Ito continues his review of the Japanese literature with a discussion of Fujii's (1948) treatment of the nature of surging as a vibration of a continuous body caused by the rising characteristic of the blower. Shimoyama (1949) is noted for his derivation of a second order ordinary differential equation that provides an approximate description of the phenomenon of surge. His paper also contains a criterion for stability of air flow and a graphical estimation method for the amplitude of surging. Surging of small fan duct systems as investigated by Katto (1960), who has used equivalent lumped models for vibrating air columns, is also noted by the author.

Ito's own experimental research on surging has led him to a number of conclusions:

- (1) Stability of a small disturbance in a pipeline with a blower can be determined from the roots of

$$(\bar{b}-4)X^N + \bar{b}X^{N-m'} - G\bar{b}X^{m'} - G(\bar{b}+4) = 0 \quad (3)$$

where $G = \frac{\bar{g}-2}{\bar{g}+2}$

\bar{b} is the slope of the blower characteristic curve, $f_B(u) = \bar{a} + \bar{b}u$

$$N = m' + n'$$

n' is the delivery pipe length

m' is the suction pipe length

\bar{g} is the slope of the valve characteristic curve, $f_V(u) = \bar{a} + \bar{g}u$

u is the velocity of air in the pipeline

If all of the roots of Equation (3) lie within the unit circle on the complex plane, the system can be considered stable.

- (2) If the blower has a rising characteristic ($\bar{b} > 0$) at the working point, there is the possibility of amplification of a small disturbance at that point. If the valve at the end of the pipe is fully open or closed, the necessary and sufficient condition for stability is $\bar{b} < 0$. However, if the blower position coincides with a node of any normal mode of vibration of the air column, the small disturbance is not depressed even if $\bar{b} < 0$.
- (3) If the pipeline cross-section is uniform and the stability condition is not satisfied, a disturbance builds up into a fixed, sustained vibration that is independent of its initial form. The wave form changes along the pipeline, and the final form depends on the blower position.
- (4) The wave form of surging is periodic in a strict sense when the pipeline cross-section is uniform, but this is not true when there is a discontinuous change of cross-section in the pipeline. Surging in such a pipeline may, however, be observed as a periodic vibration if the dominant mode is a normal one.
- (5) The final form of velocity variation at the blower position is rectangular only if the valve at the end of the pipe is closed.
- (6) In a pipeline with a high compression ratio blower the frequency of surging may be higher or lower than that of the free vibration of the standard air column because the air in the suction and that in the delivery pipe are in appreciably different states.

- (7) The more rapid the revolution of the blower, the more violent is the surging and the more important is the role that the blower characteristic plays in determining the amplitude of surge.

Finally, the author discusses an approximate solution for surging by formulating the Lagrangian differential equation of motion which describes the surging phenomenon. The solution builds upon the wave equations for pressure and velocity of air column vibration. The resulting model is a two-degree-of-freedom system whose stability conditions determine the type of surging which will result from a system with given pump characteristic curves.

Jenny (1961) has extended Bidard's (1946 and 1950) method of predicting surge from steady flow conditions and the 1950 contribution of Jenny to include unsteady flow. Both the experimental and the theoretical results have shown that the surge point is modified under unsteady flow, with the displacement depending on the frequency and amplitude of the pressure changes. A drop in compressor efficiency is seen under unsteady flow, as well. The author has not included the effect of pulse amplitude on the general compressor characteristics outside the surge region. Jenny's extended theory is reproduced in the appendix to the present report.

The optimization of matched compressor systems has been discussed by Baljé (1962). The use of similarity parameters for

establishing design criteria for optimized systems is demonstrated. The author shows how the compressor designer may compute the maximum obtainable efficiencies and optimum design geometry under fixed Mach and Reynolds number limitations.

One piece of machinery in which surging plays a role detrimental to performance is the centrifugal blower of a diesel engine supercharger. The supercharger operates under conditions in which the downstream reservoir is subject to flow interruption by the diesel inlet pistons and high frequency (600 to 4200 Hz) pressure fluctuations. Of the important work done by Japanese investigators in this area, the research of Yano (1963) deserves special examination. The author has reported the results of an experiment consisting of a centrifugal blower discharging into a straight pipe terminated by a rotary valve. Yano has applied Jenny's (1950) characteristic method to the system to compute the temporal behavior of pressure and discharge in the straight pipe joining the fan to the rotary valve. These results are compared with measurements obtained by operating the apparatus over a wide range of excitation frequencies.

From the application of Jenny's characteristic method the author has drawn several conclusions. First he has found that the mean pressure (temporal average) at any point in the system is independent of frequency. The fluctuating component of pressure (as defined by a pressure fluctuation coefficient proportional to the difference between maximum and minimum pressures) is shown to be a function of excitation frequency and varies with position in the flow system.

The mean discharge in the system varies with the frequency of excitation. The author further demonstrates an inverse phase relationship between the mean discharge and the pressure fluctuation coefficient.

The experimental results published show some significant deviation from the predicted system response. The mean discharge is generally greater than that predicted by the analytical model and does not usually show the same periodic behavior with increasing frequency. The measured pressure fluctuation coefficient does not show a systematic fluctuation corresponding to the computed cycle rate. In response to these discrepancies the author has included a discussion of the dynamic effects of the compressor and of the rotary valve as distinct from the character of the overall system. The characteristic method assumes that the performance curve of the blower under steady flow can be applied to a system operating under conditions of pulsating flow and assumes similarly that the steady flow pressure-discharge relationship for the rotating valve is also valid for unsteady flow conditions. These assumptions were examined by the author by computing the appropriate excitation frequencies or reduced frequencies for each of the mechanisms. By this technique the author was able to conclude that for his experimental system the rotary valve had qualitatively more distinctive unsteady characteristics than the compressor. The performance of the blower under unsteady flow conditions was therefore felt to resemble its steady flow performance much more than expected.

An experimental investigation of the flow characteristics of a centrifugal compressor under unsteady flow conditions has been

performed by Benson and Whitfield (1965). At low flow rates the operating range of the compressor is limited by surge and at high flow rates by choking. The authors' tests have shown that under unsteady flow conditions the surge point is displaced to a point of greater mass flow, thereby reducing the flow range of the compressor. The magnitude of this displacement is dependent upon the frequency and amplitude of the pressure pulses. It is seen that pressure pulsations can be transmitted through the compressor and that surge can be induced under certain conditions when normal steady flow matching would not indicate surge.

Overall compressor efficiency is seen to be reduced under all test conditions, with the decrease in efficiency apparently not monotonically dependent on the pulse frequency. In contrast, the authors cite Jenny's (1961) experiments which indicate that a drop in efficiency is related only to the pulse frequency. Jenny's results have shown that the higher the frequency, the smaller the decrease in efficiency.

The authors show that the flow characteristics of the compressor are displaced under all conditions of pulsating flow and that the deviation from steady flow characteristics is greatest at low frequencies and with the largest fluctuations in rotary valve area. Their study has not established whether the results are due to characteristics of the delivery system alone or to the combined characteristics of the delivery system and the compressor.

Finally, the authors present an outline of the analysis of surging developed by Bidard (1946, 1950) and extended by Jenny (1961). Their summary is included in the appendix to this report.

Myles (1965) has presented a method by which the cascade behavior of aerofoils is superimposed on a centrifugal flow field. He has shown that the use of two-dimensional aerofoil cascade performance data in the design of mixed flow fans allows the overall fan performance to be estimated within reasonable limits of tolerance. He has demonstrated in this way that the boundary-layer behavior does not appear to have a great influence on the lift behavior of blades at the design condition. No comparable conclusion is drawn for off-design performance, however, especially for near-stall conditions.

This paper is part of a series of reports by Myles and Watson (1964) and Myles, Bain, and Buxton (1965) dealing with computer design of fans and compressors. The application of this work was summarized by Hesselgreaves and Jones (1970) as briefly discussed in a subsequent paragraph.

Comparison of the static characteristics of ACV lift system fans has been improved by Burgess (1965) who has devised a new method for reducing data on hovercraft fan performance. In order to eliminate the dependence of previously published performance curves on model weight, Burgess demonstrates that presentation of volume flow data in the form of the ratio of fan discharge to the square root of the craft weight yields a relationship uniquely related to hover height (independent of weight). The author further proposes that for practical purposes the fan speed be normalized by the square root of the craft

weight and that the required power be normalized by the craft weight raised to the three-halves power. This presentation also yields relationships which are uniquely related to hover height over a range of craft weights. These results are derived for rigid seal ACV's; however, the author concludes that for flexible seal hovercraft the extent to which the weight-normalized relationships are borne out in practice is a measure of the extent to which the flexible seals deform under the differing inflation pressures which result from various craft weights.

Ohashi (1967) has performed an experimental study of the pressure characteristics of a centrifugal pump when the flow rate was forced to vary sinusoidally around an average discharge. The experiment showed that the amplitude of pressure rate fluctuation decreased and the phase lag of pressure rate fluctuation increased when the frequency of fluctuation exceeded a frequency given by

$$f = C_f \frac{N_R \phi}{\cos \lambda_R} n \quad (4)$$

where f is the frequency of forced fluctuation (H_3)

N_R is the number of blades

ϕ is the flow coefficient (rps)

λ_R is the stagger angle of the cascade (55°)

n is the rotational speed of the impeller (rps)

C_f is the frequency coefficient

Ohashi's theory gives $C_f = 0.3$, and the experimental results yield $C_f = 0.1$.

Experimental data indicate that the amplitude of the change

of pressure rise decreases with the increase of reduced frequency but at a faster rate than the Ohashi theory predicts. The phase delay of the change of pressure rate relative to the quasi-static case increases with the increase of reduced frequency, but at a rate higher than that predicted by the theory.

Parker (1967) has analyzed the resonance effects due to wake shedding from the blades of compressors through an examination of the sound pressure levels excited at a series of acoustic resonances. The author has found the tendency to shed periodic wakes to be greatest for the lowest blade loadings and to disappear prior to the incidence of stall. The author observes that the resonance mode (integral number of waves excited) is not necessarily a function of the number of compressor blades and that acoustic wave lengths correspond to propagation velocities less than sonic for an unexplained reason.

Parker (1968) also has developed an irrotational flow model of compressor cascades in relative motion. Besides irrotationality, his method is limited to the flow of incompressible fluids. A finite difference formulation is presented to evaluate the stream function through relaxation. The model therefore provides a means of estimating the pressure fluctuations which are responsible for the generation of unsteady forces on blades with small blade row spacings. The calculations seem to be adequate for low and medium speed axial flow machines which are not subject to conditions of stall. The author indicates that for typical axial flow units, the potential flow interaction may be much greater than blade wake effects except when the blade row spacings are

large. The mechanism of potential flow interaction operates through the prevention of accelerations in the direction normal to the guide vanes of the stator. This produces large unsteady pressure differences across the vanes resulting in large vane forces. The author's method may also be used to calculate the flow through single cascades or radial flow machines using either a stationary frame of reference or one moving with the rotor blades.

Helicopter rotor foils experience rates of increase in angle of attack which are often nearly constant over a significant portion of the blade cycles. Ham and Garelick (1968) performed two-dimensional airfoil experiments with a linearly increasing angle of attack in order to study the dynamic stall effects of a helicopter rotor. They have concluded that the rate of change of angle of attack is the dominant factor in determining the very large peak lift and moment acting on the airfoil during the process of stall. They further conclude that the location of the pitching axis has a relatively small effect on the peak loading but a substantial effect on the angle of attack at which dynamic stall occurs. This suggests that the loading is relatively independent of the dynamic stall angle.

The authors have measured the chordwise distribution of pressure and have concluded that "dynamic stall occurs at angles of attack ranging from 15 to 20 degrees, and is indicated by the decreasing of leading-edge suction when dynamic stall occurs. A pressure disturbance moving aft from the leading edge simultaneously increases the suction in the midchord region. Still later, the leading-edge

suction further decreases, while the pressure disturbance moves still further aft, and is of relatively large magnitude. The character of the disturbance suggests that it consists of free vorticity introduced into the blade flow field from the neighborhood of the blade leading edge as the blade loses bound vorticity during the dynamic stall process. The results indicate that the dynamic stall phenomenon has far different characteristics than those associated with the classic trailing edge separation during static stall of a blunt airfoil."

The authors have also found that a high rate of change of angle of attack delays (in time) the occurrence of stall. Evidently the sustained upper surface suction associated with the chordwise passage of the vorticity shed during the dynamic stall process contributes to high sustained lift values.

There is a specific heaving velocity of the airfoil which produces a maximum stall angle of attack for any pitching velocity. The critical heaving velocity is negative (positive up) and the maximum stall angle increases with increasing (negative) heave velocity. It is found that there is a decreasing sensitivity of the maximum stall angle to heaving velocity with increasing pitching velocity. It is also concluded that the onset of dynamic stall occurs when the airfoil is pitching about the leading edge.

Finally, the authors have presented their experimental data for the peak values of lift and moment in terms of the pitching velocity parameter $C\dot{\alpha}^{(s)}/V$ where C is the chord length, $\dot{\alpha}^{(s)}$ is the rate of change of angle of attack of the airfoil evaluated at the instant that dynamic

stall occurs, defined as the instant when suction at the 10 percent chord station no longer increases with increasing airfoil angle of attack, and V is the free stream velocity. Their results are reproduced as Figure 4. "Both the experimental and the theoretical data indicate that the maximum vortex-induced loading due to dynamic stall is relatively insensitive to pitch axis location, i.e., quarter-chord heaving velocity, for a given value of velocity parameter. This result is of particular importance in the helicopter application, since the instantaneous angle of attack of a helicopter blade element is determined by the instantaneous blade element pitch angle, heaving velocity, and wake-induced downwash. The significant effect of relatively small values of heaving and/or downwash velocity on the dynamic stall angle of attack, therefore, is of little consequence in determining the loading: the time gradient of angle of attack, rather than the magnitude of the angle of attack, is the primary factor, at least for the small values of quarter-chord heaving velocity corresponding to the range of pitching axis locations considered here."

The authors conclude that "the experimental results of the investigation indicate that at moderate to high pitching rates the aerodynamic loading on a two-dimensional wing during large amplitude pitching motion is dominated by the influence of intense vorticity shed from the vicinity of the wing leading edge following the occurrence of dynamic stall at an angle of attack substantially greater than the static stall angle. In the case of oscillatory pitching motion, this vortex-induced aerodynamic loading generates adversely phased pitching

moments that sustain the motion at certain values of reduced frequency and mean pitch angle, and the phenomenon known as stall flutter results. In the present case of arbitrary motion to high angles of attack, the vortex-induced aerodynamic loading generates peak values of dynamic lift and moment on the airfoil that are substantially greater than the maximum static values achieved on the same airfoil." Although the authors' research is not presently applicable to the ACV/SES dynamics problem it should find immediate use with the advent of the variable geometry lift fan in large scale SES applications.

Fujii (1968) has formalized a method for calculating the aerodynamic characteristics of a cascade of airfoils which is subjected to inlet distortions. The author's solution is steady, contains no time-dependent terms, but is otherwise exact in that the exact cascade and foil geometry is used in lieu of thin disc approximations.

In 1968 N.D. Ham formulated a vortex theory to represent the process of dynamic stall through the shedding of vorticity from the leading edge of an airfoil. Two vortices are assumed to constitute the dynamic lift model. Bound vorticity lost from the leading edge of a foil is assumed to take the form of free vortex elements which move with the velocity of the local flow and which have sufficient strength to maintain a stagnation point at the leading edge of the foil. A second trailing edge vortex is assumed to exist with a conventional (classical unsteady airfoil theory) trailing edge stagnation point. Trailing edge vortices are shed under the condition that the stagnation point is preserved. The conditions of leading- and trailing-edge stagnation points and Kelvin's theorem of

constancy are sufficient to determine the strengths of the two vortices, the blade-bound circulation, and the entire flow field at any time through classical potential flow theory. The resultant model is two-dimensional, and the author restricts consideration to flat plate (zero camber) foils of negligible thickness.

Through this model and the interpretation of experimental results the author has concluded that the aerodynamic loading on a two-dimensional plate subjected to large amplitude pitching motion is dominated by the influence of the intense vorticity shed from the leading edge following the occurrence of dynamic stall at an angle of attack substantially greater than the static stall angle. Out-of-phase pitching moments are produced by the vortex-induced loading. The phase relationship leads to stall-flutter conditions at certain values of excitation frequency and mean pitch angle.

The author's theoretical formulation is demonstrated to predict the experimental magnitude of peak oscillatory moment with fair accuracy and provides a reasonable prediction of the peak experimental vortex-induced lift (Figure 5). The author has noted an important conclusion resulting from the loss of leading-edge suction during the vortex shedding. Since the vortex-induced pressure drag is equal to the streamwise component of the resultant aerodynamic force normal to the airfoil, at large angles of attack the vortex-induced drag will exhibit large peak values. Finally, the author's theory has demonstrated accuracy in predicting the temporal and spatial unsteady pressure (Figure 6).

The author's model does not consider viscous-flow effects. A complete theoretical description of the shedding of leading-edge vorticity during dynamic stall is therefore beyond the capability of the author's present formulation. For this model, the initiation of both leading- and trailing-edge vortex shedding has to be determined empirically.

West (1968) has given a presentation of theoretical and experimental results for the airflow and power requirements of a compressible hovercraft jet. His report is concerned with the compressibility in the air flow under ground effect machines and not with fan dynamics per se.

An experimental and theoretical investigation of the pressure fluctuations produced by interaction between blade rows in axial flow compressors has been summarized by Parker (1969). The potential flow interaction effects (theoretical results) discussed were presented by Parker in two earlier papers (1967 and 1968). The present paper describes a series of experiments performed using axial flow devices for the purpose of establishing the validity of the analytic model. The experimental results show that in general the potential flow interaction between blade rows is a significant source of generation of fluctuating pressure in the machinery. Parker has found that the passing of blades behind flow obstructions such as guide vanes produces rather large pressure fluctuation on the surfaces of the guide vanes. The relative amplitude of the blade-excited pressure fluctuation is adequately predicted for the various geometries tested but the absolute magnitude of the pressure pulses is not accurately predicted by the author's analysis. Parker proposes the possibility of unsteady flow boundary layer development in the fan as an explanation for some of the anomalous results

observed. For example, the analytic model predicts larger pressure amplitudes on the downstream (away from the approaching rotor blades) side of the guide vanes than on the upstream side. Unfortunately the experimental results indicate just the opposite behavior.

Hysteresis type behavior in the dynamic behavior of an edge-jet hovercraft has been described by Davies and Poland (1970). The mechanism for hysteresis in edge-jet craft is not related to the fan-cushion system noted heretofore but rather to nonlinear Coanda behavior in the flow of cushion fluid under the edge-jet contour. Two states of flow have been identified by Davies and Poland and have been analyzed separately. In the first case, termed "underfed", the edge-jet flow is augmented by a jet of cushion fluid produced by the decrease in the cushion volume as the craft moves downward relative to a fixed ground surface. The second flow state, denoted as "overfed", occurs when the edge-jet craft is moving upward. The increase in cushion volume requires that the edge-jet split so that a stagnation point occurs somewhere near the cushion boundary. A portion of the jet is therefore deflected into the cushion. Davies and Poland have indicated a procedure for joining the two flow states through a switching condition in which the switch occurs when the thickness of the cushion jet in the underfed state or of the inward jet in the overfed state becomes zero. The result is a discontinuous jump from the overfed to underfed stages or vice-versa.

In a sequence of numerical experiments the authors have

demonstrated that the nonlinear behavior discussed results in a dependence of the dynamic equilibrium position on the input frequency. The authors have found the hover height to be a linearly decreasing function of oscillation frequency within the range of frequencies examined. The nonlinear character of the system is also demonstrated in the locus of points relating cushion pressure to hoverheight clearance which presents itself as a closed loop for the two phases of motion or states of edge-jet flow. The authors conclude that during the overfed phase there is a greater loss of pressure than there is a gain during the underfed phase. They observe that the ratio of gain to loss of cushion pressure in one complete cycle of the steady state oscillation is approximately three.

The nonlinear mechanism described by Davies and Poland would naturally couple with other nonlinear flow phenomena, compounding the actual dynamic behavior of edge-jet type hovercraft. The present description would appear to be valid for those vehicles in which other nonlinear characteristics are predominant at excitation frequencies outside of the range in which the edge-jet switching model shows significant response. The edge-jet model does however promote the consideration of nonlinear models. The authors sound a discouraging note for the use of linear mass-spring-dashpot systems (e.g., Duke and Hargreaves (1962)) to describe the motions of edge-jet hovercraft.

The design of air-cushion-supported vehicle lift fans by numerical methods may prove to provide optimized systems. Hesselgreaves and Jones (1970) have provided the outline of a machine-designed axial

fan and have presented the results of a series of physical experiments verifying the flow characteristics of the numerically designed unit. The future inclusion of unsteady and dynamic effects for an entire lift fan system in an optimum design will certainly require machine optimization of a form presumably similar to that employed by the authors.

The results of some rather extensive research on the unsteady performance of a diesel engine supercharger are reported by Yano and Nagata (1971). This work builds upon and extends the results of similar research reported by Yano (1963). In the present paper the authors introduce and clarify several significant aspects of the problem. First, they clearly show how the "apparent" blower characteristics compare with the steady flow characteristics of the blower. In many design applications which are not concerned with detailed dynamic behavior, the average level of performance is sufficient to display the effects of surge phenomena. The "apparent" fan curve which represents the relationship between the time-average values of the mass flow and the pressure ratio therefore indicates the mean response of the system relative to the steady flow or zero frequency performance. The apparent characteristic curve will generally follow the steady flow fan curve along the negative slope portion of the curve. In positive slope regions, however, significant deviations can be expected, usually manifested as a decrease in pressure differential for any particular discharge.

Yano and Nagata also show the difference between forced oscillations occurring at a forced frequency f_R and surging oscillations

occurring at a separate (sometimes equal) surging frequency f_s . The relationship between these two frequencies is linear, involving the integral number of repeated acoustic waves n which can exist in the length of duct work separating the compressor from the source of excitation. The relationship presented by the authors is $f_s = f_R/n$.

The authors include a discussion of the effect of moving pressure waves in the characteristic method employed in their numerical analysis. The basic conclusion reached is that the actual pressure history may be neglected when the air column length is a small percentage of the volume of air contained in the system. For long, slender duct work systems the effects of the pressure wave are too great to be neglected.

A series of experiments was performed in which a resistance (flow blockage) plate was inserted into the system to change the operating point of the blower. This allowed the authors to exert a great deal of control over the incidence of surging in their forced excitation studies. Through this means the proportional relationship between forcing and surging frequencies was firmly verified. In presenting their final results showing relationships between pressure coefficient and excitation frequency and flow coefficient and excitation frequency the authors were able to conclude that without surging, both pressure and discharge decrease rapidly with increasing excitation frequency. With the inception of surging, however, the pressure coefficient decreases only slightly with increasing frequency while the discharge coefficient exhibits the opposite behavior, increasing mildly with frequency.

McCroskey and Fisher (1972) have postulated a sequence of events in the dynamic stall process that support the three basic contentions of Ham and Garelick (1968) regarding the mechanism of retreating blade stall for temporarily changing angle of attack. The three phases identified by Ham and Garelick with a given rate of change of angle of attack are (1) the leading edge suction and maximum normal force increase above static levels, (2) the shedding of a leading edge vortex and the resulting leading edge suction loss, and (3) complete upper surface separation. This list has been expanded by the authors into a nine event process. The sequence of events for the retreating blade stall region includes:

- (1) Onset of separation-like disturbances within the boundary layer and a slight shift to the center of pressure.
- (2) Beginning of a rapid rearward shift of the center of pressure and increase in the blade element moment coefficient.
- (3) Collapse of the leading edge suction peak.
- (4) Achievement of maximum blade element normal force coefficient.
- (5) Achievement of maximum blade element moment coefficient.
- (6) Completion of the stalling process.
- (7) Reestablishment of leading edge suction.
- (8) Stabilization of the center of pressure.
- (9) Reestablishment of normal boundary layer characteristics.

The Ordnance Research Laboratory of the Pennsylvania State

University has recently provided itself with a capability for detailed research on the response of axial flow turbomachinery blade elements and/or blade rows to unsteady flows. Bruce (1972) has described the axial flow research fan and the instrumentation available for experimental dynamic response of blades. The dynamic excitation is provided through disturbance-generating grids with circumferential variations in blockage rather than by a homogeneous pulsation of the fan flow.

The unsteady stall characteristics of two-dimensional foils in an incompressible fluid have been examined by Crimi and Reeves (1972). They report the development of a method which utilizes mathematical representations of several flow elements involved in unsteady airfoil stall. The flow elements included in the model differ for various stall classifications. The three stall classifications considered by the authors are (1) leading edge stall, (2) trailing edge stall, where the flow separation streamline springs from the upper surface of the foil at some point between the leading and trailing edges of the foil, and (3) thin-airfoil stall characterized by a laminar bubble springing from the leading edge of the foil at a small angle and reattaching to the foil at some downstream point. This type of stall occurs only at low Reynolds numbers on thin foils.

The primary flow elements appropriate to leading-edge stall conditions are (1) a laminar boundary layer to the point of separation, (2) a laminar constant pressure shear layer to the point of transition, (3) a turbulent constant pressure shear layer, (4) a turbulent pressure-

recovery region and (5) a potential flow region over the foil and external to the viscous mixing region and vortical wake. For trailing-edge stall the model must include the elements listed above plus (1b) a leading edge bubble if laminar separation occurs prior to separation and (1c) a turbulent boundary layer if transition precedes separation. For conditions under which the flow is everywhere attached or reattached to the foil, the model consists of (1) a laminar boundary layer extending over the leading edge, (2) a leading edge separation bubble, (3) a turbulent boundary layer from the reattachment point of the leading edge bubble or the transition point to the trailing edge and finally (4) a potential flow model for the flow over the airfoil, including the effects of a vortical wake generated by the unsteady circulation about the foil.

To facilitate numerical solution each flow element was considered qualitatively as simply as possible. Linearized potential flow analysis was applied. Quasi-steady flow was assumed for the viscous mixing regions and the leading edge bubble. Boundary layer analysis was performed, however, via a complete second-order unsteady finite-difference method. Finally, a numerical iteration technique was employed to relate the various interacting flow elements.

The authors demonstrate the method through comparisons of computed and measured loads on a pitching airfoil. The generally good qualitative agreement is taken as a sign that the method is capable of reproducing the essential features of dynamic stall. Most significantly, the authors conclude that their results indicate that the dynamic over-

shoot of the normal force on an oscillating foil is caused by a redistribution of pressure associated with the pitch rate as well as loading induced on the aft portion of the airfoil by the presence of a dead air region on the forward end of the foil.

Johnson and Ham (1972) suggest that the laminar separation bubble is responsible for dynamic stall. The proposed model involves a bubble which is stretched by the unsteady transition process and subsequently bursts as the reattachment point enters a region of high adverse pressure gradient. Isogai (1970) has indicated in this consideration that bubbles as long as $0.15c$ (where c is the chord length) may be possible.

Philippe and Sagner (1972) review experimental and theoretical methods of computing and measuring unsteady aerodynamic forces on oscillating airfoils developed in France, including unsteady stall effects. One feature of the authors' experimental method is the use of a force balance within a section of the oscillating airfoil. This approach has the advantage over the pressure measurement technique of permitting the measurement of unsteady drag forces on the airfoil in addition to lift and moment. The drag forces are shown to up to one-third of the magnitude of the lift forces during oscillations through stall. The highest amplitude of oscillation tested by the authors was $\pm 6^\circ$, so the experimental data is applicable to the study of stall flutter oscillations at blade torsional frequencies but not to the overall blade dynamic stall onset resulting from variations in the angle of attack at rotor rotational frequencies.

An experimental and theoretical study has been performed by Thomas (1972) to develop a method for predicting the stiffness and damping parameters of a hovercraft which are attributable to changes in cushion pressure during forced excitation of the cushion. The experimental study was of two parts. The first consisted of a fixed model hovercraft suspended over a "pitching-heaving" table with a rigid surface capable of performing sinusoidal motions. The second series of experiments was carried out with the hovercraft free to pitch and heave over the "pitching-heaving" table. All experimental work was therefore restricted to zero speed.

The theoretical model discussed by Thomas is an attempted extension of Wheatley's (1969) small amplitude theory to cover large excursions in the relative motion between the hovercraft and the rigid surface. The attempt was unsuccessful, and the author has therefore limited the analytic model to an examination of the detailed effects of skirt motion.

Thomas concludes from the appearance of the cushion pressure hysteresis loops as a function of relative craft-table displacement that the dynamic behavior is produced by a rather complicated sequence of changes in the physical significance of cushion stiffness and damping as a function of time (or relative displacement) in an excitation cycle. The author proposes that:

"To obtain the final proposed solution, motion can therefore be considered in four parts:

- a. forcing surface moving upward from its equilibrium position and the model fixed thereby compressing the cushion.
- b. moving downwards to the equilibrium position,
- c. moving downwards from the equilibrium position to the lowest position,
- d. moving upwards from its lowest to the equilibrium position.

a. Due to the action of forcing, it has been suggested earlier that stiffness in this section of motion can be considered as linear, the stiffness of the cushion being given by the slope of the static stiffness curve at the equilibrium position. Superimposed on this stiffness is the contribution due to damping....

b. The motion downward from the maximum upward position of the forcing surface again follows the upward motion as regards the stiffness of the cushion, but with damping neglected as a first approximation, (peripheral jet theory suggesting a ratio of the order of 3:1 as mentioned previously) as values of damping at low frequencies and amplitudes were relatively small.

c. Damping in this segment of motion is again neglected for reasons discussed previously, and due to the air gap, stiffness is given by the corresponding part of the static stiffness curve.

d. The return to the equilibrium position to complete the cycle is considered as the corresponding section of the static stiffness curve as c) above, but with Wheatley's value of damping superimposed to define the motion.

"Summarising the above, motion upwards of the forcing surface may be considered as a 'dynamic stiffness' as discussed, with damping superimposed, the value of that damping given by Wheatley's theory. Motion downwards of the surface, again considering a fixed model, is defined by the 'dynamic stiffness' term only as a first approximation. It is suggested that this approach to the problem of predicting pressure changes within the air cushion may be valid over a reasonable range of forcing frequencies and amplitudes."

Unfortunately, this model, while seeming to yield reasonable agreement between measured and predicted pressure variations, does not account for the effects of the dynamic response of the fan system or cushion seal system. The deviation from the experimental results increases dramatically with both increasing frequency and increasing amplitude.

Wheatley's small amplitude theory is also poor in predicting cushion pressure. This model predicts only qualitatively the hysteresis in measured pressure. The substitution of a more accurate (quadratic) fan characteristic into Wheatley's model (in place of the linear pressure-discharge relationship) does improve the analytic predictions, but this is only a result of the rather large excitation amplitudes used in the experimental program. Other investigators have demonstrated hysteresis behavior even for low amplitude excitation.

Although the validity of the author's analytic formulation

may be subject to question, especially the author's introduction of "dynamic stiffness", certain of the published conclusions deserve direct quotation.

"Over the range of amplitudes and forcing frequencies tested, fan speed remained sensibly constant throughout. This confirms reports of little variation in fan speed on full-scale craft.

"During forcing in heave, pitch, and heave and pitch combinations, the pressure distribution over the base of the craft was sensibly constant at any instant in time (with perhaps some slight local variation) i.e. cushion pressure or plenum pressure is displacement (i.e. time) dependent only. The stiffness of the air cushion in pitch was therefore not provided by a pressure gradient in the air cushion, but was found to be attributable solely to the shift of the centre of pressure of the cushion, thus providing a restoring moment. This demonstrates the designed inherent stability of the H.D.L.-type skirt. The pitch stiffness of the model hovercraft was found to be 1.0% C.P. shift/degree over the range $+2.5^{\circ}$ to -2.5° , a result which is in fair agreement with that of H.D.2 full-scale.

"The behaviour of the skirt of a hovercraft may be a crucial factor in the overall behaviour of the craft and affect both the stiffness and the damping of a craft at a given instant. The model skirt, in this case, followed the motion of the forcing surface whilst the cushion was compressed, but as the craft and forcing surface moved

apart the skirt tended to remain in its compressed state for an appreciable time before finally 'cracking' back into its extended position. This observation led to the concept of a 'dynamic stiffness' of the air cushion in heave, and also that damping may be considered to be present only when the cushion is being compressed, the remainder of the motion being dominated by the stiffness term. The use of the 'dynamic' stiffness concept eliminates the necessity to measure h_e [mean height of cushion exit area in static conditions], as the stiffness is measured directly from the results of a 'zero' speed forcing test as discussed in this thesis.

"The forcing of the air cushion through large amplitudes giving correspondingly large changes in cushion pressure and air volume flow invalidates the use of a linear relationship for the fan characteristic, and the substitution of a quadratic expression was felt to be more accurate. However, at the higher frequencies of forcing, the prediction of air volume flow is difficult to obtain as the pressure-volume flow relationship of the static fan characteristic is not followed. It is felt that some form of dynamic characteristic as suggested by Benson and Whitfield (1966) may hold, but further work is needed in this area both experimentally and theoretically. Nevertheless, the use of a quadratic expression, despite the limitations, ...has given rise to theoretical predictions which correlate well with experimental results over the range of amplitude and frequencies tested.

"The theory of Wheatley applied only to heave motions and has been extended on this basis. Further work is required on the extended

theory for the accurate prediction of volume flow changes. The extension of the theory to cover pitch, and combined heave and pitch motions has been suggested, and a tentative analysis shows little coupling between pitch and heave thus simplifying the problem. It is felt that further theoretical assessments could be made of the pitch cases in order that craft behaviour can be completely understood."

A report by Ward and Young (1972) presents a survey of research activity in rotor unsteady aerodynamics, including the NASA Langley Research Center program. The authors describe the unsteady aerodynamic environment of the rotor and discuss trends in the state of the art. They indicate that the current tendency is toward complex mathematical computer models of rotor aerodynamics. They discuss experimental and theoretical research on rotor maneuver loads, level flight and maneuvering wake prediction, tip-vortex flow, blade-vortex interaction, dynamic stall, transient compressibility effects, and variable geometry rotor research aimed at alleviating blade-vortex interaction effects.

Aerojet General Corporation (1973) has reported on the lift-system characteristics of the Aerojet design for a 100 ton surface effect ship (SES-100A). The report includes a discussion of the active heave attenuation system (using cushion vent valves) designed to reduce heave accelerations during craft operation in rough water. The system operates by venting cushion air to the atmosphere in response to ship vertical acceleration. The cushion pressure is thereby reduced and the heave acceleration "minimized." During this operation "the vent valve

bleed-off may be as much as 75% of the fan air flow which during venting must ideally be replenished by the fans." The system therefore requires that the lift system discharge capability be dramatically oversized. Operation of this system also presupposes that the fan flow rate and pressure head are noticeably unsteady. The effects of unsteady operation have not been discussed by Aerojet in this report. The authors have limited the scope of the presentation to a discussion of the steady or static flow requirements of the system.

Bass and Johnson (1973) have written an interesting report concerned with the dynamic response of bag-type seals subject to flutter and other unsteady flow effects. These effects imply non-linear behavior in the air-cushion vehicle cushion but are not directly concerned with fan dynamics. The authors' work should be further examined in an analysis of cushion dynamics.

In a technical evaluation report on aerodynamics of rotary wings Ham (1973) has noted deficiencies in the knowledge of some fundamental aspects of the physics of rotor flows. The author states that detailed descriptions and models are needed for a number of physical processes, among which are the following: (1) the formation of a blade tip vortex, (2) the structure of a blade tip vortex, (3) the rolling up of the blade trailing wake, (4) the interaction of a tip vortex with a blade, (5) the onset of dynamic stall on a blade, (6) the loading on a blade due to dynamic stall, and (7) the effects of compressibility on the previously-listed processes.

The analytic model employed by McCroskey and Philippe (1975) is described by McCroskey (1973). In this presentation the author

furnishes several simple thin airfoil formulas to describe the inviscid, incompressible flowfield about an airfoil operated in an unsteady fashion for various degrees of thickness and camber. The potential flow theory predicts the magnitude and phase of leading edge pressure gradients (dynamic delay in laminar separation) for an oscillating foil but does not predict dynamic stall characteristics.

The author's theoretical method consists of three distinct parts. The first is the linearization of the boundary condition on the airfoil and in the wake, thereby permitting the velocity potential to be separated into components of thickness, camber and angle of attack. Second, the potential flow solution is formalized and Allen's method for steady airfoils is employed to improve solution accuracy. Finally the unsteady wake effects are described via Theodorsen's method for unsteady flat plates.

Although the author's theory is limited to inviscid flow, the combined theoretical and experimental results indicate that unsteady viscous effects on oscillating airfoils are less important than the unsteady potential flow effects. This opinion is however based upon the assumption that the boundary layer does not interact significantly with the main flow. The author points out that this assumption is valid for dynamic stall. For that phenomenon, the inviscid theory predicts the onset of boundary layer separation but does not predict the delay in separation (dynamic delay above the static stall angle). Further, it is noted that the inviscid model underestimates the angles of attack where the pitching moment and lift first exhibit indications of stall.

Martin, Empey, McCroskey and Caradonna (1974) have reported the results of an experimental study into the time-dependent behavior of a single oscillating two-dimensional NACA 0012 airfoil. The authors' experimental observations resulted in the detection of a short laminar separation bubble preceding the stall condition. The authors were not however able to verify the presumption of Johnson and Ham (1972) that dynamic stall is caused by the bursting of the separation bubble. From smoke-flow movies Martin, et al. have observed the formation of a conspicuous laminar separation bubble during the downstroke phase of the airfoil oscillation. This bubble was seen to move slowly downstream as the angle of attack was increased and, at its maximum, extended back along the foil to a length of $0.2c$. There was no indication of a formation of a similar bubble during the upstroke of the oscillation (decreasing angle of attack).

The results presented by the authors are conveniently compared with the model-rotor data of McCroskey and Fisher (1972) and the data of Ham and Garelick (1968) for linear variations in angle of attack. Although the three studies were quite different they tend to indicate two similar results. First there is a stall delay as the angle of attack is increased (compared with the static stall point) and second, in each case, there is a clear indication of vortex shedding with respect to vortex formation. Martin, et al. have concluded that it is normal for more than one large vortex to be shed as the angle of attack is increased. For higher oscillation frequencies there does not appear

to be time for the formation of two vortices and only one large vortex is shed during an upswing phase in the oscillation. A leading-edge vortex is always shed when the angle of attack reaches its maximum, and the authors have noted that this process appears to be different from that which occurs on the upswing.

The major finding with respect to stall initiation is that the angle of attack for stall initiation decreases with increasing Reynolds number (for $Re = 3 \times 10^6$). This is not in accord, unfortunately, with the results of Ham and Garelick (1968) or McCroskey and Fisher (1972) whose experiments were performed at lower Reynolds numbers ($Re = 3 \times 10^5$). The authors conclude therefore that the stall processes may differ for these two different flow regimes. With respect to frequency effects, the authors have shown that the maximum normal force on the foil, the maximum pitching coefficient, and the angle at which lift stall occurs all increase as the frequency of oscillation is increased. (The experiments were performed at reduced-frequencies $k = \omega c/2V$ of 0, 0.05, and 0.1.)

Maximum lift on the foil is found to increase with Reynolds number. Further, it is observed that the angle of attack at which minimum pressure was measured was not always the same as the angle at which the maximum leading edge velocity occurred. The incidence of maximum velocity usually occurred first, indicating that separation was occurring directly at the leading edge during the initiation of stall. The authors therefore state that the most appropriate criterion for indicating the initiation of the stall process is the peaking of the leading-edge velocity.

A "Fan Evaluation Rig" has been constructed recently at the David W. Taylor Naval Ship Research and Development Center. The facility consists of a 640 cubic foot plenum connected to the atmospheric test section of a subsonic wind tunnel by the fan under consideration. The plenum is vented to the atmosphere through a 30-inch diameter variable frequency butterfly exhaust valve which may be operated reliably at frequencies between zero and 5 Hz. The plenum pressure or back pressure may also be augmented through a supplementary air supply. Durkin and Langhi (1974) presented the results of their first experimental evaluation of the dynamic response of the fan-plenum system at the International Symposium on Air Cushion Vehicle Technology in 1974. The authors' objective was to measure the steady-state performance characteristics of an Aerojet Liquid Rocket Company centrifugal flow lift fan. Their second objective was to determine the fan characteristics in a dynamic environment obtained by sinusoidally varying the area of the exhaust duct from the test plenum at frequencies from 0.5 through 6.0 Hz. The overall objective of the investigation was to evaluate techniques to be used for evaluation of fans under conditions of unsteady flow.

The authors have published a set of pressure-discharge hysteresis curves representing the dynamic behavior of the fan-plenum system for various excitation frequencies, an example of which is given as Figure 1. These curves show that for a fixed fan speed the magnitude of pressure and discharge variations due to sinusoidal excitation decrease with increasing frequency in the frequency range of zero to 5 Hz. The results also show that the average discharge increases with increasing frequency;

however, the average pressure rise across the fan decreases as the excitation frequency is increased. If the published figures are interpreted correctly, the dynamic data also demonstrates that the pressure-discharge hysteresis curves may fall entirely below the steady state fan map.

The dynamic data is limited by the fact that reverse velocities at the fan could not be measured and therefore the dynamic hysteresis loops which should obviously extend over into the domain of negative flow coefficients are truncated at the origin. The authors have mistakenly shown these open curves to be closed along the ordinate of the head-flow coefficient graphs.

The authors conclude by noting that "the measured dynamic performance data show that during cyclic operation energy is periodically stored and released in the (rotor-volute-plenum) system." They state that their "preliminary data analysis has shown that the fluid inertance in the volute and the compliance of the plenum are probably responsible for the storage. However, the preliminary data do not permit the quantizing the combined effect of these elements."

McCroskey and Philippe (1975) have investigated experimentally and numerically the unsteady incompressible laminar and turbulent flow over flat plates and airfoils. In general the authors have observed that unsteady effects on laminar boundary layers decrease with increasing longitudinal pressure gradients. Turbulent separation on the airfoils tested was significantly affected by oscillatory motion near

the critical stall angle. Calculated hysteresis in turbulent separation was found to follow previously described dynamic stall delay and reattachment delay character but the authors' numerical work was otherwise unrewarding.

The authors have relied upon the analytic examination of oscillating airfoils containing the qualitative features of Ham's vortex shedding model but modified by Philippe and Sagner with potential vortices. Empirical data were used to determine the angle of attack at which the theoretical vortex shedding could be assumed to begin. The model does not include dynamic stall which is recognized to be a strong viscous-inviscid interaction phenomenon. The authors note the contributions of Crimi and Reeves (1972) but conclude that the phenomenon cannot be included in the present state of the art in fluid machinery analysis. The final analytic model is summarized in a previous paper by McCroskey (1973). The analysis is valid for laminar flow, and the authors have modeled turbulent boundary-layer flow by incorporating the eddy viscosity formulation of Cebeci et al. (1970) into the time-dependent mean momentum equation as derived by Shamroth and McDonald (1971). The final result is only quasi-steady since empirical data required in the formulation were not modified for unsteady effects.

The authors repeat previous warnings that separation cannot always be interpreted as the point of vanishing wall shear, or flow reversal in unsteady flows; however, they offer no new definition. The authors have found major differences between turbulent and laminar flat

plate flows. Unsteady effects are manifested in velocity profiles and displacement thickness more than in wall shear for the turbulent case. The kinetic energy models for both eddy viscosity and turbulence appear to break down at high dimensionless frequencies, but both are apparently valid for the range of frequencies considered by the authors. The range of validity seems to be larger for the turbulent kinetic energy model than for the eddy viscosity model.

The authors conclude that the main shortcoming of their thin boundary-layer method is its failure to provide reliable clues about the formation and shedding on an oscillating airfoil of the vortex-like disturbance that distinguishes dynamic stall from static stall. They suggest four possible causes of this analytical deficiency: (1) inadequate treatment of the bubble-bursting phenomenon near the leading edge, (2) incorrect treatment of the turbulent boundary layer just downstream of the bubble, (3) inadequate definition of turbulent separation, and (4) failure to account for interaction between the boundary layer and the unsteady potential flow around the airfoil.

Schneider and Kaplan (1975) have approached the problem of modelling fan dynamic response from an interesting point of view. They have not examined the dynamic physical response of the fan but have accounted for the inertial response excited by varying fan torque. In their computer simulation they rely on the static pressure discharge curve, recomputing the slope as a **linear** function of shaft speed. The shaft speed is computed by analyzing the dynamic response of a rotating inertial system subject to varying torque loading.

SUMMARY

The review of past research efforts on any topic is a continuing process which has no end. An attempt has been made in this review to provide a survey of literature currently available on the subject of ACV lift system and fan dynamics.

The complete and exact three-dimensional unsteady nonhomogeneous rotational viscous-flow model for an ACV lift fan or compressor does not presently exist. Such a model, when developed, will however certainly contain as contributing features some or all of the following elements:

1. Surge
2. Resonance
3. Limit cycle stall
4. Root-to-tip stall
5. Propagating stall
6. Upstream and downstream stator dynamic interactions
7. Foil laminar and turbulent boundary layers
8. Boundary layer transition
9. Separation
10. Reattachment
11. Laminar bubble formation and bursting
12. Vortex shedding from leading and trailing edges of rotating foils
13. Vortex street formation
14. Vortex formation by stators

15. Nonuniform flow fields including volute boundary layers
16. Separation delay on moving (pitching and/or heaving) air foils
17. Fan rotor inertial effects and variable rotational rate
18. Acoustic and high frequency excitation
19. Compressibility of working fluid manifested as stiffness and damping
20. Coanda effects on all elements.

These elements have been touched upon in the reviewed literature, but continued research on all phenomena and especially on the interactions among them must continue prior to the development of a complete fan dynamics model.

REFERENCES

1. Aerojet Surface Effect Ships Division, "SES-100A System Analysis Report, Lift System Analysis," (Nov 1973).
2. Baljé, O.E., "A Study on Design Criteria and Matching of Turbomachines: Part B - Compressor and Pump Performance and Matching of Turbocomponents," Transactions of the ASME, Journal of Engineering for Power, pp. 103-114 (Jan 1962).
3. Bass, R.L. and J.E. Johnson, "An Experimental Study of Skirt Flutter on Surface Effect Take-off Landing (SETOL) Craft," Southwest Research Institute Final Report, SwRI Project 02-3542 (June 1973).
4. Benson, R.S., D. Woollatt, and W.A. Woods, "Unsteady Flow in Simple Branch Systems," Proceedings of the Thermodynamics and Fluid Mechanics Convention, Paper No. 10 (1964).
5. Benson, R.S., R.D. Garg, and D. Woollatt, "A Numerical Solution of Unsteady Flow Problems," International Journal of the Mechanical Sciences, Vol. 6, No. 1 (1965).
6. Benson, R.S. and A. Whitfield, "An Experimental Investigation of the Non-Steady Flow Characteristics of a Centrifugal Compressor," Proceedings of the Institute of Mechanical Engineers, Vol. 180, part 1, no. 27, pp. 641-672 (1966).
7. Berry, Charles H., "Flow and Fan Principles of Moving Air through Ducts," The Industrial Press (1954).
8. Bidard, M.R., "La Stabilite de Regime des Compresseurs," Bulletin de l'Association Technique Maritime et Aeronautique, No. 45, pp. 301-322 (1946).
9. Bidard, M.R., "Le Pompage des Compresseurs Resultats d'Essais," Bulletin de l'Association Technique Maritime et Aeronautique, No. 49, pp. 849-863 (1950).
10. Bisplinghoff, R.L., Holt Ashley, and R.L. Halfman, Aeroelasticity, Addison-Wesley Publishing Company, Inc., Reading, Mass. (1955).
11. Brooke, G.V., "Surging in Centrifugal Superchargers - Performance Tests of Certain Experimental Designs of Diffuser and Impeller in a Centrifugal Supercharger, with Particular Reference to Their Influence upon Surging, Including the Effect of an Impressed Periodicity of Flow," British Air Ministry Report No. 1503 (Dec 1932).
12. Bruce, E.P., "The ORL Fluids Engineering Unit Axial Flow Research Fan," Pennsylvania State University Institute for Science and Engineering, Ordnance Research Laboratory Technical Memorandum, File No. TM 72-109 (June 1972).

13. Bullock, R.O., W.W. Wilcox, and J.J. Moses, "Experimental and Theoretical Studies of Surging in Continuous-Flow Compressors," National Advisory Committee on Aeronautics Technical Note No. 861 (Mar 1947).
14. Burgess, A.J., "The Performance of Fans in Hovercraft - A Method of Reducing Experimental Results," Royal Aircraft Establishment Technical Report No. 65240 (Nov 1965).
15. Cebeci, T., A.M.O. Smith, and G. Mosinskis, "Calculation of Compressible Adiabatic Turbulent Boundary Layers," AIAA Journal, Vol. 8, No. 11, pp. 1974-1982 (Nov 1970).
16. Chappel, M.S., and G.G. Levy, "Estimation of Fan Power Curve from Deceleration Characteristics," National Research Council of Canada Division of Mechanical Engineering Test Report MET-487 (Aug 1966).
17. Crimi, P. and B.L. Reeves, "A Method for Analyzing Dynamic Stall of Helicopter Rotor Blades," NASA CR-2009 (May 1972).
18. Cruse, E.A., "Centrifugal Fan Testing and Rating Versus System Performance," ASME Paper 73-IPWR-1 (May 1973).
19. Csaky, T.G., "Some Aspects of Optimum Design of Lift Fans," Proceedings of the Sixth Canadian Symposium on Air Cushion Technology, Paper No. 76/9, 1972.
20. Davies, H.J. and G.A. Poland, "Dynamic Stability of Hovercraft in Heave," Transactions of the ASME, Journal of Applied Mechanics, Vol. 92, pp. 895-900 (Dec 1970).
21. Dukes, T.A. and C.R. Hargraves, "Stability Augmentation of Ground Effect Machines," Princeton University Dept. of Aeronautical Engineering Report No. 601 (Apr 1962).
22. Durkin, J.M. and W.E. Langhi, "An Investigation of the Performance of a Centrifugal Lift Fan Operating Against Sinusoidally Varying Back Pressure," International Symposium on Air Cushion Vehicle Technology, Montreal, Canada (1974).
23. Emmons, H.W., C.E. Pearson, and H.P. Grant, "Compressor Surge and Stall Propagation," Transactions of the ASME, Vol. 77, pp. 455-469 (May 1955).
24. Fujii, Sumiji, "Stability and Surging of a Centrifugal Water Pump," Transactions of the Society of Mechanical Engineers, Japan, Vol. 14, No. 48 (1948).
25. Fujii, Sumiji, "The Cascade Subjected to Inlet Distortions," The Aeronautical Quarterly, Vol. 19, pp. 284-300 (Aug 1968).
26. Ham, N.D. and M.S. Garelick, "Dynamic Stall Considerations in Helicopter Rotors," Journal of the American Helicopter Society, Vol. 13, No. 2, pp. 49-55 (Apr 1968).

27. Ham, Norman D., "Aerodynamic Loading on a Two-Dimensional Airfoil during Dynamic Stall," AIAA Journal, Vol. 6, No. 10, pp. 1927-1934 (Oct 1968).
28. Ham, N.D., "Technical Evaluation Report on Fluid Dynamics Panel Specialists Meeting on Aerodynamics of Rotary Wings," AGARD Advisory Report No. 61 (Mar 1973).
29. Hesselgreaves, J.E. and M.R. Jones, "The Performance of an Axial-Flow Fan Designed by Computer," Ministry of Technology National Engineering Laboratory Report No. 447 (Mar 1970).
30. Heybey, W.H., "The Unsteady Compressible Flow with Rotational Symmetry," Naval Ordnance Laboratory Report No. 2444 (Nov 1951).
31. Huppert, M.C. and W.A. Benser, "Some Stall and Surge Phenomena in Axial-Flow Compressors," Journal of the Aeronautical Sciences, pp. 835-845 (Dec 1953).
32. Isogai, K., "An Experimental Study of the Unsteady Behavior of a Short Bubble on an Airfoil During Dynamic Stall with Special Reference to the Mechanism of the Stall Overshoot Effect," MIT Aeroelastic and Structures Research Lab Technical Report 130-2 (June 1970).
33. Ito, T., "Experimental Researches on the Surging of the Blower," Memoirs of the Faculty of Engineering, Nagoya University, Japan, Vol. 12, No. 2, pp. 139-226 (1960).
34. Iura, T. and W.D. Rannie, "Experimental Investigations of Propagating Stall in Axial-Flow Compressors," Transactions of ASME, Vol. 76, pp. 463-471 (Apr 1954).
35. Jaumotte, A., A. Kiedrzynski, and C. Haesevoets, "Etude Experimentale du Coussin d'Air a Deux Etages de Pression," Institut de Mecanique Appliquee, Institut d'Aeronautique, NT36 (1974).
36. Jenny, E., "Unidimensional Transient Flow with Consideration of Friction, Heat Transfer, and Change of Section," The Brown Boveri Review, pp. 447-461 (Nov 1950).
37. Jenny E., "Non-stationary Phenomena in Radial Compressors, Especially in Supercharging Sets of I.C. Engines," Schweizerische Bauzeitung, Vol. 79, No. 182 (1961); B.S.R.A. Translation No. 1395.
38. Johnson, W. and N.D. Ham, "On the Mechanism of Dynamic Stall," Journal of the American Helicopter Society, Vol. 17, No. 4, pp. 36-45 (Oct 1972).
39. Jorgensen, Robert, "Fan Engineering, An Engineer's Handbook," Buffalo Forge Company (1961).
40. Katto, Y., "Some Fundamental Natures of Resonant Surge," Bulletin of the Japan Society of Mechanical Engineers, Vol. 3, No. 12, pp. 484-495 (1960).

41. Keulegan, G.H. and L.H. Carpenter, "Forces on Cylinders and Plates in an Oscillating Fluid," National Bureau of Standards Research Paper 2857, Vol 60, No. 5 (May 1958).
42. Kusama, H., S. Tsuji and Y. Oshida, "Study on Surging of Blower (First Report)," Transactions of the Japanese Society of Mechanical Engineers, Vol. 22, No. 117 (1950).
43. Lawrence, H.R. and E.H. Gerber, "The Aerodynamic Forces on Low Aspect Ratio Wings Oscillating in an Incompressible Flow," Journal of the Aeronautical Sciences, Vol. 19, No. 11, pp. 769-781 (Nov 1952).
44. Lerbs, H.W., "Moderately Loaded Propellers with a Finite Number of Blades and an Arbitrary Distribution of Circulation," Society of Naval Architects and Marine Engineers (Nov 1973).
45. Lopez, M.L., C.C. Shen, and N.F. Wasson, "A Theoretical Method for Calculating the Aerodynamic Characteristics of Arbitrary Jet-Flapped Wings," Douglas Aircraft Company (May 1973).
46. Marble, F.E., "Propagation of Stall in Compressor Blade Rows," Proceedings of the 21st Annual Meeting of the Institute of Aeronautical Sciences (Jan 1953).
47. Martin, J.M., R.W. Empey, W.J. McCroskey, and F.X. Caradonna, "An Experimental Analysis of Dynamic Stall on an Oscillating Airfoil," Journal of the American Helicopter Society, Vol. 19, No. 1, pp. 26-32 (Jan 1974).
48. Martin, M.H., "Steady, Rotational, Plane Flow of a Gas," Naval Ordnance Laboratory Memorandum 10274 (Oct 1949).
49. Martin, M.H., "Steady, Plane Rotational Prandtl-Meyer Flows," Naval Ordnance Laboratory Memorandum 10346 (Oct 1949).
50. McCroskey, W.J., and R.K. Fisher, Jr., "Detailed Aerodynamic Measurements on a Model Rotor in the Blade Stall Regime," Journal of the American Helicopter Society, Vol. 17, No 1, pp. 20-30 (Jan 1972).
51. McCroskey, W.J., "Inviscid Flowfield of an Unsteady Airfoil," AIAA Journal, Vol. 11, No. 8, pp. 1130-1137 (Aug 1973).
52. McCroskey, W.J. and J.J. Philippe, "Unsteady Viscous Flow on Oscillating Airfoils," AIAA Journal, Vol. 13, No. 1, pp. 71-79, (Jan 1975).
53. Moore, Royce D., Donald C. Unasek, and George Kovich, "Performance of Transonic Fan Stage with Weight Flow per Unit Annulus Area of 178 Kilograms per Second per Square Meter (36.5 (lb/sec)/ft²)," NASA Technical Memorandum TMX-2904 (Nov 1973).
54. Moran, D.D., "Cushion Pressure Properties of a High Length-to-Beam Ratio Surface Effect Ship," NSRDC Ship Performance Department Report SPD-600-01 (May 1975).

55. Moran, D.D., "The Nonlinear Seakeeping Characteristics of a Surface-Effect Ship: Design II, 2KSES Model Experiments, DTNSRDC Ship Performance Department Report SPD-684-02 (May 1976).
56. Moran, D.D., "The Overland Vertical Plane Dynamic Response of the AALC JEFF(B) ACV, Model Experiments," DTNSRDC Ship Performance Department Report (In Review).
57. Myles, D.J., and J.T.R. Watson, "The Design of Axial-Flow Fans by Means of a Computer. Part I - Basic Frame Sizes," British National Engineering Laboratory Report No. 145 (1964).
58. Myles, D.J., R.W. Bain, and G.H.L. Buxton, "The Design of Axial-Flow Fans by Computer. Part II - Blade Geometry for the Rotor and Stator," British National Engineering Laboratory Report No. 181 (1965).
59. Myles, D.J., "A Design Method for Mixed-Flow Fans and Pumps," National Engineering Laboratory Report No. 177 (Mar 1965).
60. National Advisory Committee for Aeronautics, "Standard Procedures for Rating and Testing Multistage Axial-Flow Compressors," Technical Note No. 1138 (Sept 1946).
61. Nemenyi, P.F. and R.C. Prim, "Some Patterns of Vorticose Flow of a Perfect Gas," Naval Ordnance Laboratory Memorandum 9219 (1951).
62. Newman, B.G., and D. Jones, "Theoretical Analysis of an Internally-Braced, Two-Dimensional Air Strut Which is Partially Buckled," The Aeronautical Quarterly, Vol. 19, pp. 71-79 (Feb 1968).
63. Ohashi, Hideo, "Experimental Study of the Dynamic Characteristics of Turbopumps," NASA Technical Memorandum X-53659 (Sept 1967).
64. Parker, R., "Resonance Effects in Wake Shedding from Compressor Blading," Journal of Sound and Vibration, Vol. 6, No. 3, pp. 302-309 (Nov 1967).
65. Parker, R., "Calculation of Flow through Cascades of Blades Having Relative Motion and the Generation of Alternating Pressures and Forces Due to Interaction Effects," Proceedings of the Institution of Mechanical Engineers, Vol. 182, Part 1, No. 11, pp. 229-241, (1968).
66. Parker, R., "Pressure Fluctuations Due to Interaction Between Blade Rows in Axial Flow Compressors," Proceedings of the Institution of Mechanical Engineers, Vol. 183, Part 1, No. 7, pp. 153-160 (1969).
67. Pearson, H. and T. Bowmer, "Surging of Axial Compressors," The Aeronautical Quarterly, Vol. 1, pp. 195-210 (Nov 1949).
68. Perl, W. and M. Tucker, "A General Representation for Axial-Flow Fans and Turbines," National Advisory Committee for Aeronautics (1945).

69. Philippe, J.-J., and M. Sagner, "Calcul et Mesure des Forces Aerodynamiques sur un Profil Oscillant, avec et sans Decrochage," AGARD Proceedings CP 111 (Sept 1972).
70. Ricci, J.J. and D.D. Moran, "Cushion Pressure Influences on a High Length-to-Beam Ratio Surface Effect Ship in Irregular Waves," DTNSRDC Ship Performance Department Report SPD-600-02 (Apr 1976).
71. Schneider, Jesse and Paul Kaplan, "The Incorporation of Fan Dynamics into the Motion Simulation of Surface Effect Ships," Proceedings of the Fourth Ship Control Systems Symposium, Vol. 4, pp. 91-116 (Oct 1975).
72. Sears, W.R., "On Asymmetric Flow in an Axial-Flow Compressor Stage," Journal of Applied Mechanics, Contributions of the ASME Applied Mechanics Division, Vol. 20, No. 1, pp. 57-62 (Mar 1953).
73. Shamroth, S.J. and H. McDonald, "An Analysis of the Unsteady Compressible Boundary Layer," Project SQUID Symposium on Fluid Dynamics of Unsteady Three-Dimensional and Separated Flows (1971).
74. Shimoyama, Y., Transactions of the Society of Mechanical Engineers (Japan), Vol. 15, No. 50 (1949).
75. Shimoyama, Y. and T. Ito, "Experiments on the Surging of a Blower," Bulletin of the Japan Society of Mechanical Engineers, Vol. 1, No. 1, pp. 57-64 (1958).
76. Speirs, R.R.M. and J. Whitaker, "An Inlet Chamber Test Method for Centrifugal Fans with Ducted Outlet," Ministry of Technology National Engineering Laboratory Report 457 (June 1970).
77. Thomas, C.D., "An Investigation of the Response of Hovercraft to Surfaces Performing Heaving and Pitching Motions," Unpublished Doctoral Thesis, Loughborough University of Technology, Leicestershire, England (Oct 1972).
78. Tyler, R.A. and R.G. Williamson, "Balance Measured Thrust Performance of Various Cooled Axial Fan Configurations in a Mainstream at 90° Incidence," National Research Council of Canada, Division of Mechanical Engineering Aeronautical Report LR-543 (Oct 1970).
79. Voas, P. and W.A. Woods, "Measurement of Total Head Pressures in an Unsteady Flow of a Compressible Fluid in a Duct," Symposium on Accuracy of Electronic Measurements, Paper No. 3.
80. Ward, J.F., and W.H. Young, Jr. "A Summary of Current Research in Rotor Unsteady Aerodynamics with Emphasis on Work at Langley Research Center," AGARD Proceedings CP 111 (Sept 1972).
81. West, A.A., "The Compressible Hovercraft Jet," The Aeronautical Quarterly, Vol. 19, pp. 317-326 (Nov 1968).
82. Wheatley, J.H.W., "Heave Suspension Characteristics and Power Requirements of a Plenum Air Cushion," National Physical Laboratory Hovercraft Unit Report 9 (Dec 1969).

83. Wislicenus, G.F., "Hydrodynamics Design Principles of Pumps and Ducting for Waterjet Propulsion," NSRDC Report 3990 (June 1973).
84. Yamanouchi, Masao, "Researches on the Performance Characteristics of the Axial-Flow Compressors," Transportation Technical Research Institute Report No. 12 (May 1954).
85. Yano, T., "Performance of Centrifugal Blower under Pulsating Flow," Bulletin of the Japan Society of Mechanical Engineers, Vol. 6, No. 23, pp. 478-486 (1963).
86. Yano, T. and B. Nagata, "A Study of Surging Phenomena in Diesel Engine Air-Charging System," Bulletin of the Japan Society of Mechanical Engineers, Vol. 14, No. 70, pp. 364-375 (1971).

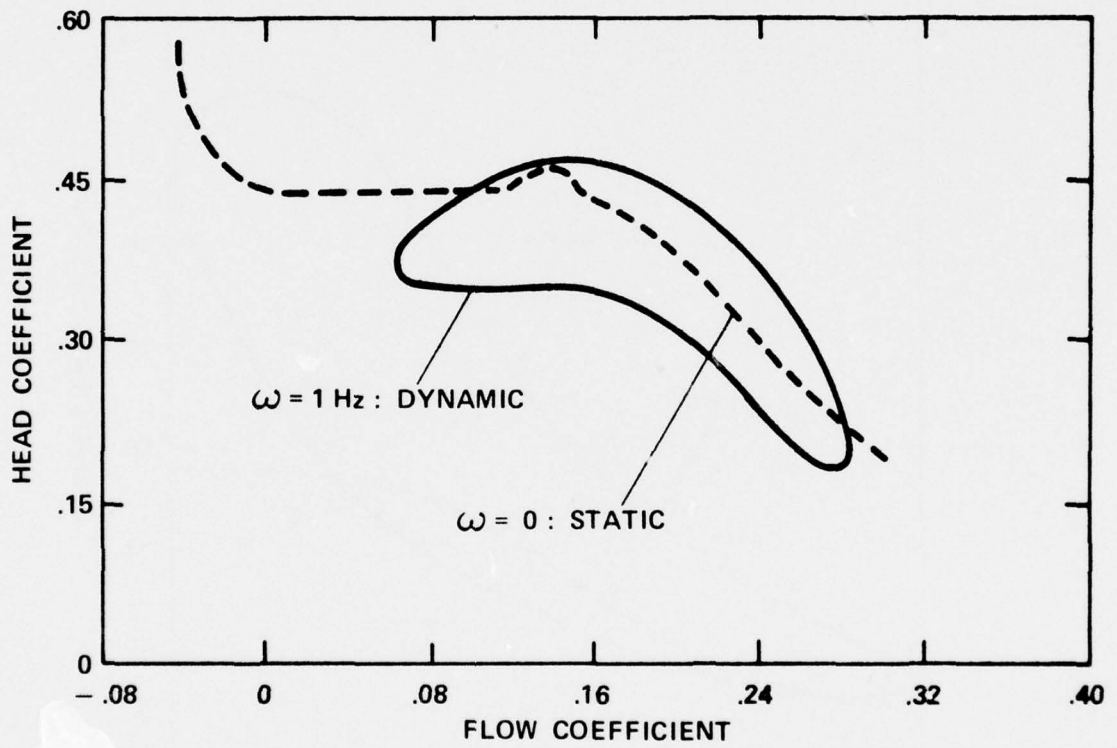

Figure 1 - Dynamic Characteristic of an SES Lift Fan

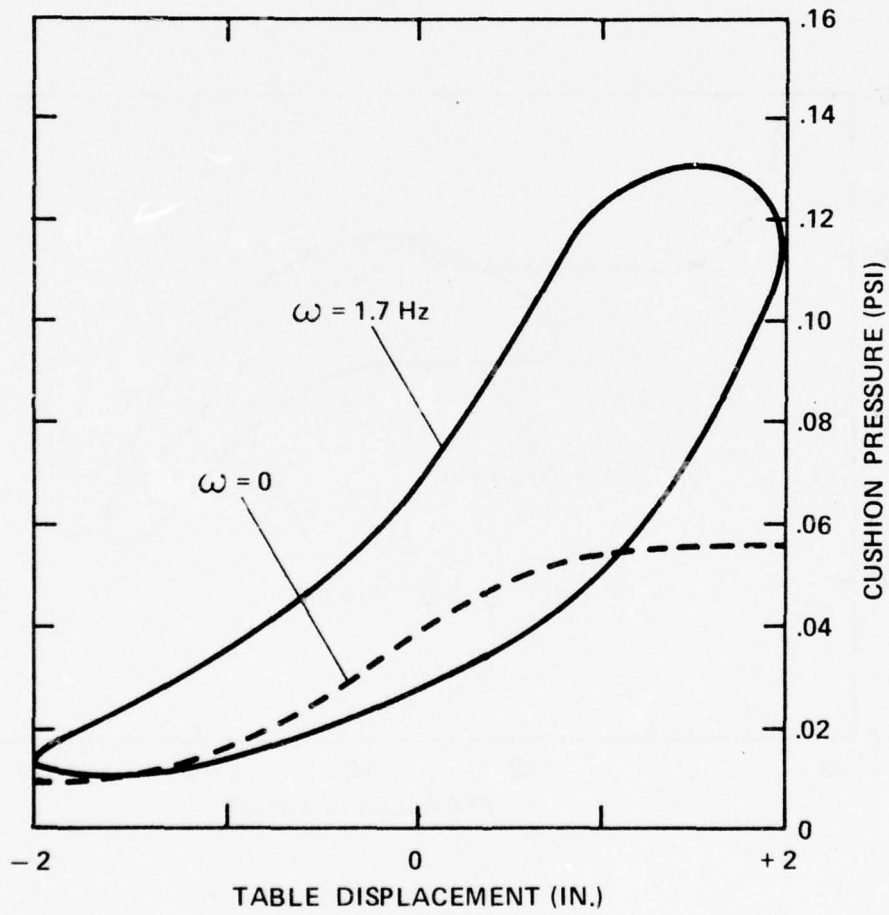

Figure 2 - Dynamic Characteristic of an ACV Lift Fan

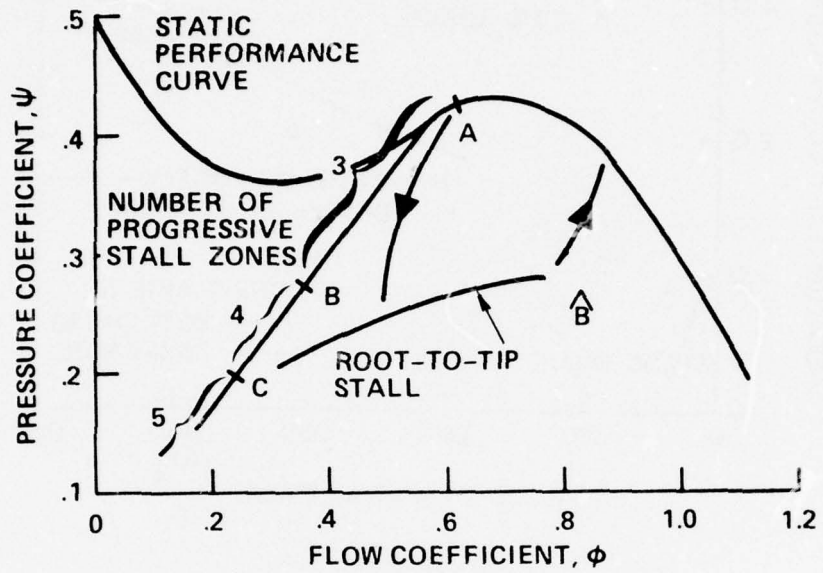

Figure 3 - Pressure Coefficient as a Function of Flow Coefficient for Progressive Stall and Root-to-Tip Stall

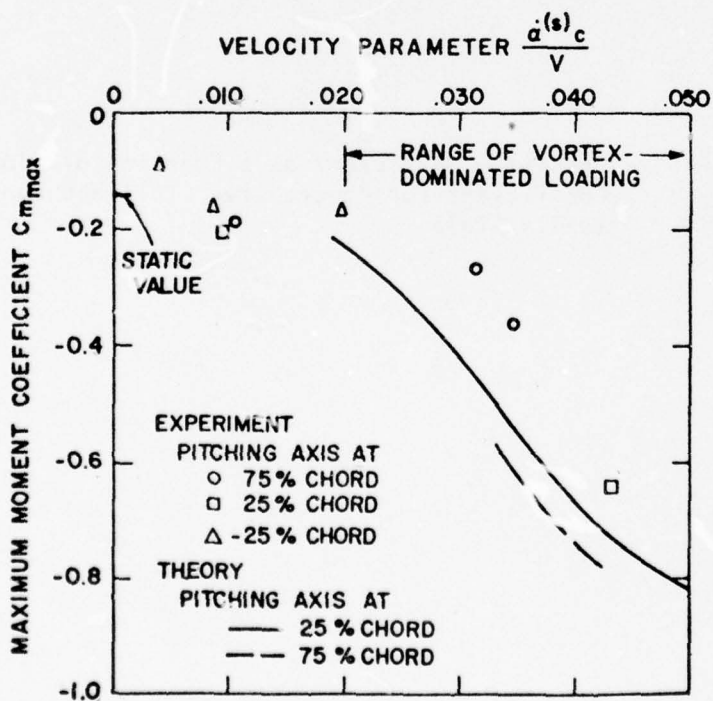
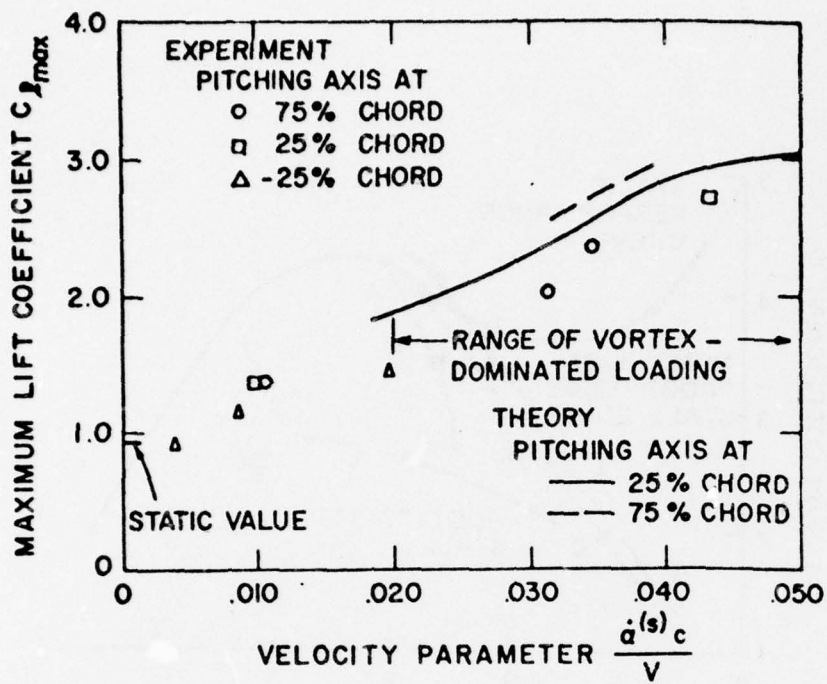

Figure 4 - Maximum Lift and Moment Coefficients as a Function of Velocity Parameter

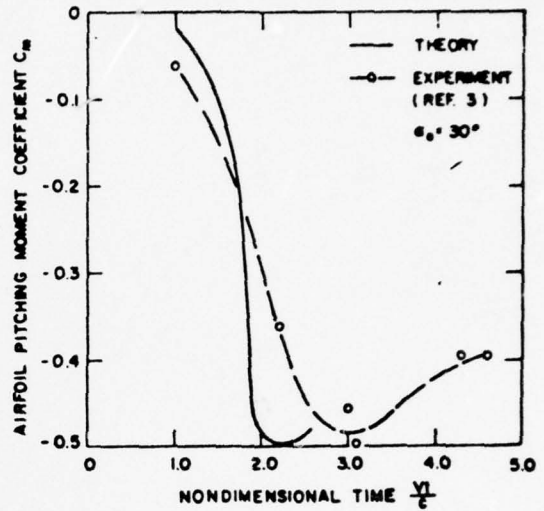
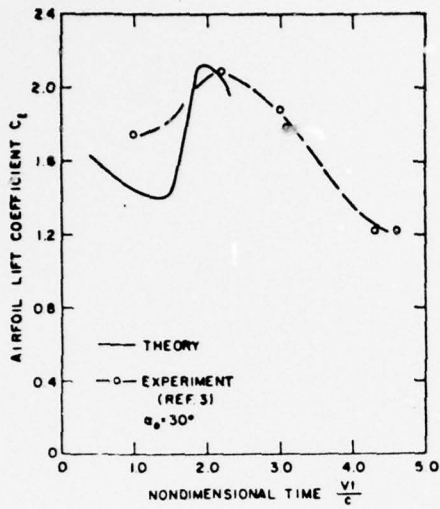

Figure 5 - Airfoil Lift Coefficient and Pitch Moment Variations Following a Sudden Onset of Flow

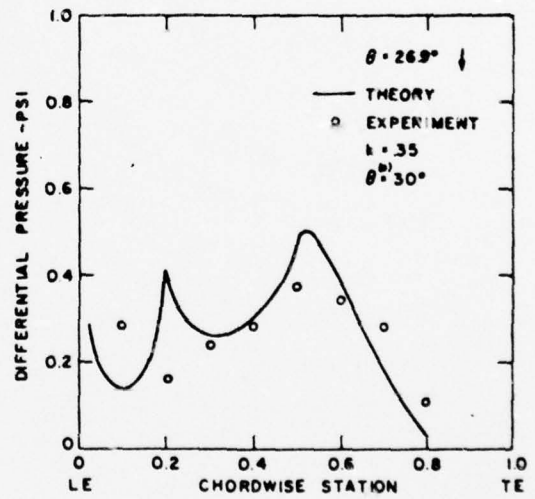
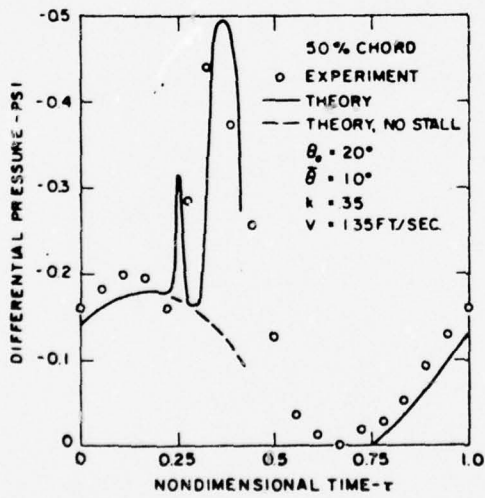

Figure 6 - Temporal and Spatial Unsteady Pressure Distributions

APPENDIX

BIDARD-JENNY ANALYSIS

This analysis is based on that developed by Bidard (1946) and Jenny (1950). The basic analysis was carried out by Bidard in order to study the surge condition. The analysis was then extended by Jenny to allow for a rotary exhaust valve.

As a first approximation the compressor installation is replaced by a model as illustrated in Figure A1a. The point α on the model corresponds to point α on the compressor operating characteristic. Similarly point γ on the model exhaust corresponds to point γ on the exhaust valve characteristic. Under non-steady flow conditions these points α and γ do not usually coincide. At point β on the model the pressure is p' whilst the mass flow is approximately \dot{m} . The point β is then located on the pressure-mass flow diagram. In order to study the non-steady flow as a function of time it is necessary to obtain the movement of point β . If this point tends towards the intersection of the characteristic, N , the system is stable, whereas if the point moves away from N the system is unstable. The compressor and exhaust valve characteristics are plotted as a ratio of the operating conditions at the peak of the compressor characteristic, Figure A1a.

As a first approximation Bidard assumed that the mass M is concentrated in one area, and the capacity Q in another, Figure A1a. The air column LA is considered to flow with the velocity c , and to be accelerated or decelerated as a whole by the difference in pressure

$p-p'$. The pressure p is taken from the steady flow compressor characteristics and has been made non-dimensional by using the reference point 0. The pressure in the receiver is p' , and the mass flow is obtained from the compressor characteristics.

The equation of motion for the gas column is

$$(p-p')A = \rho_m LA \frac{dc}{dt}$$

By substituting

$$\dot{m} = c\rho_m A = c_o\rho_o A$$

$$d\dot{m} \approx A\rho_m dc$$

and from the gas laws

$$\frac{kp}{a_o^2 \rho_o} = 1$$

then

$$\frac{p}{p_o} - \frac{p'}{p_o} = \left[\frac{d}{dt} \left(\frac{\dot{m}}{\dot{m}_o} \right) \right] T_c k M_o$$

where

$$T_c = \frac{L}{a_o}, \quad M_o = \frac{c_o}{a_o}, \quad B_1 = \frac{1}{kT_c M_o}$$

and

$$\frac{d}{dt} \left(\frac{\dot{m}}{\dot{m}_o} \right) = \frac{1}{kT_c M_o} \left(\frac{p}{p_o} - \frac{p'}{p_o} \right) = B_1 \left(\frac{p}{p_o} - \frac{p'}{p_o} \right) \quad (A1)$$

By considering continuity for the receiver, in which the change is taken isentropically in accordance with Jenny, but at variance with Bidard, the following equation is obtained

$$\frac{d}{dt} \left(\frac{p'}{p_o} \right) = \frac{k \left(\frac{a'}{a_o} \right)^2}{T_Q} \left(\frac{\dot{m}}{\dot{m}_o} - \frac{\dot{m}'}{\dot{m}_o} \right) = \left[\frac{\dot{m}}{\dot{m}_o} - \frac{\dot{m}'}{\dot{m}_o} \right] B_2 \quad (A2)$$

where

$$T_Q = \frac{Q}{Ac_o} \quad \text{and} \quad B_2 = \frac{k \left(\frac{a'}{a_o} \right)^2}{T_Q}$$

In order to obtain the stability conditions for small disturbances Bidard assumed that the operating point N became the reference point and then replaced the characteristics by the tangents:

$$\frac{p}{p_o} = n \frac{\dot{m}}{\dot{m}_o}, \quad \frac{p'}{p_o} = n' \frac{\dot{m}'}{\dot{m}_o}$$

From equations (1) and (2)

$$\begin{aligned} \frac{d^2}{dt^2} \left(\frac{p'}{p_o} \right) &= B_2 \frac{d}{dt} \left(\frac{\dot{m}}{\dot{m}_o} \right) - B_2 \frac{d}{dt} \left(\frac{\dot{m}'}{\dot{m}_o} \right) \\ &= B_2 B_1 \left(\frac{p}{p_o} - \frac{p'}{p_o} \right) - B_2 \frac{d}{dt} \left(\frac{1}{n'} \frac{p'}{p_o} \right) \end{aligned}$$

Therefore

$$\frac{d^2}{dt^2} \left(\frac{p'}{p_o} \right) + \frac{B_2}{n'} \frac{d}{dt} \left(\frac{p'}{p_o} \right) - B_2 B_1 \left(n \frac{\dot{m}}{\dot{m}_o} - \frac{p'}{p_o} \right) = 0 \quad (A3)$$

Now from equation (2)

$$B_2 \frac{\dot{m}}{\dot{m}_o} = \frac{d}{dt} \left(\frac{p'}{p_o} \right) + B_2 \frac{\dot{m}'}{\dot{m}_o}$$

Therefore, substituting into equation (A3) gives,

$$\frac{d^2}{dt^2} \left(\frac{p'}{p_o} \right) - \left(n B_1 - \frac{B_2}{n'} \right) \frac{d}{dt} \left(\frac{p'}{p_o} \right) + B_2 B_1 \frac{p'}{p_o} \left(1 - \frac{n}{n'} \right) = 0 \quad (A4)$$

Similarly, from equation (A1)

$$\begin{aligned} \frac{d^2}{dt^2} \left(\frac{\dot{m}}{\dot{m}_o} \right) &= B_1 \frac{d}{dt} \left(\frac{p}{p_o} \right) - B_1 \frac{d}{dt} \left(\frac{p'}{p_o} \right) \\ &= B_1 \frac{d}{dt} \left(n \frac{\dot{m}}{\dot{m}_o} \right) - B_1 B_2 \left(\frac{\dot{m}}{\dot{m}_o} - \frac{1}{n'} \frac{p'}{p_o} \right) \\ &= B_1 \frac{d}{dt} \left(n \frac{\dot{m}}{\dot{m}_o} \right) - B_1 B_2 \frac{\dot{m}}{\dot{m}_o} + \frac{B_2}{n'} \left(B_1 \frac{p}{p_o} - \frac{d \dot{m}}{dt} \right) \end{aligned}$$

therefore

$$\frac{d^2}{dt^2} \left(\frac{\dot{m}}{\dot{m}_0} \right) - \left(nB_1 - \frac{B_2}{n'} \right) \frac{d}{dt} \left(\frac{\dot{m}}{\dot{m}_0} \right) + B_2 B_1 \frac{\dot{m}}{\dot{m}_0} \left(1 - \frac{n}{n'} \right) = 0 \quad (A5)$$

$\frac{p'}{p_0}$ and $\frac{\dot{m}}{\dot{m}_0}$ define the point β on Figure A1a, and the identical differential equations (A4) and (A5) govern the variation of $\frac{p'}{p_0}$ and $\frac{\dot{m}}{\dot{m}_0}$ with time. For stability the coefficients of equations (A4) and (A5) must be positive.

$$\text{Then} \quad n' > n, \quad n' < \frac{C}{n}$$

$$\text{where} \quad C = \frac{B_2}{B_1} = \frac{k^2 L A M_0^2}{Q}$$

This condition for stability is illustrated by Figure A1b. For very large receivers $C \rightarrow 0$ and stability is only possible for $n \leq 0$. The limit is at the peak of the compressor characteristic and the receiver characteristic can have any slope n' in the shaded area. Hence if the compressor operates into a large receiver the surge point will be at the peak of the pressure-mass flow curve; this is generally in agreement with experimental results.

If it is assumed that the receiver characteristic is always positive it is possible to satisfy the stability condition for a positive value of n . At point D, Figure A1b, $n = n' = \sqrt{C}$ and the stability conditions are fulfilled. If n' were greater than \sqrt{C} the stability condition $n' < \frac{C}{n}$ would not be satisfied, and if n' were less than \sqrt{C} the stability condition $n' > n$ would not be satisfied. Hence

point D is the limit of stable operation. At point E the slope n is less than \sqrt{C} and stable operation is possible provided n' lies in the shaded area.

Bidard used his basic equations, (A1) and (A2), to calculate stage by stage the complete surging cycle. Figure A1c is a diagram taken from Bidard's work showing the cycle of surging obtained by his graphical solution. If the starting point lies within the stable region the construction converges on this point showing that all small disturbances are restored to the equilibrium position. If the starting point lies in the unstable region the construction builds up into the surging cycle, the direction of flow is reversed and the receiver is emptied along the negative branch, the flow is then accelerated and the receiver filled approximately along the pressure-mass flow curve.

JENNY'S EXTENSION OF BIDARD'S ANALYSIS

Jenny (1950) extended Bidard's work to allow for a rotary exhaust valve, and to calculate, stage by stage, the non-steady flow phenomenon. Equations (A1) and (A2) can be written in the form

$$\Delta \left(\frac{\dot{m}}{\dot{m}_0} \right) = B_1 \left(\frac{p}{p_0} - \frac{p'}{p_0} \right) \Delta t \quad (A6)$$

$$\Delta \left(\frac{p'}{p_0} \right) = B_2 \left(\frac{\dot{m}}{\dot{m}_0} - \frac{\dot{m}'}{\dot{m}_0} \right) \Delta t \quad (A7)$$

$\frac{\dot{m}'}{\dot{m}_0}$ is obtained from the steady flow valve characteristics for the pressure $\frac{p'}{p_0}$, and $\frac{p}{p_0}$ is taken from the compressor characteristic for the mass flow $\frac{\dot{m}}{\dot{m}_0}$.

The process of this stage by stage calculation is illustrated in Figure A1d. The rotary valve characteristics are shown so that in each time interval, Δt , the characteristic changes from t_1 to t_2 to t_3 , etc. The calculation is commenced at some point 2; the location of this point is either guessed or estimated from experience. In order to locate point 3 the values of $\left[\frac{p}{p_o} - \frac{p'}{p_o} \right]$ and $\left[\frac{\dot{m}}{\dot{m}_o} - \frac{\dot{m}'}{\dot{m}_o} \right]$ are obtained from the graph. $\left[\frac{p}{p_o} - \frac{p'}{p_o} \right]$ is the difference in pressure between the steady flow compressor characteristics and the momentary operating point 2 for the mass flow at 2, and $\left(\frac{\dot{m}}{\dot{m}_o} - \frac{\dot{m}'}{\dot{m}_o} \right)$ is the difference in mass flow between that at 2 and the mass flow for the valve characteristic t_3 for the pressure at 2. The values of $\Delta \left(\frac{\dot{m}}{\dot{m}_o} \right)$ and $\Delta \left(\frac{p'}{p_o} \right)$ are then calculated using equations (A1) and (A2). The horizontal distance from 2 to 3 is then equal to $\Delta \left(\frac{\dot{m}}{\dot{m}_o} \right)$ and the vertical distance is equal to $\Delta \left(\frac{p'}{p_o} \right)$. Thus 3 is located, and similarly round the cycle back to 2. The process is repeated until the cycle is closed. This condition is attained when a calculated point coincides with that obtained during the previous cycle.

The speed at which a calculation settles into a closed cycle depends upon the accuracy of the initial guess, and upon the magnitude of Δt . If the initial guess is perfectly correct only one cycle is necessary. A very poor guess at the starting point can make the calculation extremely long by causing the loop to enter the surge cycle.

In order to avoid this type of difficulty the starting point is usually selected so that the initial loop does not enter the surge cycle. If the calculation does not predict surge it quickly settles into a closed cycle, whereas if surge is predicted the calculation enters the surge cycle after the first loop and then quickly settles into a closed cycle.

Difficulty is also encountered on occasions when the value of Δt is not sufficiently small. When this occurs it is not found possible to obtain a closed cycle. In these cases, in order to perform a satisfactory calculation, it is necessary to reduce Δt to a value less than $\frac{1}{300}$ s.

In order to determine the constants B_1 and B_2 in equations (A6) and (A7), the compressor is replaced by an equivalent pipe using the method suggested by Jenny. The resulting equivalent system contained the same amount of kinetic energy as the compressor. The compressor is 'unwound' and the spiral replaced by a mean length. By integrating the equation of motion through the compressor the length of the equivalent pipe is found, details are given below. For the compressor used in this work the equivalent pipe was found to be 17 in long which, when added to the delivery pipe, gave a total length of 71 in. The constants B_2 and B_1 were defined as:

$$B_2 = \frac{k \left(\frac{a'}{a_o} \right)^2 A c_o}{Q}, \quad B_1 = \frac{a_o^2}{k L c_o}$$

where A = Cross-sectional area of equivalent pipe.

L = The total length of the delivery pipe; the equivalent pipe plus the length of the delivery pipe.

c_o = Air velocity at the reference condition.

a_o = Reference speed of sound.

a' = Speed of sound at point under consideration.

Q = Total receiver volume.

k = Ratio of specific heats.

By making $\frac{a'}{a_o} = 1$ and substituting the other required values,

B_2 and B_1 were found to be 10.15 and 3470 respectively. The time interval Δt could be chosen at random, but for ease of calculation Δt was selected so that each time interval occurred on a known rotary valve characteristic. For the calculations at 50 c/s eight intervals per cycle were suitable, giving $\Delta t = \frac{1}{400}$ s. When the frequency was reduced to 25 c/s it was found that eight intervals per cycle were no longer suitable as the calculation would not settle into a closed cycle. In order to overcome this difficulty it was necessary to reduce Δt by taking 12 intervals per cycle, hence $\Delta t = \frac{1}{300}$ s. For a frequency of 10 c/s it was found to be difficult to obtain a stable cycle despite the use of 24 intervals per cycle. It was necessary, therefore, to use 48 intervals per cycle; the intermediate rotary valve characteristics being obtained by extrapolation from the experimentally known 24 characteristics. This, of course, made the calculations extremely tedious, and those attempted were only continued until it was known whether the calculation would or would not predict surge. The results of two

calculations are given in Figures A2a and A2b.

JENNY'S EQUIVALENT PIPE

Jenny defined an equivalent pipe such that the dynamic behaviour of the compressor was similar to that of a column of gas of length l_{eq} . For this purpose the compressor was 'unwound' and a mean length replaced the spiral, Figure A3. The equation of motion for the fluid particle is

$$F - \frac{dp}{ds} A \delta s = \delta s A \left(\frac{\partial c}{\partial t} + c \frac{\partial c}{\partial s} \right)$$

where F contains the centrifugal and frictional forces.

$$c = c(s,t) = \text{velocity}$$

$$p = p(s) = \text{density}$$

Then

$$\frac{Z}{\rho} - \frac{1}{\rho} \frac{dp}{ds} = \frac{\partial c}{\partial t} + c \frac{\partial c}{\partial s} \quad (A8)$$

where Z is a volume force equal to $F/A \delta s$.

$$\text{For continuity} \quad c\rho A = c_1 \rho_1 A_1$$

where suffix 1 refers to the compressor delivery.

$$\text{Then} \quad c = \frac{c_1 \rho_1 A_1}{\rho A}$$

Substituting into equation (A8) and integrating from 0 to 1 gives

$$\int_0^1 \frac{\partial c_1}{\partial t} \frac{\rho_1 A_1}{\rho A} ds + \int_0^1 c dc = \int_0^1 \frac{Z}{\rho} ds - \int_0^1 \frac{1}{\rho} dp$$

$$\text{then} \quad l_{eq} = \int_0^1 \frac{\rho_1 A_1}{A \rho} ds$$

For steady flow $\frac{\partial c_1}{\partial t} = 0$

and

$$\underbrace{\frac{c_1^2 - c_0^2}{2}}_{\delta K_{\text{steady}}} = \int_0^1 \frac{Z}{\rho} ds - \left(\int_0^1 \frac{1}{\rho} dp \right)_{\text{steady}} \quad (\text{A9})$$

For unsteady flow

$$\frac{\partial c_1}{\partial t} l_{\text{eq}} = -\delta K + \int_0^1 \frac{Z}{\rho} ds - \int_0^1 \frac{1}{\rho} dp$$

Assuming that δK is small, $\delta K \approx \delta K_{\text{steady}}$; then substituting for δK from equation (A9) gives

$$\begin{aligned} \frac{\partial c_1}{\partial t} l_{\text{eq}} &= \left(\int_0^1 \frac{1}{\rho} dp \right)_{\text{steady}} - \int_0^1 \frac{1}{\rho} dp \\ &\approx \frac{p_{\text{steady}} - p}{\rho_1} \end{aligned} \quad (\text{A10})$$

According to equation (A10) the dynamic behaviour of the compressor is similar to that of a column of gas of length l_{eq} . It can easily be shown that the equivalent pipe contains the same kinetic energy as the compressor.

$$\text{Kinetic energy in the equivalent pipe} = \frac{1}{2} M c_1^2$$

therefore

$$\text{kinetic energy} = \frac{1}{2} A_1 \rho_1 l_{\text{eq}} c_1^2$$

Now

$$l_{\text{eq}} = \int_0^1 \frac{A_1 \rho_1}{A \rho} ds$$

therefore,

$$\text{kinetic energy in the equivalent pipe} = \frac{1}{2} A_1 \rho_1 \int_0^1 \frac{A_1 \rho_1}{A \rho} c_1^2 ds$$

From continuity $c = \frac{c_1 A_1 \rho_1}{A \rho}$

therefore,

kinetic energy in the equivalent pipe = $\int_0^1 A \rho c^2 ds$
which is the kinetic energy in the 'unwound' compressor.

The equivalent length l_{eq} is given by

$$l_{eq} = \int_0^1 \frac{A_1 \rho_1}{A \rho} ds = \int_0^1 \frac{c}{c_1} ds$$

This equation was solved by graphically integrating the velocity c throughout the compressor. c is that component of the velocity which is proportional to the quantity of flow.

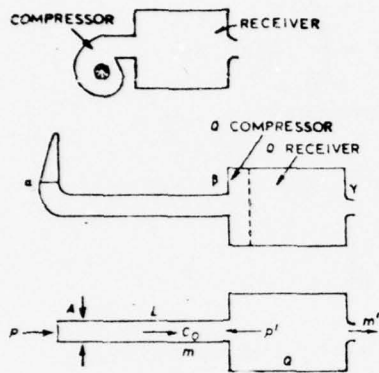

SLOPE OF THROTTLE CHARACTERISTIC

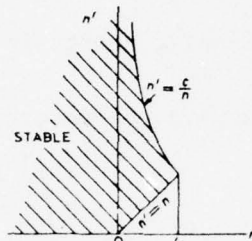

n SLOPE OF COMPRESSOR CHARACTERISTIC

STABLE WHEN n' LIES IN THE SHADED AREA

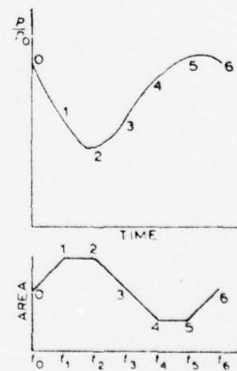
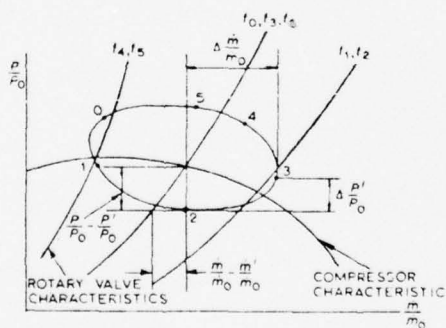
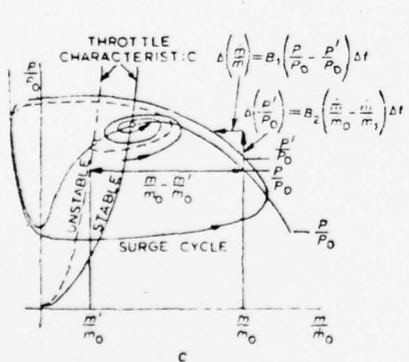
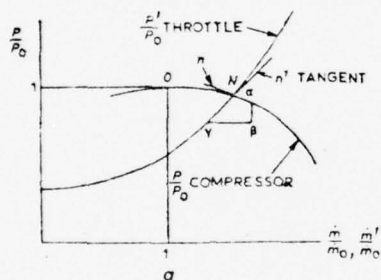
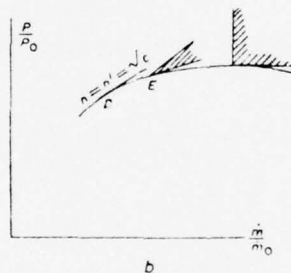
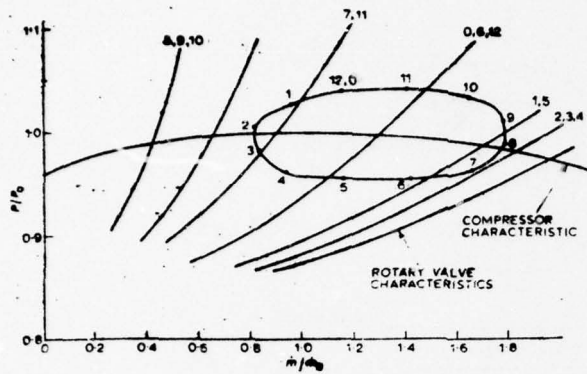
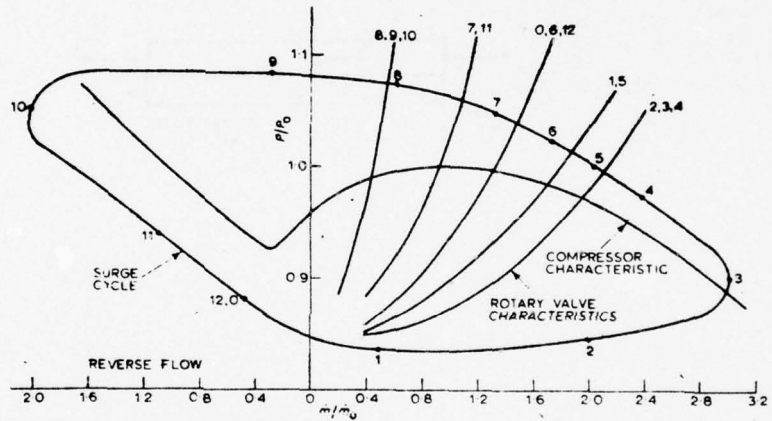

Figure A1 - Bidard-Jenny Calculations



a 50 c/s.



b 25 c/s.

Figure A2 - Unsteady Flow Solution for Exhaust Orifice A2 and Nozzle B

AD-A035 907

DAVID W TAYLOR NAVAL SHIP RESEARCH AND DEVELOPMENT CE--ETC F/G 1/3
AIR-CUSHION-SUPPORTED VEHICLE FAN DYNANIC RESPONSE: A REVIEW OF--ETC(U)
JUN 76 D D MORAN

UNCLASSIFIED

SPD-695-01

NL

2 OF 2
AD-A
035 907



END
DATE
FILMED
3-24-77
NTIS

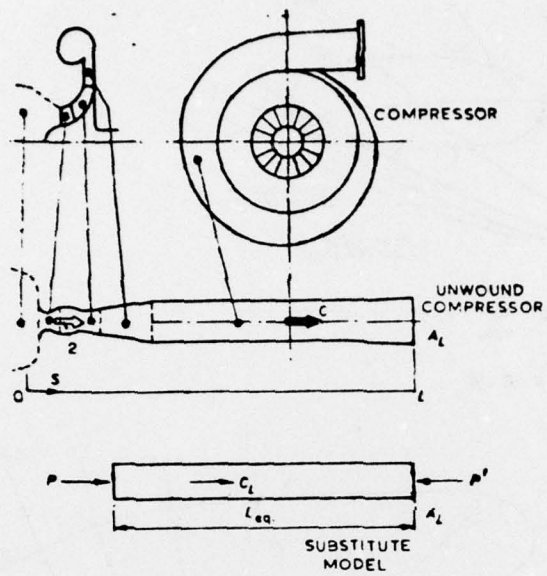

Figure A3 - The Substitute Model

DTNSRDC ISSUES THREE TYPES OF REPORTS

(1) DTNSRDC REPORTS, A FORMAL SERIES PUBLISHING INFORMATION OF PERMANENT TECHNICAL VALUE, DESIGNATED BY A SERIAL REPORT NUMBER.

(2) DEPARTMENTAL REPORTS, A SEMIFORMAL SERIES, RECORDING INFORMATION OF A PRELIMINARY OR TEMPORARY NATURE, OR OF LIMITED INTEREST OR SIGNIFICANCE, CARRYING A DEPARTMENTAL ALPHANUMERIC IDENTIFICATION.

(3) TECHNICAL MEMORANDA, AN INFORMAL SERIES, USUALLY INTERNAL WORKING PAPERS OR DIRECT REPORTS TO SPONSORS, NUMBERED AS TM SERIES REPORTS; NOT FOR GENERAL DISTRIBUTION.