

AD-A036 495

WASHINGTON UNIV SEATTLE DEPT OF ELECTRICAL ENGINEERING
GUIDED WAVES IN ALKALI-HALIDE FILMS.(U)

F/G 20/6

DEC 76 A K RICHTER, F P CARLSON
UW-TR-201

N00014-76-C-0522
NL

UNCLASSIFIED

1 OF 1
AD-A
036 495

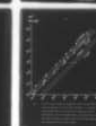
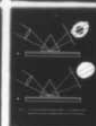
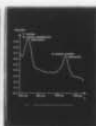

END
DATE
FILMED
4-4-77
NTIS

U.S. DEPARTMENT OF COMMERCE
National Technical Information Service

AD-A036 495

GUIDED WAVES IN ALKALI-HALIDE FILMS

WASHINGTON UNIVERSITY
SEATTLE

DECEMBER 1976

ADA 036495

(Handwritten mark)

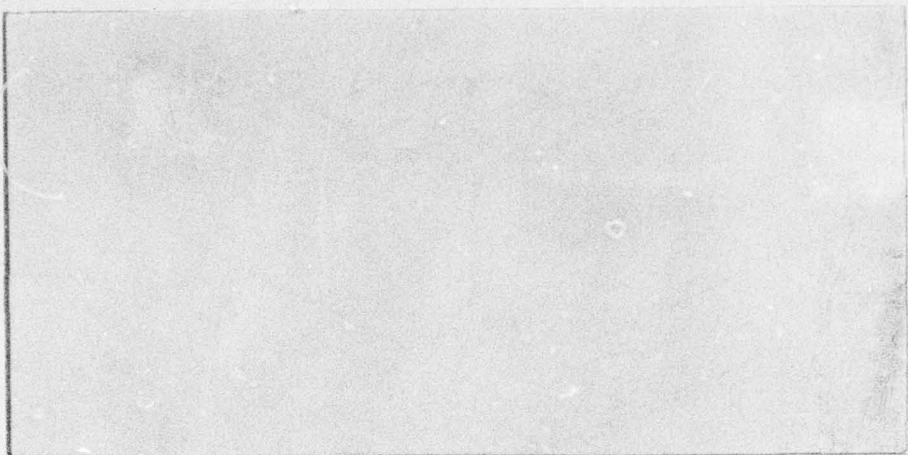

Department of Electrical Engineering
College of Engineering
University of Washington
Seattle, Washington 98195

DDC
RECEIVED
MAR 9 1977



REPRODUCED BY
**NATIONAL TECHNICAL
INFORMATION SERVICE**
U. S. DEPARTMENT OF COMMERCE
SPRINGFIELD, VA. 22161

DISTRIBUTION STATEMENT A
Approved for public release;
Distribution Unlimited

UNIVERSITY OF WASHINGTON
College of Engineering
Department of Electrical Engineering
Seattle, Washington 98195

GUIDED WAVES IN ALKALI-HALIDE FILMS

by

Andreas K. Richter

and

F. Paul Carlson

December 1976

U of W Technical Report No. 201

ONR Contract No. N00014-76-C-0522

Task No. NR 350-005

Scientific Officer

Mr. Joel Trimble

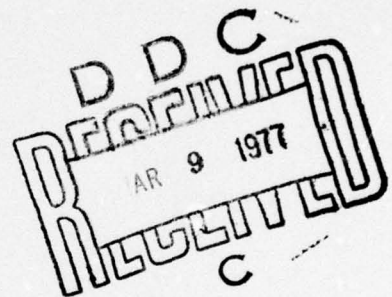

Reproduction in whole or in part is permitted for any purpose of the United States Government. Approved for public release; distribution is unlimited.

Prepared for

Office of Naval Research

Mathematical and Information Sciences Division

Code 437

Arlington, Virginia 22217

Unclassified

Security Classification

//
//

DOCUMENT CONTROL DATA - R & D

(Security classification of title, body of abstract and indexing annotation must be entered when the overall report is classified)

1. ORIGINATING ACTIVITY (Corporate author) Department of Electrical Engineering, FT-10 University of Washington Seattle, WA 98195	2a. REPORT SECURITY CLASSIFICATION Unclassified
	2b. GROUP

3. REPORT TITLE
Guided Waves in Alkali-Halide Films

4. DESCRIPTIVE NOTES (Type of report and inclusive dates)
UW Technical Report No 201

5. AUTHOR(S) (First name, middle initial, last name)
Andreas K Richter and F Paul Carlson

6. REPORT DATE December 1976	7a. TOTAL NO. OF PAGES ,20	7b. NO. OF REFS 11
---------------------------------	-------------------------------	-----------------------

8a. CONTRACT OR GRANT NO. ONR # N00014-76-C-0522 b. PROJECT NO. Task No NR 350-005 c. d.	9a. ORIGINATOR'S REPORT NUMBER(S) UW Technical Report No 201
	9b. OTHER REPORT NO(S) (Any other numbers that may be assigned this report)

10. DISTRIBUTION STATEMENT
Reproduction in whole or in part is permitted for any purpose of the United States Government. Approved for public release; distribution is unlimited.

11. SUPPLEMENTARY NOTES	12. SPONSORING MILITARY ACTIVITY Office of Naval Research Code 437
-------------------------	--

13. ABSTRACT
The feasibility of building writeable and erasable waveguides and thin film optical elements in photodichroic materials was examined. The studies involved consideration of controllable deflection or focal length using the photodichroism of color centers in alkali-halide crystals. Material properties limiting the ultimate application and areas needing further research were identified.

Abstract

The feasibility of building writeable and erasable waveguides and thin film optical elements in photodichroic materials was examined. The studies involved consideration of controllable deflection or focal length using the photodichroism of color centers in alkali-halide crystals. Material properties limiting the ultimate application and areas needing further research were identified.

Introduction

Color centers¹⁻³ formed by crystal defects in alkali-halide films can in some cases be modified by interaction with optical radiation. The centers, called M-centers, can be reoriented at wavelengths, λ_F , corresponding to the F-band absorption. These centers also interact at another wavelength, λ_M , corresponding to the M-band absorption. This latter absorption does not, however, reorient the center. Therefore, by properly orienting the crystal lattice of an M-center type photodichroic crystal in relation to the polarization of radiation, with a wavelength in the neighborhood of λ_M , it is possible to change the index of refraction of the crystal by application of radiation of wavelength λ_F , while simultaneously interacting with the crystal structure in a processing mode at wavelengths λ_M . The work presented here is the result of research towards writeable and erasable optical strip waveguides for integrated optics or thin film elements through a combination of implantation and photodichroism.⁴⁻⁸

Interaction Between Color Centers and Guided Radiation

Two kinds of defects in the cubic crystal lattice of alkali-halide films are of interest. The F-center and the M-center type defects are shown in Fig. 1.

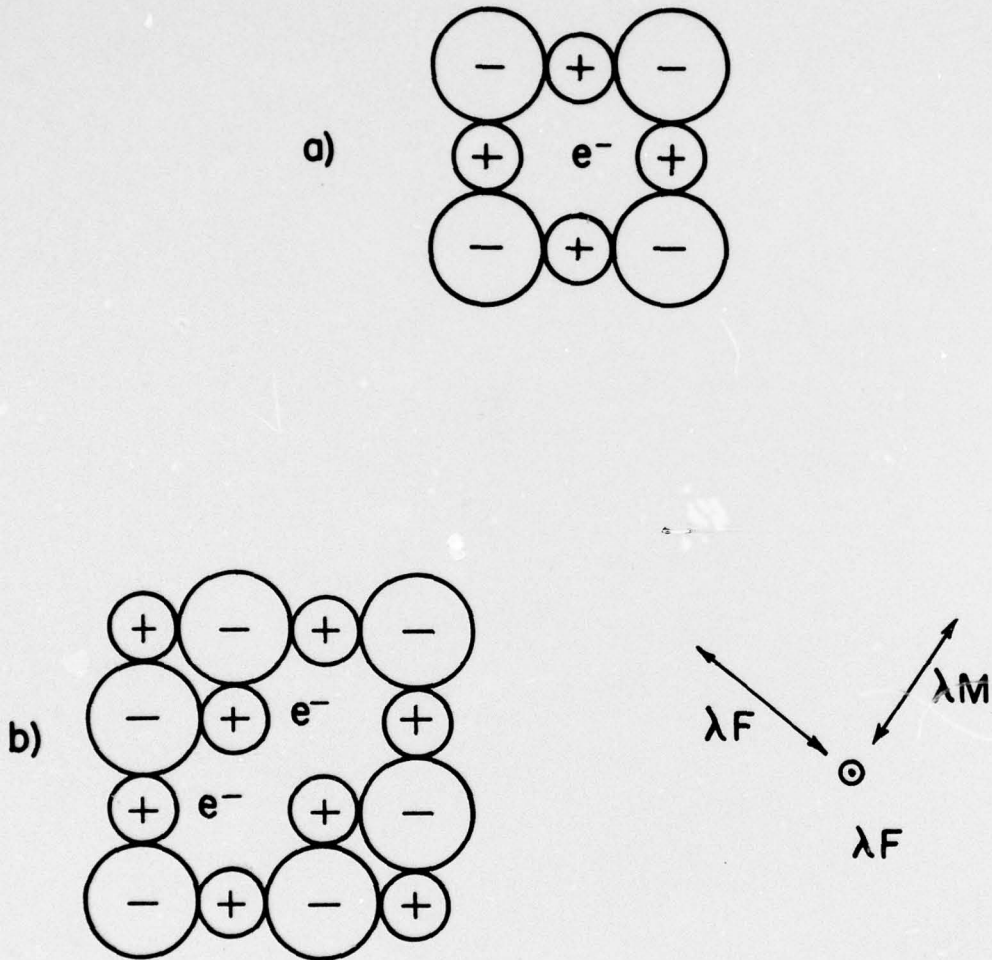

The F-center is a lattice site where an electron has replaced a missing negative ion. The F-center has an absorption peak at λ_F which is generally between 400 to 800 nm depending on the particular alkali-halide combination used. The M-center consists of two adjacent F-centers, diagonally across a face of the cubic lattice. The resonance behavior of the M-center is anisotropic. For fields parallel to the two defect sites it has an absorption peak at λ_M which is approximately $1.6 \lambda_F$, and for fields perpendicular to the two defect sites it has an absorption peak corresponding to λ_F .^{1,2} It also happens that radiation of wavelength, $\lambda = \lambda_F$, absorbed by the M-center, will reorient the center. Due to the Kramers-Kronig relation it is also known that for every change in absorption at λ_M , there exists a change in the index of refraction in the neighborhood of λ_M ,³ as shown in Fig. 2.

Therefore, if radiation corresponding to a wavelength, λ_M' , in the proximity[†] of λ_M , and a polarization in the $\langle 110 \rangle$ direction, propagates through the crystal, the material interaction corresponds to index of refraction changes which can be switched by radiation of another wavelength, λ_F , and appropriate polarization.

An example, of particular interest, is shown in Figs. 3a and 3b. A layer containing alkali-halide M-centers is deposited on a substrate of lower index of refraction. Although it would work to some degree for any crystal lattice orientation, assume that the crystal surface is $\langle 111 \rangle$ oriented. The six directions into which the M-centers can orient are: 1) three in the plane of the crystal layer and 2) three making an angle of 54.7° with respect to the plane of the crystal layer. Thus a vertically polarized beam of wavelength λ_F

[†] By proximity it is meant that minimum absorption is to be obtained while retaining a usable dispersion.

absorption

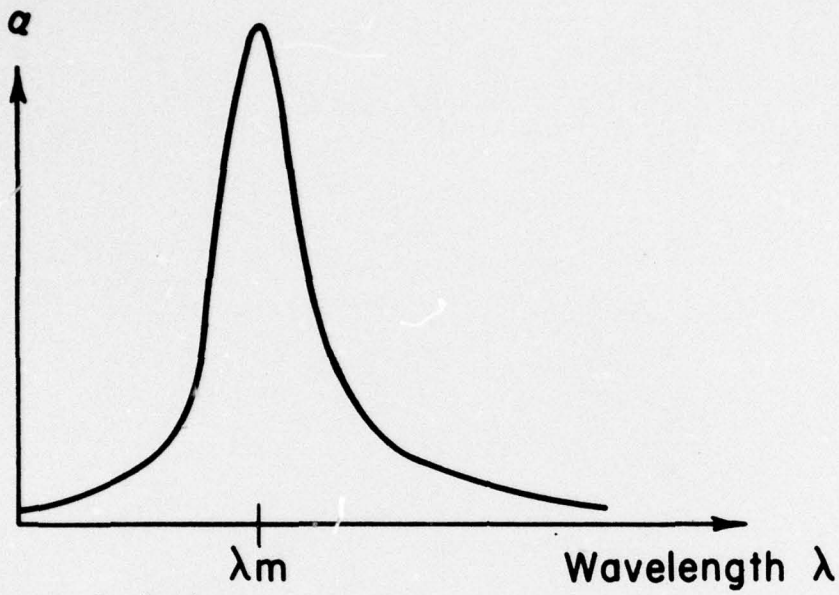

change in index of refraction

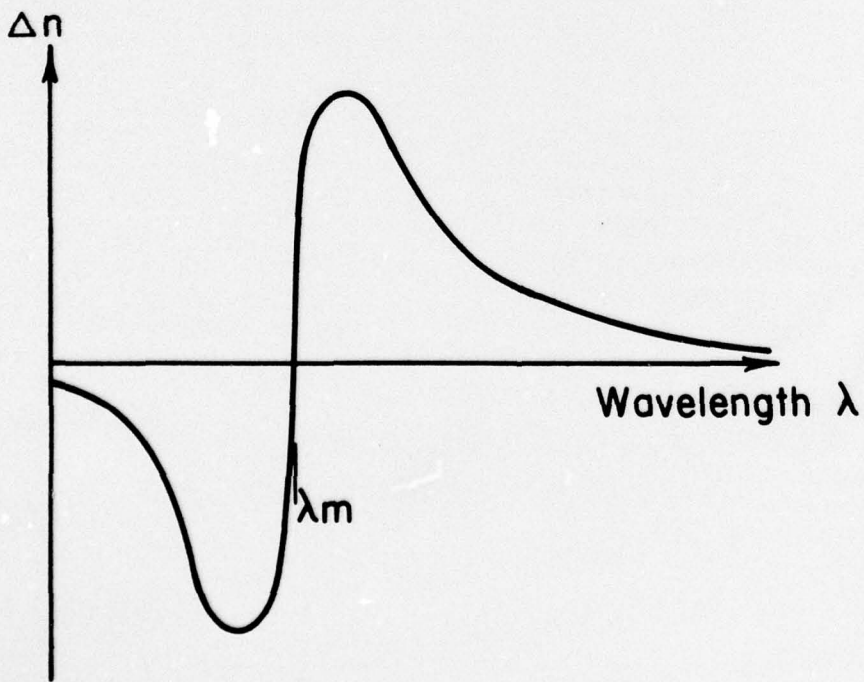

Fig. 2 Contribution of M-centers to optical properties of alkali-halide crystal.

entering along the $\langle 1, -1, -1 \rangle$ or $\langle -1, 1, -1 \rangle$ directions will orient the M-centers into the plane of the crystal. A circularly polarized beam of wavelength λ_F from above or below the crystal will orient the M-centers into the 54.7° position.

So if all M-centers are oriented into the plane first, a small circularly polarized λ_F beam from above could then write a trace of reoriented M-centers, as indicated in Fig. 3a. This perturbation in the index would act as a guiding channel for a vertically polarized beam whose wavelength is slightly larger than λ_M .

Another possibility would be to start with an unperturbed layer of alkali-halide on a substrate of lower index of refraction. Using ion-implantation through masks, optical thin film elements like prisms and lenses could be made in the layer. These elements would have controllable deflection or focal lengths. The control is provided by a vertically polarized λ_F beam from the side or a circularly polarized λ_F beam from above.

If the chosen wavelength of the guided radiation is slightly longer than λ_M , then the contribution from the M-centers will increase the index of refraction, as shown in Fig. 2. Thus a thin film lens with a positive focal length will have the conventional convex shape. Unfortunately, there will always be some absorption connected with the interaction with M-centers and the field transmitted by the lens will therefore have the form of an inverse Gaussian. The inverted Gaussian would cause a large amount of ringing around the focal point, as illustrated in Fig. 4a. This is then a good example of negative apodization.

If, on the other hand, the wavelength of the guided radiation were chosen to be slightly shorter than λ_M , then the contribution from the M-centers will

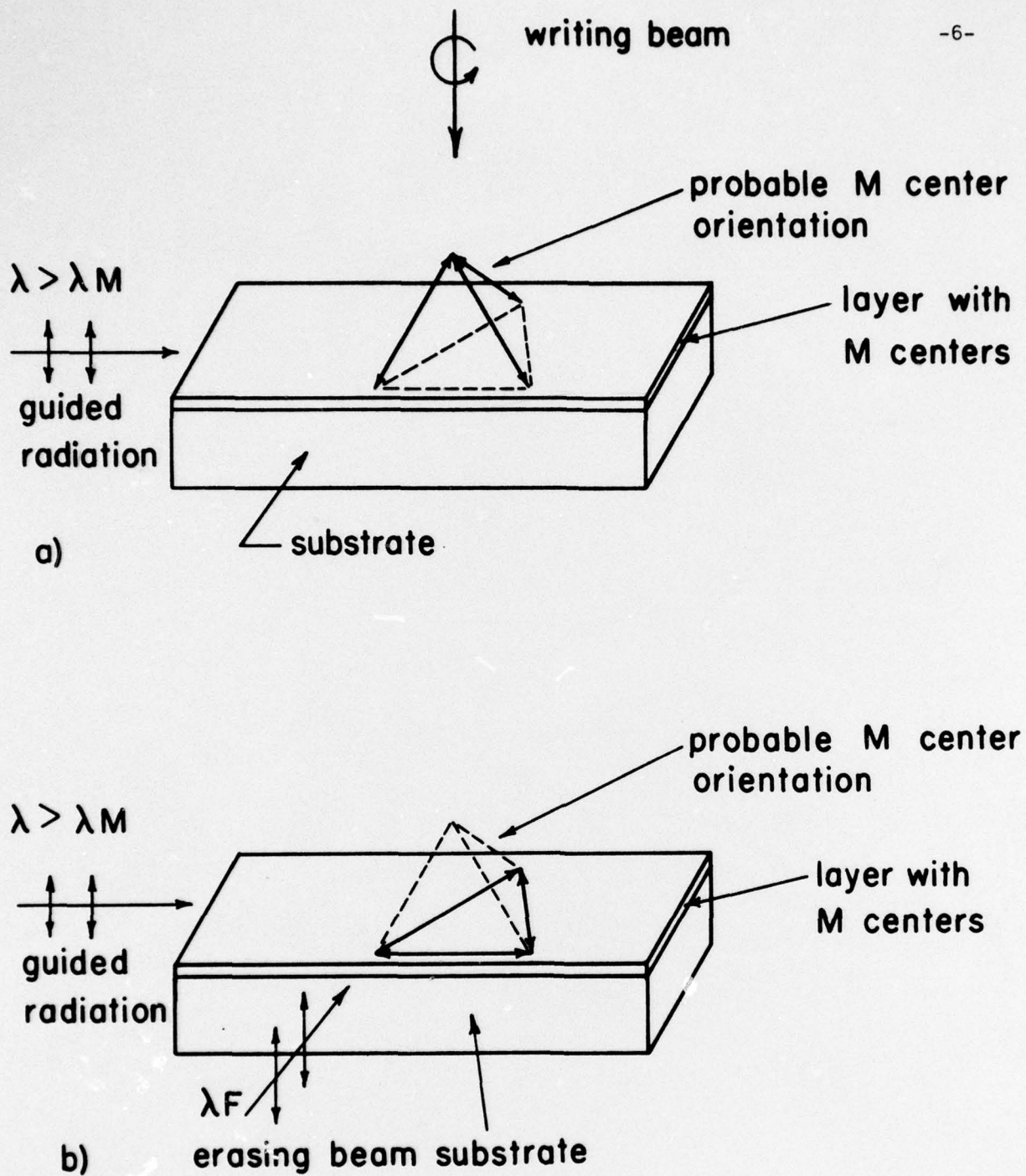

Fig. 3 a) $\langle 111 \rangle$ oriented layer with the M-centers oriented for "high" index of refraction. b) $\langle 111 \rangle$ oriented layer with the M-centers oriented for "low" index of refraction.

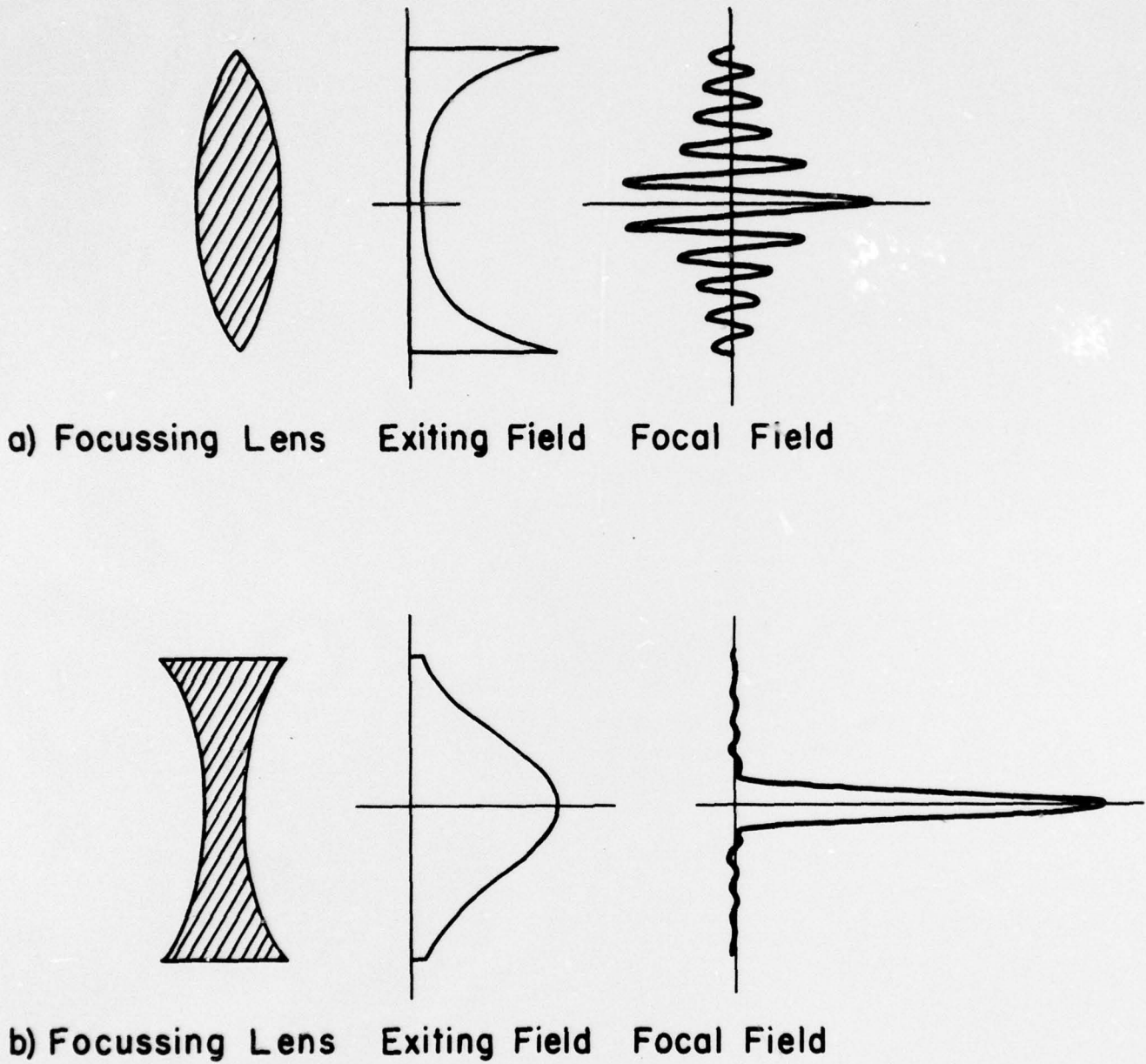

Fig. 4 a) $\lambda > \lambda_M$: Negative apodisation results in ringing in the focal field. b) $\lambda < \lambda_M$: Positive apodisation yields sharp focus.

decrease the index of refraction and a thin film lens with a concave shape will have a positive focal length. In this case the inevitable absorption will lead to a positive apodization, and therefore an improvement in the focal plane resolution, as shown in Fig. 4b.

A simpler case than the guiding layer and substrate arrangement would be the use of a polished single crystal with an ion-implanted surface. The required density of ion-implantation leads to a minimum absorption in the far infra-red, and is thus not too useful for the visible portion of the spectrum.

Bulk Properties of Alkali-Halide Crystals with Defects

To gain information on the properties of color centers in bulk alkali-halide crystals, LiF and KCl crystals were bombarded with α particles in a cyclotron. The relatively deep penetration of ~ 37 MeV α particles (~ 0.5 mm) indicated that the observations were due to bulk rather than surface effects. KCl was highly radioactive with slow decay after irradiation, but LiF could be experimented with after a few hours.¹¹ A crystal with an index of refraction $n = 1.392$ at the Na-D line, as measured in an Abbe refractometer, showed an index of $n = 1.397$ after irradiation with a density of $6 \cdot 10^{14}$ α particles per cm^2 . The measured absorption spectrum of these crystals was in good agreement with the absorption spectrum of other crystals that were only superficially irradiated with H, He and Li ions of ~ 80 keV to a depth of approximately $0.5 \mu\text{m}$. Thus it is reasonable to assume that the properties of thin-film color centers will correspond very closely to those of the bulk crystal. Figure 5 shows a typical absorption spectrum for irradiated LiF.

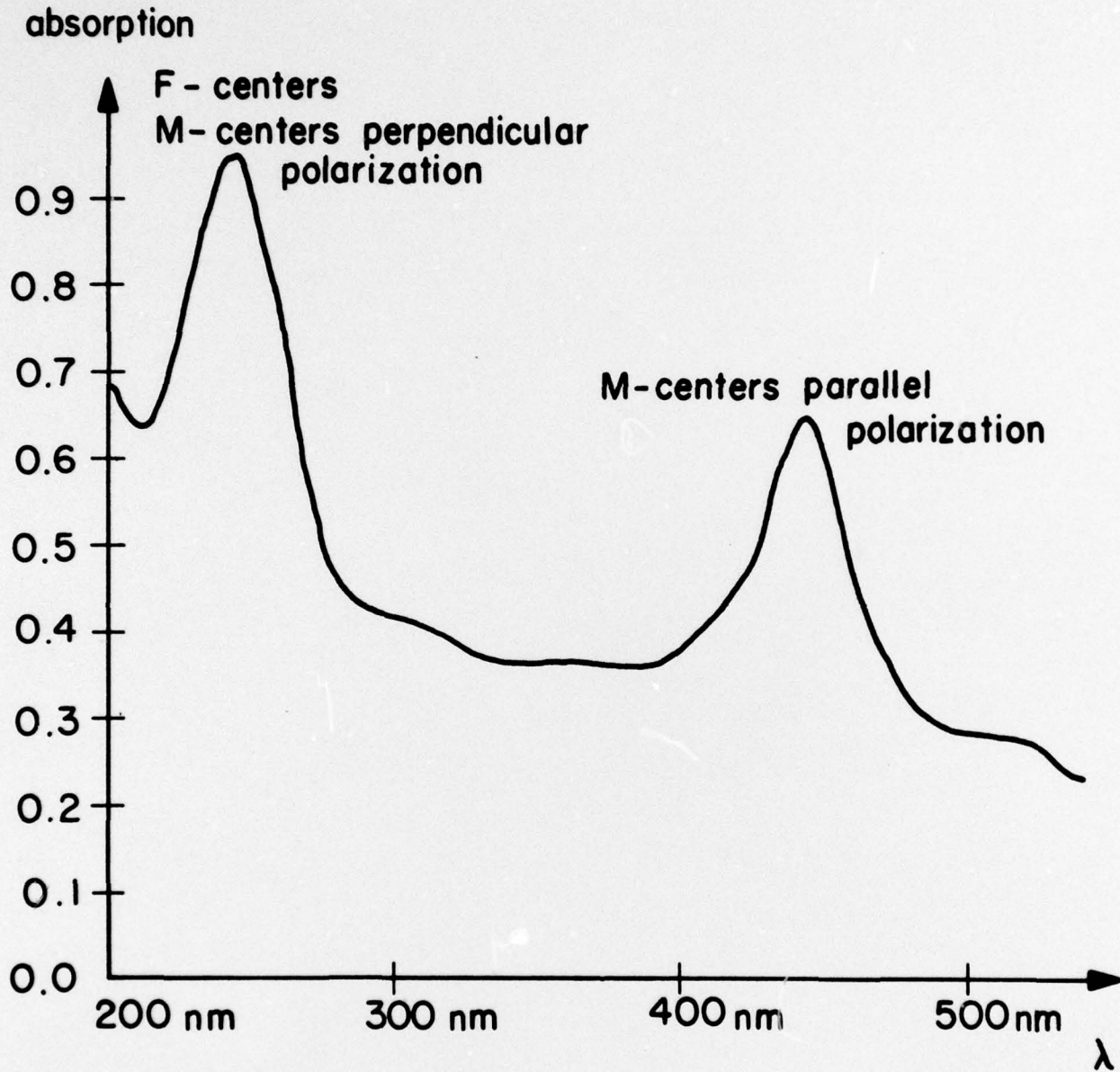

Fig. 5 Typical absorption spectrum of irradiated LiF.

Deposition of the Guiding Layer

Films of KBr, KCl, NaF and NaCl were deposited onto glass, silica, sapphire and LiF. Before deposition all substrates were cleaned ultrasonically in de-ionized water, acetone and isopropanol, then dried in prepure dry nitrogen. Vapor depositions were done in a vacuum of $5 \cdot 10^{-6}$ torr or less from a tantalum Drumheller boat that contained the alkali-halide in powder or crystal form. Because of the smaller surface area, less outgassing resulted for the crystal form. To get films of finer crystalline grain, some glass substrates were also cooled to $\sim 220^{\circ}\text{K}$ thermoelectrically or to $\sim 80^{\circ}\text{K}$ cryogenically. These films were noticeably clearer and appeared smoother in the scanning electron microscope.

Waveguiding Measurements

To find and test all the possible modes for propagation, two methods were used. 1) The reflection method as first reported by Tien, et al.⁹ (see Fig. 6a) and 2) the propagation method¹⁰ (see Fig. 6b). The reflection method indicates all modes, even the strongly attenuated ones, while the propagation method indicates only modes that can propagate at least a fraction of a mm. This pathlength corresponds to the width of the cut in the prism. Using a single prism with a cut greatly simplifies experimental work compared to the mounting and adjusting of in/out coupling prisms. Figs. 7a and 7b show an example of waveguiding for the same $1 \mu\text{m}$ film made with KBr deposited on glass.

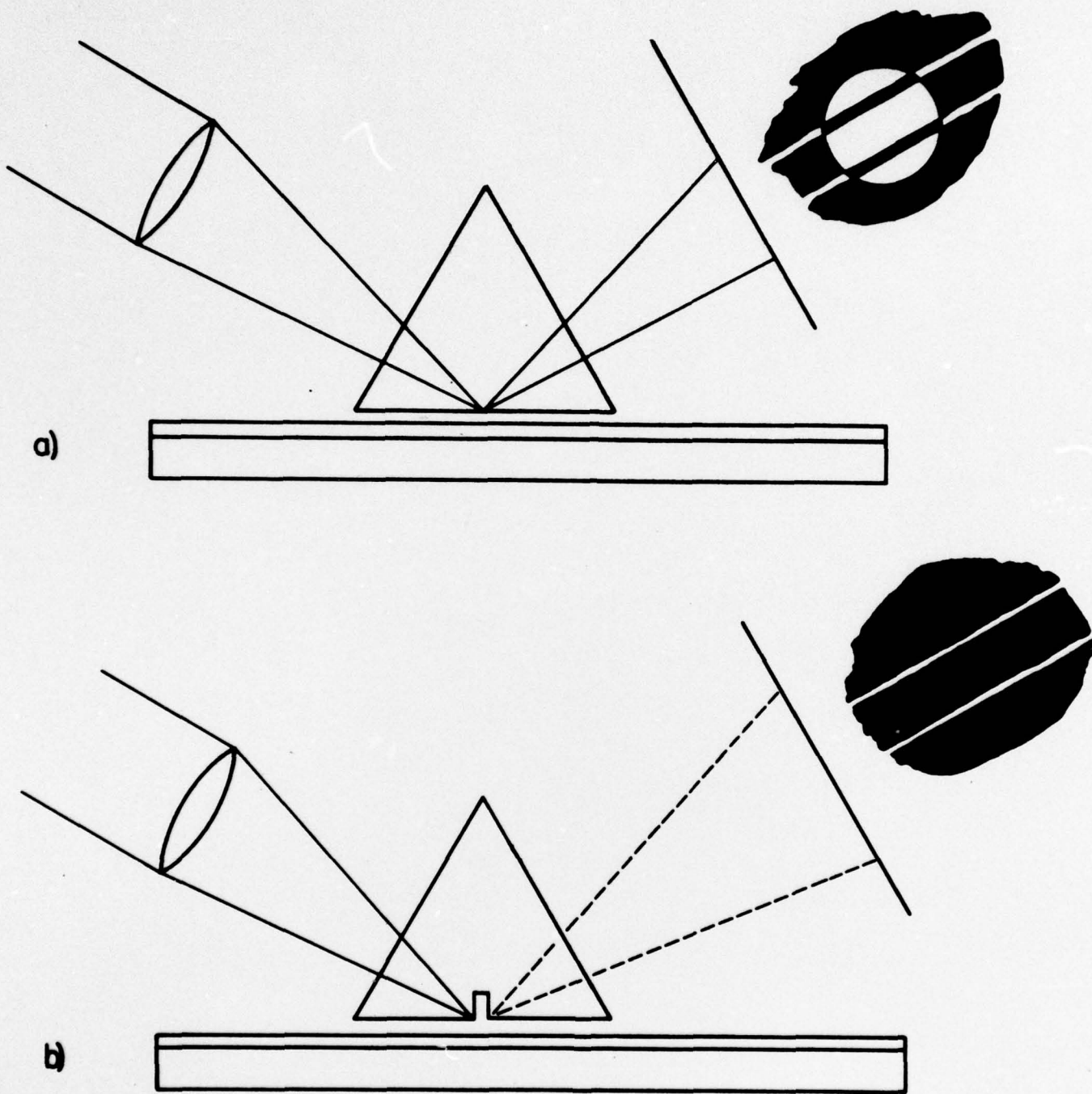
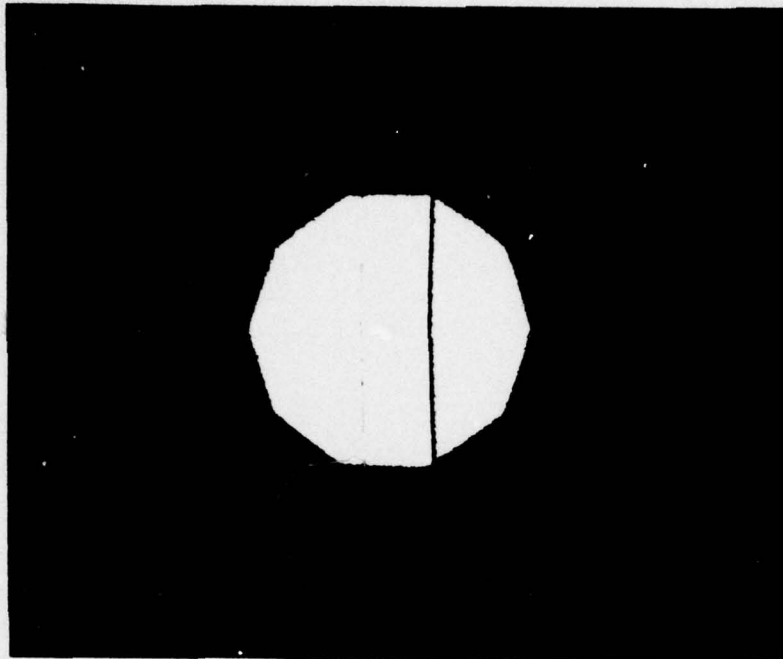

Fig. 6 a) Reflection method⁷ showing all modes. b) Propagation method showing only modes that propagate across the slot in the prism.

a)



\uparrow \uparrow
 TE_0 TE_1
 \downarrow \downarrow

b)

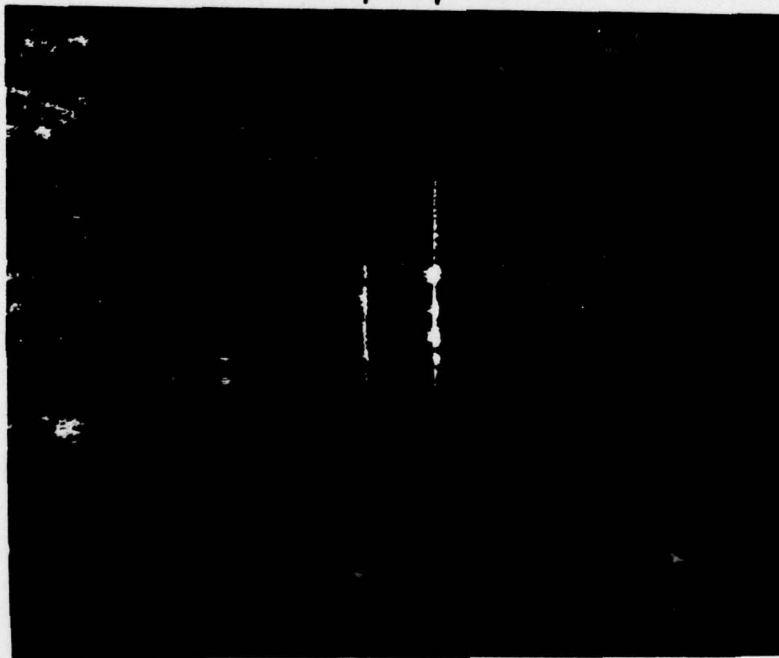

Fig. 7 Modes detected in 1 μ m KBr film on glass at wavelength $\lambda = 472.8$ mm, a) detected by the reflection method, b) by the propagation method. b) was exposed 20 times longer than a).

Difficulties Encountered

All crystals, whether irradiated superficially or in bulk, showed the same absorption spectrum with the typical F- and M-center resonances. However, there was also a broadband absorption that was about as strong as the absorption peak from the M-centers. This background absorption is shown in Fig. 5. The formation of the background absorption is part of the basic material characteristic and could not be suppressed. The result was that small changes in index of refraction could be made only at the cost of high losses due to primarily background absorption. Because of fall off in absorption for longer wavelengths the total absorption is less at longer wavelengths for guided waves. An extensive numerical study to search for a waveguide configuration that would favor changes in effective index over induced absorption showed, that the ratio of phaseshift to attenuation in a guided mode is at best equal to the ratio of phaseshift to attenuation in the bulk material. This ratio again was dependent only on the wavelength of the guided radiation (see Fig. 8). This excluded any possibility for a writeable strip waveguide in the visible part of the spectrum.

Due to equipment limitations, our work was limited to the deposition of alkali-halide films on lower index substrates. Small thin-film elements were built by irradiation through masks. However, films made of KCl, NaF and NaCl showed no guided modes. KBr showed waveguiding when deposited on glass or LiF and tested with the reflection method. Only in rare cases did the propagation method give a positive result. Even then the scattering losses were high (estimated at 40 db/mm), with no correlation between waveguiding properties and visual appearance of clearness

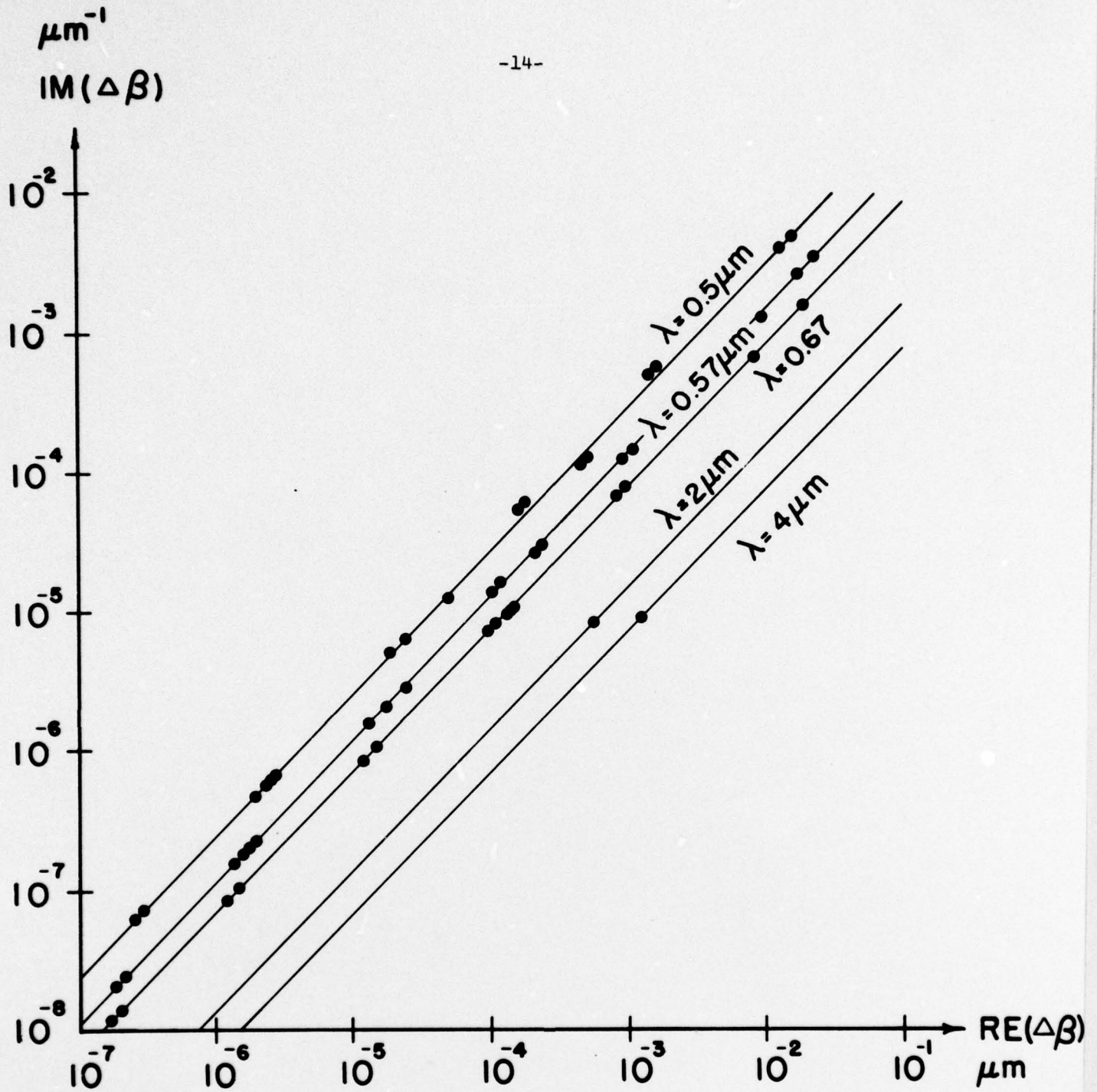

Fig. 8 M-center induced change in propagation $\text{Re}(\Delta\beta)$ versus M-center induced absorption $\text{Im}(\Delta\beta)$ with the wavelength λ as parameter. $\text{Re}(\Delta\beta)/\text{Im}(\Delta\beta)$ tends to be constant and independent of guide configuration, TE or TM and mode order, but dependent only on λ . Each point represents a computed case for some guide configuration containing LiF with color centers.

or frostiness. The reproducibility of the results was poor. Substrate cooling during evaporation gave smoother films but no improvement in the waveguiding properties.

The KBr films were very sensitive to humidity. After a few minutes of exposure to air or after an hour under the coupling prism, wave propagation became undetectable. To prevent recrystallization into coarser grains caused by humidity, some films were covered by 10nm and some by 70 nm MgF_2 to provide a protective layer. This coating, however, caused the apparent guided modes to disappear. The KBr films also recrystallized under the pressure of the coupling prism.

Conclusion

All these preliminary results point to the fact, that the main usefulness of alkali-halide photodichroism for writeable waveguides is in the far infrared. Thin film elements are less critical as far as absorption losses are concerned and the application in the visible seems therefore possible. There are two problems that require resolution for further research in this area:

- The elimination or reduction of the background absorption.
- Better and more reproducible film structures.

More work remains in our efforts to improve the vapor deposited films. Vacuum heat treating of the substrate before deposition, for instance, seems to lead to better results.

List of References

1. F. Abeles: Optical Properties of Solids, North Holland Publishing Company, Chapter 9: Structure of Trapped Electrons and Trapped Hole Centers in Alkali-Halide Color Centers.
2. Solid State Physics, Vol. 16, 1964, Academic Press, pp. 121-223: F-Aggregate Centers in Alkali-Halide Crystals.
3. I. Schneider: "Dispersion and Diffraction by Anisotropic Centers in Alkali-Halides," Physical Review Letters, 32, pp. 412-415, 25 Feb., 1974.
4. E. R. Schinellèr, R. P. Flam, D. W. Wilmot: "Optical Waveguides Formed by Proton Irradiation of Fused Silica," JOSA 58, 9, 1171, Sept., 1968.
5. D. T. Y. Wei, W. W. Lee, L. R. Bloom: "Quartz Optical Waveguide by Ion Implantation," Appl. Phys. Letters 22, 1, p. 5, Jan., 1973.
6. S. Namba, H. Aritome, T. Nishimura, K. Masuda, K. Toyoda: "Optical Waveguides Fabricated by Ion Implantation," J. Vac. Sci. Tech. 10, 6, 936, Nov. - Dec., 1973.
7. I. Schneider: "Reorientation of M-centers in KCl," Phys. Rev. Lett., 24, 23, 1296, June, 1970.
8. W. C. Collings, I. Schneider: "Optical Properties and Reorientation of M-centers in NaF," Phys. Stat. Sol. (b) 51, 769, 1972.
9. P. K. Tien, R. Ulrich, R. J. Martin: "Modes of Propagating Light Waves in Thin Deposited Semi-conductor Films," Appl. Phys. Lett. 14, 9, 291, May, 1969.
10. P. K. Tien, S. Riva-Sanseverino, R. J. Martin, A. A. Ballman, H. Brown: "Optical Waveguide Modes in Single-Crystalline LiNbO_3 - LiTiO_3 Solid Solution Films," Appl. Phys. Lett. 24, 10, p. 503, May, 1974.
11. Table of Isotopes,, p. B245, CRC Handbook of Chemistry and Physics 51st Edition, 1970-1971.