

AD-A037 773

COAST GUARD RESEARCH AND DEVELOPMENT CENTER GROTON CONN F/G 13/10
LIGHTWEIGHT LIGHTED BUOY DEVELOPMENT FOR USE AS DISCREPANCY NAV--ETC(U)
DEC 76 W E COLBURN, W R THOMPSON

UNCLASSIFIED

C6R/DC-20/76

USCG-D-2-77

NL

| OF |
AD
A037773



END

DATE
FILMED
4-77

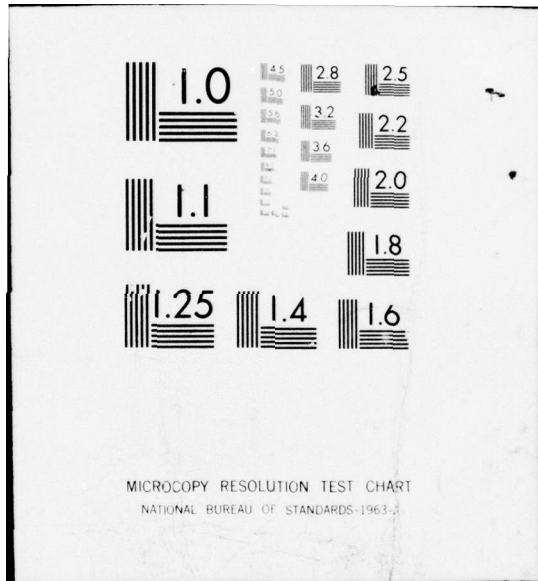

MICROCOPY RESOLUTION TEST CHART
NATIONAL BUREAU OF STANDARDS-1963-A

REPORT NO. CG-D-2-77

14
NW

LIGHTWEIGHT LIGHTED BUOY DEVELOPMENT
FOR USE AS DISCREPANCY NAVAIDS

ADA03773

W. E. Colburn, Jr.
and
W. R. Thompson



December 1976

FINAL REPORT

DDC
RECEIVED
APR 5 1977
A

Document is available to the U. S. public through the
National Technical Information Service,
Springfield, Virginia 22161

AD No. _____
DDC FILE COPY

PREPARED FOR
U.S. DEPARTMENT OF TRANSPORTATION
UNITED STATES COAST GUARD
OFFICE OF RESEARCH AND DEVELOPMENT
WASHINGTON, D.C. 20590

NOTICE

This document is disseminated under the sponsorship of the Department of Transportation in the interest of information exchange. The United States Government assumes no liability for its contents or use thereof.

The United States Government does not endorse products or manufacturers. Trade or manufacturers' names appear herein solely because they are considered essential to the object of this report.

The contents of this report reflect the views of the U.S. Coast Guard Research and Development Center, which is responsible for the facts and accuracy of data presented. This report does not constitute a standard, specification or regulation.

Technical Report Documentation Page

1. Report No. 18 U.S. CG-D-2-77 19	2. Government Accession No.	3. Recipient's Catalog No.	
4. Title and Subtitle 6 LIGHTWEIGHT LIGHTED BUOY DEVELOPMENT FOR USE AS DISCREPANCY NAVAIDS 11		5. Report Date December 1976	6. Performing Organization Code
7. Author 10 W.E. COLBURN and W.R. THOMPSON 1299p		8. Performing Organization Report No. 14 CGRDC-20/76	
9. Performing Organization Name and Address U. S. Coast Guard Research and Development Center Avery Point Groton, CT 06340		10. Work Unit No. (TRAIS) 762541	11. Contract or Grant No. 772540
12. Sponsoring Agency Name and Address Department of Transportation U. S. Coast Guard Office of Research and Development Washington, DC 20590		13. Type of Report and Period Covered 9 FINAL REPORT. 1971 - 1976	
15. Supplementary Notes			
16. Abstract This report presents the development of the Coast Guard discrepancy buoys. A discrepancy buoy is used as a temporary floating aid to navigation while the normal aid is not available due to storm damage, collision, or failure. The discrepancy buoys are also used for special aids such as the temporary marking of wrecks or the control of boats at regattas. The 190-pound prototype discrepancy buoy has survived storms with wind velocities of up to 68 mph and waves in excess of five feet. The buoy provides a one nautical mile daymark visual range of its interchangeable NUN and CAN shapes, a one nautical mile radar reflectivity, a light range of three nautical miles (with the standard 155mm lantern), and sufficient battery capacity to provide 40 days of unattended operation with "off the shelf" batteries. The buoy has potential of extended deployments such as seasonal NAVAIDS by the utilization of solar panels. The buoy has been tested in currents up to five knots and is capable of being moored at scopes as short as 1.7:1 even at currents of up to four knots. This buoy was designed for ease of handling from a small boat and minimal maintenance. The following is included in this report: a project history; a description of the pre-prototype and prototype buoys; an engineering evaluation of the tentative operational requirements; a description of a suitable lightweight mooring system; conclusions; and descriptions of the sequence of buoys that were studied during the progress of this project.			
17. Key Words discrepancy buoy, temporary buoy, emergency buoy, lighted buoy, lightweight buoy, NAVAID, navigational buoy		18. Distribution Statement Document is available to the U.S. public through the National Technical Information Service, Springfield, Virginia 22161	
19. Security Classif. (of this report) UNCLASSIFIED	20. Security Classif. (of this page) UNCLASSIFIED	21. No. of Pages 92	22. Price

408730

JB

APPROVED FOR _____
 DATE _____
 BY _____
 DIVISION/AVAILABILITY CODES _____
 DATE _____ AVAIL. AND/OR SPECIAL _____

NTC White Section
 DOD Buff Section
 UNCLASSIFIED
 UNCLASSIFIED

METRIC CONVERSION FACTORS

Approximate Conversions to Metric Measures		Approximate Conversions from Metric Measures		
Symbol	When You Know	Multiply by	To Find	Symbol
LENGTH				
in	inches	2.5	centimeters	cm
ft	feet	30	centimeters	cm
yd	yards	0.9	meters	m
mi	miles	1.6	kilometers	km
AREA				
in ²	square inches	6.5	square centimeters	cm ²
ft ²	square feet	0.09	square meters	m ²
yd ²	square yards	0.8	square meters	m ²
mi ²	square miles	2.6	square kilometers	km ²
	acres	0.4	hectares	ha
MASS (weight)				
oz	ounces	28	grams	g
lb	pounds	0.45	kilograms	kg
	short tons (2000 lb)	0.9	tonnes	t
VOLUME				
tsp	teaspoons	5	milliliters	ml
Tbsp	tablespoons	15	milliliters	ml
fl oz	fluid ounces	30	milliliters	ml
c	cups	0.24	liters	l
pt	pints	0.47	liters	l
qt	quarts	0.95	liters	l
gal	gallons	3.8	liters	l
ft ³	cubic feet	0.03	cubic meters	m ³
yd ³	cubic yards	0.76	cubic meters	m ³
TEMPERATURE (exact)				
°F	Fahrenheit temperature	5/9 (after subtracting 32)	Celsius temperature	°C
TEMPERATURE (exact)				
°C	Celsius temperature	9/5 (then add 32)	Fahrenheit temperature	°F

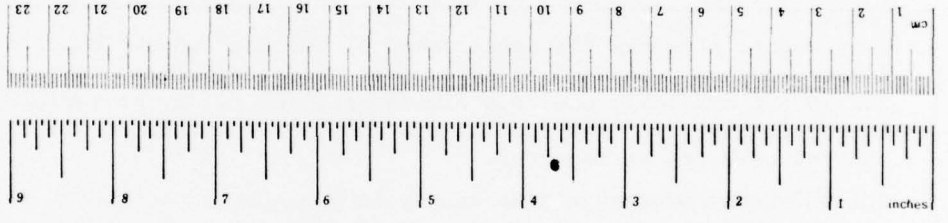

*From A. S. G. "Units, Weights and Measures, Physics 62,255, 80, C. 1941, by Van Nostrand Reinhold, 1946.

TABLE OF CONTENTS

	<u>Page</u>
1.0 INTRODUCTION	1
2.0 OBJECTIVE	2
3.0 PROJECT SUMMARY	6
4.0 DESCRIPTION AND PERFORMANCE OF THE BUOYS	6
4.1 <u>Pre-Prototype Sheltered and Exposed Water Discrepancy Buoy</u>	6
4.1.1 <u>Pre-Prototype Sheltered Water Discrepancy Buoy (PPSWDB)</u>	6
4.1.2 <u>Pre-Prototype Exposed Water Discrepancy Buoy (PPEWDB)</u>	8
4.1.3 <u>Pre-Prototype Buoy Tests, Evaluations, and Results</u>	10
4.2 <u>Wine Glass Discrepancy Buoy (WGDB)</u>	11
5.0 ENGINEERING EVALUATION OF THE DESIGN REQUIREMENTS	22
5.1 <u>Aid Presentation to the Mariner</u>	24
5.1.1 <u>Daylight Visual Characteristics</u>	24
5.1.2 <u>Night Visual Characteristics</u>	31
5.1.3 <u>Radar Reflector Characteristics</u>	32
5.2 <u>Stability and Environmental Requirements</u>	34
5.2.1 <u>Reserve Buoyancy and Static Stability</u>	37
5.2.2 <u>Wind Forces and The Resulting Overturning Moments</u>	37
5.2.3 <u>Performance in Current</u>	42
6.0 MOORING SYSTEM REQUIREMENTS	51
7.0 CONCLUSIONS AND RECOMMENDATIONS	51
REFERENCES	53
APPENDIX A - DESCRIPTION AND EVALUATION OF THE FIRST GENERATION DISCREPANCY BUOYS	A-1
APPENDIX B - DESCRIPTION AND EVALUATION OF THE SECOND GENERATION DISCREPANCY BUOYS	B-1
APPENDIX C - DESCRIPTION AND EVALUATION OF THE BASE MAYPORT AND BASE CHARLESTON DISCREPANCY BUOYS	C-1
APPENDIX D - DESCRIPTION AND EVALUATION OF THE THIRD GENERATION DISCREPANCY BUOYS	D-1

LIST OF TABLES

<u>Table</u>	<u>Title</u>	<u>Page</u>
1	MATRIX OF BUOY PERFORMANCE	5
2	HORIZON PROJECTION HEIGHT FOR 1/2 MILE DISTANCE INCREMENTS	26
3	EQUIVALENT FIXED INTENSITY FOR A 155 MM ACRYLIC LENS 12V 0.25 AMP LAMP	31
4	EQUIVALENT FIXED INTENSITIES NOMINAL RANGE (NM)	32
5	BUOY DIMENSIONS FOR WIND CALCULATIONS	40

LIST OF FIGURES

<u>Figure</u>	<u>Title</u>	<u>Page</u>
1	FLOW CHART OF DISCREPANCY BUOY PROJECT	4
2	NUN AND CAN VERSIONS OF THE PPSWDB BUOY	7
3	BATTERY COMPARTMENT ON THE PRE-PROTOTYPE BUOYS	8
4	NUN AND CAN VERSIONS OF THE PPEWDB BUOY	9
5	WGDB BUOY WITH NUN AND CAN DAYMARKS	11
6	WGDB BUOY AFTER SEVERAL STRIKES BY A SLEDGE HAMMER	12
7	WGDB BUOY CONSTRUCTION	13
8	WGDB BUOY RADAR REFLECTOR	15
9	WGDB BUOY RADAR REFLECTOR INSTALLATION	16
10	DAYMARK ATTACHMENT ON THE WGDB BUOY	17
11	PERMANENT BATTERY CONNECTION ON THE WGDB BUOY	18
12	ACCESSIBLE BATTERY COMPARTMENT ON THE WGDB BUOY	19
13	INCLINING EXPERIMENT OF THE WGDB BUOY	20
14	SELF-RIGHTING TEST OF THE WGDB BUOY	20
15	A WGDB BUOY RIDING WELL IN A 40-KNOT STORM	21
16	DESTRUCTIVE TESTING OF THE WGDB BUOY	23
17	DUNTLEY'S NOMOGRAM	25
18	LIMITATIONS OF THE DAYMARK SHAPE GUIDELINES	28
19	METHODS OF INTERCHANGING DAYMARKS	29-30
20	RADAR REFLECTOR SIZE ANALYSIS	35
21	THEORETICAL RADAR RANGE OF THE BUOYS	36
22	INCLINING EXPERIMENT METHOD	38
23	RIGHTING MOMENT CURVE FOR THE BUOYS	39
24	BUOY SHAPE FOR WIND FORCE CALCULATIONS	40
25	CALCULATED WIND FORCES AND RESULTING MOMENTS	41
26	PREDICTED PERFORMANCE OF THE WGDB BUOY	43
27	PREDICTED MOORING LINE TENSION	44
28	MEASURED MOORING LINE TENSION OF THE WGDB BUOY	46
29	CURRENT TESTS OF THE WGDB BUOY	47
30	CURRENT TESTS OF THE PRE-PROTOTYPE BUOY	48
31	MEASURED MOORING LINE TENSIONS OF THE PRE-PROTOTYPE BUOYS	49
32	MOORING SYSTEMS FOR DISCREPANCY BUOYS	50

LIST OF FIGURES FOR APPENDICES

<u>Figure</u>	<u>Title</u>	<u>Page</u>
1A	FIRST GENERATION MODIFIED BORG-WARNER BUOY	A-2
2A	1GS BUOY BEFORE MOORING MODIFICATION	A-3
3A	EXPLODED VIEW OF THE 1GS BUOY	A-4
4A	1GS BUOY AFTER MOORING MODIFICATION	A-6
5A	BATTERY REPLACEMENT ON THE 1GS BUOY	A-6
6A	TOWING OF THE 1GS BUOY	A-7
7A	1GE BUOY BEFORE MOORING MODIFICATION	A-8
8A	EXPLODED VIEW OF THE 1GS BUOY	A-9
1B	2GS BUOY AND ASSOCIATED HARDWARE	B-2
2B	BATTERY COMPARTMENT OF THE 2GS BUOY	B-3
3B	LANTERN MOUNTED ON THE 2GS BUOY	B-3
4B	2GE BUOY	B-5
5B	BATTERY STORAGE LOCATION IN THE 2GE BUOY	B-6
6B	TRANSPORT OF THE 2GE BUOY VIA PICKUP TRUCK	B-7
7B	TRANSPORT OF THE 2GE BUOY	B-8
1C	ALERP BUOY	C-1
2C	BASE MAYPORT BUOY	C-2
3C	BASE CHARLESTON BUOY (4-FOOT DIAMETER)	C-4
4C	BASE CHARLESTON BUOY (5-FOOT DIAMETER)	C-5
5C	REPAIR OF THE BASE CHARLESTON BUOY	C-6
6C	DAMAGE OF THE BASE CHARLESTON BUOY	C-7
1D	3GS AND 3GE BUOYS	D-1
2D	BATTERY COMPARTMENT IN THIRD GENERATION BUOYS	D-3

1.0 INTRODUCTION

This report presents the development of the Coast Guard discrepancy buoys. A discrepancy buoy is used as a temporary floating aid to navigation while the normal aid is not available due to storm damage, collision, or failure. The discrepancy buoys are also used for special aids such as the temporary marking of wrecks or the control of boats at regattas.

Although the formal initiation of the discrepancy buoy project did not take place until the spring of 1971, discrepancy buoys existed well before then. Almost every unit that had a need for a discrepancy buoy designed and fabricated their own. The best documented early discrepancy buoy was Coast Guard District Seven's "ALERP" (Aluminum Lighted Emergency Reinforced Plastic) buoy with its first generation appearing in 1962. By 1968 the fourth generation was being used and further re-designs were developed beyond that. This buoy was quite sufficient for the calm southeast United States environment but could not survive in other locations. Although it was probably the best buoy available at the time, it did not have a standard daymark (the standard daymark evolved subsequently), was heavy (400 pounds), had almost no radar reflectivity, and did not have a sufficient battery storage location.

The principal shortcoming of the early discrepancy buoys was their lack of performance capability as a functioning aid-to-navigation. In order for a discrepancy buoy to perform adequately, the buoy must have a daymark of sufficient size with the proper shape and color; have a lantern of sufficient intensity and with the proper characteristic; have a radar reflector with sufficient radar reflectivity; be able to withstand an adverse environment of combined waves, wind, and current; have sufficient battery capability to provide power to the lantern for the desired servicing interval; be of a size, weight, and shape that can be safely and reliably handled by various small and large vessels and to permit transport by pickup truck or possibly aircraft; be durable enough to withstand the wear and tear of repeated use and transport, and be capable of being moored by a lightweight mooring system in various seaway conditions.

In April of 1966 the Aids to Navigation section of Coast Guard Headquarters requested the Civil Engineering section to investigate a small lighted buoy that could be used as an emergency aid with requirements that were very similar to what became the discrepancy buoy tentative operational requirements (Section 2.0). Engineering reviewed all the buoys that were known to exist, and participated in making improvements such as the re-design of the "ALERP" buoy which reduced its weight to 300 pounds. When the formal initiation of the discrepancy buoy development project occurred in 1971 with the Research and Development section being tasked to develop a buoy which had more stringent requirements than that the 1966 request for an emergency aid, the Engineering section provided background literature and drawings of three untested buoys they had designed. These three designs became the first generation buoys and are discussed in Appendix A.

The discrepancy buoy development project was initiated in preparation for the Coast Guard's implementation of the ANT (Aids to Navigation Team) concept. The ANT concept originated from the results of a study of the Coast Guard's aids-to-navigation system conducted by Booz-Allen Applied Research, Inc.,

under a Coast Guard contract. The applicable result of this study was that the Coast Guard could reduce its costs and still maintain sufficient reliability if it were to utilize small craft to deploy discrepancy aids, and conduct some of the maintenance.

The ANT concept of the discrepancy buoy provided that the buoy would remain on station until the next scheduled servicing of that aid (up to a year) by the buoy tender. This concept, however, has not evolved to such an extent. What presently occurs, and what previously occurred at units that had a discrepancy buoy, is that the discrepancy buoy remains on station only as long as it takes to prepare a replacement buoy for that position, and judiciously reschedule the buoy tender to perform the replacement.

The initial ANT concept was also based on the buoy tender retrieving the discrepancy buoy upon the discrepancy buoy's relief by the primary aid. Thus the ANT would only have to deploy the buoy but not retrieve it. Although this normally occurs, the ANT's do retrieve the buoys in many cases.

The discrepancy buoy may be lighted or unlighted. Although the buoys developed under this project may be used as unlighted buoys, their primary use will be as lighted buoys.

2.0 OBJECTIVE

The goal of this project was to develop a buoy (or buoys) that would best fit the requirement for a temporary floating aid.

A set of TOR's (Tentative Operational Requirements) was developed for a sheltered water discrepancy buoy and a exposed/semi-exposed water discrepancy buoy. These following TOR's were flexible enough to permit limited trade-offs:

<u>TYPES</u>	<u>I</u>	<u>II</u>
A. Environment:	<u>Sheltered</u>	<u>Exposed/Semi-Exposed</u>
B. Servicing Interval:	As long as possible, consistent with keeping size and weight. Rechargeable on station by small craft. (At least 1 month)	Three months minimum. Rechargeable on station by small craft.
C. Moorings:	Lightweight using conventional anchor rather than a sinker. (Possibly embedment anchors in the future.)	Lightweight using conventional anchor rather than a sinker. (Possibly embedment anchors in the future.)
D. Range (clear day or night; little or no cloud cover, haze, smog or fog; 15-mile visibility*):		
	Daymark: 1 mile	2 miles
	Light: 1-1/2 miles	3 miles
	Radar: 2 miles	4 miles

*Visibility is the range of vision for an object such as a ship under conditions of light and atmosphere existing at a particular time.

<u>TYPES</u>	<u>I</u>	<u>II</u>
E. Weather		
Maximum survivable		
Wind -	40 knots	60 knots
Sea -	4 feet	12 feet
F. Current:		
Maximum survivable -	5 knots	5 knots
Average -	2-1/2 knots	2-1/2 knots
G. Weight:	Light enough to be handled by two men. If necessary to reduce weight, each disassembled component should meet this requirement. Can be carried in 1/2 ton truck.	Light enough to be handled by two men. If necessary to reduce weight, each disassembled component should meet this requirement. When assembled, can be loaded and unloaded from trailer by two men.
H. Means of placing on station:	Assemble ashore (if necessary to meet requirements of G. above) and carry in 1/2 ton truck. Carry or tow with TICWAN at 5 knots minimum.	Assemble ashore (if necessary to meet requirements of G. above) and/or trailerable, then tow by TICWAN at 5 knots minimum.
I. Characteristics:	Light, color and number can be made the same as aid replaced. Average 10% duty cycle for light. Color coat as well as other components should require low maintenance. Can or nun daymark, interchangeable.	Light, color and number same as aid replaced. Average 10% duty cycle for light. Color coat as well as other components should require low maintenance. Can or nun daymark, interchangeable.
J. Maximum time on station:	One year. Buoy should be reusable.	One year. Buoy should be reusable.

The above TOR's were technically evaluated during the progress of this project and the trade-offs were determined. Evaluation of the trade-offs in light of the anticipated usage of the buoys (size and weight that would permit deployment from a small boat) resulted in the TOR's being updated to reflect the following changes:

a. The maximum survivable current requirement was reduced to 3 knots, and the average current requirement was reduced to 1.5 knots.

b. The sheltered water buoy daymark requirement was reduced to 0.8 nautical miles (minimum) and the exposed water buoy daymark requirement was reduced to 1.0 nautical miles (minimum).

FIGURE 1
FLOW CHART OF DISCREPANCY BUOY PROJECT

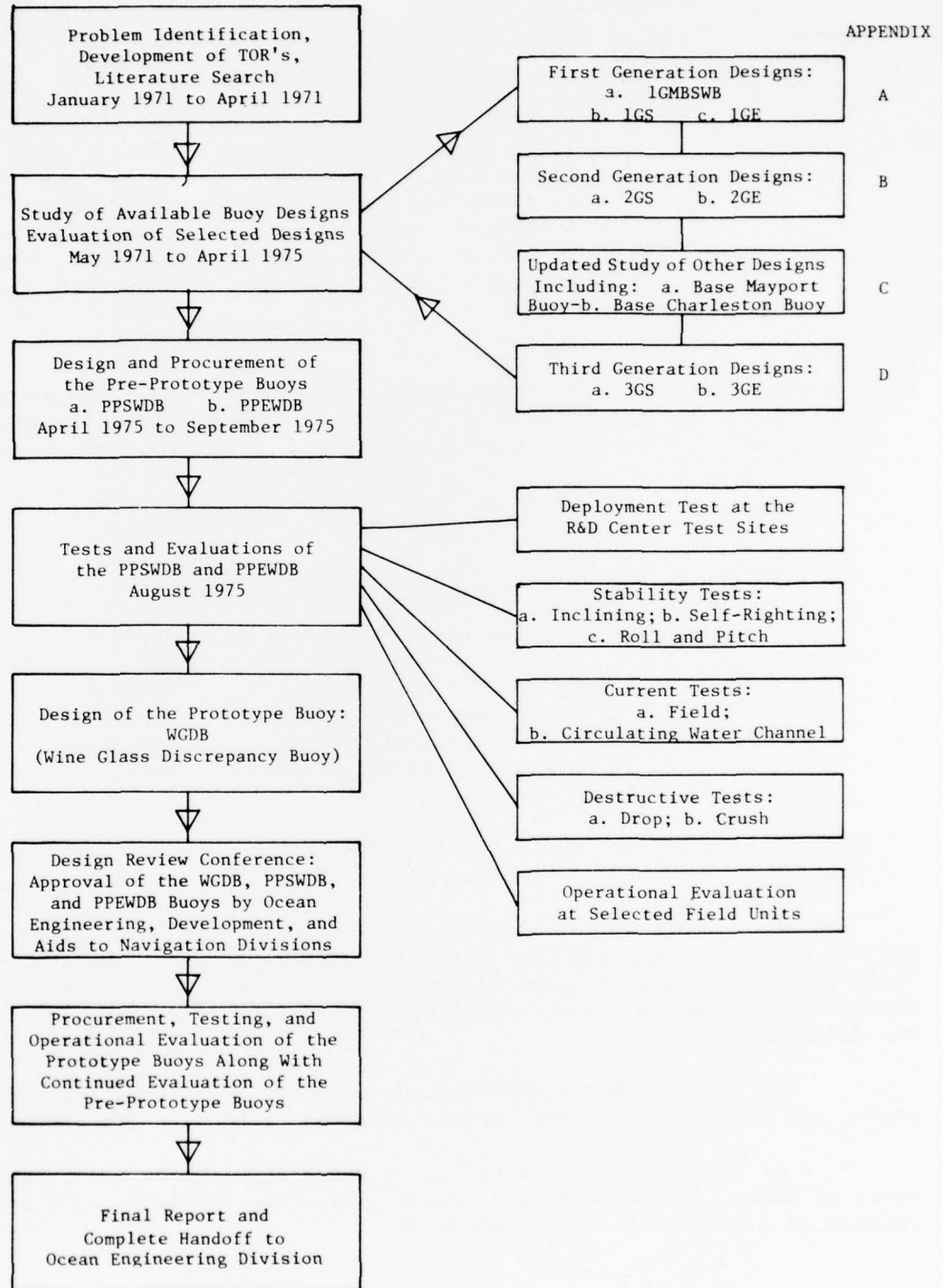

TABLE I
MATRIX OF BUOY PERFORMANCE**

	INTERCHANGEABILITY		CHARACTERISTIC		AVERAGE RANGE		DIRECTIONAL SENSITIVITY		ENVIRONMENTAL RESISTANCE		HANDLING		TRANSPORT		BATTERY CAPACITY		BATTERY AVAILABILITY		BATTERY STORAGE				
	SHAPE	SIZE (w/o hull)	INTENSITY	LANTERN	CHARACTERISTIC	AVG RANGE	R R	CURRENT	WIND	WAVES	SUNLIGHT (u.v. deterioration)	TEMPERATURE VARIATIONS	GENERAL DURABILITY	WEIGHT	SIZE	HARDWARE (mooring lifting)	PICKUP TRUCK	TICMAN/TANB	BATTERY CAPACITY	BATTERY AVAILABILITY	BATTERY STORAGE		
IGMBSWB	U	U	S	S	S	U	M	U	U	U	SHELTERED WATER DISCREPANCY BUOYS		S	M	M	S	S	M	U	S	S		
1GS	U	S	E	S	S	S	S	S	M	S	M	U	U	S	M	S	S	S	E	U	S	S	
2GS	U	U	S	S	S	S	M	M	S	U	U	U	S	M	S	S	S	S	S	S	M	U	S
BASE MAYPORT	U	S	S	S	S	U	M	S	S	S	S	S	S	U	M	M	S	S	S	S	U	S	S
BASE CHARLESTON	U	U	S	S	S	U	U	S	S	M	M	M	M	S	M	U	S	S	S	S	U	S	U
3GS	U	S	S	S	S	U	M	S	S	U	M	M	M	S	M	S	S	S	S	S	S	S	S
PFSWDB	M	S	S	S	S	S	M	S	S	M	M	M	M	S	M	S	S	S	S	S	S	S	S
WGDB	S	S	S	S	S	S	S	E	S	S	S	S	S	S	S	S	S	S	S	S	S	S	S
IGE	U	S	S	S	S	S	S	S	U	U	M	U	U	U	U	M	S*	S	S	S	S	S	S
2GE	U	S	S	S	S	S	M	M	M	U	U	U	U	U	M	S	S	S	S	S	S	M	S
3GE	U	S	S	S	S	S	M	S	U	M	M	M	M	M	M	S	S	S	S	S	S	S	S
PPEWDB	M	S	S	S	S	S	M	S	M	M	M	M	M	M	M	S	S	S	S	S	S	S	S

*TOW only

E - Exceeds the revised TOR, meets or surpasses original TOR

S - Satisfactory

M - Marginal

U - Unsatisfactory

*TOW only

**Buoy designations have been abbreviated - see appropriate buoy descriptions in report body and appendices.

c. The radar range requirements were reduced to a nominal 1.0 and 1.5 nautical miles for the sheltered water and exposed water buoys respectively.

3.0 PROJECT SUMMARY

The annotated flow chart provided in Figure 1 illustrates the chronological sequence of the project from formal initiation in January 1971 through this final report. This figure will be valuable as an aid in keeping track of the buoy names while reviewing Chapter 4 and the appendices.

A matrix of performance of the prototype (WGDB) buoy, the pre-prototype buoys, and the preliminary buoys that were studied during the discrepancy buoy development is provided in Table 1. The performance criteria for this table is the revised TOR's where applicable. Where the TOR's do not directly apply, a qualitative or quantitative determination was made on the basis of experience or engineering analysis.

4.0 DESCRIPTION AND PERFORMANCE OF THE BUOYS

This section concentrates on a discussion of the pre-prototype and prototype sheltered and exposed water discrepancy buoys. These buoy designs evolved, in part, through the collection and synthesis of extensive information on earlier R&D Center designs as well as designs available and in use at various field units. (See Figure 1.)

For clarity, detailed descriptions of this latter group of buoys is discussed in Appendices A through D.

4.1 Pre-Prototype Sheltered and Exposed Water Discrepancy Buoys

These buoys were the result of design improvements to the third generation buoys. The changes were the three corrective measures listed in Appendix D and the re-design of the bi-plane daymark/radar reflector to more closely fit the daymark guidelines discussed in Section 4.1.1. These represent two of the three buoy designs accepted for handoff.

Ten buoys of each type (size) were procured for testing and evaluation at the R&D Center and at various ANT teams.

4.1.1 Pre-Prototype Sheltered Water Discrepancy Buoy (PPSWDB)

This buoy has a flotation collar that is four feet in diameter and one foot in depth. The center tube is six inches in diameter and extends five feet eight inches below the collar. There is thirty pounds of composite ballast in the bottom of the free-flooding center tube.

The daymark is made up of two vertical perpendicular sheets of aluminum attached to the top of the battery compartment and held together by a horizontal plate at the top and horizontal corner braces at the vertical mid-point. The top horizontal plate acts also as the lantern base. The present daymark has eight styrene plastic panels that transform the daymark from CAN to NUN or visa versa. Alternately, there could be separate CAN or NUN radar reflector/daymarks. The hull and battery compartment are neutral gray and the daymarks are red or black. The maximum and minimum daymark project areas are shown in Figure 2.

A vented battery compartment is fixed to the top of the flotation collar and contains a removable battery tray. Several types of batteries can be attached to the tray and the tray can then be inserted into the battery compartment. A rectangular door closes the battery compartment and this door is held in place by a series of nuts around its perimeter. The improved battery compartment is shown in Figure 3.



FIGURE 2

THE MAXIMUM AND MINIMUM DAYMARK PROJECT AREAS OF
THE NUN AND CAN VERSIONS OF THE PPSWDB BUOY

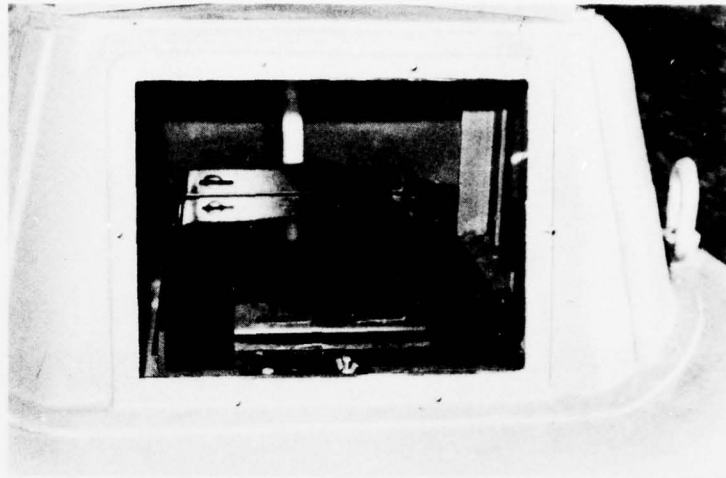

FIGURE 3

THE IMPROVED BATTERY COMPARTMENT ON THE PRE-PROTOTYPE BUOYS WITH THE STANTIONS INSIDE THE COMPARTMENT TRANSFERRING THE DAYMARK LOAD DIRECTLY TO THE HULL, THE DOUBLER PLATE ON THE COMPARTMENT'S TOP SURFACE, AND THE PVC ANGLE EXTENDING TO THE EDGE OF THE DOUBLER PLATE.

There are two locations for mooring attachment. The first location is for a bridle moor and consists of the two eyes under the flotation collar. The second is to attach onto the center tube. The best vertical location on the center tube for high currents is 17-1/2 inches below the bottom of the buoy hull.

The following are the physical characteristics:

Hull diameter	4 feet
Center tube length (hull included)	6.7 feet
Overall length (with lantern)	12.8 feet
Weight (with batteries)	225 pounds
Reserve buoyancy	560 pounds
Draft	6 feet

4.1.2 Pre-Prototype Exposed Water Discrepancy Buoy (PPEWDB)

This buoy is the same as the PPSWDB with the exception of size. The flotation collar is five feet in diameter and the center tube extends six feet below the flotation collar (Figure 4). The radar reflector/daymark is larger than on the PPSWDB buoy.

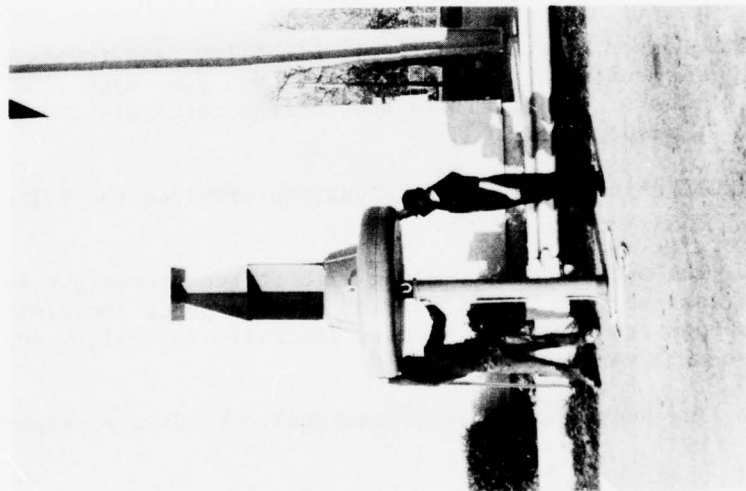
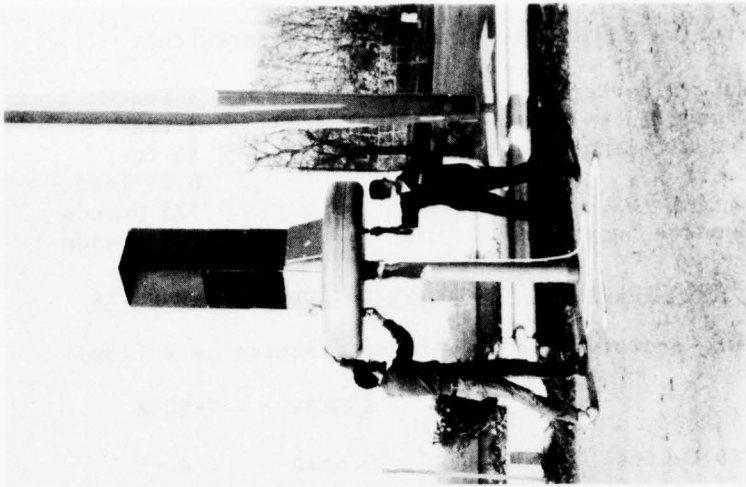

FIGURE 4
NUN AND CAN VERSIONS OF THE PPEWDB BUOY

The following are the physical characteristics:

Hull diameter	5 feet
Center tube length (hull included)	7 feet
Overall length (with lantern)	14 feet
Draft	6.25 feet
Weight (with batteries)	325 pounds
Reserve buoyancy	900 pounds

4.1.3 Pre-Prototype Buoy Tests, Evaluations, and Results

The pre-prototype buoys were distributed as follows:

	PPSWDB	PPEWDB
R&D Center, Groton, CT	2 each	4 each
ANT Galveston, TX	1 each	1 each
Base Charleston, SC	2 each	1 each
ANT St. Petersburg, FL	1 each	1 each
ANT Charleston, OR	1 each	1 each
NTL Park Service, Lake Mead, NV	1 each	None
ANT Miami, FL	1 each	None
ANT New Haven, CT	1 each	1 each
USCGC SUMACK, Keokuk, IA	None	1 each

The R&D Center conducted current, stability, and towing tests as well as test site deployments. Destructive testing was done upon completion of the other tests. Results of the stability and current tests are provided in Sections 5.2.1 and 5.2.3, respectively.

The field units conducting evaluations provided the following common observations:

- a. The overall length along with the counterweight tube length was longer than desired from the standpoint of transportation limitations. Also a shorter counterweight tube is more desirable in shallow depth areas, especially those with wave activity.
- b. The buoys were fairly susceptible to damage, especially during transport.
- c. The convenient feature of the battery access (without having to remove the daymark/radar reflector) with the sliding removable tray arrangement was well liked.
- d. The overall size was appreciated by the mariner.
- e. The buoy was light enough to be easily deployed from a small boat. While not required by the TOR, the discrepancy buoys are often recovered by a small boat, without the advantage of small davits and hand-cranked winches.

The pre-prototype buoys were most susceptible to damage during transport. During deployment they have withstood winds and seas (sheltered areas) of Hurricane Belle in Long Island Sound.

The ABS plastic was found to be easily repairable. Many of the damaged pre-prototype buoys were repaired in the field using materials from a local plumbing supplier.

4.2 Wine Glass Discrepancy Buoy (WGDB)

This buoy is designated WGDB because of its wine glass hull shape. The WGDB sheltered water discrepancy buoy was designed from scratch using the knowledge gained from the previous discrepancy buoys and fast water buoys. The NUN and CAN versions of this buoy are shown in Figure 5.

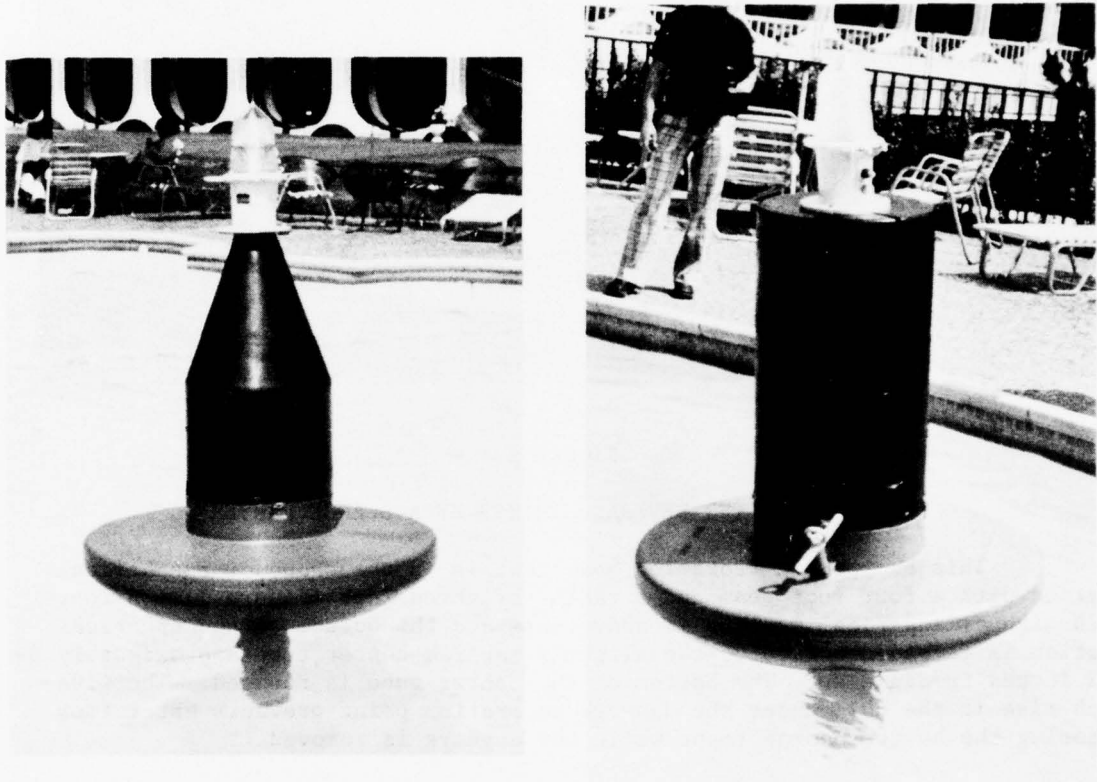

FIGURE 5

WGDB BUOY WITH NUN AND CAN DAYMARKS

The objective of this design was to develop a buoy that would be more durable than the previous buoys (Figure 6), have better performance in current (Section 5.2.3) and waves, have a daymark that fits within the guidelines of daymark shape (Section 5.1.1) and cost less than the previous designs (\$327 versus \$790 and \$690 for the PPSWDB and PPEWDB respectively).

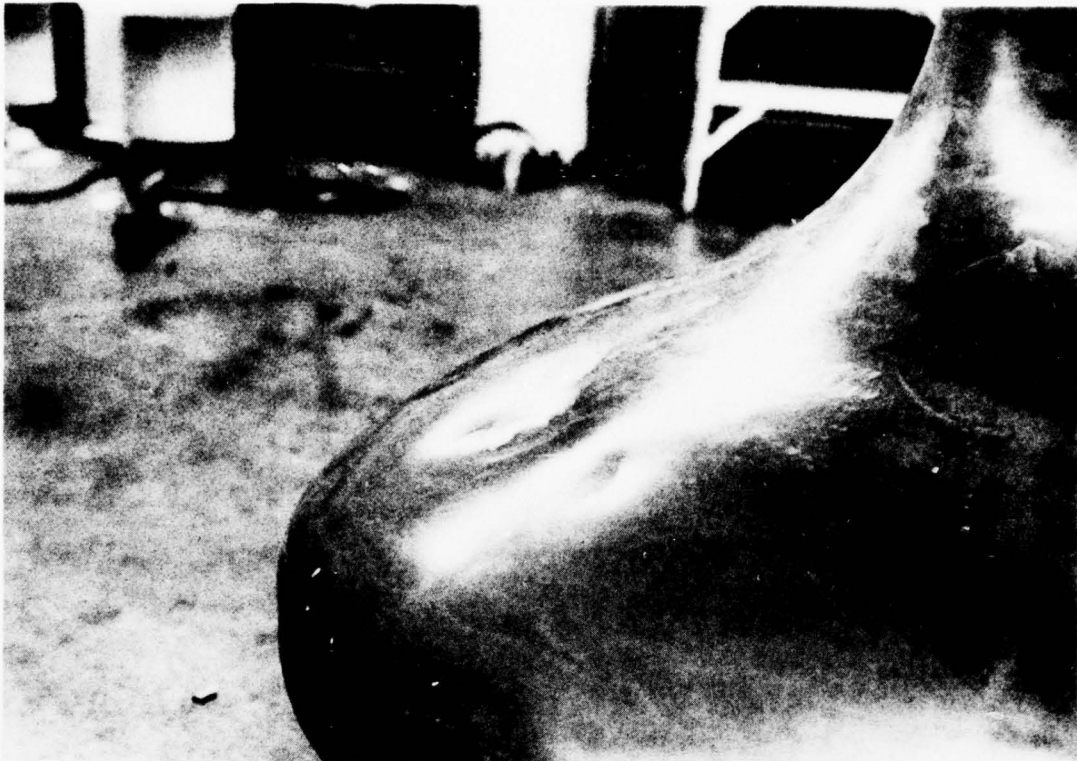

FIGURE 6

WGDB HULL AFTER SEVERAL STRIKES BY A SLEDGE HAMMER

This buoy has a flotation body that is in the shape of a spherical section with a four foot beam and a radius of three feet (Figure 7). A four-inch high cylindrical section is above this and the bottom of the spherical section is faired downward to the slightly tapered center tube approximately 6-1/2 inches in diameter. The bottom of the center tube is rounded. The five-inch rise in the hull under the daymark separation point prevents water from entering the battery compartment while the daymark is removed.

The mooring attachment is a single eye attached to a through bolt connected to the handle/lifting "T". Internally, there is an anchor plate attached to the through bolt that is embedded in the foamed hull. The through bolt/lifting "T" has worked well on some of the fast water test buoys because: (a) during repositioning or relieving the buoy, the mooring forces are transmitted through the rod and structurally do not stress the buoy; (b) as a handhold, it is much easier to grab than an eye and safer because fingers could get caught in an eye; and (c) a soft eye or doubled sling can be looped over the "T" fairly easily. An eye is added to the top of the "T" for use with a hook.

The construction is a foam-filled rotationally molded hull shell of cross-linked high density polyethylene. The daymarks are also rotationally molded of the same material. The NUN daymark is shipped containing the aluminum bi-plane radar reflector. The radar reflector (Figure 8) must be shifted to the daymark when the CAN is to be deployed (Figure 9).

The NUN or CAN daymark (containing the radar reflector) attaches (Figure 10) onto the hull's vertical extension and the lantern mounts on top of the daymark. At first, the design called for the conversion to a CAN by the covering of the NUN daymark with a black cylinder held in place by attachment to the lantern base. Subsequently, it was decided that separate NUN and CAN daymarks would be preferred.

There are two battery locations within this buoy, (1) in the lower end of the counterweight tube and (2) under the daymark. Seven of the initial twenty-five buoys had permanent, sealed, rechargeable lead acid batteries potted in place, located in the lower end of the counterweight tube. These batteries provide 25 amp hours of energy after which they can be recharged (Figure 11). If the buoy remains on station for a period longer than the service life of these integral power sources, an accessible battery compartment (under the daymark) is provided for "hot shot" (Figure 12) or other sealed batteries to provide electrical energy above the initial capacity. Normally, these supplemental batteries are added after the discharge of the internal batteries. When these internal batteries are used, it does not cause the buoy to be overweight. The internal batteries merely replace a portion of the counterweight. After an expected life of 100 recharge cycles, the internal batteries may become inoperable and revert to being counterweight only and "hot shot" or other supplemental batteries become the only power source. The internal batteries were to last seven recharges (as an average) then they would pay for themselves relative to the use of "hot shot" dry cell batteries in that the cost of seven sets of "hot shot" batteries is greater than the cost of the rechargeable batteries. Normally, new "hot shot" batteries are used for each deployment in order to provide adequate reliability.

The sixteen remaining buoys have counterweights in the counterweight tube as opposed to batteries. These buoys must utilize the battery storage location under the daymark.

The following are the physical characteristics:

Hull diameter	4 feet
Center tube length (hull included)	4 feet
Overall length (with lantern)	8.75 feet
Draft	3.6 feet
Weight (internal battery only)	190 pounds
Weight (both sets of batteries)	217 pounds
Reserve buoyancy	450 pounds

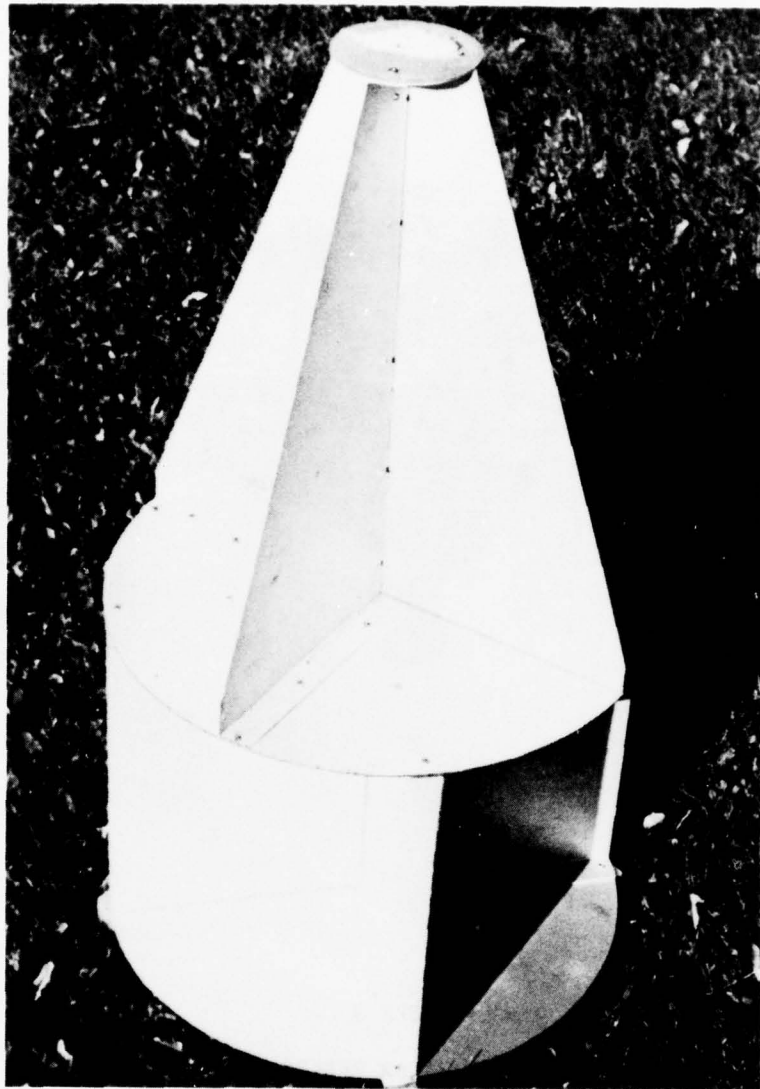

FIGURE 8

WGDB BUOY RADAR REFLECTOR

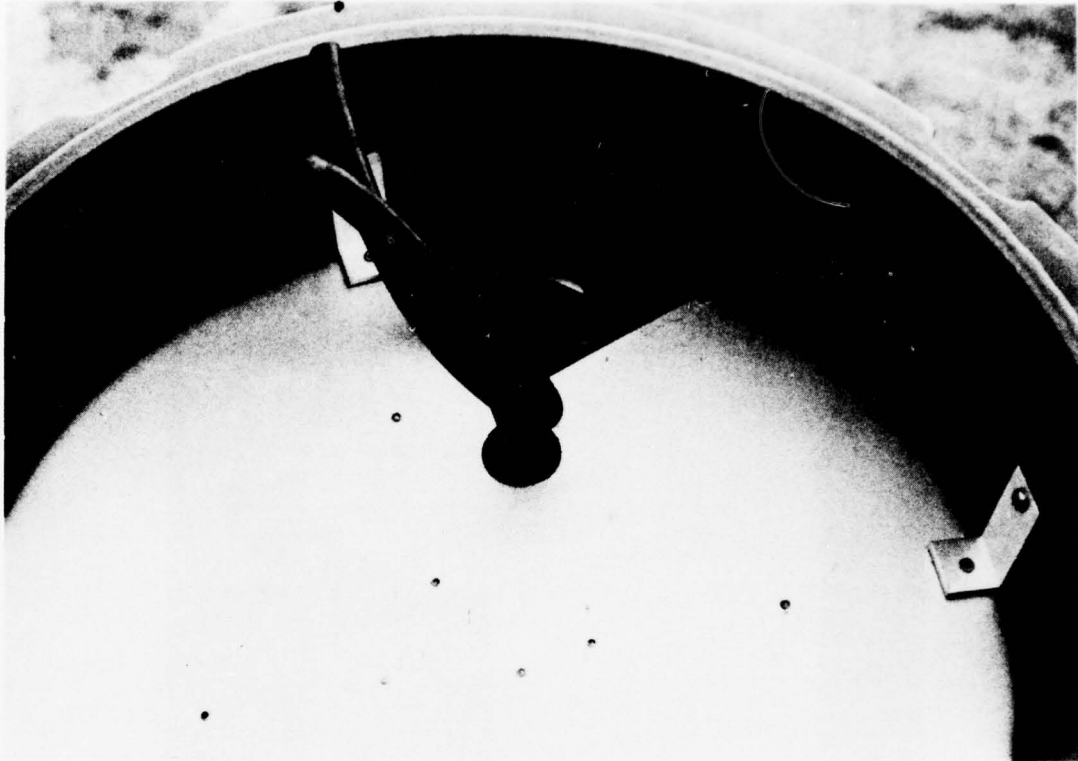
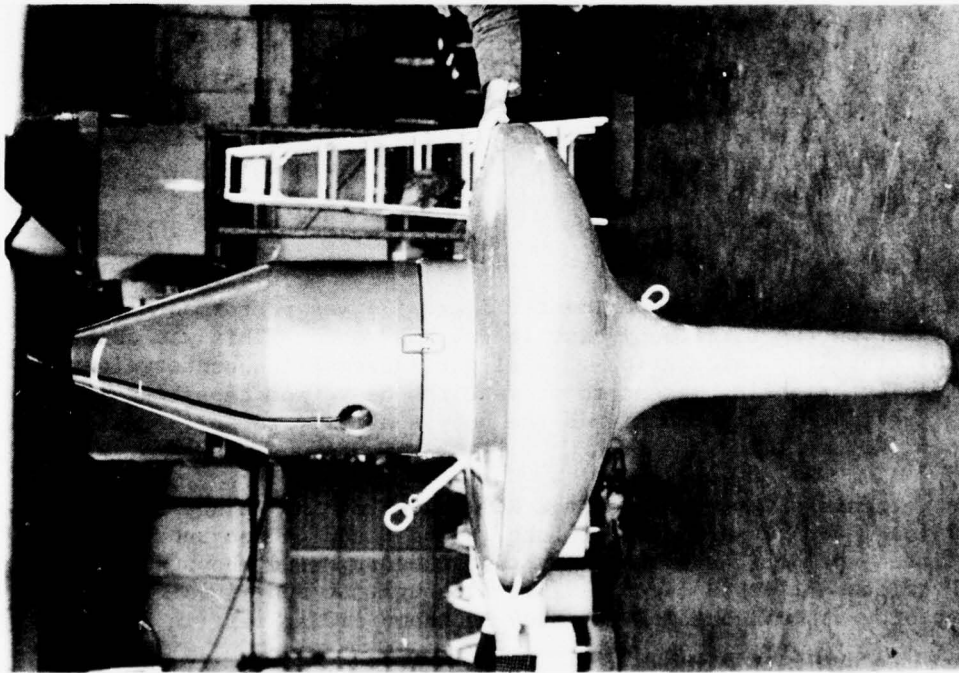
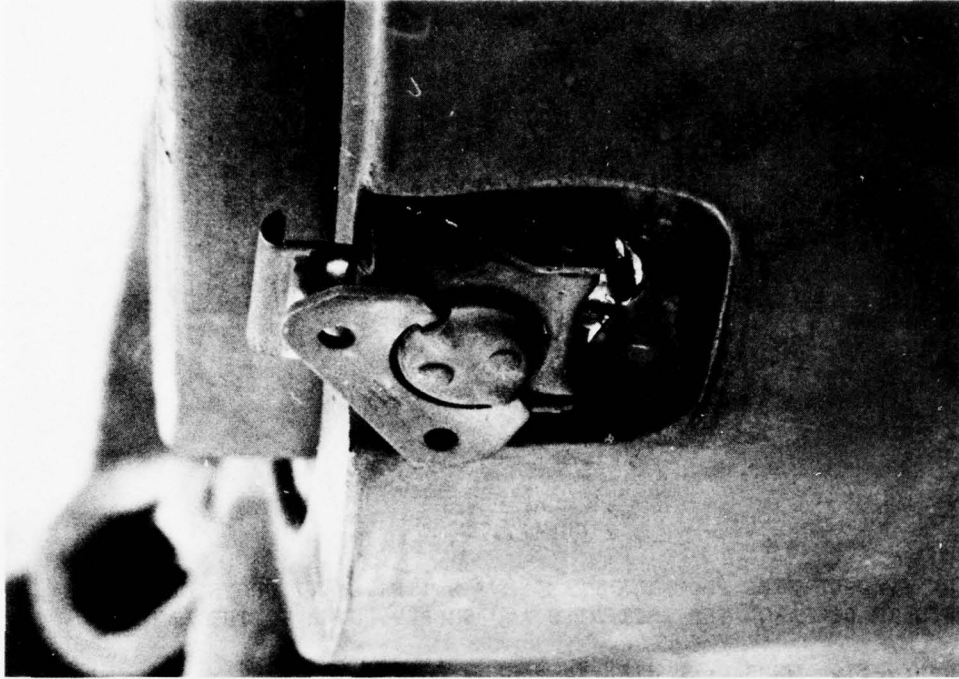

FIGURE 9

THE ATTACHMENT OF THE RADAR REFLECTOR IN EITHER THE
NUN OR CAN (THE WIRE LEADS THROUGH A STUFFING TUBE
IN THE DAYMARK AND THEN TO THE LANTERN.



(a)



(b)

FIGURE 10

THE NUN OR CAN DAYMARK IS ATTACHED ONTO THE HULL (a)
BY FOUR RECESSED LATCHES (b) HULL PART SHOWN



FIGURE 11

THE LEAD-UP WIRE FROM THE PERMANENT BATTERIES (7 BUOYS ONLY)
IS USED TO RECHARGE THE BATTERIES AND SUPPLY POWER TO THE LANTERN

Twenty-five WGDB were distributed as follows:

R&D Center, Groton, CT	8 each
ANT Astoria, OR	1 each
ANT Boston, MA	3 each
ANT St. Petersburg, FL	1 each
ANT Miami, FL	1 each
Base Charleston, SC	1 each
USCGC SUMAK Keokuk, IA	2 each
ANT San Francisco, CA	2 each
ANT Rio Vista, CA	2 each
NPS Lake Mead, NV	2 each
ANT New Haven, CT	2 each

An initial inclining experiment (Figure 13) was performed near the fabricators plant on the first buoy cast in the WGDB mold. This was done to verify initial stability calculations. A slight increase in counterweight provided sufficient righting moment to prevent the buoy from capsizing in 40-knot winds. The testing also confirmed the buoy's ability to self-right under all conditions (Figure 14).

Deployments of two buoys at the R&D Center's Pine Island test site plus an additional two buoys placed in Long Island Sound in conjunction with a NAVAID positioning project have been very satisfactory. The buoys survived the effects of Hurricane Belle in August 1976. Although the buoy is difficult to view in the photograph, Figure 15, the buoy is shown riding well in a 40-knot storm.

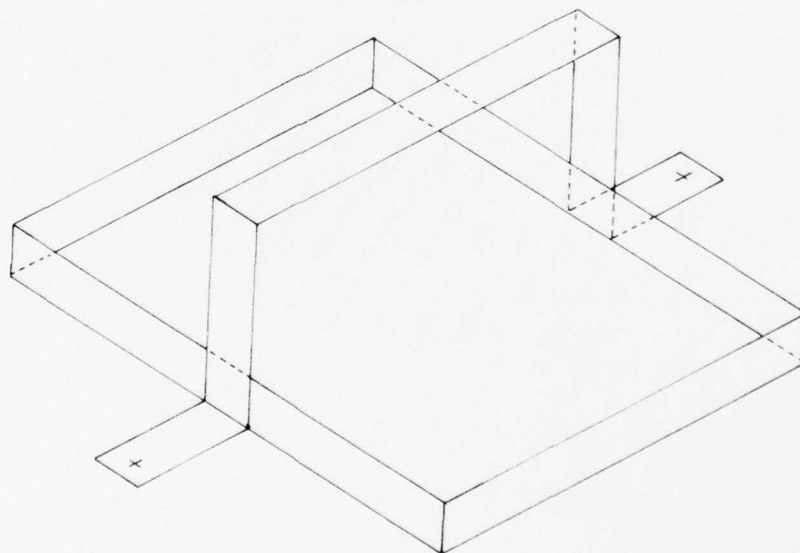
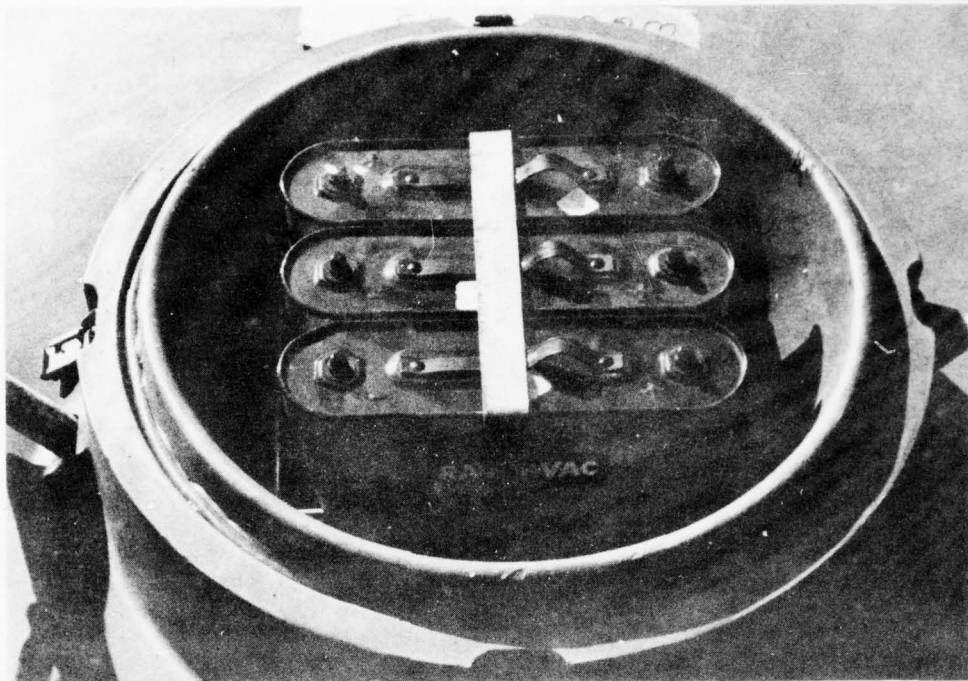

FIGURE 12

BATTERIES ((a), HOT SHOT BATTERIES ARE SHOWN HERE) ARE LOCATED UNDER THE DAYMARK AND ARE HELD IN PLACE WITH THE HOLDDOWN SHOWN (b) OR BY A STRAP.

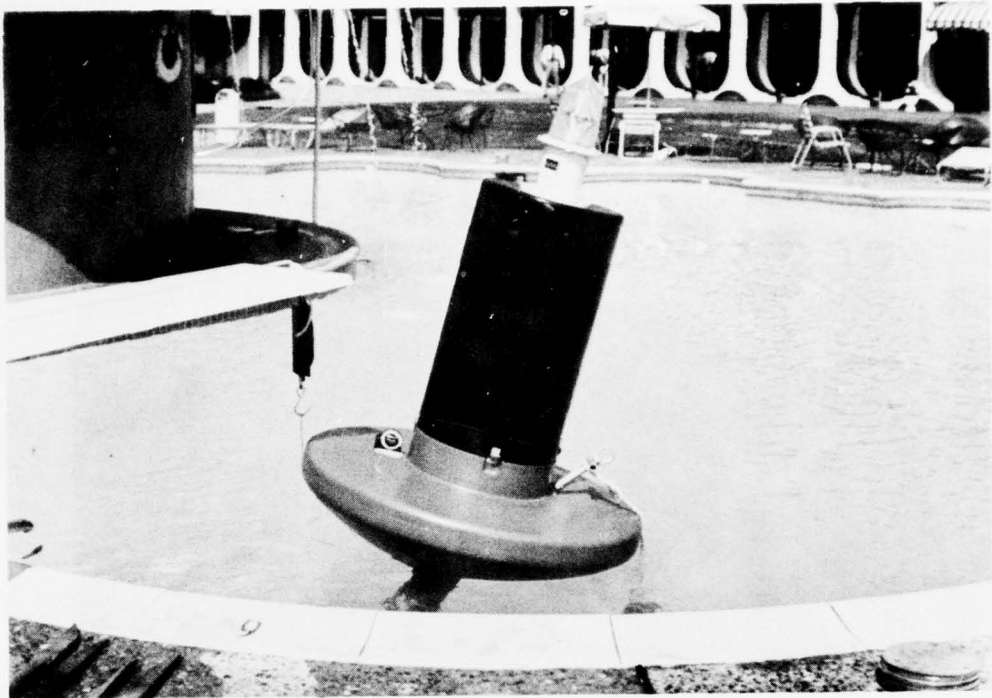

FIGURE 13

INCLINING EXPERIMENT OF THE FIRST WGDB BUOY TO VERIFY STABILITY CALCULATIONS.

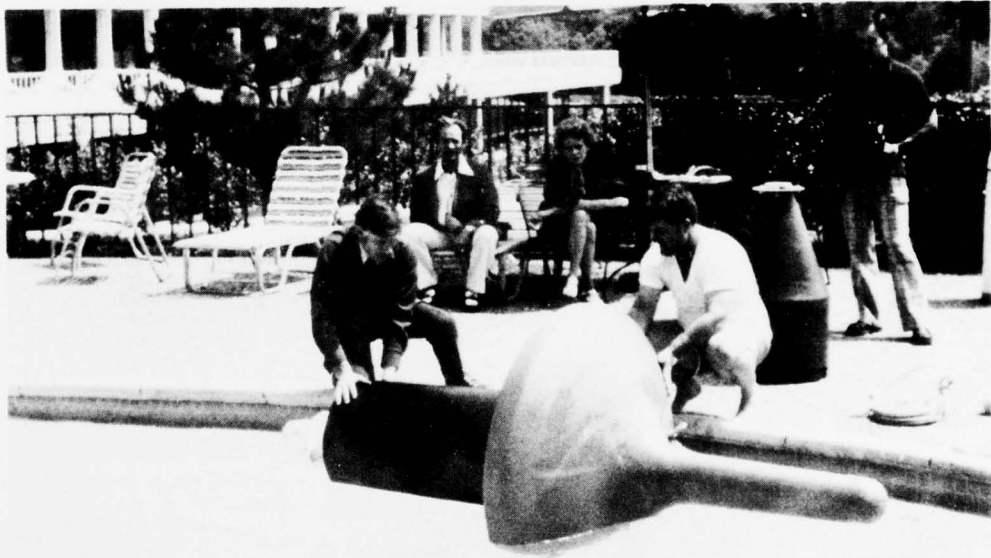

FIGURE 14

WGDB SELF-RIGHTING TEST SHOWED THAT THE BUOY WOULD NOT REMAIN CAPSIZED UNDER ANY CONDITIONS.

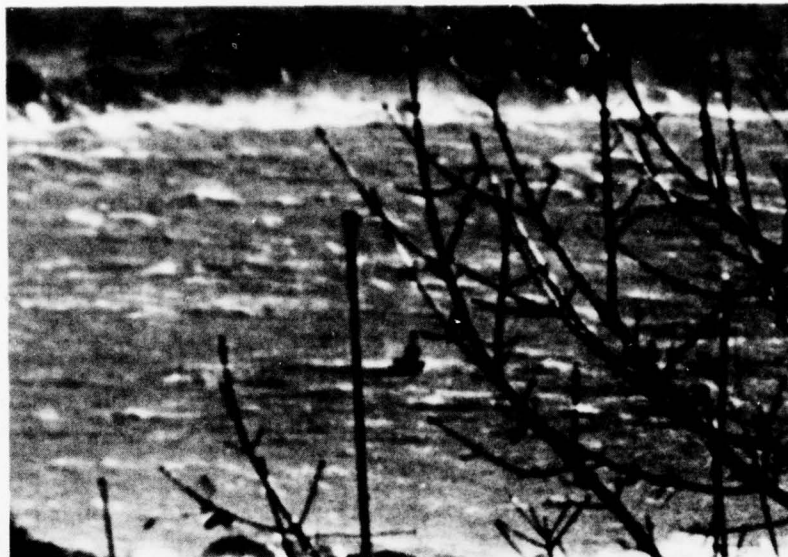

FIGURE 15

A WGDB BUOY RIDING WELL IN A 40-KNOT STORM

The field test units favor this buoy over other discrepancy designs. Their major complaint is that the lack of handholds and the smooth, slick surface of the buoy makes it more difficult to handle than the pre-prototype buoy, which is much larger overall while the weights are comparable. Exerpts from a field evaluation report follow:

". . . .ANT Rio Vista, CA, was selected to conduct an evaluation of the WG-1 type discrepancy buoy. . . .Three (3) personnel were used to assemble the buoy which took approximately forty (40) minutes. This included applying the retro-reflective materials, assembling the lantern components and the wiring hook-up.

"The method of transport was this unit's 21 foot (TANB) which carried the buoy broken down. A single point moor was utilized. . . .

"On 23 August 1976 at 1000T Sacramento Channel Temporary lighted buoy "54" Chart #18662 was established in 11 feet of water. . . . The assembled buoy with the mooring attached was put over the side first using the boat's davit. The sinker and chain were then put over the side using the slide board method.

"On 10 September a recharge exercise was conducted utilizing our 21 foot (TANB). . . .When working from the (TANB) it became a little crowded after bringing the buoy aboard with the other buoy. . . .on deck also. . . .After 18 days on station some marine growth had attached itself to the buoy underbody but was easily wiped off with a wet rag. . . .it was noticed that one of the daymark securing latches had lost some of its tension when securing the top. A check of the plastic O-ring was made and it was found in satisfactory condition. The exercise took approximately 35 to 50 minutes using 3 persons.

"This unit has had limited experience in working with other discrepancy buoys which were unlighted. In relation to those other occasions the (WGDB) has definite advantages. Its height above water, its lightweight construction the simple wiring hook-up, the location of the T-handle eye combination and being able to break it down for loading and transport make it a good piece of A/N equipment to work with. . . ."

One buoy suffered slight damage. The lower counterweight tube surface was scratched but not penetrated when it grounded on a rocky shore after going adrift. One of the expansion anchors which fasten the latches to the hull and daymark, "pulled through" the hull shell material to which it was fastened. This appeared to have also happened during the grounding. The remaining three latches held the daymark to the hull. After minor repairs the buoy was completely serviceable.

The only other damage of note of the WGDB's was a length-wise split about four inches long at the lower end of one of the counterweight tube. It is believed to have been caused by expansion of the epoxy potting material used to embed the internal batteries and lead shot counterweight. The split has not effected the use of the buoy, and there was no attempt at destroying the buoy to investigate the cause, but the design was changed (as a precautionary measure) to have only the foam holding the lead shot in place.

A series of destructive tests were conducted on this buoy and the pre-prototype buoys. This buoy survived the tests much better than the pre-prototype buoys, and in fact the buoy is still operational. The tests consisted of the following:

- a. Rolling the buoy hull from a loading dock (Figure 16a - no damage).
- b. Throwing the hull off the loading dock such that it would land on the counterweight tube (Figure 16b - some minor distortion and abrasion).
- c. Dropping the hull from a forklift (Figure 16c) onto its top (Figure 16d -distortion but the daymark still fits).
- d. Dropping the hull from a forklift (Figure 16e) onto its counterweight tube (more distortion than b. above but would not affect the buoy's use).
- e. Backing into the hull (upside down and against a wall) with the forklift from about 20 feet away (distortion of the deck near the points of impact but would not affect the buoy's use).

5.0 ENGINEERING EVALUATION OF THE DESIGN REQUIREMENTS

This chapter is included to point out some of the engineering design considerations that were undertaken to develop the discrepancy buoy. It is not intended to be an instructional text in how to design a buoy, but instead its intent is to provide a footing on which were made some of the important engineering decisions.

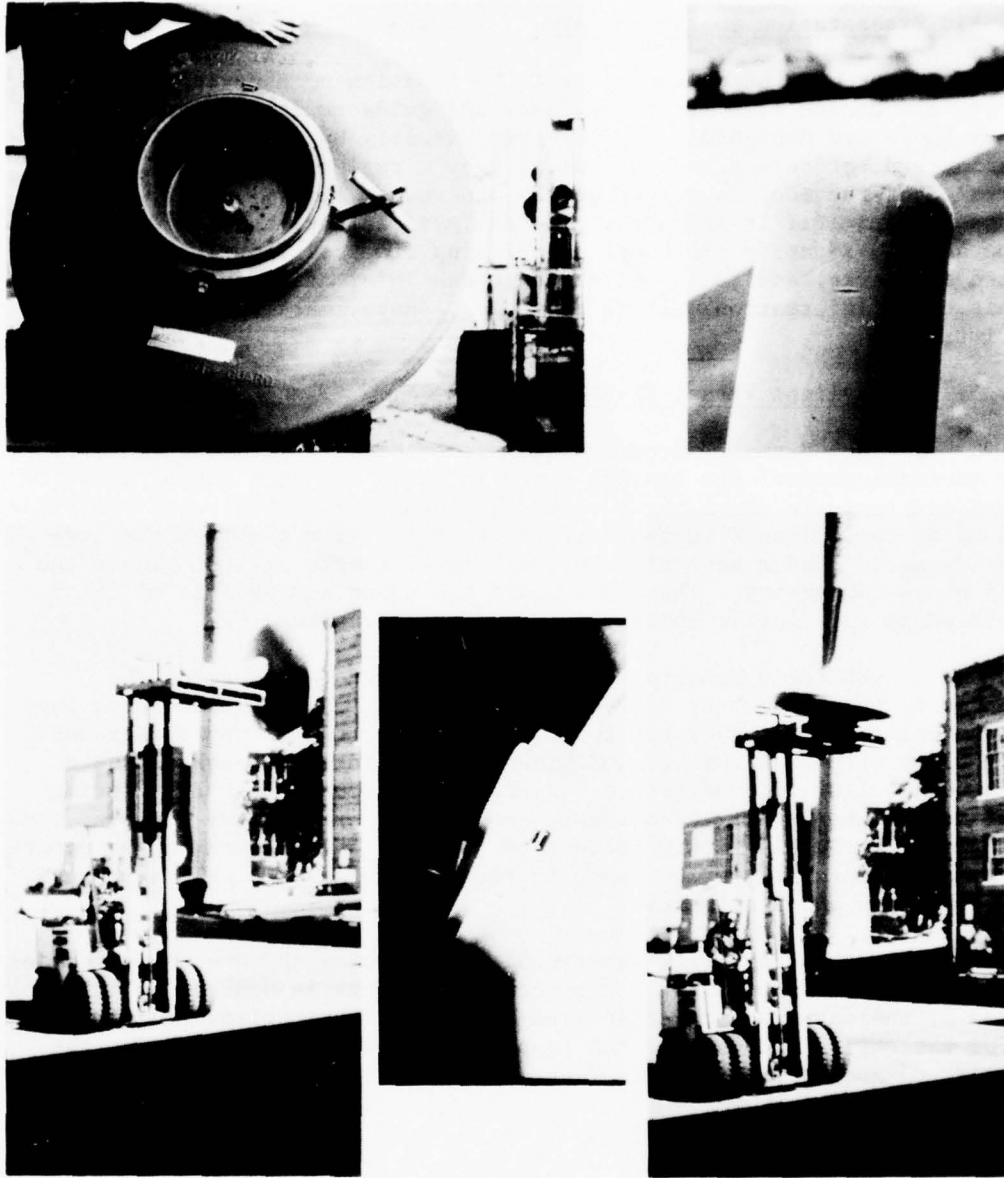

FIGURE 16

DESTRUCTIVE TESTING OF THE WGDB BUOY

The buoy was dropped from a loading dock (a) onto its gunwale and on the counterweight tube (b) with only minor distortion and abrasion damage. Then, it was dropped from a forklift (c) onto its top (d) with limited distortion (daymark still fits), and onto its counterweight tube from the forklift (e) with minimal damage. The buoy is still operational.

5.1 Aid Presentation to the Mariner

A mariner must be able to detect the location of a navigational buoy, identify it, and derive from it the navigational guidance it provides. The discrepancy buoys are designed to be detected visually by their physical being or by the lantern, or detected electronically by a reflected radar signal. Identification of the buoy is determined by its shape, color, number, or its light characteristic (if it is dark). The navigational guidance is derived from being able to identify the buoy, correlating its position with other aids and charted landmarks, and to interpret the coded information provided by the buoy. This coded information will be the color, shape, markings, and light characteristic.

5.1.1 Daylight Visual Characteristics

The "daymark" provides the visual signal. Its shape, size, and color contrast control the maximum range in which the buoy can be detected and the maximum range in which the buoy can be identified. The color and shape provide some of the guidance to the mariner as well as the markings that are put on the daymark. Under most circumstances the daymarks will be either the red NUN or black CAN shapes. The Coast Guard has adopted standards of color and daymark shape for plastic unlighted buoys designed after 1972.

DUNTLEY's Nomogram (Figure 17) is used to determine the maximum range in which the buoy can be detected. The red and black buoys have the same contrast as each other but the contrast varies as to the background. The red or black with a sky background give a 0.75 effective contrast and a water background give a 0.2 effective contrast (less contrast). By entering the nomogram with the effective contrast, the colored area of the daymark, and the meteorological visibility, the detection range of the daymark can be determined. Daymark shape affects the range in that a high daymark will have more sky background than a low daymark.

When a daymark's background is partially sky and the remainder water, a total effective contrast can be computed. This is done by calculating the portion of the daymarks projected area above the HPH (Horizon Projection Height) for the sky background and the respective area below the HPH for the water background and inputting these values into the following equation:

$$C_e = (C_w A_1 + C_s A_2) / (A_1 + A_2)$$

where: C_e is the total effective contrast
 C_w is the contrast with water background
 C_s is the contrast with sky background
 A_1 is the projected area with water background
 A_2 is the project area with sky background

The HPH can be computed from the curvature of the earth for various observer heights of eye. Table 2 provides the HPH's in 1/2 mile distance from observer increments for a standard observer's eye height of 15 feet.

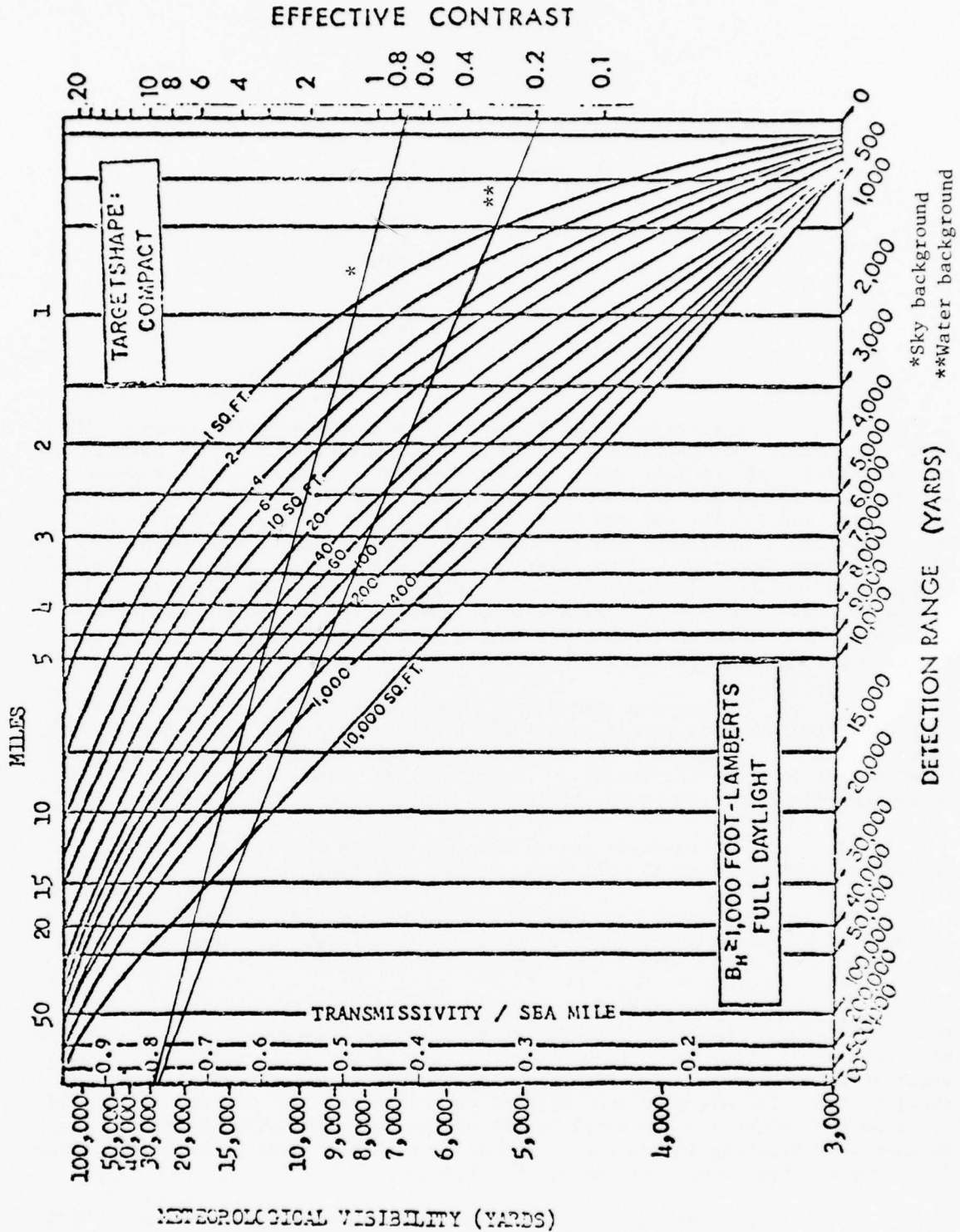

FIGURE 17
DUNTLEY'S NOMOGRAM

TABLE 2
HORIZON PROJECTION HEIGHT FOR 1/2 MILE DISTANCE INCREMENTS

<u>Distance</u>	<u>HPH in Feet</u>
1/2	11.7
1	8.9
1-1/2	6.5
2	4.4
2-1/2	2.8
3	1.4
3-1/2	0.6
4	0.2

An example of determining the maximum detection range of the WGDB discrepancy buoy is shown as follows. The project area of the daymark is approximately 5 square feet and a 15 foot observer height of eye is assumed. Entering the nomogram; the 5 square foot daymark, the assumed 15 nautical mile visibility, and for the sky and water background contrast, yield 1.9 nm and 1.0 nm respectively. Since the HPH at 2 nm is 4.4 feet, and the buoy's total height is less than that, we can conclude that the buoy will have a water background. Thus, the detection range of the WGDB discrepancy buoy is 1 nm. If the HPH was less than the daymark height at the range computed with the water background then an iterative solution would be necessary utilizing the equation for the total effective contrast.

The shape of the daymark identifies whether the buoy is a NUN or a CAN. The shape is particularly important when the buoy is backlit and the color cannot be determined. The daymark shape guidelines had not been defined when this project was initiated, but attention was given to these guidelines during the design of the pre-prototype ABS buoys and the WGDB buoy.

The following guidelines for daymark shape were set forth for the specifications of small unlighted navigational buoys:

a. The black CAN, when floating vertically, shall present to the mariner a rectangular-shaped silhouette with a height-to-width ratio between 1.8:1 and 2.2:1 visible above the waterline of the buoy.

b. The red NUN, when floating vertically, shall present to the mariner the silhouette of a truncated isosceles triangle, base down, on top of a rectangle. The width of the base of the triangle shall correspond to the width of the rectangle. The truncated altitude-to-base ratio of the triangle shall be 1:1. The angle of the sides of the triangle shall be between 18° and 22° from the vertical. The total height of the NUN silhouette visible to the mariner when floating in its normal operating position shall be between 1.8 and 2.2 times the truncated altitude of the triangle.

c. Any enlarged flotation section, commonly known as a DONUT or FLOTATION COLLAR shall be limited in visibility above the waterline to 1/8 the total height of the daymark. Its color shall be the same as the daymark.

The limitations of the above guidelines are graphically shown in Figure 18.

Since the discrepancy buoy must have interchangeable NUN and CAN daymarks, and it is undesirable to repaint the buoy body in order to change the color corresponding to the respective daymarks, a neutral gray buoy body was adopted. Because of the gray hull, the height-to-width ratios were with respect to the red or black portions of the buoy.

There are two common methods of daymark design for use on unlighted navigational buoys; these are (a) the bi-plane radar reflector being the daymark, and (b) the daymark shell (with or without a radar reflector enclosed). The advantages of the first method are: Its simplicity of fabrication and the radar reflector provides both the radar reflectivity and the daymark, but the disadvantage is that this daymark cannot meet the height-to-width ratio guidelines because as you rotate this type of daymark, the height-to-width ratio changes by a factor of 1.41:1, whereas the above guidelines only permit a variation in height to width ratios of 1.22:1 ($1.22 = 2.2/1.8$). The advantage of the second method is that the daymark retains its height-to-width ratio as the buoy rotates, but the disadvantages are that the higher level of fabrication required to make a symmetrical shell, and multiplicity of parts when a radar reflector is required.

The pre-prototype ABS discrepancy buoys were designed with the bi-plane radar reflector being the daymark. The height-to-width ratio was selected to be close to the guidelines, although it was impossible to make it fall within the limits,. The WGDB discrepancy buoy used the shell method with a radar reflector enclosed within.

Several methods of interchanging daymarks were considered. The methods for the bi-plane daymark/radar reflector are (a) separate NUN and CAN daymarks (Figure 19a); (b) reversible panels (Figure 19b); and (c) foam sections of a cylinder and a truncated cone (Figure 19c). The methods for the shell daymark are (a) separate NUN and CAN daymarks (Figure 19d); (b) CAN shell over NUN shell (Figure 19e); and (c) reversible collar over a black and red NUN shaped shell (Figure 19f).

The interpretation of the TOR requirement of the interchangeability of daymarks was that the same buoy could be changed from NUN to a CAN and visa versa without repainting, with a minimum of cost, and with a minimum of storage requirements for changeover parts. The reversible panel method developed use on the pre-prototype buoys (Figure 19b). This method allowed all changeover parts are continuously attached to the buoy preventing loss, minimizing storage and minimizing the cost,. Loss of one or more panels when the buoy was deployed would cause a non-standard, confusing daymark. The WGDB buoy design incorporated the separate NUN and CAN daymark method (Figure 19d) because it was less weight than the CAN over NUN for the same cost and storage requirement (although the radar reflector must be switched from one daymark to the other). The reversible collar was the least desirable because it would have been difficult to fabricate, and the loss of the collar would cause a non-standard daymark.

FIGURE 18
LIMITATIONS OF THE DAYMARK SHAPE GUIDELINES

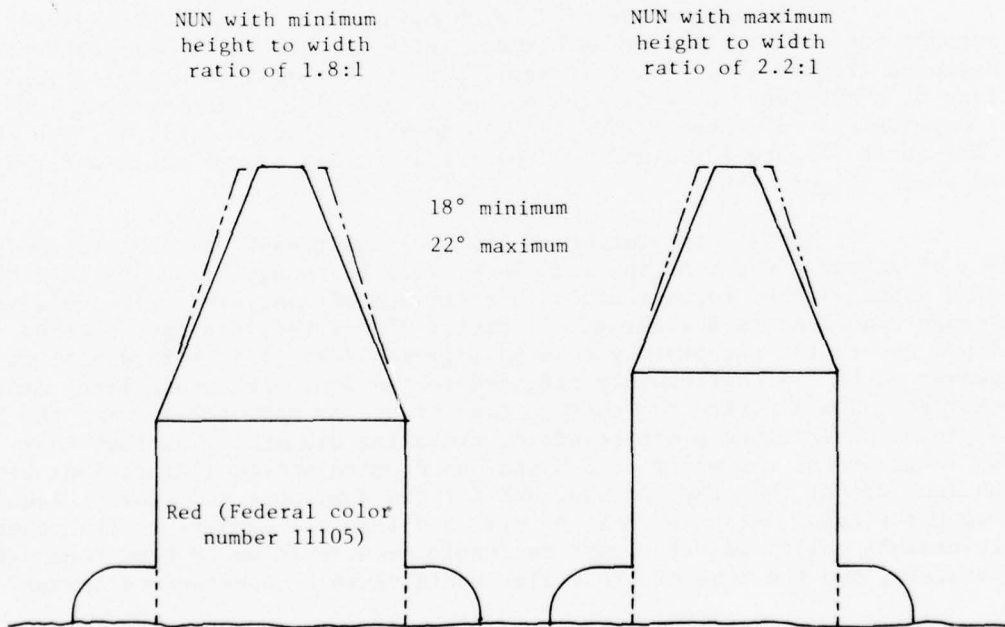
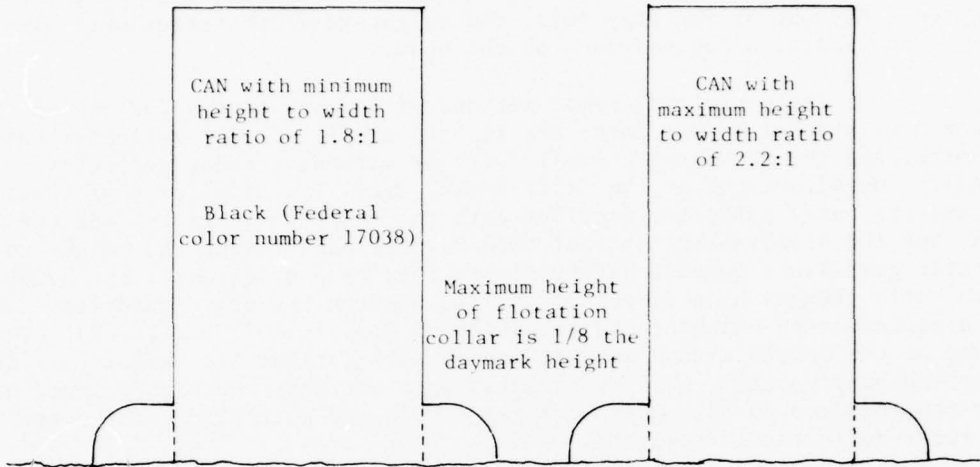
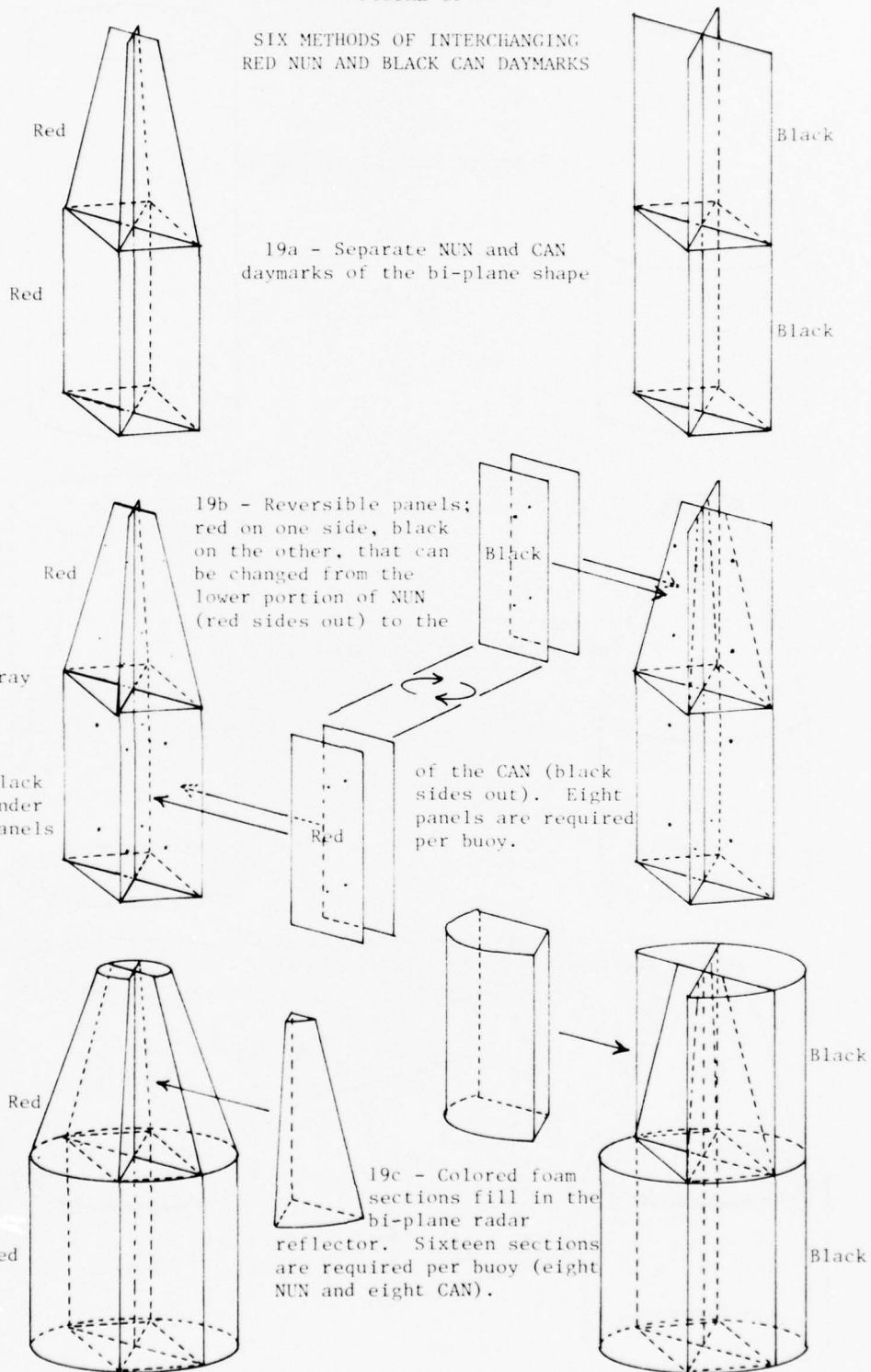
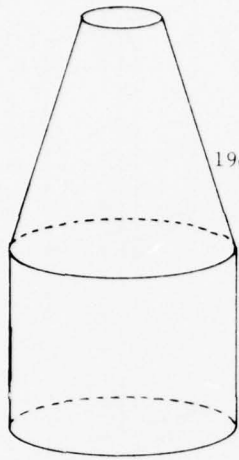

FIGURE 19

SIX METHODS OF INTERCHANGING
RED NUN AND BLACK CAN DAYMARKS





19d - Separate NUN and CAN shells

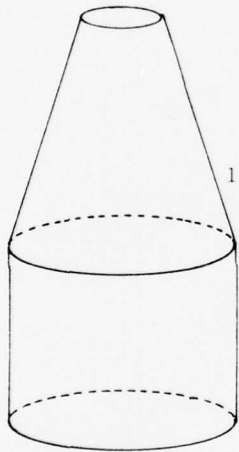

19e - CAN shell over NUN shell

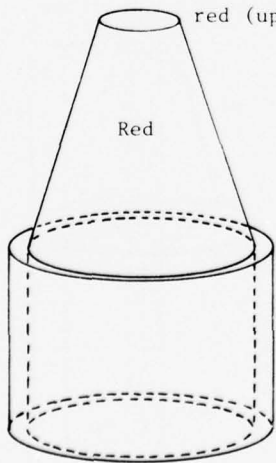
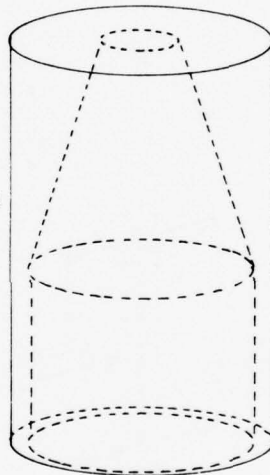

19f - Reversible collar over a half red (upper) and half black (lower) NUN daymark

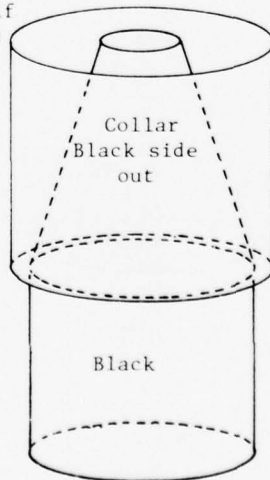
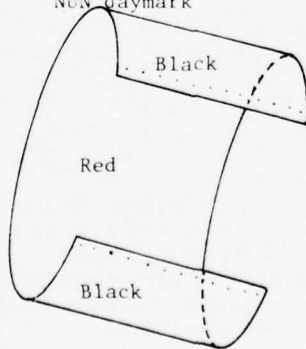

5.1.2 Night Visual Characteristics

The lantern provides the night visual characteristics of the buoy. The flash characteristic of a lighted navigational buoy aids in identifying the buoy and may provide navigational information such as a Morse "A" indicates a center channel buoy.

The two factors governing the range of a light are geographic range and luminous range. Both of these ranges are determined for a light and the lower of the two indicates the actual expected range.

The geographic range of a light is limited by the interference of the horizon with the line of sight. This range is computed from the geometry of the earth, the lantern height, and the height of the observer. Since the standard observer height of 15 feet provides a geographic range of 4.4 nautical miles with the lantern height at sea level, and since 4.4 nautical miles is in excess of the TOR requirements and lantern heights above sea level increase the geographic range above 4.4 nautical miles, further calculations of geographic range are not required.

The luminous range is determined by the intensity of the light source, optical system assistance, voltage correction factor, lantern pane loss, color correction factor, transmission loss, and the Blondel-Rey Factor (a phenomenon that occurs to the human eye out at the visible threshold of the light and most definitely affects the range at which the mariner can first acquire the light for his use). The standard Coast Guard 155 mm lantern was the best lantern for the discrepancy buoys because it is a Coast Guard stock item, known to be reliable, and CG personnel know how to use it and service it, although a smaller lantern would be lighter and might have a lower initial cost. By analyzing abstracts of two tables from CG publication CG-250-12E, Luminous Intensities of Navigational Aids dated 29 March 1972 (Reference 7), it can be seen that the 0.25 amp lamp at 12 volts in a acrylic lens is sufficient for the three mile TOR requirement for the exposed water discrepancy buoy with the exception of the red lens and the 0.3 sec closure time in which a nominal range is two nautical miles. Tables 3 and 4 are the applicable portions of the tables contained in the reference.

TABLE 3

EQUIVALENT FIXED INTENSITY (CANDELA) FOR A
155MM ACRYLIC LENS 12V 0.25 AMP LAMP

CCT*	0.3	0.4	0.5	0.6	0.8	1	2	3	FIX
Clear	27	31	34	36	39	41	45	46	50
Red	8	9	10	11	11	12	13	13	14
Green	12	14	16	17	18	19	21	21	23

*Contact closure time
Reference 7 page 4-1

TABLE 4

EQUIVALENT FIXED INTENSITIES NOMINAL RANGE (NM)

1-2 candela	1
3-8 candela	2
9-23 candela	3
24-53 candela	4

Reference 7 page 2-6

5.1.3 Radar Reflector Characteristics

The discrepancy buoy provides a passive radar target to assist the mariner in locating the buoy, particularly during periods of limited visibility. The following types of radar reflectors were considered: bi-plane (rectangular dihedral), corner reflector clusters (combinations of trihedral reflectors), cylindrical reflectors, and the Luneberg Lens. Previous Coast Guard tests and evaluations of similar physical size variations of the above types indicated the bi-plane reflector had either superior or at least comparative performance relative to the other types tested. One of the conclusions of the tests was that the bi-plane reflector would give more uniform coverage if it were stacked onto another bi-plane reflector rotated 45 degrees with respect to the first, thus a corner would be presented in all directions. The bi-plane reflector with the rotated top section was selected for the WGDB because it provides near uniform coverage, it was reasonable to design a reflector that would fit into the daymark shell, it utilizes common fabrication methods, the cost was reasonable, and the performance would be adequate for the size limitations.

During the initial buoy designs a "rule of thumb" method of estimating the radar reflectivity range was used. This method is for a 50 percent blip scan ratio and a 20 kw radar set. The following equation gives the range in nautical miles for a bi-plane radar reflector of area A_r and a steel buoy of area A :

$$\text{Range} = (1.4 A_r + 0.5 A)^{1/2}$$

Since this method was inadequate for optimization of the radar reflector, and since it is only a rough estimate, the theoretical method described in the IALA Supplements No. 1 (Reference 1) and 2 (Reference 8) and in Georgia Tech Project A-1277 report (Reference 9) was used.

This analysis requires the solution of the following equation:

$$R^4 = \left[\frac{P_r G^2 \lambda^2}{(4\pi)^3 P_r} \right] [\delta] \left[2 \sin \left(\frac{2\pi h_1 h_2}{\lambda R} \right) \right]^4$$

where: the first term is a function of the radar set, the second term is a function of the radar reflector, and the third term is a function of the relative positions of the radar set and reflector.

where the variables are:

R = Range
P_r = Power at receiver
G = Gain of radar aerial
δ = Echoing area of the reflector
h₁ = Radar aerial height
h₂ = Reflector height
P_t = Transmitted power
λ = Radar wavelength

The bi-plane radar reflector term may be characterized as follows:

$$\delta = \frac{16\pi}{\lambda^2} a^2 b^2 \sin^2\left(\frac{\pi}{4} - \alpha\right)$$

where the additional variables are:

a = reflector horizontal surface length
b = vertical surface length
α = angle from the bi-plane bi-sector

A stereotype radar set is given in Reference 9 as having the following characteristics:

Frequency (λ = 3.19cm)	9.4 GHz
Antenna height (h ₁ = 3.048m)	10 feet
Antenna gain (G)	25 dB
Scan rate	20 rpm
Azimuth beamwidth	1.5 degree
Elevation beamwidth	22 degree
Pulse repetition frequency	1 kHz
Peak transmitted power (P _t)	3 kW
Pulse length	100 ns
Dissipative loss (Dwg)	3 dB
Receiver noise figure (Rnf)	12 dB
IF bandwidth (Bw)	10 MHz
Display	7" dia. PPI
Displayed ranges	2, 4, 8 nmi
Spot size	0.02 inch
Display factor (D _f)	15 dB

The minimum power at the receiver capable of producing a detectable blip must be determined. A method of approximating this is given below:

$$P_r = 0.1 \log^{-1}(10 \log N_p + 2D_{wg} + D_f + R_{nf})$$

where: N_p = noise power = k T B
k = 1.374x10⁻²³ J/°K
T = temperature in °K
B = bandwidth in cycles

Using the above equations, the stereotype radar set can be characterized by the following coefficient: $1.87 \times 10^{12} \text{m}^2$.

Since this is the first term of the above equation ($R^4 = \dots$), and it remains constant for the radar set, the effect of varying the radar reflector and/or the reflector orientation on the range can be determined.

The radar reflector size that would be required to fulfill the original TOR requirements was determined. The assumption was made that the radar reflector would be of the WGDB type and that the maximum width of the reflector is equal to the heights of the two individual sections, the edges of the truncated cone top section are 20 degrees from vertical, and the bottom of the radar reflector is 15 inches above the water surface. The radar reflector's worst reflecting position is when the top position is at a null and the bottom portion is at its peak with respect to the direction response in the horizontal plan. Results of the analysis can be seen in Figure 20. On the basis of this analysis, the TOR was reduced to the performance of the WGDB and pre-prototype buoys.

Using the dimensions of the buoys and using the approximation that the horizontal surface length (a) is the average half width of the vertical planes, the following figure (Figure 21) shows the expected ranges of the pre-prototype and WGDB buoys.

The radar reflectors are orientated on the pre-prototype buoys such that their best reflectivity directions are parallel and perpendicular to the buoy's orientation in a current when bridle moored. The orientation of the pre-prototype buoys when center tube moored is dependent on the method of attaching onto the center tube.

The radar reflector on the WG-1 does not have a preferred orientation in that the reflector has a relatively constant range with respect to direction. The attenuation of the radar reflector performance by the plastic shell or plastic panels is not significant.

5.2 Stability and Environmental Requirements

The discrepancy buoy must reliably provide the navigational aid in adverse environmental conditions. Additionally, it must be capable of surviving severe storm conditions. For the purposes of this project, "survivable" in the TOR was interpreted as meaning that the buoy would remain on station with all components intact and would only require normal servicing, i.e., recharging the batteries and checking the lantern, after the storm passed.

The wind forces on the buoy can be related to an overturning moment on the buoy. This moment is resisted by the righting moment which is a static stability characteristic of the buoy.

The force of current on the buoy causes the mooring line to pull the buoy downward and may cause the buoy to capsize by any of several modes. The resistance to the downward pull is the reserve buoyancy and the dynamic lift (or suction) of the water passing by the hull. The resistance to capsizing is related to both the righting moment, and the dynamics of the buoy.

FIGURE 20

Theoretical analysis to determine the minimum radar reflector size that would be required to fulfill the original TOR using a stacked bi-plane reflector of the type used in the WGDB buoy and assuming the 3kw stereotype radar set. This analysis led to the reduction in the TOR.

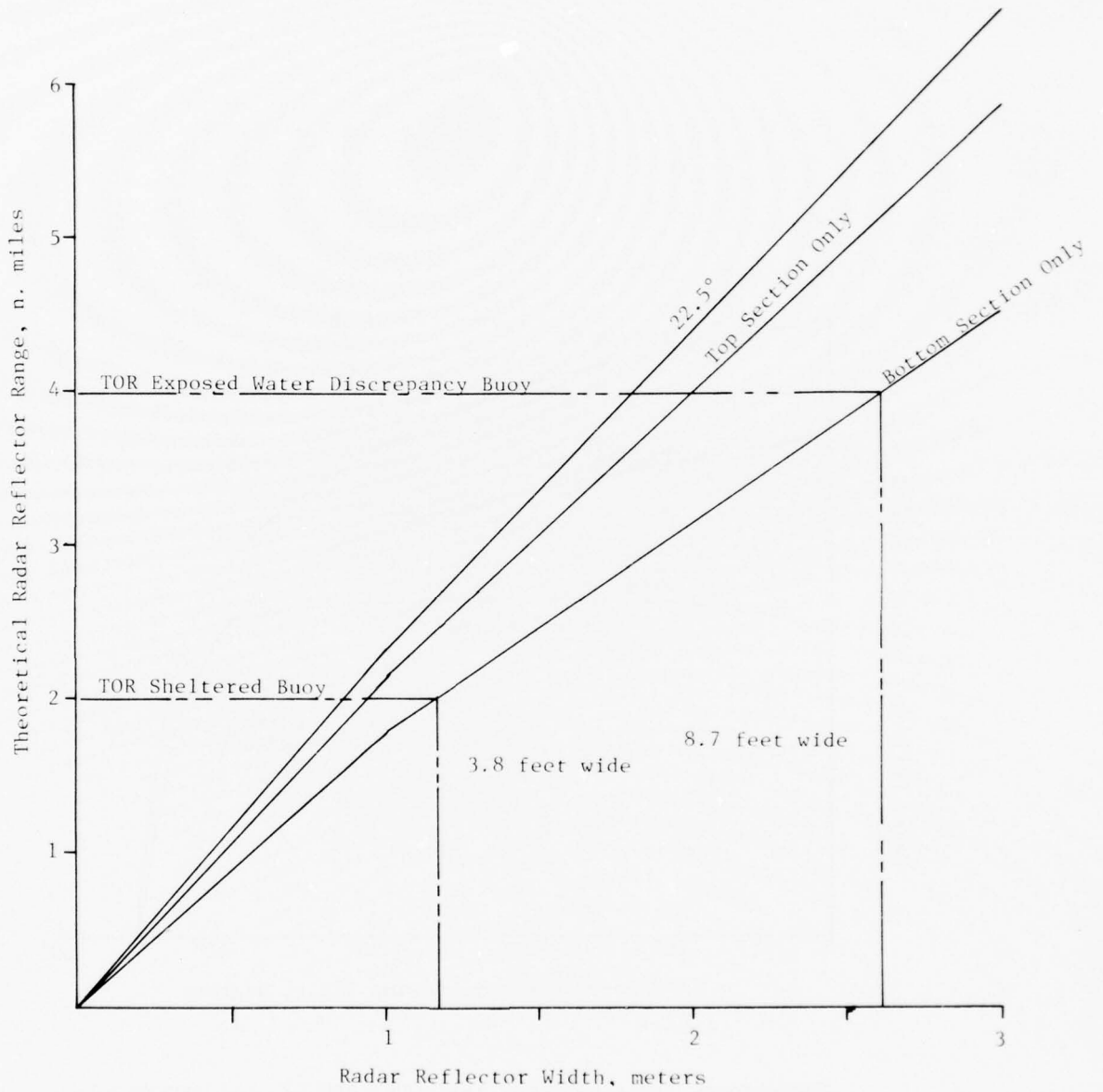
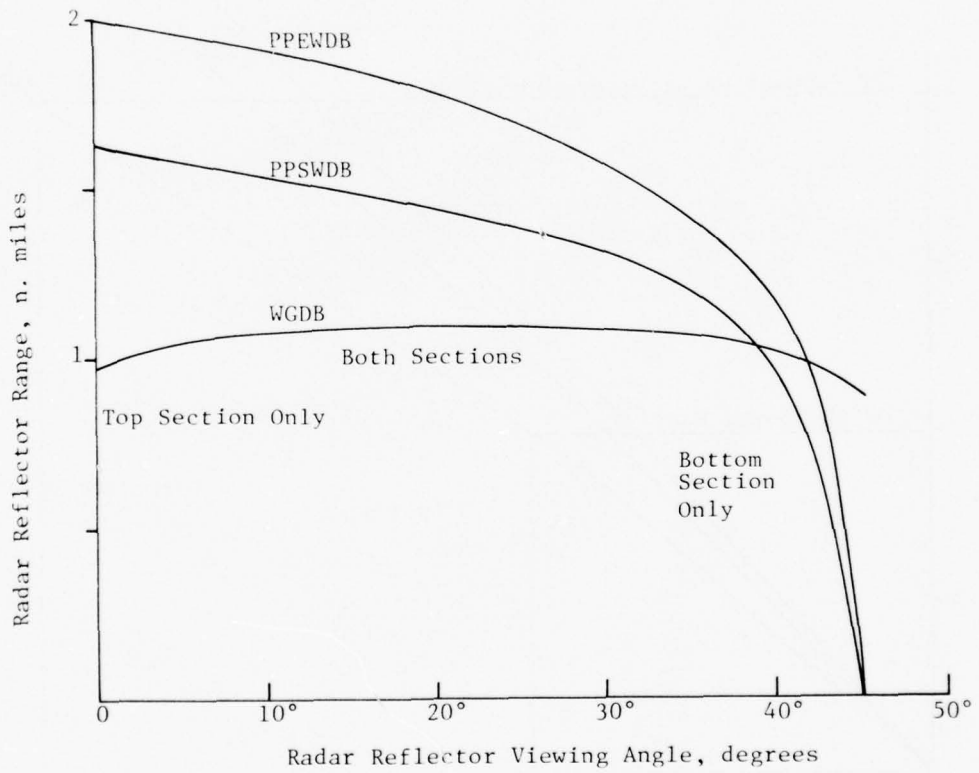

FIGURE 21



Theoretical radar range of the WGDB, PPSWDB, and PPEWDB buoys for a 3kw stereotype radar set as a function of the viewing angle (repeats beyond 45°).

The response to wave action creating structural forces in the buoy itself and at the buoy/mooring connection, damage and discoloration caused by the sun, and the corrosive action of the salt, must also be considered.

5.2.1 Reserve Buoyancy and Static Stability

The "reserve buoyancy" is important in determining the payload of the hull (daymark, batteries, lantern, radar reflector, etc.), the ability of the buoy to support a mooring, and in evaluating the performance in current. The "reserve buoyancy" is the amount of weight the buoy will support in excess of its own weight. This can be computed analytically or by tank testing.

The static stability of the buoy is the buoy's ability to remain upright. The righting moment curve is a measurement of the static stability and the metacentric height is an indication of the static stability for small angles of inclination.

Because the metacentric height is an indication of the buoy's stability, it was calculated for each of the buoys prior to fabrication. The metacentric height is the height of the point on the axis through which the buoyant force acts measured relative to the center of gravity. The metacentric height is also useful for evaluating tradeoffs of buoy size, weight, stability, and fabrication limitations.

In order to evaluate the stability characteristics over a wide range of buoy inclinations, an inclining experiment was conducted on the pre-prototype and WGDB buoys. The restoring moment for large angles of list were required using the method shown in Figure 22. Because the force up was equivalent to the downward force, the net force was zero. The overturning arm was calculated from the measured angle and the buoy's dimensions. The results of the inclining experiments are shown in Figure 23.

5.2.2 Wind Forces and The Resulting Overturning Moments

Net horizontal force and the overturning moment caused by the wind were calculated by using the standard drag equation with a coefficient of drag of 1.2 and the maximum projected area of the can. The overturning moment was taken about the mooring attachment points (bridle for the pre-prototype buoys). The wind force and resulting overturning moments initially decreases as a cosine function as the angle of list increases from zero to a point where the flotation collar rises into the wind stream. Thus, the cosine approximation is not accurate at high angles of list. The buoys were assumed to be of the general shape shown in Figure 24 and dimensions given in Table 5.

The results of the wind force and moment calculations are shown in Figure 25 overturning. These may be compared with the righting moment curves to determine the effect of a steady wind on the angle of inclination.

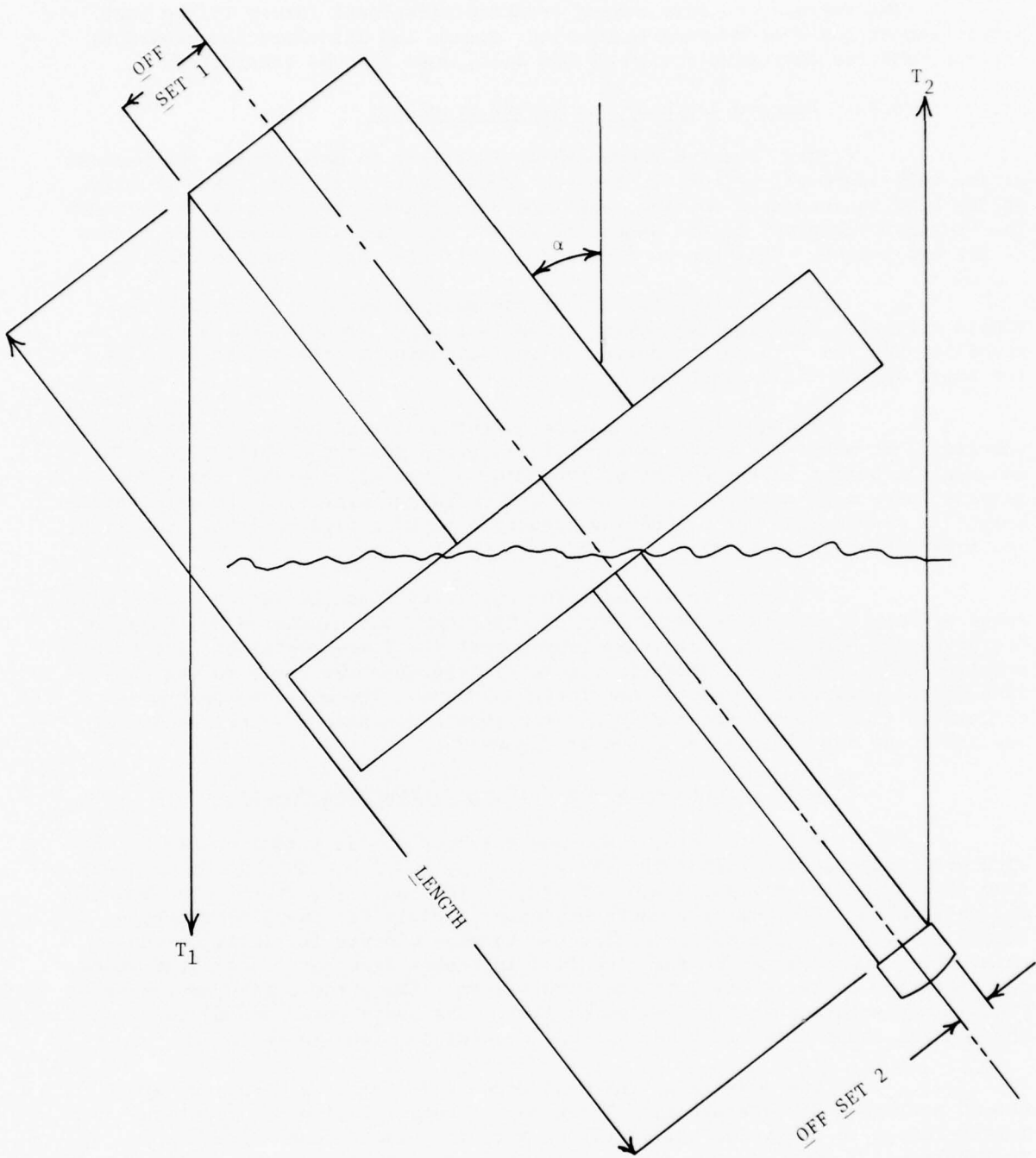

FIGURE 22

Inclining experiment method, where the righting moment is equivalent to the overturning moment. The overturning moment is induced by the "couple" with the magnitude of force being $T_1 = T_2 = T$, and an effective arm of $[L \sin \alpha + (Os_1 + Os_2) \cos \alpha]$, thus the righting moment is: $Rm = T[L \sin \alpha + (Os_1 + Os_2) \cos \alpha]$.

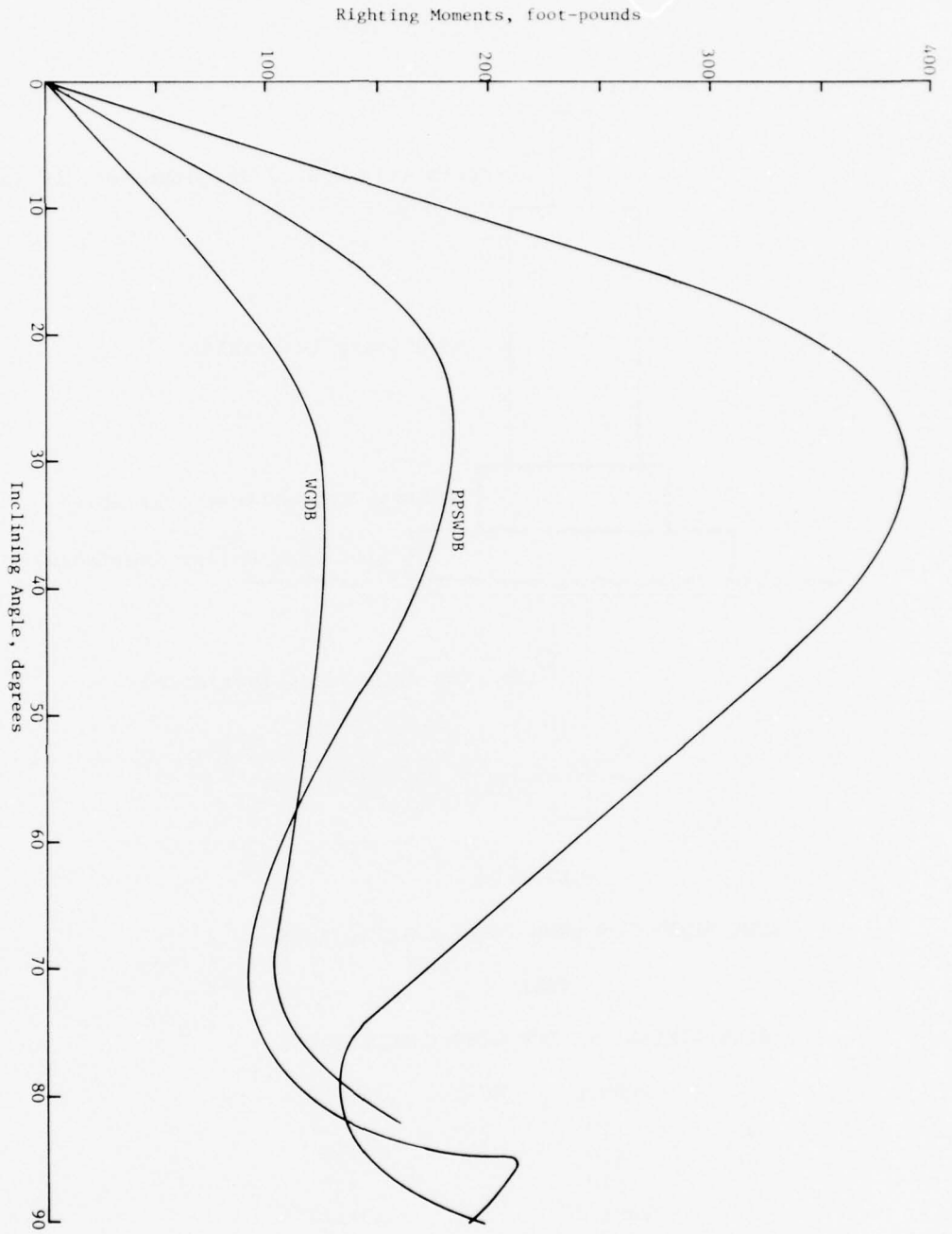

FIGURE 23
 RIGHTING MOMENT CURVES FOR THE WGDB, PPSWDB, AND PPEWDB BUOYS

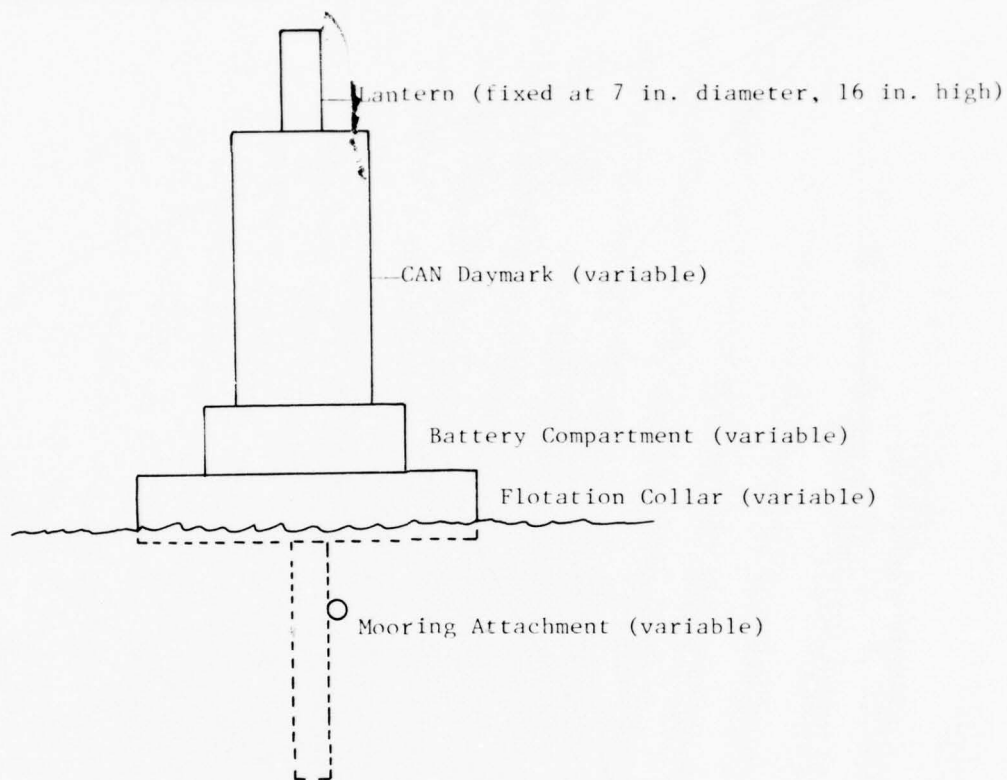

FIGURE 24

BUOY SHAPE FOR WIND FORCE CALCULATIONS

TABLE 5

BUOY DIMENSIONS FOR WIND CALCULATIONS

	PPSWDB	WG-1	PPEWDB
a.	21"	20"	27"
b.	42"	40"	54"
c.	32"		32"
d.	13-1/2"		13-1/2"
e.	48"		60"
f.	9"		10"
g.	2"	13"	2"

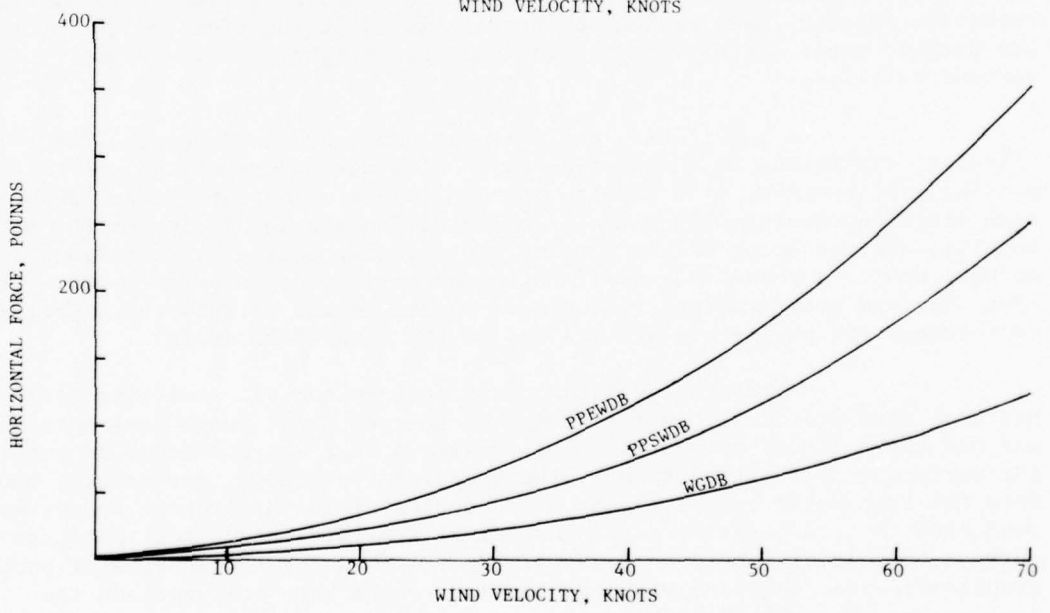
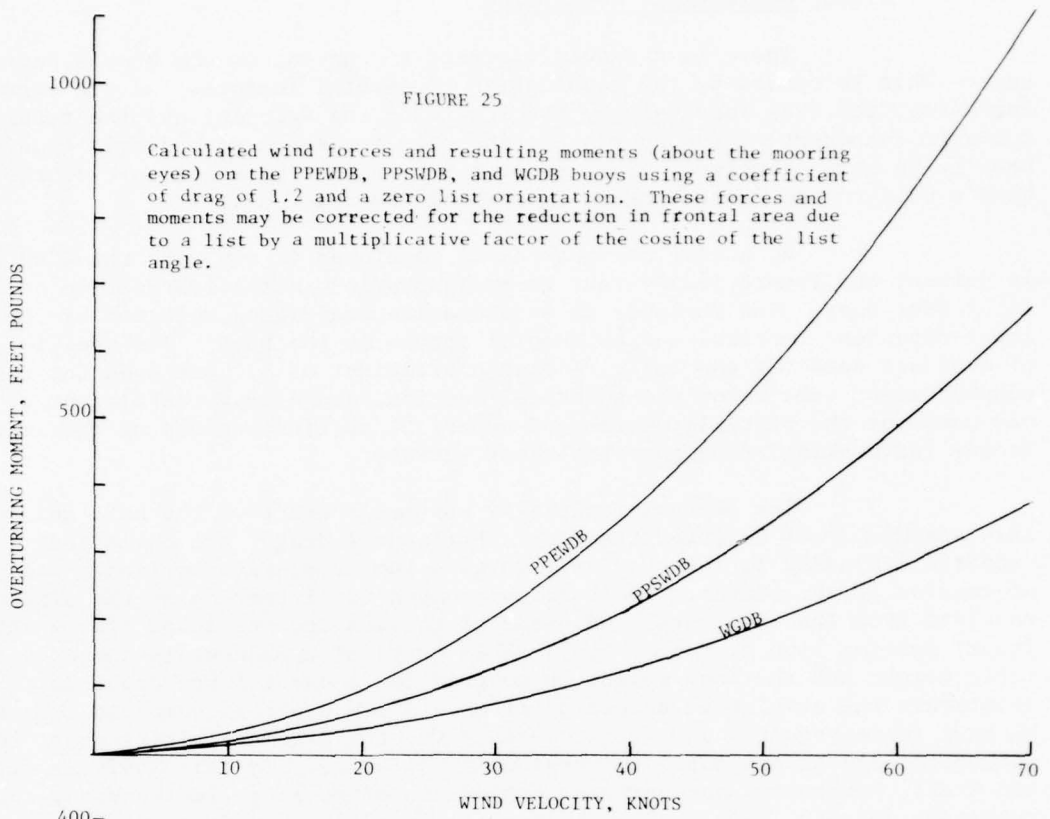

5.2.3 Performance in Current

There is a snowball effect of current on the buoy's performance. This is caused by the combination of several factors. As the current increases, the drag increases by the square of the velocity and the resulting downward component of the mooring on the buoy increases accordingly causing the buoy to be more submerged. This greater submergence presents more of the buoy's hull to the current again increasing the drag, etc.

An analytical method was developed to evaluate the WGDB buoy in current and theoretically test re-designs prior to the fabrication of the first test buoy. The analysis is an iterative converging solution of the inter-dependent vertical and horizontal forces on the buoy. Two coefficients of drag are used for the hull. A drag coefficient of 1.2 was used for the counterweight tube below the spherical section, and a drag coefficient of 2.0 was used for the partially submerged spherical section because of the increased Froude (wavemaking) drag near the water surface.

The analysis initially assumes a draft of the hull and from this assumed draft computes the buoy's horizontal drag. The cable drag is computed and added to the buoy drag to give the cumulative horizontal component of tension at the sinker. The vertical component of tension at the sinker is resolved from the horizontal component of tension and the scope (for a straight (taut) mooring line approximation). This vertical component is summed with the cable weight and the buoy weight to compute the buoyant force required to counteract the cumulative downward forces. A new draft is computed from the buoyant force required and is reinserted into the assumed initial draft for subsequent iterations until convergence is attained. By this analysis method, the draft, horizontal and vertical components of mooring line tension, and the resultant mooring line tension can be calculated as functions of the buoy size and weight, water depth, mooring line size and weight, mooring scope, and current velocity.

A sensitivity analysis was conducted to determine the relative effect of variations in the design and mooring parameters on the draft and mooring line tension. The results of this analysis indicated that the performance could be considerably affected by variations in the radius of the spherical section, and the scope of the mooring, to a lesser degree by variations in buoy weight, and to a relatively small degree by variations in water depth, mooring line size and counterweight tube size. Figure 26 and 27 show the expected performance and parametric sensitivity of the final WGDB design.

Although a similar analytical method of predicting performance had been used previously in the design of the new Coast Guard fast water buoys, and had shown itself to be reasonably valid, a test was conducted to confirm the performance of the WGDB buoy, the pre-prototype buoys, and several buoys from the fast water buoy project. The testing of the discrepancy buoys was conducted in a circulating water channel 21 feet wide and 9 feet deep for current velocities from 0 to 5 knots. The above water and underwater photographic records, combined with the tension record were analyzed and the conclusions are summarized below:

FIGURE 26

Predicted performance (free board) and parametric sensitivity of the WGDB buoy at 5 knots. The predicted performance was computed with a scope of 2.5:1, a spherical section radius of 3 feet, a buoy weight of 150 pounds, a counterweight tube projected area of 1.66 ft², a mooring wire diameter of 3/8 inches, and a water depth of 30 feet.

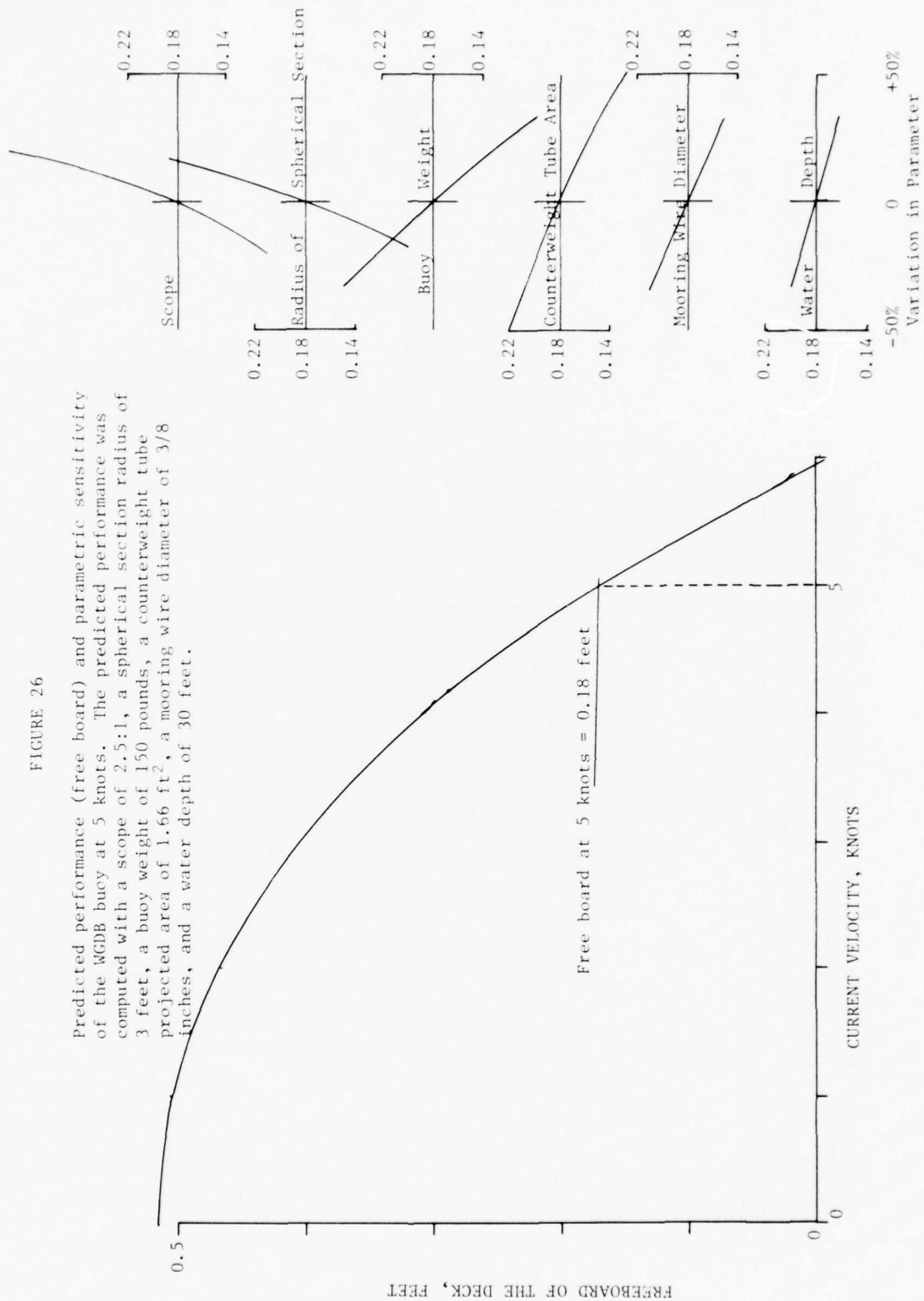

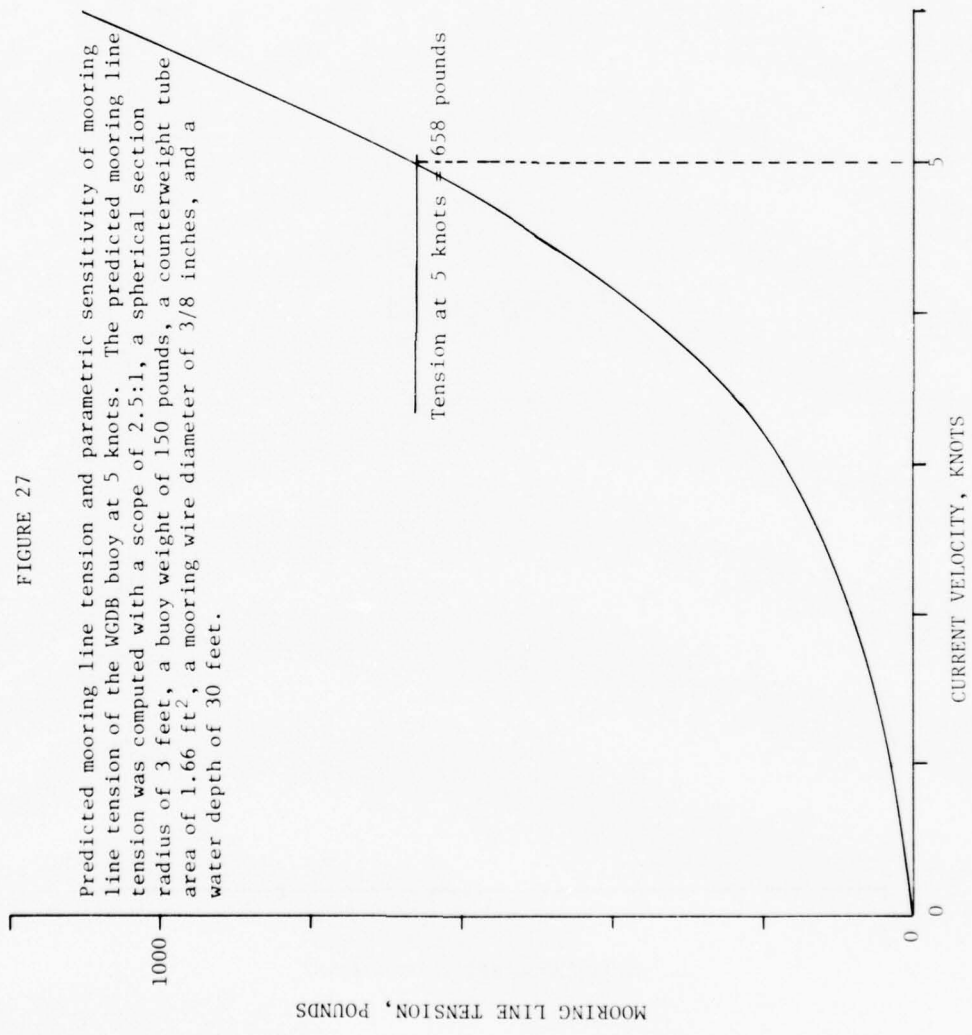
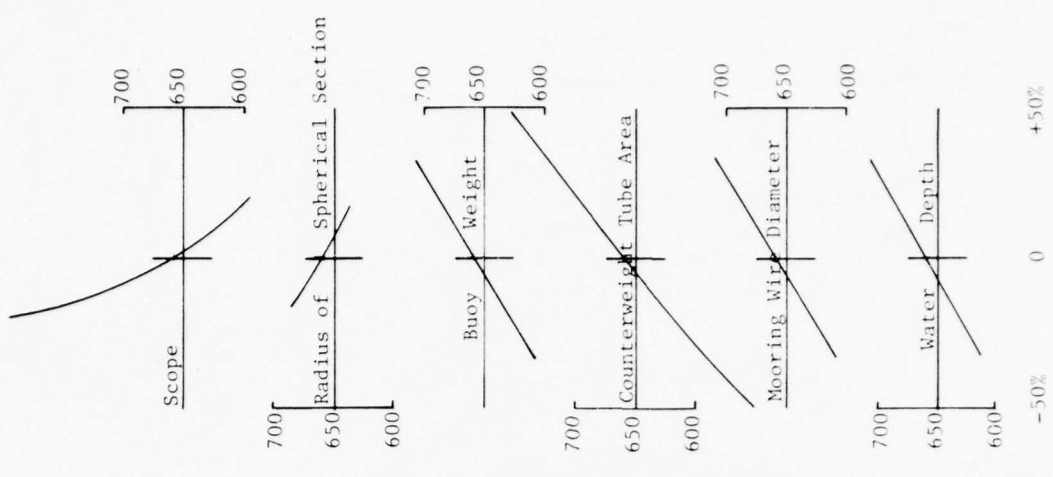

FIGURE 27

Predicted mooring line tension and parametric sensitivity of mooring line tension of the WCDB buoy at 5 knots. The predicted mooring line tension was computed with a scope of 2.5:1, a spherical section radius of 3 feet, a buoy weight of 150 pounds, a counterweight tube area of 1.66 ft², a mooring wire diameter of 3/8 inches, and a water depth of 30 feet.



a. The analytical model closely approximates the reduction in the WGDB buoy freeboard as the current increases.

b. The analytical model predicts tensions greater than those experienced for the WGDB buoy. The reason for this was discovered in a later fast water buoy test (also a spherical section hull) in that the coefficient of drag is less than the 2.0 value used in the analytical model but a negative coefficient of lift exists. The curves for mooring line tension as a function of current velocity are shown in Figure 28.

c. The WGDB buoy possesses favorable trim characteristics. As the velocity increased from 0 to 4 knots, the buoy trimmed only slightly aft. Above 4 knots the buoy trims aft to an angle of 25 degrees. At low current velocities the slight angle of trim will minimize the reduction in light intensity due to the small divergent angle of the lantern's lens, whereas the moderate angle of trim at high velocities increases the survivability of the buoy.

d. The WGDB buoy performed very well over the ranges of current velocity, buoy weights, and mooring scopes tested. The only hull design change from the mock-up buoy tested and the final buoys fabricated was the addition of 2 inches of freeboard. The test buoy is shown in Figure 29.

e. All of the discrepancy buoys demonstrated a "dancing" phenomenon as the current passed through the 1 knot range. This was characterized by a quick rolling motion of the buoy caused by vortex shedding of the counterbalance tube's wake. Calculations of the "Strouhal number" and "Reynolds number" (dimensionless hydrodynamic parameters) confirmed that the vortex shedding frequency would pass the buoy's natural resonant frequency at current velocities near 1 knot.

f. The pre-prototype buoys experienced a phenomenon that they trimmed into the current when the velocity ranged from 1 to 3 knots. Between 3 and 4 knots the buoy would abruptly shift to an aft trim. Analysis of the Reynolds number for this velocity range indicates dynamic "separation" of the counterbalance tube's wake which would (and apparently did) cause an order of magnitude drop in the tube's drag. The following other factors affect trim but to a lesser extent: the coefficient of drag for the hull is a function of the current velocity; the increased freeboard with increased current shifts the center of pressure.

g. The pre-prototype buoy's trim was very sensitive to the location of the attachment point on the center tube. When the attachment point was too high, the hull would plow through the water and would not have an angle of attack that would provide dynamic lift from the underside of the hull (shown in Figure 30a). When the attachment point was too low, the buoy would trim severely aft (shown in Figure 30b) and on the PPSWDB causing a stall of the dynamic lift and subsequently, the buoy would capsize. In the capsized position the mooring attachment point is below the counterweight tube as shown in Figures 30c and d. The best mooring attachment point positions were 17.5 inches and 25.5 inches below the hull for the PPSWDB and PPEWDB, respectively.

FIGURE 28

THE MEASURED MOORING LINE TENSIONS OF THE WGDB
BUOY IN THE CIRCULATING WATER TEST TANK AT
SCOPES OF 1.7:1 AND 3:1.

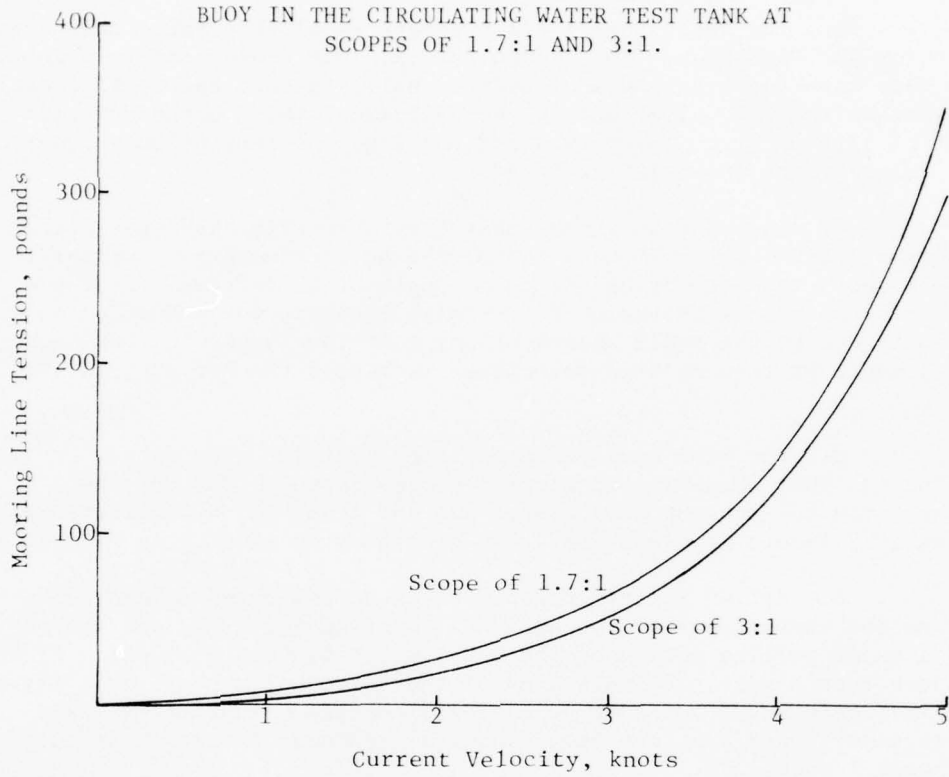

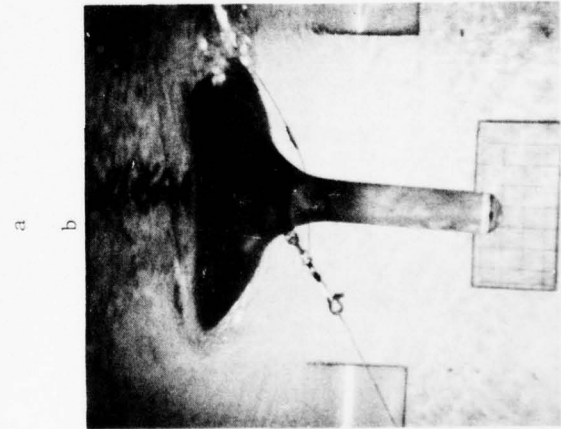
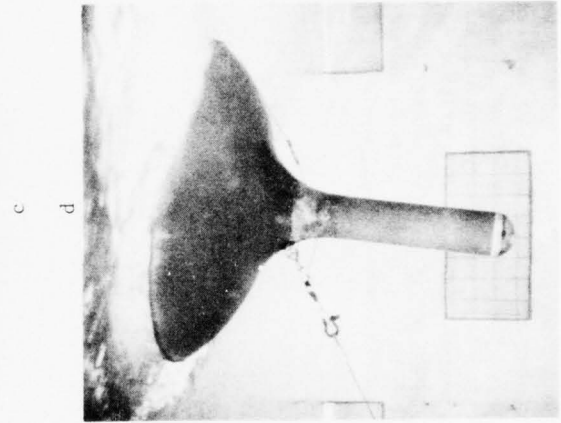
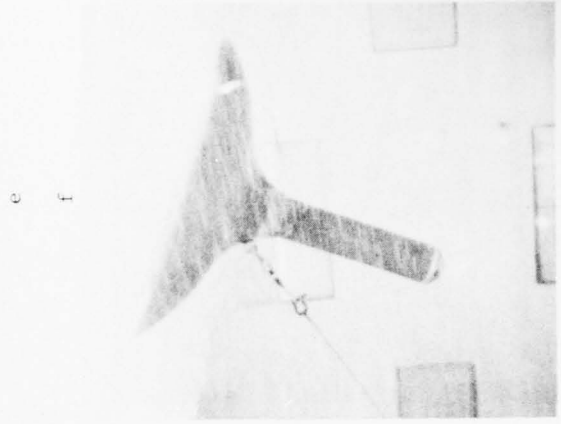
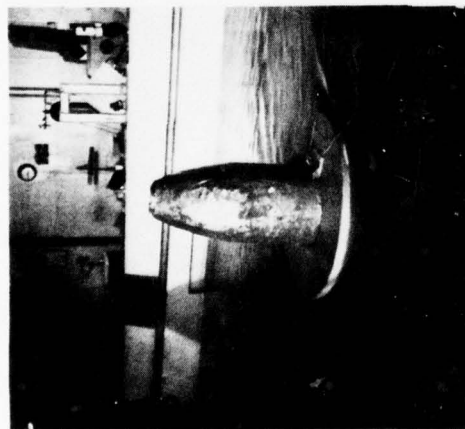
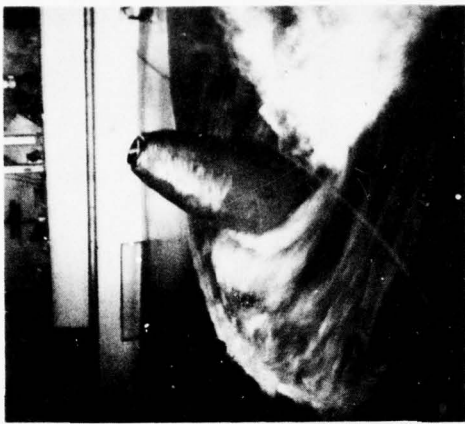

FIGURE 29
THE WGD BUOY IN A CURRENT OF 2 KNOTS AT A 2:1 SCOPE (a AND b), OF
4 KNOTS AT A 2:1 SCOPE (c AND d), AND OF 5 KNOTS AT A 1.7:1 SCOPE,



b



d

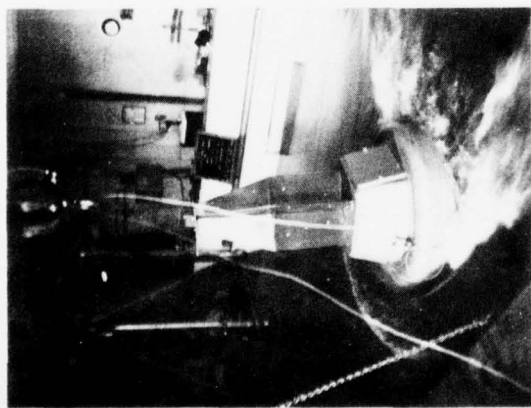

a



c

FIGURE 30

The PPSWDB in a current of 3 knots showing a significant trim forward (a). The same buoy with a lower attachment point is shown (b) in a current of 5 knots prior to capsizing (c and d). Note that the counterweight tube is above the mooring cable after capsizing (d).

FIGURE 31

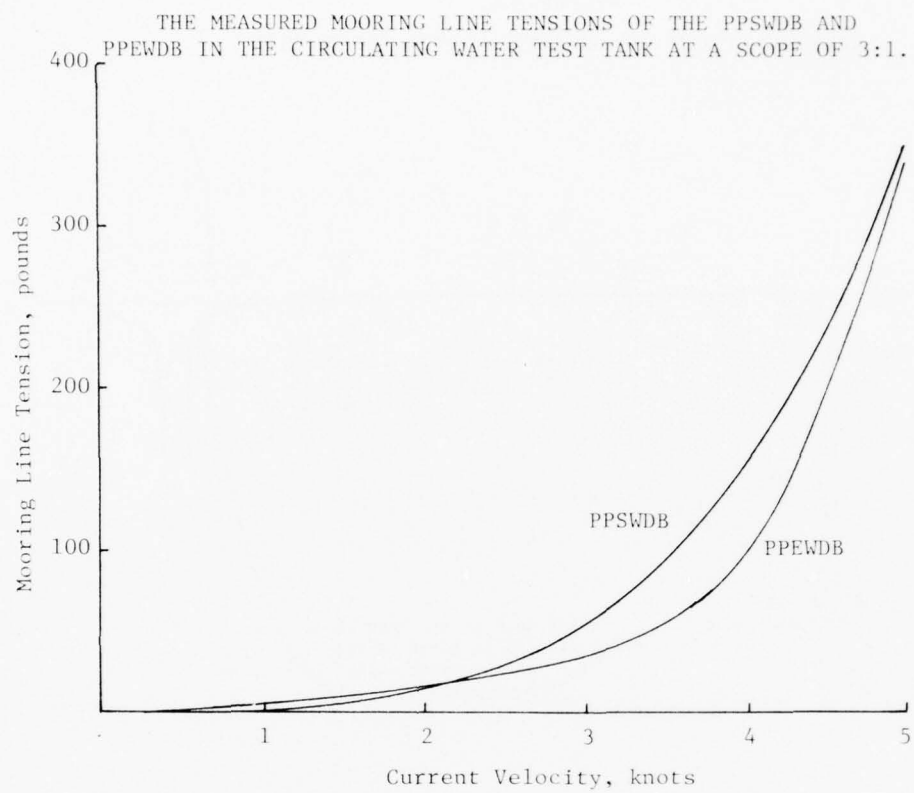

FIGURE 32a
MOORING SYSTEM FOR SHELTERED WATER ENVIRONMENT

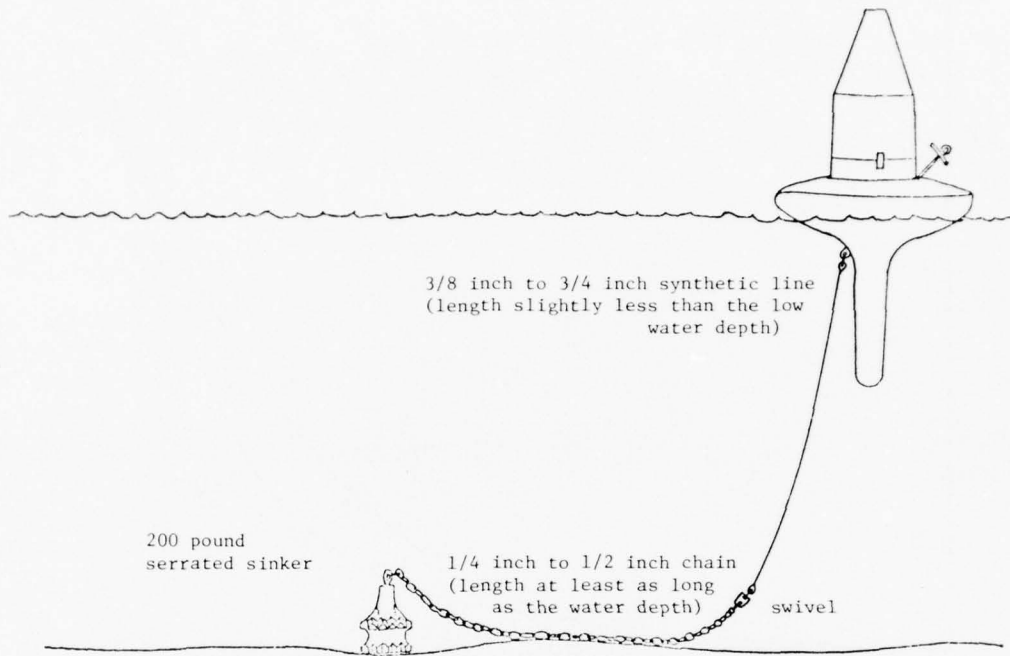
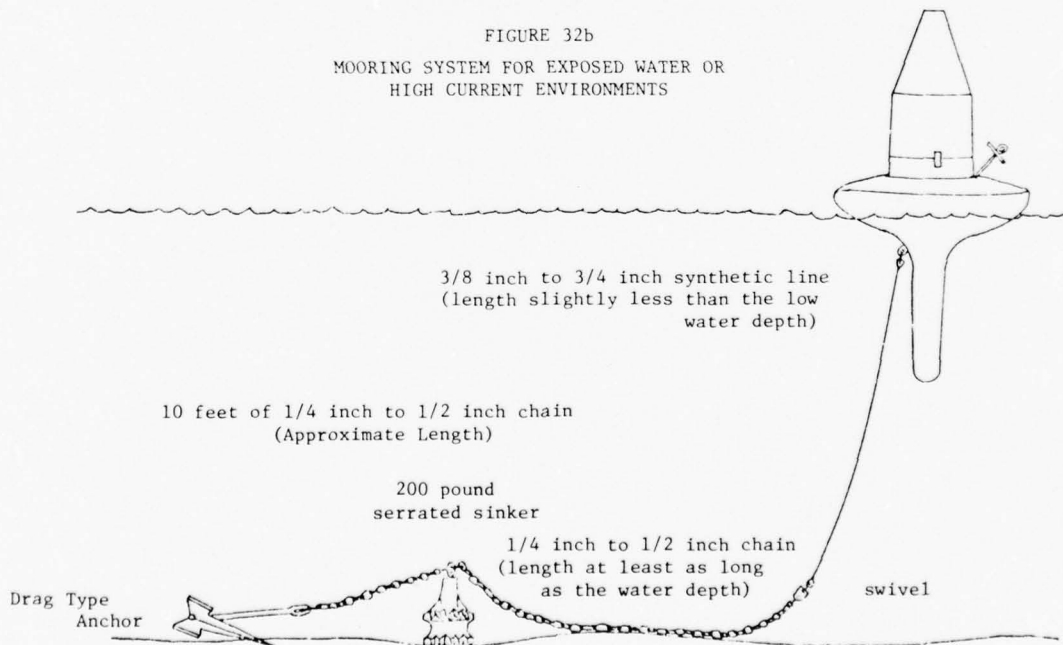

FIGURE 32b
MOORING SYSTEM FOR EXPOSED WATER OR
HIGH CURRENT ENVIRONMENTS



h. At current velocities greater than 4 knots, the pre-prototype buoys would sway and in some cases, pitch.

i. Example PPSWDB and PPEWDB mooring line tensions are shown in Figure 31.

6.0 MOORING SYSTEM REQUIREMENTS

Through experience and calculations of sinker holding power, the 200-pound Canadian Serrated Sinker (cast iron) is adequate for the WGDB and PPSWDB under almost all circumstances. All four WGDB buoys and the one PPSWDB remained on station through Hurricane Belle (68 MPH winds) moored on these sinkers. The best results have been attained with the use of 3/8-inch to 5/8-inch synthetic mooring line for the pendant (with its length being slightly less than the water depth at low water) and lightweight chain (1/4-inch to 1/2-inch nominal size) from the lower end of the synthetic to the sinker, with a swivel in between. In sheltered water areas where the current is less than 2 knots, scopes as low as 1.7:1 are adequate, but in exposed water conditions, or where higher currents exist, it is desired to have the scope exceed 2.5:1. A typical mooring system is shown in Figure 32a.

Several of the buoys with all synthetic lines have chafed the mooring line on the ocean bottom or on the sinker and resultantly have drifted free.

The PPEWDB requires more than the 200-pound Canadian Serrated Sinker if the location is exposed. What has been successfully used has been the addition of a fluke-type anchor and a length of chain to the mooring described above. This type of mooring system is shown in Figure 32b.

The 200-pound Canadian Serrated Sinker is compact and has excellent holding power in almost all bottom conditions, but is not always available. Under most circumstances the "mushroom" type anchor of similar weight or a concrete sinker of increased weight (holding power of a 200-pound concrete sinker is approximately half that of the Canadian Serrated) should be sufficient. Local knowledge of the bottom type, current conditions, wave conditions, and probability of collision (by debris or vessel) will dictate changes from the above recommendations.

7.0 CONCLUSIONS AND RECOMMENDATIONS

Three buoys were developed that closely fit the requirements for a temporary floating aid (two sheltered water buoys and one exposed water buoy).

The WGDB buoy best fits the Coast Guard requirement for a discrepancy buoy for the following reasons:

a. It is the most durable and easiest to handle of all the buoys tested.

b. It costs about half as much as the PPSWDB and PPEWDB. The 100 WGDB buoys procured for operational use and evaluation cost \$327 each (September 1976) for the hull, NUN daymark, CAN daymark, and a radar reflector.

c. Its performance in current is superior to all the other buoys tested with the possible exception of the first generation catamaran hull.

d. It meets the exposed water discrepancy TOR's with the exception of daymark range of 2 miles (it provides a nominal 1 mile range), radar range (it provides a nominal 1 mile range in lieu of the 1.5 mile range of the PPEWDB), and servicing interval of 3 months (42 days with the dry cell batteries available at most ANT units although other batteries or solar panels could extend the servicing interval beyond 3 months).

e. Because of its compact size and ease of daymark selection and attachment, it is easily transported by boat, truck, or air. At least one Coast Guard unit has indicated they will consider deployment via a helicopter under specific circumstances.

f. The greatest demand stated by most of the Coast Guard units conducting the operational evaluations is for a small discrepancy buoy with at least 3 weeks servicing interval.

The WGDB buoy may be very applicable as a lighted seasonable operational aid. Several of these buoys undergoing operational evaluation have been on station over three months without any difficulty. The changeout of batteries every 42 days, the use of higher capacity batteries, or the implementation of solar panels does not generate any insurmountable problems.

The internal batteries have worked very well where the buoys were used as discrepancy aids. They should also be compatible with solar panels for seasonal or longer deployments.

Davits, winches, and other hoisting equipment greatly aid in retrieval of discrepancy buoys or other buoys.

The rotational molding process has demonstrated its potential in the production of durable lightweight plastic buoys.

The WGDB may be moored at scopes as low as 1.7:1 if the current is moderate. If the current is low and the mooring material is resilient then the scope may be reduced below this. Since the hull is of a shape that minimizes drag, the buoy should be very compatible with synthetic mooring material (including the rubber band types) to provide a navigational aid which has a small watch circle.

REFERENCES

1. "A Method of Calculating the Maximum Range of a Radar Reflector," Supplement No. 1 to the IALA Bulletin, May 1966.
2. Clark, G.P., "On the Daytime Ranges of Buoys," CG Report of Project 712102/013, 10 May 1971.
3. Comstock, J.P. (Editor), Principles of Naval Architecture, The Society of Naval Architects and Marine Engineers, NY. 1967.
4. Amy, J.R., "Development of Radar Reflectors for Buoys in the Coast Guard," Coast Guard Engineer's Digest, Oct-Nov-Dec 1973.
5. Hill, J.H. and Abernethy, C.N., "Shape Coding for Daymarks," Final Report of CG Contract DOT-TSC-CG-72-4, Transportation Systems Center, July 1972.
6. Huddleston, G.K. and Rivers, W., "Electrical Design Data for Navigational Buoys," Report to the Coast Guard by Georgia Tech under Contract DOT-CG-10,657-A, 20 September 1971.
7. "Luminous Intensities of Navigational Aids," USCG Ocean Engineering Report No. 12E, CG-250-12E, 29 March 1972.
8. "Measurement of the Reflecting Properties of Radar Targets," Supplement No. 2 to the IALA Bulletin, November 1967.
9. Rivers, Wayne, "Aids-To-Navigation Radar Requirements," Final Report on Georgia Tech Project A-1277, prepared for the USCG on Contract DOT-CG-10657-A, 31 January 1971.
10. "Test of Radar Reflectors," report of tests conducted under Project 3965/03/01, unpublished, 29 November 1965.

APPENDIX A

A.0 DESCRIPTION AND EVALUATION OF THE FIRST GENERATION DISCREPANCY BUOYS

A.1 First Generation Modified Borg-Warner Sheltered Water Discrepancy Buoy (IGMBSWB)

The smallest sheltered water buoy design provided to the Field Testing and Development Center (FT&DC that later became the R&DC) at the project initiation was the modified Borg-Warner buoy (Figure 1A). It had a four-inch diameter central aluminum tube that acted as a main structural member and battery compartment. The two-foot diameter ABS plastic float was topped by a hollow fiberglass-reinforced plastic cylindrical daymark with interchangeable NUN and CAN shaped aluminum radar reflector on top. At the top of the central aluminum tube was a removable cap to which a standard 155mm lantern is bolted. This cap allowed access to the six 6-volt NEDA 920 batteries, wired in series-parallel for 18 volts, which were located in the bottom of the tube and acted as ballast.

Tests were conducted using this battery combination to run a F14(0.4) flasher (10% duty cycle) with 0.25 ampere lamps, 14 hours per day, at 70°F. The batteries dropped to a cutoff voltage of 10.5 volts after 25 days. At 32°F this battery combination would have been expected to last 60% as long, or 15 days. These batteries would have required more frequent servicing than was specified in the TOR's.

The lantern was 5.7 feet above the waterline, the overall buoy length was 8 feet, daymark area was 6.3 square feet, total weight was approximately 90 pounds, and the total cost was about \$435. However, the buoy had a significant negative metacentric height (GM) and floated upside down. Calculations showed that this condition could not be corrected by the simple addition of ballast and still have the buoy be handled by two men. The buoys were surveyed, and no further work done on this configuration.

A.2 First Generation Aluminum Sheltered Water Discrepancy Buoy (1GS)

The second sheltered water discrepancy buoy provided to the FT&DC at the project initiation was the Aluminum SWD buoy (Figures 2A and 3A).

The 1GS buoy had a rolled and welded aluminum hull around a central aluminum battery/ballast tube. Bolted to the flanged upper end of the tube was an aluminum rod and plate cage which retained the radar reflector and supported a daymark and standard Coast Guard 155 mm lantern. The following are the characteristics of the buoy.

Lantern height above water line	4.0 ft
Daymark area (can daymark)	2.3 ft ²
Overall length (excluding lantern)	6.7 ft
Total weight	262 lbs
Metacentric height (GM)	1.37 ft
Battery	
Servicing interval (10% duty cycle)	3 months +
Weight	50 lbs
Total number of major parts	15

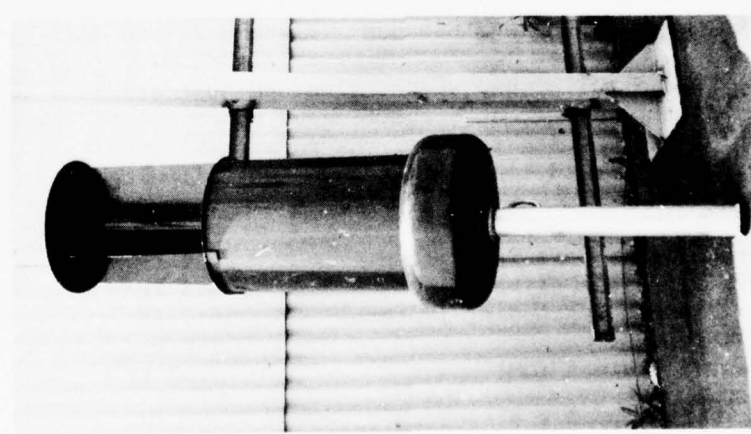
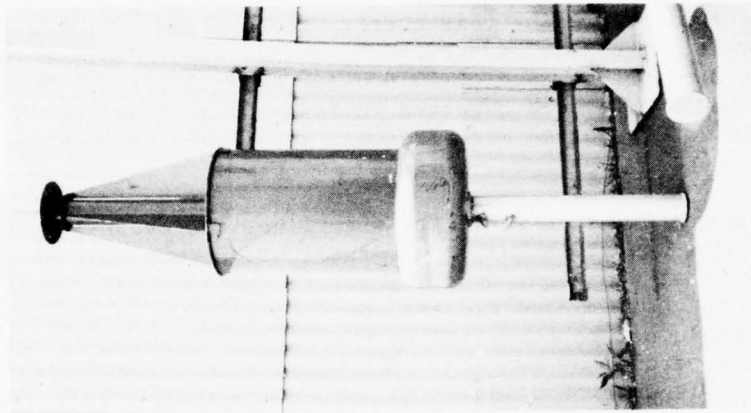
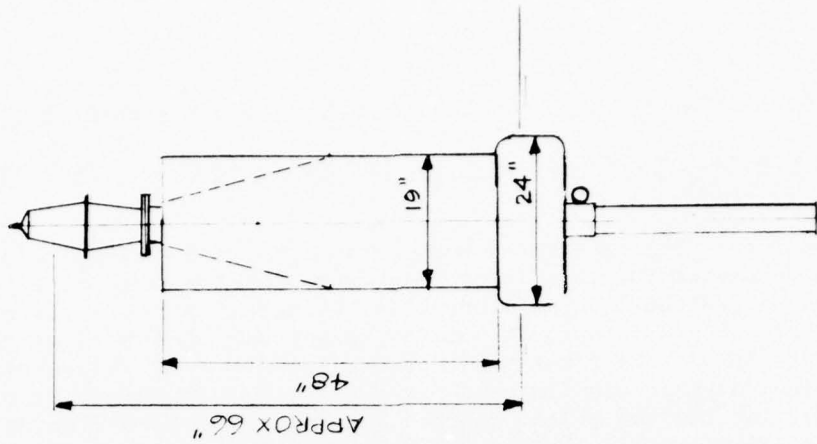

FIGURE 1A
FIRST GENERATION MODIFIED BORG-WARNER SHELTERED WATER BUOY

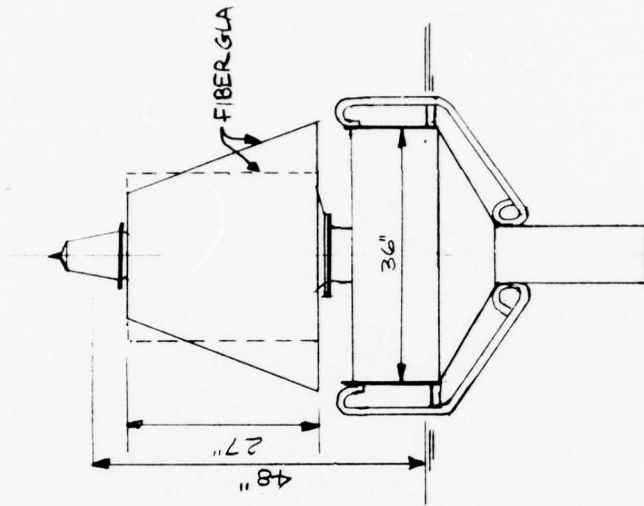
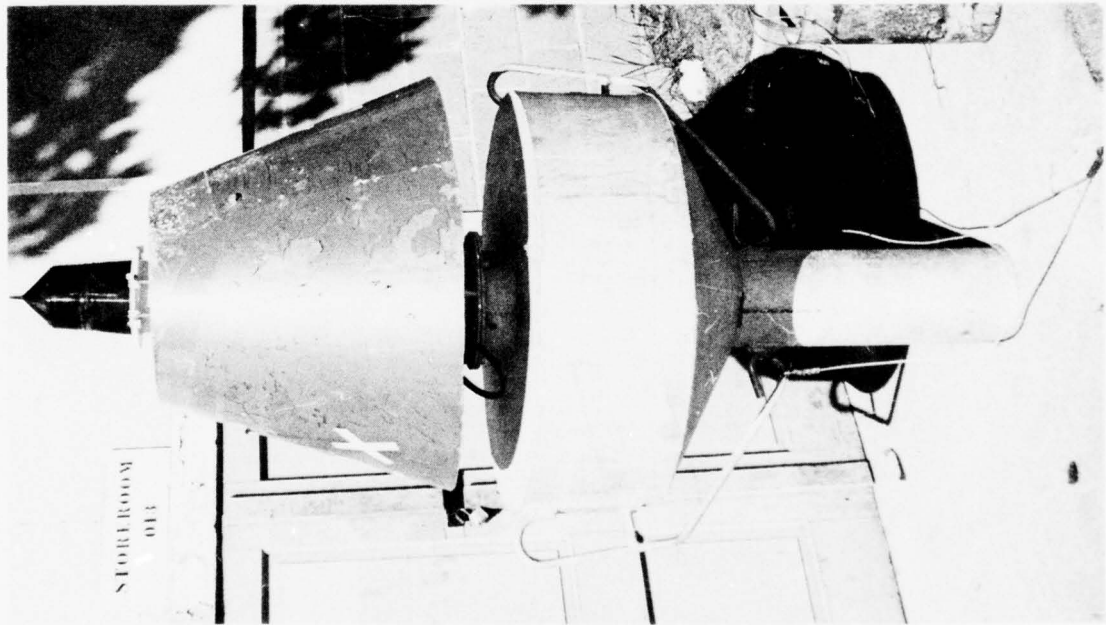

FIGURE 2A
FIRST GENERATION ALUMINUM SHELTERED
WATER DISCREPANCY BUOY (IGS, BEFORE
MODIFICATION TO THE MOORING ATTACHMENT)

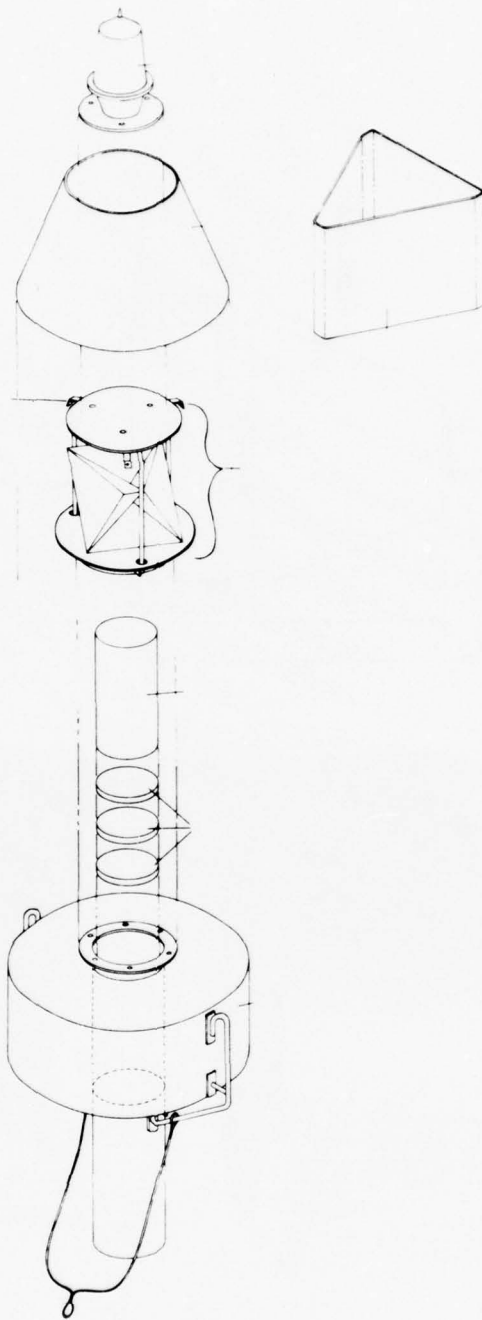

FIGURE 3A
EXPLODED VIEW OF THE 1GS BUOY
(BEFORE MODIFICATION TO THE MOORING ATTACHMENT POINT)

The battery used in the buoy was a RAY-O-VAC Number 5-3163B, 12-volt primary (non-rechargeable) dry cell battery having a rated capability of 200 ampere-hours at a cut-off voltage of 10.8 volts. The service life far exceeded the tentative operational requirements, having lasted 38 days powering a 0.55 ampere lamp with a quick flash characteristic. The visibility range required can be met with only a 0.25 ampere lamp. Powering a 0.25 ampere lamp with a 10% duty cycle, this battery will last in excess of 6 months. The battery weighed 50 pounds and was located in the bottom of the central tube where it also acts as ballast. Procurement of batteries for this buoy exhibited an ever-increasing cost from an initial cost of \$75 each to a later cost of \$92 (when purchased in small quantities) with delivery of 120 days after receipt of the order. The shelf life of this battery was approximately one year. Total buoy weight with battery, lantern, and 75 pounds counterweight was 262 pounds.

Six of these buoys were fabricated for evaluation. Two buoys were sent to Base Galveston; one each to Base Astoria, Base St. Petersburg and the ANTEVALUNIT, New Haven, Connecticut; and one unit was retained by the R&D Center for deployment and testing.

The field personnel who used these buoys were reasonably happy with them as they satisfied a need served by no other previously available hardware. The buoy was usually assembled at the storage area, loaded in a 19-foot TICWAN or 21-foot TANB, transported to station and deployed over the gunwale. The buoy was moored with good success using 5/8-inch diameter braided line, shackled to 10 feet of 1/4-inch galvanized chain, which was attached to a 200-pound serrated cast iron sinker. This operation was performed by the three man crew in an expeditious manner. The daymark was observed to be visible for approximately two miles in calm weather, but visibility decreased to about 1/2 mile in 1.5-foot seas and 15-knot winds. The radar reflector provided a sufficient target up to a one nautical mile range. The buoy's large waterplane area caused it to follow the sea surface, giving the buoy a quick motion.

Several problems arose during early deployments. The 1/4-inch stainless steel wire mooring bridle attachment points wore very quickly. In one case the aluminum rod attachment points were worn to 60% of their original area after only 39 days on station. Two buoys sank because of water flooding the hull. (One buoy was holed when it struck the wreck it was marking; the other had leaked through an air test fitting.) Field modifications were made to the buoys to correct these problems. The mooring bridle was changed to 1/4-inch galvanized chain, and the attachment modified such that all wear is on the last link of chain rather than on the buoy hull or fittings. Two-part polyurethane foam was expanded in the hull to provide positive buoyancy. The modified buoy is shown in Figure 4A.

Servicing or recovery of the buoy presented operational problems. To replace the battery, the buoy had to be brought aboard the boat in order to remove the upper structure held in place by six bolts (Figure 5A).

Recovery of the buoy by a small boat was very difficult because of its 262-pound weight and the leverage required to lift the buoy. For small boat recovery the buoy was either "man-handled" out of the water or it was towed to shore (Figure 6A). "Man-handling" the buoy resulted in the weight of the three-man crew plus the weight of the buoy being applied to one side of the boat caused



FIGURE 4A
IGS BUOY AFTER MODIFICATION TO
THE MOORING ATTACHMENT POINTS

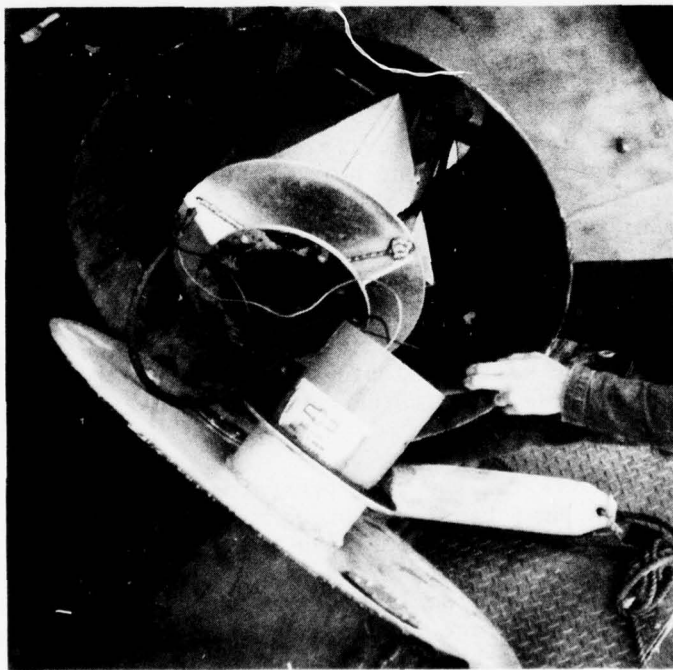

FIGURE 5A
BATTERY REPLACEMENT ON THE IGS BUOY

an unsafe condition in even the calmest sea. The ANTEVALUNIT New Haven was one of the few units participating that had a TANB equipped with winches and davits which greatly aided in handling the buoy. Most other evaluating units had boats which lacked both items.



FIGURE 6A
TOWING OF THE IGS BUOY

The lantern/battery combinations provide an adequate signal with a servicing interval greater than the tentative operational requirements. However, both Base Astoria, OR, and Base Galveston, TX, indicated that the reaction from the local tow boat captains was that the buoy presented too low a profile and that its lantern was too close to the water for good visibility. The special order battery this buoy used is no longer available from RAY-O-VAC.

A.3 First Generation Exposed Water Discrepancy Buoys (IGE)

A catamaran float-shaped buoy was selected to meet the TOR requirements for the exposed water discrepancy buoy and is shown in Figures 7A and 8A.

The catamaran discrepancy buoy had 10 hollow polyethylene floats bolted to an aluminum angle frame to form two pontoons. The pontoons were connected by an aluminum cross frame to form a rigid float. Bolted to the aluminum framework was the rigid mooring attachment, battery case, platform, tower structure, and ladder. The radar reflector was captured by the tower legs. Interchangeable fiberglass-reinforced plastic NUN and CAN-shaped day-marks fitted over the tower and rested on the platform.

A standard Coast Guard 155 mm lantern fitted with 0.55 ampere lamps and a F14(0.4) flasher was provided. The battery used was the same RAY-O-VAC No. 5-3163B, 12-volt primary battery used in the first generation aluminum sheltered water discrepancy buoy as discussed above. This battery had sufficient capacity to power the lamp/flasher combination for more than three months.

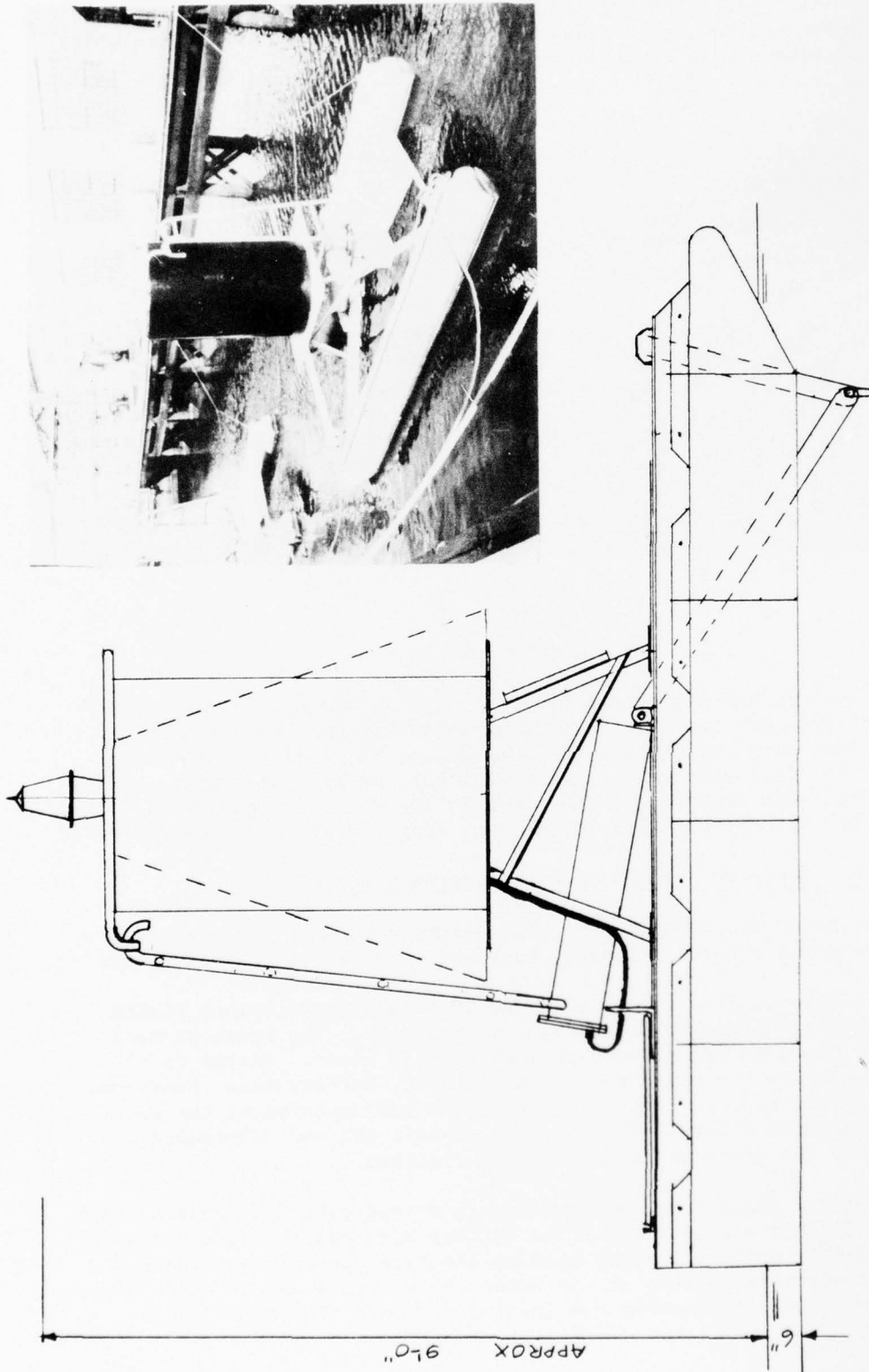

FIGURE 7A
 FIRST GENERATION EXPOSED WATER DISCREPANCY BUOY (IGE)
 BEFORE MODIFICATION TO THE MOORING ATTACHMENT

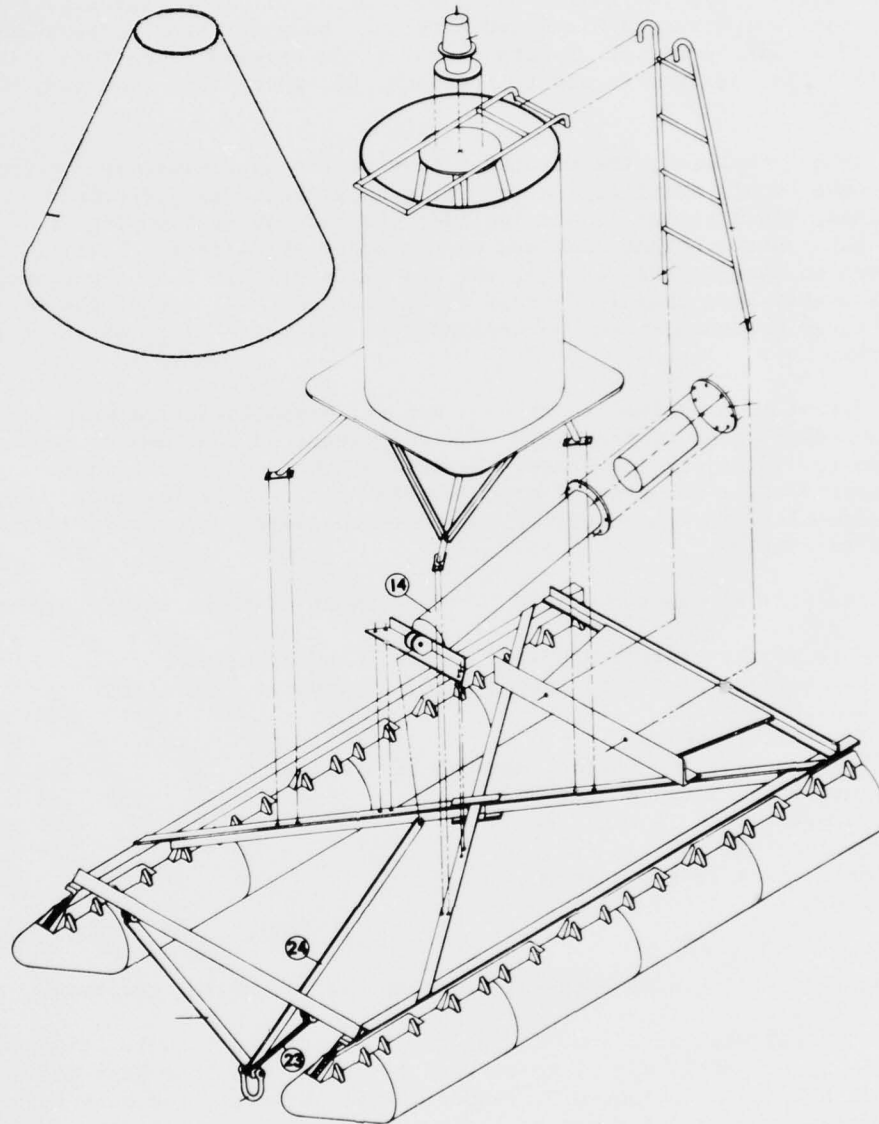

FIGURE 8A
EXPLODED VIEW OF THE IGS BUOY
(BEFORE MODIFICATION TO THE MOORING ATTACHMENT)

The mooring was made up of a 40-S Danforth anchor connected to a 200-pound serrated cast iron sinker by 10 feet of 1/4-inch chain; the serrated sinker was connected to the 100 feet of 5/8 Samson 2-in-1 nylon braided line (that led to the buoy) by an additional 10-foot section of 1/4-inch chain.

Five buoys were fabricated for field evaluation. Originally, two were sent to Base Galveston, TX, and one each sent to Base Astoria, OR, Base St. Petersburg, FL, and the ANTEVALUNIT, New Haven, CT. Subsequently, the St. Petersburg buoy was moved to Miami and Astoria's buoy was sent to Portland, OR, as they were of little use or unsuitable for their original locations. One of Galveston's buoys was transferred to Portland, OR, where this type buoy showed the most promise.

As manufactured, the catamaran buoy weighs approximately 891 pounds. To measure the buoy's stability an inclining experiment was performed. A weight of 350 pounds, added to one float, inclines the buoy about four degrees. The indicated metacentric height (GM) was on the order of 14 feet. However, this figure gives an exaggerated sense of the stability of this buoy since inclining the buoy somewhat less than 10 degrees would lift one hull out of the water causing a large decrease in the waterplane area and set a limit on the righting moment curve.

The field personnel reported a general dissatisfaction with the assembly and deployment of the buoy. The buoy required four men up to six hours to assemble its 40 major components. Because of the amount of time involved, the buoy was assembled at the storage area sometime prior to deployment. Once the buoy was assembled, it was generally placed in the water using a yard crane, and then towed to station.

The typical times required for deployment might be the following:

Hook up the trailer and load the buoy and supplies.	1	Hour
Drive from station to launch site, maximum of 50 miles.	1	Hour
Launch the TANB.		1/2 Hour
Assemble the buoy.	4	Hours
Tow the buoy to station, maximum of 4 miles.		1/2 Hour
Anchor the buoy on station.		1/2 Hour
Return to the launch area		1/4 Hour
Recover the TANB on trailer.		3/4 Hour
Drive back to the station.	1	Hour
		<hr/>
	TOTAL	9-1/2 Hours

Of the required 9-1/2 hours, over 42% was spent in assembling the buoy.

A TICWAN was capable of towing the buoy at 8 to 9 knots at maximum engine rpm. Speeds of 15 and 22 knots were reported while the buoy was towed by a 30-foot UTB and a 40-foot UTB, respectively. However, the buoy tended to veer or to dive in turns if towed at these excessive speeds. Towing the buoy at 5 knots was quite satisfactory.

The mooring successfully held the buoy on station in 40-knot winds and 5-foot seas. The anchor system (with 3/8 inch diameter 3-strand nylon line substituted for the 5/8 inch diameter braid) successfully held the buoy on station

in a current of greater than 4 knots. During the debriefings, the field units expressed the view that the buoy provided an excellent daymark. The visible range of the daymark in calm conditions was observed to be 3.5 miles, while in 3-foot seas this drops to 1.5 to 2.0 miles. A radar range of 1.25 miles was reported by a 65' ANBX operating in 2-foot seas.

One major structural problem was discovered early in the evaluation program. Due to exposure to sunlight, handling and in-service use, the polyethylene floats developed extensive cracks in the body and around the attachment points. Discussion with the manufacturer indicated the cracks could be welded by heating with a soldering iron and flowing in some of the base material to fill the void. This was tried but without success. Epoxy patches as well as fiberglass-reinforced plastic patches were also tried, but all without success. It has been concluded that these floats are not readily repairable. The floats were subsequently filled with two-part polyurethane foam to insure the necessary flotation. The float attachment points subsequently proved to be structurally inadequate. One modified buoy was deployed by Base Mayport to replace the St. Johns Entrance Buoy No. 4. On the outgoing tide, the buoy rode headed into the current with waves breaking over its stern. Two of the after floats were carried away. One additional float broke loose during recovery operations by the CGC SWEETGUM. The float attachment points had failed. The problem has been recognized by the manufacturer and this configuration float is no longer produced. Inadequate dynamic stability was also exhibited. During three deployments the catamaran buoy capsized. In one case it apparently suffered collision by an unknown vessel. In the other two cases the buoy capsized in 40-knot winds with 4 to 5-foot seas. These last two buoys were recovered without the lantern, tower, daymark and ladder. An effort was made to determine the circumstances in which the buoy would capsize. Because of the close longitudinal proximity of the center of wind drag with the mooring attachment point and the low lateral resistance of the hull in the water, the buoy had a strong tendency to sail back and forth parallel to the oncoming sea. As the buoy turned at the extremity of an excursion, the bow of the weather pontoon might have been pulled under by the taut mooring, leading to a capsizing. Two field modifications were made in an effort to decrease the probability of this happening. First, the entire cross frame with platform and daymark were moved aft 1.5 feet, moving the center of wind drag aft. Second, the mooring attachment was changed to a chain bridle. These two modifications acted to keep the buoy headed into the wind. Also, 3/8-inch diameter 3-strand nylon line has been substituted for the 5/8-inch diameter 2-in-1 braided nylon line in order to increase the compliance of the mooring.

Deployment at locations distant from the CG station (for which towing is impractical) is a real problem. A typical aid to navigation team has a 3/4-ton pickup truck and a 21-foot aluminum TANB with trailer. With the catamaran buoy disassembled and the parts loaded in both the TICWAN and the pickup truck all of the usable volume is occupied. A TANB weighs 3,360 pounds; the trailer 900 pounds, and the buoy with mooring system 1,200 pounds, for a total weight of 5,460 pounds.

In one instance the TICWAN was trailered to the deployment area and launched. Then the truck and trailer returned to the storage area, where the assembled buoy was loaded on the trailer for transportation to the launch site. At the launch site the buoy was floated off the trailer in the same manner as

the TICWAN. The buoy was then towed to station. This method required one extra round trip from the station to the deployment area. One other launching method was tried during preliminary tests. The buoy was assembled on a sand-mud beach and then pulled off by a 19-foot TICWAN with its engine running at 2,000 rpm. This method worked well except that the fixed mooring attachment could not be attached until the buoy had been floated off the beach. The chain bridle mooring attachment eliminated that problem.

APPENDIX B

B.0 DESCRIPTION AND EVALUATION OF THE SECOND GENERATION DISCREPANCY BUOY

B.1 Second Generation Sheltered Water Discrepancy Buoy (2GS)

As a result of the evaluation on the first generation buoy, a second generation sheltered water discrepancy buoy was designed and fabricated having decreased cost and weight and improved handling and servicing characteristics, while providing better visibility. This buoy is shown in Figure 1B.

The buoy had a 1-1/2-inch nominal diameter schedule 40 galvanized pipe, 10 feet long, as the main structural member. At the lower end of the pipe, 80 pounds of cast iron ballast was permanently attached. The float was expanded polystyrene foam covered with polyvinyl butyral plastic reinforced with nylon cloth. This system was used by Danco Instruments Company in manufacturing their buoys and floats, which proved to be successful during previous buoy deployments. This fabrication technique facilitated in-house manufacturing of prototype buoys. A plywood-reinforced battery compartment is located in the top of the float (Figure 2B). The reflector was held in place by the lantern bracket, which threaded onto the upper end of the tube, and provides handles to aid in deployment (Figure 3B). A lifting ring fastens to the central tube just above the float.

In the design of the second generation buoy it was felt that the TOR's for servicing interval could be met using standard batteries that were more readily available, less expensive and lighter weight than those used in the first generation buoys. The second generation buoy utilizes three standard "Hot Shot" (NEDA No. 922) batteries wired in series. A test of this battery combination powering a 0.25 ampere lamp and a F14(0.4) Flasher (10% duty cycle) at 32°F for 13 hours per day indicated a usable life of 56 days at a cutoff voltage of 10.8 volts. This value for usable life is greater than indicated by data supplied by the CG Aids to Navigation School. However, their value of 40 days is still greater than the required minimum servicing interval of 30 days. Total cost of the three batteries is about \$25 and their total weight is 27 pounds. The batteries have been made readily accessible, permitting servicing from a small boat while the buoy remains in the water. The following are the characteristics of this buoy.

Lantern height above water line	4.2 ft
Daymark area (can daymark)	6.6 ft ²
Overall length (excluding lantern)	10 ft
Total weight	200 lbs
Metacentric height (GM)	1.62 ft
Battery	
Servicing interval (10% duty cycle)	56 days
Weight	27.8 lbs
Total number of major parts	13

Nine buoys were fabricated and distributed as follows:

2 each R&D Center, Groton, CT
2 each Base Galveston, TX

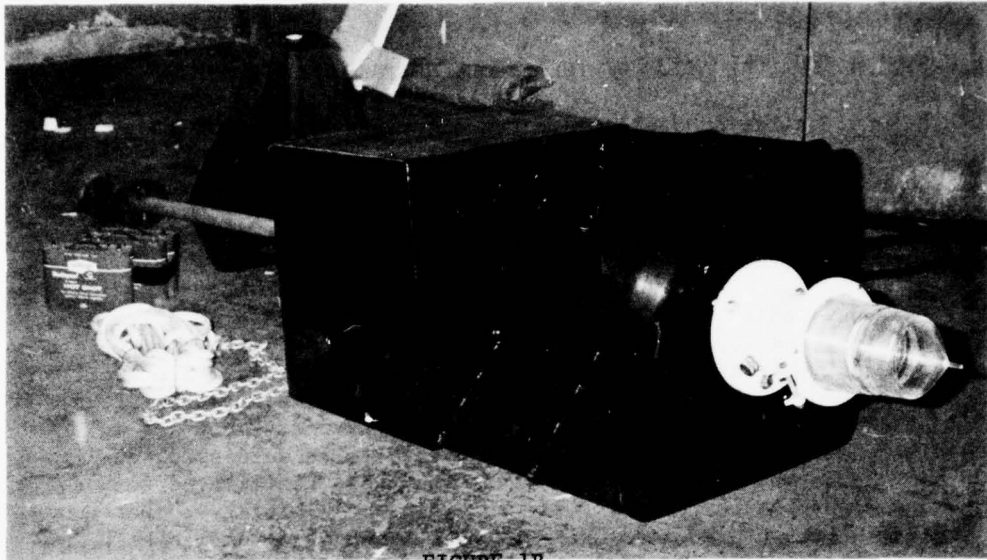
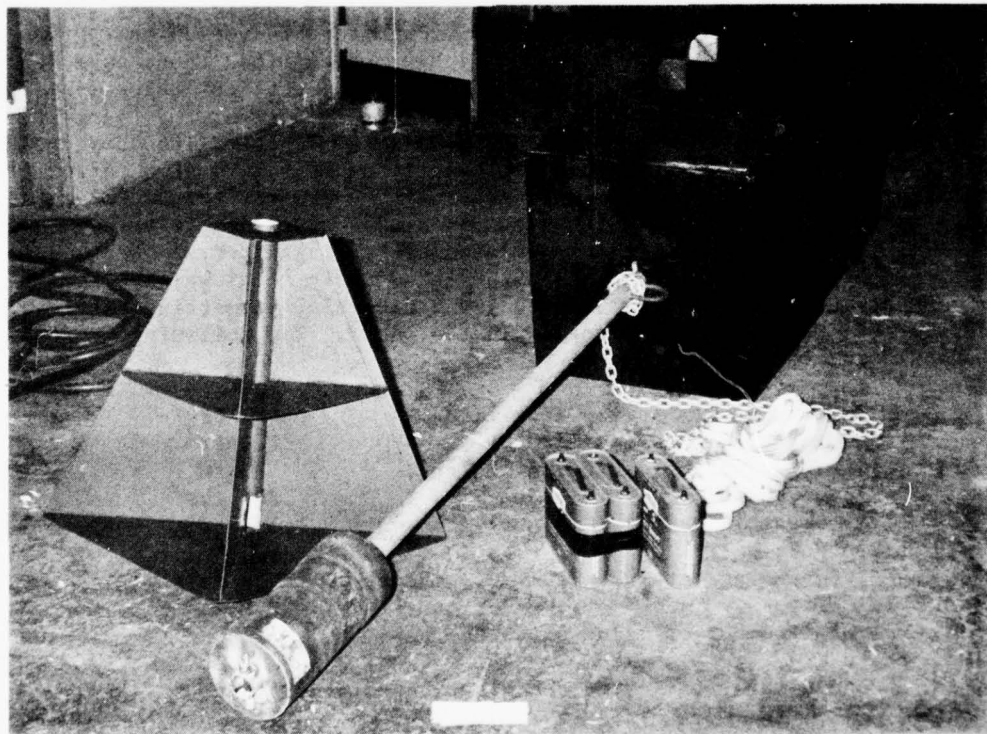

FIGURE 1B

SECOND GENERATION SHELTERED WATER DISCREPANCY BUOY (2GS) AND ASSOCIATED HARDWARE



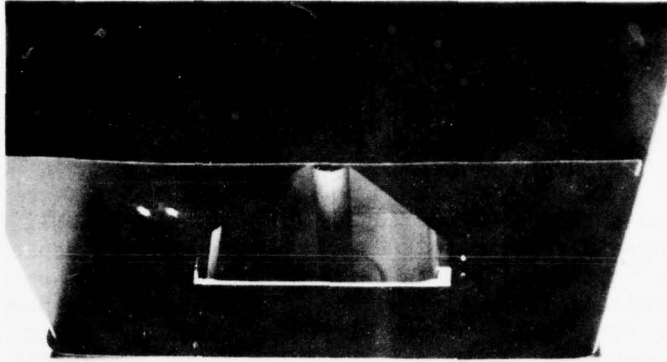

FIGURE 2B
BATTERY COMPARTMENT OF THE 2GS BUOY

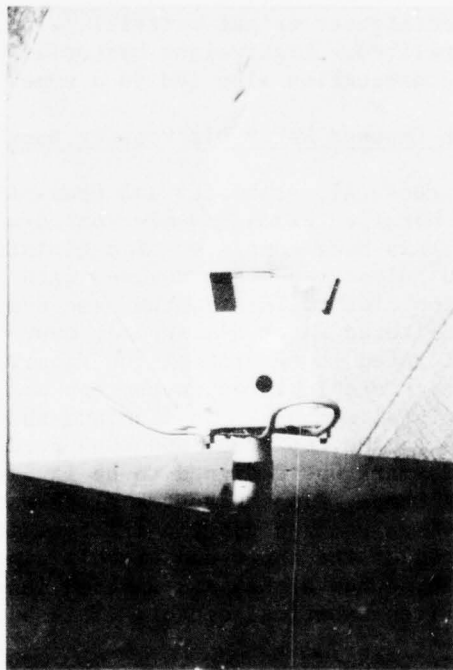

FIGURE 3B
LANTERN MOUNTED ON THE 2GS BUOY

1 each Base St. Petersburg, FL
1 each New Haven, CT
1 each Astoria, OR
1 each Charleston, SC
1 each Mayport, FL

The 2GS and a 1GS buoy were deployed by the ANTEVALUNIT in the Fort Hole Channel, New Haven Harbor, for 28 days. The buoys were deployed adjacent to one another to get comparative data on their performances. Both buoys performed well in the relatively calm conditions. A recharge was performed on each buoy using a 21-foot TANB equipped with hand winch and davit. The second generation buoy was serviced in the water but the first generation buoy required lifting aboard. The buoys were recovered using the ANBX (Experimental 45-foot Aids to Navigation Boat).

The buoy did not perform as well as desired during the operational evaluations. The main structural member (pipe) was easily bent, causing severe trim. The battery compartment was non-watertight and outages occurred due to wet batteries. The sheet aluminum radar reflector was easily damaged. The outer "skin" of the buoy ballooned and separated from the rest of the float. It is believed that this was caused by the expansion of internal gases caused by exposure to sunlight.

This buoy utilized lighter weight material (wood, foam and vinyl cloth) than had previously been utilized. Lightweight batteries were also included into the design. This type of construction also led to a somewhat fragile buoy.

B.2 Second Generation Exposed Water Discrepancy Buoy (2GE)

Because of the structural, stability and operational problems with the catamaran buoy, a second generation exposed/semi-exposed water discrepancy buoy was designed. The hull of this buoy consisted of a flotation cube, three feet on a side, made of expanded polystyrene foam covered with polyvinyl butyral plastic reinforced with nylon cloth. This is the same system used for the float on the second generation sheltered water discrepancy buoy. Two plywood-reinforced battery compartments were located in the top of the float. Four 1/2-inch diameter steel rods held 1/4-inch thick steel plates on the top and the bottom of the float and acted as the main structural members. An aluminum sheet and pipe daymark/radar reflector were bolted to the top plate and supported a standard 155 mm Coast Guard lantern. The daymark was designed to be inverted so as to provide either a CAN or NUN daymark shape. To the bottom plate was welded a 2-1/2 inch nominal diameter schedule 40 galvanized pipe, 5-1/2 feet long. A single point mooring attachment is located at the upper end of this pipe. Attached to the lower end of the pipe is 150 pounds of ballast divided into a 50-pound steel plate and a 100-pound cast iron spherical sector. This buoy is shown in Figure 4B.

In the design of the 2GS buoy, the tentative operational requirements for the light characteristic and minimum servicing interval could be met using off-the-shelf batteries that were more readily available, less expensive and lighter weight than the battery used in the catamaran buoy. Two 12-volt, 65 ampere hour lead-acid marine-type batteries with ball-valve type anti-spill caps

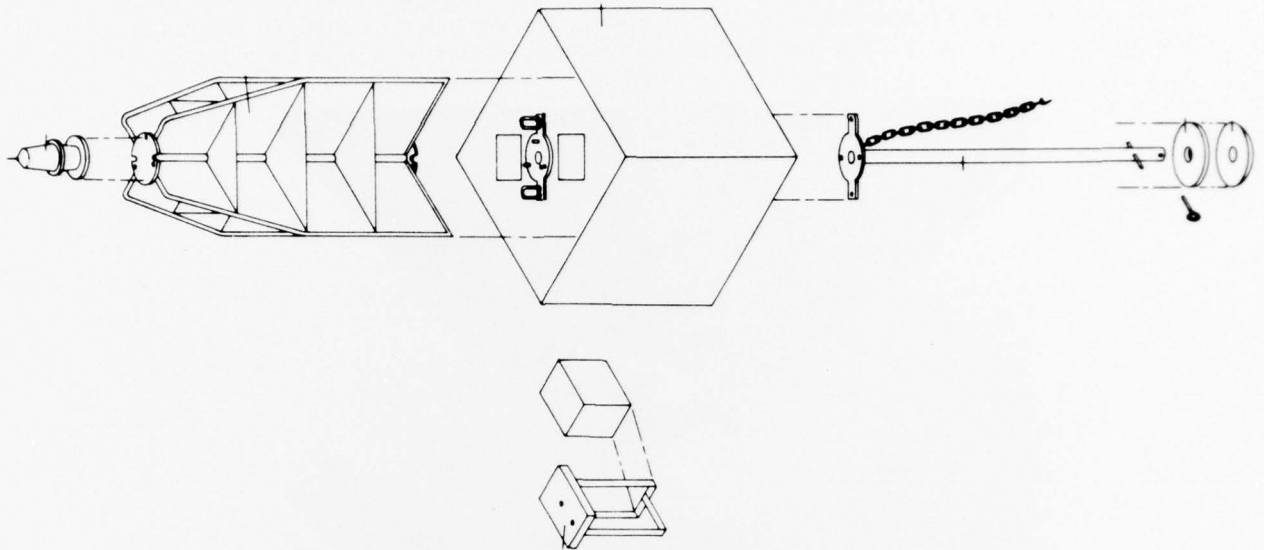

FIGURE 4B
 SECOND GENERATION EXPOSED WATER
 DISCREPANCY BUOY (2GE)

were wired in parallel. Tests conducted at the R&D Center indicated a usable life of 102 days for this battery combination while powering a 0.55 ampere lamp and a F14(.4) characteristic at 32°F for 13 hours per day at a cutoff voltage of 10.8 volts. This selection actually resulted in a battery weight increase of 32 pounds but a cost savings of \$31 (initial) as compared to the primary batteries used in the catamaran buoy. Of more significance was the demonstrated ability to use readily available batteries. In an emergency situation, automobile batteries purchased en route to the deployment area could be utilized. Figure 5B shows one of the two battery storage locations in the buoy hull.

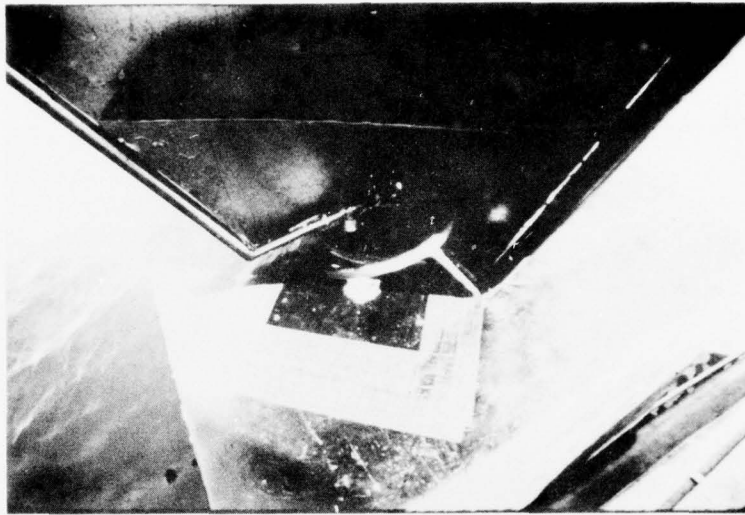

FIGURE 5B
BATTERY STORAGE LOCATION IN THE 2GE BUOY

The second generation exposed/semi-exposed water discrepancy buoys were distributed as follows:

- 1 each R&D Center, Groton, CT
- 1 each St. Petersburg, FL
- 2 each Galveston, TX
- 1 each USCGC WHITE SAGE, Woods Hole, MA
- 1 each Astoria, OR
- 1 each New Haven, CT
- 1 each Charleston, SC
- 1 each Mayport, FL

Construction and outfitting at the R&D Center resulted in a total buoy weight of 420 pounds, a metacentric height of 1.62 feet, a daymark area of 18.4 square feet, and a lantern height of 7.8 feet. Cost of prototype fabrication was approximately \$1,060, slightly more than half the catamaran buoy cost (\$1,774).

Preliminary tests were conducted on the first buoy fabricated. The buoy could readily be broken down into components that could be handled by two

men and that could be transported in a 3/4 ton pickup truck. Assembly by two men in less than 3/4 hour was demonstrated. Figure 6B shows the transport of this buoy by pickup truck.

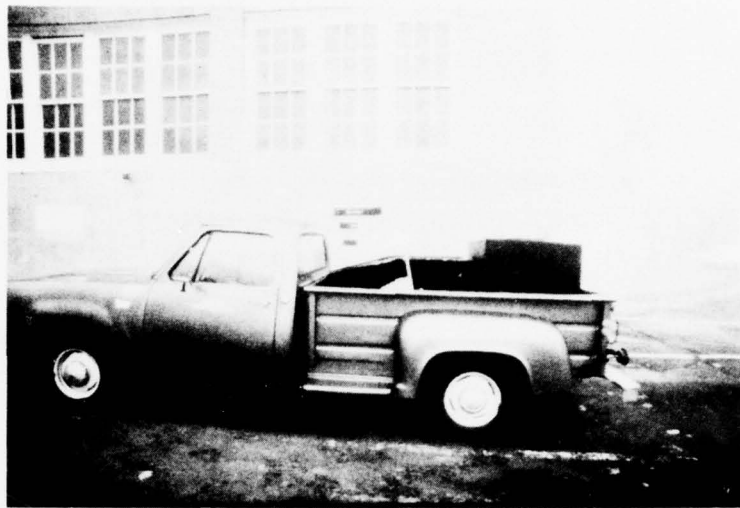

FIGURE 6B

TRANSPORT OF THE 2GE BUOY VIA PICKUP TRUCK

The buoy was deployed from a 19-foot TICWAN utilizing a readily fabricated tilt board which was temporarily installed for the purpose. The buoy could not be lifted back aboard the TICWAN, and, accordingly, was towed at 5 knots by the 19-foot TICWAN. Figure 7B shows this deployment.

The location and design of the battery boxes and covers permitted changing of the batteries from a small boat while the buoy remained in the water and at the same time provided protection from the elements and vandalism.

A 2GS buoy was deployed off Faulkner's Island Light Station, Long Island Sound, in 30 feet of water for a three-month initial evaluation. The mooring was made up of a 40-S Danforth anchor connected to a 200-pound serrated cast iron sinker by 10 feet of 3/8-inch chain; the serrated sinker was connected to the 100 feet of 5/8-inch Samson 2-in-1 nylon braided line (that led to the buoy) by an additional 10-foot section of 3/8-inch chain.

This buoy survived 50 knot winds, 5 foot seas, and strong current while remaining on station and operational.

The buoy was too large and heavy to be lifted back aboard the TICWAN or TANB. On some of the buoys the outer skin swelled and separated from the foam and a few seams have split from this expansion.

An investigation into suitable materials was required.

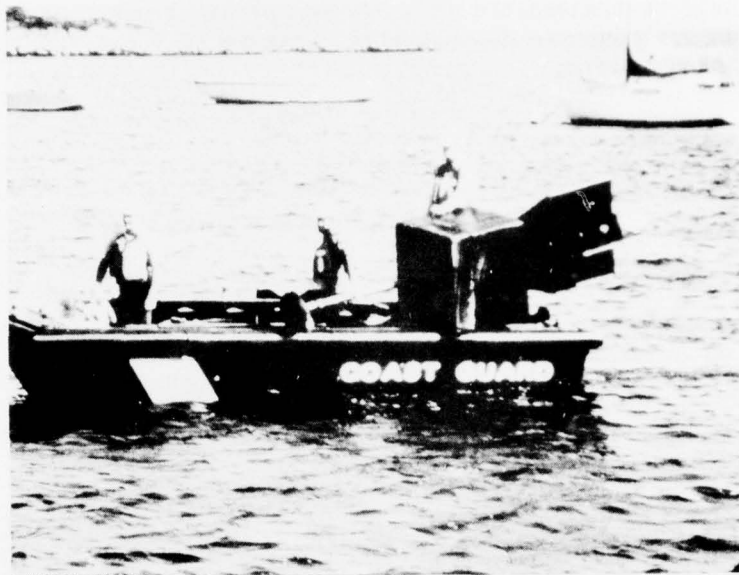

(a)



(b)

FIGURE 7B

TRANSPORT OF THE 2GE BUOY ON A 19-FOOT TICWAN (a)
AND THE 2GE AFTER DEPLOYMENT (b)

APPENDIX C

C.0 DESCRIPTION AND EVALUATION OF THE BASE MAYPORT AND BASE CHARLESTON DISCREPANCY BUOYS

C.1 Base Mayport Buoy

Upon completion of the second generation design evaluations, it was apparent that not only a lightweight design but a durable buoy was required. This appeared to be one of the shortcomings of the first and particularly the second generation buoys.

Since several CG units had improved the discrepancy buoys they had designed for their local requirements, and some of these proved more durable than the first and second generation buoys, a study of these buoys was initiated.

The Base Mayport buoy, a later generation of the Seventh District's ALERP buoy, was of all aluminum construction and had a cylindrical foam-filled body penetrated by an aluminum "I" beam to which a concrete counterweight was attached at the lower end. Figure 1C shows the older ALERP buoy and Figure 2C shows the Base Mayport buoy.



FIGURE 1C
ALERP BUOY

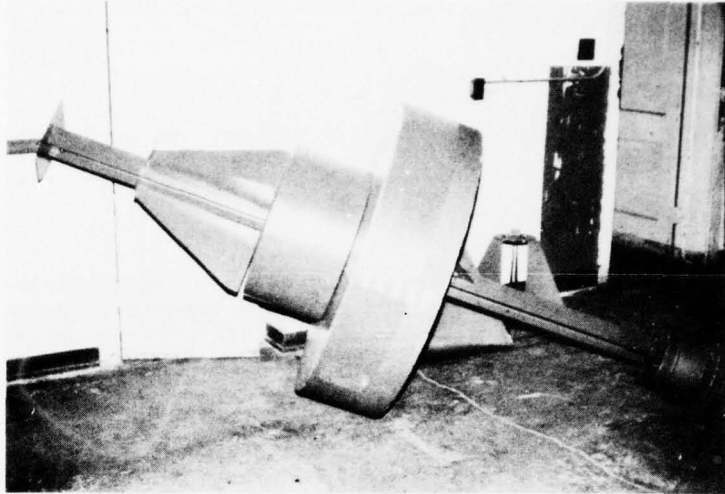

FIGURE 2C
BASE MAYPORT BUOY

An aluminum cylinder, open at the bottom down the upper portion of the beam covering "hot shot" batteries contained in brackets that were also supported by the beam. A NUN or CAN combination daymark/radar reflector slid down on top of the battery cover and was in turn topped with a bracket for the lantern, that held everything in place.

Two buoys were obtained from Base Mayport. One was used at the R&D Center, the other was sent to Base Astoria. Also, many Florida and South Carolina units have these buoys that were provided by the Seventh CG District.

Most complaints from the field units concerned three areas:

- (1) Non-watertight battery "compartment"
- (2) Poor construction methods (welded seams split open easily)
- (3) Lack of good mooring and lifting hardware.

Some units had and continue to have a problem with a shortage of component parts of the buoys. Missing or damaged lantern brackets, radar-reflectors, battery covers and counterweights rendered otherwise operational buoys useless. Some of the buoys were not foam filled and when their seams split, they sank.

The Mayport buoy was more durable than the plastic buoys, with the possible exception of its battery cover and the radar reflector. As in the IGS buoy design, the daymark and the radar reflector were low to the water. The daymark was too small and non-standard, and the radar reflector was insufficient. The battery compartment was far from being watertight, and there was only a minimum provision for recovery and mooring attachment points.

C.2 Base Charleston Buoy

This buoy was developed during 1973 by Base Charleston civilian workers for that general local. While it closely resembles the Seventh CG District ALERP buoy, its construction consisted of two joined halves of thermo-formed, 1/4-inch ABS (plastic). The counterweight tube and the cage legs were PVC pipe bonded to PVC flanges, which were in turn bonded to indentations molded into the ABS body. The body contained 2-pound per cubic foot density poured-in-place foam. An ABS thermo-formed battery box was bolted to the top of the buoy body. The top of the cage legs were enclosed by an ABS molded box-like structure which also served as a lantern stand. The buoy (less lantern, battery and counterweight) was reported to have withstood a four-foot drop to a concrete surface with no damage. The buoy could use either three "hot shot" dry cell batteries or one 12-volt lead acid battery. Figure 3C shows this buoy.

In order to evaluate the Base Charleston buoy in a configuration that would be suitable for exposed water conditions, the four-foot diameter buoy was sealed up to a five-foot diameter version (Figure 4C).

One four-foot and one five-foot buoy were tested at the R&D Center. One additional four-foot buoy was sent to Base Astoria, OR, for field evaluation.

Other than the very limited daymark and lack of a radar reflector, the main problem with the Base Charleston buoy was damage to the cage although this appeared to be a minimal drawback because the damage was easily repaired. Missing or broken cages could be replaced in the field using locally available materials and very few hand tools (Figure 5C). Even hull damage could be repaired.

The Charleston design, while admittedly less durable than the aluminum, seemed to offer the best choice for future development. Foam-filled ABS plastic provided a combination of strength and light weight. The free-flooding tube cancelled some of the counterweight requirement. Only 24 pounds of counterweight was required to maintain sufficient stability of either the sheltered or exposed water buoy designs. That's compared to a minimum of 65 pounds in the Mayport buoy to a maximum of 150 pounds for the 2GE buoy. While the cage was easily damaged, the hull and counterweight tube assembly appeared very sturdy. ANT Miami had one buoy deployed that was overrun by a small vessel, the cage, lantern and battery box were separated cleanly from the buoy, but even though the propeller had gouged a piece from the hull, it remained intact, upright and mooring on stationed (Figure 6C).

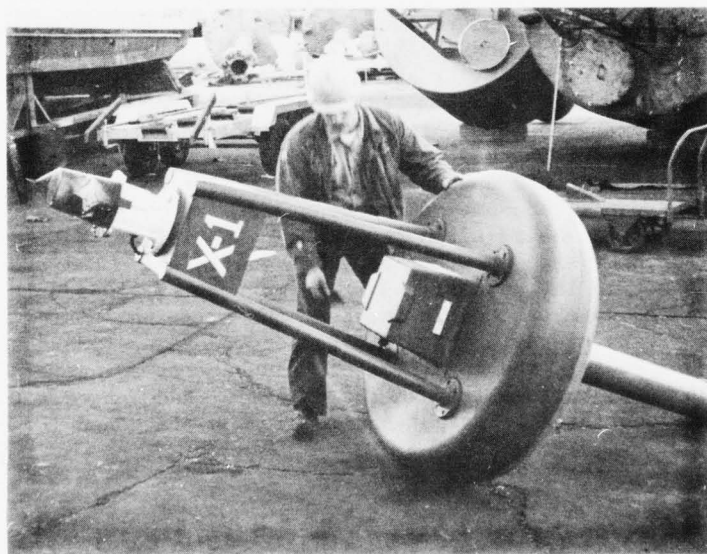
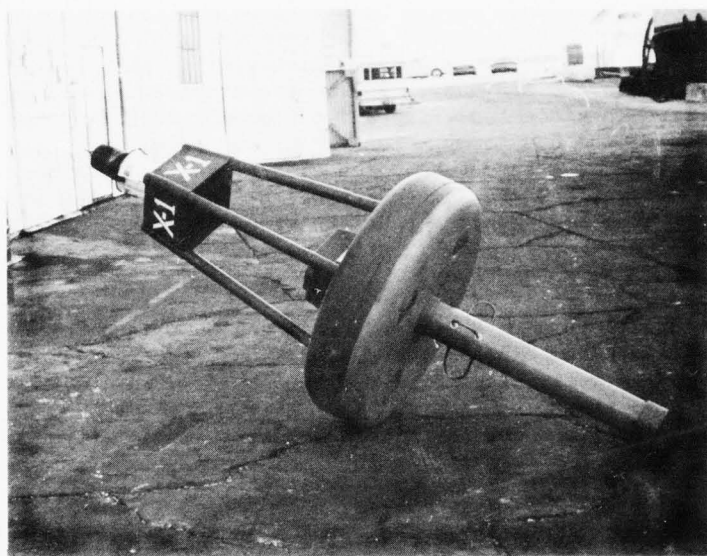

FIGURE 3C

BASE CHARLESTON BUOY (4-FOOT DIAMETER)

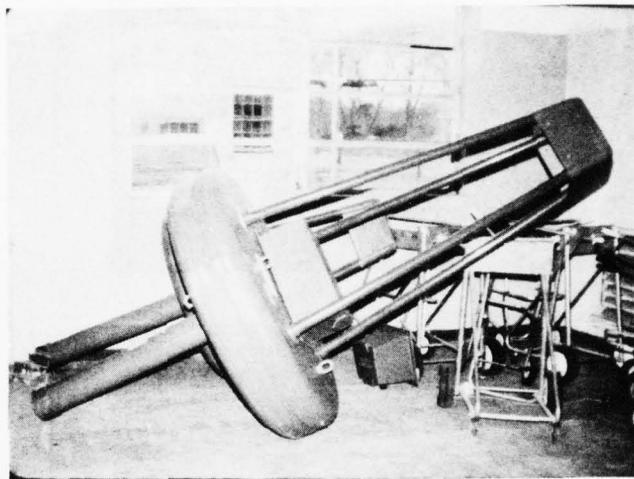
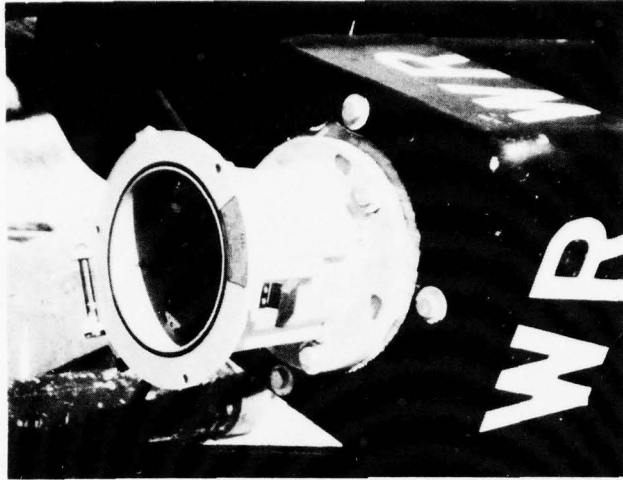
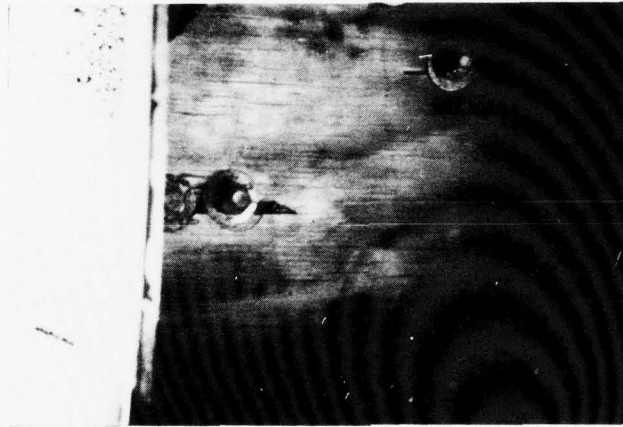

FIGURE 4C

BASE CHARLESTON BUOY (5-FOOT DIAMETER)
(4-Foot Diameter Base Charleston Buoy Is In The Background)



(a)



(b)

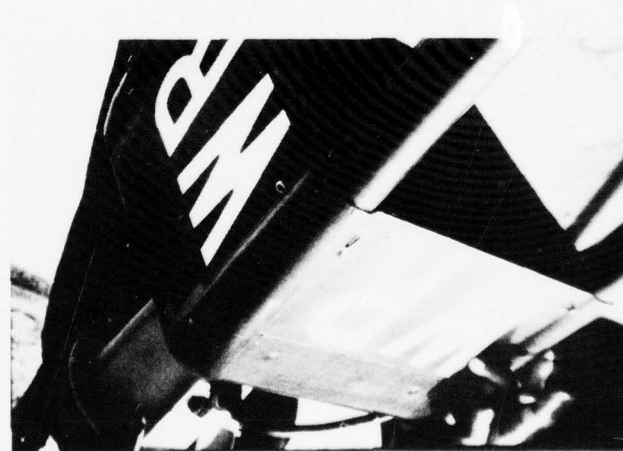

(c)

FIGURE 5C

DAMAGE TO THE CAGE OF THE BASE CHARLESTON BUOY WAS OFTEN REPAIRED USING BASIC TOOLS:

(a) A COTTER PIN WAS UTILIZED TO REINFORCE A DAMAGED GLUE JOINT;

(b) AND (c) PLYWOOD WAS USED TO REBUILD THE CAGE TOP AND TO MOUNT THE LANTERN.

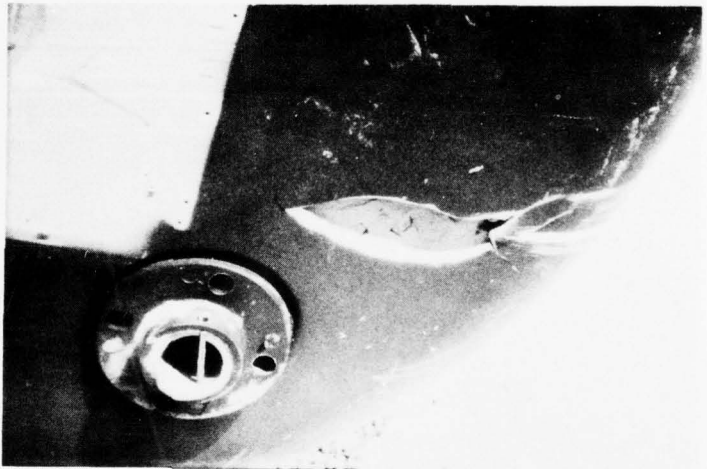
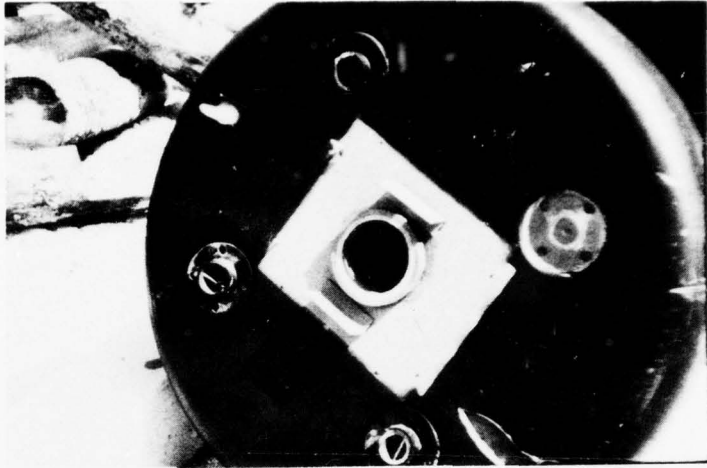

FIGURE 6C

DAMAGE TO A CHARLESTON BUOY AFTER COLLISION WITH A SMALL VESSEL:
(a) CAGE, LANTERN, AND BATTERY BOX LOST; AND (b) PROPELLER DAMAGE

APPENDIX D

D.0 DESCRIPTION AND EVALUATION OF THE THIRD GENERATION DISCREPANCY BUOYS

D.1 Third Generation Sheltered and Exposed Water Discrepancy Buoys (3GS and 3GE)

The basic soundness of the Base Charleston buoy hull combined with its light weight led to development of the third generation buoys (Figure 1D).



(a) THIRD GENERATION SHELTERED WATER DISCREPANCY BUOY (3GS)

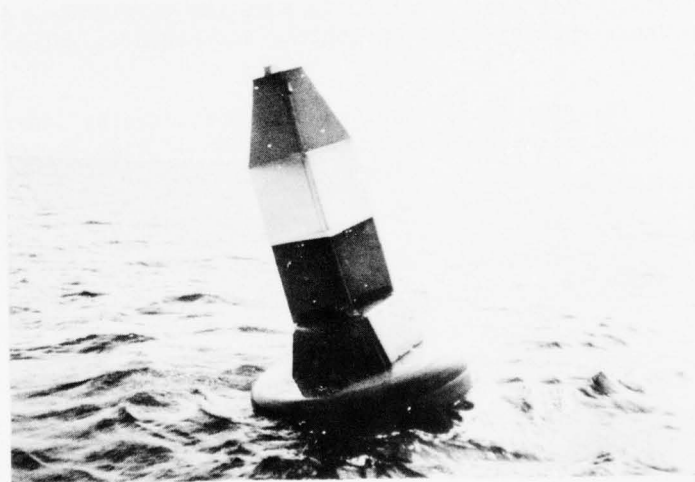

(b) THIRD GENERATION EXPOSED WATER DISCREPANCY BUOY (3GE)

FIGURE 1D

The hull and the counterweight tube were the same construction as the Charleston buoys. An ABS thermo-formed battery compartment of new design was bonded to the top of the buoy hull, and an aluminum bi-plane radar reflector was attached to the top of the battery compartment by PVC angle. The buoy could use either "hot shot" dry cell batteries or 12-volt lead acid batteries strapped to a removable tray that could be changed with the buoy in the water without removing the daymark (Figure 2D).

Six buoys were obtained by the R&D Center for testing; three sheltered and three exposed/semi-exposed. They remained exclusively at the R&D Center.

The following results were noted upon completion of the initial testing:

(1) A weakness of the top of the battery compartment providing a support for the radar reflector was indicated by cracking of the ABS near the reflector attachment points.

(2) Marginal stability on the 3GE buoy indicated that a small increase in the amount of counterweight was required.

(3) Fast current (over two knots) caused a diving tendency which was most noticeable on the five-foot diameter buoy.

The following corrective action for the above problems was determined to be necessary:

(1) Strengthening the top of the battery compartment by: increasing the thickness of the material used, and utilizing PVC pipe and flange stanchions to support the top.

(2) In order to alleviate the former requirement of having field personnel install cast iron counterweight in the buoy before deployment, a poured-in-place concrete counterweight having the increased weight required was used in future buoys.

(3) The diving tendency was corrected by lowering the mooring/towing attachment point when deployed in areas of high current.

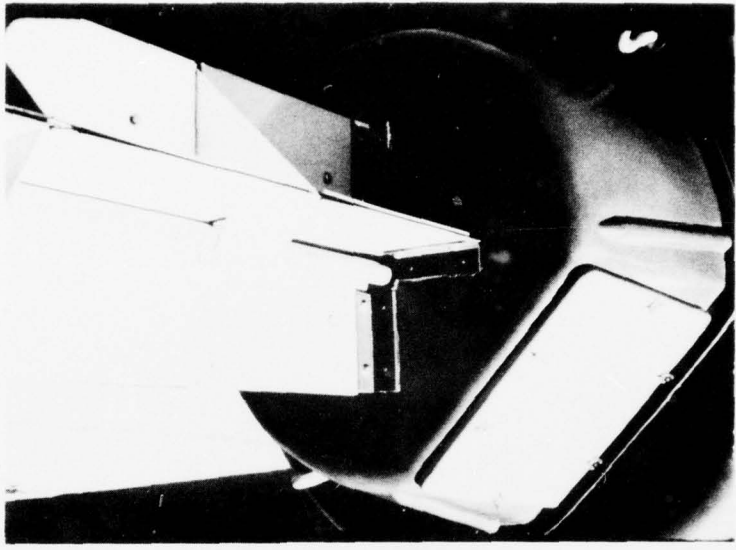

(a)

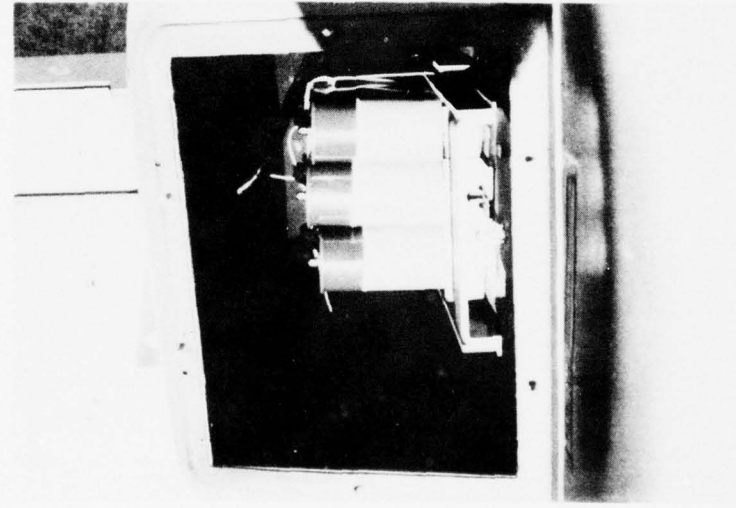

(b)

FIGURE 2D

(a) THE BATTERY TRAY WITH THE BATTERIES STILL ATTACHED
COULD BE REMOVED AS A UNIT FROM THE BATTERY COMPARTMENT;
(b) ACCESS TO THE BATTERY COMPARTMENT DID NOT REQUIRE REMOVAL OF THE
DAYMARK PERMITTING BATTERY CHANGEOUT WITH THE BUOY REMAINING IN THE WATER.