

AD-A053 935

NAVAL POSTGRADUATE SCHOOL MONTEREY CALIF

F/6 5/9

THE ESTABLISHMENT OF A NEW METHOD OF ESTIMATING THE NUMBER OF A--ETC(U)

FEB 78 P R MILCH

UNCLASSIFIED

NPS55-78-6

NL

1 OF 2
AD
A053935



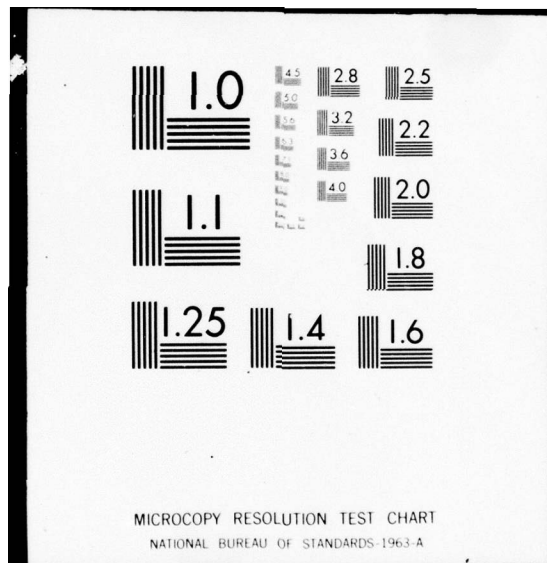

act
②

NPS55-78-6

NAVAL POSTGRADUATE SCHOOL

Monterey, California



DDC
RECEIVED
MAY 15 1978
B

AD A 053935

AD NO. ~~1~~
DDC FILE COPY

THE ESTABLISHMENT OF A NEW METHOD OF
ESTIMATING THE NUMBER OF ADVANCEMENTS
IN THE NAVY ENLISTED FORCE
by
Paul R. Milch
February 1978

Approved for public release; distribution unlimited.

Prepared for:

Bureau of Naval Personnel
Washington, DC 27370

Naval Personnel Research
and Development Center
San Diego, CA 92152

NAVAL POSTGRADUATE SCHOOL
Monterey, California

J. R. Borsting, Provost
By Direction

This work was supported by the Bureau of Naval Personnel and the
Naval Personnel Research and Development Center.

Reproduction of all or part of this report is authorized.

This report was prepared by:

Paul R. Milch, Associate Professor
Department of Operations Research

Reviewed by:

Released by:

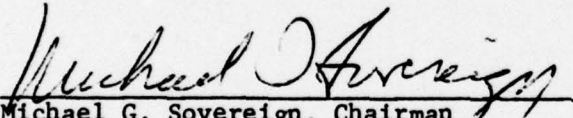
Michael G. Sovereign, Chairman
Department of Operations Research

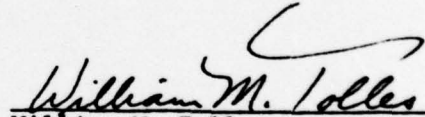
William M. Tolles
Acting Dean of Research

DISCLAIMER NOTICE

**THIS DOCUMENT IS BEST QUALITY
PRACTICABLE. THE COPY FURNISHED
TO DDC CONTAINED A SIGNIFICANT
NUMBER OF PAGES WHICH DO NOT
REPRODUCE LEGIBLY.**

UNCLASSIFIED

SECURITY CLASSIFICATION OF THIS PAGE(When Data Entered)

be superior to the currently used method of distributing advances among LOS cells. This conclusion is based on the accuracy of the FY 1976 estimates.

ACCESSION for		
NTIS	White Section	<input checked="" type="checkbox"/>
DDC	Buff Section	<input type="checkbox"/>
UNANNOUNCED		<input type="checkbox"/>
JUSTIFICATION		
BY		
DISTRIBUTION/AVAILABILITY CODES		
Dist. AVAIL. and/or SPECIAL		
A	23	-

up

B

UNCLASSIFIED

SECURITY CLASSIFICATION OF THIS PAGE(When Data Entered)

TABLE OF CONTENTS

	PAGE
I. Introduction	1
A. Background and Problem Statement	1
II. Discussion of Extending the Model	3
A. Computational Problems of Extending the Model to All Ratings	3
B. Some Data Problems	9
III. Comparison of the Model to the Currently Used Fast Method	12
IV. Conclusions and Recommendations	20
V. References	21
Appendix A. List of Ratings	A-1
Appendix B. Relationships of General Ratings to Their Service Ratings	B-1
Appendix C. List of Errors for All Ratings	C-1
1. FAST Model Errors	C-1
2. Advancement Model Errors	C-20
Appendix D. Histograms of Δ_1 Errors, All Ratings, FAST Model and Advancement Model	D-1
Appendix E. Histograms of Δ_2 Errors, All Ratings, FAST Model and Advancement Model	E-1
Appendix F. Histograms of Δ_3 Errors, All Ratings, FAST Model and Advancement Model	F-1
Appendix G. Histograms of Δ_1 Errors, High Volume Ratings Only, FAST Model and Advancement Model	G-1
Appendix H. Histograms of Δ_2 Errors, High Volume Ratings Only, FAST Model and Advancement Model	H-1
Appendix I. Histograms of Δ_3 Errors, High Volume Ratings Only, FAST Model and Advancement Model	I-1

C

List of Tables

	PAGE
1. ALLNAVY Errors	15
2. Median Errors Among All Ratings	17
3. Median Errors Among High Volume Ratings Only	19

D

ABSTRACT

↓

A model developed recently uses regression and analytic techniques to estimate the length of service (LOS) distribution of advancements in the Navy Enlisted Force by pay grade and rating. The distribution is a function of the total volume of advancees to a pay grade of the rating as well as the LOS distribution of the net inventory of the next lower pay grade of the same rating. The model previously tested for three ratings only is now extended to all ratings of the Navy Enlisted Force. The new procedure is then compared and found to be superior to the currently used method of distributing advancees among LOS cells. This conclusion is based on the accuracy of the FY 1976 estimates.

↑

E

FOREWORD

This research effort was initiated by the Naval Personnel Research and Development Center (NPRDC), San Diego, California and alternately sponsored by NPRDC and the Bureau of Naval Personnel (BUPERS), Washington, D.C. The author would like to express his appreciation for the valuable assistance provided by the staffs of Mr. Robert K. Lehto of BUPERS and Mr. Joe Silverman of NPRDC. Thanks are due to Mr. Robert Boller of NPRDC for his day-by-day assistance on the project.

I. INTRODUCTION

A. Background and Problem Statement

This is the third technical report on the problem of estimating the length of service (LOS) distribution of advancees in the Enlisted Navy. The research that was devoted to this topic was part of a series of research projects on personnel problems of the Enlisted Navy sponsored alternately by the Naval Personnel Research and Development Center (NPRDC) in San Diego and the Bureau of Naval Personnel (BUPERS) in Washington, D.C. during the fiscal years (FY) 1975-77.

The problem of estimating the LOS distribution of advancements, which is the subject of this report, originated in the notion that the shape of this distribution should be a highly sensitive function of the total "volume" of people to be advanced from one pay grade to the next. As was reported previously (Milch, 1976a and 1976b), the dependence of the LOS distribution of advancements on the total volume of advancees to a pay grade may be exhibited not from the data but through a model of the advancement system.

In fact, two models--a regression model (Milch, 1976a) and a simplified analytic model (Milch, 1976b)--were built. Both of these serve the purpose of estimating the LOS distribution of advancements as a function of the volume of advancements and the LOS distribution of the net inventory in the next lower pay grade. Net inventories are defined as inventories at the beginning of the fiscal year less losses plus nonrecruit gains to the Navy during the fiscal year. Net inventories in a pay grade serve as a resource population for advancees to the next higher pay grade.

The models developed in the reports by Milch, 1976a and 1976b were tested on three ratings (Operations Specialist, Radioman and Personnelman). They were also compared to the method of estimating the LOS distribution of advancements currently used by FAST, BUPERS' comprehensive computer model that

attempts to duplicate practically all personnel flows in the Navy Enlisted Force.

Based on these comparisons and on detailed discussions with the sponsors, it was decided to choose the analytic model (Milch, 1976b) for its conceptual and computational advantages and use it to estimate the LOS distribution of advancements of all ratings. Although based on the three ratings mentioned above the model's predictive qualities definitely surpassed those of FAST, it was considered necessary to compare the two estimating procedures for all ratings before the new method could be incorporated in FAST.

The present report summarizes some of the difficulties that were encountered when the new procedure was extended to all ratings and provides a rating-by-rating comparison with the current FAST estimating procedure. For a full understanding of the present report, it is necessary to have familiarity with the regression and analytic models both explained in Milch, 1976b.

II. DISCUSSION OF EXTENDING THE MODEL

A. Computational Problems of Extending the Model to All Ratings

In the previous report by Milch, 1976b the moments of the regression model were approximated by formulas that made their computation less cumbersome. From these formulas the parameters of the gamma distribution were estimated through the method of moments. Then the gamma distribution was used to provide an estimate of the LOS distribution of advancements to a pay grade of any given rating. This way the estimated distribution depended on only fifteen parameters. Although these fifteen parameters must originally be computed from the ninety-three regression coefficients of the regression model, this computation need be performed only once until new additional data becomes available. The fifteen parameters (for each pay grade of each rating) would then be stored in the computer.

From these parameters the model would then compute a new estimated LOS distribution of advancements for every new set of pay grade total (volume) of advancements and net inventory LOS distribution. When new data of net inventories and advancements become available the regression could be redone, a new set of fifteen parameters computed and stored in the computer. These could then be used for estimating the LOS distribution of advancements for the next fiscal year.

The extension of this procedure to all ratings presented some problems, mostly in cases where only a few years of data were available on which to perform the regression. The apparent statistical instability in the resulting regression coefficients caused the approximating formulas for the moments of the estimated LOS distribution of advancements to become highly inaccurate. This caused the formula for the sample variance to become negative in some cases which rendered the method of moments for estimating the gamma parameters infeasible.

In mathematical terms the problem is described as follows. The formulas approximating the first two moments of the regression model were given in Milch 1976b by

$$\hat{K}_1 \approx 16 \frac{S_1(\alpha) + \hat{S}_1(\beta I) + S_1(\gamma)V}{S_0(\alpha) + \hat{S}_0(\beta I) + S_0(\gamma)V} \quad (1)$$

and

$$\hat{K}_2 \approx 336 \frac{\hat{S}_2(\alpha) + \hat{S}_2(\beta I) + S_2(\gamma)V}{S_0(\alpha) + \hat{S}_0(\beta I) + S_0(\gamma)V} \quad (2)$$

where for $r = 0, 1, 2$

$$S_r(\alpha) = \frac{1}{n_r} \sum_{i=1}^{31} i^r \alpha_i, \quad n_r = \sum_{i=1}^{31} i^r$$

with $S_r(\beta I)$, $S_r(\gamma)$ defined analogously, and α_i , β_i , γ_i are the regression coefficients in the regression equations:

$$A_i = \alpha_i + \beta_i I_i + \gamma_i V, \quad i = 1, 2, \dots, 31.$$

Here A_i and I_i are the number of advancements to a pay grade and the net inventory in the next lower pay grade, respectively, both in LOS cell i .

Finally, V is the total volume of advancements to the pay grade:

$$V = \sum_{i=1}^{31} A_i.$$

Then the sample variance is computed from

$$\hat{K}'_2 = \frac{V}{V-1} (\hat{K}_2 - \hat{K}_1^2). \quad (3)$$

In order to investigate under what circumstances \hat{K}'_2 may be negative formulas (1) and (2) are rewritten as

$$\hat{K}_1 \approx 16 \frac{c + dV}{a + bV} \quad (4)$$

and

$$\hat{K}_2 \approx 336 \frac{e + fV}{a + bV} \quad (5)$$

where

$$\begin{aligned} a &= S_0(\alpha) + \hat{S}_0(\beta I) & , & & b &= S_0(\gamma) \\ c &= S_1(\alpha) + \hat{S}_1(\beta I) & , & & d &= S_1(\gamma) \\ e &= S_2(\alpha) + \hat{S}_2(\beta I) & , & & f &= S_2(\gamma) \end{aligned} \quad (6)$$

Then $\hat{K}'_2 < 0$ occurs iff

$$336(e + fV)(a + bV) - (16)^2(c + dV)^2 < 0$$

that is iff

$$P(V) = AV^2 + BV + C < 0 \quad (7)$$

where

$$\begin{aligned} A &= 21bf = 16d^2 \\ B &= 21(af + be) - 32cd \\ C &= 21ae - 16c^2 \end{aligned} \quad (8)$$

As is evident from (7) the problem becomes one of investigating the location of a parabola, $P(V) = 0$, with respect to the V-axis (see e.g. Thomas, 1962, pp. 465-473).

First, the coefficient A decides whether the parabola "opens" on the "top" or "bottom." Fortunately, A depends on the γ coefficients only and does not depend on the inventory distribution.

The case when $A \geq 0$ is the more favorable one because then--at least for

V large enough-- $P(V) > 0$ and so \hat{K}'_2 is positive for large enough volume of advancements.

The case when $A < 0$ supplied some of the instances where the problem of a negative variance arose. Even when it did not for current volume of advancements, the potential was there that at some volume levels, reached in some future fiscal year, $P(V)$ and so \hat{K}'_2 also would turn negative. To forestall such eventuality a "correction" was made in the γ coefficients. Namely a new set of γ coefficients was defined as

$$\gamma'_i = [\gamma_i]^+ = \max(0, \gamma_i) \quad \text{for } 1 \leq i \leq 31 \quad (9)$$

Then \hat{K}'_1 and \hat{K}'_2 were recomputed with γ'_i replacing every γ_i value, $1 \leq i \leq 31$. Then from (8) and (6)

$$\begin{aligned} A &= 21 S_0(\gamma') S_2(\gamma') - 16 S_1^2(\gamma') \\ &= \frac{1}{(31)^2} \frac{1}{16} \left\{ \sum_{i=1}^{31} \gamma'_i \sum_{i=1}^{31} i^2 \gamma'_i - \left(\sum_{i=1}^{31} i \gamma'_i \right)^2 \right\} \geq 0 \end{aligned} \quad (10)$$

using the Cauchy-Schwarz inequality (see e.g. Thomas, 1962, p. 152) with

$$a_i = \sqrt{\gamma'_i} \quad \text{and} \quad b_i = i\sqrt{\gamma'_i}.$$

With the case $A < 0$ eliminated by design, the possibility of $A = 0$ still remained. From (10) it is evident that $A = 0$ could occur only when $\gamma'_i =$ same value for all $i = 1, \dots, 31$. For all practical purposes this could occur only if all original $\gamma_i < 0$ thus making $\gamma'_i = 0$ for all $i = 1, \dots, 31$.

Although this did not now occur in any of the pay grades of any of the ratings, its future possible occurrence is not ignored.

With $A \geq 0$ assured the remaining question is whether or not the parabola crosses the V-axis and if so whether on the positive or negative side. Since the parabola may be written as

$$A\left(V + \frac{B}{2A}\right)^2 = P(V) - \left(C - \frac{B^2}{4A}\right)$$

its vertex is at the coordinate point (h, k) where

$$h = -\frac{B}{2A} \quad \text{and} \quad k = -\frac{B^2 - 4AC}{4A}$$

and it crosses the V-axis at the points

$$V_1 = \frac{-B - \sqrt{B^2 - 4AC}}{2A}$$

and

$$V_2 = \frac{-B + \sqrt{B^2 - 4AC}}{2A} \tag{11}$$

provided

$$\Delta = B^2 - 4AC \geq 0 \quad .$$

The case when $\Delta < 0$ causes no alarm, since then $P(V) > 0$ and so $\hat{K}'_2 > 0$ for all values of V .

If $\Delta \geq 0$ and $V_2 \leq 0$ again problems cannot arise since $P(V) > 0$ and so $\hat{K}'_2 > 0$ for all positive values of V .

If, however, $\Delta \geq 0$ and $V_2 > 0$ the problem of $\hat{K}'_2 < 0$ will occur whenever the volume V happens to be lower than V_2 . Indeed, the computations showed that after the " γ -correction" was made all problems arose in such cases. This problem was solved by the following procedure used whenever $\hat{K}'_2 < 0$ occurred:

- (i) Let \hat{V} = smallest integer that is $\geq V_2$ (12)
- (ii) Recompute \hat{K}_1 , \hat{K}_2 and \hat{K}'_2 using formulas (1), (2) and
- (3) except that \hat{V} replacing V .

Although this procedure is quite arbitrary, it does eliminate the problem of negative variance, it apparently is needed mostly in cases where the small amount of data available created a statistical instability and finally it

worked quite well in most instances. At any rate, it usually occurred when the volume was quite low and so the case was quite unimportant, yet a procedure was necessary to assure that the computer will not "hang up."

Note that the case when $A = 0$, i.e. the parabola becomes a straight line, is covered in the above case. Then

$$V_2 = \lim_{A \rightarrow 0} \frac{-B + \sqrt{B^2 - 4AC}}{2A} = -\frac{C}{B} \quad (11')$$

and the rest follows as before.

The estimation procedure may be summarized in the following points:

- (i) Perform regression analysis as described in Milch 1976b to obtain regression coefficients $\alpha_1, \beta_1, \gamma_1$ for $i = 1, 2, \dots, 31$.
- (ii) Compute the fifteen parameters $S_r(\alpha), S_r(\beta), S_r(\beta^2), S_r(\gamma)$ and ρ_r for $r = 0, 1, 2$; then compute $\hat{S}_r(\beta I)$ for $r = 0, 1, 2$ as described in Milch, 1976b.
- (iii) Compute A from formulas (8) and (6). If $A < 0$ redefine $\gamma_1, 1 \leq i \leq 31$, according to formula (9).
- (iv) Compute \hat{K}_1, \hat{K}_2 and \hat{K}'_2 from formulas (1), (2) and (3). If $\hat{K}'_2 \leq 0$ compute A, B, C from formulas (8) and define \hat{V} from formulas (12) and (11) when $A > 0$ or formulas (12) and (11') when $A = 0$. Then recompute \hat{K}_1, \hat{K}_2 and \hat{K}'_2 using \hat{V} in place V in formulas (1), (2) and (3).
- (v) Estimate the gamma parameters via the method of moments, i.e.

$$\hat{g} = \frac{\hat{K}_1^2}{\hat{K}_2} \quad \text{and} \quad \hat{\lambda} = \frac{\hat{K}_1}{\hat{K}_2} .$$

- (vi) Compute the discretized gamma distribution:

$$\hat{f}(i; \hat{g}, \hat{\lambda}) = \frac{i^{\hat{g}-1} e^{-\hat{\lambda}i}}{\sum_{j=1}^{31} j^{\hat{g}-1} e^{-\hat{\lambda}j}} \quad \text{for } 1 \leq i \leq 31 .$$

(vii) If $\hat{g} > 50$ use the discretized normal distribution instead of the above:

$$\hat{f}(i; \hat{g}, \hat{\lambda}) = \frac{e^{-\frac{1}{2} \left(\frac{i-\hat{\mu}}{\hat{\sigma}} \right)^2}}{\sum_{j=1}^{31} e^{-\frac{1}{2} \left(\frac{j-\hat{\mu}}{\hat{\sigma}} \right)^2}} \quad \text{for } 1 \leq i \leq 31$$

where $\hat{\mu} = \hat{K}_1$ and $\hat{\sigma} = \sqrt{\hat{K}_2}$

The last step was used to avoid some computational difficulties with the gamma distribution when $g > 50$.

B. Some Data Problems

Some difficulties with the data was described previously in reports Milch, 1976a and 1976b. All data used here were supplied by NPRDC. The regression analysis was performed with the data for the 1966-76 period or whatever portion of it was available for a specific pay grade and rating.

The net inventory data was computed by NPRDC from beginning inventory and non-recruit gains and losses. This data bears the label of matrix ID997. Advancement data was available both "into" a pay grade and "out of" a pay grade. Generally advancements "into" a pay grade were used here. This data bears the label of matrix ID800.

There were some exceptions to this in cases where so-called general ratings and service ratings interrelate at a certain pay grade level.

In Appendix A a list of all ratings and their codes is given. The list also indicates the range of pay grades (PG) for each rating. A distinction between general (GEN) and service (SER) ratings is also shown in the list.

This is essential because of the way service ratings are related to certain general ratings. Basically two types of relationships exist:

- (i) "branching off" relationship where a service rating branches off from a general rating at some pay grade, e.g. the rating Legalman (LN, rate code 1750) branches off the rating Yeoman (YN, rate code 1700) at pay grade E5;
- (ii) "merging" relationship where two or three service ratings merge into a general rating at some pay grade, e.g. ratings Missiles Gunners Mate (GMM, rate code 0601) and Guns Gunners Mate (GMG, rate code 0604) merge into rating Gunners Mate (GM, rate code 0600) at pay grade E8.

These service ratings and their relationships to their general rating are shown graphically in Appendix B.

For both types of service ratings some explanation is necessary regarding the use of the data and the estimation procedure. In the case of a service rating "branching off" at a certain pay grade, e.g. rating 1750 branching off rating 1700 at pay grade E5, the regression analysis for the service rating in pay grade E5 used the net inventory of pay grade E4 of the general rating. Similarly when estimating advancements to pay grade E5 of rating 1750 (service rating) via the estimation procedure described in Section A the appropriate inventories are those in pay grade E4 of rating 1700 (general rating).

Another exception arises when estimating advancements from the highest existing pay grade of services ratings that merge into a general rating. Here the advancement data used in the regression analysis was advancements "out of" a pay grade. This data is labeled as matrix ID810. In these cases there were two or three sets of estimated advancements to the lowest existing pay grade of the general rating, namely one from the highest existing pay grade of each of the relevant services ratings. To distinguish among these sets of estimated advancements, they are listed among the service ratings even though they are

advancements to a pay grade that exists for the corresponding general rating only. To draw attention to this fact the rate codes bear a negative sign in front of the code number. Thus advancements from pay grade E7 of service ratings 0601 and 0604 to pay grade E8 of general rating 0600 are shown as advancements to pay grade E8 of ratings "-0601" and "-0604." This is evident in Appendix C where the errors defined in the next section are shown for all pay grades of all ratings.

III. COMPARISON OF THE MODEL TO THE CURRENTLY USED FAST METHOD

FAST, the computer model used by BUPERS to make personnel predictions for the Navy Enlisted Force (see Boller, 1974 and Silverman, 1977) has incorporated in it a procedure to predict advancements by LOS. The procedure first computes historical rates of advancements details of which are described in a working paper by Leland (1976) of the Naval Personnel Research and Development Center. If these rates are denoted by H_i , $1 \leq i \leq 31$, the advancement LOS distribution used by FAST is given by

$$F'_i = \frac{0.9H_i + 0.1I_i}{\sum_{j=1}^{31} (0.9H_j + 0.1I_j)} \quad \text{for } i = 1, \dots, 31$$

i.e. advancements are estimated as a mixture of the historical rates of advancements and the current resource population (net inventories).

To compare the FAST estimation with the estimates produced by this study, three measures of error were devised. These errors were defined in Milch 1976b and are reproduced here for ease of reference.

- (i) The difference between the actual and the estimated mean LOS of advancements:

$$\Delta_1 = K_1 - \bar{K}_1$$

- (ii) The difference between the standard errors of the actual and the estimated LOS distributions of advancements:

$$\Delta_2 = \sqrt{K'_2} - \sqrt{\bar{K}'_2}$$

Here K'_2 is the sample variance of the actual LOS distribution of advancements and \bar{K}'_2 is the sum of squares of the difference between

the estimated number of advancements and the actual mean LOS of advancements. For example, for the estimated LOS distribution of advancements provided by the model in the previous section

$$\tilde{K}'_2 = \frac{V}{V-1} \sum_{i=1}^V (i-K_1)^2 \hat{f}_i = \frac{V}{V-1} (\hat{K}_2 - 2K_1\hat{K}_1 + K_1^2) .$$

Note that this quantity differs from \hat{K}'_2 as defined by Formula (3).

For the FAST model \tilde{K}'_2 is computed analogously.

(iii) The Kolmogorov-Smirnov (K-S) Statistic: The largest absolute difference between the actual and estimated cumulative sample distribution functions:

$$\Delta_3 = \max_{1 \leq i \leq 31} \left| \sum_{j=1}^i F_j - \sum_{j=1}^i \tilde{F}_j \right|$$

where F_j is the actual relative frequency of advances in LOS cell j and \tilde{F}_j is its estimate. In particular,

$$\tilde{F}_j = \begin{cases} \hat{f}(j; \hat{g}, \hat{\lambda}) & \text{for the advancement model} \\ F'_j & \text{for the FAST methodology} . \end{cases}$$

The meaning of error Δ_1 is quite clear and an accurate estimation procedure should have a Δ_1 close to zero. As a rule of thumb, a mean LOS which is off by no more than half a year, i.e. $|\Delta_1| \leq .5$, may be considered a quite accurate estimate of the actual mean LOS of advancements. Perhaps for the upper pay grades E7, E8 and E9 a somewhat bigger Δ_1 error is also acceptable.

The meaning of error Δ_2 is less obvious. The original thought behind it was to introduce an error that would compare the estimated and actual standard deviations of the LOS distribution of advancements. The actual standard deviation, of course, is a measure of the dispersion, about the actual mean LOS,

of the actual LOS distribution of advancements. The estimated standard deviation measures the analogous quantity for the estimated LOS distribution of advancements. It seems more appropriate, however, to compare the actual dispersion (i.e. standard deviation) to the estimated dispersion, about the actual mean LOS, of the estimated LOS distribution of advancements. This is precisely what the error Δ_2 accomplishes.

Finally, to create a gauge that measures the accuracy of the entire distribution itself, the error Δ_3 was devised. As is clear from its definition Δ_3 compares the actual and estimated cumulative distribution functions and is determined by their greatest absolute difference. Contrary to Δ_1 and Δ_2 , the error Δ_3 is always nonnegative.

Of these three errors Δ_1 and Δ_3 seemed to be the most useful. Error Δ_2 is somewhat difficult to interpret and sometimes took on values that contradicted both Δ_1 and Δ_3 . Indeed, it seems that a method of estimation that is accurate in terms of its mean (Δ_1 error) and in terms of the overall distribution (Δ_3 error) may be judged to be a satisfactory estimation procedure.

The procedure used here to compare the two estimation methods was to estimate the FY 1976 advancements for each pay grade of each rating using both the FAST and the advancement model. Since actual FY 1976 advancement data was available the errors Δ_1 , Δ_2 , and Δ_3 could be computed and compared for the two models.

In Appendix C the errors Δ_1 , Δ_2 , and Δ_3 are listed for every pay grade of every rating for both the FAST and the advancement models. These lists provide a rating by rating comparison, for each pay grade, of the two estimation procedures. One may compare them, for example, in terms of rating 000 which is the code for ALLNAVY, i.e. advancements in the entire Enlisted Force. The list of errors are shown in Table 1 for easy comparison.

ALLNAVY Errors

PG	Model	Error Δ_1	Error Δ_2	Error Δ_3
E4	FAST	0.737	0.103	0.295
	ADV.	0.349	0.232	0.143
E5	FAST	0.719	0.009	0.180
	ADV.	0.758	0.177	0.260
E6	FAST	1.317	-0.123	0.189
	ADV.	-0.032	-0.134	0.050
E7	FAST	1.319	-0.911	0.151
	ADV.	0.290	-0.217	-.075
E8	FAST	-0.249	-0.691	0.057
	ADV.	0.557	0.512	0.116
E9	FAST	-0.538	-0.924	0.089
	ADV.	0.437	-0.261	0.110

TABLE 1

From Table 1 the advancement model is seen to be superior, although not uniformly so. In terms of error Δ_1 the advancement model is occasionally, as in case of E6 and E7, vastly superior to FAST. When FAST is better than the advancement model, as in case of E5 in terms of all three measures, the difference is not very significant.

Since a rating-by-rating comparison from Appendix C is awkward between the two estimation procedures, histograms were prepared for each pay grade that show the relative frequencies of errors of each type among all the ratings. These histograms are displayed side by side for the two estimation procedures in Appendices D, E, and F for errors Δ_1 , Δ_2 , and Δ_3 , respectively. The horizontal scales were fixed for each pay grade to be the same for the FAST and the advancement models to facilitate the comparison. Each histogram carries under it a wealth of statistical information related to it. Among all these statistical measures appears the median which in this case is a value such that exactly half the ratings have errors exceeding it. These medians were selected as the best single statistical measure by which to compare the two methods. Table 2 provides a summary of these median errors for both methods for each pay grade E4 through E9. In addition to these six pay grades, the table includes the median errors of all pay grades which were taken from histograms also included in Appendices D, E, and F.

Both the histograms themselves and their brief summary in Table 2 reveal that the advancement model does almost uniformly better than the FAST model. Notable exception is pay grade E5 where FAST has somewhat smaller Δ_1 and Δ_3 errors. It is quite conspicuous from Table 2, however, that in pay grades E6, E7, and E9 FAST grossly underestimates the mean LOS whereas the advancement model makes only small errors overestimating the mean.

A disadvantage in comparing the two methods by the histograms in Appendices

Median Errors Among All Ratings

PG	Model	Error Δ_1	Error Δ_2	Error Δ_3
E4	FAST	0.6139	-0.1074	.3477
	ADV.	0.3117	0.0671	.1885
E5	FAST	0.4017	-0.3472	.1595
	ADV.	0.4416	-0.0838	.2458
E6	FAST	1.0747	-0.5788	.2549
	ADV.	-0.1318	-0.2534	.1614
E7	FAST	1.0838	-1.0086	.2138
	ADV.	0.1722	-0.524	.1467
E8	FAST	-0.3887	-1.3209	.2528
	ADV.	0.0136	-0.9930	.2824
E9	FAST	1.2677	-5.4752	.3473
	ADV.	-0.0516	-2.0066	.3709
ALL	FAST	0.6147	-0.6714	.2510
	ADV.	0.2384	-0.1969	.2100

TABLE 2

D, E, and F is that all ratings, small or large, are treated equally. In actuality accurate predictions in ratings with only few advances matter little in comparison to ratings where several hundred (or thousand) advancements are made each year. For that reason, pay grades with low volume were first eliminated and then new histograms produced of the remaining errors. What constitutes "low volume" was arbitrarily decided for each pay grade separately. Thus for pay grades E4 through E9 the ratings for which the total number (volume) of advancements made in FY 1976 were below the numbers 3, 10, 20, 32, 40, and 50, respectively, were omitted from the next set of histograms shown in Appendices G, H, and I. A summary of the median errors among these "high volume" ratings is provided in Table 3.

The results in these histograms and in Table 3 are not significantly different from those presented above for all ratings. FAST shows some improvement, especially in pay grade E9 where ratings of only one or two advances have been eliminated. The advancement model stays at the same level of accuracy or improves somewhat.

Finally, it may be pointed out that there are some cases where both FAST and the advancement model produce extremely poor estimates. Most of these cases occur in pay grades with very low volume where the data lacks statistical stability. Because of the low volume these cases are considered unimportant. There are some few instances, however, where the estimates perform poorly even though there is sufficient data to have established statistical stability. The most notable example is pay grade E4 of rating Mess Management Specialist (MS, rate code 2200). Although the volume of advancements was almost 3000 in FY 1976, FAST and the new model both underestimated the mean LOS of advancements by unacceptable amounts (2.5 and 1.6 years, respectively). The only possible explanation for this is that BUPERS made radical changes in its advancement policy for this rating in FY 1976 which rendered the statistical data of the past ten years meaningless.

Median Errors

Among High Volume Ratings Only

PG	Model	Error Δ_1	Error Δ_2	Error Δ_3
E4	FAST	0.6201	-0.0885	.3486
	ADV.	0.3121	0.0747	.1854
E5	FAST	0.4084	-0.3331	.1625
	ADV.	0.4416	-0.0838	.2452
E6	FAST	1.1032	-0.5219	.2396
	ADV.	-0.1318	-0.2176	.1427
E7	FAST	1.0664	-0.9393	.2086
	ADV.	0.1546	-0.0644	.1298
E8	FAST	-0.2780	-0.9537	.1632
	ADV.	0.0691	-0.3710	.1979
E9	FAST	0.3253	-3.4883	.2218
	ADV.	-0.2604	-1.4960	.2712
ALL	FAST	0.6139	-0.4915	.2329
	ADV.	-0.2604	-0.1156	.1889

TABLE 3

IV. CONCLUSIONS AND RECOMMENDATIONS

A rating-by-rating comparison of the estimation method of FAST, currently used by BUPERS, and the newly constructed method of estimating advancements described previously (Milch, 1976b) clearly shows the overall superiority of the latter. Exceptions to this rule do exist, depending also on which measure of comparison is used, most notably in pay grade E5. However, FAST practically nowhere appears to be overwhelmingly superior to the advancement model. The opposite of this occurs in many cases; namely, in pay grades E6, E7, and E9 the advancement model outperforms FAST by a huge degree when measured by the accuracy of the mean LOS estimate.

It is recommended therefore that BUPERS modify the FAST model by incorporating in it the newly constructed method of estimating advancements. Efforts are currently under way to produce programs that will facilitate such a conversion of FAST.

This recommendation is made in full recognition of the fact that the accuracy may deteriorate in future years. As indicated in Section III, in some ratings the estimates proved to be highly inaccurate probably due to abrupt changes in advancement policies. Obviously such changes may occur in the future again. Although in such cases the recommended estimation procedure may break down there is no reason to think that it would do so more often or to a larger extent than the currently used FAST method.

REFERENCES

Boller, R. L., "Design of Force Structure Model for the Simulation of Personnel Policy." Presented at 33rd Military Operations Research Symposium, U.S. Military Academy, West Point, New York, June 1974.

Leland, K. O., "Rifelsum," Main Program Synopsis, NPRDC Working Report, 1976.

Milch, P. R., "A Model for the Prediction of Advancements in the Navy Enlisted Force," NPS Technical Report, NPS55Mh76061, 1976.

Milch, P. R., "Estimation of Parametric Length of Service Distributions of Advancements of the Navy Enlisted Force," NPS Technical Report, NPS55Mh76121, 1976.

Silverman, J., "Design and Use of a Force Structure Simulation Model," submitted to Management Science, 1977.

Thomas, G. B., Jr., Calculus and Analytic Geometry, Addison-Wesley Publishing Company, Inc., 1962.

APPENDIX A

LIST OF RATINGS

	RATING TITLE	RATE CODE	LOW PG	HIGH PG	RATING TYPE	NO. SER. RATINGS
	ALL NAVY	0000	3	9	ALL	0
BM	BOATSWAINS MATE	0100	4	9	GEN	0
MA	MASTER AT ARMS	0150	6	9	SER	0
QM	QUARTERMASTER	0200	4	9	GEN	0
SM	SIGNALMAN	0250	4	9	GEN	0
OS	OPERATIONS SPECIALIST	0300	4	9	GEN	0
EW	ELECTRONICS WARFARE TECHNICIAN	0350	4	9	GEN	0
STG	SONAR TECHNICIAN (SURFACE)	0401	4	9	GEN	0
STS	SONAR TECHNICIAN (SUBMARINE)	0404	4	9	GEN	0
OT	OCEAN SYSTEMS TECHNICIAN	0450	4	9	GEN	0
TM	TORPEDOMANS MATE	0500	4	9	GEN	0
G4	GUNNERS MATE	0600	8	9	GEN	2
G4M	GUNNERS MATE (MISSILES)	0601	4	7	SER	0
G4T	GUNNERS MATE (TECHNICIAN)	0602	4	9	GEN	0
G4G	GUNNERS MATE (GUNS)	0604	4	7	SER	0
FT	FIRE CONTROL TECHNICIAN	0800	8	9	GEN	3
FTG	FIRE CONTROL TECH. (GUN)	0801	4	7	SER	0
FTM	FIRE CONTROL TECH. (SURFACE)	0802	4	7	SER	0
FTB	FIRE CONTROL TECH. (BALLISTIC)	0803	4	7	SER	0
MT	MISSILE TECHNICIAN	0810	4	9	GEN	0
MN	MINEMAN	0900	4	9	GEN	0
ET	ELECTRONICS TECHNICIAN	1000	6	9	GEN	2
ETM	ELECTRONICS TECHNICIAN (COMM.)	1001	4	5	SER	0
ETR	ELECTRONICS TECHNICIAN (RADAR)	1002	4	5	SER	0
US	DATA SYSTEMS TECHNICIAN	1010	4	9	GEN	0
IM	INSTRUMENTMAN	1100	4	9	GEN	0
	ALL NAVY - USN	1111	3	9	ALL	0
OM	OPTICIAN	1200	4	9	GEN	0
NC	NAVY COUNSELLOR	1400	6	9	SER	0
RM	RADIOMAN	1500	4	9	GEN	0
CTT	COMMUNICATIONS TECH. (TECHNICAL)	1611	4	9	GEN	0
CTA	COMMUNICATIONS TECH. (ADMIN.)	1622	4	9	GEN	0
CTM	COMMUNICATIONS TECH. (MAINT.)	1633	4	9	GEN	0
CTO	COMMUNICATIONS TECH. (COMM.)	1644	4	9	GEN	0
CTR	COMMUNICATIONS TECH. (COLLECT.)	1655	4	9	GEN	0
CTI	COMMUNICATIONS TECH. (INTERP.)	1666	4	9	GEN	0
YN	YEOMAN	1700	4	9	GEN	1
LN	LEGALMAN	1750	5	9	SER	0
PN	PERSONNELMAN	1800	4	9	GEN	1
DP	DATA PROCESSING TECHNICIAN	1900	4	9	GEN	0
SK	STOREKEEPER	2000	4	9	GEN	1
DK	DISBURSING CLERK	2100	4	9	GEN	0
MS	MESS MANAGEMENT SPECIALIST	2200	4	9	GEN	0
IS	INTELLIGENCE SPECIALIST	2300	4	9	GEN	0
SH	SHIPS SERVICEMAN	2490	4	9	GEN	0
JO	JOURNALIST	2600	4	9	GEN	0
PC	POSTAL CLERK	2700	4	9	GEN	0
LI	LITHOGRAPHER	3100	4	9	GEN	0
DM	ILLUSTRATOR DRAFTSMAN	3200	4	9	GEN	0
MU	MUSICIAN	3300	4	9	GEN	0
	ALL NAVY - USNR	3333	3	9	ALL	0
MM	MACHINISTS MATE	3700	4	9	GEN	0
EN	ENGINEER	3800	4	9	GEN	0

APPENDIX A (Continued)

RATING	TITLE	RATE CODE	LOW PG	HIGH PG	RATING TYPE	NO. SER. RATINGS
MR	MACHINERY REPAIRMAN	3900	4	9	GEN	0
BT	BOILERMAN	4000	4	9	GEN	0
EM	ELECTRICIANS MATE	4100	4	9	GEN	0
IC	INTERIOR COMMUNICATION ELEC.	4200	4	9	GEN	0
HT	HULL TECHNICIAN	4300	4	9	GEN	0
PM	PATTERNMAKER	4600	4	9	GEN	0
ML	MOULDER	4700	4	9	GEN	0
EA	ENGINEERING AID	5100	4	9	GEN	0
CE	CONSTRUCTION ELECTRICIAN	5300	4	9	GEN	0
EO	EQUIPMENT OPERATOR	5410	4	9	GEN	0
CM	CONSTRUCTION MECHANIC	5500	4	9	GEN	0
BU	BUILDER	5600	4	9	GEN	0
SW	STEEL WORKER	5700	4	9	GEN	0
UT	UTILITIESMAN	5800	4	9	GEN	0
AD	AVIATION MACHINISTS MATE	6200	4	9	GEN	0
AT	AVIATION ELECTRONICS TECH.	6300	4	9	GEN	0
AX	AV. ANTISUB. WARFARE TECH.	6310	4	9	GEN	0
AW	AV. ANTISUB. WARFARE OPERATOR	6400	4	9	GEN	0
AO	AVIATION ORDANCEMAN	6500	4	9	GEN	0
AQ	AV. FIRE CONTROL TECHNICIAN	6520	4	9	GEN	0
AC	AIR CONTROLMAN	6600	4	9	GEN	0
AB	AVIATION BOATSWAINS MATE	6700	8	9	GEN	3
ABE	AV. BOATS MATE (LAUNCH/RECOVER)	6704	4	7	SER	0
ABF	AV. BOATS MATE (FUELS)	6705	4	7	SER	0
ABH	AV. BOATS MATE (HANDLING)	6706	4	7	SER	0
AE	AVIATION ELECTRICIANS MATE	6800	4	9	GEN	0
AM	AVIATION STRUCTURAL MECHANIC	6900	8	9	GEN	3
AMS	AV. STRUCT. MECH. (STRUCTURES)	6901	4	7	SER	0
AMH	AV. STRUCT. MECH. (HYDRAULICS)	6902	4	7	SER	0
AME	AV. STRUCT. MECH. (SAFETY EQP.)	6903	4	7	SER	0
PR	AIRCREW SURVIVAL EQUIPMENTMAN	7000	4	9	GEN	0
AG	AEROGRAPHERS MATE	7100	4	9	GEN	0
TD	TRADESMAN	7200	4	9	GEN	0
AK	AVIATION STOREKEEPER	7300	4	9	GEN	0
AZ	AV. MAINT. ADMINISTRATIONMAN	7400	4	9	GEN	0
AS	AV. SUPPORT EQUIP. TECHNICIAN	7500	6	9	GEN	3
ASE	AV. SUP. EQ. TECH. (ELECTRICAL)	7501	4	5	SER	0
ASH	AV. SUP. EQ. TECH. (HYD/STRUCT)	7502	4	5	SER	0
ASM	AV. SUP. EQ. TECH. (MECHANICAL)	7503	4	5	SER	0
PH	PHOTOGRAPHERS MATE	7600	4	9	GEN	0
HM	HOSPITAL CORPSMAN	8000	4	9	GEN	0
DT	DENTAL TECHNICIAN	8300	4	9	GEN	0

APPENDIX B

RELATIONSHIPS OF GENERAL RATINGS TO THEIR SERVICE RATINGS

(1) "Branching Off" Type

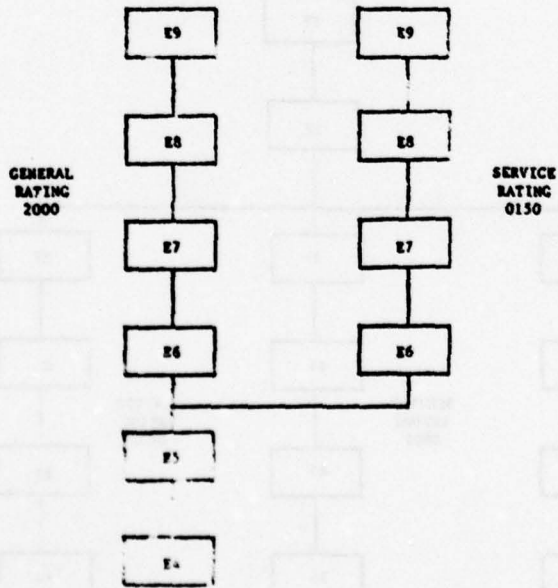
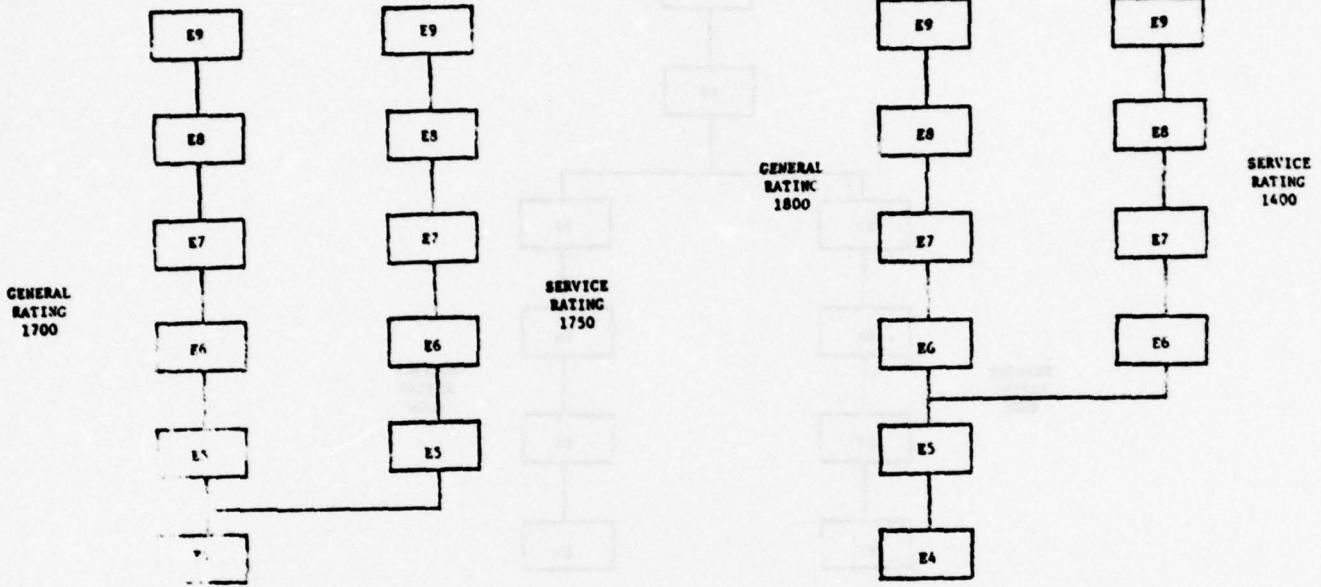

APPENDIX B (Continued)

(ii) "Merging" Type

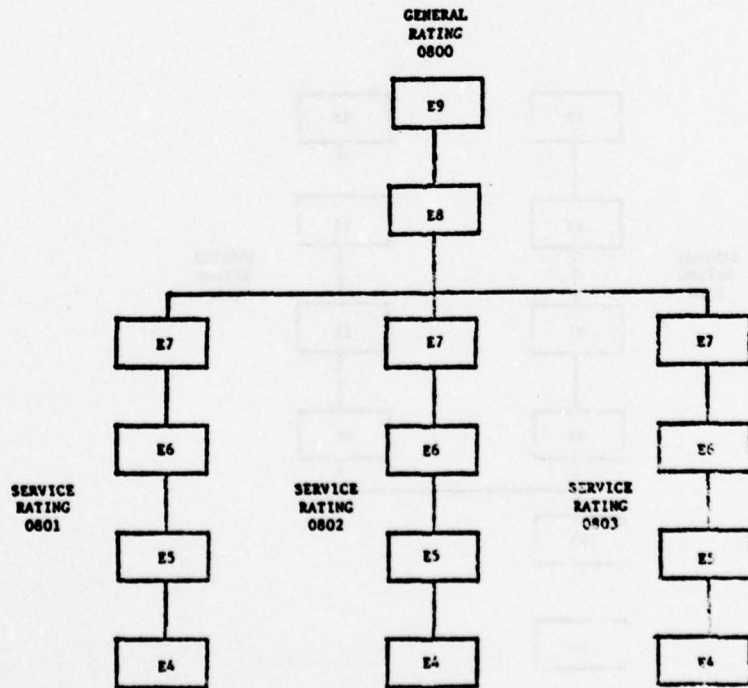
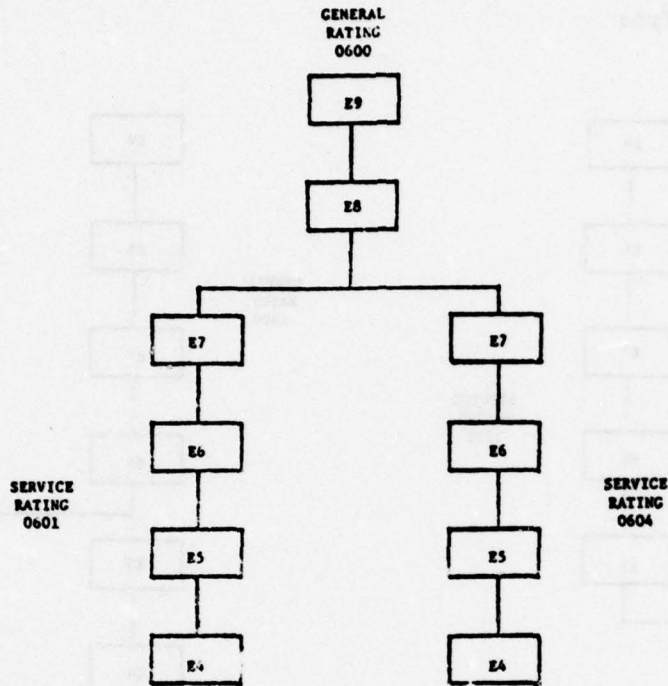

APPENDIX B (Continued)

(ii) "Merging" Type

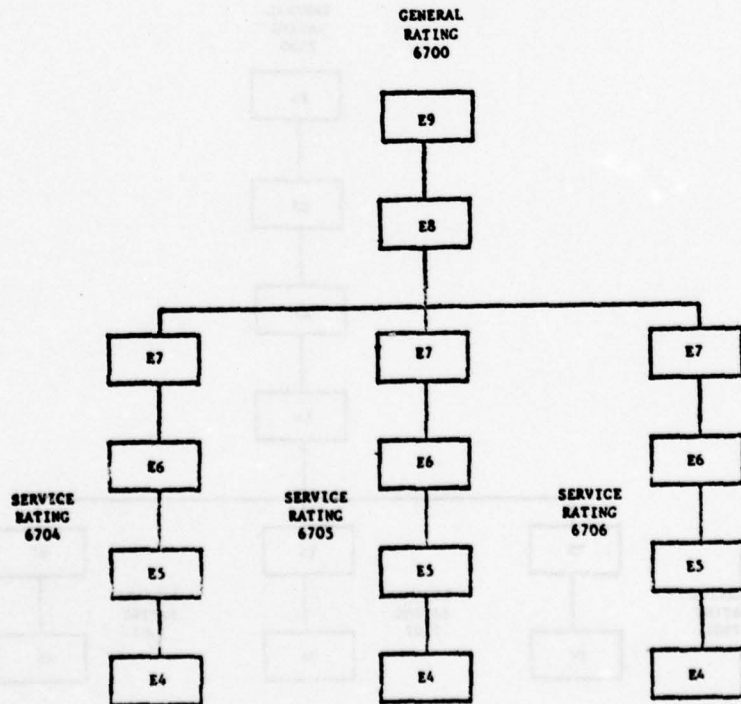
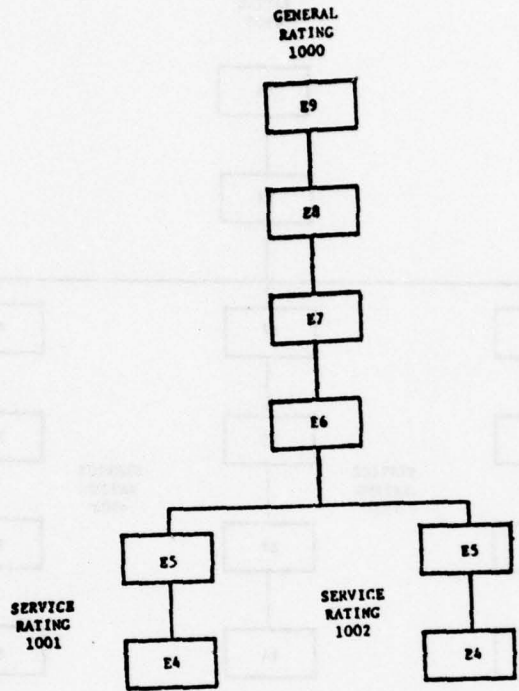

APPENDIX B (Continued)

(ii) "Merging" Type

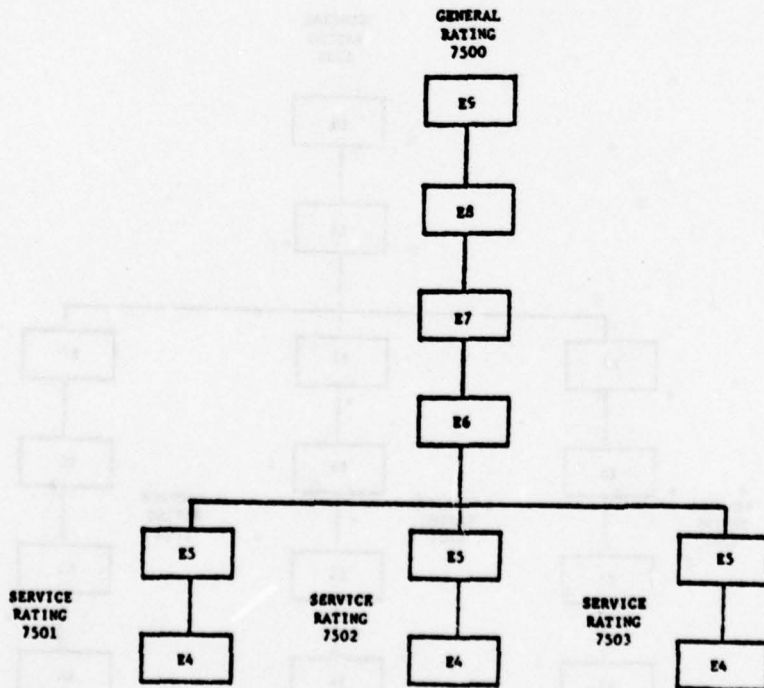
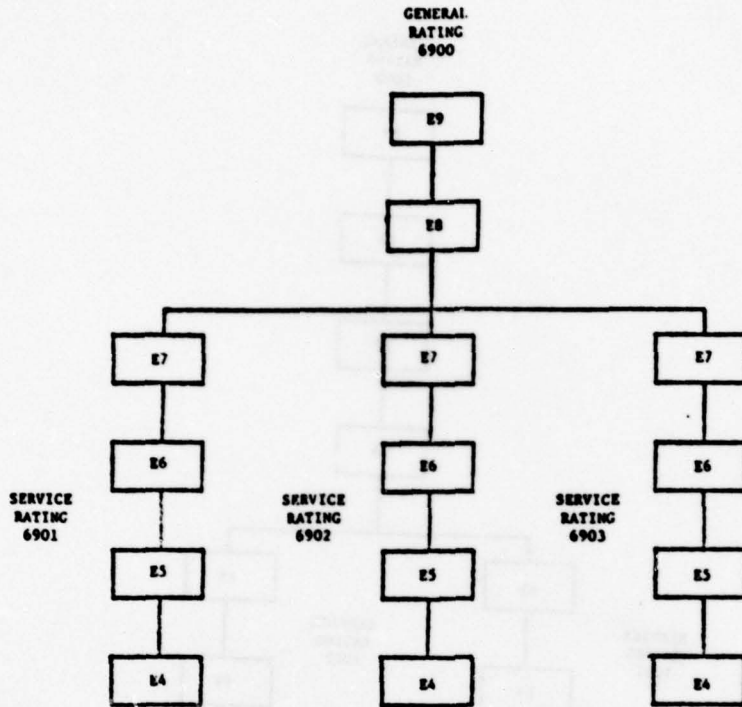

APPENDIX C

LIST OF ERRORS OF ALL RATINGS

1. FAST Model Errors

PAYGRADE E4

NAIF CODE	VOLUME	ERR # 1	ERR # 2	ERR # 3
0	54345.0	0.737	0.103	0.235
100	2000.0	-0.054	-0.358	0.023
150	0.0	999.000*	999.000	999.000
200	707.0	0.057	-0.199	0.348
250	386.0	0.043	-0.270	0.432
300	1259.0	-0.720	-0.017	0.397
350	510.0	-0.733	-0.287	0.462
401	150.0	-0.172	-0.125	0.091
404	350.0	-0.463	0.051	0.340
450	227.0	-0.614	-0.089	-0.349
500	419.0	0.725	0.037	0.335
600	0.0	999.000	999.000	999.000
601	105.0	0.754	-0.057	0.396
601	0.0	999.000	999.000	999.000
602	179.0	0.971	-0.107	0.403
604	671.0	1.115	0.203	0.443
604	0.0	999.000	999.000	999.000
600	0.0	999.000	999.000	999.000
601	624.0	0.391	0.281	0.127
601	0.0	999.000	999.000	999.000
602	458.0	0.010	0.155	0.052
602	0.0	999.000	999.000	999.000
603	200.0	-3.032	-2.946	0.815
603	0.0	999.000	999.000	999.000
610	406.0	-1.350	-1.743	0.760
600	71.0	-0.620	-0.335	0.375
1000	0.0	999.000	999.000	999.000
1001	953.0	-0.034	-0.673	0.273
1001	0.0	999.000	999.000	999.000
1002	505.0	-0.324	-0.180	0.183
1002	0.0	999.000	999.000	999.000
1010	344.0	-0.777	-0.025	0.460
1100	58.0	0.717	-0.373	0.333
1200	42.0	0.531	-0.314	0.401
1400	0.0	999.000	999.000	999.000
1500	2522.0	0.612	0.054	0.305
1511	105.0	0.723	0.373	0.381
1622	146.0	0.555	-0.242	0.441
1635	151.0	-2.220	-2.445	0.684

1644	304.C	0.601	-0.042	0.419
1655	173.J	0.366	0.011	0.501
1666	124.C	0.416	-0.035	0.230
1700	1341.C	0.605	-0.224	0.382
1750	0.C	999.000	999.000	999.000
1800	1025.C	0.621	-0.200	0.423
1900	420.C	0.581	-0.334	0.415
2000	1543.C	0.726	-0.123	0.331
2100	329.C	0.675	-0.011	0.376
2200	2011.0	2.479	-0.614	0.469
2300	156.0	0.436	0.610	0.248
2450	1041.C	1.263	-0.153	0.431
2600	144.0	0.412	0.283	0.169
2700	279.C	0.715	-0.058	0.322
3100	114.C	0.555	-0.172	0.249
3200	40.0	-0.563	-1.152	0.213
3300	63.C	-0.089	-0.626	0.083
3700	3151.0	0.575	0.357	0.246
3800	1529.C	0.742	0.064	0.330
3900	552.C	0.579	0.116	0.236
4000	2174.0	0.701	-0.377	0.303
4100	1962.C	0.405	0.062	0.193
4200	1035.C	0.455	0.039	0.204
4300	2137.0	0.663	0.343	0.297
4600	18.C	-0.023	-0.751	0.149
4700	45.0	0.561	-0.391	0.289
5100	13.0	0.723	0.235	0.233
5200	165.C	1.005	-0.165	0.425
5410	264.0	1.253	-0.146	0.490
5500	205.C	0.795	-0.557	0.457
5600	398.C	0.304	-0.125	0.380
5700	116.C	0.354	0.013	0.388
5800	196.C	0.879	-0.047	0.349
6200	1532.0	1.050	-0.219	0.537
6300	1152.0	0.420	0.270	0.196
6510	310.C	0.369	0.481	0.086
6400	544.C	0.665	0.312	0.331
6500	578.C	0.881	-0.143	0.414
6520	327.C	-0.072	0.008	0.043
6600	409.0	0.577	0.150	0.279
6700	0.C	999.000	999.000	999.000
6704	374.0	1.021	-0.150	0.422
6706	0.C	999.000	999.000	999.000
6705	309.C	0.863	-0.068	0.387

-6705	0.0	999.000	999.000	999.000
6706	698.C	0.880	-0.463	0.404
-6706	0.C	999.000	999.000	999.000
6800	1171.C	0.687	-0.044	0.351
6900	0.C	999.000	999.000	999.000
6901	1131.C	0.780	-0.704	0.330
-6901	0.C	999.000	999.000	999.000
6902	1005.C	0.749	-0.061	0.335
-6902	0.0	999.000	999.000	999.000
6903	375.C	0.572	0.204	0.310
-6903	0.C	999.000	999.000	999.000
7000	220.0	0.765	-0.340	0.416
7100	234.C	0.499	-0.025	0.339
7200	141.0	0.658	0.141	0.324
7300	529.0	0.501	-0.153	0.268
7400	507.C	0.732	-0.229	0.359
7500	0.0	999.000	999.000	999.000
7501	57.C	0.511	-0.457	0.325
-7501	0.C	999.000	999.000	999.000
7502	86.C	0.229	-0.261	0.163
-7502	0.C	999.000	999.000	999.000
7503	110.C	0.400	-0.179	0.167
-7503	0.C	999.000	999.000	999.000
7600	203.C	0.340	0.021	0.232
8000	2953.0	0.732	-0.186	0.257
8500	223.C	0.350	-0.114	0.272

* NOTE: An "error" of 999.000 means that this pay grade does not exist in that rating.

PAYGRADE E5

RATE CODE	VOLUME	ERR # 1	ERR # 2	ERR # 3
0	32509.0	0.719	0.009	0.130
100	799.0	-0.414	-0.348	0.081
150	0.0	999.000*	999.000	999.000
200	476.0	0.203	-0.688	0.137
250	154.0	0.355	-0.310	0.187
300	304.0	0.403	-0.693	0.206
350	165.0	0.429	-0.058	0.231
401	373.0	0.654	-0.394	0.277
404	532.0	0.317	-0.331	0.151
450	154.0	0.034	-0.397	0.066
500	507.0	0.371	-0.382	0.148
600	0.0	999.000	999.000	999.000
601	66.0	0.313	-0.613	0.179
-601	0.0	999.000	999.000	999.000
602	106.0	0.527	-0.332	0.240
604	473.0	-0.150	-0.823	0.085
-604	0.0	999.000	999.000	999.000
800	0.0	999.000	999.000	999.000
801	383.0	0.650	-0.447	0.305
-801	0.0	999.000	999.000	999.000
802	255.0	0.587	-0.476	0.269
-802	0.0	999.000	999.000	999.000
803	100.0	0.226	-0.246	0.113
-803	0.0	999.000	999.000	999.000
910	177.0	0.309	-0.247	0.160
900	48.0	0.234	-0.953	0.171
1000	0.0	999.000	999.000	999.000
1001	320.0	0.943	-0.268	0.266
-1001	0.0	999.000	999.000	999.000
1002	629.0	0.922	-0.455	0.273
-1002	0.0	999.000	999.000	999.000
1010	311.0	0.145	-0.187	0.129
1100	58.0	0.031	-0.505	0.142
1200	39.0	-0.317	-1.040	0.029
1400	0.0	999.000	999.000	999.000
1500	320.0	0.709	-0.468	0.240
1511	133.0	0.625	-0.751	0.265
1622	93.0	-0.175	-0.811	0.043
1633	210.0	0.770	-0.273	0.297

1644	196.0	0.470	-0.082	0.165
1655	51.0	0.381	-0.019	0.143
1666	71.0	-0.067	-0.492	0.074
1700	1007.0	0.235	-0.070	0.104
1750	43.0	-4.440	-3.327	0.681
1800	347.0	0.200	0.006	0.114
1900	193.0	0.400	-0.031	0.177
2000	229.0	0.411	-0.232	0.137
2100	174.0	0.553	0.220	0.143
2200	1708.0	2.164	-1.077	0.249
2300	105.0	-0.091	-0.393	0.124
2490	165.0	0.555	-0.364	0.115
2600	55.0	0.351	-0.211	0.157
2700	36.0	0.480	-0.312	0.199
3100	55.0	-0.597	-1.058	0.096
3200	25.0	-0.060	-0.239	0.034
3300	27.0	0.258	-0.563	0.203
3700	3171.0	0.602	-0.321	0.239
3800	650.0	0.557	-0.373	0.200
3900	313.0	0.583	-0.355	0.143
4000	1067.0	0.709	-0.649	0.282
4100	1553.0	0.527	-0.173	0.194
4200	735.0	0.427	-0.335	0.175
4300	1171.0	0.509	-0.386	0.219
4600	15.0	0.929	-0.454	0.341
4700	32.0	-0.054	-1.375	0.143
5100	15.0	0.064	-0.389	0.121
5300	81.0	0.605	-0.400	0.217
5410	41.0	0.814	-0.260	0.291
5500	70.0	0.722	-0.556	0.307
5600	203.0	0.307	-0.104	0.146
5700	61.0	0.909	0.155	0.225
5800	130.0	0.535	0.054	0.145
6200	742.0	0.670	-0.120	0.263
6300	529.0	0.064	-0.118	0.193
6310	259.0	0.246	-0.288	0.108
6400	351.0	0.226	-0.403	0.124
6500	562.0	0.335	-0.251	0.143
6520	151.0	1.183	0.068	0.365
6600	299.0	0.369	-0.278	0.150
6700	0.0	999.000	999.000	999.000
6704	154.0	0.004	-0.567	0.114
6704	0.0	999.000	999.000	999.000
6705	168.0	0.141	-0.578	0.127

-6705	0.0	999.000	999.000	999.000
6706	181.0	-0.037	-0.546	0.101
-6706	0.0	999.000	999.000	999.000
6800	838.0	0.544	-0.154	0.133
6900	0.0	999.000	999.000	999.000
6901	710.0	0.370	-0.205	0.148
-6901	0.0	999.000	999.000	999.000
6902	614.0	0.429	-0.192	0.149
-6902	0.0	999.000	999.000	999.000
6903	225.0	0.252	-0.086	0.183
-6903	0.0	999.000	999.000	999.000
7000	169.0	0.086	-0.652	0.126
7100	149.0	0.347	0.249	0.134
7200	105.0	0.408	-1.052	0.249
7300	211.0	0.496	-0.059	0.138
7400	124.0	0.782	-0.287	0.296
7500	0.0	999.000	999.000	999.000
7501	53.0	0.547	0.220	0.130
-7501	0.0	999.000	999.000	999.000
7502	45.0	0.614	0.192	0.238
-7502	0.0	999.000	999.000	999.000
7503	55.0	0.725	0.006	0.135
-7503	0.0	999.000	999.000	999.000
7500	45.0	0.802	0.350	0.295
8000	1569.0	0.901	-0.239	0.378
8300	92.0	1.080	-0.254	0.593

*NOTE: An "error" of 999.000 means that this pay grade does not exist in that rating.

PAYGRADE E6

RATE CODE	VOLUME	ERR / 1	ERR / 2	ERR / 3
0	14771.0	1.517	-0.122	0.189
100	458.0	1.440	-0.411	0.238
150	64.0	-1.225	-1.212	0.179
200	103.0	0.459	-0.220	0.130
250	146.0	1.865	-0.576	0.233
300	166.0	0.360	0.050	0.121
350	102.0	0.823	-0.142	0.188
401	75.0	1.071	-0.239	0.353
404	165.0	0.806	-0.623	0.285
450	55.0	0.467	-0.646	0.206
500	96.0	1.910	-0.669	0.335
600	0.0	999.000*	999.000	999.000
601	54.0	0.205	-0.914	0.141
-601	0.0	999.000	999.000	999.000
602	70.0	1.073	-0.078	0.195
604	303.0	0.227	-0.246	0.064
-604	0.0	999.000	999.000	999.000
600	0.0	999.000	999.000	999.000
801	134.0	0.728	-0.321	0.249
-801	0.0	999.000	999.000	999.000
802	162.0	1.121	-0.026	0.302
-802	0.0	999.000	999.000	999.000
803	71.0	0.220	-0.905	0.172
-803	0.0	999.000	999.000	999.000
910	54.0	0.444	-0.536	0.233
900	14.0	-0.136	-2.686	0.333
1000	0.0	999.000	999.000	999.000
1001	0.0	999.000	999.000	999.000
-1001	155.0	0.938	-0.068	0.254
1002	0.0	999.000	999.000	999.000
-1002	194.0	0.615	-0.108	0.218
1010	95.0	0.955	-0.072	0.266
1100	19.0	2.113	0.388	0.366
1200	8.0	0.312	-1.112	0.266
1400	31.0	-3.021	-3.140	0.402
1500	295.0	2.480	-1.201	0.419
1611	52.0	0.627	-0.582	0.284
1622	13.0	1.253	-0.658	0.290
1633	27.0	1.300	-1.212	0.300

1644	51.C	0.855	-0.552	0.330
1655	11.C	1.150	0.182	0.252
1666	12.0	1.012	-0.169	0.231
1700	269.C	1.419	-0.278	0.236
1750	7.0	2.744	-2.510	0.546
1800	365.C	1.604	-0.428	0.259
1900	54.C	1.220	-1.132	0.280
2000	647.0	1.551	-0.568	0.215
2100	104.C	1.040	-1.047	0.240
2200	715.C	1.252	-0.778	0.130
2300	46.C	1.030	0.014	0.201
2440	259.C	1.158	-0.357	0.179
2600	12.0	2.980	-0.572	0.293
2700	17.C	1.843	-2.168	0.352
3160	24.0	0.953	-0.369	0.183
3200	6.C	2.879	-3.321	0.426
3500	26.C	-2.016	-0.671	0.370
3700	1292.0	0.712	-0.070	0.233
3800	480.0	0.979	-0.221	0.151
3900	128.C	1.355	-0.492	0.221
4000	350.0	0.934	-0.134	0.172
4100	636.0	0.397	-0.225	0.149
4200	266.C	0.371	-0.247	0.102
4300	457.0	0.493	-0.255	0.139
4600	14.C	-0.372	-1.635	0.161
4700	10.C	-0.659	-3.231	0.277
5100	7.0	0.416	-0.757	0.197
5200	21.C	2.730	-0.498	0.302
5410	37.0	-0.117	-1.635	0.129
5500	26.0	0.422	-0.585	0.142
5600	74.C	0.766	-0.227	0.153
5700	18.0	0.007	-0.922	0.112
5800	33.C	1.592	-0.508	0.278
6200	50.C	1.184	-0.243	0.186
6300	531.0	2.158	-0.610	0.364
6310	115.C	0.719	-0.957	0.227
6400	105.0	1.434	-0.232	0.261
6500	555.0	1.303	-0.358	0.224
6520	70.C	1.034	-0.105	0.346
6600	147.0	1.212	-0.626	0.334
6700	0.C	555.000	555.000	555.000
6704	59.C	-0.870	-2.174	0.213
6704	0.C	555.000	555.000	555.000
6705	45.C	0.739	-1.395	0.294

-6705	0.0	999.000	999.000	999.000
6706	94.0	1.905	-1.491	0.299
-6706	0.0	999.000	999.000	999.000
6800	416.0	1.607	-0.552	0.309
6900	0.0	999.000	999.000	999.000
6901	445.0	1.750	-0.672	0.247
-6901	0.0	999.000	999.000	999.000
6902	351.0	1.709	-0.013	0.268
-6902	0.0	999.000	999.000	999.000
6903	126.0	1.473	-0.608	0.312
-6903	0.0	999.000	999.000	999.000
7000	94.0	2.799	-1.757	0.340
7100	53.0	1.086	-0.470	0.239
7200	38.0	1.629	-0.922	0.335
-7300	200.0	1.926	-0.821	0.260
7400	56.0	2.565	-0.763	0.353
7500	0.0	999.000	999.000	999.000
7501	0.0	999.000	999.000	999.000
-7501	34.0	-1.186	-0.981	0.256
7502	0.0	999.000	999.000	999.000
-7502	20.0	0.431	-1.104	0.321
7503	0.0	999.000	999.000	999.000
-7503	40.0	1.996	-0.826	0.294
7600	63.0	2.149	-0.990	0.330
8000	299.0	1.763	0.140	0.316
8300	56.0	2.634	-1.192	0.430

*NOTE: An "error" of 999.000 means that this pay grade does not exist in that rating.

PAYGRADE E7

RATE CODE	VOLUME	ERR # 1	ERR # 2	ERR # 3
0	7112.0	1.319	-0.911	0.151
100	310.0	0.573	-0.489	0.091
150	104.0	0.594	-1.342	0.161
200	153.0	1.081	-0.873	0.177
250	22.0	1.122	-0.731	0.150
300	124.0	2.120	-1.821	0.296
350	61.0	1.052	-0.531	0.215
401	16.0	1.342	-1.196	0.349
404	19.0	1.357	-1.306	0.307
450	23.0	1.084	-0.702	0.256
500	39.0	0.022	-0.562	0.090
600	0.0	999.000*	999.000	999.000
601	32.0	3.389	-1.222	0.324
601	0.0	999.000	999.000	999.000
602	40.0	1.258	-1.102	0.214
604	128.0	0.904	-0.539	0.095
604	0.0	999.000	999.000	999.000
700	0.0	999.000	999.000	999.000
801	130.0	2.103	-0.997	0.403
801	0.0	999.000	999.000	999.000
802	49.0	0.855	-1.343	0.275
802	0.0	999.000	999.000	999.000
803	39.0	3.161	-2.134	0.465
803	0.0	999.000	999.000	999.000
810	30.0	3.751	-1.947	0.515
900	25.0	1.682	-1.659	0.244
1000	36.0	-1.276	-2.055	0.339
1001	0.0	999.000	999.000	999.000
1001	0.0	999.000	999.000	999.000
1002	0.0	999.000	999.000	999.000
1002	0.0	999.000	999.000	999.000
1110	30.0	1.448	-0.872	0.389
1100	14.0	1.382	-1.782	0.319
1200	12.0	1.731	-1.516	0.284
1400	77.0	0.865	-0.606	0.106
1500	244.0	-0.137	-0.402	0.057
1611	15.0	0.622	-1.009	0.137
1622	16.0	-1.492	-0.601	0.194
1633	19.0	0.437	-0.598	0.222

1644	21.0	-0.194	-1.350	0.179
1655	10.0	0.142	-0.221	0.109
1666	0.0	0.597	-1.587	0.264
1700	297.0	0.955	-0.653	0.133
1750	15.0	3.991	-1.641	0.482
1800	200.0	0.401	-0.579	0.083
1900	40.0	-0.155	-0.054	0.073
2000	353.0	0.476	-0.438	0.071
2100	20.0	3.997	-3.279	0.518
2200	353.0	1.175	-0.797	0.166
2300	20.0	0.221	-0.916	0.146
2490	129.0	2.077	-1.242	0.252
2600	10.0	1.452	-0.892	0.195
2700	10.0	0.937	-0.017	0.173
3100	7.0	0.747	-2.070	0.211
3200	4.0	0.127	-2.169	0.247
3300	10.0	1.469	-2.874	0.246
3700	312.0	1.905	-1.362	0.304
3800	240.0	0.718	-0.605	0.133
3900	36.0	2.932	-2.487	0.347
4000	253.0	1.409	-1.723	0.184
4100	350.0	1.158	-1.195	0.235
4200	103.0	1.514	-1.459	0.251
4300	215.0	1.349	-0.812	0.209
4600	7.0	1.912	-2.803	0.323
4700	5.0	1.313	-2.554	0.293
5100	3.0	0.221	-3.711	0.365
5300	19.0	0.411	-0.648	0.119
5410	51.0	-0.057	0.656	0.073
5500	17.0	1.413	-0.528	0.201
5600	50.0	0.795	-0.522	0.122
5700	18.0	2.345	-0.325	0.252
5800	10.0	-0.408	-0.471	0.119
5200	248.0	0.700	-0.137	0.097
6300	113.0	0.776	-0.655	0.134
6310	51.0	2.751	-2.426	0.356
6400	19.0	1.111	0.171	0.163
6500	131.0	0.427	-0.358	0.084
6520	12.0	3.043	-1.397	0.460
6600	50.0	2.568	-2.127	0.293
6700	0.0	999.000	999.000	999.000
6704	33.0	2.876	-2.170	0.253
6704	0.0	999.000	999.000	999.000
6705	29.0	1.782	-1.803	0.214

-6705	0.0	999.000	999.000	999.000
6706	42.0	-0.402	-0.652	0.153
-6706	0.0	999.000	999.000	999.000
6800	173.0	0.690	-0.842	0.119
6900	0.0	999.000	999.000	999.000
6901	133.0	0.093	-0.661	0.044
-6901	0.0	999.000	999.000	999.000
6902	145.0	1.551	-1.331	0.243
-6902	0.0	999.000	999.000	999.000
6903	20.0	0.884	-1.395	0.253
-6903	0.0	999.000	999.000	999.000
7000	35.0	0.505	-0.452	0.208
7100	41.0	1.704	-1.793	0.282
7200	23.0	1.833	-1.509	0.214
7300	56.0	2.017	-1.664	0.284
7400	30.0	1.027	-0.439	0.167
7500	0.0	3.153	-2.803	0.465
7501	0.0	999.000	999.000	999.000
-7501	0.0	999.000	999.000	999.000
7502	0.0	999.000	999.000	999.000
-7502	0.0	999.000	999.000	999.000
7503	0.0	999.000	999.000	999.000
-7503	0.0	999.000	999.000	999.000
7600	32.0	0.551	-0.772	0.162
8000	263.0	2.194	-1.111	0.246
8500	30.0	-0.182	-0.332	0.138

*NOTE: An "error" of 999.000 means that this pay grade does not exist in that rating.

PAYGRADE E8

RATE CODE	VOLUME	FRR # 1	FRR # 2	FRR # 3
0	1594.0	-0.249	-0.691	0.057
100	43.0	-1.444	-2.092	0.233
150	29.0	1.061	-0.317	0.152
200	10.0	0.127	-2.090	0.195
250	5.0	-0.764	-0.405	0.330
300	16.0	-1.674	-1.742	0.351
350	19.0	-0.132	-0.715	0.141
401	9.0	0.363	-0.901	0.176
404	9.0	-0.778	0.160	0.177
450	4.0	0.547	-0.953	0.231
500	13.0	-1.313	-1.104	0.272
600	0.0	999.000 *	999.000	999.000
601	0.0	999.000	999.000	999.000
-601	0.0	999.000	999.000	999.000
602	2.0	-1.253	-2.427	0.317
604	0.0	999.000	999.000	999.000
-604	24.0	-1.353	-1.930	0.225
600	0.0	999.000	999.000	999.000
601	0.0	999.000	999.000	999.000
-601	20.0	1.267	-0.754	0.282
602	0.0	999.000	999.000	999.000
-602	9.0	0.563	0.565	0.242
603	0.0	999.000	999.000	999.000
-603	4.0	-0.414	-3.063	0.207
610	2.0	-1.305	-2.680	0.436
600	4.0	1.167	-3.336	0.251
1000	55.0	-4.135	-3.352	0.572
1001	0.0	999.000	999.000	999.000
-1001	0.0	999.000	999.000	999.000
1002	0.0	999.000	999.000	999.000
-1002	0.0	999.000	999.000	999.000
1010	4.0	-1.364	-0.861	0.265
1100	1.0	2.397	-3.560	0.739
1200	3.0	-3.044	-4.165	0.776
1400	22.0	-0.243	-0.512	0.083
1500	47.0	-1.400	0.261	0.192
1611	5.0	-0.404	-0.018	0.151
1622	4.0	-1.749	-2.839	0.469
1633	5.0	0.507	-1.040	0.293

1644	4.0	-1.221	-2.844	0.540
1655	10.0	-0.460	-1.375	0.262
1666	2.0	0.306	-2.083	0.293
1700	43.0	-0.761	-1.006	0.210
1750	10.0	0.560	0.006	0.251
1800	24.0	-0.710	-1.283	0.233
1900	4.0	-1.537	-0.419	0.184
2000	43.0	-1.015	-1.073	0.255
2100	3.0	0.537	-2.106	0.279
2200	61.0	-0.739	-0.902	0.143
2300	4.0	0.592	-1.106	0.230
2490	44.0	-0.530	-1.192	0.163
2600	7.0	2.488	-2.096	0.428
2700	2.0	1.111	-4.452	0.513
3100	1.0	-2.772	-4.738	0.705
3200	0.0	999.000	999.000	999.000
3300	3.0	2.309	-2.105	0.309
3700	104.0	0.307	-0.352	0.089
3800	35.0	-0.427	-1.398	0.109
3900	9.0	-1.457	-1.454	0.340
4000	65.0	-0.203	-0.323	0.087
4100	66.0	0.226	-0.732	0.087
4200	20.0	-0.373	-0.796	0.145
4300	48.0	0.019	-0.746	0.106
4600	2.0	0.053	-1.651	0.233
4700	0.0	999.000	999.000	999.000
5100	2.0	2.549	-3.472	0.436
5300	4.0	1.327	-2.658	0.286
5410	3.0	-6.546	-7.769	0.791
5500	5.0	0.183	-3.425	0.322
5600	17.0	0.100	0.143	0.149
5700	3.0	-0.679	-4.646	0.444
5800	7.0	-1.009	-0.887	0.233
6200	57.0	0.256	-0.830	0.097
6300	26.0	-0.678	-1.499	0.112
6310	13.0	0.962	-1.502	0.259
6400	16.0	0.161	0.059	0.154
6500	10.0	-0.301	-0.652	0.144
6520	4.0	-1.190	-1.436	0.253
6600	7.0	-0.742	-2.436	0.236
6700	0.0	999.000	999.000	999.000
6704	0.0	999.000	999.000	999.000
6704	3.0	-2.122	-4.698	0.535
6705	0.0	999.000	999.000	999.000

-6705	0.0	1.908	-0.970	0.293
6706	0.0	999.000	999.000	999.000
-6706	4.0	-1.207	-1.359	0.407
6800	37.0	-0.254	-1.029	0.077
6900	0.0	999.000	999.000	999.000
6901	0.0	999.000	999.000	999.000
-6901	14.0	-0.924	-1.452	0.275
6902	0.0	999.000	999.000	999.000
-6902	17.0	-0.623	-1.053	0.209
6903	0.0	999.000	999.000	999.000
-6903	4.0	-0.262	-1.755	0.234
7000	4.0	-0.640	-1.714	0.219
7100	5.0	-0.719	-1.146	0.306
7200	5.0	-1.514	0.240	0.255
-7300	7.0	-1.777	-2.556	0.459
7400	5.0	-1.276	-0.558	0.346
7500	7.0	0.807	-1.222	0.256
7501	0.0	999.000	999.000	999.000
-7501	0.0	999.000	999.000	999.000
7502	0.0	999.000	999.000	999.000
-7502	0.0	999.000	999.000	999.000
7503	0.0	999.000	999.000	999.000
-7503	0.0	999.000	999.000	999.000
7600	4.0	-0.515	-3.489	0.442
8000	45.0	-0.254	-0.357	0.106
8300	7.0	0.276	-0.541	0.152

*NOTE: An "error" of 999.000 means that this pay grade does not exist in that rating.

PAYGRADE E9

RA TE CODE	VOLUME	FRR # 1	FRR # 2	FRR # 3
0	453.0	-0.558	-0.924	0.089
100	6.6	0.325	0.073	0.159
150	6.0	1.216	-3.488	0.195
200	7.0	-0.293	-3.679	0.187
250	1.0	2.197	-8.119	0.626
300	6.0	0.600	-4.661	0.272
350	1.0	-0.602	-5.168	0.631
401	6.0	2.571	-2.022	0.365
404	0.0	999.000*	999.000	999.000
450	2.0	0.234	-8.034	0.499
500	2.0	-0.194	-3.685	0.267
600	4.0	-0.255	-0.553	0.144
601	0.0	999.000	999.000	999.000
601	0.0	999.000	999.000	999.000
602	3.0	3.386	-7.196	0.511
604	0.0	999.000	999.000	999.000
604	0.0	999.000	999.000	999.000
600	21.0	0.044	-0.060	0.130
801	0.0	999.000	999.000	999.000
801	0.0	999.000	999.000	999.000
802	0.0	999.000	999.000	999.000
802	0.0	999.000	999.000	999.000
803	0.0	999.000	999.000	999.000
803	0.0	999.000	999.000	999.000
810	0.0	999.000	999.000	999.000
900	2.0	5.587	-14.602	0.583
1000	21.0	-0.655	-4.555	0.472
1001	0.0	999.000	999.000	999.000
1001	0.0	999.000	999.000	999.000
1002	0.0	999.000	999.000	999.000
1002	0.0	999.000	999.000	999.000
1010	1.0	5.492	-8.405	0.734
1100	1.0	2.954	-7.120	0.410
1200	1.0	7.759	-10.610	0.771
1400	9.0	0.293	-1.159	0.098
1500	16.0	0.041	-2.365	0.142
1611	5.0	1.534	-6.365	0.295
1622	1.0	4.395	-8.751	0.520
1633	4.0	3.716	-6.922	0.618

1644	2.0	5.774	-10.272	0.595
1653	3.0	3.204	-8.285	0.608
1666	5.0	7.166	-6.930	0.407
1700	10.0	-2.020	-2.581	0.287
1750	2.0	2.253	-8.077	0.466
1800	9.0	0.577	-3.333	0.163
1900	6.0	1.268	-5.177	0.226
2000	9.0	-1.567	-3.113	0.313
2100	1.0	-1.264	-7.665	0.816
2200	30.0	-0.355	-2.736	0.167
2300	2.0	2.620	-11.360	0.428
2450	10.0	0.067	-3.969	0.193
2600	3.0	3.225	-8.121	0.246
2700	2.0	14.403	-23.232	0.891
3100	1.0	7.478	-11.679	0.799
3200	1.0	7.350	-12.261	0.598
3300	4.0	0.298	-4.895	0.344
3700	34.0	-0.341	0.505	0.110
3800	9.0	-0.135	-3.633	0.177
3900	7.0	3.143	-5.475	0.347
4000	21.0	0.565	-1.778	0.064
4100	31.0	-0.036	-2.149	0.072
4200	3.0	5.595	-7.061	0.457
4300	21.0	0.401	-3.193	0.149
4600	0.0	999.000	999.000	999.000
4700	1.0	9.351	-12.145	0.755
5100	0.0	999.000	999.000	999.000
5300	2.0	7.519	-15.856	0.713
5410	1.0	2.619	-9.278	0.504
5500	1.0	7.143	-10.794	0.755
5600	5.0	2.236	-5.797	0.313
5700	2.0	4.644	-11.641	0.558
5800	0.0	999.000	999.000	999.000
6200	15.0	-1.016	-2.795	0.273
6300	21.0	-0.721	-2.648	0.194
6310	4.0	1.811	-5.050	0.222
6400	2.0	2.003	-8.127	0.593
6500	4.0	0.735	-6.425	0.335
6520	3.0	1.793	-1.377	0.269
6600	3.0	2.560	-5.007	0.217
6700	9.0	-0.495	-1.578	0.197
6704	0.0	999.000	999.000	999.000
6704	0.0	999.000	999.000	999.000
6705	0.0	999.000	999.000	999.000

-6705	0.0	999.000	999.000	999.000
6706	0.0	999.000	999.000	999.000
-6706	0.0	999.000	999.000	999.000
6800	8.0	0.323	-3.885	0.172
6900	17.0	-2.956	-0.443	0.422
6901	0.0	999.000	999.000	999.000
-6901	0.0	999.000	999.000	999.000
6902	0.0	999.000	999.000	999.000
-6902	0.0	999.000	999.000	999.000
6903	0.0	999.000	999.000	999.000
-6903	0.0	999.000	999.000	999.000
7000	1.0	7.465	-13.124	0.589
7100	1.0	0.705	-7.327	0.574
7200	1.0	1.244	-6.334	0.534
7300	2.0	4.262	-9.844	0.561
7400	3.0	1.442	-4.441	0.209
7500	3.0	0.547	-3.222	0.336
7501	0.0	999.000	999.000	999.000
-7501	0.0	999.000	999.000	999.000
7502	0.0	999.000	999.000	999.000
-7502	0.0	999.000	999.000	999.000
7503	0.0	999.000	999.000	999.000
-7503	0.0	999.000	999.000	999.000
7600	1.0	2.519	-9.523	0.490
8000	11.0	-0.537	-2.140	0.197
8300	2.0	1.412	-10.425	0.509

*NOTE: An "error" of 999.000 means that this pay grade does not exist in that rating.

2. Advancement Model Errors

PAYGRADE E4

RATE CODE	VOLUME	ERR # 1	ERR # 2	ERR # 3
0	54345.0	0.349	0.232	0.143
100	2060.C	0.357	-0.065	0.164
200	787.C	0.269	0.035	0.119
250	380.C	0.355	0.070	0.124
300	1269.C	0.247	0.385	0.088
350	310.0	-0.262	0.067	0.197
401	450.0	0.012	0.291	0.113
404	360.C	-0.077	0.321	0.184
450	227.0	0.377	0.251	0.142
500	419.C	0.385	0.210	0.151
600	0.0	999.000*	999.000	999.000
601	105.0	0.278	0.462	0.191
-601	0.0	999.000	999.000	999.000
602	179.0	0.688	0.265	0.281
604	671.0	0.285	0.587	0.230
-604	0.0	999.000	999.000	999.000
800	0.0	999.000	999.000	999.000
801	624.C	0.074	0.410	0.110
-801	0.0	999.000	999.000	999.000
802	438.C	-0.115	0.028	0.091
-802	0.0	999.000	999.000	999.000
803	200.0	-0.079	0.128	0.100
-803	0.0	999.000	999.000	999.000
810	400.C	-0.116	-0.079	0.113
900	71.0	0.463	0.053	0.202
1000	0.0	999.000	999.000	999.000
1001	968.C	-0.240	-0.089	0.225
-1001	0.0	999.000	999.000	999.000
1002	885.0	-0.088	0.288	0.167
-1002	0.0	999.000	999.000	999.000
1010	344.0	0.271	-0.042	0.263
1100	58.C	0.502	-0.120	0.264
1200	42.0	0.448	-0.107	0.301
1500	2522.C	0.212	0.221	0.089
1611	169.C	0.140	0.420	0.079
1622	146.C	0.322	-0.156	0.250
1633	131.C	-0.300	-0.180	0.274
1644	304.C	0.165	0.037	0.158
1655	173.0	0.395	0.249	0.166
1666	124.0	0.321	0.286	0.105

1700	1341.0	0.574	0.017	0.244
1750	0.0	999.000	999.000	999.000
1800	1029.0	0.306	-0.118	0.261
1400	0.0	999.000	999.000	999.000
1900	420.0	0.312	-0.258	0.275
2000	1548.0	0.328	0.002	0.180
150	0.0	999.000	999.000	999.000
2100	329.0	-0.110	-0.094	0.213
2200	2911.0	1.605	-0.252	0.275
2300	136.0	0.238	-0.075	0.244
2490	1041.0	0.187	0.080	0.080
2600	144.0	0.447	0.265	0.202
2700	279.0	0.837	0.243	0.244
3100	114.0	0.560	-0.072	0.238
3200	40.0	-0.578	0.486	0.545
3300	63.0	-0.268	1.102	0.460
3600	0.0	999.000	999.000	999.000
3700	3151.0	0.370	0.163	0.146
3800	1529.0	0.204	0.241	0.093
3900	552.0	0.351	0.173	0.134
4000	2194.0	0.055	0.054	0.056
4100	1962.0	0.252	0.088	0.126
4200	1039.0	0.409	0.184	0.144
4300	2137.0	0.302	0.222	0.117
4600	18.0	-0.116	-0.363	0.083
4700	46.0	0.516	-0.123	0.250
5000	0.0	999.000	999.000	999.000
5100	13.0	0.227	0.026	0.190
5300	135.0	0.661	0.007	0.275
5410	264.0	0.700	0.065	0.294
5500	203.0	0.203	-0.084	0.284
5600	398.0	0.542	-0.060	0.289
5700	116.0	0.538	0.213	0.305
5800	196.0	0.568	0.338	0.282
6000	0.0	999.000	999.000	999.000
6200	1602.0	0.251	0.225	0.123
6300	1152.0	0.263	0.306	0.108
6310	310.0	0.024	0.565	0.121
6400	544.0	0.382	0.361	0.236
6500	878.0	0.412	0.053	0.177
6520	327.0	-0.155	0.097	0.123
6600	409.0	0.383	0.268	0.208
6700	0.0	999.000	999.000	999.000
6704	344.0	0.502	0.056	0.190

-6704	0.C	999.000	999.000	999.000
6705	309.0	0.140	-0.197	0.189
-6705	0.C	999.000	999.000	999.000
6706	658.C	0.228	-0.268	0.178
-6706	0.0	999.000	999.000	999.000
6800	1171.C	0.436	0.148	0.221
6900	0.C	999.000	999.000	999.000
6901	1131.0	0.416	0.157	0.160
-6901	0.C	999.000	999.000	999.000
6902	1003.0	0.448	0.116	0.164
-6902	0.0	999.000	999.000	999.000
6903	575.C	0.314	0.227	0.224
-6903	0.0	999.000	999.000	999.000
7000	220.0	0.431	0.065	0.242
7100	284.C	0.309	0.083	0.260
7200	141.C	0.593	0.293	0.201
7300	589.C	0.070	-0.084	0.149
7400	507.0	0.511	-0.089	0.262
7500	0.C	999.000	999.000	999.000
7501	57.C	0.422	-0.143	0.259
-7501	0.0	999.000	999.000	999.000
7502	66.C	0.313	0.060	0.140
-7502	0.0	999.000	999.000	999.000
7503	116.0	0.042	-0.151	0.145
-7503	0.0	999.000	999.000	999.000
7600	208.0	-0.053	-0.029	0.184
7600	0.0	999.000	999.000	999.000
8000	2958.C	0.436	-0.016	0.187
8300	225.C	0.197	-0.579	0.297

*NOTE: An "error" of 999.000 means that this pay grade does not exist in that rating.

PAYGRADE E5

RATE CODE	VOLUME	ERR # 1	ERR # 2	ERR # 3
0	32509.0	0.756	0.177	0.260
100	799.0	0.376	-0.309	0.201
200	476.0	0.677	-0.406	0.343
250	194.0	0.248	-0.156	0.261
300	804.0	0.602	-0.454	0.357
350	165.0	0.339	0.480	0.091
401	373.0	0.390	-0.072	0.172
404	382.0	0.060	0.040	0.024
450	134.0	0.359	0.185	0.152
500	307.0	0.988	0.200	0.315
600	0.0	999.000*	999.000	999.000
601	66.0	1.193	-0.078	0.329
-601	0.0	999.000	999.000	999.000
602	106.0	0.913	-0.157	0.333
604	473.0	0.169	-0.661	0.220
-604	0.0	999.000	999.000	999.000
800	0.0	999.000	999.000	999.000
801	383.0	0.461	0.010	0.196
-801	0.0	999.000	999.000	999.000
802	365.0	-0.103	-0.245	0.098
-802	0.0	999.000	999.000	999.000
803	100.0	-0.032	0.522	0.261
-803	0.0	999.000	999.000	999.000
810	177.0	-0.023	0.270	0.176
900	48.0	0.672	-0.460	0.289
1000	0.0	999.000	999.000	999.000
-1001	820.0	0.666	-0.046	0.199
-1001	0.0	999.000	999.000	999.000
1002	825.0	0.733	-0.291	0.259
-1002	0.0	999.000	999.000	999.000
1010	311.0	0.062	-0.197	0.127
1100	58.0	1.289	-0.424	0.369
1200	39.0	0.638	-0.373	0.380
1500	920.0	0.602	0.046	0.231
1611	155.0	1.213	-0.523	0.463
1622	93.0	0.250	0.156	0.140
1633	210.0	-0.008	0.041	0.067
1644	156.0	0.451	0.235	0.171
1655	64.0	0.608	0.320	0.150
1666	71.0	0.000	0.192	0.100

1700	1007.0	0.785	0.060	0.270
1750	43.0	0.049	-0.582	0.202
1800	347.0	0.093	-0.255	0.246
1400	0.0	999.000	999.000	999.000
1900	148.0	-0.218	0.028	0.196
2000	929.0	0.375	-0.220	0.273
150	0.0	999.000	999.000	999.000
2100	174.0	-0.147	0.224	0.152
2200	1708.0	2.995	-1.337	0.404
2300	108.0	0.639	-0.059	0.292
2490	765.0	0.397	-0.761	0.151
2600	53.0	0.128	-0.234	0.149
2700	56.0	0.284	-0.451	0.266
3100	56.0	0.755	-0.335	0.302
3200	25.0	1.251	0.056	0.355
3300	27.0	0.000	1.199	0.444
3600	0.0	999.000	999.000	999.000
3700	3171.0	0.286	-0.222	0.189
3800	656.0	0.590	-0.173	0.330
3900	318.0	0.825	-0.079	0.307
4000	1067.0	0.613	-0.440	0.363
4100	1388.0	0.276	-0.155	0.164
4200	785.0	0.560	-0.155	0.246
4300	1171.0	0.734	-0.378	0.360
4600	15.0	0.987	-0.001	0.210
4700	32.0	0.123	-0.578	0.266
5000	0.0	999.000	999.000	999.000
5100	15.0	-0.398	-0.228	0.197
5300	81.0	0.594	-0.060	0.213
5410	41.0	-0.491	1.005	0.263
5500	78.0	0.270	0.093	0.127
5600	213.0	0.546	-0.161	0.234
5700	61.0	1.185	0.529	0.242
5800	130.0	0.831	0.093	0.209
6000	0.0	999.000	999.000	999.000
6200	742.0	1.352	0.775	0.222
6300	525.0	0.186	0.321	0.053
6310	259.0	0.355	0.162	0.095
6400	361.0	0.302	0.199	0.196
6500	562.0	0.432	0.008	0.267
6520	151.0	1.177	0.311	0.322
6600	299.0	0.659	-0.139	0.287
6700	0.0	999.000	999.000	999.000
6704	124.0	0.625	-0.476	0.387

-6704	0.0	999.000	999.000	999.000
6705	168.0	0.428	0.062	0.226
-6705	0.0	999.000	999.000	999.000
6706	181.0	0.261	-0.466	0.187
-6706	0.0	999.000	999.000	999.000
6800	888.0	0.492	-0.089	0.287
6900	0.0	999.000	999.000	999.000
6901	716.0	0.345	-0.472	0.271
-6901	0.0	999.000	999.000	999.000
6902	614.0	0.558	-0.163	0.290
-6902	0.0	999.000	999.000	999.000
6903	225.0	0.477	-0.452	0.278
-6903	0.0	999.000	999.000	999.000
7000	169.0	0.180	-0.177	0.256
7100	149.0	0.362	0.188	0.301
7200	105.0	0.691	0.741	0.448
7300	211.0	0.362	0.014	0.177
7400	124.0	-0.060	-0.480	0.145
7500	0.0	999.000	999.000	999.000
7501	53.0	0.312	-0.260	0.275
-7501	0.0	999.000	999.000	999.000
7502	45.0	0.343	-0.159	0.294
-7502	0.0	999.000	999.000	999.000
7503	55.0	0.317	-0.508	0.169
-7503	0.0	999.000	999.000	999.000
7600	45.0	0.674	2.117	0.400
7800	0.0	999.000	999.000	999.000
8000	1369.0	0.748	0.034	0.245
8300	99.0	-0.407	0.570	0.478

* NOTE: An "error" of 999.000 means that this pay grade does not exist in that rating.

PAYGRADE E6

RATE CODE	VOLUME	FRR # 1	FRR # 2	FRR # 3
0	14091.0	-0.032	-0.134	0.050
100	458.0	-0.176	-0.357	0.044
200	133.0	-0.780	-0.624	0.177
250	146.0	0.737	0.074	0.106
300	186.0	-0.235	-0.143	0.147
350	102.0	-0.328	0.081	0.177
401	75.0	-0.006	0.007	0.119
404	163.0	0.004	0.008	0.050
450	55.0	-0.332	-0.054	0.170
500	90.0	0.493	0.170	0.097
600	0.0	999.000*	999.000	999.000
601	84.0	-1.251	-1.466	0.289
-601	0.0	999.000	999.000	999.000
602	70.0	-0.063	0.569	0.118
604	303.0	-1.110	-0.217	0.160
-604	0.0	999.000	999.000	999.000
800	0.0	999.000	999.000	999.000
801	184.0	0.245	-0.252	0.183
-801	0.0	999.000	999.000	999.000
802	162.0	0.800	0.448	0.148
-802	0.0	999.000	999.000	999.000
803	71.0	0.171	-0.442	0.131
-803	0.0	999.000	999.000	999.000
810	84.0	-0.277	-1.159	0.207
900	14.0	-0.832	-0.836	0.224
1000	0.0	999.000	999.000	999.000
1001	0.0	999.000	999.000	999.000
-1001	195.0	0.102	-0.146	0.104
1002	0.0	999.000	999.000	999.000
-1002	194.0	-0.296	0.401 ^{10/16}	0.140
1010	95.0	0.480	0.289	0.104
1100	19.0	0.362	0.738	0.099
1200	8.0	1.175	-0.556	0.219
1500	295.0	1.086	-0.530	0.168
1611	52.0	0.400	0.093	0.151
1622	13.0	-0.209	-0.533	0.119
1633	27.0	0.010	0.682	0.163
1644	31.0	0.219	-0.147	0.110
1655	11.0	0.217	0.903	0.195
1666	12.0	-0.357	0.780	0.171

1700	289.0	-0.502	-0.421	0.120
1750	7.0	2.537	-0.545	0.412
1800	365.0	-1.153	-0.169	0.205
1400	31.0	-5.522	-2.651	0.903
1900	54.0	0.152	-0.915	0.138
2000	647.0	0.475	-0.131	0.075
150	64.0	-2.645	-1.111	0.339
2100	104.0	-0.375	-0.671	0.143
2200	715.0	0.446	-0.135	0.180
2300	46.0	-0.198	-0.320	0.124
2490	259.0	-0.645	-0.400	0.098
2600	12.0	0.362	-0.254	0.142
2700	17.0	0.218	-1.159	0.146
3100	24.0	-2.005	-1.342	0.289
3200	6.0	1.288	-0.270	0.289
3300	28.0	-1.242	-0.576	0.163
3600	0.0	999.000	999.000	999.000
3700	1292.0	-0.271	-0.398	0.184
3800	480.0	0.660	-0.225	0.088
3900	128.0	0.368	-0.257	0.079
4000	350.0	-0.204	0.296	0.093
4100	636.0	-0.930	-0.809	0.208
4200	266.0	-0.383	-0.447	0.130
4300	437.0	-0.970	-0.772	0.200
4600	14.0	-0.335	-1.301	0.172
4700	10.0	-0.749	-1.116	0.230
5000	0.0	999.000	999.000	999.000
5100	7.0	-0.425	-1.216	0.182
5300	21.0	1.050	0.141	0.183
5410	37.0	0.120	-2.163	0.211
5500	28.0	-0.436	0.163	0.163
5600	74.0	-0.088	-0.111	0.071
5700	18.0	-1.767	-1.152	0.301
5800	38.0	0.424	-0.379	0.107
6000	0.0	999.000	999.000	999.000
6200	586.0	0.096	0.407	0.098
6300	331.0	0.343	-0.285	0.116
6310	115.0	-0.727	-0.482	0.173
6400	105.0	-0.567	0.155	0.191
6500	355.0	0.266	0.077	0.078
6520	70.0	0.565	-0.368	0.319
6600	147.0	-1.470	-0.831	0.230
6700	0.0	999.000	999.000	999.000
6704	35.0	-2.113	-1.618	0.463

-6704	0.0	999.000	999.000	999.000
6705	45.0	-1.828	-0.886	0.265
-6705	0.0	999.000	999.000	999.000
6706	94.0	1.558	-0.500	0.235
-6706	0.0	999.000	999.000	999.000
6800	486.0	-0.809	-0.281	0.167
6900	0.0	999.000	999.000	999.000
6901	445.0	0.572	0.351	0.106
-6901	0.0	999.000	999.000	999.000
6902	351.0	-0.661	0.395	0.187
-6902	0.0	999.000	999.000	999.000
6903	126.0	0.639	-0.193	0.133
-6903	0.0	999.000	999.000	999.000
7000	94.0	0.525	0.170	0.113
7100	93.0	-0.399	0.392	0.122
7200	88.0	-1.393	-0.690	0.122
7300	200.0	0.119	0.271	0.066
7400	56.0	1.035	0.037	0.151
7500	0.0	999.000	999.000	999.000
7501	0.0	999.000	999.000	999.000
-7501	34.0	-1.148	-0.738	0.203
7502	0.0	999.000	999.000	999.000
-7502	20.0	-1.309	0.229	0.399
7503	0.0	999.000	999.000	999.000
-7503	48.0	-0.644	0.893	0.176
7600	68.0	0.564	0.092	0.104
7800	0.0	999.000	999.000	999.000
8000	259.0	0.422	0.066	0.142
8300	50.0	-0.486	-0.219	0.107

*NOTE: An "error" of 999.000 means that this pay grade does not exist in that rating.

PAYGRADE E7

RATE CODE	VOLUME	ERR # 1	ERR # 2	ERR # 3
0	7112.0	0.290	-0.217	0.075
100	310.0	-0.914	-0.425	0.145
200	133.0	0.090	-0.302	0.047
250	22.0	-0.312	1.511	0.242
300	124.0	0.743	-0.355	0.127
350	61.0	0.184	0.244	0.065
401	18.0	0.069	-0.074	0.127
404	19.0	-0.299	-0.416	0.082
450	23.0	0.520	0.437	0.104
500	89.0	-0.226	-0.257	0.046
600	0.0	999.000*	999.000	999.000
601	32.0	0.554	0.171	0.231
-601	0.0	999.000	999.000	999.000
602	40.0	0.542	-0.509	0.144
604	128.0	-0.212	0.543	0.093
-604	0.0	999.000	999.000	999.000
800	0.0	999.000	999.000	999.000
801	130.0	0.033	-0.308	0.090
-801	0.0	999.000	999.000	999.000
802	49.0	0.215	-0.652	0.126
-802	0.0	999.000	999.000	999.000
803	59.0	1.294	-0.295	0.293
-803	0.0	999.000	999.000	999.000
810	30.0	2.761	-0.510	0.395
900	23.0	-0.798	-0.180	0.100
1000	101.0	-0.647	0.242	0.208
1001	0.0	999.000	999.000	999.000
-1001	0.0	999.000	999.000	999.000
1002	0.0	999.000	999.000	999.000
-1002	0.0	999.000	999.000	999.000
1010	30.0	0.347	0.166	0.064
1100	14.0	0.557	-0.172	0.188
1200	12.0	2.810	-1.657	0.370
1500	248.0	-0.267	0.303	0.062
1611	15.0	0.576	-0.917	0.155
1622	16.0	-1.335	0.244	0.231
1633	19.0	-0.849	-0.356	0.211
1644	21.0	-0.443	-1.035	0.139
1655	10.0	-0.037	-0.190	0.055
1666	8.0	0.150	-1.195	0.228

1700	257.0	-0.217	0.031	0.029
1750	15.0	2.178	0.535	0.321
1800	206.0	-0.566	0.153	0.112
1400	77.0	-0.176	0.158	0.073
1900	40.0	0.172	0.512	0.147
2000	353.0	0.485	-0.152	0.123
150	104.0	-0.627	0.195	0.130
2100	20.0	2.008	-0.508	0.460
2200	338.0	-0.435	-0.258	0.070
2300	20.0	-0.215	-0.026	0.144
2450	125.0	-0.067	0.802	0.102
2500	14.0	1.467	-0.226	0.216
2700	16.0	0.394	0.166	0.122
3100	7.0	-0.847	-1.248	0.365
3200	4.0	-0.044	1.261	0.486
3300	10.0	1.425	-2.314	0.316
3600	0.0	999.000	999.000	999.000
3700	512.0	0.775	-0.001	0.093
3800	240.0	0.275	-0.050	0.083
3900	36.0	1.013	-0.719	0.159
4000	253.0	0.939	-0.093	0.177
4100	350.0	0.143	-0.140	0.062
4200	168.0	-0.147	0.011	0.033
4300	215.0	0.108	-0.064	0.036
4600	7.0	1.956	-2.392	0.384
4700	6.0	1.278	-1.089	0.326
5000	0.0	999.000	999.000	999.000
5100	3.0	-0.229	-2.527	0.326
5300	19.0	0.463	-0.084	0.146
5410	51.0	-0.359	0.723	0.183
5500	17.0	-0.403	-1.060	0.192
5600	60.0	-0.002	-0.232	0.063
5700	18.0	0.577	0.767	0.140
5800	16.0	-1.289	-0.406	0.168
6000	0.0	999.000	999.000	999.000
6200	246.0	0.316	-0.565	0.147
6300	115.0	0.463	-0.164	0.139
6310	51.0	1.563	-1.164	0.289
6400	17.0	0.575	0.477	0.203
6500	131.0	0.155	-0.175	0.081
6520	12.0	0.491	0.899	0.219
6600	60.0	1.259	-0.414	0.266
6700	0.0	999.000	999.000	999.000
6704	32.0	1.052	0.076	0.245

-6704	0.C	999.000	999.000	999.000
6705	29.0	0.142	-0.024	0.090
-6705	0.0	999.000	999.000	999.000
6706	42.0	-0.244	-0.364	0.194
-6706	0.0	999.000	999.000	999.000
6800	173.0	0.747	-0.044	0.197
6900	0.C	999.000	999.000	999.000
6901	135.0	1.186	-0.677	0.251
-6901	0.C	999.000	999.000	999.000
6902	148.0	0.089	0.275	0.096
-6902	0.C	999.000	999.000	999.000
6903	20.C	0.036	-0.588	0.115
-6903	0.0	999.000	999.000	999.000
7000	35.C	0.028	0.503	0.179
7100	41.C	1.132	-0.752	0.225
7200	28.0	0.186	-0.021	0.220
7300	56.C	2.147	-1.180	0.372
7400	30.0	0.025	0.084	0.108
7500	38.0	0.838	0.109	0.237
7501	0.C	999.000	999.000	999.000
-7501	0.0	999.000	999.000	999.000
7502	0.C	999.000	999.000	999.000
-7502	0.C	999.000	999.000	999.000
7503	0.0	999.000	999.000	999.000
-7503	0.C	999.000	999.000	999.000
7600	32.0	0.734	-0.645	0.219
7800	0.0	999.000	999.000	999.000
8000	263.C	0.331	0.144	0.085
8300	30.0	-0.781	0.210	0.175

* NOTE: An "error" of 999.000 means that this pay grade does not exist in that rating.

PAYGRADE E8

RATE CODE	VOLUME	ERR # 1	ERR # 2	ERR # 3
0	1394.0	0.557	0.512	0.116
100	43.0	0.772	1.773	0.442
200	10.0	0.780	0.088	0.198
250	5.0	2.920	-6.351	0.643
300	16.0	-1.223	-0.707	0.305
350	19.0	-0.243	-0.216	0.115
401	9.0	-0.089	-0.126	0.080
404	9.0	-0.063	-0.163	0.074
450	4.0	-0.139	-1.818	0.249
500	18.0	0.150	0.338	0.088
500	0.0	999.000*	999.000	999.000
601	0.0	999.000	999.000	999.000
-601	0.0	999.000	999.000	999.000
602	2.0	-4.920	-6.467	0.787
604	0.0	999.000	999.000	999.000
-604	24.0	-0.181	-1.187	0.158
800	0.0	999.000	999.000	999.000
801	0.0	999.000	999.000	999.000
-801	20.0	-0.023	-0.814	0.113
802	0.0	999.000	999.000	999.000
-802	9.0	0.685	0.988	0.220
803	0.0	999.000	999.000	999.000
-803	4.0	-0.185	-1.542	0.220
810	2.0	-1.282	-4.951	0.450
900	4.0	-0.082	-1.490	0.211
1000	36.0	-2.920	-0.853	0.623
1001	0.0	999.000	999.000	999.000
-1001	0.0	999.000	999.000	999.000
1002	0.0	999.000	999.000	999.000
-1002	0.0	999.000	999.000	999.000
1010	4.0	-2.754	-1.709	0.490
1100	1.0	3.563	-3.997	0.957
1200	3.0	-0.196	-3.624	0.408
1500	47.0	-1.542	1.564	0.392
1611	5.0	0.141	-1.235	0.162
1622	4.0	-0.752	-1.436	0.201
1633	5.0	0.730	-1.648	0.382
1644	4.0	-0.793	-2.126	0.368
1655	10.0	0.965	-2.580	0.329
1666	2.0	1.167	-2.461	0.416

1700	43.0	-1.024	-0.567	0.265
1750	10.0	0.510	0.974	0.182
1800	24.0	0.451	-1.500	0.290
1400	22.0	0.550	-1.250	0.207
1900	8.0	-0.325	0.437	0.123
2000	45.0	0.069	-0.271	0.109
150	29.0	0.572	-0.124	0.158
2100	3.0	0.369	1.902	0.667
2200	81.0	-1.444	-0.758	0.257
2300	4.0	0.426	-0.504	0.178
2450	44.0	-0.919	0.019	0.126
2600	7.0	2.425	-1.475	0.411
2700	2.0	1.216	-3.903	0.413
3100	1.0	-0.118	-3.089	0.445
3200	0.0	999.000	999.000	999.000
3300	3.0	0.562	1.238	0.310
3600	0.0	999.000	999.000	999.000
3700	104.0	0.741	-0.689	0.154
3800	35.0	0.357	-1.265	0.124
3900	9.0	-0.863	-1.274	0.189
4000	65.0	-0.073	-0.258	0.111
4100	66.0	0.532	-0.655	0.144
4200	20.0	-0.306	-0.173	0.123
4300	48.0	-0.188	-0.113	0.099
4600	2.0	1.130	-4.170	0.398
4700	0.0	999.000	999.000	999.000
5000	0.0	999.000	999.000	999.000
5100	2.0	0.887	-3.024	0.370
5300	4.0	0.412	-1.915	0.257
5410	3.0	-5.716	-8.818	0.663
5500	3.0	0.911	-3.077	0.343
5600	17.0	0.222	1.274	0.174
5700	3.0	0.689	-7.315	0.501
5800	7.0	0.227	-1.447	0.220
6000	0.0	999.000	999.000	999.000
6200	97.0	0.050	-0.271	0.064
6300	26.0	-0.914	-1.477	0.266
6310	19.0	1.473	-0.994	0.380
6400	10.0	0.644	0.934	0.250
6500	10.0	-0.169	1.379	0.378
6520	8.0	-2.297	-0.424	0.692
6600	7.0	0.429	0.935	0.429
6700	0.0	999.000	999.000	999.000
6704	0.0	999.000	999.000	999.000

-6704	3.0	-2.396	-2.953	0.864
6705	0.0	999.000	999.000	999.000
-6705	3.0	1.014	-1.824	0.355
6706	0.0	999.000	999.000	999.000
-6706	4.0	1.939	-0.214	0.686
6800	37.0	0.619	-1.067	0.195
6900	0.0	999.000	999.000	999.000
6901	0.0	999.000	999.000	999.000
-6901	14.0	-1.571	-0.408	0.786
6902	0.0	999.000	999.000	999.000
-6902	17.0	-0.525	0.950	0.631
6903	0.0	999.000	999.000	999.000
-6903	4.0	-2.575	-2.931	0.526
7000	4.0	-0.503	-2.402	0.275
7100	5.0	0.276	-0.268	0.234
7200	3.0	-0.655	0.814	0.231
7300	7.0	-1.620	-1.705	0.426
7400	5.0	-3.196	-1.743	0.530
7500	12.0	2.482	-0.552	0.425
7501	0.0	999.000	999.000	999.000
-7501	0.0	999.000	999.000	999.000
7502	0.0	999.000	999.000	999.000
-7502	0.0	999.000	999.000	999.000
7503	0.0	999.000	999.000	999.000
-7503	0.0	999.000	999.000	999.000
7600	4.0	-0.611	-2.748	0.399
7800	0.0	999.000	999.000	999.000
3000	45.0	1.597	1.174	0.520
8300	7.0	1.054	-0.755	0.253

*NOTE: An "error" of 999.000 means that this pay grade does not exist in that rating.

PAYGRADE E9

RATE CODE	VOLUME	ERR # 1	ERR # 2	ERR # 3
0	453.C	0.437	-0.261	0.110
100	6.C	1.430	3.680	0.323
200	7.0	-1.356	-1.919	0.289
250	1.0	0.435	-3.206	0.512
300	6.C	0.698	-1.149	0.280
350	1.0	-4.503	-4.727	0.998
401	6.C	2.977	-0.546	0.551
404	0.0	999.000*	999.000	999.000
450	2.C	-1.306	-1.751	0.457
500	2.C	0.044	0.853	0.371
600	8.C	-1.613	-0.530	0.202
601	0.C	999.000	999.000	999.000
-601	0.0	999.000	999.000	999.000
602	3.0	-1.037	-3.618	0.408
604	0.C	999.000	999.000	999.000
-604	0.0	999.000	999.000	999.000
800	7.C	0.355	-1.679	0.198
801	0.C	999.000	999.000	999.000
-801	0.0	999.000	999.000	999.000
802	0.C	999.000	999.000	999.000
-802	0.0	999.000	999.000	999.000
803	0.0	999.000	999.000	999.000
-803	0.0	999.000	999.000	999.000
810	0.0	999.000	999.000	999.000
900	2.C	-0.052	-2.652	0.344
1000	11.C	0.660	-2.127	0.309
1001	0.C	999.000	999.000	999.000
-1001	0.C	999.000	999.000	999.000
1002	0.0	999.000	999.000	999.000
-1002	0.0	999.000	999.000	999.000
1010	1.0	0.262	-3.504	0.501
1100	1.0	-1.464	-2.474	0.692
1200	1.C	-0.042	-3.519	0.464
1500	16.C	-0.752	-2.105	0.287
1611	3.0	0.155	-1.630	0.295
1622	1.C	0.823	-0.510	0.021
1633	4.0	1.535	-2.166	0.594
1644	2.0	0.984	-1.558	0.495
1655	3.C	-1.182	-2.500	0.503
1666	3.0	1.759	1.406	0.331

1700	16.0	-1.563	-1.116	0.216
1750	2.0	0.614	-0.286	0.493
1800	9.0	-0.112	-0.990	0.177
1400	9.0	2.799	-1.022	0.497
1900	6.0	-0.572	-1.940	0.269
2000	9.0	-0.987	-2.427	0.265
150	8.0	0.645	-0.619	0.184
2100	1.0	-3.940	-5.192	0.868
2200	30.0	-1.556	-1.145	0.247
2300	2.0	-1.932	-3.309	0.675
2490	10.0	-1.739	-0.757	0.287
2600	3.0	-1.040	-3.424	0.459
2700	2.0	7.754	-10.921	0.853
3100	1.0	-1.499	-3.258	0.636
3200	1.0	1.073	-4.918	0.575
3300	4.0	-2.101	-2.366	0.407
3600	0.0	999.000	999.000	999.000
3700	34.0	-0.202	1.646	0.096
3800	9.0	-0.319	-1.836	0.177
3900	7.0	0.305	-1.533	0.211
4000	21.0	0.708	-0.678	0.181
4100	31.0	0.455	-0.891	0.154
4200	5.0	-0.497	0.279	0.199
4300	21.0	-0.027	-1.366	0.140
4600	0.0	999.000	999.000	999.000
4700	1.0	-0.948	-1.494	0.656
5000	0.0	999.000	999.000	999.000
5100	0.0	999.000	999.000	999.000
5300	2.0	4.495	-10.777	0.731
5410	1.0	-1.762	-3.496	0.648
5500	1.0	1.731	-5.070	0.618
5600	5.0	0.166	-1.631	0.299
5700	2.0	0.672	-6.921	0.482
5800	0.0	999.000	999.000	999.000
6000	0.0	999.000	999.000	999.000
6200	15.0	2.719	-1.444	0.582
6300	21.0	-0.073	-1.522	0.150
6310	4.0	-0.476	-2.305	0.290
6400	2.0	0.253	-5.253	0.499
6500	4.0	-0.904	-2.432	0.346
6520	3.0	0.335	-0.420	0.238
6600	5.0	0.052	-0.369	0.232
6700	5.0	-1.767	-2.007	0.274
6704	0.0	999.000	999.000	999.000

-6704	0.0	999.000	999.000	999.000
6705	0.0	999.000	999.000	999.000
-6705	0.0	999.000	999.000	999.000
6706	0.0	999.000	999.000	999.000
-6706	0.0	999.000	999.000	999.000
6800	8.0	-0.793	-2.252	0.316
6900	17.0	-1.108	-2.040	0.231
6901	0.0	999.000	999.000	999.000
-6901	0.0	999.000	999.000	999.000
6902	0.0	999.000	999.000	999.000
-6902	0.0	999.000	999.000	999.000
6903	0.0	999.000	999.000	999.000
-6903	0.0	999.000	999.000	999.000
7000	1.0	-0.834	-3.534	0.552
7100	1.0	-5.152	-6.488	0.880
7200	1.0	0.743	-3.325	0.553
7300	2.0	2.088	-4.544	0.524
7400	3.0	-0.806	-1.023	0.224
7500	1.0	1.925	-2.787	0.763
7501	0.0	999.000	999.000	999.000
-7501	0.0	999.000	999.000	999.000
7502	0.0	999.000	999.000	999.000
-7502	0.0	999.000	999.000	999.000
7503	0.0	999.000	999.000	999.000
-7503	0.0	999.000	999.000	999.000
7600	1.0	0.419	-4.936	0.505
7800	0.0	999.000	999.000	999.000
8000	11.0	-0.947	-1.465	0.226
8300	2.0	-1.457	-4.705	0.532

* NOTE: An "error" of 999,000 means that this pay grade does not exist in that rating.

APPENDIX D

HISTOGRAMS OF Δ_1 ERRORS, ALL RATINGS, FAST MODEL AND ADVANCEMENT MODEL

Δ_1 Errors of FAST Model for Pay Grade E4

SAMPLE SIZE = 83

FREQUENCIES

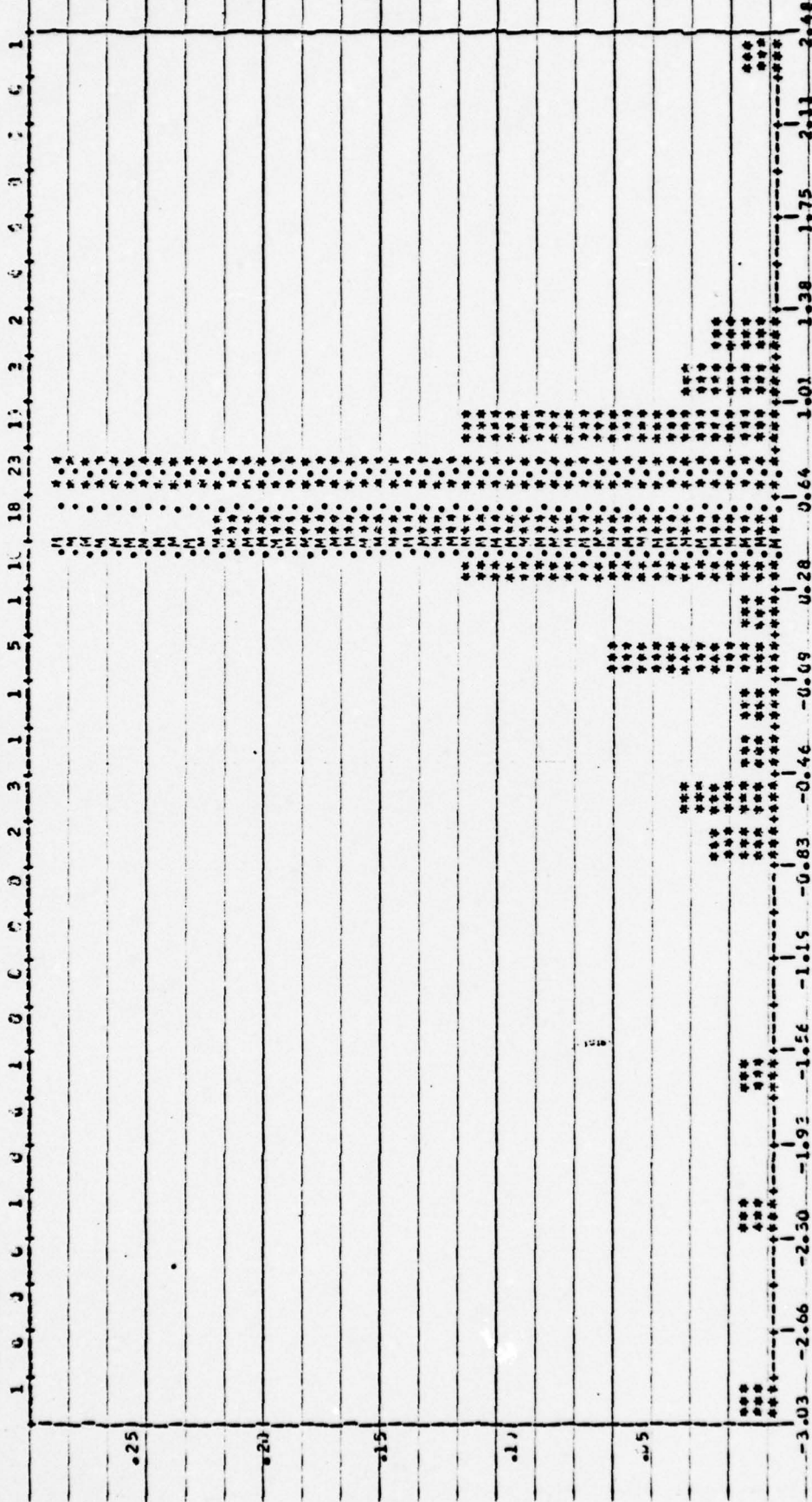

SCALE FIXED FROM -3.030000 TO 2.480000

CENTRAL TENDENCY

MEAN 4.52678E-01
 MEDIAN 6.13543E-01
 TRIMMEAN 5.99464E-01
 MODE 6.17551E-01
 MIDRANGE -2.763438E-01

SPREAD

VARIANCE 5.16234E-01
 STD DEV 7.18480E-01
 COEF VAR 3.99225E-01
 RANGE 5.51039E-01
 MIDSRAD 3.67549E-01

HIGHER CENTRAL MOMENTS

M3 -8.23693E-01
 M4 3.02485E-01
 SKEWNESS -2.24874E-01
 KURTOSIS 8.48735E-01
 BETA1 -8.02300E-01
 BETA2 -2.93317E-01

DISTRIBUTION

MINIMUM 2.31231E-01
 .10 QUANTILE 4.47108E-01
 .25 QUANTILE 4.23543E-01
 .50 QUANTILE 6.17551E-01
 .75 QUANTILE 7.61464E-01
 MAXIMUM 2.47864E-01

Δ_1 Errors of Advancement Model for Pay Grade E4

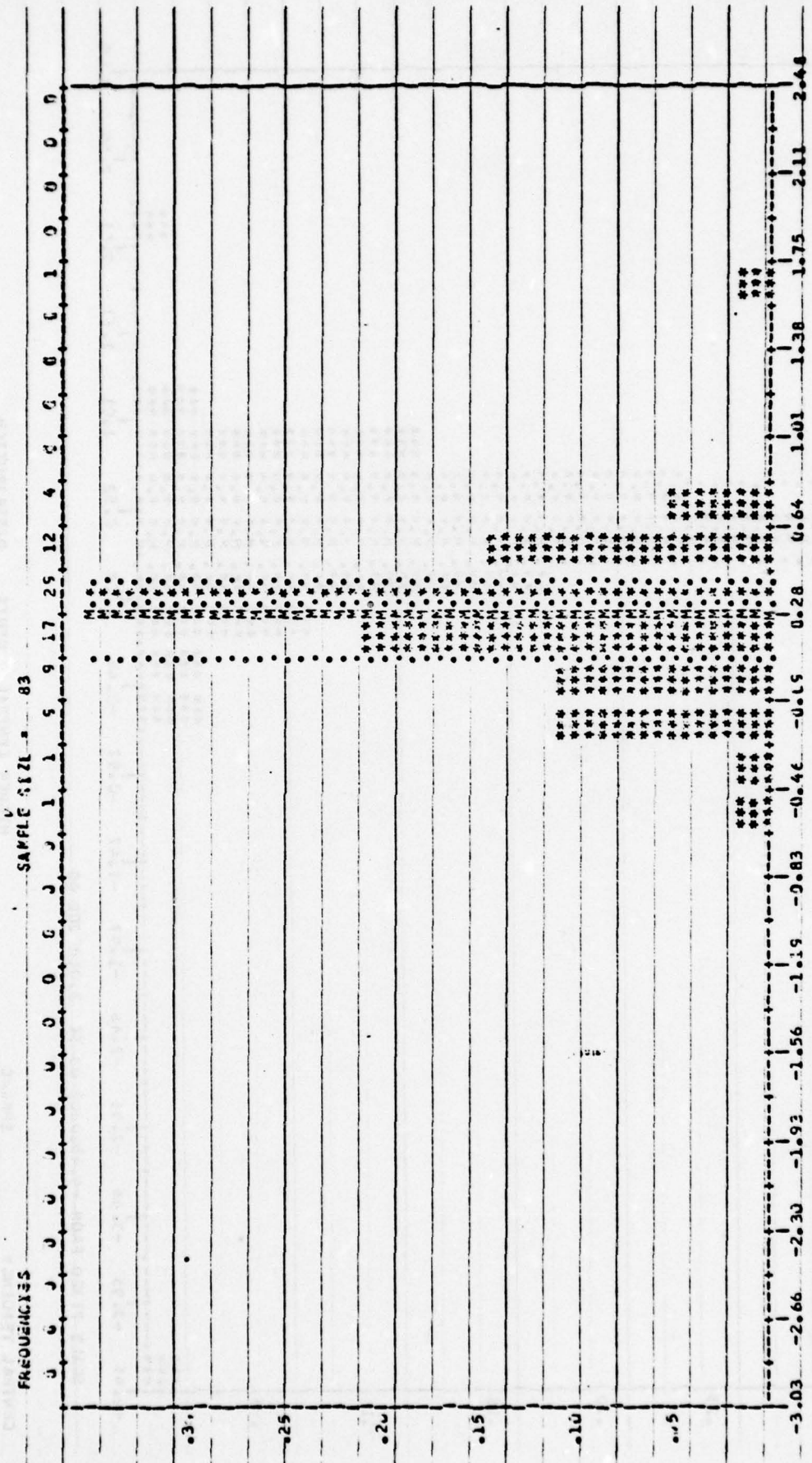

SCALE FIXED FROM 3.03 TO 2.44

CENTRAL TENDENCY		SPREAD		HIGHER CENTRAL MOMENTS		DISTRIBUTION	
MEAN	2.7273E-01	VARIANCE	9.25248E-02	M3	1.25248E-02	MINIMUM	-5.72472E-01
MEDIAN	2.81663E-01	STD DEV	3.0427E-01	M4	4.5230E-01	.10 QUANTILE	-5.72472E-01
TRIMEAN	2.83705E-01	CUBE VAR	1.11527E-01	SKEWNESS	3.05237E-02	.25 QUANTILE	5.72472E-01
MODE	2.81663E-01	CUBE DEV	2.18248E-01	KURTOSIS	3.05237E-02	.50 QUANTILE	5.72472E-01
MIDRANGE	5.13403E-01	RANGE	5.04605E-01	BETA1	5.23482E-02	.75 QUANTILE	5.72472E-01
		PLUSMEAN	5.04605E-01	BETA2	5.23482E-02	.90 QUANTILE	5.72472E-01
						MAXIMUM	5.72472E-01

Δ_1 Errors of FAST Model for Pay Grade E5

FREQUENCIES / SAMPLE SIZE = E4

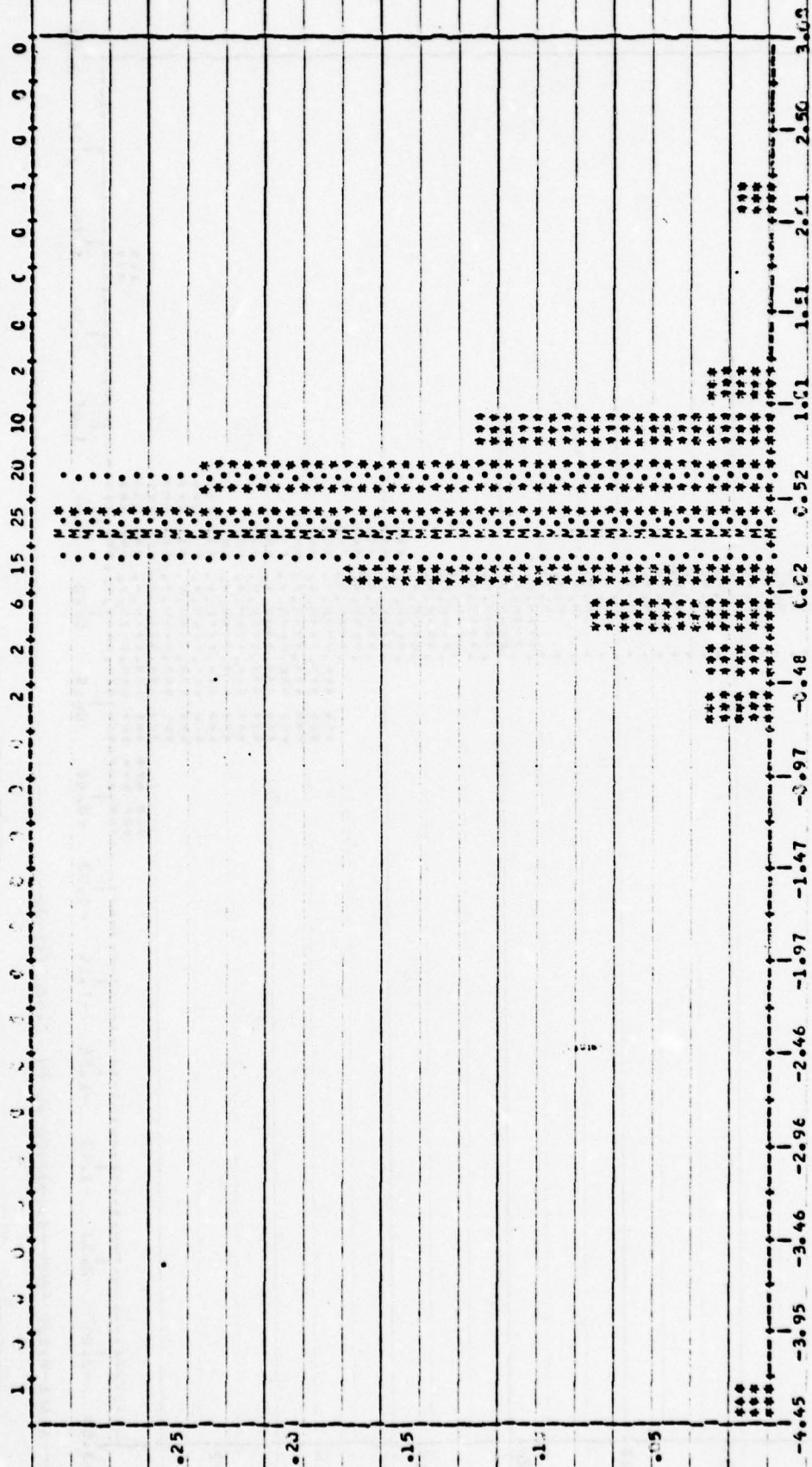

SCALE FIXED FROM -4.45 TO 3.05

CENTRAL TENDENCY	SPREAD	HIGHER CENTRAL MOMENTS	DISTRIBUTION
MEAN 3.618979E-01	VARIANCE 4.408185E-01	M2 1.311887E 00	MANS NUM 4.48295E 00
MEDIAN 4.017420E-01	STD DEV 2.102187E 00	M3 2.824474E 00	QUANTILE 6.62273E 00
TRIMMED 4.167445E-01	COEF VAR 5.714611E 00	M4 SKENESS -4.482355E 01	QUANTILE 2.271761E 01
MODE 4.191043E-01	MEAN DEV 3.376445E 01	KURTOSIS 3.222541E 01	QUANTILE 4.017420E 01
MIDRANGE -1.142397E 00	RANGE 6.611822E 00	BETA1 -1.055104E 00	QUANTILE 8.017420E 01
	MIDSPREAD 4.113822E 01	BETA2	PAXI NUM 2.183550E 00

Δ_1 Errors of Advancement Model for Pay Grade E5

SAMPLE SIZE = 64

FREQUENCIES

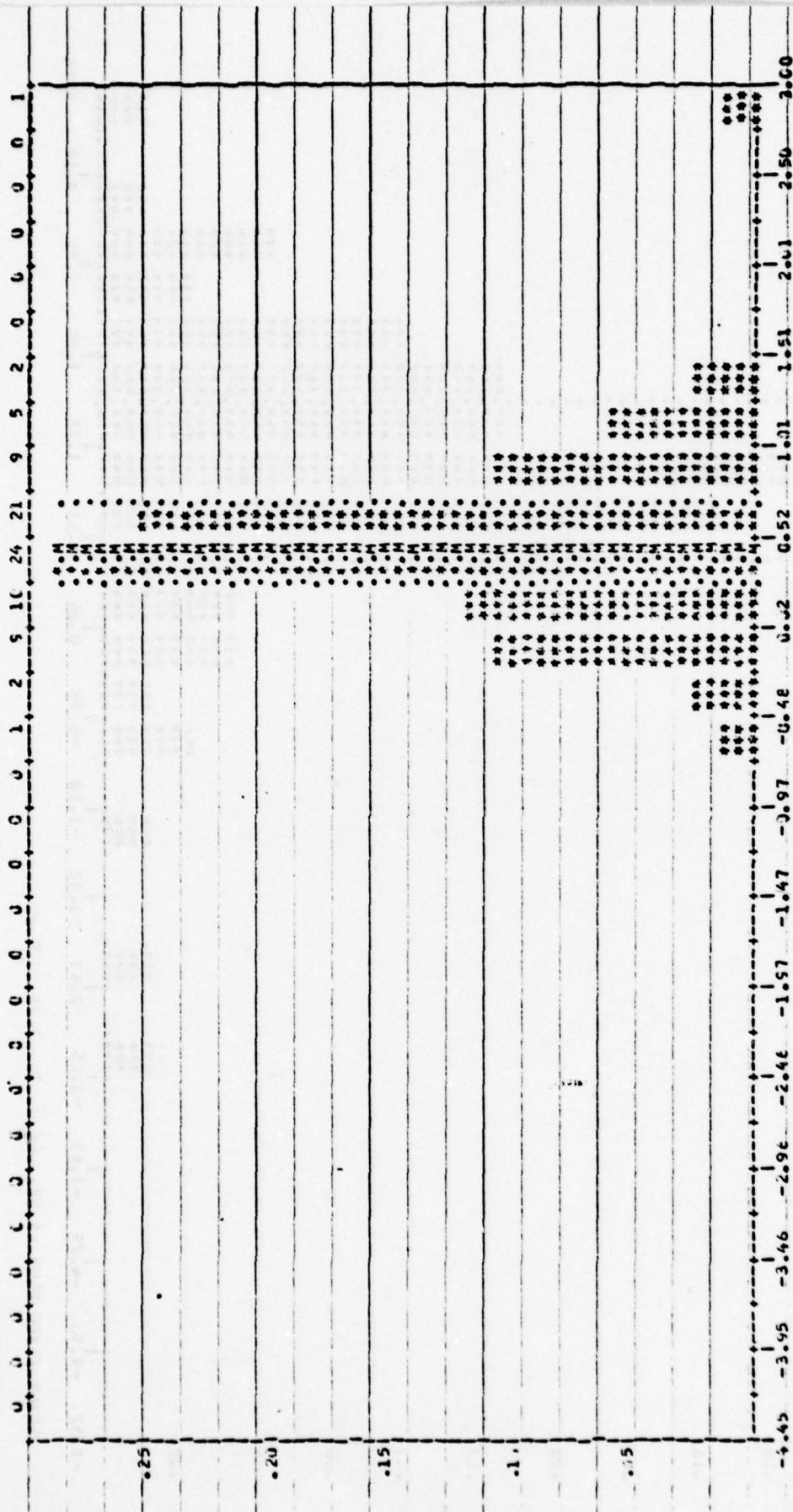

SCALE FIXED FROM -4.4500000F 00 YG 3.000000E 00

CENTRAL TENDENCY

MEAN 4.946461E-01
 MEDIAN 4.415636E-01
 TRIMMEAN 4.626634E-01
 MIDRANGE 4.76641E-01
 MIDSPREAD 1.252397E 00

SPREAD

V. MAX 2.328196E-01
 STD DEV 4.625126E-01
 C. OF VAR 9.754726E-01
 RANGE 3.381414E-01
 M. ANGE 3.4286114E-01
 MIDSPREAD 4.470336E-01

HIGHER CENTRAL MOMENTS

M3 1.87439E-01
 M4 5.604792E-01
 SKEWNESS 7.635855E-01
 BETA2 5.372885E-01

DISTRIBUTION

MINIMUM 0.25
 QUANTILE 0.25
 QUANTILE 0.50
 QUANTILE 0.75
 QUANTILE 0.90
 QUANTILE 0.95
 QUANTILE 0.99
 MAXIMUM 3.00

Δ_1 Errors of FAST Model for Pay Grade E6

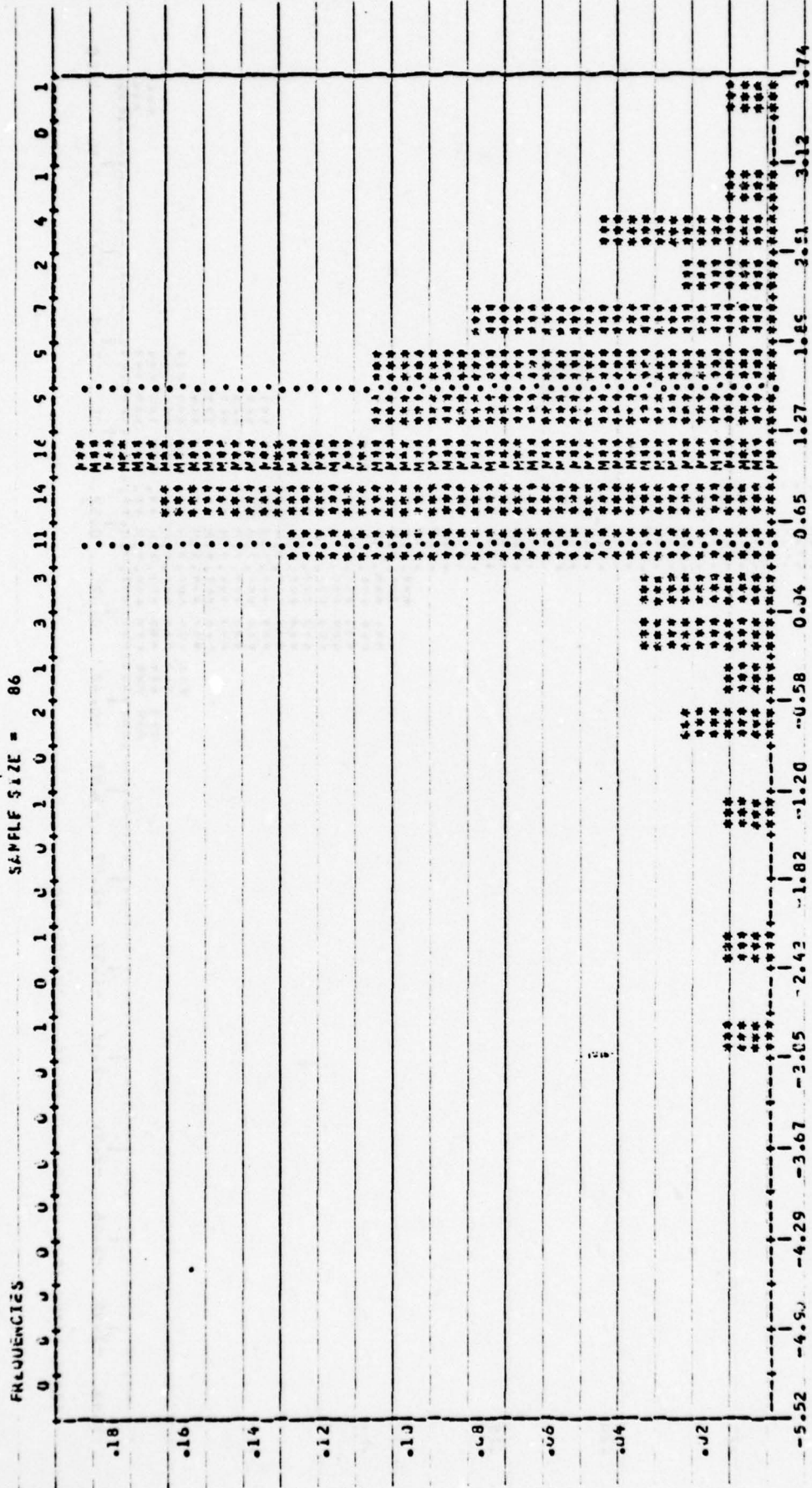

CENTRAL TENDENCY	SPREAD	HIGHER CENTRAL MOMENTS	DISTRIBUTICA
M34	VARIANCE	M2	PERCENTILE
MEAN	STD DEV	SKWENESS	.10 QUANTILE
TRIMED	COEF VAR	KURTOSIS	.25 QUANTILE
MODAN	MEAN DEV	BETA2	.50 QUANTILE
MIDRANGE	RANGE		.75 QUANTILE
	MIDSPREAD		MAXIMUM

Δ₁ Errors of Advancement Model for Pay Grade E6

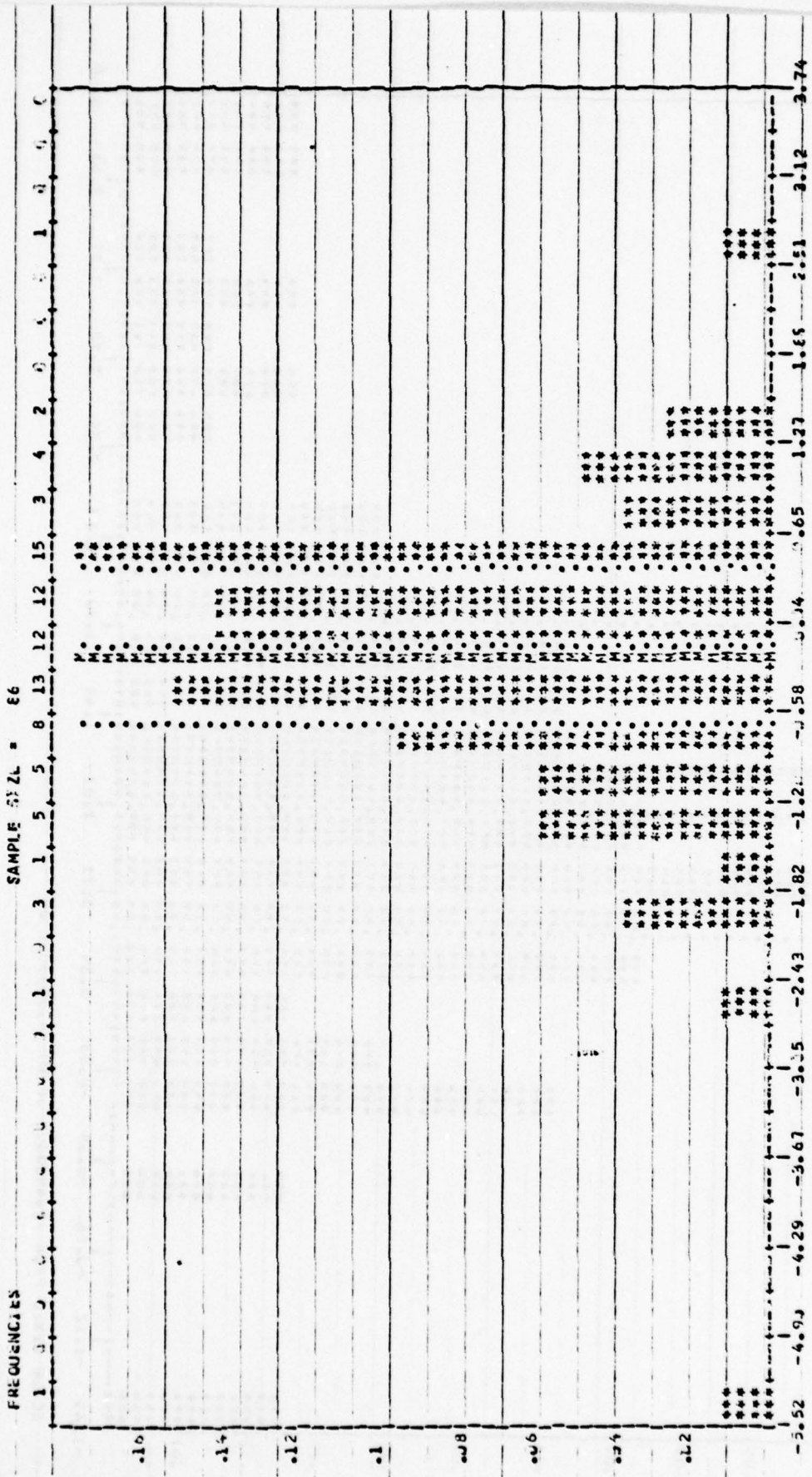

SCALE FIXED FROM -5.523198 TO 2.536776

CENTRAL TENDENCY	SPREAD	HIGHER CENTRAL MOMENTS	DISTRIBUTION
MEAN	VARIANCE	M3	MINIMUM
MEDIAN	STDEV	M4	0.25 QUANTILE
RANGE	C.V.	M5	0.50 QUANTILE
MIDRANGE	SKWESS	M6	0.75 QUANTILE
	KURTOSIS	BET1	MAXIMUM
	BET2	BET72	
	MIDSPREAD		

Δ_1 Errors of FAST Model for Pay Grade E7

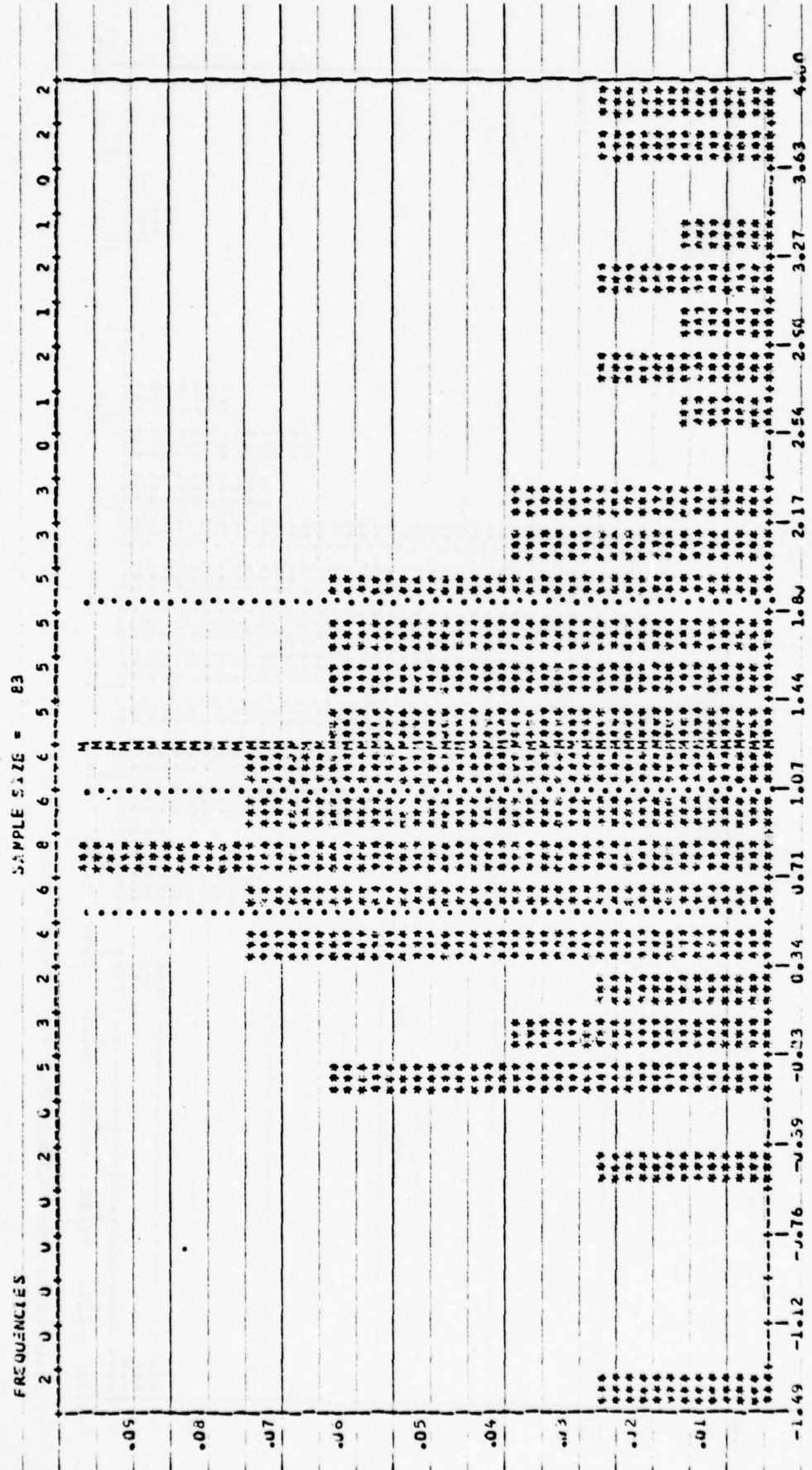

SCALE FIXED FROM -1.49000000 TO 4.00000000

CENTRAL TENDENCY	SPREAD	HIGHER CENTRAL MOMENTS	DISTRIBUTION
MEAN 1.243755E 00	VARIANCE 1.23355E 00	M3 5.39488E-01	MINIMUM 1.42459E 00
STDEV 1.110729E 00	STDEV 1.110729E 00	M4 3.17892E-01	10% QUANTILE 1.07155E 00
TRIMEAN 1.187200E 00	COEF VAR 8.93282E-01	M5 2.63452E-01	50% QUANTILE (MEAN) 1.00000E 00
MEAN 1.187200E 00	MEAN DEV 8.72707E-01	M6 2.00152E-01	90% QUANTILE (INCH) 1.00000E 00
MEDEV 1.052497E 00	MEDEV 8.48995E-01	M7 1.4229E-01	MAXIMUM 3.597475E 00
MEDEV 1.052497E 00	MEDEV 8.48995E-01	M8 1.00000E-01	

Δ_1 Errors of FAST Model for Pay Grade E8

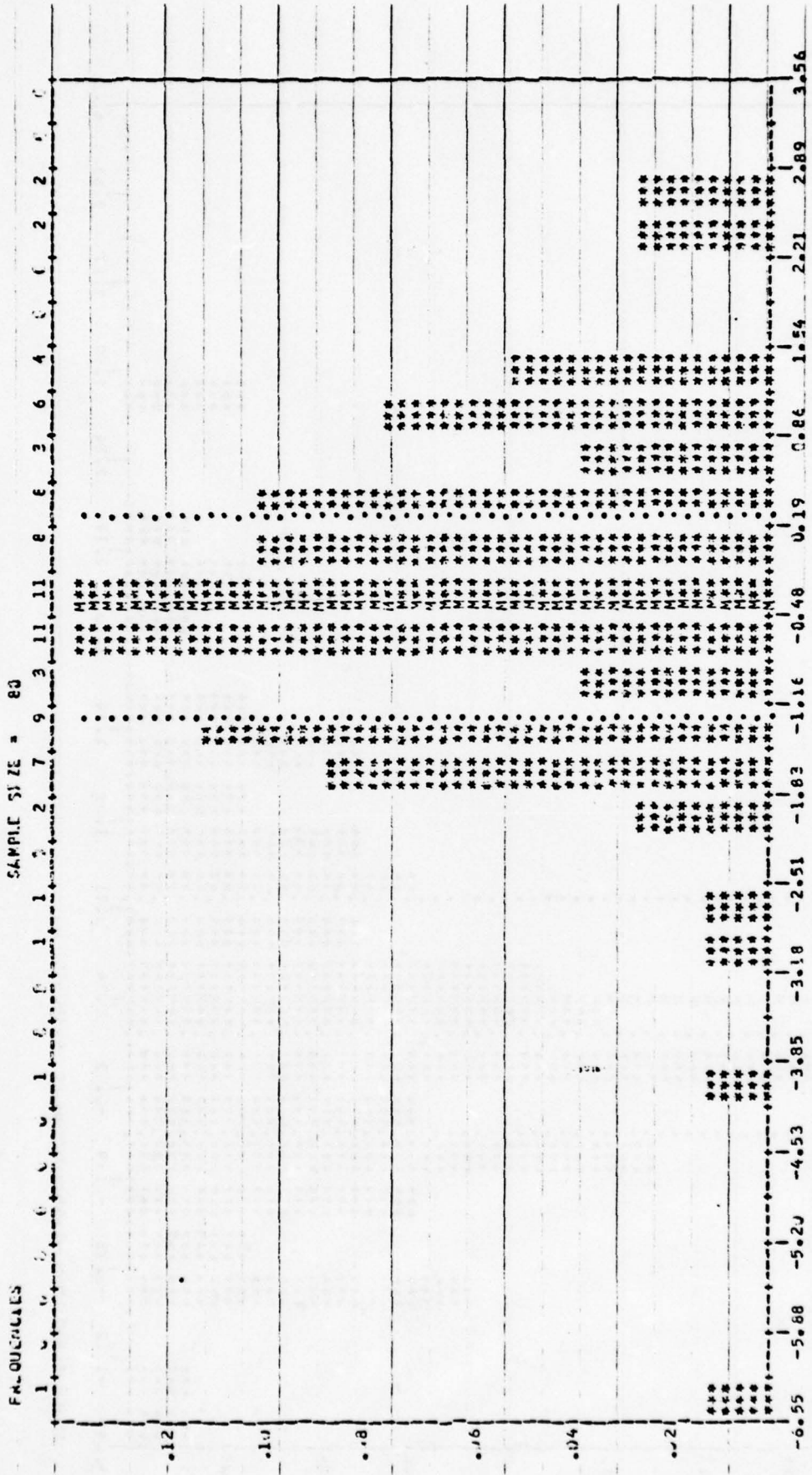

SCALE FACTOR FROM -6.549995E-06 TO 3.559999E-03

GENERAL TENDENCY	SPRCAD	HIGHER CENTRAL MOMENTS	DISTRIBUTION
MEAN	-3.957433E-01	M3	MINIMUM
STDEV	-3.887482E-01	M4	.10 QUANTILE
VARIANCE	2.24715E-00	SKWNESS	.25 QUANTILE
CORR	3.595904E-01	KURTOSIS	.50 QUANTILE
COEF VAR	3.16897E-01	BETA1	.75 QUANTILE
MEAN DEV	9.355227E-01	BETA2	MAXIMUM
RANGE	1.583057E-01		
MIDSPREAD	1.583057E-01		

Δ₁ Errors of Advancement Model for Pay Grade E8

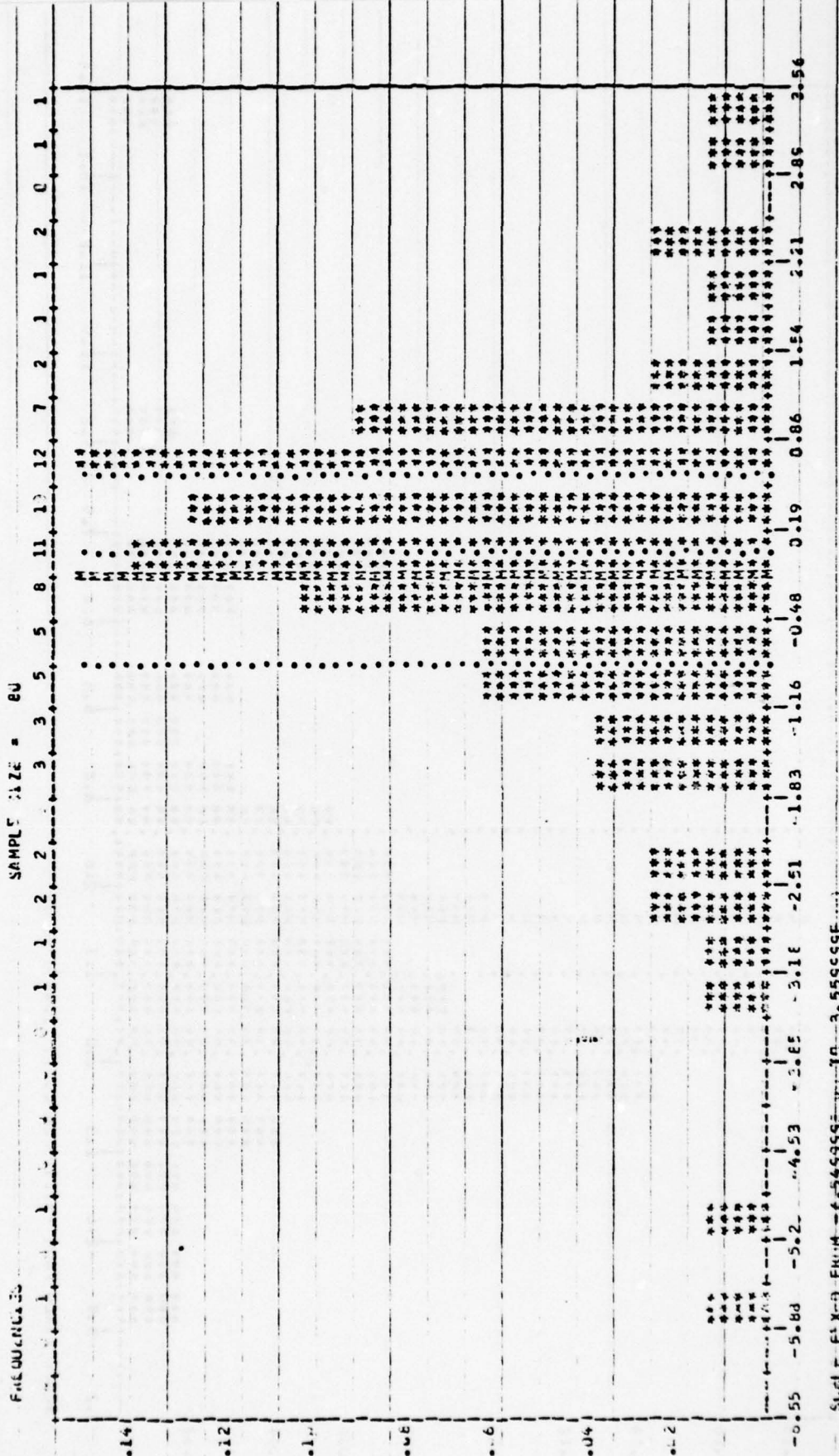

SCALE FROM -6.549999 TO 3.559999

CENTRAL TENDENCY		SPREAD		HIGHER CENTRAL MOMENTS		DISTRIBUTION	
MEAN	-1.3483	VARIANCE	2.24692E 01	M3	-2.297743E 00	MIN	NUM
STDEV	1.50146E 01	COEFF VOK	1.26418E 01	SKEWNESS	-1.023019E 00	.25	QUANTILE
MEAN DEV	1.26252E 01	RANGE	5.27877E 00	BETA1	-3.278962E 01	.50	QUANTILE
MEAN RANGE	1.77645E 01	M.L.S.P.R.E.A.D	1.45911E 00	BETA2	2.788962E 01	.75	QUANTILE
						.90	QUANTILE
						.95	QUANTILE
						MAXIMUM	

A_1 Errors of FAST Model for Pay Grade E9

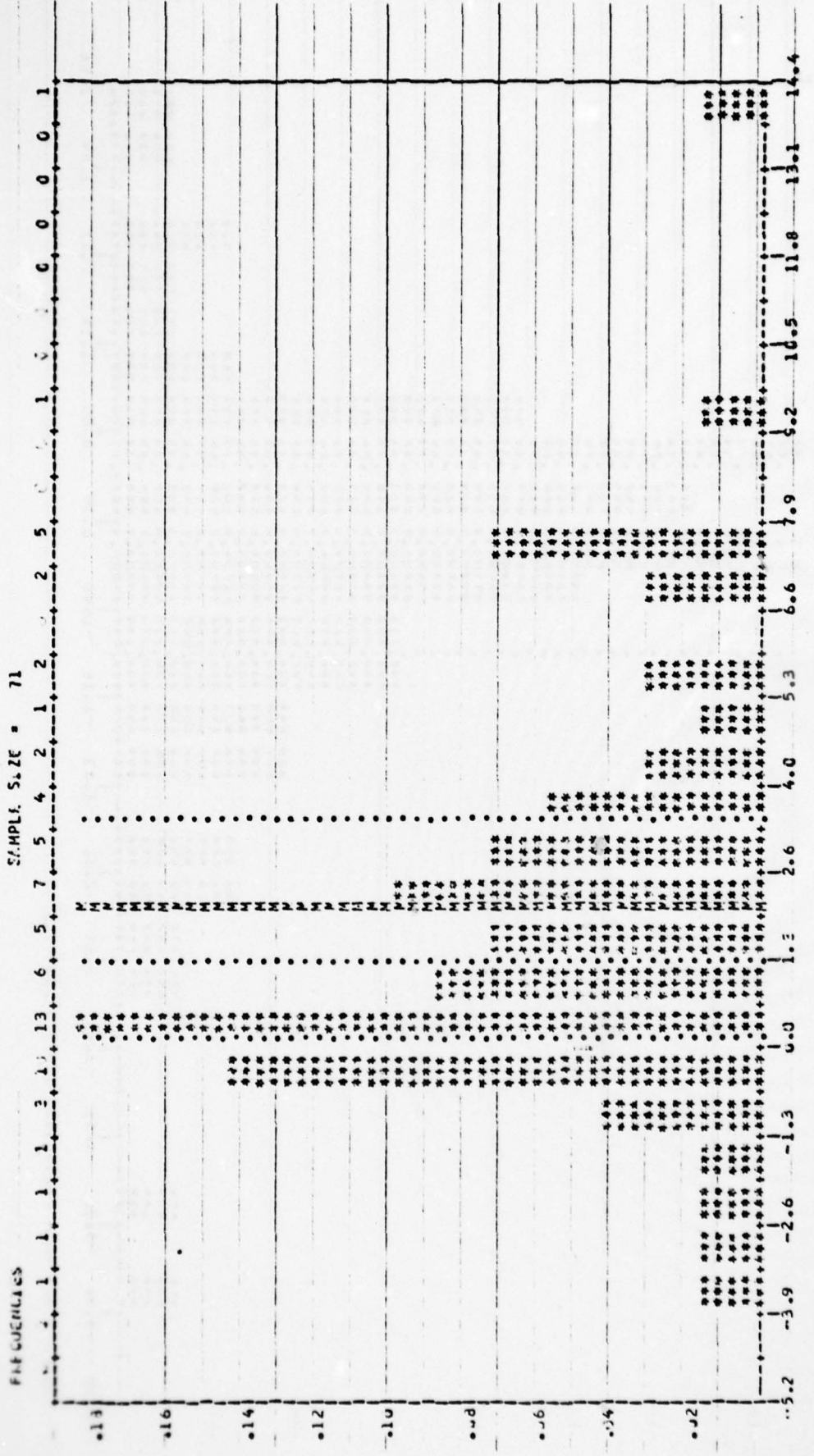

SCALE FIXED FROM -5.19 TO 1.44

GENERAL TENDENCY		SPREAD		HIGHER CENTRAL MOMENTS		DISTRIBUTION	
MEAN	2.998579E 00	VARIANCE	9.72337E 00	M3	4.05213E 01	MID NUM	3.28411E 01
TR 1-AN	1.20766E 00	STD DEV	3.11856E 00	M4	5.9694E 00	QUANTILE	3.28411E 01
MID 4-AN	1.44586E 00	CLF VAR	1.48419E 01	SKWNESS	1.34616E 00	.25 QUANTILE	4.1488E 00
RANGE	5.555216E 00	PLAN DEV	2.072319E 01	KURTOSIS	2.485581E 01	.50 QUANTILE	1.44586E 00
		RANGE	1.76866E 01	BETA1	3.885517E 02	.75 QUANTILE	1.44586E 00
		MIDSPREAD	3.34442E 00	BETA2	4.885517E 02	.90 QUANTILE	1.44586E 00
						MAXIMUM	1.44586E 00

Δ_1 Errors of FAST Model for All Pay Grades

SAMPLE SIZE = 487

FREQUENCIES

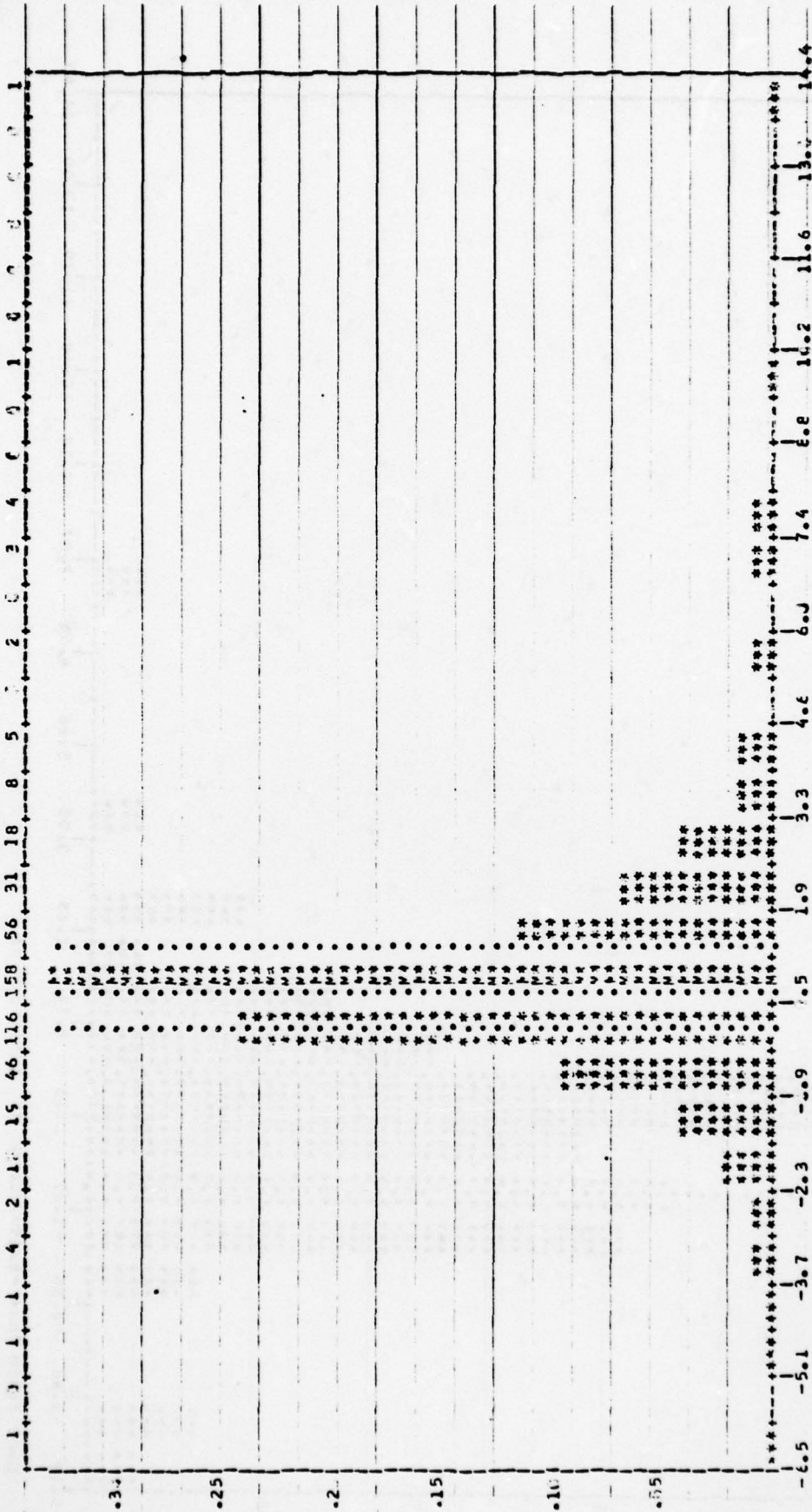

SCALE FIXED FROM -6.5 TO 14.4

CENTRAL TENDENCY		SPREAD		HIGHER CENTRAL MOMENTS		DISTRIBUTION	
MEAN	7.766875	VAR	2.862315	M3	9.567189	MINIMUM	1.440355
STDEV	1.693321	COEF VAR	2.071879	M4	1.317735	.10 QUANTILE	7.277942
TRIMMED MEAN	6.324719	MEAN DELV	1.135512	SKURTOSIS	1.975688	.25 QUANTILE	5.146412
MIDRANGE	3.928282	RANGE	1.948442	BETA1	1.308329	.50 QUANTILE	2.218159
		MIDSPREAD	1.121152	BETA2	1.302752	.75 QUANTILE	2.218159
						MAXIMUM	14.400000

Δ₁ Errors of Advancement Model for All Pay Grades

SAMPLE SIZE = 487

FACTOR: 0.0000

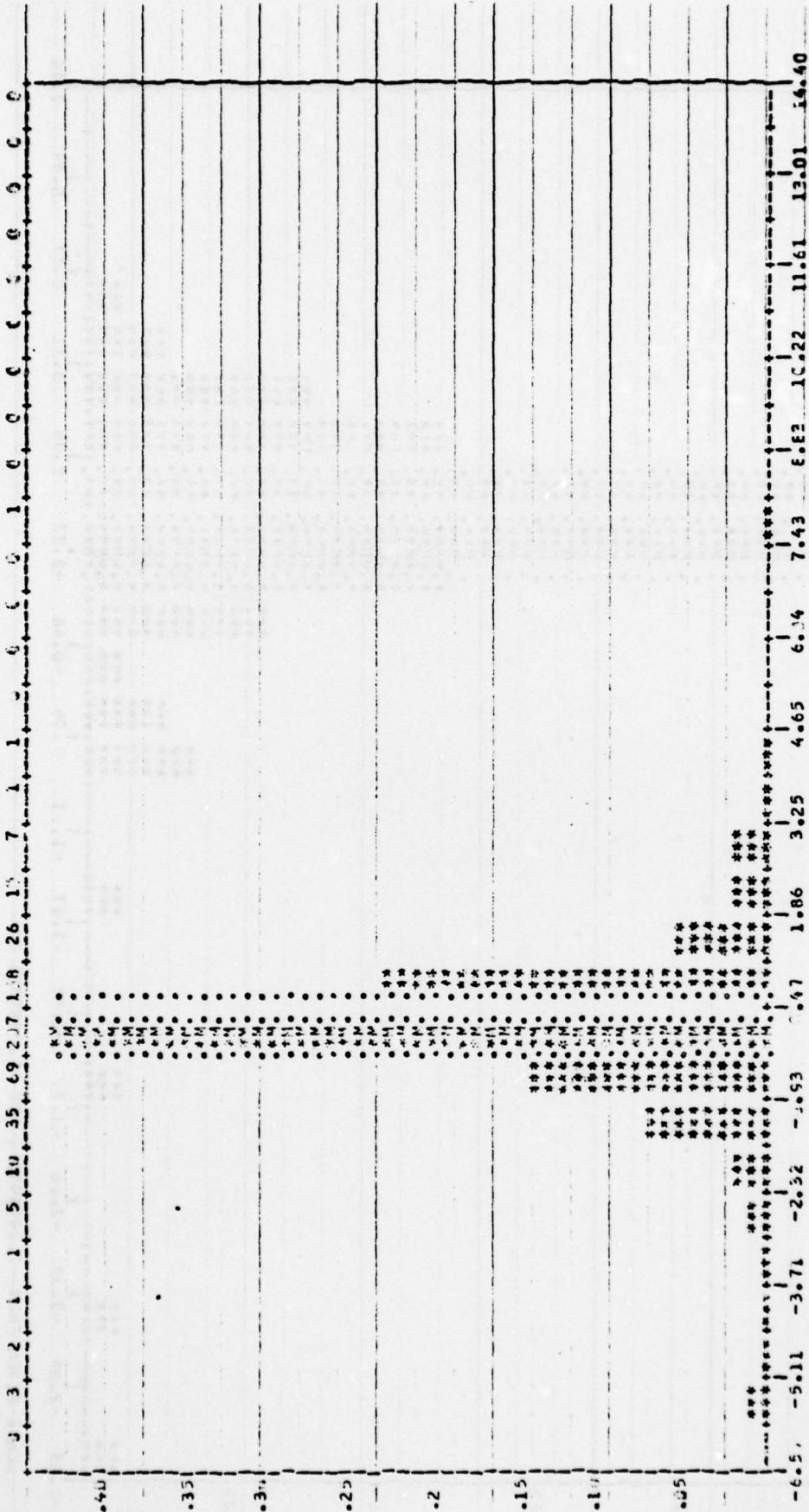

SCALE FIXED FROM -6.5 TO 16.40

CENTRAL TENDENCY	SKEW	HIGHER CENTRAL MOMENTS	DISTRIBUTION
MEAN	1.45162E-01	M3	MINI MUM
STDEV	2.33394E-01	M4	QUANTILE
VAR	5.44521E-01	M5	.25 QUANTILE
COEFF VAR	1.64777E+00	M6	.50 QUANTILE (MEDIAN)
MEAN DEV	2.44777E+00	M7	.75 QUANTILE
RANGE	1.11683E+00	M8	.90 QUANTILE
MINIMUM	1.11683E+00	M9	MAXI MUM

APPENDIX E

HISTOGRAMS OF Δ_2 ERRORS, ALL RATINGS, FAST MODEL AND ADVANCEMENT MODEL

Δ_2 Errors of the FAST Model for Pay Grade E4

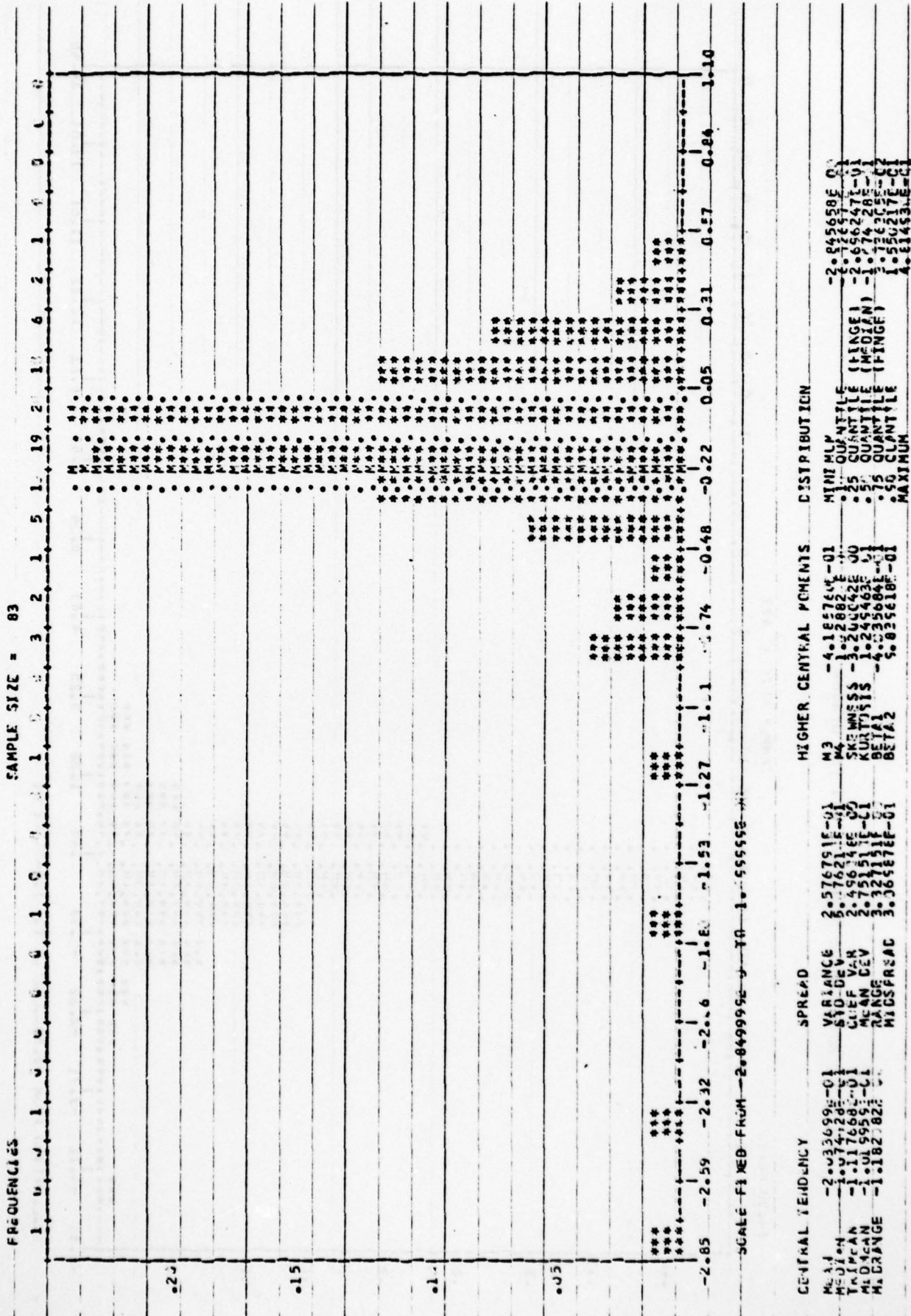

Δ_2 Errors of the Advancement Model for Pay Grade E4

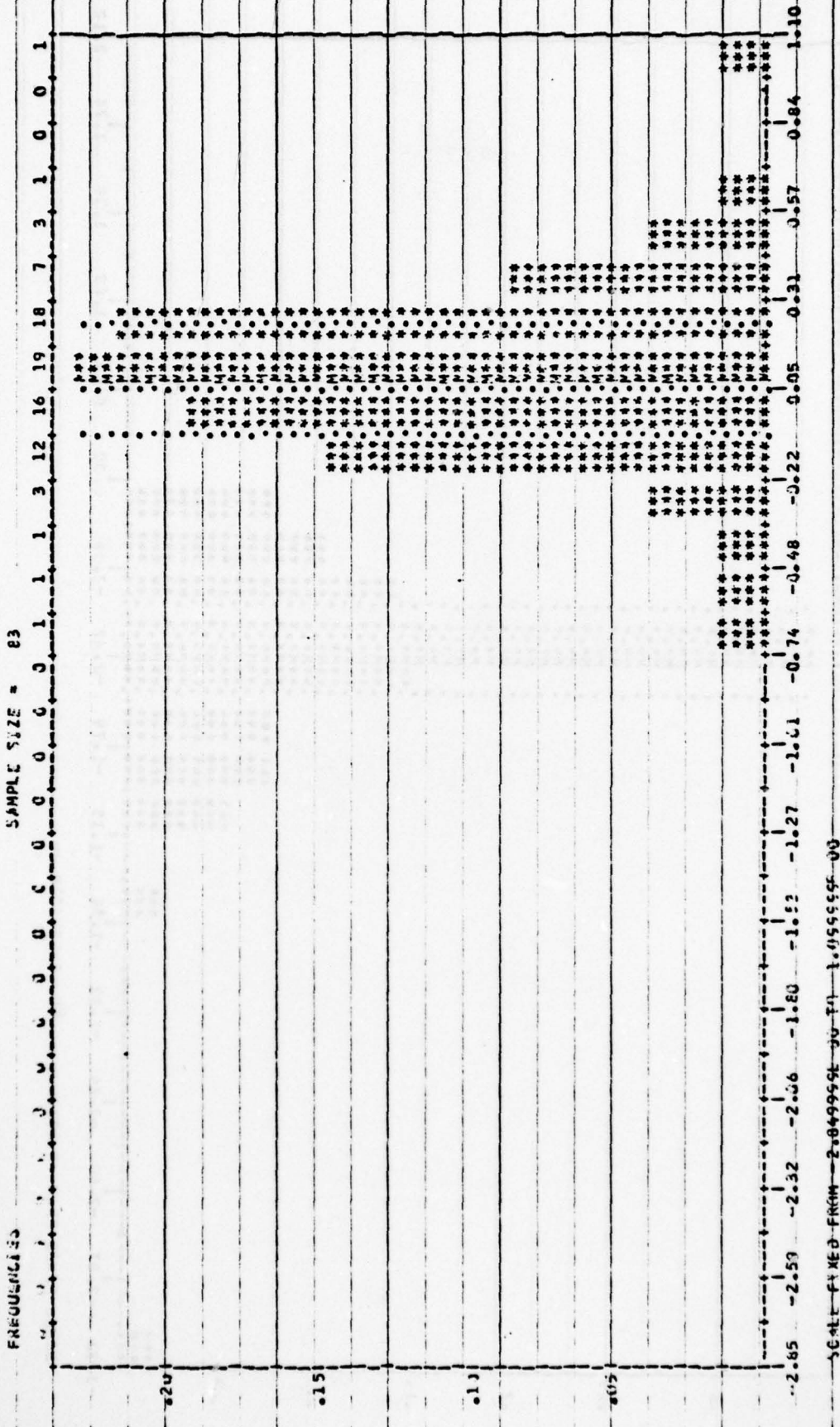

CENTRAL TENDENCY	SPREAD	HIGHER CENTRAL MOMENTS	DISTRIBUTION
MEAN	VAR	M3	MINIMUM
MEDIAN	COEF VAR	M4	.10 QUANTILE
MODE	MEAN DEV	SKURTOSIS	.25 QUANTILE (MEDIAN)
MIDRANGE	STANDARD DEVIATION	ENTROPY	.50 QUANTILE (MEAN)
	MIDRANGE	ENTROPY	.75 QUANTILE
			MAXIMUM

Δ_2 Errors of FAST Model for Pay Grade E5

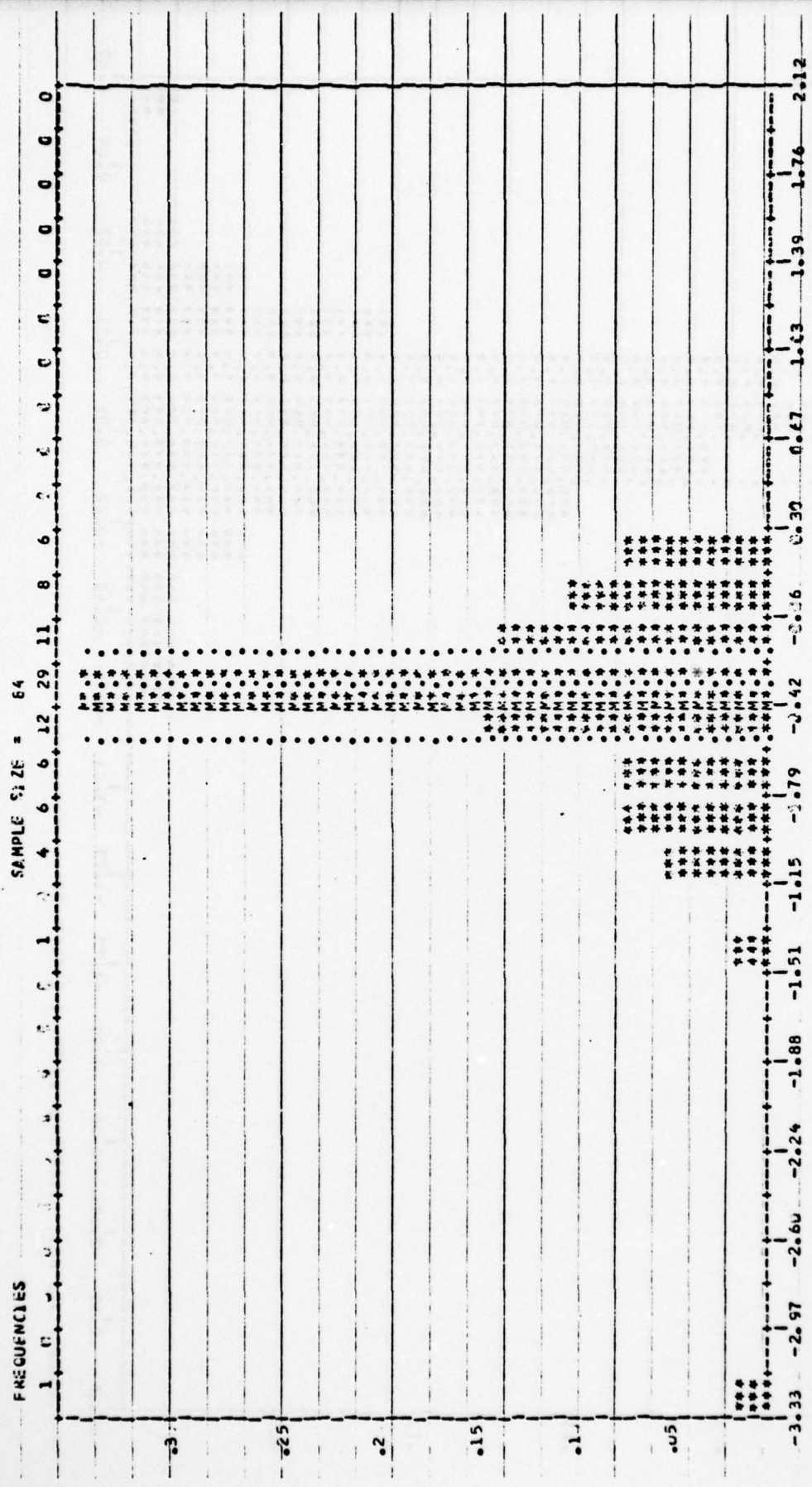

SCALE: MED FROM -3.33 TO 2.12; 100% JU

CENTRAL TENDENCY		SPRUAL		HIGHER CENTRAL MOMENTS		DISTRIBUTION	
MEAN	-4.1367E-01	VARIANCE	2.13451E-01	M3	-3.1889E-01	MINIMUM	-3.2263E-01
MEDIAN	-3.47180E-01	STD DEV	4.62555E-01	M4	-3.40252E-01	.10 QUANTILE	-1.68280E-01
MODE	-3.56415E-01	Coeff VAR	1.02612E+01	SKEWNESS	-3.15155E-01	.25 QUANTILE	-1.66198E-01
MIDRANGE	-1.53855E-00	MEAN DEV	3.87652E-01	KURTOSIS	-1.76338E-01	.50 QUANTILE	-1.66198E-01
		WING LEAD	3.71379E-01	BETA1	-6.98914E-01	.75 QUANTILE	-1.66198E-01
				BETA2	8.98914E-01	MAXIMUM	2.49730E-01

Δ₂ Errors of Advancement Model for Pay Grade E5

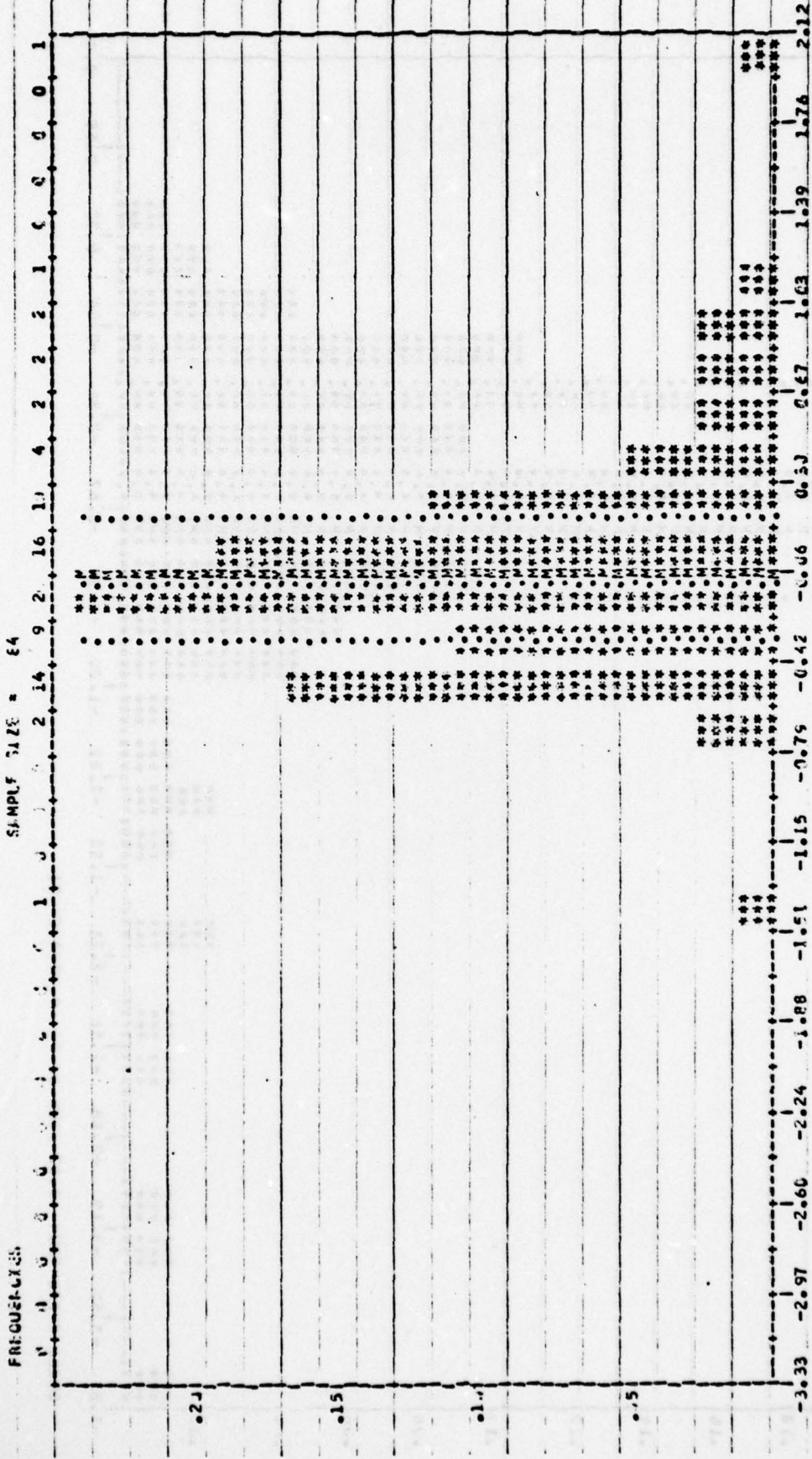

SCALE: F, XED FROM -2.336666-00-111-2.120000E-00

CENTRAL TENDENCY	SPREAD	HIGHER CENTRAL MOMENTS	DISTRIBUTION
MEAN -4.38213E-02	VARIANCE 2.173655E-01	M3 1.452919E-01	MINIMUM -1.3273E-00
STDEV -6.61873E-02	STD DEV 4.66193E-01	M4 3.906699E-01	.10 QUANTILE -1.3273E-00
MODE -8.268499E-02	COEFF VPH 3.186E-01	M5 5.270442E-01	.25 QUANTILE -1.3273E-00
MEAN -8.582833E-02	MEAN OLV 3.45418E-01	KURTOSIS 3.245418E-01	.50 QUANTILE -1.3273E-00
MIDRANGE -3.898632E-01	MIDSFRAC 4.87495E-01	BETA1 3.75377E-01	.75 QUANTILE -1.3273E-00
		BETA2	MAXIMUM 2.120000E-00

Δ_2 Errors of FAST Model for Pay Grade E6

SAMPLE SIZE = E6

FREQUENCIES

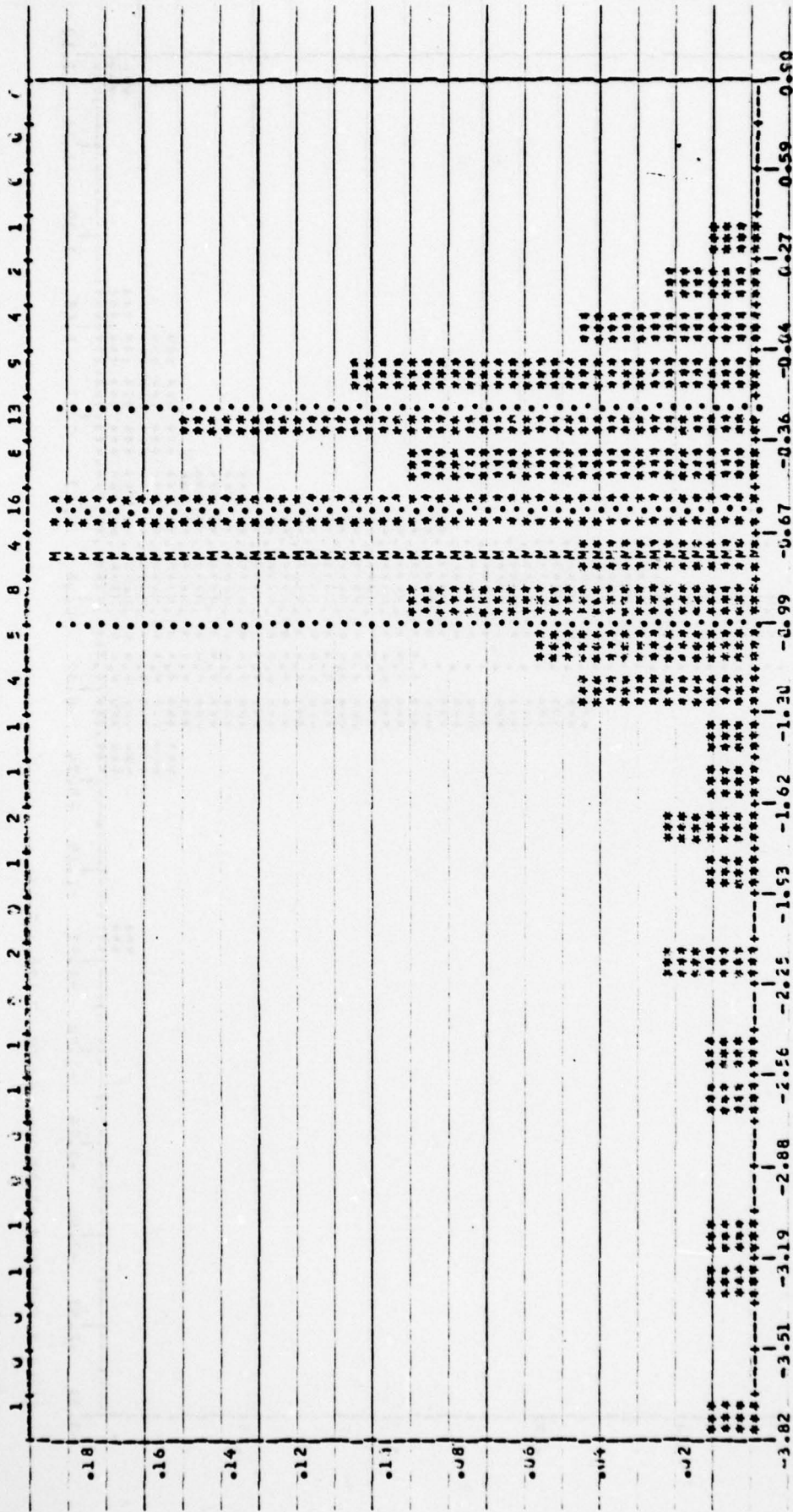

SCALE FIXED FROM -3.82 TO 0.90

CENTRAL TENDENCY		SPREAD		HIGHER CENTRAL MOMENTS		DISPOSITION	
MEAN	-1.567476	VARIANCE	5.964399E-01	M3	-8.442845E-01	MINIMUM	-3.522266E-01
STD DEV	2.441775	STD DEV	2.441775	M4	-2.425562E-01	.10 QUANTILE	-2.816802E-01
1st QUANTILE	-2.816802	COEF VAR	1.528671E-01	SKWNESS	-1.821648E-01	.25 QUANTILE	-2.091772E-01
MIDMEAN	-5.873322	MLAG DEV	4.328850E-01	KURTOSIS	-3.746615E-01	.50 QUANTILE	-1.500000E-01
MIDRANGE	-1.716924	MLAG	7.423227E-01	PEYAL	2.318179E-01	.75 QUANTILE	-1.013198E-01
		M. DISPREAD		PEYAL2		.90 QUANTILE	-7.427120E-01
						MAXIMUM	

Δ₂ Errors of Advancement Model for Pay Grade E6

SAMPLE SIZE = 86

FREQUENCIES

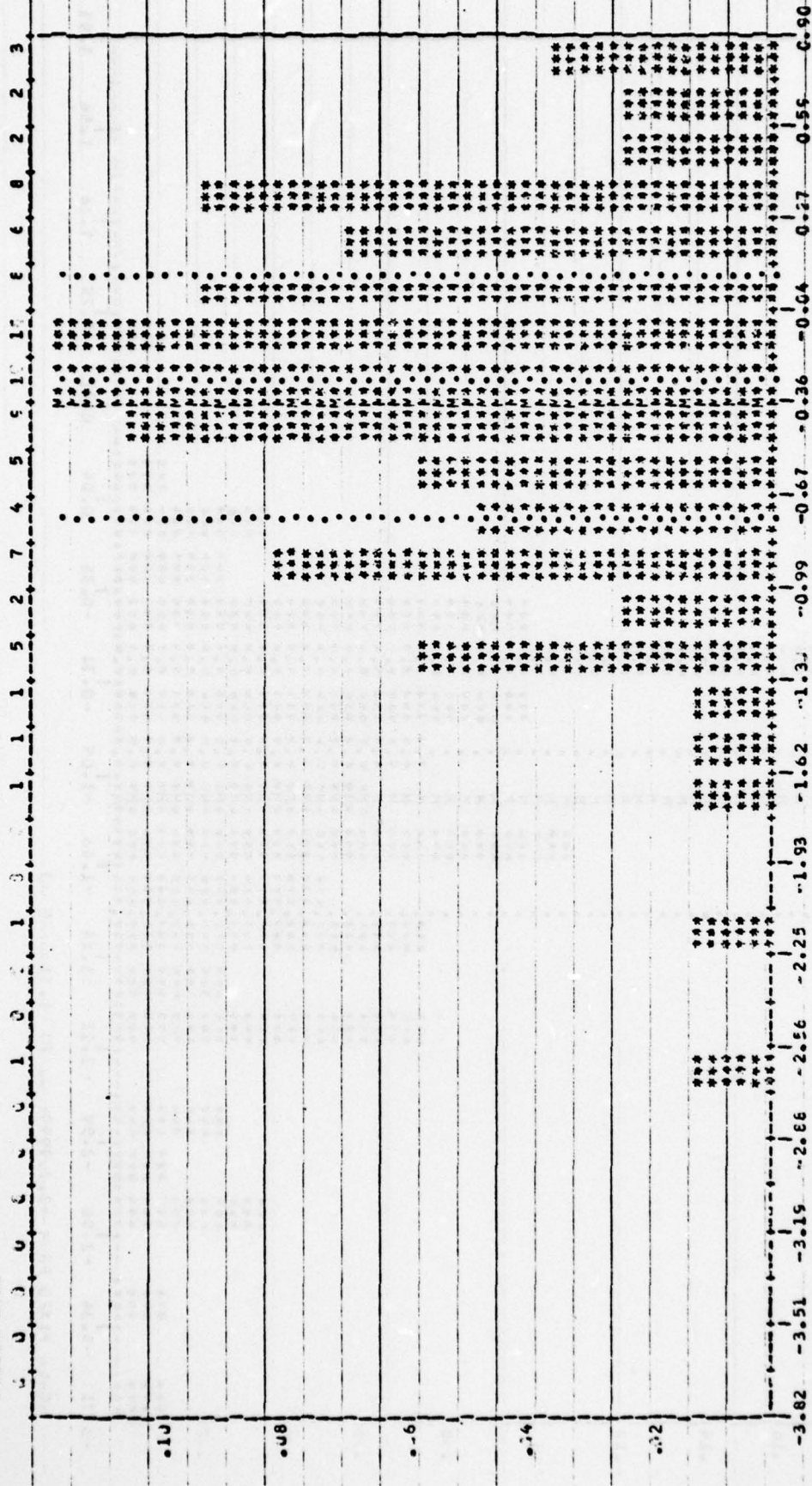

SCALE FROM -9 TO 9

CENTRAL TENDENCY	SPREAD	HIGHER CENTRAL MOMENTS	DISTRIBUTION
MEAN -2.251372-01	VARIANCE 4.21553E-01	M3 -2.104384E-01	MINIMUM -2.6513E-01
MEDIAN -2.2883513E-01	STU-DEV 6.49269E-01	M4 -7.525265E-01	QUANTILE (1)
TRAMPAN -2.2883513E-01	COEF V/R 1.956907E-00	SKWNESS -1.688665E-01	.25 QUANTILE (MEDIAN)
MODAL -2.287375E-01	HLAD CV 4.89152E-01	KURTOSIS -1.223349E-01	.5 QUANTILE
MODRANGE -8.759367E-01	RANGE 8.553152E-01	BEV2 -1.271039E-01	.75 QUANTILE
	M.C.PREAC 8.301624E-01		MAXIMUM 3.03239E-01

Δ_2 Errors of FAST Model for Pay Grade E7

SAMPLE SIZE = 63

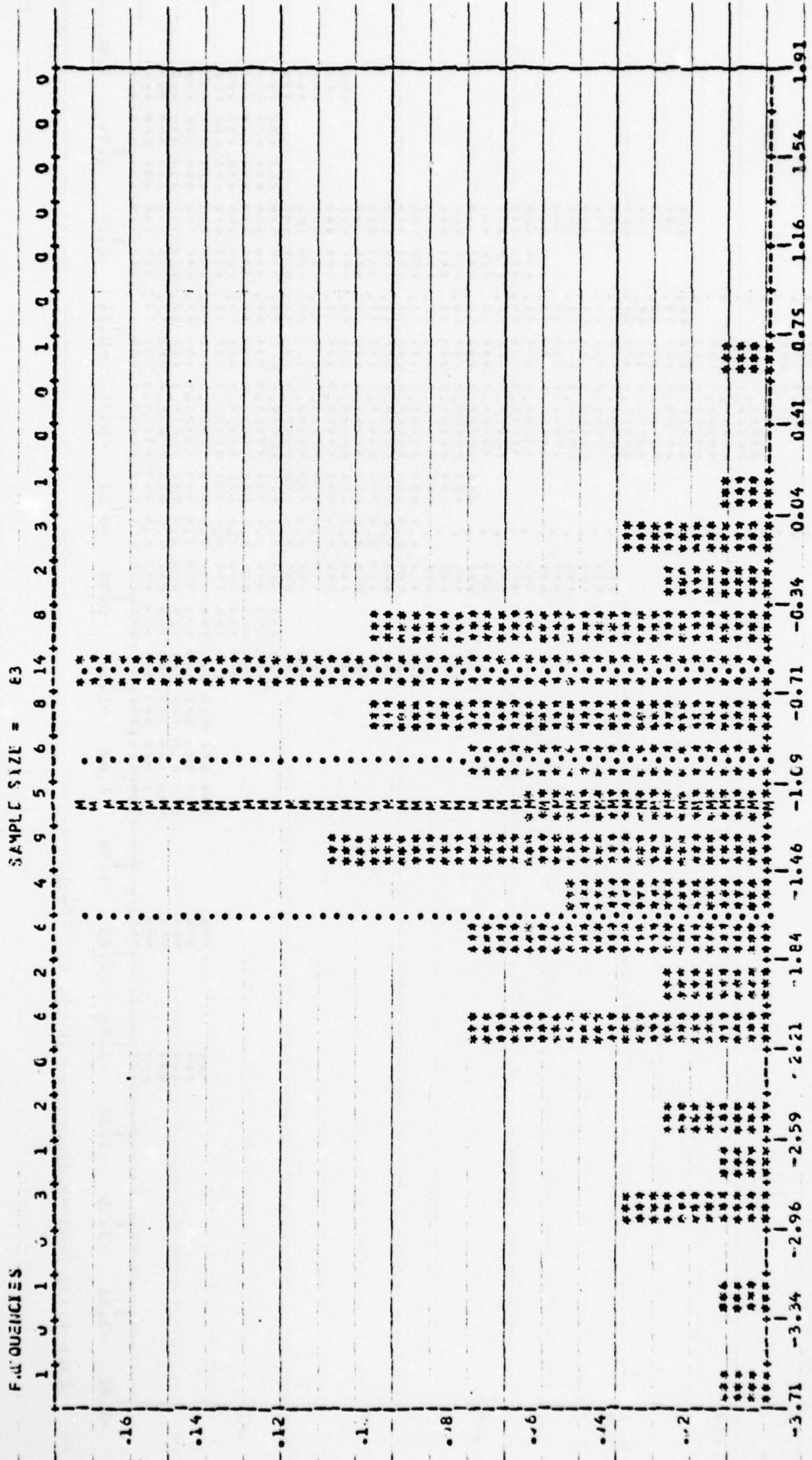

SCALE FIXED FROM -3.71 TO 1.91

CENTRAL TENDENCY	SPREAD	HIGHER CENTRAL MOMENTS	DISTRIBUTION
MEAN	VARIANCE	M3	MINIMUM
MEDIAN	COEFF. OF VAR.	M4	.25 QUANTILE
MODE	MEAN DEV.	KURTOSIS	.50 QUANTILE
RANGE	MEAN RANGE	BETA1	.75 QUANTILE
	MEAN RANGE	BETA2	MAXIMUM

Δ_2 Errors of Advancement Model for Pay Grade E7

SAMPLE SIZE = 83

FREQUENCIES

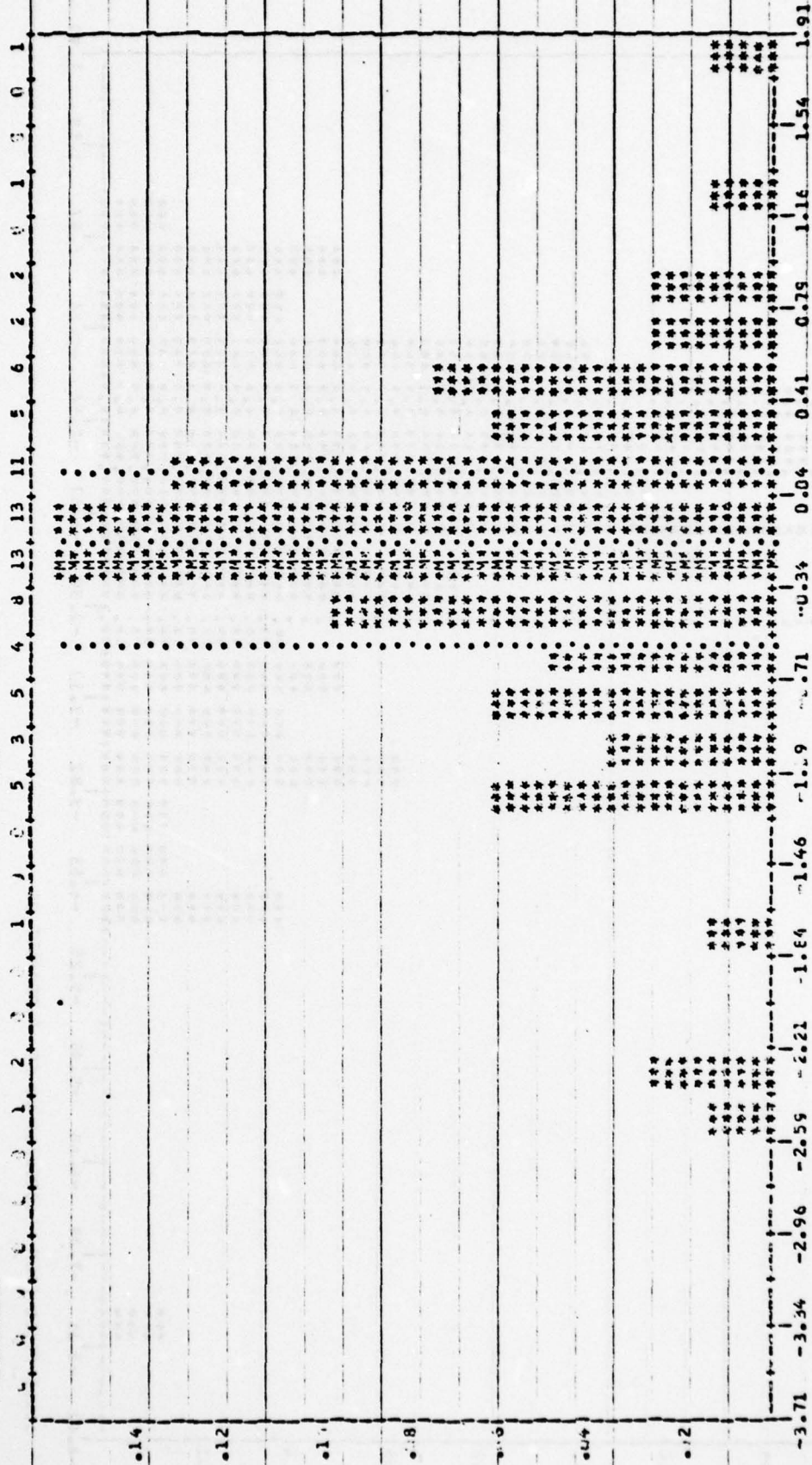

SAMPLE FIXED FROM -3.71 TO 1.91

CENTRAL TENDENCY	SPREAD	HIGHER CENTRAL MOMENTS	DISTRIBUTION
MEAN -2.272256-01	VARIANCE 5.221951E-01	M3 -2.555576E-01	MINIMUM -4.526941E-01
STDEV -1.507066E-01	STD DEV 2.281121E-01	M4 3.924811E-01	.25 QUANTILE -1.373333E-01
MODALY -1.485134E-01	CURTOSIS 3.175966E-01	M5 2.735555E-01	.50 QUANTILE (MEDIAN) -5.645926E-01
MODALNCE -3.078139E-01	MEAN DEV 5.181722E-01	M6 1.448971E-01	.75 QUANTILE -1.222533E-01
	RANGE 7.330855E-01	BETA2 -1.344741E-00	MAXIMUM 1.515151E-01

Δ_2 Errors of FAST Model for Pay Grade E8

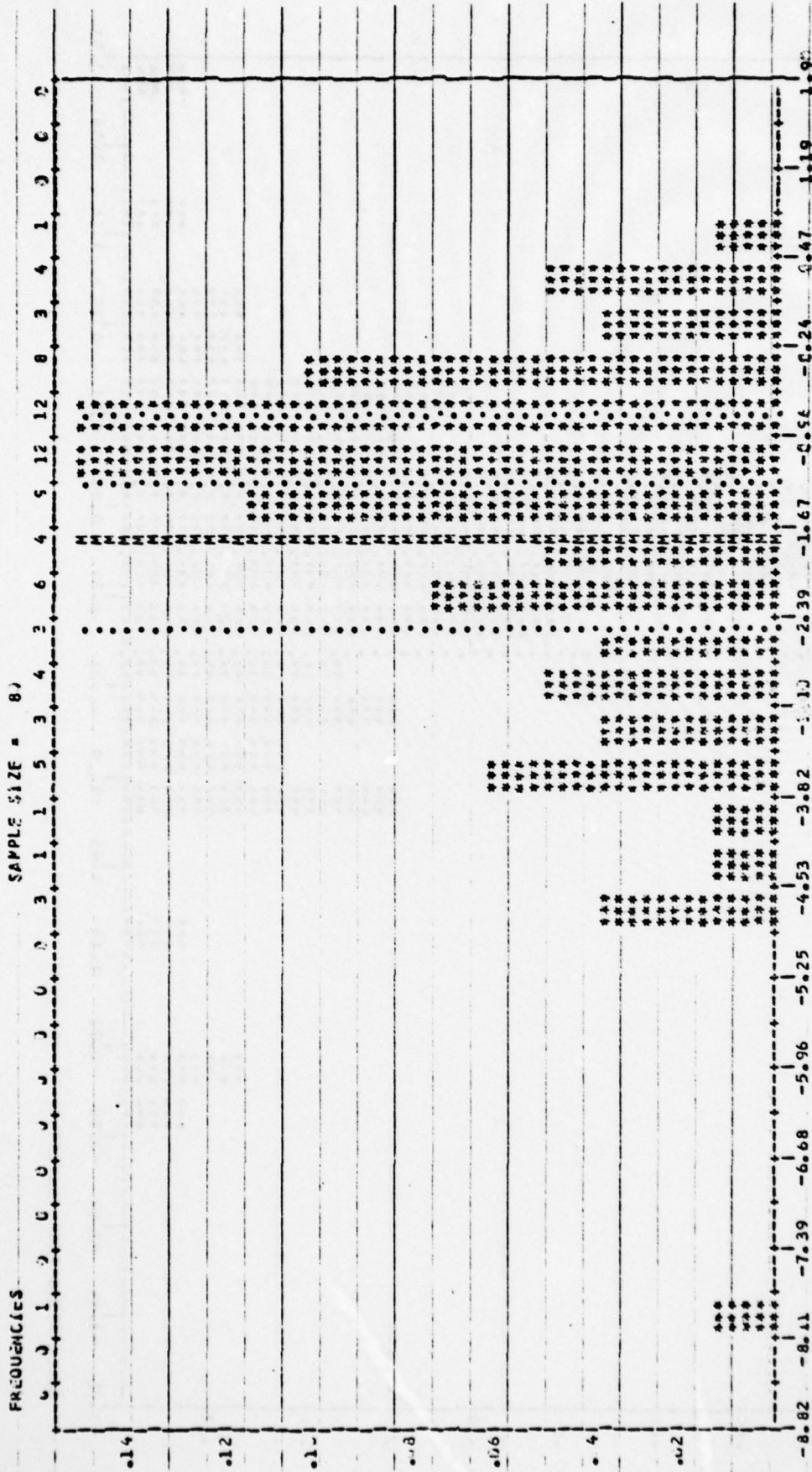

SCALE FIXED FROM -8.82 TO 1.90 IN 0.01

CENTRAL TENDENCY	SPREAD	HIGHER CENTRAL MOMENTS	DISTRIBUTION
MEAN	VAR	M3	MINIMUM
STDEV	COEFF VAR	M4	25 QUANTILE
MEAN DEV	RANGE	KURTOSIS	50 QUANTILE (MEAN)
MID-RANGE		BETA1	75 QUANTILE
		BETA2	MAXIMUM

Δ_2 Errors of Advancement Model for Pay Grade E8

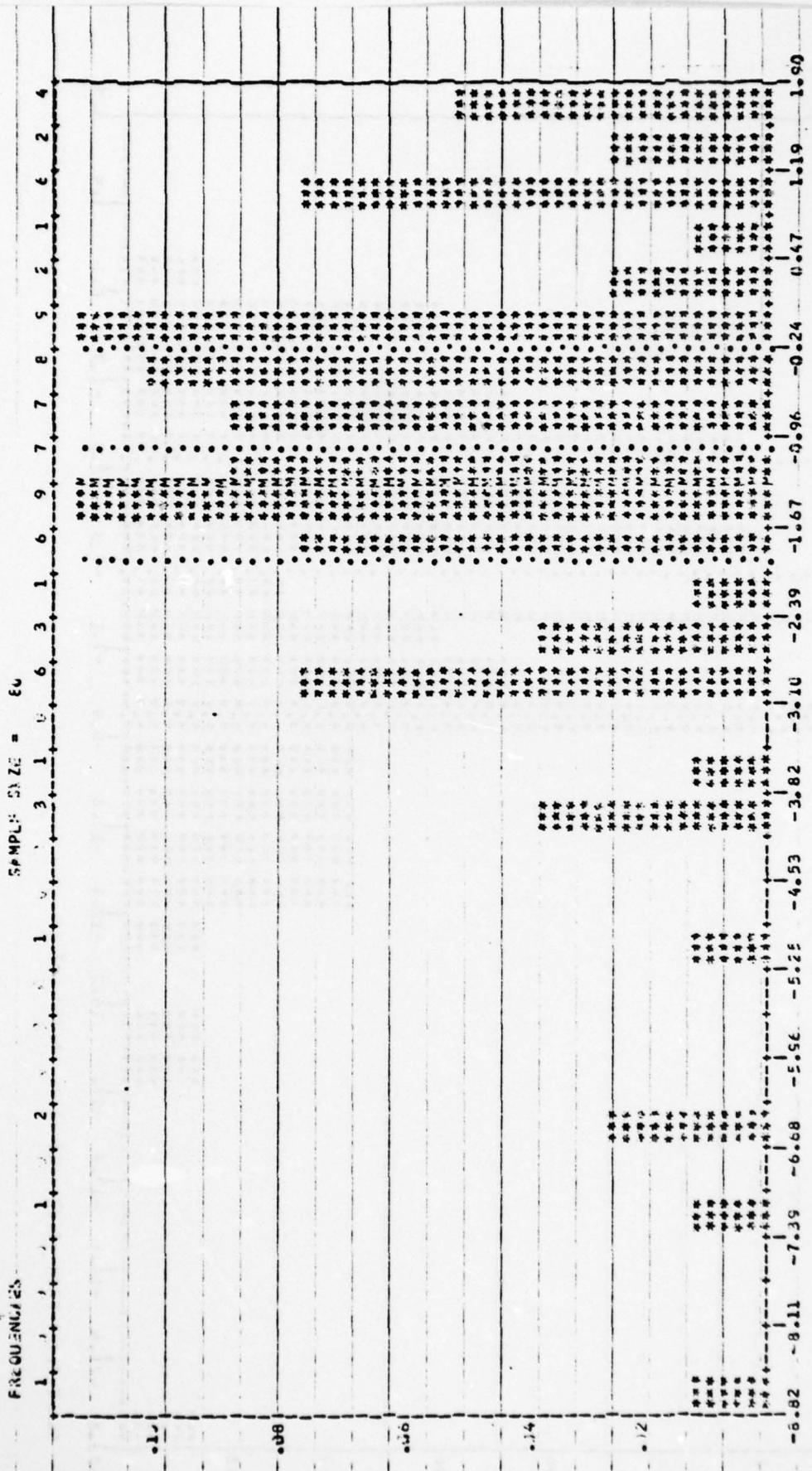

SCALE FROM -8.82 TO 1.90

GENERAL TENDENCY		SPREAD		HIGHER CENTRAL MOMENTS		DISTRIBUTION	
MEAN	-1.265735	VARIANCE	4.978612	M3	-1.181237E 01	MINIMUM	-8.82
STDEV	2.231417	SKEWNESS	-1.23114E 00	M4	9.193114E 00	.10 QUANTILE	-1.874441E 01
MEAN DEV	1.43451E 01	KURTOSIS	2.474576E 01	BIAS	1.044029E 01	.25 QUANTILE	-1.525581E 01
RANGE	1.07157E 01	BIAS	1.07157E 01	BIAS	8.85711E 01	.50 QUANTILE	-1.445408E 01
MEAN	1.72991E 00	MEAN	1.72991E 00	BIAS	8.85711E 01	.75 QUANTILE	-1.273238E 01
MEAN	1.72991E 00	MEAN	1.72991E 00	BIAS	8.85711E 01	MAXIMUM	1.90

AD-A053 935

NAVAL POSTGRADUATE SCHOOL MONTEREY CALIF
THE ESTABLISHMENT OF A NEW METHOD OF ESTIMATING THE NUMBER OF A--ETC(U)
FEB 78 P R MILCH
NPS55-78-6

F/6 5/9

UNCLASSIFIED

NL

2 OF 2
AD
A053935

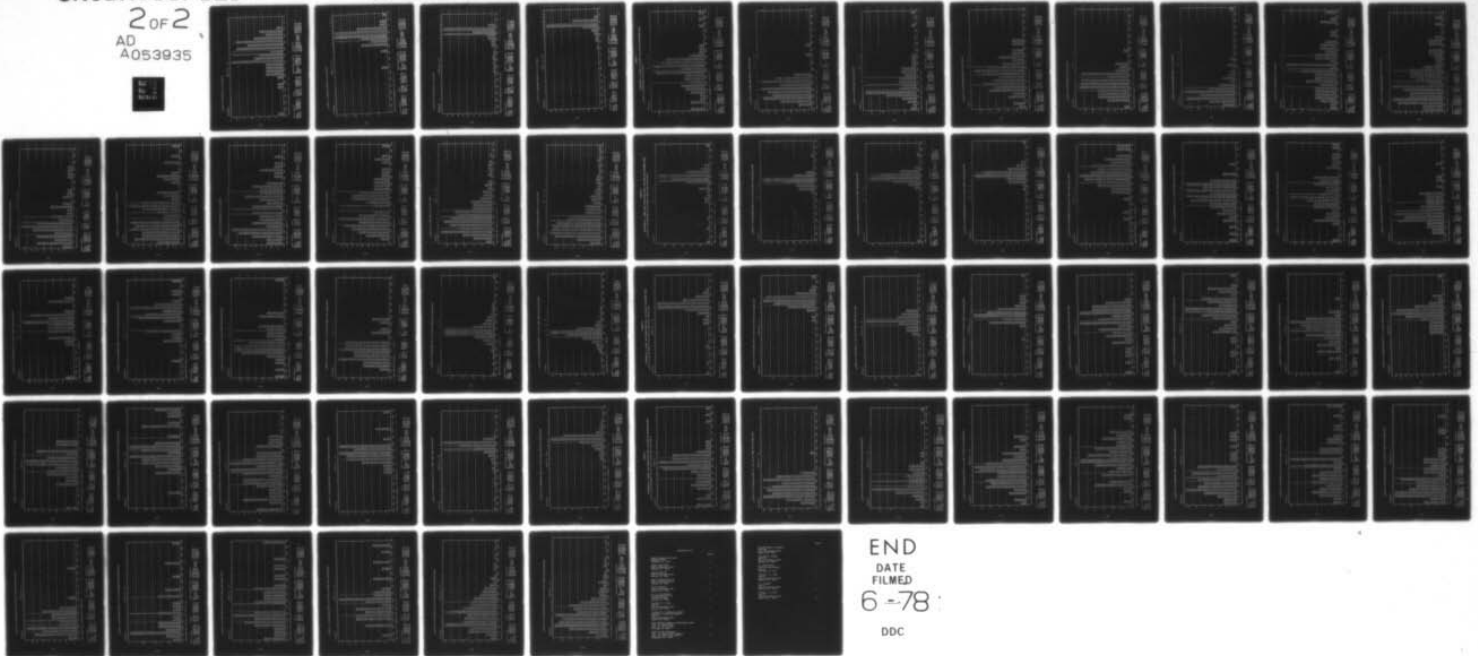

END
DATE
FILMED
6 -78
DDC

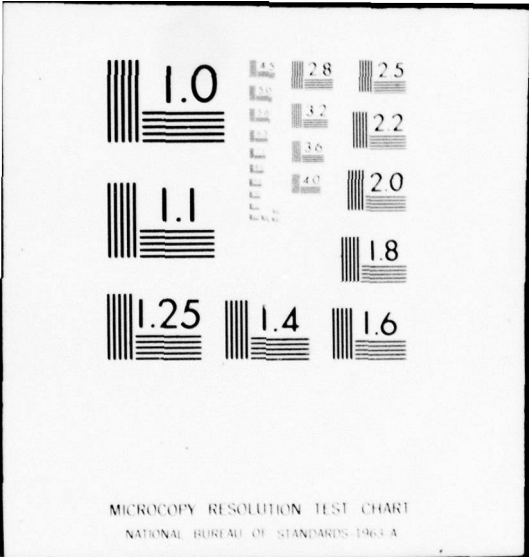

MICROCOPY RESOLUTION TEST CHART
NATIONAL BUREAU OF STANDARDS-1963-A

Δ_2 Errors of FAST Model for Pay Grade E9

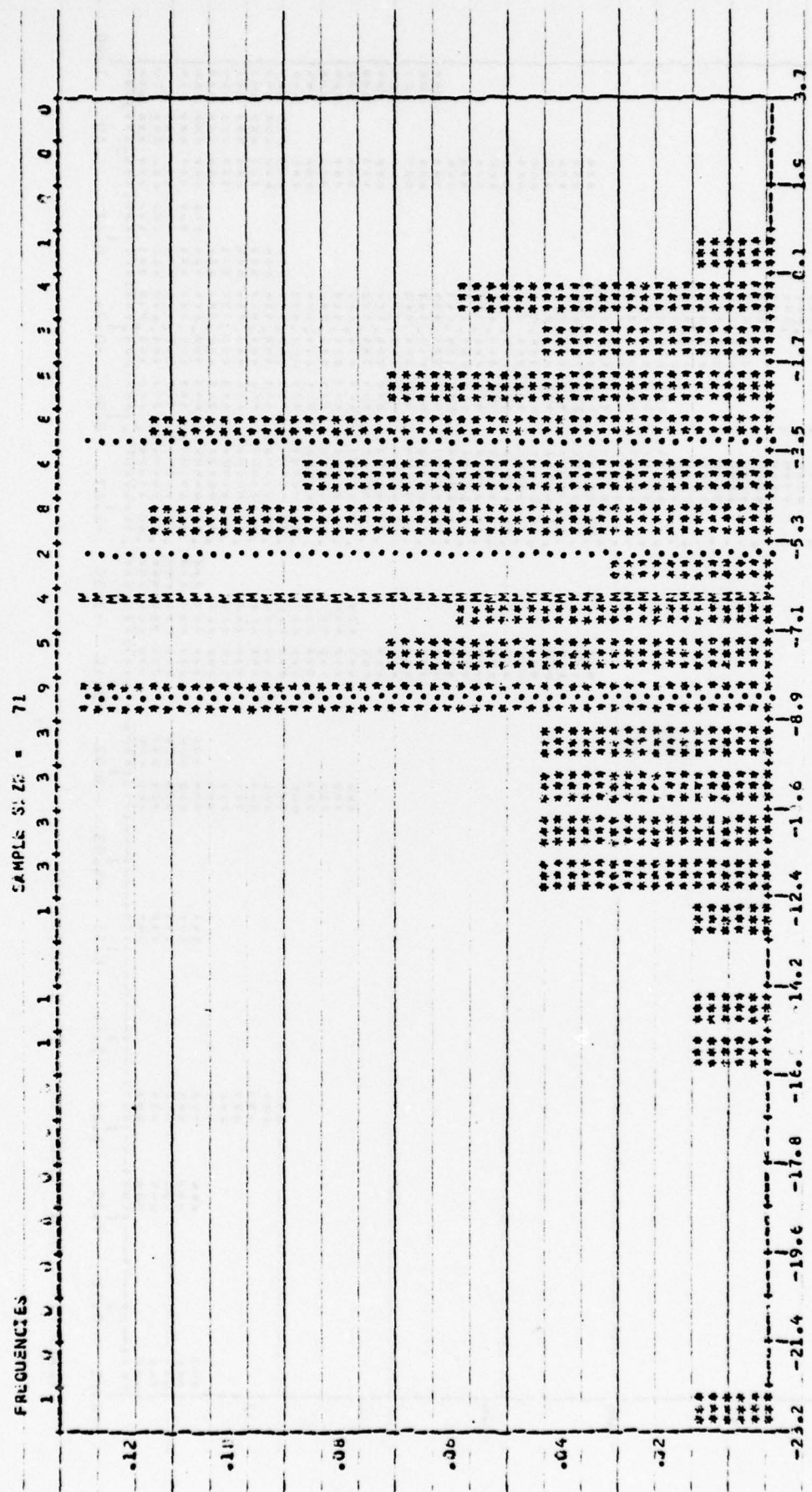

SCALE FIXED FROM -2.92 TO 3.75

CENTRAL TENDENCY	SPREAD	HIGHER CENTRAL MOMENTS	DISTRIBUTION
MEAN	VAR	M3	MIN
STDEV	COEF VAR	M4	1.5 QUANTILE
MEAN	MEAN DEV	KURTOSIS	.5 QUANTILE
RANGE	RANGE/MEAN	BETA1	.25 QUANTILE
		BETA2	.75 QUANTILE
			MAXIMUM

Δ_2 Errors of Advancement Model for Pay Grade E9

SAMPLE SIZE = 71

FRACTIONALS

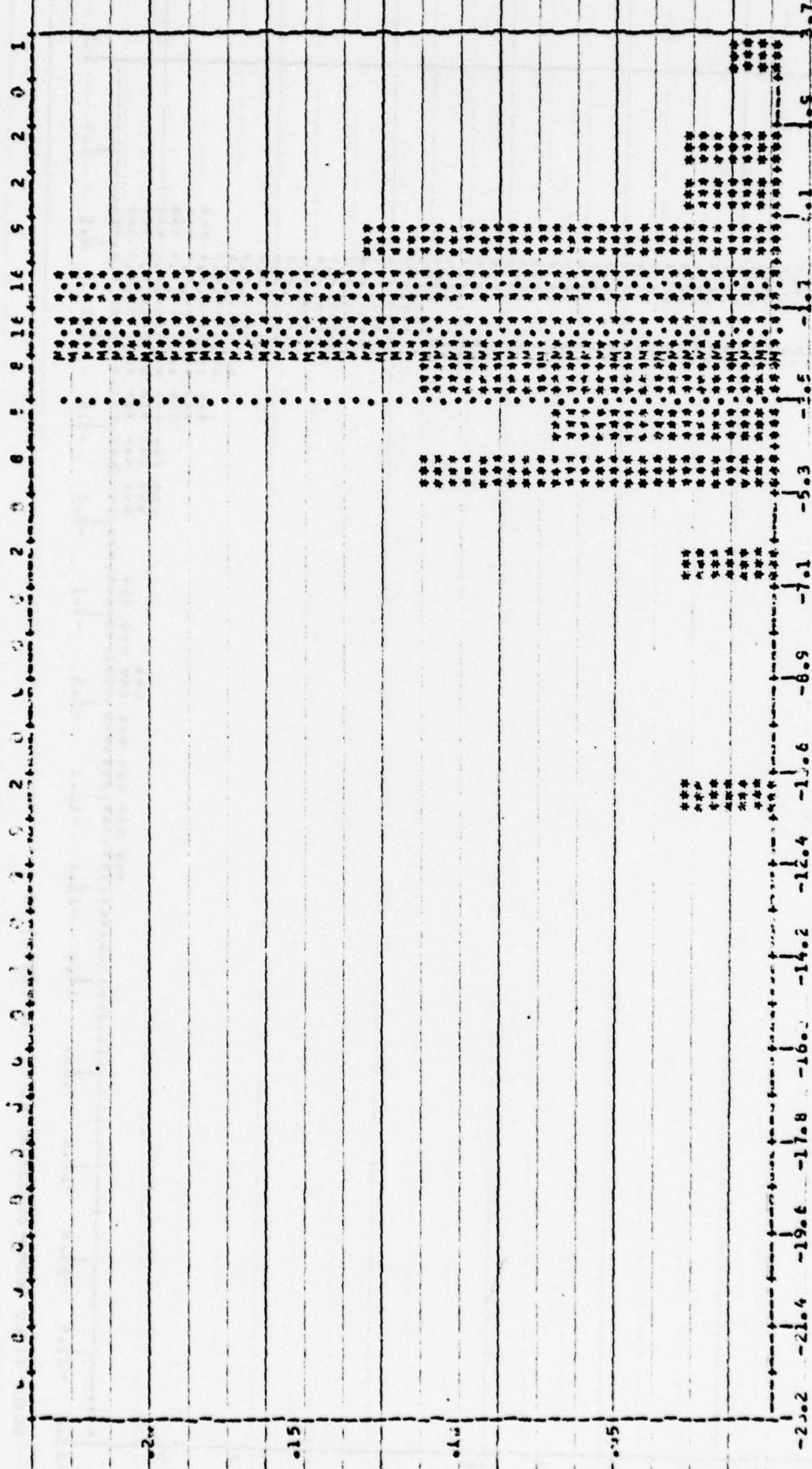

SCALE FROM -20.2 TO 3.7

CENTRAL TENDENCY		SPREAD		HIGHER CENTRAL MOMENTS		DISTRIBUTION	
MEAN	-2.380956	V. RANGE	5.147575	M2	-1.538731E 01	MIN	NUM
STDEV	2.333413E 00	STDEV	9.826138E 00	M3	-1.211222E 00	.15	QUANTILE
VAR	5.442781E 00	CORR VAR	1.587346E 00	SKWNESS	-1.211222E 00	.25	QUANTILE
MEAN DEV	1.461191E 01	MEAN DEV	1.461191E 01	KURTOSIS	-1.474325E 01	.50	QUANTILE
RANGE	2.41766E 00	RANGE	2.41766E 00	BETA1	1.898052E 02	.75	QUANTILE
MADSPREAD		MADSPREAD		BETA2	1.898052E 02	.90	QUANTILE
							MAXIMUM

Δ_2 Errors of FAST Model for All Pay Grades

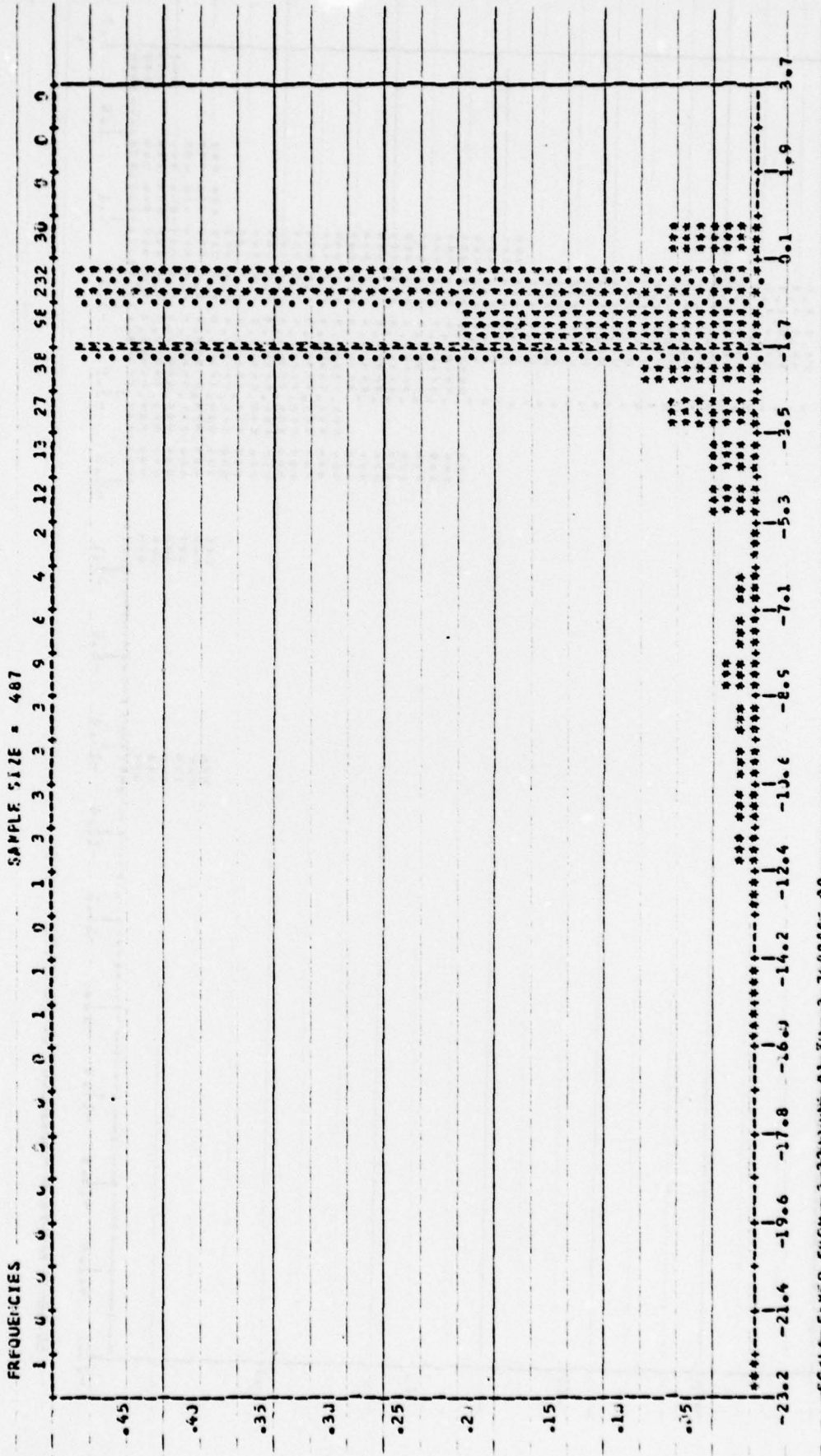

CENTRAL TENDENCY		SPREAD		HIGHER CENTRAL MOMENTS		DISTRIBUTION	
MEAN	-1.632228E-01	VARIANCE	7.173337E-01	M2	-6.232579E-01	MINIMUM	-2.023174E-01
MEDIAN	-8.713395E-01	STD DEV	2.677168E-01	M3	5.037423E-01	.10 QUANTILE	-1.793248E-01
MODE	-9.733735E-01	COEF V/P	1.007632E-01	SKWNESS	1.374237E-01	.25 QUANTILE	-1.732498E-01
MEAN	-1.120702E-01	MEAN DEV	1.132731E-01	KURTOSIS	1.1493268E-01	.50 QUANTILE	-1.732498E-01
		RANGE	1.535856E-01	BE11	-8.685268E-01	.75 QUANTILE	-1.508551E-01
		P.D)FREAD		BE12		MAXIMUM	

Δ_2 Errors of Advancement Model for All Pay Grades

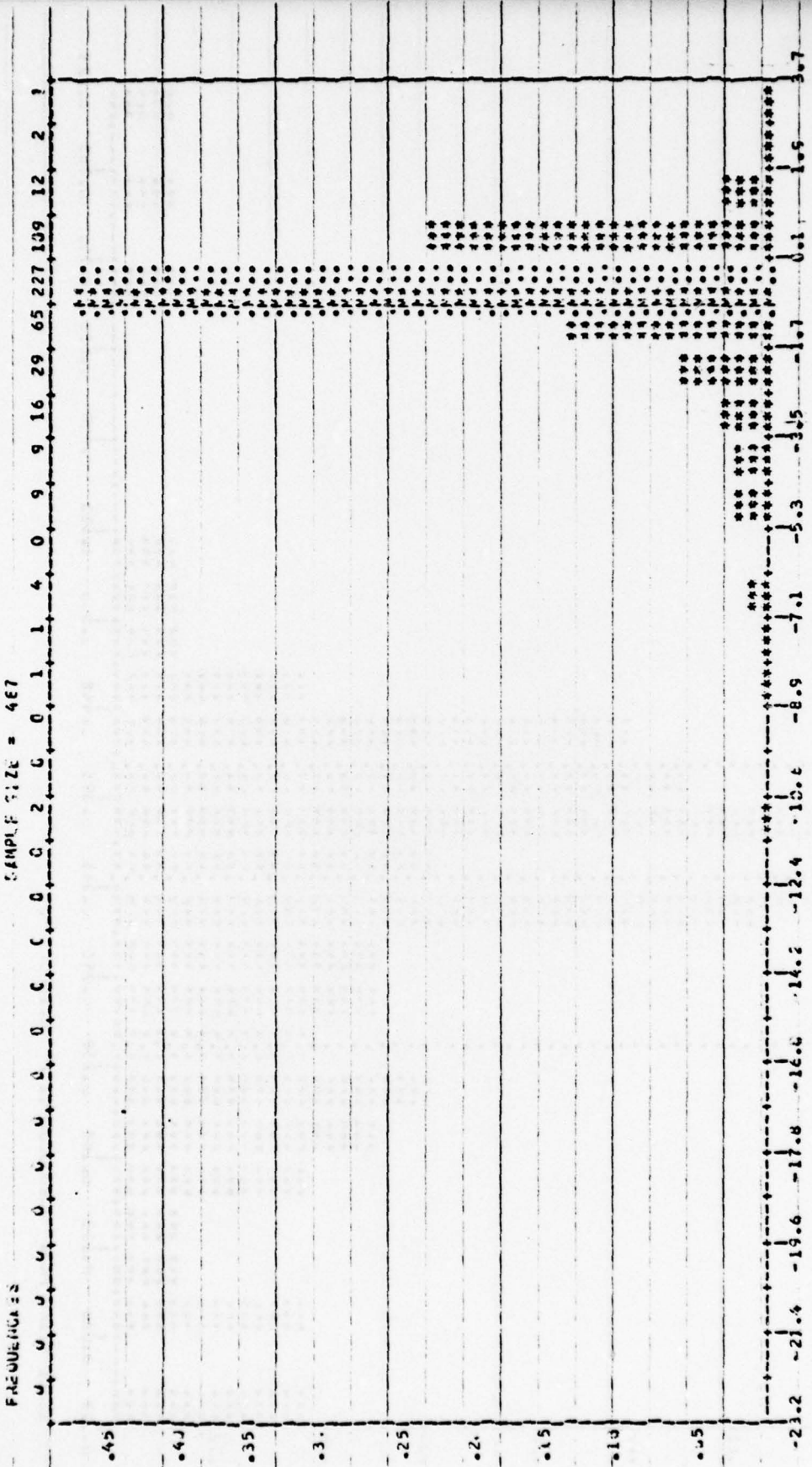

SCALE FIXED FROM -2.3277 TO 1.17 - 3.7

GENERAL TENDENCY		SPREAD		HIGHER CENTRAL MOMENTS		DISTRIBUTION	
MEAN	MEDIAN	VAR. (ANCE)	STD. DEV.	M3	M4	MINI. QUANTILE	MAXIMUM
-6.428866	-6.428866	2.327735	1.525365	-9.7688	17.58	.15 QUANTILE	21.9
-2.652289	-2.652289	2.327735	1.525365	-2.669785	11.09	.25 QUANTILE	1.428396
-2.652289	-2.652289	2.327735	1.525365	-1.223619	3.91	.50 QUANTILE	1.428396
-2.652289	-2.652289	2.327735	1.525365	-1.048976	3.91	.75 QUANTILE	1.428396
-2.652289	-2.652289	2.327735	1.525365	-1.048976	3.91	MAXIMUM	3.718616

APPENDIX F

HISTOGRAMS OF Δ_3 ERRORS, ALL RATINGS, FAST MODEL AND ADVANCEMENT MODEL

Δ_3 Errors of the FAST Model for Pay Grade E4

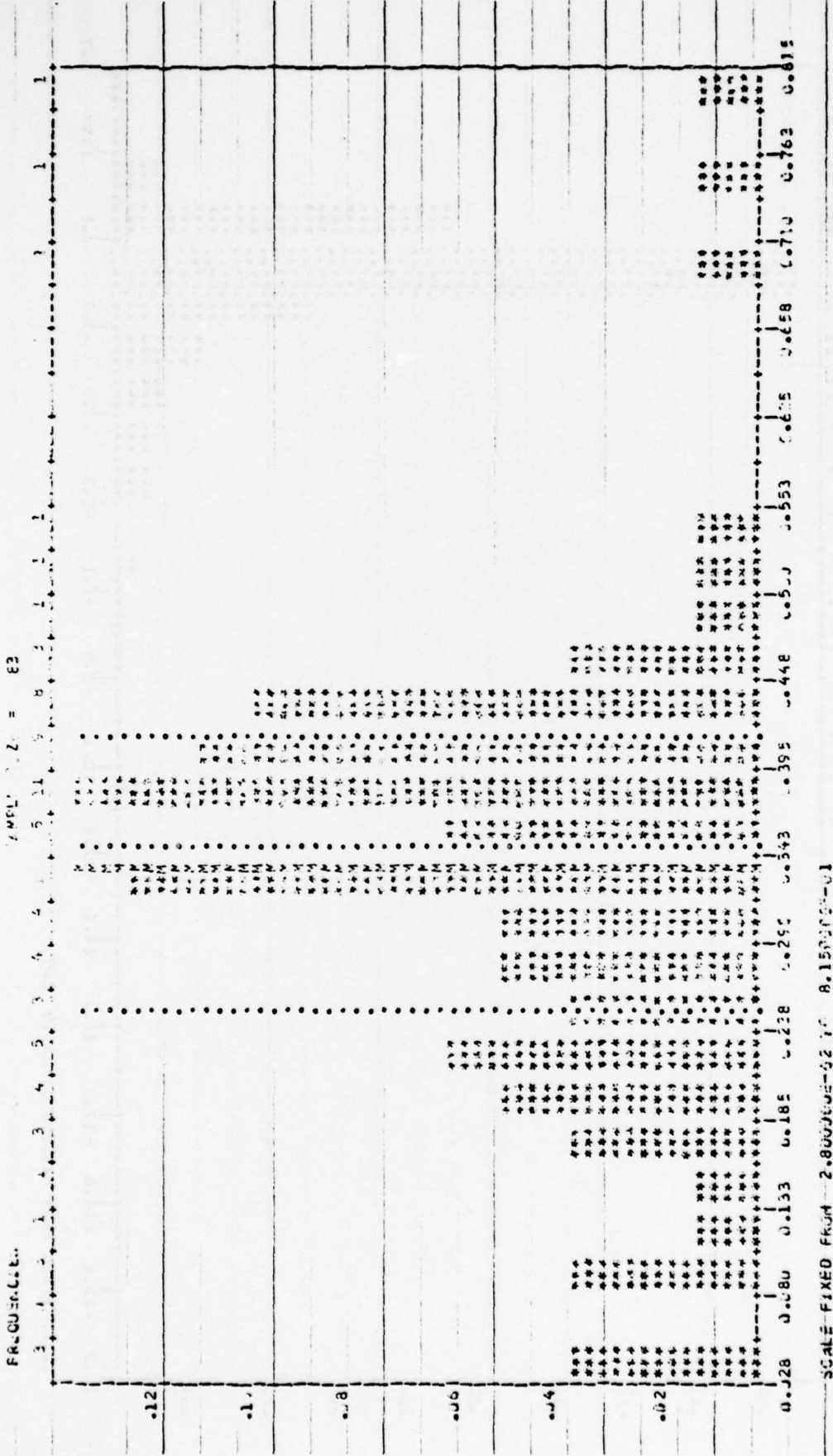

Central Tendency	SPREAD	HIGHER CENTRAL MOMENTS	DISTRIBUTION
MEAN	3.35492E-01	M3	MIX: MIX
TR. MEAN	3.47653E-01	M4	.100 CURTAIL
MEAN	3.33847E-01	M5	.25 CURTAIL
MEAN	3.33475E-01	M6	.75 CURTAIL
MEAN	3.33357E-01	M7	MIX: MIX
MEAN	2.93345E-01	M8	
MEAN	2.32462E-01	M9	

A₃ Errors of the Advancement Model for Pay Grade E4

SAMPLE SIZE = 83

FREQUENCY

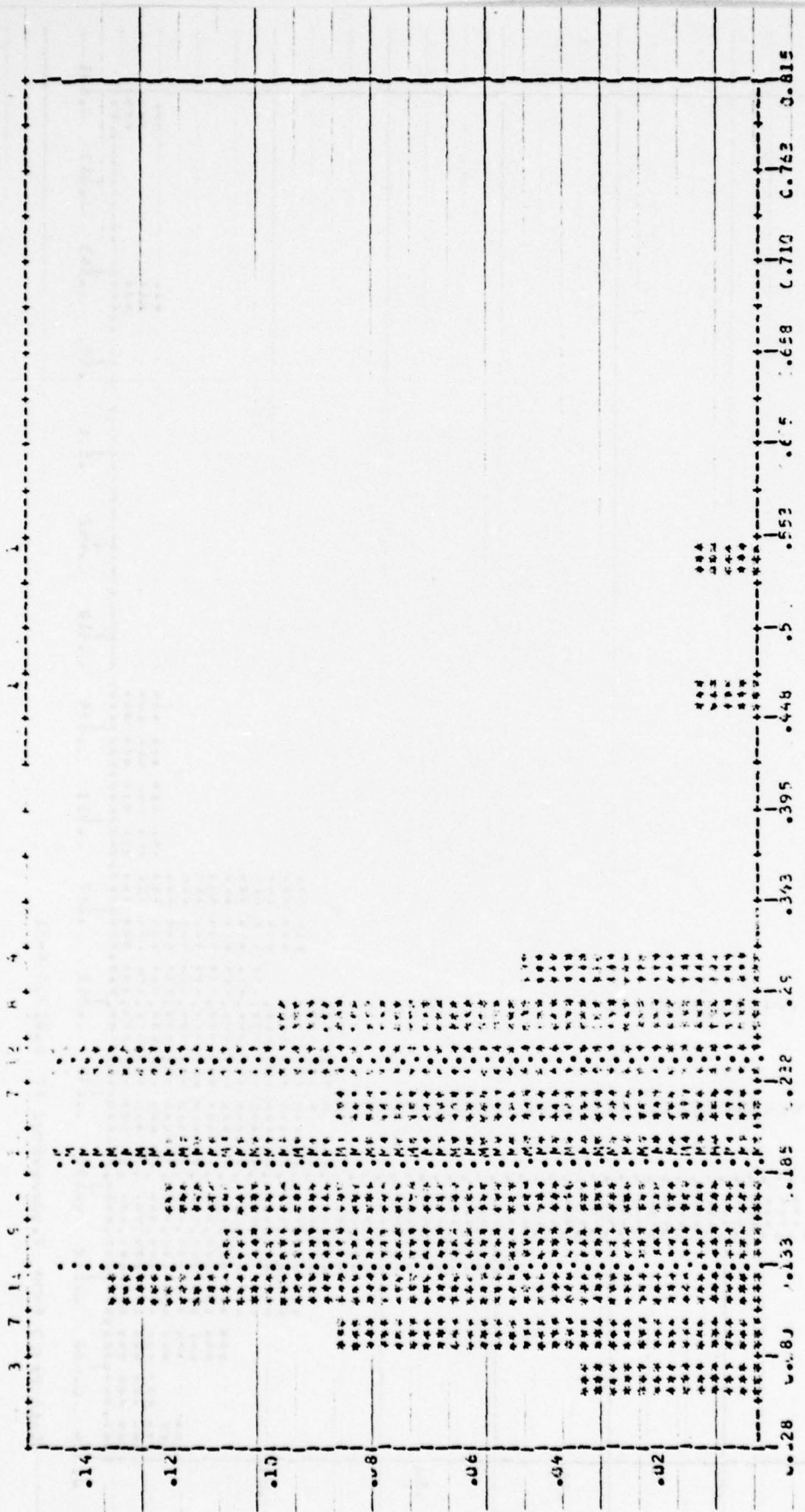

SCALE FROM 2.0 TO 8.15

CENTRAL TENDENCY		SPREAD		HIGHER CENTRAL MOMENTS		DISTRIBUTION	
MEAN	1.924869	VAR	0.7944	M2	5.668884	MINIMUM	0.000000
MODE	1.085150	SD	0.891300	M3	2.295672	Q1	0.000000
TRIMED	1.085150	MEAN CV	0.467482	M4	1.015247	Q2	0.000000
MIDRANGE	1.041375	MEAN CV	0.467482	M5	0.223993	Q3	0.000000
MEAN CV	1.041375	MEAN CV	0.467482	M6	0.025584	MAXIMUM	0.000000
GEOM MEAN	1.025150	MEAN CV	0.467482				
HARM MEAN	1.035450						

Δ_3 Errors of the FAST Model for Pay Grade E5

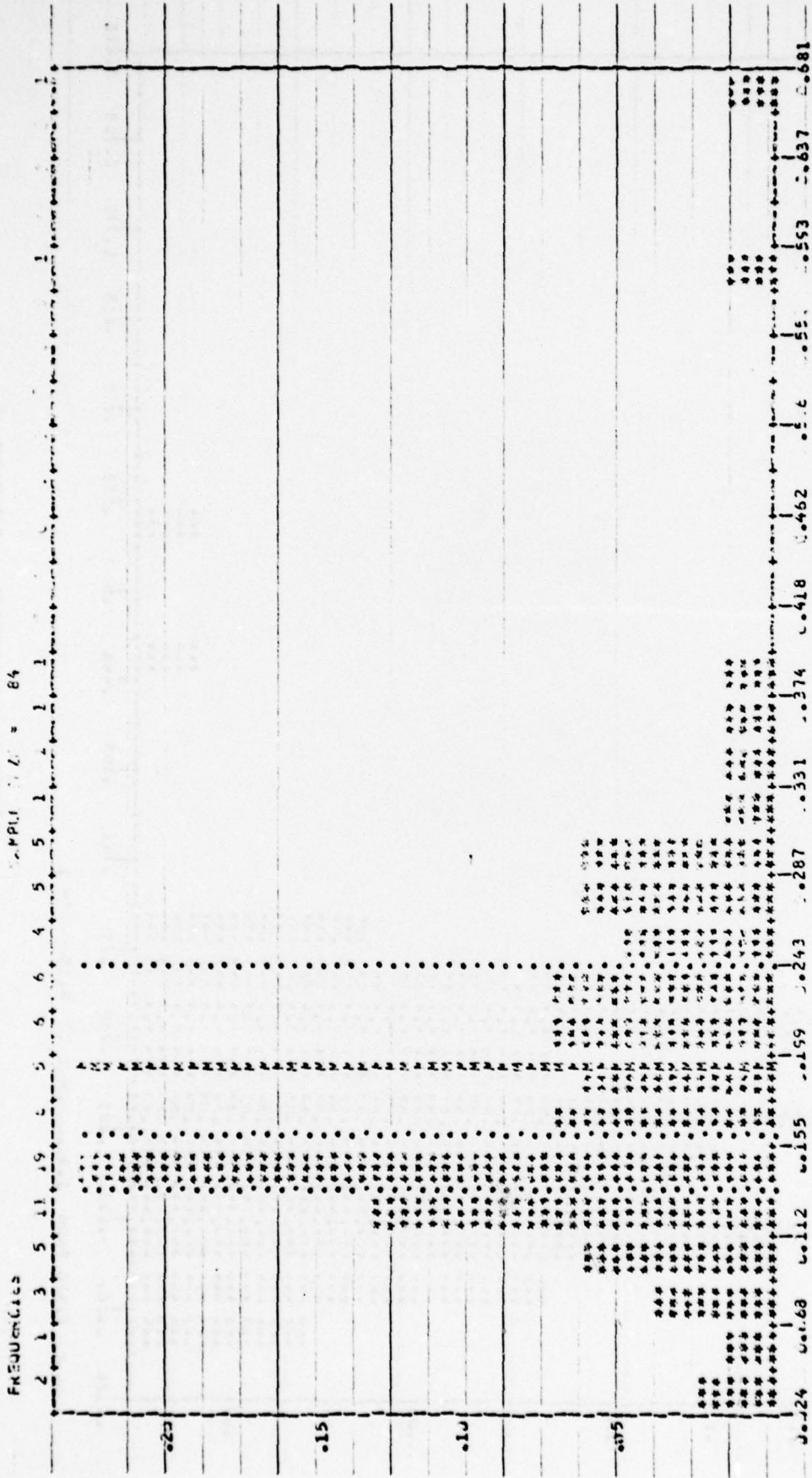

SCALE FIXED FROM 2.400000E-02 TO 6.810000E-01

CENTRAL TENDENCY

MEAN	1.92	2.25	1
MEAN	1.92	2.25	1
TRIM MEAN	1.718767	1.91	1
MODE	3.00	3.67	1
GEOM MEAN	1.711152	1	1
HARM MEAN	1.521243	1	1

SPREAD

VARIANCE	1.37	1.81	12
STD DEV	1.17	1.34	11
COEFF VAR	0.61	0.58	12
MEAN CV	0.32	0.26	1
COV	0.00	0.00	1
A. DISP	1.00	0.92	1

HIGHER CENTRAL MOMENTS

M2	2.25	3.00	13
M3	1.17	1.35	11
M4	0.72	0.81	9
M5	0.21	0.21	3
M6	1.00	1.00	3

DISTRIBUTION

MIN	0.24	0.25	1
Q1	0.25	0.25	1
Q2	0.37	0.37	1
Q3	0.55	0.55	1
MAX	0.68	0.68	1

Δ₃ Errors of the Advancement Model for Pay Grade E5

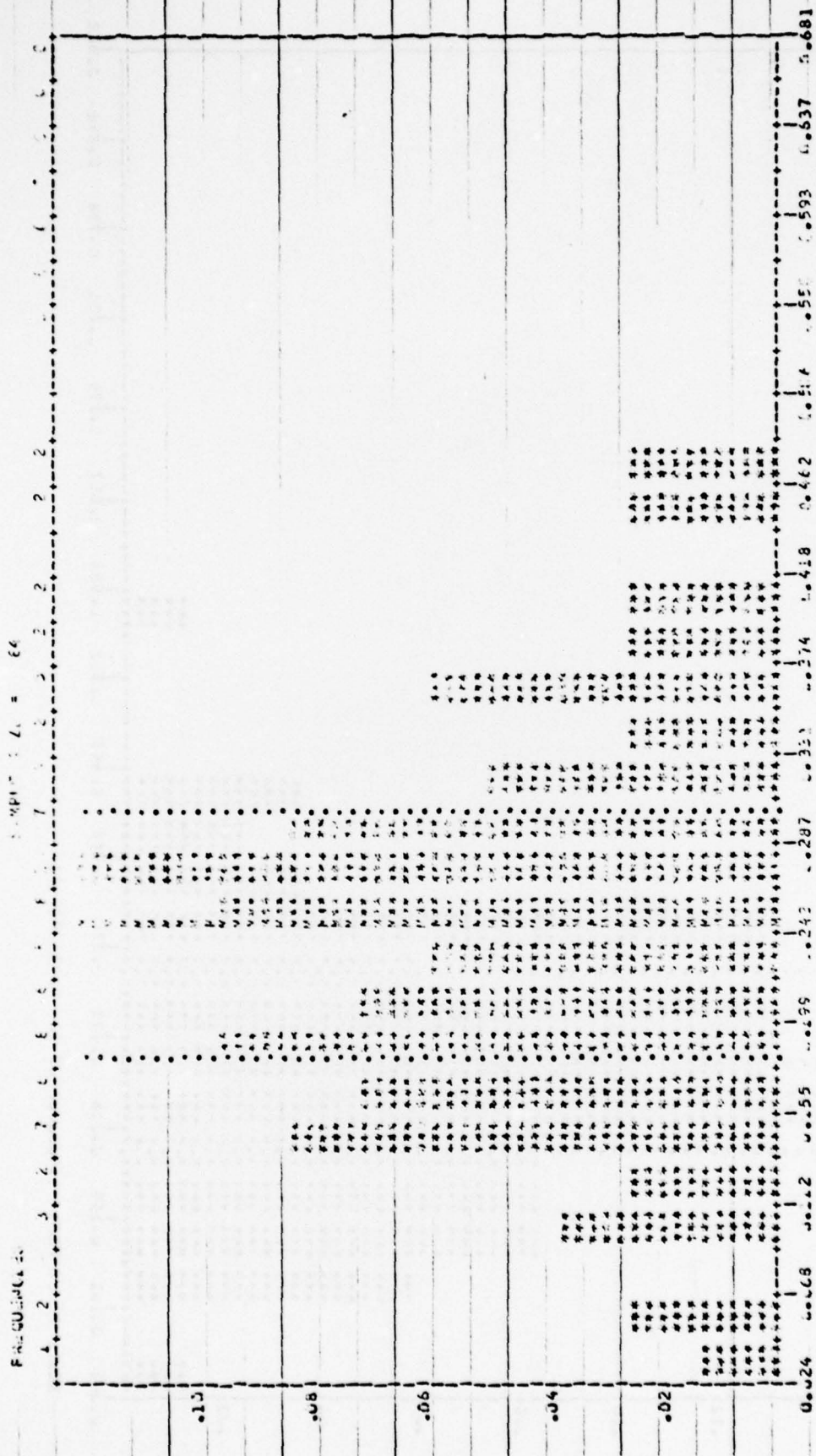

SCALE FIXED FROM 2-0000000002 TO 6-0100000000

GENERAL TENDENCY	APPROX	HIGHER GENERAL MOMENTS	DISTRIBUTION
MEAN 2.498750-01	M2 2.0001497-04	MINIMUM	0.0000000000
MAXIMUM 2.498750-01	M3 2.9226475-04	0.25 QUANTILE (M.O.T)	0.0000000000
MIDRANGE 2.498750-01	M4 1.8241275-04	0.50 QUANTILE (M.O.T)	0.0000000000
MIDRANGE 2.498750-01	M5 1.2221275-04	0.75 QUANTILE (M.O.T)	0.0000000000
GEN. MEAN 2.498750-01	M6 2.0274535-04	MAXIMUM	0.0000000000

Δ_3 Errors of the FAST Model for Pay Grade E6

SCALE FACTOR = .86

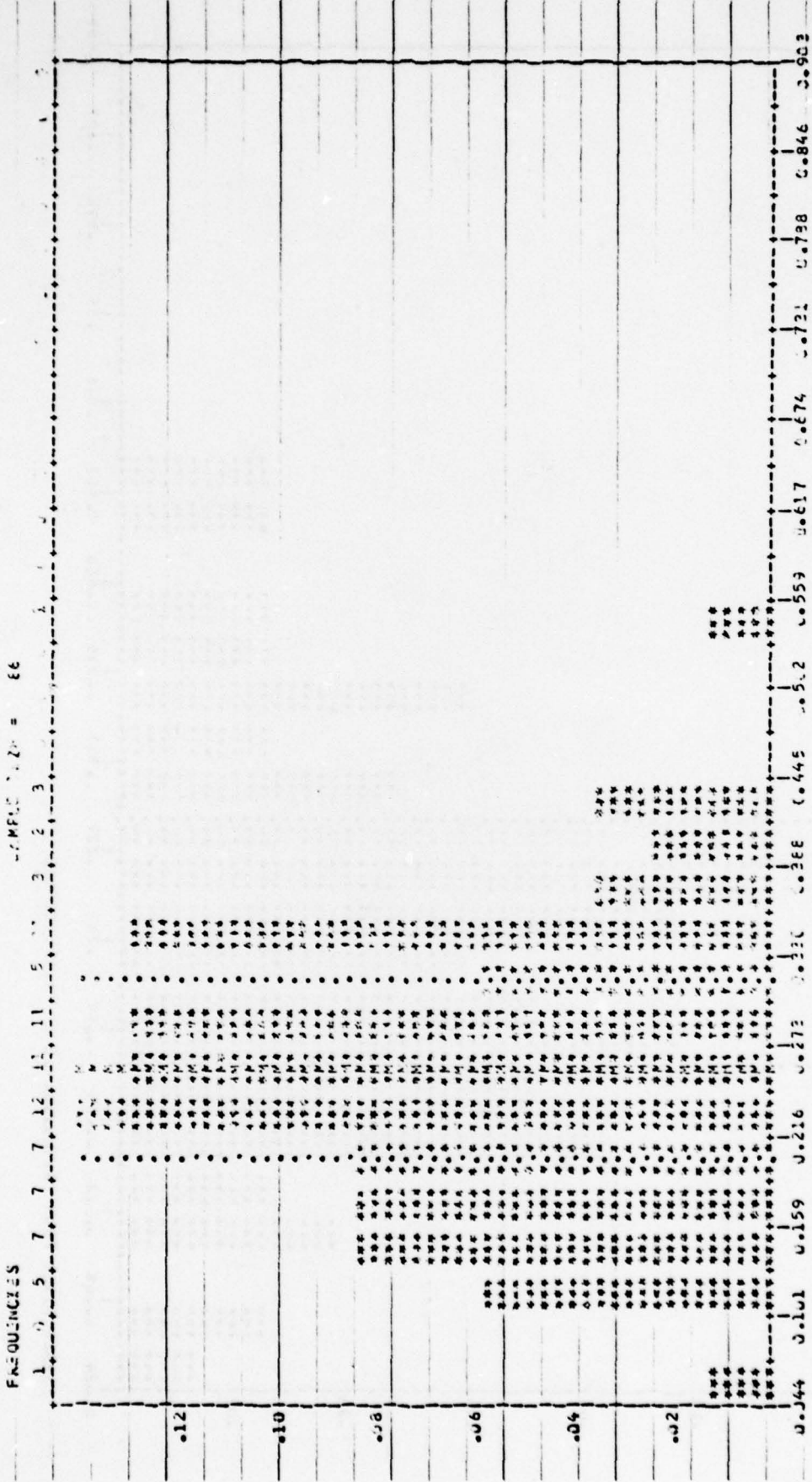

CENTRAL TENDENCY	APR 68	HIGHER GRADE RANGES	DISTRIBUTION
MEAN	2-5743781-01	M3	MINIMUM
MEDIAN	2-5528241-01	M4	.10 QUANTILE
MODE	2-5528241-01	KUG	.25 QUANTILE
MEAN DEV	2-5528241-01	B-1	.50 QUANTILE
MIDRANGE	2-5528241-01	B-2	.75 QUANTILE
GEOM MEAN	2-5528241-01	B-3	PERCENTUM
PARA MEAN	2-2357791-01	B-4	

Δ_3 Errors of the FAST Model for Pay Grade E7

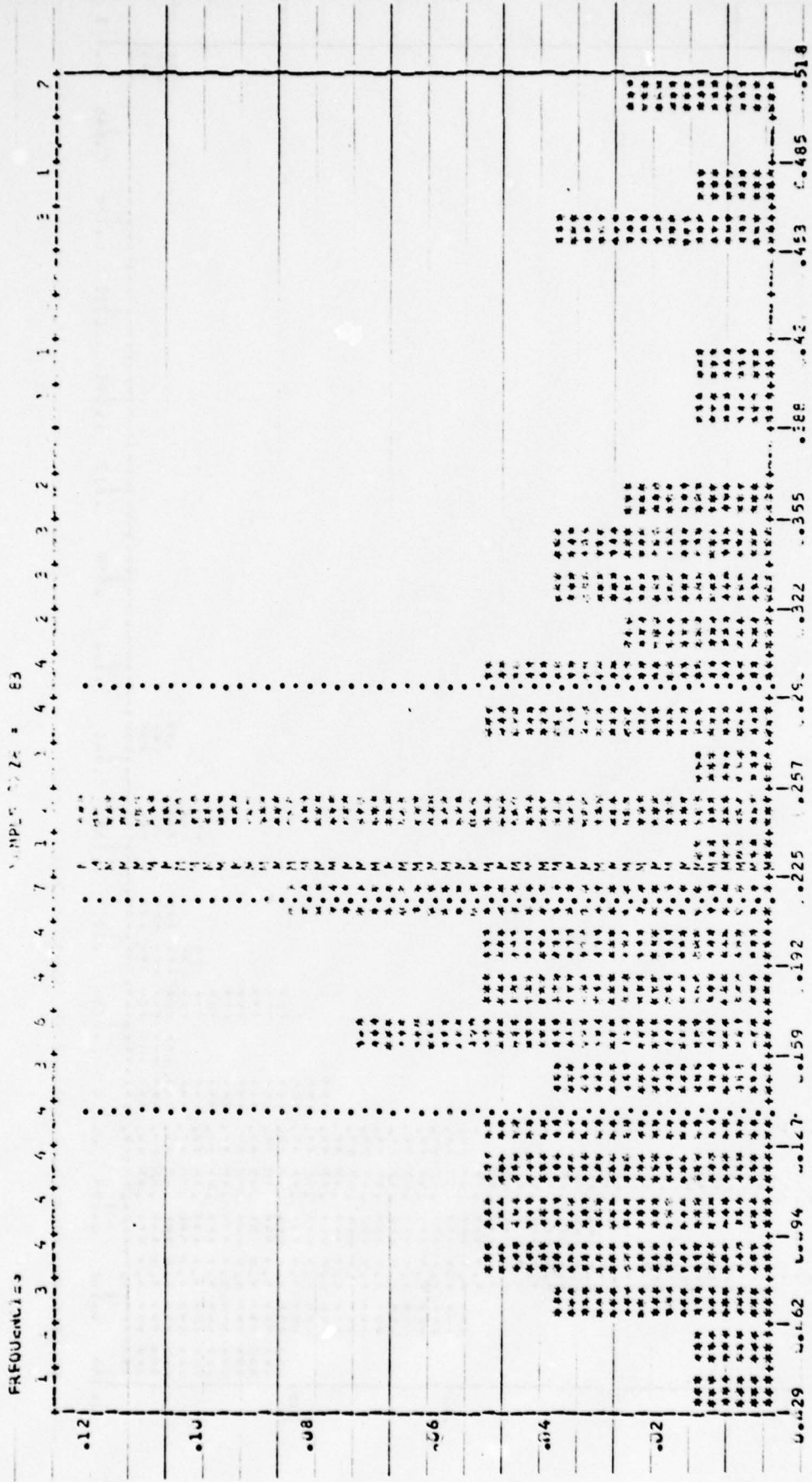

SCALE FROM -2.9000000000000000 TO 5.1799999999999999

GENERAL TENDENCY	SPREAD	HIGHER CENTRAL MOMENTS	DISTRIBUTION
MEAN 2.2827350000000000	VAR 1.2589340000000000	5.4761580000000000	MUL MOM
STDEV 1.5125230000000000	SKW 4.0127700000000000	4.7112300000000000	QUANTILE
MIDMEAN 2.1678000000000000	KURT 8.3333330000000000	3.0512220000000000	.25 QUANTILE
MIDRANGE 2.5099450000000000	MFNG 4.7388300000000000	2.5122220000000000	.75 QUANTILE
GEN MEAN 2.5099450000000000	MAX 1.5518300000000000	4.3266170000000000	MAX MUL
RANGE MEAN 2.7152180000000000			

Δ₃ Errors of the Advancement Model for Pay Grade E7

1971 Z₁ = 83

FACU.AGENT

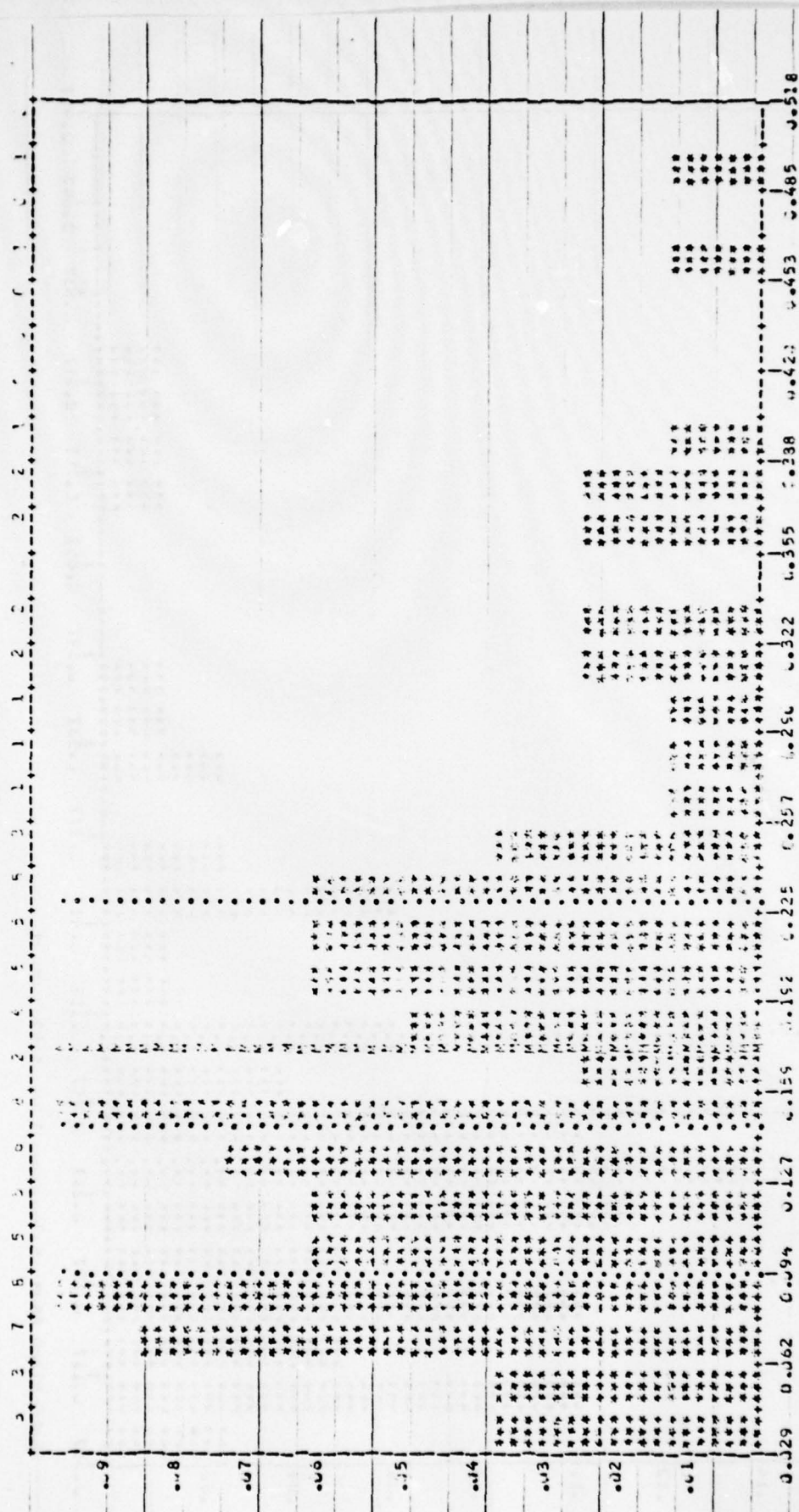

SCALE FIXED FROM 2.4777777777777777 TO 5.1755555555555555

CENTRAL TENDENCY		SPREAD		HIGHER CENTRAL MOMENTS		DISTRIBUTION	
MEAN	1.747052-04	VARIANCE	1.522245-02	M3	1.817489-04	MINIMUM	2.671225-02
TRIM-MEAN	1.968878-04	STDEV	1.233831-01	M5	5.271169-04	.10 QUANTILE	5.811542-02
MID-MEAN	1.513472-04	MEAN DEV	7.526869-01	SKW	4.559893-04	.25 QUANTILE	1.466667-01
MID-RANGE	2.573512-04	LONG	6.572367-01	KURT	5.882269-04	.50 QUANTILE	2.622675-01
GEOM MEAN	1.450788-04	MID-FRAC	1.834822-01	B1	2.718695-04	.75 QUANTILE	2.622675-01
HARM MEAN	1.186115-04			B2	2.718695-04	MAXIMUM	4.460315-01

Δ₃ Errors of the Advancement Model for Pay Grade E8

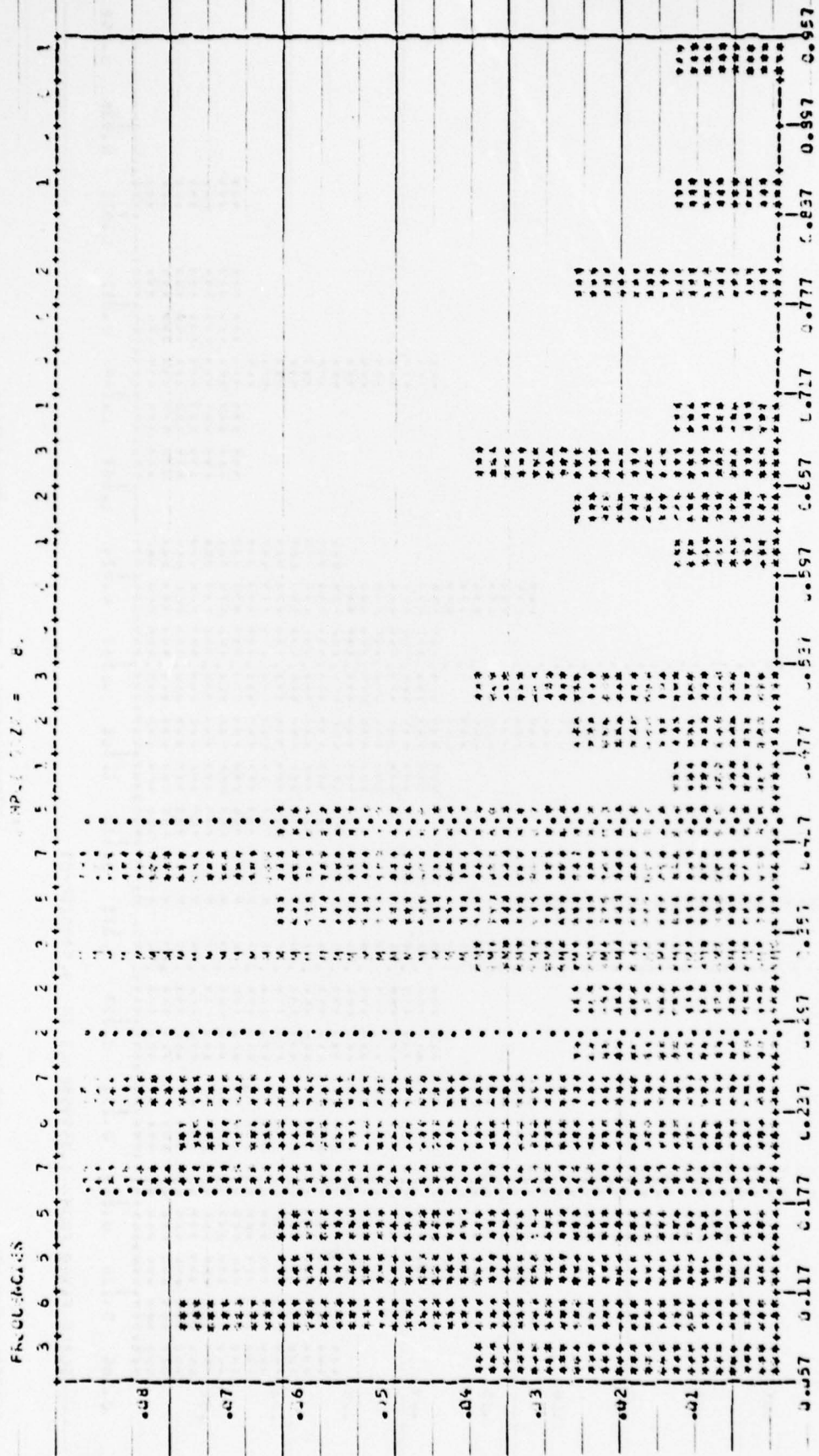

SCALE: FROM 5.700000E-02 TO 6.575000E-01

GENERAL TENDENCY	SPECIAL	HIGHER GENERAL MOMENTS	DISPERIBUTORA
MEAN	MEAN	MEAN	MEAN
STDEV	STDEV	STDEV	STDEV
MIN	MIN	MIN	MIN
MAX	MAX	MAX	MAX
...

Δ_3 Errors of the Advancement Model for Pay Grade E9

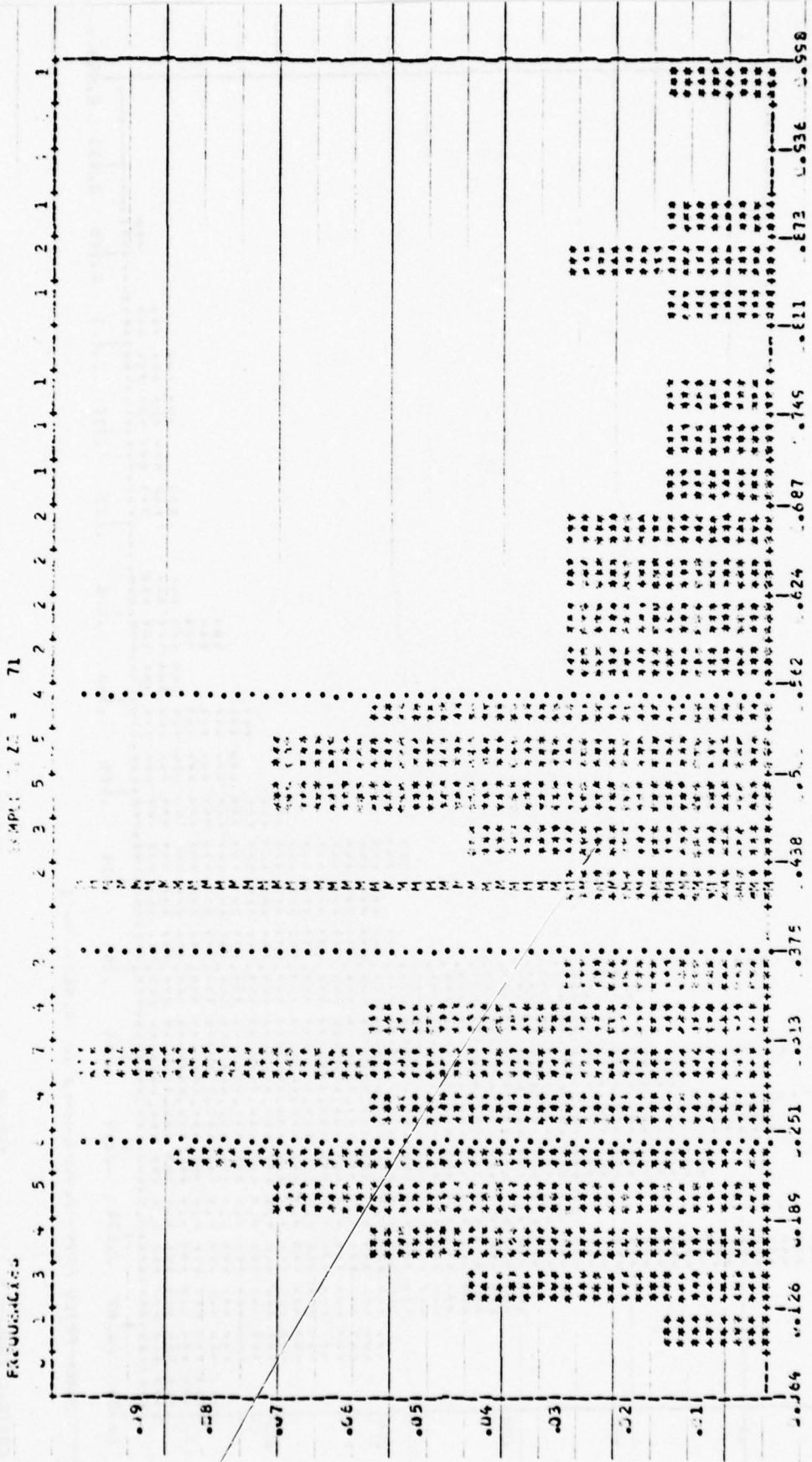

SCALE-FIXED FROM 6.399995E-02 TO 9.98E-01

GENERAL TENDENCY	SPREAD	HIGHER CENTRAL MOMENTS	DIST. / BUTION
MEAN	VAR. INC.	M3	MIN. NUM
MEDIAN	STD. DEV.	M4	MAX. NUM
TRIMMED	CHEF. DEV.	KURTOSIS	.15 QUANTILE (FREQ)
MIDRANGE	MEAN DEV.	BURT	.25 QUANTILE (MOM)
GEOM. MEAN	RECIPROCAL	B1	.50 QUANTILE (MEAN)
HARM. MEAN	RECIPROCAL	B2	.75 QUANTILE
			.90 QUANTILE
			MAX. NUM

Δ_3 Errors of the FAST Model for All Pay Grades

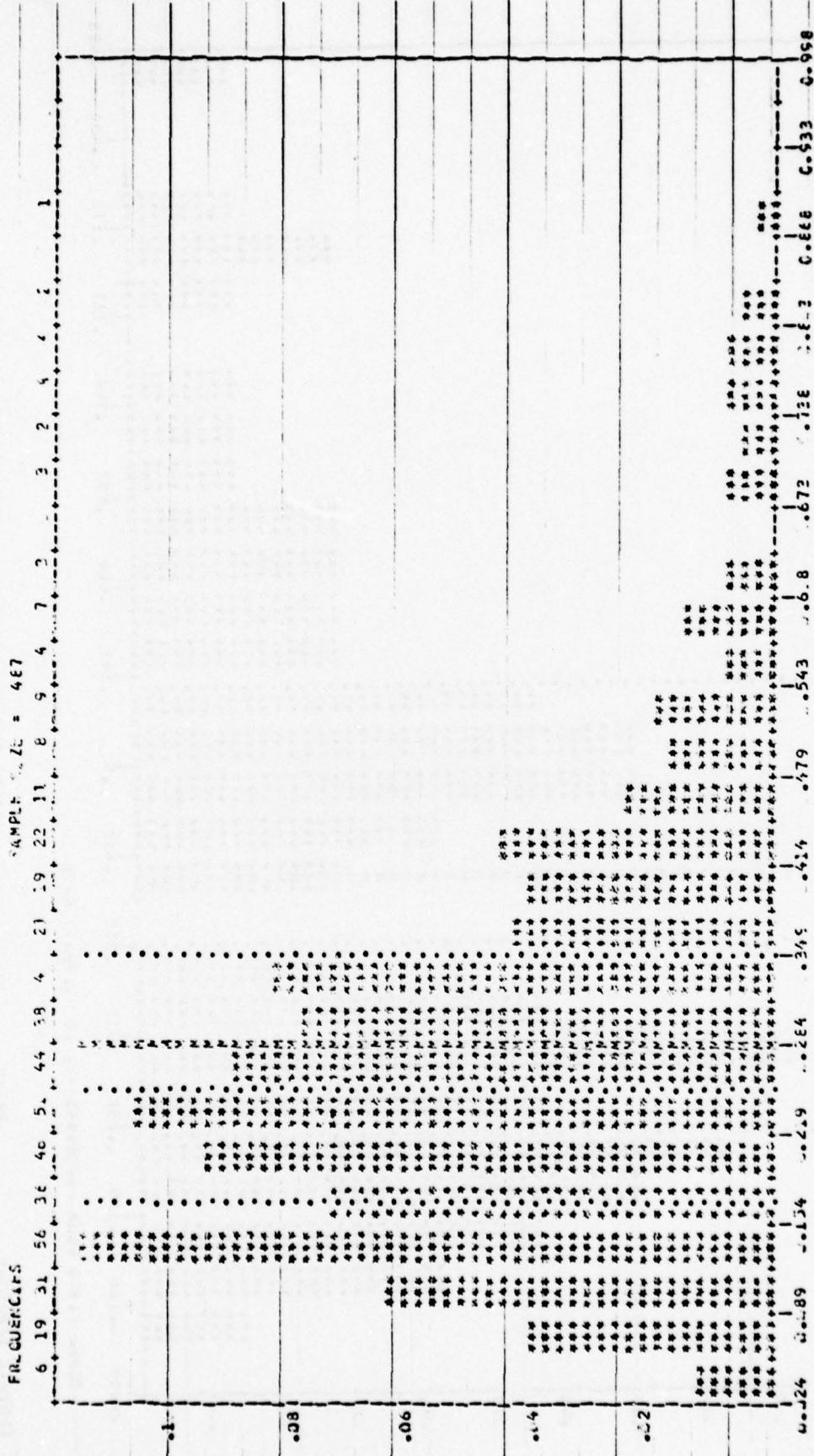

CENTRAL TENDENCY	SPREAD	HIGHER CENTRAL MOMENTS	DISTRIBUTION
MEAN 2.78509E-01	VARIANCE 2.34863E-02	4.34492E-03	MYNCLM
MEAN 2.55664E-01	STD DEV 1.53223E-01	1.27223E-02	.15 QUANTILE
MEAN 2.53943E-01	MEAN DEV 1.27223E-01	1.27223E-02	.25 QUANTILE
MEAN 2.53885E-01	MEAN DEV 1.27223E-01	1.27223E-02	.50 QUANTILE
MEAN 2.53706E-01	MEAN DEV 1.27223E-01	1.27223E-02	.75 QUANTILE
MEAN 2.53266E-01	MEAN DEV 1.27223E-01	1.27223E-02	.90 QUANTILE

APPENDIX G

HISTOGRAMS OF Δ_1 ERRORS, HIGH VOLUME RATINGS ONLY, FAST MODEL AND ADVANCEMENT MODEL
 Δ_1 Errors of the FAST Model for Pay Grade E4 (High Volume Ratings Only)

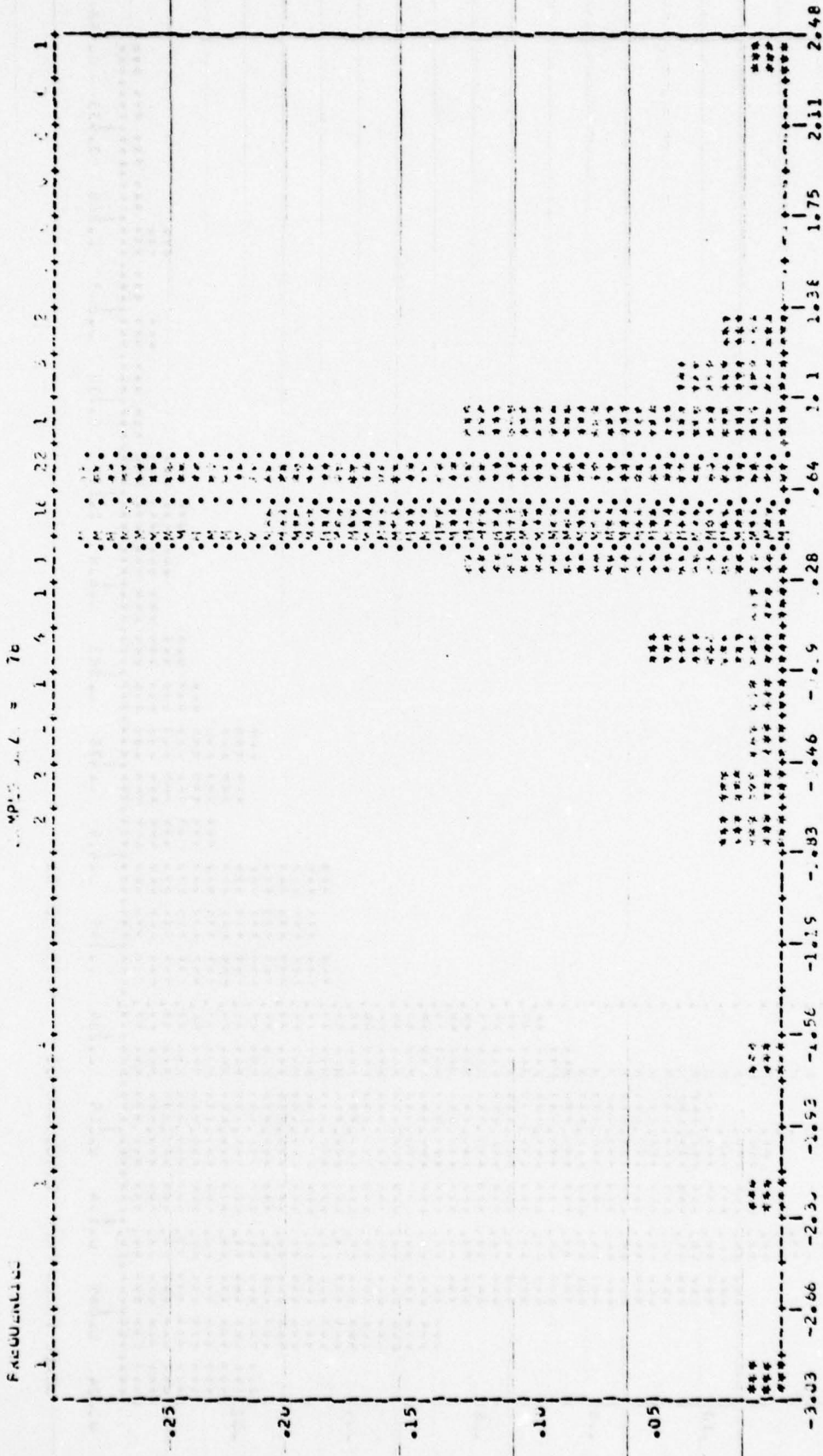

CENTRAL TENDENCY	SPREAD	F. GRP. CENTRAL MOMENTS	DISTRIBUTION
MEAN 4.65938	VAR. 1.46	M1 0.94925	MUM
STDEV 1.20827	COV. 0.00000	M2 0.33274	QUANTILE
TRIMEAN 6.08344	ALPHA 0.00000	M3 -2.33274	0.25 QUANTILE
MIDRANGE 9.26578	W. QUANTILE 0.00000	M4 0.60891	0.50 QUANTILE
	W. QUANTILE 0.00000	M5 -5.60891	0.75 QUANTILE
	W. QUANTILE 0.00000	B1 1.2	MAXIMUM

Δ_1 Errors of the Advancement Model for Pay Grade E4 (High Volume Ratings Only)

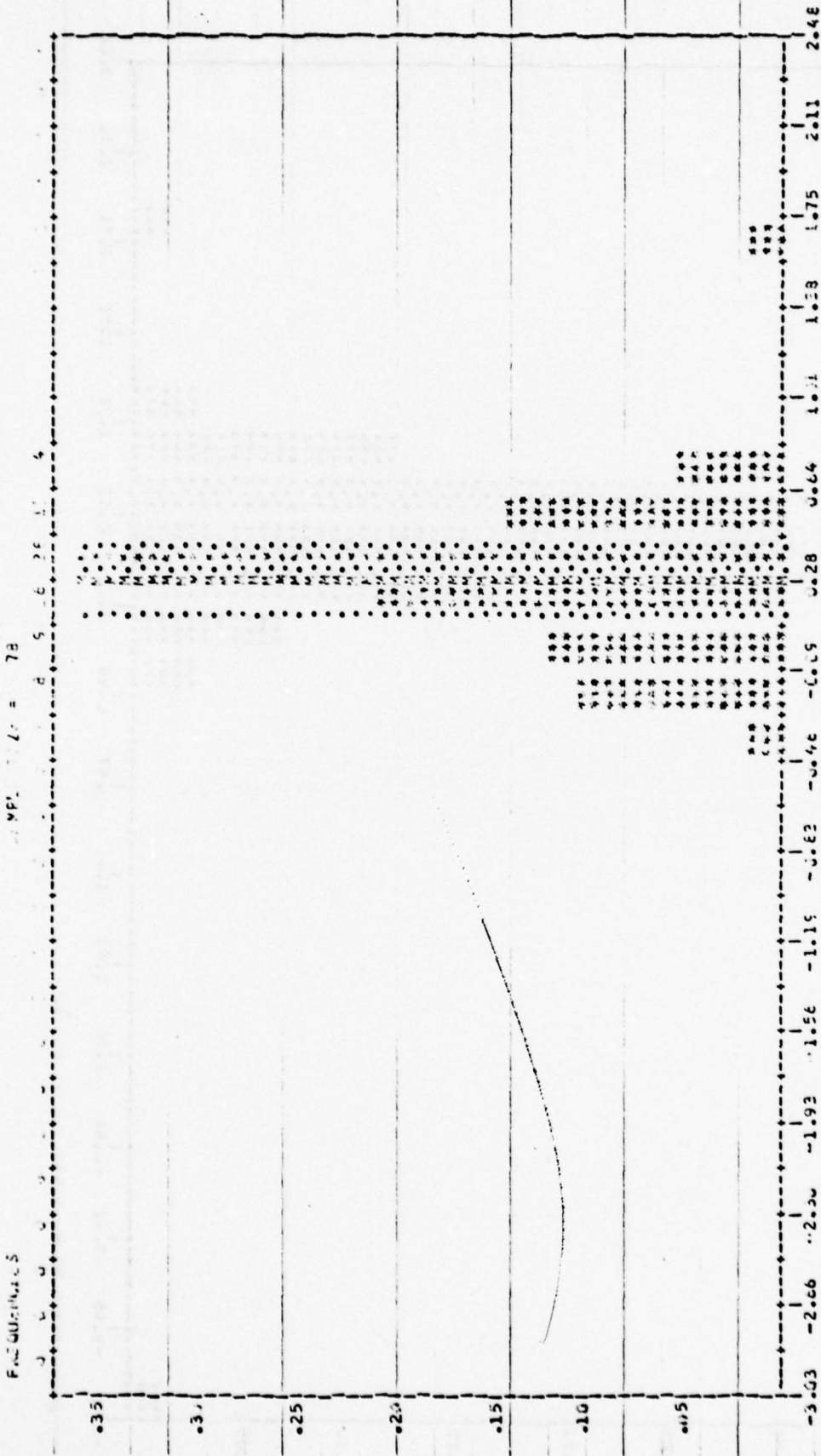

SCALE FIXED FROM -3.03 TO 2.48

CENTRAL TENDENCY	SPREAD	HIGHER CENTRAL MOMENTS	DISTRIBUTION
MEAN 5.83875E-01	VARIANCE 8.585417E-02	1.917298E-02	MINIMUM
MEDIAN 5.82087E-01	STD DEV 2.92976E-01	1.177245E-02	10 QUANTILE
TR. MEAN 5.93800E-01	COEF VAR 2.0276E-01	7.663175E-03	.25 QUANTILE
MIDRANGE 6.32775E-01	MEAN CV 2.0276E-01	4.823170E-03	.5 QUANTILE
	STD. DEVIATION 2.92976E-01	1.844187E-02	.75 QUANTILE
		4.888547E-02	MAXIMUM
			(H-RANGE)
			(H-RANGE)
			5.7473E-01
			1.62428E-01

Δ_1 Errors of the FAST Model for Pay Grade E5 (High Volume Ratings Only)

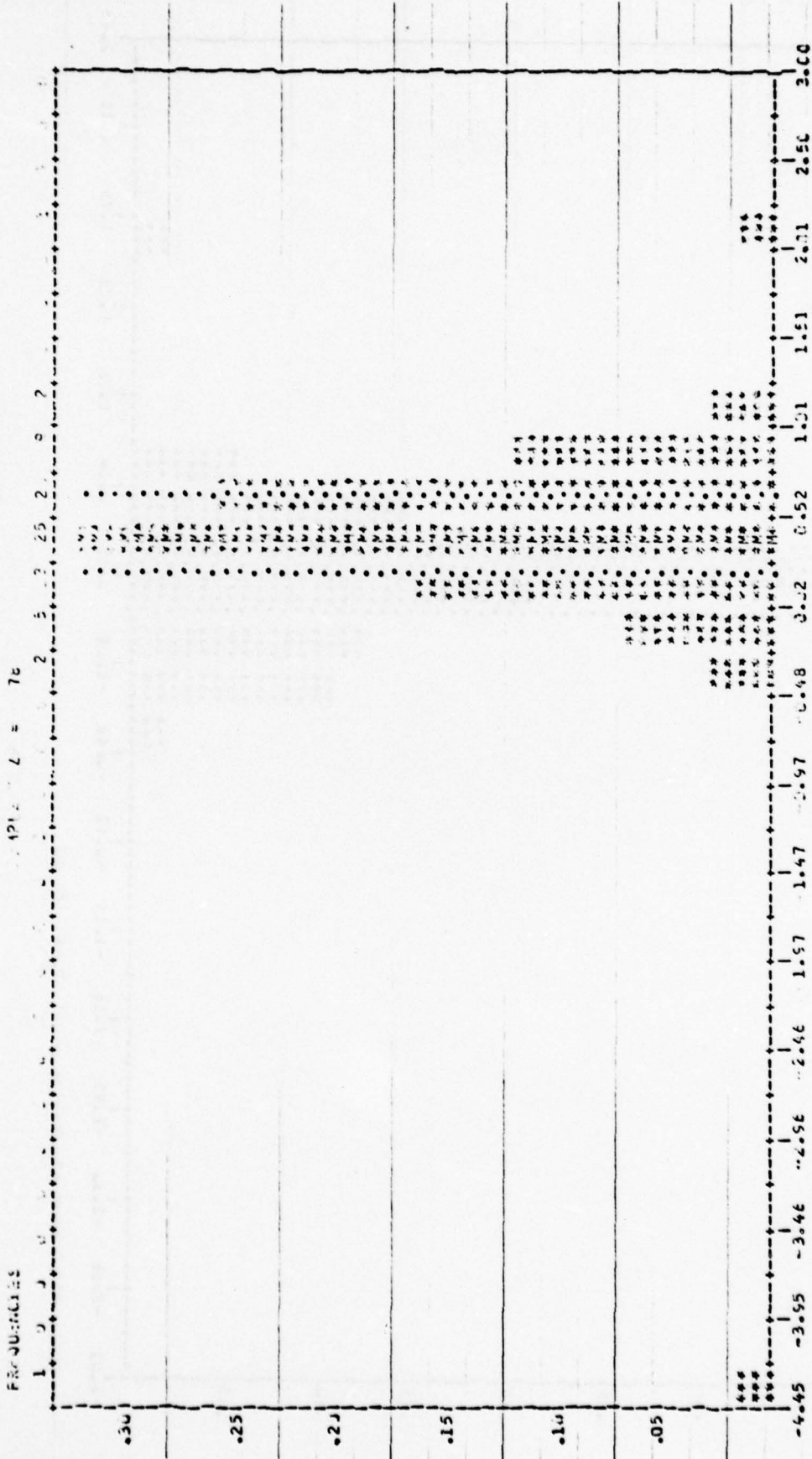

SCALE FIXED FROM -4.45 TO 3.00

GENERAL TENDENCY	SPREAD	HIGHER GENERAL MOMENTS	DISTRIBUTION
MEAN 3.945845701	V. H. ANS 4.619433774	M3 -7.424213	MIN. NUM 0.01
MEDIAN 4.0284437701	S.D. OLV 3.047665774	M4 -9.5551204	.25 QUANTILE (P.100)
MODE 4.281350701	S.C.F. VAL 1.714332774	M5 -10.87432	.50 QUANTILE (P.100)
MIDRANGE 4.383547701	ALNS C.V 3.187383774	M6 -12.548335	.75 QUANTILE (P.100)
MIDRANGE -1.142397774	R. ANS 3.171	M7 -14.37035	.90 QUANTILE
	M. COEFF. C 4.144895774		MAX. NUM 2.1122111

Δ_1 Errors of the Advancement Model for Pay Grade E5 (High Volume Ratings Only)

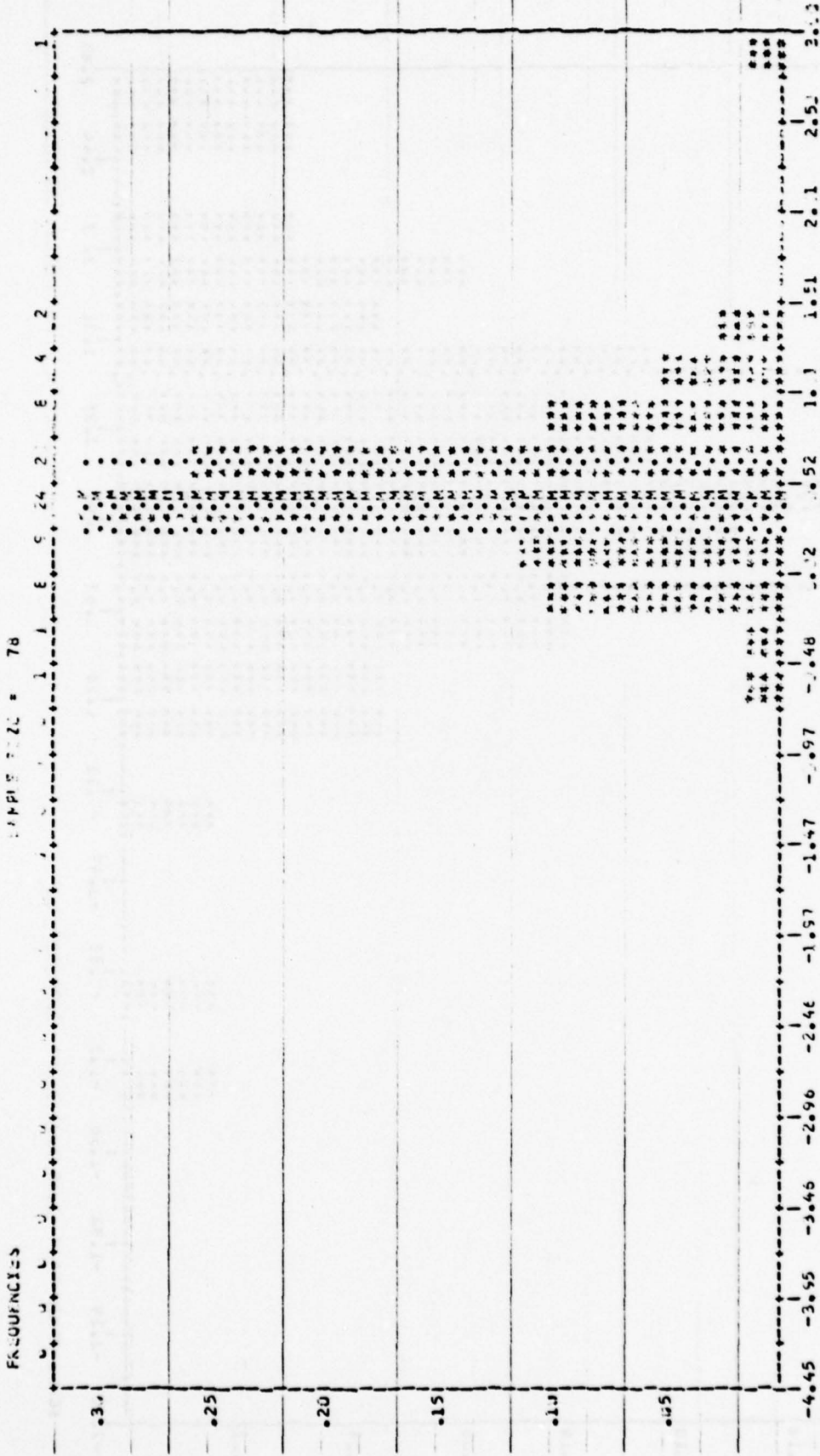

SCALE FIXED FROM -4.45 to 2.55

CENTRAL TENDENCY		SPREAD		HIGHER CENTRAL MOMENTS		DISTRIBUTION	
MEAN	4.993331E-01	VAR	2.247666E-01	M2	1.962122E-01	MAXIMUM	2.55
STANDARD DEVIATION	4.711758E-01	COEF. VAR	4.074977E-01	M3	1.872735E-01	MINIMUM	-4.45
MEDIAN	4.711758E-01	MEAN DEV	9.149618E-01	M4	1.842223E-01	QUANTILE (0.25)	-0.5
MIDRANGE	1.222597E-00	MEAN ABS. DEV.	3.023718E-01	KURTOSIS	1.888824E-01	QUANTILE (0.5)	0.0
		MODAL RANGE	4.021831E-01	SKENESS	5.612355E-01	QUANTILE (0.75)	1.0
						MAXIMUM	2.55

Δ_1 Errors of the FAST Model for Pay Grade E6 (High Volume Ratings Only)

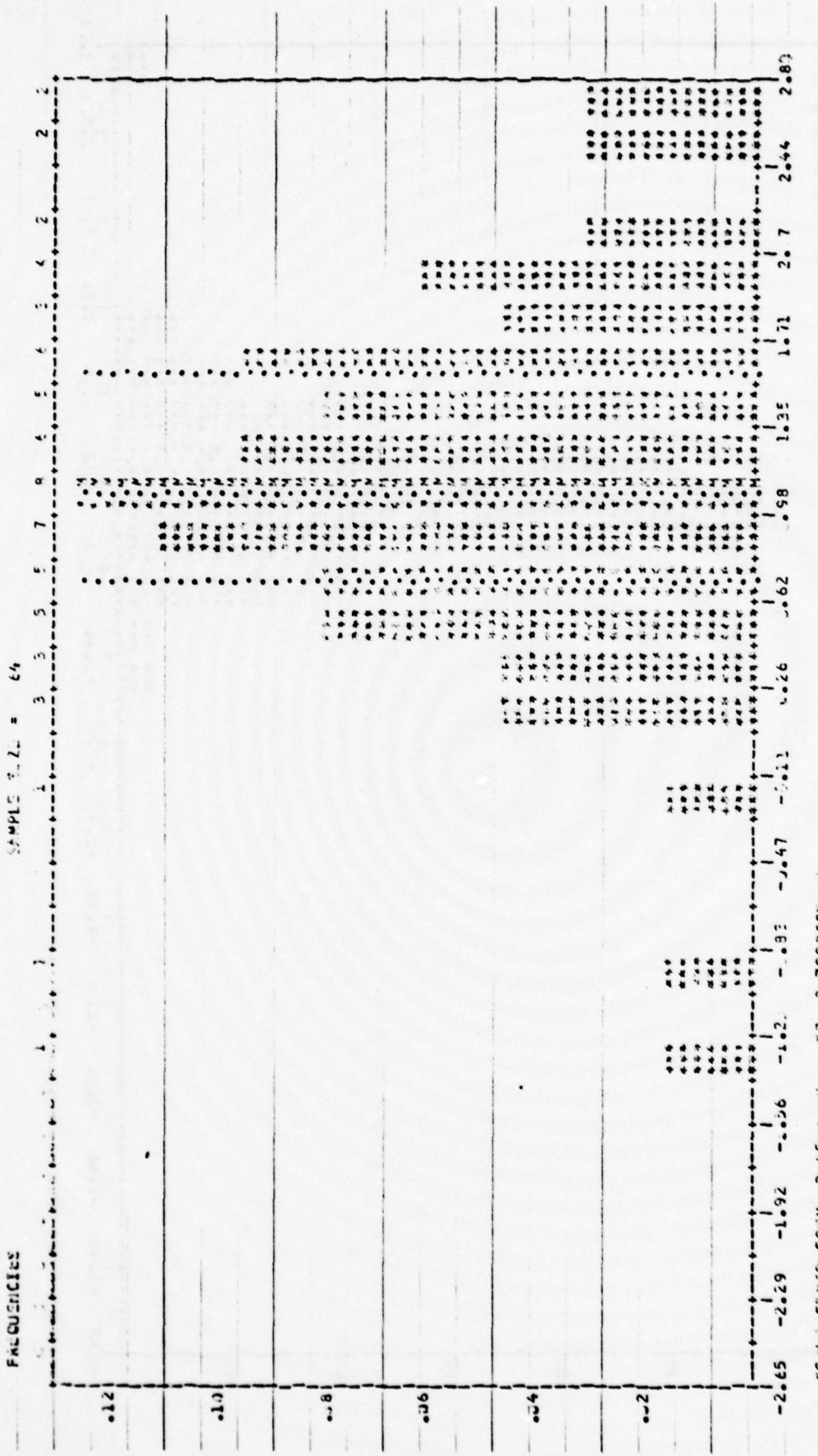

SCALE FIXED FROM -2.65 TO 2.795350

CENTRAL TENDENCY		SPREAD		F-OPEN CENTRAL MOMENTS		DISCRETE	
MEAN	1.137333	V-K-S-MCL	5.92592	M1	1.57692	M1	1.57692
MEDIAN	1.13175	SID-LV	7.37327	M2	3.21264	M2	3.21264
TRIMEAN	1.13541	COEF-VAR	6.507258	M3	3.78244	M3	3.78244
MICHIEAN	1.139175	MEAN-LV	3.54335	M4	1.23222	M4	1.23222
MICHANGE	7.876325	MEAN-PAC	4.91724	M5	1.42734	M5	1.42734
		MEAN-PAC	8.91724	M6	1.23241	M6	1.23241
				M7	1.57692	M7	1.57692
				M8	3.21264	M8	3.21264
				M9	3.78244	M9	3.78244
				M10	1.23222	M10	1.23222
				M11	1.42734	M11	1.42734
				M12	1.23241	M12	1.23241

Δ₁ Errors of the Advancement Model for Pay Grade E6 (High Volume Ratings Only)

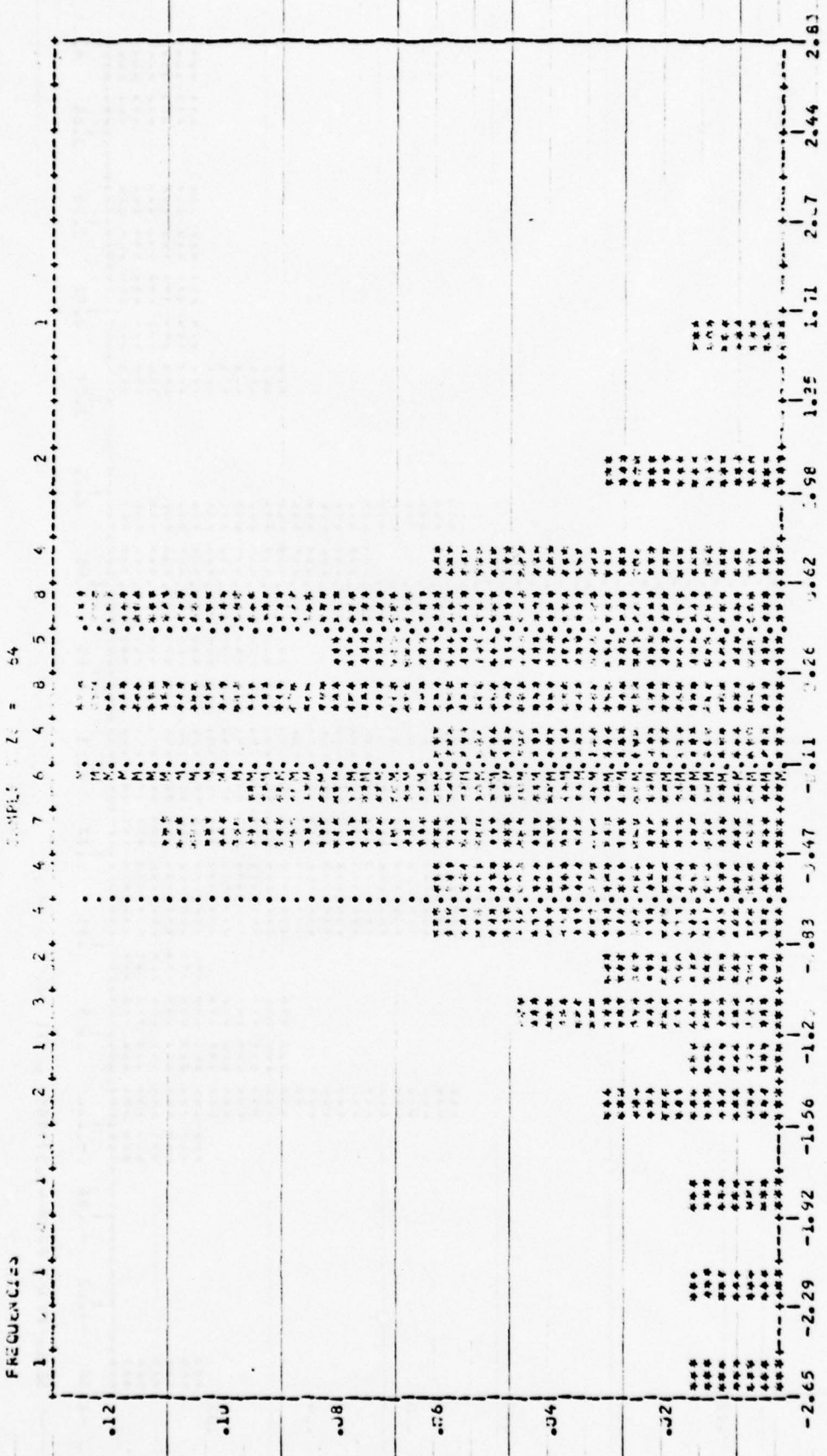

SCALE FIXED FROM -2.005 TO 2.799955555

CENTRAL TENDENCY	SPREAD	HIGHER CENTRAL MOMENTS	DISTRIBUTION
MEAN -1.7839155-01	VARIANCE 6.1532355-01	M3 -3.3358955-01	MINIMUM -1.693171-01
TRIMEAN -1.2168335-01	STDEV 2.4786455-01	M4 -7.3342215-01	1 st QUANTILE -1.2526742-01
MODE -8.8755375-02	MEAN DEV 4.3074295-01	SKWNESS -7.3342215-01	.25 QUANTILE (P=0.25) -1.0233277-01
MIDRANGE -5.4363915-01	MEAN DEV 4.3074295-01	KURTOSIS -7.3342215-01	.50 QUANTILE (MEDIAN) 4.0233277-01
	MAXIMUM 1.693171-01	MEAN DEV 4.3074295-01	.75 QUANTILE 1.0233277-01
			MAXIMUM 1.693171-01

Δ_1 Errors of the FAST Model for Pay Grade E7 (High Volume Ratings Only)

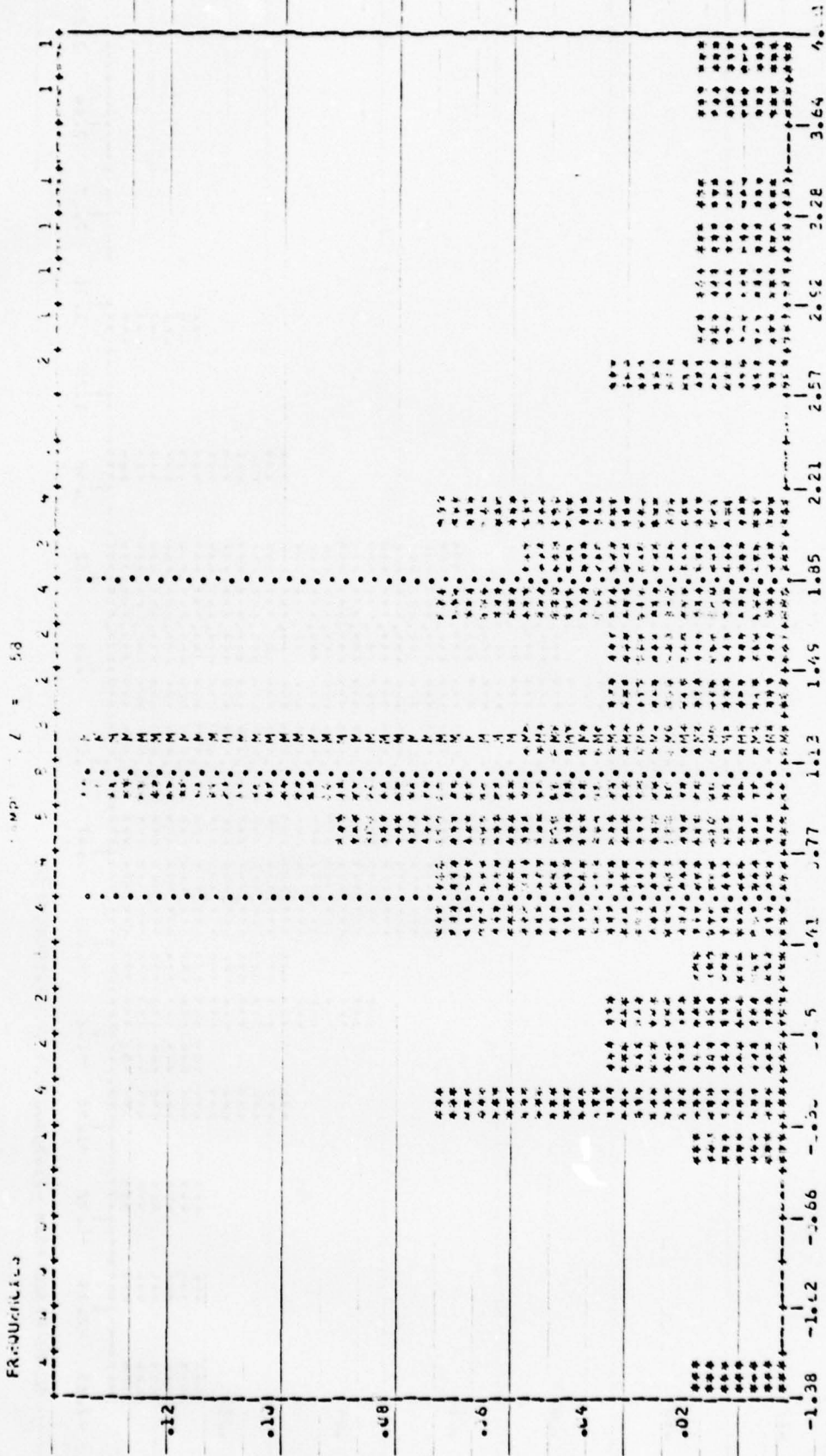

SCALE FIXED FROM -1.0379955 TO 4.0000000

CENTRAL TENDENCY	SPREAD	HIGHER CENTRAL MOMENTS	CURTOSIS
MEAN 1.234706	VAR-UNB 1.175266	M3 5.61138	NEW NUM 3763.7
MEDIAN 1.006249	VAR-COV 8.716999	M4 4.032268	OLD NUM 10000
TRIMMED 1.139271	VAR 8.716999	M5 2.018938	COEFF 1.000000
MIDMEAN 1.315864	DEV 9.337341	M6 4.114152	(M-3) 1.000000
MIDRANGE 1.315864	MIDRANGE 1.23735		(M-2) 1.000000
			(M-1) 1.000000
			MAX NUM 3763.7
			MIN NUM 10000
			MAX NUM 3763.7
			MIN NUM 10000

Δ_1 Errors of the Advancement Model for Pay Grade E8 (High Volume Ratings Only)

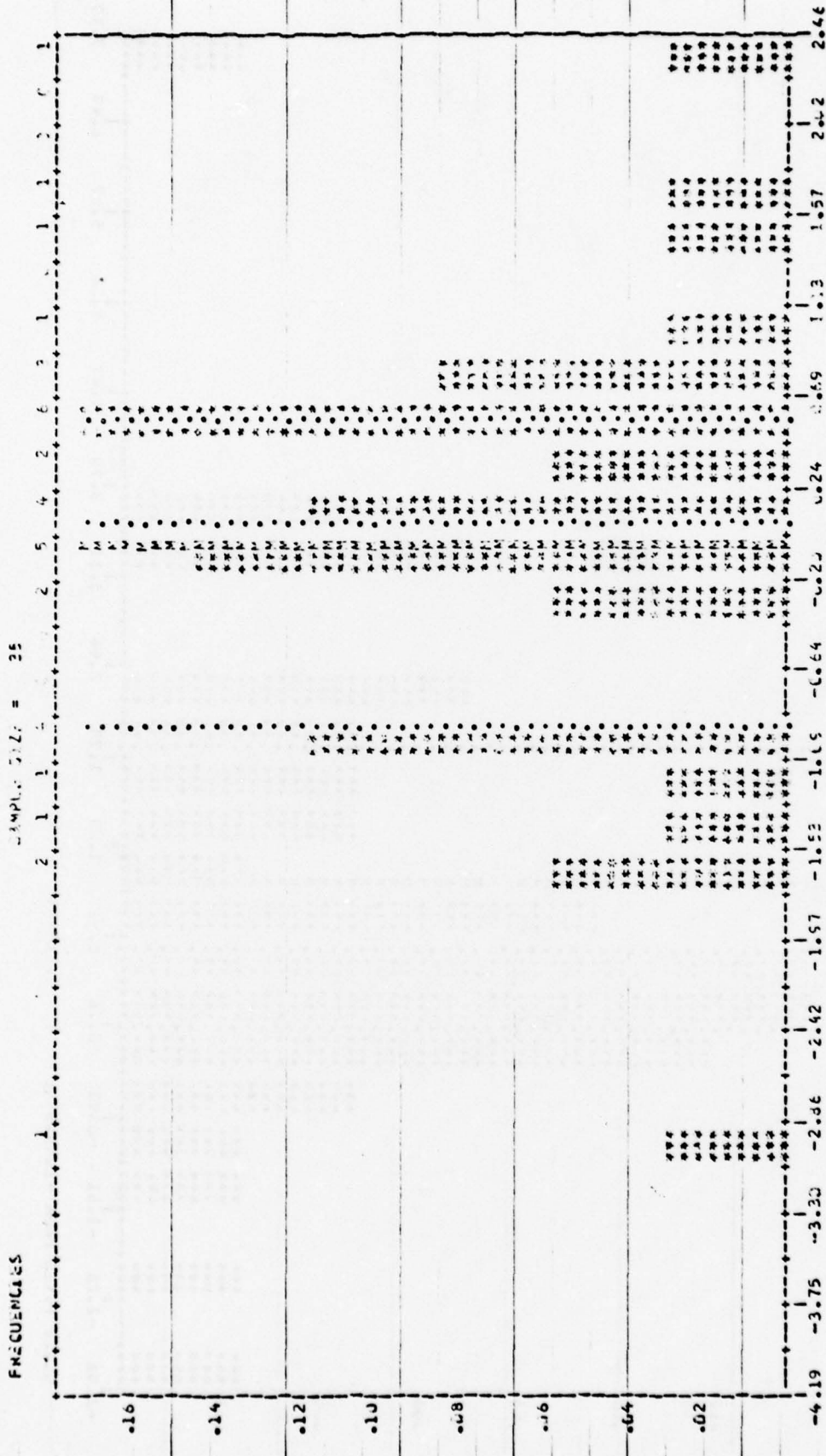

SCALE FIXED FROM -4.19 TO 2.4555555555555555

CENTRAL TENDENCY	SPREAD	HIGHER CENTRAL MOMENTS	DESTEP/BUSCH
MEAN -4.2437415-01	MS-SCALE 1.779185	M3 -4.5421551-01	MINIMUM 0.000000
TR-MEAN 6.915875-02	STD DEV 2.382287	M4 -4.4489541-01	MAXIMUM 2.4555555555555555
MID-MEAN 3.915875-02	COEF VAR 7.7191131-01	M5 -4.3558721-01	QUANTILE (P=0.01) 0.000000
MID-RANGE 1.4453475-01	MEAN DEV 5.7191131-01	M6 -4.2644341-01	QUANTILE (P=0.05) 0.000000
	MEANUS 1.02354631	M7 -4.1692315-01	QUANTILE (P=0.10) 0.000000
	MEANUS2 1.02354631	M8 -4.0740289-01	QUANTILE (P=0.25) 0.000000
		M9 -3.9788263-01	QUANTILE (P=0.50) 0.000000
		M10 -3.8836237-01	QUANTILE (P=0.75) 0.000000
		M11 -3.7884211-01	QUANTILE (P=0.90) 0.000000
		M12 -3.6932185-01	QUANTILE (P=0.95) 0.000000
		M13 -3.5980159-01	QUANTILE (P=0.99) 0.000000
		M14 -3.5028133-01	QUANTILE (P=0.995) 0.000000
		M15 -3.4076107-01	QUANTILE (P=0.999) 0.000000
		M16 -3.3124081-01	QUANTILE (P=0.9995) 0.000000
		M17 -3.2172055-01	QUANTILE (P=0.9999) 0.000000
		M18 -3.1220029-01	QUANTILE (P=0.99995) 0.000000
		M19 -3.0268003-01	QUANTILE (P=0.99999) 0.000000
		M20 -2.9315977-01	QUANTILE (P=0.999995) 0.000000
		M21 -2.8363951-01	QUANTILE (P=0.999999) 0.000000
		M22 -2.7411925-01	QUANTILE (P=0.9999995) 0.000000
		M23 -2.6459899-01	QUANTILE (P=0.9999999) 0.000000
		M24 -2.5507873-01	QUANTILE (P=0.99999995) 0.000000
		M25 -2.4555847-01	QUANTILE (P=0.99999999) 0.000000

Δ_1 Errors of the FAST Model for Pay Grade E9 (High Volume Ratings Only)

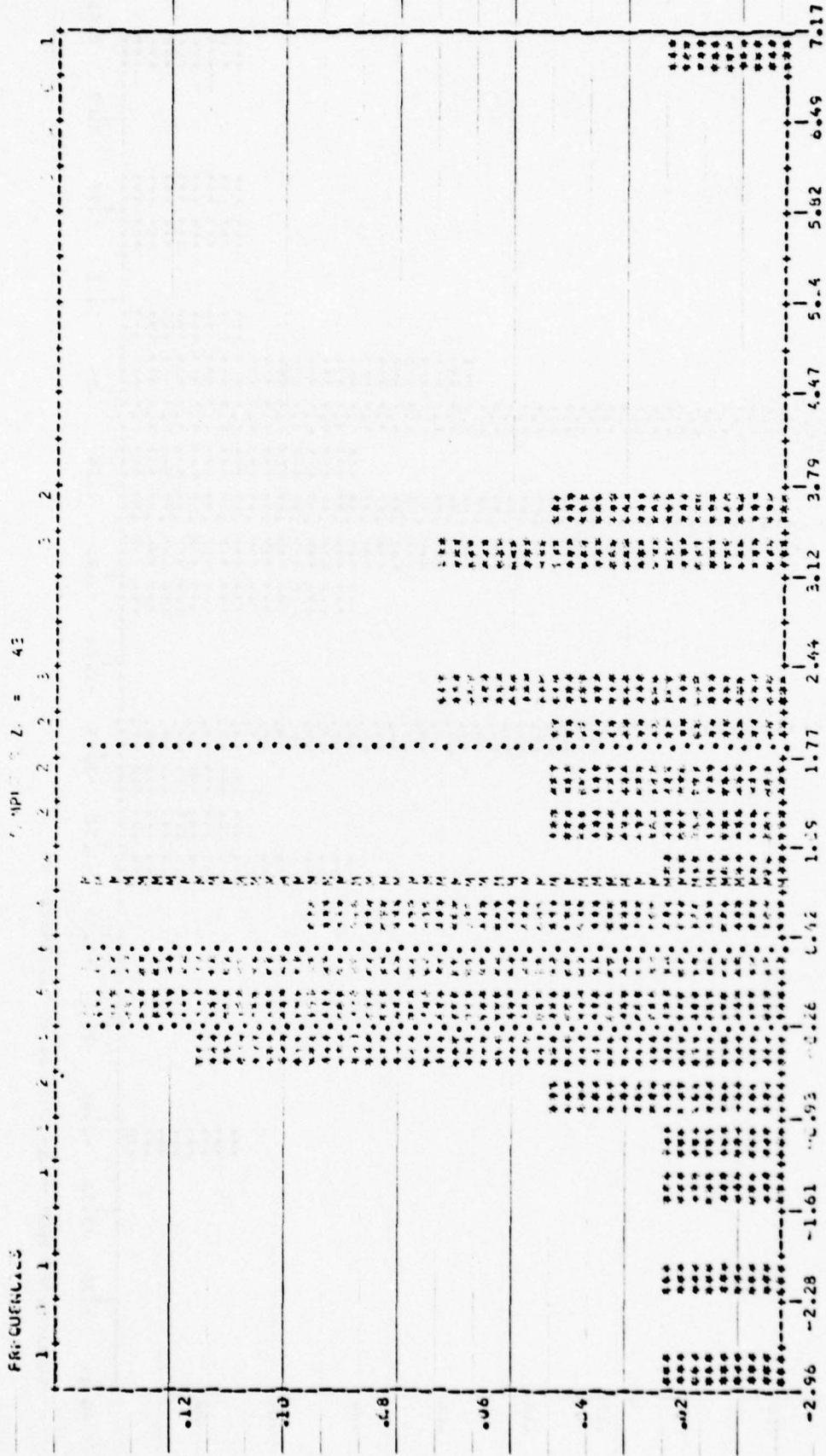

SCALE FIXED FROM -2.5555555 TO 7.1655555

GENERAL TENDENCY	SPREAD	HIGHER GENERAL MOMENTS	DISTRIBUTION
MEAN 5.005922101	MEAN 3.2185971	M2 5.99557	MIN. NUM 2.0562845
STD DEV 2.221145001	STD DEV 2.738271	M3 5.573871	MAX. NUM 7.1655555
TRIMEAN 2.211450001	TRIMEAN 2.221145001	M4 2.877555	MIN. QUANTILE (P=0.05)
MIDRANGE 2.211450001	MIDRANGE 2.211450001	M5 2.775555	MAX. QUANTILE (P=0.95)
			MIN. QUANTILE (P=0.01)
			MAX. QUANTILE (P=0.99)

Δ_1 Errors of the Advancement Model for Pay Grade E9 (High Volume Ratings Only)

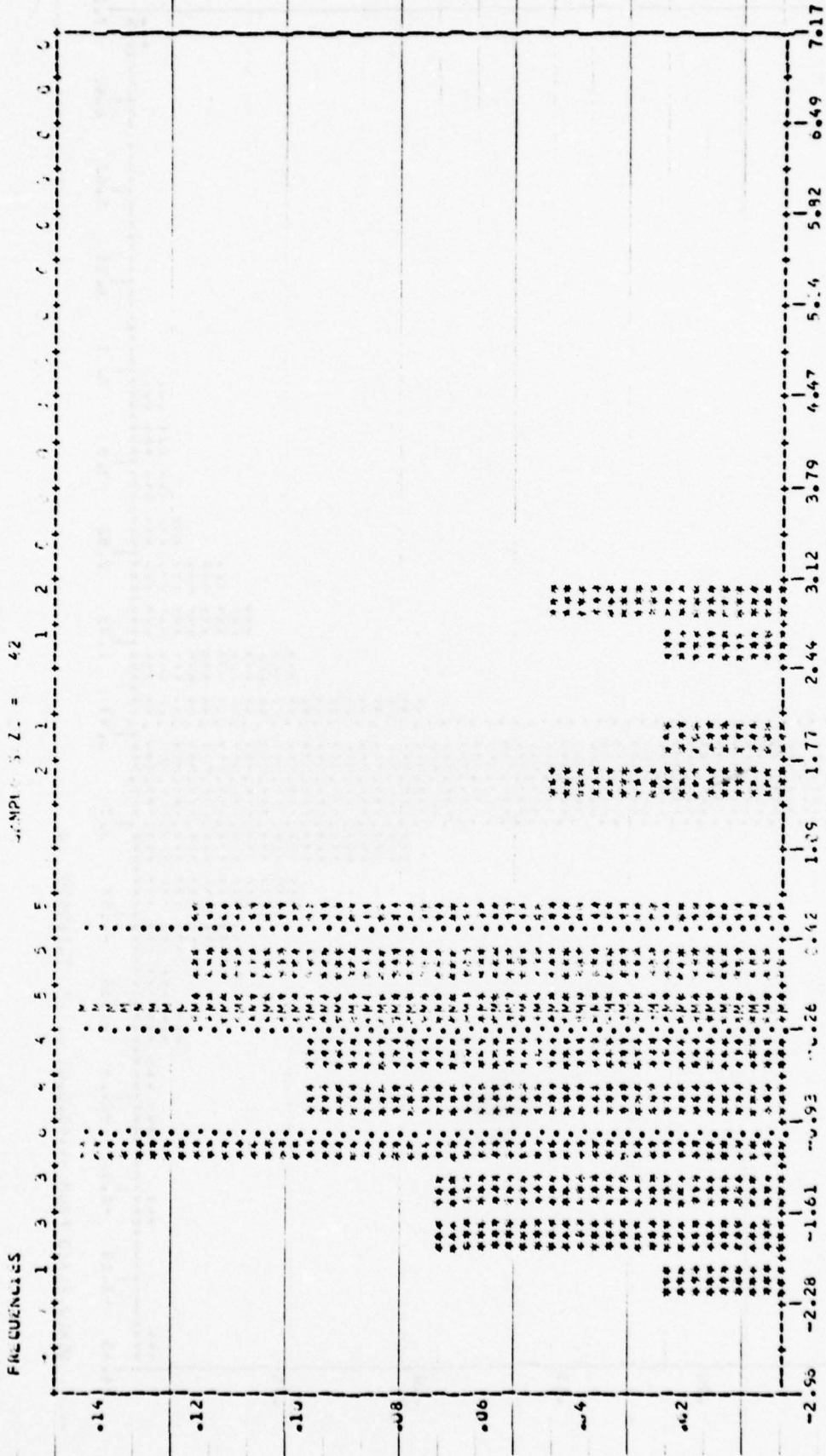

GENERAL TENDENCY	SPREAD	HIGHER CENTRAL MOMENTS	DISTRIBUTION
MEAN	0.398243	1.034636	MINIMUM
MEDIAN	-2.650665	7.962853	.15 QUANTILE
TRIMEAN	-2.757912	6.332126	.50 QUANTILE (MEDIAN)
MEAN	-3.017968	2.552447	.75 QUANTILE
MIDRANGE	4.375578	1.552622	.95 QUANTILE
			MAXIMUM

Δ_1 Errors of the FAST Model for All Pay Grades (High Volume Ratings Only)

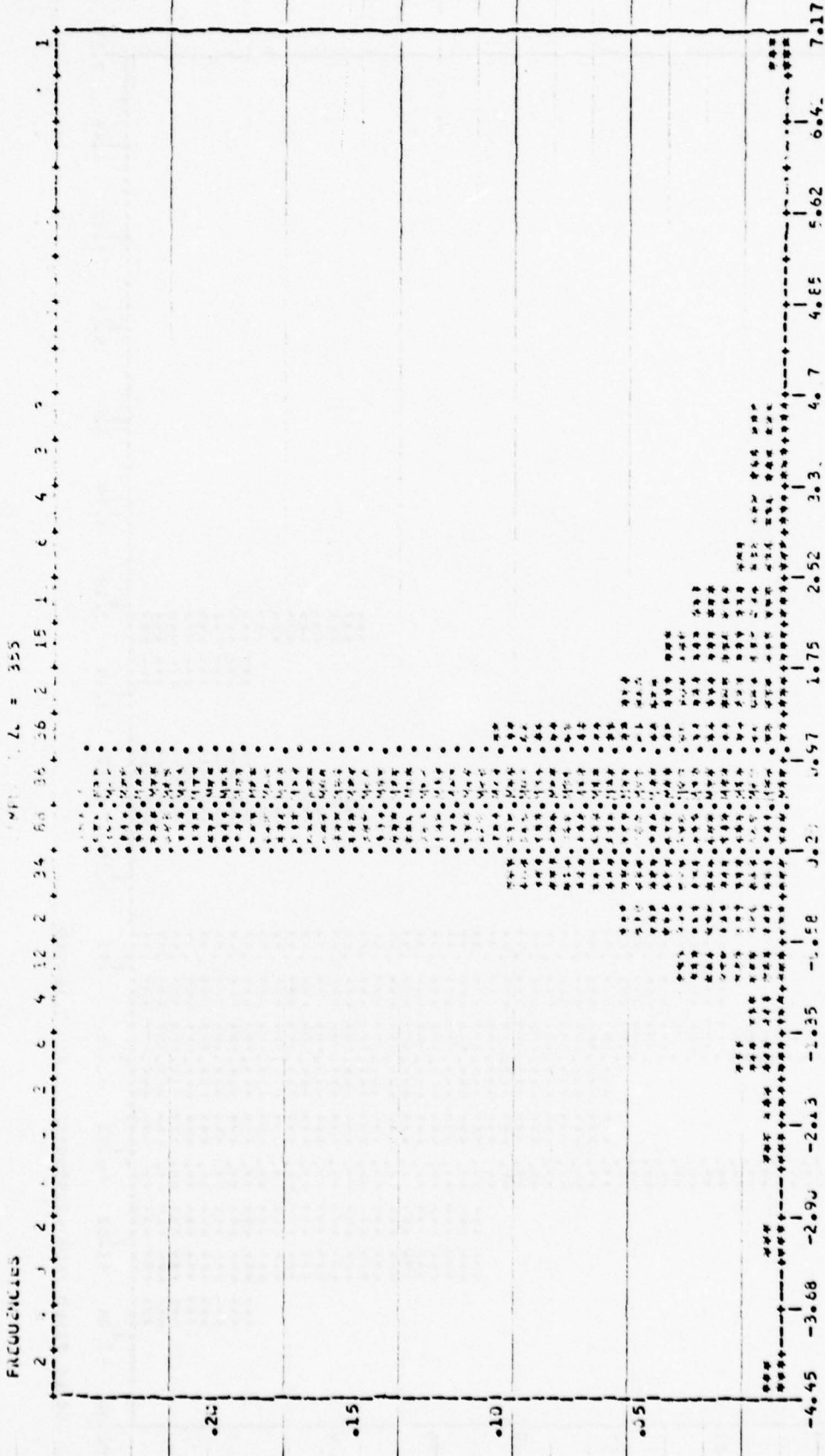

SCALE: FIXED FROM -6.6500000000000000 TO 7.1699999999999999

CENTRAL TENDENCY	SPREAD	HIGHEST CENTRAL MOMENTS	DISTRIBUTION
MEAN 0.523555	VAR. 1.211482	2.989211	W. NUM
TRIMED 0.134811	COEF. 1.091682	2.327886	QUANTILE
MODIAN 0.231881	MAN. 7.134822	2.151461	.75 QUANTILE
MODIAN 0.132381	MAN. 7.134822	2.355771	.50 QUANTILE
MODIAN 1.335928	MAN. 7.134822	2.666521	.25 QUANTILE
	MAN. 7.134822	1.314758	MAX. NUM

Δ_1 Errors of the Advancement Model for All Pay Grades (High Volume Ratings Only)

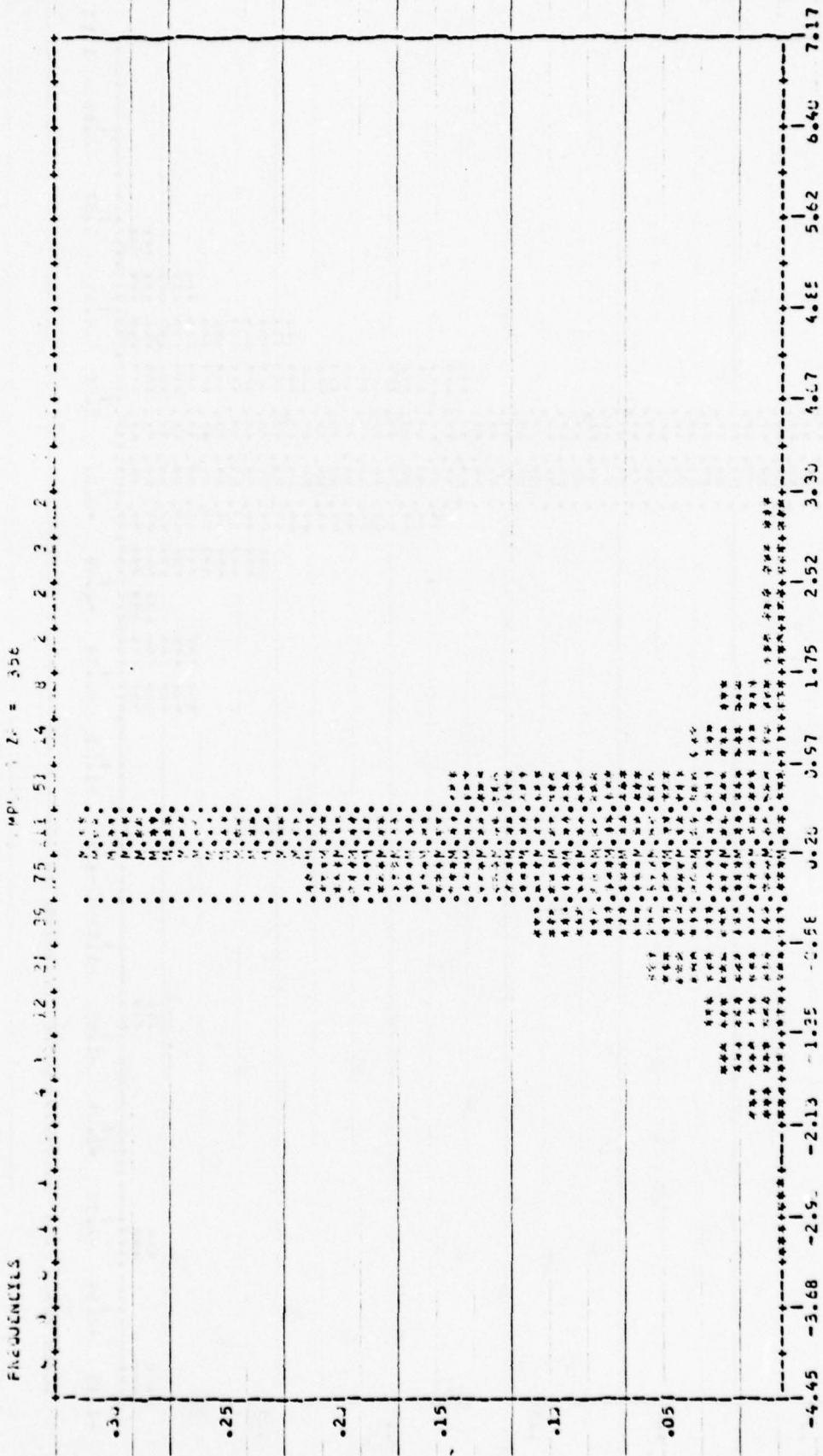

CENTRAL TENDENCY	SPREAD	HIGHER CENTRAL MOMENTS	DISTRIBUTION
MEAN 1.726491	VARIANCE 6.182343	M3 -6.436378	MINIMUM
MEDIAN 2.061785	STD DEV 2.485827	M4 2.122473	Q1 QUANTILE
TRIMEAN 2.280850	COEF VAR 1.439199	M5 -1.857118	.25 QUANTILE
MIDMEAN 2.331519	MEAN DEV 5.447967	M6 5.822255	.75 QUANTILE
MIDRANGE 3.776336	MAXIMUM 7.098161	M7 2.811871	MAXIMUM

APPENDIX H

HISTOGRAMS OF Δ_2 ERRORS, HIGH VOLUME RATINGS ONLY, FAST MODEL AND ADVANCEMENT MODEL

Δ_2 Errors of the FAST Model for Pay Grade E4 (High Volume Ratings Only)

SAMPLE SIZE = 78

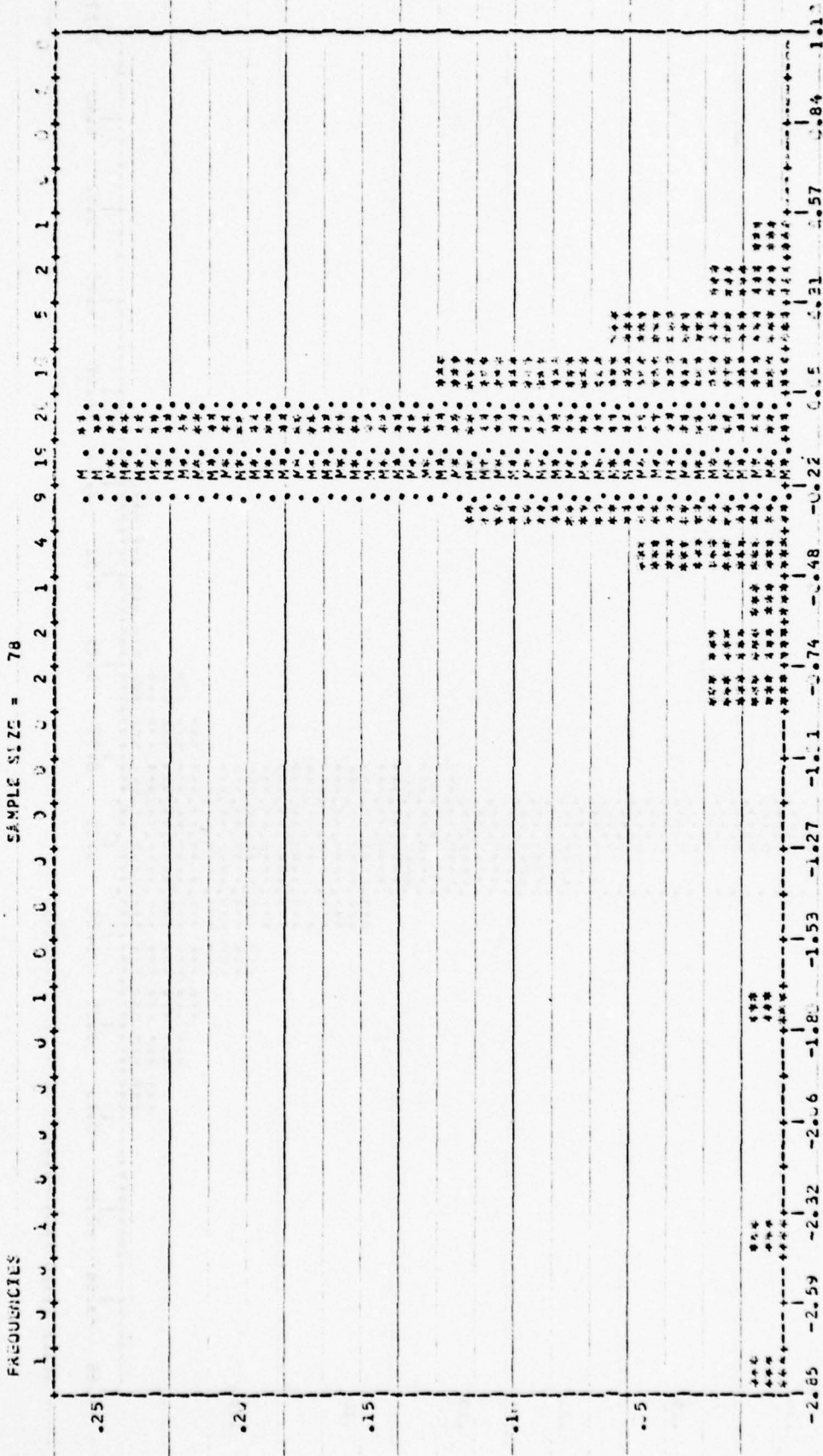

SCALE FIXED FROM -2.000000 TO 1.000000

GENERAL TENDENCY	SPREAD	HIGHER CENTRAL MOMENTS	DISTRIBUTION
MEAN	V-R-MODE	M2	MINI MUM
MEAN	U-CV	M3	10 QUANTILE
MEAN	U-CV	M4	25 QUANTILE
MEAN	U-CV	M5	50 QUANTILE
MEAN	U-CV	M6	75 QUANTILE
MEAN	U-CV	M7	MAXI MUM
MEAN	U-CV	M8	(HINGE)
MEAN	U-CV	M9	(HINGE)
MEAN	U-CV	M10	(HINGE)
MEAN	U-CV	M11	(HINGE)
MEAN	U-CV	M12	(HINGE)
MEAN	U-CV	M13	(HINGE)
MEAN	U-CV	M14	(HINGE)
MEAN	U-CV	M15	(HINGE)
MEAN	U-CV	M16	(HINGE)
MEAN	U-CV	M17	(HINGE)
MEAN	U-CV	M18	(HINGE)
MEAN	U-CV	M19	(HINGE)
MEAN	U-CV	M20	(HINGE)
MEAN	U-CV	M21	(HINGE)
MEAN	U-CV	M22	(HINGE)
MEAN	U-CV	M23	(HINGE)
MEAN	U-CV	M24	(HINGE)
MEAN	U-CV	M25	(HINGE)
MEAN	U-CV	M26	(HINGE)
MEAN	U-CV	M27	(HINGE)
MEAN	U-CV	M28	(HINGE)
MEAN	U-CV	M29	(HINGE)
MEAN	U-CV	M30	(HINGE)
MEAN	U-CV	M31	(HINGE)
MEAN	U-CV	M32	(HINGE)
MEAN	U-CV	M33	(HINGE)
MEAN	U-CV	M34	(HINGE)
MEAN	U-CV	M35	(HINGE)
MEAN	U-CV	M36	(HINGE)
MEAN	U-CV	M37	(HINGE)
MEAN	U-CV	M38	(HINGE)
MEAN	U-CV	M39	(HINGE)
MEAN	U-CV	M40	(HINGE)
MEAN	U-CV	M41	(HINGE)
MEAN	U-CV	M42	(HINGE)
MEAN	U-CV	M43	(HINGE)
MEAN	U-CV	M44	(HINGE)
MEAN	U-CV	M45	(HINGE)
MEAN	U-CV	M46	(HINGE)
MEAN	U-CV	M47	(HINGE)
MEAN	U-CV	M48	(HINGE)
MEAN	U-CV	M49	(HINGE)
MEAN	U-CV	M50	(HINGE)
MEAN	U-CV	M51	(HINGE)
MEAN	U-CV	M52	(HINGE)
MEAN	U-CV	M53	(HINGE)
MEAN	U-CV	M54	(HINGE)
MEAN	U-CV	M55	(HINGE)
MEAN	U-CV	M56	(HINGE)
MEAN	U-CV	M57	(HINGE)
MEAN	U-CV	M58	(HINGE)
MEAN	U-CV	M59	(HINGE)
MEAN	U-CV	M60	(HINGE)
MEAN	U-CV	M61	(HINGE)
MEAN	U-CV	M62	(HINGE)
MEAN	U-CV	M63	(HINGE)
MEAN	U-CV	M64	(HINGE)
MEAN	U-CV	M65	(HINGE)
MEAN	U-CV	M66	(HINGE)
MEAN	U-CV	M67	(HINGE)
MEAN	U-CV	M68	(HINGE)
MEAN	U-CV	M69	(HINGE)
MEAN	U-CV	M70	(HINGE)
MEAN	U-CV	M71	(HINGE)
MEAN	U-CV	M72	(HINGE)
MEAN	U-CV	M73	(HINGE)
MEAN	U-CV	M74	(HINGE)
MEAN	U-CV	M75	(HINGE)
MEAN	U-CV	M76	(HINGE)
MEAN	U-CV	M77	(HINGE)
MEAN	U-CV	M78	(HINGE)
MEAN	U-CV	M79	(HINGE)
MEAN	U-CV	M80	(HINGE)
MEAN	U-CV	M81	(HINGE)
MEAN	U-CV	M82	(HINGE)
MEAN	U-CV	M83	(HINGE)
MEAN	U-CV	M84	(HINGE)
MEAN	U-CV	M85	(HINGE)
MEAN	U-CV	M86	(HINGE)
MEAN	U-CV	M87	(HINGE)
MEAN	U-CV	M88	(HINGE)
MEAN	U-CV	M89	(HINGE)
MEAN	U-CV	M90	(HINGE)
MEAN	U-CV	M91	(HINGE)
MEAN	U-CV	M92	(HINGE)
MEAN	U-CV	M93	(HINGE)
MEAN	U-CV	M94	(HINGE)
MEAN	U-CV	M95	(HINGE)
MEAN	U-CV	M96	(HINGE)
MEAN	U-CV	M97	(HINGE)
MEAN	U-CV	M98	(HINGE)
MEAN	U-CV	M99	(HINGE)
MEAN	U-CV	M100	(HINGE)

Δ_2 Errors of the Advancement Model for Pay Grade E4 (High Volume Ratings Only)

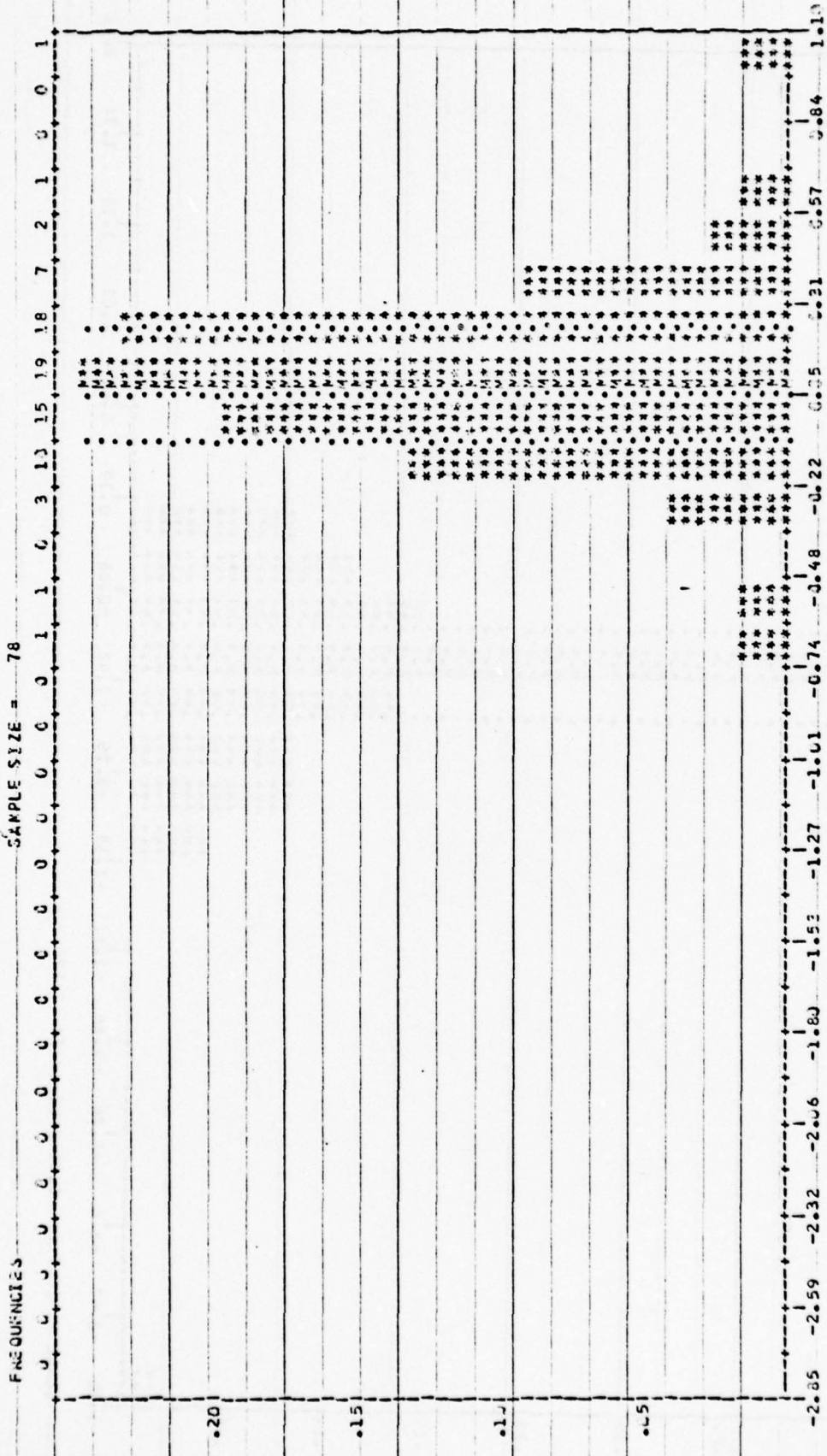

SCALE FIXED FROM -2.849995 TO 1.059999

CENTRAL TENDENCY		SPREAD		HIGHER CENTRAL NUMERIS		DISTRIBUTION	
MEAN	1.57375E-01	VARIANCE	6.21013E-01	M3	5.36622E-03	MIN	1.64375E-01
STDEV	7.97281E-02	COEFF CVR	2.07191E-01	M4	5.79282E-04	Q1	1.64375E-01
MODAL	8.34220E-02	MEAN DLR	1.83156E-01	KURTOSIS	3.12340E-02	Q2	1.64375E-01
MIDRANGE	2.18676E-01	RANGE	1.78657E-01	BETA2	2.34718E-02	Q3	1.64375E-01
		MODSPREAD	3.14199E-01			MAXIMUM	1.64375E-01
						(HANGE)	1.64375E-01
						(MODAL)	1.64375E-01
						(HANGE)	1.64375E-01
						(MODAL)	1.64375E-01
						(HANGE)	1.64375E-01

Δ_2 Errors of the FAST Model for Pay Grade E5 (High Volume Ratings Only)

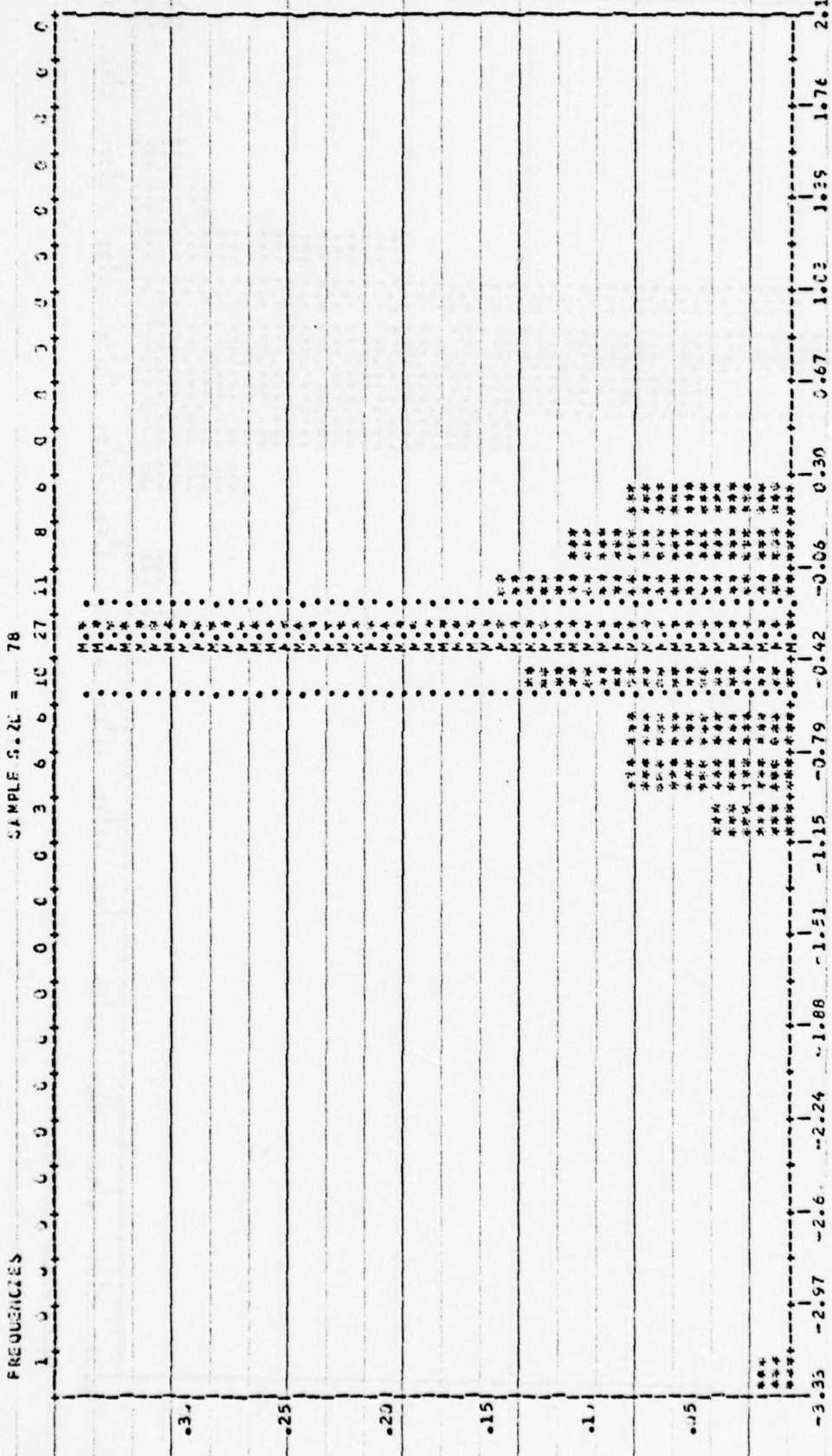

SCALE FIXED FROM -3.33 TO 2.12

CENTRAL TENDENCY	SPREAD	HIGHER CENTRAL MOMENTS	DISTRIBUTION
MEAN -3.883399E-01	VARIANCE 2.1204235E-01	M2 -3.346264E-01	MINIMUM QUANTILE
MIDMEAN -3.333817E-01	STD DEV 4.604452E-01	M3 1.0131875E-01	.25 QUANTILE
TRIMEAN -3.498685E-01	COEF VAR 1.185054E-01	SKWNESS -3.427755E-01	(F-RANGE)
MIDRANGE -3.40711E-01	MEAN DEV 2.747633E-01	KURTOSIS 1.995619E-01	.50 QUANTILE
M4DRANGE -1.53652E-01	RANGE 3.576566E-01	BETA1 3.21862E-01	.75 QUANTILE
	M4DRANGE 3.596725E-01	BETA2 5.823224E-01	.95 QUANTILE
			MAXIMUM

Δ_2 Errors of the Advancement Model for Pay Grade E5 (High Volume Ratings Only)

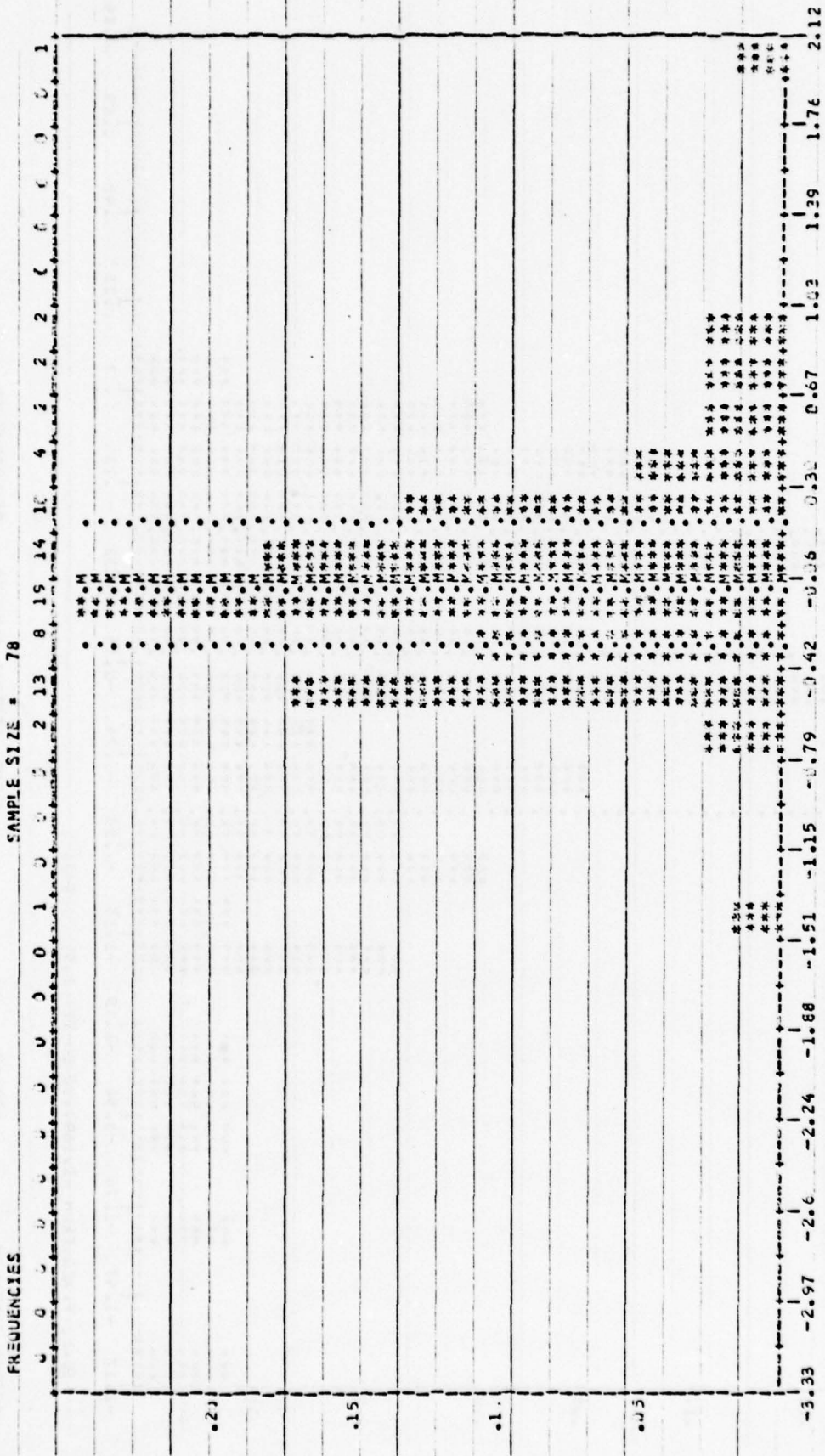

SCALE F: XED FROM -3.33 TO 2.12

CENTRAL TENDENCY	SPREAD	HIGHER CENTRAL MOMENTS	DISTRIBUTION
MEAN	VARIANCE	M3	MINIMUM
MODE	STD DEV	M4	1 QUANTILE
MEAN	COEFF VAR	SKENESS	.25 QUANTILE (MAGE)
MIDRANGE	MEAN DEV	KURTOSIS	.50 QUANTILE (MAGE)
	MAX DISP	BEYR2	.75 QUANTILE (MAGE)
			MAXIMUM

Δ_2 Errors of the FAST Model for Pay Grade E6 (High Volume Ratings Only)

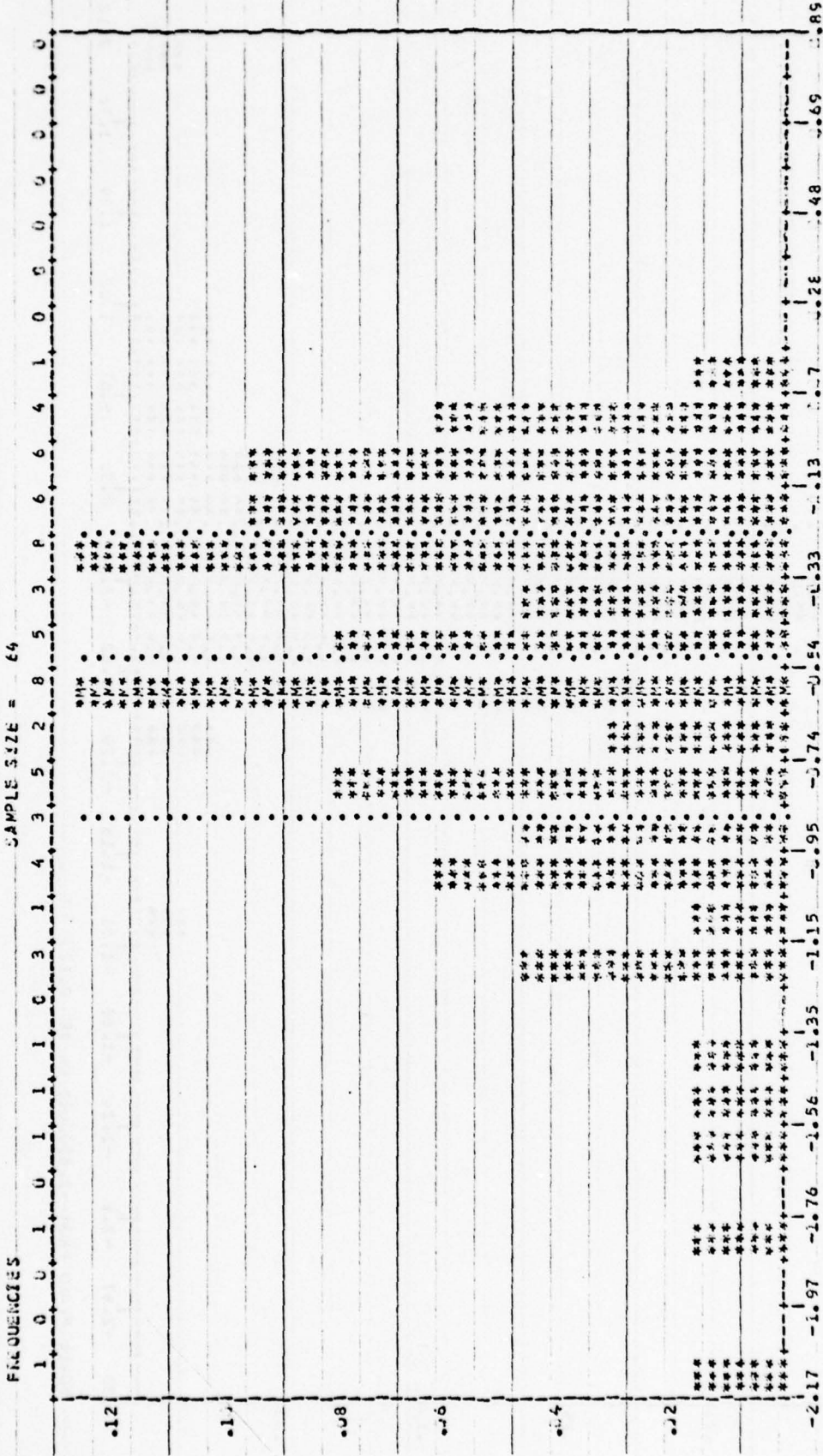

SCALE: FAXED FROM -2.169999E 00 TO 8.900000E 01

CENTRAL TENDENCY	SPREAD	HIGHER CENTRAL MOMENTS	DISTRIBUTION
MEAN	VARANCE	M3	MUM
MEDIAN	STD DEV	M4	QUANTILE
PK MEAN	Coeff VAR	KURTOSIS	QUANTILE
PK MEAN	MUM LEV	BETA1	QUANTILE
MEDIAN	MEDSPREAD	BETA2	QUANTILE
			MAX MUM

Δ_2 Errors of the Advancement Model for Pay Grade E6 (High Volume Ratings Only)

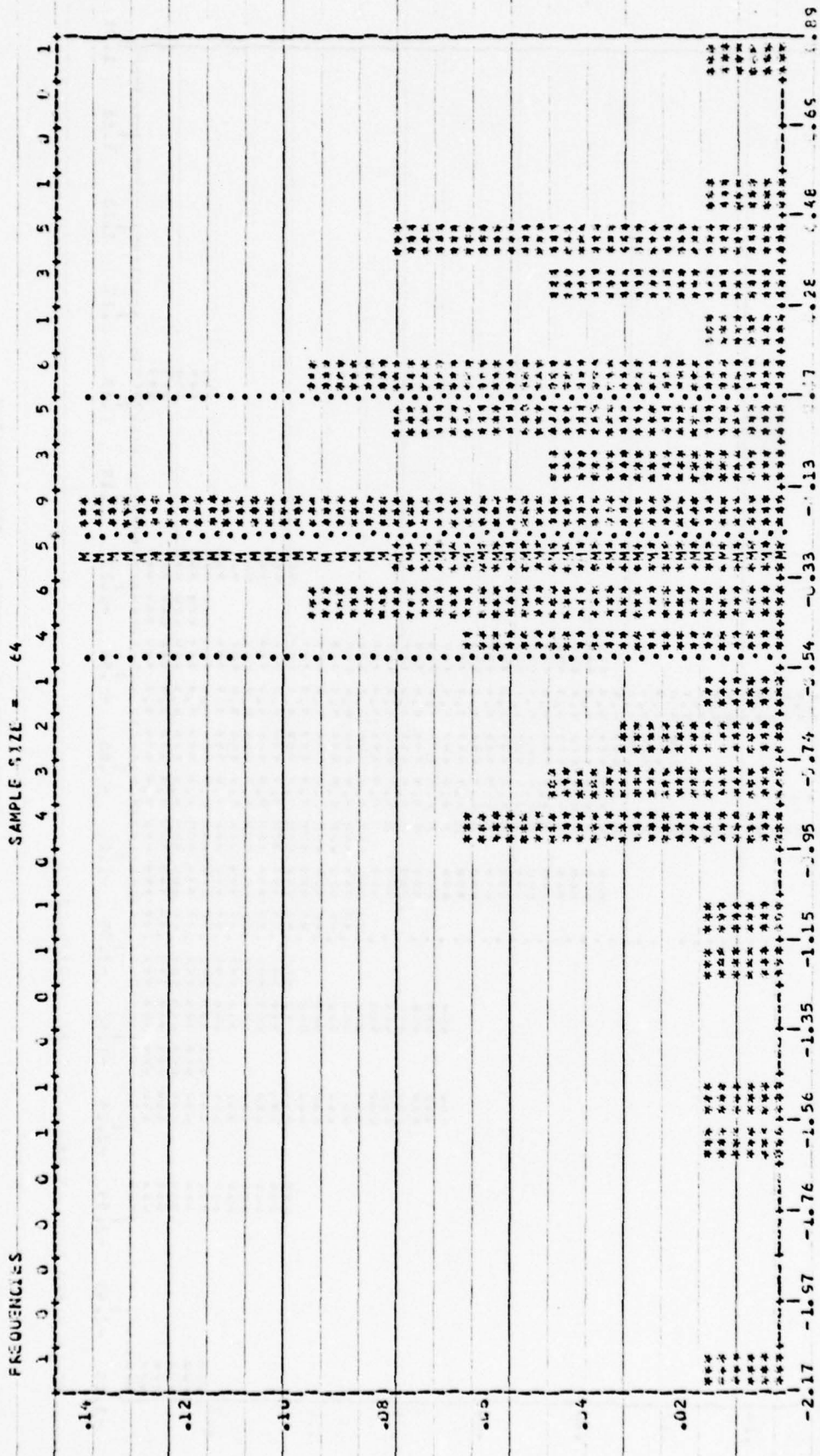

SCALE: FIXED-FROM -2.1699995 TO 1.8900005

CENTRAL TENDENCY		SPREAD		HIGHER CENTRAL MOMENTS		DISTRIBUTION	
MEAN	-2.7181616-01	VARIANCE	2.5981288-01	M2	-1.4550478-01	MINIMUM	2.1612582E-01
STDEV	2.1759133-01	COEF VAR	5.4755168-01	M3	3.9177666-01	.15	QUANTILE
MEAN DEV	-2.1501193-01	MEAN DEV	2.1442800-01	KURTOSIS	8.8342958-01	.25	QUANTILE
MIDRANGE	-2.0071823-01	SPREAD	4.1497428-01	KURTOSIS	1.4775522E-01	.75	QUANTILE
RANGE	-6.3455645-01	MIDSPREAD	3.8493288-01	BETA1	-1.3849441E-01	.90	QUANTILE
				BETA2	3.8949441E-01	MAXIMUM	2.5345172-01

Δ_2 Errors of the FAST Model for Pay Grade E7 (High Volume Ratings Only)

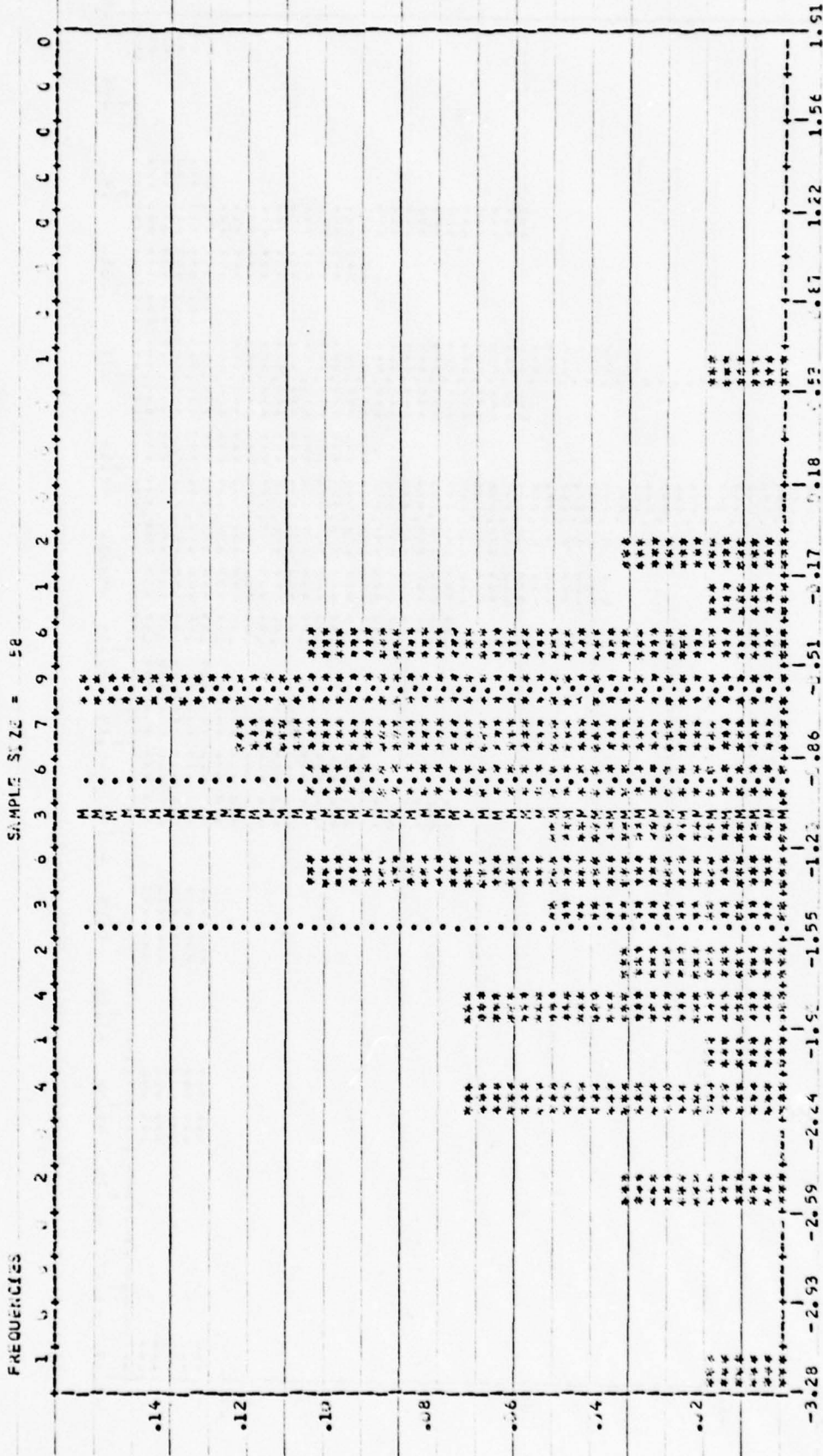

SCALE: FIXED-FRUM-3.28-1.91

CENTRAL TENDENCY		SPREAD		HIGHER CENTRAL MOMENTS		DISTRIBUTION	
MEAN	-1.975694	VAR	5.021558	M3	-1.978449	MINIMUM	-2.973879
STD DEV	2.242005	COV	7.362951	M4	9.757751	QUANTILE	2.124357
MEAN	-9.951125	COV	6.443878	SKW	-5.558933	QUANTILE	1.188321
MEAN	-9.953174	COV	5.544970	KURTOSIS	6.607511	QUANTILE	0.250000
MEAN	-1.291654	COV	3.975472	BETA1	-1.871288	QUANTILE	0.250000
		MEAN	9.035878	BETA2	8.707821	QUANTILE	0.250000
						MAXIMUM	2.973879

Δ_2 Errors of the Advancement Model for Pay Grade E7 (High Volume Ratings Only)

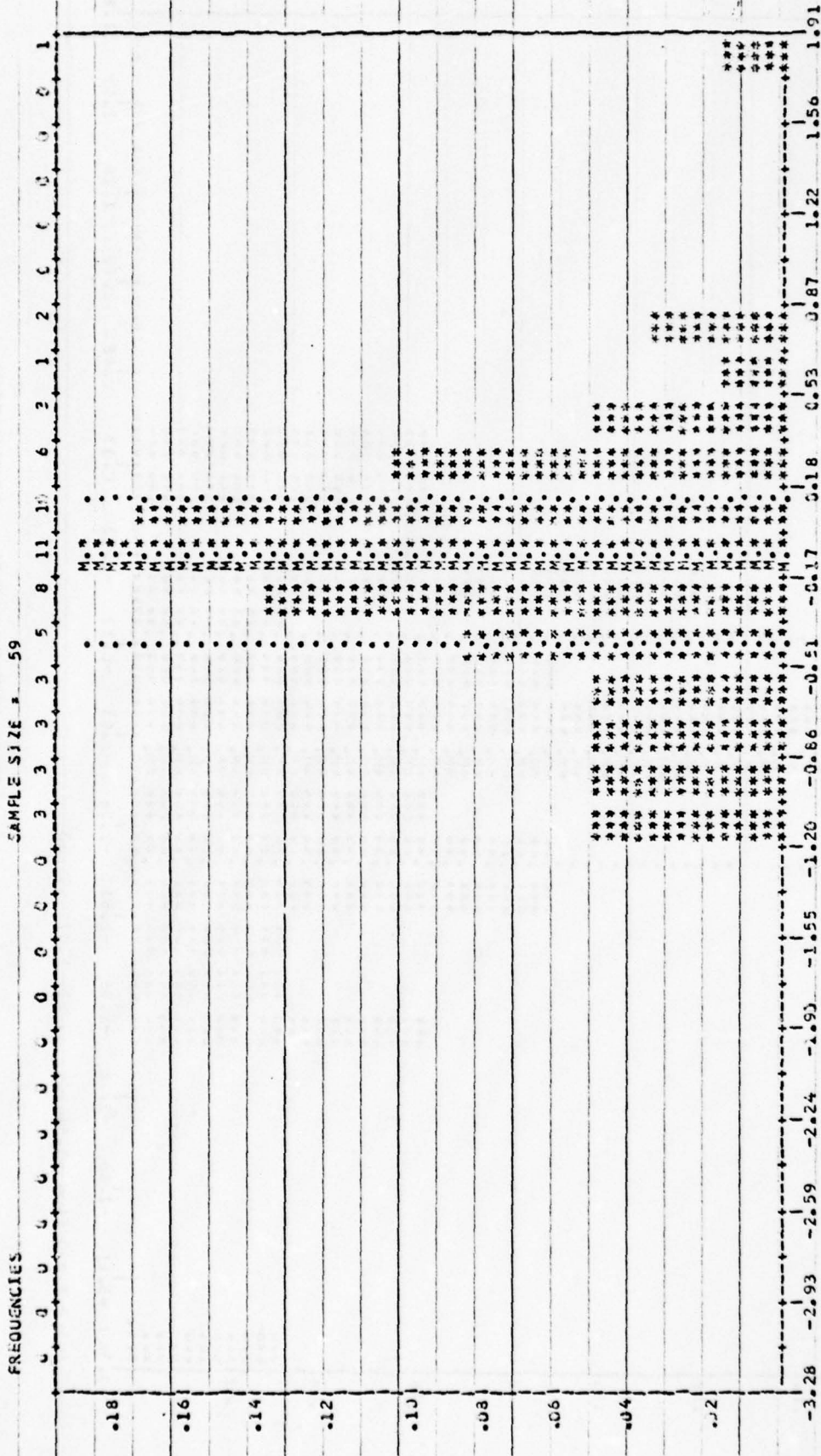

SCALE FIXED FROM -3.28 TO 0.00 TO 1.9100000000

CENTRAL TENDENCY	SPREAD	HIGHER CENTRAL MOMENTS	DISTRIBUTION
MEAN -1.183792E-01	VARIANCE 2.744942E-01	M3 9.739536E-02	MINIMUM -1.171766E-01
STDEV -6.741307E-02	STD DEV 5.239222E-01	M4 4.235191E-01	1st QUANTILE -8.022291E-01
KURTOSIS -9.700088E-02	SKEWNESS 4.425795E-01	KURTOSIS 4.235191E-01	25 QUANTILE (MCCVAN) -4.425795E-01
MIDRANGE -9.835141E-02	MEAN DEV 3.825454E-01	BETA1 2.626161E-01	50 QUANTILE (MCCVAN) -1.663937E-01
BETA2 3.655767E-01	MIDSPREAD 5.017845E-01	BETA2 4.026631E-01	75 QUANTILE 1.514519E-01
			MAXIMUM 1.514519E-01

Δ_2 Errors of the FAST Model for Pay Grade E8 (High Volume Ratings Only)

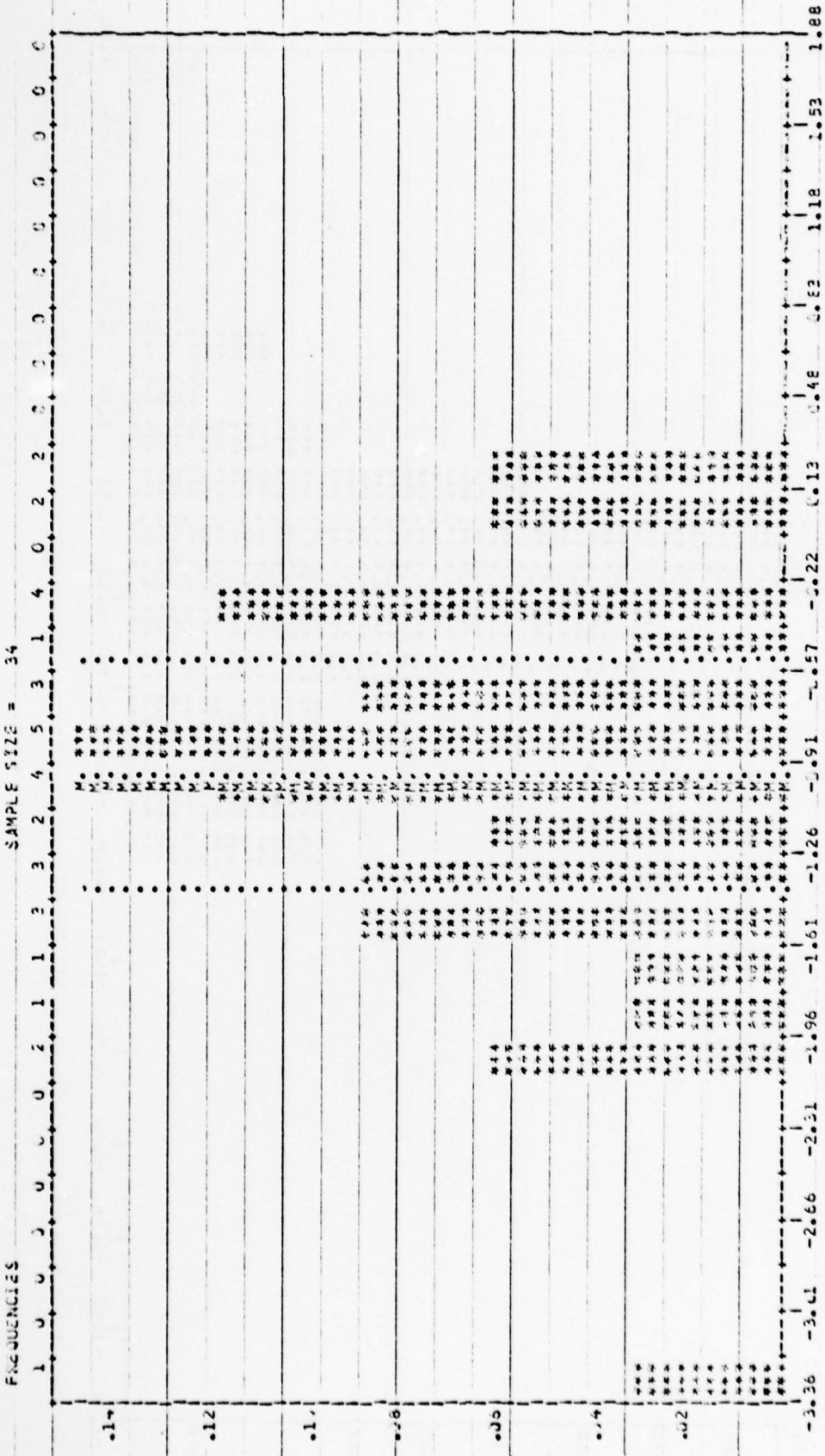

SCALE: FREQ FROM 34560000 TO 75 148799000

CENTRAL TENDENCY	SPREAD	FIGHER CENTRAL MOMENTS	DISTRIBUTION
MEAN -9.942435 -01	VAR/MCC 5.485566 -01	M3 -3.448713 -01	MINIMUM
MEDIAN -9.857445 -01	STD DEV 7.415431 -01	M4 10.367242 -01	QUANTILE
TRIM-MEAN -9.543936 -01	COEF VAR 7.432544 -01	M5 47.8178 -01	QUANTILE
MODE -9.229371 -01	MAD/M DEV 5.516249 -01	KURTOSIS 1.513451 -01	QUANTILE
MODE -9.546631 -01	SKW 3.619515 -01	BETA1 -3.151333 -01	QUANTILE
	MAD/SRSD 8.889346 -01	BETA2 1.257466 -01	MAXIMUM

Δ_2 Errors of the FAST Model for Pay Grade E9 (High Volume Ratings Only)

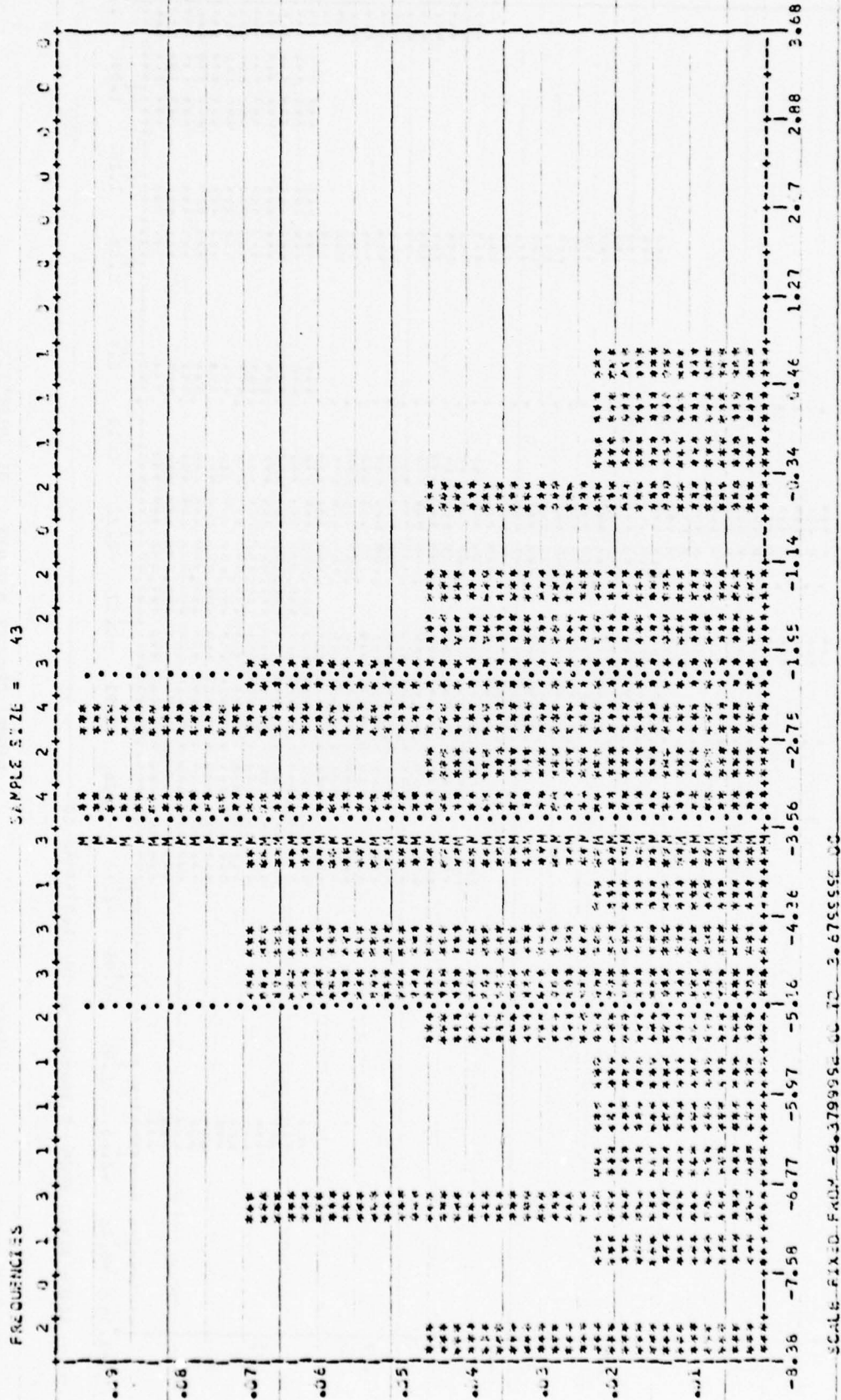

Δ_2 Errors of the Advancement Model for Pay Grade E9 (High Volume Ratings Only)

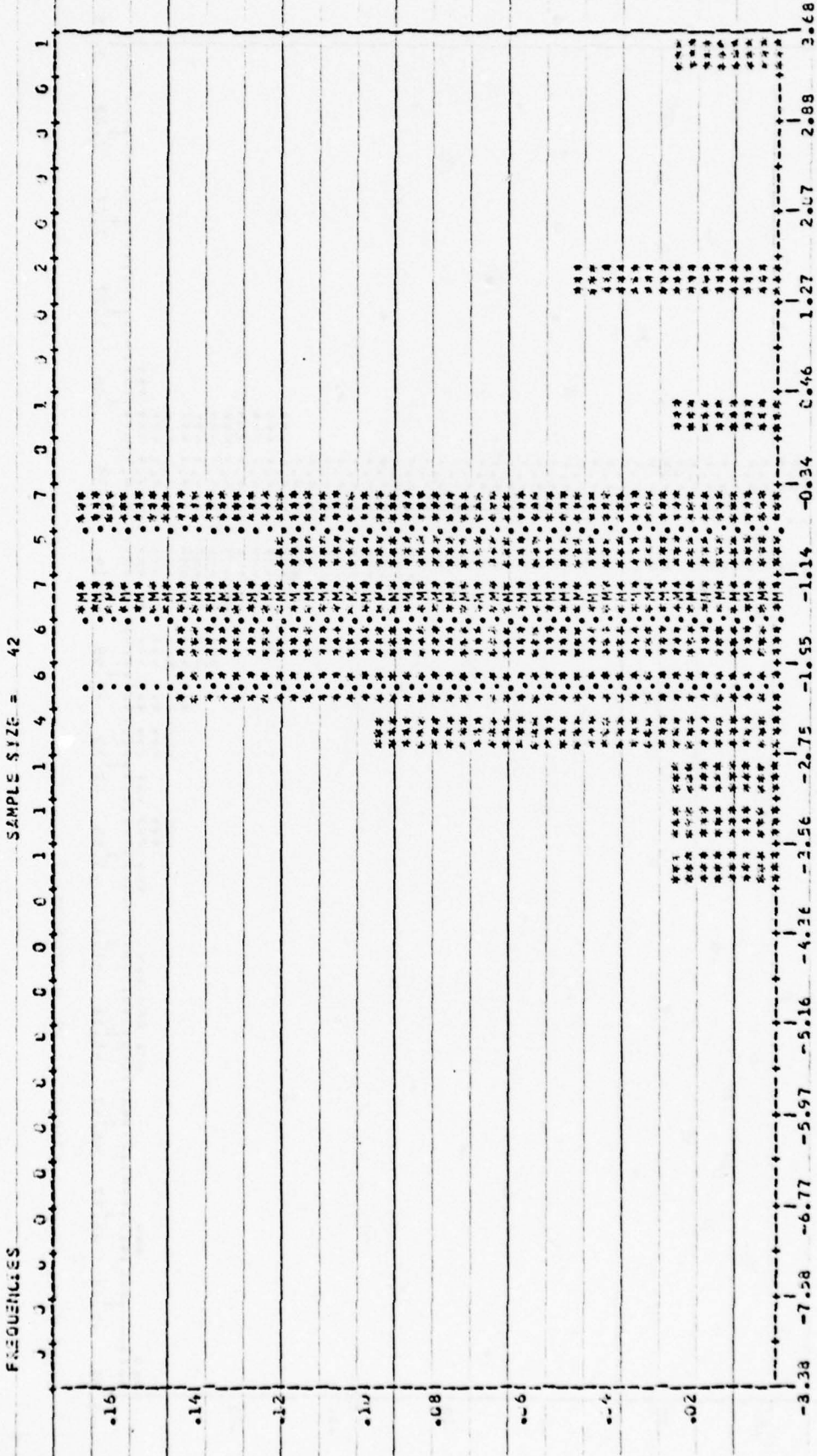

SCALE FIXED FROM 6.375955E-04 TO 3.675555E-00

CENTRAL TENDENCY	SPREAD	HIGHER CENTRAL MOMENTS	DISTRIBUTION
MEAN	VARIANCE	M3	MINIMUM
STDEV	COEF VAR	SKWNESS	.13 QUANTILE
MEAN CLV	MEAN CLV	KURTOSIS	.25 QUANTILE
MEAN CLV	MEAN CLV	PL1A2	.5 QUANTILE
MEAN CLV	MEAN CLV	PL1A2	.75 QUANTILE
MEAN CLV	MEAN CLV	PL1A2	MAXIMUM

Δ_2 Errors of the FAST Model for All Pay Grades (High Volume Ratings Only)

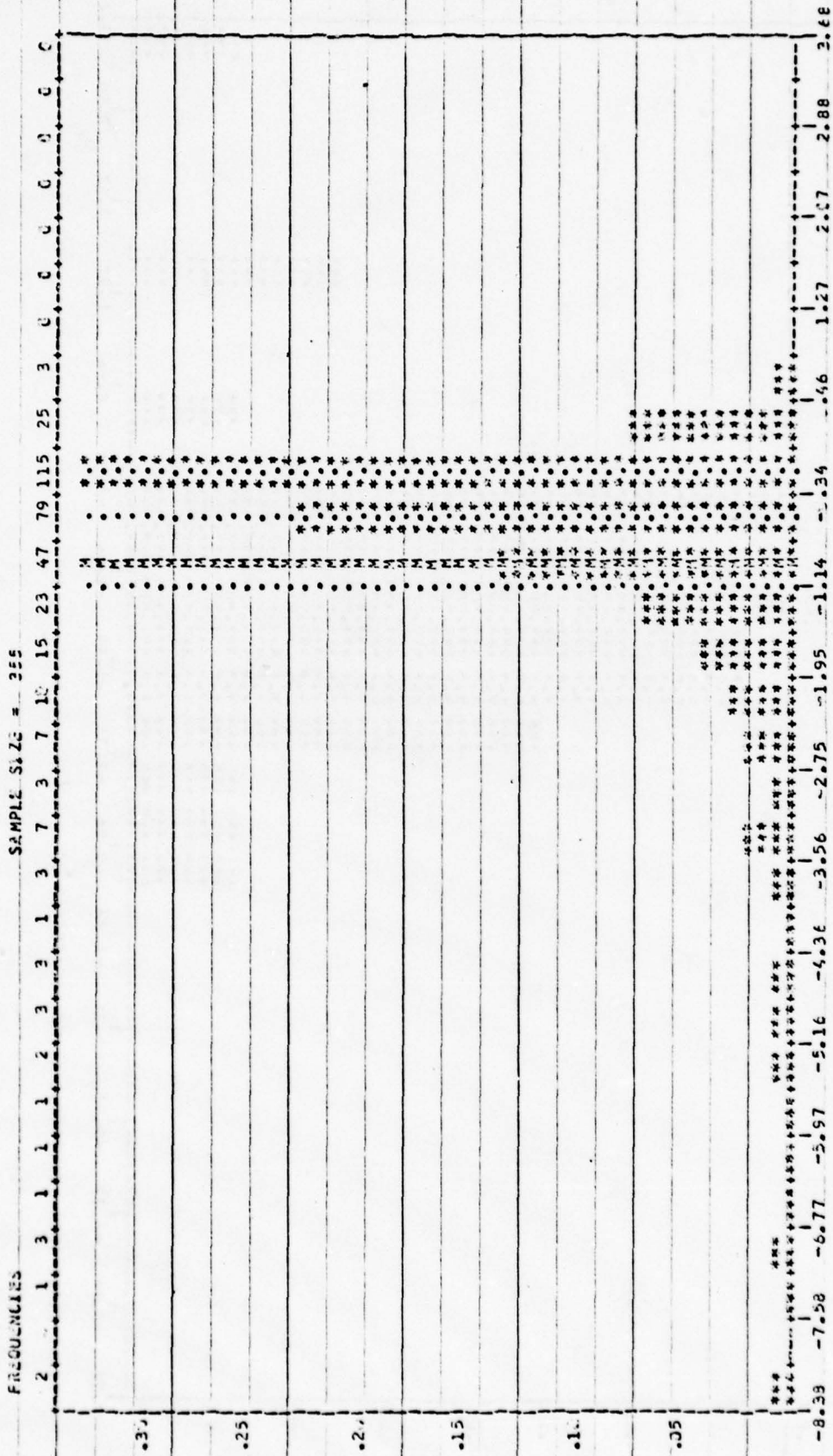

SCALE FIXED FROM -6.379996E-01 TO 3.679999E-01

CENTRAL TENDENCY	SPREAD	HIGHER CENTRAL MOMENTS	DISTRIBUTION
MEAN	VAR	M3	MINIMUM
STDEV	COV	M4	1. QUANTILE
COEFF VAR	CVAR	SKWNESS	.25 QUANTILE
MEAN DEV	MEAN	KURTOSIS	.5 QUANTILE
SEMG	SEMG	BEYAL	.75 QUANTILE
MIDSPREAD	MIDSPREAD	BEYAL	.9 QUANTILE
			MAXIMUM

Δ_2 Errors of the Advancement Model for All Pay Grades (High Volume Ratings Only)

FREQUENCIES

SAMPLE SIZE = 356

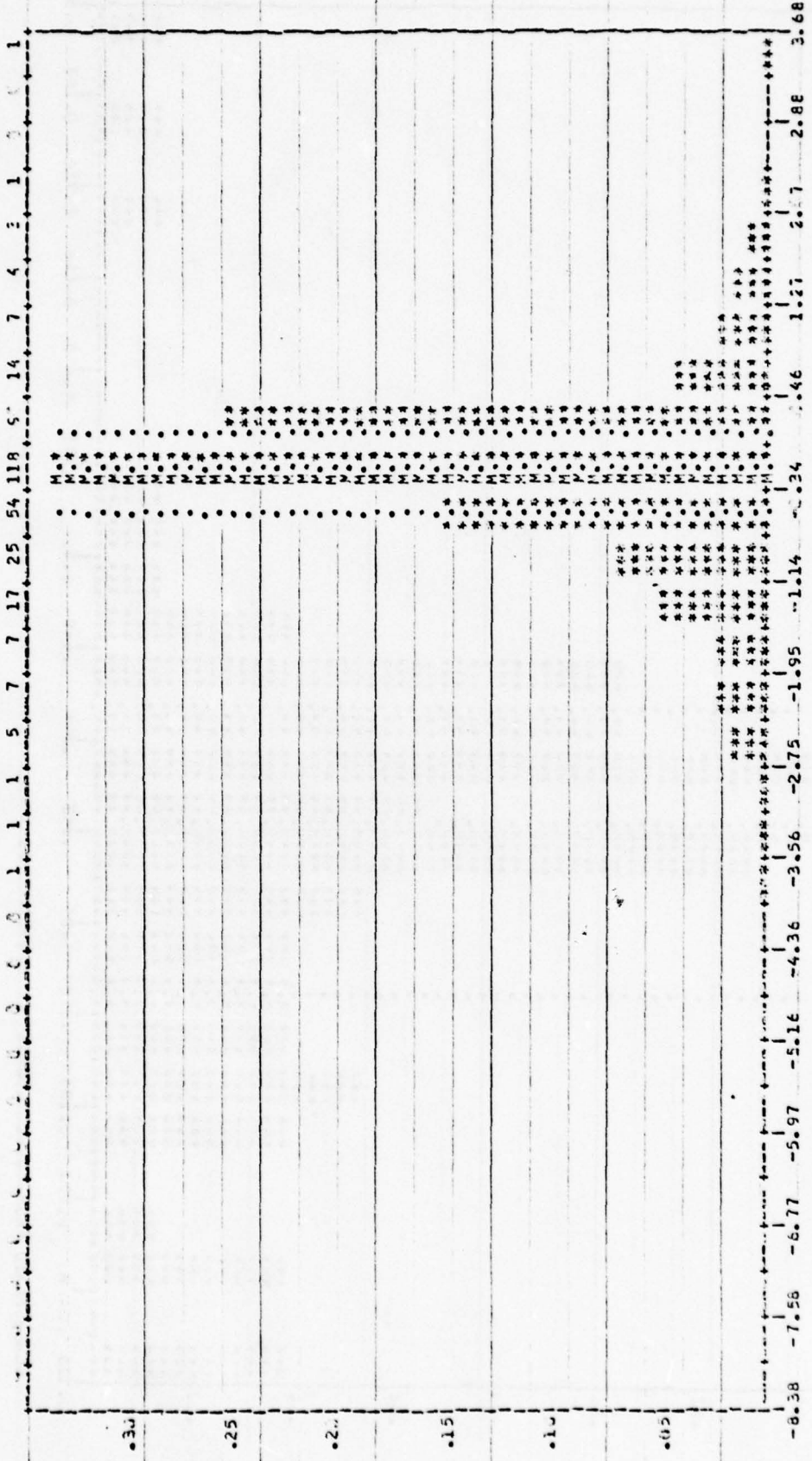

SCALE: FREQ. FROM -6.379999E-01 TO 3.679999E-00

CENTRAL TENDENCY	SPREAD	HIGHER CENTRAL MOMENTS	DISTR.(BUTTON)
MEAN	VALANCE	M3	MINIMUM
MODE	DIFF CV	M4	15 QUANTILE
VARIANCE	MEAN CV	SKWNESS	25 QUANTILE
STANDARD DEVIATION	MEAN CV	KURTOSIS	50 QUANTILE
MEAN RANGE	MIDSPREAD	BETA1	75 QUANTILE
MEAN RANGE		BETA2	90 QUANTILE
			MAXIMUM

APPENDIX I

HISTOGRAMS OF Δ_3 ERRORS, HIGH VOLUME RATINGS ONLY, FAST MODEL AND ADVANCEMENT MODEL

Δ_3 Errors of the FAST Model for Pay Grade E4 (High Volume Ratings Only)

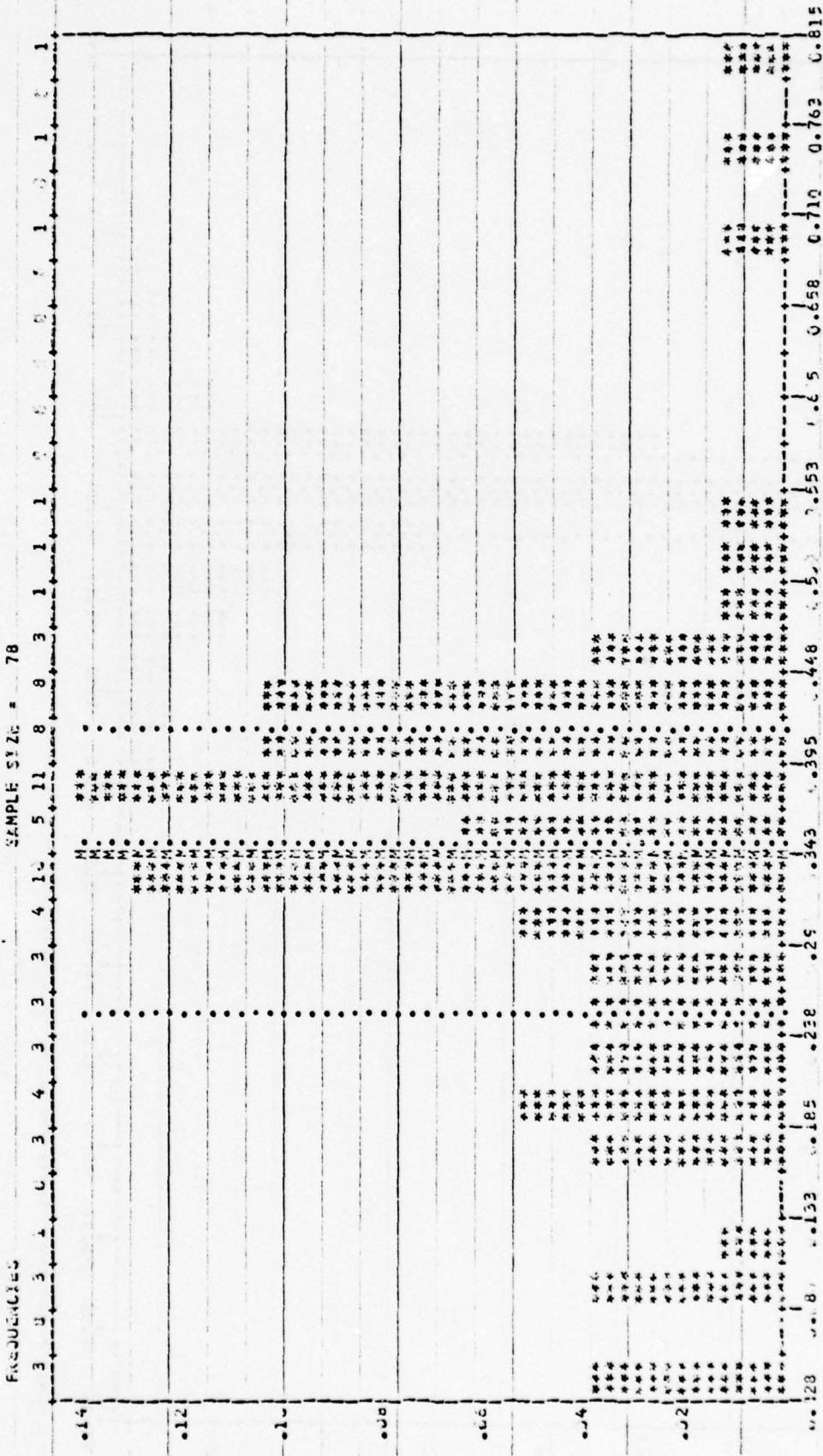

SCALE FIXED FROM -2.800000-2 TO 8.150000-1

CENTRAL TENDENCY	JPRFD	HIGHER CENTRAL MOMENTS	DISTRIBUTION
MEAN	1.998776E-02	M3	MINIMUM
STDEV	1.413776E-01	M4	QUANTILE
VAR	4.011319E-01	M5	.25 QUANTILE
COEFF VAR	1.011599E-01	M6	.5 QUANTILE
MEAN CLV	7.862458E-01	M7	.75 QUANTILE
RANGE	1.658560E-01	M8	.90 QUANTILE
MIDSPREAD		M9	MAXIMUM
MEAN M.A.A	2.326353E-01		
MEAN M.A.A	2.326353E-01		

Δ₃ Errors of the Advancement Model for Pay Grade E4 (High Volume Ratings Only)

SAMPLE SIZE = 78

FREQUENCIES

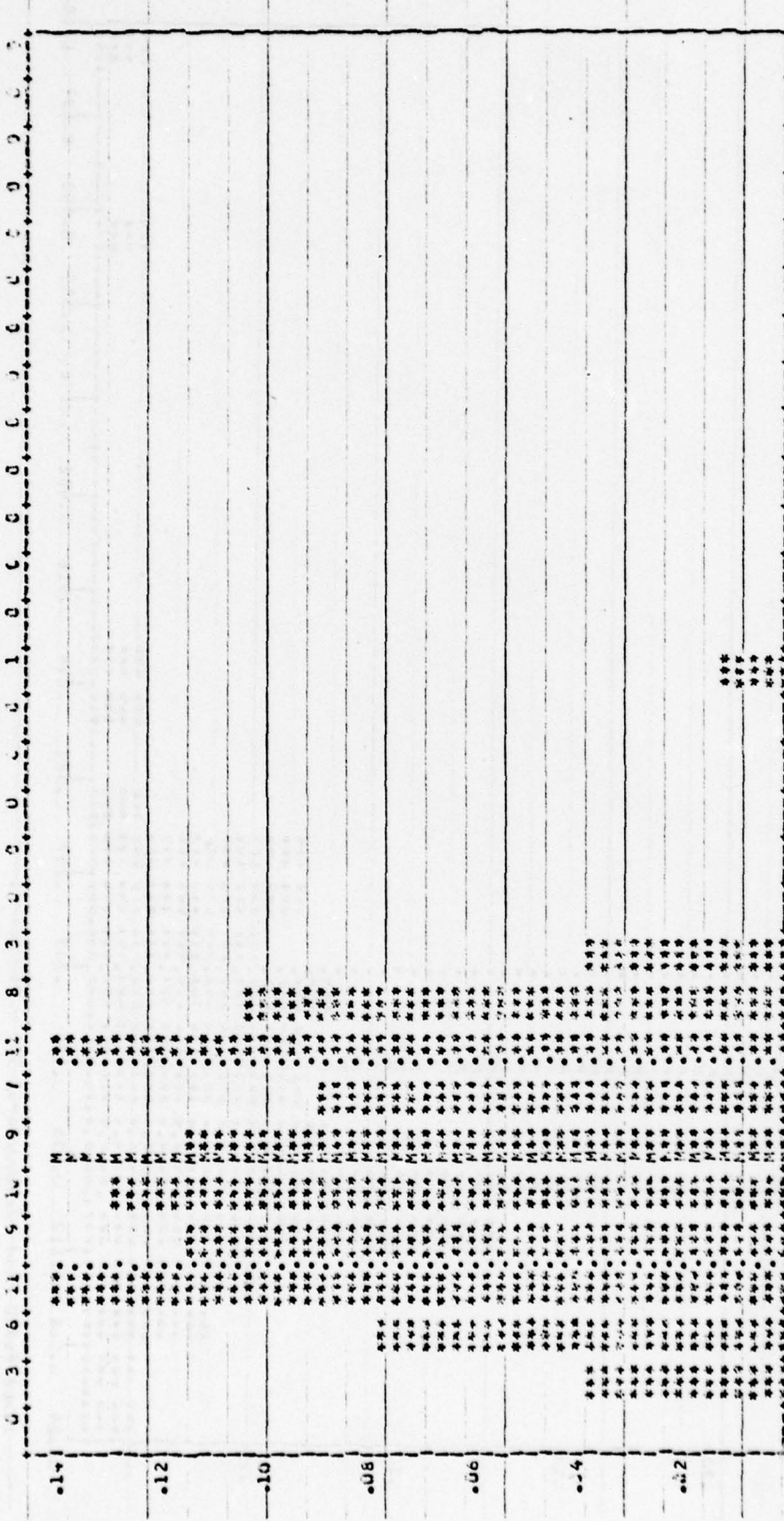

0.28 0.30 0.32 0.34 0.36 0.38 0.40 0.42 0.44 0.46 0.48 0.50 0.52 0.54 0.56 0.58 0.60 0.62 0.64 0.66 0.68 0.70 0.72 0.74 0.76 0.78 0.80 0.815

SCALE FIXED FROM -2.80 TO 8.15

CENTRAL TENDENCY	SPREAD	HIGHER CENTRAL MOMENTS	DISTRIBUTION
MEAN	V-RANGE	M3	MINIMUM
TRIMEAN	S.D. DEV	M4	.1 QUANTILE
MIDRANGE	Coeff VAR	SKWNESS	.25 QUANTILE
MICRANGE	PLAN DEV	KURTOSIS	.5 QUANTILE
OCUM MEAN	RANGE	BETA1	.75 QUANTILE
PLA MEAN	M.CS REAC	BETA2	.9 QUANTILE
			MAXIMUM

1.944557-01 5.266171E-03 2.245485-04 5.585 31-02
 1.854157-01 7.256834E-02 1.051981E-04 5.82066E-01
 1.871359-01 3.810249E-01 5.884288E-01 1.255538E-01
 2.375512-01 5.925151E-02 7.931922E-01 1.81417E-01
 1.787893-01 4.47324E-01 2.163707E-04 2.25545E-01
 1.621271-01 1.184126E-01 1.018663E-04 2.75379E-01

0.23 0.28 0.32 0.36 0.40 0.44 0.48 0.52 0.56 0.60 0.64 0.68 0.72 0.76 0.815

0.815

0.78 0.815

0.710 0.763

0.553 0.625

0.448 0.555

0.395 0.530

0.238 0.448

0.185 0.448

0.135 0.448

0.085 0.448

0.035 0.448

0.015 0.448

0.005 0.448

0.001 0.448

0.000 0.448

0.000 0.448

0.000 0.448

0.000 0.448

0.000 0.448

0.000 0.448

0.000 0.448

0.000 0.448

0.000 0.448

0.000 0.448

0.000 0.448

0.000 0.448

0.000 0.448

0.000 0.448

0.000 0.448

0.000 0.448

0.000 0.448

0.000 0.448

0.000 0.448

0.000 0.448

0.000 0.448

0.000 0.448

0.000 0.448

0.000 0.448

0.000 0.448

0.000 0.448

0.000 0.448

0.000 0.448

0.000 0.448

0.000 0.448

0.000 0.448

0.000 0.448

0.000 0.448

0.000 0.448

0.000 0.448

0.000 0.448

0.000 0.448

0.000 0.448

0.000 0.448

0.000 0.448

0.000 0.448

0.000 0.448

0.000 0.448

0.000 0.448

0.000 0.448

0.000 0.448

0.000 0.448

0.000 0.448

0.000 0.448

0.000 0.448

0.000 0.448

0.000 0.448

0.000 0.448

0.000 0.448

0.000 0.448

0.000 0.448

0.000 0.448

0.000 0.448

0.000 0.448

0.000 0.448

0.000 0.448

0.000 0.448

0.000 0.448

0.000 0.448

0.000 0.448

0.000 0.448

0.000 0.448

0.000 0.448

0.000 0.448

0.000 0.448

0.000 0.448

0.000 0.448

0.000 0.448

0.000 0.448

0.000 0.448

0.000 0.448

0.000 0.448

0.000 0.448

0.000 0.448

0.000 0.448

0.000 0.448

0.000 0.448

0.000 0.448

0.000 0.448

0.000 0.448

0.000 0.448

0.000 0.448

0.000 0.448

0.000 0.448

0.000 0.448

0.000 0.448

0.000 0.448

0.000 0.448

0.000 0.448

0.000 0.448

0.000 0.448

Δ_3 Errors of the FAST Model for Pay Grade E5 (High Volume Ratings Only)

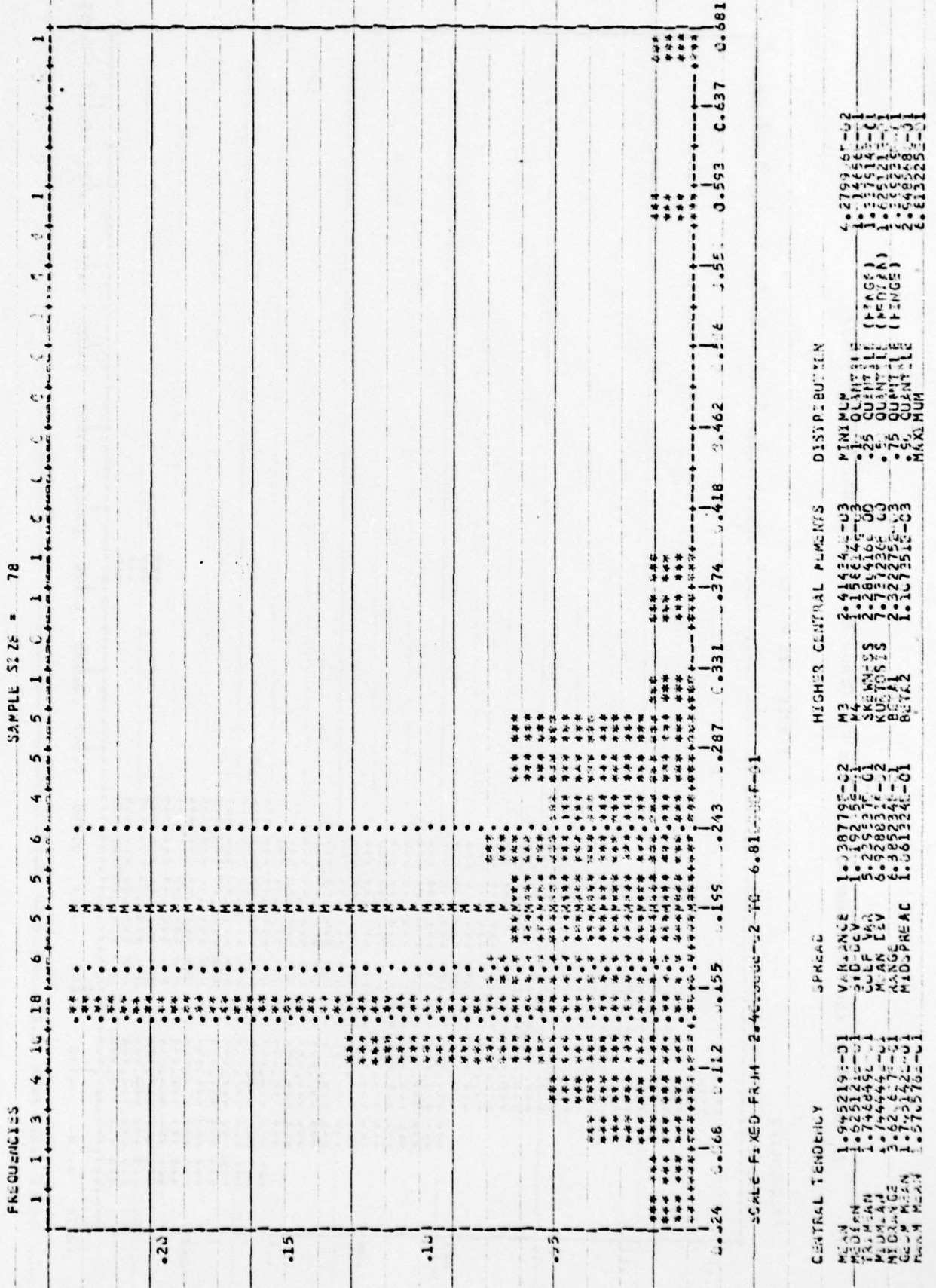

Δ_3 Errors of the Advancement Model for Pay Grade E5 (High Volume Ratings Only)

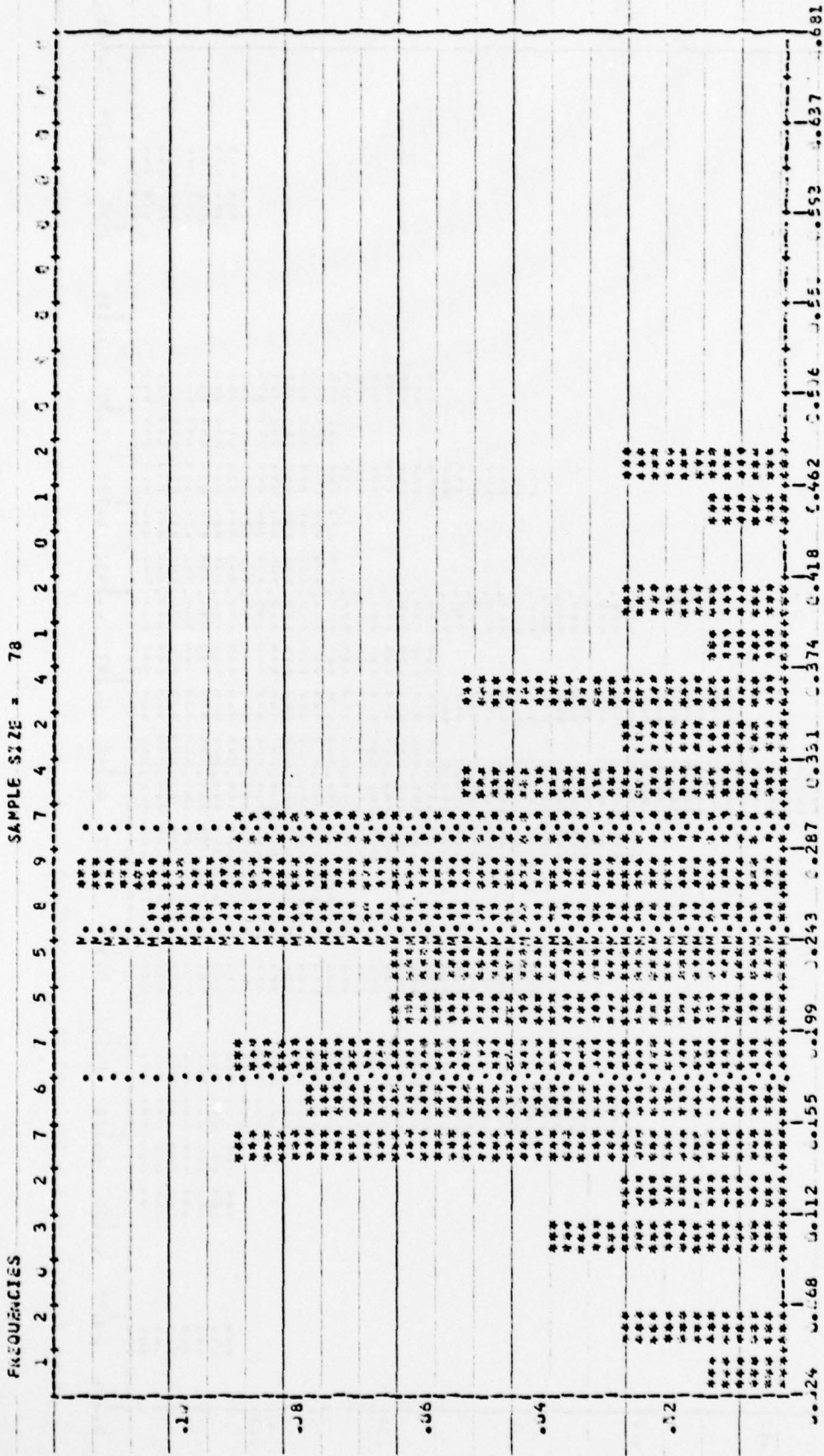

SCALE: F1 MED FROM 2.400000E-02 TO 6.810000E-01

CENTRAL TENDENCY	SPREAD	HIGHER CENTRAL MOMENTS	DISTRIBUTION
MEAN 2.42255E-01	VAR 8.76556E-03	M2 1.55519E-04	MINI NUM 2.93166E-02
MODIAN 2.44475E-01	STD DEV 9.36245E-02	M3 2.27265E-04	1.5 QUANTILE 1.26634E-01
MODEAN 2.39622E-01	CURT VAR 3.85512E-01	KURTOSIS 1.94839E-02	.5 QUANTILE (.P5) 2.56934E-01
MIDYRGE 2.51877E-01	PLANK LCV 7.42081E-02	BETA1 1.21753E-04	.5 QUANTILE (HTNGE) 2.56934E-01
GEA MEAN 2.21444E-01	RANGE 4.53542E-01	BETA2 2.21468E-04	.75 QUANTILE 3.24566E-01
MEAN 1.86842E-01	MADIPACK 1.18242E-01		.90 QUANTILE 3.77858E-01
			MAXI NUM 4.77858E-01

Δ_3 Errors of the FAST Model for Pay Grade E6 (High Volume Ratings Only)

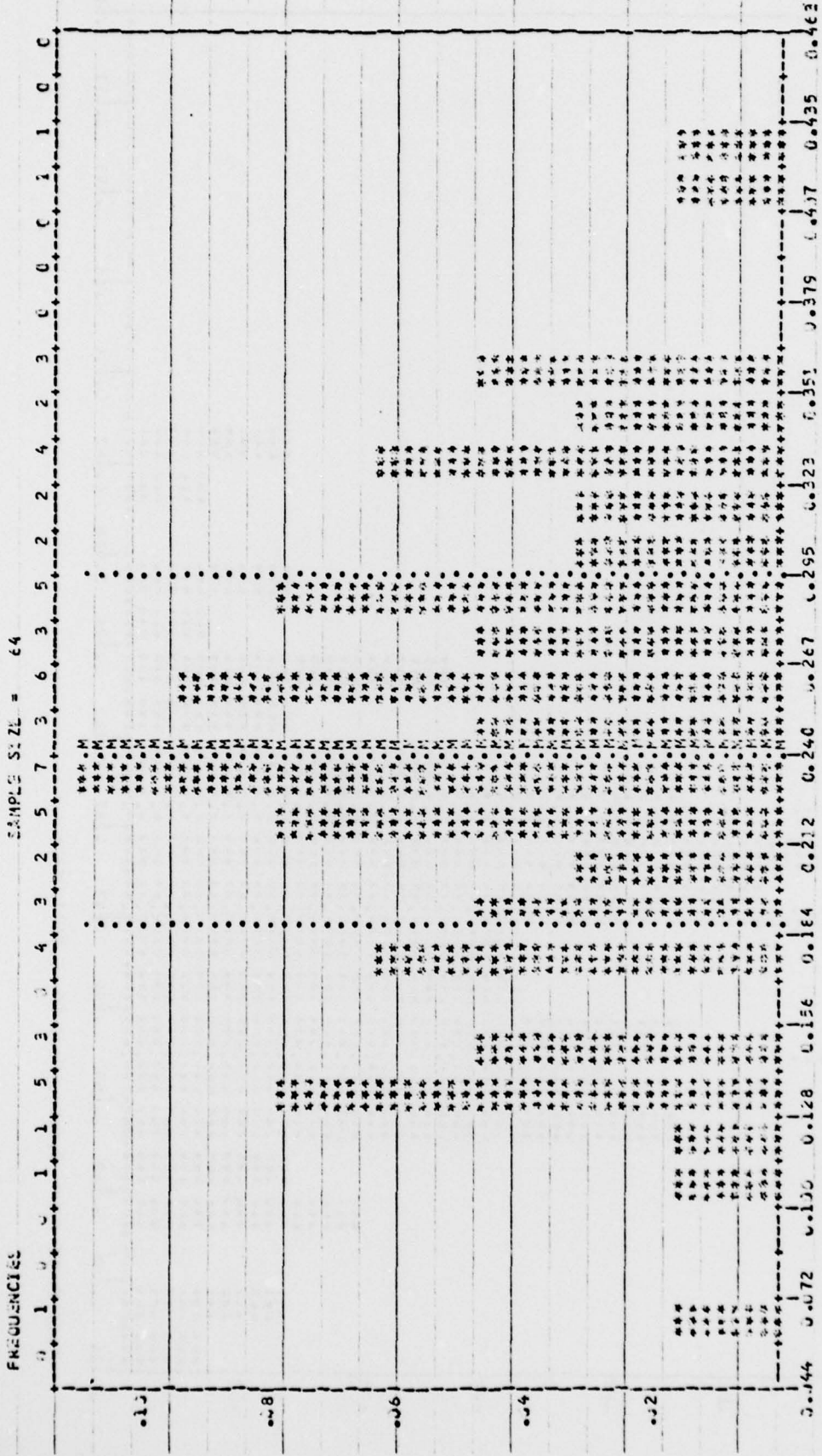

SCALE FIXED FROM 4-400000-02-10-4-630400-01

GENERAL TENDENCY	SPREAD	HIGHER CENTRAL MOMENTS	DISTRIBUTION
MEAN	2.44279	0.85745	MINIMUM
STDEV	2.30331	0.97161	.25 QUANTILE
MEAN	2.44279	0.85745	.50 QUANTILE (MEDIAN)
STDEV	2.30331	0.97161	.75 QUANTILE
MEAN	2.44279	0.85745	MAXIMUM
STDEV	2.30331	0.97161	

Δ_3 Errors of the Advancement Model for Pay Grade E6 (High Volume Ratings Only)

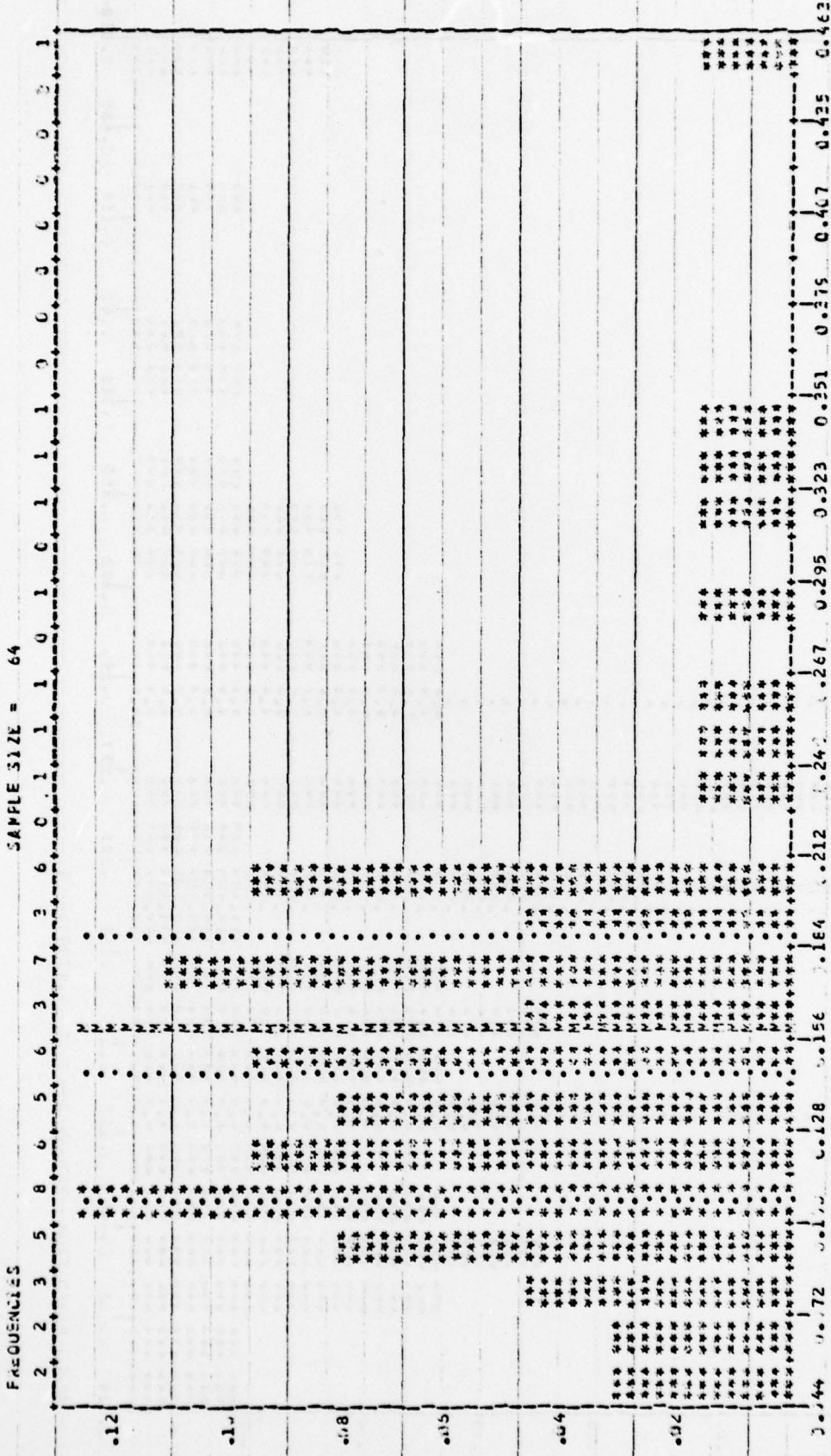

SCALE FIXED FROM 4.46 TO 2.10 4.63 TO 2.10

CENTRAL TENDENCY		SPREAD		HIGHER CENTRAL MOMENTS		DISTRIBUTION	
MEAN	1.571388-01	VARIANCE	5.654719E-03	M3	6.732557E-04	MINY	MLM
TRIM MEAN	1.442809E-01	COEF VAR	4.780117E-01	M4	2.81624E-04	15	QUANTILE
MID MEAN	1.447211E-01	MEAN DEV	5.359134E-02	SKURTOSIS	1.583303E-00	25	QUANTILE
GEOM MEAN	1.228153E-01	RMSPREAD	4.758338E-01	BETA1	3.621246E-04	50	QUANTILE
HARM MEAN	1.257153E-01		7.985388E-02	BETA2	1.981111E-04	75	QUANTILE
						90	MAXIMUM

Δ_3 Errors of the FAST Model for Pay Grade E9 (High Volume Ratings Only)

FREQUENCIES	SAMPLE SIZE = 43														
	2	1	1	1	1	1	1	1	1	1	2				
0.064	0.101	0.138	0.175	0.212	0.249	0.286	0.323	0.359	0.396	0.433	0.471	0.508	0.544	0.581	0.618
0.1	0.2	0.3	0.4	0.5	0.6	0.7	0.8	0.9	1.0	1.1	1.2	1.3	1.4	1.5	1.6
0.064	0.101	0.138	0.175	0.212	0.249	0.286	0.323	0.359	0.396	0.433	0.471	0.508	0.544	0.581	0.618
0.1	0.2	0.3	0.4	0.5	0.6	0.7	0.8	0.9	1.0	1.1	1.2	1.3	1.4	1.5	1.6
0.064	0.101	0.138	0.175	0.212	0.249	0.286	0.323	0.359	0.396	0.433	0.471	0.508	0.544	0.581	0.618
0.1	0.2	0.3	0.4	0.5	0.6	0.7	0.8	0.9	1.0	1.1	1.2	1.3	1.4	1.5	1.6
0.064	0.101	0.138	0.175	0.212	0.249	0.286	0.323	0.359	0.396	0.433	0.471	0.508	0.544	0.581	0.618
0.1	0.2	0.3	0.4	0.5	0.6	0.7	0.8	0.9	1.0	1.1	1.2	1.3	1.4	1.5	1.6
0.064	0.101	0.138	0.175	0.212	0.249	0.286	0.323	0.359	0.396	0.433	0.471	0.508	0.544	0.581	0.618
0.1	0.2	0.3	0.4	0.5	0.6	0.7	0.8	0.9	1.0	1.1	1.2	1.3	1.4	1.5	1.6
0.064	0.101	0.138	0.175	0.212	0.249	0.286	0.323	0.359	0.396	0.433	0.471	0.508	0.544	0.581	0.618
0.1	0.2	0.3	0.4	0.5	0.6	0.7	0.8	0.9	1.0	1.1	1.2	1.3	1.4	1.5	1.6

SCALE FIXED FROM 0.0399995E-02 TO 6.180000E-01

CENTRAL TENDENCY	SPREAD	HIGHER CENTRAL MOMENTS	DISTRIBUTION
MEAN	VARIANCE	M3	MINI NUM
MEDIAN	STD DEV	M4	QUANTILE
MODE	COEF VAR	M5	QUANTILE
MEAN MEAN	MEAN DEV	M6	QUANTILE
MODE MEAN	RANGE	M7	QUANTILE
MEAN MODE	MAXIMUM	M8	QUANTILE
MODE MODE	MAXIMUM	M9	QUANTILE
MEAN MEAN	MAXIMUM	M10	QUANTILE
MODE MEAN	MAXIMUM	M11	QUANTILE
MEAN MODE	MAXIMUM	M12	QUANTILE
MODE MODE	MAXIMUM	M13	QUANTILE
MEAN MEAN	MAXIMUM	M14	QUANTILE
MODE MEAN	MAXIMUM	M15	QUANTILE
MEAN MODE	MAXIMUM	M16	QUANTILE
MODE MODE	MAXIMUM	M17	QUANTILE
MEAN MEAN	MAXIMUM	M18	QUANTILE
MODE MEAN	MAXIMUM	M19	QUANTILE
MEAN MODE	MAXIMUM	M20	QUANTILE
MODE MODE	MAXIMUM	M21	QUANTILE
MEAN MEAN	MAXIMUM	M22	QUANTILE
MODE MEAN	MAXIMUM	M23	QUANTILE
MEAN MODE	MAXIMUM	M24	QUANTILE
MODE MODE	MAXIMUM	M25	QUANTILE
MEAN MEAN	MAXIMUM	M26	QUANTILE
MODE MEAN	MAXIMUM	M27	QUANTILE
MEAN MODE	MAXIMUM	M28	QUANTILE
MODE MODE	MAXIMUM	M29	QUANTILE
MEAN MEAN	MAXIMUM	M30	QUANTILE
MODE MEAN	MAXIMUM	M31	QUANTILE
MEAN MODE	MAXIMUM	M32	QUANTILE
MODE MODE	MAXIMUM	M33	QUANTILE
MEAN MEAN	MAXIMUM	M34	QUANTILE
MODE MEAN	MAXIMUM	M35	QUANTILE
MEAN MODE	MAXIMUM	M36	QUANTILE
MODE MODE	MAXIMUM	M37	QUANTILE
MEAN MEAN	MAXIMUM	M38	QUANTILE
MODE MEAN	MAXIMUM	M39	QUANTILE
MEAN MODE	MAXIMUM	M40	QUANTILE
MODE MODE	MAXIMUM	M41	QUANTILE
MEAN MEAN	MAXIMUM	M42	QUANTILE
MODE MEAN	MAXIMUM	M43	QUANTILE
MEAN MODE	MAXIMUM	M44	QUANTILE
MODE MODE	MAXIMUM	M45	QUANTILE
MEAN MEAN	MAXIMUM	M46	QUANTILE
MODE MEAN	MAXIMUM	M47	QUANTILE
MEAN MODE	MAXIMUM	M48	QUANTILE
MODE MODE	MAXIMUM	M49	QUANTILE
MEAN MEAN	MAXIMUM	M50	QUANTILE

Δ_3 Errors of the Advancement Model of Pay Grade E9 (High Volume Ratings Only)

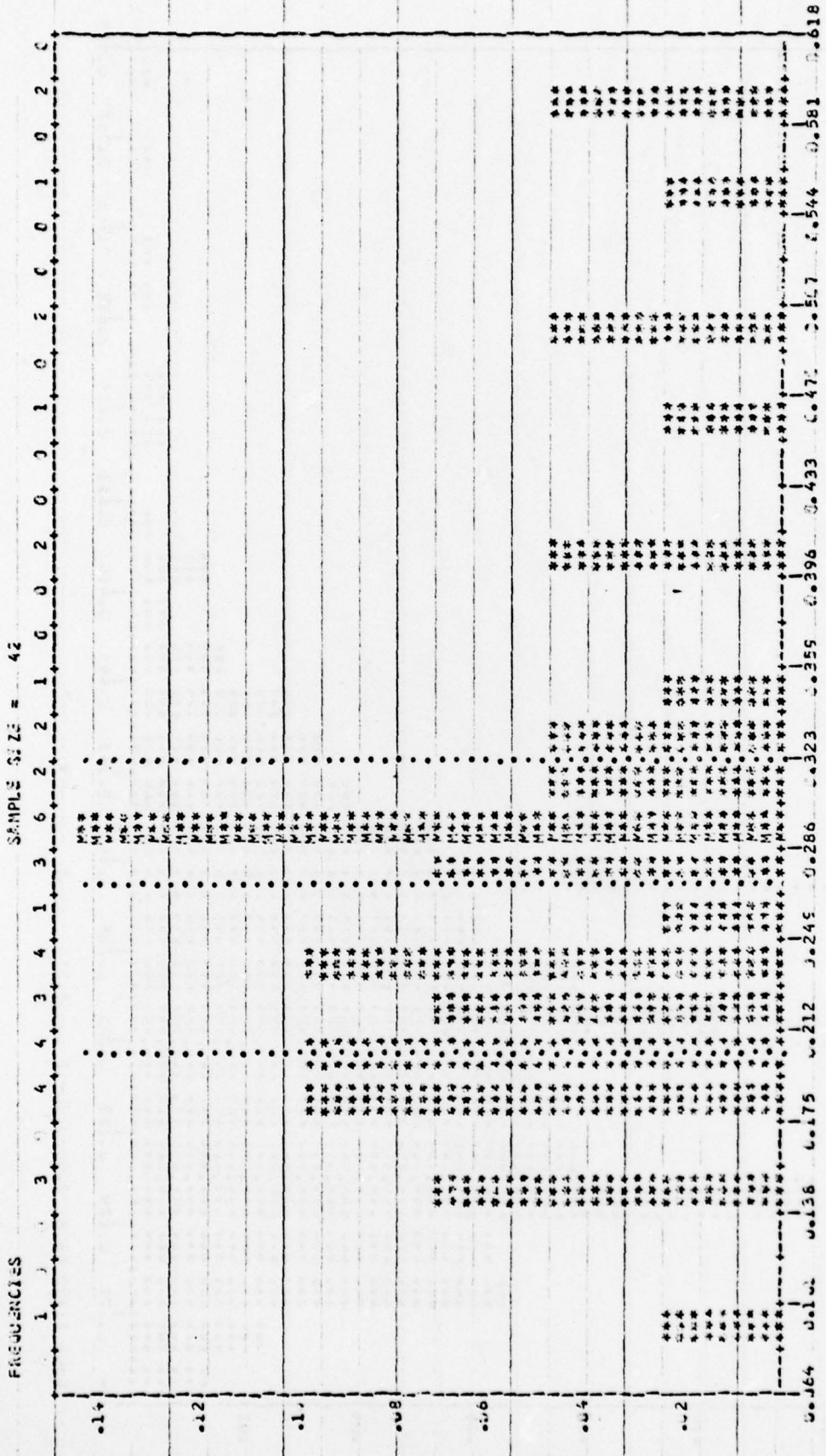

SCALE FIXED FROM 6.309955E-02 TO 6.180000E-01

CENTRAL TENDENCY	SPREAD	HIGHER CENTRAL MOMENTS	DISTRIBUTION
MEAN 2.409034E-01	VARIANC 1.46594E-02	M3 1.893595E-03	MINIMUM 9.54192E-01
STDEV 4.91757E-02	COEFF VAR 2.01757E-02	M4 3.41267E-04	Q1 2.22323E-01
COEFF SKW 8.87648E-03	COEFF KURT 3.07699E-03	M5 7.08787E-05	Q2 2.22323E-01
MEAN MEAN 2.409034E-01	MEAN DEVI 2.01757E-02	M6 7.72378E-05	Q3 2.22323E-01
MEAN MEAN 2.409034E-01	MEAN DEVI 2.01757E-02	M7 1.1692E-05	MAXIMUM 5.53883E-01
MEAN MEAN 2.409034E-01	MEAN DEVI 2.01757E-02	M8 1.27661E-05	MAXIMUM 5.53883E-01

Δ_3 Errors of the FAST Model for All Pay Grades (High Volume Ratings Only)

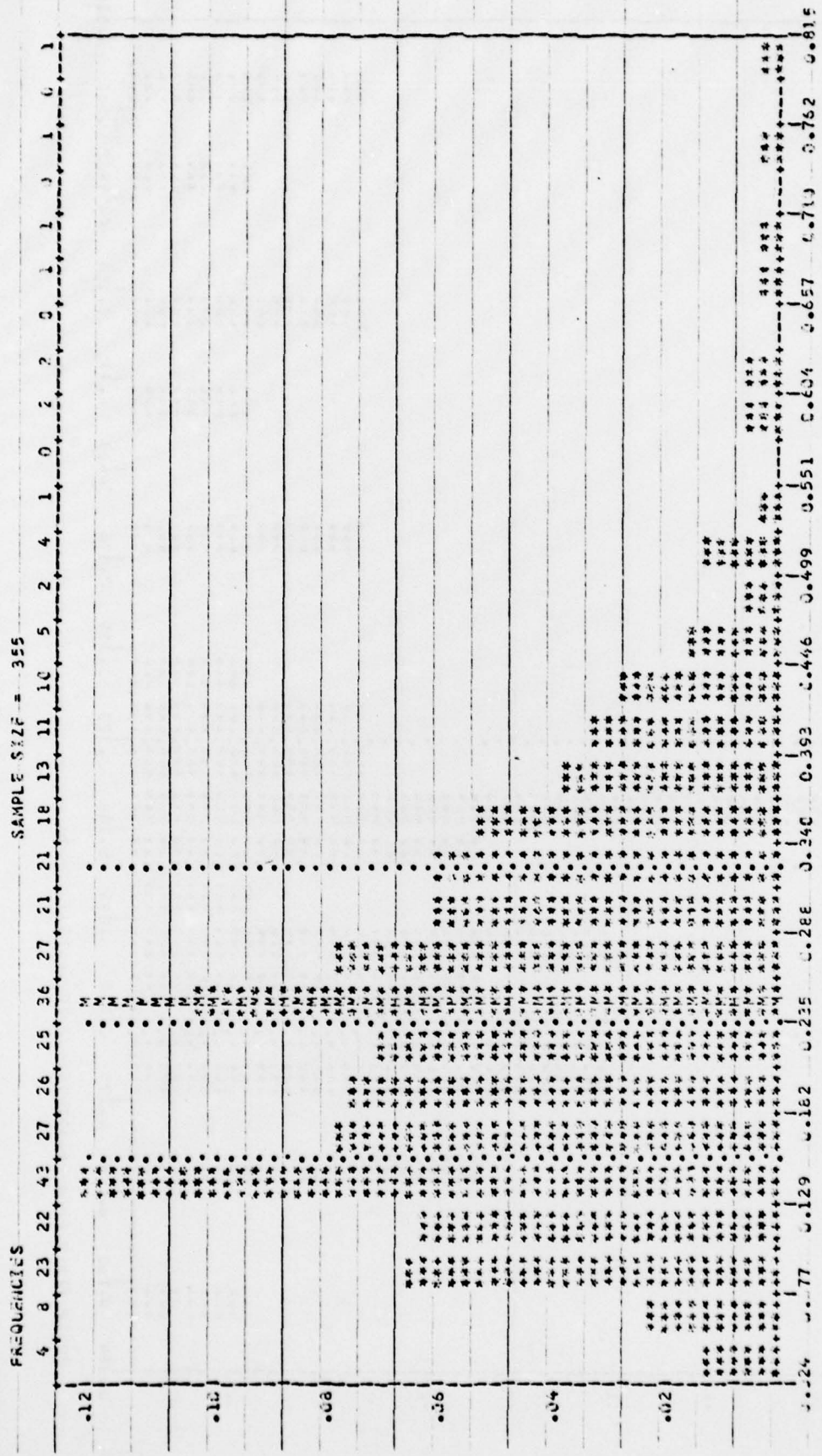

SCALE FIXED FROM 2.400 RANGE 2.00 - 8.15

CENTRAL TENDENCY	SPREAD	HIGHER CENTRAL TENDENCIES	DETERMINATION
MEAN 2.40190501	VAR-MOD 1.57862202	M3 2.08354803	MIN-MOD 2.08354803
STDEV 1.57862202	COV 0.00000000	M4 3.00000000	Q1 0.25000000
MAX 4.00000000	CORR VAR 9.73737800	KURTOSIS 3.00000000	Q2 0.50000000
MIN 0.00000000	ALFA 0.00000000	SKWNESS 1.00000000	Q3 0.75000000
RANGE 4.00000000	RANGE 4.00000000	BE11 2.00000000	MAX 0.75000000
Q1 0.25000000	MOD-PALAC 1.79538100	BE12 2.00000000	MAX-MOD 2.00000000
Q2 0.50000000			
Q3 0.75000000			
MAX 4.00000000			

Δ_3 Errors of the Advancement Model for All Pay Grades (High Volume Ratings Only)

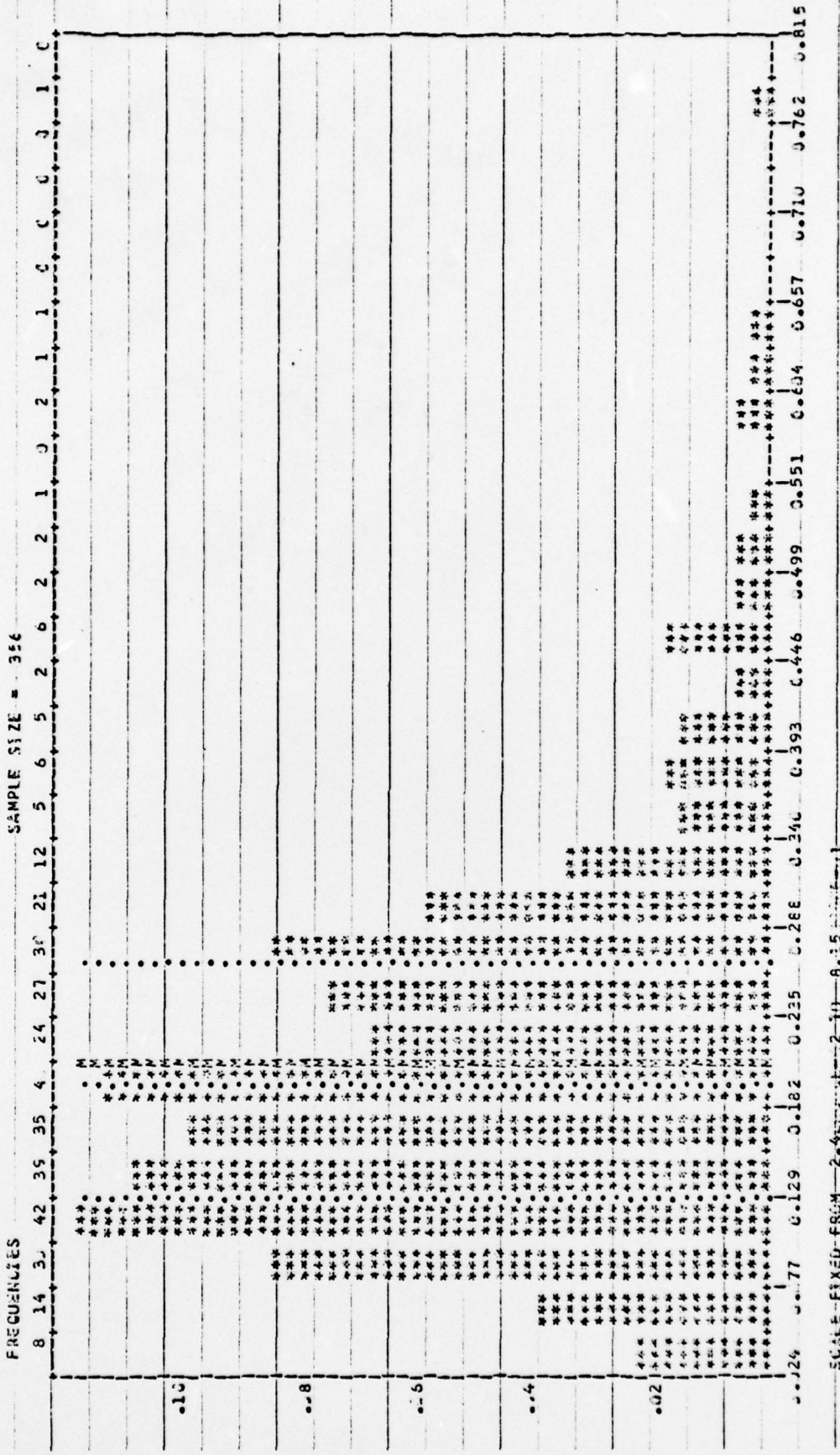

SCALE FIXED FROM 2.400000E-02 TO 8.150000E-01

CENTRAL TENDENCY		SPREAD		HIGHER CENTRAL MOMENTS		DISTRIBUTION	
MEAN	2.187321E-01	VARIANCE	1.240134E-02	M3	1.871376E-03	MINIMUM	2.431611E-01
STDEV	1.092392E-01	COEF VAR	5.320719E-01	M4	1.934156E-04	.15 QUANTILE	9.004822E-01
MIDRANGE	1.923414E-01	MEAN DEV	8.208111E-02	SKURTOSIS	1.244613E-03	.25 QUANTILE	1.245578E-01
PICKURGE	4.885134E-01	RANGE	7.633528E-01	BOYAL	1.855636E-03	.50 QUANTILE	1.669446E-01
GENM MEAN	1.877180E-01	MEANSPREAD	1.443528E-01	BOYAL2	5.822282E-04	.75 QUANTILE	3.061818E-01
HARM MEAN	1.537712E-01					.90 QUANTILE	4.655821E-01
						MAXIMUM	7.857142E-01

Distribution List

	Copies
Defense Documentation Center Camerson Station Alexandria, VA 22314	2
Library (Code 0212) Naval Postgraduate School Monterey, Ca. 93940	2
Library (Code 55) Naval Postgraduate School Monterey, CA 93940	2
Dean of Research (Code 012) Naval Postgraduate School Monterey, CA 93940	1
Provost (Code 01) Naval Postgraduate School Monterey, CA 93940	1
Dr. R. W. Butterworth Systems Exploration Inc. 419 Webster Street Monterey, CA 93940	1
Professor D. P. Gaver Code 55 Naval Postgraduate School Monterey, CA 93940	1
Professor M. G. Sovereign, Chairman Department of Operations Research Code 55 Naval Postgraduate School Monterey, CA 93940	1
Naval Personnel Research and Development Center Attn: Mr. Robert Boller	3
Attn: Mr. Joe Silverman San Diego, CA 92152	1
Bureau of Naval Personnel Attn: Dr. Richard Elster, PERS OR	1
Attn: Mr. Robert Lehto, PERS 2X Washington, D.C. 20370	4

	Copies
Professor Kneale T. Marshall Code 55Mt Naval Postgraduate School Monterey, CA 93940	1
Dean David A. Schrady Code 013 Naval Postgraduate School Monterey, CA 93940	1
Dr. Thomas Varley Office of Naval Research Code 434 Arlington, VA 22217	1
Professor J. K. Arima Code 54 Naval Postgraduate School Monterey, CA. 93940	1
R. J. Stampfel Code 55 Naval Postgraduate School Monterey, CA. 93940	1
Professor P. R. Milch Code 55 Naval Postgraduate School Monterey, CA. 93940	15