

AD-A055 648

YALE UNIV NEW HAVEN CONN DEPT OF GEOLOGY AND GEOPHYSICS F/6 8/8
FIELD STUDY OF THE MECHANICS OF THE PLACEMENT OF DREDGED MATERI--ETC(U)
APR 78 H J BOKUNIEWICZ, J GEBERT, R B GORDON DACW39-76-C-0105

UNCLASSIFIED

WES-TR-D-78-7-VOL-2

NL

1 of 2

AD
A055 648

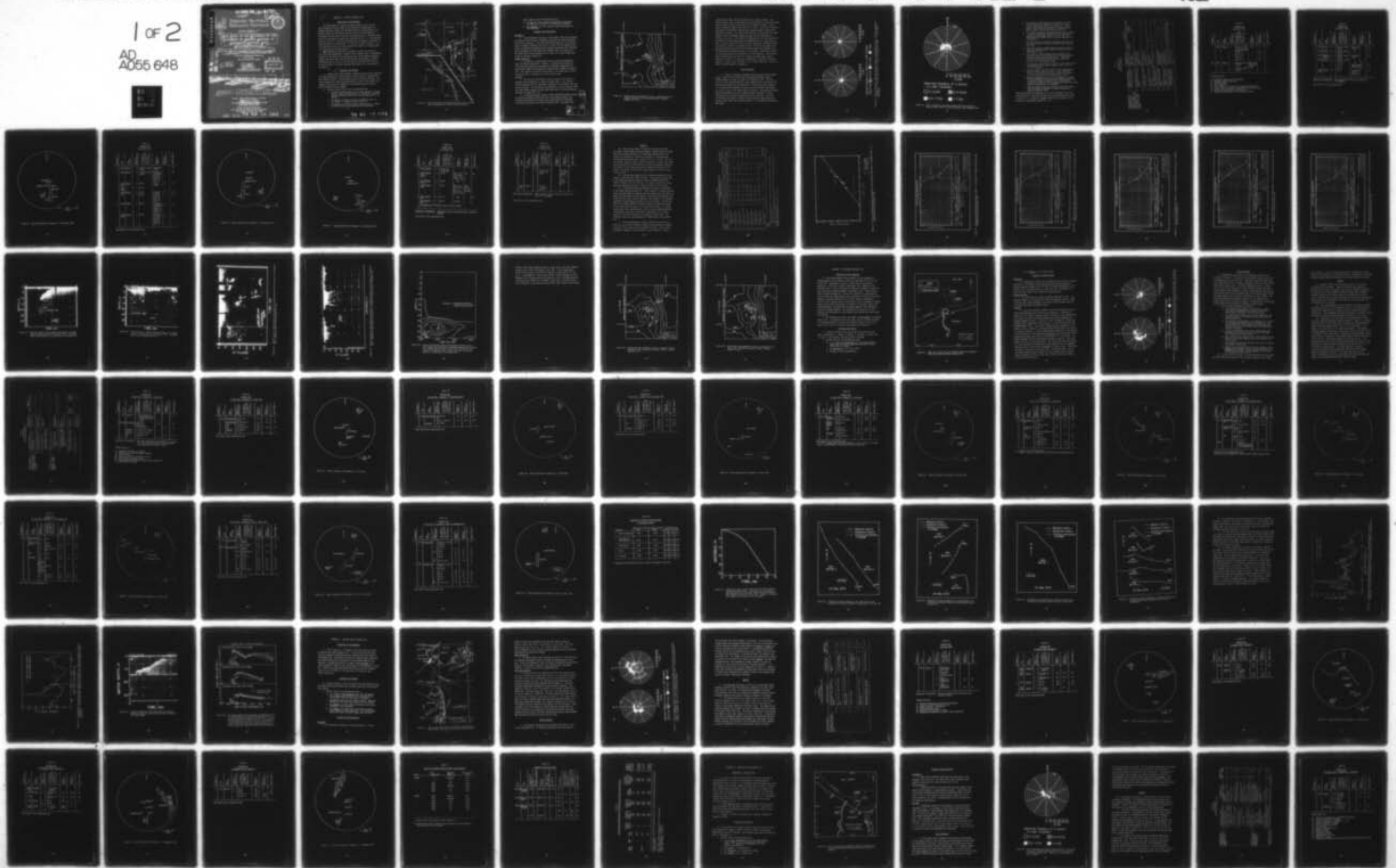

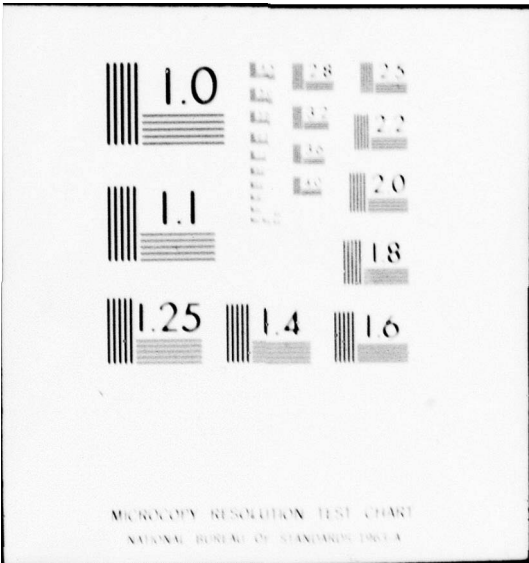

AD A 055648

AD No. 1

DDC FILE COPY

FOR FURTHER TRAN
A055647

12

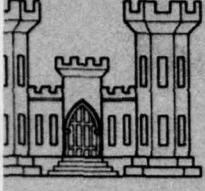

DREDGED MATERIAL RESEARCH PROGRAM



6

9 TECHNICAL REPORT D-78-7

FIELD STUDY OF THE MECHANICS OF THE PLACEMENT OF DREDGED MATERIAL AT OPEN-WATER DISPOSAL SITES.
VOLUME II APPENDICES J-O

10

by Henry J. Bokuniewicz, Jeffrey Gebert, Robert B. Gordon, Jane L. Higgins, Peter Kaminsky, Carol C. Pilbeam, Matthew Reed, Catherine Tuttle

Department of Geology and Geophysics
Yale University
New Haven, Connecticut 06520

12 179e

11 April 1978

9 Final Report

Approved For Public Release; Distribution Unlimited

DDC
JUN 26 1978
E

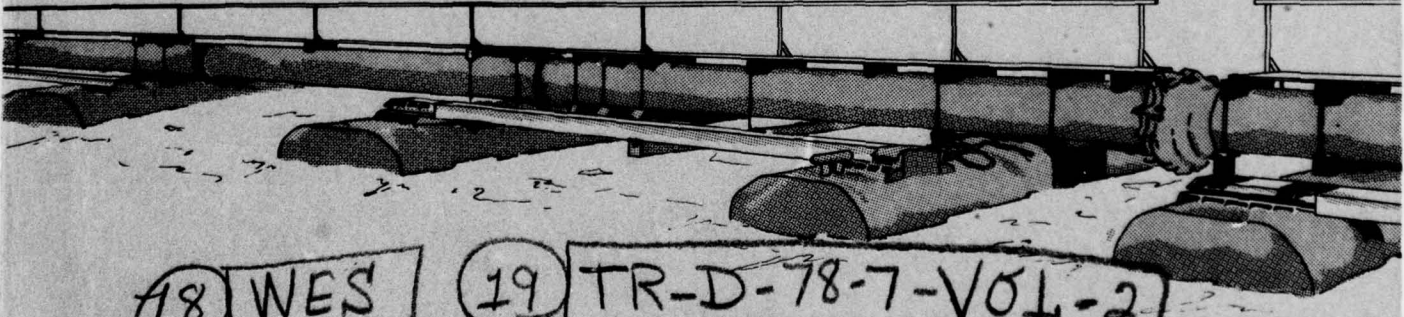

18 WES

19 TR-D-78-7-VOL-2

Prepared for Office, Chief of Engineers, U. S. Army
Washington, D. C. 20314

Under Contract No. ~~DACW39-76-C-0105~~ Mod. P001
(DMRP Work Unit No. 1B09)

Monitored by Environmental Laboratory
U. S. Army Engineer Waterways Experiment Station
P. O. Box 631, Vicksburg, Miss. 39180

402 051 78 06 12 085 JOB

APPENDIX J: SEATTLE DISPOSAL SITE

Objectives of the Research

1. Observations at the Elliott Bay disposal site on 24, 25 and 26 February 1976 were made of the descent of dredged material through the water column, the spreading velocity and thickness of the density surge over the bottom, and the drift of residual material introduced into the water column by the descending jet. Baseline bathymetry and postdisposal surveys were conducted by the U. S. Army Engineer District, Seattle, in order to determine the distribution and amount of disposed material on the bottom. In addition to these surveys, a 7.5-kHz subbottom profiler was used to detect the deposit of disposed material during the observation period.

2. Dredging was done with a clamshell bucket into two split-hull scows and transported in tandem to the disposal site. The dredging location at the time of the observations was in the Duwamish Waterway between South Park Reach and the 14th Avenue Bridge Reach. Disposal operations were at a site in Elliott Bay less than 825 m off the end of the dry docks in the West Waterway (See Figure J1 for index map of the area).

Personnel and Vessels

3. Persons from Yale University involved with the data collection were Henry Bokuniewicz, Jeffrey Gebert, Peter Kaminsky, Matthew Reed, and Catherine Tuttle. Participating from WES was Barry Holliday. Two other groups doing research simultaneously as part of the overall WES Duwamish study were the University of Washington and the National Marine Fisheries Service (NMSF).

6. Vessels used by Yale for the observations were:

- a. Clamshell bucket dredge and two scows; scows 61 m length overall (LOA), holding capacity of 382-535 m³, owned and operated by Manson Construction and Engineering Co., in Seattle.
- b. R/V Davies; 10 m LOA, owned and operated by the U. S. Army Corps of Engineers, Seattle District.
- c. M/V Whaler; a 5-m Boston whaler owned by the U. S. Army Corps of Engineers and operated by Yale personnel.

Other vessels used for observations were:

- a. R/V HOH; 24 m LOA, owned by University of Washington and operated by University of Washington personnel.
- b. R/V Streeter; 20 m LOA, owned by NMFS and operated by NMFS personnel.

Disposal Site Description

Bathymetry

5. Three bathymetric surveys of the disposal site were completed by Seattle District Corps of Engineers personnel and contour maps were made by Yale personnel. The first survey was made prior to the beginning of disposal operations and used as a basic line for measuring the amount of sediment accumulated after disposal operations were completed and to determine the distribution of sediment from the impact area. The water depth at the disposal site is about 67 m, and the bay floor slopes to the west (Figure J2).

Bottom Materials

6. No samples of bottom materials were collected immediately prior to disposal operations. However, a sediment investigation of Elliot Bay was conducted by Northwest Environmental Consultants for the National Oceanic and Atmospheric Administration (NOAA) in November 1975. The samples collected at the disposal site showed grain size as 75 percent sand, 21 percent silt, and 4 percent clay.

Currents

7. Currents were monitored at three stations in Elliot Bay in December 1975 by Benjamin G. Patten for NOAA's NMFS. The flow was tidally dominated but also measurably affected by river runoff and wind-driven currents. For the period of observation, 23 to 27 February 1976, the tidal height average for mean high water was 3.2 m and the average for mean low water was 1.0 m.

8. To ensure accurate records of the background current activity during the observation period for this field report, currents were monitored with vertical arrays of four current meters in operation from 1600 23 February until 1600 26 February 1976. The meters were

Section	<input checked="" type="checkbox"/>
Section	<input type="checkbox"/>
Section	<input type="checkbox"/>
TY CODES	
Dist.	AVAIL. SPECIAL

A		
---	--	--

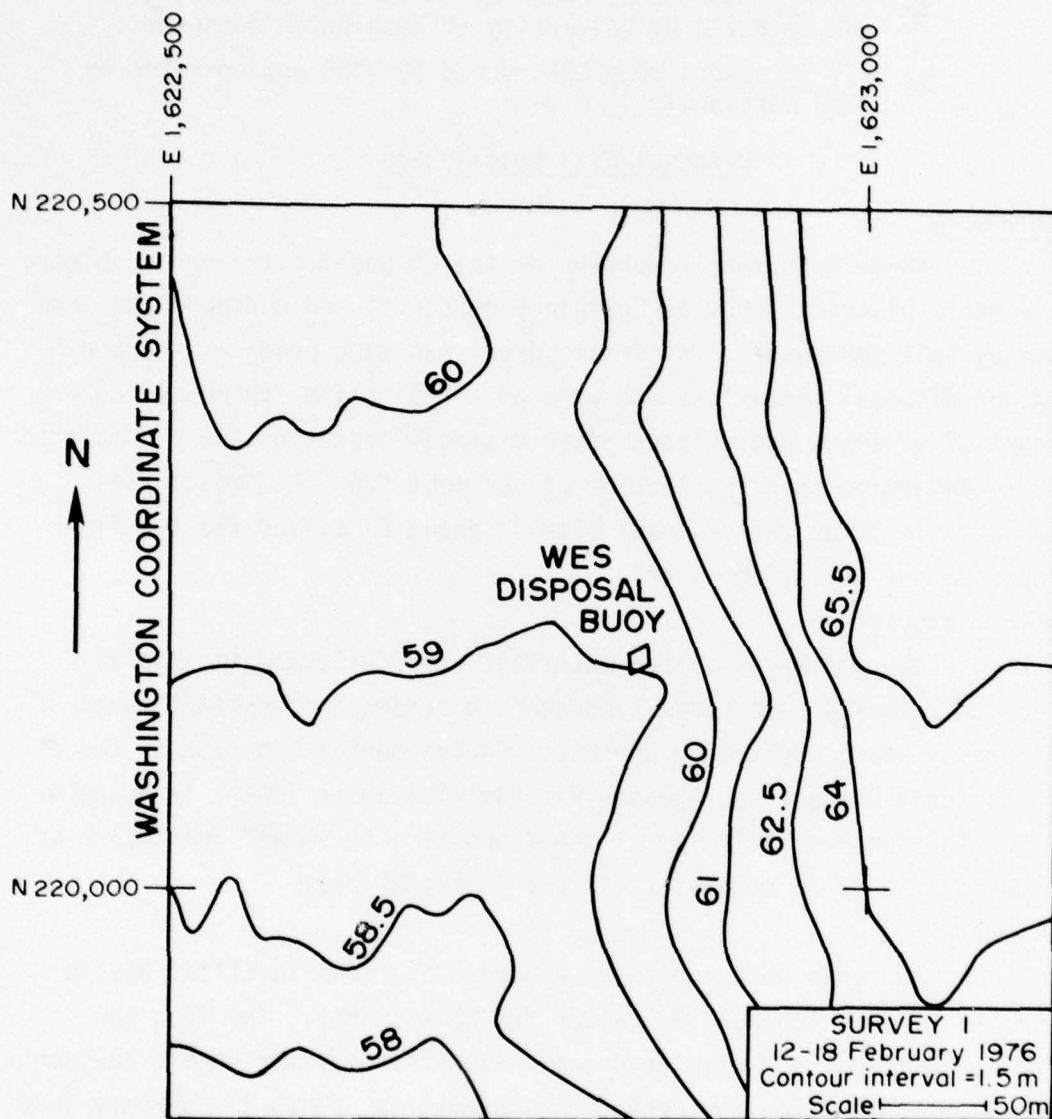

Figure J2. Contour map from bathymetric Survey 1 completed prior to disposal operations, 12-18 February 1976. Contour interval is 1.5 m.

anchored about 300 m from the disposal site in 65 m of water. Two General Oceanic (GO) current meters were positioned 55 m above the bottom and one General Oceanic current meter 33 m above the bottom. These three instruments sampled the flow every 7.5 min. The fourth instrument, a Braincon current meter, measured the average current 2 m above the bottom every 20 min. The film records from all of the meters are represented in polar histograms showing current velocity and direction (Figures J3 and J4). The current distribution over this time period for the meters 55 m above the bottom was predominantly in a SSE direction with a typical velocity of 0 to 0.1 m/sec; velocities infrequently were as high as 0.3 m/sec in an eastward flow. For the current meter 33 m above the bottom, the direction of flow was again most frequently SSE but the typical velocity was only 0 to .05 m/sec; a velocity as high as 0.4 m/sec occurred only occasionally in a SSE direction. The Braincon meter recording every 20 min at 2 m above the bottom had a typical velocity of 0.05 to .15 m/sec most frequently in a westward direction, however in a 180° range, from 252° to 72°, lower velocities, 0.05 to 0.1 m/sec, occurred almost as frequently.

Study Procedure

9. A Corps of Engineers permanent buoy was used as the disposal marker. Material was dredged from the Duwamish Waterway and was transported by two scows in tandem to the disposal site. Only one scow at a time released material (scow capacities were 382 and 535 m³), but both were emptied at each operation. The tug and scows remained in a fixed position heading into the wind with aftermost scow upwind of, but as close to, the marker buoy as possible. The observing vessels were held alongside the scow, anchored, and/or tethered in various configurations according to operation plan for each day. Positions of the observing vessels relative to the scows were determined by an optical range finder and a bearing compass. The following observations were made:

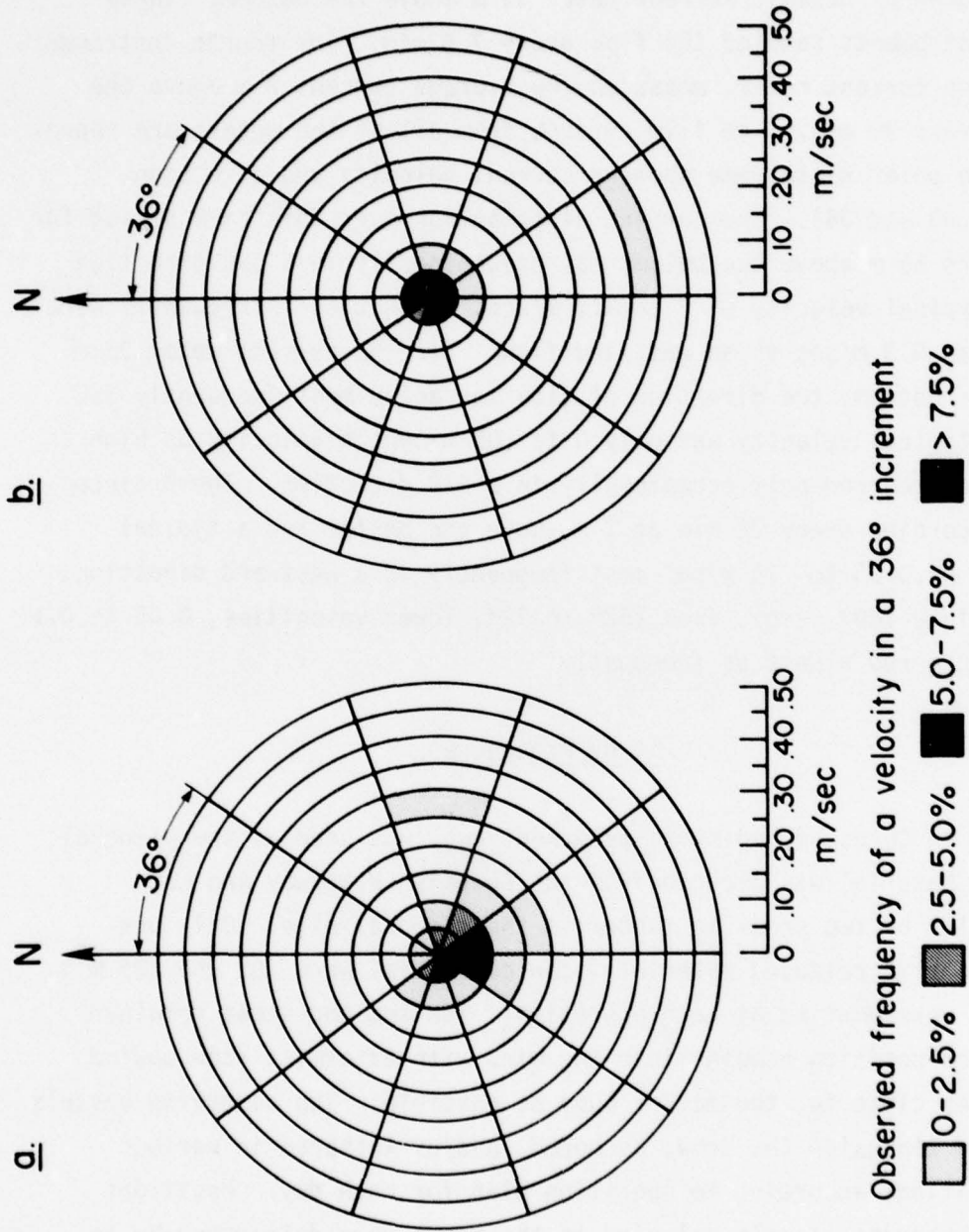
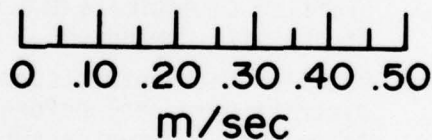
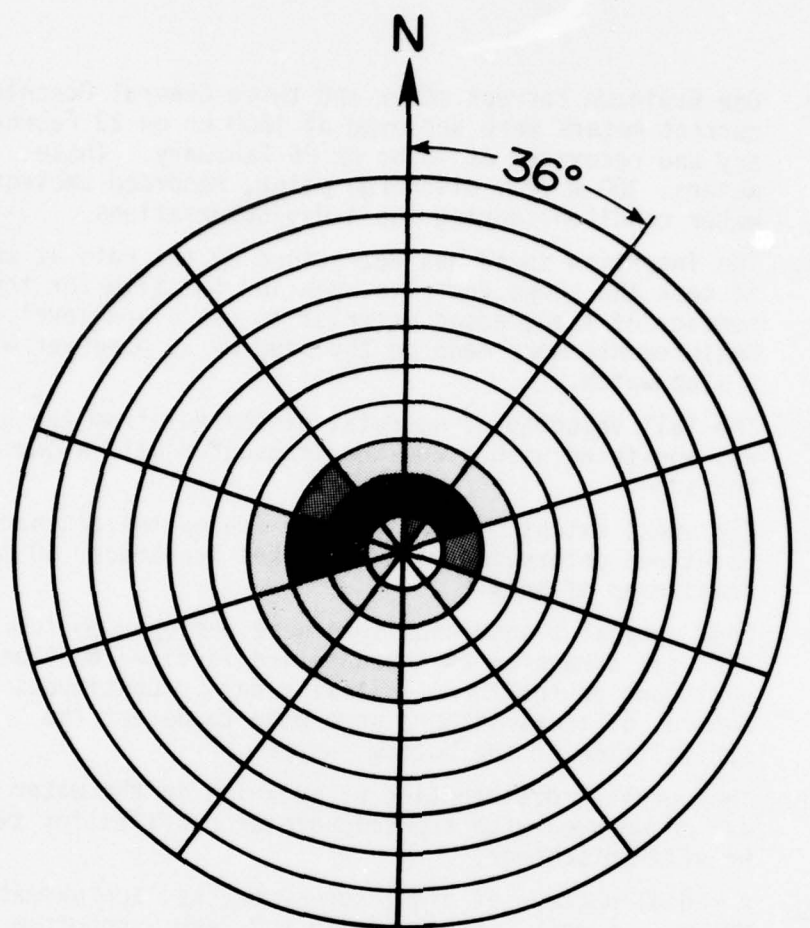

Figure J3. Polar histogram of observed current velocity, 23-26 February 1976. Figure a represents 60 meter "F", 55 m above the bottom. Figure b represents 60 meter "C", 33 m above the bottom.



Observed frequency of a velocity
in a 36° increment

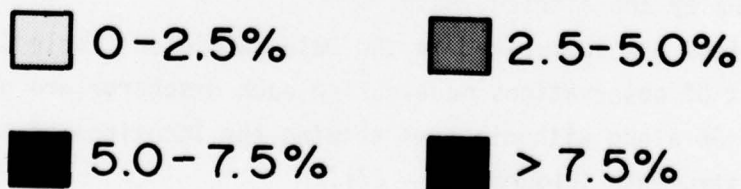

Figure J4. Polar histogram of observed current velocity recorded by Braincon meter #108, 2 m off the bottom, 23-26 February 1976.

- a. One Braincon current meter and three General Oceanic current meters were deployed at 1600 hr on 23 February and recovered at 16 hr on 26 February. These meters, 300 m from discharge point, recorded ambient water conditions during the 4-day observations.
- b. The insertion speed was determined by the rate at which it took the scows doors to open and the time for the surface of the dredged material to reach sea level. Measurements were made on the scow by an observer with a stop watch.
- c. The fall velocity of material discharged from the scow was monitored with a 200-kHz transducer held alongside the scow.
- d. The areal extent of turbid water around the discharge point was determined with a 200-kHz transducer 60 m downstream of scow.
- e. Four optical transmissometers were deployed in two vertical arrays on 24 February and in fixed horizontal positions on the three following days. Continuous records of transmittance were made to detect the arrival time of the bottom surge.
- f. The vertical distribution of material in the water column was documented with transmissometer profiles for two hr after discharge.
- g. A radial pattern of eight survey tracks, approximately 600 m in length, were run with a 7.5-kHz subbottom profiler to estimate the volume of material disposed at the site during the 4-day observation period.
- h. Detailed bathymetric surveys were completed by Seattle District personnel before and after disposal operations to measure sediment accumulation and distribution. Contour maps covering a 183-m square area around the marker buoy were produced by Yale personnel.
- i. Sediment samples from the scow were collected to determine the physical properties; analysis was done by Haley and Aldrich, Mass.

These observations are summarized in the Data Catalogue (Table J1), and the details of observations made during each discharge are given in Tables J2 - J6 along with diagrams showing the locations of the vessels and instruments (Figures J5 - J7).

Table J1

Data Catalogue

23-27 February, 1976

Project Objectives	Observations Undertaken	Instrumentation and Information Used			Disposal No.			
		One Braincon Current Meter; three G. O. Current Meters	230276 Deployed 1600 hrs	240276	250276	260276	270276	Recovered 1600 hrs
To monitor the descent of the jet, spread of bottom surge, and the drift of residual material introduced into the water column.	1. Background information on ambient water conditions							
	2. Sediment samples from scow to determine physical properties	Nine syringe samples at 3 depths, three scooped samples from surface						X
	3. Insertion speed of material into water column	Rate of doors opening; time taken for scow to empty						X
	4. Fall velocity of material discharged	200 kHz acoustic transducer	1,2	1,2,3	1			
	5. Areal extent of turbid water around discharge point	200 kHz transducer	1,2	2	2			
	6. Arrival time and sediment concentration of bottom surge	Fixed transmissometer arrays; horizontal transmissometers		3	2,3	2,3,4		
	7. Vertical distribution of material in water column	Transmissometer profiles, boat moving		3	2,3	3,4		
	8. Volume and distribution of discharged material on the bottom over time	4 Bathymetric surveys 7.5 kHz transducer survey	Pre and Post Disposal Operations					X

Table J2

Station Log

23 February 1976

Disposal #	Time	Name of Boat	Type of Observation*	Instrumentation Used (XM = transmissometer, CM = current meter)	Range to Dredge, m	Depth of Instrument, m	Water Depth, m
	1349	<u>Whaler</u>	1	Braincon #108 <u>Vertical Array:</u> GO CM "F" GO CM "O" GO CM "C" GO CM "E"	~ 300 " " "	64 10 10 38 47	65 " " " "
1&2	1420	<u>Whaler</u>	4	200-kHz transducer	Boat held alongside scow		"
			5	200-kHz transducer	60		"

*Observation Key:

- 1) Background ambient water conditions
- 2) Sediment samples from scow
- 3) Insertion speed
- 4) Fall velocity
- 5) Areal extent of turbid water around discharge point
- 6) Arrival time and sediment concentration of bottom surge
- 7) Vertical distribution in water column
- 8) Volume and distribution of sediment on bottom.

Table J3
Station Log
24 February 1976

Disposal #	Time	Name of Boat	Type of Observation*	Instrumentation Used (XM = transmitter, CM = current meter)	Range to Dredge, m	Depth of Instrument, m	Water Depth, m
1	0830	<u>Whaler</u>	4	200-kHz transducer	Alongside scow		65
2	1150	<u>Whaler</u>	5	200-kHz transducer	60		65
3	1440	<u>Whaler/Scow #2</u>	4	200-kHz transducer	Alongside scow		62
	1440	<u>Davies</u>	6	Vertical array: XM #0 XM #2 XM #3	24 Downstream from site	14 23 55	65
	1550-1600	<u>Davies</u>	7	XM #3	24 m downstream from site		65

Additional Information: Water samples collected by R/V HOH and R/V Streeter.

*See Table J2 for observation key.

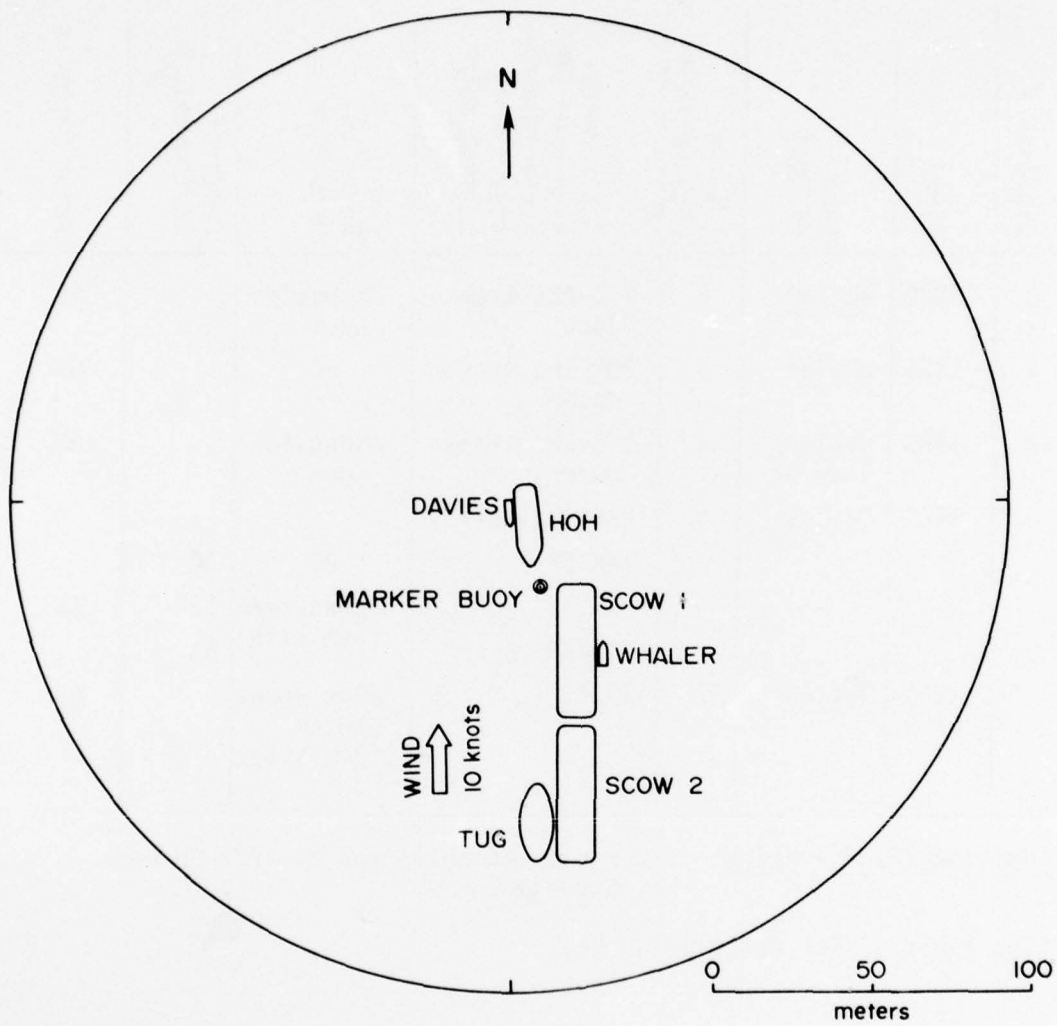

Figure J5. Vessel positions for Disposal 3, 24 February 1976.

Table J4
Station Log
25 February 1976

Disposal #	Time	Name of Boat	Type of Observation*	Instrumentation Used (XM = transmitter, CM = current meter)	Range to Dredge, m	Depth of Instrument, m	Water Depth, m
1	0930	<u>Whaler</u>	4	200-kHz transducer	Alongside scow		65
2	1349	<u>Whaler</u>	5	200-kHz transducer	Tethered to <u>Davies</u> ; 74 m to scow #1, ~20 m to scow #2		62
	1349-1357	<u>Whaler</u>	6	XM #1	Same as above	57	65
	1400-1600	"	7	XM #1			
	1349-1357	<u>Davies</u>	6	XM #3	Tethered to Buoy; 50 m to scow #1, ~95 m to scow #2	57	65
			7	XM #3			65
3	1609	<u>Whaler</u>	6	XM #1	Tethered to <u>Davies</u> ; ~110 m to scow #1, ~156 m to scow #2	57	65
	1609-1628	<u>Davies</u>	6	XM #3	Tethered to Buoy; 50 m to scow #1, 95 m to scow #2	57	65

*See Table J2 for observation key.

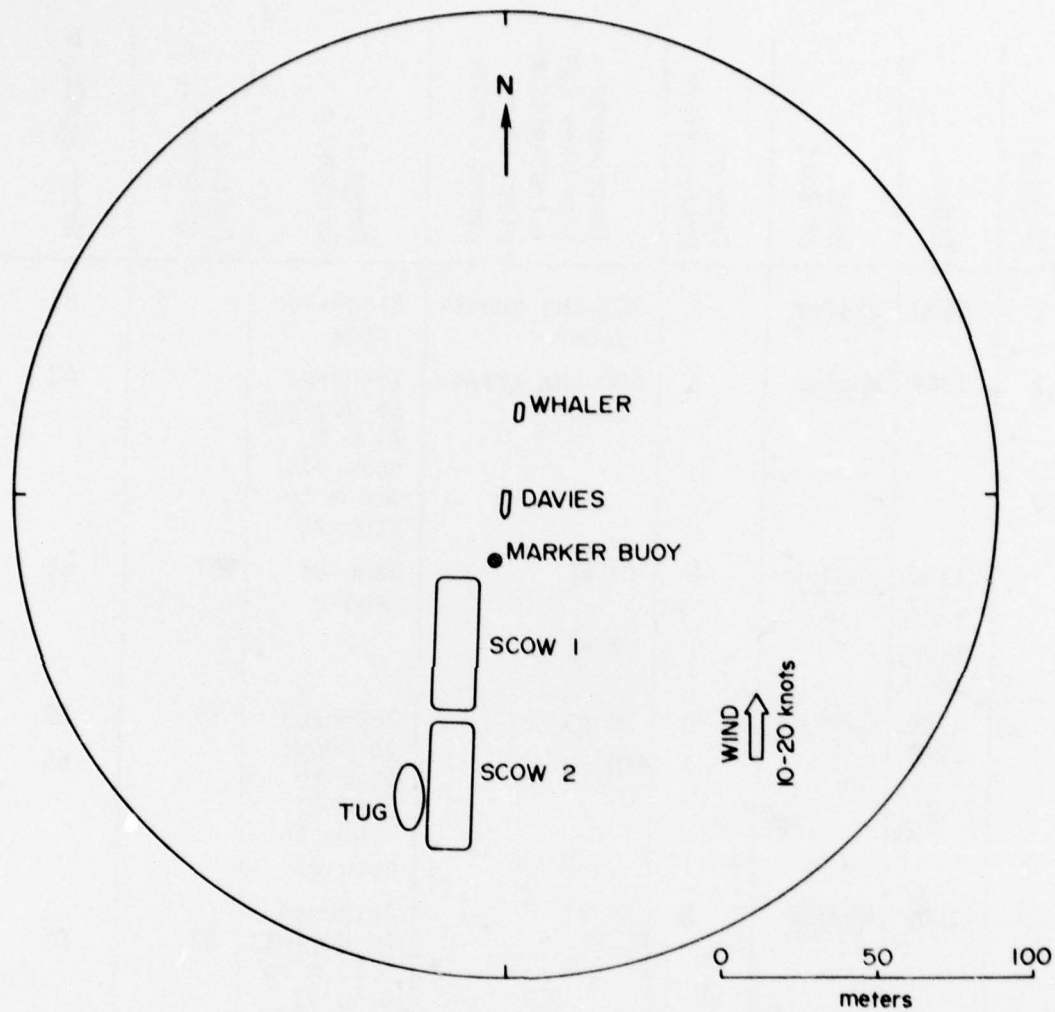

Figure J6. Vessel positions for Disposal 2, 25 February 1976.

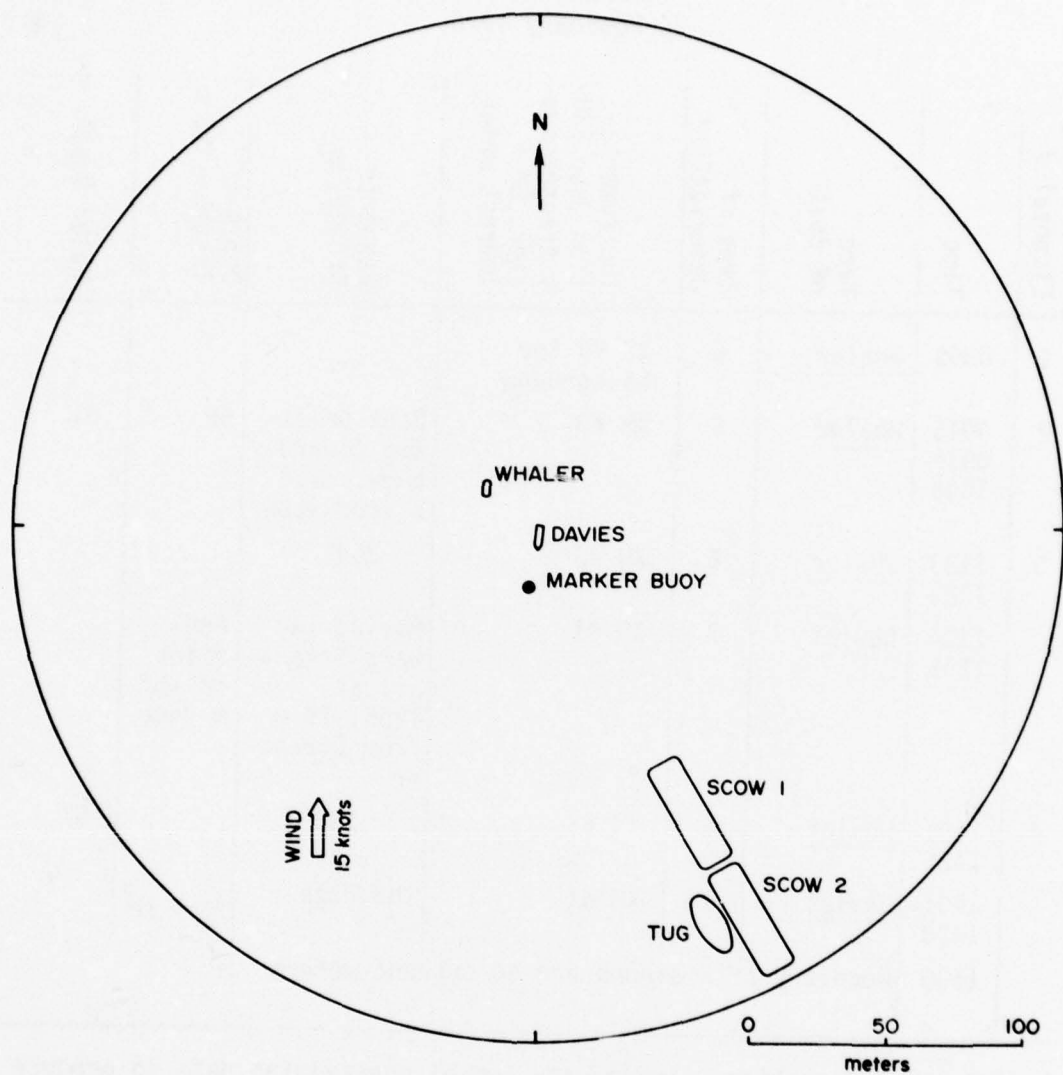

Figure J7. Vessel positions for Disposal 3, 25 February 1976.

Table J5
Station Log
 26 February 1976.

Disposal #	Time	Name of Boat	Type of Observation*	Instrumentation Used (XM = transmitter, CM = current meter)	Range to Dredge, m	Depth of Instrument, m	Water Depth, m	
1	0809	<u>Whaler</u>	6	XM #3 for background				
2	0915- 0915- 1053	<u>Whaler</u>	6	XM #3	Boat drifting toward buoy. ~274 m from scow	55	61	
3	1133- 1223	<u>Whaler</u>	6	XM #3	304			
	1134- 1255	<u>Davies</u>	7	XM #1	Moving toward Street-er, at 1255, 19 m from Street-er	Pro-files to ~57 m deep		
4	1401- 1425	<u>Whaler</u>	6	XM #3	182		57	
	1401- 1428	<u>Davies</u>	7	XM #1	No Data			
	1600	Recovery of Braincon and GO current meters						

Additional Information: Inadequate vessel positioning data to produce diagram.

*See Table J2 for observation key.

Table J6
 Station Log
 27 February 1976

Disposal #	Time	Name of Boat	Type of Observation*	Instrumentation Used (XM = transmitter, CM = current meter)	Range to Dredge, m	Depth of Instrument, m	Water Depth, m
		Scow	3 9 2	Syringe and scoop samples		Syringe at three depths- 0.3, 1.8, 2.7 Scoops at surface	
	0730-1500	<u>Davies</u>	8	7.5-kHz transducer survey			

Additional Information: Water samples taken by personnel aboard R/V HOH and R/V Streeter.

*See Table J2 for observation key.

Results

10. Nine syringe samples of material from the scow were collected at three depths and three samples scooped from the surface were sent to Haley and Aldrich in Cambridge, Massachusetts, for analysis by standard soil mechanics procedures. The quantities determined were percent water, liquid limit (LL), plastic limit (PL), unit weight, organic content, specific gravity of solids, void ratio, and the particle-size distribution by sieve and hydrometer analysis. The results of the laboratory analysis showed the material at all depths to be black, fine-grained, sandy organic silt (Table J7 and Figures J8-J13).

11. The insertion speed and fall velocity estimates are discussed in the text (see Tables 5 and 6). The acoustic records used to calculate the descent speed of clods of dredged material are shown in Figures J14, J15, and J16. The speed at which the bottom surge was observed to travel is shown in Figure 18 of the text.

12. A very small amount of material is placed in suspension at the water surface (Figure J17). This material is probably not the result of entrainment of sediment from the falling mass but rather is washed off the barge when the vessel is moved from the disposal site. Aside from this minor surface turbidity, the effects of the disposal operation are **only** detected within 25 m of the bottom. At the disposal site a small amount of material remains in suspension within 25 m of the bottom for about 2.5 hr after the disposal. A contour diagram made from transmissometer profiles shows suspended sediment concentration converted from percent transmittance for a 60-min period 20 min after discharge on 24 February (Figure J18). The observing vessel was approximately 26 m downstream of the disposal site.

13. From the bathymetric surveys completed by the Seattle District, the volume of material disposed was calculated by summing the areas of the traverse cross-sectional profiles. Four surveys provided a sequence of four profiles for each traverse: Survey 1,

Table J7

SUMMARY OF LABORATORY TEST RESULTS*
 Dredged Soil Samples
 Seattle, Washington

File No. 3817
 Sheet 1 of 1

SAMPLE NUMBER	DESCRIPTION	(1) DEPTH FEET	(1) NATURAL WATER CONTENT (%)		ATTENBERG LIMITS & FL.		UNIT WEIGHT LB./CU. FT.	ORGANIC CONTENT (%)	SPECIFIC GRAVITY	(2) VOID RATIO	SHRINKAGE LIMIT (%)	HYDRO-METER
			LL	PL	LL	FL						
1	Black fine sandy organic SILT	6	110.2	62.0	28.9	91.6	10.5	-	2.85	-	-	See curve
2	Black fine sandy organic SILT	8	90.5	-	-	-	9.6	2.62	-	36.1	-	-
3	Black fine sandy organic SILT	2	92.1	51.8	30.9	88.8	6.7	2.68	2.45	-	-	See curve
4	Black organic silty fine SAND	2	96.8	-	-	95.4	-	-	2.61	-	-	See curve
5	Black fine sandy organic SILT	9	64.9	61.0	30.9	102.5	-	2.65	1.69	-	-	See curve
6	Black fine sandy organic SILT	2	69.0	53.5	29.3	-	-	-	-	-	-	-
7	Black fine sandy organic SILT	9	73.6	45.2	27.3	-	-	-	-	-	-	-
8	Black fine sandy organic SILT	2	108.1	68.5	30.8	92.7	10.8	2.62	2.91	-	-	-
9	Black organic silty fine SAND	9	48.0	-	-	107.8	-	-	1.25	-	-	See curve

NOTES

- Depth noted indicates depth of sample below surface of dredged material stockpiled in the receiving barge.
- Void ratio determined from measurements by Eley Volumeter, manufactured by Soiltest, on soil samples as received in sample jars.

* Laboratory tests completed by Haley & Aldrich, Inc., Mass.

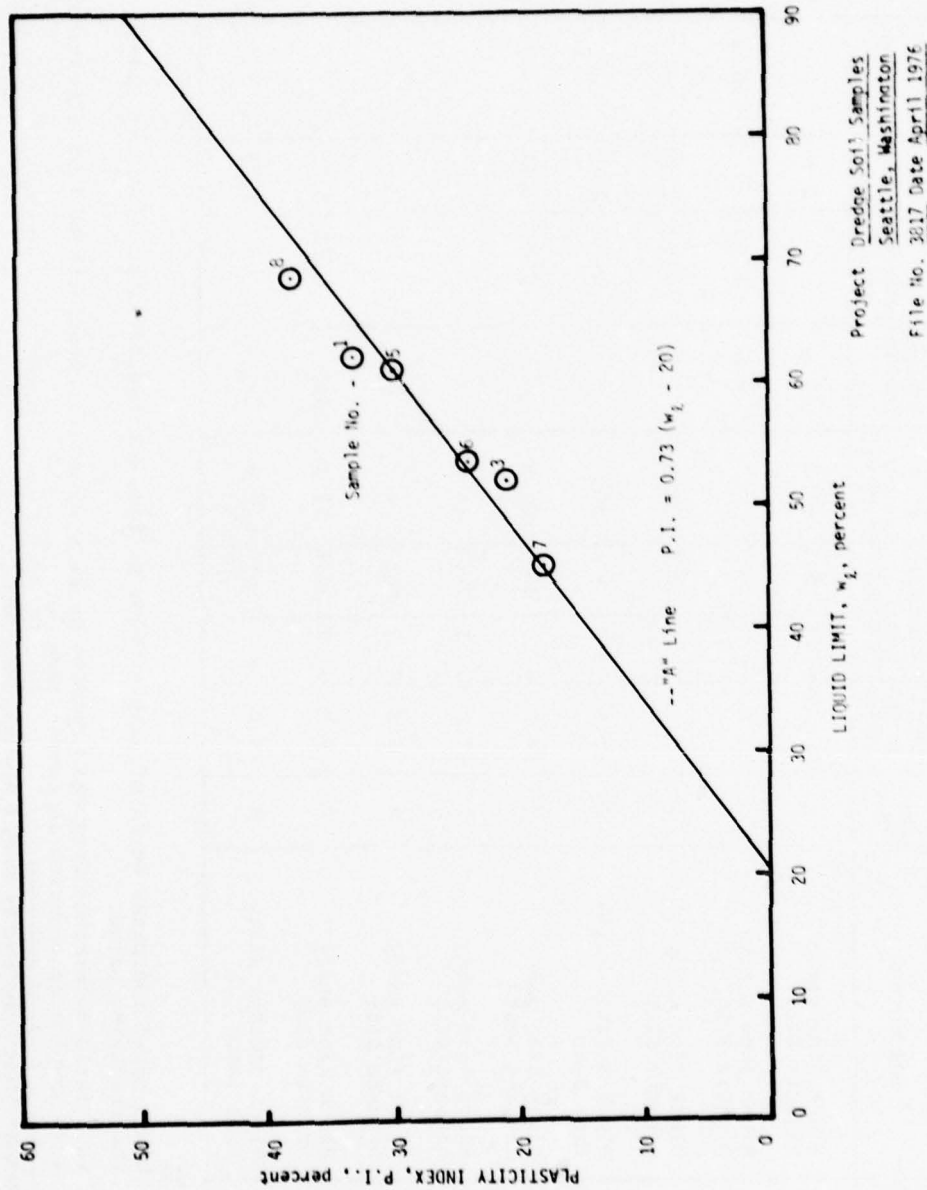

Figure J8. Plot of sediment samples on plasticity chart collected from scow, 27 February 1976, and analyzed by Haley and Aldrich, Inc.

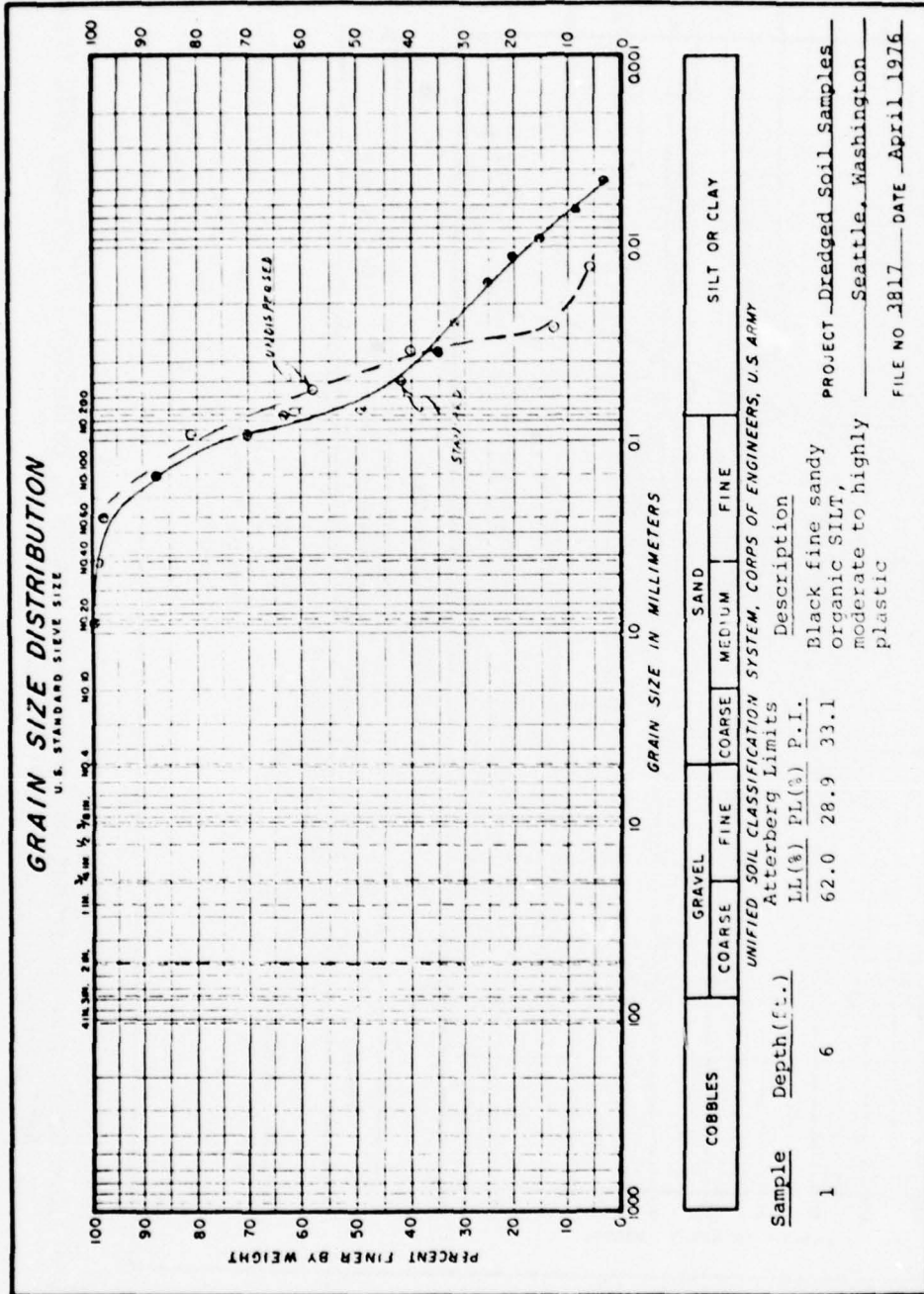

Figure J9. Grain-size distribution for sediment sample 1, collected 27 February 1976 from SCOW. Analyzed by Haley and Aldrich, Inc.

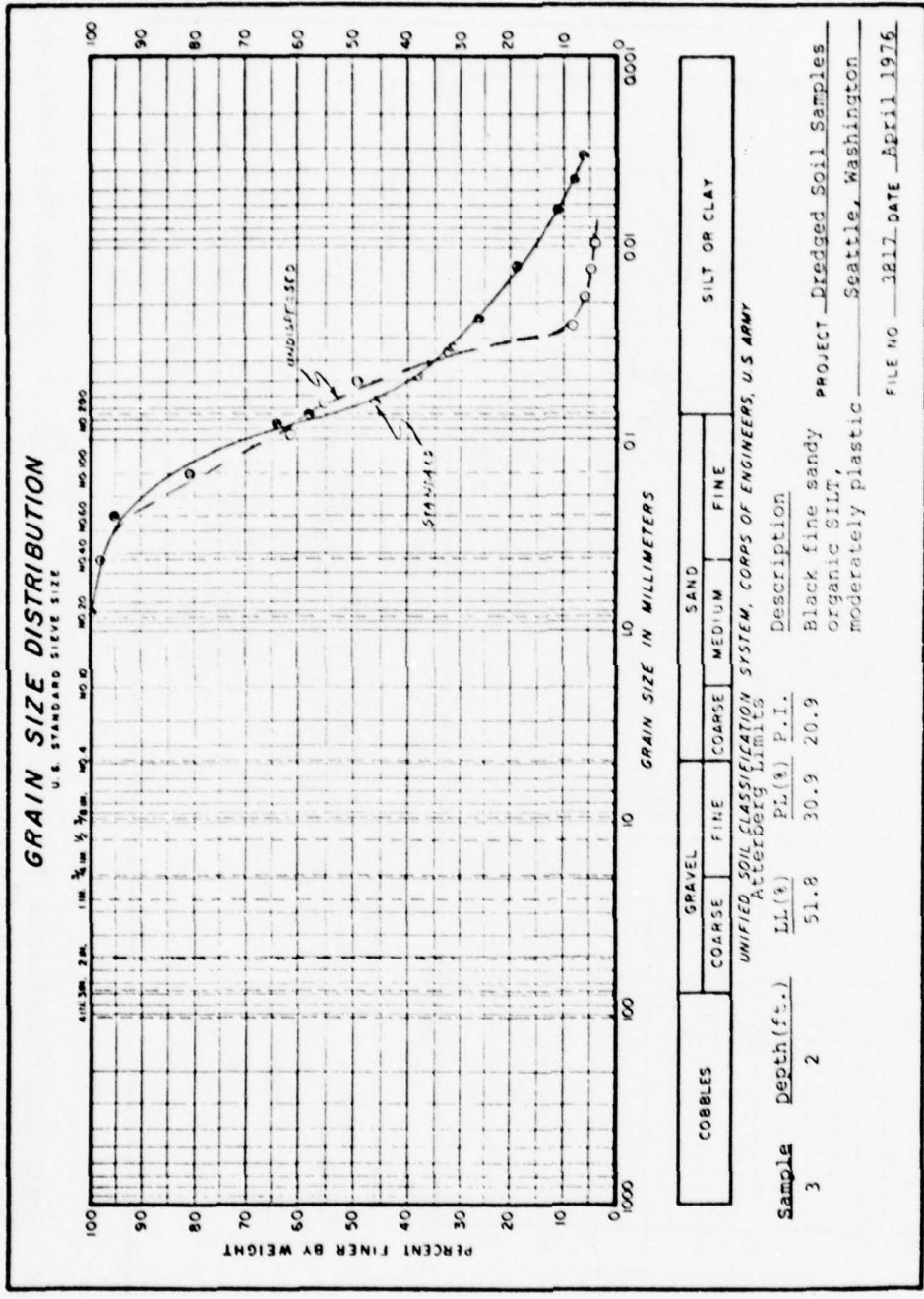

Figure J10. Grain-size distribution for sediment sample 3, collected 27 February 1976 from scow. Analyzed by Haley and Aldrich, Inc.

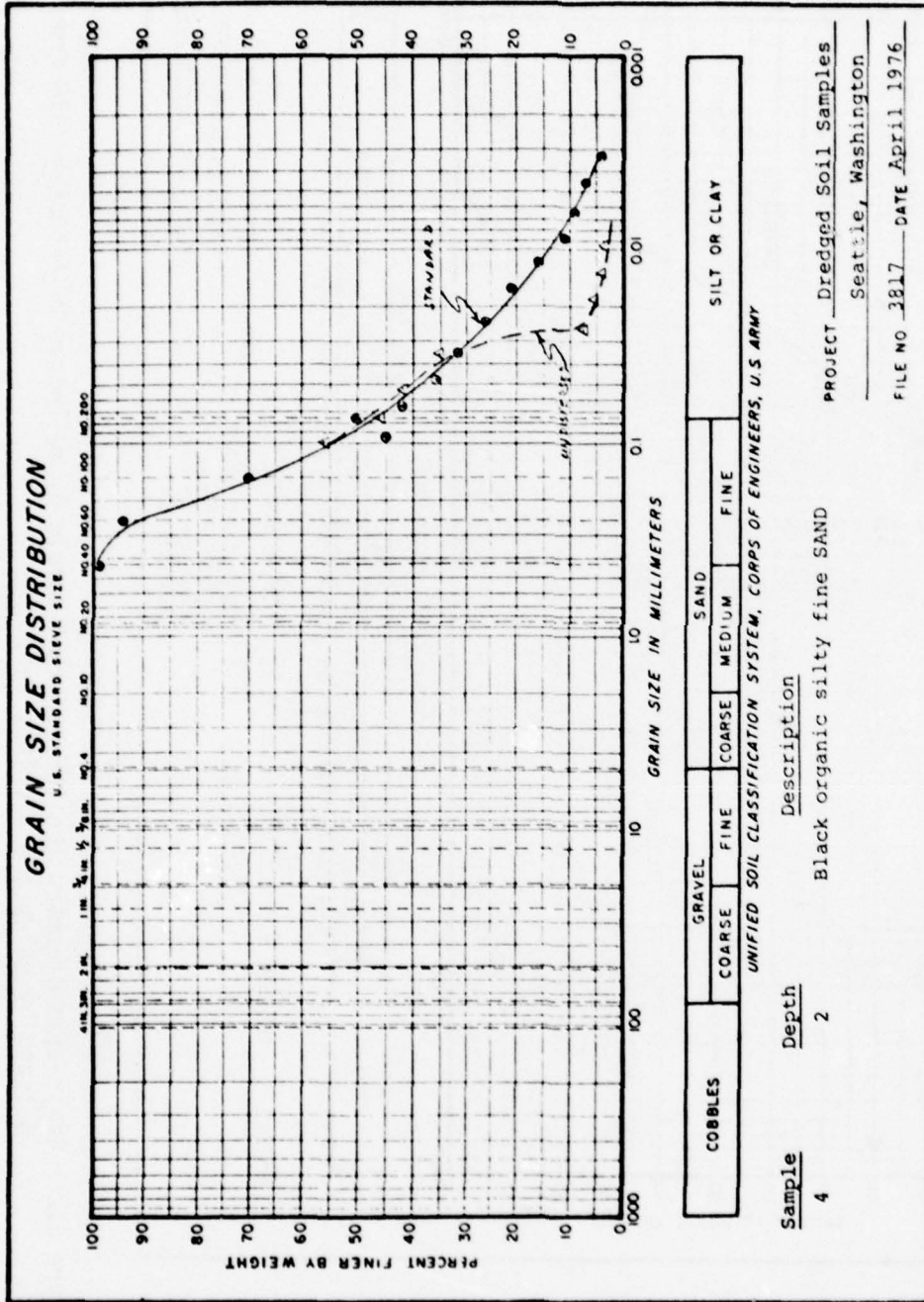

Figure J11. Grain-size distribution for sample 4, collected 27 February 1976 from scow. Analyzed by Haley and Aldrich, Inc.

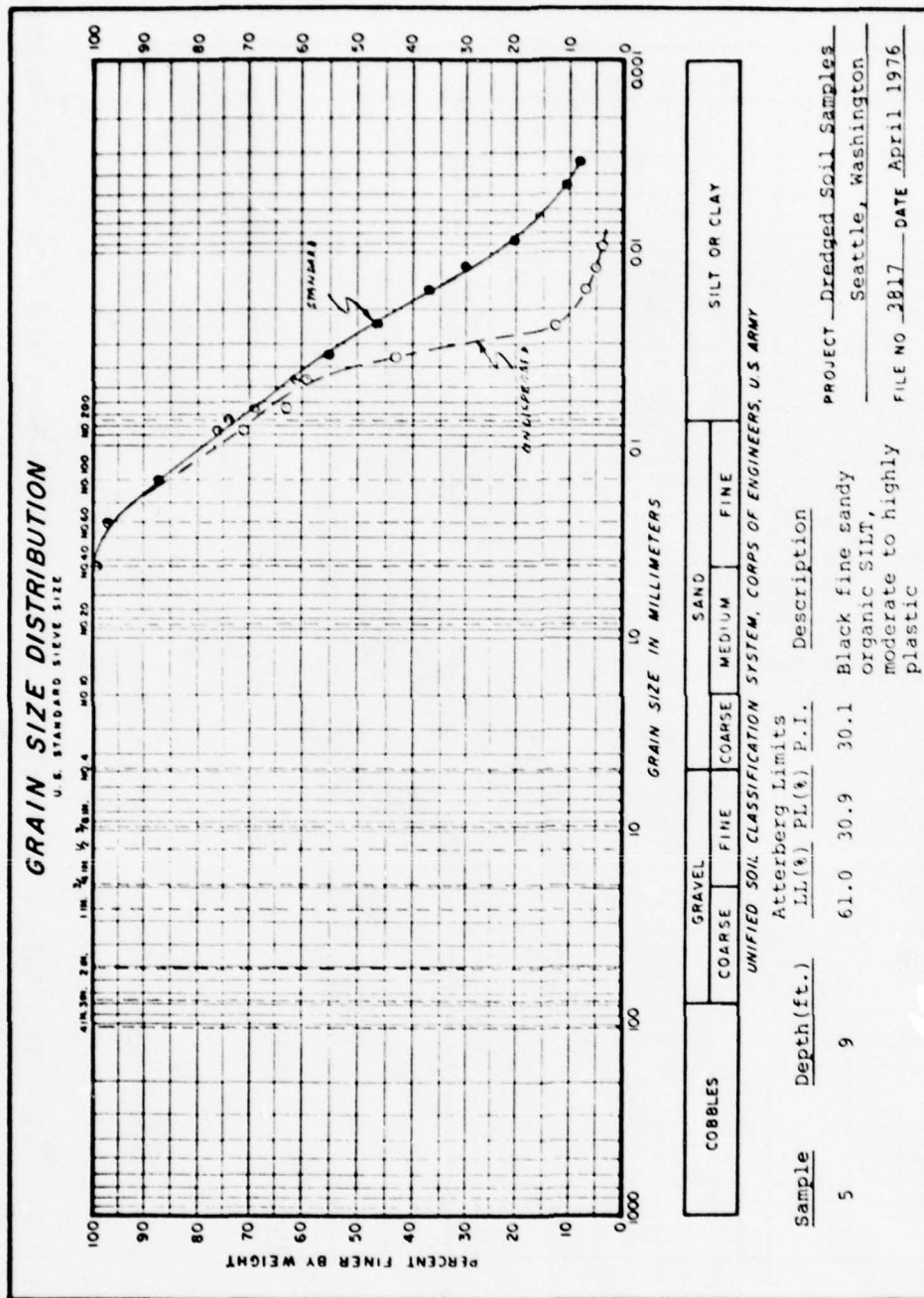

Figure J12. Grain-size distribution for sediment sample 5, collected 27 February 1976 from SCOW. Analyzed by Haley and Aldrich, Inc.

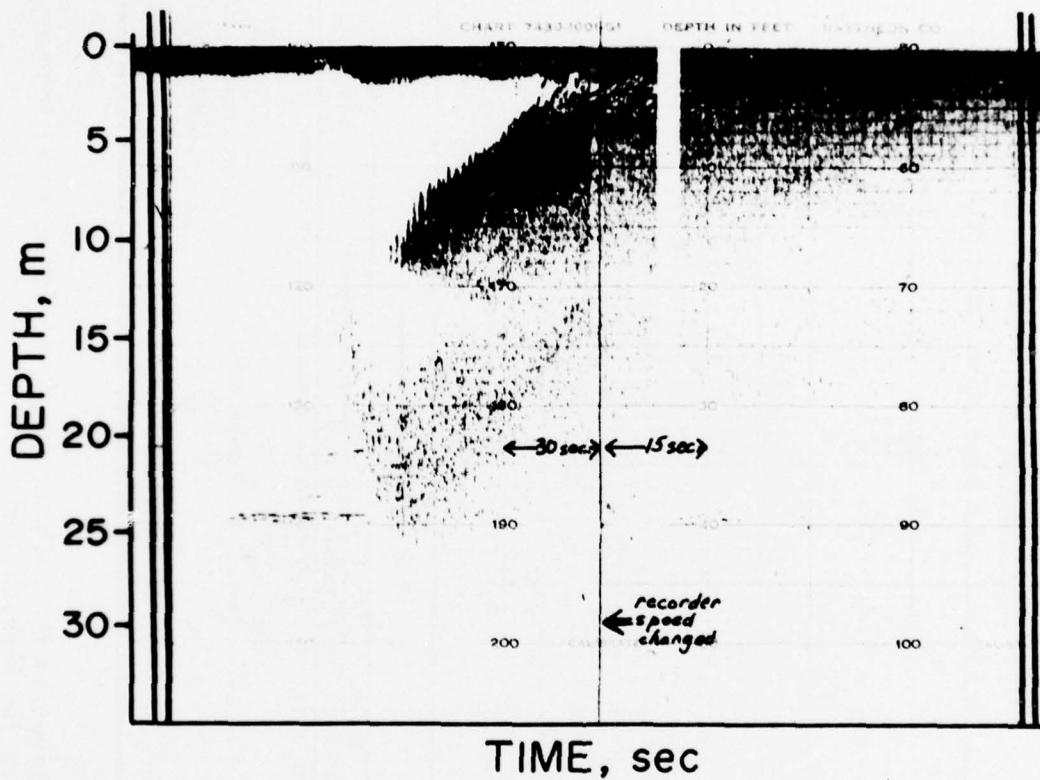

Figure J14. 200-kHz acoustic record showing the descent of dredged material from the scow on 25 February 1976. Observing vessel approximately 45 m downstream of discharge site.

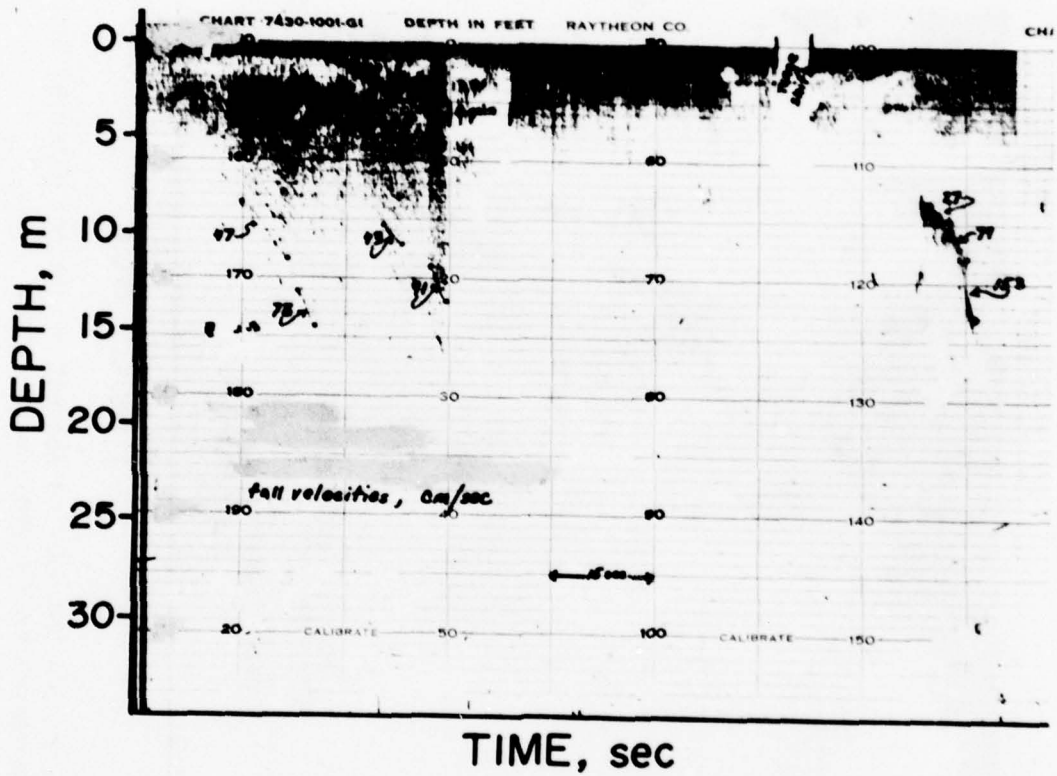

Figure J15. 200-kHz acoustic record showing the descent of dredged material from the scow on 23 February 1976. Observing vessel held alongside the scow.

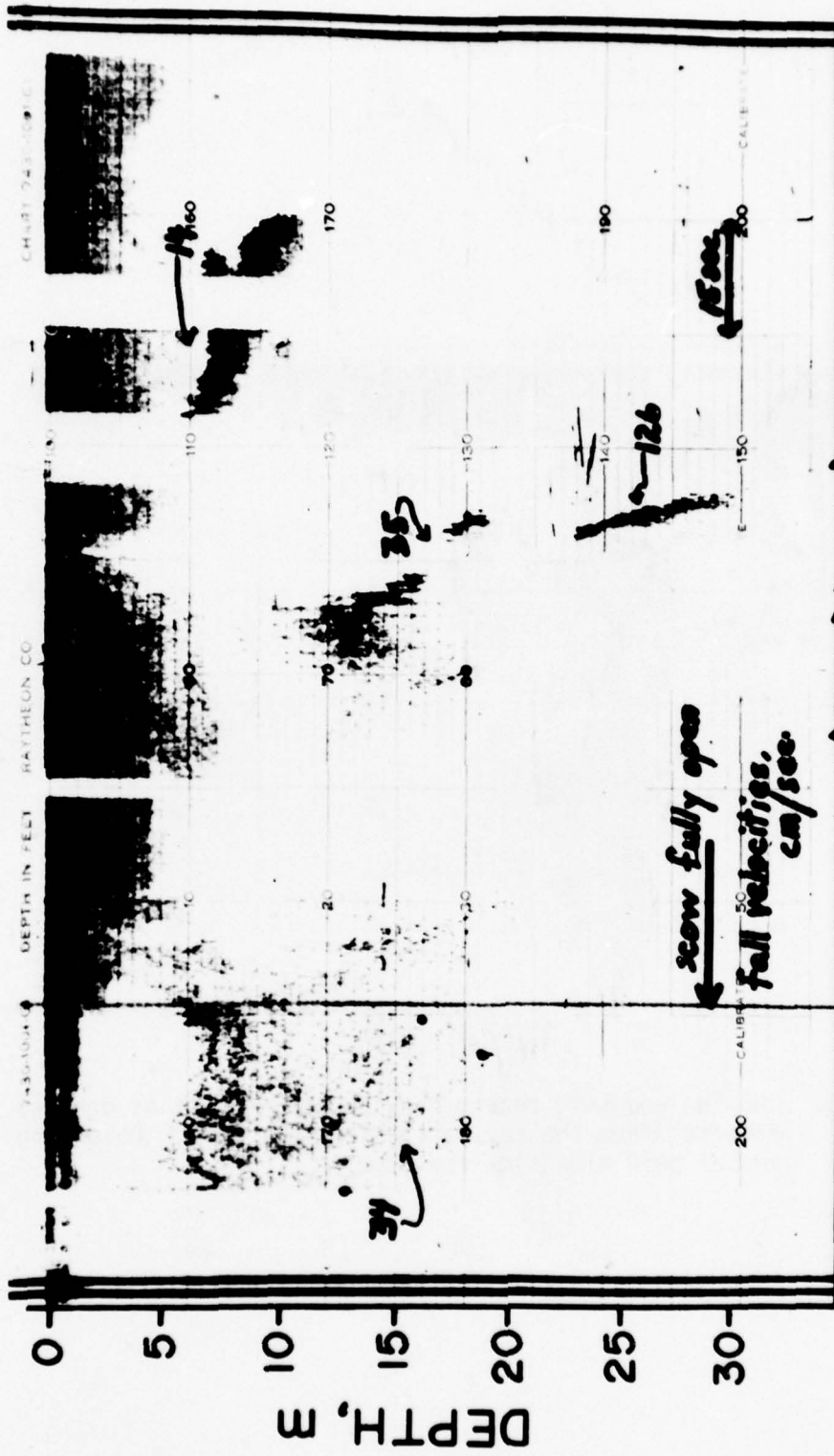

Figure J16. 200-kHz acoustic record showing the descent of dredged material from the scow on 24 February 1976. Observing vessel held alongside the scow.

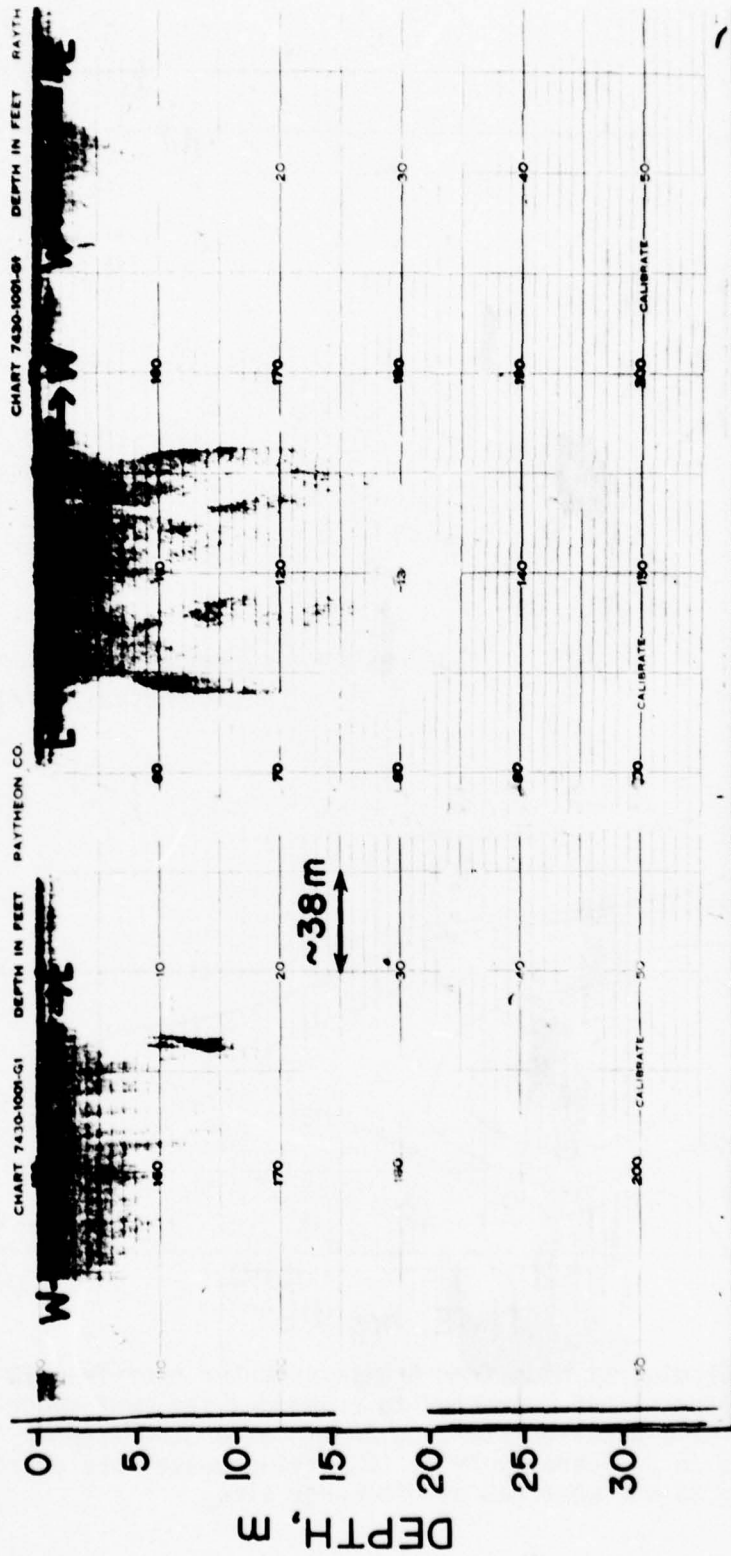

Figure J17. 200-kHz acoustic record showing the descent of dredged material from the scow on 24 February 1976. Observing vessel making successive E-W tracks 60 m downstream of discharge site.

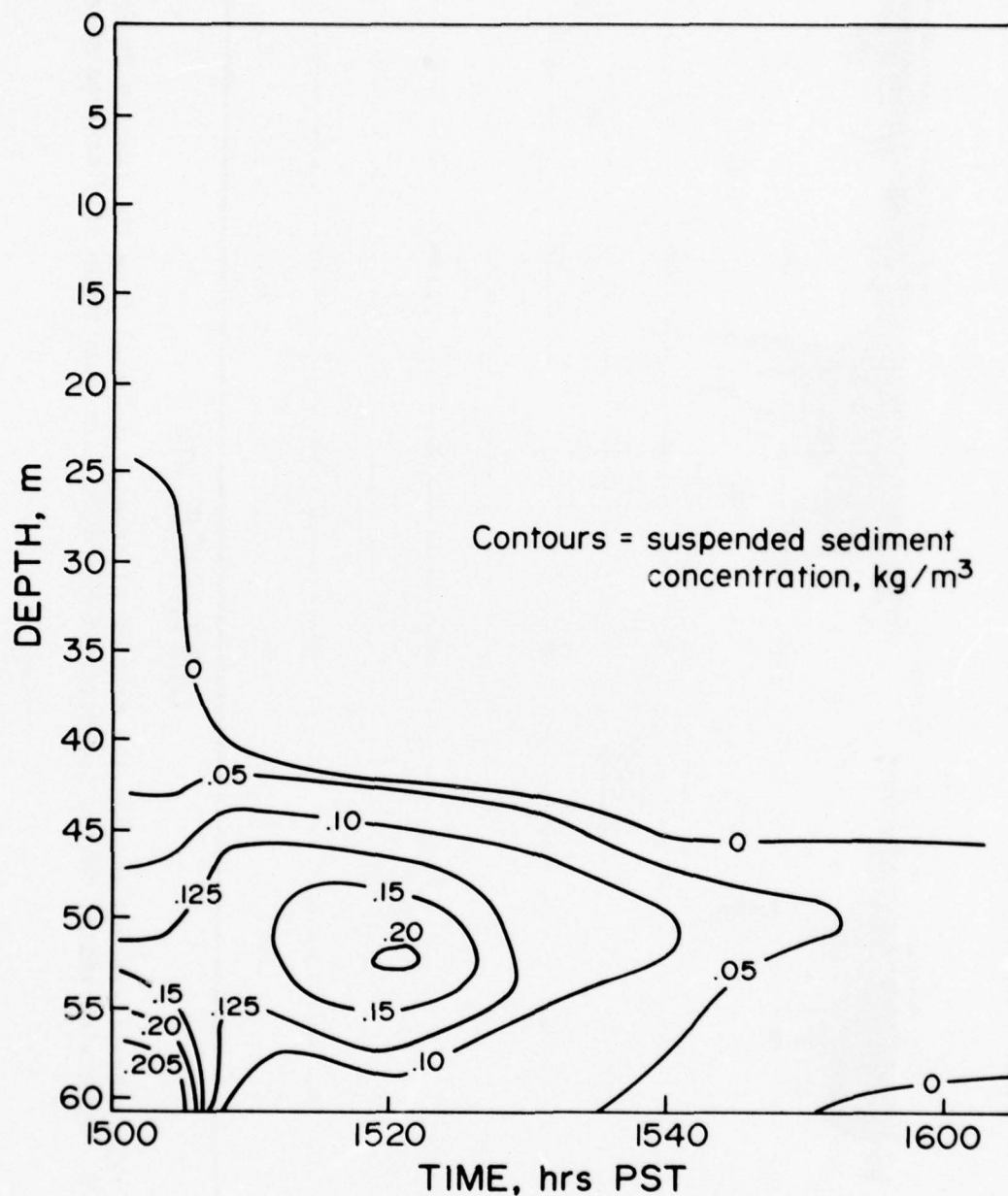

Figure J18. Contour diagram made from transmissometer profiles (10-cm path length) and converted to suspended sediment concentration for a 60-min period starting 20 min after the 1440 hr discharge on 24 February 1975. Observing vessel was approximately 26 m downstream of discharge site.

February 1976, before dumping; Survey 2, March 1976, soon after dumping; Survey 3, April 1976; and Survey 4, June 1976. Total volumes were 40,327 m³ for Survey 2, 35,929 m³ for Survey 3, and 44,787 m³ for Survey 4. The bathymetric survey made with the 7.5-kHz transducer by Yale personnel on 27 February gave an estimate of a pile of disposed material containing about 16,000 m³ of sediment at that time. For the distribution of material on the bottom see the contour maps (Figures J19 and J20).

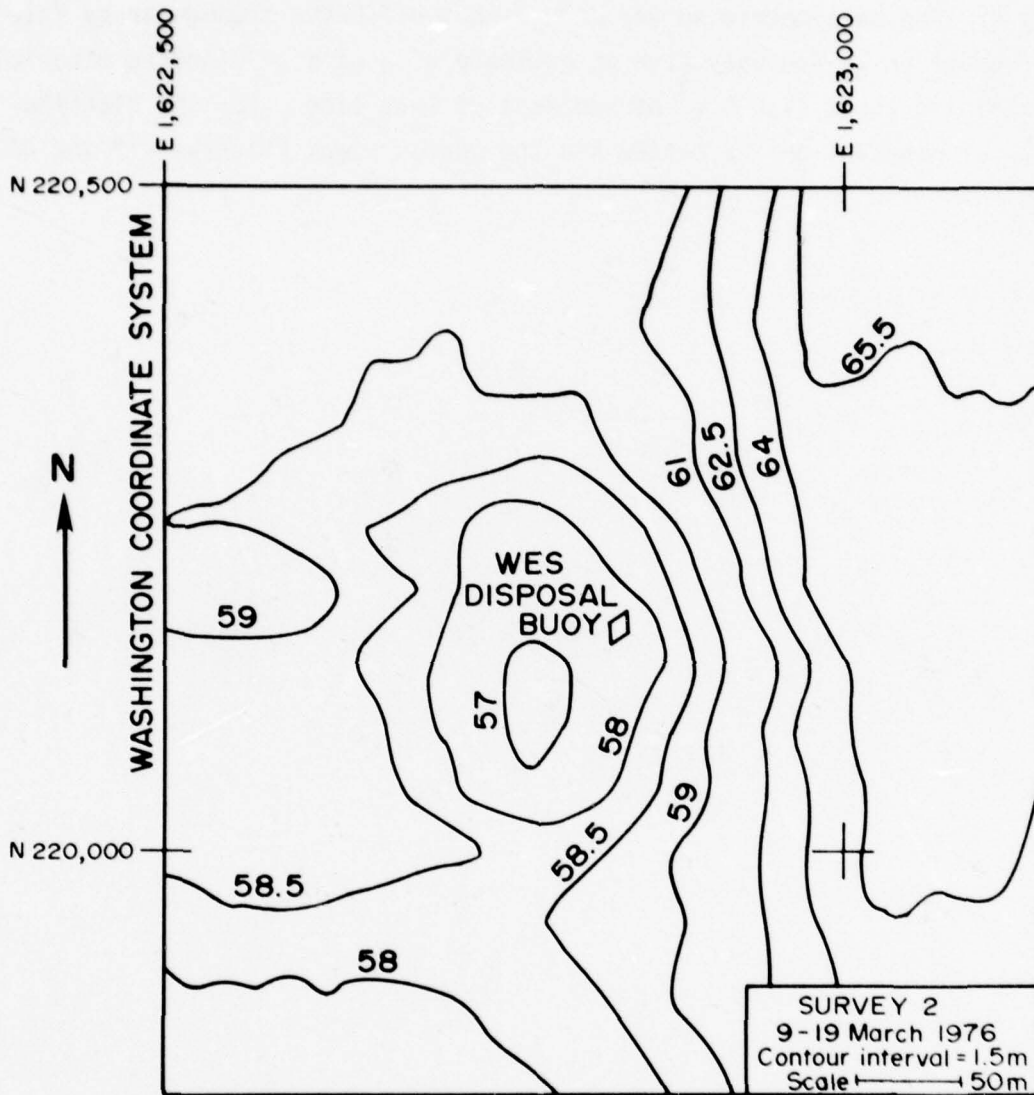

Figure J19. Contour map from bathymetric Survey 2 conducted during 9-19 March 1976; corrected to Survey 1 datum. Contour interval 1.5 m.

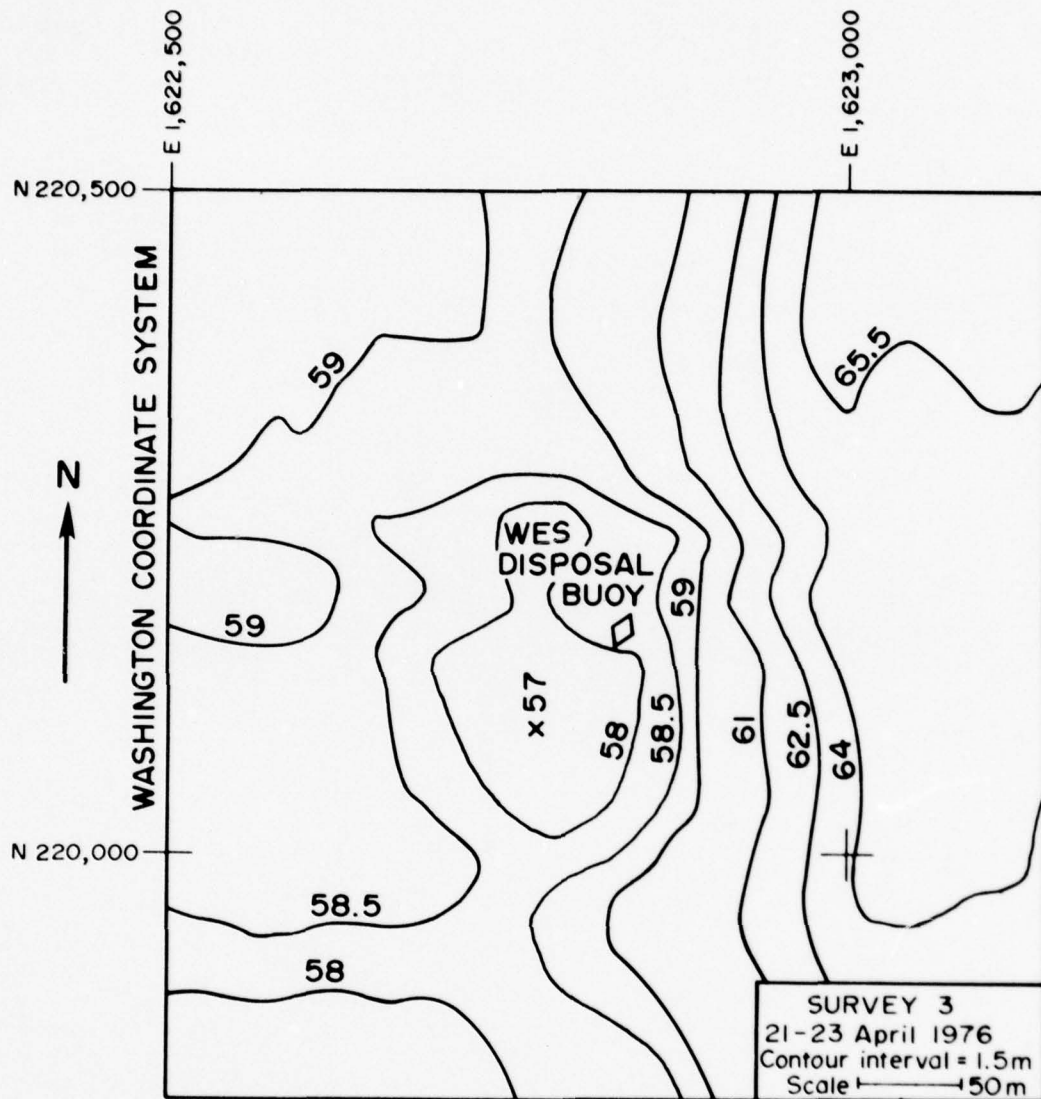

Figure J20. Contour map from bathymetric Survey 3 conducted 21-23 April 1976; corrected to Survey 1 datum. Contour interval 1.5 m.

APPENDIX K: ASHTABULA DISPOSAL SITE

Objectives of the Research

1. Field observations of the mechanics of the placement of dredged material on the bottom of Lake Erie were made on 24, 25, and 26 May 1976. Observations similar to those made at the disposal operation in Elliot Bay, Seattle, Washington, were repeated at the Ashtabula site in order to examine the effects of disposal of cohesionless, high water content sediment in shallower water. These observations included determining: initial fall velocity of cloud based on rate at which the dredge empties; fall velocities of particles and areal extent of suspended material with a 200-kHz acoustic transducer; arrival time of descent cloud at the bottom, rate of spreading of bottom surge, and vertical distribution of material in the water column with transmissometers; and properties of dredged material from laboratory analysis of hopper samples. New techniques for measuring the fall velocity and acceleration of the descent cloud through the water column were tested.

2. The dredging was done by the hopper dredge Hoffman in Ashtabula Harbor, Ohio. Two disposal sites were used: one with a depth of about 18 m and approximately 4 km north of Ashtabula Harbor and one with a depth of 13 m and 3.2 km north of the harbor (see Figure K1).

Personnel and Vessels

3. Persons involved in data collection from Yale University were H. Bokuniewicz, J. Gebert, R. Gordon, P. Kaminsky, M. Reed, and C. Tuttle. Participating from WES was Barry Holliday.

4. Vessels used for the observations were:

- a. U. S. Hopper Dredge Hoffman; 66 m LOA, eight hoppers, hopper capacity 703 m³, operated by Buffalo District Army Corps of Engineers.
- b. M/V Whitehorse, a 12-m Chris Craft.
- c. M/V Wes, a 5.8-m Boston Whaler.

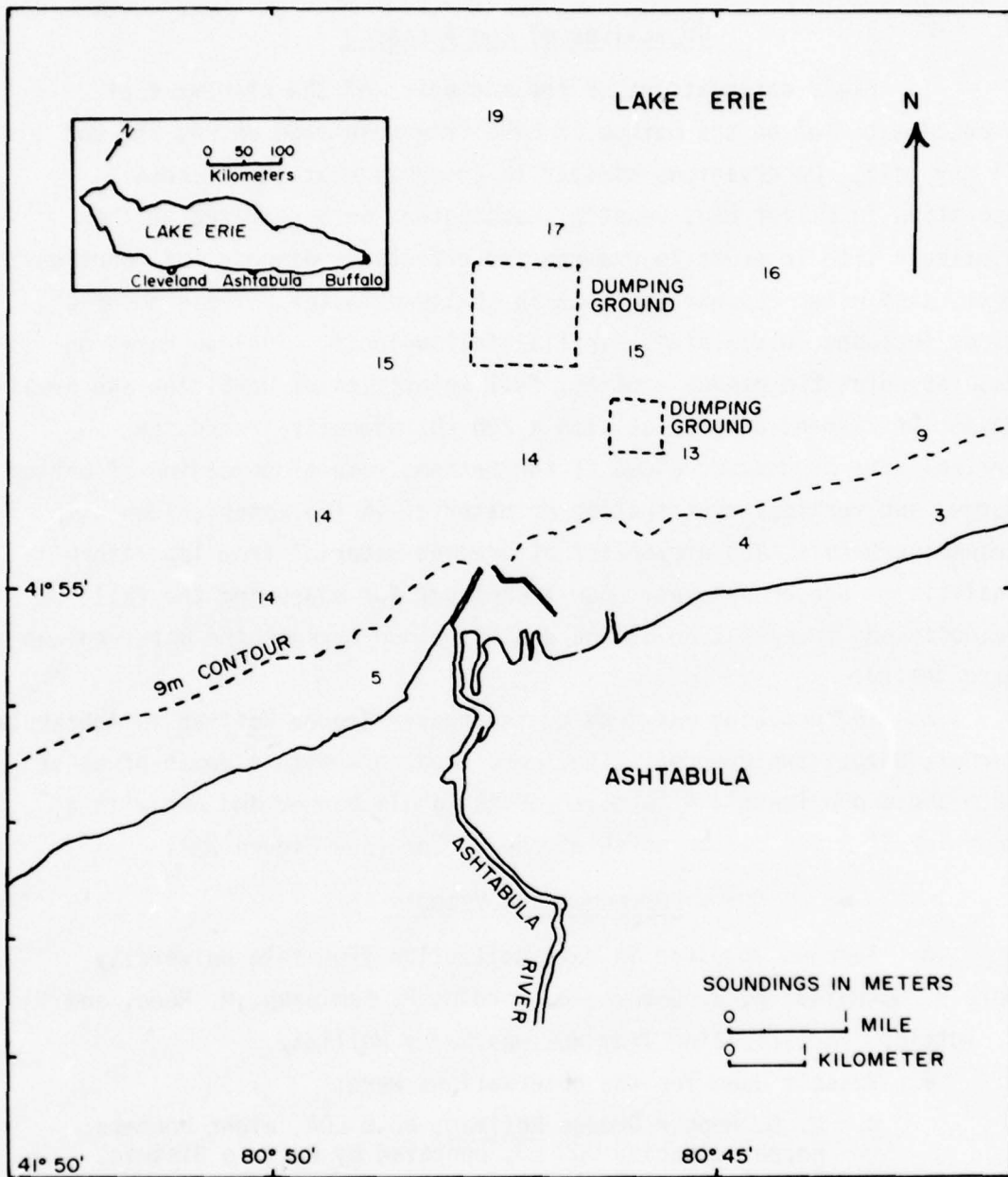

Figure K1. Index map of the study area showing location of disposal sites and Ashtabula Harbor dredging area.

d. M/V Hotspur, a 6.1 m McKee Craft.

Disposal Site Description

Bathymetry

5. No bathymetric surveys were conducted by Yale prior to disposal operations. From contour maps produced by the NALCO Environmental Sciences Quarterly Report to WES in 1976, the bottom topography at both disposal sites was determined to be flat with only a few tenths of a meter variation within 100 m around the discharge point.

Bottom materials

6. No core samples at either site were collected by Yale. The Quarterly Report to WES prepared by NALCO Environmental Sciences (1976) shows the lake bottom sediments to be coarse grained (mainly sand and clay-sized materials) and poorly sorted.

Currents

7. It was not possible to obtain long-term background records on current distribution prior to the field observation. According to Gedney and Lick (1972), although currents on Lake Erie are predominantly wind driven, current circulation depends upon bottom topography and boundary geometry as well. Currents at 1 and 3 m above the bottom near Ashtabula were predominantly shore parallel in the directions NE-E and WSW-WNW (NALCO, 1976). The current speeds were most frequently in the range 0.03 to 0.12 m/sec at 3 m above bottom and less than 0.03 m/sec at 1 m above the bottom. To record ambient water conditions at the disposal site two Braincon current meters were deployed at the north side of the designated disposal area (41°57.8'N, 80°46.9'W) in 17 m of water. The meters recorded velocity and direction at 20-min intervals. One meter, number 319, was 5.5 m off the bottom. The record from the meter placed 5.5 m off the bottom indicated the current generally ran in a WSW-WNW direction with a typical velocity between 0.1 and 0.2 m/sec. There were velocities as high as 0.25 to 0.30 m/sec. The current meter 2 m off the bottom showed currents running in a SSE direction with a typical velocity between 0.05 to 0.1 m/sec and at times velocities as high as 0.15 m/sec (see Figure K2).

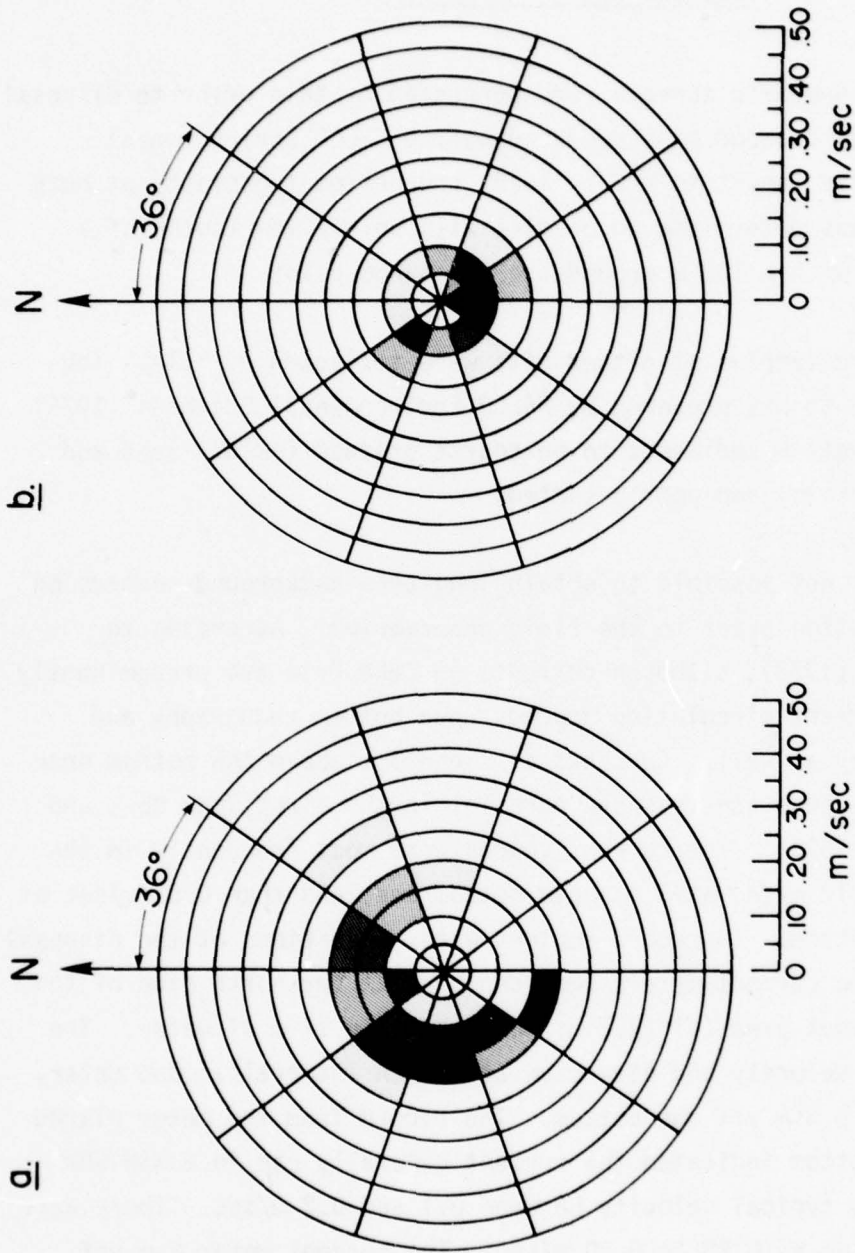

Observed frequency of a velocity in a 36° increment

- 0-2.5%
- ▒ 2.5-5.0%
- 5.0-7.5%
- > 7.5%

Figure K2. Polar histograms of current velocity and direction distributions, 24-26 May 1976. Histogram a is Braincon current meter No. 319, 5.5 m off the bottom; histogram b is Braincon meter No. 385, 2 m off the bottom.

Study Procedure

8. Observations were made at two designated disposal areas as shown on Figure K1. An Army Corps of Engineers marker buoy was in a permanent position at each site. Additional temporary marker buoys were established by Yale University personnel on the north edge of the larger main disposal site. The dredge Hoffman remained in a fixed position near the permanent marker buoy for each disposal operation. Three anchored boats arranged in various configurations around the discharge point observed the characteristics of the descent phase and bottom surge formed by the release of the material at the surface. The observing vessels were positioned relative to the dredge with an optical range finder and bearing compass. The position of the Braincon current meters was determined by horizontal sextant angles.

9. The following observations were made:

- a. Two Braincon current meters were deployed at 1250 hr on 24 May and recovered 52 hr later to record the ambient water conditions in the disposal area.
- b. An inverted echo sounder placed on the bottom was used to record the fall of dredged material during the discharge operations.
- c. Four optical transmissometers were deployed in a variety of horizontal and vertical array configurations. Continuous records of transmittance were made to detect the arrival times of the bottom surges generated by the disposal operations.
- d. Four GO current meters and a Price current meter were deployed on the bottom to detect surge arrival times and to measure the surge velocity.
- e. Water samples were collected from a fixed location on the bottom by continuous pumping during the passage of the bottom surge.
- f. Echo sounder records were made from the surface to detect the passage of the surge.
- g. Samples of the dredged material from the hoppers of the Hoffman were collected. Samples of the continuously discharged overflow water from the Hoffman were collected for suspended sediment analysis.

10. Included in this section is a data catalogue which describes the observations undertaken for each disposal operation on all three

days (Table K1). Also included for each day of observation is information on the location of all stations and the instrumentation deployed for each disposal operation (Tables K2 to K11 and Figures K3 to K11).

Results

11. Sediment samples of the Ashtabula Harbor area were not collected by Yale personnel. Table K12 contains data supplied by Buffalo District Corps of Engineers just prior to dredging operations. The results of the Environmental Protection Agency Harbor Sediment Sampling Program in 1975 indicate most of the harbor to be mostly silt or clay with some sand and predominantly sand along the boundaries. Samples taken within the hoppers were too small to be analyzed, but were mostly sand in content.

12. The upward-looking, 200-kHz transducer was used to measure the descent velocity of the discharged material. Two discharges were examined and Figure K12 is a travel-time curve compiled from these observations. The discharged sediment cloud attains a terminal velocity of about 0.6 m/sec after falling through only about 3 m of water.

13. Impacting on the lake floor, the dredged material creates a density surge which spreads radially outward. Figure 17 in the text shows the arrival time of the surge as detected by transmissometers, General Oceanics current meters, and a Price current meter. This figure is a compilation of all observed discharges. The average, recorded speeds are indicated in text Figure 17 by thick lines through the plotted, arrival time points. Progressive vector diagrams of the surge velocity as detected by the General Oceanics meters are shown in Figures K13-16. These meters sample the flow every 15 sec. The background velocity is measured immediately before the arrival of the surge and the measured surge velocities are plotted for the first 2 min after the surge arrival. The surge velocity is found by vectorially subtracting the background velocity from the average measured velocity for the first 2 min after the arrival of the surge. Instruments at 300 m did not detect the surge which does not appear to have extended beyond 200 m from the dredge.

Table K1

Data Catalogue

24 May, 25 May, 26 May, 1976

Project Objectives	Observations Undertaken	Instrumentation and Information Used		Disposal No.	
		240576	250576	260576	260576
To examine the effects of disposal of cohesionless sediment in shallow water.	1. Suspended sediment in overflow water from hopper	Water samples - pump	1		
	2. Physical and mechanical properties of material before disposal	Syringe samples of sediment in hoppers	1		
	3. Discharge characteristics Fall velocity and acceleration of the descending dredged material	Inverted 200 kHz on bottom			3,4
To measure the distribution of disposed material in time and space.	4. Movement of material in time a.) Arrival time of surge-velocity, direction and duration	Transmissometer, G.O. Current Meters and Price Meter	1,2,3,4	1,2,3,4	1,2,3,4
	b.) Areal extent of turbid water around disposal site - height of surge, vertical distribution of material in water column	200 kHz Transmissometer profiles Transmissometer array		4	1
	5. Background information on ambient water conditions away from site	Two Braincon Current Meters	Deployed Pre-disposal 1		Recovered Post-disposal 4
	6. Mass balance in surge	In laboratory - velocity, height and concentration data			1,2,3,4

Table K2

Station Log

24 May 1976 - Disposal 1 - Main Site

Disposal #	Time	Name of Boat	Type of Observation*	Instrumentation Used (XM = transmissometer, CM = current meter)	Range to Dredge, m	Depth of Instrument, m	Water Depth, m
1	1250	<u>Hotspur</u>	5	Deployment of Braincon current meter #385 and #319			17
	1501:10	<u>Whitehorse</u>	4a and 4b	XM #1 200-kHz GO CM "E"	42	15	17
		<u>Hoffman</u>	2	Syringe sampler			
		<u>Hoffman</u>	1	Pump samples			
		<u>Wes</u>	4a	GO CM "F"		11	17

Additional Information: Position information insufficient for Disposal #1. Data from XMS and CMS used for travel-time diagram only (Figure 17 text).

*Observation Key:

- 1) Suspended sediment in overflow
- 2) Properties of material before disposal
- 3) Fall velocity
- 4a) Arrival, velocity, duration of surge
- 4b) Areal extent of turbid water
- 5) Background information on ambient water conditions
- 6) Mass balance in surge.

Table K3
Station Log

24 May 1976 - Disposal 2 - Main Site

Disposal #	Time	Name of Boat	Type of Observation*	Instrumentation Used (XM = transmitter, CM = current meter)	Range to Dredge, m	Depth of Instrument, m	Water Depth, m	
2	1624	<u>Whitehorse</u>	4a	XM #1	42	14	17	
			4b					
		<u>Whitehorse</u>	4a	GO CM "E"	61	19.9	20	
		<u>Wes</u>	4a	XM #4	158			
		<u>Wes</u>	4a	GO CM "F"	158	19.9	20	
		<u>Hotspur</u>	4a	XM #3	158			

*See Table K2 for observation key.

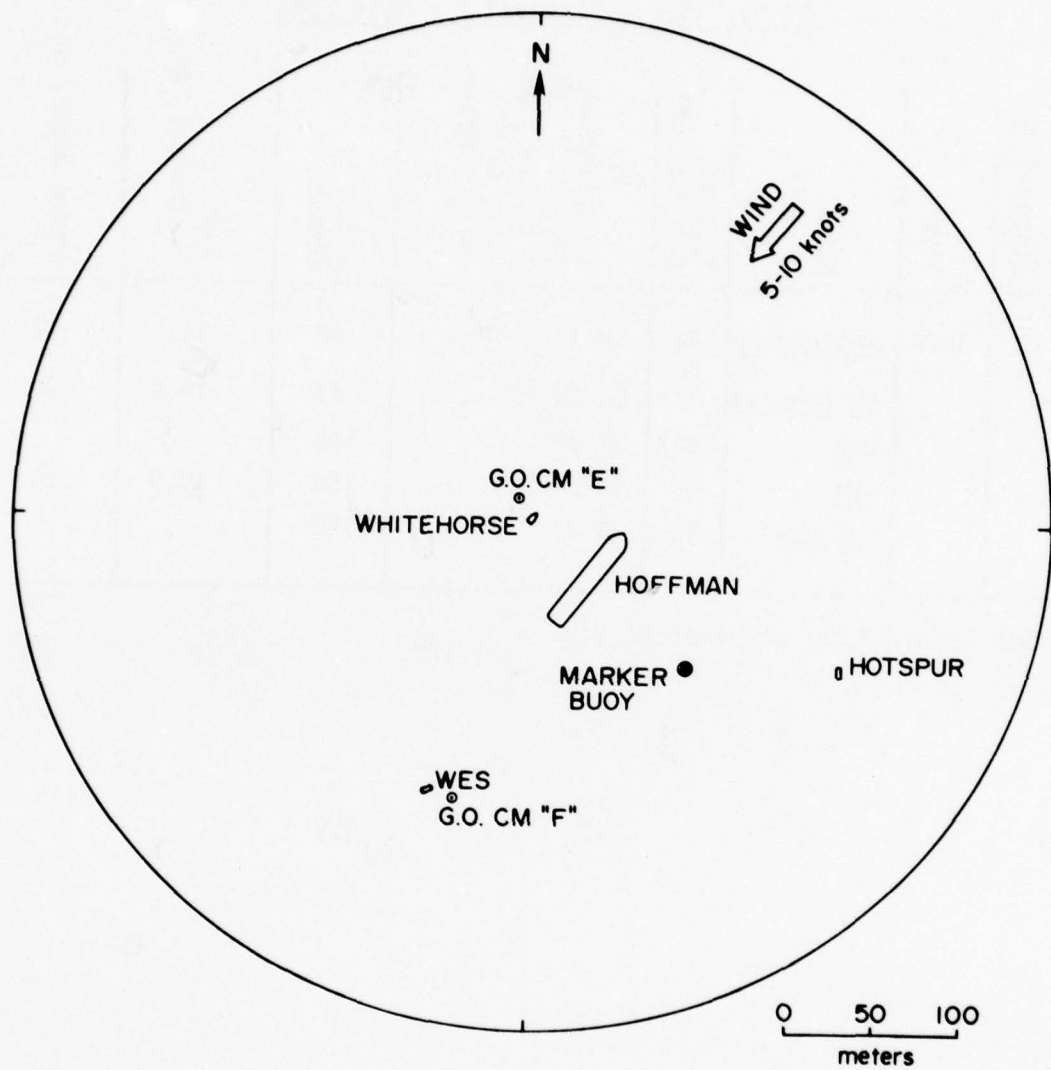

Figure K3. Vessel positions for Disposal 2, 24 May 1976.

Table K4

Station Log24 May 1976 - Disposal 3 - Alternate Site

Disposal #	Time	Name of Boat	Type of Observation*	Instrumentation Used (XM = transmissometer, CM = current meter)	Range to Dredge, m	Depth of Instrument, m	Water Depth, m
3	1748	<u>Whitehorse</u>	4a	XM #1	64	11.5	14.5
			4b				
		<u>Hotspur</u>	4a	G.O. CM "E"	37	15.9	16.0
			4a	XM #3			

*See Table K2 for observation key.

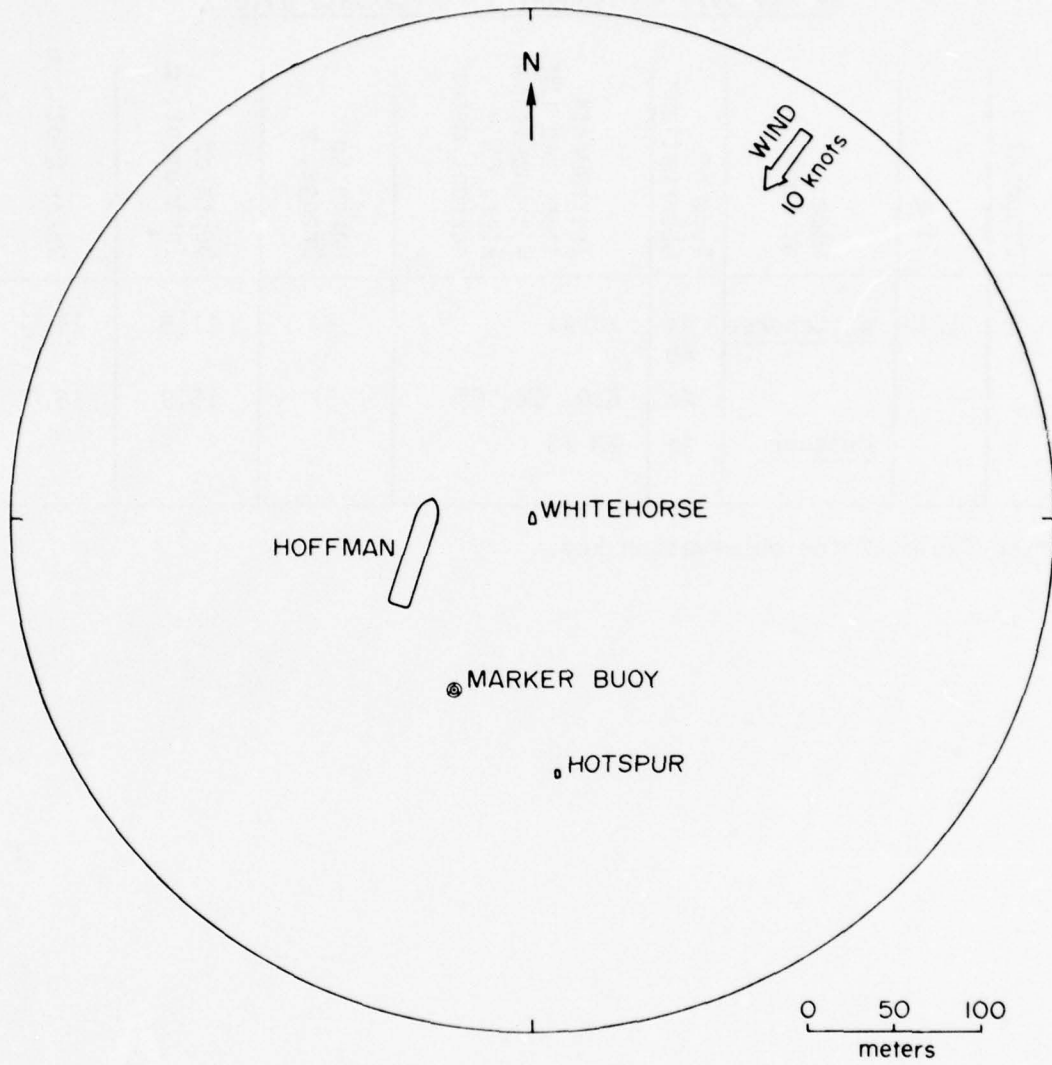

Figure K4. Vessel positions for Disposal 3, 24 May 1976.

Table K5

Station Log

24 May 1976 - Disposal 4 - Alternate Site

Disposal #	Time	Name of Boat	Type of Observation*	Instrumentation Used (XM = transmissometer, CM = current meter)	Range to Dredge, m	Depth of Instrument, m	Water Depth, m
4	1855	<u>Whitehorse</u>	4a	XM #1	137	14	14.5
			4b				
		<u>Wes</u>	4a	GO CM "E"	182	15.9	16.0
			4a	XM #4	305		14.5
		<u>Hotspur</u>	4a	GO CM "F"	305	15.9	16.0
			4a	XM #3	305		

*See Table K2 for observation key.

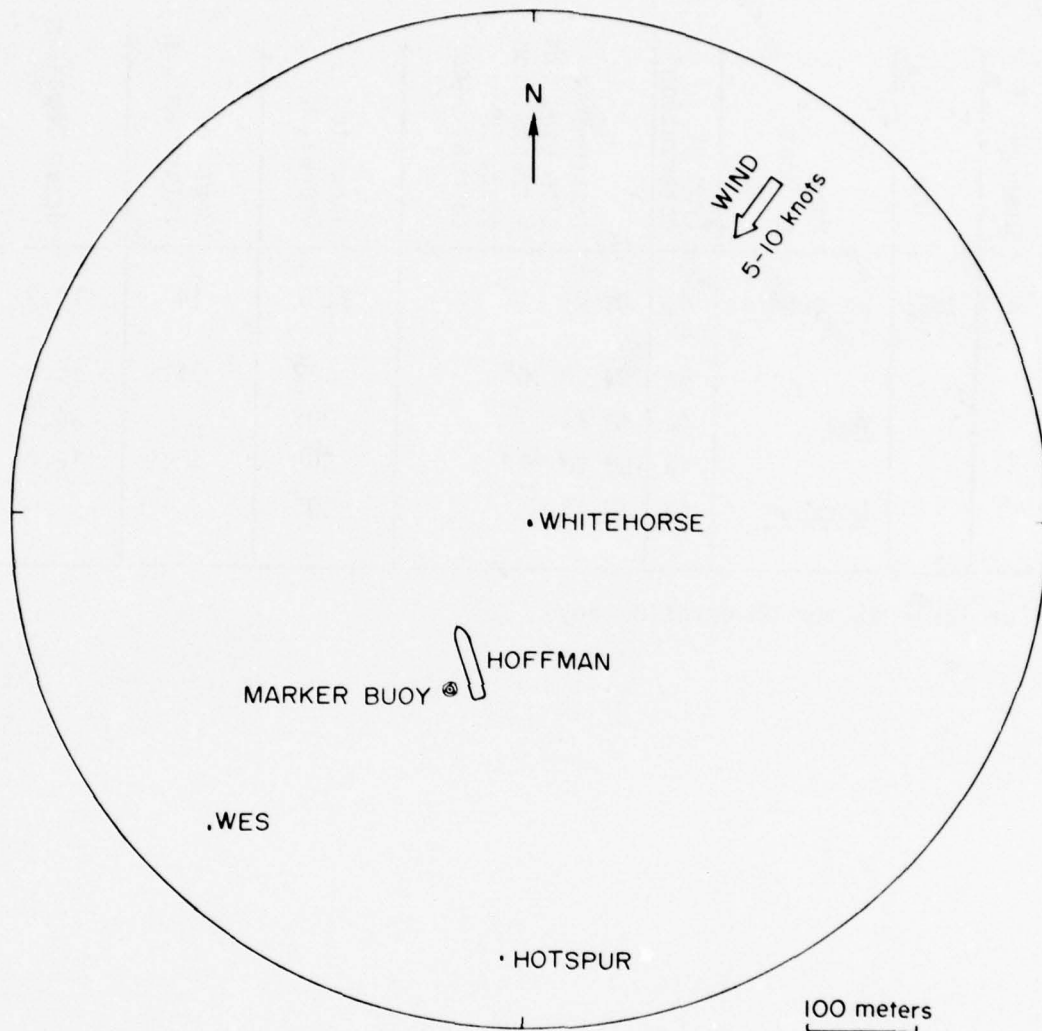

Figure K5. Vessel positions for Disposal 4, 24 May 1976.

Table K6

Station Log25 May 1976 - Disposal 1 - Main Site

Disposal #	Time	Name of Boat	Type of Observation*	Instrumentation Used (XM = transmissometer, CM = current meter)	Range to Dredge, m	Depth of Instrument, m	Water Depth, m
1	1251:30	<u>White-horse</u> bow	4a	XM #2	55	16.5	17.5
			4a	Price meter	55	16.5	17.5
		<u>White-horse</u> stern	4a	XM #1	55	16.5	17.5
			4b				
		<u>Wes</u>	4a	XM #4	78	16.5	17.5
			4a	GO CM "F"	78	17.9	18.0
		<u>Hotspur</u>	4a	XM #3	112		
			4b	200-kHz**			

*See Table K2 for observation key.

**At 1349 hr Hotspur made 200-kHz bathymetric tracts, GO CM "F" to Dump Buoy - (current meter positioning on bottom profiling).

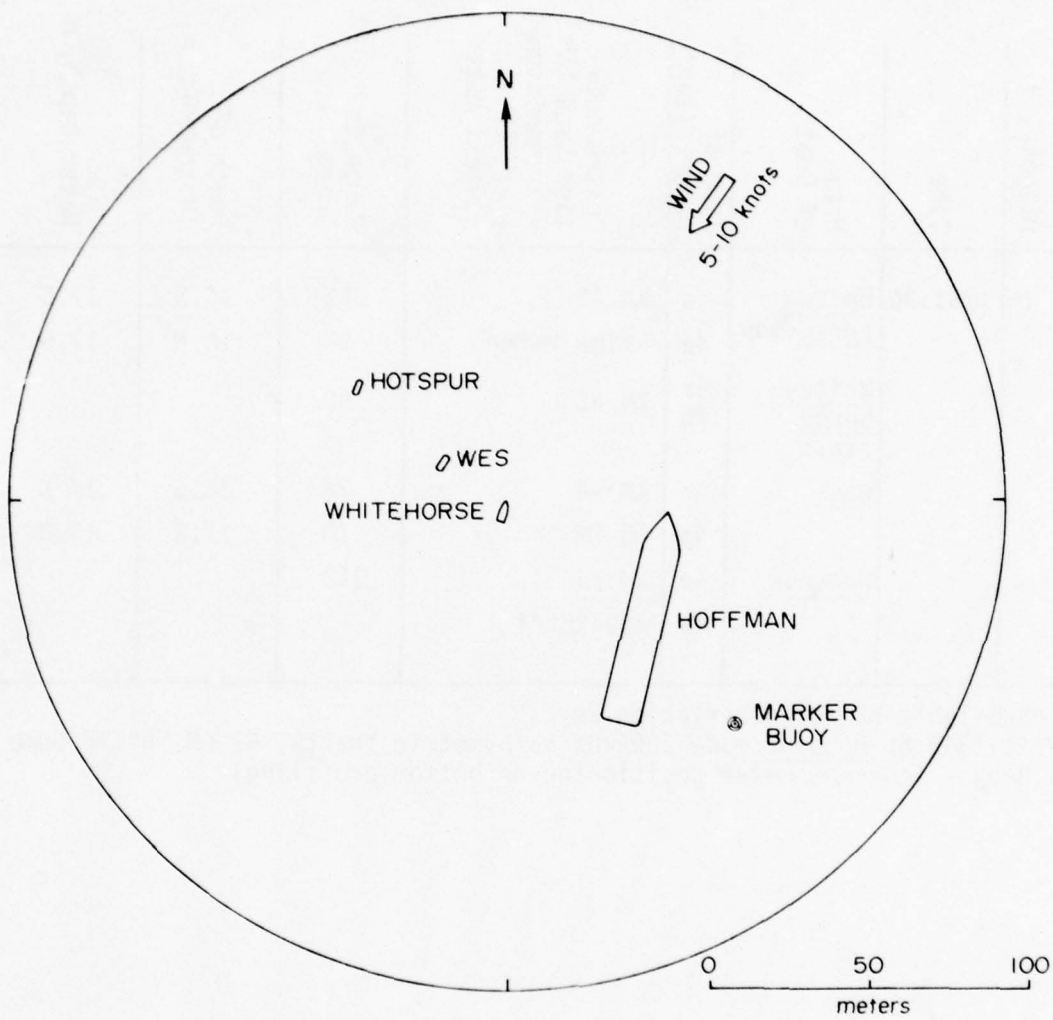

Figure K6. Vessel positions for Disposal 1, 25 May 1976.

Table K7

Station Log

25 May 1976 - Disposal 2 - Main Site

Disposal #	Time	Name of Boat	Type of Observation*	Instrumentation Used (XM = transmitter, CM = current meter)	Range to Dredge, m	Depth of Instrument, m	Water Depth, m	
2	1424	<u>Whitehorse</u> Bow	4a	XM #2	45	16	17	
			4b					
		<u>Whitehorse</u> Stern	4a	Price meter	45	16	17	
			4b	XM #1	45	16	17	
		<u>Wes</u>	4b	Pump samples #1-3				
			4a	XM #4	70	13	17	
		<u>Hotspur</u>	4a	XM #3	98		17	
				200-kHz**				
			4a	GO CM "F"	117	17.9	18	
	4a	GO CM "E"	132	17.9	18			

*See Table K2 for observation key.

** Bathymetric tracks to determine CM positioning on bottom profiling.

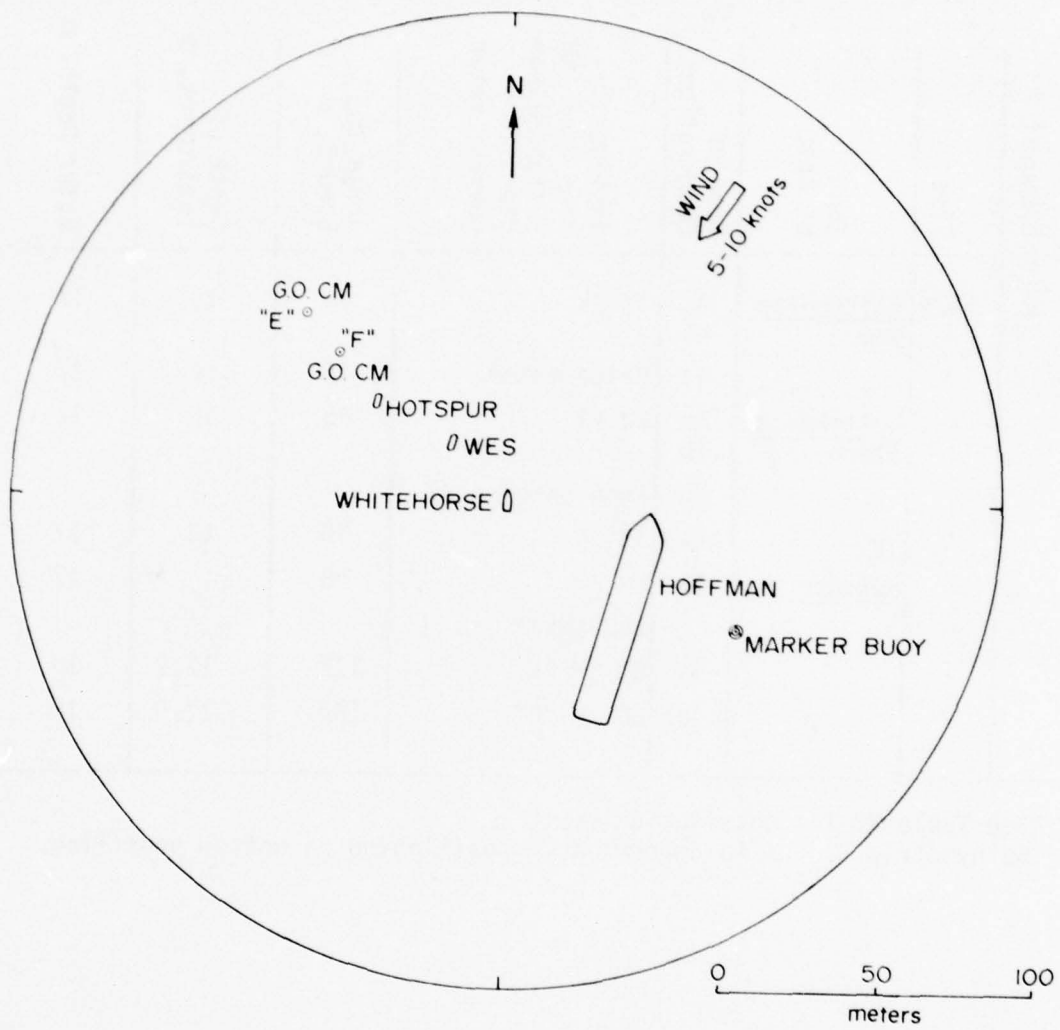

Figure K7. Vessel positions for Disposal 2, 25 May 1976.

Table K8

Station Log25 May 1976 - Disposal 3 - Alternate Site

Disposal #	Time	Name of Boat	Type of Observation*	Instrumentation Used (XM = transmissometer, CM = current meter)	Range to Dredge, m	Depth of Instrument, m	Water Depth, m	
3	1614	Whitehorse Bow	4a	XM #2	96	14.9	15	
			4b**					
		Whitehorse Stern	4a	Price meter	96	14.9	15	
			4b**	XM #1	99		15	
		1650	Wes	4b	Pump samples #4-7	99		15
				4a	XM #4	66		15
	4b**							
		4a	GO CM "E"	21	12.9	13		
			200-kHz bottom profiling past <u>Whitehorse</u>					

*See Table K2 for observation key.

**Profiles were attempted but results were not good enough to use.

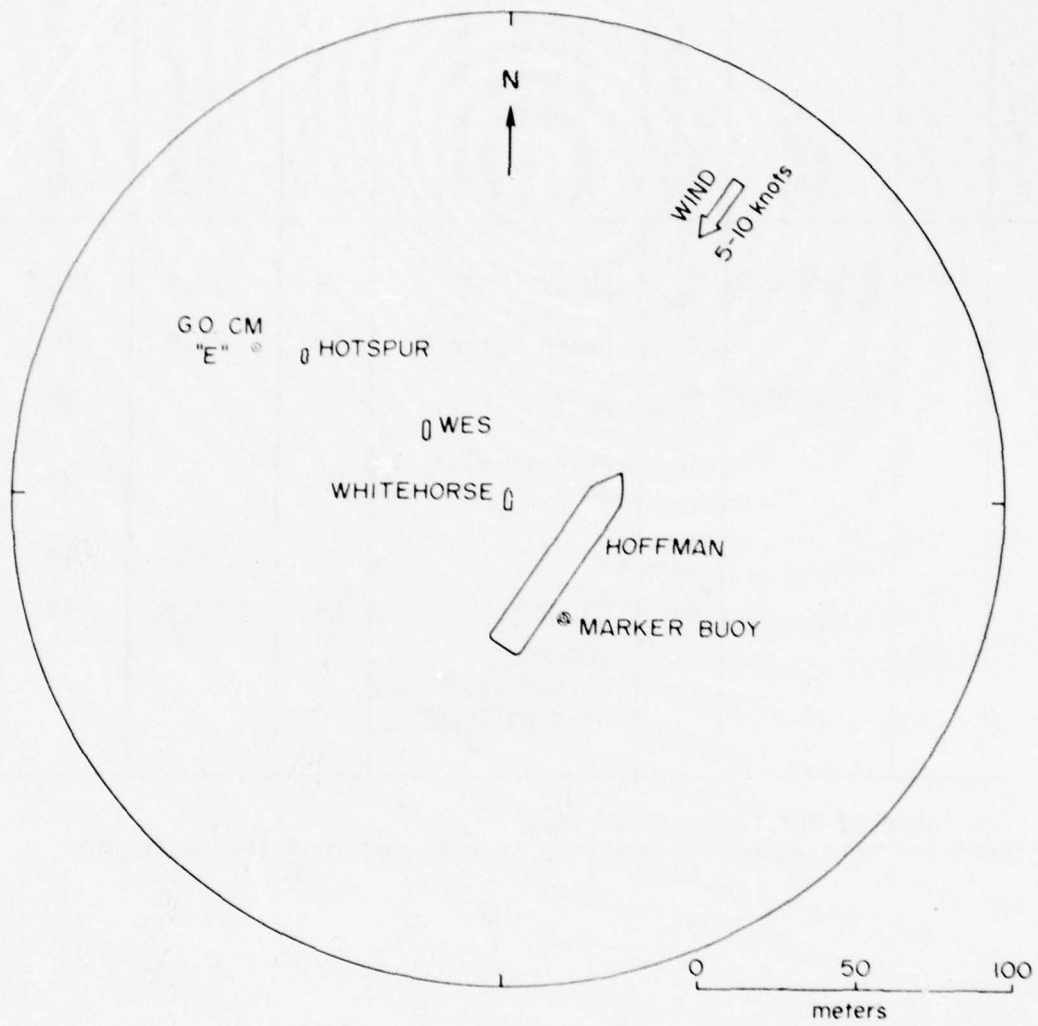

Figure K8. Vessel positions for Disposal 3, 25 May 1976.

Table K9
Station Log
 25 May 1976 - Disposal 4 - Alternate Site

Disposal #	Time	Name of Boat	Type of Observation*	Instrumentation Used (XM = transmitter, CM = current meter)	Range to Dredge, m	Depth of Instrument, m	Water Depth, m	
4	1753	Whitehorse Bow	4a					
			4b	XM #2	21	13	13	
		Whitehorse Stern	4b	XM #1	21	13	13	
			4b	200 kHz	21		13	
			4b	Pump sample #8	21		13	
		Wes	4a					
			4b	XM #4	73		13	
		Hotspur	4a					
			4b	XM #2	134	13	13	
				Bottom profiling during vertical profiling	200-kHz	133		13
				4a	GO CM "F"	124	15.9	16
		4a	GO CM "E"	168	15.9	16		

*See Table K2 for observation key.

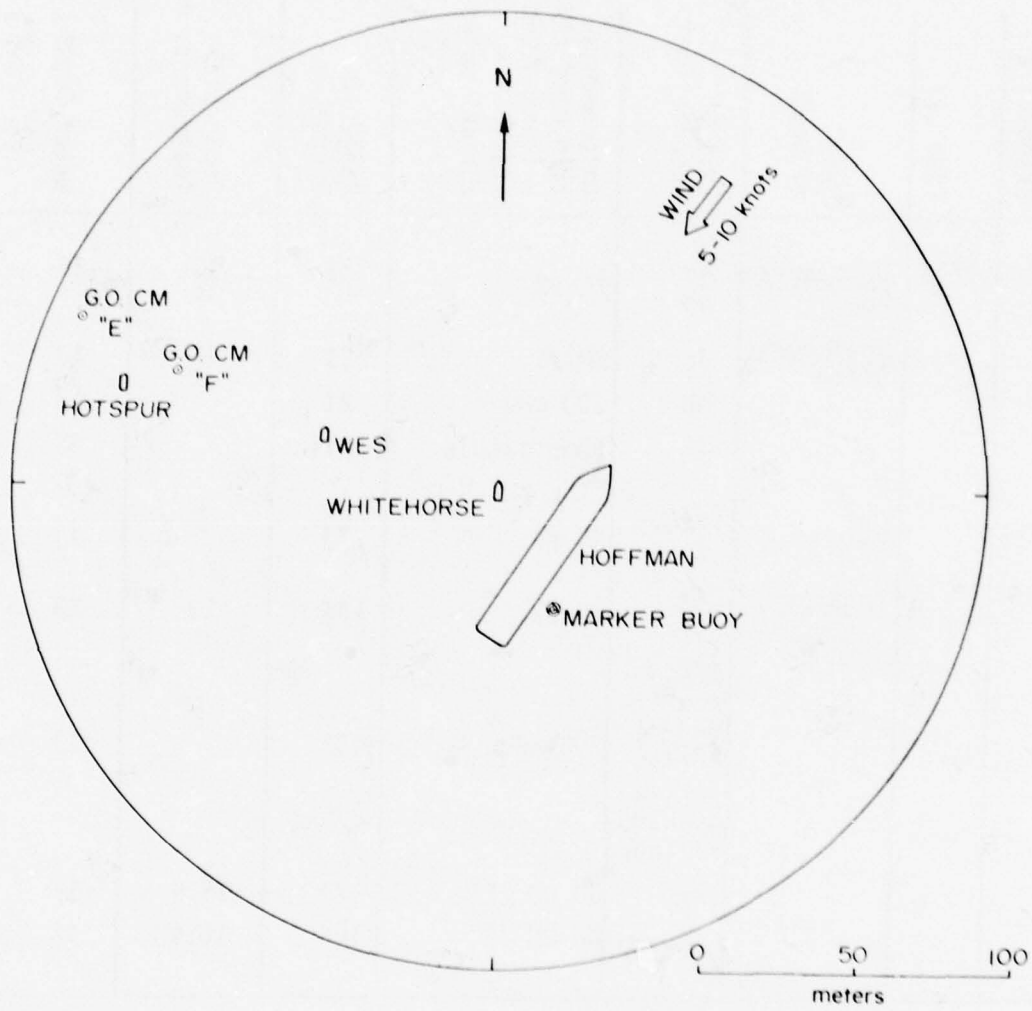

Figure K9. Vessel positions for Disposal 4, 25 May 1976.

Table K10

Station Log

26 May 1976 - Disposals land 2 - Main Site

Disposal #	Time	Name of Boat	Type of Observation*	Instrumentation Used (XM = transmissometer, CM = current meter)	Range to Dredge, m	Depth of Instrument, m	Water Depth, m
1	1115	Whitehorse	4b	200-kHz Rhoads	60		16
			4a	Price meter	60	15.7	16
2	1238:15	Whitehorse	4b	200-kHz Rhoads	64		18
			4b	Pump samples #1-10	64	17.5	
			4b	XM Array			
				XM #1	64	17	18
				XM #2	64	16	18
				XM #3	64	15	18
				XM #4	64	14	18
	4a	Price meter	64	17.7	18		
		6					

*See Table K2 for observation key.

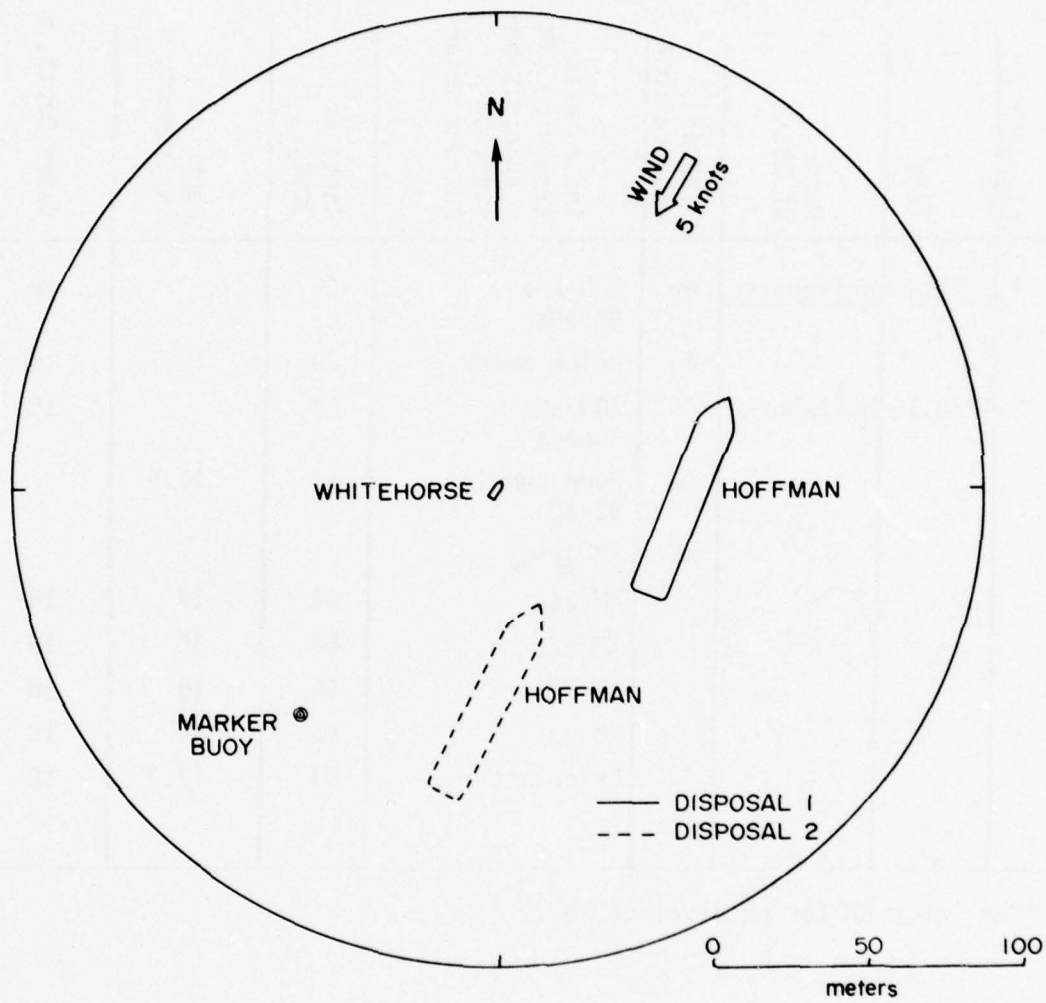

Figure K10. Vessel positions for Disposals 1 and 2, 26 May 1976.

Table K11

Station Log

26 May 1976 - Disposals 3 and 4, Alternate Site

Disposal #	Time	Name of Boat	Type of Observation*	Instrumentation Used (XM = transmitter, CM = current meter)	Range to Dredge, m	Depth of Instrument, m	Water Depth, m
3	1529	Whitehorse	3	200-kHz, upward looking	55		15
				XM Array			
			4b	XM #1	55	14	15
				XM #2	55	13	15
				XM #3	55	12	15
				XM #4	55	11	15
4a 6	Price meter	55	14.7	15			
4	1647	Whitehorse	3	200-kHz, upward looking	58		15
				XM Array			
			4a 6	XM #1	58	14	15
				XM #2	58	13	15
				XM #3	58	12	15
				XM #4	58	11	15
4a 6	Price meter	58	14.7	15			

*See Table K2 for observation key.

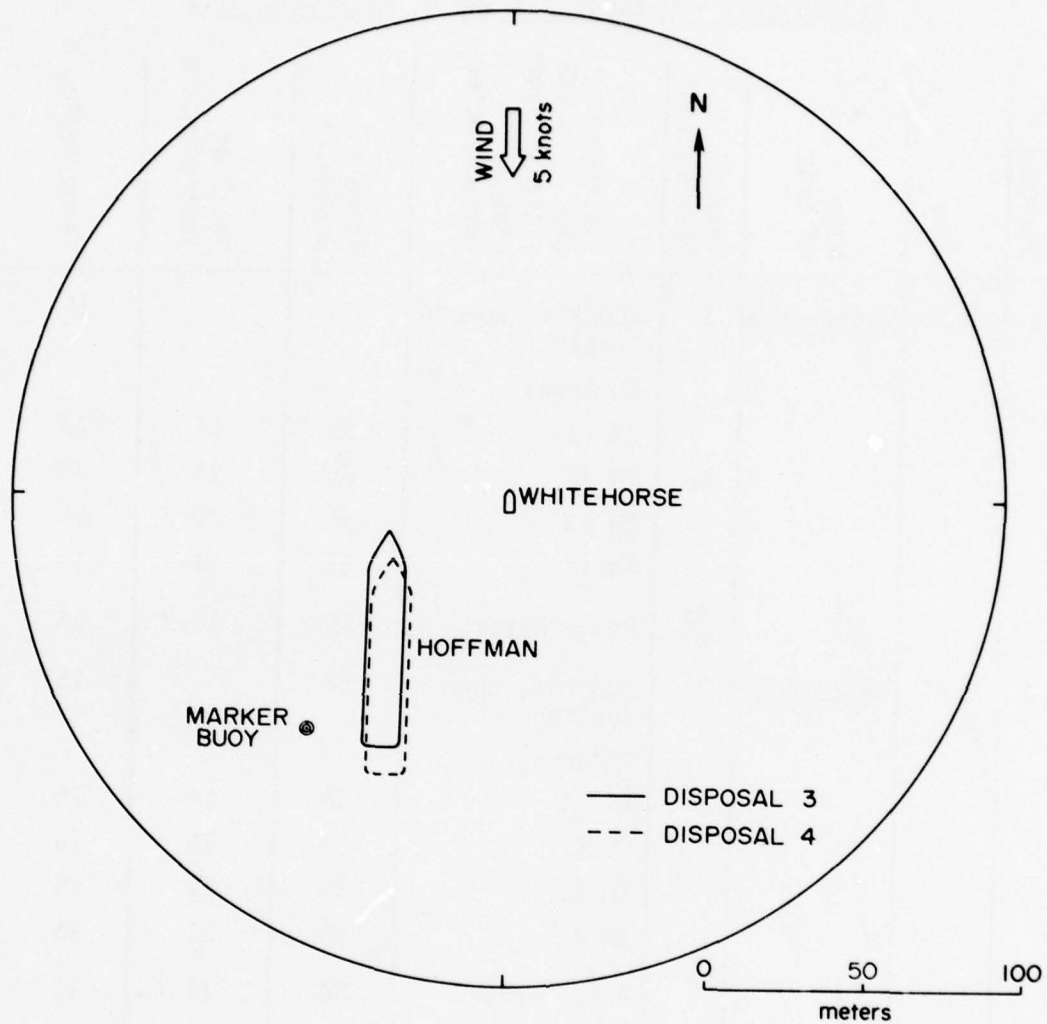

Figure K11. Vessel positions for Disposals 3 and 4, 26 May 1976.

Table K12
Properties of Material Being Dredged
in Ashtabula Harbor*

Location	Density in place Mg/m ³	Density solids Mg/m ³	Percent by wt		
			D20	D50	D80
1. Inner Breakwater	1.598	1.590	0.005	0.016	0.037
2. Penn Central Minnesota Slip	1.628	2.605	0.005	0.013	0.042
3. East Harbor	1.647	2.600	0.003	0.013	0.027
4. River	1.647	2.600	0.003	0.013	0.027
5. Polluted	1.484	2.530	0.007	0.017	0.034

*Supplied by the Buffalo District, Corps of Engineers, May 1976.

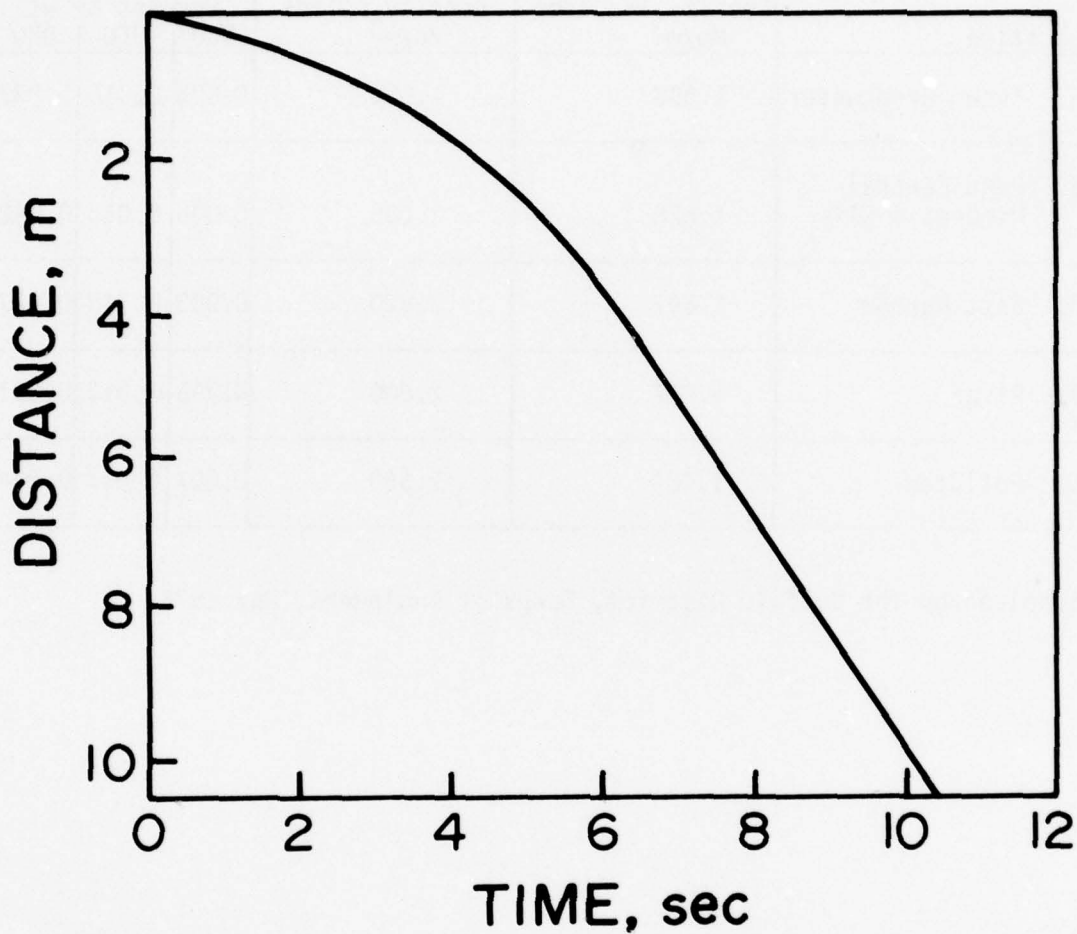

Figure K12. Travel-time curve for the descent of discharged sediment through the water column. This figure is a composite of data collected with the upward-looking 200-kHz transducer for Disposals 3 and 4 on 26 May 1976. Distance is measured from bottom of the dredge to the transducer.

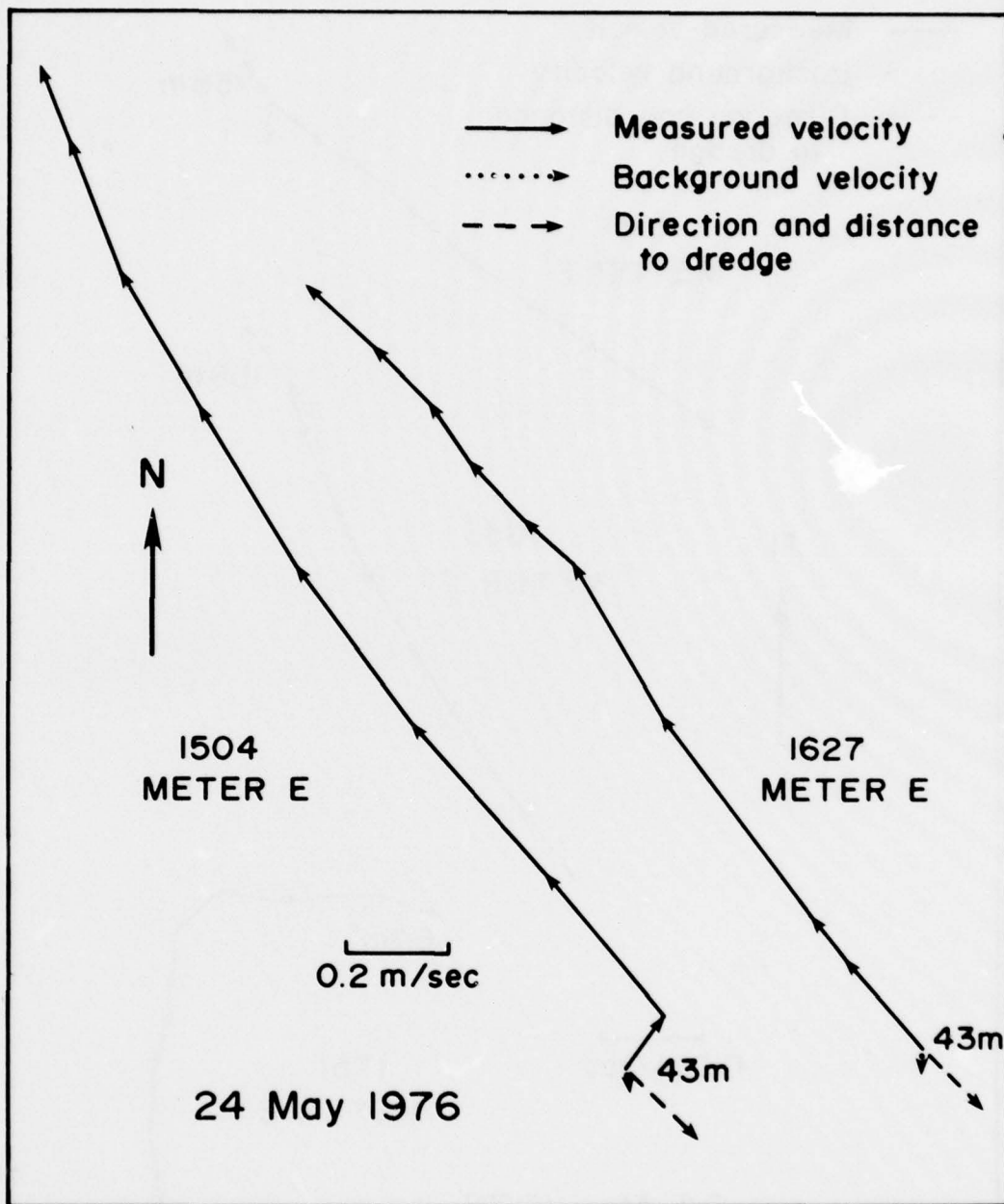

Figure K13. Progressive vector diagrams of the surge velocity and direction from General Oceanics current meter E, 24 May 1976.

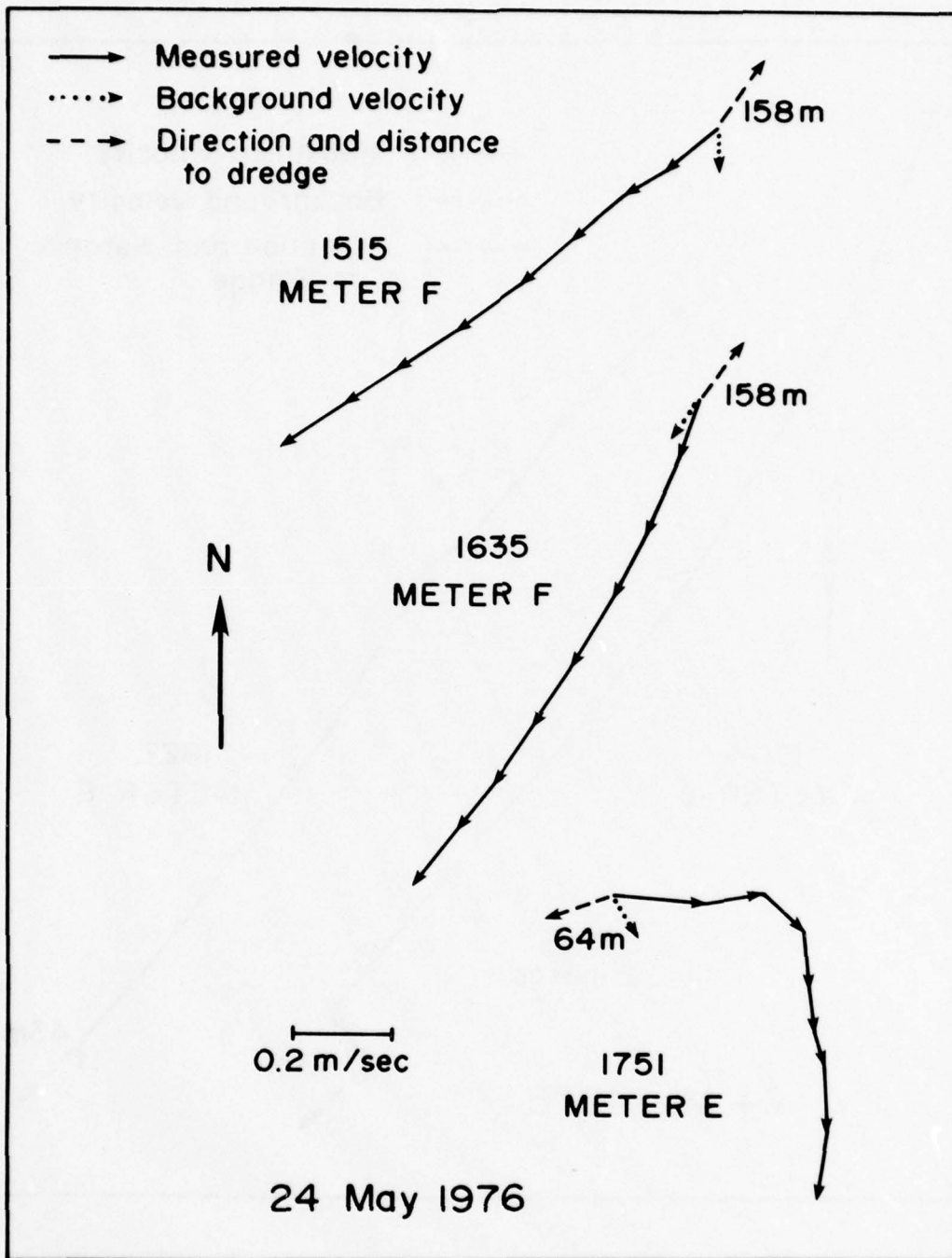

Figure K14. Progressive vector diagrams of the surge velocity and direction from General Oceanics current meters E and F, 24 May 1976.

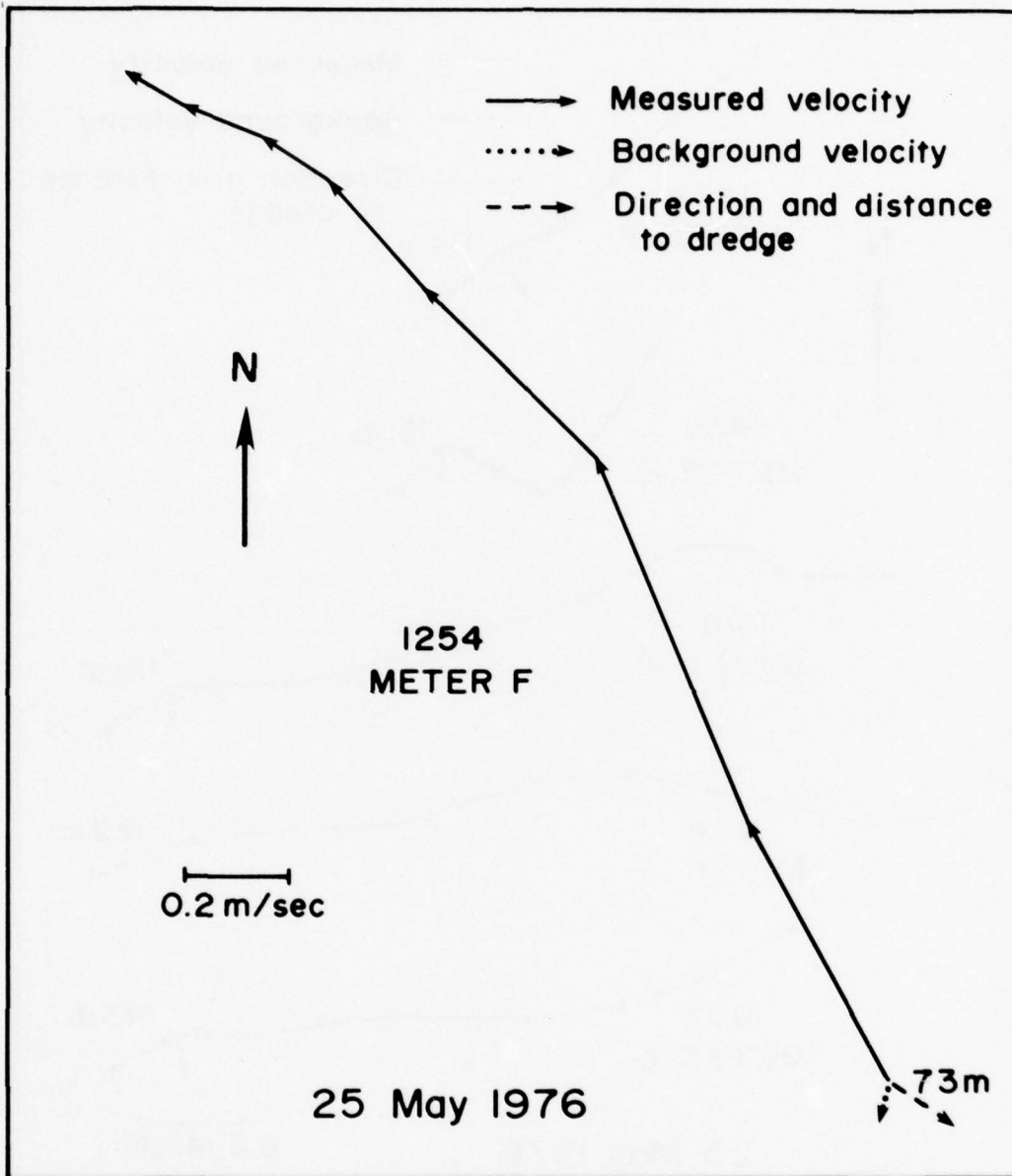

Figure K15. Progressive vector diagrams of the surge velocity and direction from General Oceanics meter F, 25 May 1976.

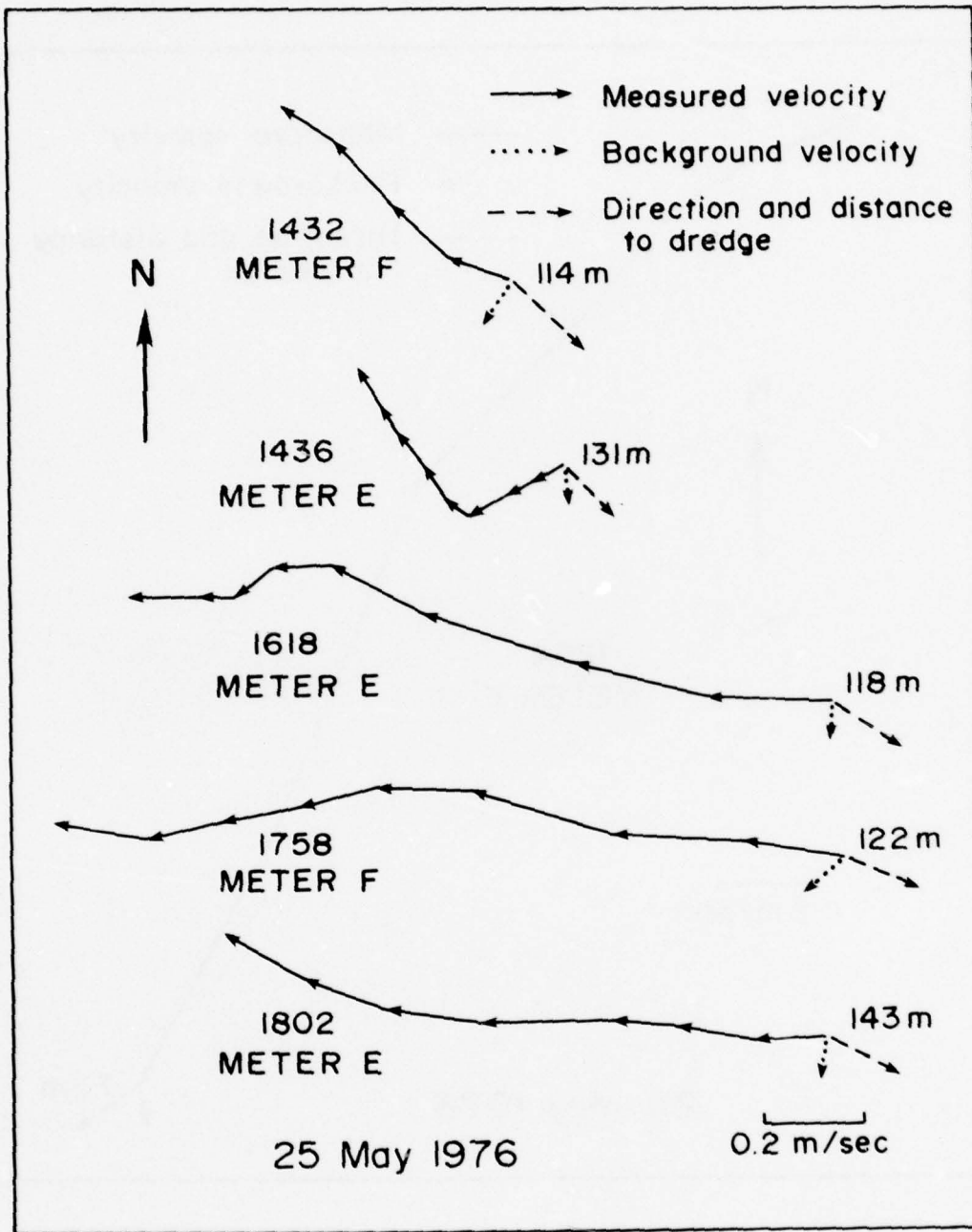

Figure K16. Progressive vector diagrams of the surge velocity and direction from General Oceanic meters E and F, 25 May 1976.

14. The surge passes each observation point quickly, spreading outward as a toroid. See Figure F1 in Appendix F. The lifetime of the surge as recorded by current meters about 60 m from the discharge point ranges from 1 to 4 min, while at distances of 100 m or greater the anomolous velocities persist for 3 to 7 min.

15. For four discharges, the Price current meter was placed about 0.25 m above the bottom and approximately 60 m from the discharge point. The speeds recorded by this instrument are shown in Figures K17 and K18. These speed time series suggest that the surge is not simply spreading radially outward, but also has some internal circulation as discussed in the text (Figure 20 of text).

16. To further examine the structure of the surge, a 200-kHz transducer record shows the thickness of the cloud (Figure K19) and the data from a vertical array of four transmissometers are contoured in Figure K20. The instruments were spaced about 1 m apart with the lowermost device held about 1 m above the lake floor. This array was about 60 m from the discharge point, and the Price current meter was established below it. The speeds recorded by the current meter are also indicated in Figure K20. A surge 2 to 3 m in height passes the instrument array at a velocity of about 0.5 m/sec in about 1 min. Thus, the traveling surge is about 30 m across. Water samples collected in the surge have suspended sediment concentration as high as 16 kg/m^3 (see Figure 23 in the text). As the surge passes it sheds behind it a cloud of suspended sediment. This cloud, unlike the surge, has little or no horizontal velocity; material settles from this stationary cloud at a rate of about 0.01 m/sec.

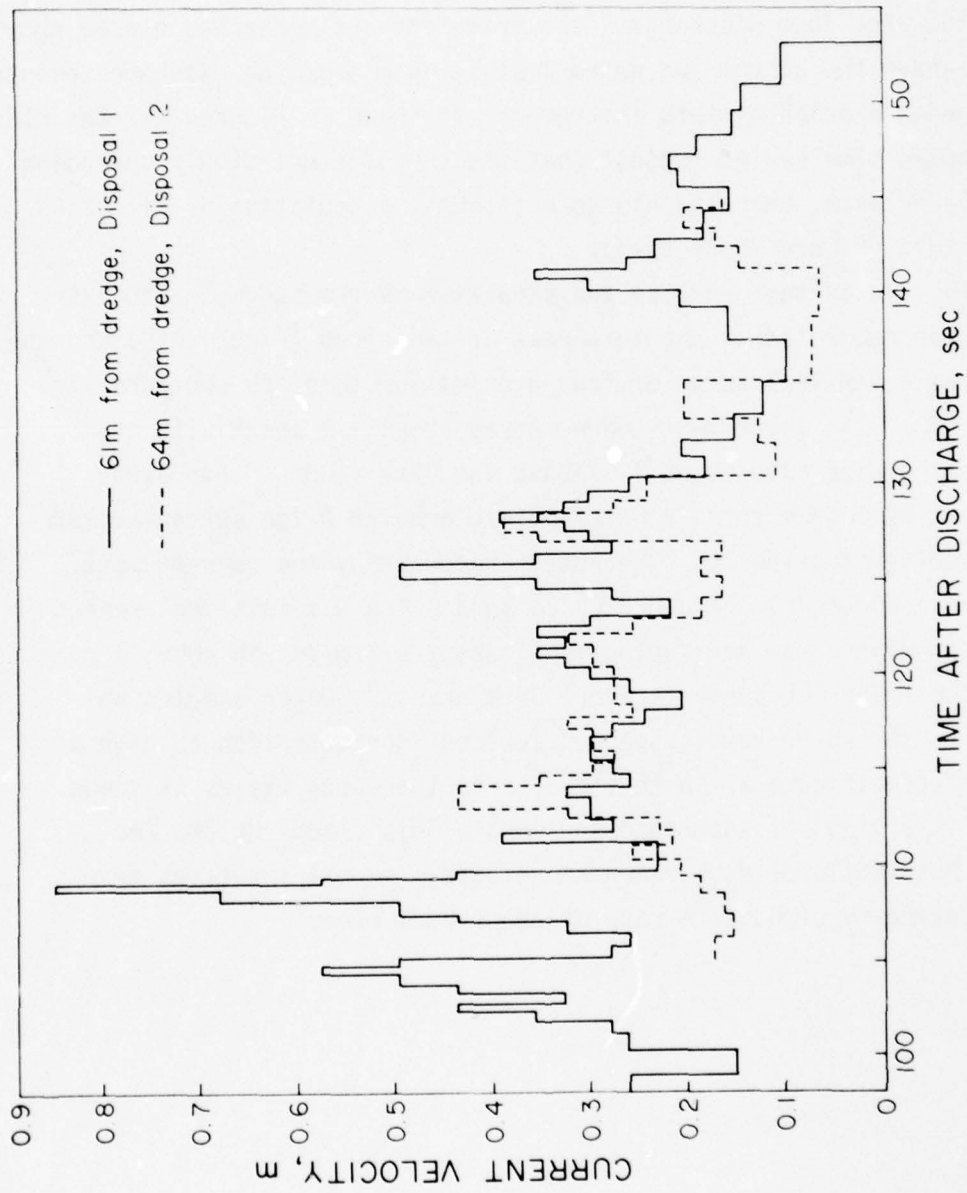

Figure K17. Histogram of Price current meter records of velocity vs. time after Disposals 1 and 2 on 26 May 1976. Arrival times are normalized to travel-time curve in Figure 17 of the main text.

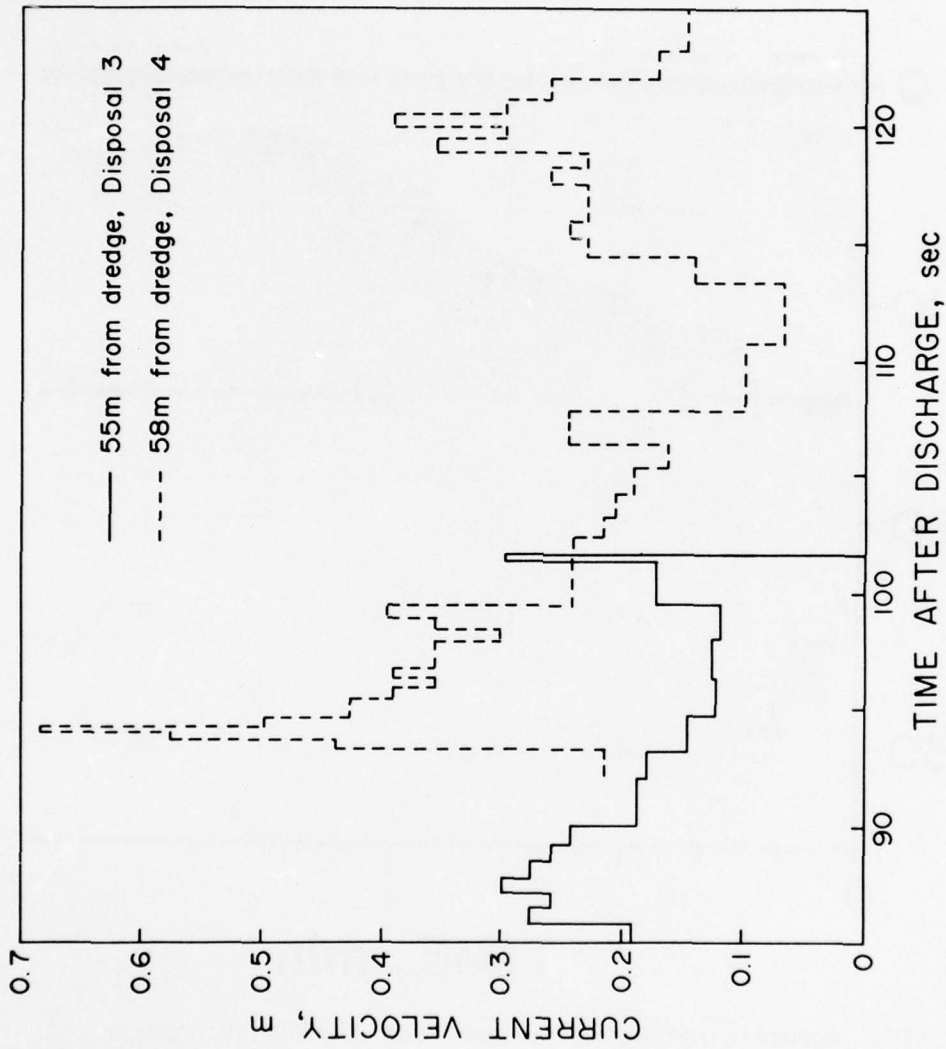

Figure K18. Histogram of Price current meter records of velocity vs. time after Disposals 3 and 4, 26 May 1976. Arrival times are normalized to travel-time curve in Figure 17 of the main text.

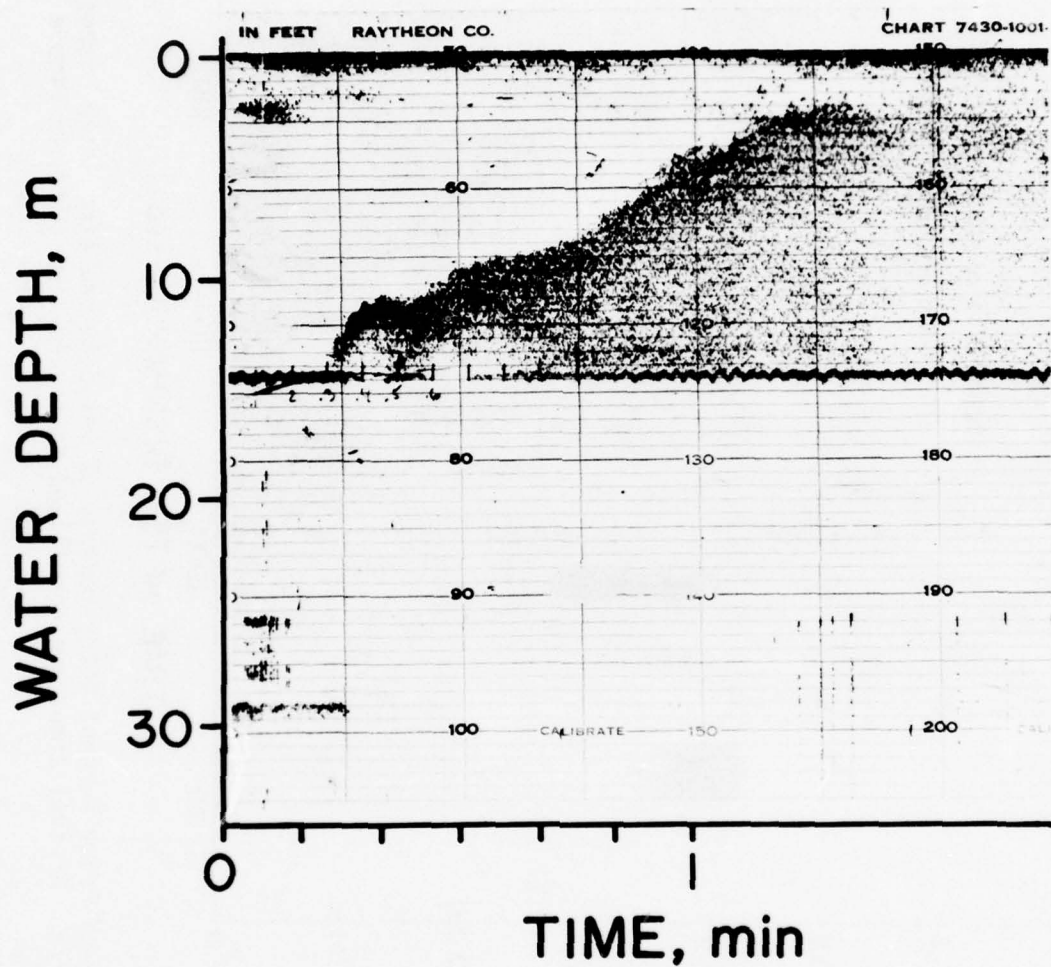

Figure K19. Acoustic reflection record from 200-kHz transducer showing thickness of surge on 25 May 1976, Disposal 4, 20 m from dredge.

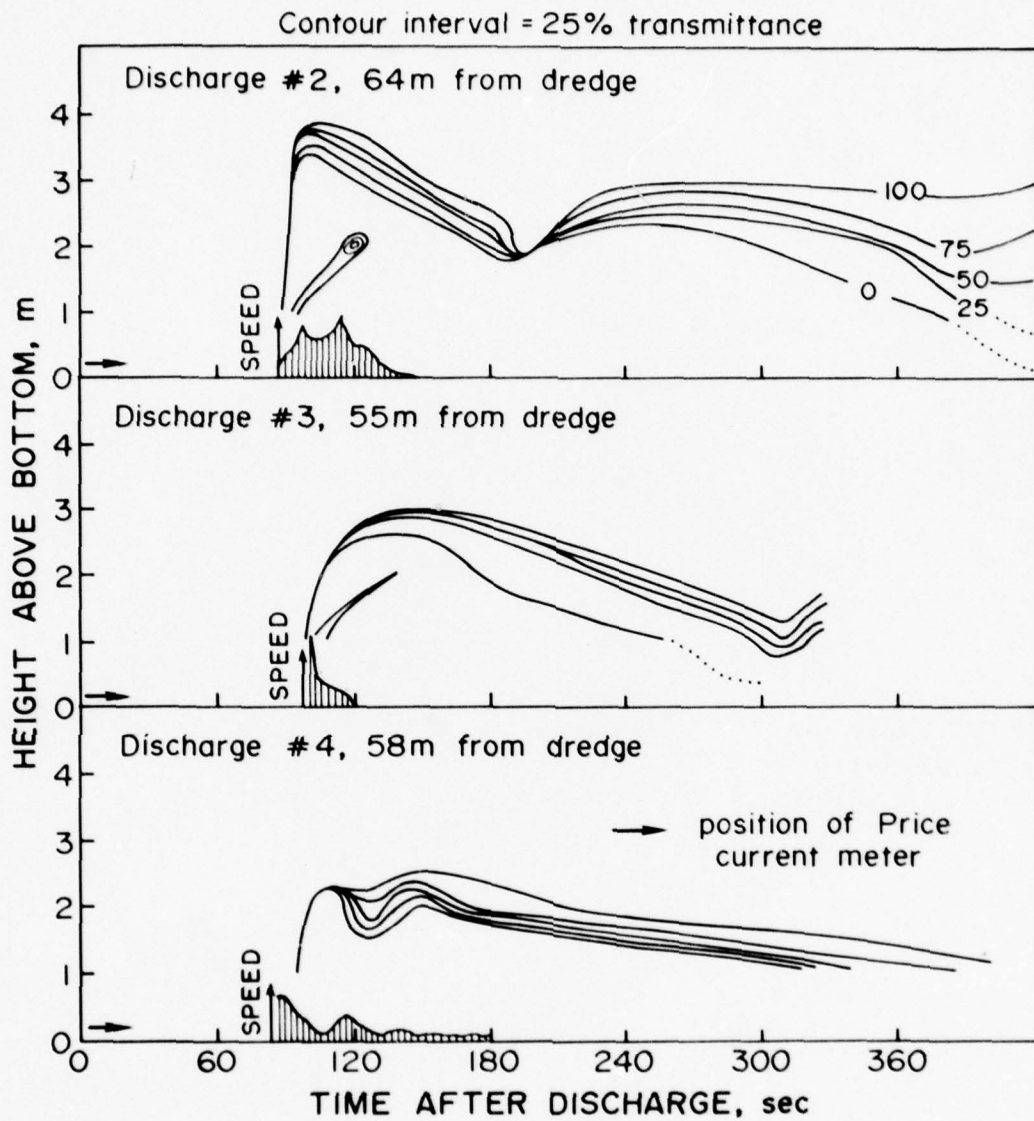

Figure K20. The time evolution of the sediment concentrations near the bottom observed with four transmissometers at 1, 2, 3, and 4 m above the bottom on 26 May 1976. The 100% transmittance level is arbitrarily set to correspond to the background turbidity. Inset on each plot is a small plot of the surge speed measured by the Price current meter (see Figures 17 and 18 of the main text).

APPENDIX L: NEW YORK BIGHT DISPOSAL SITE

Objectives of the Research

1. From 31 August to 1 September 1976 observations were made at the New York Bight disposal site. This was the only open ocean locality studied and observations were concerned with the spread of the bottom surge. Background information on ambient water conditions was obtained and physical properties of the dredged material were analyzed. Dredging was done by the hopper dredge Essayons and a bucket dredge off Staten Island's South Beach at the entrance to Lower Bay. Material was deposited approximately 28 km from the dredging area and 9.7 km offshore in the open ocean off Highlands, New Jersey (Figure L1).

Personnel and Vessels

2. Persons involved in data collection from Yale University were Jeff Gebert and Peter Kaminsky; WES personnel were Barry Holliday and Mitch Granat.

3. Vessels used for the observations were:

- a. U.S. Hopper Dredge Essayons; 160 m LOA, 16 hoppers, with a hopper capacity of 6322 m³; operated by the Philadelphia District Army Corps of Engineers.
- b. Bottom-dump scow; holding capacity 2339 m³; owned and operated by the Great Lakes Dredge and Dock Company.
- c. R/V Hatton, 17-m Army Corps of Engineers survey boat; operated by Corps personnel.
- d. R/V Hudson, 17-m Army Corps of Engineers surveying boat; operated by Corps personnel. No Yale personnel aboard this boat, but water sample data collected.

Disposal Site Description

Bathymetry

4. No predisposal bathymetric data were obtained. A Hydro-

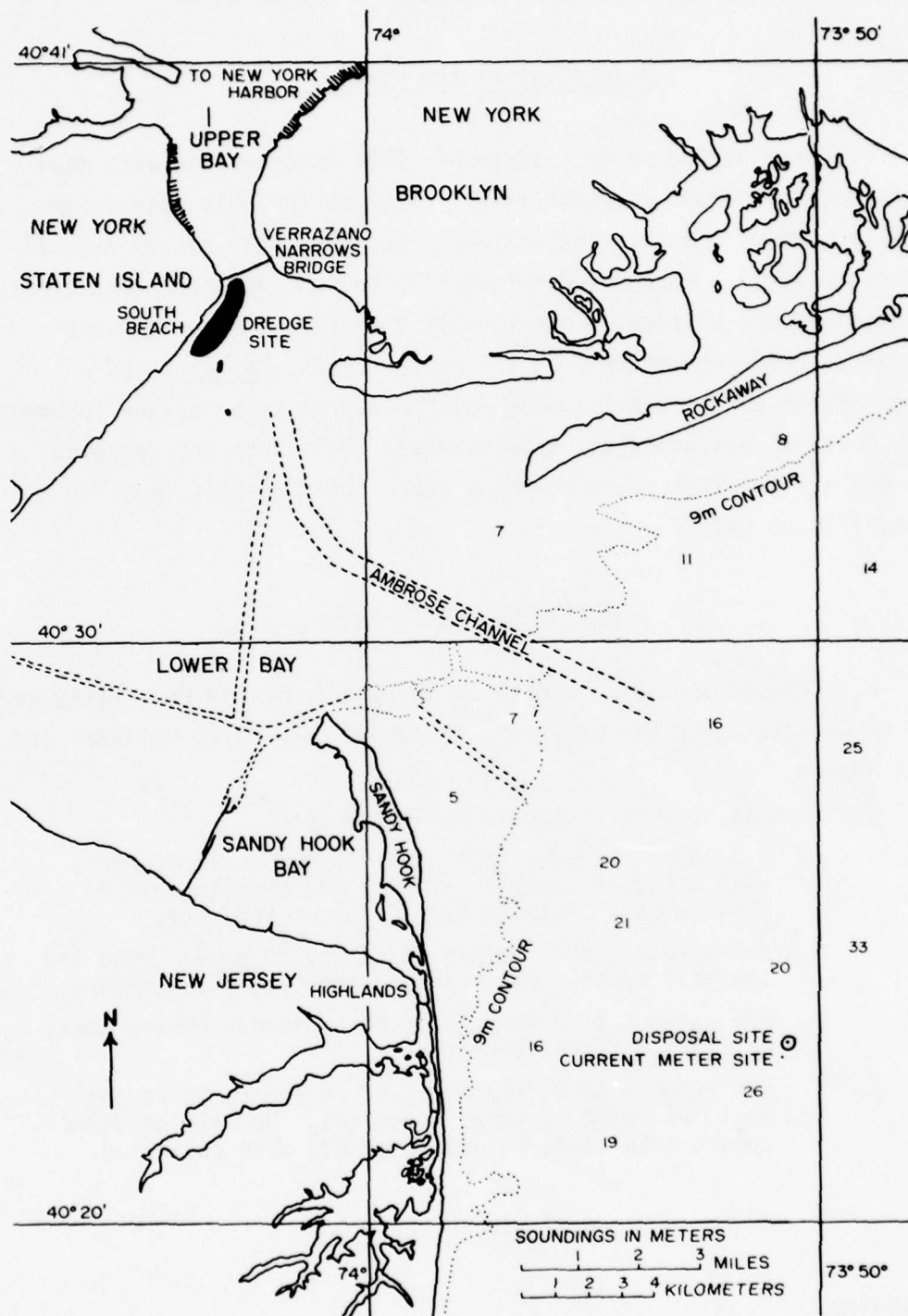

Figure L1. Map of the study area in the New York Bight showing the disposal site and the area where dredging occurred.

graphic Survey chart provided by the New York District Corps of Engineers shows the seafloor sloping gently to the south. The water depths range from 18 to 22 m. This survey, however, was done in 1973 and dumping at this site has continued regularly, thus the bottom configuration may have been changed.

Bottom materials

5. No bottom samples were collected at the site. The Army Corps of Engineers hydrographic charts indicate the bottom material to be mud. As with the bathymetric data, no recent information was available. Because of the length of time this site has been used, the bottom material is likely to be entirely dredged material.

Tides and currents

6. During the period of observation the New York Bight disposal area had a semidiurnal average tidal range of 1.5 m at mean high water. The tidal current flows predominantly in an E-W direction with a mean velocity of about 0.2 m/sec. For purposes of this field work two Braincon current meters were deployed from 30 August to 1 September to obtain background information on ambient water conditions. One meter, No. 385, was 1 m off the bottom in 27 m of water at $40^{\circ}22.92'N$, $73^{\circ}50.95'W$. The other meter, No. 319, was 6 m off the bottom in 25.5 m of water at $40^{\circ}22.9'N$, $73^{\circ}50.87'W$. The data collected by these meters are presented in the polar histograms of Figure L2. The record from the meter 1 m off the bottom shows the current was generally running in a direction between WSW and WNW with a typical velocity 0.10-0.15 m/sec. The highest velocity recorded on this meter was 0.35-0.40 m/sec. From the meter 6 m off the bottom the record shows the current most frequently running in a northwesterly direction with typical velocities between 0.15-0.20 m/sec, but after the current direction ranged between NNW and NNE with velocities from 0.10-0.30 m/sec.

Study Procedure

7. Two disposal operations were monitored each day for 2 days at the designated site. A temporary buoy marker was established in

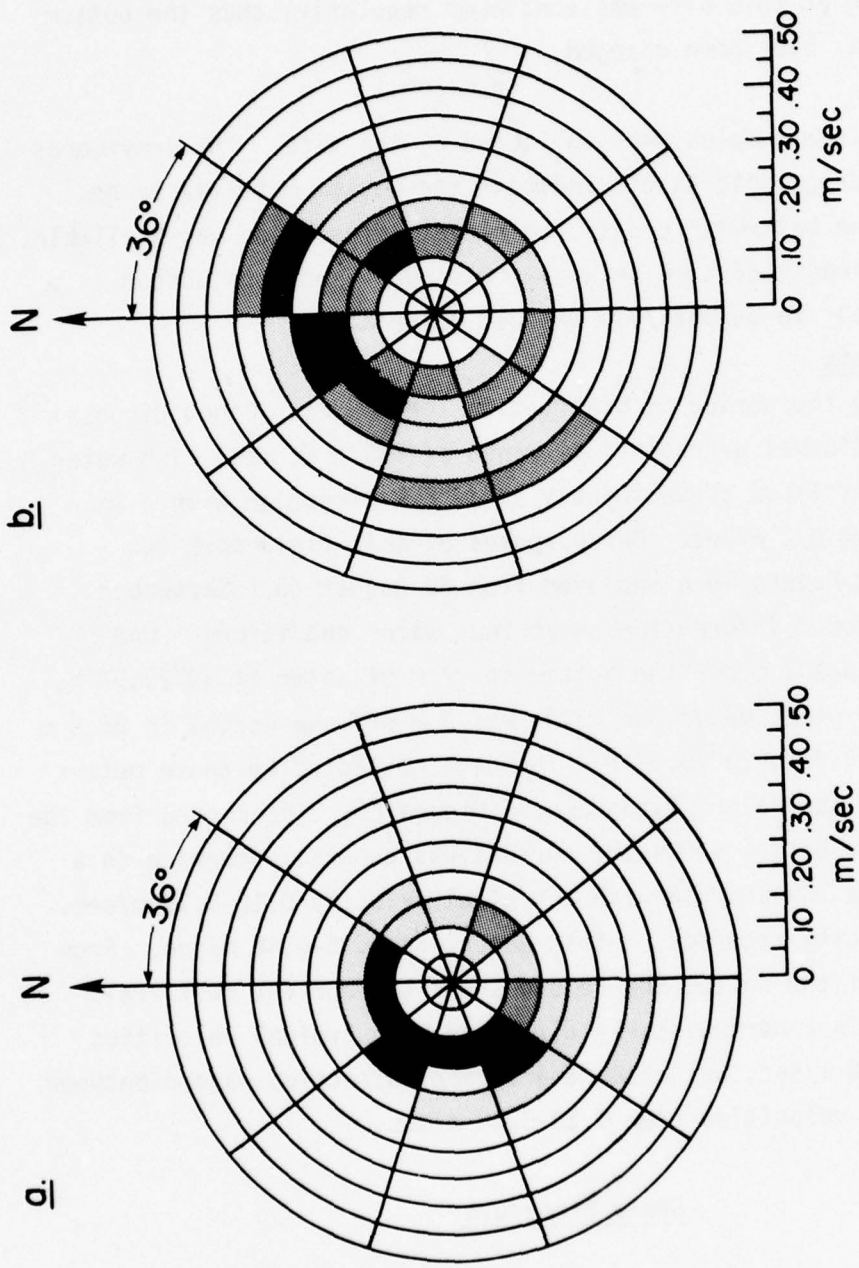

Observed frequency of a velocity in a 36° increment

0-2.5%
 2.5-5.0%
 5.0-7.5%
 > 7.5%

Figure L2. Polar histograms of Braincon current meter data recorded at 20-min intervals from 30 August through 1 September 1976. Figure a represents meter No. 385, 1 m above the bottom and Figure b represents meter No. 319, 6 m above the bottom.

the area before the first disposal on 30 August. The two Braincon current meters were deployed approximately 1 km from the discharge site. A CUBIC microwave navigation system aboard R/V Hatton and Hudson was used for positioning the current meters. The observing boats were located relative to the dredge using an optical range finder and bearing compass for positioning. The observing vessel was anchored near the marker buoy. The dredge or the tug and scow maneuvered as closely as possible to the stern of the observing boat (Hatton), released the dredged material, and proceeded on without stopping, so that all disposals in this study are considered "running discharges." The observations made at this site are summarized in Table L1. Detailed daily logs including instrumentation aboard each vessel are presented in Tables L2-L6 accompanied by diagrams (Figures L3-L6) showing each vessel's location during each discharge.

Results

8. The discharge operations at this site involved much larger volumes of material than the operations examined at the other study sites (Table 1, in text). The results were compared to results from the other sites with the intention of detecting how the disposal processes change as the volume of material released is increased.

9. The dredged material was organic marine silt with bulk densities ranging from 1.17 to 1.51 Mg/m³ (Table L7). The discharged material reached the seafloor and formed a bottom surge which was similar to the surges examined at the other sites. The height of the surge was measured to be about 5 m which is greater than that observed at the other sites (Table L8). The surge is observed to travel faster than those at other sites (Table 18 in text, Table L9). An attempt to correlate the suspended sediment concentrations determined from water samples with the transmittance measurements was unsuccessful because distance between the locations of the instruments was large compared to scale of variability in the concentrations within the surge.

Table L1
Data Catalogue
31 August and 01 September, 1976

Project Objectives	Observations Undertaken	Instrumentation and Information Used	Disposal No.
To monitor the spread of the bottom surge with time	1. Physical properties of material from hoppers - (bulk density, water content)	Sediment samples from hoppers	1
	2. Arrival time and duration of bottom surge	Fixed transmissometer (1 m above the bottom)	1,2
	3. Height of surge: vertical distribution in water column	Transmissometer profiles	1,2
	4. Suspended sediment	Water samples taken and analyzed by University of Texas at Dallas	1,2
	5. Velocity and direction of spreading bottom surge	G. O. current meters	1,2
	6. Background information on ambient water conditions away from site	Braincon current meters	1,2

Table L2

Station Log30 August 1976

Disposal #	Time	Name of Boat	Type of Observation*	Instrumentation Used (XM = transmission meter, CM = current meter)	Range to Dredge, m	Depth of Instrument, m	Water Depth, m
	1100	<u>Hatton</u>		Deployment buoy marker			
			6	Deployment Braincon current meters: #385 - 40°22.92'N 73°50.95'W		26	27
			6	#319 - 40°22.90'N 73°50.87'W		21	27

Additional Information: Braincon current meters and marker buoy recovered 010976.

*Observation Key:

- 1) Physical properties of material from hoppers
- 2) Arrival time and duration of surge
- 3) Height of surge - XM profiles
- 4) Concentration of surge
- 5) Velocity and direction of surge
- 6) Background information on ambient water conditions.

Table L3

Station Log31 August 1976, Disposal 1

Disposal #	Time	Name of Boat	Type of Observation*	Instrumentation Used (XM = transmitter, CM = current meter)	Range to Dredge, m	Depth of Instrument, m	Water Depth, m
1	1050 1135	<u>Essayons</u>	1	Six sediment samples			
	1145 1200	<u>Hatton</u>	5	Deployed GO CM "F"	232	25.8	26
			5	Deployed GO CM "G"	274	25.8	26
	1319	<u>Hatton</u>	2	XM #1	159	27	26
			3	XM #4	159		26
	1344 1405	<u>Hudson</u>	4	Four pump samples		23	

*See Table L2 for observation key.

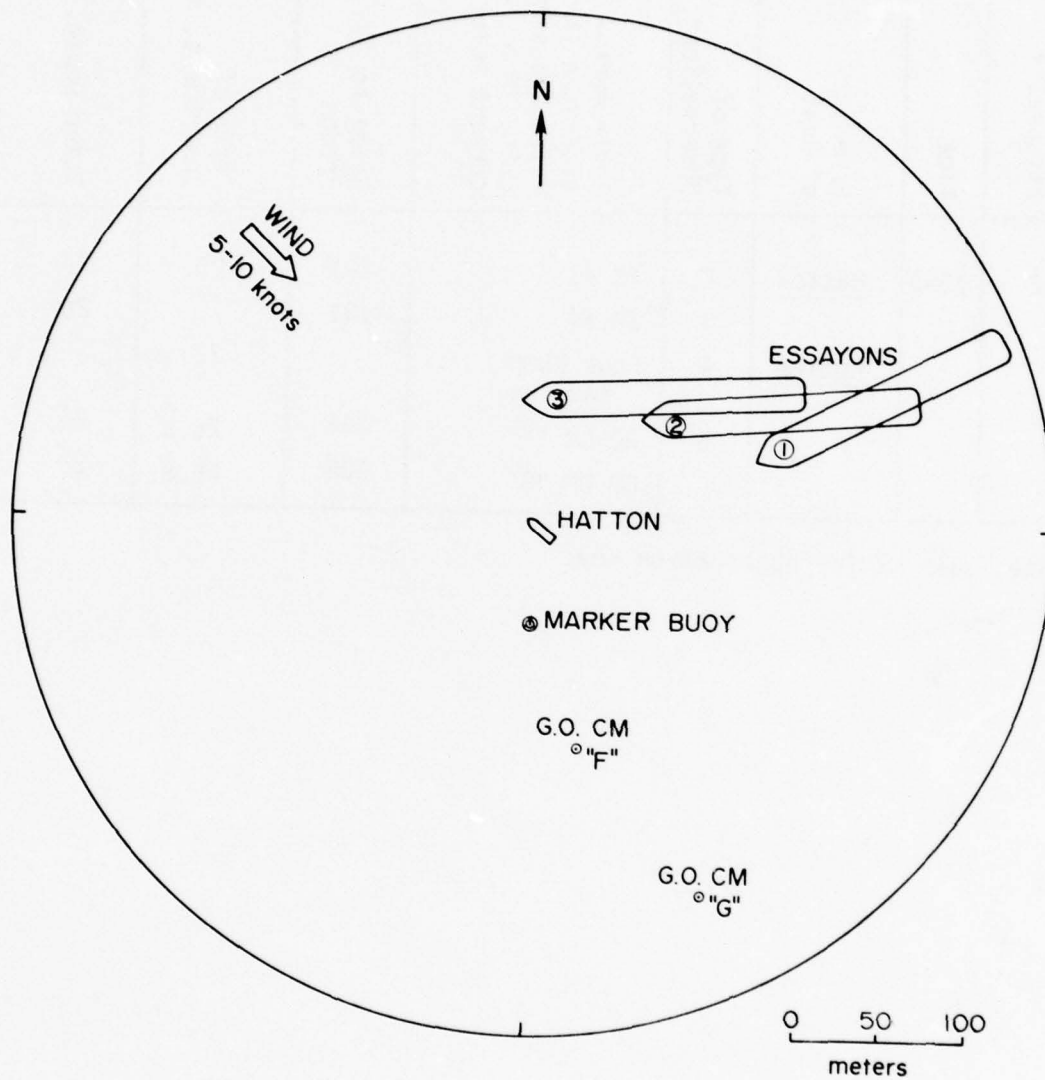

Figure L3. Vessel positions for Disposal 1, 31 August 1976.

Table L4

Station Log

31 August 1976, Disposal 2

Disposal #	Time	Name of Boat	Type of Observation*	Instrumentation Used (XM = transmitter, CM = current meter)	Range to Dredge, m	Depth of Instrument, m	Water Depth, m	
2	1543	<u>Hatton</u>	2	XM #1	101	25	26	
			3	XM #4	101		26	
		<u>Hudson</u>	4	Four pump samples		23		
			5	GO CM "F"	264	25.8	26	
				GO CM "G"	305	25.8	26	

*See Table L2 for observation key.

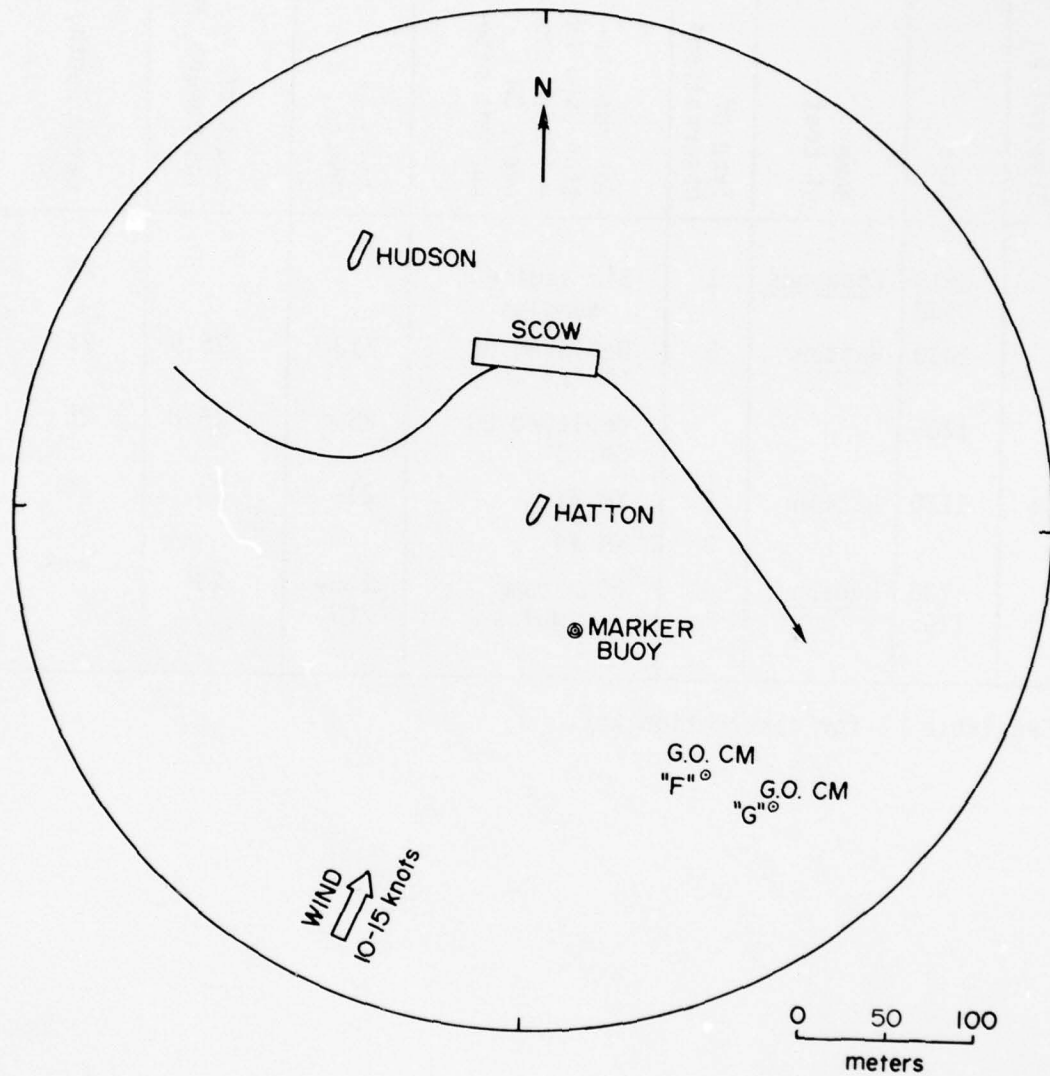

Figure L4. Vessel positions for Disposal 2, 31 August 1976.

Table L5

Station Log01 September 1976, Disposal 1

Disposal #	Time	Name of Boat	Type of Observation*	Instrumentation Used (XM = transmitter, CM = current meter)	Range to Dredge, m	Depth of Instrument, m	Water Depth, m	
1	0918 0950	<u>Essayons</u>	1	Six sediment samples			25	
	1030	<u>Hatton</u>	5	Deployed G0 CM "F"	213	25.8	25	
	1108			Deployed G0 CM "G"	250	25.8	25	
	1120	<u>Hatton</u>	2	XM #1	214	24	25	
				3	XM #4			
	1133 1155	<u>Hudson</u>	4	Four pump samples	236- 289	23		

*See Table L2 for observation key.

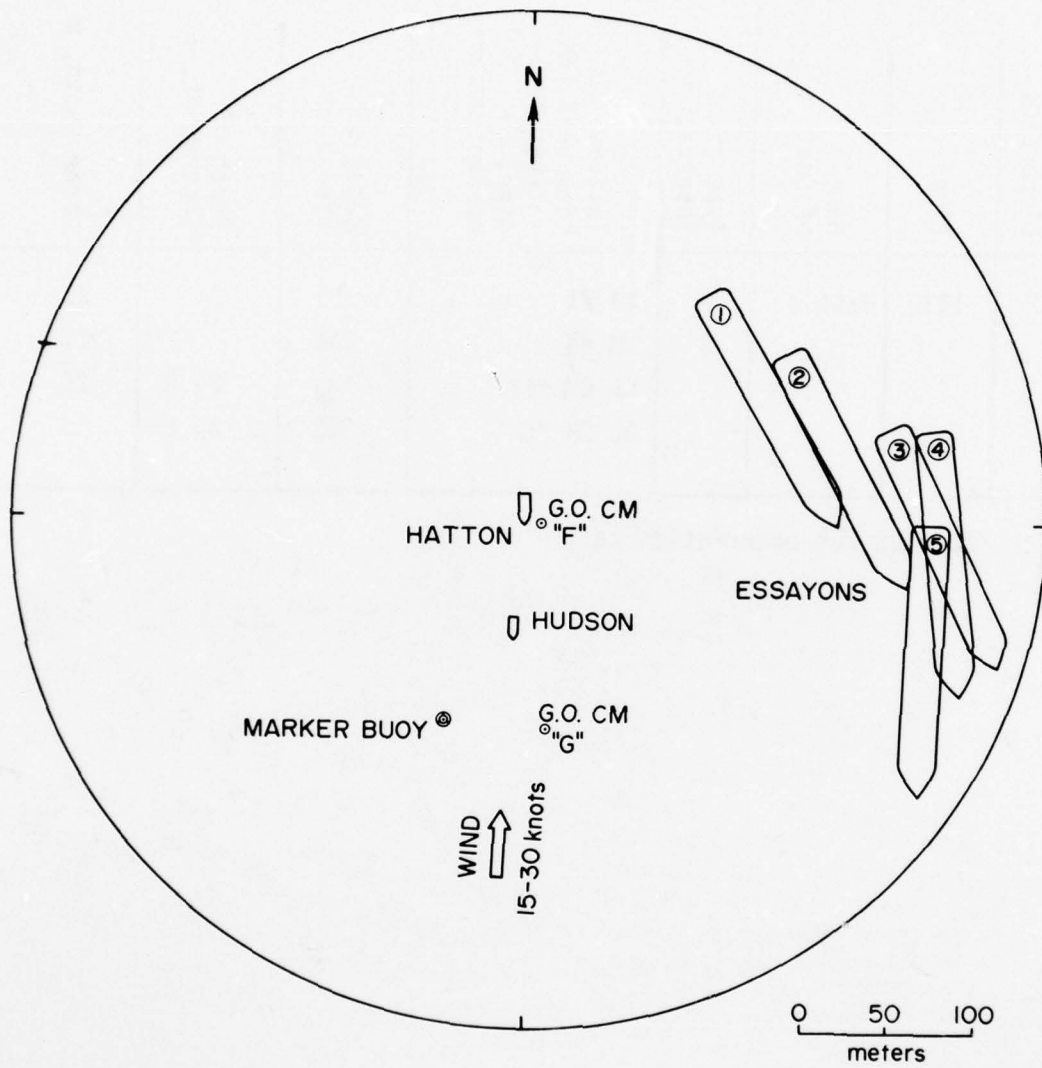

Figure L5. Vessel positions for Disposal 1, 1 September 1976.

Table L6
Station Log
1 September 1976, Disposal 2

Disposal #	Time	Name of Boat	Type of Observation*	Instrumentation Used (XM = transmitter, CM = current meter)	Range to Dredge, m	Depth of Instrument, m	Water Depth, m
2	1132	Hatton	2	XM #1	191	24	25
			3	XM #4	191		25
				GO CM "F"	183	24.8	25
				GO CM "G"	293	24.8	

*See Table L2 for observation key.

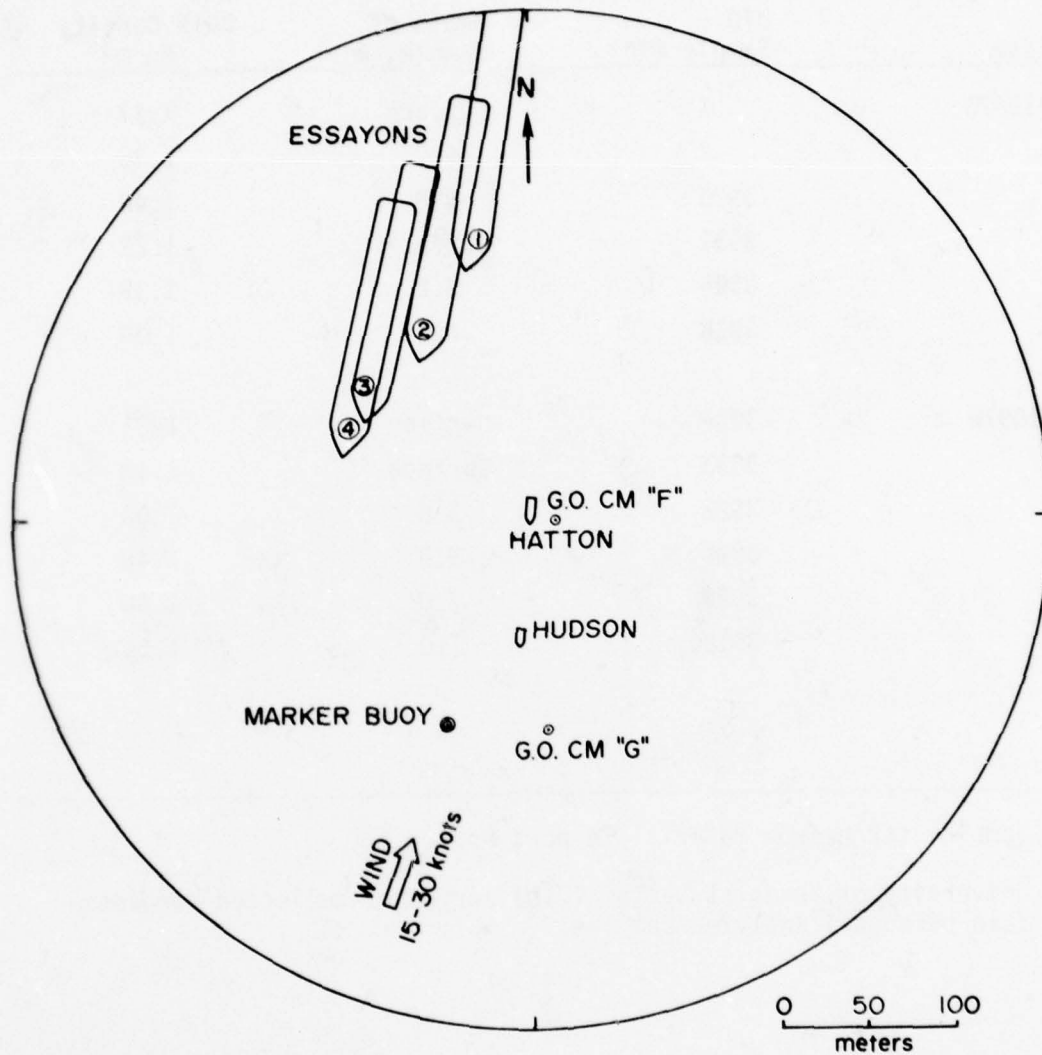

Figure L6. Vessel positions for Disposal 2, 1 September 1976.

Table L7

Density of Sediment Samples Taken from Essayons*

Date	UTD Sample #**	Depth of Sample, m	Bulk Density Mg/m ³
310876	1	Surface	1.17
	2	5.2	1.35
	3920	8.0	1.40
	3931	Surface	1.21
	3925	5.2	1.39
	3918	8.0	1.39
010976	3919	Surface	1.21
	3933	Surface	1.18
	3922	3.8	1.50
	3926	3.8	1.46
	3923	7.0	1.50
	3916	7.0	1.51

* Samples taken from material in port hopper #1.

** University of Texas at Dallas (UTD) personnel collected samples -
Yale personnel analyzed samples.

Table L8

Summary of Thickness Data

Date	Boat	Distance from dredge, m	No. of Disposal Operation	Time of Disposal	Time arrival of surge, sec	Thickness, m	Instrument	Time of profile after arrival of surge, min	Thickness of surge at profile, m	Water depth, m
310876	Hatton/ Essayon	~159	1	1318:58	3.4	>1.5	XM 1			26
"	"	"	"	"			XM 4	1.5	6.0	26
310876	Hatton/ Scow	~101	2	1543:10	3.2	>2.6	XM 1			26
"	"	"	"	"			XM 4	1.5	0.0	26
010976	Hatton/ Essayon	~214	1	1120:30	2.1	>1.2	XM 1			25
"	"	"	1				XM 4	2.1	2.0- 3.5	25
"	"	~197	2	1132:00			XM 4	.68	4.0	25

Table L 9

Current Meter Measurement of Bottom Surge Velocity and Direction

<u>Date</u>	<u>Dump</u>	<u>Time</u>	<u>General Oceanics Meter</u>	<u>Distance, Dredge to Meter, m</u>	<u>Direction, Dredge to Meter, °</u>	<u>Surge Detected</u>	<u>Indicated Direction of Surge Flow (Average)</u>	<u>Highest Indicated Velocity</u>
310876	1	1319	F	200	210 ⁰	?*	190 ⁰	35 cm/sec
			G	275	170 ⁰	No	--	--
	2	1543	F	270	160 ⁰	Yes	230 ⁰	48 cm/sec
			G	305	150 ⁰	?*	190 ⁰	36 cm/sec
010976	1	1120	F	190	270 ⁰	Yes	260 ⁰	36 cm/sec
			G	250	240 ⁰	No	--	--
	2	1132	F	160	150 ⁰	Yes	170 ⁰	43 cm/sec
			G	260	170 ⁰	Yes	170 ⁰	51 cm/sec

*Large, background velocity fluctuations made it impossible to distinguish the surge velocity satisfactorily.

Meter used: General Oceanics #2010, film recording.

Sample frequency: 4 frames/min.

Height above bottom: ≤ 20 cm.

APPENDIX M: ROCHESTER 1976 DISPOSAL SITE

Objectives of the Research

1. On 18, 19, 20 and 21 October 1976 a field trip was made to the Genesee River for study of the placement of dredged material. Objectives of the trip were: 1) to determine physical properties of the jet discharge from a hopper dredge including initial velocity, acceleration, spread angle, and volume of water entrained; 2) to measure the flux of water and sediment passing two observing points in the bottom surge by use of transmissometers, pumped water samples, and flow meters. (Concurrent acoustic measurements were made by Proni et al. from NOAA to examine the distribution of sound scattering elements in the water around the disposal site.)

2. Dredge Lyman operated in the Genesee River from the mouth to the turning basin (at the cement offloading facility). Disposal was within the designated dumping grounds NNE of the river mouth in Lake Ontario (see Figure M1).

3. Appendix O contains information on a disposal conducted at Rochester in 1977.

Personnel and Vessels

4. Participants in the data collection from Yale University were Henry Bokuniewicz, Robert B. Gordon, Jeffrey A. Geber, Jane Higgins, Matthew Reed, and Peter Kaminsky. WES personnel were Barry Holliday and Harry L. Horstmann, Jr.

5. Vessels used in the operations were:

- a. U. S. Hopper Dredge Lyman; 66 m LOA, eight hoppers, hopper capacity 690 m³; operated by Buffalo District, U. S. Army Corps of Engineers, Mr. John Malloy, Acting Master.
- b. M/V Sampler; a 9.4-m Bertram.
- c. M/V Aquaguard; an EPA owned 8.5-m Owens.
- d. M/V Hotspur; a 6.1-m McKee Craft.

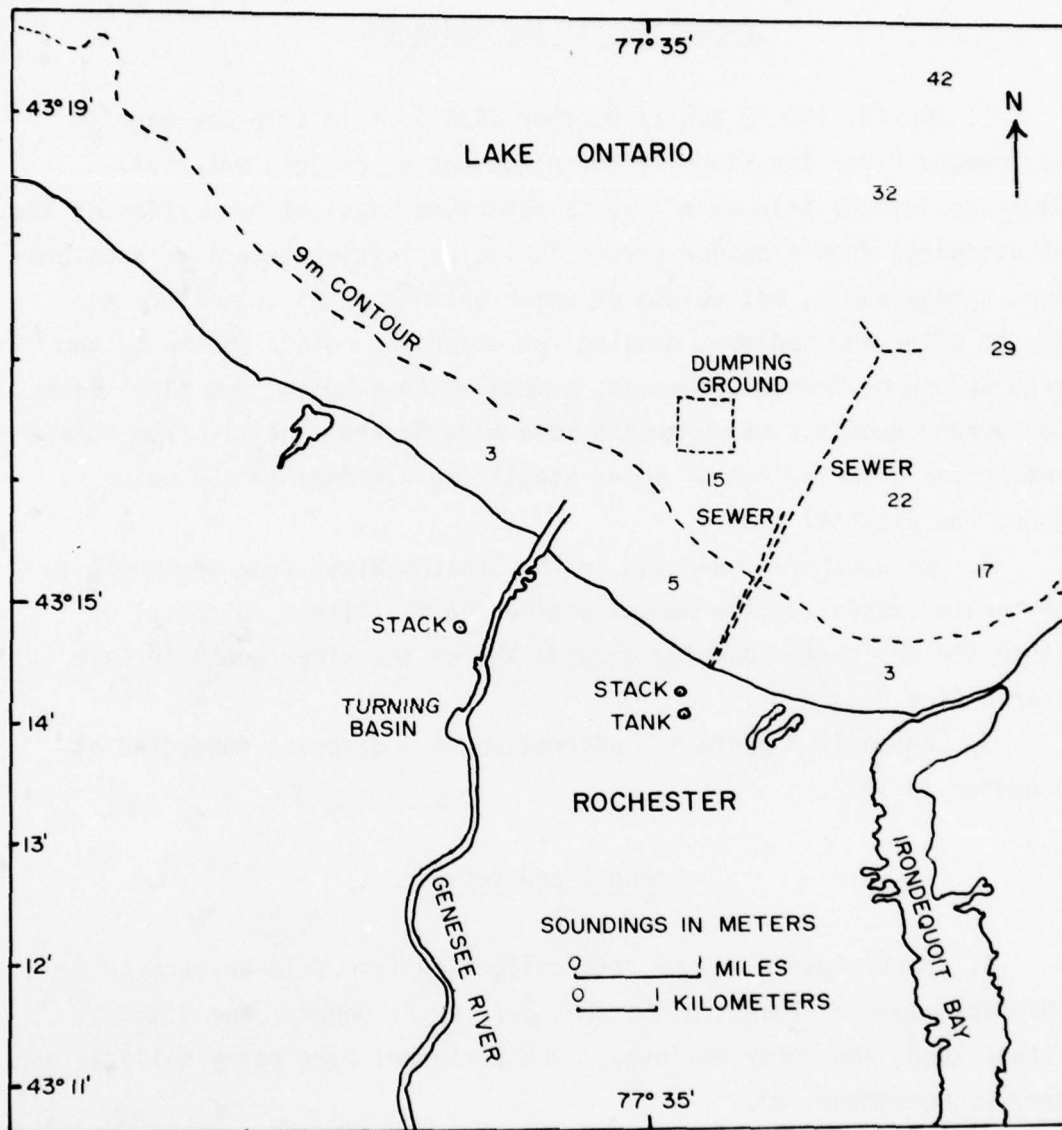

Figure M1. Map of the study area showing location of disposal site in Lake Ontario and the Genesee River where dredging occurred.

Disposal Site Description

Bathymetry

6. NOAA charts 14805 and 14815 show the water depth at the disposal site to be 18 m. The lake floor at this location slopes, deeping to the north at a rate of about 6 m in 1.9 km.

Bottom materials

7. Sample densities of this area have not been examined by the Army Corps of Engineers in approximately 20 years. The EPA had completed bottom sediment quality surveys of Rochester Harbor (20 April 1976), but not at the disposal sites (personal communication with Philip Berekely, WES, 1977). The NOAA charts of this area describe the bottom as sand and mud.

Currents

8. Predominant currents at the disposal site are wind driven (Paskausky, 1971). For purposes of this study, a Braincon current meter was deployed to record ambient water conditions in the disposal area. The meter was placed 2 m above the bottom in 22 m of water at the northern edge ($43^{\circ}17.2'N$, $77^{\circ}34.1'W$) of the designated disposal area. This instrument recorded the water velocity every 20 min from 18 to 21 October 1976. These data show the current generally ran in either a WNW direction with a speed between 0.05 and 0.15 m/sec or in a SE direction with a speed between 0 and 0.1 m/sec. Peak velocities as high as 0.2 m/sec were recorded (see Figure M2).

Study Procedure

9. On 18 October 1976, a temporary marker buoy was established in the disposal area for the 3-day period and the Braincon current meter was established on the site. The positions of the marker and current meter were fixed with horizontal sextant angles. On 19 October observations were made during three disposal operations. For the first two the dredge Lyman was at anchor at the marker buoy, for the third the dredge was held in a fixed position without anchoring with the bow as close

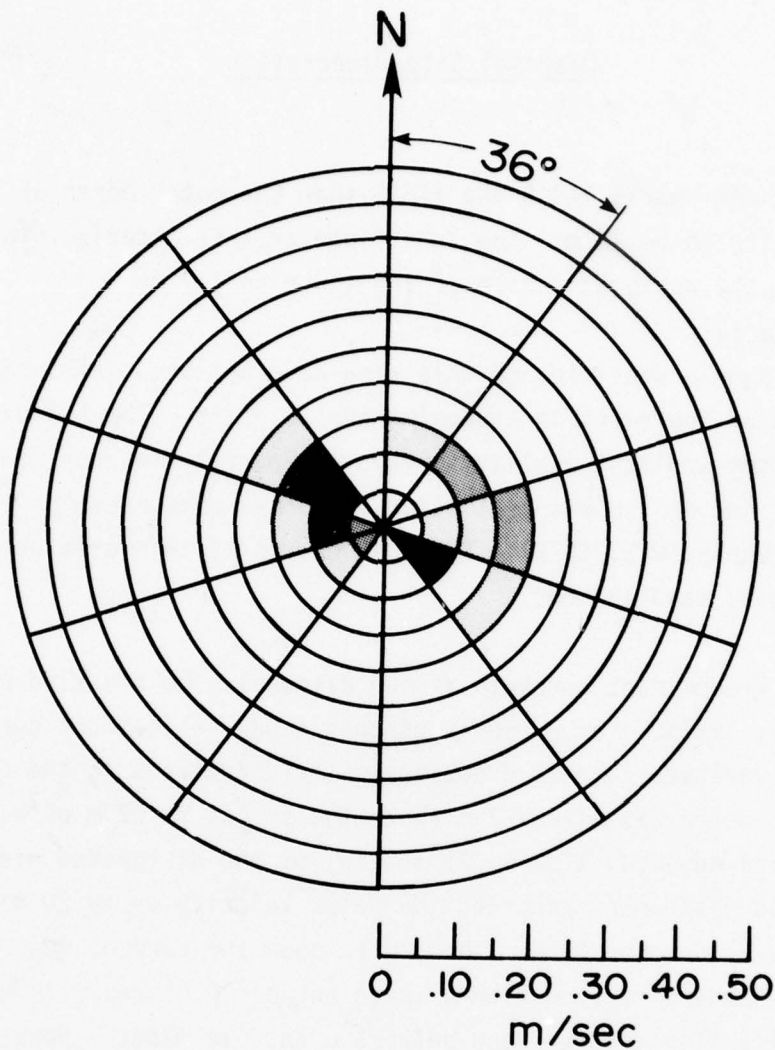

Observed frequency of a velocity
in a 36° increment

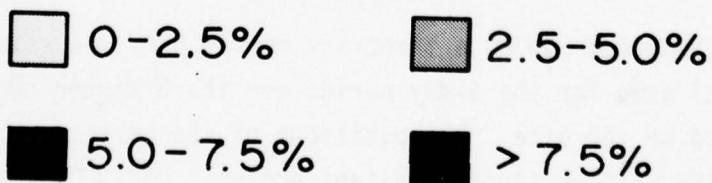

Figure M2. Polar histogram of Braincon current meter No. 385 record of current velocity and direction at 20-min intervals from 18-21 October 1976. Meter was 2 m off bottom in 22 m of water.

to the marker buoy as possible. For two disposal operations on 20 October the dredge was held in a fixed position parallel to the observing vessels and between the marker buoy and closest boat. The position of the instruments and the observing vessels was measured relative to the dredge by both an optical range finder and bearing compass. The observations made at this site are summarized in Table M1. Detailed daily station logs (Tables M2-M6) are accompanied by diagrams (Figure M3-M8) showing the location of the instruments and observing vessels during each discharge.

Results

10. The disposal operations at the Rochester site were similar to those at Ashtabula. The observations made at the Rochester site were intended to extend and supplement the observations made earlier at Ashtabula. Many of the results of these observations are discussed in the text and in its appendices and will not be repeated here.

11. The rate of discharge measured during these experiments is discussed in the text. Measurements of the ship's draft were used to calculate the mass of the dredged material, the amount discharged (Table 7, text), and the potential energy of the dredged material. These draft measurements are listed in Table M7. As the material left the hoppers, its horizontal spread was observed (Figures M9-M14); its fall speed was observed acoustically (Figure 10 in text) and also by means of a flow meter (Figure M15). These data were used to calculate Table 7 in the text and used in the text to describe the descent phase of the disposal operation.

12. The travel of the bottom surge was detected acoustically (Figures M16 - M17), optically (Table M8), and with current meters (Figures M18 - M21). These data were used to construct the travel-time plot in the text (Figure 18 in text). The thickness of the surge was monitored acoustically (Figures M22 - M23) and optically (Table 8, text). Because the bottom surge is thin and changes thickness rapidly, the technique of using transmissometer profiles to document

Table M1

Data Catalogue

10 October and 20 October, 1976

Project Objectives	Observations Undertaken	Instrumentation and Information Used	Operation No.*	
			191076	201076
To determine physical properties of the jet discharge from the hoppers.	1. Physical and mechanical properties of material before dump.	Syringe samples of sediment in hoppers	3	
	2. Quantities of material in hoppers	Draft measurements. Also: hopper dimensions.	2	
	a) Volume of material in hoppers			
	b) Height of material in hopper with time	Photographs of hoppers	3	
	c) Mass of material in hoppers	Draft measurements, hopper dimensions, blueprints of Lyman	1,2,3	1,2
	3. Discharge characteristics			
	a) Initial injection velocity	Photographs, hopper door dimensions, rate doors open	3	
	b) Fall velocity	Inverted 200 kHz transducer, flow meter	1,2	
	c) Spread of descending jet	Horizontal 200 kHz transducer	1,2	
	d) Impact velocity	Downward 200 kHz, flow meter	2,3	
	4. Movement of material in time			
	a) Arrival of surge	Downward 200 kHz transducer, Price meter 7.5 kHz transducer, 200 kHz transducers, transmissometer on bottom	3	1,2
	b) Thickness of surge			
c) Concentration in surge, vertical distribution in water column	Transmissometer profiles, water samples		1,2	
d) Velocity in surge	G.O. current meters			
5. Background information on ambient water conditions away from site	Braincon current meter	1,2,3	1,2	

*On 19 October, Operation No. 1 includes disposal No. 1, Operation No. 2 includes disposals 2-7 and Operation No. 3 includes disposal No. 8.

Table M2

Station Log19 October 1976 - Operation 1, Disposal 1

Disposal #	Time	Name of Boat	Type of Observation*	Instrumentation Used (XM = transmitter, CM = current meter)	Range to Dredge, m	Depth of Instrument, m	Water Depth, m
1	1149	<u>Lyman</u>	3b	200-kHz inverted		17.7	18
			3b	GO flow		17	18
			3d	meter			
				<u>Hotspur</u>	2a	<u>Lyman</u> draft gage	
			3c	200-kHz, horizontal	4	5	60

*Observation Key:

- 1) Physical and mechanical properties of material
- 2a) Volume of material in hoppers
- b) Height of material in hoppers vs. time
- c) Mass of material in hoppers
- 3a) Initial injection velocity
- b) Fall velocity
- c) Spread of descending jet
- d) Impact velocity
- 4a) Arrival of surge
- b) Thickness of surge
- c) Concentration in surge
- d) Velocity in surge
- 5) Background information on ambient water conditions away from site.

AD-A055 648

YALE UNIV NEW HAVEN CONN DEPT OF GEOLOGY AND GEOPHYSICS F/G 8/8
FIELD STUDY OF THE MECHANICS OF THE PLACEMENT OF DREDGED MATERI--ETC(U)
APR 78 H J BOKUNIEWICZ, J GEBERT, R B GORDON DACW39-76-C-0105

UNCLASSIFIED

WES-TR-D-78-7-VOL-2

NL

2 of 2

AD
A055 648

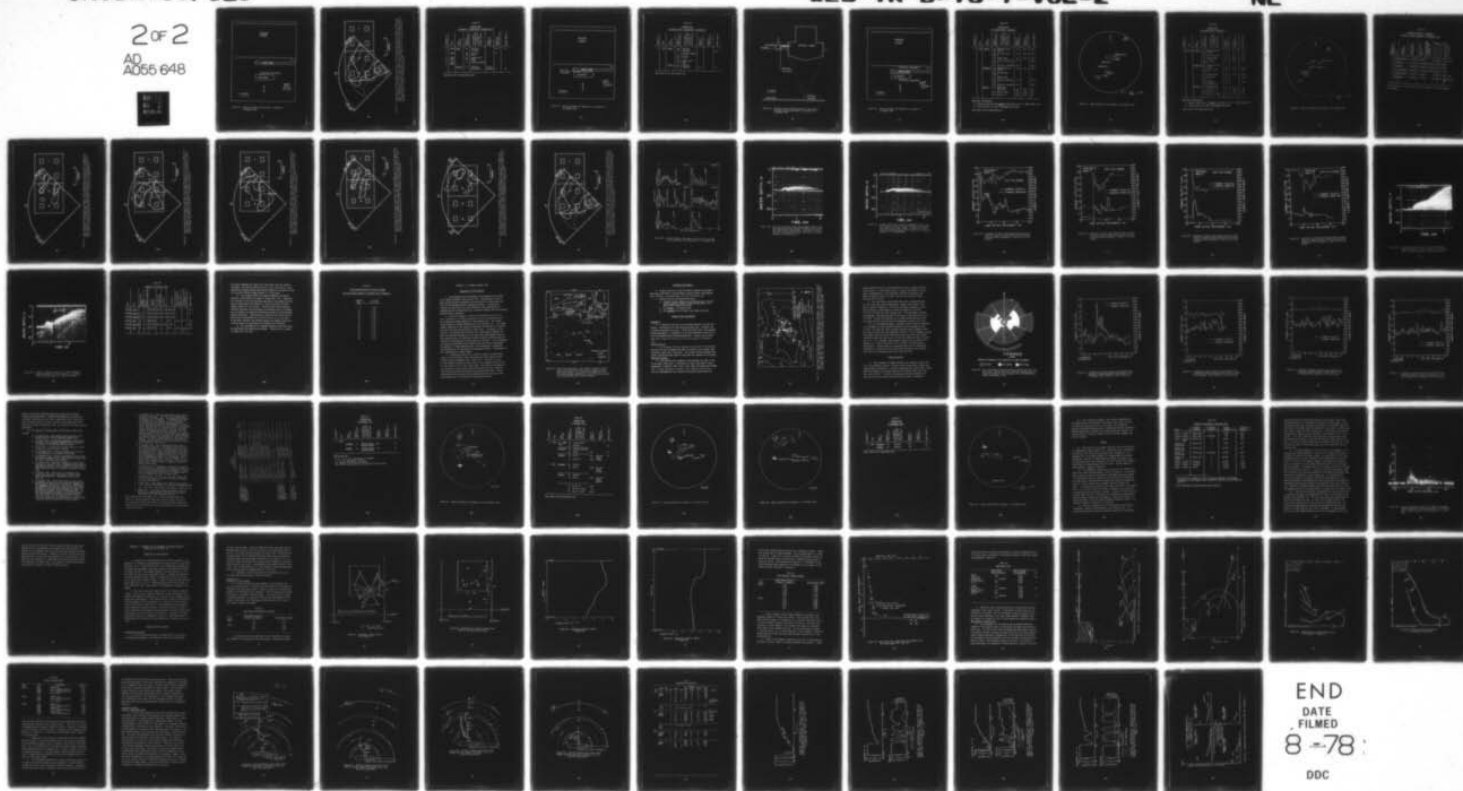

END
DATE
FILMED
8 -78 :
DDC

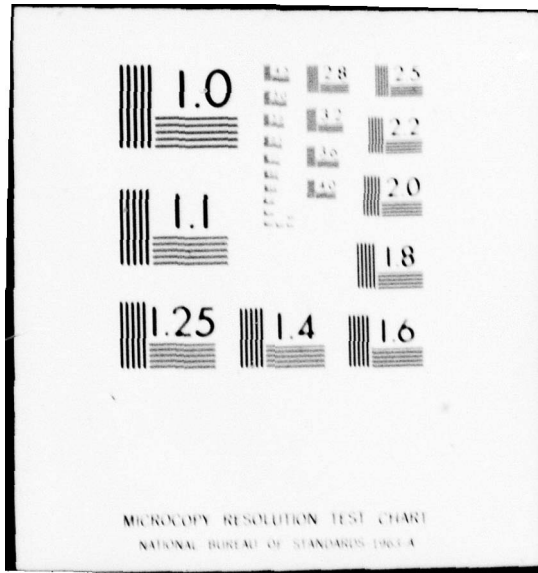

MICROCOPY RESOLUTION TEST CHART
NATIONAL BUREAU OF STANDARDS-1963-A

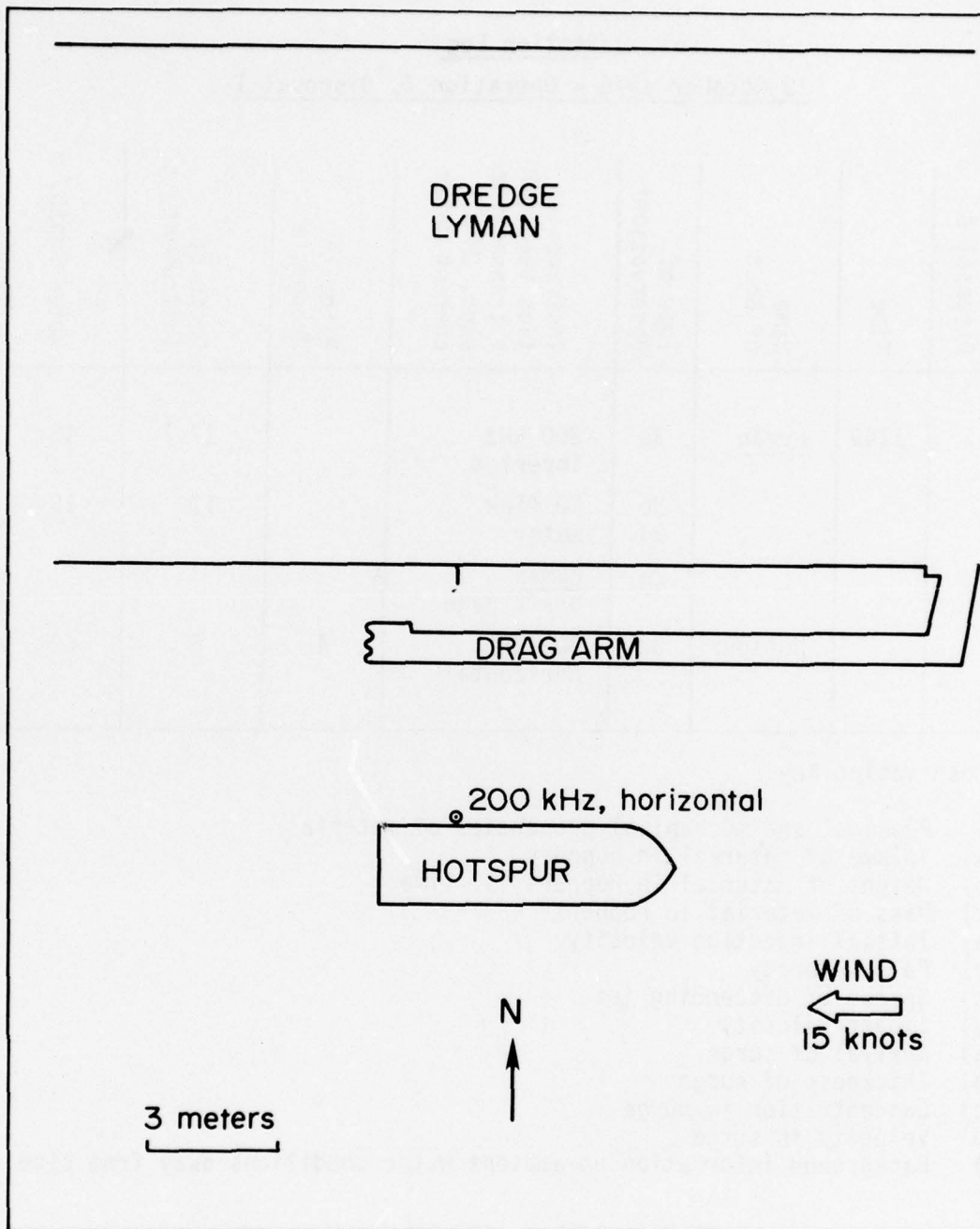

Figure 113. Vessel positions for Operation 1, Disposal 1, 19 October 1976.

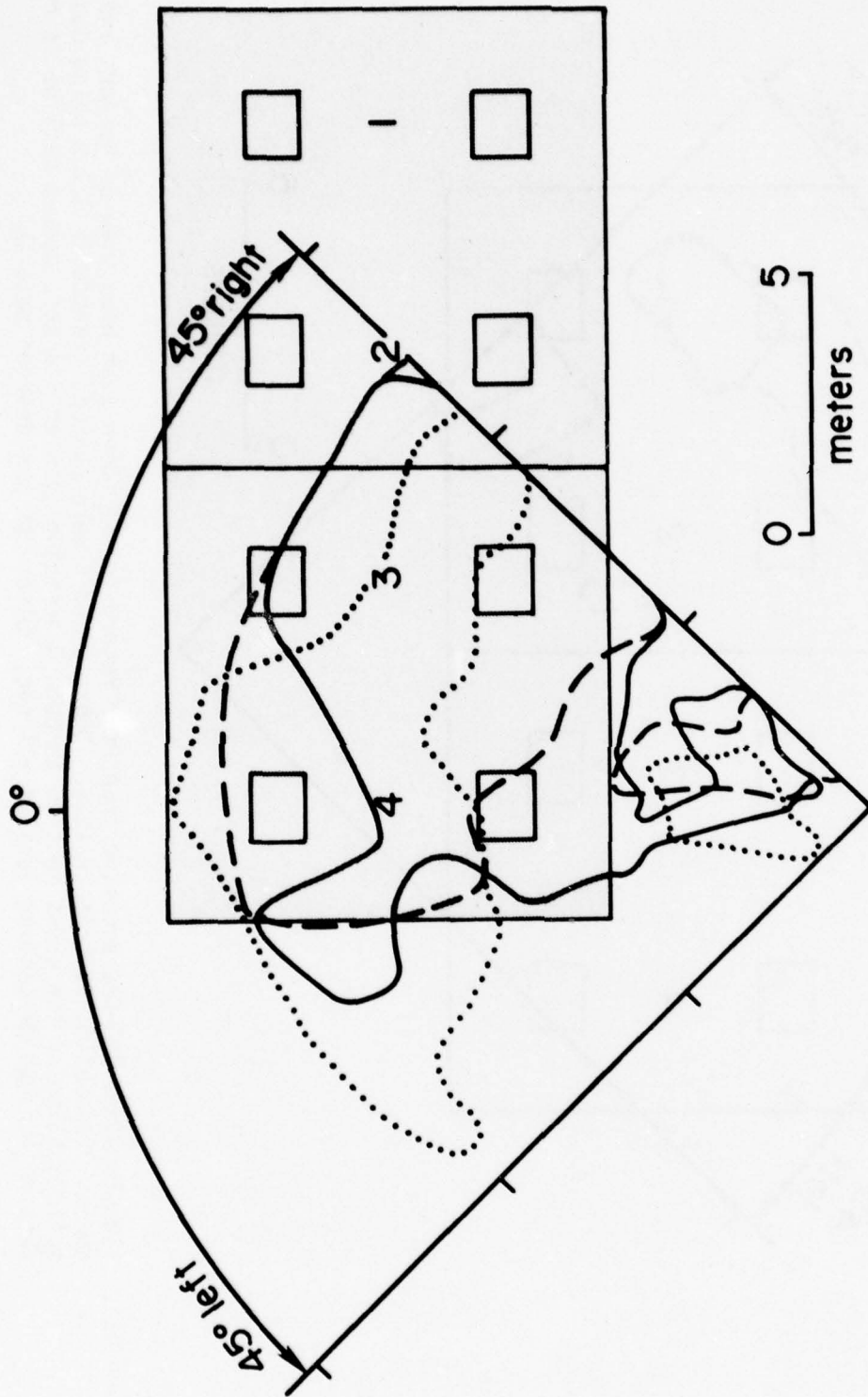

Figure M14. Side-looking, 200-kHz acoustic transducer record superimposed over plan view of hoppers and doors, Disposal 7, 19 October 1976. Doors 4, 3, 2, and 1 were opened; transducer 4 m below doors; solid outline is the cross section through descending jets at +24 sec, dashed outline is cross section through descending jets at +35 sec, dotted line is cross section through descending jets at +46 sec. Discharge was washout.

Table M3

Station Log19 October - Operation 2, Disposals 2-7

Disposal #	Time	Name of Boat	Type of Observation*	Instrumentation Used (XM = transmitter, CM = current meter)	Range to Dredge, m	Depth of Instrument, m	Water Depth, m
2	1216	<u>Lyman</u>	3b	200-kHz, inverted		17.7	18
3	1226		3b 3d	GO flow meter		17	
4	1234		2a	<u>Lyman</u> draft			
5	1515		2c	gage			
6	1528		1	Syringe sampler			
7	1541	<u>Hotspur</u>	3c	200-kHz, horizontal	3 m to gunwhale	7	18

*See Table M2 for observation key.

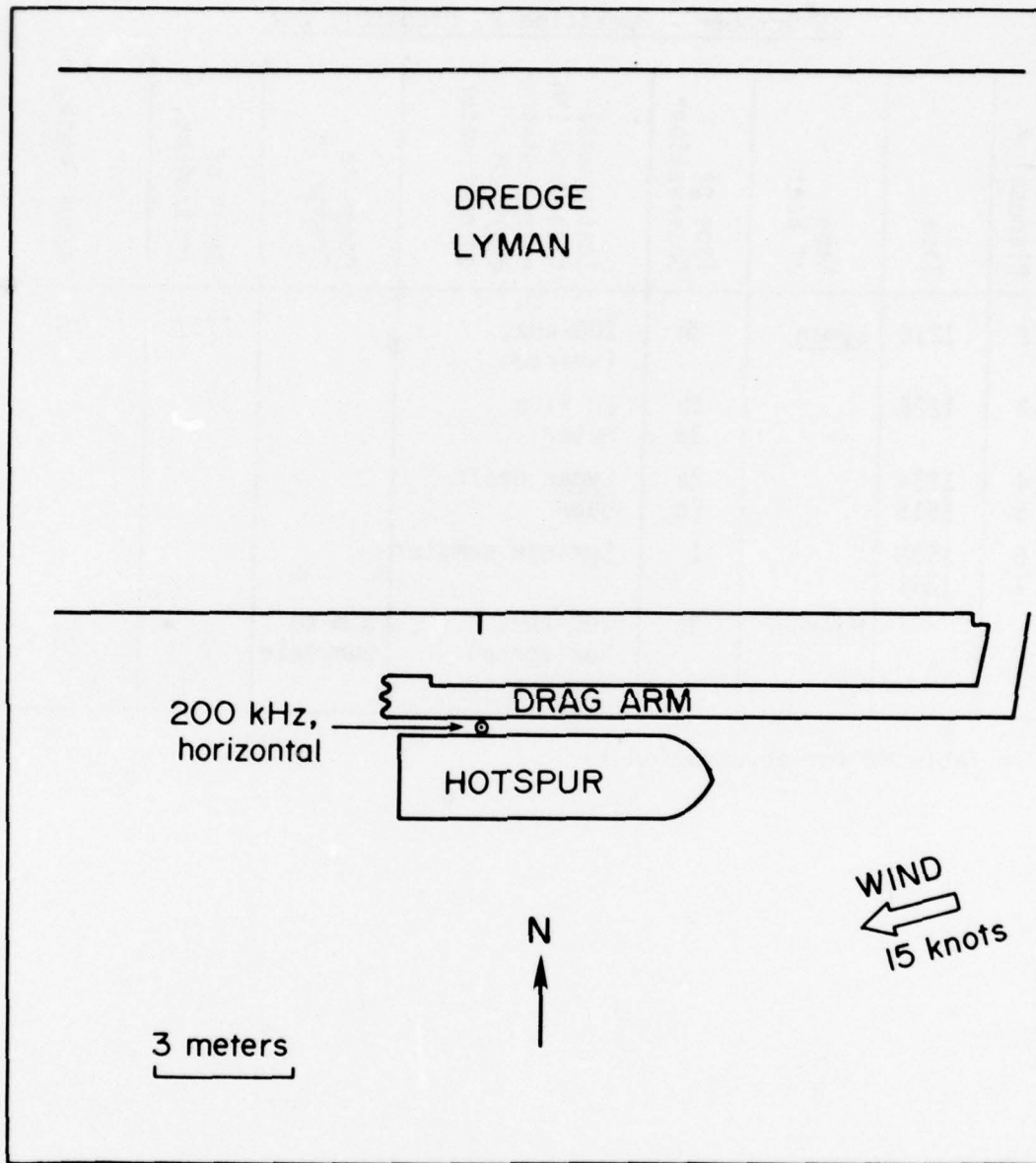

Figure M4. Vessel positions for Operation 2, Disposals 2-7, 19 October 1976.

Table M4

Station Log

19 October 1976 - Operation 3, Disposal 8

Disposal #	Time	Name of Boat	Type of Observation*	Instrumentation Used (XM = transmissometer, CM = current meter)	Range to Dredge, m	Depth of Instrument, m	Water Depth, m
8	1730	<u>Lyman</u>	4a	200-kHz, downward			16.5
			4b				
			1	Syringe sampler			
			2b	Photos -			
		3a	35 mm				
		2a	<u>Lyman</u> draft				
		2c	gage				
		<u>Hotspur</u>	4a	200-kHz, downward			4.5
4b							

*See Table M2 for observation key.

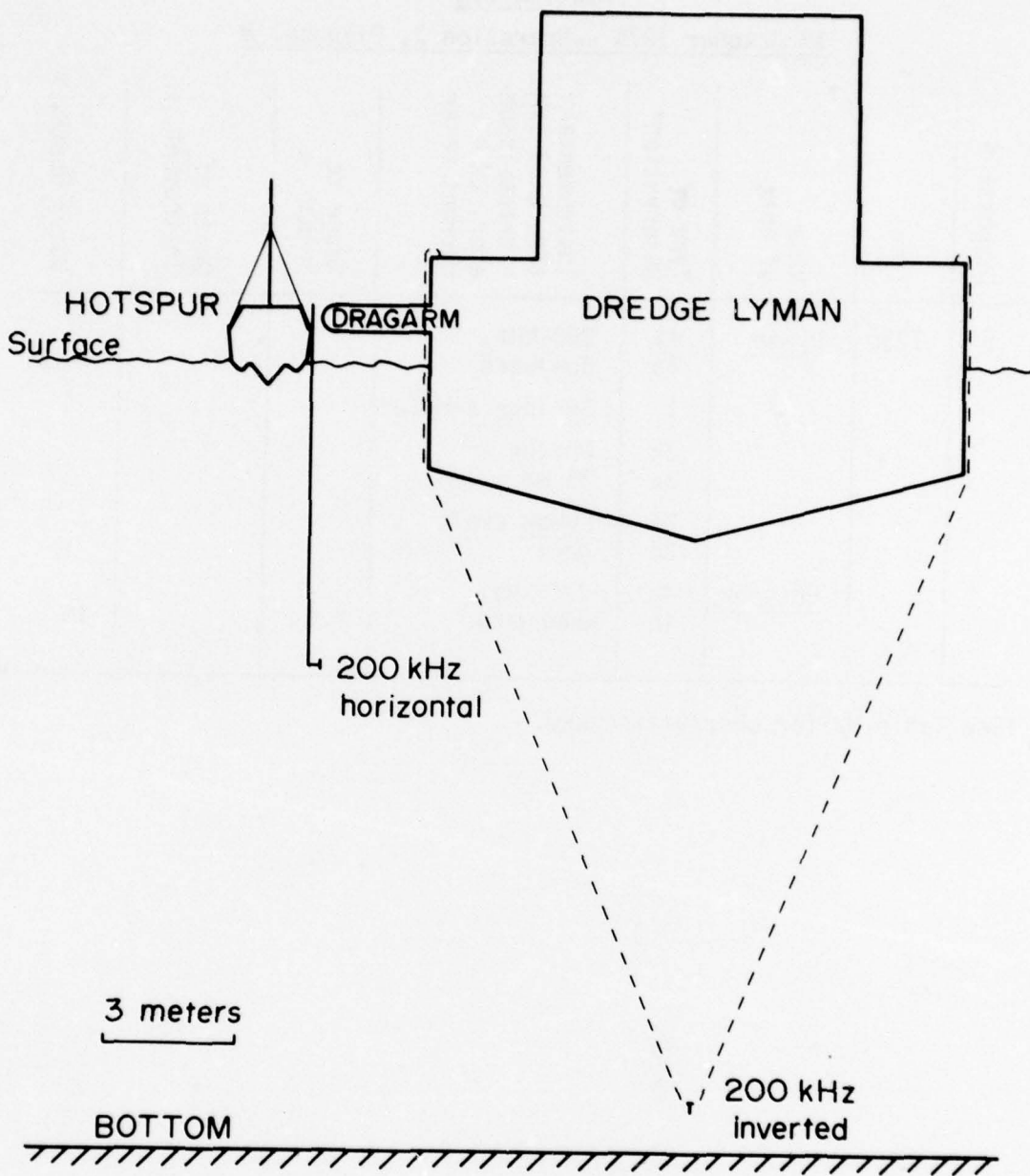

Figure M5. Vertical section showing position of two 200-kHz transducers during Operation 2, Disposals 2-7, 19 October 1976.

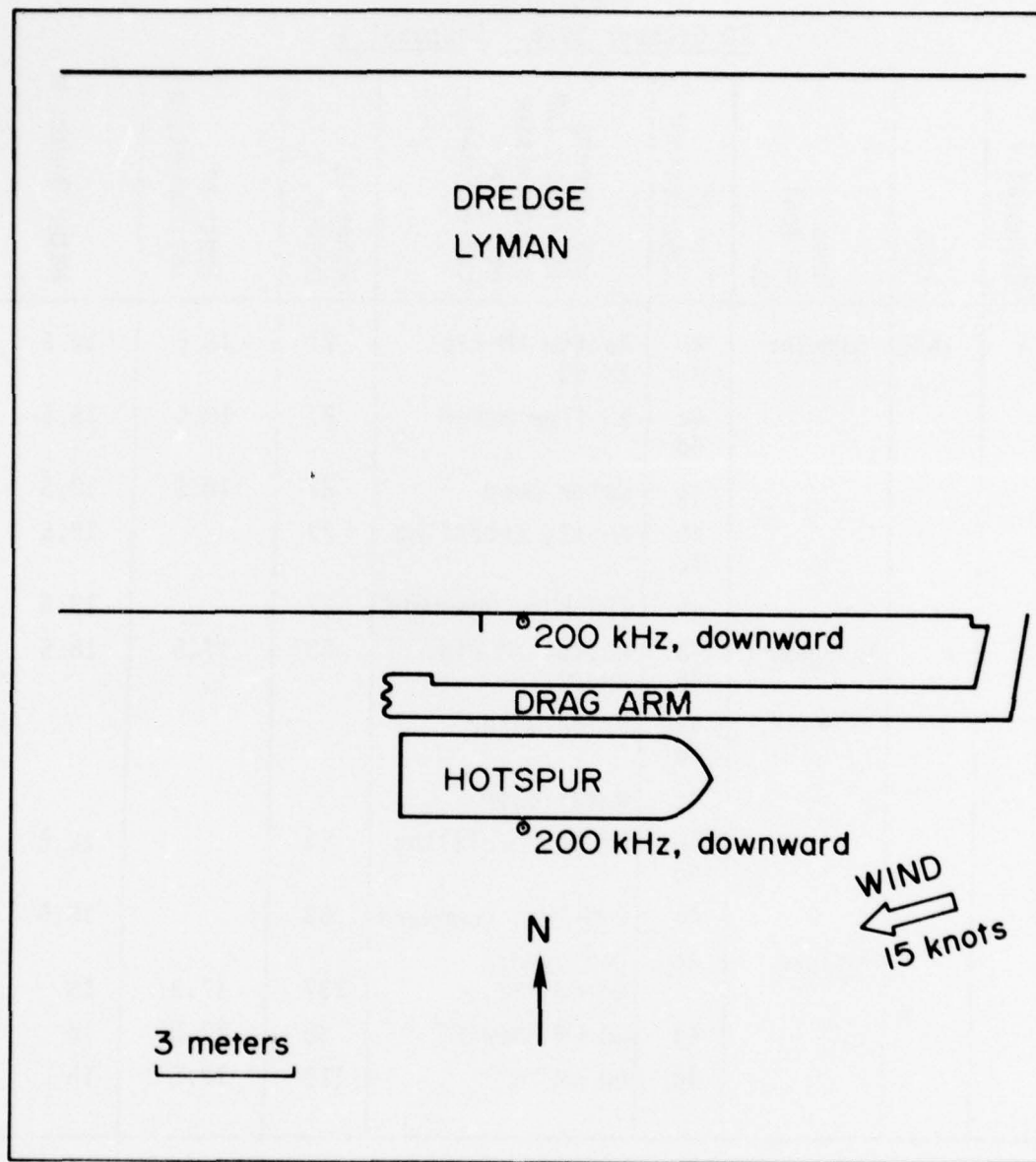

Figure M6. Vessel positions for Operation 3, Disposal 8,
19 October 1976.

Table M5

Station Log

20 October 1976 - Disposal 1

Disposal #	Time	Name of Boat	Type of Observation*	Instrumentation Used (XM = transmitter, CM = current meter)	Range to Dredge, m	Depth of Instrument, m	Water Depth, m
1	1450	<u>Sampler</u>	4a	Bottom XM rig:	27	18.5	19.5
			4b	XM #3			
			4a	GO flow meter	27	18.5	19.5
			4d				
			4c	Water pump	27	18.5	19.5
			4b	XM #1, profiling	27		19.5
		<u>Aquaguard</u>	4b	200-kHz, downward	27		19.5
			4a	Bottom XM rig:	53	17.5	18.5
			4b	XM #2			
			4a	Price meter			
			4d				
			4c	Water pump			
		<u>Hotspur</u>	4b	XM #4, profiling	53		18.5
			4c				
			4b	200-kHz, downward	53		18.5
			4d	Deployed: GO CM "F"	137	17.8	18
4d	GO CM "New F"		88	17.8	18		
4d	GO CM "G"		110	17.8	18		

Additional Information:

- 1) Acoustic data from R/V Damback (John Proni et al. - NOAA, Miami, FL).
- 2) Draft records via radio from Lyman draft gage.

*See Table M2 for observation key.

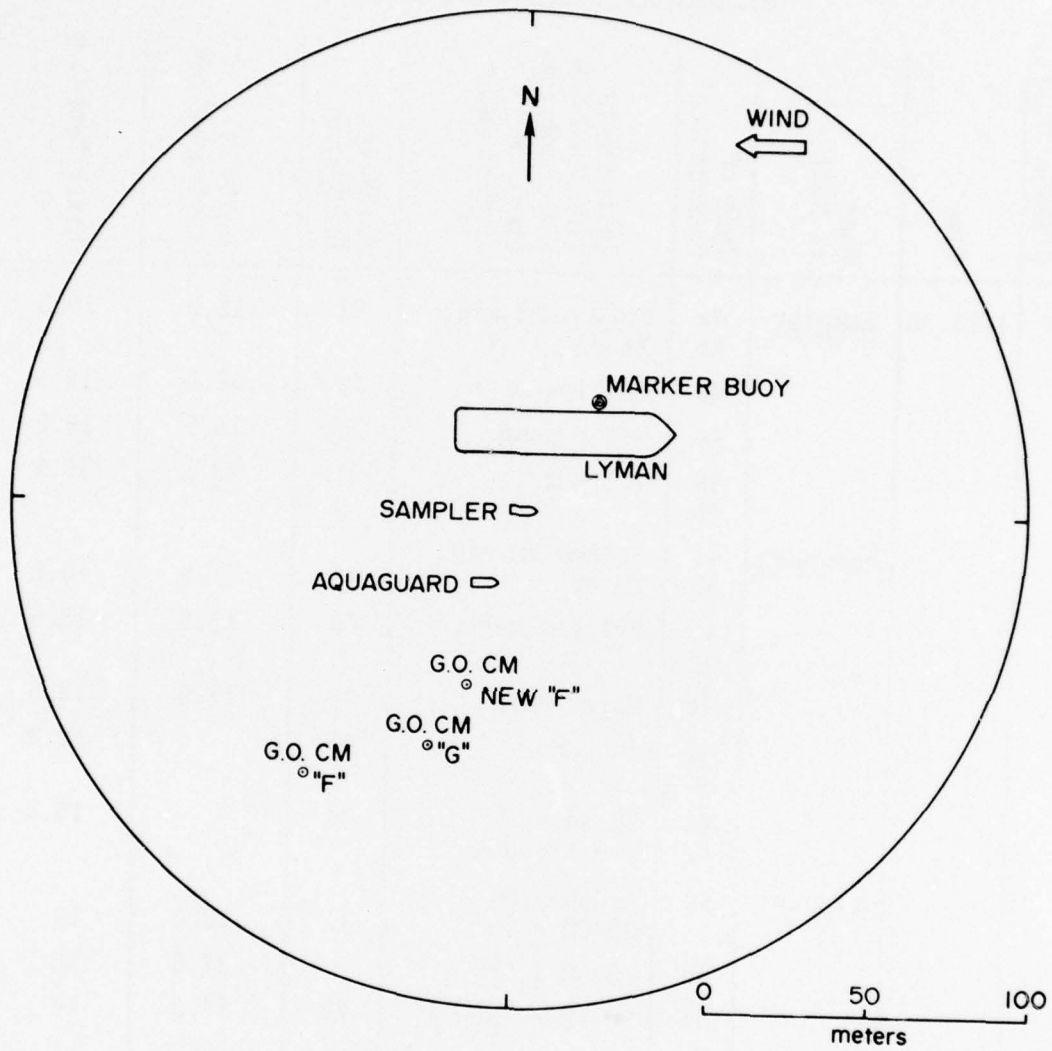

Figure #17. Vessel positions for Disposal 1, 20 October 1976.

Table M6

Station Log

20 October 1976 - Disposal 2

Disposal #	Time	Name of Boat	Type of Observation*	Instrumentation Used (XM = transmitter, CM = current meter)	Range to Dredge, m	Depth of Instrument, m	Water Depth, m
2	1713:30	Sampler	4a	Bottom XM rig:	21	18.5	19.5
			4b	XM #3			
			4a	GO flow meter			
			4c	Water pump			
			4a	7.5-kHz			
			4b				
		Aquaguard	4a	Bottom XM rig:	43	17.5	18.5
			4b	XM #2			
			4a	Price meter			
			4d				
			4c	Water pump			
			4a	200-kHz			
		Hotspur	4b	XM #4	43		18.5
			4c	profiling			
			4d	Redeployed GO CM # "G"			
			4d	GO CM # "F"			
		4d	GO CM # "New F"	73	17.8	18	

Additional Information:

- 1) Acoustic data from R/V Damback (John Proni et al. - NOAA, Miami, FL)
- 2) Draft records via radio from Lyman draft gage.

*See Table M2 for observation key.

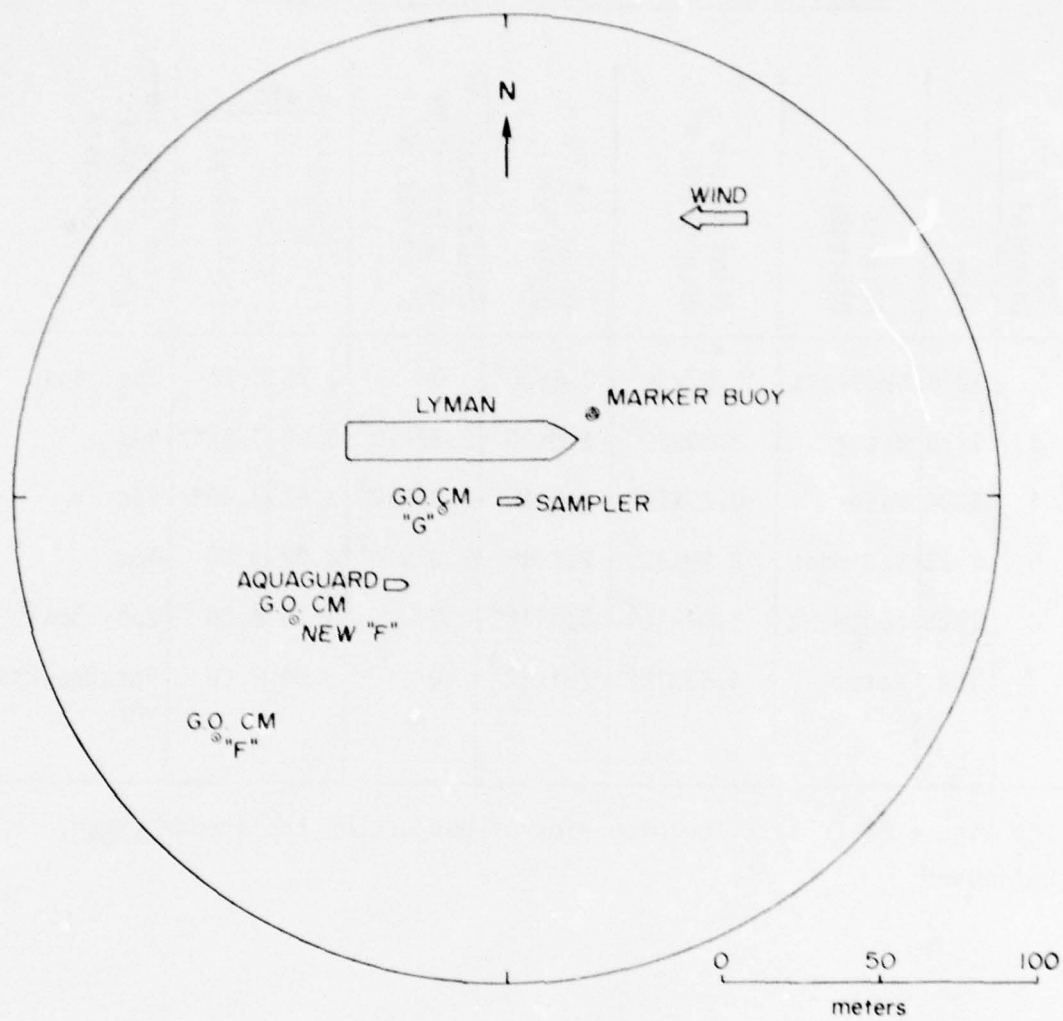

Figure 118. Vessel positions for Disposal 2, 20 October 1976.

Table M7

Volume of Material in Hoppers
Before and After Disposal - 19 October 1976

Operation 2, Disposal #	Time	Material Discharged	Total Volume ³ Discharged, m ³	Volume at 16-m depth, m ³	Volume remaining in hopper after discharge, m ³	Draft, m		Order doors open- ed*, p = port s = starboard
						Predisposal	Postdisposal	
2	1216	Sediment	1.07×10^2	3.6×10^3	0	3.75	2.92	3ps, 4ps
3	1226	Water	2.59×10^2	1.8×10^4	2.37×10^2	3.68	3.65**	4ps
4	1234	Water	0.29×10^2	2.3×10^3	2.37×10^2	3.42	3.39**	4ps
5	1515	Sediment	2.59×10^2	2.1×10^2	2.37×10^2	3.92	3.70	4ps
6	1528	Sediment	1.07×10^2	5.2×10^3	0	3.70	2.94	2ps, 3ps
7	1541	Water	4.43×10^2	7.1×10^3	0	3.64	2.92	4ps, 3ps, 2ps 1ps

* See Figure B2 in text for plan view of hoppers on the dredge Lyman.

** Estimated.

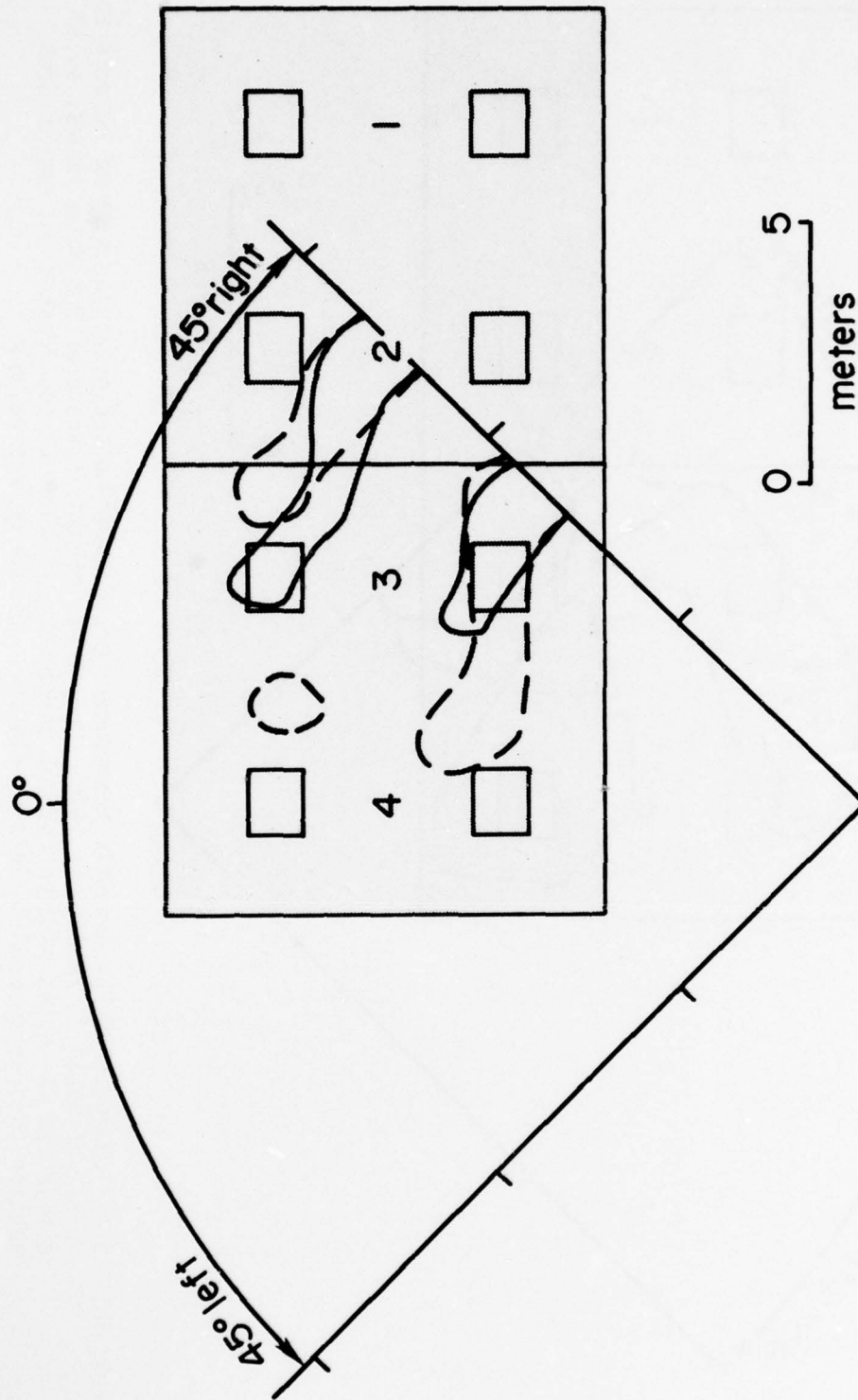

Figure M9. Side-looking, 200-kHz acoustic transducer record superimposed over plan view of hoppers and doors, Disposal 2, 19 October 1976. Doors 3 and 4 were opened; transducer 3 m below doors; solid outline is the cross section through descending jets at +10 sec, dashed outline is cross section through descending jets at +20 sec. Discharge was dredged material.

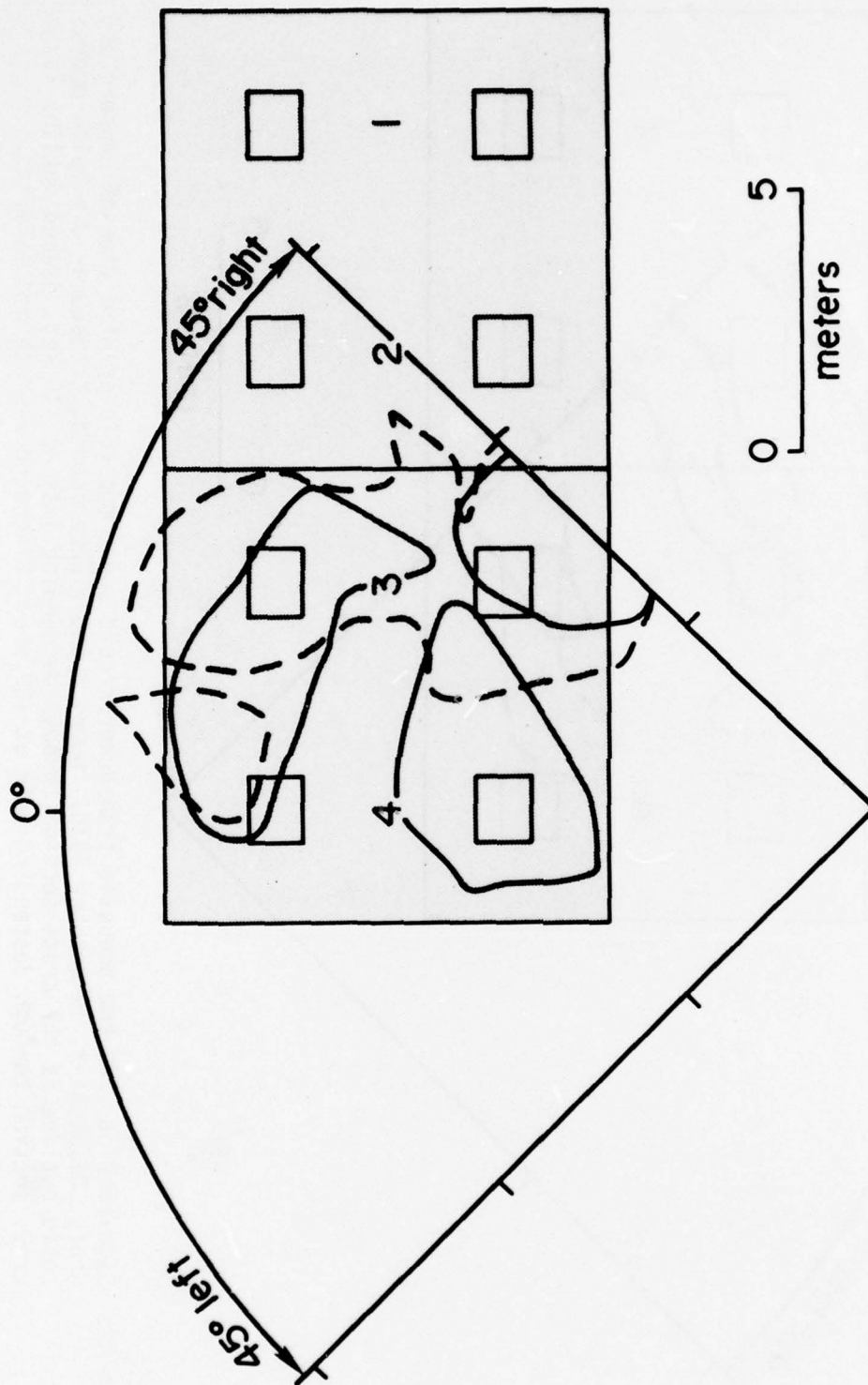

Figure M10. Side-looking, 200-kHz acoustic transducer record superimposed over plan view of hoppers and doors, Disposal 3, 19 October 1976. Door 4 was opened; transducer 3 m below doors; solid outline is the cross section through descending jets at +27 sec, dashed outline is cross section through descending jets at +44 sec. Discharge was washout.

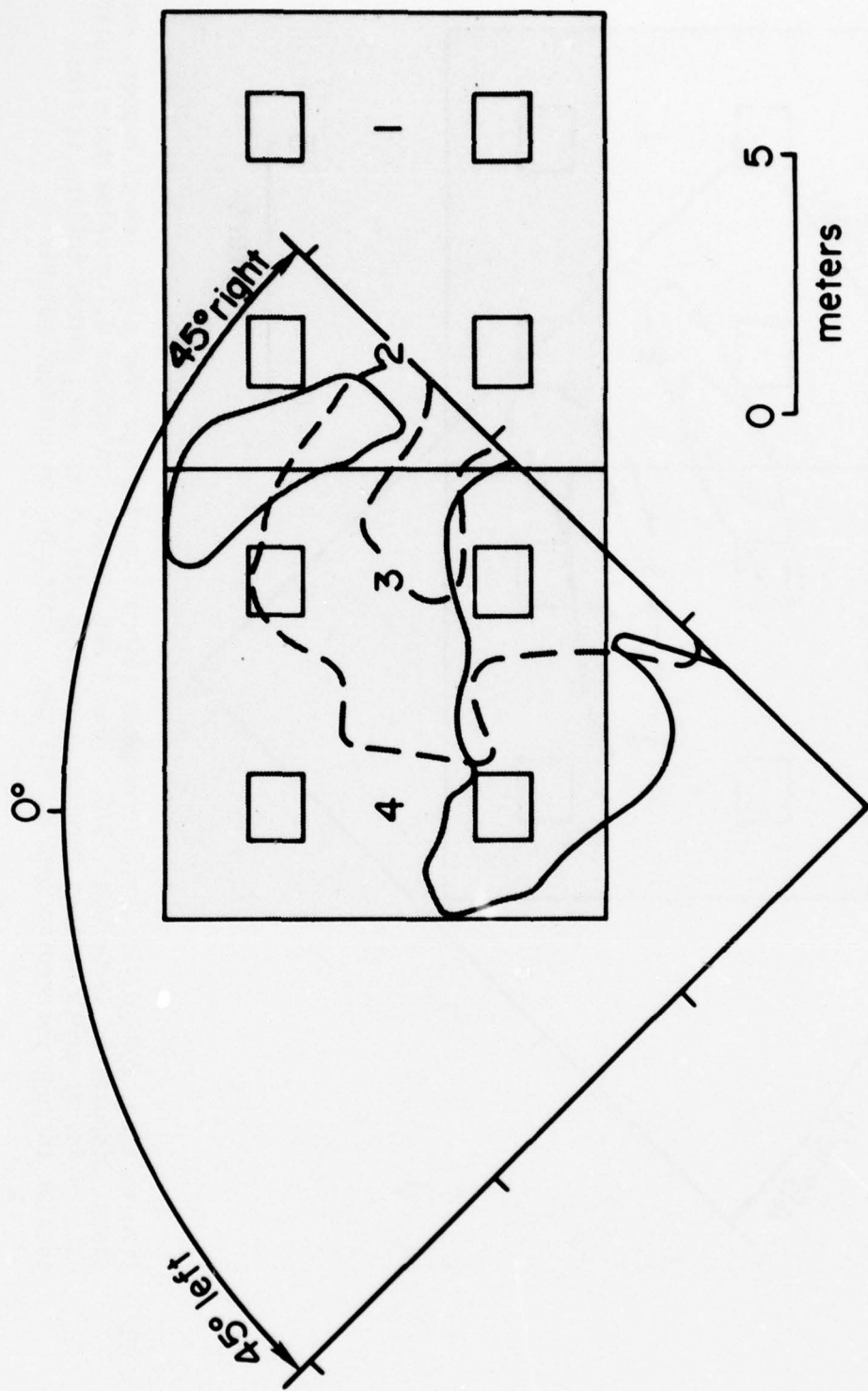

Figure M11. Side-looking, 200-kHz acoustic transducer record superimposed over plan view of hoppers and doors, Disposal 4, 19 October 1976. Door 4 was opened; transducer 3 m below doors; solid outline is the cross section through descending jets at +27 sec, dashed outline is cross section through descending jets at +45 sec. Discharge was washout.

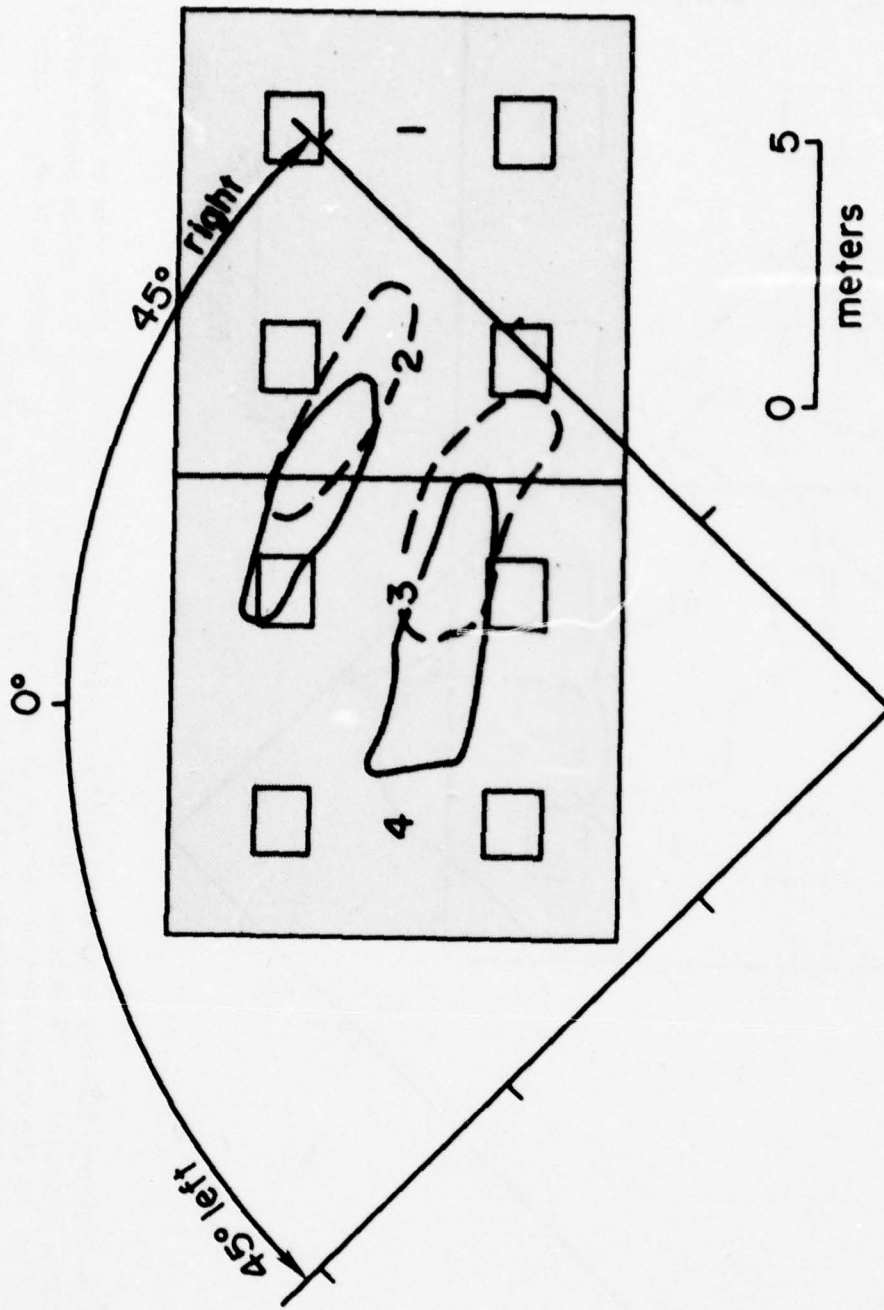

Figure M12. Side-looking, 200-kHz acoustic transducer record superimposed over plan view of hoppers and doors, Disposal 5, 19 October 1976. Door 4 was opened; transducer 3.7 m below doors; solid outline is the cross section through descending jets at +19 sec, dashed outline is cross section through descending jets at +33 sec. Discharge was dredged material.

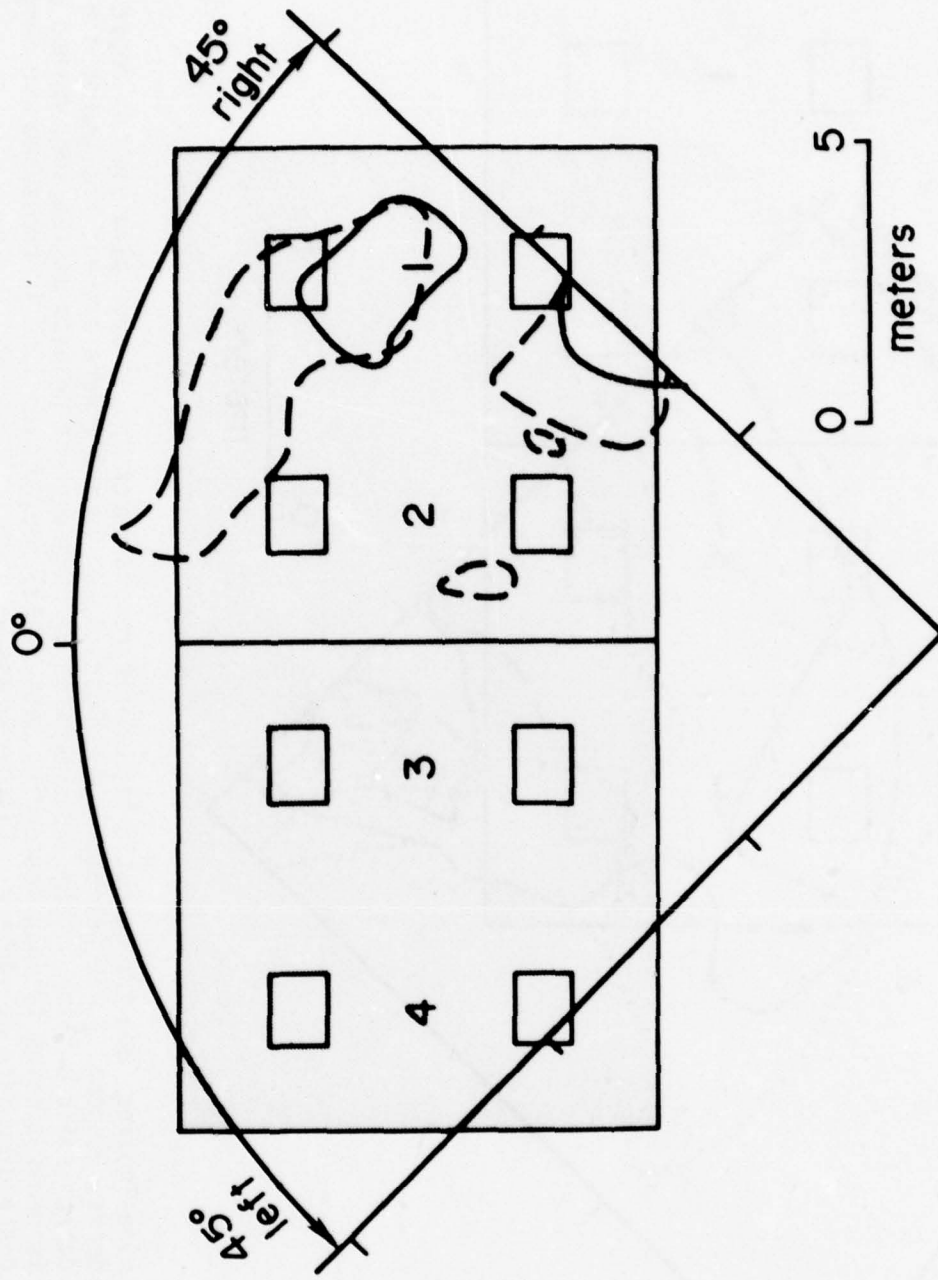

Figure M13. Side-looking, 200-kHz acoustic transducer record superimposed over plan view of hoppers and doors, Disposal 6, 19 October 1976. Doors 2 and 3 were opened; transducer 3.7 m below doors; solid outline is the cross section through descending jets at +18 sec, dashed outline is cross section through descending jets at +31 sec. Discharge was dredged material.

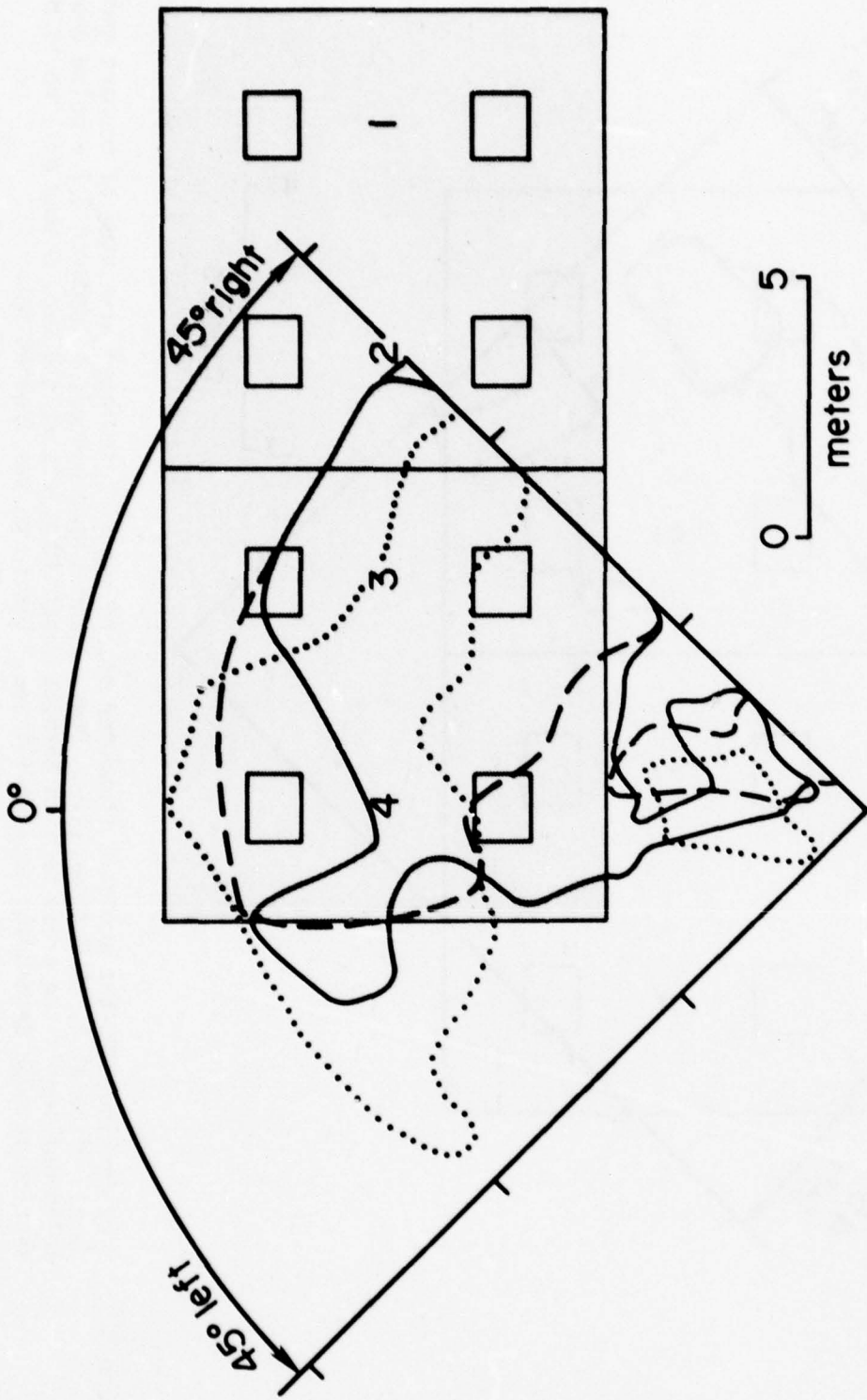

Figure #14. Side-looking, 200-kHz acoustic transducer record superimposed over plan view of hoppers and doors, Disposal 7, 19 October 1976. Doors 4, 3, 2, and 1 were opened; transducer 4 m below doors; solid outline is the cross section through descending jets at +24 sec, dashed outline is cross section through descending jets at +35 sec, dotted line is cross section through descending jets at +46 sec. Discharge was washout.

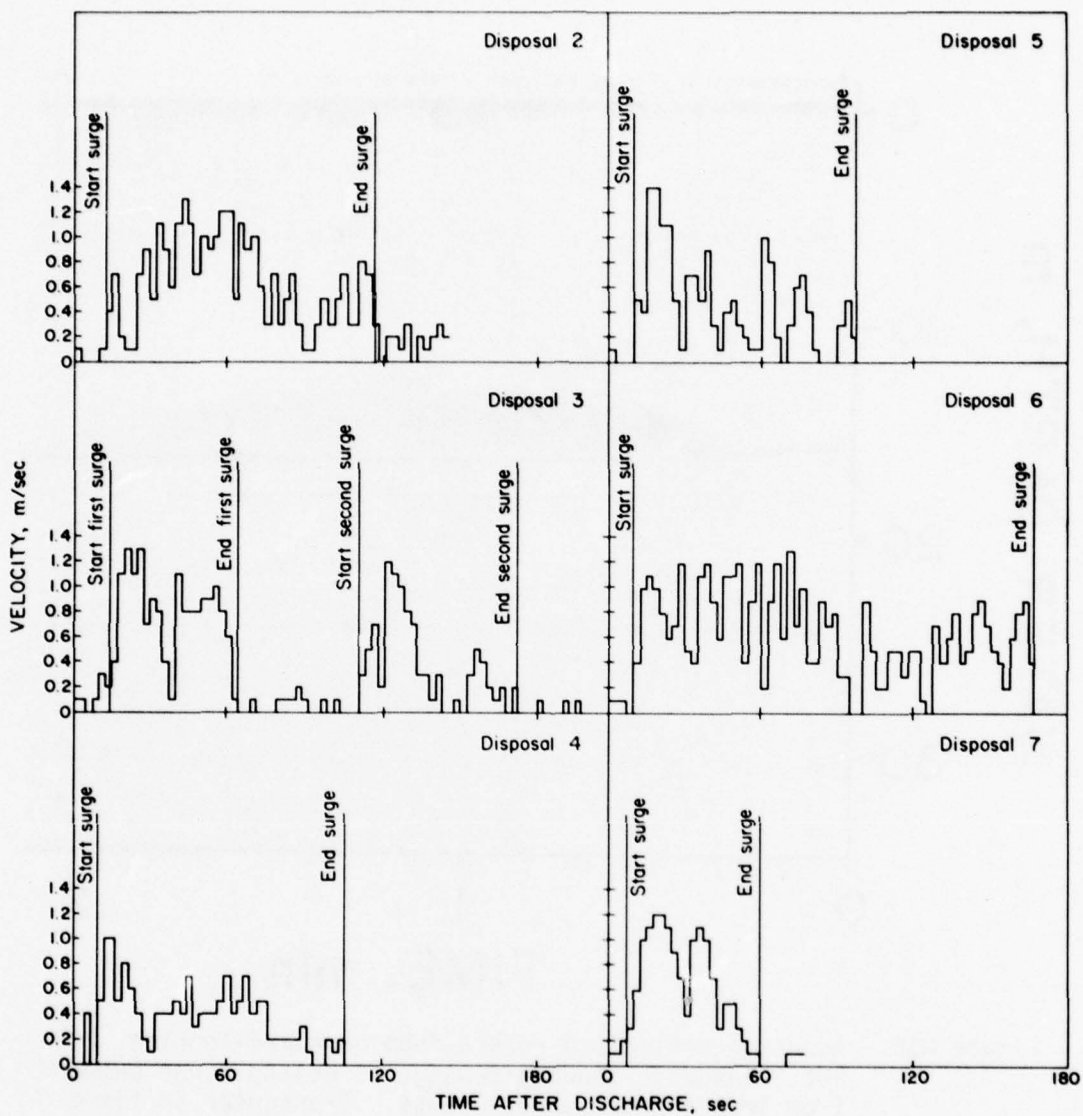

Figure M15. General Oceanics flow meter records of fall velocity of descending jet for Disposals 2-7, 19 October 1976.

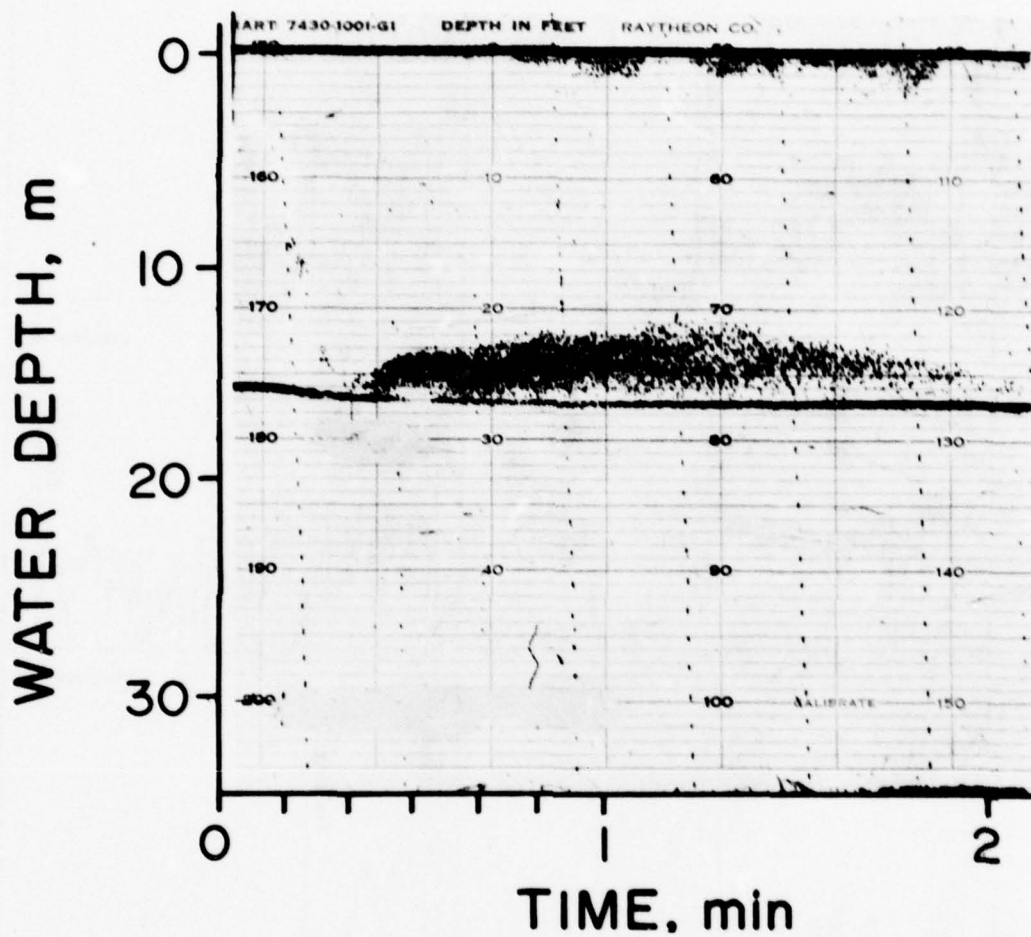

Figure M16. Acoustic reflection record from downward-looking, 200-kHz transducer showing passage of bottom surge outward from impact point under dredge. Transducer in fixed position alongside dredge (see Figure M6 for location). Disposal 8, 19 October 1976.

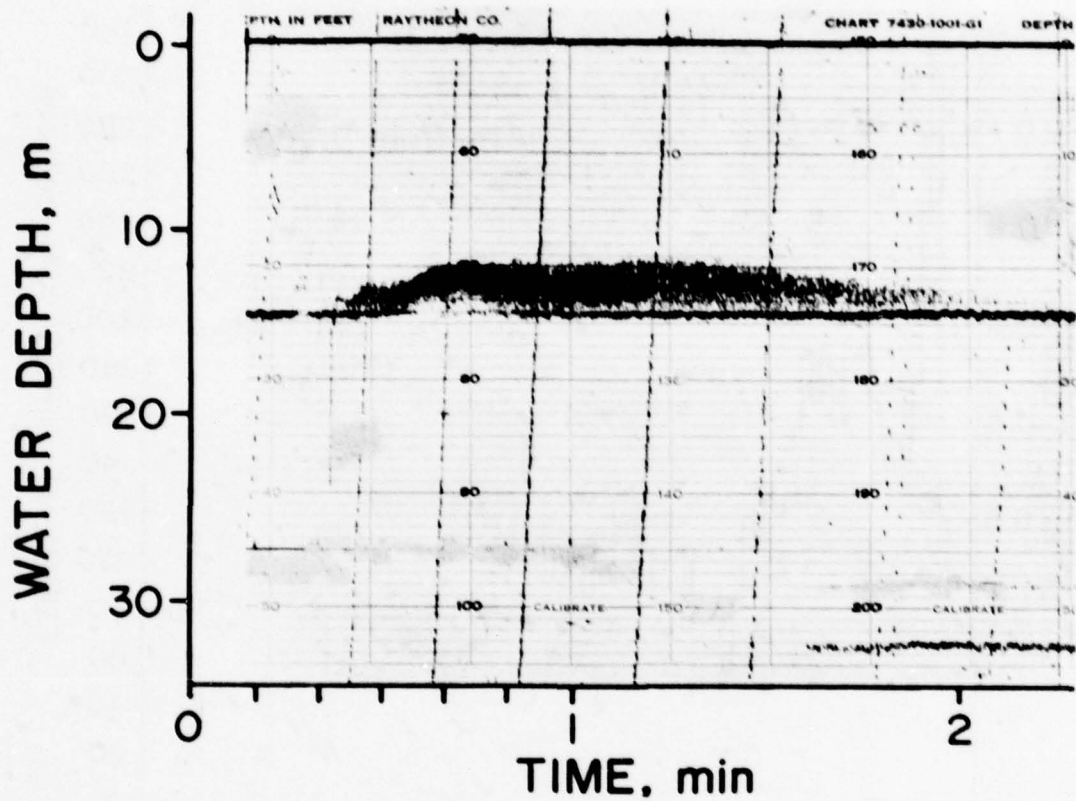

Figure M17. Acoustic reflection record from downward-looking, 200-kHz transducer showing passage of bottom surge outward from impact point under dredge. Transducer in fixed position alongside Hotspur (see Figure M6 for location). Disposal 8, 19 October 1976.

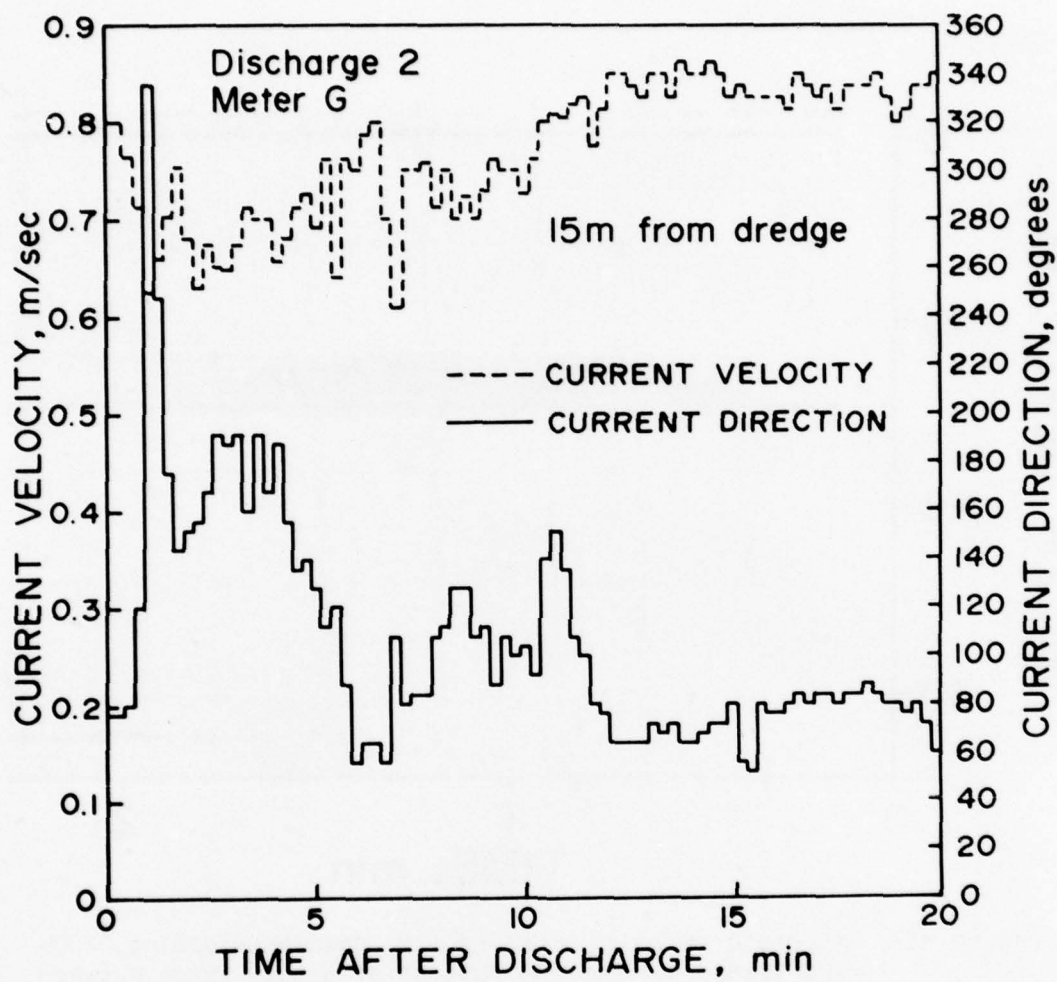

Figure M18. Histogram of record from General Oceanics current meter "G" showing current velocity and direction, 20 October 1976, Discharge 2. Meter is 0.3 m off bottom.

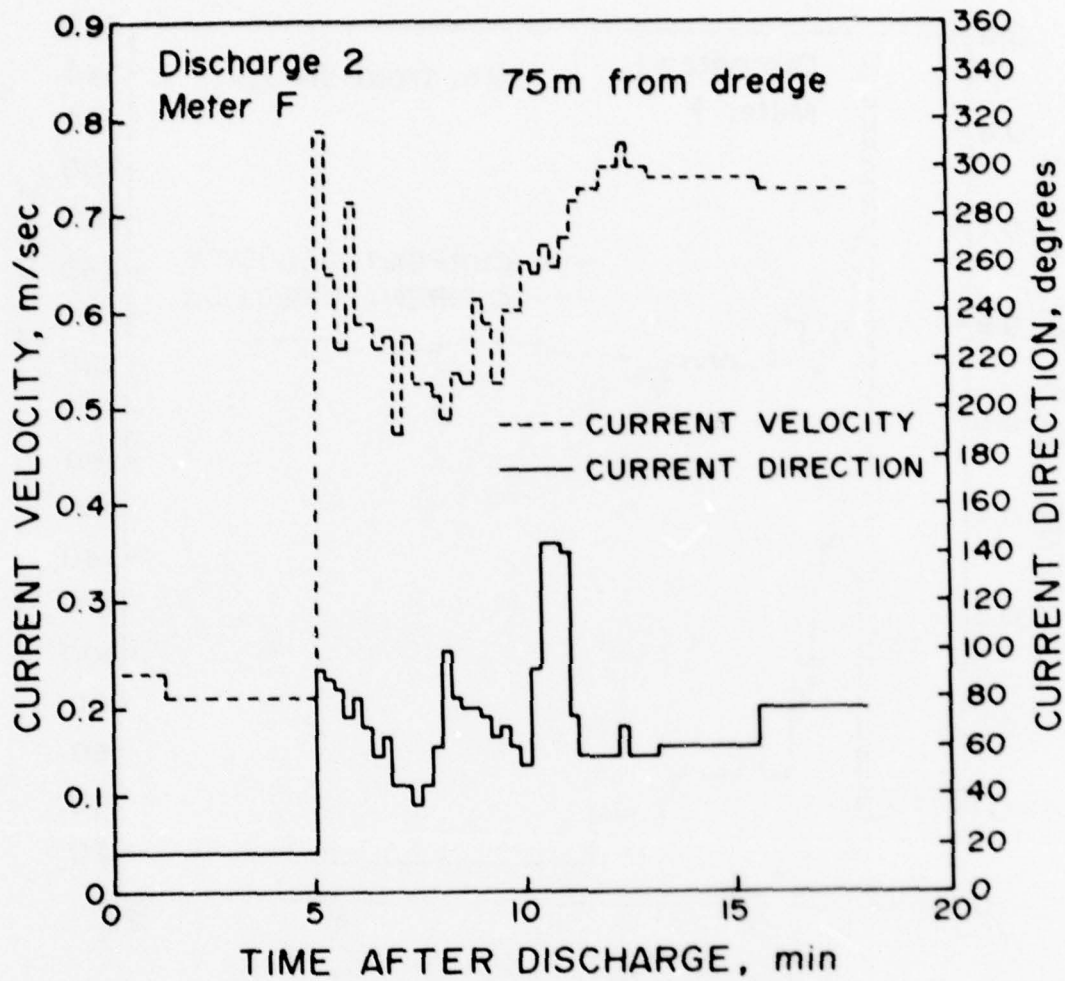

Figure M19. Histogram of record from General Oceanics current meter "F" showing current velocity and direction, 20 October 1976, Discharge 2. Meter is 0.3 m off bottom.

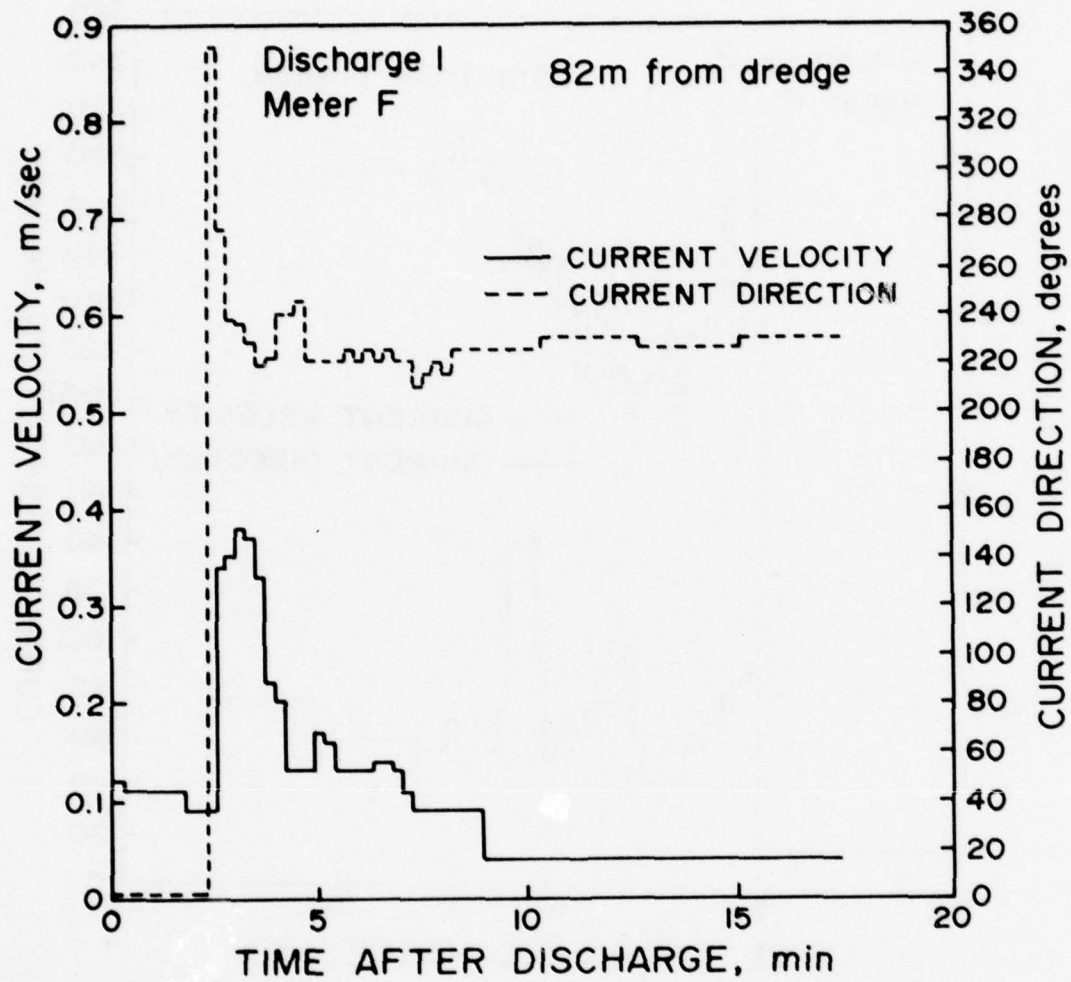

Figure M20. Histogram of record from General Oceanics current meter "F" showing current velocity and direction, 20 October 1976, Discharge 1. Meter is 0.3 m off bottom.

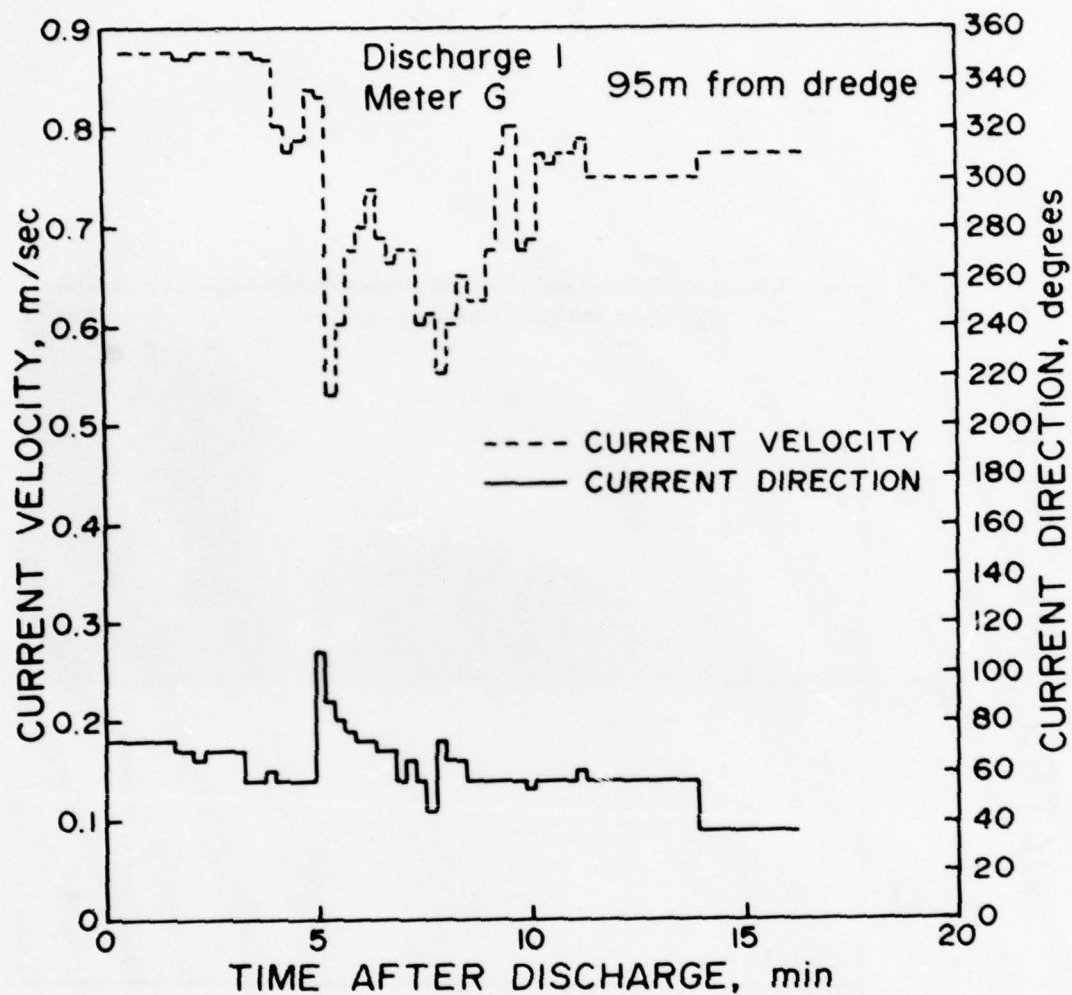

Figure M21. Histogram of record from General Oceanics current meter "G" showing current velocity and direction, 20 October 1976, Discharge 1. Meter is 0.3 m off bottom.

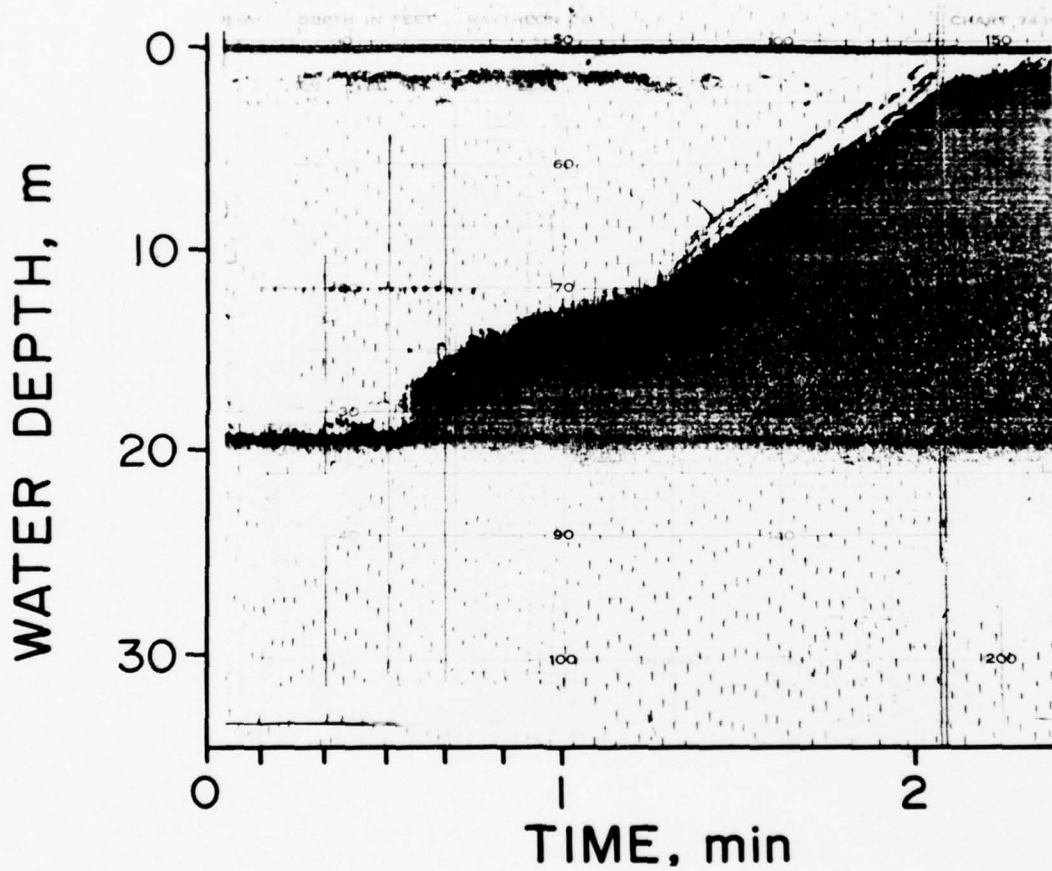

Figure M22. Acoustic reflection record of 200-kHz transducer showing thickness of surge, Disposal 1, 20 October 1976. Observing vessel 27 m away from dredge.

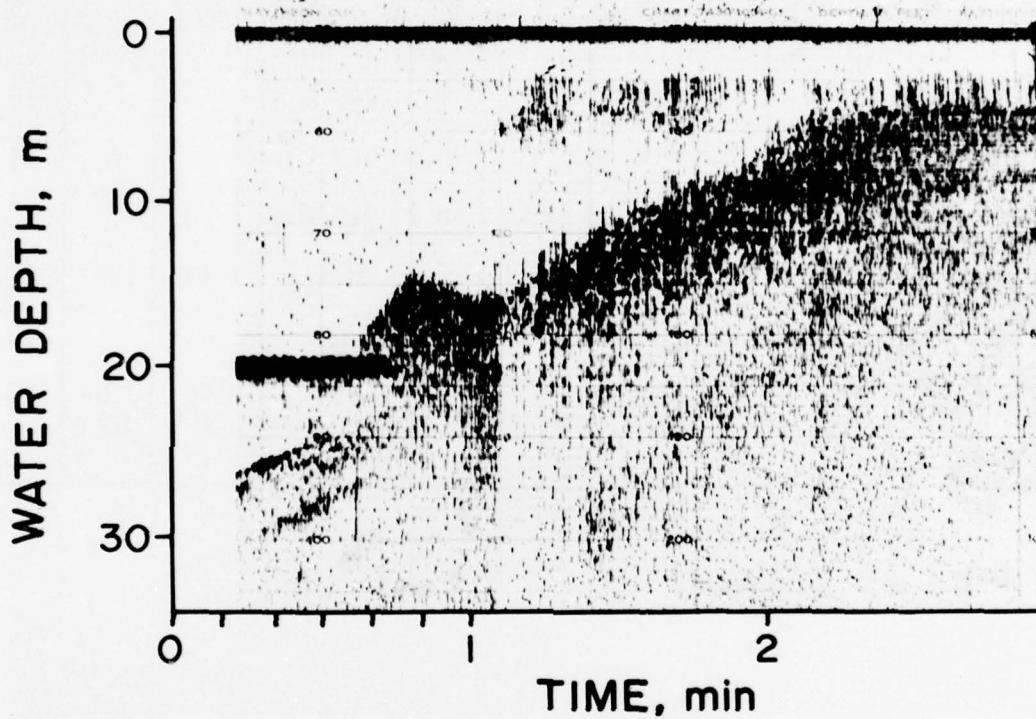

Figure M23. Acoustic reflection record of 7.5-kHz transducer showing thickness of surge, Disposal 2, 20 October 1976. Observing vessel 21 m away from dredge.

Table M8

Summary of Thickness Data

Date	Boat	Distance from dredge, m	No. of Disposal Operation	Time of Disposal	Time arrival of surge, sec	Thickness, m	Instrument	Time of profile after arrival of surge, min	Thickness of surge at profile, m	Water depth, m
191076	<u>Lyman</u>		3	1730:00	18.0	>1.0	200 kHz			16.5
191076	<u>Hotspur</u>	2.4	3	1730:00	22.0	>0.9	200 kHz			15
201076	<u>Sampler</u>	27.4	1	1450:00	28.0	>0.7	200 kHz			
201076	<u>Aqua</u>	52	1	1450:00			XM 4	1.49	1.7	18.5
201076	<u>Sampler</u>	21	2	1713:30	38.3	>1.0	7 kHz			19.5
201076	<u>Aqua</u>	47	2	1713:30			XM 4	0.46	3.0-0.7	18.5

the surge thickness was found to be less useful than the acoustic technique. The acoustic data were used in the construction of the generalized diagram showing the surge thickness as a function of time and distance from the dredge (Figure 22, in the text).

13. The currents within the surge recorded by the General Oceanics current meters are shown in Figures M18 - M21. These data are discussed in the text and have been used in the generalized diagram of surge speed as a function of time and distance from the dredge (Figure 24, in the text). The Price meter and the General Oceanics flow meter did not produce satisfactory data on 20 October due to problems in anchoring the observing vessels in deteriorating weather conditions. Table M9 gives a portion of the Price current meter data; unfortunately 30 sec after the arrival of the surge at the meter location, the recorded speeds are probably unreliable since the meter was beginning to be dragged over the bottom.

14. The concentration of suspended sediment within the surge was determined from pumped water samples. These data are included in Figure 23 of the text.

Table M9

Price Meter Record of Arrival of Surge

For First Sixty Seconds, 20 October 1976, Disposal 2

<u>Interval, sec</u>	<u>5-second avg, m/sec</u>
0	
5	0.29
10	0.35
15	0.45
20	0.39
25	0.39
30	0.29
35	0.29
40	0.25
45	0.22
50	0.16
55	0.22
60	0.22

APPENDIX N: SAYBROOK DISPOSAL SITE

Objectives of the Research

1. Investigations were undertaken at the Saybrook site periodically between September 1976 and July 1977. Observations of the disposal operations were concerned with the effects of strong tidal currents on the dredged material placement processes. Of particular interest was the effects of tidal currents on the distribution of dredged material on the bottom over a period of months after the disposal operations were completed.

2. Detailed bathymetric surveys were completed prior to, and after completion of, disposal operations for use in determination of the accumulated dredged material at the disposal site. The initial survey showed the bottom configuration to be roughly a pit. This added another dimension to the study of containment of material in a specific area which had not been possible at other sites. In addition to the surveys, core samples were collected four times between November and March to establish boundaries of the area containing dredged material. The strong currents and continuous adverse weather conditions severely hampered the observations and the quality of the data. A set of mechanical tests was completed on the material from the scow to investigate the behavior of clods impacting with a hard bottom and to determine the maximum size of clods that can be deposited intact. (See Appendix H for a description of these tests.)

3. Dredging was done with a clamshell bucket and bottom-dump scows at three locations along the Connecticut River below Hartford during the period November 1976 - March 1977. Figure N1 is a map of the dredging location at North Cove, in the Connecticut River, and of the disposal site in Long Island Sound. The material discharged at the disposal site during the onsite observations for this study was from the channel going into North Cove and from North Cove. Onsite observations were not made during dredging operations at Essex Shoal and Brockway Bar, to the north in the Connecticut River.

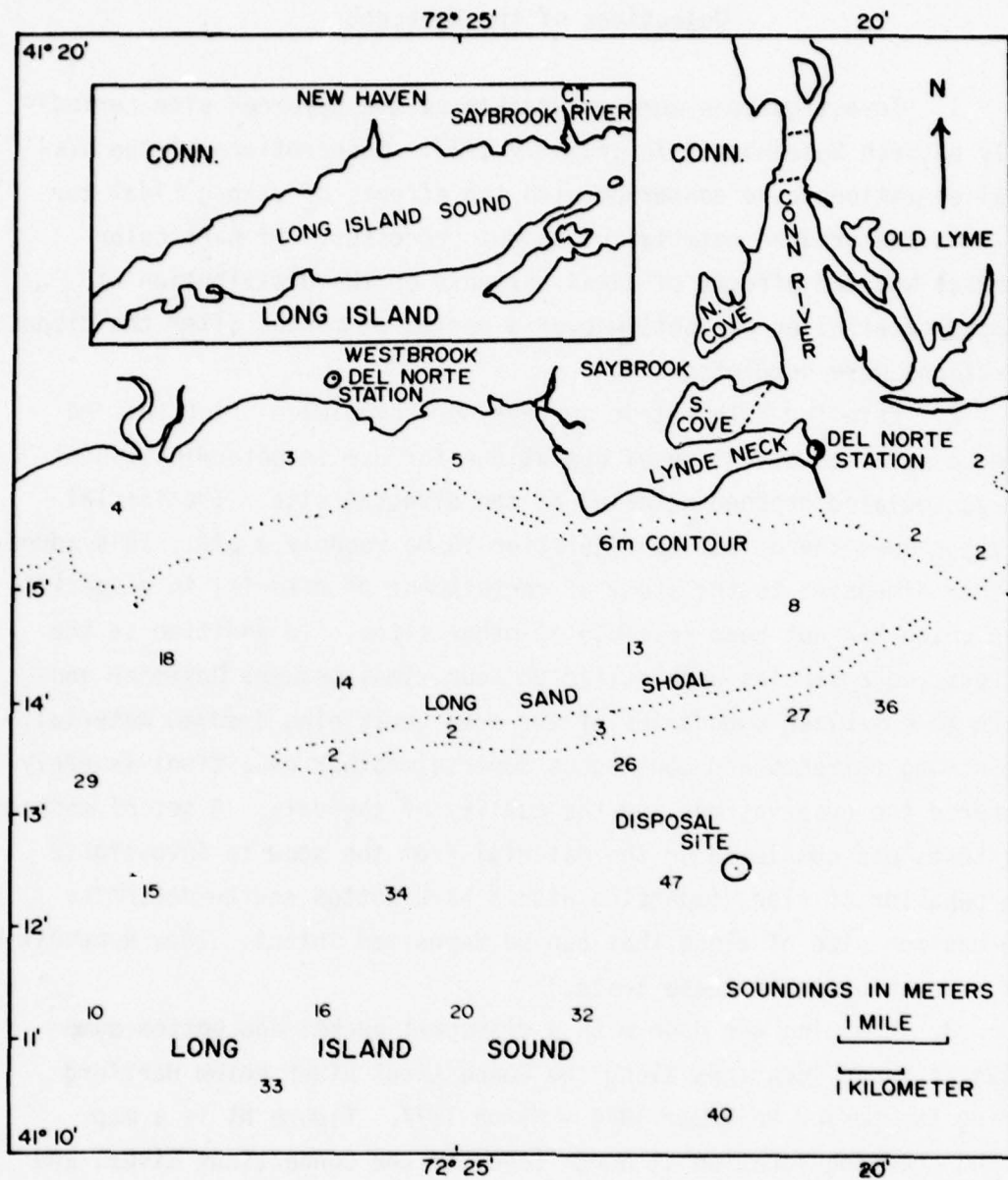

Figure N1. Map of the study area - the dredging location at North Cove in the Connecticut River and the disposal site in Long Island Sound. Essex Shoal and Brockway Bar (the two other dredging locations) are not shown and are north in the Connecticut River, below Hartford.

Personnel and Vessels

4. Persons involved in data collection reduction and analysis were Henry Bokuniewicz, Jeffrey Gebert, Robert Gordon, Jane Higgins, Peter Kaminsky, and Matthew Reed, all from Yale University.

5. Vessels used for the observations were:

- a. Clamshell Bucket dredge and bottom-dump scow; 72 m LOA, holding capacity 1150 m³; owned and operated by the Great Lakes Dredge and Dock Co.
- b. M/V Hotspur; a 6-m McKee Craft.
- c. M/V Hereward; an 8-m former Coast Guard surb boat.

Disposal Site Description

Bathymetry

6. A bathymetric survey of the intended disposal site was completed. See Figure N2 for the resulting contour map. (Contours are in meters below mean low water.) Unlike the other sites, the Saybrook bottom topography is a depression or pit and provided an obvious location for proposed point-discharge operations. Contours for an area about 450 m square go from 53 to 57 m at the bottom of the depression.

Bottom materials

7. On 18 August 1976 core samples of the bottom at the proposed disposal site were collected and show the material to be greater than 90 percent coarse sand with gravel. The natural bottom sediments were coarser grained and more poorly sorted than the sediment to be dredged.

Tides and currents

8. The currents were stronger at the Saybrook site than at any of the other study sites. Circulation in Long Island Sound is well documented by Redfield, 1950; Riley, 1952, 1956; and Gordon and Pilbeam, 1975. Strong, semidiurnal currents of the resonant cooscillating tide are superimposed on an estuarine circulation consisting of an

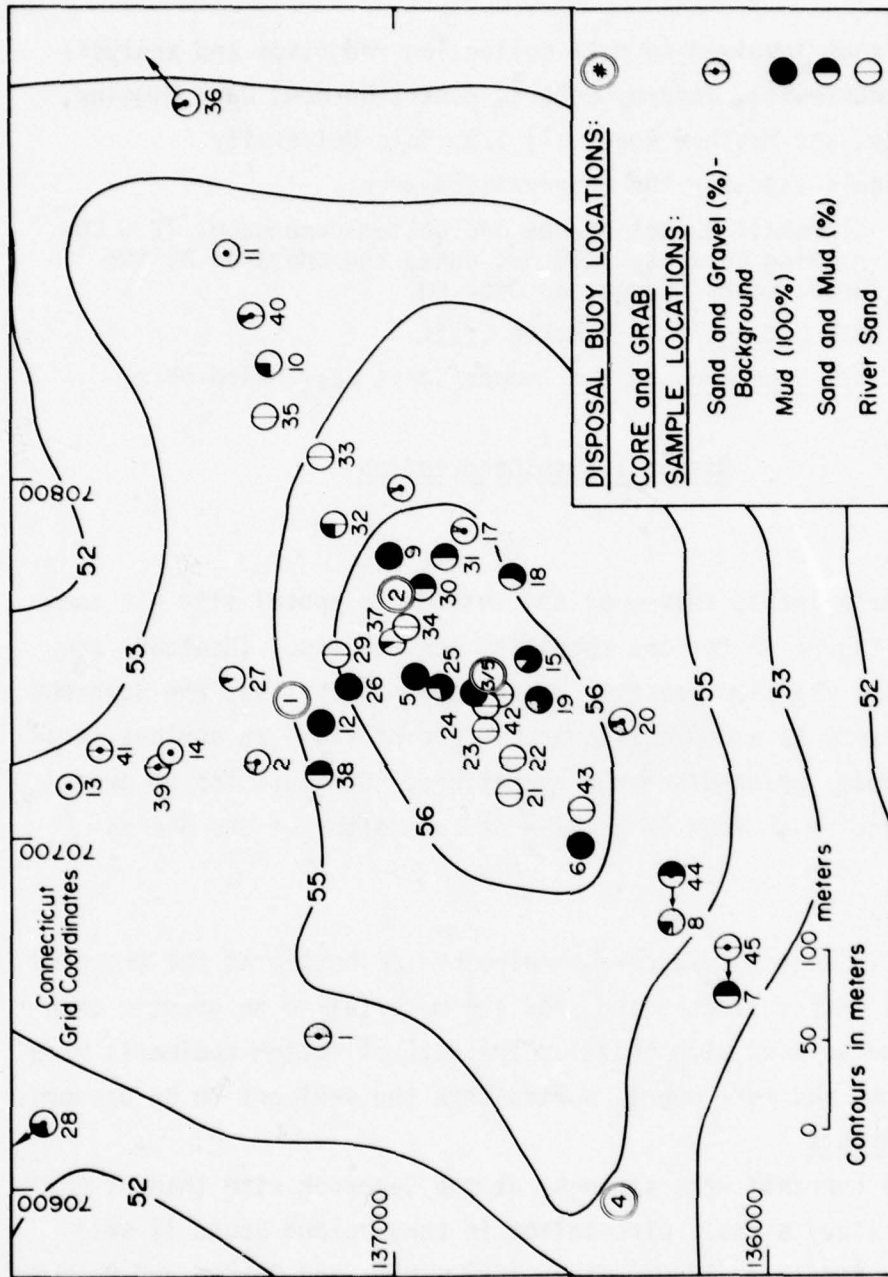

Figure 12. Contour map of the Saybrook disposal site made from a bathymetric survey completed 11 October 1976. Core and grab samples collected are indicated as follows: Nos. 1 and 2 collected on 18 August 1976, Nos. 3 and 4 on 2 December 1976, Nos. 5-14 on 6 December 1976, Nos. 15-18 on 7 March 1977, Nos. 19-28 on 10 March 1977, and Nos. 29-45 from 20-27 July 1977.

inward (westward) flow of saline bottom water and an outward flowing surface water. In the eastern Sound, 2 m above the bottom, the tidal flow is predominantly in the east-west direction and maximum tidal speed is typically about 0.4 m/sec; the net drift velocity ranges from 0.01 to 0.1 m/sec.

9. The most recent records which were used as background data for this study were made by Bokuniewicz, Gordon, and Kastens, 1976, and are shown in Figure N3. This polar histogram represents records from a Braincon current meter 2 m above the bottom at a station ($72^{\circ}17'W$, $41^{\circ}12'N$) SE of the disposal site. The instrument recorded instantaneous flow velocity every 20 min over a 10-day period in early July 1975. Current distribution was in a WSW and ESE direction with an average velocity of 0.3 m/sec but frequently as high as 0.4 m/sec.

10. For the Saybrook study, a Braincon current meter was deployed on 9 September to record ambient conditions over an extended period of time. The meter was never recovered despite several attempts after the disposal operations were completed in March. From 12 November through 19 November, when the onsite observations were made, the tidal height average for mean high water was 2.8 m and the average for mean low water was 0.1 m. On 17 November three General Oceanics current meters were deployed 0.2 m above the bottom in 57 m of water for two discharge observations. Figures N4-N7 are histograms with 5 min of background information of short-term tidal stream velocity before the discharge and 15 min of the observed velocities after discharge.

Study Procedures

11. The discharge of dredged material was intended to take place at a fixed (buoyed) location. Because of the strong tidal currents and adverse weather conditions, "running" discharges were usually made, during which the disposal site marker buoy was lost several times and a new buoy had to be set. To ensure consistent and precise navigation for the surveys (and for marker buoy positioning as well), theodolite

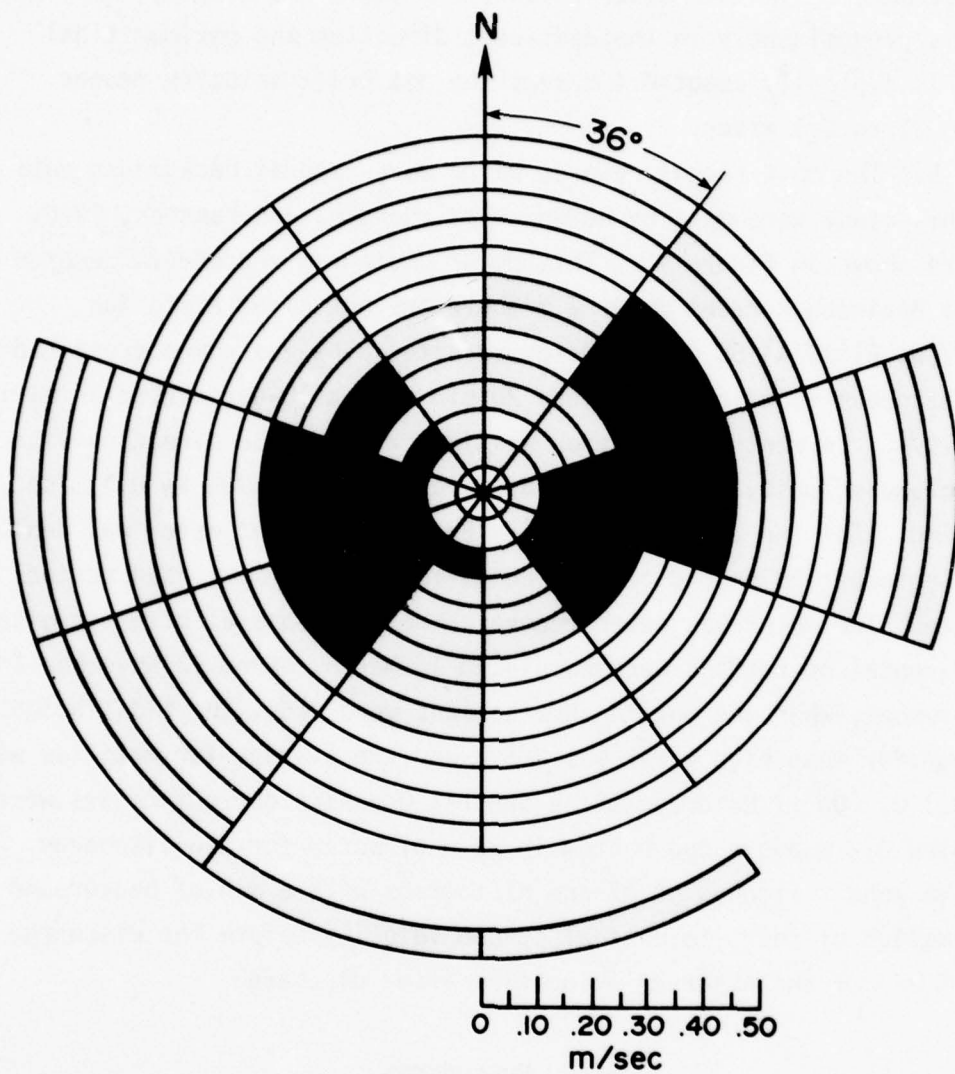

Figure N3. Polar histogram of current velocity and direction for a 10-day period. Records are from a Braincon current meter, 2 m above the bottom SE of the disposal site (from Bokuniewicz Gordon and Kastens, 1976).

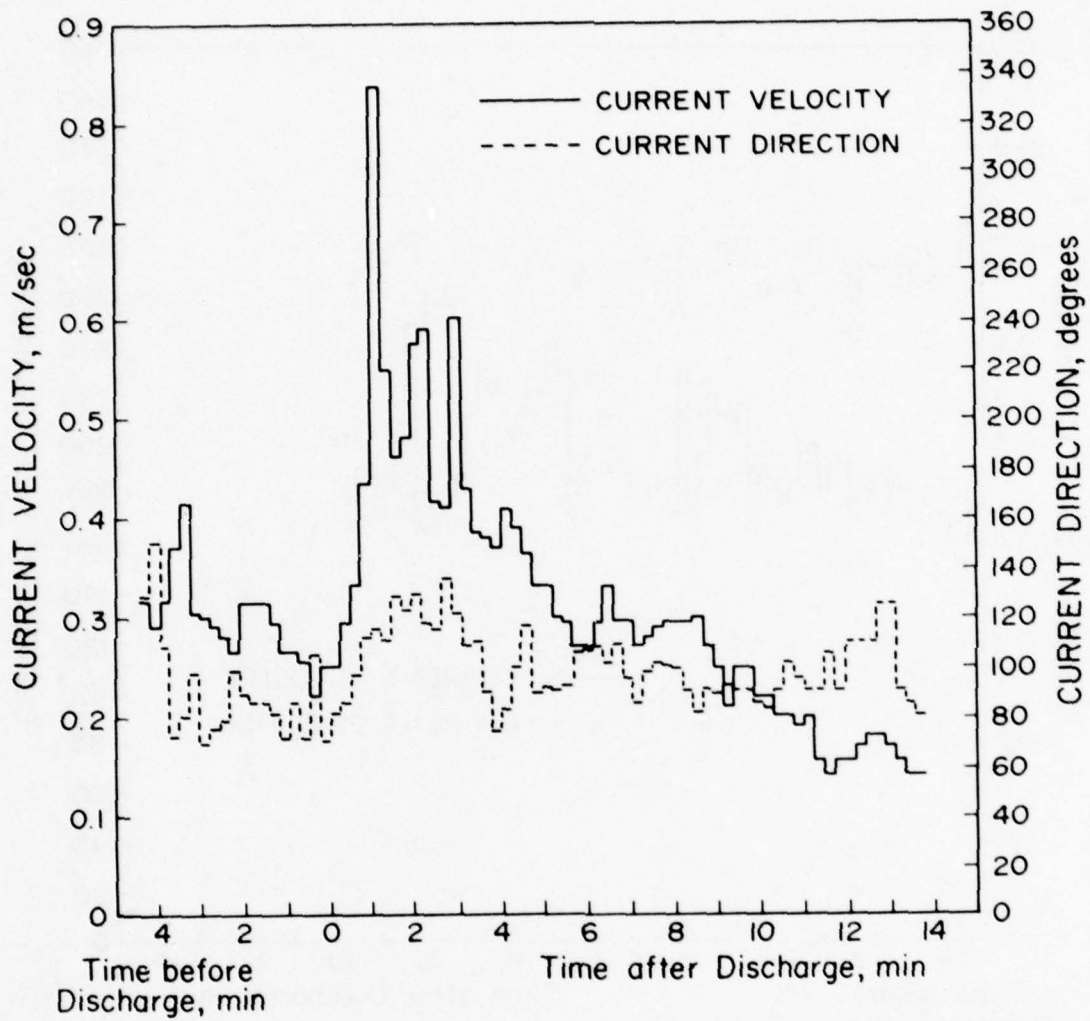

Figure N4. Histogram of current velocity and direction from records of General Oceanics current meter "G" on 17 November 1976, Disposal 1, 120 m from scow.

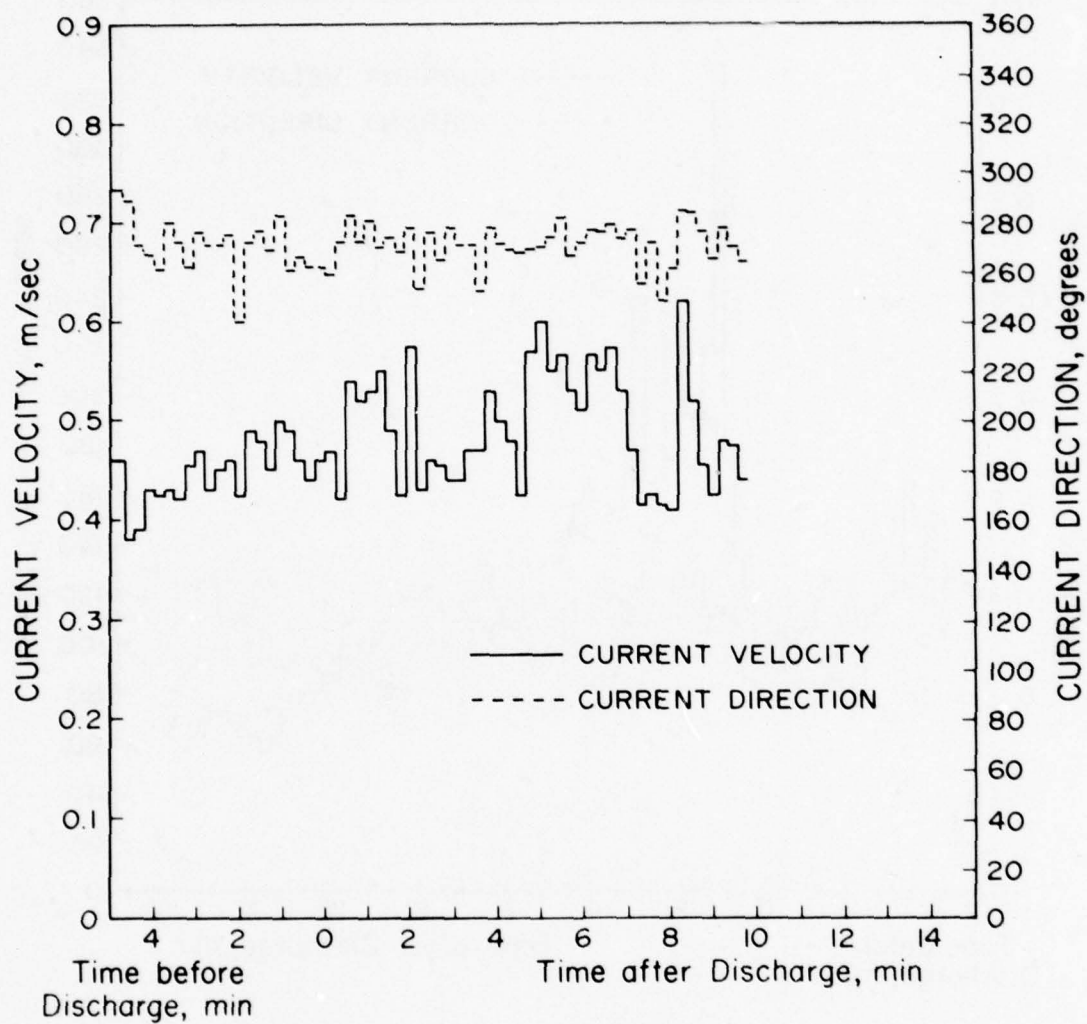

Figure N5. Histogram of current velocity and direction from records of General Oceanics current meter "F Match" on 17 November 1976, Disposal 2, 85 m from scow.

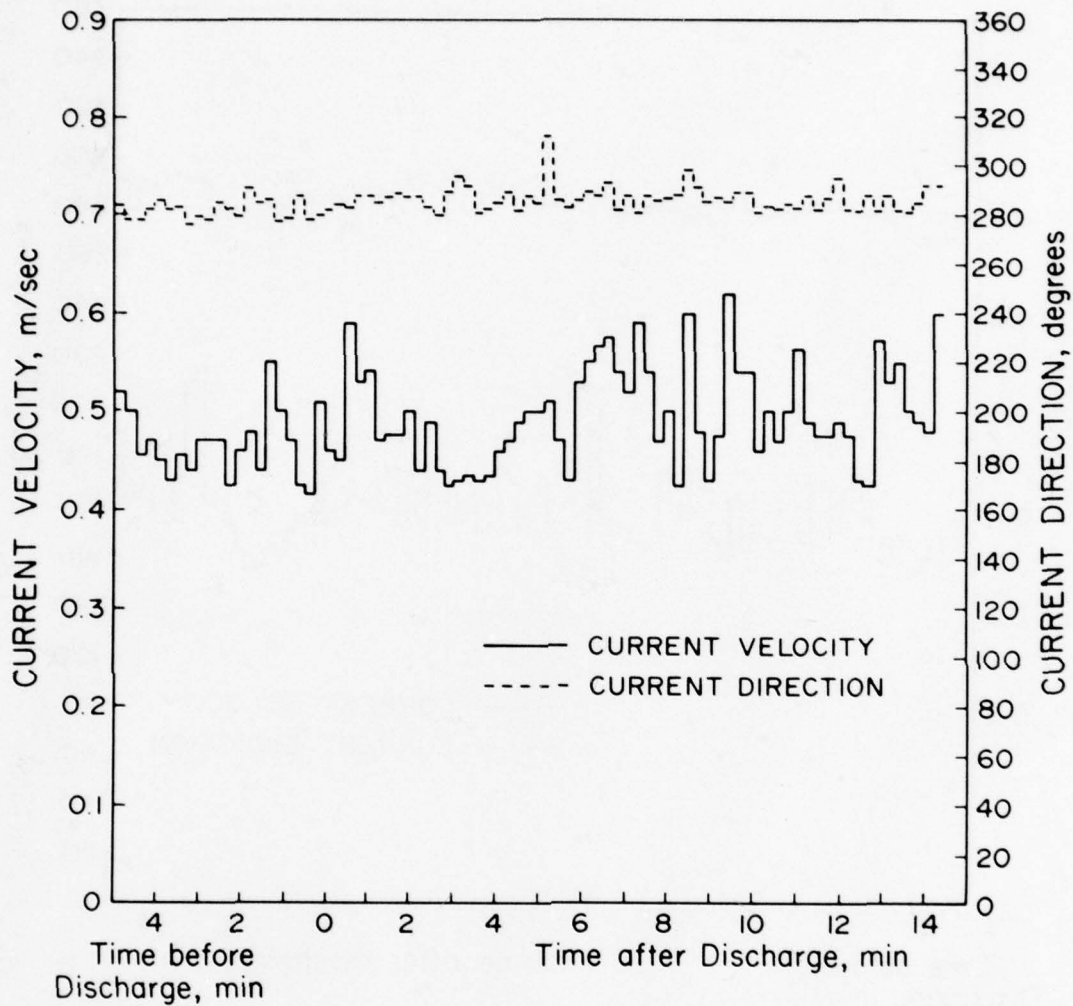

Figure 116. Histogram of current velocity and direction from records of General Oceanics current meter "G" on 17 November 1976, Disposal 2, 110 m from scow.

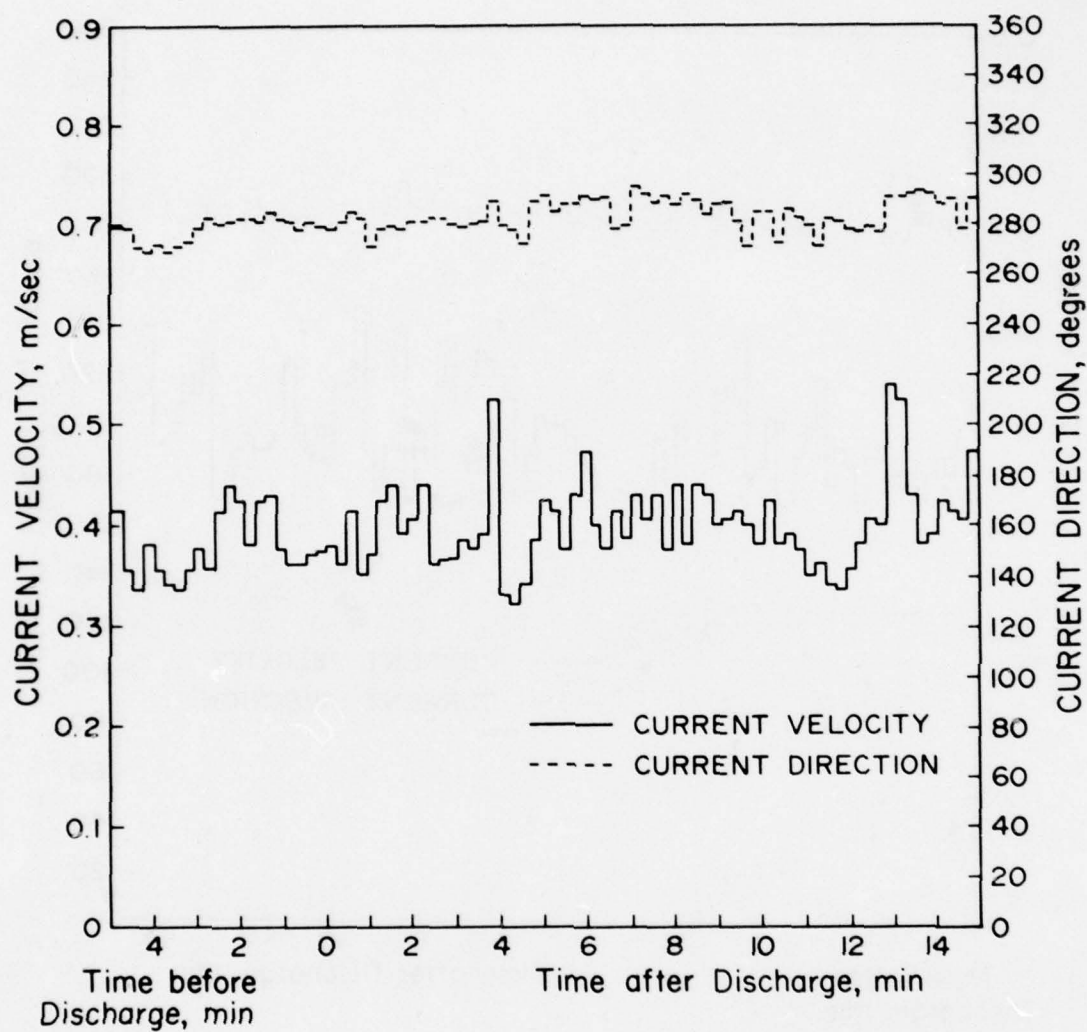

Figure #17. Histogram of current velocity and direction from records of General Oceanics current meter "F Led" on 17 November 1976, Disposal 2, 135 m from scow.

angles or Del Norte microwave ranges were taken from accurately located station positions. Theodolite measurements were made from Lynde Neck Lighthouse and the spire in Westbrook, Conn., and the Del Norte microwave system used shore stations at the Lynde Neck Lighthouse and the tank in Westbrook, Conn. (see Figure N1 for these station positions).

12. The schedule of observations for the entire study was as follows:

- a. 18 August 1976 - Grab samples were collected of the bottom materials at the proposed disposal site.
- b. 18 August 1976 - Preliminary bathymetric survey tracks were made at the proposed disposal site to determine a boundary for the ensuing detailed survey.
- c. August 1976 - Installation of two Del Norte, microwave navigation shore units was completed.
- d. 13 September 1976 - Short core samples were collected of the sediment to be dredged in North Cove.
- e. 24 September 1976 - East-west bathymetric survey tracks were made at disposal site using theodolite angles and Del Norte microwave ranging system.
- f. 11 October 1976 - Additional bathymetric survey tracks were made at disposal site. A temporary marker buoy was deployed to serve as a visible position for the Great Lakes Dredge and Dock Co. to deploy a permanent disposal buoy.
- g. 9 November 1976 - Great Lakes Co. deployed first marker buoy with aid of Yale vessels and Del Norte units for positioning. Bathymetric survey tracks were run.
- h. 12 November 1976 - Onsite observation of the disposal operation were made with Yale vessels M/V Hotspur and M/V Hereward at anchor in 57 m of water. Each vessel was equipped with a 200-kHz acoustic reflection system to monitor the descent (from injection to impact) of the material released from the bottom-dump scow. Tug with scow attempted to remain in a fixed position at Yale marker buoy with observing vessels parallel to scow, but down current of discharge point. During discharge, ranges were determined with an optical range finder and bearings taken with a bearing compass.

- i. 17 November 1976 - Onsite observations of two disposal operations were made. Yale vessel M/V Hereward was tethered to the marker buoy. M/V Hotspur was tethered to Hereward 15.5 m downwind. For first disposal one GO current meter was deployed and each observing vessel deployed one optical transmissometer to record the arrival time and vertical distribution of the bottom surge. Onboard the tug a 200-kHz acoustic transducer recorded the descent of material from the scow, and samples of dredged material were collected. For the second operation, three GO current meters were deployed and each observing vessel deployed one transmissometer. The 200-kHz acoustic transducer was in operation on M/V Hotspur. For both disposal operations, the tug with scow was upwind from and as close as possible to marker buoy heading into the current.
- j. 18 November 1976 - Onsite observations were made of one disposal operation. To eliminate some of the difficulties encountered with anchoring and tug maneuvering procedures and to make all measurements in a radial line down current, a towing experiment was conducted. The M/V Hotspur was tethered to the stern of the scow; the M/V Hereward was tethered to the Hotspur, 300 and 100 ft apart, respectively. The tug stopped at the marker buoy, heading into the current. Each observing vessel used a 200-kHz acoustic transducer system for detecting the surge.
- k. 2 December 1976 - A bathymetric survey of the disposal site was made after completion of dredging at North Cove, but prior to dredging operations at Brockway, to determine accumulation and distribution of dredged material. Two core samples were taken at marker buoy.
- l. 6 December 1976 - Ten short core and grab samples were taken at the disposal site prior to onset of dredging of sand at Brockway Bar.
- m. 3 March 1977 - Grab samples were taken at the disposal site to define the boundary of accumulated dredged material.
- n. 20-27 July 1977 - Grab samples were taken at disposal site.
- o. August 1977 - Laboratory analysis mechanical tests of North Cove dredged material were made to investigate the behavior of clods impacting on bottom.

These observations are summarized in a data catalogue (Table N1). Details of the observations made during each discharge are given in the station logs (Tables N2 to N4), along with diagrams showing the location of the observing vessels and instruments for each experiment (Figures N8 to N11).

Table #1

Data Catalogue

18 August 1976 - 27 July 1977

Project Objectives	Observations Undertaken	Instrumentation and Information Used	Dates	Disposal No.
To determine the area of accumulated dredged material at disposal site, pre and post disposal sample collection.	1. Short core samples at disposal site	Laboratory analysis - physical properties	18 Aug. 1976	
	2. Preliminary bathymetric surveys	Theodolite angles and Del Norte Navigation system	18 Aug. 1976	
	3. Short core samples at North Cove	Laboratory analysis - physical properties	13 Sept. 1976	
	4. Bathymetric survey	Theodolite and Del Norte	24 Sept. 1976	
	5. Bathymetric survey	Theodolite and Del Norte	11 Oct. 1976	
	6. Bathymetric survey	Theodolite and Del Norte	02 Dec. 1976	
	7. Short core samples at disposal site	Laboratory analysis - physical properties	02 Dec. 1976	
	8. Short core samples at disposal site	Laboratory analysis - physical properties	06 Dec. 1976	
	9. Grab samples at disposal site	Shipek sampler	03 Mar. 1977	
	10. Grab samples at disposal site	Shipek sampler	20-27 July 1977	
To observe the descent of the material (especially impact) and the spread of bottom surge under strong tidal conditions and in deep water.	11. Monitor descent of material from hopper	200 kHz transducers hopper samples	12 Nov. 1976	1
	12. Monitor movement of surge: arrival time, velocity and direction	200 kHz transducer, current meters Transmissometers	17 Nov. 1976	1,2
To perform mechanical tests on clods impacting with bottom	13. Grab samples at disposal site	200 kHz transducer, current meters	18 Nov. 1976	1
	14. Mechanical tests on material from North Cove - in laboratory	See Appendix M	Aug. 1977	

Table N2
Station Log
12 November 1976

Disposal #	Time	Name of Boat	Type of Observation*	Instrumentation Used (XM = transmissometer, CM = current meter)	Range to Dredge, m	Depth of Instrument, m	Water Depth, m
1	1513	<u>Hereward</u>	11	200-kHz transducer/recorder	~20		57
		<u>Hotspur</u>	11	200-kHz transducer/recorder	60		57

*Observation Key

- 1, 3, 7, 8, 9, 10) Bottom and scow samples
- 2, 4, 5, 6) Bathymetric surveys
- 11) Descent of material from hopper
- 12) Arrival time, velocity, and spread of bottom surge.

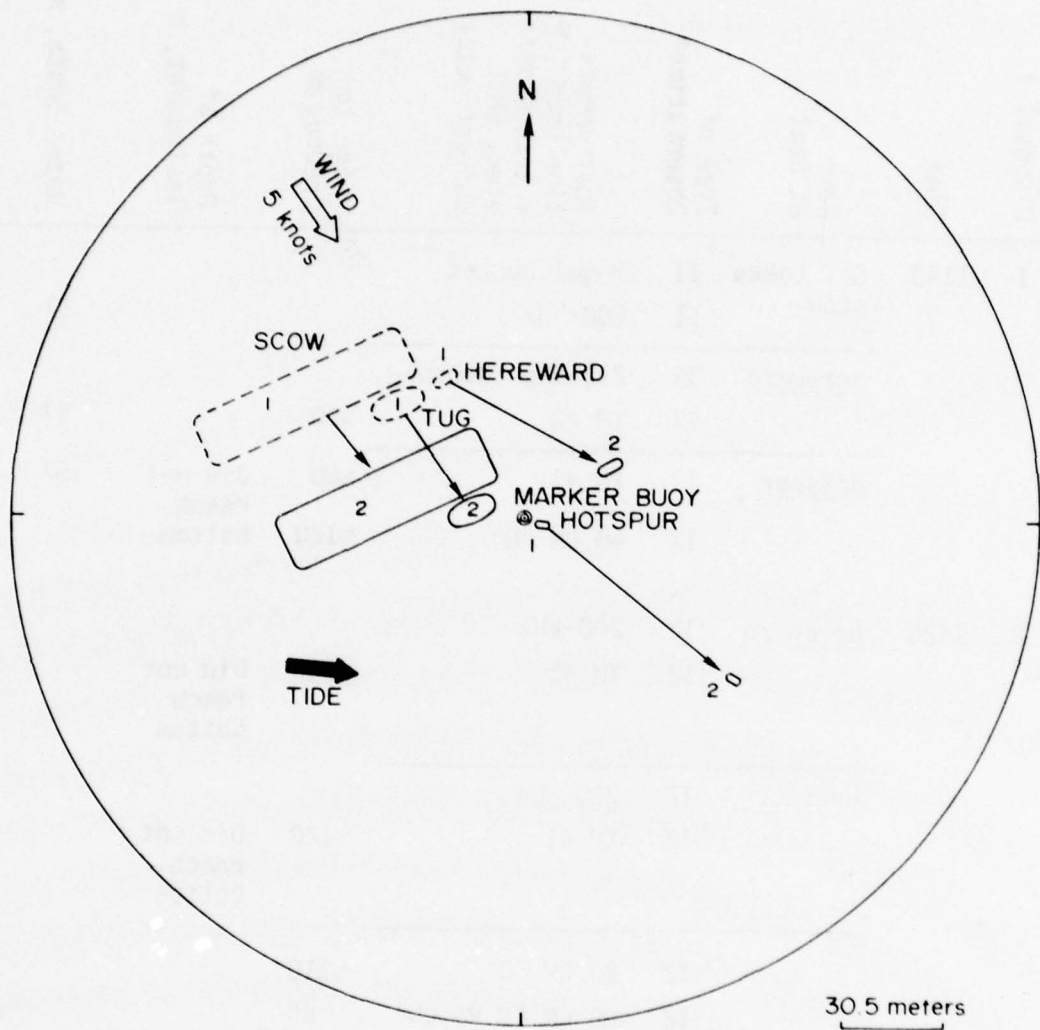

Figure N8. Vessel positions for Disposal 1, on 12 November 1976.

Table N3
Station Log
17 November 1976

Disposal #	Time	Name of Boat	Type of Observation*	Instrumentation Used (XM = transmitter, CM = current meter)	Range to Dredge, m	Depth of Instrument, m	Water Depth, m	
1	1140	Gr. Lakes scow	11	5-gal bucket				
			11	200-kHz			57	
		<u>Hereward</u>	12	200-kHz recorder				
			12	XM #3	~50		57	
		<u>Hotspur</u>	12	XM #1	~80	Did not reach bottom	57	
			12	GO CM "G"	~120			
2	1428	<u>Hereward</u>	12	200-kHz				
			12	XM #3	~100	Did not reach bottom		
		<u>Hotspur</u>	12	200-kHz				
			12	XM #1	~120	Did not reach bottom		
			12	GO CM "G"	~110			
			12	GO CM "F Watch"	85			
			12	GO CM "F Led"	~135			

*See Table N2 for observation key.

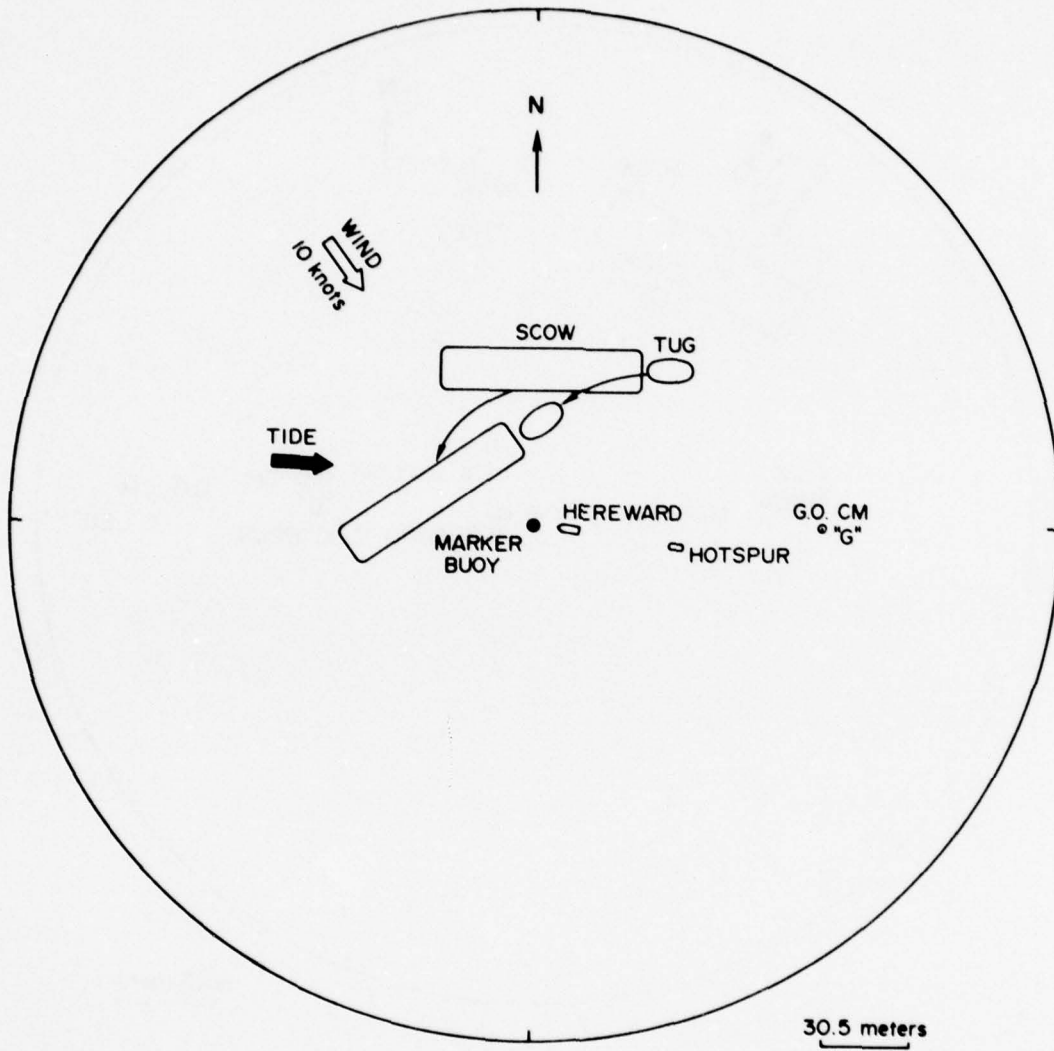

Figure N9. Vessel positions for Disposal 1, 17 November 1976.

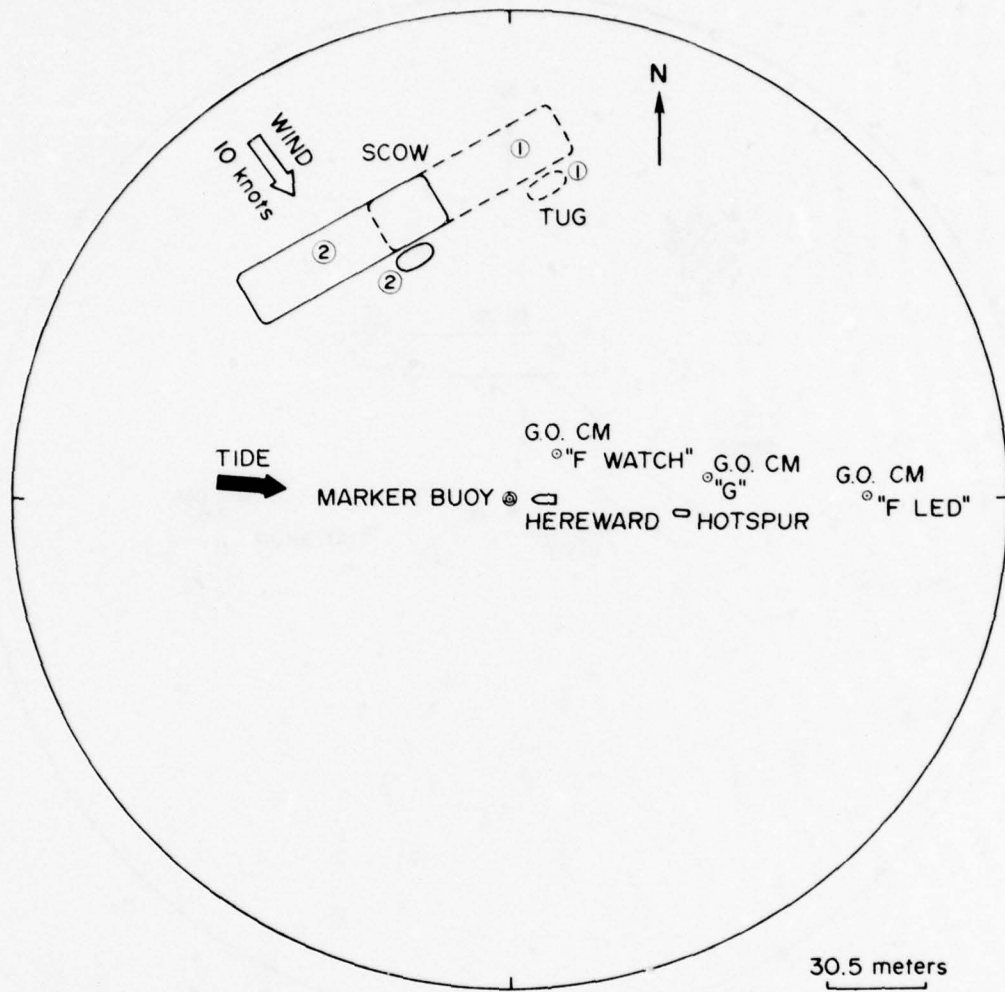

Figure 1110. Vessel positions for Disposal 2, 17 November 1976.

Table N4
Station Log
18 November 1976

Disposal #	Time	Name of Boat	Type of Observation*	Instrumentation Used (XM = transmitter, CM = current meter)	Range to Dredge, m	Depth of Instrument, m	Water Depth, m
1	1230	<u>Hereward</u>	12	200-kHz	150		57
		<u>Hotspur</u>	12	200-kHz	90		57

*See Table N2 for observation key.

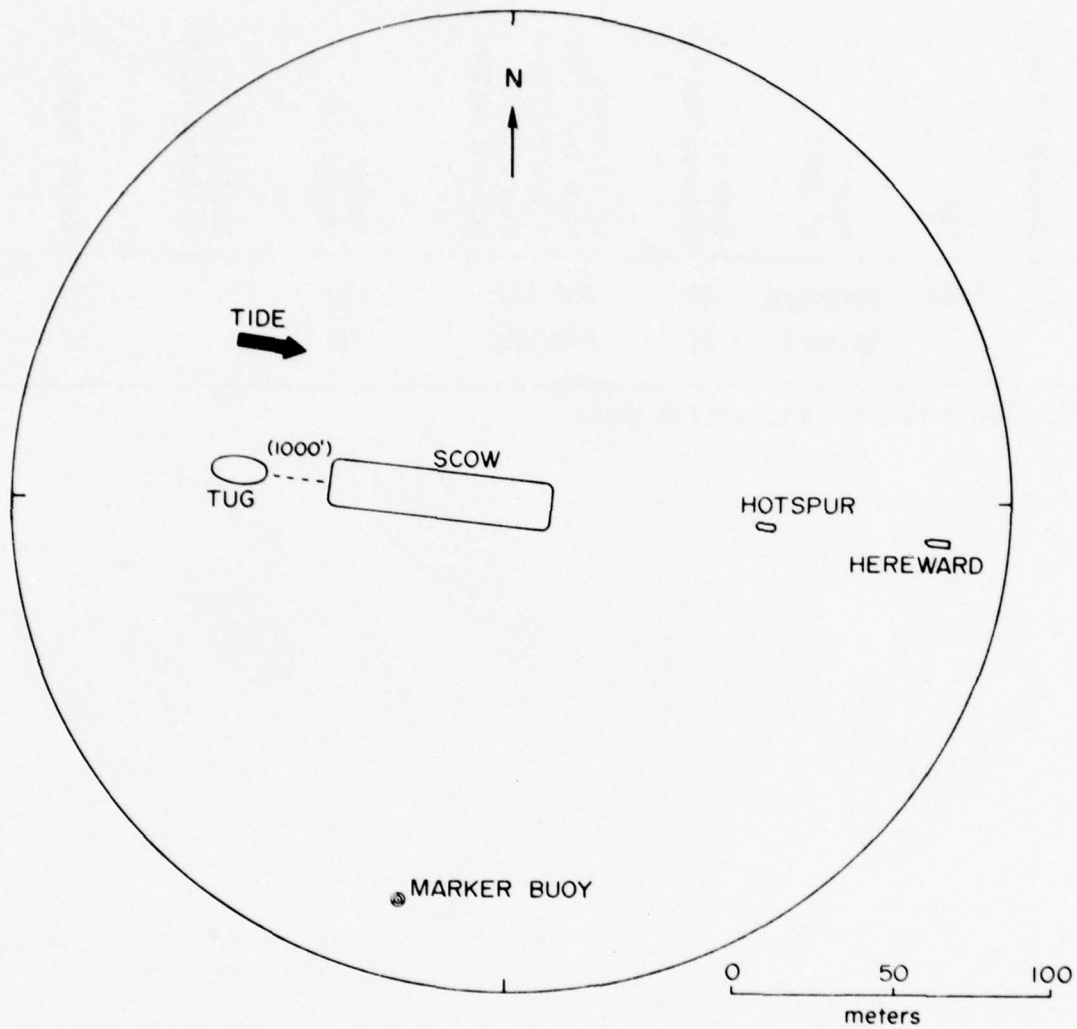

Figure H11. Vessel positions for Disposal 1, 18 November 1976.

13. "Daily Inspection Reports" and "Monthly Transportation and Dumping Logs" were provided by the Great Lakes Dredge and Dock Co. under the supervision of Mr. John Fisher, the Contractor's Approved Authorized Representative. Information included location of dredging operations, location of discharge operations, weather conditions, amount of material dredged, type of material dredged, and time of disposal.

Results

14. The material to be dredged from North Cove was classified as nonpolluting, organic marine silt. Mechanical tests conducted on this material are discussed in the text and in Appendix M. On 17 November 1977, after about 30,000 m³ of dredged material had been discharged, five sets of bottom material samples collected at the site were analyzed in the laboratory for water content, bulk density, coefficient of consolidation, and void ratio. The description of these samples is shown in Figure N2.

15. The bathymetric survey that was made of the intended disposal site before dredging began is shown in Figure N2. The disposal marker buoy was placed at the location indicated as position number 1 on the contour diagram. Because of the difficulty in maintaining the marker buoy, five different locations were actually used between the beginning of dredging on 9 November 1976 and 29 March 1977. These five locations are shown in Figure N2; in Table N5 is the approximate number of cubic meters of material discharged at each location as calculated from the dredger's records. Between 18 November and 22 November about 24,104 m³ of material was discharged at approximately position number 1 which was not marked by a buoy at this time but fixed with LORAN and the Del Norte microwave navigation system. The disposal schedule is summarized in Table N5.

16. Several discharges of silt were monitored with acoustic transducers, optical transmissometers, and current meters. The events which occurred during the disposal operation at the Saybrook

Table N5

Material Discharged at Saybrook Site*

Dates	Dredging Location	Discharge Location **	Volume Dredged, m ³	Contents of Material
091176 - 121176	North Cove	1	6,555	Mud
121176 (1 Dump)	North Cove	No marker	917	Mud
121176 - 151176 Noon	North Cove	2	14,827	Mud
151176 p.m. - 161176 Noon	North Cove	3	5,454	Mud
161176 p.m. - 181176 Noon	North Cove	4	16,203	Mud
181176 p.m. - 221176 Noon	North Cove	No marker	24,104	Mud
221176 p.m. - 171276	North Cove	5	157,181	Mud
181276 - 291276	Brockway	5	35,511	Sand
150377 - 210377	Brockway	5	17,583	Sand
220377 - 290377	Essex	5	25,840	Sand

* This table is a summary of "Daily Inspection Reports" and "Monthly Transportation and Dumping Logs" provided by the Great Lakes Dredge and Dock Co.

** See Figure N2 for disposal marker buoy positions.

site were similar to those events observed at the other study areas. The dredged material is emplaced on the bottom in three stages. After release from the scows, the material descends to the bottom, impacts on the bottom, and spreads radially outward over the bottom in a thin layer. This layer is about 3 m thick (Figure N12). The arrival of the bottom surge was only detected by one instrument (current meter, GO "G", Figure N4). This record indicates that the surge is moving faster than was observed at any other site except the New York Bight (Figure 24 in text), and that the descent speed must have been on the order of 1 m/sec. The lateral extent of the bottom surge could not be delimited at the Saybrook site.

17. A second bathymetric survey was made as the dredging of silt in North Cove neared completion. This was on 2 December after about 140,668 m³ of material had been removed. No accumulation of silt could be detected by this survey, therefore, any accumulation was less than about 0.3 m thick. Core samples, however, confirmed the presence of silt on the naturally sandy bottom within about 305 m of the intended disposal location. The composition of core samples collected on 6 December is indicated on Figure F3. A layer of silt containing about 76,450 m³ of material could have been emplaced on the bottom and remained undetected in the bathymetric survey comparisons. In discounting the 19,724 m³ of material released at location 4 (see Figure N2) as not being represented in the sampled area, about 60 percent of the material discharged could have been present on the bottom at the time of the survey. Therefore, although material does reach the bottom, not all of the discharged material can be accounted for in a deposit on the disposal site.

18. It was anticipated that the bathymetric surveys could be used to determine the amount of dredged material actually accumulated on the bottom at the disposal site. This could only have been accomplished if the point discharge was used. In fact, the discharge point was not fixed and was moved several times during the dredging operation. No provision had been made for assuring that the disposal buoy was maintained in a fixed position until after 22 November. It was apparent that at this site LORAN navigation alone was not adequate for position-

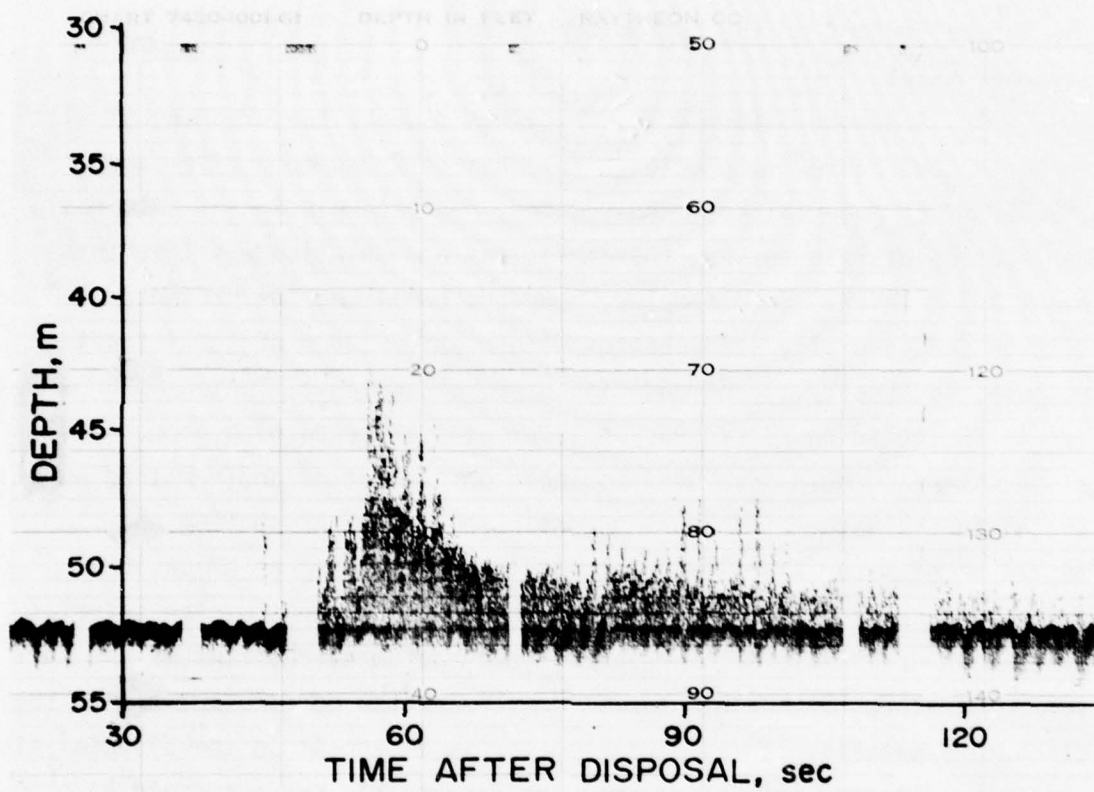

Figure N12. Acoustic reflection record from a 200-kHz transducer showing thickness of surge for Disposal 2, 17 November 1976. Observing vessel was approximately 120 m from scow.

ing the scow, but that the Del Norte microwave navigation system was needed; in fact, the movement of the marker buoy from position 3 to position 4 on 16 November (see Figure N2) would not have been detected without the Del Norte System. Theodolite or transit angles taken from known positions on shore are also adequate to fix the location of the buoy, but, this procedure is cumbersome if the scow must be positioned in the absence of a marker buoy. The problem of fixing the discharge point deserves attention in future disposal projects.

APPENDIX 0: MECHANICS OF THE PLACEMENT OF DREDGED MATERIAL,
ROCHESTER FIELD STUDY, 1977

Objectives of the Research

1. A second set of field observations on several aspects of the mechanics of placement of dredged material on the bottom was conducted at Rochester, N. Y., in May and June 1977. The dredging was performed by the hopper dredge Lyman in the lower reaches of the Genesee River where it enters the lake. The dredged sediment consisted primarily of silt with some fine sand, clay, and organic debris. Disposal was done both on the designated disposal ground, 3 km northeast of the river mouth, and in deeper water further offshore. Depths at which observations were made ranged from 17 to 73 m. Observations were made on the dredge itself, from small boats, and by means of instrumentation deployed on the bottom.

2. There were three basic goals of the field research conducted in May. The first was to obtain information on the distribution and physical and mechanical properties of a typical load of dredged material within the dredge hoppers. The second goal was to obtain information on the development of the bottom surge as it spreads out from the impact point--in particular, the effect of increasing ambient water depth on surge height and spreading velocity. The third goal was to obtain a field calibration of the optical transmissometers by taking simultaneous water samples for later analysis by filtration. The goal of the work performed in June was to determine if there is a depth beyond which bottom impact of the descent jet and formation of a bottom surge do not occur.

Disposal Site Description

Background information

3. Prior to any observations of dredged material discharge, a reconnaissance bathymetric and subbottom survey of the designated

disposal site was made. Figure 01 shows the tracks which were run and the approximate location of areas exhibiting a microtopography characteristic of a bottom on which disposal has taken place. Unlike the surrounding smooth, nearly featureless bottom, these areas are marked by irregular mounds and depressions with relief on the order of 1 to 2 ft. Figure 02 shows the 50- and 60-ft isobaths and the depths at the beginning and end of each track, as determined by the 200-kHz acoustic transducer. Lack of penetration by the 7-kHz transducer prevented determination of the thickness of dredged material at the site.

4. Temperature profiles were made at the disposal sites used 16-17 May 1977 and are shown in Figures 03 and 04.

Conditions on dredge prior to discharge

5. In order to obtain an understanding of the mechanical processes by which material is released from the hoppers of the dredge and introduced into the ambient water, a number of physical and mechanical properties of the material were measured. Table 01 shows the calculated bulk density of sediment from the hoppers. An inverted 50-cm³ plastic syringe was mounted on a long pole, inserted into the sediment at the bottom of the hopper, and the plunger extended by means of a line to the surface to obtain the sample.

Table 01
Bulk Density of Sediment in Hoppers

<u>Date</u>	<u>Depth Below Surface of Water in Hopper, m</u>	<u>Bulk Density, Mg/m³</u>
160577	5.2	1.72
	5.5	1.73
170577	4.8	1.29
	5.2	1.67
	5.5	1.62

6. The density of the suspension of solids and water overlying the sediment in the hoppers was also determined. Samples were pumped

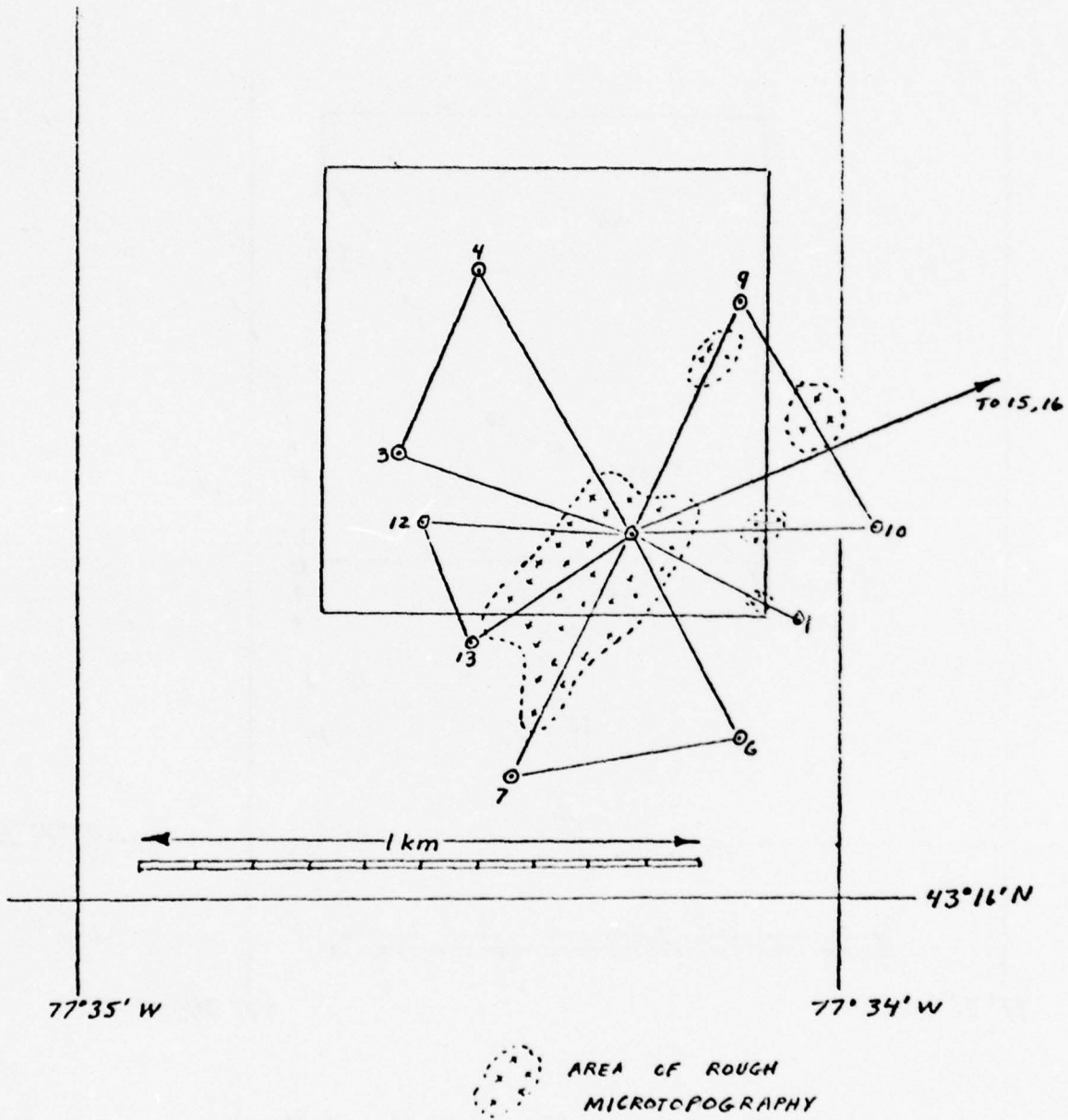

Figure 01. Bathymetric survey tracks,
for 15 May 1977.

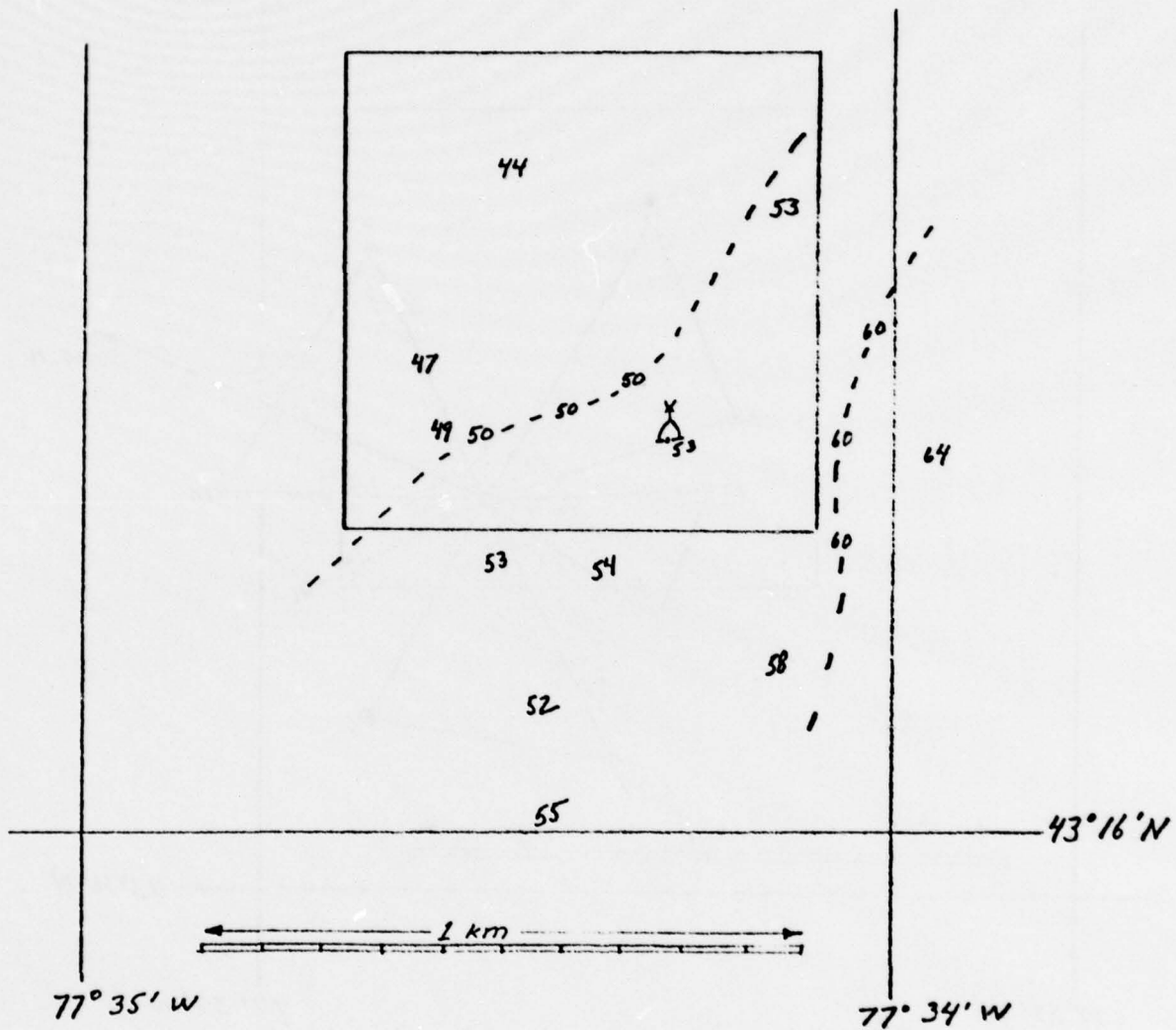

Figure 02. Rochester 50- and 60-ft isobaths and depth at the ends of each track.

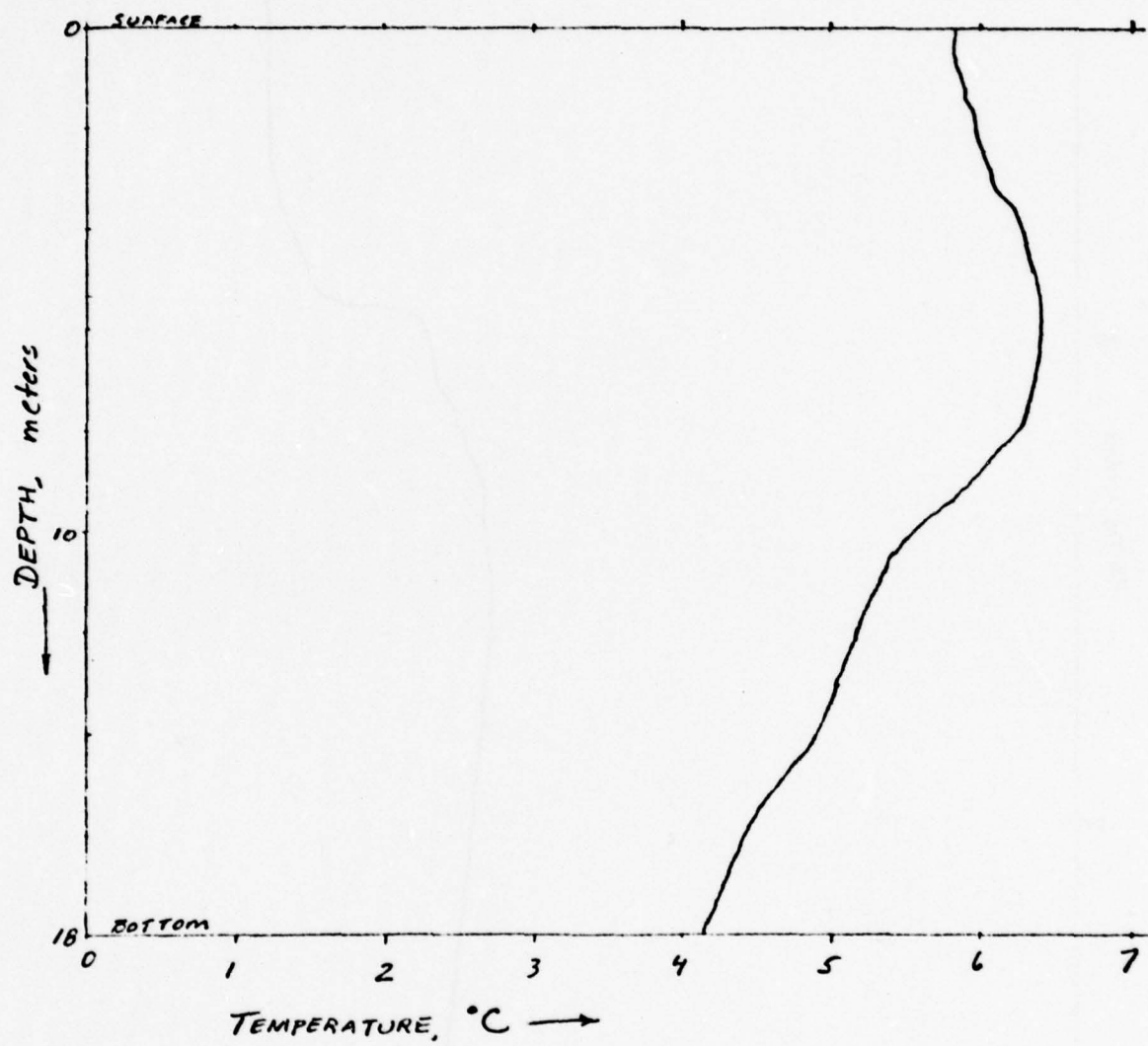

Figure 03. Temperature profile, 1240 hr,
16 May 1977.

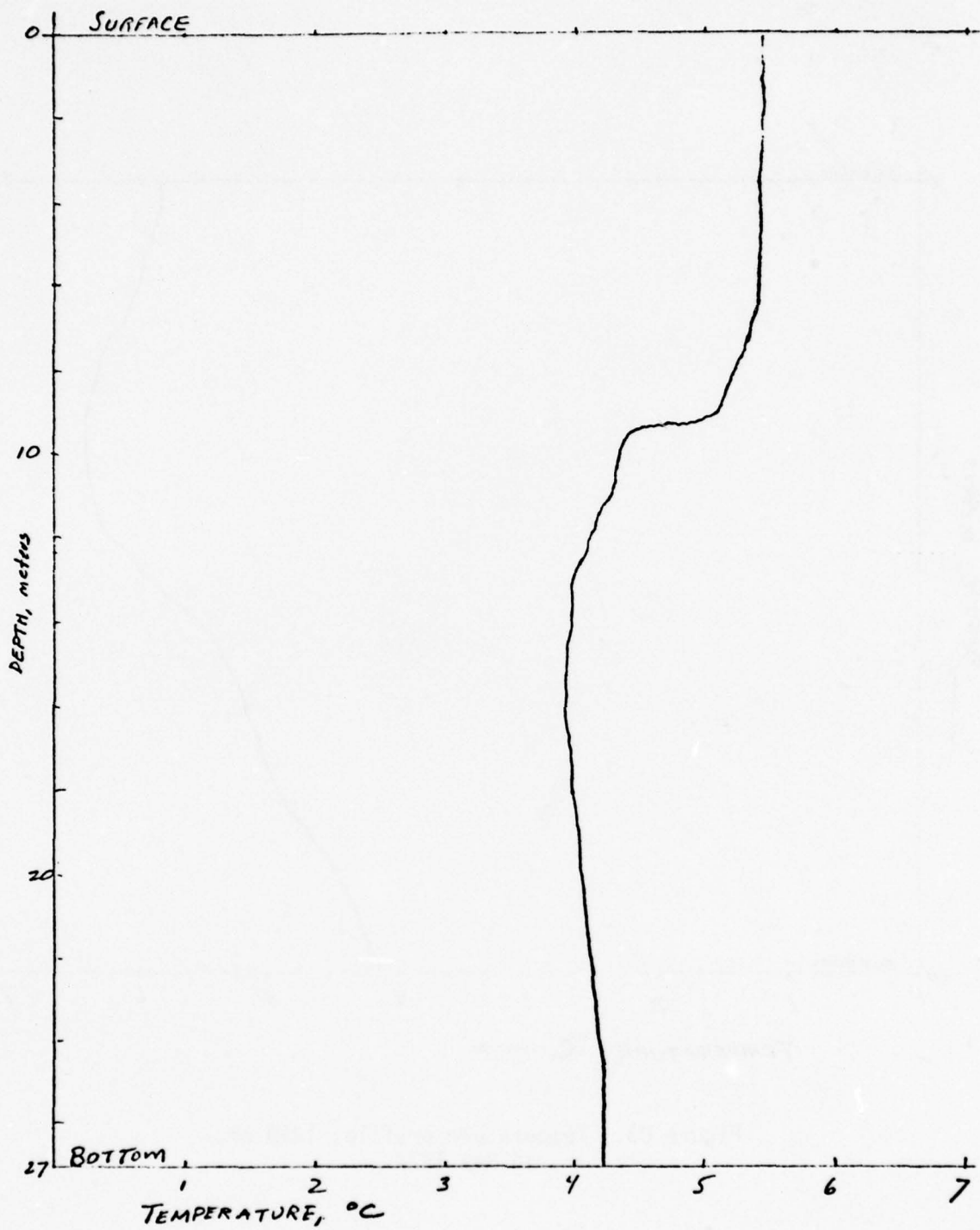

Figure 04. Temperature profile, 1200 hr,
17 May 1977.

from various depths below the surface to a graduated cylinder. Volume was recorded and the sample weighed. The calculated density is shown in Table 02. Figure 05 is a profile of density from water surface to below the sediment-water interface and is compiled from the data of Tables 01 and 02. The effective bulk density of 1.083 Mg/m^3 for the overlying water-solids suspension corresponds to a dry weight of soil solids of about 130 kg/m^3 of suspension.

Table 02
Bulk Density of Water Samples

<u>Date</u>	<u>Depth Below Surface of Water in Hopper, m</u>	<u>Bulk Density, Mg/m^3</u>
160577	0.61	1.043
	1.52	1.075
	2.13	1.089
	2.74	1.102
	3.35	1.114
	3.96	1.134
	4.57	1.120
170577	0.61	1.002
	1.53	1.064
	2.28	1.086
	3.36	1.096
	4.13	1.130
	4.57	1.155

7. Shear strength of the dredged sediment in the hoppers was measured by means of a vane shear tester. This consisted of a long metal tube with vanes 7.6 cm wide by 10.2 cm high on the bottom, and a 0 to 20 inch-pound "torque-screw driver" at the top. The vanes were inserted to various depths in the sediment and torque was increased until shear of the sediment occurred. The calculated shear strength, s , and sensitivity, S_t , (virgin s /remolded s) are presented in Table 03. Torque required to turn the tube alone has been corrected for in the calculation of s .

8. Draft of the dredge as measured by the ship's draft gauge was recorded at various stages of loading throughout the operation. These

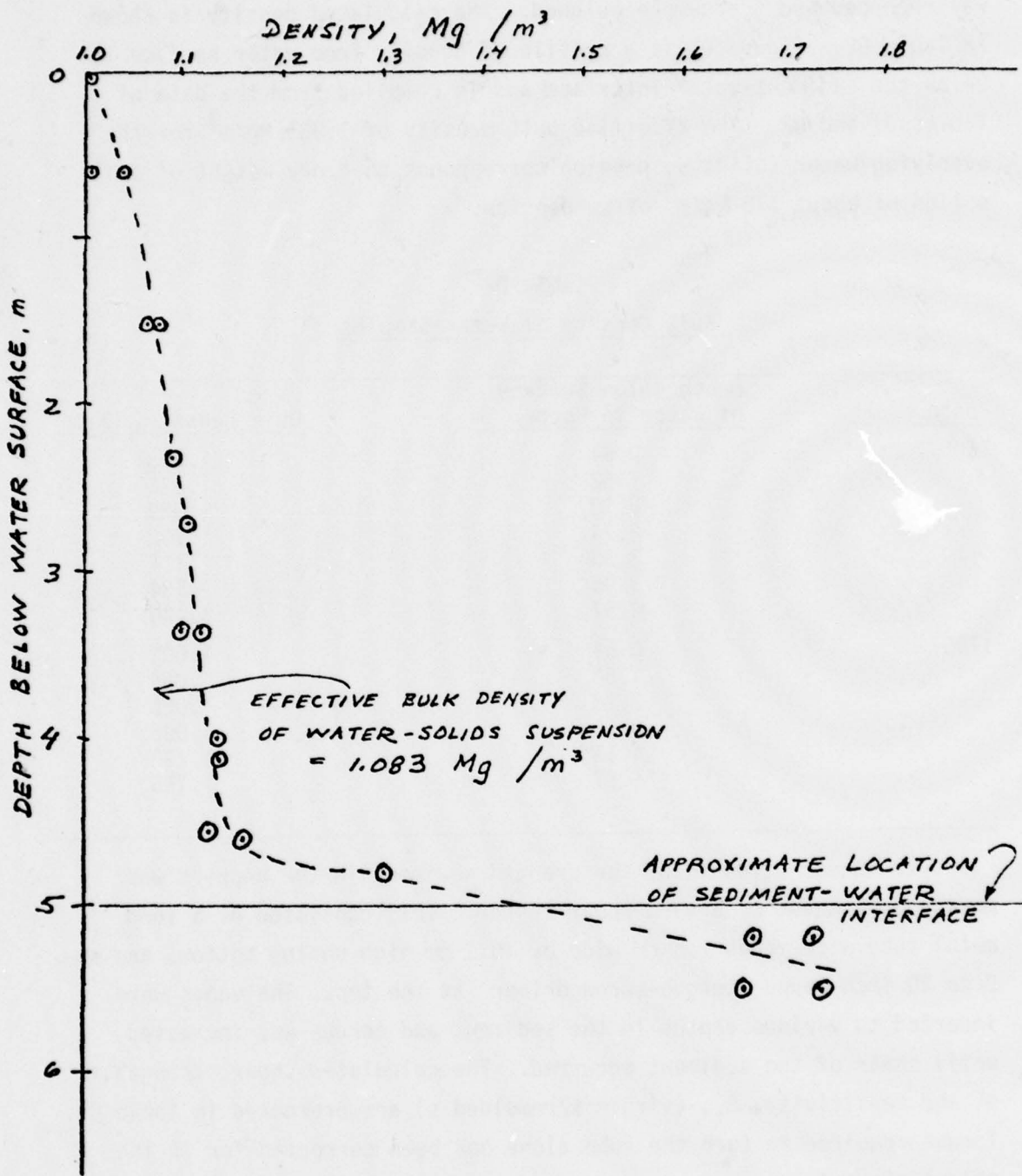

Figure 05. Density profile, hopper water and sediment from the dredge Lyman, 16-17 May 1977.

data can be used to calculate the quantity of water and sediment solids in a given load, as described in the Results section of the final report and presented in Table 04.

Table 03
Vane Shear Tests

	Depth Below Water Surface, m	Shear Strength, 10^3 dynes/cm ²	S_t
160577	5.2	13.41	
Stbd. bow	5.2	10.97	1.8
hopper, top	remolded	6.09	
of sediment at	5.5	10.97	
4.9 m	5.5	10.97	
170577	5.1	13.41	
Port bow	remolded	8.54	1.6
hopper, top of	5.2	7.32	
sediment at	6.1	4.88	
5.0 m	5.5	8.54	
	remolded	4.88	1.8
	5.9	8.54	

9. Additional data collected during this research which are not presented in this report include: 16-mm motion pictures taken of the timed fall of the water level in the hoppers during discharge (in storage for future reference); and large volume samples of sediment from the hoppers (in storage for use in future mechanical properties tests).

Development of bottom surge

10. The development of the bottom surge was observed from the dredge and from observer boats and instruments deployed around the disposal site. The observations from the dredge were made with an array of five 200-kHz acoustic transducers spread out along a 15-m-long aluminum "boom" deployed amidships, perpendicular to the long axis of the ship. The transducers pointed downwards, with the intention of monitoring the descent, impact, and subsequent spread of the surge. The results of these experiments are presented in Figures 06-09 as a series of vertical

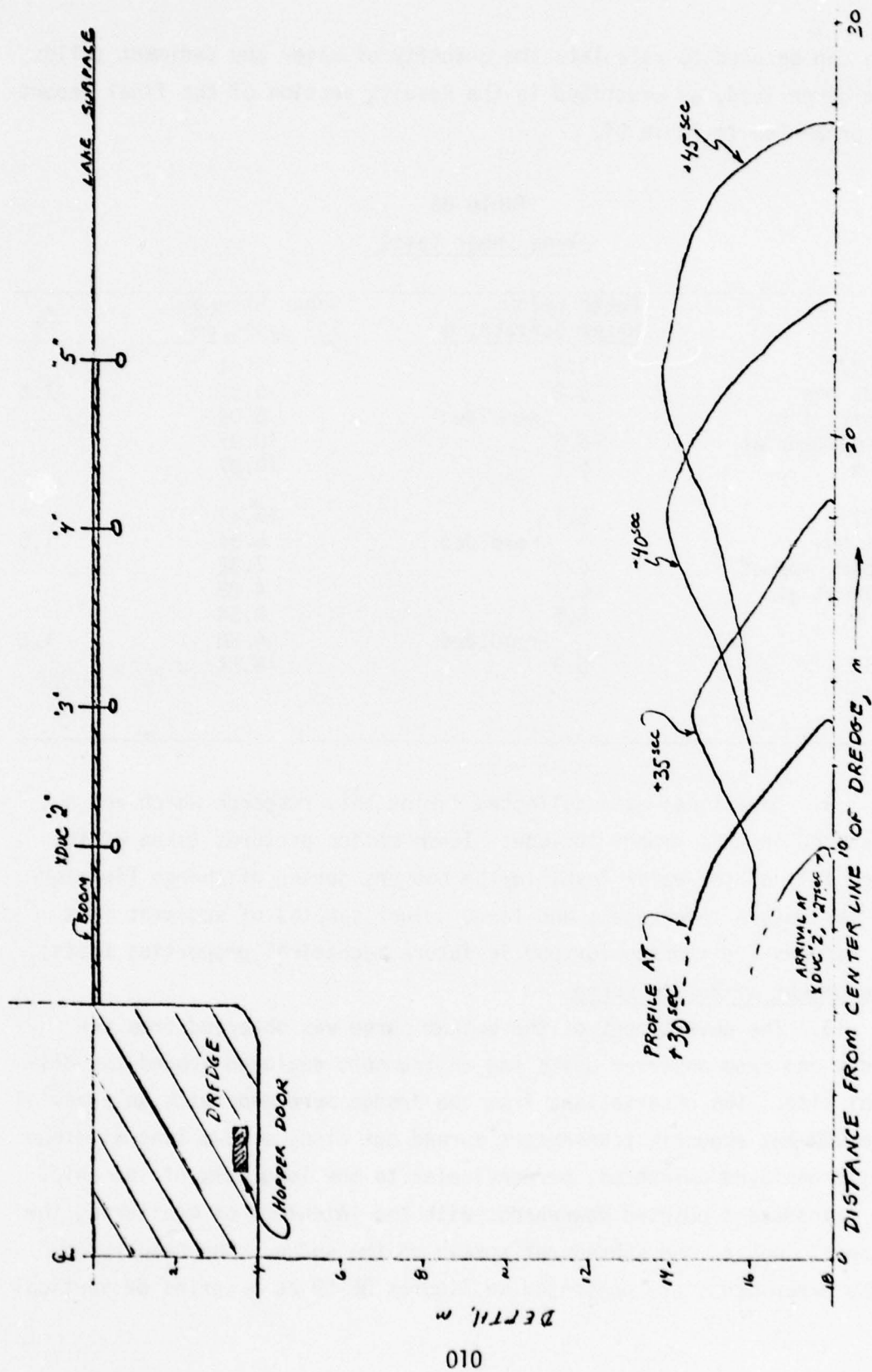
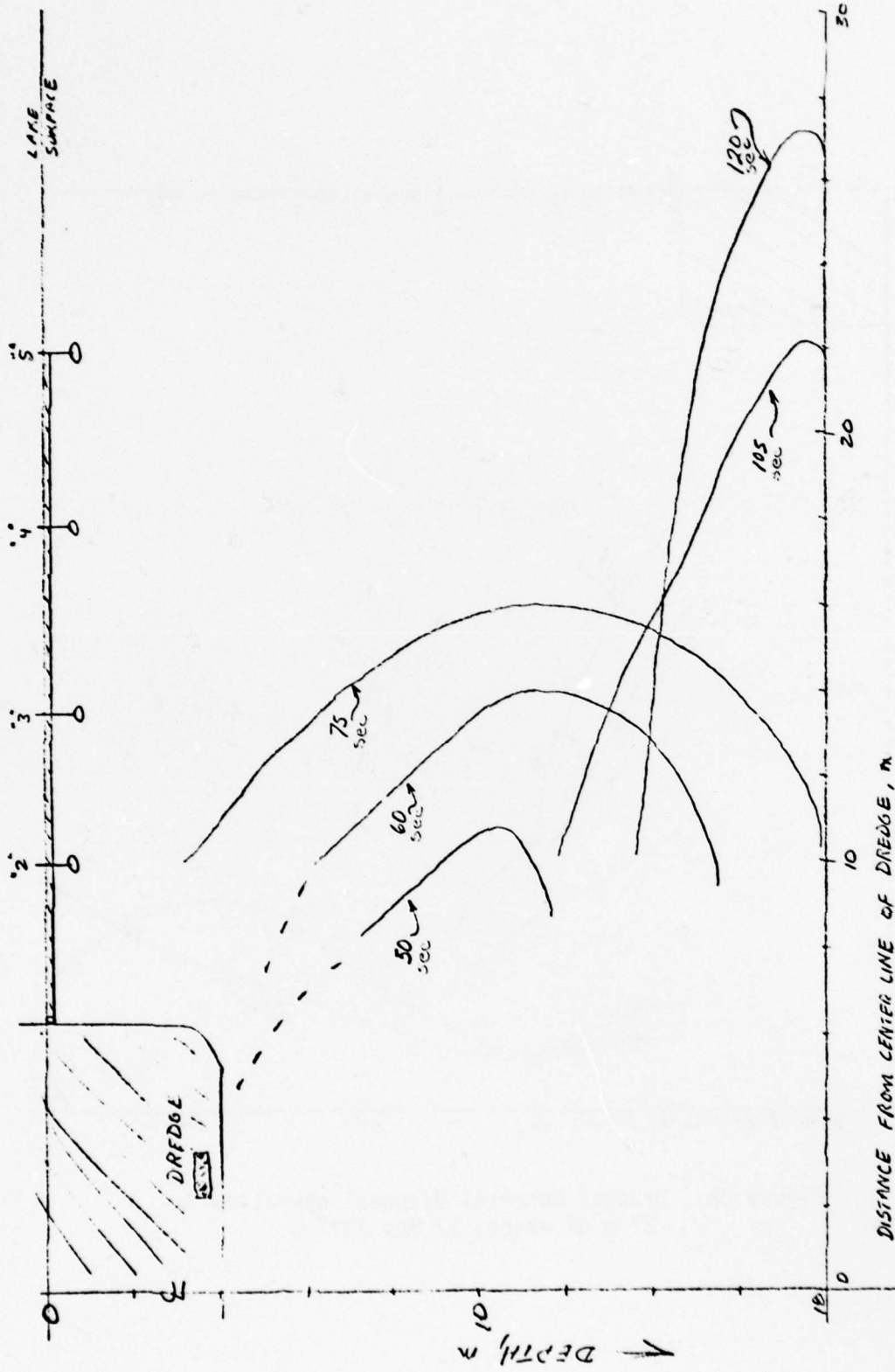

Figure 06. Dredged material disposal operation in 18 m of water, 16 May 1977



DISTANCE FROM CENTER LINE OF DREDGE, m

Figure 07. Washout disposal operation in 18 m of water, 16 May 1977.

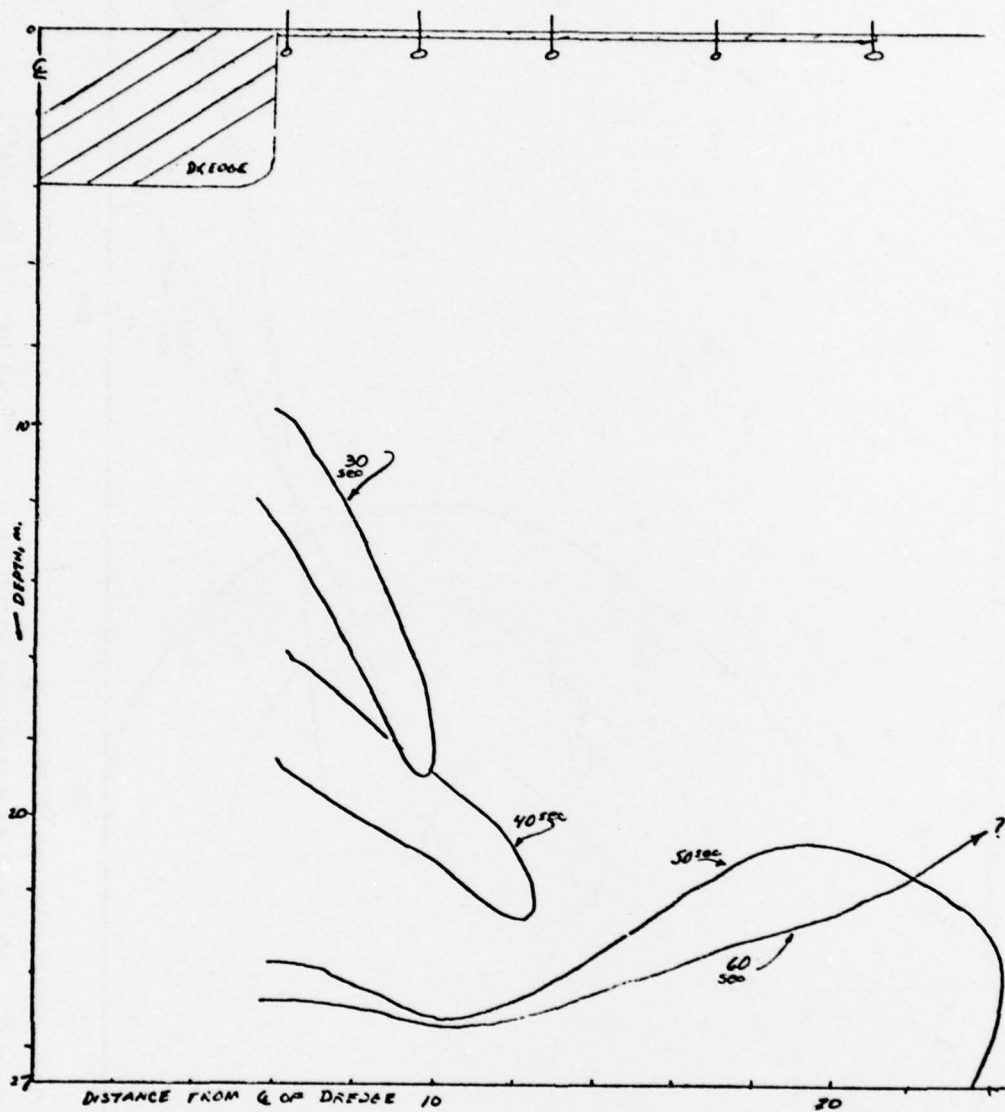

Figure 08. Dredged material disposal operation in 27 m of water, 17 May 1977.

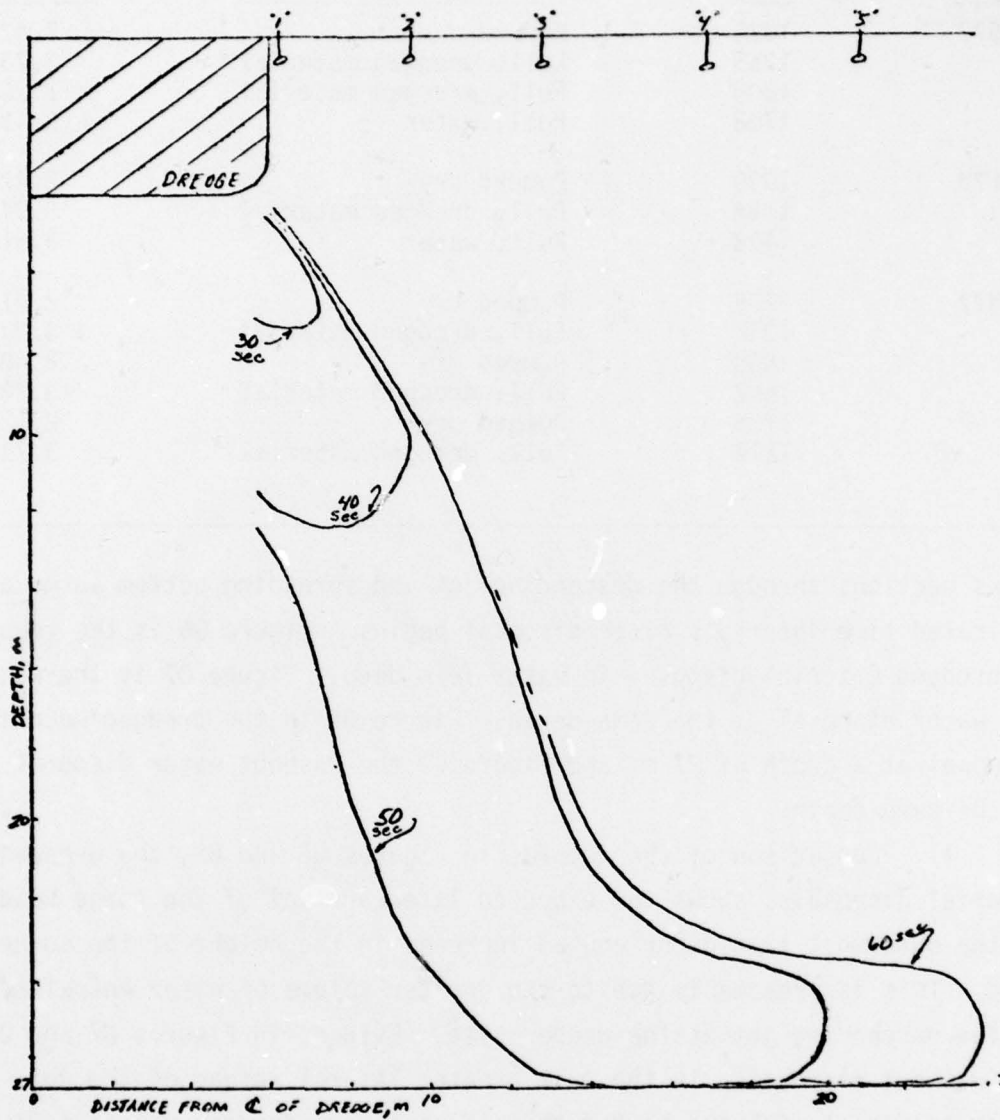

Figure 09. Washout disposal operation in 27 m of water, 17 May 1977.

Table 04
Draft of Dredge Lyman

<u>Day</u>	<u>Time</u>	<u>Condition</u>	<u>Draft, m</u>
160577	1025	Pumped dry	2.42
	1355	Full, dredged material	3.73
	1608	Full, dredged material	3.75
	1708	Full, water	3.42
170577	1030	Pumped dry	2.42
	1354	Full, dredged material	3.71
	1438	Full, water	3.51
180577	1235	Pumped dry	2.41
	1340	Full, dredged material	3.87
	1600	Pumped dry	2.48
	1652	Full, dredged material	3.78
	1738	Pumped dry	2.42
	1814	Full, dredged material	3.74

cross sections through the descending jet and spreading bottom surge at indicated time intervals after disposal begins. Figure 06 is the record of dredged material disposed in water 18 m deep. Figure 07 is the washout water disposal at the same depth. Figure 08 is the dredged material disposal at a depth of 27 m, and Figure 09 the washout water disposal at the same depth.

11. Comparison of the records in Figures 06 and 08, the dredged material disposals, shows the expected later arrival of the surge head at the outermost transducer and an increase in the height of the surge head. This is presumably due to the greater volume of water entrained by the descending jet at the deeper site. Evident in Figures 07 and 09, the washout disposals, is the much greater lateral spread of the jet prior to impact with the bottom than is seen with dredged material disposals at equivalent depths.

12. The discharges represented in Figures 06-09 were observed at distances out from the dredge by several methods. An observer boat tracked the spread of the surge with a 200-kHz transducer. Navigation on this boat was by means of distance fixes from the bow and stern of

the dredge with the Del Norte positioning system. The position and time after discharge began at which the surge head was detected are indicated by an arrowhead on the track lines in Figures 010-013, which correspond to the four discharges represented in Figures 06-09. Also presented in Figures 010-013 are the position and surge arrival time at bottom-mounted, film-recording current meters with a sampling interval of 15 sec, and the position of the surge head at 1-min intervals predicted by the Ashtabula travel-time curve for discharge in water 18 m deep. Additional data from the bottom-mounted current meters are presented in Table 05.

Suspended sediment -
optical transmittance data

13. The last major objective of the field research was to obtain simultaneous data on optical transmittance and suspended sediment concentration during an actual disposal operation, rather than in a laboratory experiment. The procedure was to pump water samples from the transmissometer to the surface for later analysis of suspended sediment concentration by filtration at the laboratory. Two boats, each with two transmissometers and one water pump, were deployed at the disposal site. One transmissometer on each boat was held stationary 1 m above the bottom. The other transmissometer was raised and lowered as necessary in order to detect the thickness of the bottom surge. The records of transmittance as a function of time after discharge and height above the bottom are presented in Figures 014-017. Figure 018 is a plot of 1-min average suspended sediment concentrations from the time of the arrival of the surge head. Preliminary correlation of pumped sample concentration with transmittance shows a general agreement as far as major changes of sediment concentration are concerned. However, final precision calibration of the transmissometers from this set of data may not prove possible because of unresolved problems with travel time and mixing of the water samples in the hose and because of large localized differences in sediment concentration in the surge.

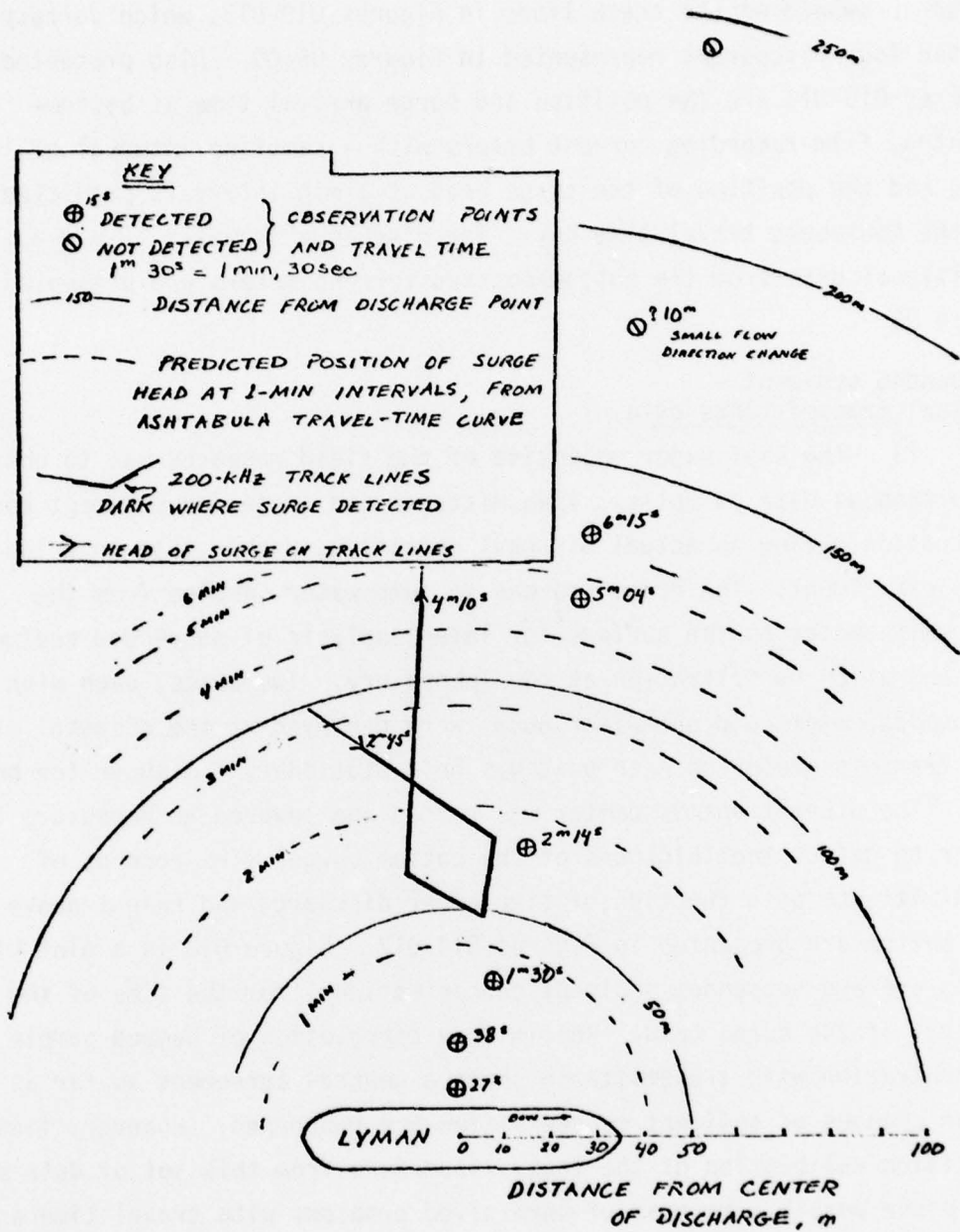

Figure 010. Spread of bottom surge travel times, dredged material disposal at depth of 18 m, 16 May 1977, operation 1.

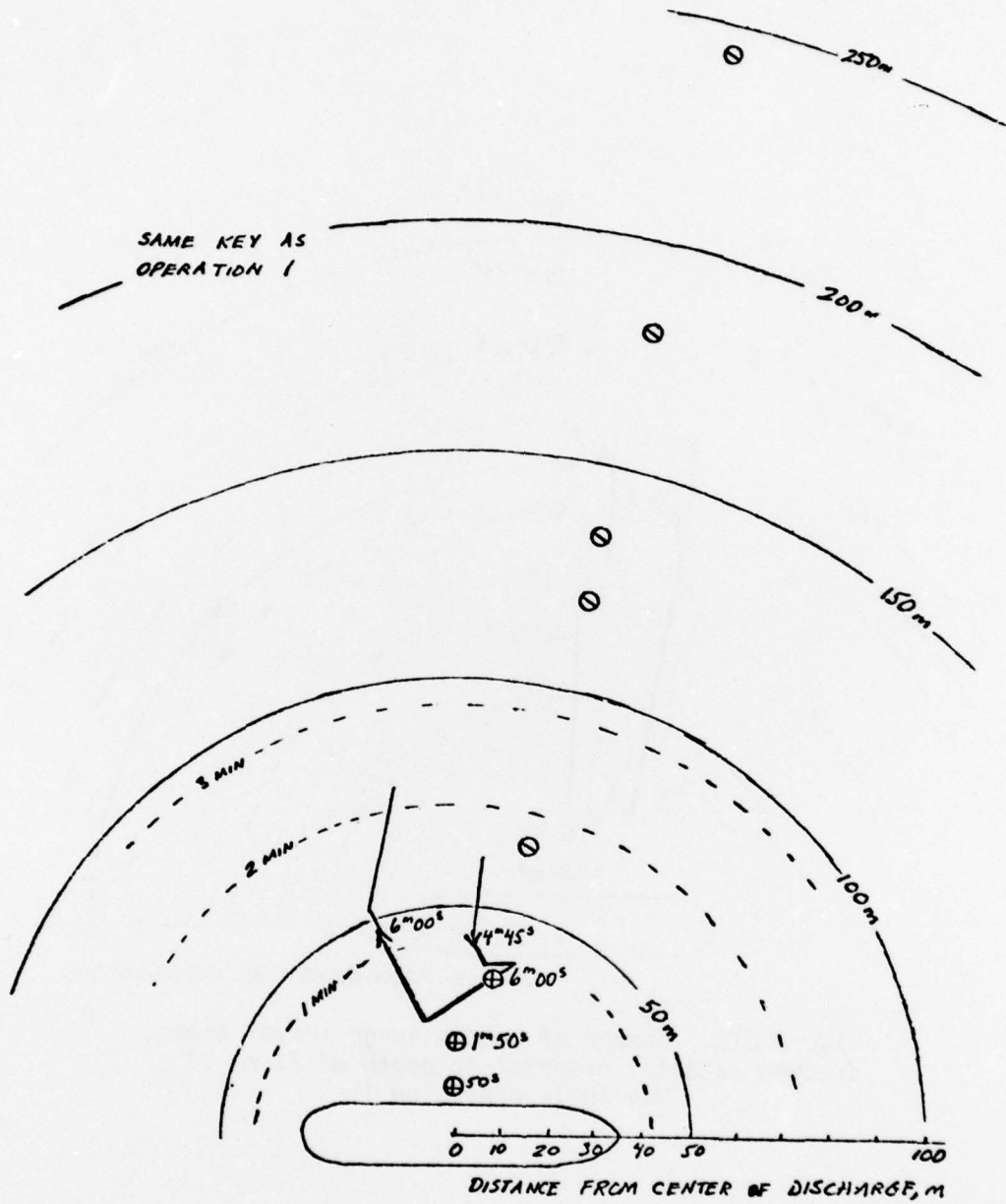

Figure 011. Spread of bottom surge travel times,
washout disposal operation at depth of 18 m, 16
May 1977, operation 2.

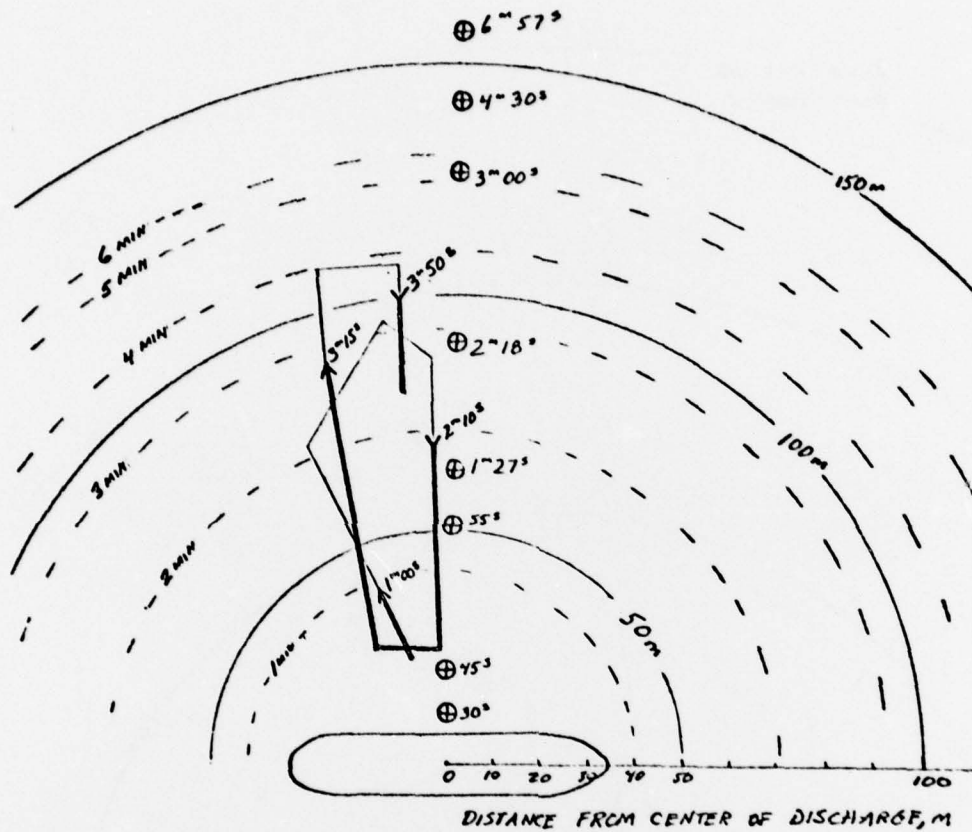

Figure 012. Spread of bottom surge travel times, dredged material disposal at depth of 27 m, 17 May 1977, operation 1.

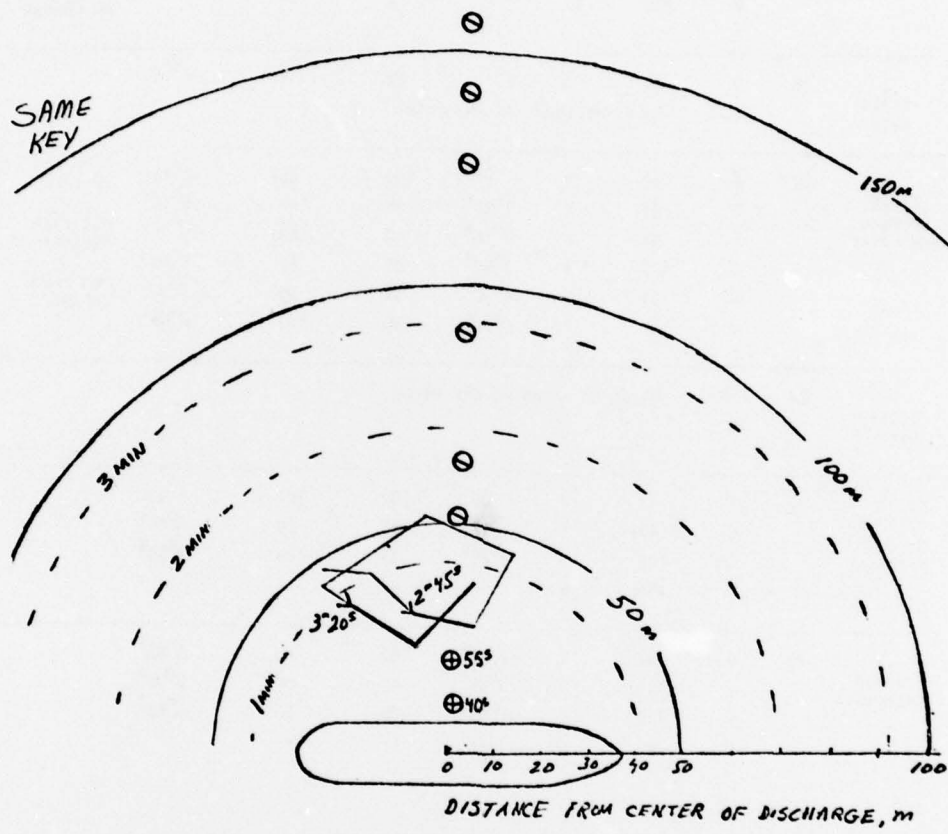

Figure 013. Spread of bottom surge travel times, washout disposal operation at depth of 27 m, 17 May 1977, operation 2.

Table 5
Bottom-Mounted Current Meter Data

Day	Disposal No.	Depth m	Meter	Distance m	Surge	Raw Travel Time	Max. Vel. Over Back-ground cm/sec	Total Flow in Surge, m	Duration of Surge	Notes
160577	1 (1615) Dredged Material	18	O	34	Y	1 ^m 30 ^s	60	43	1 ^m 45 ^s	
			C	65	Y	2 ^m 14 ^s	37	53	5 ^m 15 ^s	
			D	117	Y	5 ^m 04 ^s	25	41	3 ^m 45 ^s	
			J	135	Y	6 ^m 15 ^s	25	32	2 ^m 15 ^s	
			F	180	?	10 ^m ?	8	?	?	very small vel & dir. changes no change
			G	250	No	--	--	--	--	--
	2 (1715) Water	18	O C-G	34 No surge shows on any meter	Y	6 ^m	20	?	1 ^m 15 ^s	
17577	1 (1418) Dredged Material	27	F	52	Y	51 ^s	100	66?	>2 ^m 15 ^s	film not read further
			D	62	Y	1 ^m 27 ^s	85	147	10 ^m 15 ^s	
			C	91	Y	2 ^m 18 ^s	50	128?	>11 ^m	not read further
			O	125	Y	3 ^m 00 ^s	40	53	5 ^m 00 ^s	
			G	139	Y	4 ^m 30 ^s	30	93?	> 7 ^m 30 ^s	not read further
			J	157	Y	6 ^m 57 ^s	30	103	8 ^m 45 ^s	
	2 (1441) Water	27	F-J	No surge shows on any meter						
18577	1 (1529:40) Dredged Material	17	F	43	Y	35 ^s	100	157	6 ^m 30 ^s	
			G	40(?)	Y	1 ^m 12 ^s	55	80	5 ^m 15 ^s	
			C	106	Y	2 ^m 05 ^s	35	34	3 ^m 15 ^s	
			D	146	No	--	--	--	--	--
	2 Dredged Material	26	G	92	Y	2 ^m 07 ^s	40	95	5 ^m 45 ^s	
			F	131	Y	3 ^m 55 ^s	40	80	5 ^m 00 ^s	
			C	180	Y	6 ^m 00 ^s	26	56	4 ^m 45 ^s	
			D	245	No	--	--	--	--	

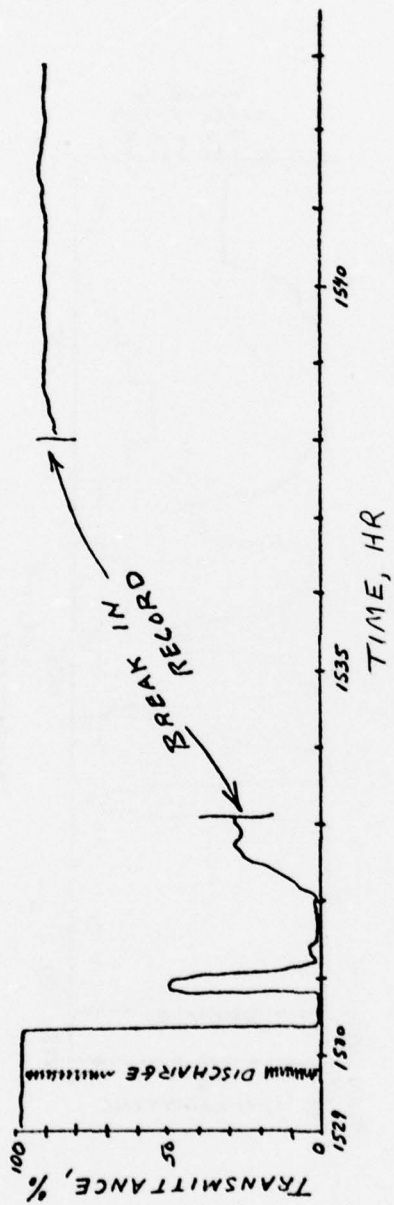

Figure 014. Transmittance as a function of time after discharge and height above bottom. Discharge 1, 18 May 1977, transmissometer height above bottom = 1 m, path length = 1 cm, Bertram, range = 34 m, depth = 18 m.

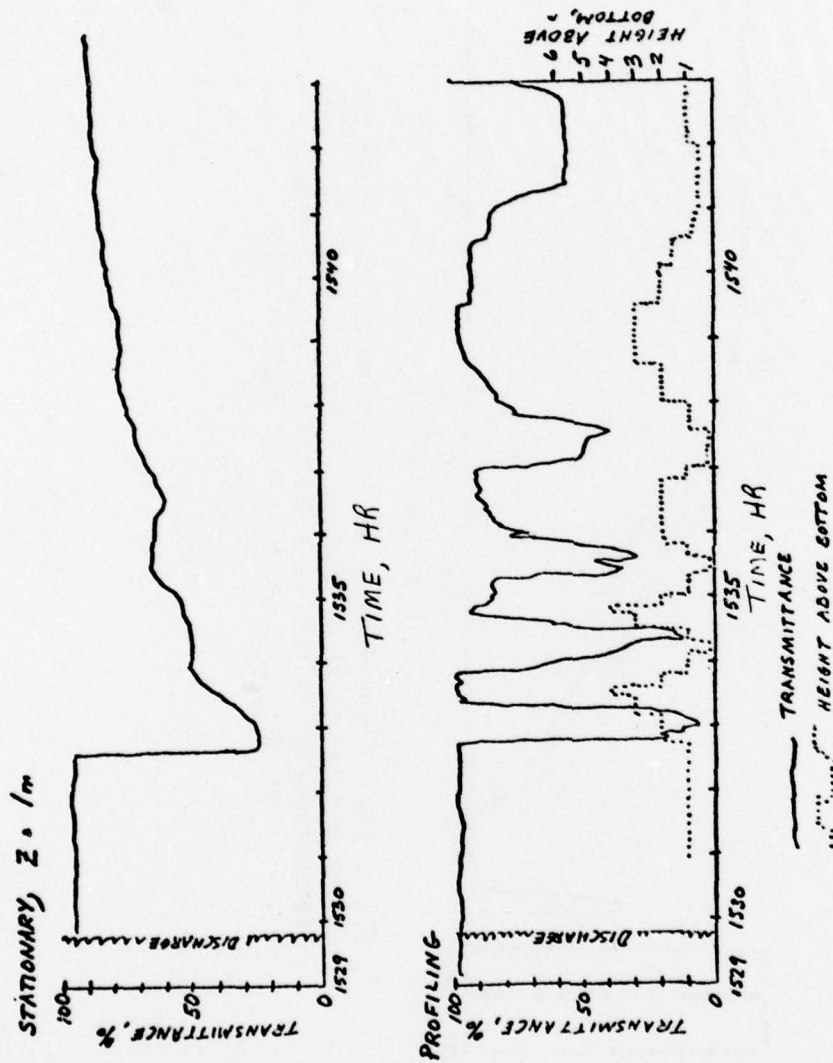

Figure 015. Transmittance as a function of time after discharge and height above bottom. Discharge 1, 18 May 1977, Owens, range = 85 m, depth = 18 m, transmittance, path lengths = 1 cm.

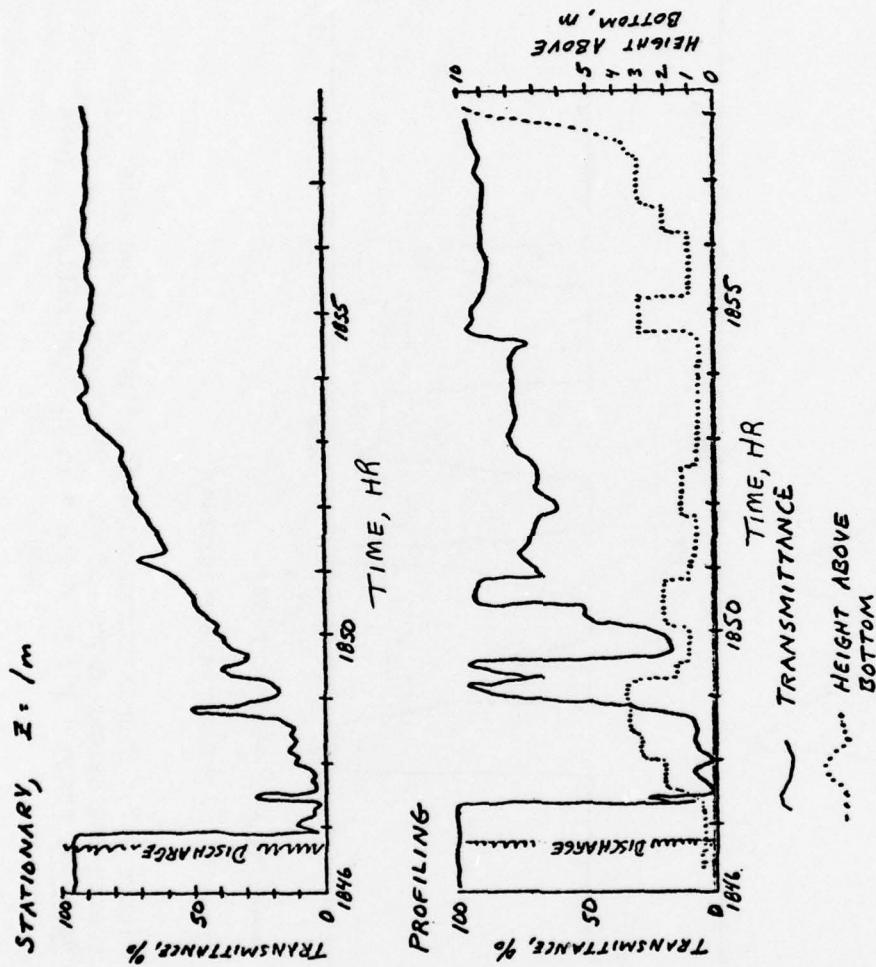

Figure 016. Transmittance as a function of time after discharge and height above bottom. Discharge 2, 18 May 1977, Owens, range = 30 m, depth = 26 m, transmittance, path length = 1 cm.

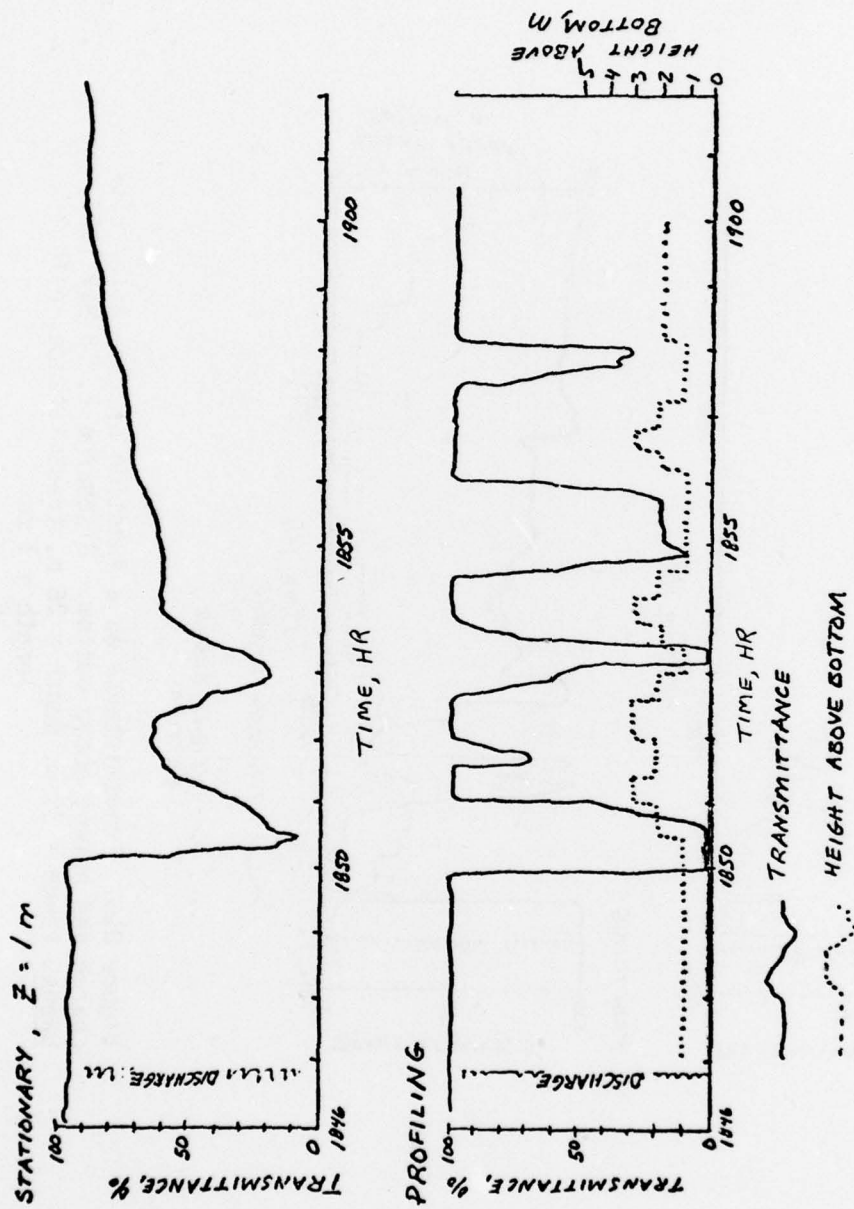

Figure 017. Transmittance as a function of time after discharge and height above bottom. Discharge 2, 18 May 1977, Bertram, range = 107 m, depth = 26 m, transmittance, path length = 1 cm.

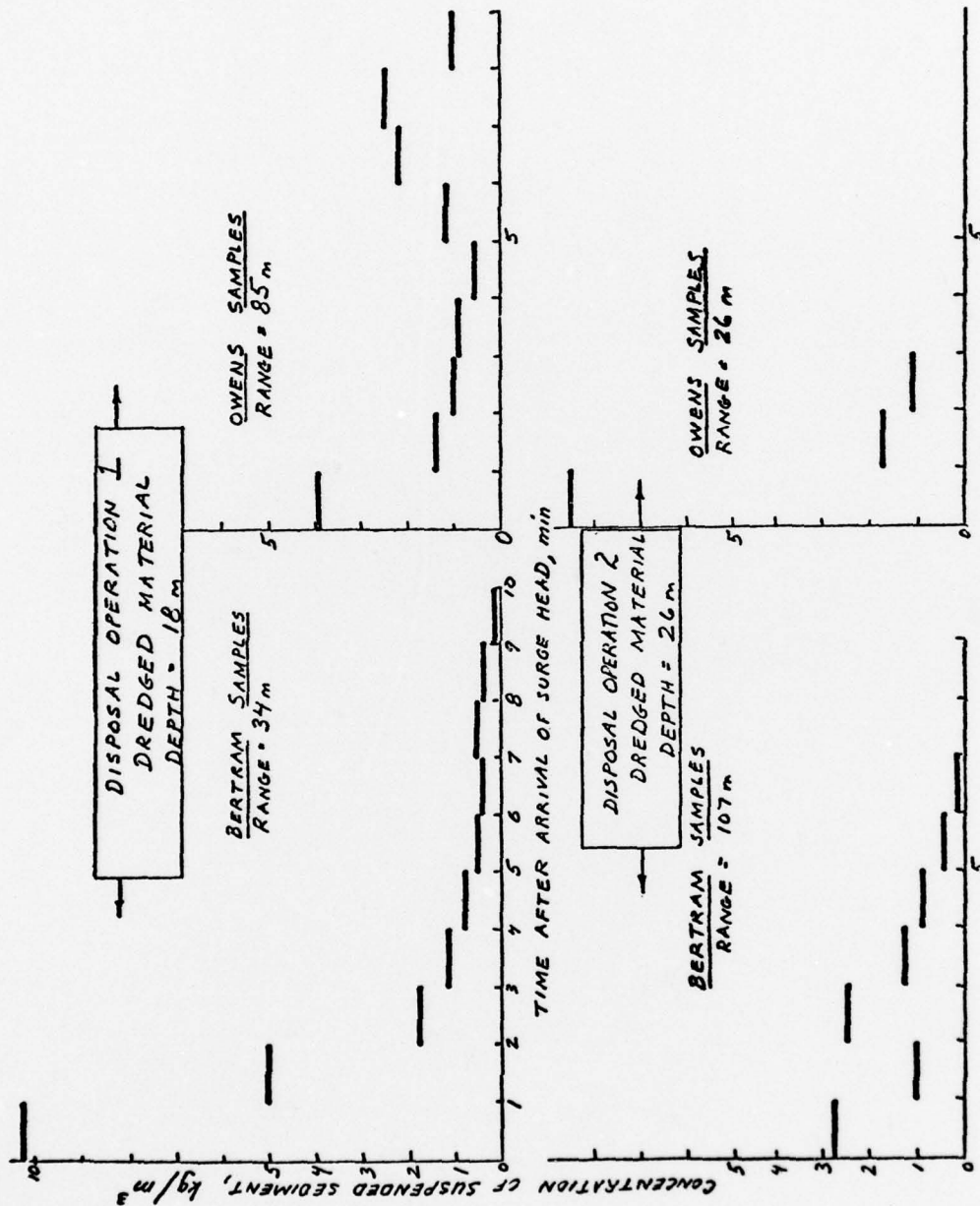

Figure 018. Suspended sediment concentration, 18 May 1977, Rochester II.