

AD-A063 191

LIFE SYSTEMS INC CLEVELAND OHIO
DATA ACQUISITION, MONITOR AND CONTROL SYSTEM DEVELOPMENT FOR FI--ETC(U)
AUG 78 P Y YANG, J Y YEH, R A WYNVEEN
LSI-ER-314-7-6

F/G 13/2
DAMD17-76-C-6063
NL

UNCLASSIFIED

| OF |
AD A
063191



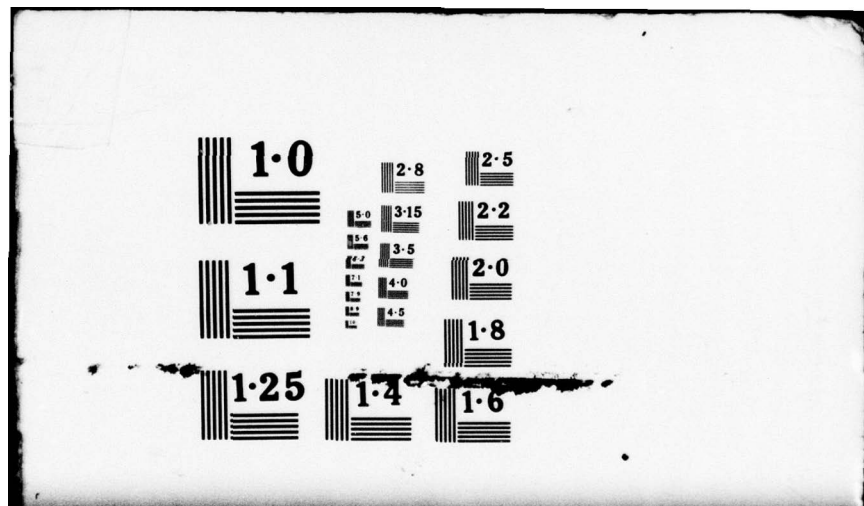

1.0

2.8

2.5

5.0

3.15

2.2

5.6

3.5

2.0

1.1

4.0

4.5

1.8

1.25

1.4

1.6

AD A063191

DDC FILE COPY

LEVEL II

AD _____

13

LSI ER 314-7-6

DATA ACQUISITION, MONITOR AND CONTROL SYSTEM DEVELOPMENT FOR FIELD ARMY MEDICAL FACILITIES

TECHNICAL REPORT

by
P.Y. Yang, J.Y. Yeh,
and R.A. Wynveen

August, 1978

DDC
RECEIVED
12 JAN 1979
E

Project Officers:
Major Walter P. Lambert and William J. Cooper
Environmental Protection Research Division
US Army Medical Bioengineering
Research and Development Laboratory
Ft. Detrick, Frederick, MD 21701

Supported by
**US Army Medical Research
and Development Command**
Ft. Detrick, Frederick, MD 21701

Contract DAMD17-76-C-6063

Life Systems, Inc.
Cleveland, OH 44122

Approved for Public Release; Distribution Unlimited

The findings in this report are not to be construed as an official Department of the Army position unless so designated by other authorized documents

Disclaimer

The findings in this report are not to be construed as an official Department of the Army position, unless so designated by other authorized documents.

Disposition

Destroy this report when no longer needed. Do not return it to the originator.

UNCLASSIFIED

SECURITY CLASSIFICATION OF THIS PAGE (When Data Entered)

REPORT DOCUMENTATION PAGE		READ INSTRUCTIONS BEFORE COMPLETING FORM
1. REPORT NUMBER ER-314-7-6 ¹	2. GOVT ACCESSION NO.	3. RECIPIENT'S CATALOG NUMBER
4. TITLE (and Subtitle) Data Acquisition, Monitor and Control System Development for Field Army Medical Facilities		5. TYPE OF REPORT & PERIOD COVERED Technical Report, August 1, 1976 thru August 31, 1978
		6. PERFORMING ORG. REPORT NUMBER
7. AUTHOR(s) P. Y. Yang, J. Y. Yeh and R. A. Wynveen		8. CONTRACT OR GRANT NUMBER(s) DAMD17-76-C-6063
9. PERFORMING ORGANIZATION NAME AND ADDRESS Life Systems, Inc. 24755 Highpoint Road Cleveland, OH 44122		10. PROGRAM ELEMENT, PROJECT, TASK AREA & WORK UNIT NUMBERS 62720A 3E762720A835.00.064
11. CONTROLLING OFFICE NAME AND ADDRESS U. S. Army Medical Research & Development Command Department of the Army Ft. Detrick, Frederick, MD 21701		12. REPORT DATE August, 1978
		13. NUMBER OF PAGES 55
14. MONITORING AGENCY NAME & ADDRESS (if different from Controlling Office) Environmental Protection Research Division U. S. Army Medical Bioengineering Res. & Dev. Lab Ft. Detrick, Frederick, MD 21701		15. SECURITY CLASS. (of this report) UNCLASSIFIED
		15a. DECLASSIFICATION/DOWNGRADING SCHEDULE
16. DISTRIBUTION STATEMENT (of this Report) Approved for public release, distribution unlimited		
17. DISTRIBUTION STATEMENT (of the abstract entered in Block 20, if different from Report)		
18. SUPPLEMENTARY NOTES		
19. KEY WORDS (Continue on reverse side if necessary and identify by block number) Computer System, Control, Data Acquisition, Data Retrieval, Data Storage, Foreground/Background Architecture, Instrumentation, Monitor, Report Generation, Water Processing System		
20. ABSTRACT (Continue on reverse side if necessary and identify by block number) A Data Acquisition, Monitor and Control System has been designed and fabricated to collect test data from a Water Processing System pilot plant with minimal operation intervention. This system, designed to enhance the effectiveness of the water processing pilot plant operation, was installed at the U. S. Army Medical Bioengineering Research and Development Laboratory, Fort Detrick, Frederick, MD. <i>over</i>		

continued-

UNCLASSIFIED

UNCLASSIFIED

SECURITY CLASSIFICATION OF THIS PAGE(When Data Entered)

20. continued

△ The system was designed with the following capabilities: (1) control and monitor the Water Processing System through a remote satellite controller, (2) acquire and store the Water Processing System testing data, (3) retrieve and generate testing reports and (4) develop new computer programs by project engineers without interruption of the Data Acquisition System.

A distributed processing technique was used in the design. Real-time tasks such as data acquisition and monitor and control functions were implemented on the foreground computer. Data retrieval, report generation and program development were implemented on the background computer for batch processing. The system mainframe was equipped with moving head cartridge disk drives, floppy disk drives and magnetic tape transports for data and program storage. Peripheral devices including line printer, card reader, paper tape reader and paper tape punch were multiplexed to the foreground/background computers.

UNCLASSIFIED

SECURITY CLASSIFICATION OF THIS PAGE(When Data Entered)

ACCESSION for	
NTIS	Write Section <input checked="" type="checkbox"/>
DOC	B. H. Section <input type="checkbox"/>
UNANNOUNCED	<input type="checkbox"/>
JUSTIFICATION	
BY	
DISPATCH SYMBOL	
Dis:	
A	

14 LSI-ER-314-7-6

6 DATA ACQUISITION, MONITOR AND CONTROL SYSTEM DEVELOPMENT FOR FIELD ARMY MEDICAL FACILITIES.

9 TECHNICAL REPORT. 1 Aug 76-31 Aug 78,

by

10 P. Y. Yang, J. Y. Yeh and R. A. Wynveen

11 Aug 1978

12 56p.

Distribution of this report is provided in the interest of information exchange. Responsibility for the contents resides in the authors or organization that prepared it.

Prepared Under Contract No. DAMD17-76-C-6063

15
16 3E762720A835

LIFE SYSTEMS, INC.
Cleveland, OH 44122

17 00

for

US Army Medical Research and Development Command
Ft. Detrick, Frederick MD 21701

390 850

EXECUTIVE SUMMARY

The U. S. Army Medical Research and Development Command has been developing a waste water reuse system applicable for use in the Army field environment. The system is called the Water Processing Element. Under Contract No. DAMD17-76-C-6063, Life Systems, Inc. designed and fabricated a full-scale Water Processing System pilot plant and delivered it to the U. S. Army Medical Bioengineering Research and Development Laboratory, Fort Detrick, Frederick, MD. As part of the development effort, a Data Acquisition, Monitor and Control System was designed and fabricated to collect the pilot plant testing data with minimal operation intervention. The system was designed with the capabilities to:

- Control and monitor the Water Processing System through a remote satellite controller
- Acquire and store the Water Processing System testing data
- Retrieve and generate testing reports
- Allow development of new computer programs by project engineers without interruption of data acquisition

With those capabilities the system provides the user with the following benefits:

- Reduction of people-power requirements in pilot plant operation
- Reduction of people power requirements in pilot plant data reduction and analysis
- Ease of modifying the control and monitor instrumentation and thus increased effectiveness of the pilot plant
- Use of the system as a general-purpose computer

The Data Acquisition, Monitor and Control System consists of a foreground system, a background system, a built-in monitor and a remote satellite controller with provision to be expanded to 15 satellite controllers. Foreground refers to computer real-time tasks which require immediate system attention. Background refers to computer tasks which do not require real-time service and thus have lower priority in computer task scheduling. For example, control/monitor and data acquisition are real-time tasks and, therefore, belong to the foreground. On the other hand, report generation and data analyses are not real-time tasks and, therefore, belong to the background. A remote satellite controller is a self-contained, computerized control/monitor instrumentation linked to the Data Acquisition, Monitor and Control System via a communication channel.

The system mainframe was equipped with moving head cartridge disk drives, floppy disk drives and magnetic tape transports for data and program storage. Peripheral devices including line printer, card reader, paper tape reader and paper tape punch are multiplexed to the foreground/background computer.

The foreground system is capable of monitoring 160 analog sensors and 512 digital sensors through its built-in monitor or one of the satellite controllers. It has the capacity of 384 digital control points. The data acquisition scan rate is adjustable by the user at 5, 15, 30 and 60 minutes for each sensor.

The background system can be used as a general-purpose computer to develop user written computer programs in assembly language or Fortran. It can also be used to retrieve the testing data acquired by the foreground system and generate sensor data reports. Three such report formats were supplied with the system. The on-call report lists operator-selected sensor data in engineering units with the date and time when they are acquired. The 24-hour report lists the averaged sensor data, high and low peaks of data and the number of excursions beyond sensor setpoints. The command log report lists the operator-initiated actions on the satellite controller such as modifications of scale factors, allowable ranges, setpoints and timing sequences and commands to activate/deactivate the Water Processing System.

The Data Acquisition, Monitor and Control System was designed with communication links to six terminals with provisions for immediate expansion to eight terminals. Five of the terminals are within one mile of the mainframe and were therefore designed with hardwired links. The sixth link is equipped with a modem which can be used for terminals located hundreds of miles away such as the manufacturer's site in Cleveland, OH. These remote links allow users at the remote terminals to operate the Data Acquisition, Monitor and Control System as if the operator were at the mainframe.

With the built-in monitor and a satellite controller the system has a capacity to store two days' sensor data on the cartridge disk and 16 days' sensor data on the backup magnetic tape transport at a sampling period of five minutes.

FOREWORD

This program was conducted for the U. S. Army Medical Research and Development Command, Fort Detrick, Frederick, MD, under Contract No. DAMD17-76-C-6063. The program manager was Dr. R. A. Wynveen. Technical effort was completed by Dr. P. Y. Yang, Dr. J. Y. Yeh, J. D. Powell, Jr., G. G. See, C. T. Burger, Y. Shimono, D. Etling, D. C. Walter, J. W. Schmidt and P. Reagan. The administrative and documentation support was provided by B. A. Ginunas, C. A. Lucas and B. M. Jaras.

Mr. W. J. Cooper and Major W. P. Lambert, Environmental Protection Research Division, U. S. Army Medical Bioengineering Research and Development Laboratory, Fort Detrick, Frederick, MD, were the technical monitors of this program. The technical contributions, assistance and program guidance offered by Lt. Col. L. H. Reuter, Mr. M. J. Small, Capt. B. W. Peterman and Mr. R. Pace are gratefully acknowledged.

Results of Contract No. DAMD17-76-C-6063 have been published in six technical reports as follows:

<u>Title</u>	<u>Report No.</u>
Pilot Plant Development of an Automated, Transportable Water Processing System for Field Army Medical Facilities	ER-314-7-1
Water Treatment Unit Development for Field Army Medical Facilities	ER-314-7-2
Water Purification Unit Development for Field Army Medical Facilities	ER-314-7-3
Advanced Instrumentation Development for a Water Processing Pilot Plant for Field Army Medical Facilities	ER-314-7-4
UV/Ozone Oxidation Technology Development for Water Treatment for Field Army Medical Facilities	ER-314-7-5
Data Acquisition, Monitor and Control System Development for Field Army Medical Facilities	ER-314-7-6

TABLE OF CONTENTS

	<u>PAGE</u>
EXECUTIVE SUMMARY	1
FOREWORD	3
LIST OF FIGURES	6
LIST OF TABLES	7
ACRONYMS	7
INTRODUCTION	8
Background	8
Program Objectives	11
SYSTEMS CONFIGURATION	11
Hardware Architecture	13
Foreground System	13
Background System	13
Satellite Controller	17
Computer Links	17
Software Architecture	17
Foreground Software - DATARCS	17
Background Software - DOS	20
DATA ACQUISITION SYSTEM DESIGN	22
System Commands	22
BEGIN Command	23
CANCEL Command	25
DATE Command	26
RATE Command	26
SEND Command	26
STATUS Command	27
TIME Command	27
Disk Files	27
Sensor Definition File	28
Sample Control File	28
Data Base File	28

continued-

Table of Contents - continued

	<u>PAGE</u>
Tape Files	35
Data Base Backup Tape File	35
Fast Scan Tape File	35
Sensor Table Builder	36
Satellite Control Program Loader	41
Report Generation Programs	41
On-Call Report Generator	43
24-Hour Report Generator	43
Command Log Report Generator	43
DAS Data Flow	43
Data Transfer Rates and Storage Capacity	48
CONCLUSIONS	48
REFERENCES	51

LIST OF FIGURES

<u>FIGURE</u>		<u>PAGE</u>
1	DAMCS Layout	9
2	Water Processing/Data Acquisition System Overview	10
3	DAMCS Functional Block Diagram	14
4	DAMCS Hardware Block Diagram	15
5	Data Acquisition System	16
6	Data Acquisition and Retrieval Control Software Block Diagram .	19
7	DAS Background Software Block Diagram	21
8	Sensor Definition File	30
9	Sensor Definition Cards	31
10	Sample Control File Record	33
11	Data Base Block	36
12	Command Log Data Base Record	37
13	Analog Sensor Data Base Record	38
14	Digital Sensor Data Base Record	39
15	Fast-Scan Sensor Data Tape File	40
16	Sensor Definition Process	42
17	On-Call Report	44
18	24-Hour Report	45
19	Command Log Report	46
20	DAS Data Flow	47
21	DAS Data Transfer Rates	49
22	Disk and Tape Capacity By Sample Period and Number of Satellite Controllers	50

LIST OF TABLES

<u>TABLE</u>		<u>PAGE</u>
1	DAMCS Characteristics	12
2	DATARCS Commands	24
3	Sensor Definition File	29
4	Sample Control File	32
5	Data Base Block	34

ACRONYMS

C/M I	Control/Monitor Instrumentation
CPU	Central Processing Units
DAMCS	Data, Acquisition, Monitor and Control System
DAS	Data Acquisition System
DATARCS	Data Acquisition and Retrieval Control System
DOS	Disk Operating System
FMP	Functional Module Programming
I/O	Input/Output
RTC	Real-Time Clock
RTX	Real-Time Executive
WPS	Water Processing System

INTRODUCTION

The Data Acquisition, Monitor and Control System (DAMCS) was designed as a part of the pilot plant developmental effort of the transportable Water Processing System (WPS) for the U. S. Army Medical Bioengineering Research and Development Laboratory (USAMBRDL) of the U. S. Army Medical Research and Development Command (USAMRDC). The WPS, also known as the Water Processing Element (WPE), was developed for a mission-oriented medical treatment system known as the Medical Unit, Self-contained, Transportable (MUST). The DAMCS was designed to permit data acquisition and retrieval of the WPS pilot plant which was an experimentation leading to the complete mechanical, hydraulic, electrical and instrumentation design of an automated WPS prototype for the field Army medical facilities.

The purpose of this report is to describe the design, configuration and operation of the DAMCS. This report is intended to be supplementary to Life Systems' Final Report entitled "Pilot Plant Development of an Automated, Transportable Water Processing System for Field Army Medical Facilities."⁽¹⁾

Background

The mechanical portion of the WPS is an integration of several complex chemical processes such as equalization, prescreening, ultrafiltration, depth filtration, ion exchange, carbon adsorption, reverse osmosis, ultraviolet-activated ozone oxidation and hypochlorination. The WPS pilot plant was heavily instrumented for process automation, system and personnel protection and scientific data collection. There were 86 electrical actuators and 106 electrical sensors of the WPS pilot plant in addition to mechanical gauges, pressure regulators, hand valves and other manual adjustments. Among the 106 electrical sensors, 67 were used for process automation and monitoring and 39 were used for valve position indications. The WPS pilot plant was designed, fabricated and packaged into three pallets. They were installed in a laboratory area of approximately 900 sq ft in Building 1054, Fort Detrick, Frederick, MD. The DAMCS mainframe was installed at a location approximately 20 ft from the pilot plant area. Figure 1 depicts the DAMCS layout at Fort Detrick.

Figure 2 is the WPS/DAMCS block diagram. The mechanical portion of the WPS pilot plant consists of three pallets: Water Treatment Unit (WTU), Water Purification Unit (WPU) and UV-activated Ozone Oxidation Unit (O₃/UV). They are designed to process natural fresh, brackish and medical complex wastewater for potable or reuse water production. During the pilot plant phase of the WPE, two types of Control/Monitor Instrumentation (C/M I) were designed for the WPS: semiautomatic and automatic. The semiautomatic and automatic instrumentation could be converted back and forth rapidly. This enabled the project engineers to perform unit process testing under the semiautomatic operation and integrated system testing under automatic instrumentation. The automatic C/M I is a functionally remote satellite controller of the DAMCS. The DAMCS also has a built-in monitor which can be used to bypass the automatic C/M I and acquire sensor data directly from the semiautomatic C/M I. The DAMCS was

(1) References cited are at the end of this report.

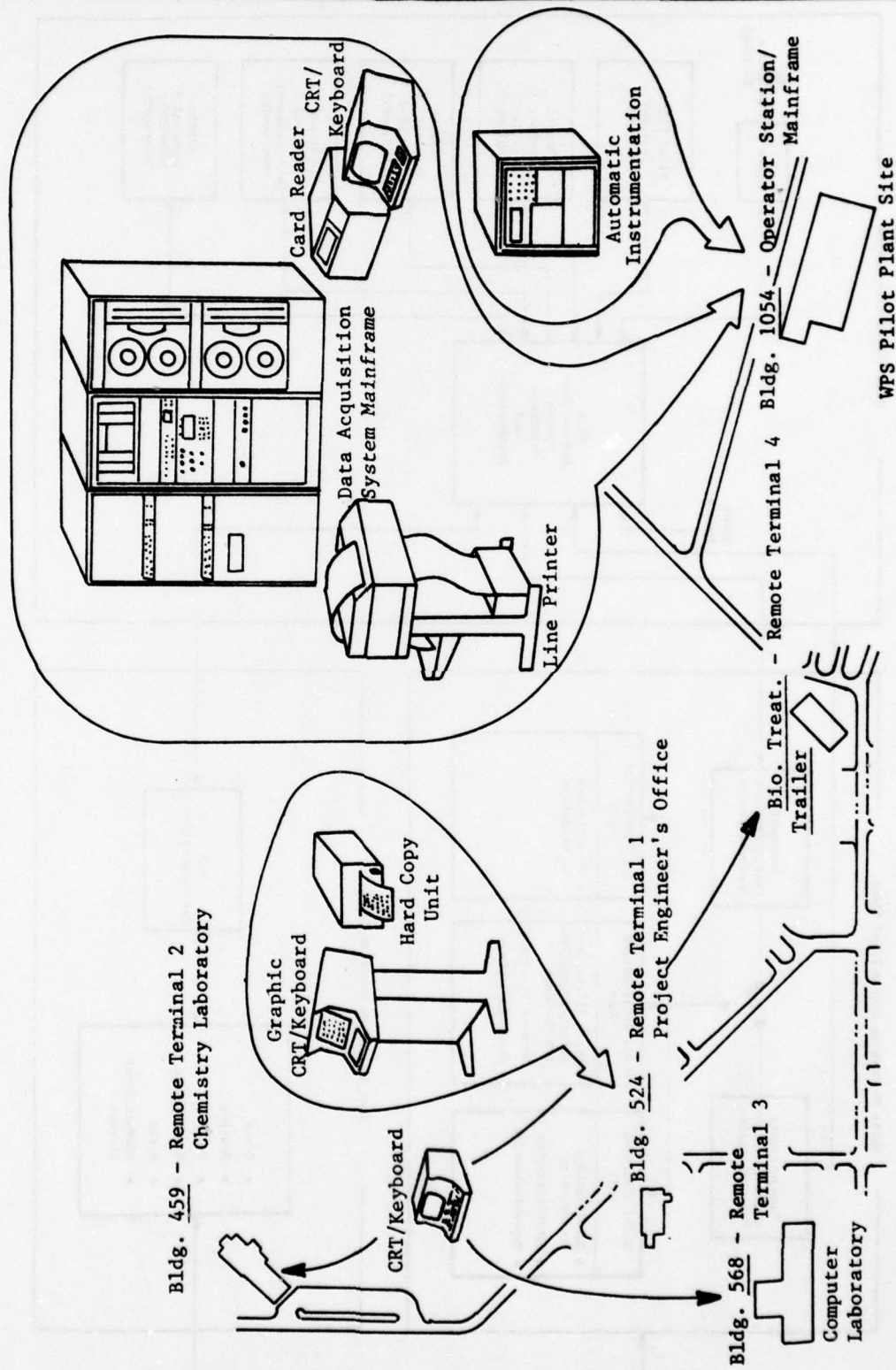

FIGURE 1 DAMCS LAYOUT

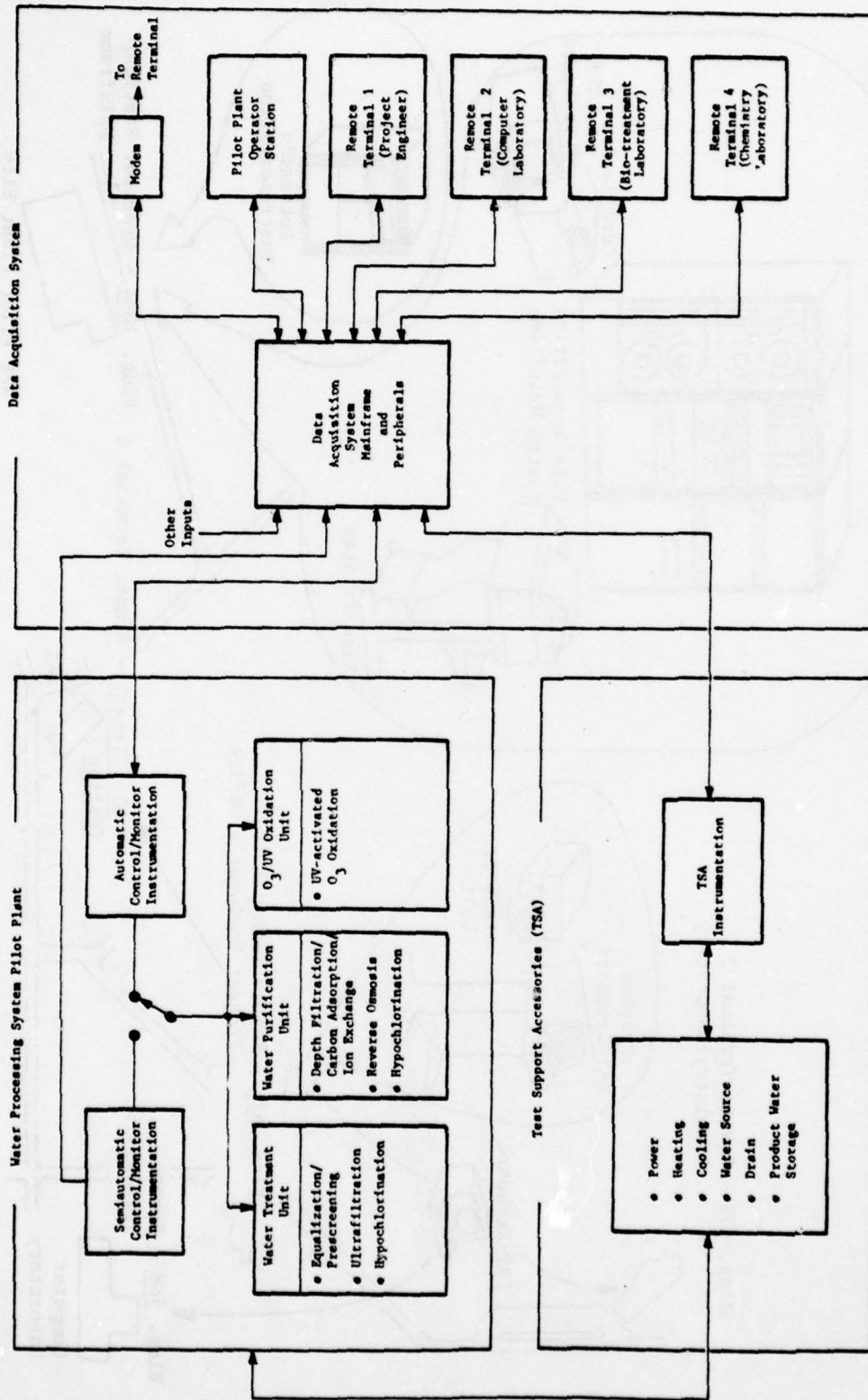

FIGURE 2 WATER PROCESSING/DATA ACQUISITION SYSTEM OVERVIEW

designed with provisions for other inputs through additional satellite controllers up to a total of 15 satellites. The automatic C/M I hardware was physically packaged in a separate enclosure and located between the WPS pilot plant and the Data Acquisition System (DAS) of the DAMCS. This report covers the DAS and treats the automatic C/M I as merely a functional block of the DAMCS.

The major operational requirements of the DAMCS are:

- Data acquisition of the WPS pilot plant
- Data retrieval and report generation
- Computer program development using the DAMCS without interruption of the data acquisition function
- Operation by a single operator at the operator's station or a remote terminal

Program Objectives

The overall objective of Contract No. DAMD17-76-C-6063 was the development of a fully-operational WPS pilot plant incorporating the DAMCS to gather testing data required for the complete mechanical, hydraulic, chemical and electrical design of the fully-operational, automated WPS for the Army field medical facilities.

The specific objectives of the DAMCS development program were:

1. Develop a foreground/background technique whereby real-time data acquisition tasks could be executed in the foreground and report generation/software development tasks could be run in the background.
2. Design, fabricate, install and check out the hardware with foreground/background capability and terminals at the pilot plant site, Project Engineer's Office, Biological Treatment Laboratory, Chemistry Laboratory, Computer Laboratory and other sites equipped with modem links.
3. Design, program and check out the software for the foreground system to gather the pilot plant testing data.
4. Design, program and check out the software for the background system capable of generating testing data reports, modifying the control/monitor algorithms and developing new software.

SYSTEMS CONFIGURATION

This section describes the DAMCS hardware and software architecture. Table 1 shows the DAMCS characteristics.

TABLE 1 DAMCS CHARACTERISTICS

<u>Parameter</u>	<u>Characteristics</u>
Dimensions (Length x Width x Height), ft	5.5 x 2.6 x 5.7
Weight, lb	<1,600
Power, kW	6.0
Capacity	
a. Sensors, Analog	160
b. Sensors, Digital	512
c. Control Points	384 Digital
Scan Rates, min	5, 15, 30, 60
Scan Rate Selection	Individual
Data Storage Capacity, hr	100 (Worst Case, One Satellite)
Expandability	
a. Sensors, Analog	2,560 by Satellite Expansion
b. Sensors, Digital	8,192 by Satellite Expansion
Operational Requirements	
a. Number of Personnel	1
b. Communication	Interactive
Reporting	24-Hour On-Call Command Log
Formats	Scaled Data and Time High and Low Peaks (24 hr) Excursions Beyond Setpoints Averages (24 hr)
Distances Between DAS and Satellites	Limited Only by Availability of 19.2K Baud Telephone Lines

Hardware Architecture

The DAS hardware architecture is a foreground/background distributed processing structure with capabilities to handle a built-in sensor data monitor, 15 satellite controllers and eight remote user terminals. One satellite controller and six user terminals were implemented in the current design.

One of the DAS design requirements was to run data acquisition in the foreground and other lower priority tasks in the background. This foreground/background capability was achieved with a design utilizing multiple Central Processing Units (CPU's) with each of the CPU's designed to handle specific tasks. The foreground CPU is designed to collect sensor data from the built-in monitor or any of the satellite controllers, the background CPU is designed to retrieve sensor data and generate reports upon the user's request. When the background CPU is not used for report generation, it is available for program development as a general-purpose computer. The satellite CPU's are dedicated to control and monitor functions and to transmit sensor data periodically to the DAS foreground CPU.

Figure 3 is a functional block diagram of the DAMCS, including its expandability. Figure 4 is the DAMCS hardware block diagram. Figure 5 is a photograph of the DAS.

Foreground System

The heart of the foreground system is Computer Automation's LSI-2/60, a 16-bit minicomputer, with 32K core memory. The minicomputer has built-in hardware multiply/divide, priority interrupt, power fail/restart, real-time clock, automatic bootstrap loader, Direct Memory Access (DMA) and other Input/Output (I/O) interface capabilities. The foreground system has a five-megabyte, dual platter, moving head cartridge disk and a 23-megabyte, 8½-inch reel, 1600 bits/in (BPI), Phase-Encoded (PE) magnetic tape transport. It has a built-in Analog/Digital (A/D) interface for 160 analog and 128 digital inputs. There is an Automatic Calling Unit which can be used to dial telephone numbers under computer program control. The foreground computer can communicate with one of the six Cathode-Ray Tube (CRT)/keyboard terminals through the private communication exchange switch. The foreground computer can also interface with the line printer, card reader, high speed paper tape reader and high speed paper tape punch through the peripheral sharer. The peripheral sharer is a unique piece of hardware designed for the foreground/background computers to share a common pool of peripheral devices. The connection of the peripheral devices to either of the computers can be selected by the user at the operator's station by activating a toggle switch.

Background System

The background system has a Computer Automation's LSI-2/20 CPU which is similar to that of the foreground system. It has 64K core memory, a moving head cartridge disk, a magnetic tape transport, a communication link through the private communication exchange switch to the six CRT/keyboard terminals and an interface through the peripheral sharer to the common peripheral devices pool. The background computer, however, does not have an Automatic Calling

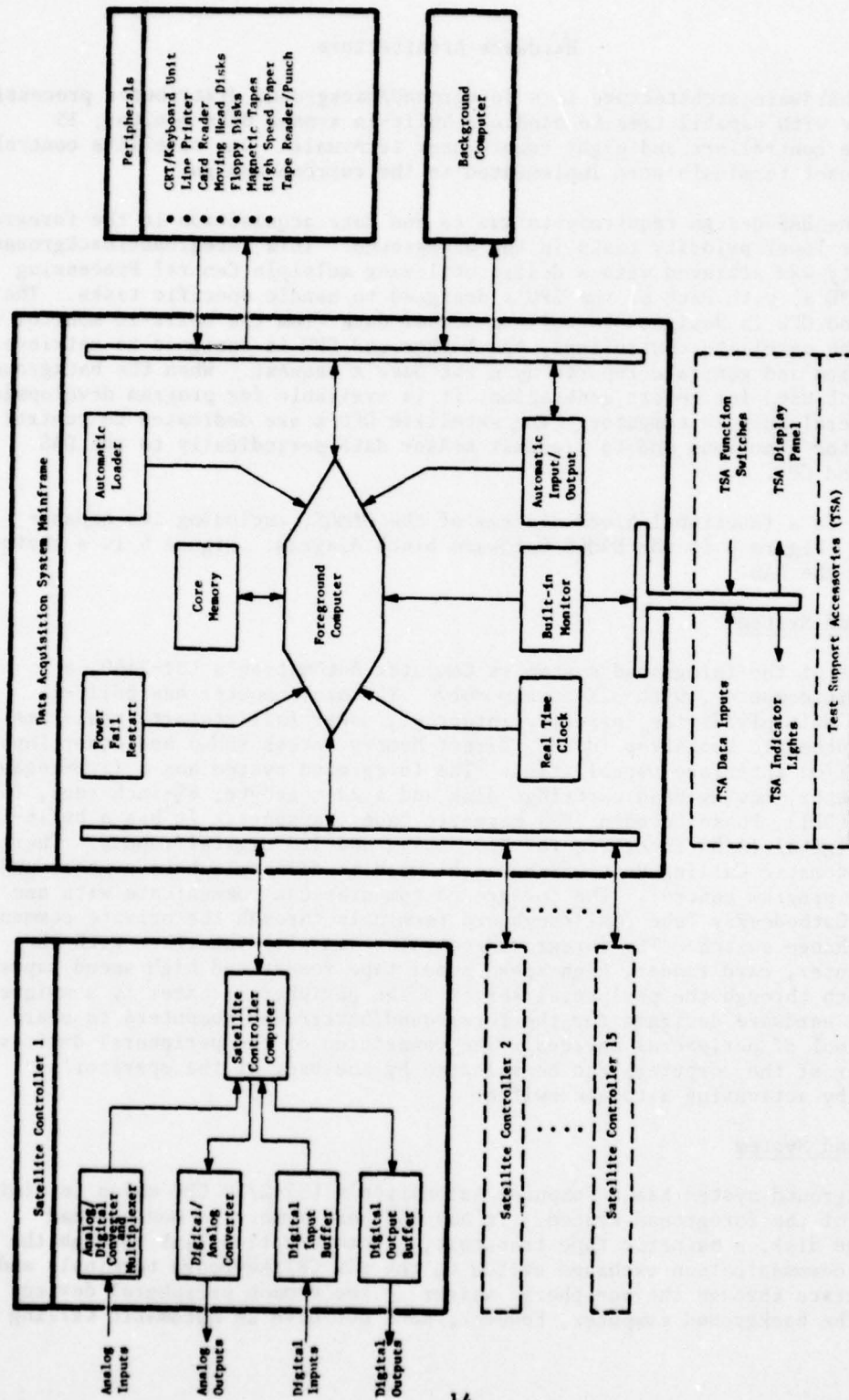

FIGURE 3 DAMCS FUNCTIONAL BLOCK DIAGRAM

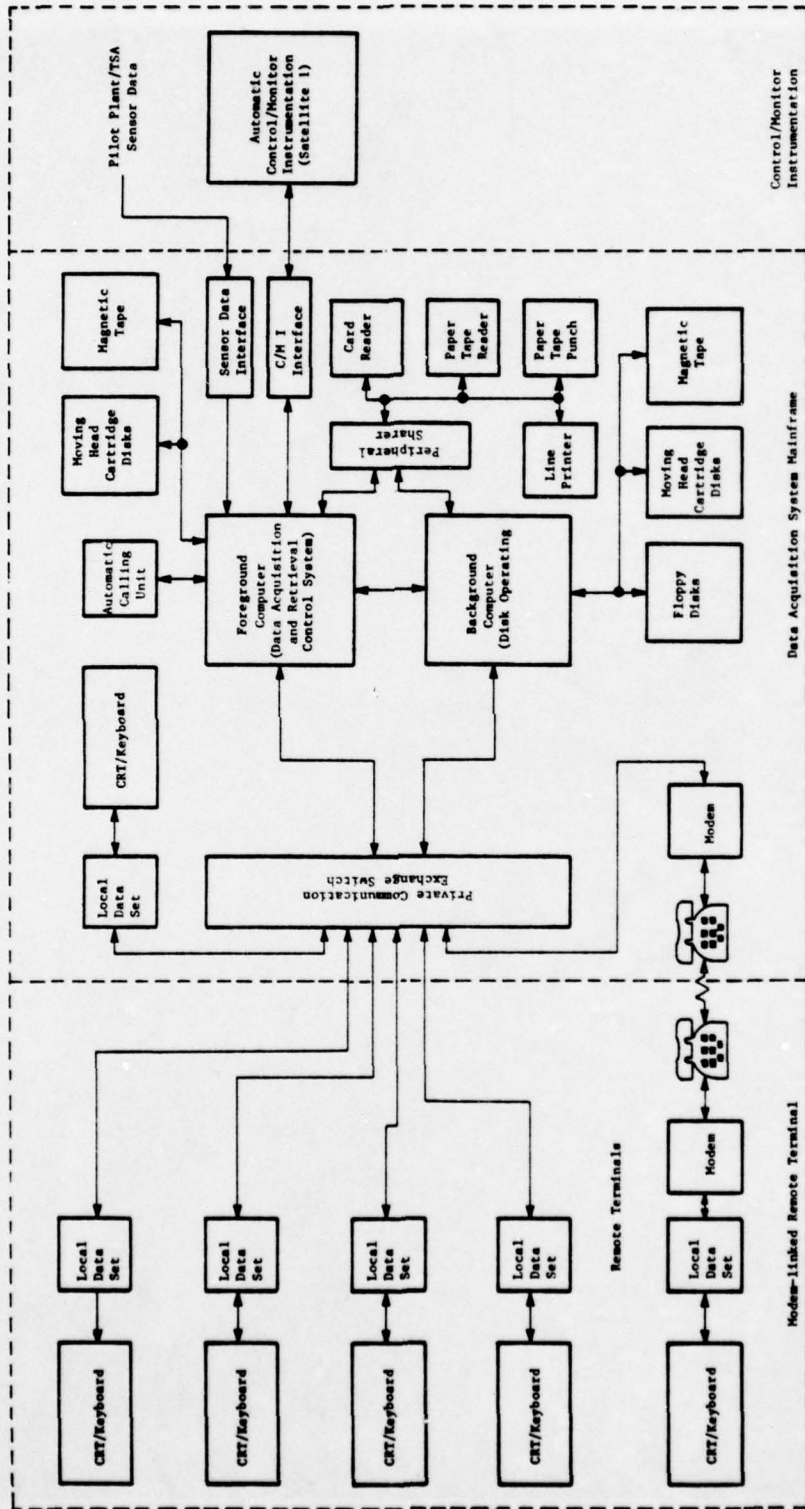

FIGURE 4 DAMCS HARDWARE BLOCK DIAGRAM

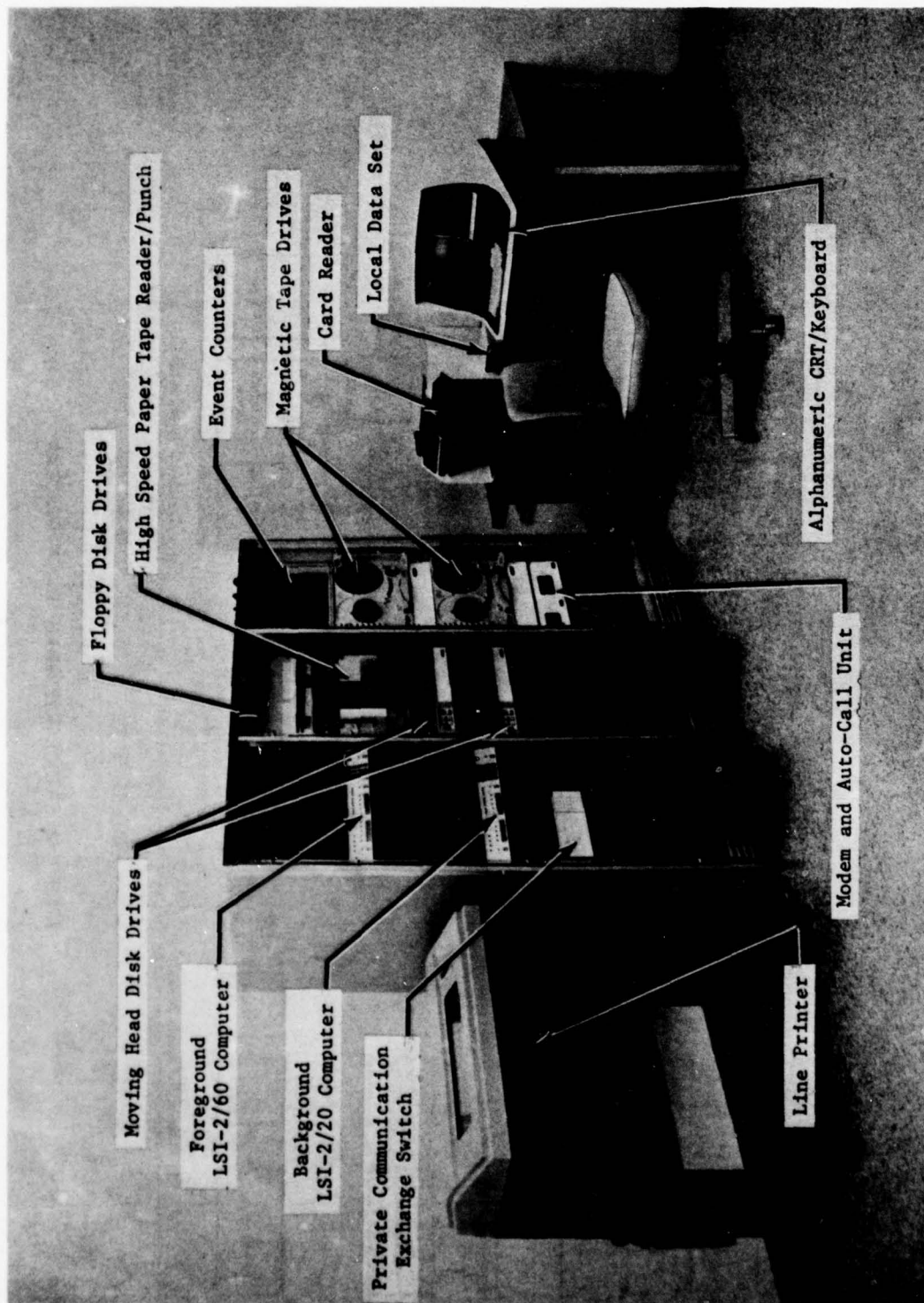

FIGURE 5 DATA ACQUISITION SYSTEM

Unit nor an A/D interface. Instead, it has a dual floppy disk subsystem for program storage.

Satellite Controller

Satellite Controller No. 1 is the automatic C/M I of the WPS pilot plant. It has a CPU similar to the foreground/background system with a 16K core memory and a built-in A/D interface. Detailed information of this satellite controller can be found in Life Systems' technical report entitled "Advanced Instrumentation Development for a Water Processing Pilot Plant for Field Army Medical Facilities."⁽²⁾

Computer Links

There are two computer-to-computer links in the DAMCS: one between the foreground and background computer and the other between the foreground computer and the satellite. Electronically these two links are identical. Functionally the link between the foreground computer and the background computer was designed to (1) transmit sensor data and operator commands from the foreground cartridge disk to the foreground computer and then to the background computer during a data retrieval operation and (2) transmit a new program or a new sensor definition file from the background computer to the foreground computer. The link between the foreground computer and the satellite controller was designed to (1) transmit digitized sensor data from the satellite controller to the foreground computer and then to the cartridge disk or the magnetic tape, (2) transmit operator commands from the foreground computer to the satellite controller and (3) transmit a new program from the background computer to the foreground computer and then to the satellite controller during a program loading operation.

Software Architecture

Although the hardware configurations of the foreground and background systems are similar to each other, their software architectures are completely different. The foreground software is a real-time system called the Data Acquisition and Retrieval Control System (DATARCS) designed for controlling the tasks of data acquisition/storing and retrieving the collected data relating to the built-in monitor or an external satellite controller. The DATARCS includes software for monitoring a single process and has the ability to communicate with up to 15 additional process monitor and/or control computers. The background software is primarily composed of a Disk Operating System (DOS) which is a disk-oriented programming system designed to eliminate costly, tedious, and time-consuming tasks normally associated with program preparation, debugging, execution and maintenance.⁽³⁾ The DOS provides the user with the necessary tools for efficient program development using both the assembly language and the Fortran programming language. The background software also includes satellite controller loading programs and report generation programs designed to be executed under the DOS.

Foreground Software - DATARCS

The foreground DATARCS software employs a design philosophy usually referred to as Functional Module Programming (FMP), a technique that uses a highly

reliable and flexible software system. Functional Module Programming requires that the system be considered in terms of the functions it performs as opposed to the classical considerations of the data to be handled. In general, these functions can be divided into four categories:

1. I/O functions - control the interfaces between the program modules and the outside world (i.e., the operator, storage devices, other computers and peripherals)
2. Process functions - translate data collected from an input function into a form expected by an output function.
3. Utility functions - perform operations useful to several other functions (e.g., sum a table of numbers, calculate a square root, etc.).
4. Control functions - control the sequence in which other functions are performed.

The four functional categories can be expanded to produce hierarchical-type structures within an FMP system. For example, a true FMP system has a single main control function that sequences the entire system but there may be several auxiliary control functions which control the sequence of related process functions. The definition of which category a specific function belongs to depends on its relationship to the other modules in the system.

Since the DATARCS was designed to operate in a real-time environment, it was designed to be an FMP system capable of performing several functions concurrently. In keeping with the FMP philosophy, the DATARCS has defined a hierarchy of control functions that, within the DATARCS, is referred to as a partition structure. To the DATARCS, the term partition refers to a collection of program modules which relate to a single, general function. In general each partition fits into a contiguous segment of core memory and operates on one or more common data areas. Each partition also has access to the base page, the first 256 words of memory, which constitutes a general data area that allows communication among partitions.

Figure 6 is the DAS foreground software block diagram. The DATARCS includes eight partitions:

1. Partition 1 is the nucleus of the entire DATARCS system. It includes the main control function module of the entire system which actually controls the operator communication subsystem, provides the mechanism for controlling all other partitions and provides the linkage between the base page and all other partitions. Partition 1 also includes a Real-Time Executive (RTX) program, a general base page and a collection of utility function subroutines for use by the entire system.
2. Partition 2 (CLOCK) contains all of the functions related to the DATARCS timing sequence and the Real-Time Clock (RTC).

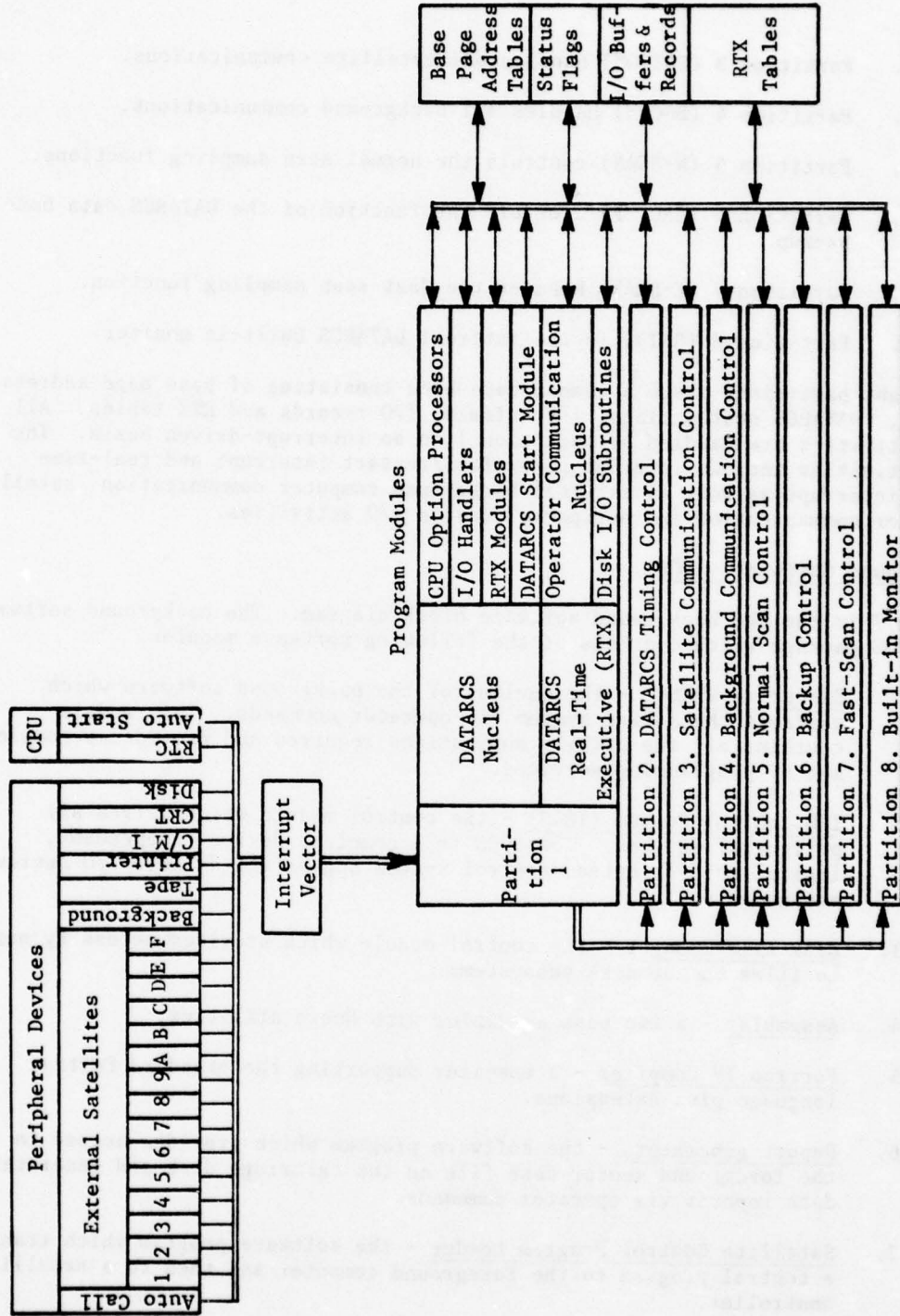

FIGURE 6 DATA ACQUISITION AND RETRIEVAL CONTROL SOFTWARE BLOCK DIAGRAM

3. Partition 3 (SATCOM) handles all satellite communications.
4. Partition 4 (BGC0M) handles all background communications.
5. Partition 5 (N-SCAN) controls the normal scan sampling functions.
6. Partition 6 (BACKUP) controls the function of the DATARCS data base backup.
7. Partition 7 (F-SCAN) handles the fast scan sampling function.
8. Partition 8 (SAT0) is the internal DATARCS built-in monitor.

The eight partitions share a common data base consisting of base page address tables, DATARCS status flags, I/O buffers, I/O records and RTX tables. All I/O activities are handled by partition 1 on an interrupt-driven basis. The I/O activities include internal power fail/restart interrupt and real-time clock interrupt as well as external background computer communication, satellite computer communication and peripheral device I/O activities.

Background Software - DOS

Figure 7 is the DAS background software block diagram. The background software is a DOS package which consists of the following software modules:

1. Executive (EXEC) - the nucleus of the background software which controls the entire system via operator commands. This module contains all the utility subroutines required and provides a complete set of programming services.
2. I/O Control System (IOCS) - the control module which drives all peripheral devices. The IOCS is a complete device independent, logical unit oriented, control system supporting dynamic I/O device assignments.
3. Disk File Manager - the control module which provides access by name to files on the disk subsystems.
4. Assembler - a two-pass assembler with Macro utilities.
5. Fortran IV Compiler - a compiler supporting the standard Fortran language plus extensions.
6. Report generators - the software program which provides access to the foreground sensor data file on the cartridge disk and generates data reports via operator commands.
7. Satellite Control Program Loader - the software program which transmits a control program to the foreground computer and then to a satellite controller.

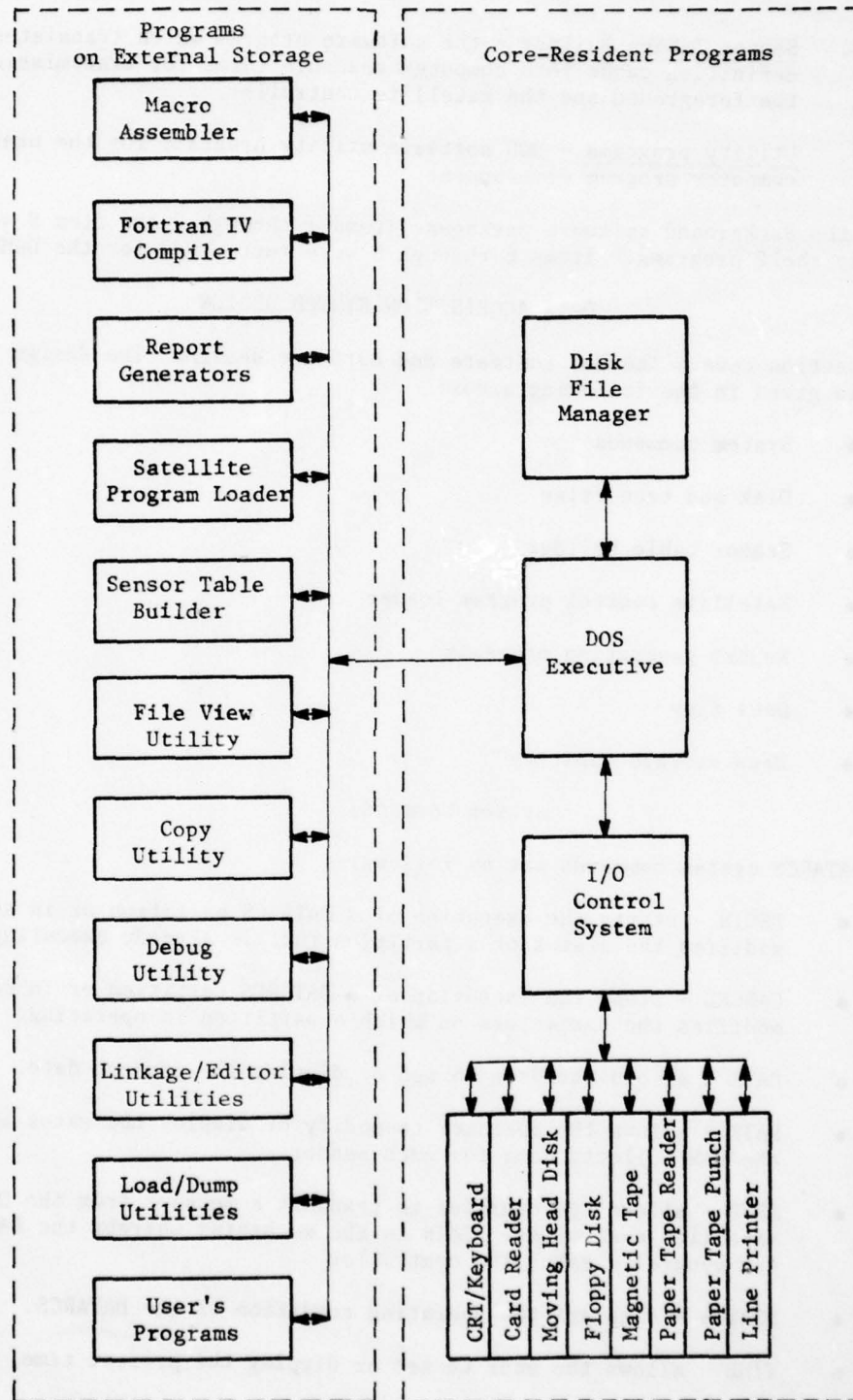

FIGURE 7 DAS BACKGROUND SOFTWARE BLOCK DIAGRAM

8. Sensor Tables Builder - the software program which translates sensor definition cards into computer readable forms for transmission to the foreground and the satellite controller.
9. Utility programs - DOS software utility programs for the user's computer program development.

Among the Background software packages, items 1 through 5 and item 9 were off-the-shelf programs. Items 6 through 8 were customized for the DAMCS.

DATA ACQUISITION SYSTEM DESIGN

This section covers the DAS software and hardware design. The design information is given in the following areas:

- System commands
- Disk and tape files
- Sensor table builder
- Satellite control program loader
- Report generation programs
- Data flow
- Data storage capacity

System Commands

The DATARCS system commands are as follows:

- BEGIN - starts the execution of a DATARCS partition or in some cases modifies the status of a partition that is already executing.
- CANCEL - stops the execution of a DATARCS partition or in some cases modifies the parameters on which a partition is operating.
- DATE - allows the user to set or display the present date.
- RATE - allows the operator to modify or display the rates at which the DAS collects data for each sensor.
- SEND - allows the operator to transmit a message from the DAS to a satellite controller. This is the mechanism whereby the DAS operator can control a satellite controller.
- STATUS - displays the operating condition of the DATARCS.
- TIME - allows the user to set or display the present time.

The DATARCS commands are summarized in Table 2. When each command is entered, the keyword may be abbreviated to the first two characters. For example, DA for DATE, SE for SEND, etc. The keyword must be preceded by a slash (/) at all times. For example, /DA or /DATE.

BEGIN Command

The BEGIN Command is used to start or modify a partition. It has the following format:

BEGIN name (, parameters)

If the partition is already running the operator must supply parameters relating to a nonexecuting option of the partition. If the partition is not running the parameters may or may not be supplied, depending on the partition, as described in the following.

1. BEGIN CLOCK, date, time - Starts the RTC at the date and time specified. Note that the values supplied must be greater than or equal to the current DATARCS date and time and in the following format:

date = mm/dd/yy
time = hh:mm.mmm

If a power failure occurs within the DATARCS system, the operator may restart the system by entering the command "/BEGIN CLOCK, date, time" at the current date and time.

2. BEGIN SATCOM (, sat. no. (, sat. no.) ...) - Enables satellite communication to the specified satellite. If SATCOM is not already running the parameters need not be included, in which case DATARCS will use the list of satellites that were enabled when SATCOM was cancelled. If SATCOM is not already running and the parameters are included, only the satellites named in the parameters will be enabled. If SATCOM is running, the parameters must be included and the named satellites will be added to the list of enabled satellites.
3. BEGIN BGCOP - Enables communication to the Background CPU. No parameters are required. Note that while all foreground/background communication is initialized by Background, BGCOP must be running to allow DATARCS to respond.
4. BEGIN N-SCAN (, sat. no. (, sat. no.) ...) - Starts normal sampling of the specified satellite. The list of satellites has the same intent and restrictions explained under SATCOM. Note that SATCOM and CLOCK must be running for N-SCAN to begin.
5. BEGIN BACKUP - Starts automatic backup of the DATARCS Data Base stored on the cartridge disk to magnetic tape. No parameters are required. Note that BACKUP and F-SCAN use magnetic tape and are, therefore, mutually exclusive, only one may be running at a time.

TABLE 2 DATARCS COMMANDS

BEGIN	name (, parameters) ^(a)
CANCEL	(name (, parameters))
DATE	(mm/dd/yy)
RATE	sat. no. (, type (. code (. code...))) = sample rate
SEND	sat. no., message
STATUS	(name)
TIME	(hh:mm.mmm)

where name = a valid partition name as follows:

CLOCK

SATCOM

BGCOM

N-SCAN

BACKUP

F-SCAN

parameters = a list of options associated with a given partition

^(a) Parenthesis indicate non-mandatory specifications to command.

6. BEGIN F-SCAN (, sat. no., type . code (, type . code) ...) - Starts fast-scan sampling of the specified satellite including only the sensors on the list. There may be up to five sensors on the list and each one is specified by sensor type (A = Analog, D = Digital) and sensor code. Note that for F-SCAN to begin, SATCOM must be running with communication to the appropriate satellite enabled, CLOCK must be running and BACKUP must be cancelled. Since BACKUP and F-SCAN use the same tape drive it is the operator's responsibility to ensure that the correct tape is mounted. The F-SCAN function was designed for laboratory analytical data collection purposes. It requires a significant amount of CPU time and therefore may not be operational unless the satellite controller is dedicated to transmitting F-SCAN data to the DAMCS.

CANCEL Command

The CANCEL Command halts the execution of the specified partition. It has the following format:

CANCEL name (, parameters)

If a name is not specified in the input command it will stop all partitions that are currently executing. If a name and/or parameter(s) are entered by the operator then only this entry will be cancelled. The CANCEL Command can be used as follows:

1. CANCEL CLOCK - Stops the RTC.
2. CANCEL SATCOM (, sat. no.) - Disables satellite communication to the specified satellite. If the name is not present disable all satellite communication; otherwise disable the specified satellite. If the satellite has already been disabled the message "SAT. XX ALREADY CANCELLED" is displayed on the CRT, where XX is the satellite number.
3. CANCEL BGCNOM - Disables communication to the background processor. The same constraints as specified in the BEGIN command apply here.
4. CANCEL N-SCAN (, sat. no. (, sat. no.) ...) - Stops normal sampling of the specified satellite. The same intent and conditions apply here as explained under N-SCAN in the BEGIN command.
5. CANCEL BACKUP - Stops the store of data on the backup magnetic tape. The intent and constraints which were discussed in the BEGIN backup command apply here as well.
6. CANCEL F-SCAN (, sat. no., type . code (, type . code) ...) - Cancel the fast-scan sampling of the specified satellite including the sensor list which applies to the satellite. There may be up to five sensors in the list and each one is specified by sensor type and code. In order to cancel F-SCAN, satellite communication must be linked to the appropriate satellite and be in the running mode. The RTC must be running and BACKUP must not be in use. The operator must ensure that BACKUP and F-SCAN tapes are not both mounted.

DATE Command

The DATE Command is used to display and/or modify the date. It has the following format:

DATE (mm/dd/yy)

The DATE Command can be used as follows:

1. DATE - This command, when initiated by the operator, displays the date on an alphanumeric CRT.
2. DATE (mm/dd/yy) - This command changes the date to the operator-entered date.

RATE Command

The RATE Command is used to display and/or modify the DATARCS sample rates. The format is:

RATE sat. no. (, type (. code (. code) ...)) = Sample Rate

There may be only one sampling rate specified. However, it may apply to more than one sensor of the specified satellite. The allowable sampling rates are:

- 15 samples/min
- 30 samples/min
- 60 samples/min

Each sensor will have a sensor type of Analog or Digital and the code identifies the sensor with a unique four-place alphanumeric. The first character of the sensor code must be alphabetic, the remaining three characters will be numeric. Note that to set the sampling rate, SATCOM does not need to be operational and communication does not need to be established with the appropriate satellite. Also CLOCK must be running for this command to be executed.

Note that the sampling rate may be set for a specified sensor within a specified satellite. If the sampling rate is not specified then the sampling rate will be displayed for a specified satellite number and selectable sensors, possibly all sensors within the satellite complex.

SEND Command

The SEND Command is used to transmit an operator's command to a satellite. It has the following format:

SEND sat. no., message

Note that communication with the satellite must be enabled, SATCOM running and the CLOCK operational. The message may be any alphanumeric string within the limitation of I/O format control and the constraints of the sending device.

STATUS Command

The STATUS Command is used to display the DATARCS status. It has the following format:

STATUS (name)

The variable states of a partition include resident, swappable, run enabled, not enabled, running and not running. If no partitions are loaded the command is not executed. If a name is not specified the status of all preselected system variables are displayed on the CRT. The STATUS Command can be used as follows:

1. STATUS - Display all DATARCS system status indicators.
2. STATUS CLOCK - Display RTC status.
3. STATUS SATCOM - Display the status of all satellites.
4. STATUS N-SCAN - Display status of normal-scan sampled data. This includes the sampling rate and the list of satellites with communication enabled/disabled.
5. STATUS BACKUP - Display the status of the BACKUP tape; that is, has the DATARCS BACKUP tape been utilized or is the BACKUP tape currently in use?
6. STATUS F-SCAN - Display the status of the fast-scan sampling. This includes display of sampling rate currently in use, display of the satellite communication status, display of the sensor type (analog or digital) and sensor code.

TIME Command

The TIME Command is used to display and/or modify the time. It has the following format:

TIME (hh:mm.mmm)

The TIME Command can be used as follows:

1. TIME - Displays the current time in the format hh:mm.mmm, where h is an hour digit and m is a minute digit. Note that time is displayed to the nearest thousandth of a minute.
2. TIME (hh:mm.mmm) - Changes the time in the DATARCS system to the operator input time within the parenthesis.

Disk Files

The DATARCS maintains three files on the cartridge disk. They are Sensor Definition, Sample Control and Data Base. All of these files are random access in a binary format, they are not accessible directly from the standard DOS.

Sensor Definition File

This is a file of sensor definition records, one record for each sensor on each satellite. These records are either 32 or 64 bytes, depending on whether the sensor is digital or analog. The records are grouped in blocks of 512 bytes (1 sector) and the blocks are arranged in the sequences as shown in Table 3.

Note that space is reserved for all 160 analog and 512 digital sensors on all satellites. Records are written initially to this file by the Satellite Control Program Loader in the background computer during the satellite load function.

Records in this file follow the format shown in Figure 8. This file is generated from the sensor definition cards which follow the format shown in Figure 9. The translation from the sensor definition cards to the sensor definition file is described later in this report.

Sample Control File

This file contains one 2,048 byte record for each satellite. These records are used to store the normal scan sampling rate assigned to each sensor on each satellite. Records are arranged as shown in Table 4.

The format of each record is shown in Figure 10.

Data Base File

The DATARCS Data Base is a random access file containing chained, variable length records in 2,048 byte blocks.

The DATARCS maintains a Chain Control Table in the core memory which contains head and tail pointers for each record chain and each record contains a next-in-chain pointer for the next record in the same chain. Each of these pointers consist of two words, word one points to the relative block address (RBLA), and word two points to the relative byte address (RBYA) of the record within the block. The chains are arranged sequentially according to the time at which the record was written on the data base. Therefore, the head of chain pointer in the core table points to the earliest record in the chain, the tail of chain pointer points to the latest record.

Data base blocks are numbered sequentially as shown in Table 5.

Even though the number of blocks is finite, the DATARCS is designed to update the data base indefinitely. To do this the DATARCS uses the Logical Block concept. Initially, when the DATARCS is first loaded the first Logical Block, which contains the earliest record on the data base, corresponds to Relative Block 1 and the last Logical Block, which contains the latest record, also corresponds to Relative Block 1. As more and more records are written the last Logical Block moves down the data base through Relative Blocks 1, 2, 3, etc. Eventually the last Logical Block will correspond to Relative Block 1,200 and when that block is filled the data base must then begin to write

TABLE 3 SENSOR DEFINITION FILE

<u>Relative Sector Number</u>	<u>Relative Block Number</u>	<u>Built-in Monitor Satellite</u>	<u>Sensor Channel Number</u>
1	1	Built-in Monitor	1 to 8
2	2	Built-in Monitor	9 to 16
-	-	-	-
-	-	-	-
-	-	-	-
-	-	-	-
20	20	Built-in Monitor	153 to 160
21	21	Built-in Monitor	161 to 168
22	22	Built-in Monitor	169 to 176
-	-	-	-
-	-	-	-
-	-	-	-
-	-	-	-
52	52	Built-in Monitor	665 to 672
53	53	Satellite 1	1 to 7
-	-	-	-
-	-	-	-
-	-	-	-
-	-	-	-
104	104	Satellite 1	665 to 672
105	105	Satellite 2	1 to 7
-	-	-	-
-	-	-	-
-	-	-	-
-	-	-	-
512	512	Satellite 15	665 to 672

1	2	3	5	29	31	33	41	45	64
Sample Rate	BB	BB	X	Special Control Word	BB	BB	X	Low Range	BB
Sensor Code	BB	BB	X	Engineering Unit Number	BB	BB	X	High Range	BB
Satellite No.	BB	BB	X	Sensor Description	BB	BB	X	Control Data	BB
								Setpoints	BB
								Low	BB
								Warning	BB
								Caution	BB
								Caution	BB
								Warning	BB
								Alarm	BB
								Control	BB
								High	BB
								Control	BB
								Alarm	BB
								Warning	BB
								Caution	BB
								Caution	BB
								Warning	BB
								Alarm	BB
								Intercept	BB
								Scale Factor	BB
								Slope	BB

(a) Analog Sensor Record Format (Record Length = 32 Words)

1	2	3	5	29	31	32
Sample Rate	BB	BB	X	Special Control Word	BB	BB
Sensor Code	BB	BB	X	Sensor Description	BB	BB
Satellite No.	BB	BB	X	Control Word	BB	BB
				I/O Channel	BB	BB
				Number	BB	BB

(b) Digital Sensor Record Format (Record Length = 16 Words)

1	3	6	80
Built-in Monitor Records	Satellite 1 Records	Satellite 15 Records	
Analog Sensors	Digital Sensors		

(c) Sensor Definition File Sequence (Each File = 80 Blocks, Each Block = 256 Words)

FIGURE 8 SENSOR DEFINITION FILE

TABLE 4 SAMPLE CONTROL FILE

<u>Relative Sector Number</u>	<u>Relative Record Number</u>	<u>Built-in Monitor or Satellite</u>
1 to 4	1	Built-in Monitor
5 to 8	2	Satellite 1
9 to 12	3	Satellite 2
13 to 16	4	Satellite 3
-	-	-
-	-	-
-	-	-
-	-	-
-	-	-
61 to 64	16	Satellite 15

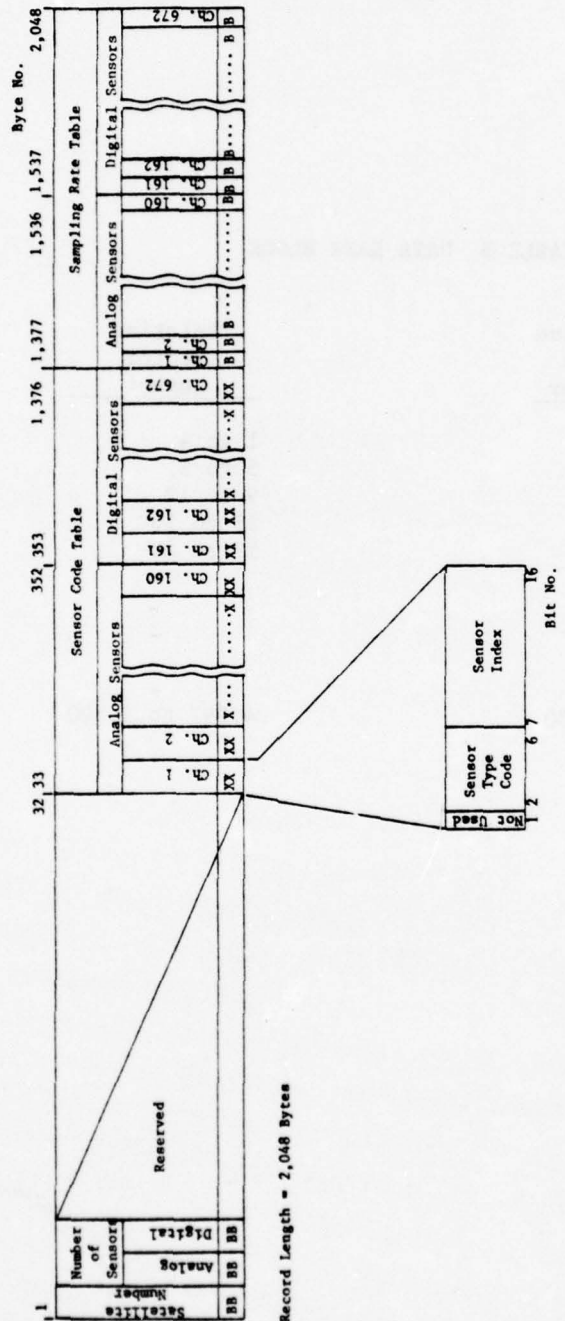

FIGURE 10 SAMPLE CONTROL FILE RECORD

TABLE 5 DATA BASE BLOCK

<u>Relative Block Number</u>	<u>Relative Sector Number</u>
1	1 to 4
2	5 to 8
3	9 to 12
4	13 to 16
5	17 to 20
-	-
-	-
-	-
-	-
-	-
1,200	4,797 to 4,800

over itself. When this happens all of the records in the first Logical Block are deleted from the data base, with the associated head of chain pointers corrected, and the first Logical Block will then correspond to Relative Block 1. As even more records are written, both the first and last logical blocks will move down the data base. This process can continue indefinitely, with the data base always containing the most recent 1,200 blocks of data.

The actual time span covered by the data base depends on the amount of data written per unit time which is a function of the number of satellites collecting data and the length of each record generated.

Figure 11 shows the general format of a data base block, including the control information contained in all records. Currently, the DATARCS maintains three types of records on the data base with separate chains for each type on each satellite.

Type 1, shown in Figure 12, contains command log messages received from the satellite.

Type 2, shown in Figure 13, contains analog sensor data collected during the normal scan process.

Type 3, shown in Figure 14, contains normal scan digital data.

Tape Files

The DATARCS can generate two files on magnetic tape, although not simultaneously. They are the Data Base Backup tape file and the Fast Scan tape file. Both files are written in binary format in 2,048 byte blocks.

Data Base Backup Tape File

This file is in identical format with the DATARCS data base but it should be treated as a sequential file since the next-in-chain pointers in each record become meaningless.

Note that the first block written on the tape is always the first Logical Block on the data base when BACKUP is begun. Since each block contains a pointer to the relative byte address of the first record starting in the block, and each record contains a count of the number of bytes it contains, it is not difficult to treat this file sequentially.

Fast Scan Tape File

The format of the Fast Scan tape file is shown in Figure 15.

Sensor Table Builder

The sensor definition cards contain the following information:

1. Satellite controller number in which the sensor is located
2. I/O channel number whereby the sensor is transmitted

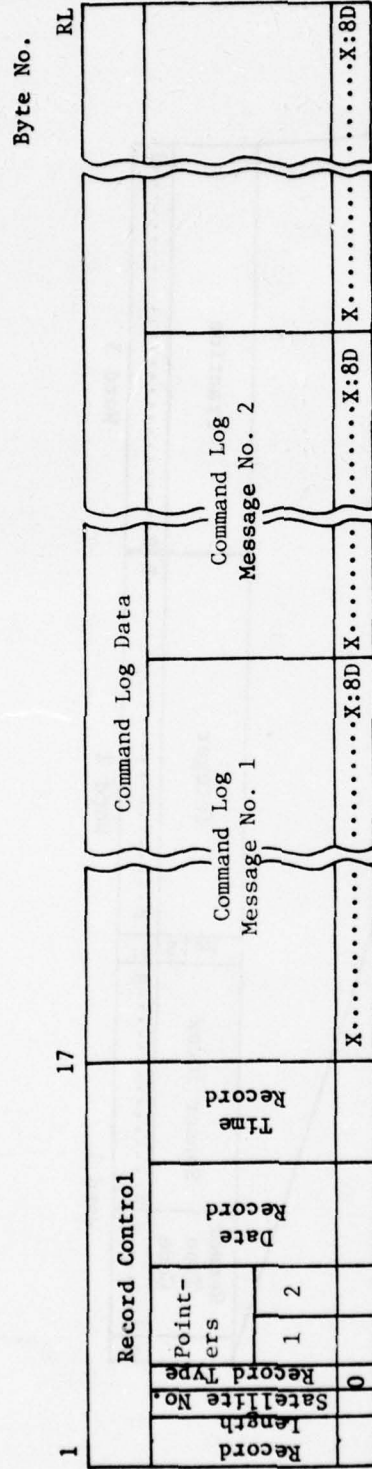

- RL = 16 + (Command Log Data Length)
- Each Command Message Length Less Than or Equal to 40 Words
- Each Command Message Terminated by a Carriage Return Code (:8D)
- Each Record Less Than or Equal to 708 Bytes

FIGURE 12 COMMAND LOG DATA BASE RECORD

Byte No. RL

1		Record Control				Sensor Data				Sensor n				
Record Length	Satellite No.	Record Type	Point-ers		Date Record	Time Record	Sensor Code	Scaled Sensor Data	Sensor Code	Scaled Sensor Data	Sensor Code	Scaled Sensor Data	Sensor Code	Scaled Sensor Data
BB	B	1	1	2	BBBB	BBBB	BB	BBBB	BB	BBBB	BB	BBBB	BB	BBBB

RL = 16 + 16n (typically < 976 bytes)
 n = No. of Sensors

Word 1		Word 2		Word 3	
Sensor Type Code	Sensor Index	Integer	Fraction		
0 A.....A B.....B ±	B.....B ±	B.....B	B.....B	B.....B	

FIGURE 13 ANALOG SENSOR DATA BASE RECORD

3. Sensor code
4. Sensor description
5. Sample rate
6. Engineering unit
7. Scale factor (offset and slope)
8. Allowable range
9. Control setpoints
10. Caution/Warning/Alarm setpoints

The format of the sensor definition cards was shown in Figure 9. Type 1 cards include information of items 1 through 7 and Type 2 cards include that of items 8 through 10. Each analog sensor requires two 80-column cards, a Type 1 and a Type 2, to define the sensor characteristics. A digital sensor does not require allowable range, control setpoints and caution/warning/alarm setpoints and needs only one 80-column card (Type 1 only).

After the sensor definition cards are prepared the sensor definition file can be generated automatically by the Sensor Table Builder program. This operation is described by Figure 16.

The sensor definition file has basically the same information as the sensor definition cards but in a different format (See Figures 8 and 9). The allowable range and setpoints are in engineering units on the sensor definition cards but are in a computer-readable binary form in the sensor definition file. The sensors in the sensor definition file are arranged in chronological order with digital sensors following the analog sensors. Each analog sensor requires 32 words of computer memory and each digital sensor requires 16 words.

Satellite Control Program Loader

The C/M I program of a satellite controller can be modified or even redesigned by a user on the DAS background computer. When a new C/M I program is ready to be loaded into the satellite controller the Satellite Control Program Loader can be called by the operator using a standard operating system command. (3) When the Loader is executed the C/M I program is transmitted from the background computer to the foreground computer and then to the designated satellite controller.

After the C/M I program is loaded in a satellite controller, the DAS background computer then queries the user to initialize the DATARCS sample control and sensor definition records. If the user decides to do so the sensor definition file in the background computer is then transmitted to the foreground, replacing the old file.

Report Generation Programs

There are three programs in the background system that produce reports of the testing data stored in the foreground system. The testing data consist of the sensor data and the operator commands recorded on the DATARCS data base for a given satellite. The three report generation programs are:

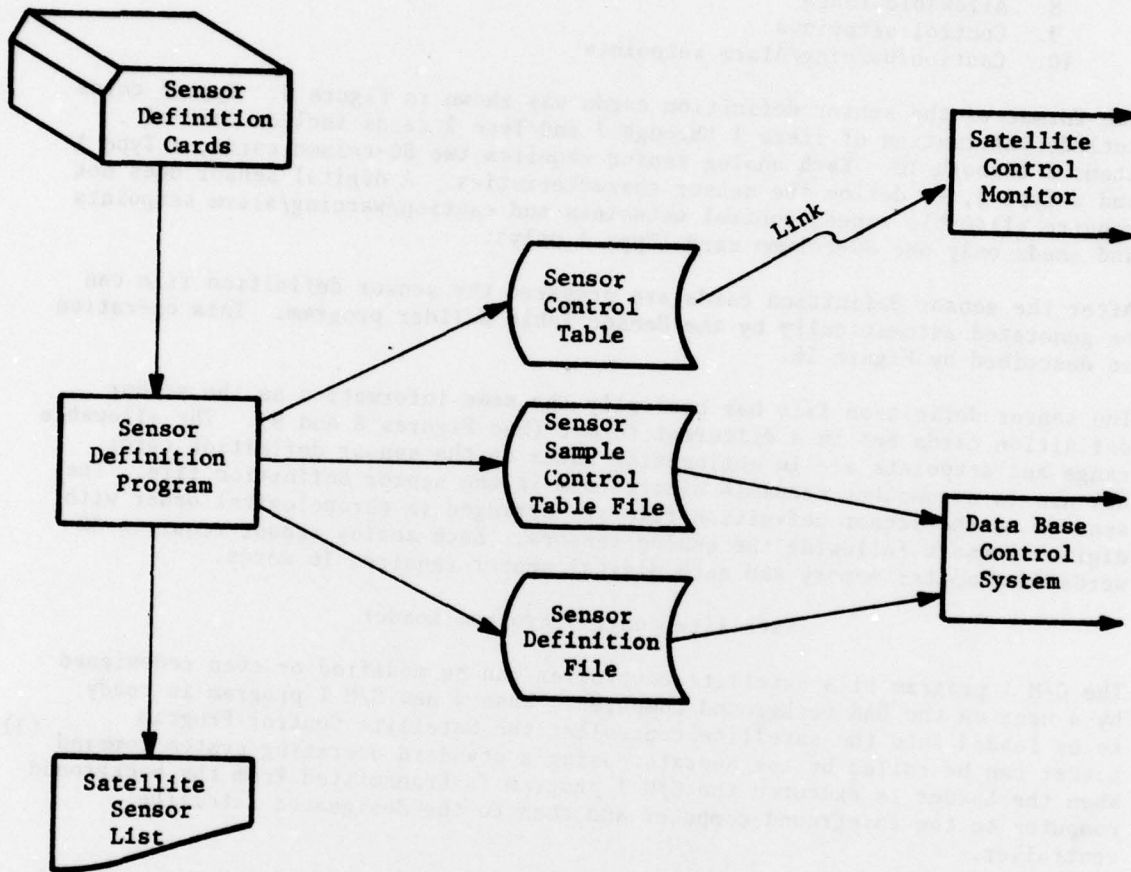

FIGURE 16 SENSOR DEFINITION PROCESS

- The On-Call Report Generator
- The 24-hour Report Generator
- The Command Log Generator

On-Call Report Generator

The On-Call Report Generator lists the individual sensor values recorded for each sensor attached to a given satellite. An example is shown in Figure 17.

The On-Call Report Generator Program was designed to communicate with the operator in an interactive manner. Once the report generator is called by a user the program will begin with a series of questions intended to establish the time period the report should cover. These question and answer interchanges should then establish the beginning and ending point of the samples. Only the samples recorded after the beginning point, but before the ending point, will be included in the report printout. When requesting a report printout the operator may also specify some of the sensors be excluded from the report. In addition, the operator may specify that only one out of a number of records be printed out in the report. For example, the operator may elect to report every fourth record and thus cut down the number of records printed by 75%.

24-Hour Report Generator

The 24-Hour Report Generator collects and summarizes all sensor data stored on the DATARCS data base over a specified period of time. It does not print out the individual sensor reading as the On-Call Report Generator would. Instead, the average, minimum and maximum sensor data values within the specified beginning/ending time are listed. In addition, the number of excursions beyond limits are included in the report. These numbers are calculated by comparing the sensor data values against the high and low alarm/warning/caution setpoints of that particular sensor. Figure 18 is an example of the 24-hour report.

Command Log Report Generator

The Command Log Report Generator lists all the operator commands entered to a given satellite. Figure 19 is an example of the Command Log Report.

DAS Data Flow

Figure 20 depicts the major data flows in the DAS.

The sensor definition cards prepared by the user are read by the card reader into the background computer. The information is then stored on the background disk in the form of a sensor sample control file and sensor definition file. These two files are also linked into the satellite controller program and become part of it. During the satellite controller program loading, the satellite controller program, which contains the sensor definition, is transmitted from the background disk to the background computer, then to the foreground computer and finally to the satellite controller. At the same time, upon the operator's initiation, the sensor sample control/sensor definition files are transmitted via the background computer to the foreground computer.

THIS PAGE IS BEST QUALITY PRACTICABLE
FROM COPY FURNISHED TO DDC

-----LIFE SYSTEMS, INC. - DATABASE CONTROL SYSTEM-----
ON CALL REPORT START 10/19/77 00:00 PAGE 1
SATTELLITE SO STOP 10/20/77 00:00 REPORTED MM/DD/YY 00:01

-----ANALOG SENSORS-----
10/19/77 10:01.206 (IOCH.CODE=VALUE)
0.L101= 60.205 1.I101= 2.2779 2.T101= 98.291
3.J101= 504.38 4.W201= 9.8340 5.W202= 10.840
6.L201= 47.339 7.P201= 9.6387 8.P202= 39.429
9.P203= 9.1431 10.T201= 150.66 11.J201= 6.3867
12.I201= 3.4131 15.C401= 175.61 16.W401= 3.9624
17.W402= 4.8065 18.P401= .26855 19.P402= 34.204
24.T401= 183.91

-----DIGITAL SENSORS-----
10/19/77 10:01.208 (IOCH.CODE=VALUE)
167.L424=OFF 170.P421=OFF 171.P422=OFF

-----ANALOG SENSORS-----
10/19/77 10:06.065 (IOCH.CODE=VALUE)
0.L101= 44.824 1.I101= 1.1719 2.T101= 64.893
3.J101= 396.09 4.W201= 7.8906 5.W202= 60.645
6.L201= 36.914 7.P201= 7.3096 8.P202= 28.589
9.P203= 15.857 10.T201= 120.85 11.J201= 9.1992
12.I201= 4.2579 15.C401= 277.07 16.W401= 2.7148
17.W402= 4.1162 18.P401= 5.1392 19.P402= 27.515
24.T401= 167.72

-----DIGITAL SENSORS-----
10/19/77 10:06.072 (IOCH.CODE=VALUE)
167.L424=OFF 170.P421=OFF 171.P422=OFF

FIGURE 17 ON-CALL REPORT

-----LIFE SYSTEMS, INC. - DATABASE CONTROL SYSTEM-----
 24 HOUR REPORT
 SATELITF 30
 START 07/17/78 1200
 STOP 07/17/78 1800
 REPORTED 07/17/78 1711

-----ANALOG SENSOR ANALYSIS-----

CODE	DESCRIPTION	NO. SMP	AVERAGE VALUE	UNITS	MINIMUM		MAXIMUM		EXCURSIONS BEYOND LIMITS							
					VALUE	TIME	VALUE	TIME	BELOW WARM	LOW	CAUT.	CAUT.	WARM	ALARM		
V101	TURBIDITY (SCENT.)	10	310	NTU	182	08	570	08	00	00	00	00	00	00	00	00
V102	TANK WATER LEVEL	10	14	INCH	10	08	14	08	00	00	00	00	00	00	00	00
V103	TANK WATER LEVEL	10	14	INCH	10	08	14	08	00	00	00	00	00	00	00	00
V201	FILTER DIFF. PRESSURE	10	20	PSID	20	08	20	08	00	00	00	00	00	00	00	00
V202	FILTER DIFF. PRESSURE	10	20	PSID	20	08	20	08	00	00	00	00	00	00	00	00
V203	MODULE DIFF. PRESSURE	10	20	PSID	20	08	20	08	00	00	00	00	00	00	00	00
V204	CONCENTRATE ALARM	10	20	PSID	20	08	20	08	00	00	00	00	00	00	00	00
V205	PERMEATE FLOW RATE	10	20	GPM	20	08	20	08	00	00	00	00	00	00	00	00

THIS PAGE IS BEST QUALITY PRACTICABLE FROM COPY FURNISHED TO DDG

FIGURE 18 24-HOUR REPORT

THIS PAGE IS BEST QUALITY PRACTICABLE
FROM COPY FURNISHED TO DDC

-----LIFE SYSTEMS, INC. - DATABASE CONTROL SYSTEM-----			
COMMAND LOG	START 06/23/77 06:00	PAGE	1
SATELLITE S1	STOP 06/23/77 18:00	REPORTED MM/DD/YY	00:06
06/23/77 12:40.780	1234,0,	SOURCES D	'
06/23/77 12:40.952	1234,N,	NORMAL	'
06/23/77 12:41.176	1234,S,	STANDBY	'

FIGURE 19 COMMAND LOG REPORT

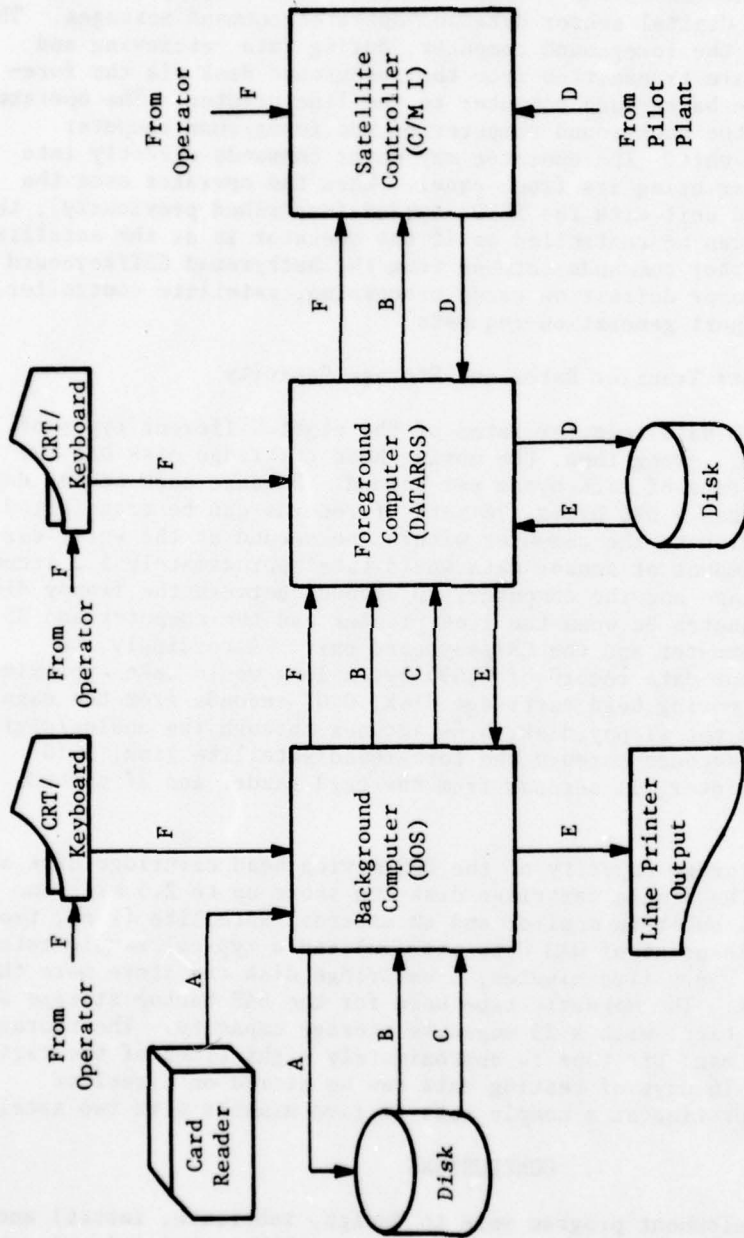

Where A = Sensor Definition
 B = Satellite Controller Program, C = Sensor Sample Control/Sensor Definition Files
 D = Testing Data, E = Stored Testing Data and F = Operator Commands

FIGURE 20 DAS DATA FLOW

During a normal data acquisition operation, testing data from the WPS Pilot Plant are collected by the satellite controller and transmitted to the foreground computer to be stored on the foreground disk. The testing data consists of analog sensor data, digital sensor data and operator command messages. The stored testing data on the foreground computer, during data retrieving and reporting operations, are transmitted from the foreground disk via the foreground computer and the background computer to the line printer. The operator may enter commands to the background computer or the foreground computer through a CRT/keyboard unit. The operator may enter commands directly into the satellite controller using its front panel. When the operator uses the foreground CRT/keyboard unit with the SEND command (described previously), the Pilot Plant operation can be controlled as if the operator is at the satellite controller site. Operator commands entered from the background CRT/keyboard unit are limited to sensor definition cards processing, satellite controller program loading and report generation requests.

Data Transfer Rates and Storage Capacity

Figure 21 shows the DAS data transfer rates of the eight different types of communication channels. Among them, the moving head cartridge disk has the highest data transfer rate of 312K bytes per second. Because each sensor data record requires less than 4,096 bytes, 76 sets of records can be transferred from the moving head disk to the computer within one second at the worst case. To transfer the same amount of sensor data would take approximately 5.2 seconds between the magnetic tape and the computer, 10 seconds between the floppy disk and the computer, 4 minutes between the line printer and the computer and 35 minutes between the computer and the CRT/keyboard unit. Accordingly, to transfer a set of sensor data record of 4,096 bytes long would take approximately 0.01 seconds from the moving head cartridge disk, 0.07 seconds from the magnetic tape, 0.13 second from the floppy disk, 0.44 seconds through the analog/digital interface board, 1.71 seconds through the foreground/satellite link, 3.10 seconds on the line printer, 11 seconds from the card reader and 27 seconds to the CRT/keyboard unit.

Figure 22 shows the storage capacity of the DAS moving head cartridge disk and the magnetic tapes. The single cartridge disk can store up to 2.5 million words of data. With a built-in monitor and an external satellite (i.e., two satellites from the viewpoint of DAS data storage) and a typical sample rate of one set of samples every five minutes, a cartridge disk can store more than two days' testing data. The magnetic tape used for the DAS backup storage are 8½-inch reel magnetic tapes with a 23 megabyte storage capacity. The storage capacity of a reel of magnetic tape is approximately eight times of the cartridge disks. Approximately 16 days of testing data can be stored on a reel of magnetic tape when operating at a sample rate of five minutes with two satellites.

CONCLUSIONS

The goals of this development program were to design, fabricate, install and check out a DAMCS with the capability of data acquisition, retrieval, report generation, program development and remote operations from the WPS Pilot Plant operator's station, biological treatment laboratory, chemistry laboratory, computer laboratory, project engineer's office and any remote terminal equipped

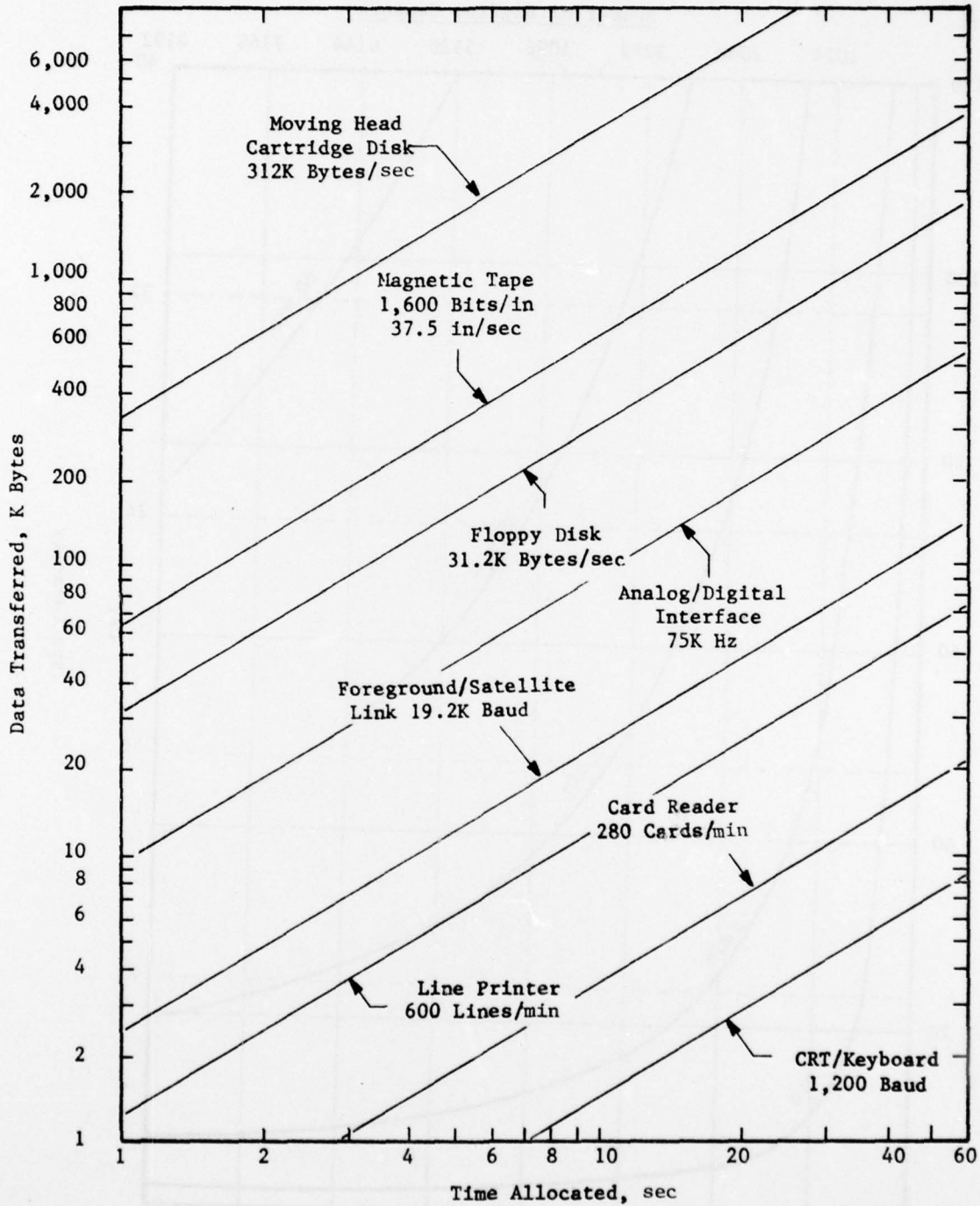

FIGURE 21 DAS DATA TRANSFER RATES

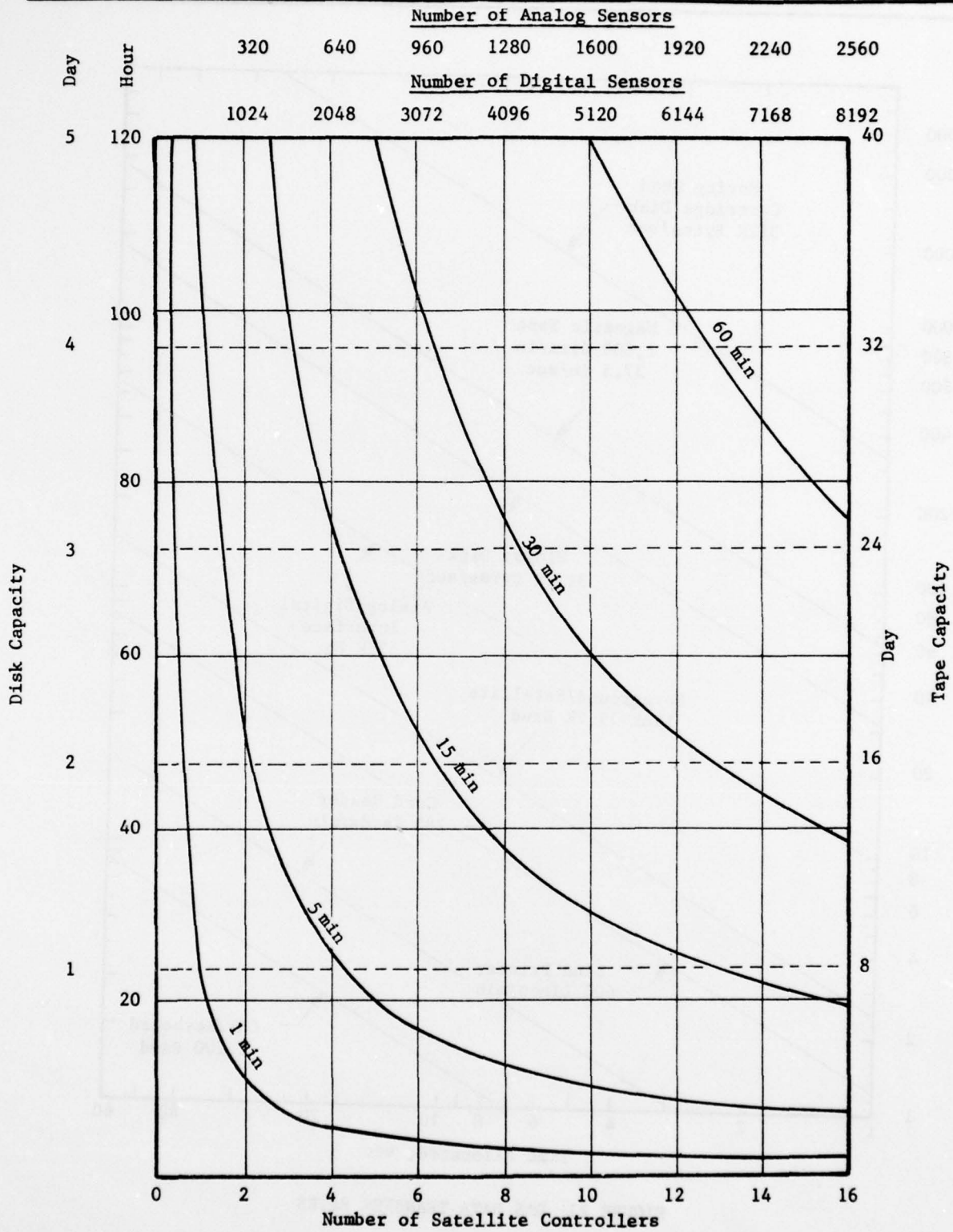

FIGURE 22 DISK AND TAPE CAPACITY BY SAMPLE PERIOD AND NUMBER OF SATELLITE CONTROLLERS

with a modem communication link. These goals were successfully achieved and the following conclusions reached:

1. Distributed processing is an effective technique in realizing a foreground/background system. The design was based on task distribution to multiple CPU's as opposed to dynamic software task scheduling on a single CPU. This technique fully utilized off-the-shelf hardware components for more cost effectiveness and better performance.
2. Multiplexing peripheral devices among computers in a distributed processing system is a cost effective design which allows flexible usage of peripheral devices.
3. The design using the private communication switch, local data sets and modems to link remote terminals to the DAS mainframe is a flexible and cost effective design which provides convenient remote control of the DAS from multiple points of command entry.
4. The fast scan sampling can run in a satellite controller only when the CPU time permits. For this reason, further distribution of the tasks is necessary in which a satellite controller is dedicated to the fast scan task only. Presently, the fast scan task is handled at the same priority level as the control and monitor tasks by Satellite 1 which has experienced task abortions when the CPU time ran out.
5. The modular programming approach to partition the DAS software is an effective design technique.
6. The DAS utility programs, including the sensor table builder, satellite control program loader and report generation programs, are useful to the Pilot Plant project engineers. Further data analyses programs are needed to process the testing data.

REFERENCES

1. Lee, M. K., Yang, P. Y., Wynveen, R. A. and See, G. G., "Pilot Plant Development of an Automated, Transportable Water Processing System for Field Army Medical Facilities," Final Report, Contract DAMD17-76-C-6063, ER-314-7-1, Life Systems, Inc., Cleveland, OH, June, 1978.
2. Yang, P. Y., Yeh, J. Y. and Wynveen, R. A., "Advanced Instrumentation Development for a Water Processing Pilot Plant for Field Army Medical Facilities," Technical Report, Contract DAMD17-76-C-6063, ER-314-7-4, Life Systems, Inc., Cleveland, OH, July, 1978.
3. "Operating System User's Manual," 96530-0004, Computer Automation, Inc., Irvine, CA, March, 1976.

DISTRIBUTION LIST

HQDA (SGRD-AJ) Fort Detrick Frederick, MD 21701	4 copies
Defense Documentation Center (DDC) Attn: DDC-TCA Cameron Station Alexandria, VA 22314	12 copies
Superintendent Academy of Health Sciences, US Army Attn: AHS-COM Fort Sam Houston, TX 78234	1 copy
Dean School of Medicine Uniformed Services University of the Health Sciences 4301 Jones Bridge Road Bethesda, MD 20014	1 copy
Commander US Army Medical Bioengineering Research and Development Laboratory Attn: SGRD-UBG Fort Detrick, Frederick, MD 21701	132 copies