

AD-A065 403

UNDERWRITERS' LABS INC NORTHBROOK ILL
FIRE TESTS OF POLYURETHANE FOAM ROOF DECK CONSTRUCTION ON STEEL--ETC(U)
DEC 78 K RHODES

F/G 13/13

N68305-78-C-0010

UNCLASSIFIED

CEL-CR-79.004

NL

1 OF
ADA
085403

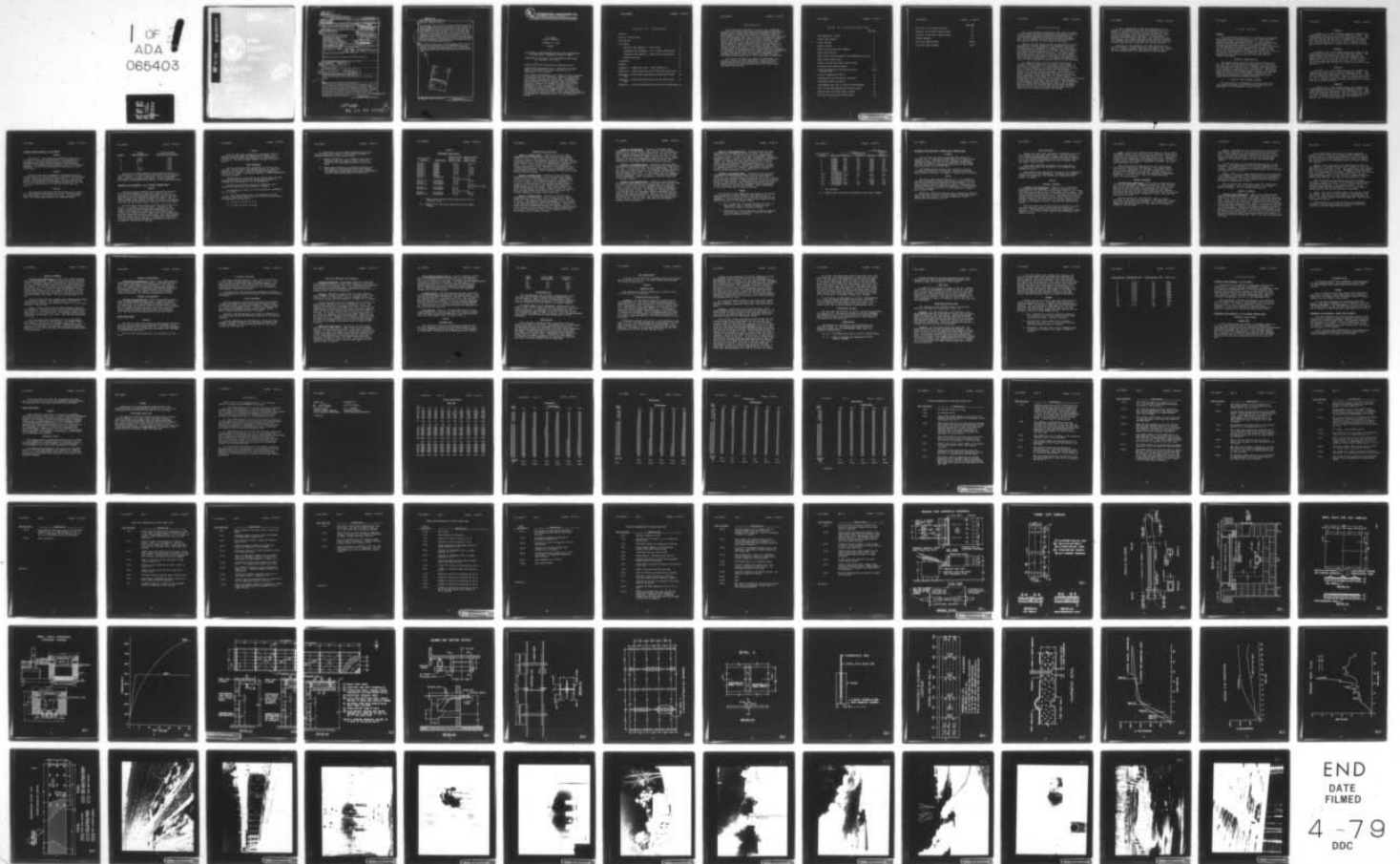

END
DATE
FILMED

4-79
DDC

DDC FILE COPY

ADA065403

64410N

SECRET UNCLASSIFIED

SECURITY CLASSIFICATION OF THIS PAGE (When Data Entered)

REPORT DOCUMENTATION PAGE		READ INSTRUCTIONS BEFORE COMPLETING FORM
1. REPORT NUMBER CR-79-004	2. GOVT ACCESSION NO.	3. RECIPIENT'S CATALOG NUMBER
4. TITLE AND SUBTITLE FIRE TESTS OF POLYURETHANE FOAM ROOF DECK CONSTRUCTION ON STEEL DECKS		5. TYPE OF REPORT & PERIOD COVERED Final Rept., December 1978
7. AUTHOR(s) Kenneth Rhodes		6. PERFORMING ORG. REPORT NUMBER USNC77; 77N11796
9. PERFORMING ORGANIZATION NAME AND ADDRESS Underwriters Laboratories Inc. 333 Pfingsten Road Northbrook, IL 60062		8. CONTRACT OR GRANT NUMBER(s) N68305-78-C-0010 New
11. CONTROLLING OFFICE NAME AND ADDRESS Civil Engineering Laboratory Naval Construction Battalion Center Port Hueneme, CA 93043		10. PROGRAM ELEMENT, PROJECT, TASK AREA & WORK UNIT NUMBERS 63724N; Z0829-01-004C; Z0371-01-007
14. MONITORING AGENCY NAME & ADDRESS (if different from Controlling Office) Naval Material Command Washington, DC 20360		12. REPORT DATE December 1978
16. DISTRIBUTION STATEMENT (of this Report) Approved for public release; distribution unlimited.		13. REPORT TYPE AND PERIOD OF PUBLICATION 101
18. SUPPLEMENTARY NOTES 20829, 20371		15. SECURITY CLASS. (of this report) Unclassified
19. KEY WORDS (Continue on reverse side if necessary and identify by block number) Roofs; polyurethane resins; expanded plastics; fire safety; foam		15a. DECLASSIFICATION/DOWNGRADING SCHEDULE
20. ABSTRACT (Continue on reverse side if necessary and identify by block number) Fire tests were conducted on built-up roof assemblies specified by the Navy consisting of spray-applied polyurethane foamed plastic covered with specified elastomeric coatings. The Standard UL 790 entitled "Tests for Fire Resistance of Roof Covering Materials," was utilized to measure the resistance to fire originating from sources outside a building on which they may		

12 96p.

→ over

DD FORM 1 JAN 73 1473 EDITION OF 1 NOV 65 IS OBSOLETE

UNCLASSIFIED
SECURITY CLASSIFICATION OF THIS PAGE (When Data Entered)

409630

79 03 06 024

B

UNCLASSIFIED

SECURITY CLASSIFICATION OF THIS PAGE (When Data Entered)

Block 20. Abstract Cont'd

be installed. A 20 ft by 100 ft building ("White House") was used to evaluate the ability of the built-up roof assembly to resist spread of fire on the underside as a result of fire originating from interior sources. Prior to the White House test, 25 ft tunnel tests and small-scale furnace tests were conducted to 1) provide data for screening and selection of candidate systems likely to perform successfully in the "White House" test and 2) provide additional data on underdeck spread of flame and damage for comparison with performance characteristics of "Fire Classified" assemblies.

As a result of these fire tests and comparisons with previous results for other assemblies, three candidate systems are eligible for Underwriters Laboratories Inc.'s Classification and Follow-Up Service as "Fire Classified" Roof Deck Constructions.

ACCESSION	
NTIS	White Station <input checked="" type="checkbox"/>
DDC	Buff Station <input type="checkbox"/>
UNANNOUNCED	<input type="checkbox"/>
JUSTIFICATION	<input type="checkbox"/>
BY	
DISTRIBUTION/AVAILABILITY CODES	
Dis:	SPECIAL
A	

UNCLASSIFIED

SECURITY CLASSIFICATION OF THIS PAGE (When Data Entered)



UNDERWRITERS LABORATORIES INC.
CHICAGO · NORTHBROOK, ILL. · MELVILLE, N.Y. · SANTA CLARA, CALIF.

an independent, not-for-profit organization testing for public safety

File USNC77
Project 77NK11796

December 29, 1978

REPORT

on

FIRE TESTS OF POLYURETHANE FOAM ROOF DECK CONSTRUCTION
ON STEEL DECKS STATEMENT OF WORK 77-0054

Department of the Navy, Civil Engineering Laboratory
Port Hueneme, California

Copyright (C) 1978 Underwriters Laboratories Inc.

Underwriters Laboratories Inc. authorizes the above
named to reproduce this Report provided it is
reproduced in its entirety.

"This report was prepared as an account of work sponsored
by the United States Government. Neither Underwriters
Laboratories Inc. nor the United States Government nor
any of their employees nor any of their contractors,
sub-contractors, or their employees make any warranty,
express or implied, or assumes any legal liability or
responsibility for the accuracy, completeness, or
usefulness of any information, apparatus, product, or
processes disclosed, or represents that its use would
not infringe on privately owned rights. This report may
not be used in any way to infer or to indicate acceptability
by Underwriters Laboratories Inc. for any product or
system."

T A B L E O F C O N T E N T S

Abstract	1
List Of Illustrations	3
Introduction	5
Fire Tests	7
Exterior Fire Exposure - UL790 Tests	9
Underdeck Fire Exposure - 25 Ft Tunnel Furnace Test	10
Underdeck Fire Exposure - Small Scale Furnace Test	18
White House Test	24
Discussion	35
Summary	39
Appendix A - Temperature Data - White House Test	41
Appendix B - Topside Observations Of The White House Test	47
Appendix C - South Side Observations Of The White House Test	53
Appendix D - North Side Observations Of The White House Test	57
Appendix E - Flue End Observations Of The White House Test	59

A B S T R A C T

Fire tests were conducted on built-up roof assemblies specified by the Navy consisting of spray-applied polyurethane foamed plastic covered with specified elastomeric coatings. The Standard UL 790 entitled "Tests For Fire Resistance Of Roof Covering Materials," was utilized to measure the resistance to fire originating from sources outside a building on which they may be installed. A 20 ft by 100 ft building ("White House") was used to evaluate the ability of the built-up roof assembly to resist spread of fire on the underside as a result of fire originating from interior sources. Prior to the White House test, 25 ft tunnel tests and small-scale furnace tests were conducted to 1) provide data for screening and selection of candidate systems likely to perform successfully in the "White House" test and 2) provide additional data on underdeck spread of flame and damage for comparison with performance characteristics of "Fire Classified" assemblies.

As a result of these fire tests and comparisons with previous results for other assemblies, three candidate systems are eligible for Underwriters Laboratories Inc.'s Classification and Follow-Up Service as "Fire Classified" Roof Deck Constructions.

L I S T O F I L L U S T R A T I O N S

	<u>ILL. No.</u>
Test Apparatus - UL790	1
Tunnel Test Samples	2
Tunnel Furnace	3
Tunnel Furnace	4
Small Scale Furnace Test Samples	5
Small Scale Furnace	6
Small Scale Furnace Exposure Time Temperature Curves	7
White House Construction	8
Blower and Ignition Detail (White House)	9
Bridging Detail (White House)	10
Steel Deck Fastening and Overlap Detail (White House)	11-12
Control Thermocouple Detail	13
Thermocouple and Calorimeter Locations	14
Calorimeter Mounting Detail	15
Time-Temperature Plot of Control Thermocouples	16
Plot of Flue End Temperatures (White House)	17
Radiant Heat Flux Graph (White House)	18
Post Test Observations (White House)	19

File USNC77

Issued: 12-29-78

	<u>ILL. No.</u>
Post Test 25 Ft Tunnel Flue End	20
Exterior of Structure (White House)	21
Interior of Structure (White House)	22
Burner Assembly	23
Fire Test (White House)	24-29
Post Test (White House)	30-31

I N T R O D U C T I O N

The Civil Engineering Laboratory (CEL) has an interest in roof systems for Navy installations throughout the world, including spray-applied polyurethane foam surfaced with fluid-applied elastomeric coatings and ceramic granules. This type of assembly would be particularly advantageous when applied directly to steel roofs of buildings.

Concern for fire safety as well as requirements of the Department of Defense resulted in recommending only those systems which are Classified as Class A, B or C Built-Up Roof Coverings as evaluated in accordance with the Standard of Underwriters Laboratories Inc. UL 790, "Tests For Fire Resistance Of Roof Covering Materials." The application of the foamed plastic directly to steel deck without thermal barrier protection may create the potential for the built-up roof covering to contribute to fire spread and damage as a result of fire originating from the interior of the building.

UL Classifications in the Roof Deck Construction category, wherein assemblies are evaluated with respect to internal fire exposures, are predicated on performance in datum tests conducted on full-scale constructions in a 20 by 100 ft building, hereinafter called the "White House." However, for certain roof deck systems, correlation of the results from the White House Test and tests in the 25-ft tunnel furnace has been developed, and Classifications have been established on the basis of 25 ft tunnel results. Information on the use of the 25 ft tunnel for such Classifications is described in the Subject 1256 "Outline Of The Proposed Investigation For Roof Deck Constructions." White House Test data on systems where foamed plastic insulation is spray-applied directly to the steel deck had not been developed. Thus, the use of the 25 ft tunnel furnace alone was not sufficient for Classification of such systems.

In this investigation, tests were conducted on four systems in accordance with UL 790 to establish Class C (or better) Classifications under the Built-Up Roof Covering Materials category. Each roof system consisted of a spray applied polyurethane foam covered with an elastomeric coating, both specified by the Navy. Following the UL 790 evaluations, 25 ft tunnel and small-scale furnace underdeck fire exposure tests were conducted on the four built-up roof systems utilizing both corrugated and ribbed steel deck.

Selection of the system for the White House Test was based on analysis of data obtained in the small-scale furnace and 25 ft tunnel underdeck fire exposure tests so as to be the most representative of these built-up roof systems.

F I R E T E S T SGENERAL:

The investigation consisted of 1) exterior fire exposure tests conducted in accordance with UL 790, "Tests For Fire Resistance Of Roof Covering Materials," 2) 25-ft tunnel furnace underdeck fire exposure tests, 3) small-scale furnace underdeck fire exposure tests and 4) a White House test. Two polyurethane foam materials, intended for spray application, and two elastomeric coating systems were utilized to form four built-up roof covering systems. For purposes of this report the foam materials will be referred to as "PUF 1" (2-1/2 pcf density) and "PUF 2" (3 pcf density). The coating systems will be referred to as "C1" (Silicone) and "C2" (Acrylic elastomer).

MATERIAL IDENTIFICATION

The foamed plastic material identified as PUF2 did not bear the label of Underwriters Laboratories for Classified Built-Up Roof Covering Materials. However, analysis verified that the material received was of the same basic composition as the material Classified by the Laboratories. The coating materials and the PUF1 foamed plastic material were produced under the Follow-Up Service Program as evidenced by the Classification Marking of Underwriters Laboratories for Classified Built-Up Roof Covering Materials.

BUILT-UP ROOF COVERING SYSTEMS

The following is a description of the four built-up roof covering systems utilized for this investigation as referenced in the "Statement of Work 77-0054."

System 1

A nominal 3 in. thick foamed plastic was formed by the simultaneous spraying of two liquid components (PUF1). The foamed plastic was coated with a two coat system (C1). Both the base coat and the top coat were applied at the nominal rate of 1-1/2 gal per 100 sq ft. (Total 3 gal per 100 sq ft). With the top coat still wet, No. 11 mineral roofing granules were applied at a nominal rate of 50 lb per 100 sq ft.

System 2

A nominal 3 in. thick foamed plastic was formed by the simultaneous spraying of two liquid components (PUF2). The foamed plastic was coated with a two coat (system C1). Both the base coat and the top coat were applied at the nominal rate of 1-1/2 gal per 100 sq ft. (Total 3 gal per 100 sq ft). With the top coat still wet, No. 11 mineral roofing granules were applied at a nominal rate of 50 lb per 100 sq ft.

System 3

A nominal 3 in. thick foamed plastic was formed by the simultaneous spraying of two liquid components (PUF1). The foamed plastic was coated with a two coat system (C2). Each coat was applied at the nominal rate of 1-1/2 gal per 100 sq ft (total 3 gal per 100 sq ft). With the second coat still wet, No. 11 mineral roofing granules were applied at a nominal rate of 50 lb per 100 sq ft.

System 4

A nominal 3 in. thick foamed plastic was formed by the simultaneous spraying of two liquid components (PUF2). The foamed plastic was coated with a two coat system (C2). Each coat was applied at the nominal rate of 1-1/2 gal per 100 sq ft (total 3 gal per 100 sq ft). With the second coat still wet, No. 11 mineral roofing granules were applied at a nominal rate of 50 lb per 100 sq ft.

EXTERIOR FIRE EXPOSURE UL 790 TESTS:

SAMPLES

The built-up roof covering systems were applied to 13 ft long by 40 in. wide plywood decks. The systems were prepared by craftsmen contracted by the Laboratories in accordance with instructions provided by each materials supplier. The assemblies were allowed to cure at an ambient temperature of 70 F for a minimum of 27 days prior to the fire tests.

METHOD I

The fire tests were conducted in accordance with the Standard Tests For Fire Resistance Of Roof Covering Materials, UL 790. The test apparatus is shown by ILL. 1. At the conclusion of the spread-of-flame tests, the requirements are that the flaming shall not have spread beyond 6 ft for Class A, 8 ft for Class B and 13 ft (the top of the deck) for Class C.

RESULTS

The Spread-Of-Flame Tests were conducted with a Class A gas flame applied continuously for 10 min. The test decks were positioned at an incline of 3-1/2 in. per horizontal foot. The flame spread results are tabulated below:

<u>System</u>	<u>Maximum Flame Spread (Ft)</u>	<u>Time Of Maximum Flame Spread (Min:Sec)</u>
1	4-1/2	3:20
1	4-1/2	2:30
2	11-1/2	4:10
2	12	4:30
3	5	4:00
3	5	3:15
4	4-1/2	5:00
4	5-1/2	4:00

No flying or flaming brands of roof covering material nor exposure of the roof deck occurred during any of the above tests. Systems 1, 3 and 4 comply with Class A requirements when applied to non-combustible decks. System 2 complies with Class C requirements when applied to non-combustible decks.

UNDERDECK FIRE EXPOSURE - 25 FT TUNNEL FURNACE TEST"

SAMPLES

The spray applied foamed plastic and coating built-up roof covering systems were applied to nominal 2 by 8 ft sections of 26 gauge galvanized steel deck (raised rib and corrugated) with a longitudinal centerline seam. The joint detail, support and fastener schedule are shown by ILL. 2. A chlorinated rubber primer was used to provide a recommended bond coat for the foamed plastic material to the steel deck.

For each test, three sections of deck were joined with a 1-1/2 in. overlap of the steel deck. Because of the manner in which the corrugated decks contacted the tunnel ledges a duplicate set of tests was conducted with 1 in. mineral wool insulation positioned on the tunnel ledges to provide a more positive seal. These tests will be identified with the letter "I" in the results below. The foamed plastic material was allowed to cure for a minimum of 16 days prior to testing. The coating systems were allowed to cure for a minimum of 7 days prior to testing.

METHOD

The fire tests were conducted in accordance with the methods described under the Laboratories' Subject 1256 "Outline Of The Proposed Investigation For Roof Deck Construction." The 25 ft tunnel furnace is shown by ILLS. 3 and 4.

Test Procedure

The test assemblies were subjected to a 30 min fire exposure. After 10 min, the maximum distance of flame propagation was recorded. After 20 min more of exposure to flame (30 min total), the maximum distance of flame propagation was again recorded.

Observations were made during the testing from the open fire end and side of the tunnel furnace with respect to flammability characteristics of the assemblies.

Following the exposure period the assemblies were removed for examination with respect to damage.

The guideline criteria for "Fire Classified" assemblies are as follows:

1. The flame propagation on the underside of each assembly tested shall not exceed the following limits within the designated time periods:

- A. 10 feet (3.04 m) in 10 min
- B. 14 feet (4.26 m) in 30 min

2. Examination of fire tested assemblies shall show the following, with respect to the extent of damage of component materials of the construction:

- A. Thermal degradation (i.e., damage in the form of charring, loss of integrity, etc.) shall not extend to the downstream extremity of the test deck.
- B. Damage shall diminish at increasing distance from the immediate fire exposure area to the extent that material located beyond the area of degradation could be judged acceptable for further use.

RESULTS

Underdeck Flame Spread

<u>Roof Covering System</u>	<u>Steel Deck</u>	<u>Maximum Flame Spread (Ft)+ After 10 Min</u>	<u>Maximum Flame Spread (Ft)+ After 30 Min</u>
System 1	Ribbed	10-1/2	10-1/2
System 1	Ribbed	8-1/2	9
System 2	Ribbed	9-1/2	9-1/2
System 2	Ribbed	7-1/2	7-1/2
System 3	Ribbed	9-1/2	12-1/2
System 3	Ribbed	6-1/2	6-1/2
System 4	Ribbed	5-1/2	5-1/2
System 4	Ribbed	5	5
System 1	Corrugated	19-1/2	-
		at 5 min, 48 sec	
System 1(I)	Corrugated	8-1/2	8-1/2
System 2	Corrugated	3-1/2	4
System 2(I)	Corrugated	8-1/2	19-1/2
		at 17 min, 24 sec	
System 3	Corrugated	12-1/2	12-1/2
System 3(I)	Corrugated	19-1/2	-
		at 7 min, 45 sec	
System 4	Corrugated	13-1/2	13-1/2
System 4(I)	Corrugated	6-1/2	6-1/2

+ - Flame travel recorded during test minus 4-1/2 ft igniting flame.

(I) - Mineral wool insulation positioned on the tunnel ledges.

Observations During Test

System 1 (Ribbed Deck) - Ignition of the roof deck assemblies at the centerline joint occurred after elapsed times of 1 min, 10 sec and of 1 min, 36 sec, respectively, for the two tests. The underdeck flaming in the first test progressed 4-1/2 ft, followed by intermittent flashes of flame, which started after 3-1/2 min of elapsed time, and ceased after 7 min. In the second test the initial underdeck flaming progressed to 8 ft, followed by intermittent flashes of flame which started after 9-1/2 min of elapsed time and ceased after 10-1/2 min. After termination of the tests there was no residual flaming.

System 2 (Ribbed Deck) - Ignition of the roof deck assemblies at the centerline joint occurred after elapsed times of 1 min, 30 sec and of 1 min, 40 sec, respectively, for the two tests. The underdeck flaming progressed 5-1/2 to 6-1/2 ft early in the tests followed by intermittent flashes of flame outward to the maximum recorded extent of flame spread. After 10 min the intermittent flashes of flame had ceased in both tests. After termination of the test a slight amount of residual flaming at the fire-end of the first deck section was noted in the first test. No residual flaming was noted in the second test.

System 3 (Ribbed Deck) - Ignition of the roof deck assemblies at the centerline joint occurred after elapsed times of 45 sec and of 1 min, 15 sec, respectively, for the two tests. The underdeck flaming progressed 5 to 6 ft early in the test followed by intermittent flashes of flame outward to the maximum recorded extent of flame spread. In the first test the intermittent flashes of flame continued through 18 min, whereas in the second test the flashes ceased prior to 10 min of elapsed test time. After termination of the tests there was no residual flaming.

System 4 (Ribbed Deck) - Ignition of the roof deck assemblies at the centerline joint occurred after elapsed times of 1 min and of 58 sec, respectively, for the two tests. The underdeck flaming progressed 4-1/2 to 5 ft early in the test. Momentary flashes of flame occurred at 5 min, 22 sec and at 6 min, 32 sec, respectively, for the two tests. These resulted in the maximum recorded spreads of flame. After termination of the tests there was no residual flaming.

System 1 (Corrugated Deck) - Ignition of the roof deck assemblies at the centerline joint occurred after elapsed times of 1 min, 12 sec and of 1 min, 13 sec, respectively, for the two tests. In the first test, the underdeck flaming progressed over the end of the furnace at 5 min, 48 sec and the test was terminated after 8 min. In the second test the underdeck flaming progressed to 8-1/2 ft early in the test and receded shortly afterward. After termination of the test there was no residual flaming.

System 2 (Corrugated Deck) - Ignition of the roof deck assemblies at the centerline joint occurred after elapsed times of 3 min, 44 sec and of 41 sec, respectively, for the two tests. In the first test the underdeck flaming progressed 3-1/2 ft early in the test, retreated and then progressed to 4 ft shortly after 10 min. No flashes of flaming occurred. In the second test the underdeck flaming progressed 8-1/2 ft early in the test and retreated. After 15 min the underdeck flaming again progressed until it extended over the end of the tunnel at 17 min, 24 sec. The test was terminated after 18 min, 15 sec. In the first test there was no residual flaming after termination.

System 3 (Corrugated Deck) - Ignition of the roof deck assemblies at the centerline joint occurred after elapsed times of 1 min, 15 sec and of 1 min, 30 sec, respectively, for the two tests. In the first test the underdeck flaming progressed 8-1/2 ft early in the test, followed by intermittent flashes of flame outward to the maximum recorded spread of flame. The flashes of flame ceased after 10 min. In the second test the underdeck flaming progressed to 11-1/2 ft and retreated momentarily. Thereafter intermittent flashes of flaming occurred and eventually progressed over the end of the furnace at 7 min, 45 sec. There was no residual flaming after termination of either test.

System 4 (Corrugated Deck) - Ignition of the roof deck assemblies at the centerline joint occurred after elapsed times of 2 min, 10 sec and of 54 sec for the two tests. In the first test underdeck flaming progressed 13-1/2 ft, followed by intermittent flashes of flame outward to the maximum recorded extent of flame spread. The flashing ceased after 6-1/2 min. In the second test the initial underdeck flaming progressed 6-1/2 ft early in the test and receded. After termination of the tests there was no residual flaming.

Damage

The following table summarizes the damage to the foamed plastic material as noted through visual observation at distances of 16 ft and of 23-1/2 ft from the fire end of the assemblies. For purposes of this description damage will be defined according to two damage levels.

1. Char - Change due to thermal exposure resulting in significant loss in structural integrity and significant change in material texture.
2. Discoloration - Color change due to thermal exposure with some loss in structural integrity and some change in material texture.

Roof Covering System	Steel Deck	16 Ft		23-1/2 Ft	
		Depth(In.)	Discoloration Depth(In.)	Depth(In.)	Discoloration Depth(In.)
1	Ribbed	None	3/4	None	1/8
1	Ribbed	3/8	3/4	None	3/4
2	Ribbed	3/4	1/4	None	1/2
2	Ribbed	1/4	1/2	None	1/2
3	Ribbed	3/4	1/4	None	1/4
3	Ribbed	None	3/4	None	1/2
4	Ribbed	1/4	3/4	None	3/4
4	Ribbed	None	1/4	None	Trace
1	Corrugated	+	+	+	+
1(I)	Corrugated	1-1/2	1/2	5/8	1/2
2	Corrugated	1/2	1/2	None	1/4
2(I)	Corrugated	+	+	+	+
3	Corrugated	None	1	None	1/4
3(I)	Corrugated	2	1	None	1/4
4	Corrugated	None	1/2	None	1/8
4(I)	Corrugated	3/8	1/4	None	1/8

+ - Not recorded.

(I) - Mineral wool insulation positioned on the tunnel ledges.

UNDERDECK FIRE EXPOSURE - SMALL-SCALE FURNACE TEST:

SAMPLES

The built-up roof covering systems were applied to nominal 3 by 3 ft sections of steel deck with a longitudinal centerline seam. The joint detail, support and fastener schedule are shown by ILL. 5. A chlorinated rubber primer was used to provide a recommended bond coat for the foamed plastic material to the steel deck.

The foamed plastic material was allowed to cure for minimum of 16 days prior to testing. The coating systems were allowed to cure for a minimum of 7 days prior to testing.

METHOD

The small-scale furnace shown by ILL. 6 is intended to provide fire exposure conditions similar to those of UL 263, "Fire Tests Of Building Construction and Materials," but on smaller samples than are required by UL263. The small-scale furnace fire allows the same time-temperature curve specified by UL 263 as shown on ILL. 16. It is fired with a natural gas diffusion flame.

Additional exposure conditions were simulated by altering the firing rate of the gas flame to produce time-temperature curves with 850 and 500 F as upper temperature limits. These curves are shown by ILL. 7.

Test Procedure

Twelve fire tests were conducted on assemblies utilizing both ribbed and corrugated steel decks. Each of the four roof covering systems applied to ribbed deck were subjected to 1) the Standard Time Temperature Curve contained under UL 263 and 2) the time-temperature curve with an upper limit being 850 F after 30 min.

Tests were conducted on Systems 1 and 2 applied to corrugated steel deck and subjected to the Standard Time Temperature Curve.

Observations were made during the testing of flammability characteristics of the assemblies. Following the exposure period, the assemblies were removed for examination with respect to damage.

RESULTS

System 1 (Ribbed)

Standard Time Temperature - After 50 sec, emission of smoke began at the periphery. Underdeck flaming was first detected along the south edge of the sample after 5 min. Underdeck flaming occurred only at the periphery of the sample. Top surface flaming first occurred at the southwest corner and was immediately extinguished with water. Recurrences of the top surface flaming at the sample periphery were similarly extinguished. After 10 min and 30 sec, no further flaming (top surface or underdeck) occurred. The test was terminated at 30 min.

The top surface of the sample was discolored but intact (without fissures) except where peripheral flaming had occurred. The foamed plastic material was completely charred except for a thin film of the material which adhered to the surface coating.

850 F - After 2 min, smoke emission began at the periphery. Underdeck flaming first occurred at the northwest corner and at the center joint near the north edge after 10 min. Top surface flaming first occurred at 16 min and 40 sec at the southwest corner and was immediately extinguished with water. No further flaming action (top surface or underdeck) occurred. The test was terminated at 30 min.

The top surface was discolored only at the periphery. There were no fissures in the coating. The foamed plastic was charred in the center of the sample except for a 1/4 to 1/2 in. layer adhered to the coating. Outward toward the periphery of the sample the char and discoloration decreased. There was a 1-1/2 in. thick layer of unaffected foamed plastic at the periphery.

System 2 (Ribbed)

Standard Time Temperature - After 30 sec, smoke emission began at the periphery. Underdeck flaming was first detected at 5 min at the centerline joint near the south edge. Underdeck flaming occurred only at the periphery of the sample. Flaming of the top surface occurred along the west edge and the south edge after 11 min. This edge flaming was extinguished with water, but reoccurred throughout the test. The test was terminated at 30 min.

The top surface was discolored but intact (without fissures) in the center of the sample. The edges were charred due to the top surface edge flaming. The foamed plastic was completely charred except for a thin layer of the material adhered to the coating.

850 F - Underdeck ignition occurred only at the periphery and was first detected at 11 min and 30 sec along the west edge. Smoke emission was first observed after 19 min and 45 sec. No top surface flaming occurred until the gas ignition source was shut off at 30 min. At this time top surface flaming at the periphery began and was extinguished with water.

The top surface was discolored and charred only at the periphery. The foamed plastic was charred completely at the center of the sample except for a thin layer adhered to the coating. Toward the periphery the foamed plastic was discolored and charred 1-1/2 to 2 in.

500 F - After 3 min, smoke emission began at the periphery of the sample. Flashes of flame (outgassing) were observed at 5 min along the west edge of the sample and water was used to extinguish flaming. No further flaming action was observed. The test was terminated at 30 min.

The top surface was unaffected except for discoloration at the periphery. Char and discoloration of the foamed plastic extended 1-1/2 in. through the material.

System 3 (Ribbed)

Standard Time Temperature - After 1 min, smoke emission began at the sample periphery. Underdeck flaming was first detected at 2 min and 15 sec at the center joint near the south wall. After 4 min and 40 sec, underdeck flaming started at the center joint near the north wall. Flaming of the top surface first occurred at the north-west corner at 9 min and 30 sec and was extinguished immediately with water. Occasional recurrences of the top surface flaming at the sample periphery were similarly extinguished. Underdeck flaming was observed only at the periphery of the sample and did not spread to the middle along the center joint of the deck. At 27 min and 30 sec a crack in the top surface developed toward the center of the sample. No flaming was emitted through this crack. The test was terminated at 30 min.

The foamed plastic material was charred completely except for a thin film of the material which adhered to the surface coating. Fissures had developed in the top surface. The surface coating was discolored in the middle of sample and charred only at the periphery where top surface ignition had occurred.

850 F - After 1 min and 30 sec smoke emission began at the periphery. Underdeck flaming first occurred at the northwest corner at 8 min and 10 sec. The center joint began flaming near the south wall after 11 min. Underdeck flaming occurred only at the periphery of the sample. Flaming of the top surface first occurred at 19 min at the southeast corner and was extinguished with water. After 21 min, no further underdeck flaming was observed. The test was terminated at 30 min.

The top surface was discolored but intact (without fissures). Toward the center of the sample the foamed plastic was charred except for a 1/4 to 1/2 in. thick layer of the material which adhered to the surface coating. At the periphery there was approximately 1-1/2 in. thick layer of foamed plastic that had not charred or discolored.

500 F - The initial flaming surge of the furnace caused top surface ignition at the East edge of the sample at 3 min and 45 sec. This ignition was immediately extinguished with water. No further flaming action was observed. The test was terminated at 30 min.

The appearance of the top surface of the sample was unchanged. Char and discoloration extended approximately 1-1/2 in. into the foamed plastic material.

System 4 (Ribbed)

Standard Time Temperature - After 1 min, smoke emission began at the periphery. Underdeck flaming was first observed at the centerline joint near the south wall after 2 min and 30 sec. Underdeck flaming occurred only at the periphery of the sample. Top surface flaming first occurred at the north-east corner at 17 min and 50 sec and was immediately extinguished with water. A crack or fissure developed in the top surface near the center of the sample at 22 min and 45 sec. Flaming through this crack started at 25 min and 30 sec but was extinguished with water. The test was terminated at 30 min.

The top surface had two fissures which exposed the charred foamed plastic beneath. The foamed plastic over most of the sample area was charred completely except for a thin layer adhered to the coating.

850 F - After 2 min and 50 sec smoke emission began at the periphery. Underdeck flaming first occurred at the southwest corner at 10 min and 40 sec. Top surface flaming first occurred at 17 min and 40 sec at the southwest corner and was immediately extinguished with water. The test was terminated at 30 min.

The top surface was discolored only at the periphery. There were no fissures in the coating. The foamed plastic was charred in the center of the sample except for a 1/4 to 1/2 in. layer adhered to the coating. Outward toward the periphery of the sample the char and discoloration decreased. There was a 1-1/2 in. thick layer of unaffected foamed plastic at the periphery.

System 1 (Corrugated)

Standard Time Temperature - After 1 min, smoke emission began at the periphery of the sample. Underdeck flaming at the middle of the centerline joint began at 1 min and 30 sec. Top surface flaming first occurred at the southwest corner at 2 min and was immediately extinguished with water. The underdeck flaming at the centerline joint slackened after 2 min and 30 sec, however, the joint was severely distorted and open. The test was terminated at 10 min.

System 2 (Corrugated)

Standard Time Temperature - After 45 sec smoke emission began at the periphery of the sample. Underdeck flaming first occurred at the northeast and southwest corners at 2 min and 20 sec. Top surface flaming at the periphery (south and north edges) occurred at 4 min and 30 sec. At 10 min and 20 sec flaming occurred underdeck across the centerline joint (which had opened) and around the entire periphery such that the test was terminated at 10 min and 30 sec.

WHITE HOUSE TEST:

GENERAL

The test structure was erected by Laboratories' personnel. The foam and roof coating were applied by craftsmen in the employ of Underwriters Laboratories Inc. The firing equipment, instrumentation and fire suppression equipment were installed by Laboratories' personnel.

Built-up roof covering System 1 was selected for this test.

BUILDING STRUCTURE

The test structure was 20 ft wide, 100 ft long and 10 ft high (floor to steel decking), as shown in ILL. 8. The walls of the structure were constructed from nominal 8 in. thick concrete block. The walls of the first 40 ft were protected on the interior by a nominal 1 in. thickness of spray-applied cementitious mixture.

The flue end of the structure was closed with a sheet-metal breeching which diverted the exhaust gases from horizontal to vertical.

FIRING EQUIPMENT

The fire exposure was provided by heptane fuel pumped through two Sprayco 4C atomizing nozzles as shown on ILL. 9. A continuous pilot ignition was provided by LP-Gas torches and a high voltage spark ignitor. Flow of the heptane fuel was measured by pressure gauges and flow meters, while manual valves controlled the fuel flow rates.

The fuel used was heptane with a heat of combustion of 116,000 Btu per gallon per ASTM D2015 modified to use gelatin capsules.

Air for combustion was furnished by a blower and duct assembly located outside the test building as shown on ILL. 9. The air supply of 4700 cfm was delivered by four ducts through the fire-end wall.

ROOF DECK MATERIALS AND ASSEMBLY

Structural Supports - The primary supports of the roof deck assembly were W6 X 16 steel beams running in the north-south direction and spaced 20 ft O.C. The beams were supported at each end by the masonry walls. The second and fourth bays between the steel beams were cross-braced using 1/2 in. diameter steel rods with turnbuckles.

Purlins - The purlins used in the roof deck assembly were C-shaped channels formed from No. 14 gauge steel. The purlins were 7 in. deep with 2-1/2 in. flanges and 3/4 in. stiffening flanges and were supplied in nominal 25 ft lengths.

The purlins were installed perpendicular to the W6 X 16 steel beams, spaced 40 in. O.C., as shown in ILL. 8. The purlins were secured to the beams with welds. Adjoining lengths of purlins were overlapped 4 ft, 11-1/4 in. over the steel beams, as shown in ILL. 10, and were secured together near the ends of each overlap with steel bolts with nuts. In addition, a 1-1/2 by 1-1/2 by 1/8 in. thick steel angle, 6 in. long, was welded to the steel beam upper flange and the purlin web at each beam/purlin intersection (seven per beam) as shown in ILL. 8. Nominal 3/8 in. diameter steel rods, 48 in. long with threaded ends, were used as bridging between purlins at the center of each purlin span as shown in ILLS. 8 and 10.

Metal Roof Deck Panels - The metal roof deck panels were 24-1/4 in. wide (24 in. cover width) and were formed from No. 26 gauge galvanized steel. Each panel contained a nominal 1 in. high rib along its longitudinal centerline and ribbed side edges. The panels were installed perpendicular to and screw-attached to the purlins with No. 1/4-14 by 1-1/4 in. long self-drilling, self-tapping hex-head steel fasteners as shown in ILLS. 11 and 12. Each row of panels contained one end lap joint with the ends lapped 6 in. as shown in ILLS. 11 and 12.

Spray-Applied Foamed Plastic - The two component foamed plastic was spray-applied over the metal roof deck panels. Prior to application of the foam, the metal roof deck panels were given a light coat of primer. The foam was then spray-applied following the contour of the metal roof deck panels, to a nominal thickness of 3 in. over the entire roof assembly. The thickness was continually checked by probing covered areas. The spray-application of the foam was completed 36 days prior to the fire test.

Coating System - The fluid-applied silicone elastomeric roof coating was spray-applied over the foamed plastic. The coating was applied in two layers. The base coat was applied at a nominal rate of 1.5 gal per 100 sq ft. The top coat was also applied at a nominal rate of 1.5 gal per 100 sq ft. The roof was surfaced with No. 11 mineral granules embedded in the wet top coat at a nominal rate of 50 lb per 100 sq ft. The application of the coating system was completed 14 days prior to the fire test.

End Closures - Prior to the spray-application of the foamed plastic, end closures consisting of courses of common brick with mortar joints and beds were laid atop the north, west and south masonry walls as shown in ILL. 8.

METHOD

Furnace Fire

The following firing rate of heptane as used for this test was originally selected through experimentation so as to produce temperatures in the first 20 ft of the building to approximate the Standard Time Temperature Curve (UL263).

<u>Time (Min)</u>	<u>Flow (GPM) Both Nozzles</u>	<u>Fuel Total (Gal)</u>
0-2	1.0	2.0
2-4	1.5	5.0
4-7	2.0	11.0
7-17	2.5	36.0
17-30	2.7	71.1

Instrumentation

The thermocouples used to monitor temperatures in the fire end were enclosed in black pipe and supported with concrete pylons. These "Control" thermocouples, shown on ILL. 13, were positioned to provide a 1 ft radial clearance from the bottom of the steel decking and support members.

To gather general fire information, twenty-two No. 20 gauge chromel-alumel thermocouples were installed at locations shown on ILL. 14. In addition, two calorimeters for heat flux measurements were mounted in the roof 40 and 60 ft from the fire end, as shown in ILLS. 14 and 15. Heat flux measurements could assist observations of flame progression at those distances.

Observations

Four observers recorded events at specified locations during the conduct of the test. One observer was on scaffolding located near the flue end to observe the top of the roof. Two observers viewing the underside of the roof moved laterally, one along each exterior side of the structure, as the test developed. Another observer was located at the flue end of the structure at ground level. Transcribed voice records of these observers appear in App. B through E of this Report. In addition, the test development was recorded on film with both still and movie cameras, and on video tape.

Fire Suppression

A system of sprinklers was installed inside the structure as can be seen in ILL. 22. Two hose streams were provided for exterior application.

RESULTS

Exposure Fire

The average fire control temperature is shown on ILL. 16 along with the firing rates.

Observations During Test

Interior - The test was started with ignition of the gas-fired burners. The burner flames projected outward approximately 4 ft from the end wall of the structure with light impingement on the underside of the roof deck by 2-1/2 min. Some of the liquid fuel dropped to the floor of the structure where it burned for about 2 min. The outward projection of the burner flames increased as the flow rate of heptane was increased. At the maximum heptane flow rate (2.7 GPM at 17 min and beyond), the outward projection of the burner flames was approx 20 ft from the end wall of the structure.

Smoke began issuing from joints in the underside of the roof at 4 min. The smoke became very dense after 8 min such that vision by the flue end observer was obscured. The smoke cleared after 11-1/2 min as reported by the flue end observer. The density of the smoke fluctuated as the test progressed but did not further obscure vision.

Flaming on the underside of the deck commenced at 4 min and extended from the fire end wall of the structure to approximately the 8 ft mark. By 5 min the underdeck flaming was observed to 18 ft and burning was present at the transverse deck sidelap joints located 4, 6 and 10 ft from the fire end wall of the structure. The underdeck flaming was observed outward to 30 ft at 8 min, outward to 34 ft at 9-1/4 min, and outward to 40 ft at 11 min. Underdeck flaming receded to approx 20 ft by 15 min. Except for sporadic flaming at the transverse deck sidelap joints at the 22 ft mark, the underdeck flaming ceased after 17 min. No further underdeck flaming was observed in the interior of the structure during the remainder of the test.

At 23 min the center purlins in the first span rotated at their midspans. At 27-3/4 min a sharp report was heard, apparently emanating from the first bay. The cause was not known.

Exterior - Beginning at 3 min into the test, light smoke issued from the roof edges around the perimeter of the fire end out to the 8 ft mark of the north and south walls. By 4-1/4 min the smoke intensity had increased, partially obscuring visibility over the burner region.

At 6-1/4 min, flaming was emitted from between the end closure bricks along the perimeter of the fire end out to the 10 ft mark of the north wall. By 7-1/4 min the edge flaming along the north wall had extended to the 13 ft mark. By 8 min, the roof flaming had progressed to the 18 ft mark along the north edge and extended southward half way across the roof. By 8-3/4 min, the roof flaming extended across the entire roof up to the 18 ft mark. By 10-1/4 min the roof flaming had progressed to the 21 ft mark across the width of the roof. By 14 min the flame front was at the 23 ft mark across the width of the roof. At that time it appeared that the roof was flaming along the three walls and at the flame front while the flaming in the encircled area had ceased. By 14-1/2 min the flame front was at the 28 ft mark across the width of the roof. By 16 min, the flame front had progressed to the 31 ft mark in the center of the roof. At that time, the majority of the flaming was at 31 ft mark while the flaming between the 5 and 30 ft marks had ceased.

By 18 min, the flame front across the width of the roof was angled due to the wind gusting at 26 mph from the northwest. At that time, the flame front was at the 36 ft mark at the south edge and at the 32 ft mark at the north edge. By 19-3/4 min, the flame front was at the 41 ft mark at the south edge, the 38 ft mark near the center, and at the 30 ft mark at the north edge. By 22-3/4 min, the flame front near the center and at the south edge was at the 45 ft mark near the center, and at the 38 ft mark at the north edge. By 29-3/4 min, the flame front was at the 53 ft mark at the south edge, the 50 ft mark near the center, and at the 45 ft mark at the north wall. No further progress was recorded.

At 23-3/4 min, a large bubble or blister, approximately 8 in. high, was observed between the 60 and 70 ft marks which extended across the entire width of the roof. At 27-1/4 min, the roof in the center of the first bay in the burner region was deflected downward approximately 18 in.

Termination Of Test

The fuel pump was shut-off at 30 min, thereby extinguishing the heptane fire. The residual flaming of the roof assembly was quenched at 30-1/2 min by activating the sprinkler heads within the structure and by application of a hose stream on the exterior of the structure.

Temperatures

The temperatures recorded by the thermocouples are tabulated in App. A. This temperature data was used to prepare the more specific measurements shown under the following illustrations:

- ILL. 16 - Time-temperature plot of control thermocouples.
- ILL. 17 - Graph of average flue temperature versus Standard assembly.

Further discussion of these temperatures and those obtained in the test of the Standard roof assembly are presented under the Discussion of this Report.

Heat Flux

A graph of the readings is shown on ILL. 18. Malfunctions of the two calorimeters occurred at 18 min and 7 sec and at 29 min and 47 sec at the 40 ft and 60 ft locations, respectively. The calorimeter at the 40 ft location was engulfed in the flaming of the built-up roof system at the time of the malfunction. The cause of the malfunction of the calorimeter at the 60 ft location, late in the test, was not determined.

Observations After Test

The locations of the affected areas, exterior and interior, are depicted graphically in ILL. 19.

Exterior - At the firing end of the structure, the spray-applied foam and fluid-applied coating were consumed, exposing the metal roof deck panels. Beyond the exposed metal roof deck panels, the spray-applied foam and fluid-applied coating were charred through their entire thickness and appeared intumesced. Beyond the charred area to the flue end of the structure, the roof covering was bubbled in several locations but was not discolored.

Interior - At the firing end of the structure, the steel purlins were rotated and deflected downward. The amount of purlin rotation ranged from approximately 15 deg near the north wall to approximately 80 deg near the south wall. The center purlin and the two purlins immediately south of the center purlin experienced the greatest rotation and lateral snaking. The downward deflection of the purlins in the first beam bay was approximately 6 to 8 in. Beyond the first beam span, the steel purlins exhibited no significant distortion.

In the area beneath the consumed roof covering, the metal roof deck panels were discolored and wrinkled and several sidelap joints were separated such that openings were present in the steel roof deck. Due to the rotation and deflection of the purlins in the south half of the first beam bay at the firing end of the structure, the fasteners securing the metal roof deck panels to the purlins tore through, leaving holes in the metal roof deck panels. In the area beneath the charred roof covering, the metal roof deck panels were wrinkled and discolored. In the area beneath the bubbled roof covering, the metal roof deck panels appeared unchanged except for smoke discoloration.

Damage

A sketch showing the overall post test observations of damage is shown by ILL. 19. Cross-sections were taken to visually observe the extent of damage to the foamed plastic material. The cross-sections taken nearer the fire end of the structure were reduced in thickness due to the fire exposure. The table below summarizes these observations as defined according to three damage levels.

1. Char - Change due to thermal exposure resulting in significant loss in structural integrity and significant change in material texture.
2. Discoloration - Color change due to thermal exposure with some loss in structural integrity and some change in material texture.
3. Unaffected - Original color with no apparent loss in structural integrity nor change in material texture.

Cross-Section Unaffected (In.) Discoloration (In.) Char (In.)

1	2-1/2	1/2	None
2	2-1/2	1/2	None
3	2-1/4	3/4	None
4	2-1/4	3/4	None
5	2-1/2	1/2	None
6	2-1/4	3/4	None
7	2-1/2	1/2	None
8	2-1/2	1/2	None
9	2-1/4	3/4	None
10	1-1/2	3/4	Trace
11	1-1/4	1/2	1/8
12	1-1/4	1	Trace
13	1	1/2	1/8
14	1-1/2	1/2	1/8
15	1	1/2	1/4

D I S C U S S I O NEXTERIOR FIRE EXPOSURE - UL 790 TESTS:

The results of the spread of flame tests indicate that System Nos. 1, 3 and 4 meet the requirements of Class A built-up roof covering systems as applied to noncombustible deck at inclines not exceeding 3-1/2 in. to the horizontal foot. Whereas, the results of the spread of flame tests indicate that System No. 2 meet the requirements of Class C built-up roof covering system as applied to noncombustible deck at inclines not exceeding 3-1/2 in. to the horizontal foot.

Since System No. 2 showed considerably less resistance to flame spread from exterior fire exposures than did System Nos. 1, 3 and 4. In order to maximize the test information developed with regard to underdeck flame spreading, Systems 1, 3 and 4 were selected for further screening as potential candidates for use on the "White House" Test.

UNDERDECK FIRE EXPOSURE - 25 FT TUNNEL FURNACE TEST:

UNDERDECK FLAME SPREAD

Ribbed Deck

In the tunnel tests, the spread of underdeck flaming of the four roof systems applied to the raised ribbed steel deck compared favorably with the Laboratories current requirements contained in Subject 1256 "Outline Of The Proposed Investigation For Roof Deck Construction." Only one test (System No. 1) resulted in an underdeck flame spread, which exceeded the guideline limit of 10 ft in the first 10 min. All test results were within the guideline limit of 14 ft after 30 min.

Corrugated Deck

Of the eight tunnel tests conducted on the four built-up roof systems applied to corrugated deck, five exceeded the flame spread limits prescribed by the Subject 1256 Outline.

Damage

For all tests utilizing the ribbed steel deck panels, the extent of damage to the foamed plastic was judged to comply with the intent of the statements related to damage contained in the Subject 1256 Outline.

For the tests utilizing the corrugated steel deck panels, three were considered as not in compliance with the damage requirements. One test showed a 1-1/4 in. char of the foamed plastic at the extremity and two were not recorded due to extent of flaming and early termination of the test.

UNDERDECK FIRE EXPOSURE - SMALL SCALE FURNACE:

The tests conducted utilizing the three exposure conditions showed increasing flaming and damage with increasing intensity of exposure conditions. The increased propensity for System No. 2 to support exterior flaming (top surface) as compared to System Nos. 1, 3 and 4 was evident in the difficulty of controlling exterior flaming that occurred at the periphery of the samples.

The C1 coating system demonstrated in the testing that it is more resistive than the C2 coating system against thermal degradation and flaming break-through.

In the two tests utilizing the corrugated steel deck, the joints tended to open under the Standard Time Temperature fire exposure such that early termination was necessary.

WHITE HOUSE TEST:

GENERAL

When subjected to this test in the past, an assembly consisting of a metal deck with 1 in. plain vegetable fiberboard attached by mechanical fasteners and with a built-up (tar or asphalt) roof covering and gravel surface produced underdeck flame spread to approximately 60 ft with occasional flashes of flame extending to approximately 72 ft. Beyond 60 ft, damage to the fiberboard diminished and only a light char of the fiberboard occurred at the far end of the structure. This performance, judged on the basis of underdeck fire spread and damage, has served as the basis for judging other roof assemblies. The assembly is referred to in this Report as the Standard roof assembly.

UNDERDECK FLAMING

The maximum spread of underdeck flaming was 40 ft which is to be compared to a maximum spread of underdeck flaming of approximately 60 ft with flashes of flame extending to 72 ft as recorded in the test of the Standard roof assembly.

Air temperatures measured at the flue end of the White House for this and the Standard roof assembly are compared on ILL. 14. The temperatures after 4 min into the test are significantly lower than those recorded for the test of the Standard assembly.

DAMAGE

Inspection of the spray-applied foamed plastic roof insulation after the test showed a nominal 1/2 to 3/4 in. of discoloration near the 100 ft flue end of the structure

CORRUGATED STEEL DECK

The results of the 25 ft tunnel and small-scale furnace, interior exposure, fire tests using 26 gauge corrugated galvanized steel deck suggests that additional laboratory scale and/or White House tests would be required to establish the qualification of this type of deck for use in "Fire Classified" assemblies. All the tests conducted were predicated on the fastening, support recommendations, and manner of use associated with the raised ribbed deck sections.

S U M M A R Y

Based upon the data presented herein, the following specific summarization statements can be made:

1. The foamed plastic built-up roof coverings identified in this Report as System Nos. 1, 3 and 4 are eligible for Classification and Follow-Up Services by Underwriters Laboratories Inc., through its promulgation procedure, as Class A Built-Up Roof Coverings as applied to "noncombustible" deck at inclines not exceeding 3-1/2 in. to the horizontal foot.

2. The foamed plastic built-up roof coverings identified in this Report as System No. 2 are eligible for Classification and Follow-Up Services by Underwriters Laboratories Inc., through its promulgation procedure, as Class C Built-Up Roof Coverings as applied to "noncombustible" deck at inclines not exceeding 3-1/2 in. to the horizontal foot.

3. The foamed plastic built-up roof coverings identified in this Report as System Nos. 1, 3 and 4 are eligible for Classification and Follow-Up Services by Underwriters Laboratories Inc., through its promulgation procedure including Fire Council advisement, as Roof Deck Construction Materials for use in a Roof Deck Construction utilizing specified raised rib steel roof deck panels in accordance with recommended support and fastener practices.

4. The information contained in this Report provides a data base upon which evaluations of roof systems of the type described herein can be conducted, for Classification by Underwriters Laboratories Inc. as "Roof Deck Construction Materials," using Standardized laboratory-scale fire testing procedures.

File USNC77

Issued: 12-29-78

Report by:

Kenneth Rhodes

KENNETH RHODES
Senior Project Engineer
Fire Protection Department

Reviewed by:

G T Castino

G. T. CASTINO
Managing Engineer
Fire Protection Department

KR:GTC:SJ

CONTROL TEMPERATURES

TC No.	<u>Time, Min</u>									
	<u>1</u>	<u>2</u>	<u>3</u>	<u>4</u>	<u>5</u>	<u>6</u>	<u>7</u>	<u>8</u>	<u>9</u>	<u>10</u>
1C	100	150	260	400	570	740	875	1065	1215	1280
2C	95	180	370	590	940	1170	1280	1530	1655	1625
3C	100	140	240	420	835	1215	1385	1640	1700	1735
4C	90	130	215	335	480	635	740	920	1080	1150
5C	85	120	200	340	530	680	785	930	1070	1160
6C	105	175	350	520	785	980	1100	1260	1360	1385
A	96	149	273	434	690	903	1028	1224	1347	1389
	<u>11</u>	<u>12</u>	<u>13</u>	<u>14</u>	<u>15</u>	<u>16</u>	<u>17</u>	<u>18</u>	<u>19</u>	<u>20</u>
1C	1275	1280	1285	1290	1300	1310	1330	1360	1400	1420
2C	1605	1595	1585	1590	1595	1590	1620	1695	1720	1745
3C	1715	1745	1720	1705	1725	1780	1795	1855	1885	1880
4C	1170	1170	1180	1185	1200	1220	1235	1285	1315	1335
5C	1190	1200	1205	1205	1200	1250	1265	1315	1370	1410
6C	1390	1405	1405	1410	1420	1440	1450	1525	1575	1580
Avg	1391	1399	1397	1398	1407	1432	1449	1506	1544	1562
	<u>21</u>	<u>22</u>	<u>23</u>	<u>24</u>	<u>25</u>	<u>26</u>	<u>27</u>	<u>28</u>	<u>29</u>	<u>30</u>
1C	1445	1440	1435	1435	1420	1425	1430	1430	1440	1430
2C	1750	1725	1725	1715	1705	1720	1740	1730	1745	1710
3C	1900	1915	1925	1915	1905	1910	1905	1910	1900	1865
4C	1360	1365	1370	1375	1380	1380	1380	1385	1385	1370
5C	1425	1450	1455	1470	1510	1500	1495	1490	1485	1470
6C	1600	1600	1600	1600	1595	1600	1605	1605	1600	1585
Avg	1580	1583	1585	1585	1586	1589	1593	1592	1593	1572

TEMPERATURES

Time (Min)	Thermocouple					
	1	2	3	4	5	6
1:00	215	130	90	215	95	120
2:00	315	165	90	370	95	160
3:00	470	250	90	545	95	225
4:00	620	360	89	725	95	310
5:00	830	480	91	855	95	405
6:00	1040	545	99	970	94	510
7:00	1130	700	98	1105	91	610
8:00	1220	810	96	1255	90	710
9:00	1250	895	95	1285	90	780
10:00	1280	975	100	1290	90	835
11:00	1270	995	295	1290	90	855
12:00	1265	1015	525	1285	90	865
13:00	1260	1030	1020	1295	90	870
14:00	1260	1055	1410	1300	90	875
15:00	1270	1105	1325	1325	90	875
16:00	1320	1160	1105	1335	90	875
17:00	1420	1230	565	1305	90	880
18:00	1450	1275	230	1290	245	885
19:00	1420	1320	230	1330	990	895
20:00	1390	1330	270	1350	1540	945
21:00	1360	1310	355	1330	1550	1165
22:00	1335	1270	420	1305	1425	1305
23:00	1310	1240	460	1270	1000	1155
24:00	1310	1210	480	1250	950	1080
25:00	1310	1195	490	1245	1370	1155
26:00	1310	1185	495	1250	1510	1160
27:00	1305	1185	490	1255	1355	1065
28:00	1295	1180	490	1255	995	1000
29:00	1285	1180	485	1255	500	960
30:00	850	715	470	950	295	855
Maximum Temp.	1450	1330	1410	1350	1550	1305
1	18:00	20:00	14:00	20:00	21:00	22:00

TEMPERATURES

Time (Min)	<u>Thermocouple</u>				
	<u>7</u>	<u>8</u>	<u>9</u>	<u>10</u>	<u>11</u>
1:00	230	195	110	95	200
2:00	390	325	150	95	340
3:00	540	455	190	98	480
4:00	680	580	260	98	620
5:00	800	685	335	98	740
6:00	885	750	410	95	785
7:00	970	820	490	92	830
8:00	1055	890	560	93	920
9:00	1100	935	625	95	995
10:00	1115	945	680	95	985
11:00	1125	950	725	92	980
12:00	1125	955	755	90	990
13:00	1120	960	755	90	1000
14:00	1120	960	790	90	995
15:00	1120	965	800	90	1000
16:00	1120	970	810	90	1005
17:00	1125	975	820	85	1010
18:00	1130	980	825	80	1015
19:00	1130	990	830	85	1025
20:00	1140	1000	840	90	1040
21:00	1180	1005	845	95	1045
22:00	1225	1010	850	98	1055
23:00	1265	1015	850	690	1060
24:00	1290	1020	870	1315	1065
25:00	1250	1020	1085	955	1065
26:00	1210	1020	1240	660	1065
27:00	1180	1020	1080	1070	1060
28:00	1160	1020	955	1420	1050
29:00	1150	1020	930	1515	1050
30:00	900	875	870	1410	1000
Maximum Temp.	1290	1020	1240	1515	1065
Time	24:00	24:00	26:00	29:00	24:00

TEMPERATURES

Thermocouple

<u>Time (Min)</u>	<u>12</u>	<u>13</u>	<u>14</u>	<u>15</u>	<u>16</u>	<u>17</u>
1:00	160	100	95	130	120	95
2:00	270	100	130	245	200	95
3:00	385	100	165	365	285	95
4:00	495	100	210	470	365	90
5:00	600	100	260	570	445	95
6:00	640	100	305	630	495	95
7:00	685	100	350	680	530	95
8:00	740	100	410	720	575	95
9:00	795	100	460	765	630	95
10:00	800	100	500	780	645	95
11:00	805	100	545	795	650	95
12:00	815	95	575	800	665	95
13:00	820	90	605	810	680	90
14:00	825	95	630	815	685	90
15:00	830	95	650	820	695	90
16:00	830	95	665	820	700	90
17:00	830	95	675	820	700	85
18:00	840	90	680	825	705	85
19:00	845	90	690	830	715	85
20:00	850	90	705	840	720	85
21:00	850	90	715	845	730	90
22:00	860	90	725	850	735	85
23:00	860	90	735	855	740	85
24:00	860	90	740	855	740	85
25:00	865	90	745	855	740	85
26:00	865	90	750	855	745	85
27:00	870	90	750	850	745	85
28:00	870	90	755	850	750	85
29:00	865	93	755	850	745	85
30:00	870	95	755	850	745	85
Maximum Temp. At Time	870 27:00	100 1:00	755 28:00	855 23:00	750 28:00	95 1:00

TEMPERATURES

Time (Min)	<u>Thermocouple</u>				
	<u>18</u>	<u>19</u>	<u>20</u>	<u>21</u>	<u>22</u>
1:00	90	90	145	140	140
2:00	115	185	200	200	205
3:00	140	285	220	220	215
4:00	175	380	230	235	225
5:00	215	470	215	215	215
6:00	255	545	210	205	210
7:00	295	590	230	225	230
8:00	340	630	250	250	250
9:00	380	670	285	280	280
10:00	415	690	310	310	300
11:00	450	695	310	310	305
12:00	470	705	325	325	305
13:00	495	715	320	320	305
14:00	519	720	325	325	315
15:00	530	720	330	330	330
16:00	545	725	350	350	345
17:00	560	730	370	370	360
18:00	575	735	390	390	380
19:00	590	745	415	415	410
20:00	605	750	430	430	425
21:00	620	755	440	440	430
22:00	630	760	440	445	445
23:00	640	760	445	450	455
24:00	650	765	475	465	460
25:00	655	770	505	480	470
26:00	655	770	495	475	480
27:00	660	770	485	470	485
28:00	670	770	470	450	465
29:00	670	760	450	430	445
30:00	665	735	425	400	390
Maximum Temp. At e	670 28:00	770 25:00	505 25:00	480 25:00	485 27:00

KR:GTC:SJ

TOPSIDE OBSERVATION OF THE WHITE HOUSE TEST

<u>Time (Min:Sec)</u>	<u>Observation</u>
1:00	No topside action as of yet
3:00	No topside action
3:50	Light wispy smoke appears to be emitted from between the bricks around the perimeter of the test deck up to 8 ft
4:20	Heavy smoke appears to be emitted from between the bricks that surround the perimeter of the test deck on the north side of the building. Topside observation is being partially obscured due to the heavy smoke that is emitting from the bricks surrounding the perimeter of the building
5:20	Very heavy smoke at the fire end of the test deck is being emitted from between bricks surrounding the perimeter of the test deck
6:00	There is very light wispy smoke in the middle of the test deck at 40 ft (calorimeter location)
6:10	Flames are being emitted from around the perimeter of the test deck between the bricks up to 10 ft (north side of the building)
6:45	Very heavy smoke is obscuring the topside observer's view, however, there are flames being emitted at the 10 ft level from between the bricks that surround the perimeter of the test deck

<u>Time (Min:Sec)</u>	<u>Observation</u>
7:15	Flames on the north end of the building are being observed up to about 13 ft which are caused by the emission of the flames from between the bricks that surround the perimeter of the test deck. The flames appear to have ignited the roof and are progressing to about 2 ft inward from around the perimeter of the test deck at the 10 to 13 ft level. (North side of the building)
8:00	The flaming is progressing and has now engulfed the north end of the test deck up to about 18 ft half way across the test deck. Also at this time the bricks surrounding the perimeter of the test deck appear to be separating and opening at the fire end of the test deck
8:50	The flames up to 18 ft appear to be across the complete width of the test deck
9:30	The surface flames have progressed down to approximately 20 ft across the width of the building
10:15	The surface flames have progressed to approximately 21 ft across the entire width of the building. Also, the flames appear to be extending approximately 5 ft into the air
10:50	When the smoke clears you can see that there are large blisters in the roof up to approximately 20 ft

<u>Time (Min:Sec)</u>	<u>Observation</u>
12:00	The surface flames still appear to be at 21 ft (on the top of the test deck across the width of the building)
12:25	Very large blisters are being observed at the flue end perimeter of the flaming area. The blisters appear to be approximately 8 in. to 1 ft high
13:15	The surface flames appear to have progressed to approximately 23 ft across the width of the test deck
14:00	When the wind changes you can see the test deck and the flaming appears to be around the perimeter forward, aft and on both sides. The flames in the center of the test deck appear to have extinguished themselves
14:35	The flames appear to be progressing up to approximately 28 ft across the width of the test deck with flames extending approximately 5 ft into the air. Very heavy smoke is being emitted from the topside of the test deck
15:30	The flames appear to be progressing to approximately 30 ft at the center of the test deck
16:00	The flames appear to be progressing to approximately 31 ft at the center of the test deck. The majority of the heavy flaming is at the 31 ft level with the flaming at the fire end of the test structure being very light. The flames between the 5 and 30 ft level appear to have extinguished themselves

<u>Time (Min:Sec)</u>	<u>Observation</u>
17:15	The flames appear to have progressed to approximately 32 ft in the center and the south side of the test deck
18:00	On the south side of the structure the flames appear to have progressed up to approximately 36 ft. The flames on the far edge of the north side of the building are still at approximately 32 ft this being due to the wind direction which is coming out of the northwest
19:00	The flames on the south side of the building appear to be at approximately 40 ft
19:45	The flames are progressing approximately 41 ft on the south side of the building, approximately 38 ft in the center of the building and approximately 30 ft on the north side of the building
20:00	Again, you can observe large blistering around the perimeter of the test deck in the fire area
21:00	When the wind direction changes you can see that there are flames at approximate the 42 ft level at the very far extreme south side of the structure
22:00	The surface flames appear to have progressed to approximately 43 ft from the center to the south side of the building

<u>Time (Min:Sec)</u>	<u>Observation</u>
22:45	The surface flames on the center and south sides of the building appear to have progressed to approximately 45 ft
23:50	There appears to be a very large blister between the 60 and 70 ft mark. It appears to be extending approximately the width of the building and approximately 8 in. high
24:00	The surface flames have progressed to approximately 49 ft on the south side of the building, however, the flames on the north side of the building appear to be at 38 ft with the flames in the center of the building at 45 ft
25:45	No change in the surface action
26:40	The flames on the south side of the building appear to be out to approximately 50 ft
27:15	After looking back over the fire end of the test deck you can see that the test deck has sunken outward to approximately 12 ft, it appears to have sunken approximately 1-1/2 ft
28:00	The large blister from the 60 to 70 ft mark in the test deck still has not opened
29:00	The flames still appear to be up to approximately 50 ft on the south side of the building
29:30	The flames on the south side of the building appear to have progressed to approximately 52 ft

File USNC77

App. B

Issued: 12-29-78

Time (Min:Sec)

Observation

29:40

The flames on the south side of the building appear to be up to approximately 53 ft, to 50 ft in the center of the building and to 45 ft on the north side of the building

30:00

Test terminated

KR:GTC:SJ

SOUTH SIDE OBSERVATION OF WHITE HOUSE TEST

<u>Time (Min:Sec)</u>	<u>Observation</u>
0:45	Flames from the burners are extending out about 2 ft; there is some flaming of residual fuel on the floor extending about 7 or 8 ft from the burners. Some flaming on the pylon on the north side
1:30	Balls of flame from burners are slightly higher, about 2 ft in diameter. Burning on the floor is about the same. Slight discoloration of the underside of the deck above the burners
2:30	Flames from the burners are very bright yellow with orange tint and extend out about 4 ft from the nozzles. Discoloration on the underside of deck is about the same as the last comment
4:00	There is ignition on the underside of deck down to about 8 ft
4:20	Flaming on the underside of deck is down to about 16 ft
4:45	Smoke on south side from top is getting a little heavy
5:00	Underside flaming extends down to about 18 ft
5:40	Was forced to evacuate the south side due to heavy smoke affecting breathing
6:10	Surface flames are visible at the northwest corner of assembly on the outside

<u>Time (Min:Sec)</u>	<u>Observation</u>
8:45	Have switched to the north side to avoid the smoke
9:45	Underside flames from the north side appear to extend down to about 28 ft
9:55	The tongues of flame on underside extent to about 33 ft
10:30	Flaming extends to about 38 ft down the center on underside of the assembly
11:55	Perimeter flaming on surface extends to about 12 ft from fire end
12:30	There are spasmodic flames from transverse joints in the deck noted at 30 and 34 ft. Main body of flame extends to roughly 25 ft
14:10	Underside of flames are extending to about 25 ft. No flaming noted beyond that point
15:30	The underside flaming is about the same to about 20 ft. Underside smoking seems to be diminishing
17:20	There was spasmodic underside flaming at a transverse joint at roughly 22 ft
19:25	Flames from burners extend down to about 18 ft but no underside flaming is visible
21:45	Still no apparent flaming on underside of deck, flame from the burners is extending out to about 16-18 ft

<u>Time (Min:Sec)</u>	<u>Observation</u>
23:00	Once again tried to make observations from south side. Was able to look in port at 15 ft and could see no underside flaming
25:15	There appears to be no change in underside flaming. Flames from the burners extend out to about the same distance, 16-18 ft
28:15	Still no visible sign of flaming on underside of deck at any point. Flames from the burners coming out to about 20 ft
29:15	Still no change on underside. The test was terminated at 30 min as scheduled. At that time there was still no underside flaming visible

KR:GTC:SJ

NORTH SIDE OBSERVATION OF WHITE HOUSE TEST

<u>Time (Min:Sec)</u>	<u>Observation</u>
0:00	Test start
0:20	Both burners in operation
0:45	Burning of fuel on floor at 12 ft
1:30	Burning of fuel on floor at 14 ft
4:00	Slight burning at transverse joints in steel decking at 4 ft
4:30	Burning at transverse joint in steel decking at 6 ft
5:15	Burning at transverse joint in steel decking at 10 ft
5:21	Dark gray smoke exiting from roof/wall joint from zero to 2 ft
6:00	Flames on ceiling of structure at 18 ft
6:30	Flames at roof/wall joint from zero to 10 ft
7:25	Flames on ceiling of structure at 26 ft
8:00	Flames on ceiling of structure at 30 ft
9:15	Flames on ceiling of structure at 34 ft
9:49	Flames on ceiling of structure at 38 ft
11:00	Flames on ceiling of structure at 38 to 40 ft at longitudinal butt joints in steel decking

<u>Time (Min:Sec)</u>	<u>Observation</u>
14:00	The amount of smoke being produced is not inhibiting the view of the steel decking
17:00	No apparent flaming on ceiling of structure beyond 20 ft
23:00	Igniting fire out to about 18 to 20 ft on ceiling
24:20	Popping and cracking sounds from interior at 16 ft mark
28:00	Igniting fire out to about 16 to 20 ft on ceiling. No apparent flaming on steel decking
29:00	Same comments as at 28 min
30:00	Test extinguished

KR:GTC:SJ

FLUE END OBSERVATION OF WHITE HOUSE TEST

<u>Time (Min:Sec)</u>	<u>Observations</u>
0:47	Heptane flaming on floor
1:39	Ignition rising flame 1 to 2 ft above the burner port
2:30	The north burner is impinging on ceiling
3:32	North burner appears to be producing larger flame than south burner
3:51	Underdeck ignition (north side)
4:40	Smoke density increasing near ceiling
4:45	Flaming from deck on north side spreading across width of structure
5:56	Dense smoke stratified downward from ceiling 3 to 4 ft
7:09	Smoke is building within structure
7:28	Odor of burning urethane can be detected
8:15	The only visible flaming is from the ignition source due to density of smoke
9:51	Flaming of the deck has spread to far east side of structure
10:22	Flaming has been reported to be at 38 ft mark
11:59	Smoke has cleared such that the ceiling can be easily seen the full length of structure. There is still flickering flames from the deck near the first I-beam (nominal 20 ft outward).

<u>Time (Min:Sec)</u>	<u>Observations</u>
12:42	The deck appears to be flaming only at points located near the first beam (nominal 20 ft outward). This is isolated flickers of flaming
13:30	The flickers of flaming continue near first beam (nominal 20 ft outward). The ignition flames from the burners appear to be of equal intensity
14:08	Flickers of underdeck flaming can be seen along the longitudinal channel members on the north side
14:38	The intermittent flickers of underdeck flaming continues along the longitudinal channel members on the north side
15:55	The smoke density is increasing again
17:00	Color of flaming has changed to a dark orange, impinging on the ceiling. No underdeck flaming can be seen
18:00	Ignition flames are now bright orange. No observed underdeck flaming
20:00	Same
21:00	Same
22:50	The ignition flames are still bright orange. The center longitudinal channel can be seen warping eastward

<u>Time (Min:Sec)</u>	<u>Observations</u>
23:00	The longitudinal channel adjacent and north of the center channel can be seen warping northward
23:40	Large amounts of dark smoke appear to be coming from north side of structure (area under direct flame impingement from north ignition burner). The flaming from the interior of the structure seems hotter with more smoke emission
25:30	Flaming from the burners is dark orange in color. Smoke emission on north side is greater than south side
26:32	Flaming from north burner appears to be more intense than south burner. The center longitudinal channel is warped southward
27:40	A loud noise and vibration was heard inside the structure
28:47	Flaming from north burner appears more intense than south burner. Smoke emission from north side greater than south side of structure
30:00	Burners extinguished and sprinkler system was activated

KR:GTC:SJ

ROOFING TEST APPARATUS - SCHEMATIC

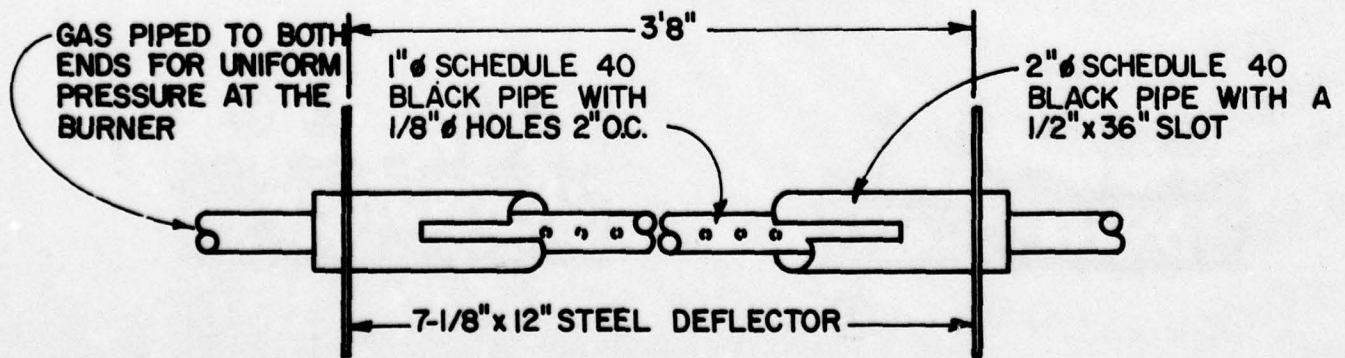
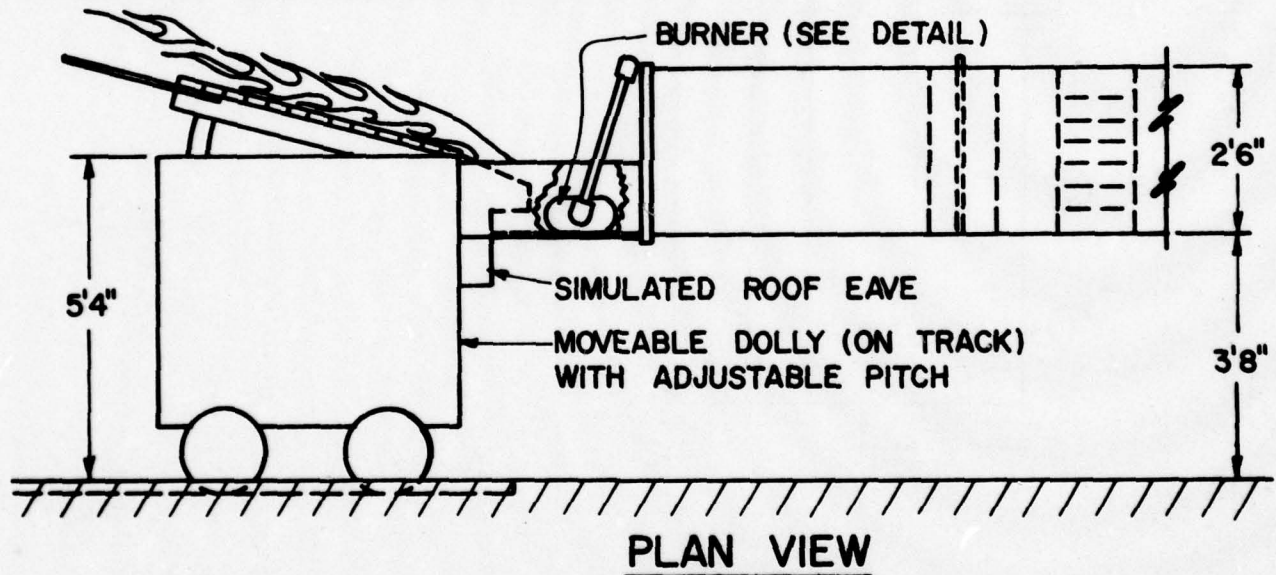
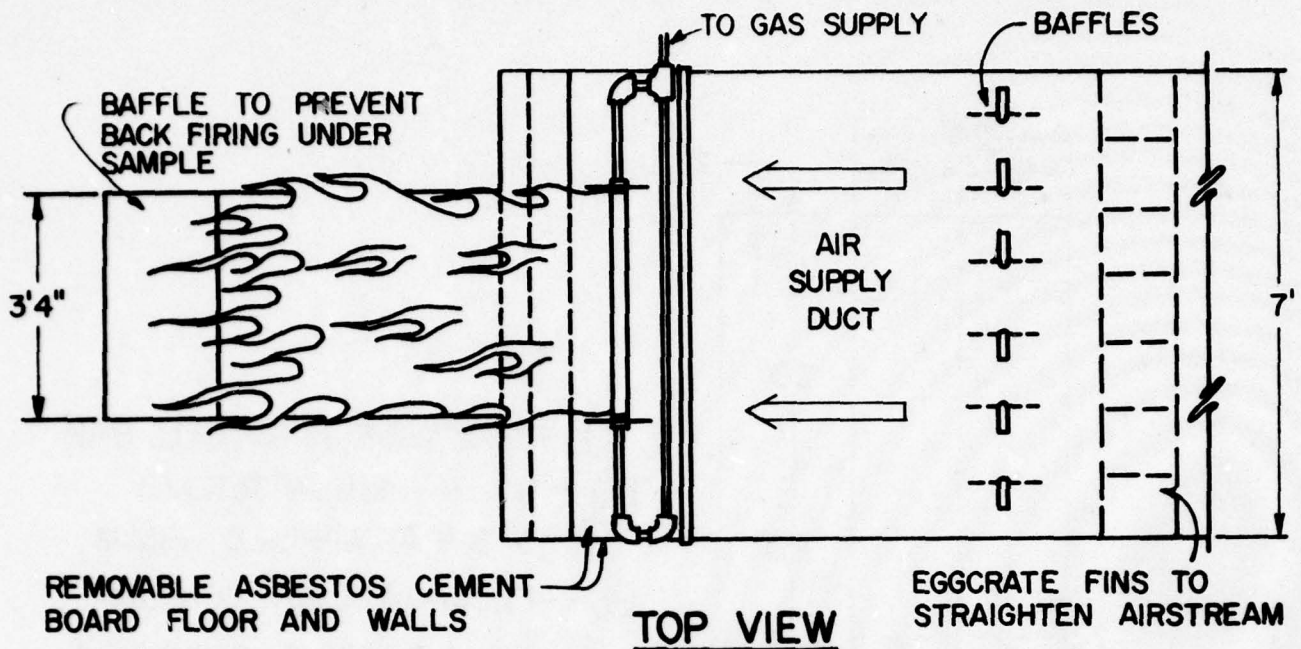

ILL. 1
USNC77

TUNNEL TEST SAMPLES

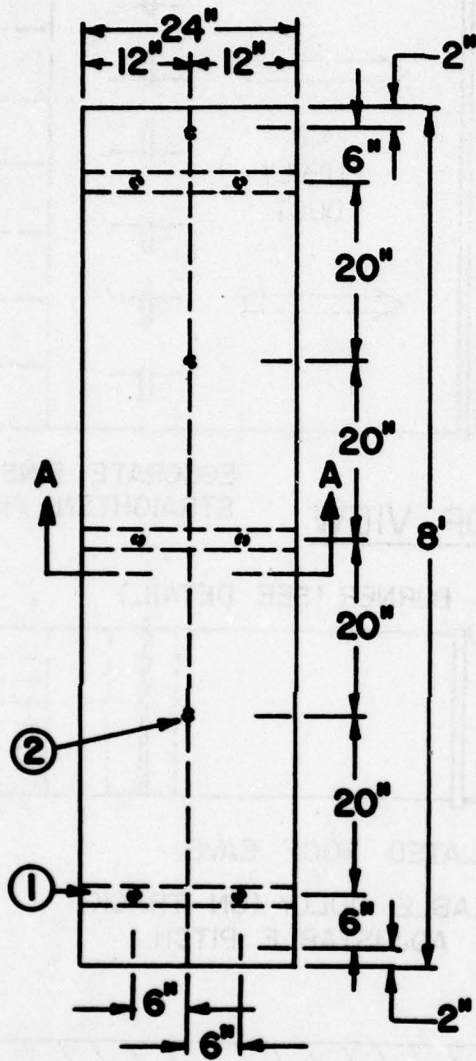

- ① — 2-1/2" WIDE, 14 GA. STL. BAR
- ② — NO. 1/4-14x1-1/4" TEKS/3
- ③ — 3" SPRAY-APPLIED FOAM
- ④ — FLUID-APPLIED COATING
- ⑤ — NO. 11 ROOFING GRANULES

ILL. 2
USNC77

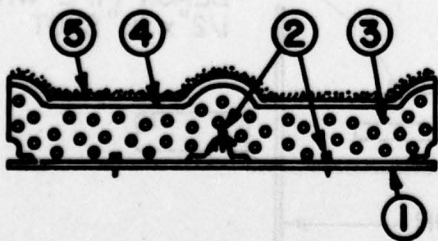

SECTION A-A
(RIB PANELS)

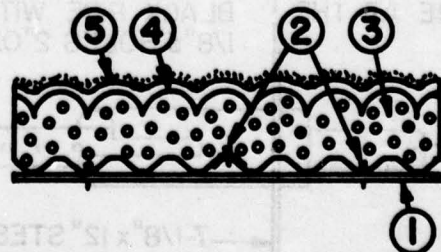

SECTION A-A
(9/16" CORRUGATED DECK)

DETAILS OF TEST FURNACE

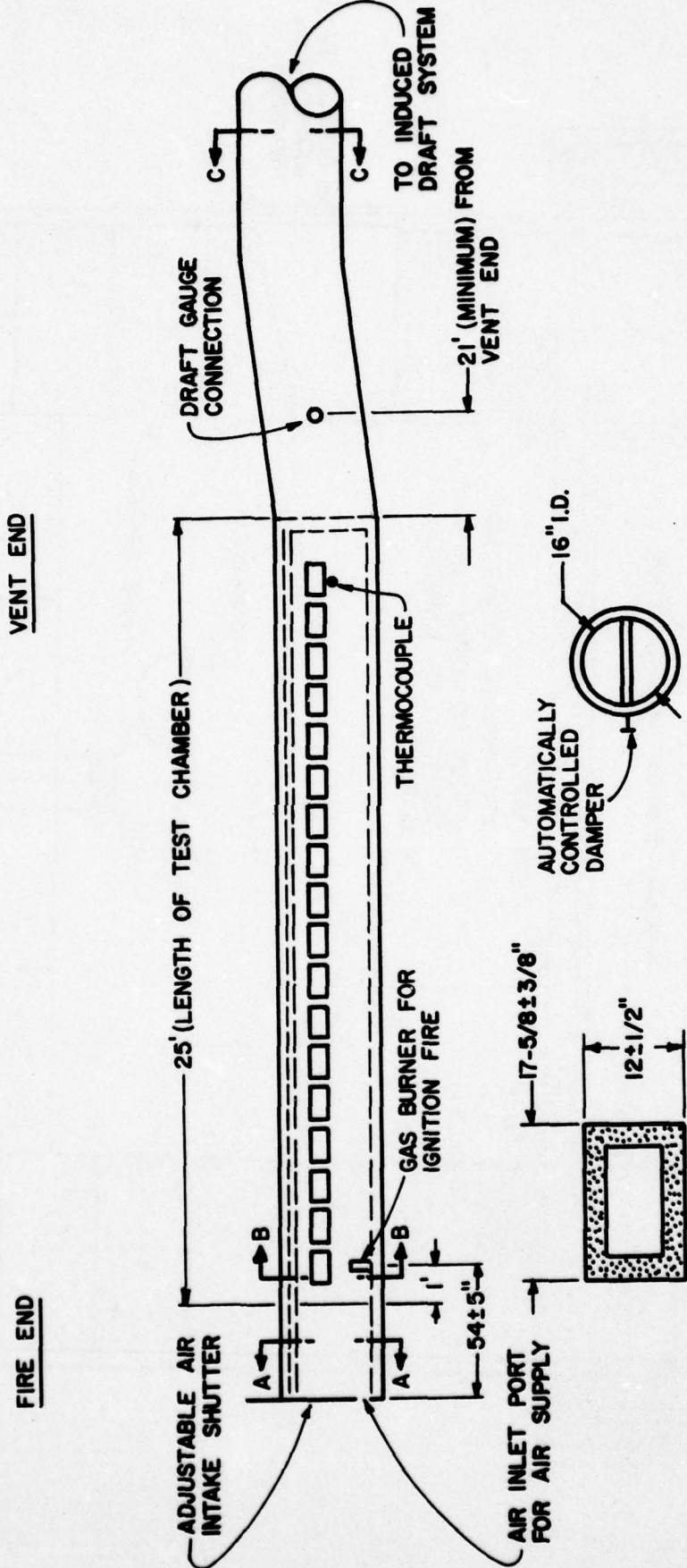

VENT END

FIRE END

SECTION C-C

SECTION A-A

SECTION B-B

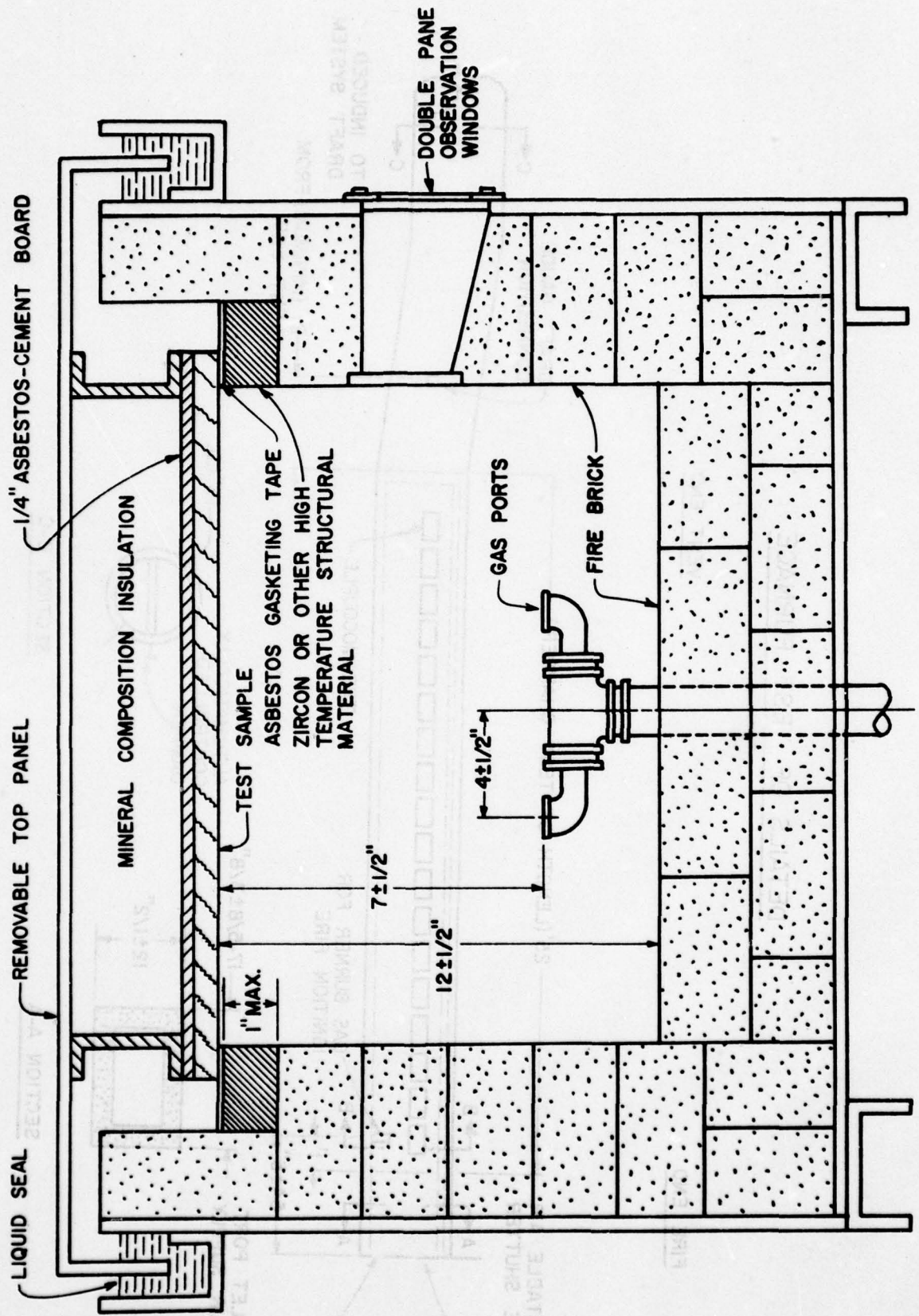

ILL. 4
USNC77

SMALL SCALE FIRE TEST SAMPLES

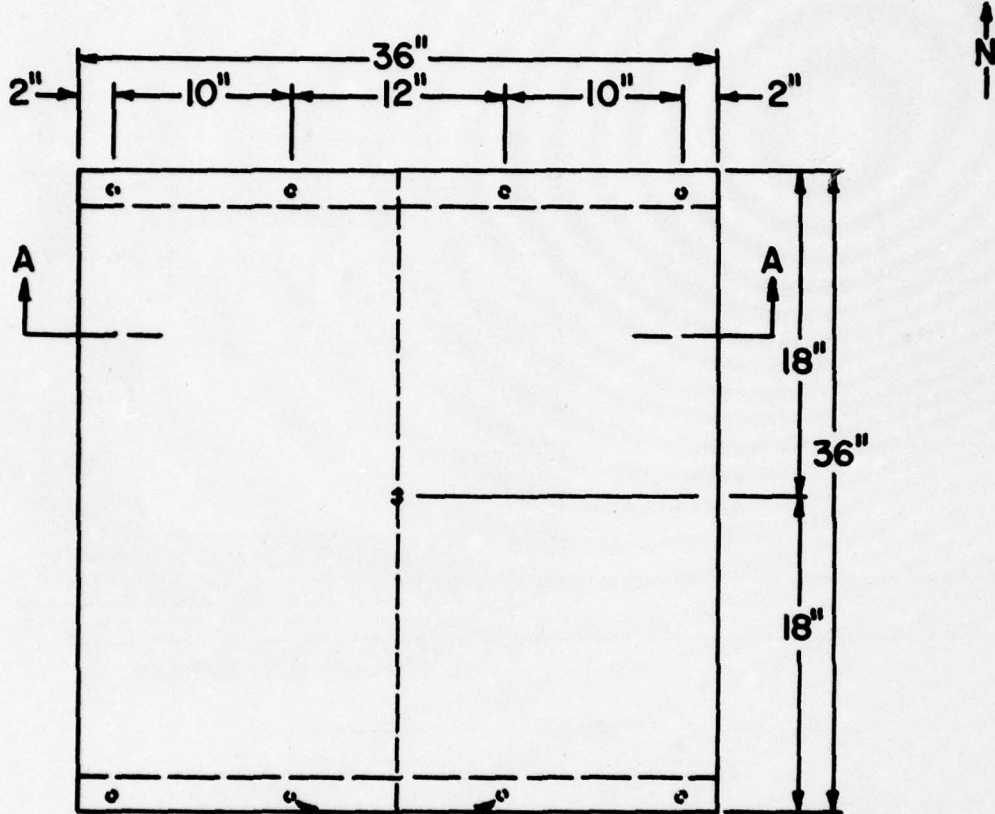

NO. 1/4-14 x 1-1/4" TEKS/3
 NO. 11 ROOFING GRANULES

FLUID-APPLIED COATING
 SPRAY-APPLIED FOAM

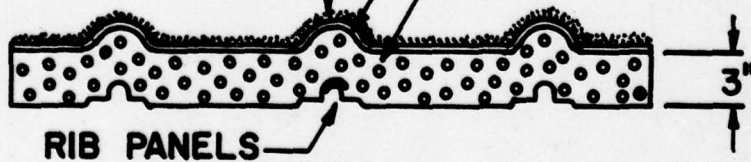

SECTION AA

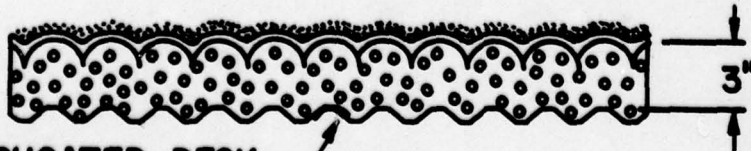

9/16" CORRUGATED DECK

SECTION AA

SMALL SCALE HORIZONTAL EXPOSURE FURNACE

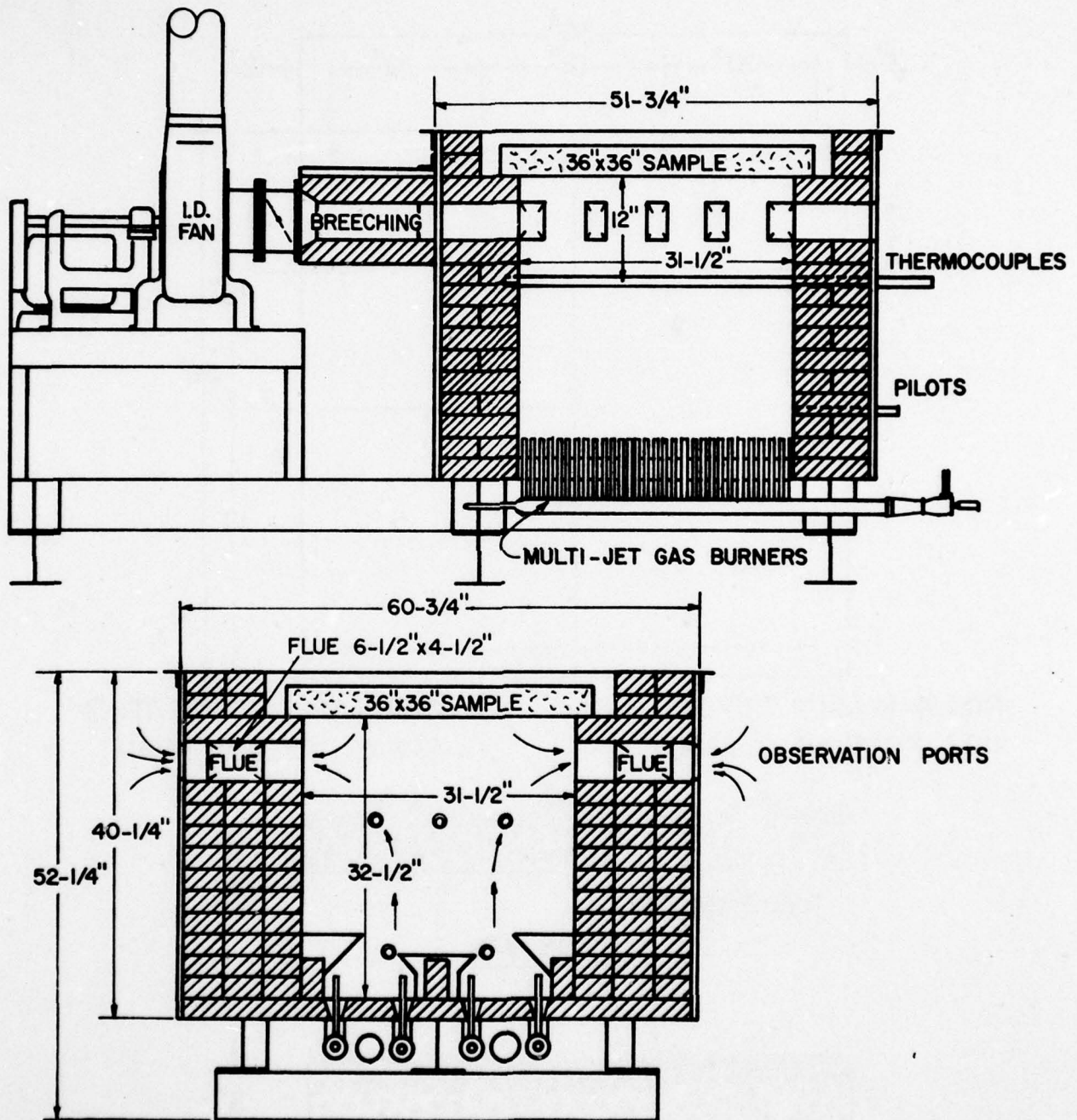

ILL. 6
USNC77

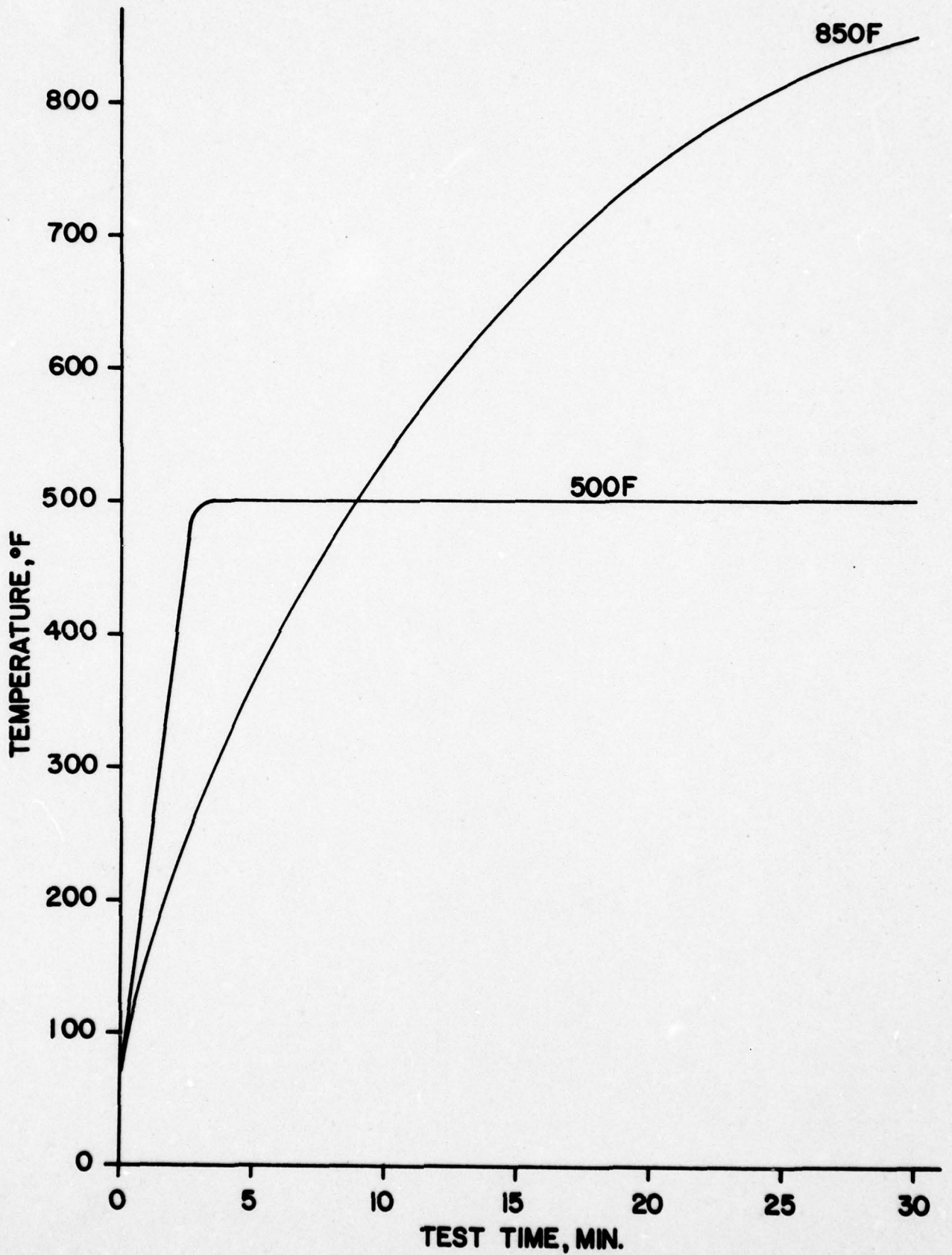

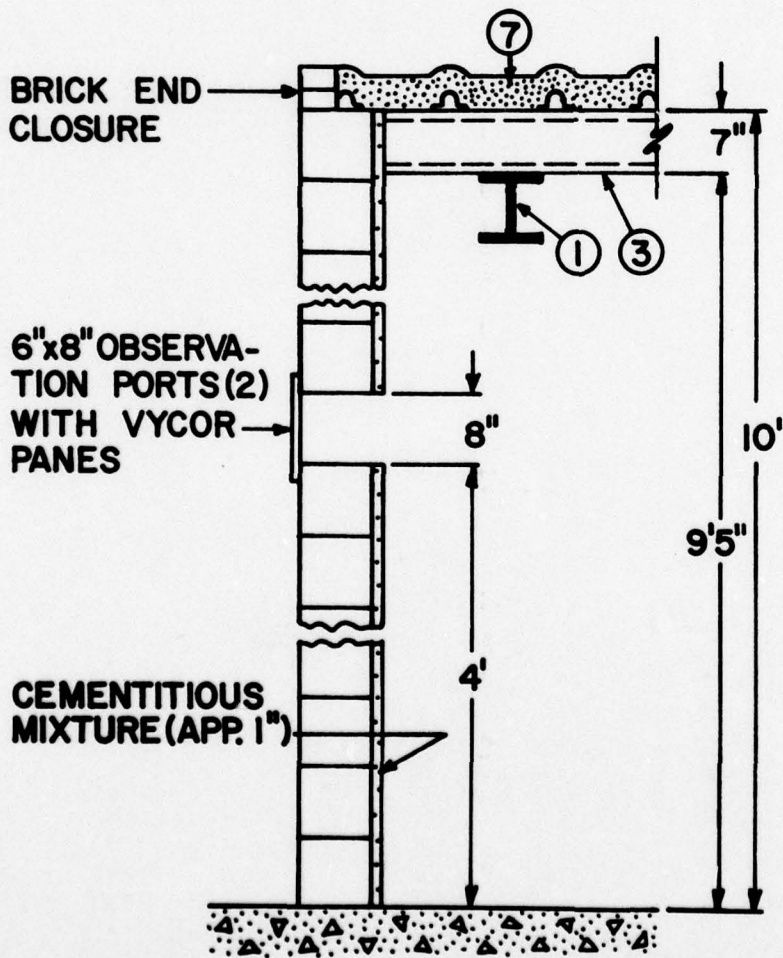
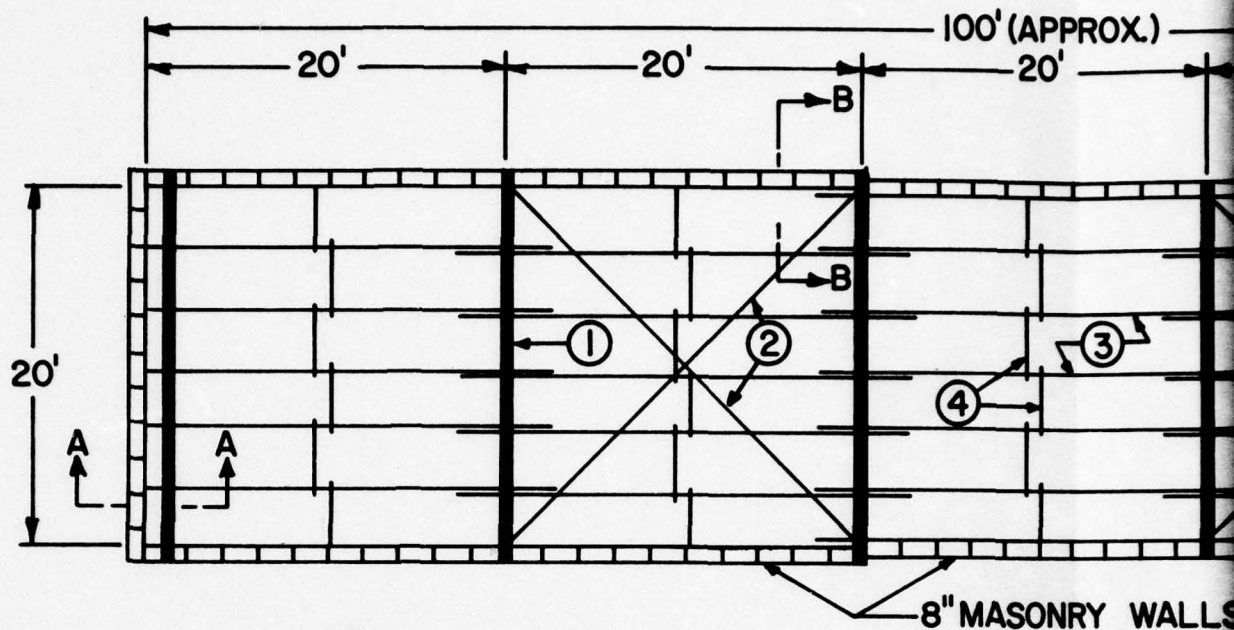

SECTION A-A

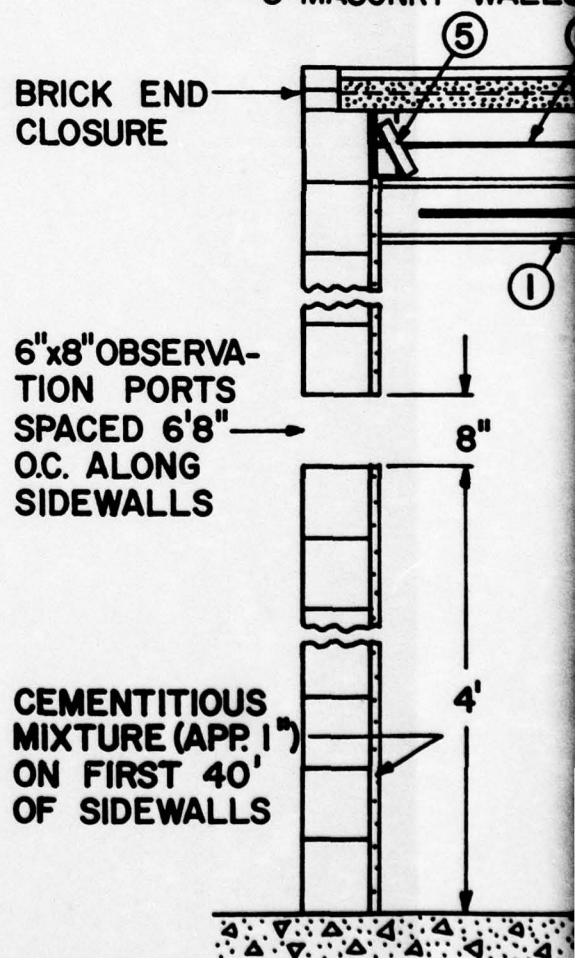

SECTION B-B

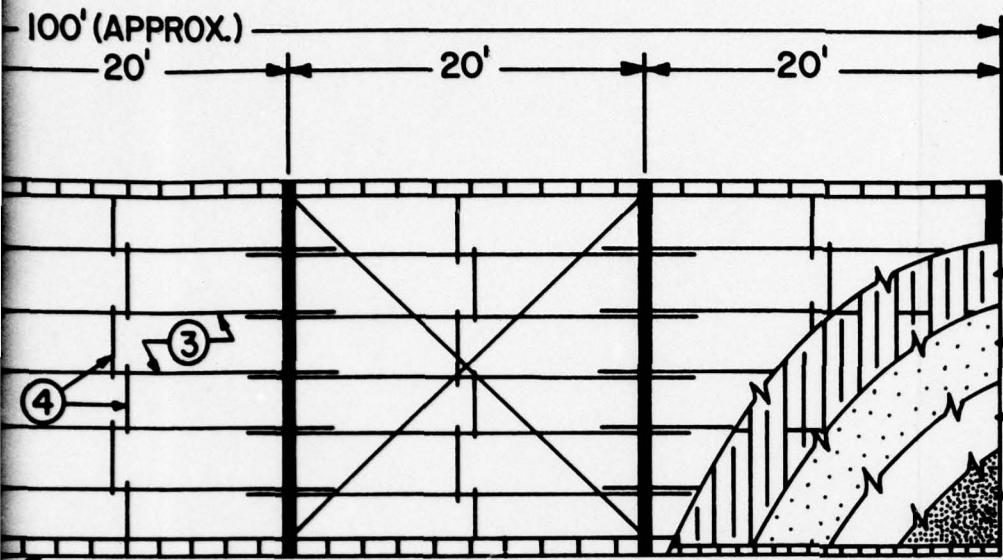

8" MASONRY WALLS

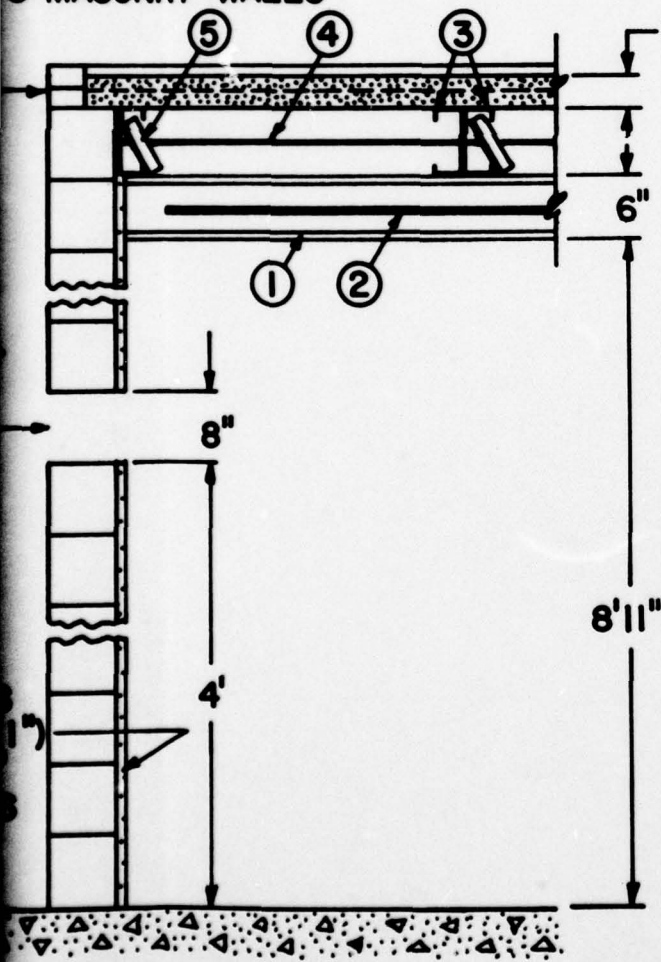

- ①—W6X16 STEEL BEAM
- ②—1/2"Ø STEEL ROD WITH TURNBUCKLES
- ③—7" DEEP, 14 GA. STEEL CHANNEL-SHAPED PURLINS, 24' 11-1/4" LONG, SPACED 40" O.C.
- ④—3/8"Ø STEEL BRIDGING RODS
- ⑤—1-1/2"x1-1/2"x1/8"x6" LONG STEEL ANGLE, WELDED TO BEAM AND PURLIN (7/BEAM)
- ⑥—RIB METAL ROOF DECK PANELS, 26 GA. GALV. STEEL, 24" WIDE
- ⑦—SPRAY-APPLIED FOAM, 3" THICK
- ⑧—FLUID-APPLIED COATING, TWO COATS APPLIED AT A RATE OF 1.5 GAL / 100 SQ FT FOR EACH COAT
- ⑨—NO. 11 ROOFING GRANULES APPLIED AT A RATE OF 50 LB / 100 SQ FT

SECTION B-B

BLOWER AND IGNITION DETAILS

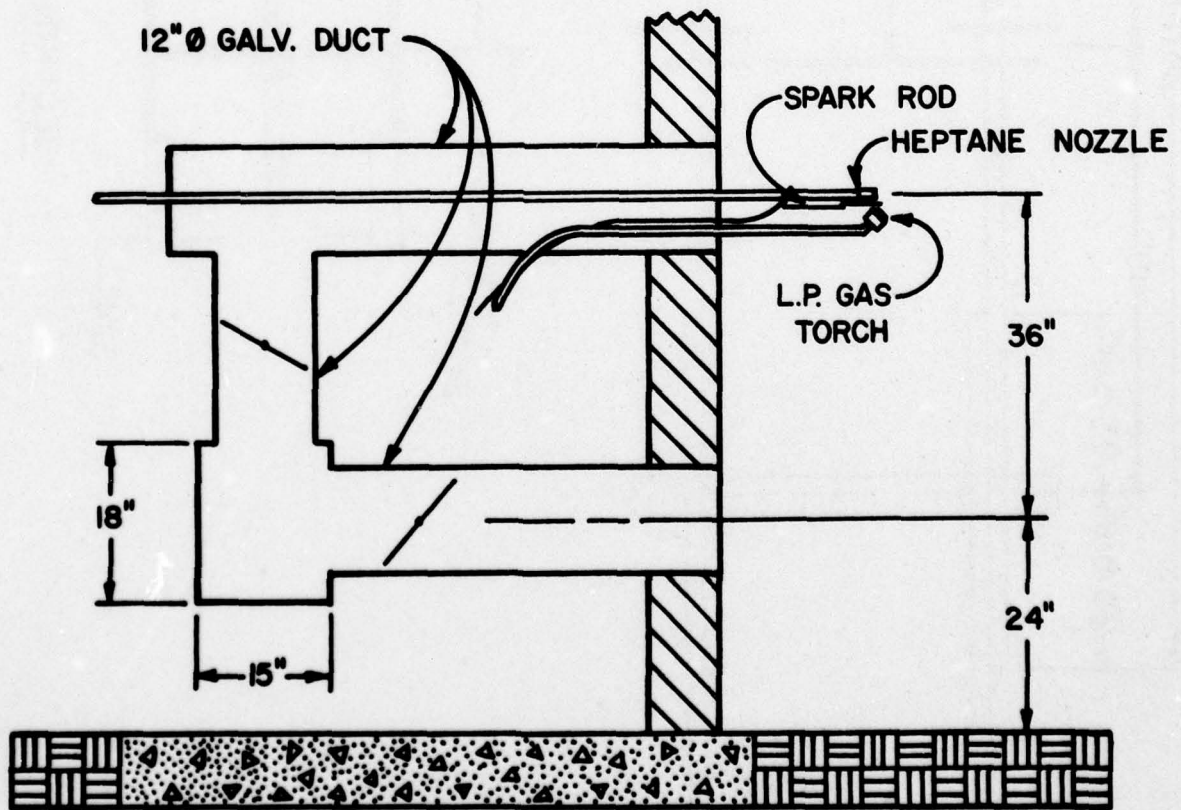
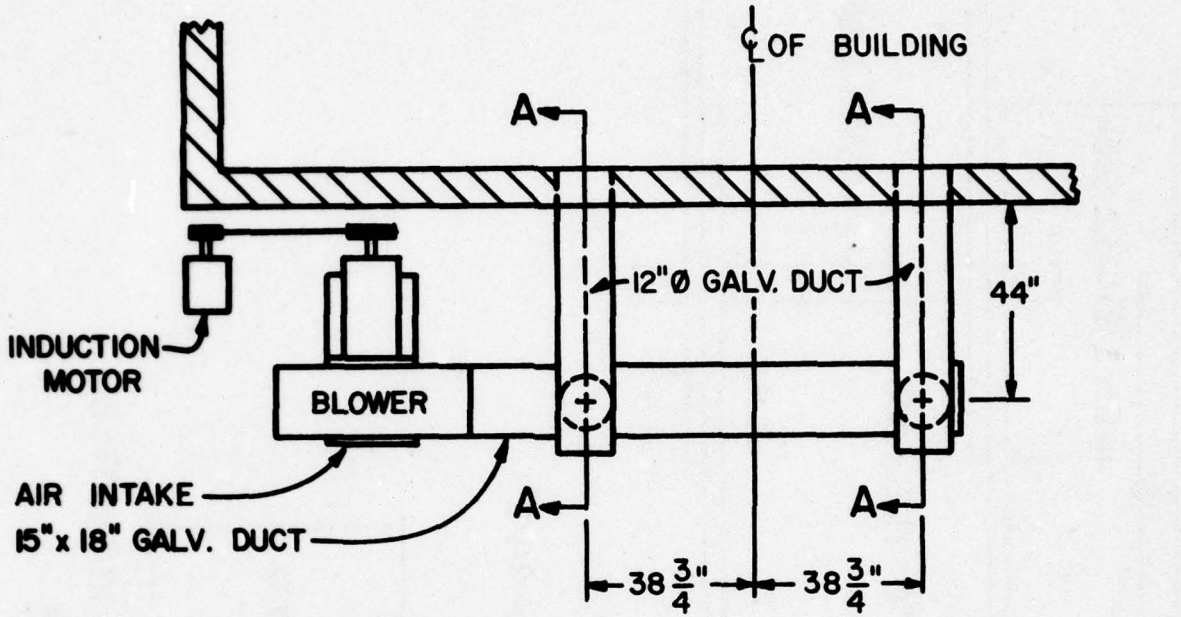

SECTION A-A

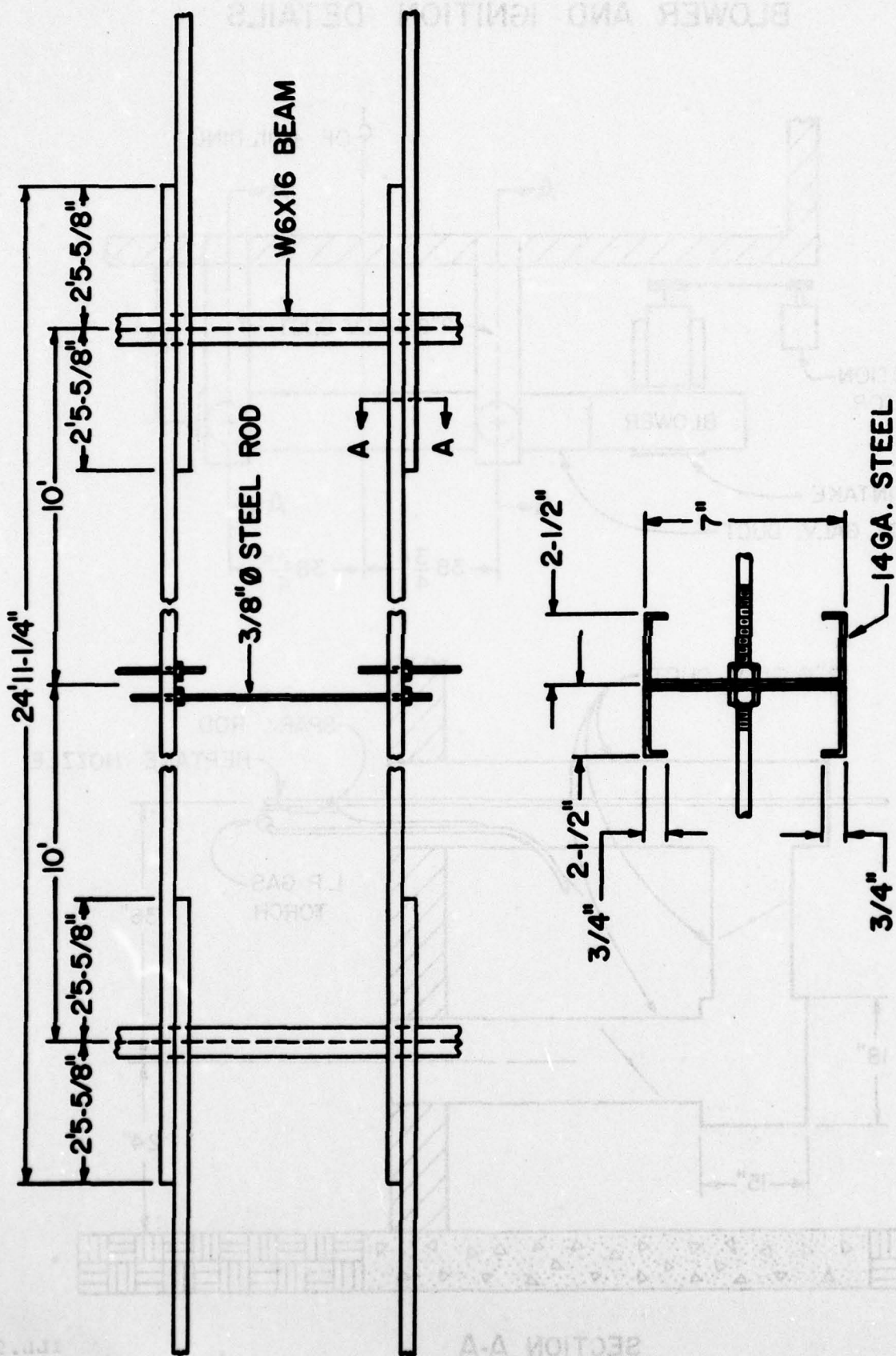

USNC77 ILL.10

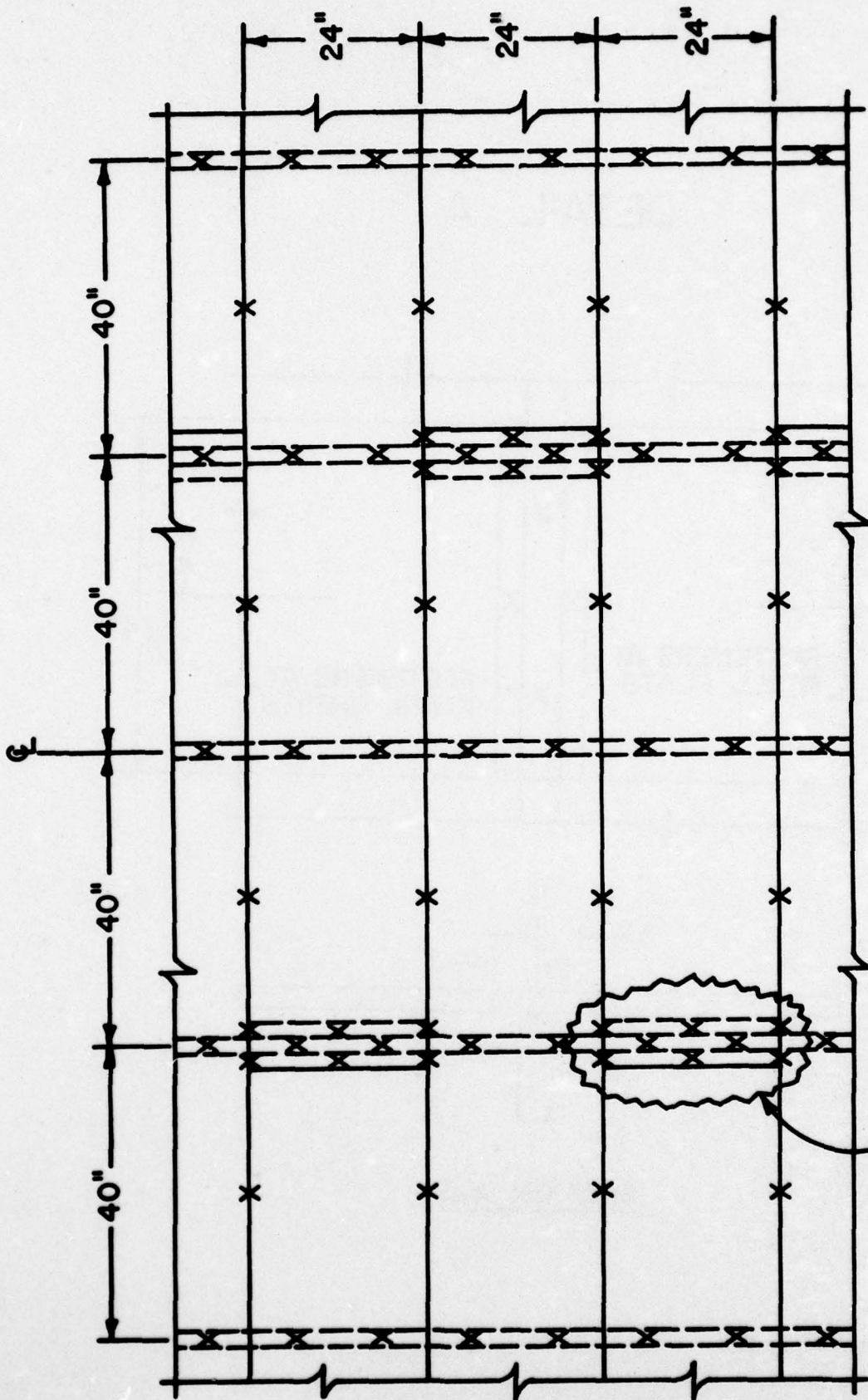

SEE DETAIL A
 X - NO. 1/4-14 x 1-1/4" TEKS / 3 (ALL FASTENERS)

ILL. 11
 USNC 77

DETAIL A

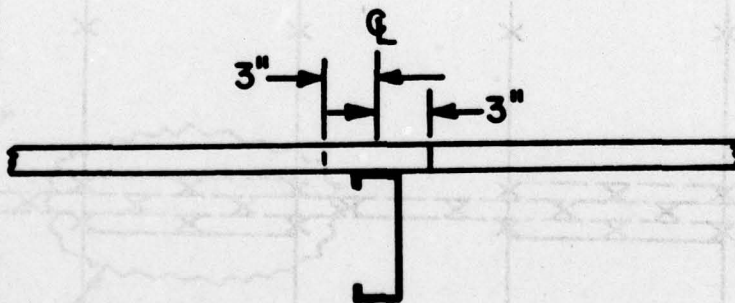
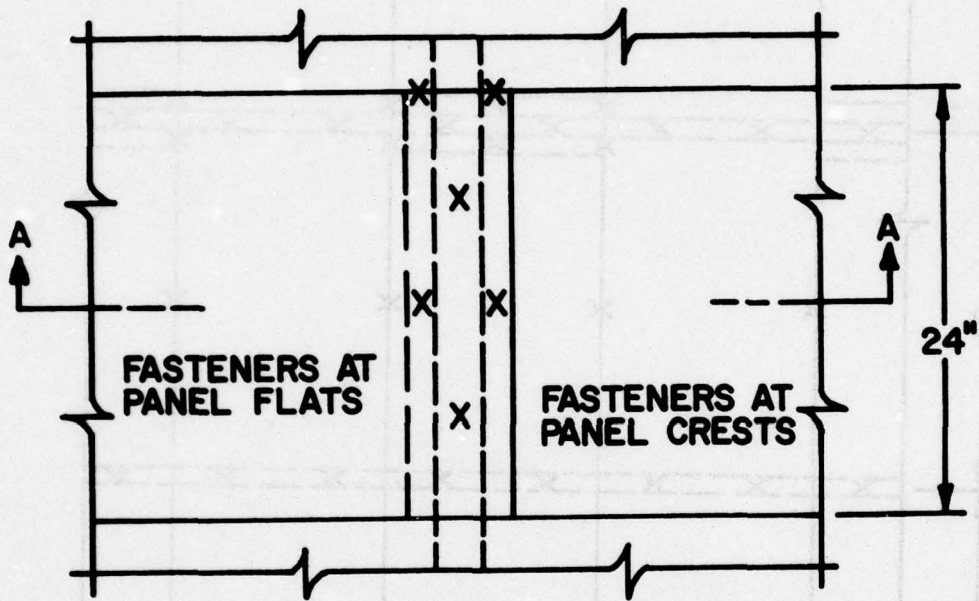

SECTION A-A

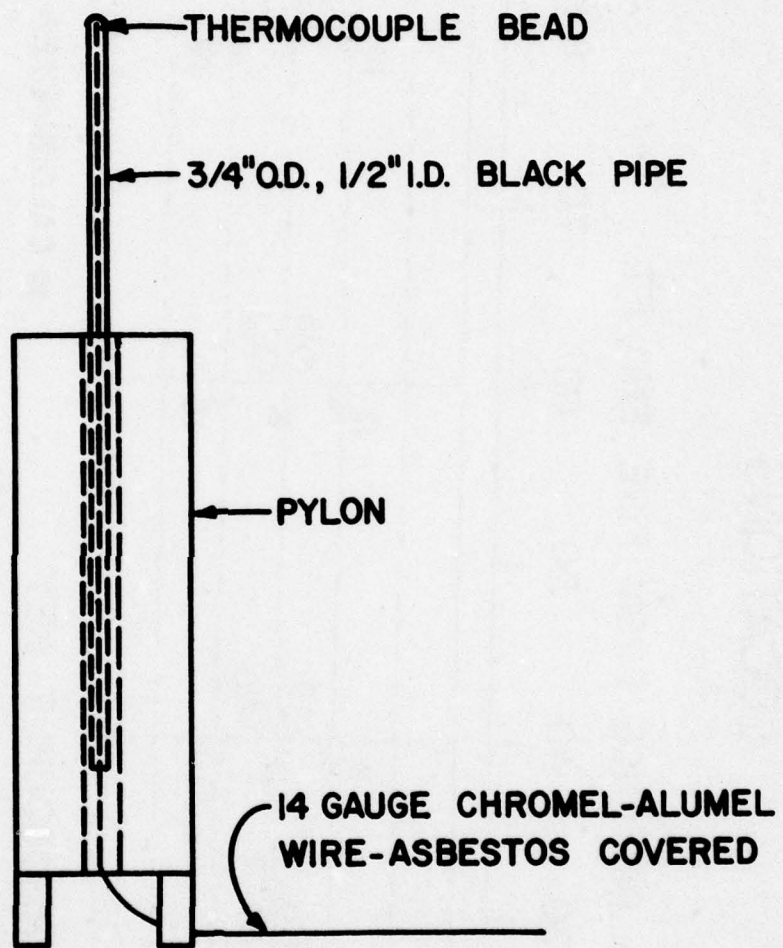

THERMOCOUPLE & CALORIMETER LOCATIONS

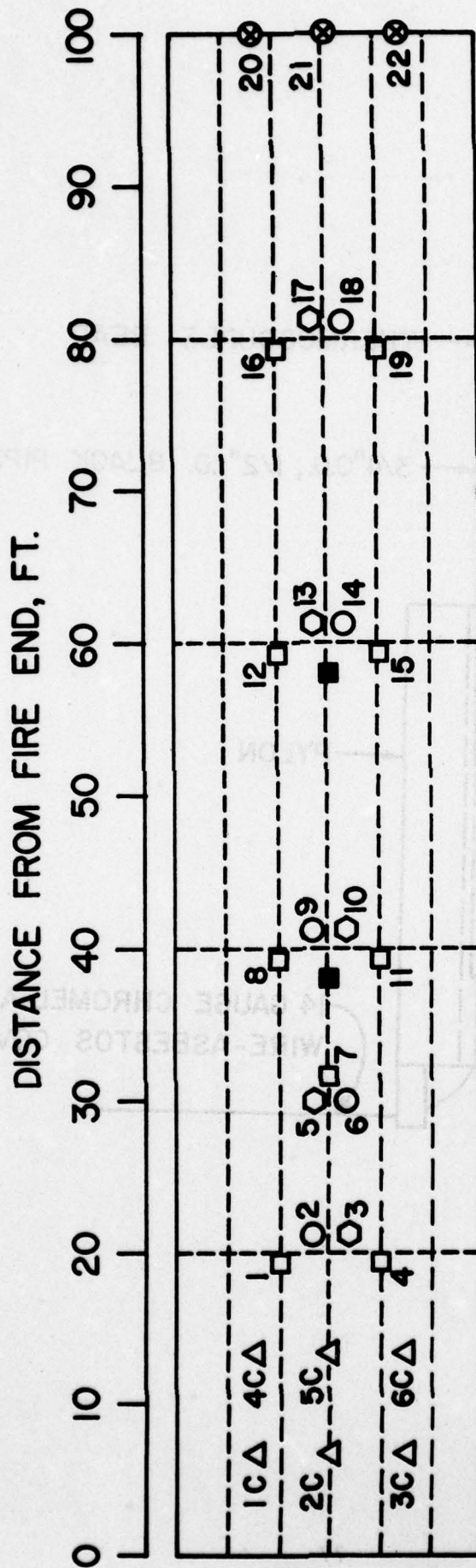

- THERMOCOUPLE KEY**
- △ FIRE CONTROL (NOS. 1C-6C)
 - IN AIR 2" BELOW PURLIN (NOS. 1,4,8,11,12,15,16,19)
 - TOP OF STEEL ROOF DECK (NOS. 2,6,9,14,18)
 - TOP OF ROOF DECK ASSEMBLY (NOS. 3,5,10,13,17)
 - ⊙ IN AIR 3' BELOW STEEL ROOF DECK (NOS. 20,21,22)
- CALORIMETER**

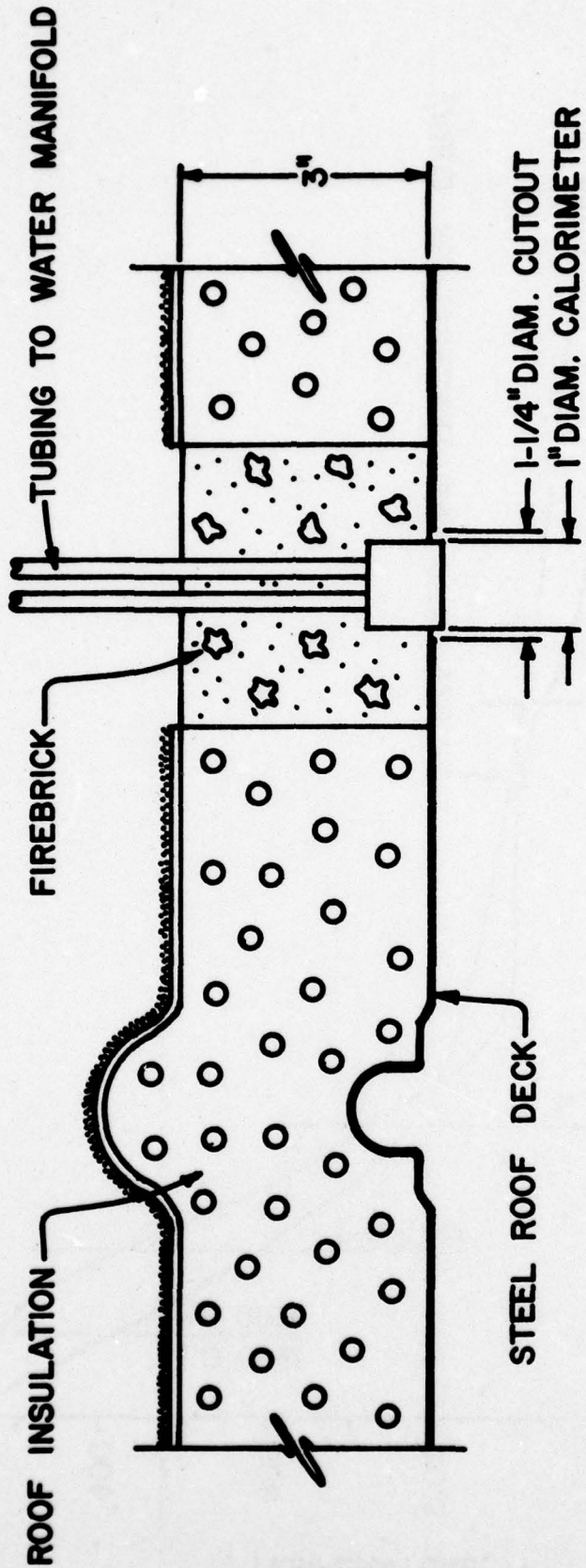

CALORIMETER DETAIL

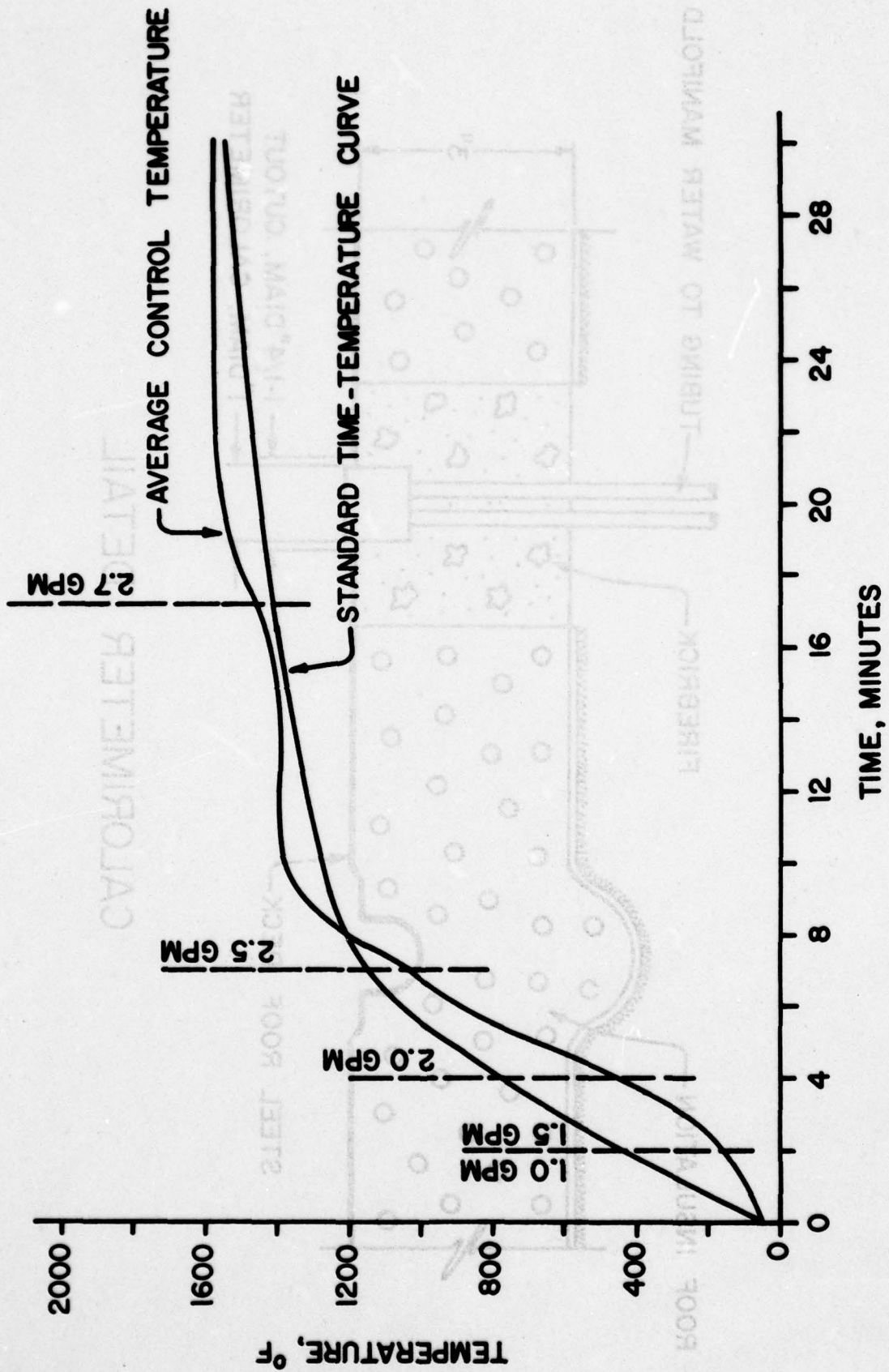

ILL. 16
USNC77

AVERAGE FLUE TEMPERATURE

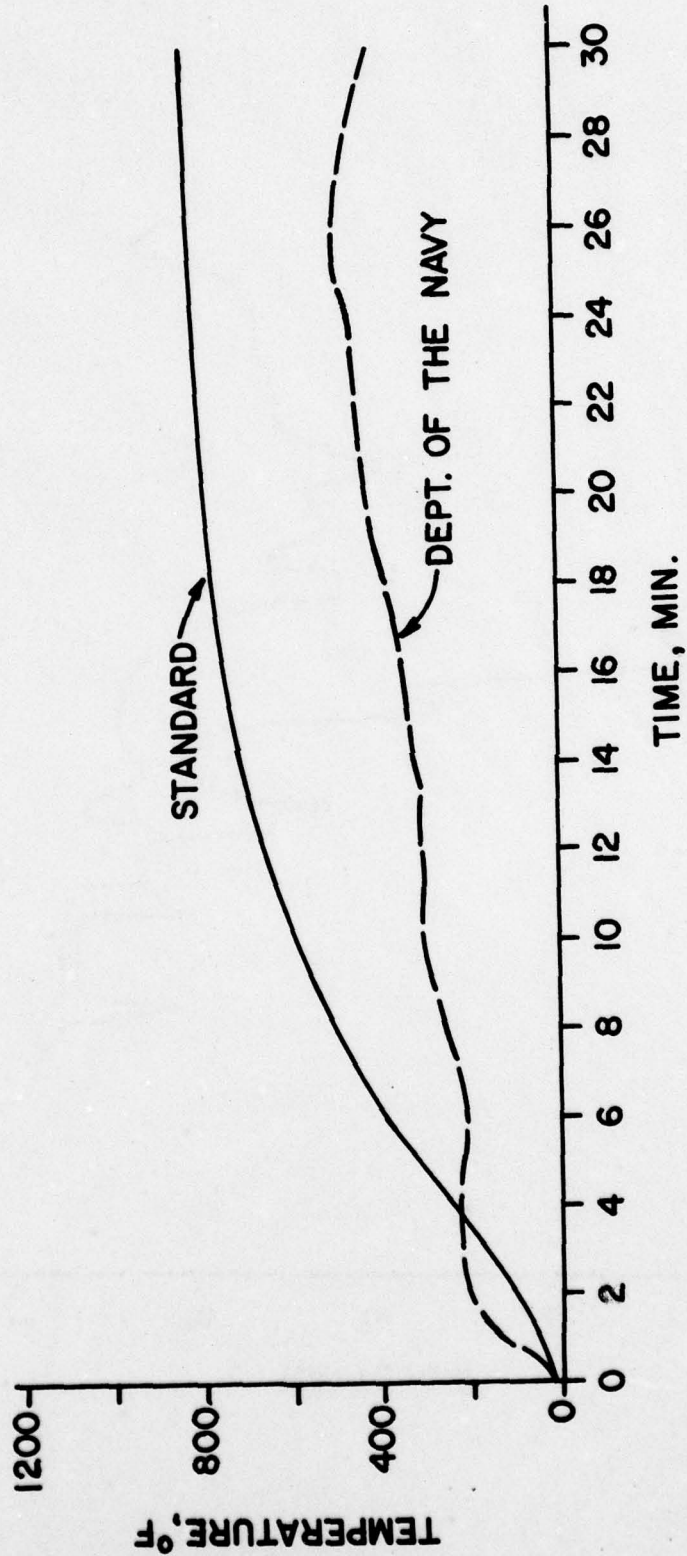

ILL.17
USNC77

RADIANT HEAT FLUX

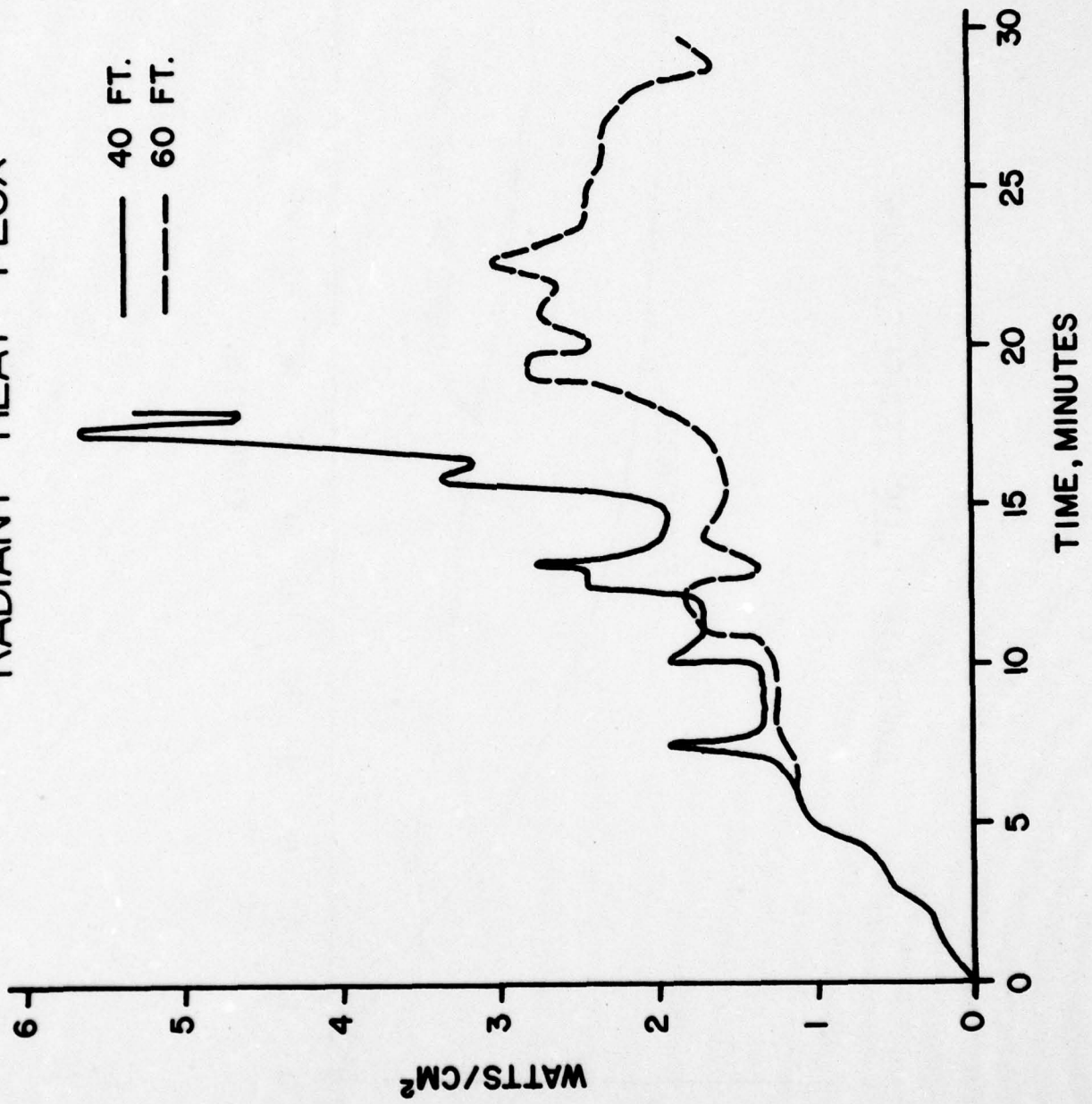

ILL.18
USNC77

WIND DIRECTION
FROM NORTHWEST
DURING TEST

OBSERVATIONS AFTER TEST



■ CROSS SECTION CUT LOCATION

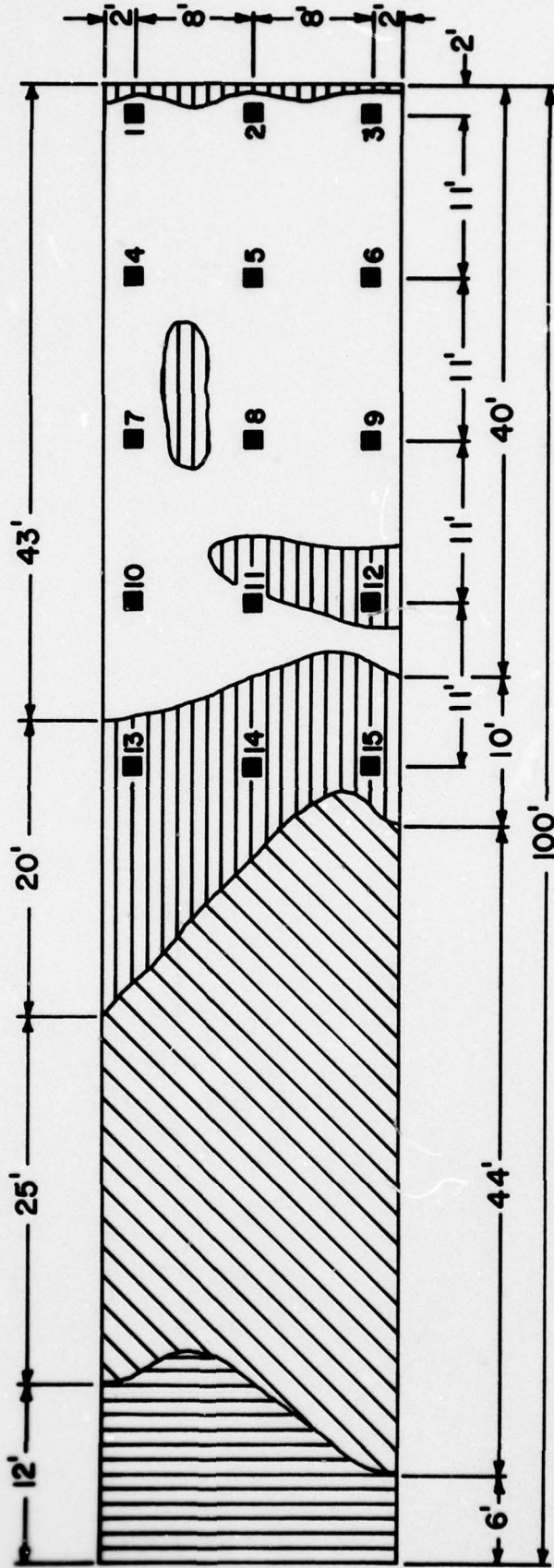

EXTERIOR

-  STEEL DECK EXPOSED
-  ROOF COVERING CHARRED THROUGH ENTIRE THICKNS.
-  ROOF COVERING BUBBLED

INTERIOR

-  STEEL DECK RIPPLED, SEVERAL DECK SIDELAP JOINTS OPEN
-  STEEL DECK RIPPLED





PRECEDING PAGE BLANK-NOT FILMED

USNC 77
ILL. 22

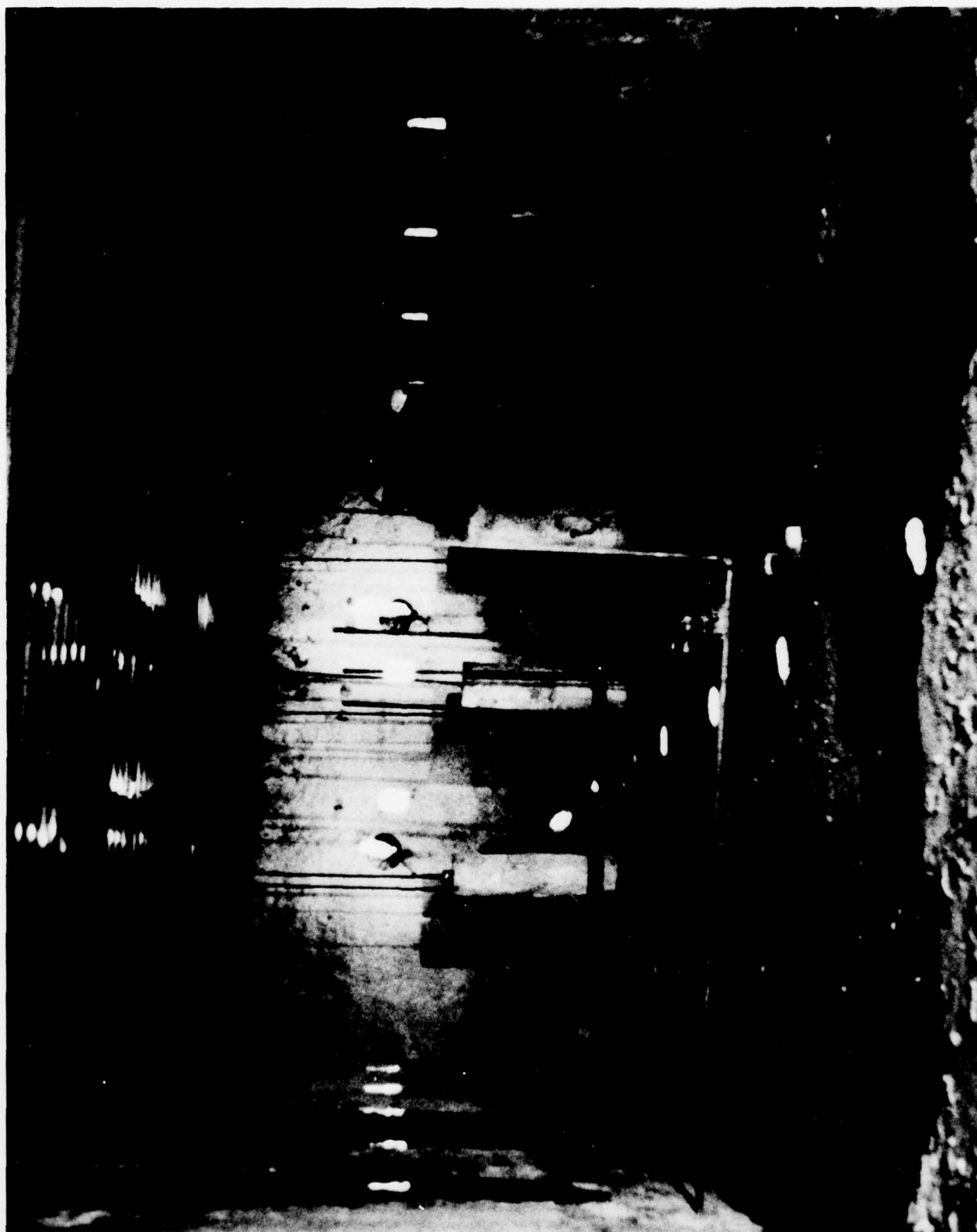



USNC 77
ILL. 24

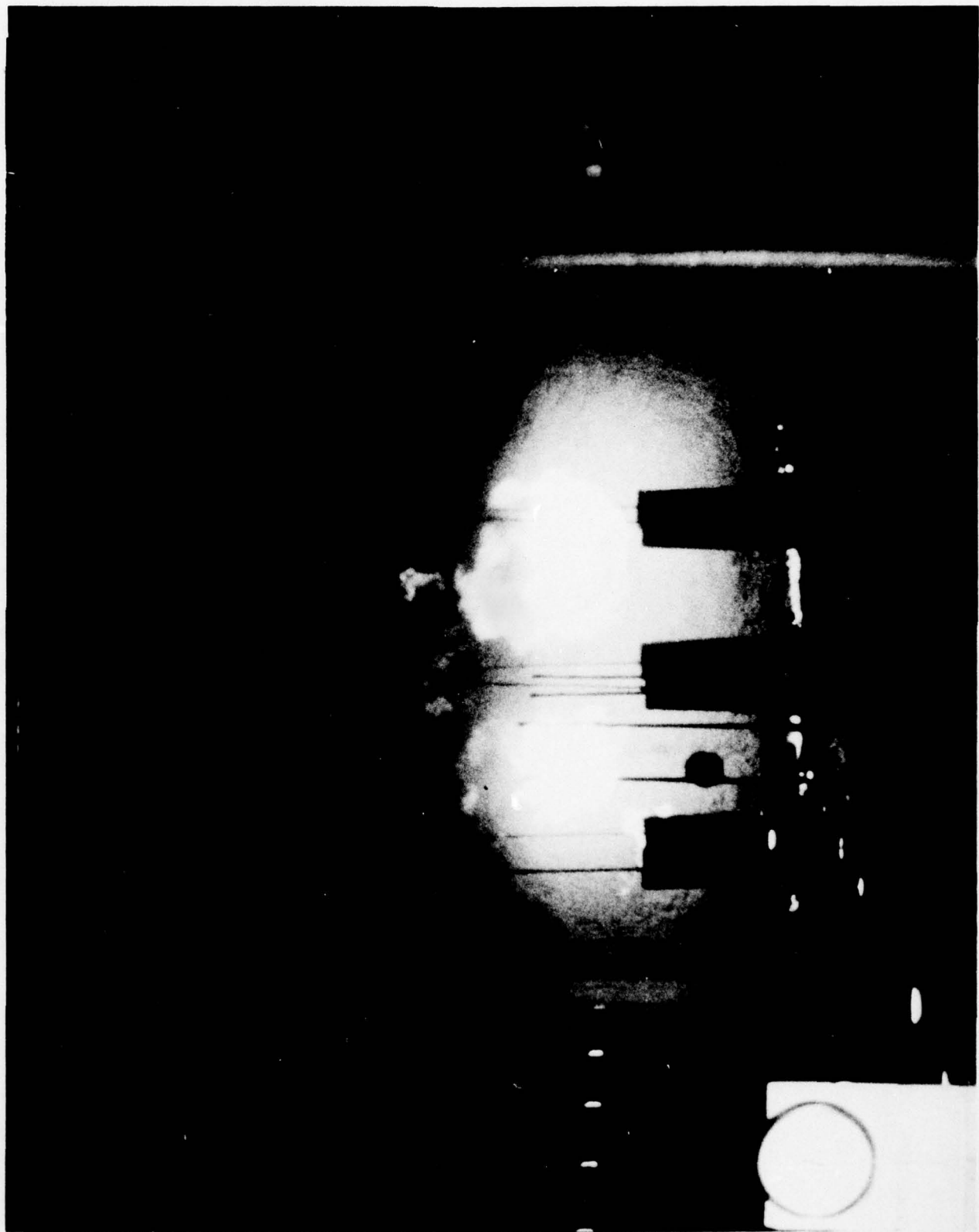

PRECEDING PAGE BLANK-NOT FILMED



USNC 77
ILL. 26

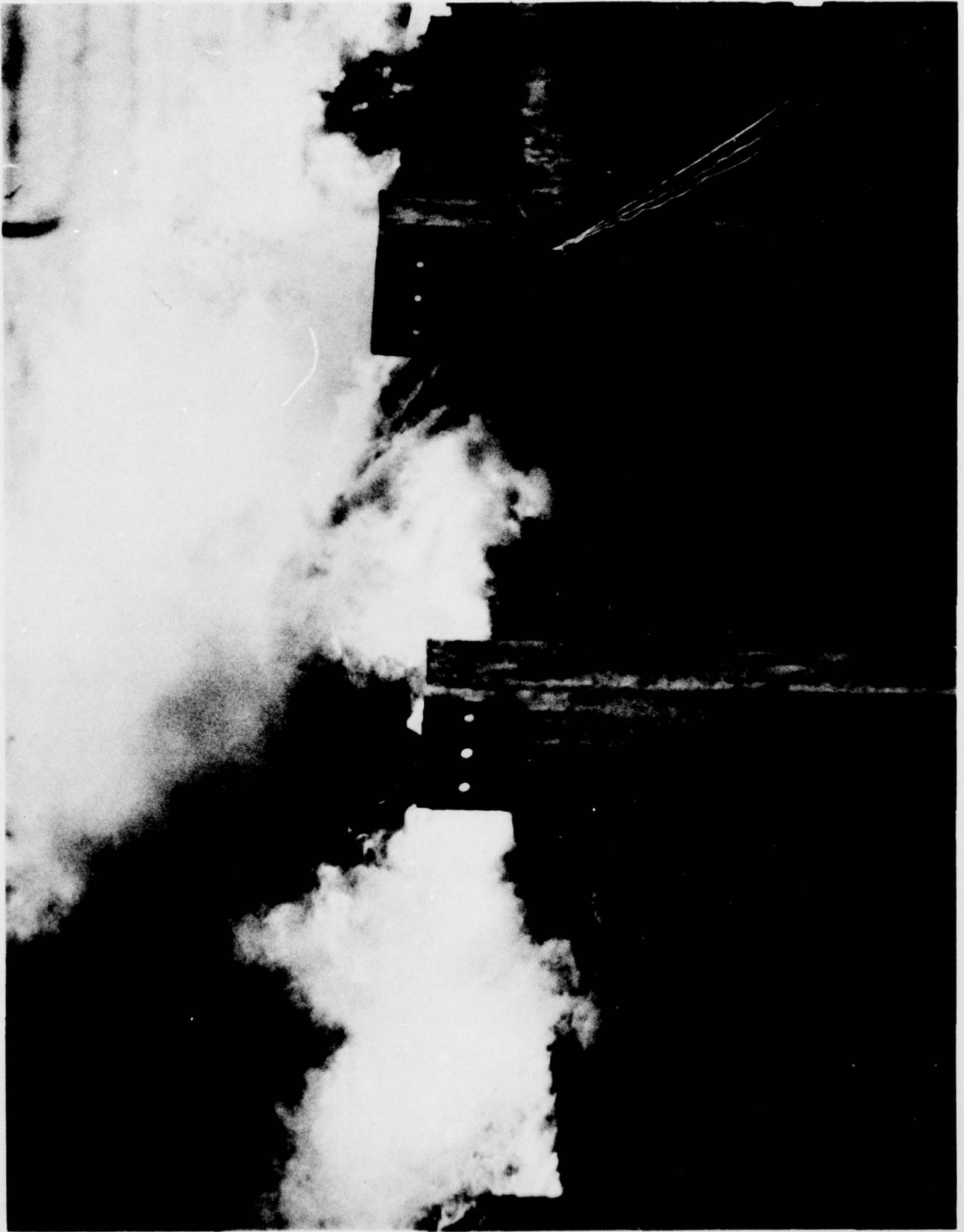

PRECEDING PAGE BLANK-NOT FILMED





USNC 77
ILL. 29



103

PRECEDING PAGE BLANK-NOT FILMED



PRECEDING PAGE BLANK-NOT FILMED

USNC 77
ILL. 31



107

PRECEDING PAGE BLANK-NOT FILMED