

AD-A065 455

COAST GUARD WASHINGTON D C OFFICE OF RESEARCH AND DE--ETC F/G 6/6
FIELD TESTS OF SIX OFFSHORE OIL CONTAINMENT BOOMS. PART I.(U)
NOV 78 P R CORPUZ, R A GRIFFITHS
USCG-D-78-78-PT-1

UNCLASSIFIED

NL

/ OF |
AD
A065455

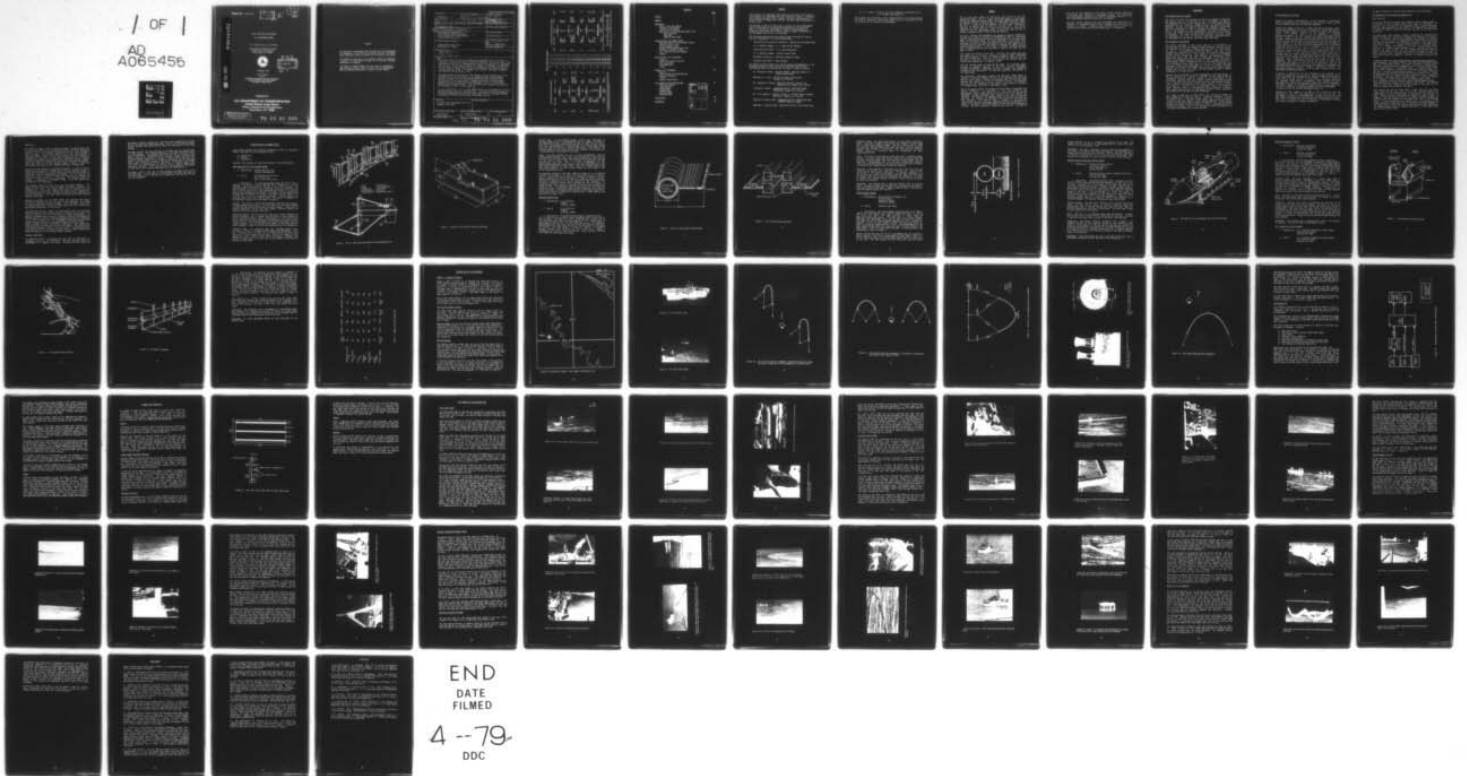

END
DATE
FILMED
4 --79
DDC

Report No. CG-D-78-78

LEVEL II

12
NW

AD A0 65455

FIELD TESTS OF SIX OFFSHORE
OIL CONTAINMENT BOOMS

P. R. Corpuz and R. A. Griffiths

Environmental Technology Branch
United States Coast Guard
Washington, DC 20590



DDC
RECEIVED
07 MAR 1979
E

DDC FILE COPY

November 1978

Final Report
Part 1

Document is available to the public through the
National Technical Information Service,
Springfield, Virginia 22151

Prepared for

U.S. DEPARTMENT OF TRANSPORTATION
United States Coast Guard
Office of Research and Development
Washington, D.C. 20590

DISTRIBUTION STATEMENT A
Approved for public release;
Distribution Unlimited

79 03 01 006

NOTICE

This document is disseminated under the sponsorship of the Department of Transportation in the interest of information exchange. The United States Government assumes no liability for its contents or use thereof.

The contents of this report do not necessarily reflect the official view or policy of the Coast Guard; and they do not constitute a standard, specification, or regulation.

This report, or portions thereof may not be used for advertising or sales promotion purposes. Citation of trade names and manufacturers does not constitute endorsement or approval of such products.

1. Report No. CG-D-78-78		2. Government Accession No. (14) 24526-D-78-78-PT-1		3. Recipient's Catalog No.	
4. Title and Subtitle (6) FIELD TESTS OF SIX OFFSHORE OIL CONTAINMENT BOOMS Part I				5. Report Date (11) November 1978	
7. Author(s) (10) P. R. Corpuz and R. A. Griffiths				6. Performing Organization Code	
8. Performing Organization Name and Address Environmental Technology Branch Office of Research and Development United States Coast Guard				8. Performing Organization Report No.	
12. Sponsoring Agency Name and Address United States Coast Guard Washington, DC 20590				10. Work Unit No. (TRAIS)	
				11. Contract or Grant No.	
				13. Type of Report and Period Covered (9) Final Report, Part 1	
15. Supplementary Notes (12) 72 p.				14. Sponsoring Agency Code	
16. Abstract This report describes the test procedures and equipment used in testing six different oil containment booms in the Gulf of Mexico. Oil was not used. Each boom was evaluated for its seakeeping and logistic requirements for deployment and retrieval. Each boom was moored in a U shape, or catenary, configuration. This was done by establishing two sets of mooring buoys on opposite sides of the Navy platform, Stage I, off Panama City, Florida. Tests were conducted from 28 March through 28 April 1977. The booms tested were obtained on loan from the various manufacturers, their representatives, or other sources. An attempt was made to obtain booms suitable for open water use that employ different means of maintaining flotation and of carrying tension. Seakeeping data was obtained through documentation with a videotape system developed by the U. S. Coast Guard Research and Development Center. The videotapes were analyzed, and the data are presented in Part 2 of this report. In seas varying from 1 to 2 m, three booms suffered serious mechanical failures that made them incapable of containing oil. Two booms suffered no mechanical failure but demonstrated significant containment failure. One boom suffered no mechanical failures and only minor containment failure.					
17. Key Words Oil booms, Oil Containment, Oil Spill Cleanup, Field Tests			18. Distribution Statement		
19. Security Classif. (of this report) Unclassified		20. Security Classif. (of this page) Unclassified		21. No. of Pages	22. Price

METRIC CONVERSION FACTORS

Approximate Conversions to Metric Measures		Approximate Conversions from Metric Measures		
Symbol	When You Know	Multiply by	To Find	Symbol
LENGTH				
in	inches	2.5	centimeters	cm
ft	feet	30	centimeters	cm
yd	yards	0.9	meters	m
mi	miles	1.6	kilometers	km
AREA				
in ²	square inches	6.5	square centimeters	cm ²
ft ²	square feet	0.09	square meters	m ²
yd ²	square yards	0.8	square meters	m ²
mi ²	square miles	2.6	square kilometers	km ²
	acres	0.4	hectares	ha
MASS (weight)				
oz	ounces	28	grams	g
lb	pounds	0.45	kilograms	kg
	short tons (2000 lb)	0.9	tonnes	t
VOLUME				
sp	teaspoons	5	milliliters	ml
tblsp	tablespoons	15	milliliters	ml
fl oz	fluid ounces	30	milliliters	ml
c	cups	0.24	liters	l
pt	pints	0.47	liters	l
qt	quarts	0.95	liters	l
gal	gallons	3.8	liters	l
ft ³	cubic feet	0.03	cubic meters	m ³
yd ³	cubic yards	0.76	cubic meters	m ³
TEMPERATURE (exact)				
°F	Fahrenheit temperature	5/9 (after subtracting 32)	Celsius temperature	°C
TEMPERATURE (approx)				
°C	Celsius temperature	9/5 (then add 32)	Fahrenheit temperature	°F

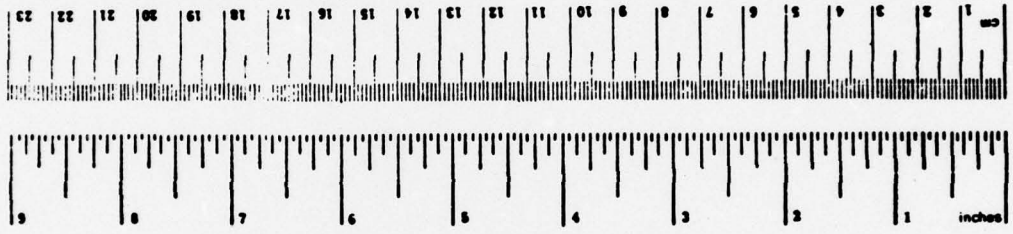

* 1 m = 2.54 (exactly). For other exact conversions and more detailed tables, see NBS Misc. Publ. 226, Units of Weight and Measure, Price \$2.25. SD Catalog No. C13.10-286.



CONTENTS

	<u>PAGE</u>
PREFACE	2
SUMMARY	4
BACKGROUND	6
State of the Art Program	
Problem of Containment	
Limitations of Testing	
Approach to Evaluating Boom Capabilities	
Boom Selection	
Boom Test	
Computer Boom Model	
DESCRIPTION OF OIL BOOMS TESTED	11
USCG Open Water Oil Containment System	
Sjuntorp Coastal Boom	
Vikoma Seapack System	
Bennett Inflatable Offshore Boom	
Whittaker Expandi-Oil Boom	
B. F. Goodrich 36-onch Seaboom	
Summary	
DESCRIPTION OF TEST EQUIPMENT	27
Stage I	
Coast Guard Support Vessels	
Mooring Systems	
Instrumentation	
Lights	
PLANNED TEST PROCEDURES	38
General	
Video Targets and Boom Markings	
Mooring Procedures	
Lights	
Weather Requirements	
TEST NARRATIVE AND OBSERVATIONS	41
Coast Guard Boom	
Sjuntorp Boom	
Vikoma Boom	
Bennett Boom	
Whittaker Boom	
Goodrich Boom	
CONCLUSIONS	66
REFERENCES	68

ACCESSION FOR	
NTIS	White Section <input checked="" type="checkbox"/>
DOC	Buff Section <input type="checkbox"/>
UNANNOUNCED	<input type="checkbox"/>
JUSTIFICATION.....	
.....	
BY.....	
DISTRIBUTION/AVAILABILITY CODES	
Dist. 4872. 4872. 4872. 4872.	
A	

PREFACE

This is Part 1 of a two-part final report of full-scale field tests of six different oil containment barriers conducted at Stage I, a platform maintained by the Naval Coastal Systems Laboratory approximately 12 miles offshore of Panama City, Florida. The tests ran from 28 March to 28 April 1977.

The purposes of the field tests were to obtain full-scale performance data for each boom for verifying the predictions of an analytical model, to evaluate the performance of several selected booms not analyzed by the model, and to obtain logistic support information on the deployment and retrieval of each boom.

The following organizations provided the booms indicated for testing and their cooperation is sincerely appreciated:

Harding Pollution Control Corporation - Bennett 60" Inflatable Boom
B. F. Goodrich Company - B. F. Goodrich 36" Seaboom
USCG Gulf Strike Team - U. S. Coast Guard Boom
A. B. Sjuntorp, Sweden - Sjuntorp Coastal Boom
Whittaker Corporation - Whittaker Expandi-Oil Boom
Canadian Coast Guard - Vikoma Seapack

The authors are also grateful for the assistance and cooperation of the following personnel of the organizations and Coast Guard Forces indicated who were involved one way or another in the test program:

Mr. Terrence M. Hayes - Regional Manager, Emergency Operations,
Canadian Coast Guard
BMC Maxiel L. Laing - Officer-in-Charge, USCG Station
Panama City, Florida
Mr. Theordore M. Nelson - Operations Officer, Flotilla 16,
USCG Auxiliary, Panama City, Florida
LTJG Gary W. Palmer - Commanding Officer, USCG POINT LOBOS
(OWPB-82366) Panama City, Florida
Mr. A. B. Reynolds - Project Liaison, U. S. Naval Coastal Systems
Laboratory, Panama City, Florida
CW04 Dan R. Riksen, USCG - Commanding Officer, USCGC WHITE PINE
(WLM-547) Mobile, Alabama
CW04 Paul E. Sparrow, USCG - Operations Officer, Gulf Strike Team

Mr. J. P. Tebeau - Director, Carriers, Drawbacks and Bonds Division
U. S. Customs, Washington, DC

The guidance and assistance of Dr. Jerome Milgram of the Massachusetts Institute of Technology contributed substantially to the success of the test program and are gratefully acknowledged.

SUMMARY

This is the final report of full-scale field tests of six oil containment booms: The U. S. Coast Guard Open Water Oil Containment Barrier, the Sjuntorp Coastal Boom, the Vikoma Seapack/Seaboom System, the Bennett 60-inch Inflatable Boom, the Whittaker Expandi-Oil Boom, and the B. F. Goodrich 36-inch Seaboom. The tests were conducted in the Gulf of Mexico from 28 March to 28 April 1977. This effort comprises the second phase of a three phase program to evaluate the suitability of oil containment booms for high sea state use and to develop a computer model to predict boom performance.

Initially, contract DOT-CG-61803-A was awarded to Marine Professional Services for a study to evaluate the seakeeping of seven oil containment booms by modifying and exercising an existing model for the Coast Guard boom. In the second phase, the tests described in this report were conducted to obtain full-scale performance data for each boom to verify the predictions of the model and simply to evaluate the capabilities of several selected booms. A third phase is planned, in which the wave data recorded during the test are used as input to the model and the model is rerun.

This report will consist of two parts. Part One, this volume, describes the conduct of the test: rationale, equipment, booms, deployment and test procedures. Practical features such as ease of use are discussed in this part. Part Two will present the recorded data and discuss boom seakeeping in a separate volume.

Much was learned simply by handling the booms. For different booms, problems of assembly, delivery to the site, on-scene deployment, on-scene maintenance, inadequate structural strength, and inadequate seakeeping were encountered. No boom was completely satisfactory in all these areas.

The relatively lightweight Sjuntorp and Whittaker booms posed no assembly or delivery problems and were easily deployed from the buoy deck of a buoy tender. However, the Sjuntorp boom suffered from minor problems and, eventually, a serious structural failure. The Whittaker boom did not fail mechanically but clearly lacked adequate seakeeping in one-meter seas, resulting in containment failure.

Two of the heavier booms, the Vikoma and Coast Guard, are deployed from special containers. As described in the Test Narrative and Observations, both of these methods led to a minor problem that delayed deployment, though deployment went smoothly once the problem was resolved. The Goodrich and Bennett booms had no special procedures specified, and assembly and deployment were relatively difficult and time consuming. (The Goodrich boom is intended for semi-permanent installation, and rapid deployment apparently was not considered in its design.) The Bennett and Vikoma booms suffered from serious mechanical failures. No useful seakeeping information was obtained. The Goodrich

boom did not fail mechanically but clearly lacked adequate seakeeping in one-meter seas, resulting in containment failure. The Coast Guard boom experienced no mechanical or obvious seakeeping failures in seas up to three meters that would affect oil containment.

The test results indicate that the development and construction of offshore oil containment booms require considerable engineering, with attention to detail. Repeated field testing under a variety of conditions with modifications made between tests is recommended.

BACKGROUND

The State-of-the-Art Program

This series of tests was conducted as part of an attempt to determine the state of the art in high seas oil spill containment and removal. The Deepwater Port Act of 1974 charges the U. S. Coast Guard with the responsibility for licensing offshore ports and monitoring their operation. The Act also requires that the port operators use the best available technology in order to minimize environmental damage. As part of the response to these requirements, the Coast Guard began a study of the capabilities and limitations of available oil spill clean up equipment. This study includes market research, literature survey of experiments and tests, the series of boom tests described herein, and development of the computer boom model described below.

The Problem of Containment

Our present knowledge of what occurs when oil is contained by a floating boom is based on numerous studies supported primarily by the oil industry, the oil spill clean up industry, the U. S. Coast Guard, and the U. S. Environmental Protection Agency. The bulk of the research has concerned oil held by a boom in a current; some studies included waves plus current. The results of studies by Lindenmuth, Miller and Hsu (1970) and Hale, Norton, and Rodenberger (1974) demonstrate clearly that the limit to containing oil in a current is usually a hydrodynamic problem of the oil itself, rather than being a boom problem. Unless the quantity of oil to be contained results in a slick thickness great enough for the oil to flow under the boom (drainage failure), the containment is limited by droplet formation upstream of the boom (entrainment failure) at current speeds roughly greater than 0.5 m/s (1.0 knot), and entrainment failure is nearly independent of the boom design.

Because this failure mode is nearly independent of the boom design, it was not judged to be a factor to consider in this state-of-the-art evaluation. Currents might be a factor in the effectiveness of the containment operation, but their effects could be controlled by proper use of the boom (which would be the case for wind-induced currents, river currents, and relative current due to towing), or their effects are viewed as a natural limit to containment (e.g., see Leibovich, 1975). Natural limits to containment are being studied as a separate Coast Guard effort and are not considered to have a direct bearing on the evaluation of the best available technology.

For a boom in rough seas, Milgram (1973) cites structural strength and good seakeeping as important factors. Effective containment in waves is possible only if the boom remains intact and is able to maintain sufficient draft and freeboard, which implies moderate vertical motion relative to the moving water surface and moderate roll. Milgram argues further that proper horizontal motion, or sway in synchronism with the flow due to the waves, must also be achieved to minimize the possibility of droplet entrainment failure near the boom.

The Limitations of Testing

Besides the general considerations of the problems of containment, there are many practical limitations on what could be done and what could be measured when testing high seas equipment.

Perhaps the biggest limitation is simply the test environment itself. The easiest environment to work in is a test tank, such as the Environmental Protection Agency's OHMSETT described by Farlow and Freestone (1975). Even OHMSETT, however, is not capable of simulating appropriate spectra for waves or the 2-m significant wave heights desired. Effects of the tank sidewalls and bottom and effects due to the short length of boom that must be used need to be considered. By working at sea, these problems are partially solved, but new ones are added. Appropriate sea conditions may be found, but they are completely uncontrollable, so test preparations and measurements must be scheduled around the weather once the site is selected. At any given site, conditions will never recur exactly; so, unless all of the booms to be tested are tested simultaneously, a strictly comparative test is not possible. Also, it is not feasible to test booms with oil at sea. A suitable test for several booms would require a large amount of oil. The test logistics would be complicated considerably, and a parallel, large-scale oil skimming operation would have to be included in the planning. Other limitations arise from the costs of the booms themselves. Boom costs directly affect the number of booms to be tested and the nature of the tests to be performed. One of the considerations brought out as part of the problem of containment was the simple matter of structural integrity. Destructive testing is not economically practical, however, so the ultimate strength limits of the boom cannot be determined easily.

A problem in determining the test procedure to be followed is the matter of intended use vs. actual use. Often equipment must be used in a way other than that intended by the designer. The possibilities for booms include towing, mooring, or free-floating, and quick deployment vs. permanent installation. Furthermore, booms intended for quick deployment use a variety of deployment schemes and auxiliary equipment. The support vessels or equipment available during a test usually are limited, so compromise is required between the desired deployment/simulated use and the intended deployment/actual use.

Perhaps the final comments to be made on test limitations are ones applicable to any test and, especially, to any test at sea: the environment is harsh, so instrumentation is prone to failure, and the test results may become obsolete when the item tested becomes obsolete. The latter is expected to occur frequently as manufacturers improve their existing designs or complete new designs.

The general approach to handling these problems is described below.

The Approach to Evaluating Boom Capabilities

Boom Selection:

A survey of the market was made that turned up several booms claimed to be suitable for use in "open water," "high seas," or "offshore." In addition, two solicitations for information about recently developed high sea state equipment were published in the Commerce Business Daily to check for products that were available but had not yet been well advertised.

The booms thus found employed several techniques for achieving the proper flotation and ballast and, perhaps more important, involved a variety of different fabrication procedures and methods for carrying stress. As a first step in determining which booms should be tested, they were divided among four categories according to the method used for carrying stress: 1. designs carrying tension in the boom fabric itself, 2. designs with tension lines along the mid-draft and/or waterline, 3. bottom tension designs, and 4. external tension line designs. At least one boom from each category was desired; however, booms in only three of the four were actually obtained for test. No booms that were judged reasonably likely to be suitable for high seas use could be found in category 2, mid-draft or waterline tension line types.

A number of booms that were judged possibly suitable were selected as test candidates. An external tension line boom, the Coast Guard's Open Water Oil Containment Barrier, was readily available. Bottom tension and fabric tension booms were requested on loan from the manufacturers, their representatives, or interested users. In enough cases, these sources were completely cooperative; five booms were volunteered for the test. Two were bottom tension designs -- the Bennett Inflatable Offshore boom (manufactured by Bennett Pollution Control Corp., loaned by Bennett) and the Expandi-Oil Boom (Whittaker Corp., loaned by Whittaker). Three were fabric tension designs -- the 36-inch Seaboom (B. F. Goodrich, loaned by Goodrich), the Sjuntorp Coastal Boom (A. B. Sjuntorp, loaned by Sjuntorp), and the Vikoma Seapack System (British Petroleum, loaned by the Canadian Coast Guard). The Sjuntorp boom also uses lines along the top and bottom of the boom, but the stress is primarily sustained by the fabric.

Both Sjuntorp and Goodrich booms come in larger sizes, but the larger sizes could not be made ready in the time available between the manufacturers' offers to participate in the test and the start of the test. They are usually fabricated on demand and require months to prepare. The test period could not be moved, because suitable sea conditions were not expected at the planned test site in the following months. It was determined that similarities in the designs of the larger and smaller booms would allow a reasonably accurate judgement of the capabilities of both, and that evaluation of the larger booms would be straightforward using the computer boom model, if the model worked well for the smaller booms.

Boom Test:

For these six booms, a test at sea was planned to evaluate their ease of use, their abilities to withstand rough seas, and their seakeeping. Because of the test limitations outlined previously, it was decided to moor the booms. This allowed selection of a site that provided a stable platform. Several sites were examined for the frequency of occurrence and severity of rough seas, availability of a platform, strength of currents, and availability of additional logistic support. The Gulf of Mexico off Panama City, Florida, was selected, and arrangements were made to use the platform Stage I, which is owned and maintained by the Naval Coastal Systems Laboratory in Panama City.

Ease of use was primarily a qualitative measure; it could be partly quantified by noting the manpower and auxiliary equipment needed to launch the boom and move it about and by recording the time needed for launching or making connections to moorings. In this part of the evaluation, more so than the others, the question of intended use versus our actual use must be considered. The Goodrich boom, for example, is considered a "permanent" boom; it was not specifically designed for quick deployment.

One important aspect of ease of use was not checked, however. This aspect concerns retrieval from the water, cleaning, inspection, and repacking for reuse. The booms tested may be expected to vary substantially in the effort required for each of this. Cleaning was not required after this test. Some of the booms were too damaged to be repacked immediately. And other events during the test often required breaks in this work.

Structural strength was evaluated simply by observing each boom's ability to withstand the seas to which it was subjected. No attempt was made to determine ultimate strength. Each boom spent several days at sea and experienced a mild storm that created seas with a significant wave height of one meter (1.0m) or more.

The booms were moored. Towing and free-floating were not considered feasible means of testing booms, primarily because of the vessels that would be required and the difficulty of making measurements. By mooring the booms near the Stage I platform, recording instrumentation could be kept in a better controlled atmosphere and the data telemetered to it. As it turned out, the measurement techniques selected were primarily remote sensing, so mooring the booms and recording from Stage I became an ideal arrangement. Mooring was also appropriate, considering the expected means of using the booms. Many applications will require mooring or towing. Both will result in catenary configurations and will result in similar stresses within a boom, though towing might be expected to yield somewhat higher stresses.

Computer Boom Model:

An important factor in designing the test and, in particular, in accepting certain of the compromises that were made was the prior development of a computer boom model. Milgram and O'Dea (1974) had

developed a computer program for calculating the seakeeping of a boom such as the Coast Guard Open Water Boom. As part of the State-of-the-Art Program, Milgram (1977) modified this model for application to other boom designs.

The model has not yet been verified, so the boom test will provide data for that purpose. This combined approach to the boom evaluation offers several advantages: environmental data from the test can be used in the model so the two use identical forcing functions; output from the model provided advance suggestions of things to observe during the test; the model, if verified, can be used to compare the capabilities of two booms tested under different conditions; the model, if verified, may provide easy means for manufacturers to analyze and to improve booms where necessary; the model, if verified, will solve the problem of obsolescence of test results due to design improvements by the manufacturers.

The model itself is not part of this program, so details will not be presented here. A final report is planned after the model has been run for those booms used in the test and a comparison with the test results has been completed.

DESCRIPTION OF OIL BOOMS TESTED

This section provides the following information on the oil containment booms in the order in which they were tested:

- a. manufacturer
- b. source
- c. description

Schematics and sketches are reprinted courtesy of the manufacturers.

USCG Open Water Oil Containment System

- a. Manufacturer: Offshore Devices, Inc.
Peabody, Massachusetts
- b. Source: USCG National Strike Force
Gulf Strike Team
Bay St. Louis, Mississippi

c. Description: The Coast Guard-owned booms are 612 ft (187 m) long with a draft of 27 inches (680 mm) and a freeboard of 21 inches (530 mm). The average weight of the boom is 16.7 lb/ft (25 kg/m). The general design is a curtain with rigidizing struts and flotation every 6 ft (1.83 m) and bridle lines connecting the struts to an external tension line upstream of the curtain. The boom is stored, shipped, and deployed from a floatable 18 ft long x 9 ft wide x 62 inch high (5.5 m x 2.75 m x 1.57 m) air delivery container. Further details are provided below (see also Tierney, 1975). The general arrangement of the boom and a typical strut are shown in Figure 1.

Curtain: The curtain is fabricated of 48-inch (1220 mm) wide, two-ply, elastomer-coated nylon fabric. 1.0-inch (25.4 mm) wide nylon webbing is sewn into the top and bottom hems for extra strength. Three vertical pockets containing 1/4-inch (6.3 mm) diameter fiberglass battens are sewn onto the curtain between each strut.

Rigidizing Struts: The struts are 48 inches by 22 inches (1220 mm) and nearly rectangular, with a rounded top and bottom to avoid jamming in the Air Delivery Container (ADC). Construction is 1-1/4 inch (32 mm) square tubing with a face clamp around the periphery to secure the strut to the curtain. Solid foam attached to the rear of each strut provides neutral buoyancy, and a flotation bag clamped to the rear provides excess buoyancy. Ring bolts at various points provide line connections.

Flotation Bags: The flotation bags are elastomer-coated fabric cylinders 13 inches in diameter and 48 inches long (330 mm dia. x 1220 mm). Inflation occurs by means of an inflation valve and CO₂ bottle carried in a lace-in pocket on each bag. The bag is clamped at right angles to a strut on the oil-free side of the curtain. Tie-down lines extend from the end of the bag to the top and bottom of the strut to maintain a right angle.

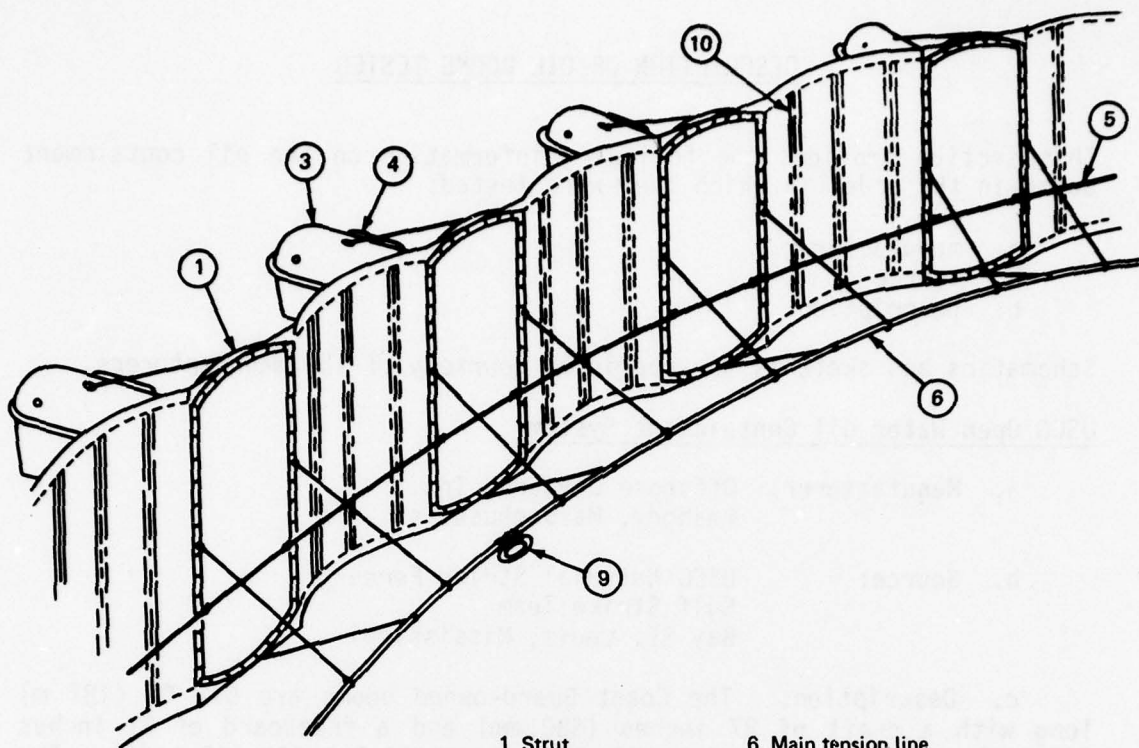

- | | |
|----------------------------------|------------------------------|
| 1 Strut | 6 Main tension line |
| 2 Curtain | 7 Dynamic bucket ballast |
| 3 Inflatable float | 8 Foam flotation |
| 4 CO ₂ bottle & valve | 9 Pickup loop |
| 5 Slack retention line | 10 Batten pocket with batten |

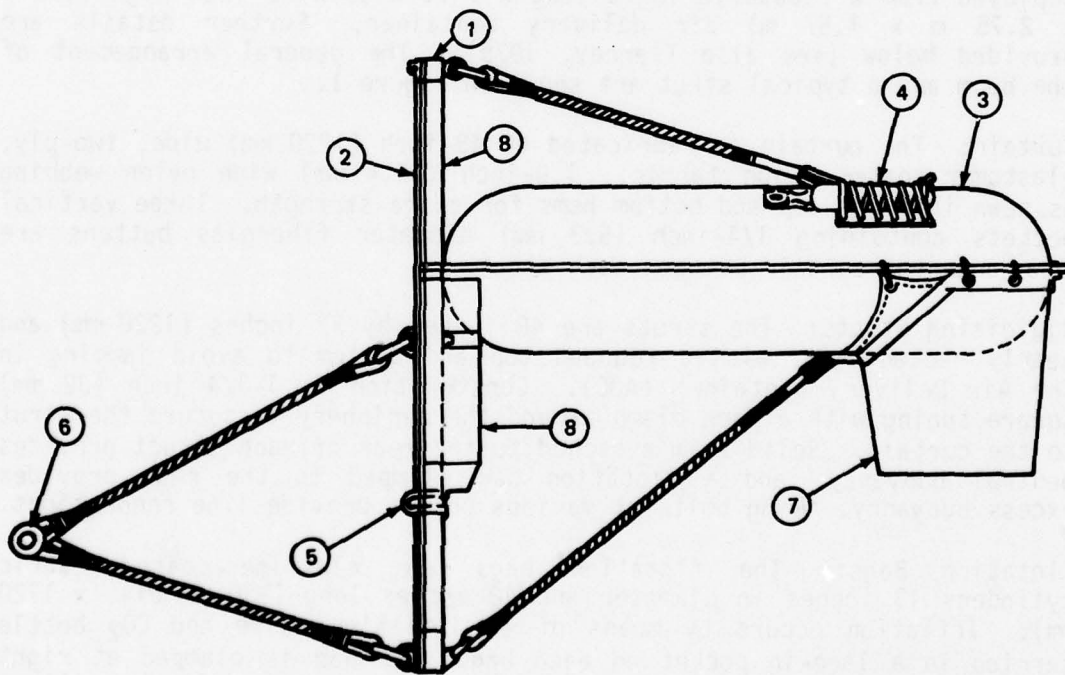

Figure 1. The U.S. Coast Guard Open Water Oil Containment Barrier

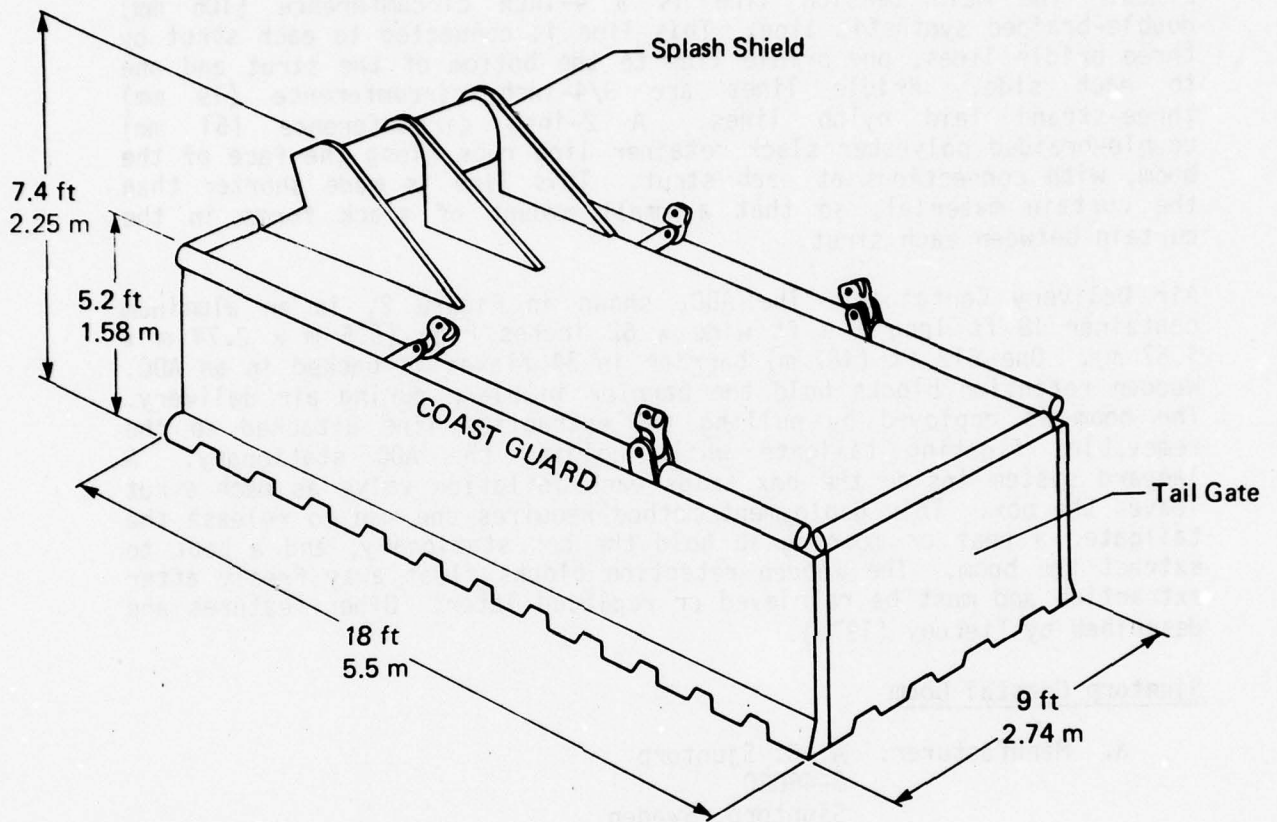

Figure 2. Sketch of the USCG Air Delivery Container

Ballast Bags: A free-flooding dynamic ballast bag, fabricated of elastomer-coated fabric, is attached by means of grommets and laces to the underside of each flotation bag on the end away from the strut. Each bag is approximately 13 inches diameter by 18 inches deep (330 mm dia x 457 mm) and carries a circular lead plate in the bottom. The combined weights of this plate and the water retained in the bag provide a counterbalance to the weight of the strut.

Lines: The main tension line is a 4-inch circumference (106 mm) double-braided synthetic line. This line is connected to each strut by three bridle lines, one bridle line to the bottom of the strut and one to each side. Bridle lines are 3/4-inch circumference (19 mm) three-strand laid nylon lines. A 2-inch circumference (51 mm) double-braided polyester slack retainer line runs along the face of the boom, with connections at each strut. This line is made shorter than the curtain material, so that a small amount of slack forms in the curtain between each strut.

Air Delivery Container: The ADC, shown in Figure 2, is an aluminum container 18 ft long x 9 ft wide x 62 inches high (5.5 m x 2.74 m x 1.57 m). One 612 ft (187 m) barrier in 34 flakes is packed in an ADC. Wooden retention blocks hold the barrier in place during air delivery. The boom is deployed by pulling the extraction line attached to the removable, floating tailgate while holding the ADC stationary. A lanyard system inside the box trips each inflation valve as each strut leaves the box. This deployment method requires one man to release the tailgate, a boat or mooring to hold the box stationary, and a boat to extract the boom. The wooden retention blocks float away freely after extraction and must be retrieved or replaced later. Other features are described by Tierney (1975).

Sjuntorp Coastal Boom

a. **Manufacturer:** A. B. Sjuntorp
S-46020
Sjuntorp, Sweden

b. **Source:** A. B. Sjuntorp
S-46020
Sjuntorp, Sweden

c. **Description:** The Sjuntorp Coastal Boom is produced in 25 m (82 ft) sections with stainless steel connecting bars at each end to join sections. The boom has a skirt of 550 mm (22.5 inches) and an air-filled flotation tube of 420 mm diameter (17 in). These result in approximately 610 mm (24 in) draft and 380 mm (14 in) freeboard. Double-nylon-wound lead lines are built into the bottom of the skirt for ballast. The boom weighs 5.6 kg/m (3.8 lb/ft). The standard package includes five sections, or 125 m (410 ft). Figure 3 illustrates the Sjuntorp boom construction. Seven sections, totaling 175 m (578 ft), were used in this test.

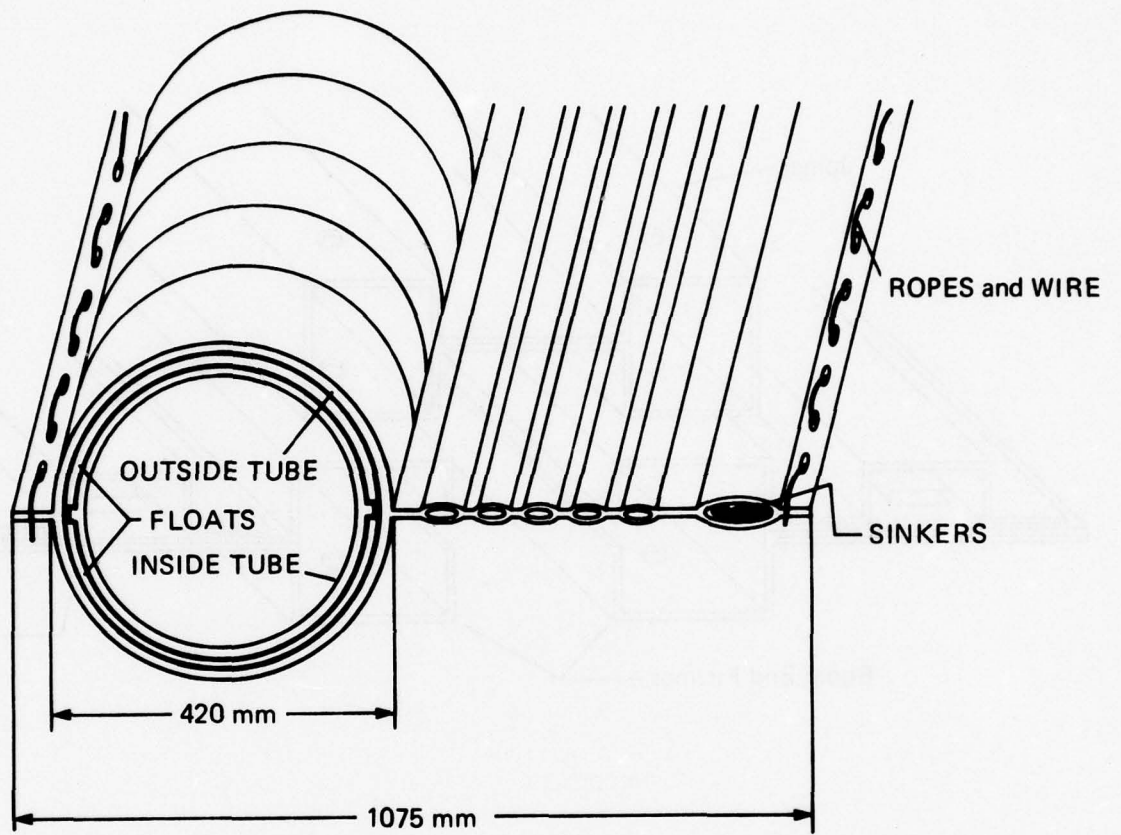

Figure 3. Sketch of the Sjuntorp Coastal Boom

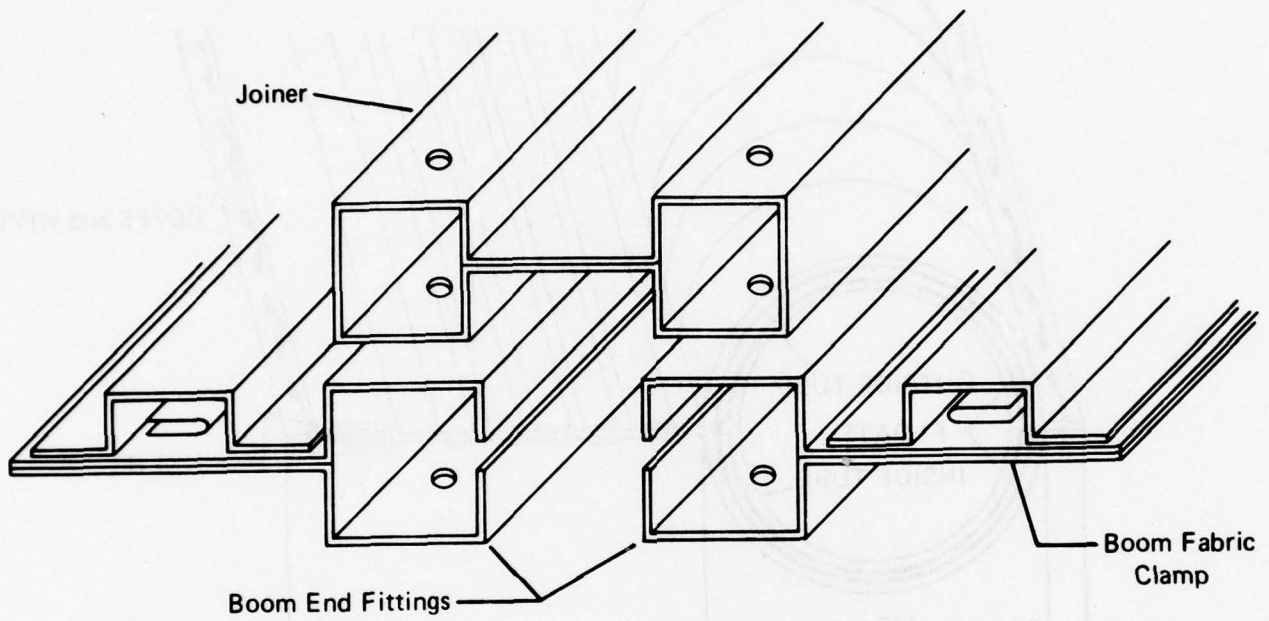

Figure 4. The Sjuntorp Boom Connectors

Flotation Tubes: The boom body consists of two coaxial cylindrical tubes. Each tube is made of nylon yarn with integral circular weave and is coated with synthetic rubber. Two thin, wide strips of closed cell foam are inserted between the inner and outer tubes for positive buoyancy when the boom is uninflated. Each tube has four nonreturn (check) valves for inflation, which is accomplished by small engine-powered fans.

Skirt: The skirt is also made of nylon yarn with a synthetic rubber coating. The skirts have lead ballast lines built into the bottom hem and have anchoring points near the waterline midway between the end connectors. Approximately 3/4 inch (20 mm) circumference synthetic lines run along the bottom of the skirt and the narrow strip of fabric at the top of the flotation tube for ease of handling.

Connectors: The connectors distribute the stress into the skirt and flotation tube fabrics, since there is no tension line. Figure 4 shows the design of the Sjuntorp connectors. A connector comprised of a narrow strip with smaller square tubes along two edges to slide inside the larger tubes on the boom ends completes the connection. The pins of shackles are inserted through the holes in each fitting and joiner to secure the connector.

Deployment: The Sjuntorp boom is deployed directly from its shipping crate. The boom is payed out from the crate, inflated one section at a time, and lowered to the water. Sjuntorp supplies small, low pressure, gasoline powered blowers for inflation.

Vikoma Seapack System

a. **Manufacturer:** British Petroleum Company, Ltd
Chertsey Road
Sunburg-on-Thames
Middlesex, England

b. **Source:** Canadian Coast Guard

c. **Description:** The Vikoma Seapack System includes up to 1600 ft (488 m) of Vikoma Seaboom and a special nonpropelled boat for storing and using the boom. The boom consists of three tubes of Butachlor-coated nylon fabric. The lower tube is 17 inches diameter (432 mm), the approximate draft, and is water inflated for ballast. The middle tube is 27 inches diameter (686 mm) and is air inflated for buoyancy. A third 3-inch diameter (76 mm) tube above the middle air tube is inflated by compressed air cylinders during deployment, so the boom remains afloat while the larger air tube is being inflated. The boom weighs 3 lb/ft (4.5 kg/m) when uninflated. A cross-section of the Vikoma boom is shown in Figure 5.

Besides storing the boom, the 23 ft (7 m) Seapack boat also contains a diesel engine, a fan, and a ducted-propeller water pump. These fill the air and water tubes of the boom, which lead directly into the stern of the boat. The boat remains in-line during use, and the diesel

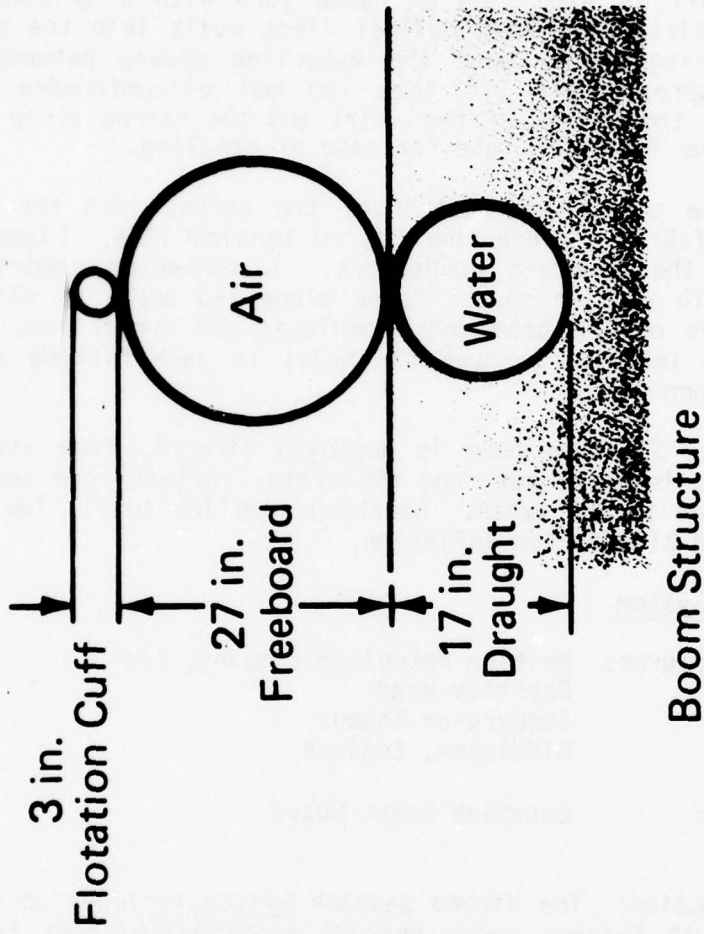

Figure 5. Cross-section of the Vikoma Boom

engine continues to run to maintain low pressure in the boom. The Seapack-trailer combination is approximately 25 ft long, 9 ft wide, (7.6 m x 2.75 m) and weighs 4 tons.

Deployment: The boom is deployed at sea by releasing the backboard at the stern of the Seapack and towing the Seapack. The backboard and a drogue provide drag to extract the boom. During extraction, compressed air bottles are tripped to fill the flotation cuff on the boom. When extraction is complete, the diesel system is used to inflate the boom.

Bennett 60-inch Inflatable Offshore Boom

- a. Manufacturer: Bennett Pollution Controls
119 Charles Street
North Vancouver B.C.
Canada, V7H 1S1
- b. Source: Harding Pollution Controls (Bennett Affiliate)
13115 NE 24 Street
Kirkland, WA 98033

c. Description: The Bennett Offshore Boom is produced in 110 ft (33.5 m) sections with Bennett Roto-Lok connectors at each end to join sections. The boom has a skirt depth of 30 inches (762 mm) and an air-filled flotation tube of 30 in diameter (762 mm). These result in approximately 33 inches (838 mm) draft and 27 inches (686 mm) freeboard. A "Kevlar" tension line and a lead ballast line are built into the bottom of the skirt. The boom weighs 11.6 lb/ft (17.2 kg/m). A bullet-shaped towing attachment for the ends of the boom and diesel inflation blower are useful auxiliary equipment. Figure 6 is a cut-away drawing showing a portion of Bennett boom connected to a towing attachment. Six sections of boom were used in this test.

Flotation Tubes: The boom body consists of two coaxial cylindrical tubes. The inner tube is vinyl. A flotation sleeve of closed cell polyethylene foam is inserted between the inner and outer tubes for positive buoyancy when the boom is uninflated. The outer tube is made of woven nylon with a PVC coating.

Skirt: The skirt is a polyester fabric with PVC coating. A Kevlar main tension line is built into the bottom hem of the skirt. Ballast, a lead line with woven fabric casing, is also built into the hem.

Connectors: The Bennett Roto-Lok connectors are a special ring assembly designed to join adjacent sections of the flotation tubes, allow air to be pumped in from one end of the boom and inflate all sections simultaneously, and prevent air from leaking back out, as from an inflated section to a damaged, deflated section. A toggle connector joins the main tension lines along the bottom of the boom to minimize stress on the Roto-Lok.

Deployment: This boom design was new at the time of the test, and no deployment procedures had been specified by the manufacturer.

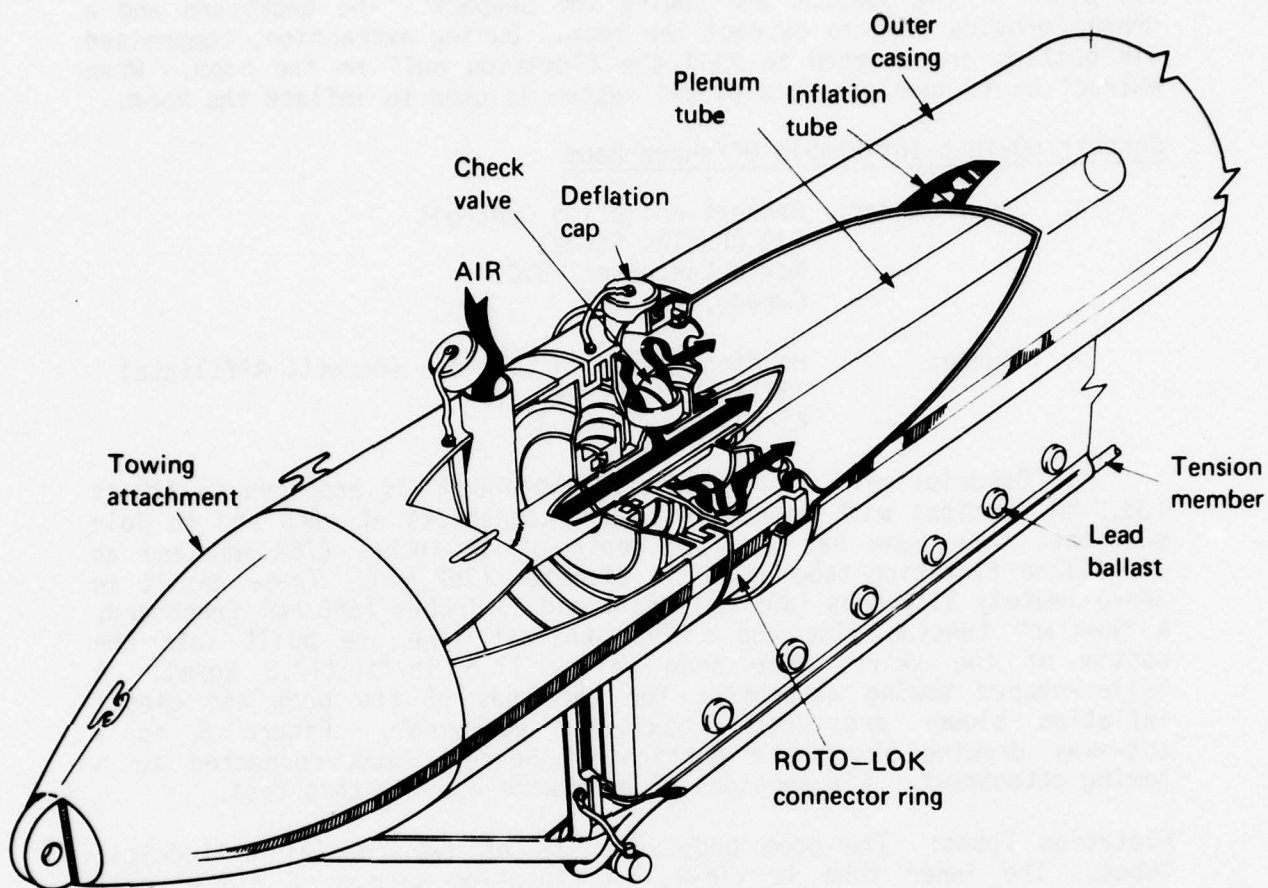

Figure 6. The Bennett Towing Attachment and the Offshore Boom

Whittaker Expandi-Oil Boom

a. Manufacturer: Whittaker Corporation
5159 Baltimore Drive
La Mesa CA 92041

b. Source: Whittaker Corporation
5159 Baltimore Drive
La Mesa CA 92041

c. Description: The Whittaker Expandi-Oil Boom is produced in 15 m (50 ft) sections with an arrangement of rope and sliding clamps at each end to join sections. The boom has a skirt of approximately 600 mm (24 inches) and a nonpressurized air-filled flotation tube approximately 350 mm (14 inches) square. These result in 650 mm draft and 450 mm freeboard. A chain is built into the bottom of the skirt for ballast and for carrying tension. The boom weighs 5.3 kg/m (3.5 lb/ft). The Expandi-Oil boom construction is illustrated in Figure 7. Eight sections totaling 122 m (400 ft) were used in this test.

Flotation Tube: The boom flotation is a square tube made of plastic-covered nylon fabric. The fabric is held in a square shape by internal welded pliable frames of polypropylene plastic. The frames are held open (square) by springs, but they may be collapsed, allowing the boom to be flattened for compact storage. Each 25 m tube is divided into fourteen (14) airtight subsections. Subsections have separate air inflation valves to admit air when the tube expands. Fabric grip handles rings are attached at 8-m intervals.

Skirt: The skirt is also made of plastic-covered nylon fabric. A chain built into the bottom hem carries tension and serves as ballast. Anchoring rings are provided at 8-m intervals.

Connectors: Sections are joined by inserting the rope end of one section into the metal clip end of another. The fabric at the end is rolled around a rope to form a bead, and the mating end has a series of rounded metal clips under which the rope slides. The anchoring ring at the bottom of the skirt and grip handle at the top of the boom are pulled to slide two sections together once the rope and clips have been aligned. A simple key through two links of the tension/ballast chain joins adjacent chains. Figure 8 shows the Whittaker boom connector and joining method.

Deployment: The Whittaker boom is deployed from a pallet. No inflation is required. The boom is payed out and expands itself.

B. F. Goodrich 36-inch Seaboom

a. Manufacturer: B. F. Goodrich Engineered Systems Company
430 South Main Street
Cohasset MA 02025

b. Source: B. F. Goodrich Engineered Systems Company
430 South Main Street
Cohasset MA 02025

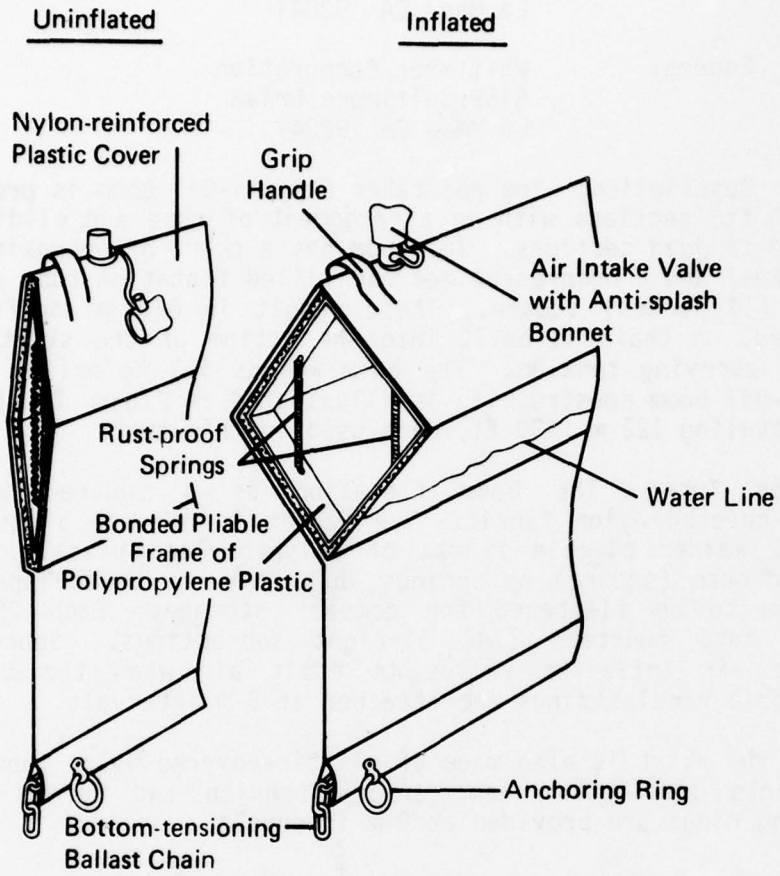

Figure 7. The Whittaker Expandi-Oil Boom

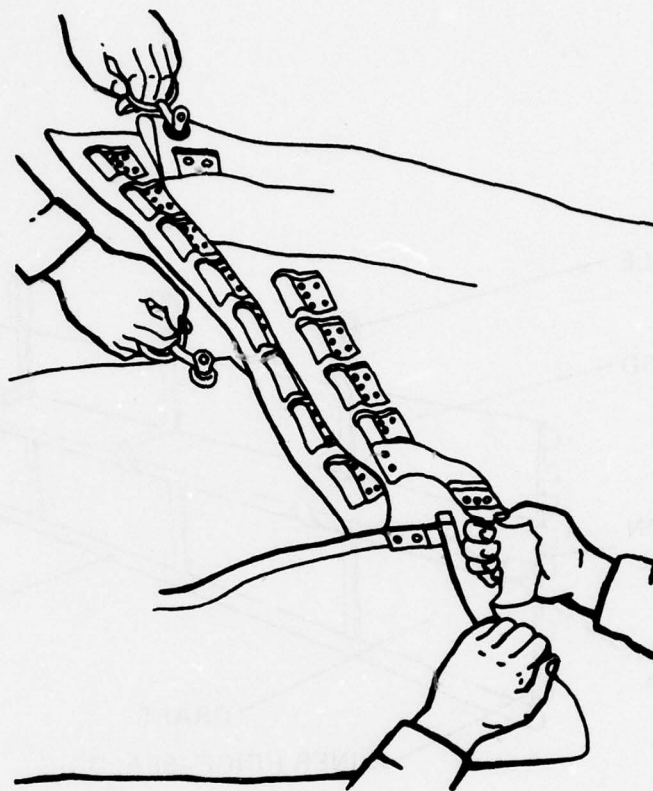

Figure 8. The Whittaker Boom Connector

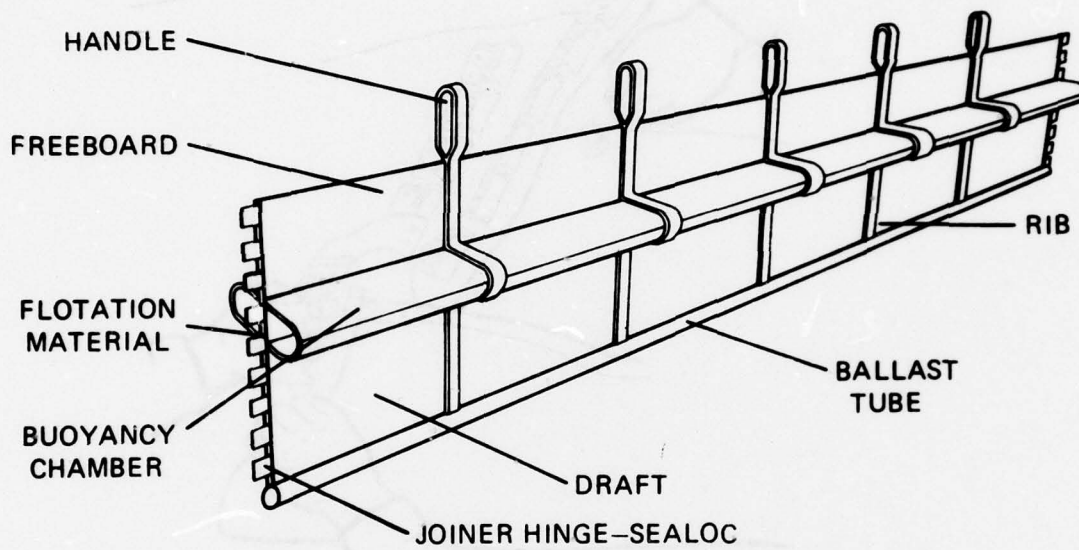

Figure 9. The Goodrich Seaboom

c. Description: The Goodrich 36-inch Seaboom is produced in 23.5 ft (7.16 m) sections with a hinge-and-pin type connector to join sections. Two similar versions are offered: the 36 HD (Heavy Duty) and the 36 PFS (Permanent). The basic boom has a draft of 24 inches (610 mm) and a freeboard of 12 inches (305 mm). Lead shot and sand are packed into a tube on the bottom of the skirt to provide ballast. Rigid foam supplies flotation. The boom weighs 12 lb/ft (18.2 kg/m). No standard package is offered, as the boom is intended for permanent installation with a suitable number of sections to enclose the desired space. For this test, 234 ft (71 m) of 36 HD were used as a center section, which was flanked by two 195 ft (59.5 m) lengths of 36 PFS, for 624 ft (190 m) overall. The Goodrich boom design is shown in Figure 9.

Each section is a 1/4-inch (6 mm) thick, 36-inch high vinyl sheet reinforced with urethane ribs, which are molded to form a handle on the top. Flotation is provided by closed cell foam, protected by a 1/4-inch PVC coating. The ends of the floats are sealed with wood plugs.

Connectors: The connectors are an arrangement of interlocking spools held together by a fiberglass pin, similar in design to a piano hinge. Mooring plates are attached to the free ends of an assembled boom to distribute stress from the mooring line into the boom.

Deployment: No rapid deployment method has been developed for the Goodrich boom.

	Coast Guard	Sjuntorp	Vikoma	Bennett	Whittaker	Goodrich
length per section (m)	187	25	488	33.5	15.2	5.94
length tested (m)	187	175	488	201	122	190
draft (mm)	687	610	432	838	650	610
freeboard (mm)	533	380	686	686	450	305
total height (mm)	1220	990	1118	1524	1100	915
wieght (kg/m)	25	5.6	4.5	17.2	5.3	18.2
tension member	external line	fabric	fabric	bottom line	bottom line	fabric

Table 1. Summary of basic boom data

DESCRIPTION OF TEST EQUIPMENT

STAGE I: Offshore Platform

Stage I, shown in Figure 51, is operated and maintained by the U. S. Naval Coastal Systems Laboratory, Panama City, Florida. The platform is located in the Gulf of Mexico at 30-00-40 N, 85-54-20 W, as shown in Figure 10. It consists of three decks 32 m x 32 m (105 ft x 105 ft). The upper deck is approximately 17 m (55 ft) above mean sea level and includes a flight deck (helicopter landing pad) and an instrument house, built on the southern corner. The mean depth of the water is approximately 31 m (102 ft).

One of two video cameras used to record boom motions was positioned inside the instrument house to cover the mooring buoy line located off the southeast side of the platform. A second video camera was placed on the lower deck to cover the northwest side.

Coast Guard Support Vessels

The USCGC WHITE PINE (WLM-547) served as the main support vessel for the tests. The WHITE PINE (Figure 11) is a coastal buoy tender with twin screws, 40.5 m (133 ft) LOA, homeported in Mobile, Alabama. At various times during the test, the WHITE PINE set boom moorings, moved moorings, transported equipment and supplies, and deployed and retrieved the oil booms.

Regular support was also provided by the USCGC POINT LOBOS (WPB-82366). The POINT LOBOS (Figure 12) is a 25 m (82 ft) patrol boat homeported in Panama City. During the test, the POINT LOBOS towed booms to the test site and maneuvered booms for deployment, mooring, and retrieval. For various operations, a 41 ft (12.5 m) utility boat (USCG 41345) and a Boston whaler from the USCG Station Panama City lent further assistance. Two 16 ft (5 m) Zodiac boats were used for close work during mooring and inspecting.

Mooring Systems

Two separate mooring systems were set out so that two booms could be observed simultaneously. The booms and moorings were placed on opposite sides of Stage I, as shown in Figure 13, affording a similar view of each location and the same angles of the systems relative to the wind and incident seas. This orientation was chosen because historical data showed winds primarily from the quadrant west through south. A shift to the orientation shown in Figure 14 was made later, when winds appeared to be coming primarily from the south.

To maintain adequate resolution with the video system, it was necessary to keep the booms as close to the Stage as possible. An arrangement of three sinkers and two buoys was devised that held the booms near the tower at all times and allowed sufficient scope on the anchor lines but prevented the booms from swinging into the tower during a change of wind direction. This mooring arrangement is illustrated in Figure 15.

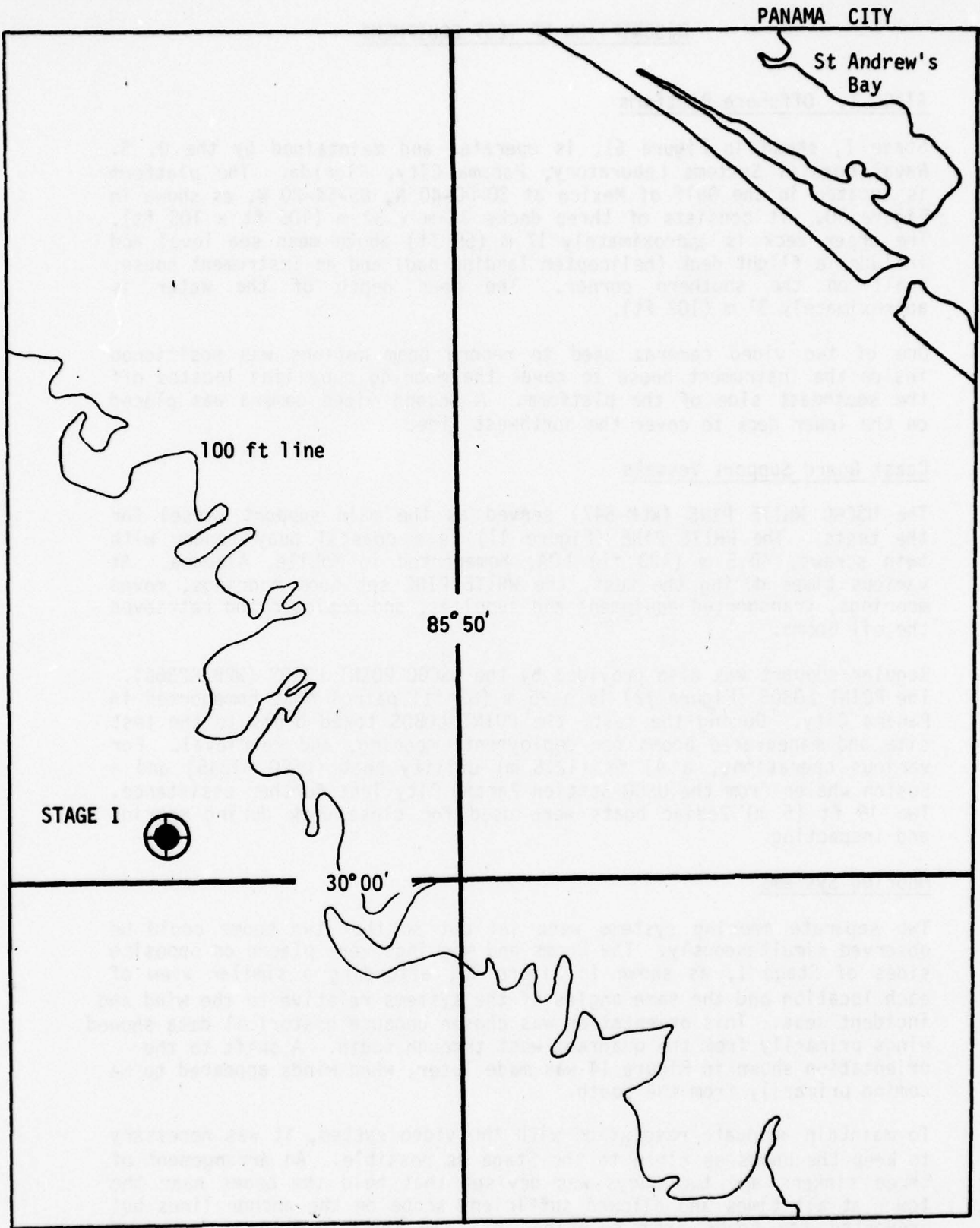

Figure 10. Location of Stage I, the center of the test site



Figure 11. The USCGC WHITE PINE



Figure 12. The USCGC POINT LOBOS

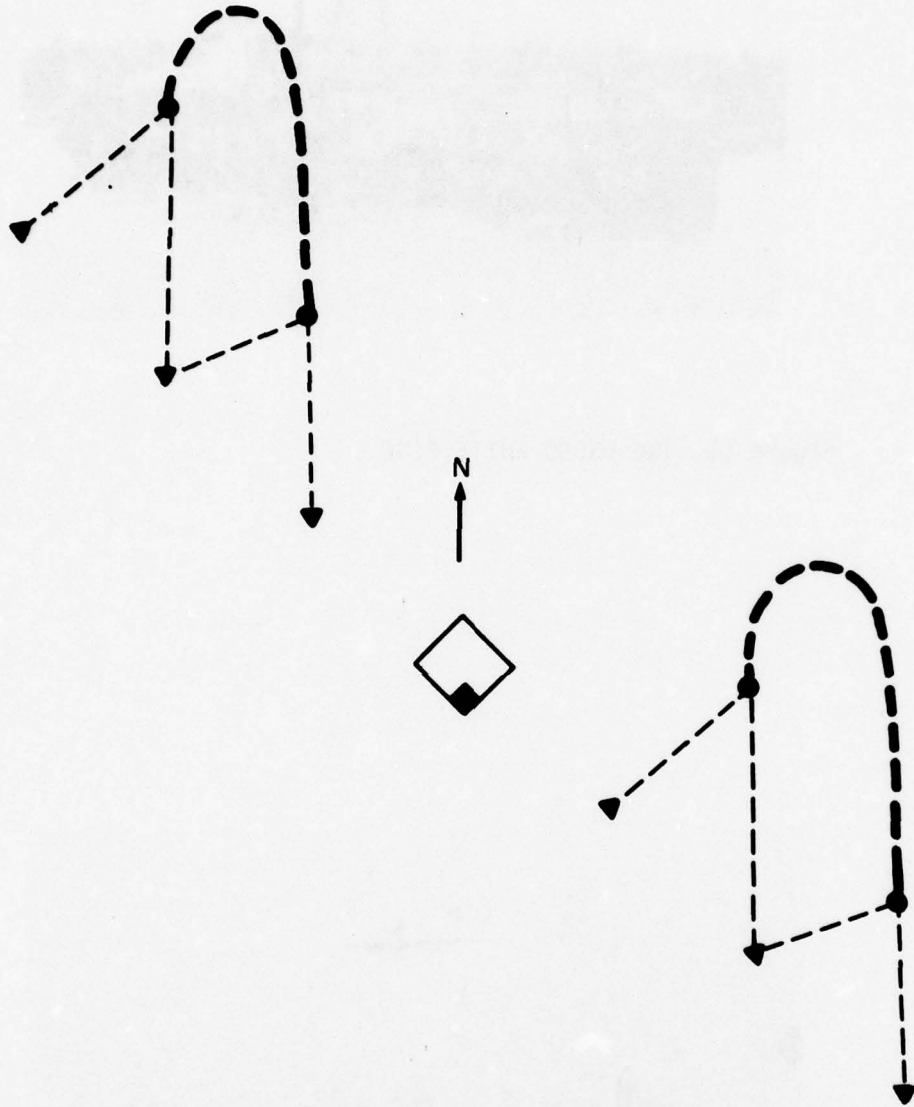

Figure 13. The initial mooring arrangement, showing the shapes the booms typically assumed due to the predominantly southern winds

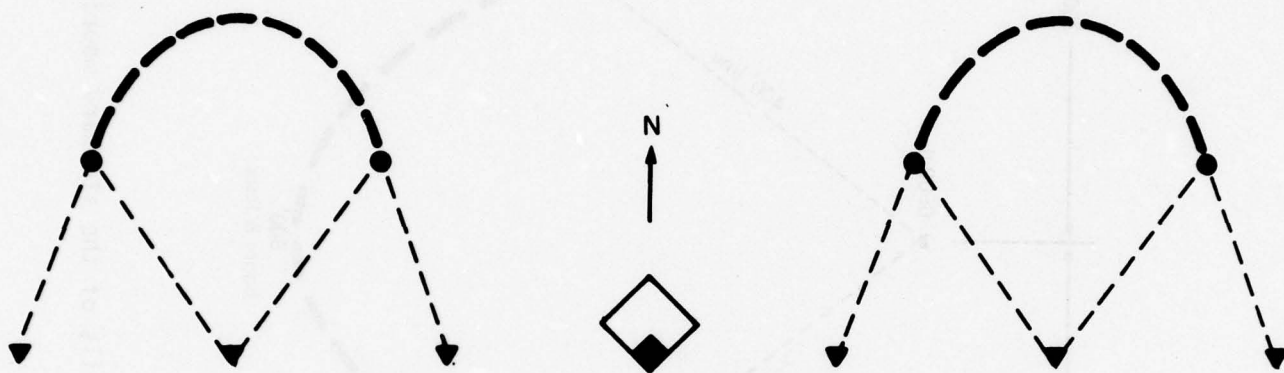

Figure 14. The standard mooring arrangement, re-oriented to take better advantage of the southerly winds

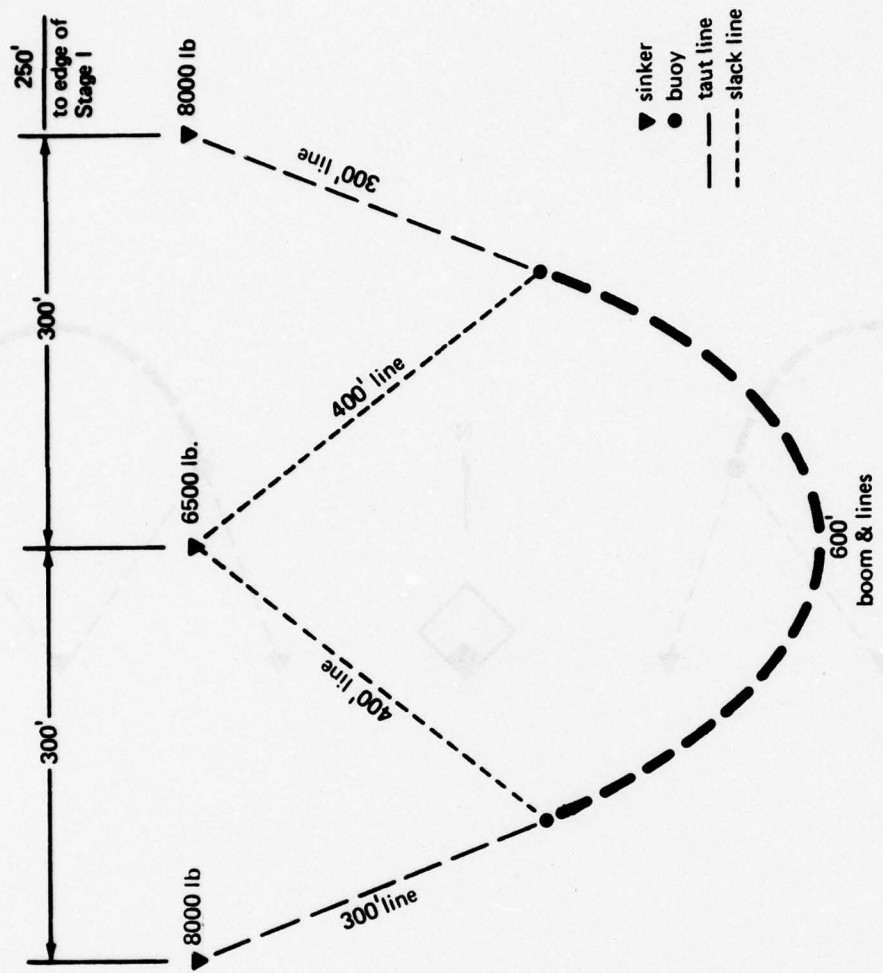

Figure 15. Details of the standard mooring arrangement

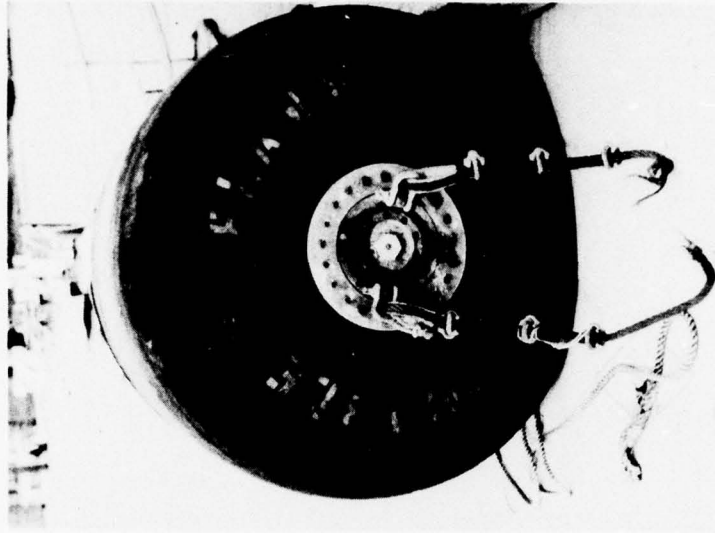

Figure 17. A rubber fuel-bladder buoy, showing the frayed wire rope mooring loop.

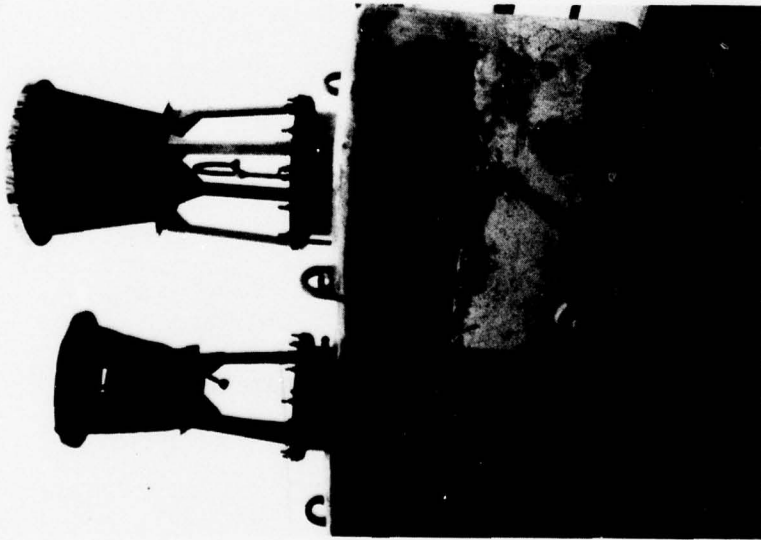

Figure 16. The 5-ft diameter by 11-ft high steel mooring buoys.

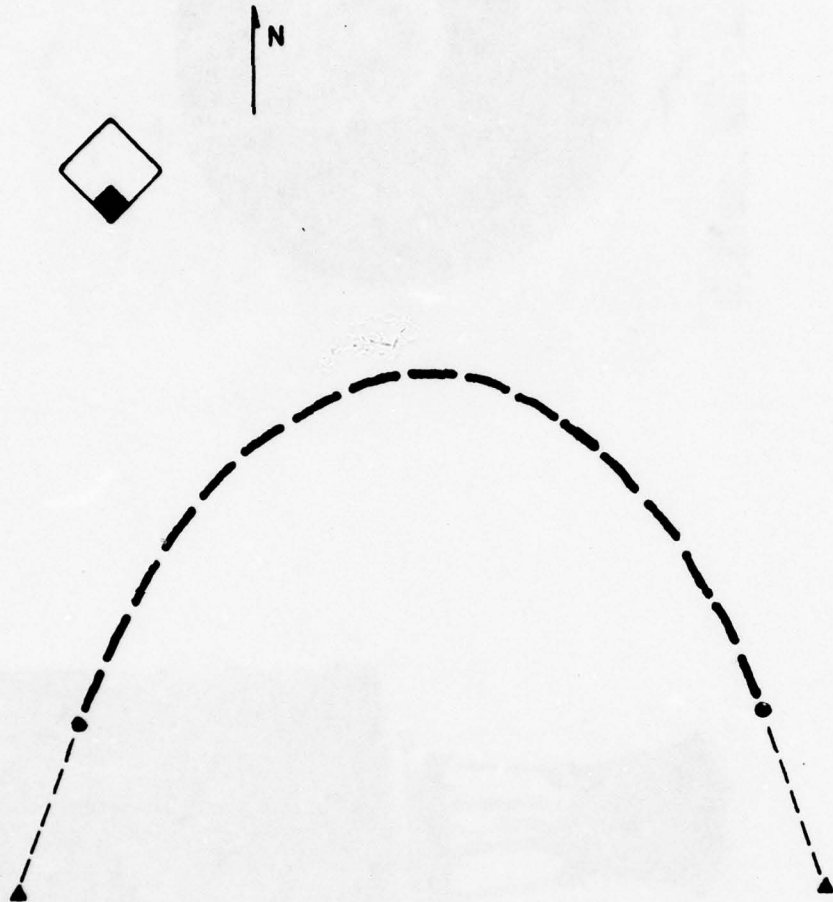

Figure 18. The Vikoma boom mooring arrangement

Each mooring system consisted of two 8000-lb (3640 kg) concrete sinkers and one 6500-lb (2950 kg) sinker, two 300-ft (91 m) and two 400-ft (122 m) lengths of line and chain, and two 5 ft x 11 ft lighted steel bell buoys (Figure 16). Rubber fuel bladders (Figure 17) are preferred as buoys in this application, but the steel buoys were selected because the cages on top could accommodate instrument and battery packages for telemetering boom tension data to the Stage.

The three concrete sinkers were laid in a straight line 300 ft apart, with the smaller sinker in the middle. Two 400 ft anchor legs connected each buoy to the center sinker and one 300 ft leg connected each buoy to one of the end sinkers.

For the Vikoma boom, a separate and simpler mooring was set at a greater distance from Stage I. The center sinker and lines were omitted. The Vikoma arrangement is illustrated in Figure 18.

Instrumentation

The complete instrumentation will be described in detail in Part 2. Since the objective of this Part is to provide only qualitative information and observations, only a general description will be provided here.

The instrumentation supplied by the USCG R&D Center recorded the voltage output of five NCSL sensors, video signals from the one of three R&DC cameras and audio commentary of personnel observing the barriers during test conditions.

The block diagram of the system (Figure 19) identifies the eight major groupings of equipment. They are:

- a. NCSL Sensor Data
- b. FM Coding and Multiplexing of NCSL Sensor Data
- c. Video Camera
- d. Observers' Audio Commentary
- e. IVC Video Tape Recorder
- f. De-Multiplexing/Decoding and Display of Sensor Data
- g. Read-After-Write Monitoring of Video Tape Recording
- h. Line Voltage and Frequency Monitoring

Operation of the system centered on the International Video, Inc. Model 825A Video Tape Recorder. This recorder is capable of recording two tracks of audio and one video channel on a single one-inch reel of magnetic tape. It also has a second video head that allows "Read-After-Write" monitoring of video signals. The configuration of the system was such that all the NCSL sensor data was coded and multiplexed onto one audio channel, while the observers' comments were recorded on the second audio channel. A series of coax switches was used to switch the video input to any of three cameras that were in use.

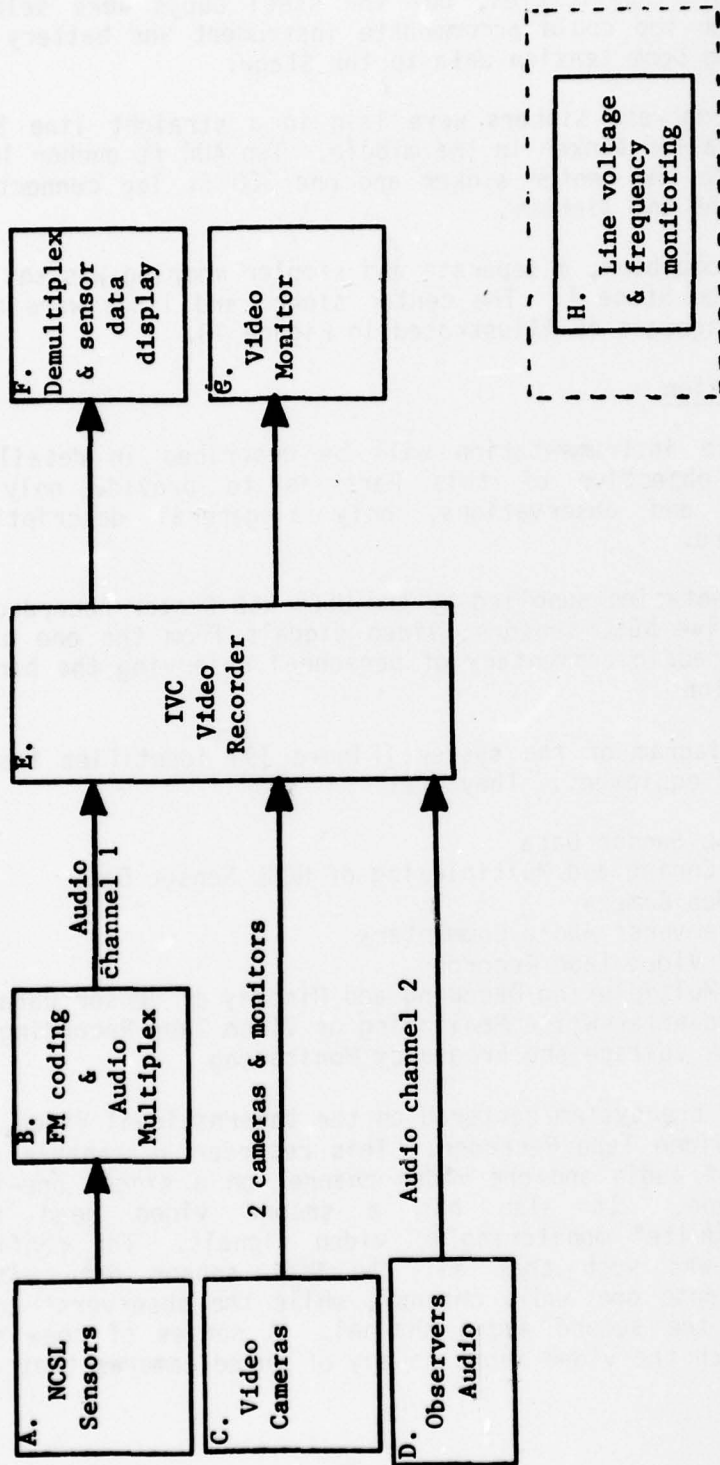

Figure 19. Instrumentation System Basic Block Diagram.

The cameras used included two Sanyo VCS3100 silicon diode array units using either a Canon FD 300 or 600 millimeter lens and one Telemation TMC 2100 VLO. The Sanyo cameras used Panasonic WV-760 monitors at the location of the camera for proper focusing and alignment monitoring. The Telemation camera contained a studio type monitor in the housing proper. All cameras used tripod type mounts. A common SYNC generator was used for all cameras (Panasonic WJ-1100).

An audio system that provided closed circuit communication between a remote camera location and the recording site was also included. All audio on this channel was mixed and recorded on the second IVC 825A audio channel.

The voltage signals of five NCSL sensor packages were available on site. These parameters were wind direction, wind speed, wave height, water current East/West, and water current North/South. Each of these voltage signals were conditioned and used to modulate separate voltage Controlled Oscillators. These Oscillators operated on IRIG channels 1 through 5. The output of the Oscillators was mixed and recorded on the first IVC 825A audio channel.

The proper recording of video data could be verified during recording by monitoring the video signal picked up by the "Read-After-Write" head on the IVC 825A recorder. This signal was monitored during recording periods at the recording site on a CONRAC SNA/14R video monitor. The NCSL sensor data being recorded on the first IVC 825A audio channel was monitored by separating the signals and converting them into voltage signals for display on a strip chart recorder.

The IVC 825A is sensitive to fluctuations in the line frequency. Since all power on the platform was being generated by one generator, a frequency counter and AC voltmeter were used to set the adjustments on the generator for proper frequency (60 HZ) and voltage.

Load cells rated for 10,000 lb (4500 kg) were placed in line between the wire rope pendants on the mooring buoys and the tow lines of the booms. Signals from the load cells were to be telemetered to Stage I; however, an early failure resulted in discontinuing this attempt.

Lights

Floating lights were prepared to mark the booms at night. As there were no directly applicable standards for lighting oil containment booms, the standards for lighting dredge pipe were followed. Brackets and floats were made to support highway flashers with 7-inch (178 mm) amber lenses approximately one meter above the water, with lights every 10 m. Because of the rigidizing struts, the flasher support brackets could be secured directly to the Coast Guard boom. For the other booms, the brackets were fastened to floats made from small automobile tire inner tubes sandwiched between suitably sized sheets of plywood for stiffness and ballasted for stability. These lights were secured to each boom with short lines, and otherwise placed no loads on the booms.

PLANNED TEST PROCEDURES

An attempt was made to handle every boom in a similar way. Typically, variations in the test procedures were planned only to allow for differences in the deployment methods or the length of the boom. Circumstances forced occasional changes. This section describes the test procedures as planned. Changes decided during the course of the tests are described under TEST NARRATIVE AND OBSERVATIONS.

General

Every boom arrived at the Naval Coastal Systems Laboratory several days or more prior to its scheduled test. This period was used to inspect the booms, to prepare and install video targets where possible, and to complete any last minute assembly or other preparation.

Moorings were prepared to test two booms at a time, except for the Vikoma boom. The greater length of this boom required that the moorings be moved, so the boom was tested alone. The other five booms were all closer in length, so the same buoy positions could be used, with some of the length differences compensated by the mooring lines. The five booms were installed at the two mooring positions in rotation. Rough seas were desired for the boom observations, and intervening calm conditions provided time to remove two booms and install the next two.

Video Targets and Boom Markings

Various target and marking designs were tried to improve the contrast between the booms and the sea. These also had to allow for some means of inferring the three-dimensional motions of the boom, particularly roll and heave, from the two-dimensional video image. Desirable characteristics for video purposes will be discussed in Part 2, when details of the video system are presented.

It was, of course, important that any targets not impair the seakeeping performance of the booms. This alone made it difficult to design one target suitable for every boom and forced continued reconsideration of target designs during the test. Initially, separate targets of masonite and threaded rod with aluminum support brackets were tried. This design is shown in Figure 20. It was judged that the wind resistance and the mounting problems of these were so great that they could be used only on the Coast Guard boom. Subsequent targets consisted of stripes of self-adhesive tape or paint applied directly to each boom or to canvas lashed to the boom, as shown in Figures 26, 29, and 35.

Mooring Procedures

The mooring procedure was a straightforward method evolved for use with the Coast Guard boom. Two lines or pendants are connected to each end of the boom to be moored. The primary tow vessel uses one of these lines to maneuver one end of the boom near a mooring buoy, being sure

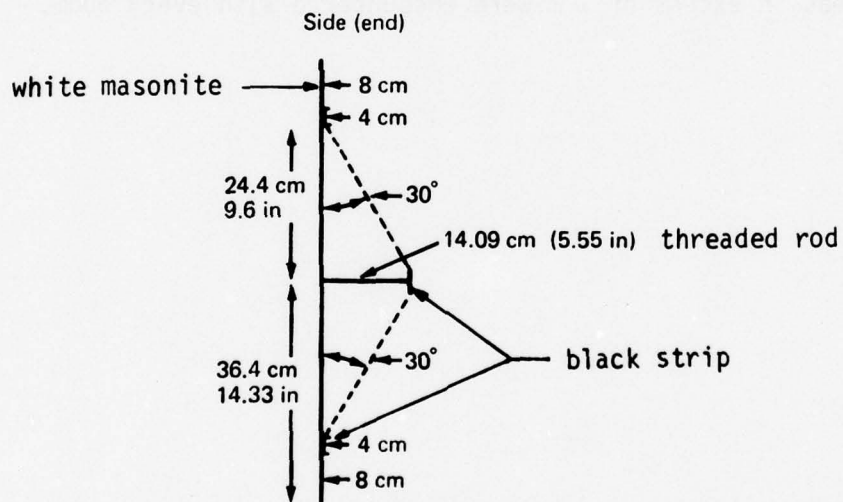
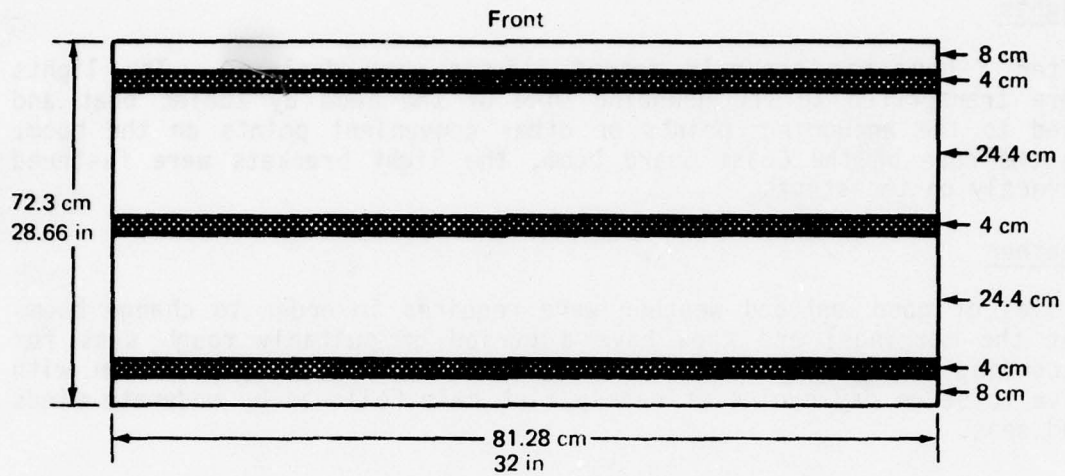

Figure 20. The video target used with the Coast Guard boom

to head into the wind or current. A Zodiac boat waits at the buoy, takes the unused pendant, and secures the pendant to a loop or bridle on the buoy using a shackle or a quick-release hook, if available. The tow vessel then allows the mooring to take the strain from the tow line, the Zodiac boat releases the tow line from the boom, and the tow vessel drops back to receive the other end of the boom. The procedure is repeated to complete the second mooring.

Lights

After a boom was securely moored, lights were deployed. The lights were transported to the downwind side of the boom by Zodiac boat and tied to the anchoring points or other convenient points on the boom. In the case of the Coast Guard boom, the light brackets were fastened directly on the struts.

Weather

Cycles of good and bad weather were required in order to change booms (at the moorings) and then have a period of suitably rough seas for recording data. The test period came near the end of a season with five to seven day cycles of nearly flat calm followed by moderate winds and seas.

A significant wave height of approximately 2 m was desired for each weather cycle, though much was learned in seas less than 1 m. Seas of approximately 3 m were encountered with the Coast Guard and Sjuntorp booms, and seas in excess of 1 m were encountered with every boom.

TEST NARRATIVE AND OBSERVATIONS

Coast Guard Boom

The Coast Guard boom in the ADC was transported to sea aboard the USCGC WHITE PINE on 30 March 1978. It was planned to transport the ADC close to the test site at Stage I and then to lower the box to the water and deploy the boom.

Upon leaving the channel to the Gulf of Mexico, however, rough seas and swell were encountered, and it was judged that the ADC might be severely damaged against the hull of the buoy tender when it was raised or lowered. While such damages might be accepted during spill response, they were considered unnecessary during the boom test. WHITE PINE returned to St. Andrew's Bay and lowered the ADC in essentially calm water.

Figure 21 shows the boom being extracted from the ADC by the USCGC POINT LOBOS. A man is needed aboard the ADC to release the tailgate and assist in connecting the tow line. During extraction, four flotation bags failed to inflate. The CO₂ bottle on one of these four triggered but failed to inflate the bag due to an improperly tightened valve. The valve was corrected, and the bag inflated properly with a spare CO₂ bottle. The other three did not trigger during extraction, but inflated properly when triggered manually from a Zodiac boat.

The POINT LOBOS then towed the boom fully stretched out as a string tow to the test site at a speed over ground of approximately 3 kt. The drag due to the seas and motion through the water (the actual speed relative to the water is unknown), apparently required most of the available power for the 82 ft patrol craft.

At the test site, the boom was towed into the wind, and secured to the northwest mooring buoys by men in a Zodiac boat, as shown in Figure 22. The boom typically assumed the skewed U shape shown in Figures 13 and 23 due to predominant winds from the south during the test, rather than the anticipated southwesterly winds.

This boom was subjected to the most severe sea conditions encountered during the entire test. Significant wave heights of 2.5 to 3m (8 to 10 ft) were recorded. Waves up to 4.3 m (14 ft) were observed visually, and clipping occurred with the NCSL sensors, which flat-top at 10 ft. No structural failures occurred, though some minor damages occurred at various times during the test. Abrasion damage resulted from rubbing against the steel mooring buoys, as shown in Figure 24. This happened at times in both calm and rough seas. Also, when the boom forms a catenary reversed from its intended direction, as is beginning to occur in Figure 24, the flotation bags may chafe against one another. Minor abrasion of this sort occurred. Figure 25 shows the splits that occurred in the hem of one end flap, probably during the tow to the site. These end flaps are simply excess fabric that may be used to secure two booms together. They are unrestrained when not used to join booms. The boom also lost some of the upper foam flotation pads from the backs of the struts. These pads provide buoyancy for the ADC when it is immersed and do not affect the boom.



Figure 21. The Coast Guard boom being extracted from the ADC.

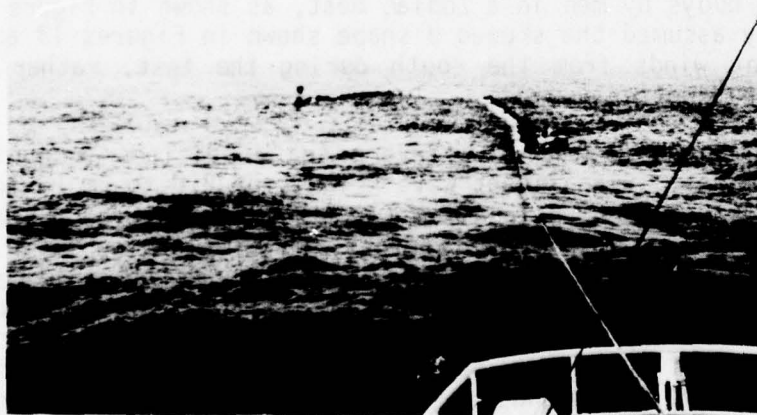

Figure 22. Crewmen in a Zodiac boat complete the Coast Guard boom mooring, while USCGC POINT LOBOS holds the position.

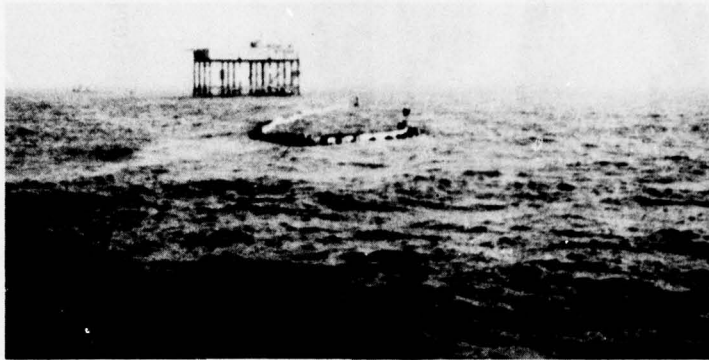

Figure 23. The Coast Guard boom moored in a skewed U shape.

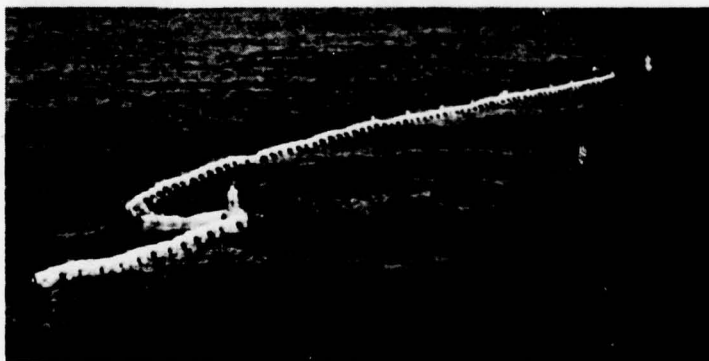

Figure 24. The Coast Guard boom rubbing against a mooring buoy after a change in the surface current direction.



Figure 25. Minor damage to the end flap on the Coast Guard boom.



Figure 26. Video target painted on the Sjuntorp boom.

Signs of possible containment failure were observed only occasionally. These were primarily intermittent splashover - a light surge of water against the face of the boom followed by splashing of a small amount of water over the boom.

On 7 April, after eight days at sea, the boom was freed from the moorings. While the boom was being released from the buoy, the buoy parted its mooring line and had to be retrieved. The remainder of the line and chain sank and was retrieved later. The boom was towed back to the Naval Coastal Systems Laboratory. It was retrieved using a special recovery rack on the dock. This rack includes a windlass to assist in hauling each strut up from the water to the rack. The struts are then hung on hooks, which may be moved fore and aft on a tramway, and gradually pushed to the rear of the rack as the boom is retrieved. Once in the rack, the boom is ready for inspection, subsequent cleaning or repair, and repacking into the ADC.

Sjuntorp Coastal Boom

The Sjuntorp boom was transported to the test site in a crate aboard the WHITE PINE on 30 March. Once on scene, deployment began directly from the crate on the buoy deck. Figure 27 shows the procedure for each section of boom. Most of the section was lowered over the side while a Zodiac boat pulled the free end away from the ship. A minimum crew of three was needed to haul on the boom, hold it, and inflate the section with the small gasoline powered blowers provided by A. B. Sjuntorp. A crew of five was generally used, however, to make the work easier and safer.

The process of lowering a section, inflating it, and lowering the next section was repeated until all seven sections were inflated. This took approximately 17 minutes.

When the boom was fully inflated, the Zodiac boat with the first section towed the boom to the outer southeast mooring buoy, where the crew of a second Zodiac boat secured the mooring line. Similarly, the free end of the boom was then towed to and secured to the inner southeast buoy.

Like the Coast Guard boom, the Sjuntorp boom typically formed the skewed U shape shown in Figures 13 and 28. Figure 29 is a photograph of the farther, nearly straight side, with a video roll target and a black vertical stripe near the boom connector to show the waterline clearly. Because the Sjuntorp skirt is flexible, waterline readings do not accurately indicate the boom's draft. The "barber poles" shown in Figure 31 were used in an attempt to check the draft at several points. The poles are styrofoam cylinders with 3 inch (76 mm) stripes and a wood dowel through the centerline.

The bottom of the dowel was fastened to the bottom of the skirt, and the styrofoam was slid up or down the dowel so that the pole would float almost vertically but not pull up the skirt excessively. This trick was also tried later with the Whittaker and Bennett booms; however, it failed and provided no useful information.



Figure 27. The Sjuntorp boom being inflated and deployed from the USCGC WHITE PINE.



Figure 28. The Sjuntorp boom moored in a skewed U shape.

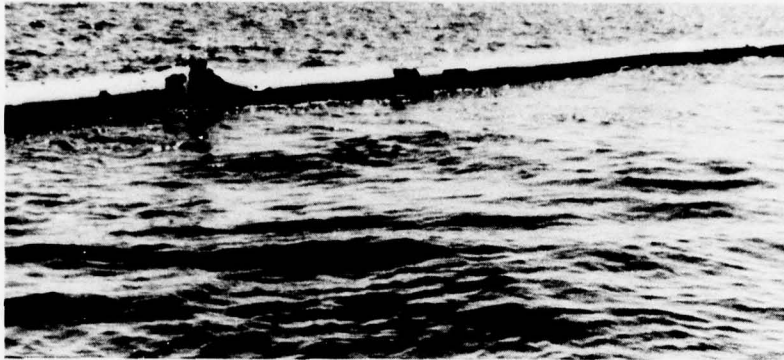

Figure 29. A section of Sjuntorp boom showing a video target, boom connector, and black vertical stripe for waterline readings.

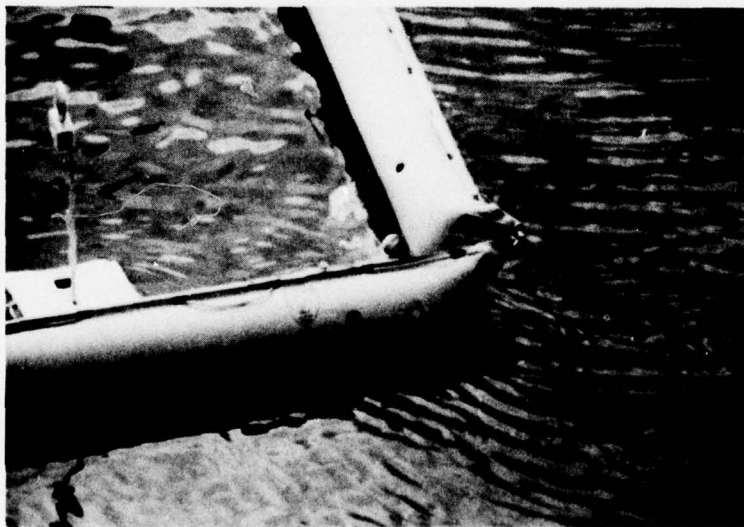

Figure 30. Close-up showing the skirt of Sjuntorp boom rising to the surface.



Figure 31. A "barber pole," which was attached to the bottom of the Sjuntorp boom skirt to attempt to observe the skirt motions.

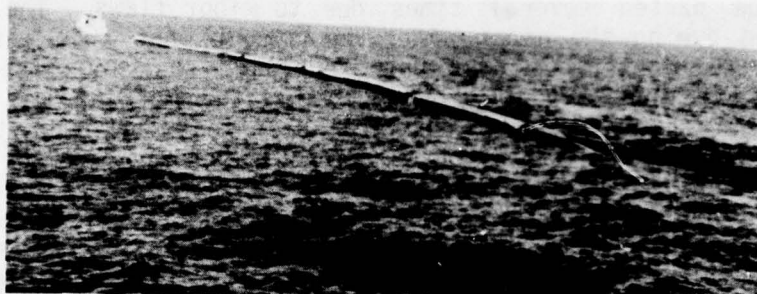

Figure 32. The Sjuntorp boom being towed back to port, trailing a damaged section.



Figure 33. The Vikoma Seapack with the boom being deployed from the stern.

The first failure observed was not a break or separation but was related to the structural design. Air apparently migrated within the laminations and formed pockets that caused the skirt to rise to the surface, as may be seen in Figure 25. The pockets were slit by men working from a Zodiac boat to release the air and allow the skirt to sink.

The boom parted several times due to minor flaws. The first incident occurred during the night after deployment, but this was traced to an improperly tightened, Coast Guard-supplied shackle. The boom had come free of the outer southeast mooring. The mooring was secured again using only a Zodiac boat. On later occasions, however, the boom parted twice at boom connectors. This first occurred on 2 April between the second and third sections, counting from Stage I. On 4 April, it occurred between the third and fourth connectors. In both instances, the top and bottom shackles on the connectors worked free, allowing the connectors to slide apart. When reinstalled, the pins were seized with light line to prevent further working and failure.

In addition to these failures, the boom began to experience a major structural failure. The boom began to lose air, and daily reinflation was required. During the rough seas of 4 April, the fabric separated from a connector, deflating the section of boom and leaving the two parted lengths streaming freely from the buoys.

The two parted lengths were towed back to the docks when the seas subsided on 7 April 1977. One of these lengths with the damaged, deflated section is shown in Figure 32.

Vikoma Seapack and Boom

It was necessary to move one set of moorings prior to mooring the Vikoma boom, because of its 1600 ft (488 m) length. The USCGC WHITE PINE moved the southeast moorings farther to the south during the morning of 7 April, while the USCGC POINT LOBOS towed the Seapack to the test site. Besides moving the moorings away from Stage I, the gap was increased to maintain approximately the same ratio of gap to boom length, and the NW-SE orientation was changed to take better advantage of the predominantly southerly winds and seas. Figure 18 shows the Vikoma mooring arrangement relative to Stage I.

The boom was deployed from the Seapack with the assistance of Canadian Coast Guard personnel. The boom did not deploy automatically as the towing continued after releasing the backboard on the Seapack, however. An installation error resulted in premature inflation of the flotation cuff on the top of the boom, making it very difficult to complete deployment and causing a split seam on the cuff. A further complication was caused by a jammed mechanism in the Seapack which had to be forced physically before deployment could be completed. Rather than merely towing the Seapack to deploy the boom, a Zodiac boat assisted in extracting the boom, as shown in Figure 33.

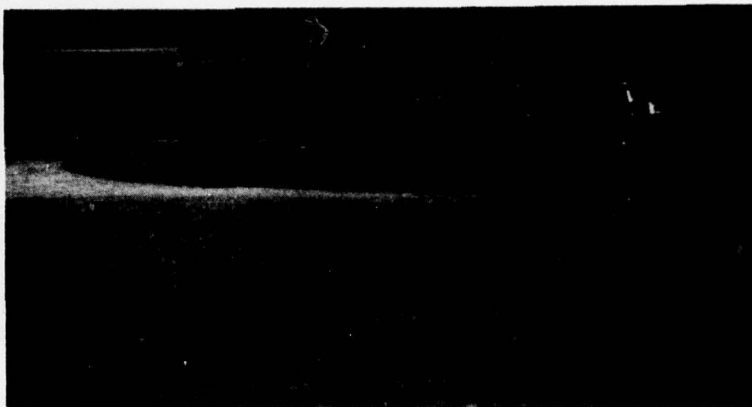

Figure 34. Crewmen in a Zodiac boat complete the Vikoma boom mooring.

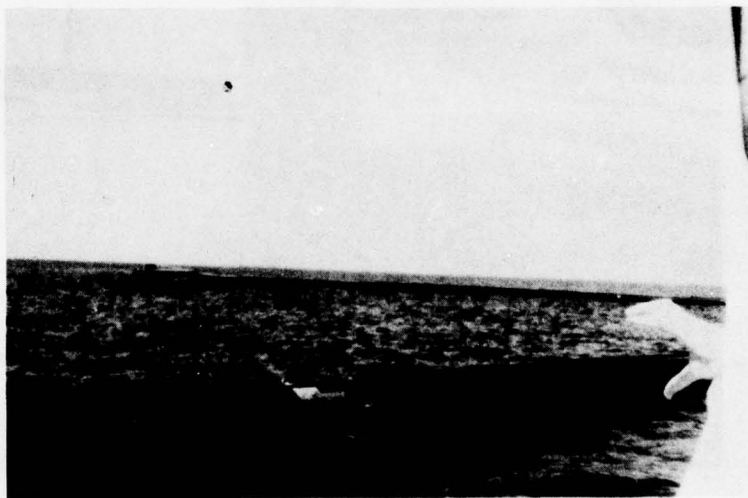

Figure 35. The Vikoma boom, showing the lashed-on video target.

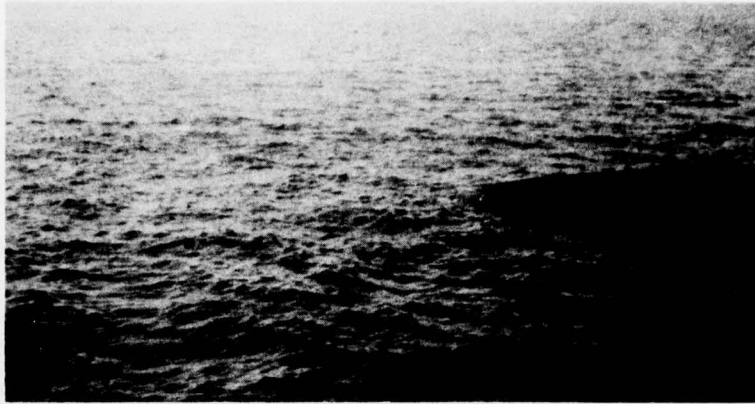

Figure 36. The Vikoma boom sinking after loss of power in the Seapack.

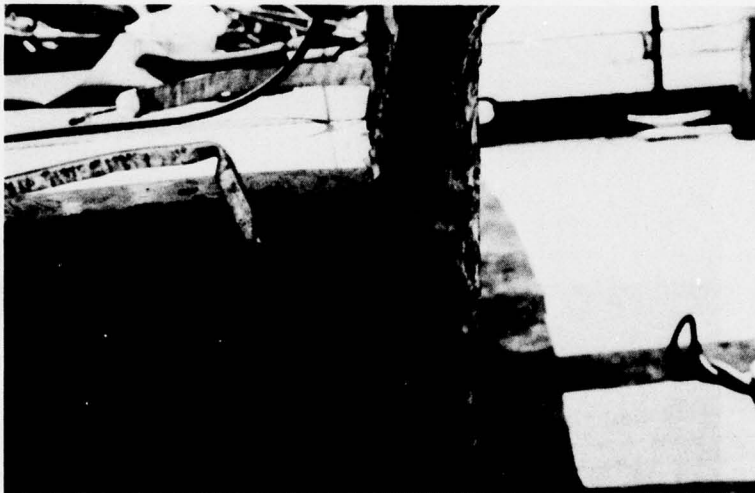

Figure 37. Damages to the stern of the Vikoma Seapack caused by the steel buoys.

Once properly inflated with air and water, mooring continued as planned. Figures 34 and 35 show the moorings being secured and a view of a video roll target, which was lashed to the back of the boom on 8 April. The rigid targets of Figure 20 could not be mounted effectively. The entire operation, from the arrival of the Seapack on-scene to securing the moorings, required nearly 4 hrs in this case. Except for the problems in the Seapack, it may be expected that considerably less time could have been taken.

On 9 April, after one day at sea, problems began to occur in the Seapack. The diesel engine would not restart after being shut down for checks, and a cracked fuel line was found. Repairs were not completed until the next afternoon. The boom had begun to sink early in the morning, as shown in Figure 36, and the later attempt at reinflation brought about 90% of the boom back to the surface, but the remainder would not resurface. The repaired fuel line failed again after four hours, causing the engine to stop and aborting further attempts to raise the boom. During the afternoon of 10 April, another fuel line arrived from Canada, permanent fuel line repairs were completed, and another attempt to raise the boom was begun, with assistance from divers to remove a twist found below the surface. These efforts failed, however, and the boom was subsequently raised by releasing the moorings and towing the boom. The twist traveled down the boom to the end, and the boom was refloated and removed.

On 11 April further problems occurred in the Seapack. A clutch failed and was repaired while the boom remained afloat. On restart, bearing and support bracket failures in the drivetrain were found. It was decided to remove the boom from service on 15 April without collecting seakeeping performance data.

Minor damages unrelated to the Vikoma system were incurred by the Seapack. As with the Coast Guard boom, the steel mooring buoys damaged the stern of the boat during intermittent contact as seen in Figure 37. This damage did not affect the performance of the Seapack system and could have been avoided by using rubber buoys, which later replaced the steel buoys. The damage could have led to sinking, but the Canadian Coast Guard had prevented this by filling the void in the double bottom hull with foam.

To recover the boom, the backboard-end (opposite from the Seapack) was released from its mooring and towed to the USCGC WHITE PINE. As shown in Figures 38 and 39, the boom was gradually brought aboard by the five-man buoy deck crew using a Marco power block and was faked on the deck for inspection and later repacking. A Zodiac boat tended the Seapack, which was also hoisted aboard WHITE PINE after retrieving the boom. The boom retrieval took 1 hr 07 min for five men, plus approximately 15 min for the Seapack. During inspection later back on the deck at NCSL, three minor tears were found.

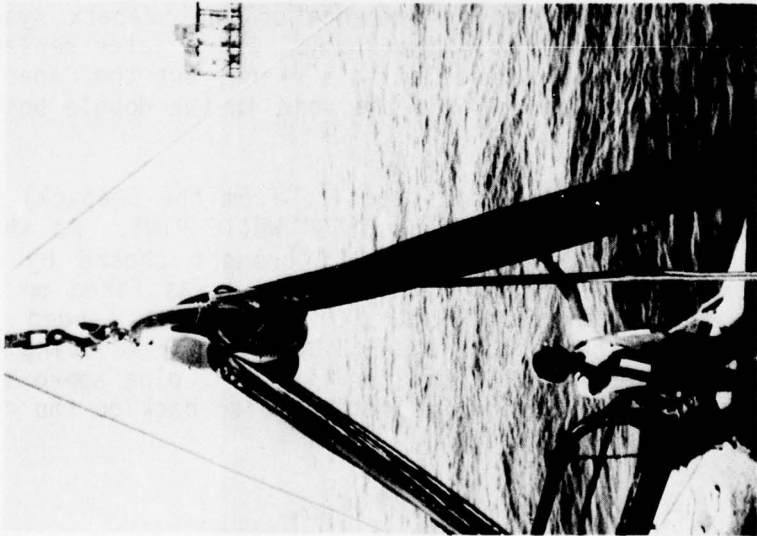

Figure 38. The Vikoma boom being retrieved through a Marco power block.

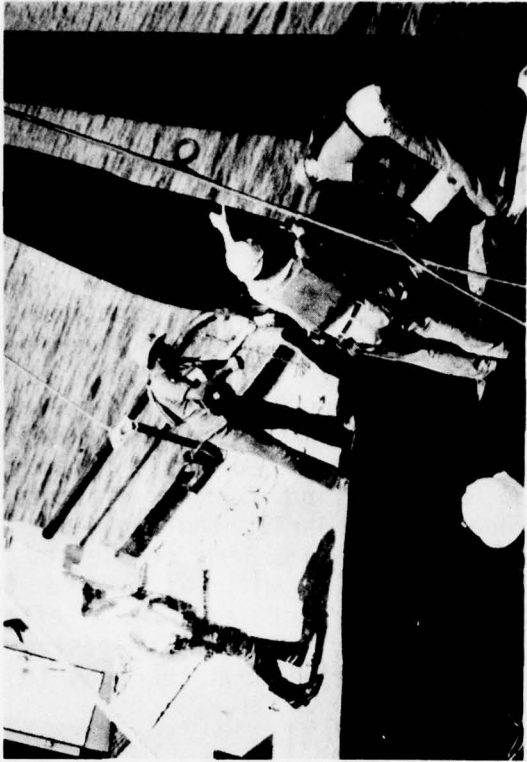

Figure 39. Crewmen fake lengths of Vikoma boom on deck during retrieval.

Bennett Inflatable Offshore Boom

The Bennett boom arrived at the dock stowed on a flatbed truck. On 12 April, a crane, a small boat, and five additional men moved the towing attachments and six sections from the truck to the water (Figure 40). The boom was assembled in the water, and inflation was attempted using the Bennett-supplied blower feeding the inlet on the towing attachment, as shown in Figure 41. The boom would not inflate properly during this attempt or during later attempts at the test site, so air was added directly to the individual sections, thus bypassing the plenum tube inside the boom.

Also on 12 April, WHITE PINE and a diving crew located the missing line and chain from the outer northwest mooring buoy. The northwest moorings were then relocated as shown in Figure 14 off the west corner of Stage I, and the steel buoys were replaced with neoprene fuel bladder buoys. The Bennett boom was towed from the dock to the test site by POINT LOBOS and moored with the assistance of a Zodiac boat and WHITE PINE, as shown in Figures 42 and 43. Figure 45 shows the completed mooring. A tear in the skirt approximately 0.6 m long was noted at this point.

The boom lost air continuously during the test and sank repeatedly at the connectors as shown in Figures 44 and 46. The Bennett blower was too large to take to the test site, so a small sand-blasting compressor was used to reinflate the boom on-scene. The compressor was placed on the lower level of Stage I, and a 1-inch (25 mm) air line was run 700 ft (210 m) to reach the farthest connector. Air was added frequently for two days until the compressor ceased to operate. Furthermore, rising seas at the end of this period made reinflation difficult.

On 19 April, a wire rope looped on the inboard mooring buoy broke, allowing the boom to stream freely from one mooring. The frayed loop is shown in Figure 14. A new mooring was set by WHITE PINE, and the free end of the boom was secured again. At that time WHITE PINE reported that the skirt of at least two sections of the barrier had become disconnected from the flotation tubes and were attached only at the metal connectors.

On 25 April, the seas subsided, permitting retrieval of the boom. The boom was released from the moorings, and POINT LOBOS towed the boom to WHITE PINE for retrieval. Because of the damage to the boom's skirt and because the boom was partially filled with water, retrieval from the water to the buoy deck took approximately 3 hours.

Whittaker Expandi-Oil Boom

The moorings used for the Vikoma boom were moved to the east corner (Figure 14) of Stage I prior to deploying the Whittaker boom.

The boom came palletized, as shown in Figure 47, and was deployed directly from the pallet on the buoy deck of the USCGC WHITE PINE on 18 April. Since the boom is self expanding and lightweight and needed

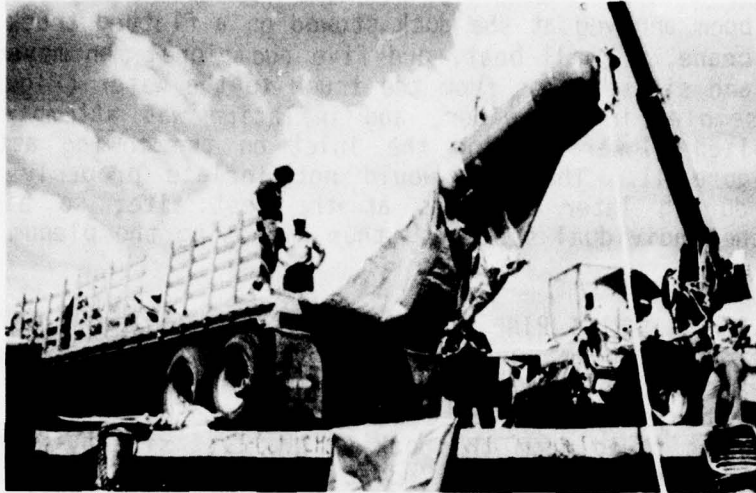

Figure 40. The Bennett boom and towing attachment being offloaded from a truck.

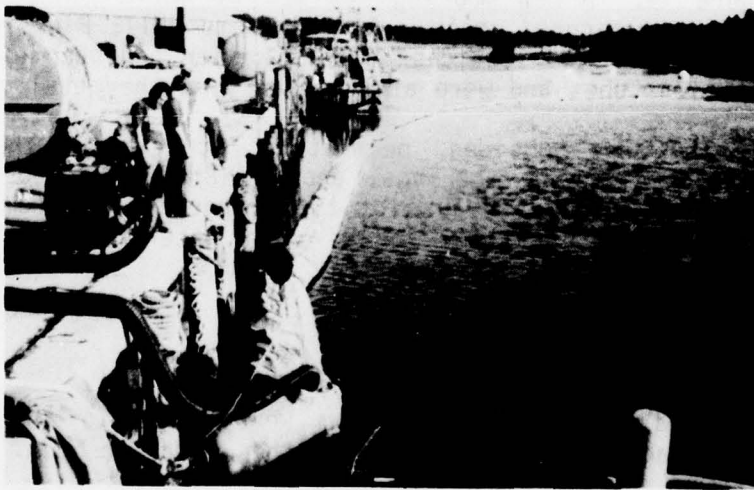

Figure 41. Inflating the Bennett boom at dockside.



Figure 42. Mooring the Bennett boom at the test site. The steel buoys have been replaced by rubber fuel bladders.

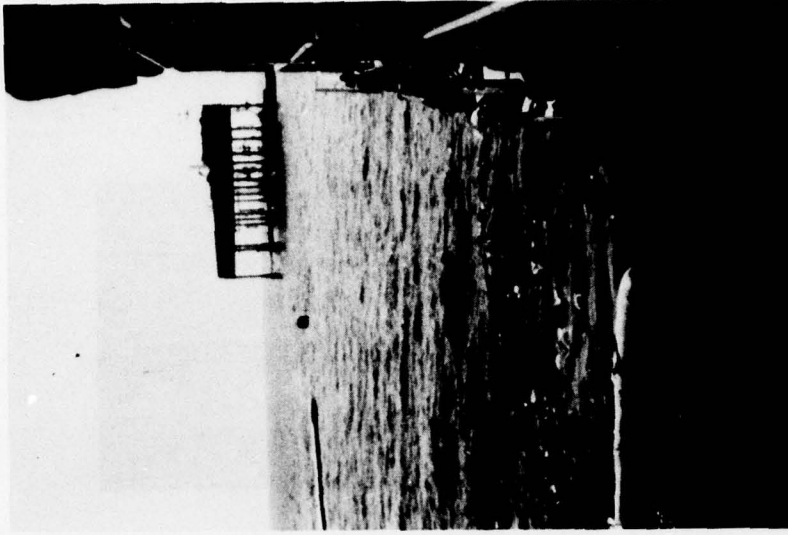

Figure 43. The USCGC WHITE PINE towing the free end of the Bennett boom to a mooring buoy.

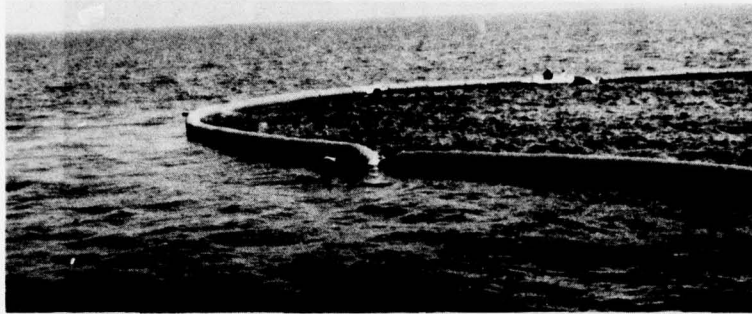

Figure 44. Crewmen in a Zodiac boat tending the Bennett boom, which is sinking at the connectors. A video target may be seen to the left of the Zodiac boat.

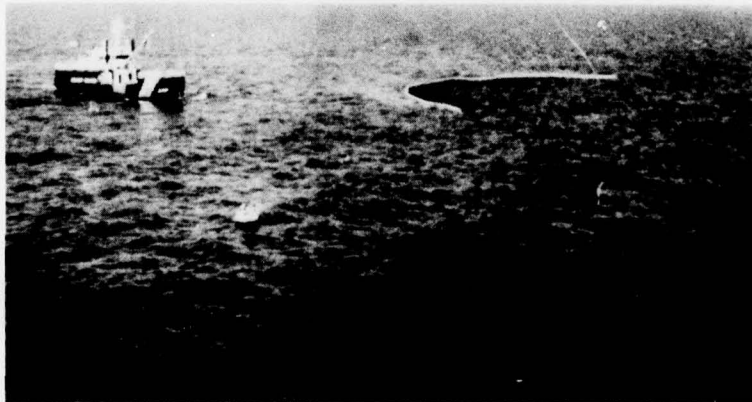

Figure 45. The Bennett boom moored in a U shape.



Figure 46. Air leaks in the Bennett boom connectors led to sinking.

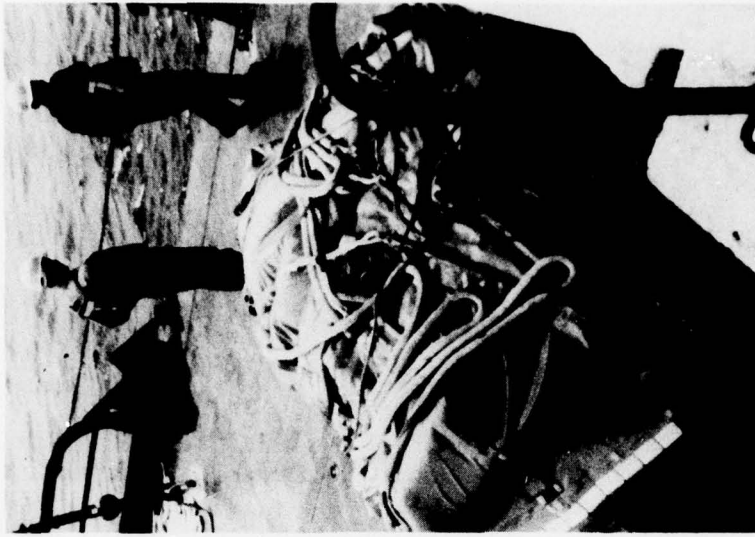

Figure 47. Whittaker boom pallet on the buoy deck of the USCGC WHITE PINE.

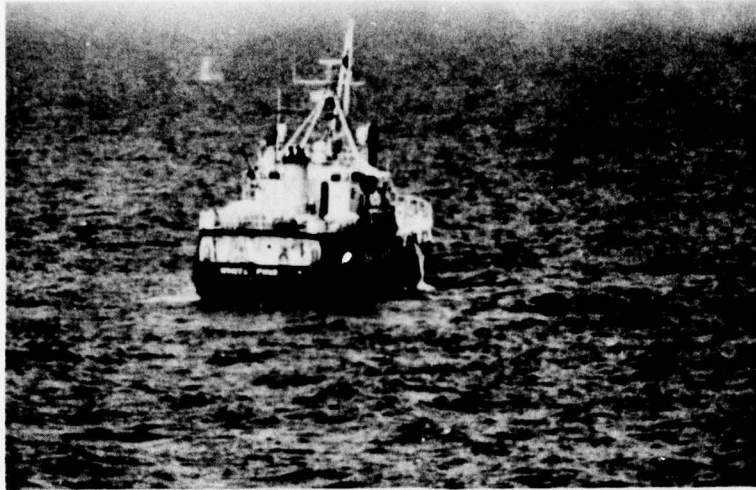

Figure 48. Whittaker boom being deployed.

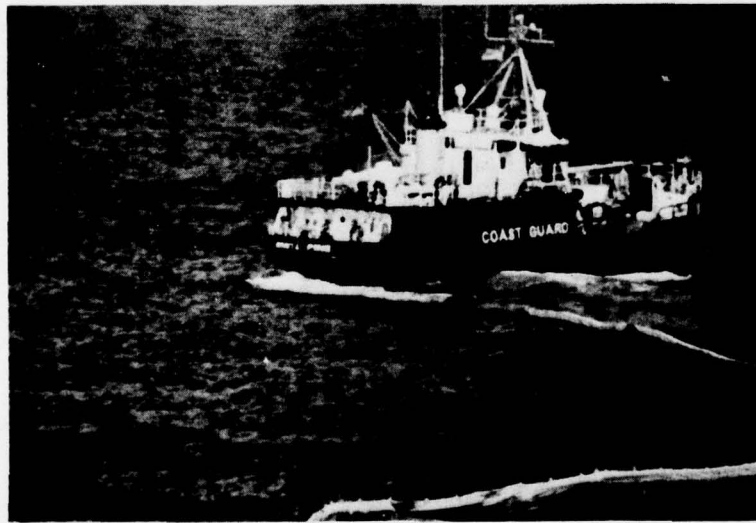

Figure 49. Whittaker boom being maneuvered near a mooring buoy.

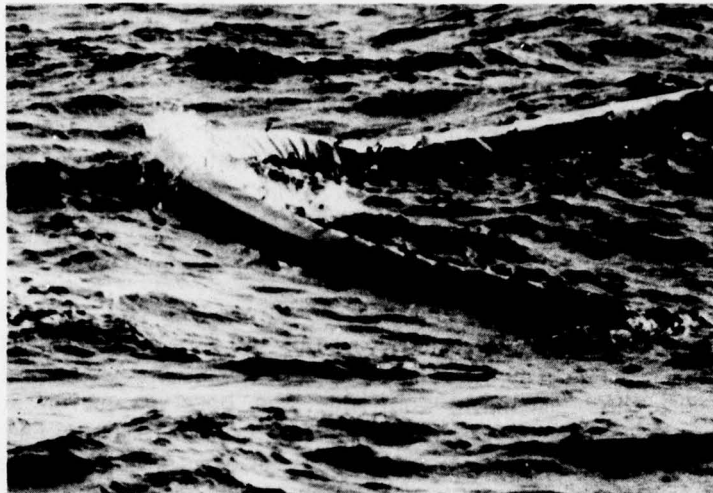

Figure 50. An example of splashover, which occurred with all three booms that remained afloat and undamaged.

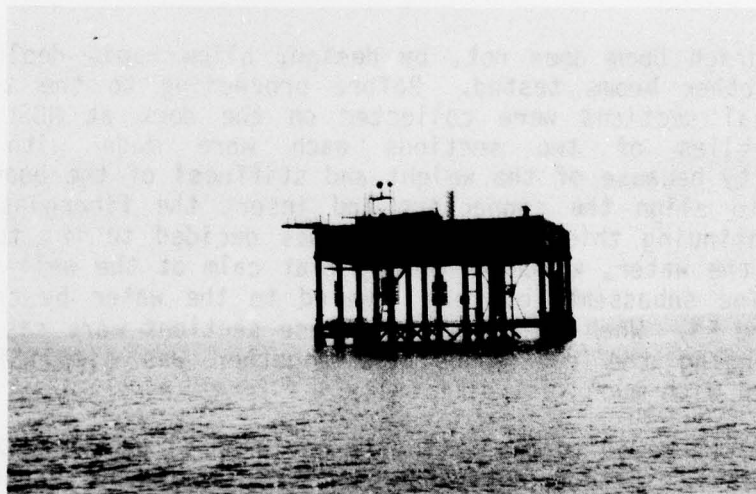

Figure 51. Stage I, the observation platform at the center of the test site, seen looking from the northwest

only to be payed out from the pallet directly to the water, two men were able to deploy it in 13 minutes, though five men were available in the buoy deck crew. As shown in Figure 48, the boom was simply fed over the side while WHITE PINE kept slowly underway.

In this case a slightly different mooring procedure was used in that WHITE PINE towed the boom past a buoy, and a Zodiac boat crew connected the free end. The end in tow was then drawn to the second buoy (Figure 49) and secured by the Zodiac crew. The Zodiac crew then proceeded to release by hand approximately ten of the self-expanding plastic frames that had not released during deployment.

The boom experienced no mechanical failures during the test. While in a skewed U shape, it experienced waves up to 1 m (3 ft). The outer mooring bridle also parted with this boom on 20 April and, while streaming from the remaining mooring, the boom experienced seas up to 2 m (7 ft). However, symptoms of oil containment failure occurred repeatedly while the boom was properly moored. Splashover (spray over the boom), washover (surge of water over the boom), and washunder (surge under the boom) occurred clearly after the seas reached 0.6 m (2 ft). An example of splashover is shown in Figure 50. This failure occurred with other booms; this is merely one of the few still photographs of this short-lived event available.

Seas were too rough on 20 April to allow repair of the parted mooring. On 22 April the boom was doubled up by attaching both ends to the remaining buoy. On 24 April, after six days at sea, the Whittaker boom was freed from its moorings and towed backed to NCSL. WHITE PINE retrieved the boom from the water on 25 April.

Goodrich 36-inch Seaboom

The Goodrich boom does not, by design, allow rapid deployment similar to the other booms tested. Before proceeding to the test site, the individual sections were collected on the dock at NCSL (Figure 52). Subassemblies of two sections each were made with considerable difficulty because of the weight and stiffness of the boom and the care needed to align the connectors and insert the fiberglass pin. Rather than continuing this procedure, it was decided to try to assemble the boom in the water, which is nearly flat calm at the well-sheltered NCSL dock. The subassemblies were lowered to the water by crane, as shown in Figure 53. When in the water, these sections were easier to handle, and bringing the end connectors together was simplified. Assembly proceeded with much less difficulty.

The boom was towed to the test site on 25 April by the USCGC POINT LOBOS (Figure 54). Before entering the test area, the Goodrich boom was passed to a Coast Guard Auxiliary vessel to be tended while POINT LOBOS participated in releasing the Bennett boom from the west moorings and delivering the boom to the USCGC WHITE PINE for retrieval.

The standard mooring procedures were then followed as shown in Figure 55. Winds in excess of 20 kt slowed the operation, and maneuvering to the second mooring buoy was time consuming. The complete mooring operation took approximately 1 hr 20 min.

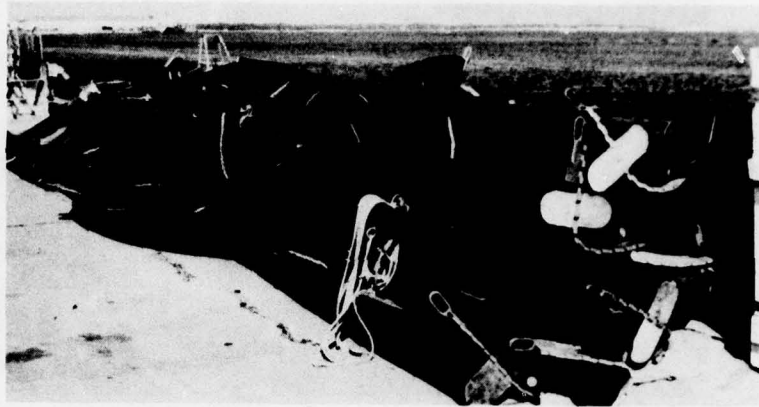

Figure 52. A spreader bar and lengths of Goodrich boom awaiting assembly.

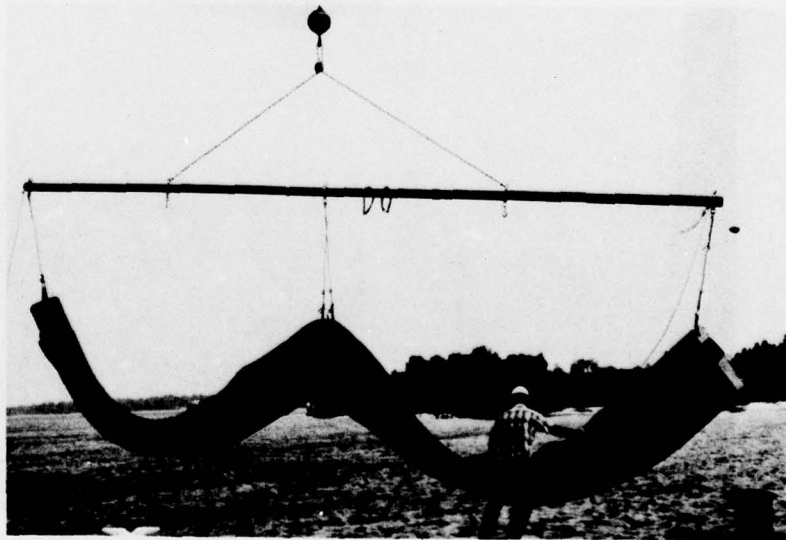

Figure 53. Two sections of Goodrich boom being lowered to the water.

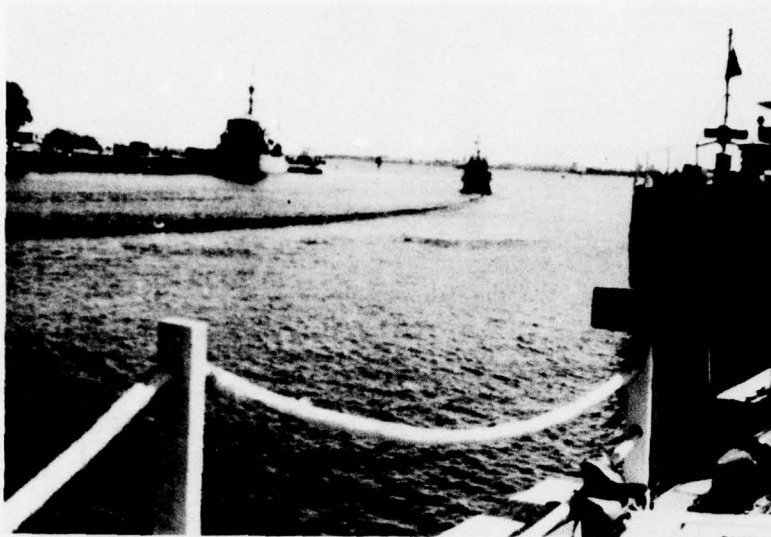

Figure 54. The assembled Goodrich boom being towed to sea.



Figure 55. The USCGC POINT LOBOS maneuvering the Goodrich boom to the moorings.

The Goodrich boom experienced no mechanical failures of any kind, but showed many symptoms of oil containment failure due to inadequate seakeeping. After mooring, the boom assumed a skewed catenary shape similar to that formed by the other booms. With steady winds from 20 to 25 kt, the seas increased from near calm to approximately 1 m significant wave height. Splashover, washover, and washunder occurred clearly and regularly after the seas reached 0.6 m (2 ft). In a typical case, a wave could be seen running along the nearly straight section of the boom, gradually rising over the boom or raising the boom up (as occurs in wave bridging), and eventually engulfing the boom as the bottom of the catenary was approached and the curve of the boom sharpened.

On 28 April, after three days at sea, the Goodrich boom was released from its moorings and towed back to the dock. A crane was used to remove the boom from the water as it was disassembled.

CONCLUSIONS

Several lessons were learned about offshore oil containment booms, boom tests, and the support equipment.

1. Most oil containment booms are not suitable for offshore use. The booms tested are believed to be representative of the better available booms. Five of the six booms tested experienced severe mechanical failures or clearly inadequate seakeeping in seas less than 1 m significant wave height. The Coast Guard boom performed well in 3 m seas and experienced no mechanical failure.

2. Several types of mechanical failures occurred, indicating the need for more basic and intensive engineering as part of the boom design process. Fabric-to-fabric seams, fabric-to-hardware connections, and boom connectors in particular need more engineering attention. Air filled booms need better self-sealing and failsafe mechanisms to minimize the extent of a failure; provision should be made for emergency inflation with lightweight blowers. Air filled booms should not fill with water when the air is lost.

3. Hydrodynamic factors also demand greater attention. A useful boom should not experience seakeeping failures more severe than splashover. It appears that both ballast and excess buoyancy must be as high as practical, and, in any case, must be high compared with the boom's stiffness. Shape and smoothness may be important considerations.

4. The assumption that much could be learned about booms from a test of seakeeping without oil was a good one. Structural and performance differences among the booms were sufficient to allow a clear judgment of boom capabilities and problems in a seaway. It must be noted, however, that currents were typically less than 0.5 kt. Adequate performance in waves alone does not imply adequate performance in calm with a higher current speed or towing speed.

5. The details of the design of every major component -- boom, lines, moorings -- must include careful consideration of abrasion and cyclic stressing. Besides having adequate strength, hardware must not simply work its way apart by screwing or sliding. Loops must not be free to chafe against one another. Repeated collisions between hard floating objects (boats, buoys, boom end caps, lights, etc.) must be avoided. Deployment techniques should be examined more carefully. Packaging methods must allow for occasional errors: mistakes in packaging should not cause long delays or great difficulty during deployment. Specialized equipment, such as cranes or large blowers, should not be necessary.

6. On a sandy bottom, a suitable mooring system for use in seas up to approximately 3 m (10 ft) significant wave height with 150 m (500 ft) between moorings includes two 8000-lb (3640 kg) concrete sinkers, two suitable lengths of 4-inch (10 cm) circumference nylon line for a 3.5:

1 scope, and two neoprene fuel bladders for buoys. If the swing of the boom with changes in current or wind direction must be limited, the three sinker arrangement shown on page 32 may be used. In most cases, however, backmoors may be preferred.

7. Deployment procedures for the Coast Guard boom that will not result in severe damage to the ADC in rough seas are needed. It may be advisable to have procedures that do not require lifting the ADC off the deck.

8. As much as possible, the work should be performed by machines or vessels. These must be designed to suit the environment and have capabilities well in excess of those required by the task. The 133 ft buoy tender proved to be an excellent vessel for this test. The 82 ft patrol boat appeared to be well suited to the string-towing assignments, but is known to have too high a minimum speed for catenary towing a 600 ft boom.

9. A good variety of shackles and types of quick releasing connectors should be available when working with booms to simplify passing lines and securing to tow vessels or moorings. These connectors may become especially valuable to a crew not familiar with the boom they must use.

10. Personnel specifically trained for using spill cleanup equipment are not essential to conducting a test and probably are not essential to using booms during offshore oil spill cleanup. The personnel should, however, be experienced seamen who bring a variety of skills to the job. Supervisors must be familiar with the equipment, a variety of scenarios for using the equipment, and the problems likely to be encountered. Communication among the personnel and supervisors must be active and straightforward.

11. The requirements for lighting are not clear. The dredge pipe lighting specification used in this test was difficult to satisfy and probably could not be met during an oil spill cleanup. A specific, practical specification for lighting offshore booms is needed.

REFERENCES

- J. S. Farlow and F. J. Freestone: 1975, "United States Environmental Protection Agency's Test Facility OHMSETT: The First Six Months," Proc. 1975 Conf. on Prevention and Control of Oil Spills, American Petroleum Institute, Washington, DC.
- L. A. Hale, D. J. Norton, and C. A. Rodenberger: 1974, "The Effects of Currents and Waves on an Oil Slick Retained by a Barrier," U. S. Coast Guard Report No CG-D-53-75, NTIS No. AD 004 675.
- S. Leibovich: 1975, "A Natural Limit to Containment and Removal of Oil Spills at Sea," Ocean Engineering, 3.
- W. T. Lindenmuth, E. R. Miller, and C. C. Hsu: 1970, "Studies of Oil Retention Boom Hydrodynamics," U. S. Coast Guard Report No 714102/A/008, NTIS No. AD 719 294.
- J. H. Milgram: 1973, "Physical Requirements for Oil Pollution Control Barriers," Proc. 1973 Conf. on Prevention and Control of Oil Spills, American Petroleum Institute, Washington, DC.
- J. H. Milgram and J. F. O'Dea: 1974, "Evaluation of the Strength and Seakeeping Ability of Pollution Control Barriers," U. S. Coast Guard Report No. CG-D-55-75, NTIS No. AD 004 674.
- J. H. Milgram: 1976, "Seakeeping Calculations for Seven Oil Pollution Control Barrier Design," Interim Report - not yet published.
- J. M. Tierney: 1975, "Research, Design, and Development of the U. S. Coast Guard High Seas Oil Containment System," U. S. Coast Guard Report No. CG-D-42-76, NTIS No. AD A025 749.