

AD-A065 856

FOREIGN TECHNOLOGY DIV WRIGHT-PATTERSON AFB OHIO

F/G 9/5

CALCULATION OF LOGARITHMIC AMPLIFIERS WITH NONLINEAR ELEMENTS I--ETC(U)

OCT 77 G M KRYLOV, A S KAKUNIN, V I PANOV

UNCLASSIFIED

FTD-ID(RS)T-1829-77

NL

1 OF 2
ADA
065856



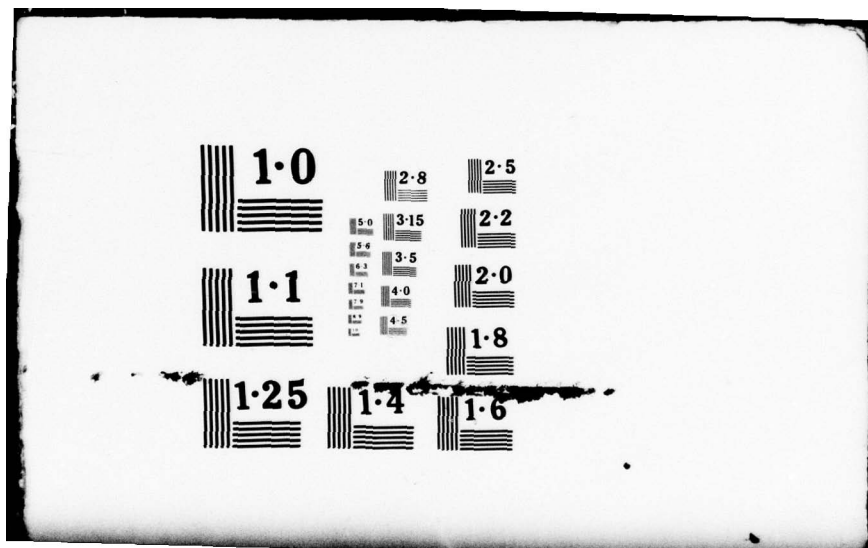

060 80 II 82

FTD-ID(RS)T-1829-77



AD-A065856

FOREIGN TECHNOLOGY DIVISION



CALCULATION OF LOGARITHMIC AMPLIFIERS WITH
NONLINEAR ELEMENTS IN LOAD CIRCUITS

by

G. M. Krylov, A. S. Kakunin,
V. I. Panov

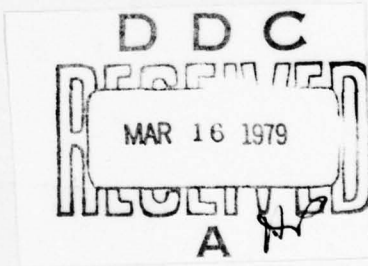

Distribution limited to U. S.
Government Agencies Only;
Proprietary (Copyright) Information;
Other requests for this document
must be referred to FTD/STINPD.
Approved for public release;
distribution unlimited.



UNEDITED MACHINE TRANSLATION

FTD-ID(RS)T-1829-77 25 Oct 1977

MICROFICHE NR: *FTD-77-c-001344*

CALCULATION OF LOGARITHMIC AMPLIFIERS WITH
NONLINEAR ELEMENTS IN LOAD CIRCUITS

By: G. M. Krylov, A. S. Kakunin, V. I. Panov

English pages: 184

Source: Raschet Logarifmicheskikh Usiliteley s
Nelineynymi Elementami v Tsepyakh
Nagruzki, "Energiya", Moscow, 1969,
pp. 1-103.

Country of origin: USSR

This document is a machine translation.

Requester: FTD/ETWR

Approved for public release; distribution
unlimited.

ACCESSION FOR	
ATIS	Write Section <input checked="" type="checkbox"/>
DOC	Ref Section <input type="checkbox"/>
ORAN/RORCED	<input type="checkbox"/>
JUSTIFICATION	
BY	
DISTRIBUTION/AVAILABILITY CODES	
MAIL	AVAIL. AND/OR SPECIAL
A	

THIS TRANSLATION IS A RENDITION OF THE ORIGINAL FOREIGN TEXT WITHOUT ANY ANALYTICAL OR EDITORIAL COMMENT. STATEMENTS OR THEORIES ADVOCATED OR IMPLIED ARE THOSE OF THE SOURCE AND DO NOT NECESSARILY REFLECT THE POSITION OR OPINION OF THE FOREIGN TECHNOLOGY DIVISION.

PREPARED BY:
TRANSLATION DIVISION
FOREIGN TECHNOLOGY DIVISION
WP-AFB, OHIO.

78 11 08 000

Table of Contents

U. S. Board on Geographic Names Transliteration System.....	11
Preface.....	3
Introduction.....	4
References.....	183

U. S. BOARD ON GEOGRAPHIC NAMES TRANSLITERATION SYSTEM

Block	Italic	Transliteration	Block	Italic	Transliteration
А а	А а	A, a	Р р	Р р	R, r
Б б	Б б	B, b	С с	С с	S, s
В в	В в	V, v	Т т	Т т	T, t
Г г	Г г	G, g	У у	У у	U, u
Д д	Д д	D, d	Ф ф	Ф ф	F, f
Е е	Е е	Ye, ye; E, e*	Х х	Х х	Kh, kh
Ж ж	Ж ж	Zh, zh	Ц ц	Ц ц	Ts, ts
З з	З з	Z, z	Ч ч	Ч ч	Ch, ch
И и	И и	I, i	Ш ш	Ш ш	Sh, sh
Й й	Й й	Y, y	Щ щ	Щ щ	Shch, shch
К к	К к	K, k	Ъ ъ	Ъ ъ	"
Л л	Л л	L, l	Ы ы	Ы ы	Y, y
М м	М м	M, m	Ь ь	Ь ь	'
Н н	Н н	N, n	Э э	Э э	E, e
О о	О о	O, o	Ю ю	Ю ю	Yu, yu
П п	П п	P, p	Я я	Я я	Ya, ya

*ye initially, after vowels, and after ъ, ь; e elsewhere.
When written as ë in Russian, transliterate as yë or ë.

RUSSIAN AND ENGLISH TRIGONOMETRIC FUNCTIONS

Russian	English	Russian	English	Russian	English
sin	sin	sh	sinh	arc sh	sinh ⁻¹
cos	cos	ch	cosh	arc ch	cosh ⁻¹
tg	tan	th	tanh	arc th	tanh ⁻¹
ctg	cot	cth	coth	arc cth	coth ⁻¹
sec	sec	sch	sech	arc sch	sech ⁻¹
cosec	csc	csch	csch	arc csch	csch ⁻¹

Russian English

rot curl
lg log

CALCULATION OF LOGARITHMIC AMPLIFIERS WITH NONLINEAR ELEMENTS IN LOAD
CIRCUITS.

G. M. Krylov, A. S. Kakunin, V. I. Panov.

Are examined the methods of calculation and design of the logarithmic amplifiers, which have nonlinear cell/elements in load circuits. Considerable attention is devoted to the solution of the problem of providing an independence of the bandwidth of amplifier from changes of input signal level.

The book is intended for the design and planning engineers and designers of radio-electronics equipment.

Page 3.

PREFACE.

Logarithmic amplifiers find ever increasing use in radio-electronics equipment and measuring devices of different designation/purpose. In connection with this in the course of the past decade in the Soviet Union and abroad appeared a series of works, in which were examined the methods of logarithmic operation, and also the special feature/peculiarity of the calculation of logarithmic computing circuits. However, the trends of works indicated in the majority of cases has either a especially theoretical character or a character of the description of the results of experimental study, which creates the definite difficulties of using them by wide circles of the engineers - the developers of radio-electronics equipment.

In the proposed book are examined the most important practical questions of design and calculation of the logarithmic amplifiers, in the composition of the circuit diagrams of interstage communication/connection of which enter nonlinear cell/elements. Specifically, are examined the different methods of the realization of nonlinear resistors or logarithmizing circuits, special

feature/peculiarity of the execution of the logarithmic amplifiers of aperiodic and resonance types, are examined methods of the stabilization of the bandwidth of logarithmic amplifiers, and also a series of other questions, which have great practical value.

On the basis of theoretical analysis is developed the new procedure of the engineering calculation of the logarithmic amplifiers, made according to the principle of the shunting of load by nonlinear cell/elements. This procedure, suitable for the calculation and transistor and vacuum-tube amplifiers, differs in terms of simplicity, which does not affect the accuracy of the calculation. In this case complex theoretical positions are led to simple formulas and the convenient in use curve/graphs, which make it possible to give actually the synthesis of the logarithmic amplifier.

Page 4.

It is necessary to note that the basic condition/positions of the proposed calculation procedure are universal and can be used during the design not only logarithmic amplifiers of the type indicated, but also other devices, which contain the nonlinear cell/elements whose resistor/resistance changes under the action either of the amplified signal or signal AGC.

In connection with the fact that the transistorization of electronic circuits is given at present the special importance, in that proposed to reader's attention to the book are examined mainly the transistor circuits of logarithmic amplifiers.

It is assumed that the book can be used by the qualified specialists in area of radio-receiving technology, by the well familiar with the basic condition/positions of theory. In connection with this special feature/peculiarity of the set-forth below material is the wide use of different formulas and expressions, known from theoretical radio engineering and for this reason for those given without the comprehensive derivations.

Page 5.

INTRODUCTION.

CIRCUITS AND METHODS OF LOGARITHMIC OPERATION.

Logarithmic amplifier they find as has already been indicated, wide application in the different radio engineering devices, which in

accordance with the character fulfilled - in the common/general/total complex of equipment - problems must work under conditions of the effect of signals with the changing over wide limits level. Being are introduced into the composition of such devices, logarithmic amplifiers make it possible to solve the following tasks:

First, to prevent the possibility of the overloading of the final stages of the receiver by powerful input signals;

in the second place, to carry out functional transformation of the electrical signal, which enters the input; this makes it possible subsequently to carry out processing signals, for example division - by the subtraction of the logarithmized signals, and so forth;

thirdly, to ensure continuously increasing character of amplitude characteristic over a broad range of a change of input signal levels, but on the basis of this - the possibility of the continuous indication of increments in the latter on reproducer.

On the final effect of their action on these or other characteristics of radio engineering device, the logarithmic amplifiers are equivalent to systems with the automatic gain control of usual type. However, in comparison with these systems logarithmic amplifiers (especially amplifiers with the shunting of load by

nonlinear cell/elements) differ in terms of the high speed of response, which is determined exclusively by the inertness of amplifier cell/elements.

Page 6.

In contemporary radio engineering is known the sufficiently large number of methods of obtaining logarithmic amplitude characteristic (let us call/name them the methods of logarithmic operation). They all can be united several groups, which differ in terms of the generality of chart technology solution (by methods of the technical realization, which provide obtaining logarithmic amplitude characteristic in this circuit) independent of the method of execution of load circuit and type of amplifier cell/element. This approach to the analysis of logarithmic computing circuits makes it possible to the determined stage to conduct their research by the most general methods irrespectively of the concrete/specific/actual cell/elements of amplifier circuit.

As base for the grouping of logarithmic computing circuits can serve the generalized formula of voltage amplification factor $(K_U)_0$ of the multistage amplifier:

$$(K_U)_0 = (mY_{21}Z_{\text{анн.н}})^n \frac{1}{1 - K_U^2}$$

Here Y_{21} is conductivity of the direct drive of amplifier instrument;

$Z_{\text{DPP II}}$ - the resulting quantity of the resistor/resistance of load circuit;

m - the coefficient, which determines the degree of the communication/connection of the jet/reactive two-terminal network, which causes the form of the frequency characteristic of cascade/stage, with amplifier instrument and the subsequent cell/elements of the circuit of cascade/stage;

n - the number of amplifier stages;

β - the transmission factor of feedback loop.

On the basis of the presented formula it is not difficult to indicate the possible methods of obtaining logarithmic amplitude characteristic in amplifier. 1) a change in the value of the resistor/resistance of load circuit; 2) a change in the conductivity of the direct drive of amplifier instrument; 3) a change in the amount of feedback.

All variable parameters (resistor/resistance of load circuit, the conductivity of direct drive, the depth of negative feedback)

indicated must change their value under the effect of control signal.

Page 7.

As the latter can be used or direct/constant voltage (or the current) whose level is proportional to the amplitude of the amplified signal, or signal itself. The first of the mentioned versions of control signal can be obtained by introduction into the amplifier of circuit, analogous to circuit AGC. The second version (use as the control pressure of the most amplified signal) is specific for the contemporary logarithmic amplifiers, which have considerable operating speed.

Is given below the short characteristic of the used methods of logarithmic operation.

The simplest method of the realization of logarithmic amplifiers is the inclusion of nonlinear cell/elements in the circuit of their inputs or in the load circuit of amplifier instruments - tubes and transistors. The value of the resistor/resistance of these cell/elements changes depending on of input signal level, causing thereby the appropriate change in the value of the resulting load impedance and factor of amplification (or the coefficient of the division of output signal).

Also are comparatively simple in realization the logarithmic amplifiers, made with the introduction of nonlinear cell/elements into the circuit of the negative feedback, which encompasses entire amplifier or part of it cascade/stages. In this amplifier a change of input signal level leads to a change in the depth of negative feedback and, consequently, also amplification factor.

It is necessary to note that in logarithmic amplifiers of the type in question the nonlinear cell/element is in fact the unique specific part, which differs logarithmic amplifier from the linear. Therefore the selection of the type of nonlinear cell/element and the determination of its operational conditions are the fundamental questions with analysis and the practical implementation of this type logarithmic amplifiers. Serious value during the construction of multistage logarithmic amplifiers has also a question of the coupling of several sections of the resulting amplitude characteristic, caused by operation of those corresponding logarithmizing stages. In essence this - the task of achievement of the required accuracy of the logarithmic amplitude characteristic.

Furthermore, by the important question, which are of definite interest for the developers of radio-electronics equipment, is the account of the specific features of amplifier instruments (are in form transistors) s I nonflow the provisions for the maximum effectiveness of the action of nonlinear cell/elements. There is large interest also in the analysis of the special feature/peculiarities of the construction-engineering execution of the logarithmic amplifiers, made with the use of nonlinear cell/elements in those or other parts of the circuit.

The third of the mentioned methods of logarithmic operation, that is comprised in a change in the conductivity of the direct drive of the amplifier instrument under the effect of the amplified signal, is feasible only when through the amplifier pass the signals of considerable amplitude. Amplifier instrument no longer can in this case be considered as active linear four-pole, since changes of the amplified signal level are such, that in work is used virtually for all its extent/elongation the volt-ampere characteristic of instrument - substantially nonlinear curve. This as the final result leads to the fact that the transmission factor of active electrical network depends as it is obvious, from signal level. The required form of the amplitude characteristic of amplifier can be reached by the selection of the position of operating point on the static volt-ampere characteristic of amplifier instrument.

Besides above methods indicated, logarithmic amplitude characteristic can be obtained by the construction of the logarithmizing device in the form of the multichannel system of several parallel-connected linear amplifiers, the factors of amplification of which are located in multiple relationship/ratios, with limiters. The output voltages of amplifiers store/add up then in adder. This method is known by the name of "consecutive" or "continuous" detection.

1. Methods of the construction of the logarithmizing circuits.

Thus, the easiest method of the construction of logarithmic amplifiers is the introduction into the composition of the interstage networks of the nonlinear cell/elements, which possess the completely determined form of volt-ampere characteristic.

Page 9.

However, there are no special semiconductor devices, which possess the volt-ampere characteristic whose form would be described

by the required mathematical dependence (in this case logarithmic), at present.

The accuracy of the real amplitude characteristics of the logarithmic amplifiers, made in the principle of the shunting of load by nonlinear cell/elements, is small and it comprises not more than 15-20%. This is explained by the facts that the radio engineering industry does not release the special logarithmizing cell/elements with the guaranteed form of volt-ampere characteristic and for developers is necessary to be adapted to the available types of the nonlinear instruments, which are applied during the solution of the different problems of nonlinear radio engineering (modulation, detection, etc.).

As the cell/elements, which possess nonlinear volt-ampere characteristic and which ensure obtaining the logarithmic dependence $U_{\text{out}} = \psi(U_{\text{in}})$, in contemporary amplifiers are utilized the semiconductor diodes, transistors, and also electron tubes. Nonlinear circuit with logarithmic characteristic can be realized also with the aid of the carborundum resistor/resistances, the ferromagnetic and ferroelectric cells, and also some other instruments.

The simplest circuit with logarithmic amplitude characteristic is depicted on Fig. 1a, the circuit, which is the semiconductor

diode.

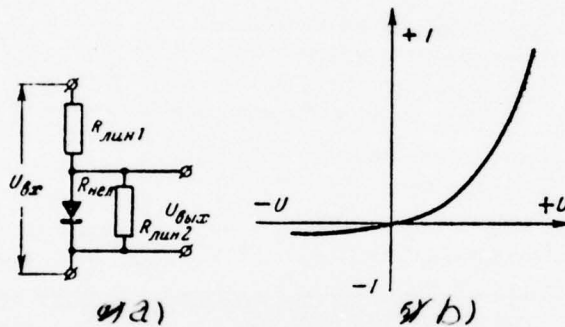

Fig. 1. Asymmetric logarithmizing circuit.

a) circuit; b) volt-ampere characteristic. Page 10.

Page 10.

It is known that the static volt-amperes characteristic of the majority of semi conductor junctions diode (in forward direction) in their significant part are subordinated to logarithmic (more precise, close to it) dependence. In this region of characteristic the current through the diode (planar p-n junction) is described by the expression

$$I = I_0 \left(e^{\frac{qU}{nkT}} - 1 \right), \quad (1)$$

where I_0 - the computed value of saturation current; $\hbar q = 1.6 \cdot 10^{-19}$ k - electron charge; U - voltage on p-n junction; $k = 1.38 \cdot 10^{-23}$ J/deg are Boltzmann constant; T - absolute temperature; n - constant, that considers effect on the current of different physical phenomena; value n ranges from 1 to 3, which is determined by structure and the material of junction. It is shown, for example, that if the germanium diodes are characterized by value $n = 1$, then for the majority of silicon diodes $n = 1-3$.

For that region of volt-ampere characteristic, where is satisfied the condition

$$e^{\frac{qU}{nkT}} \gg 1,$$

equation (1) it can be recorded in the form

$$\ln \frac{I}{I_0} = \frac{qU}{nkT}, \quad (2)$$

i.e. the voltage on diode proportional to the logarithm through it of the current taking place. Approximately analogous properties possess vacuum-tube diodes.

All forms of the semiconductor and vacuum-tube diodes, utilized as the logarithmizing cell/elements, are related to the type of

asymmetric nonlinear cell/elements. To this type of nonlinear cell/element is characteristic that that the branches of its volt-ampere characteristic (for positive and negative voltages), depicted on Fig. 1b, sharply differ one from another from.

Page 11.

The inclusion of linear resistors into the logarithmizing circuit in the manner that it is shown in Fig. 1a, makes it possible to raise the degree of coincidence of the real amplitude characteristic of nonlinear circuit with ideal logarithmic curve. This method is very common in engineering practice. This type of the logarithmizing circuit can be used when the design/projected circuit is intended for the amplification of the signals only of one polarity. Nonlinear cell/element is made in this case in the form of one diode (but sometimes also several, connected in parallel), connected such that the output potential of device it changed for the input signals of the datum of polarity on logarithmic law. Introduction into the logarithmic circuit of several in parallel connected diodes (instead of one) is caused by the tendency not only to obtain volt-ampere characteristic, with larger degree of accuracy coinciding with ideal logarithmic curve, but also to raise the reliability of nonlinear cell/element and, consequently, also the reliability of amplifier circuit. In this case occurs the redundancy of nonlinear cell/element

and during the malfunction of one of the diodes the nonlinearity of load diagram is retained.

But if appears the need for carrying out a nonlinear compression of bipolar signals (for example, sine voltage or the voltage, which is the combination of positive and negative pulse premise/impulses), then the conductivity of nonlinear cell/element it must be identical for the signals of each polarity, i.e., nonlinear cell/element must be symmetrical and the form of the branches of its volt-ampere characteristic must be identical both for positive and for negative voltages.

As the symmetrical logarithmizing cell/elements is possible the application/use of asymmetric nonlinear cell/elements, i.e., semiconductor or vacuum-tube diodes, when they are included by vapors - in antiparallel connection, as shown in Fig. 2a. A volt-ampere characteristic of the simplest type of symmetrical nonlinear cell/element is depicted on Fig. 2c. The linear resistors (R_{min1} and R_{min2}), connected in series with nonlinear cell/element (Fig. 2b), make it possible to achieve the higher degree of the coincidence of the amplitude characteristic of nonlinear four-pole with ideal logarithmic curve within the wider limits of a change in the level of input effect.

Page 12.

It is interesting to note that the role of the linear resistors, included consecutively with nonlinear cell/elements (R_{nonl}), is not limited only to adjustment of the form of real amplitude characteristic. Simultaneously with this is achieved certain increase in the amplitude of output voltage, which is especially important for logarithmic amplifiers of the type in question. Thus, the linear resistors, entering the composition of the logarithmizing circuit, can be considered as cell/elements of the correction of logarithmic amplitude characteristic. Consequently, similar to other cell/elements of the same assignment of the value of the resistor/resistances of linear resistors they are selected empirically in the alignment procedure and tuning of logarithmic amplifiers. Will be given below some practical recommendations (based on theoretical analysis) by choice of the values of the resistor/resistance of the linear resistors of the logarithmizing circuits.

The action of asymmetric and symmetrical nonlinear cell/elements

on sinewave voltage is shown in Fig. 3 and 4. From the given Fig. 3 and 4 diagrams shows that the application/use of a symmetrical nonlinear resistor turns out to be more favorable on the level of the nonlinear distortions of the amplified in logarithmic signal amplifier. In this case from the spectrum of the signal, which subjected to nonlinear compression, are removed (on the strength of the symmetry of the circuit of the logarithmizing circuit) even harmonics.

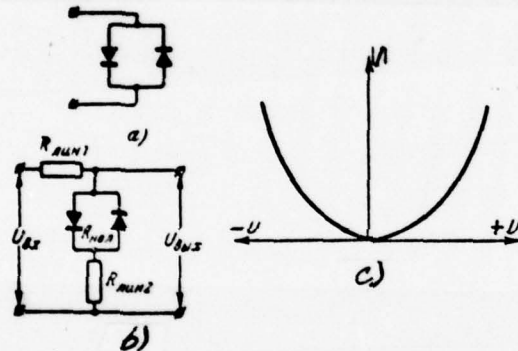

Fig. 2. Symmetrical logarithmizing circuit. a, b) circuit; c) volt-ampere characteristic.

Page 13.

It should be noted, however, that during parallel connection of two asymmetric nonlinear cell/elements as a result of the considerable scatter of their static characteristics it is sufficiently difficult to carry out a nonlinear cell/element with a sufficient degree of the symmetry of the branches of volt-ampere characteristic. In particular this is related to the semiconductor

diodes, which must be thoroughly selected before the setting into the logarithmizing node. In the case of applying semiconductor diodes the circuit can become complicated (for obtaining larger accuracy and extent of logarithmic curve) not only by the introduction of linear resistors, but also by the application of voltage of bias to diodes. In the most general case nonlinear circuit can be depicted in the form of the complex combination of linear resistors and nonlinear cell/elements (Fig. 5).

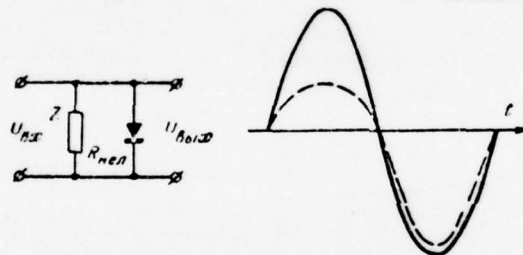

Fig. 3. Action of asymmetric nonlinear cell/element on sine voltage. — - voltage on the input of nonlinear circuit; - - - - is voltage on the input of nonlinear circuit.

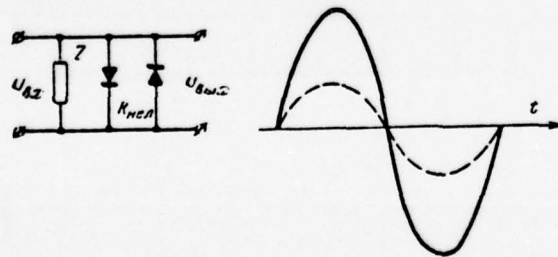

Fig. 4. Action of symmetrical nonlinear cell/element on sine voltage. - - - voltage on the input of nonlinear circuit; — - is an output

potential of nonlinear circuit.

Page 14.

For obtaining the maximum extent of the logarithmic section of amplitude characteristic and accuracy of its realization the best results it can give the application/use of the bridge logarithmic computing circuit (Fig. 6). However, this circuit is sufficiently complex in tuning and comparatively rarely is utilized in logarithmic amplifiers.

Amplitude characteristic with the logarithmic section of one extent or the other can be obtained also, by utilizing as nonlinear cell/elements different types of electron tubes and transistors (with by the corresponding shape the selected operating mode on direct current).

During the construction of logarithmic amplifier with the shunting of load by nonlinear cell/elements it is necessary to focus special attention on the connection point of nonlinear cell/elements in the interstage network of amplifier circuit.

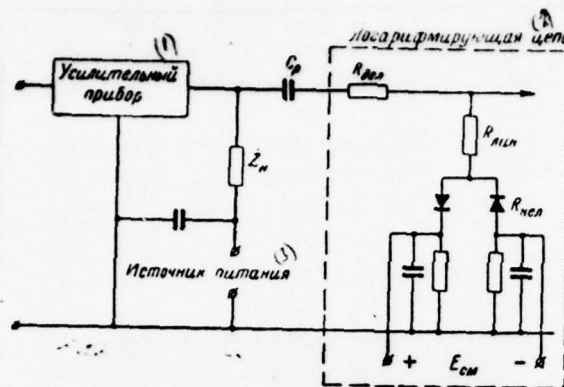

Fig. 5. Circuit of the complex logarithmizing circuit.

Key: (1). Amplifier instrument. (2). Logarithmizing circuit. (3). Power supply.

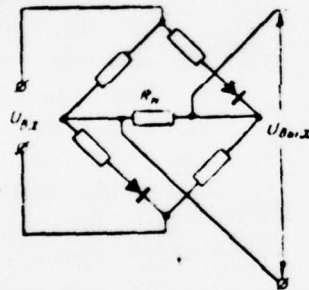

Fig. 6. Bridge logarithmizing circuit.

Page 15.

Actually, if we include/connect nonlinear cell/elements in the load circuit of amplifier instrument on direct current, then depending on of input signal level the value of the resistor/resistance of nonlinear cell/element and, consequently, also the resulting quantity of the resistor/resistance of load circuit on direct current are changed within more or less wide limits. In turn, this will lead to a change of the mode/conditions of work of amplifier instrument on direct current and as the final result - to an undesirable change in

the amplification factor.

So, at an increase in the amplitude of input signal the value of the resistor/resistance of nonlinear cell/element falls and increases the potential of that electrode of the amplifier instrument, where is included the resistor of load (in transistor amplifiers this usually collector/receptacle). With respect increases the conductivity of direct drive V_{21} transistor. As the final result increases the factor of amplification of cascade/stage, and this increment to the certain degree compensates for the decrease in the amplification factor, caused by the presence of nonlinear cell/element, i.e., decreases the dynamic range of amplifier in input signals.

All this determines the need for the inclusion of nonlinear cell/element little more than into load circuit according to alternating current, whereupon not only from the collector/receptacle of amplifier transistor, but also from the input electrode of the transistor of the subsequent cascade/stage (base or emitter). The latter is caused by the same reasons - by the wish to ensure the independence of the mode of work of transistor on direct current from changes in the amplification factor. Therefore the circuit of the logarithmizing cascade/stage must be made in accordance with the circuit, shown in Fig. 7.

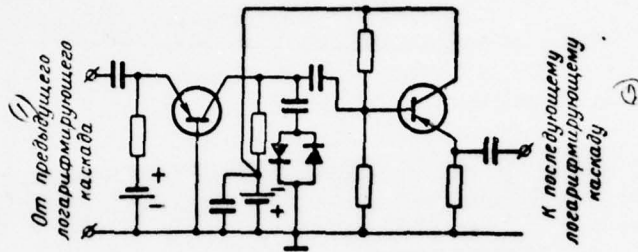

Fig. 7. Circuit of the logarithmizing cascade/stage.

Key: (1). From the preceding/previous logarithmizing cascade/stage.

(2). To the subsequent logarithmizing cascade/stage.

Page 16.

Before passing to the analysis of the concrete/specific/actual circuits of logarithmic amplifiers, it is necessary to find the mathematical expression, by which is described the dependence of the value of the resistor/resistance of nonlinear cell/element from changes of input signal level, which ensures ideal logarithmic amplitude characteristic.

Assuming that the load of amplifier instrument on alternating current consists of parallel-connected linear resistor R_{Π} and nonlinear cell/element $R_{\text{нел}}$, we determine output potential of the logarithmizing cascade/stage for any values of the amplitude of the input voltage:

$$U_{\text{вых}} = U_{\text{вх}} Y_{21} R_{\text{нел}} / (R_{\Pi} + R_{\text{нел}}) = U_{\text{вх}} Y_{21} \frac{R_{\Pi} R_{\text{нел}}}{R_{\Pi} + R_{\text{нел}}}. \quad (3)$$

At the same time the output potential of the cascade/stage, which works on the logarithmic section of its amplitude characteristic, i.e., with $U_{\text{вх}} \geq U_{\text{вх.л}}$, is described by the equation

$$U_{\text{вых}} = U_{\text{вх.л}} K_0 \left(\ln \frac{U_{\text{вх}}}{U_{\text{вх.л}}} + 1 \right), \quad (4)$$

where $U_{\text{вх.л}}$ - the input voltage, with which begins the logarithmic amplitude characteristic of amplifier;

K_0 - the factor of amplification of cascade/stage in linear conditions.

Equalizing expressions (3) and (4) and designating

$$\ln \frac{U_{\text{вх}}}{U_{\text{вх.л}}} + 1 = x \text{ и } e^{x-1} = \frac{U_{\text{вх}}}{U_{\text{вх.л}}},$$

it is possible to find that mathematical dependence, according to

which must change the value of the resistor/resistance of nonlinear cell/element during a change in the amplitude of the input signal:

$$R_{\text{нел}} = \frac{U_{\text{вх.н}} R_{\text{н}} x}{U_{\text{вх}} - x U_{\text{вх.н}}} = \frac{R_{\text{н}}}{\frac{U_{\text{вх}}}{x U_{\text{вх.н}}} - 1} = \frac{R_{\text{н}}}{\frac{1}{x} e^{x-1} - 1} \quad (5)$$

In order that the amplitude characteristic of amplifier stage would be within some limits ideal logarithmic curve, the resistor/resistance of the nonlinear cell/element, connected in the load circuit of amplifier instrument, must change its value under the action of the applied signal according to the dependence, given by equation (5). This dependence is depicted on Fig. 8.
Page 17.

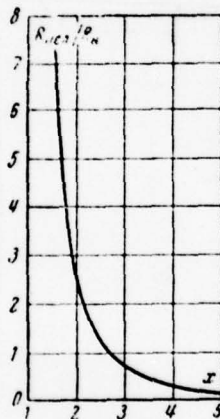

Fig. 8. Dependence of the standardized/normalized resistor/resistance of the ideal logarithmizing cell/element on changes in the relative amplitude of input signal.

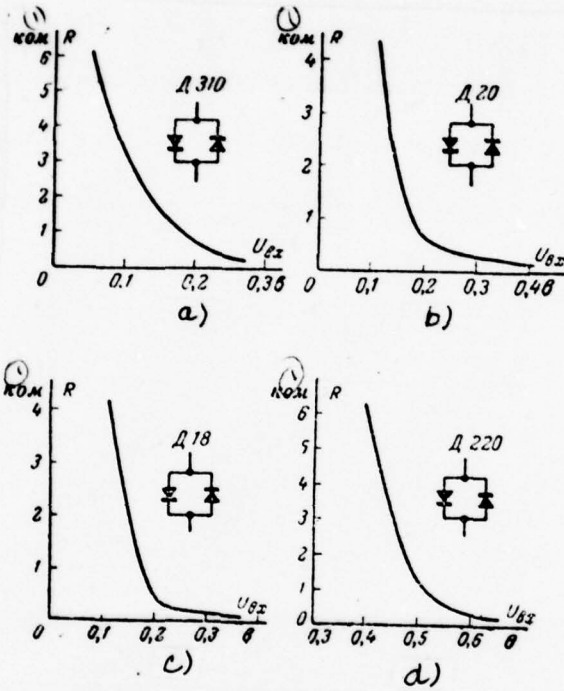

Fig. 9. Dependence of the resistor/resistance of some real types of diodes on voltage.

Key: (1) $k\Omega$.

Page 18.

However as has already been indicated above, not one of the existing semiconductor devices, utilized for purposes of logarithmic operation, do not possess this characteristic. The characteristics of real nonlinear instruments only approach the required curve in more or less wide range of stress. This forces to complicate the schematic of the logarithmizing devices by the introduction of linear resistors and by the supply of constant bias voltages to nonlinear cell/elements.

Because of the absence of the nonlinear resistors, which possess the guaranteed by plant form of dependence $R_{\text{нел}} = \varphi(U_{\text{нел}})$, with the practical implementation of the logarithmic amplifiers, constructed according to the principle of the shunting of load circuits as nonlinear cell/elements, it is necessary to have the experimental taken curves of the dependence indicated for the different types of semiconductor diodes. Some of such empirically obtained dependences are shown in Fig. 9.

2. Frequency properties of nonlinear cell/elements.

The questions, examined in this section, can be used during development and design of the broad class of the logarithmic amplifiers, made by the introduction of nonlinear cell/elements either into load circuit or into the circuit of negative feedback.

And in that and in other the versions of the circuit of logarithmic amplifier with nonlinear resistors, the frequency properties of the latter one should consider at the design of the device, which possesses some assigned parameters, in particular if the develop/processed device is intended for work in the range of comparatively high frequencies.

The effectiveness of the nonlinear cell/elements of amplifier circuit, such as semiconductor diodes or junction emitter - the base of transistors, descends in high-frequency operation. This is developed in the fact that during just one change in the amplitude of input signal the absolute limits of a change in the value of the resistor/resistance of nonlinear cell/element decrease, therefore, and the dynamic range of amplifier at input signals it is shortened the more considerable, the higher the frequency of the amplified signal.

Page 19.

This is explained by the physical special feature/peculiarities of p-n junctions. As is known, p-n junction with a sufficient degree of accuracy can be represented by **simple equivalent circuit** - parallel connection of active resistor ($R_{\text{нел}}$) **and of capacitor** ($C_{\text{нел}}$).

Then the input admittance of p-n junction, determined by the ratio of the amplitude of the fundamental harmonic of high-frequency current to the amplitude of the stress, which operates at the input

$$Y_{\text{вх}} = \frac{I_{\text{м1}}}{U_{\text{м вх}}} = \frac{1}{R_{\text{нел}}} + j\omega C_{\text{нел}}. \quad (6)$$

The module/modulus of the value of the resistor/resistance of nonlinear cell/element is determined as follows:

$$|Z_{\text{нел}}| = \frac{1}{\sqrt{(1/R_{\text{нел}})^2 + (\omega C_{\text{нел}})^2}}. \quad (7)$$

The capacitance/capacity $C_{\text{нел}}$ is determined by the capacitance/capacity of the barrier layer of diode. It is obvious that at high frequencies the capacitance of transition decreases, that also causes the limit inferiors of a change in the modulus of resistance of nonlinear cell/element. During the study of the character of a change in the input and output resistance is necessary

to accept into consideration considerably more factors. For example, by utilizing Π -shaped replacement scheme (common-emitter connection), it is possible to obtain [7] the following expressions: for the input admittance

$$Y_{11} = \frac{r_0 + r + (\omega\tau)^2 r_0}{(r_0 + r)^2 + (\omega\tau r_0)^2} + j \left[\frac{\omega\tau r}{(r_0 + r)^2 + (\omega\tau r_0)^2} + \omega C_{00} + \omega C_{0K} \right], \quad (8)$$

where $\tau = rC_D$, and for the output conductance

$$Y_{22} = \frac{C_K}{C_D} \frac{(f/f_0)^2}{1 + (f/f_0)^2} S_K + j \left[\frac{C_K}{C_D} \frac{f/f_0}{1 + (f/f_0)^2} S_K + \omega C_K + \omega C_{0K} \right]. \quad (9)$$

Here r_0 is the distributed resistance of base;

r - the resistor/resistance, which considers the recombination of minority carriers in base;

C_D is a diffusion capacitance/capacity;

C_K, r_K - the capacitance/capacity and the resistor/resistance of collector junction;

C_{6n}, C_{6e} - the capacitance/capacity of housing (base) to collector/receptacle and emitter;

S_n is slope/transconductance of transient characteristic; f_s - cut-off frequency on slope/transconductance;

ω is angular frequency.

Page 20.

The designed in accordance with expressions (8) and (9) values Y_{11} and Y_{22} sufficiently closely coincide with experimentally measured over a wide range of frequencies. However, this calculation is sufficiently bulky and for practical use unsuitable. From this viewpoint more useful would be the curve/graphs, representing the dependence of the parameters of the different types of the utilized in equipment transistors on the operating mode on direct current and on frequency.

The dependences of the value of the real and imaginary components of the entry impedance of the transistor (resistor/resistances of the junction of transistor), utilized as the

nonlinear cell/element of amplifier circuit, from frequency are given in Fig. 10. As is evident, these dependences (in particular for a real component) bear considerably more complex character, rather than for diodes.

In order to determine the frequency band, in which sufficiently effectively works as the nonlinear controlled resistor the collector junction of transistor, it is possible to utilize results of the study of the generalized theoretical model of transistor.

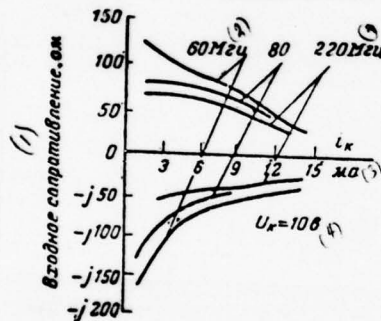

Fig. 10. Dependences of the real and imaginary components of the entry impedance of transistor on the current of collector/receptacle and frequency.

Key: (1). Entry impedance ohm. (2). MHz. (3). mA. (4). V.

Page 21.

The output conductance of the generalized theoretical model of transistor (during short circuit in input circuit) is determined by the expression

$$Y_{22} = g_{22}(1 + j0,81 \varepsilon), \quad (10)$$

where g_{22} - the value of output conductance at low frequency;

$\varepsilon = \omega/\omega_a$ - the standardized/normalized frequency;

ω_a - the limiting frequency, at which the module/modulus of current amplification factor α decreases to 0.7 maximum values α to low frequency.

To frequencies of the order ω_a the output conductance can be represented in the form of parallel connection of capacitance/capacity and the conductance whose values change within sufficiently wide limits during insignificant changes in the voltage on collector/receptacle, namely:

$$\left. \begin{aligned} g_{22} &= g_0 e^{\alpha U_{N0}}; \\ C_{22} &= \frac{0,81}{\omega_a} g_0, \end{aligned} \right\} \quad (11)$$

where g_0 is the maximum value of output conductance at zero frequency;

U_{N0} - the initial voltage on collector/receptacle.

At more high frequencies it is necessary to consider the effect of charge collector transition capacitance (C_0), connected in parallel to output conductance, as a result of which the value of the latter and the course of its dependence on control voltage substantially change.

Then after the simple conversions

$$Y'_{22} = Y_{22} + j\omega C_0 = Y_{22}\Delta C, \quad (12)$$

where $\Delta C = (1 + j\omega C_0/Y_{22})$ - an increment in the capacitance/capacity, equal at $\omega \leq \omega_c$

$$\Delta C = \sqrt{1 + \frac{(\omega C_0/g_0 + 1,62e^{2U_{10}}) \omega C_0}{e^{2aU_{10}}(1 + 0,66e^2) g_0}} e^{j\varphi_C}; \quad (13)$$

with $\omega \geq \omega_c$

$$\Delta C = \sqrt{1 + \frac{(\omega C_0/g_0 + 2,2V e^{aU_{10}}) \omega C_0}{2,43e^{2aU_{10}} g_0}} e^{j\varphi_C}. \quad (14)$$

The constructed in accordance with expressions (13) and (14) dependence $\Delta C = \psi(\varepsilon)$ for data, that correspond to low-frequency transistor ($C_0 = 100$ pF; $g_0 = 2 \cdot 10^{-4}$ 1/ohm; $f_c = 1$ MHz), is given in Fig. 11. As it follows from the constructed curve/graph, the use of an output conductance of transistor as nonlinear cell/element at frequencies, which exceed (3-4) ω_c , becomes unsuitable.

Page 22.

Furthermore, some types of transistors (for example, the high-frequency drift transistors of the type P401-P403 and others, to them similar) are characterized by the facts that in work in the range of high frequencies - on the order of 60-100 MHz the active component of their input admittance decreases with an increase of the current of emitter, instead of increasing. The reactive component of input admittance at high frequencies changes its sign.

This character of a change in the input admittance of the transistor is caused by the effect of the parasitic resistance of the derivations of transistor, which have composite character. Specifically, serious effect on the depth of self-feedback and, consequently, also on the character of a change in the input capacitance of transistor exerts capacitance/capacity between emitter and collector derivations ($C_{c.o}$), and also wiring capacitance (C_{wout}). Capacitance/capacity $C_{c.o}$ usually has value 1 pF, a C_{wout} - the order of several picofarads, which is determined by the design features of node. The effect of these capacitance/capacities can be not considered in the amplifiers, made on the low-frequency alloy-junction transistors, the time constant of collector circuit of

which is sufficiently great. However, during the use of high-frequency transistors with the fast time constant of collector circuit, order of ones and dozen nanoseconds, neglect of capacitance/capacities C_{in} and C_{out} inadmissibly one should take these or other measures to the elimination of their effect on the parameters of amplifiers.

However, the capacitance/capacities indicated affect the characteristics of nonlinear resistors only on high frequencies (100 MHz and above).

Consequently, the frequency limitations of nonlinear resistors - p-n junctions are developed mainly in a decrease in the limits of a change of the resistor/resistance of nonlinear cell/element, i.e., value $d_p = R_{\text{max}}/R_{\text{min}}$. This in turn, leads to a decrease in the value of the dynamic range of amplifier in input signals.

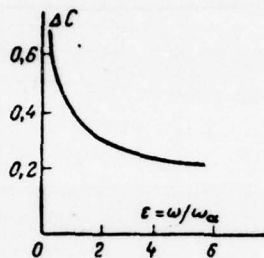

Fig. 11. Dependence of the parameter ΔC on the standardized/normalized frequency.

Page 23.

3. Common/general/total principles of the analytical study of logarithmic amplifiers.

The fundamental index, which makes it possible to qualitatively rate/estimate the effectiveness of work of logarithmic amplifier, is the value of dynamic range at input signals, determined mainly by the

extent of the logarithmic section of amplitude characteristic, i.e., by the parameters of load circuit and by the type of the used nonlinear cell/element. In connection with this it is necessary to derive the analytical expression, which would connect the fundamental indices of logarithmic amplifier with the parameters of load circuit and thereby would give possibility to find the value of dynamic range from the input signals of any concrete/specific/actual amplifier circuit. In this case must be accepted two simplifying the analysis of condition.

The first of these conditions lies in the fact that during derivation they are limited only to the determination of the value of dynamic range from input signals for a single amplifier stage.

The second condition is related to the method of the estimate/evaluation of the range of logarithmic operation, i.e., the limits of a change in the value of the resistor/resistance of nonlinear cell/element. It is known that the dependence of the resistor/resistance of the majority of contemporary semiconductor diodes on the applied voltage sufficiently closely coincides within those or other limits with the ideal exponential curve, described by equation (5). Therefore for the calculation it proves to be sufficient to know only the limits of a change of the value of the resistor/resistance of nonlinear cell/element in the range of the

section of characteristic $R_{\text{нел}} = \varphi(U)$, close in form to exponential, i.e., the value of the resistor/resistance $R_{\text{нел. макс}}$, which corresponds to the beginning of exponential section, and the value of the resistor/resistance $R_{\text{нел. мин}}$, which corresponds to the end/lead of the exponential section. Values $R_{\text{нел. макс}}$ and $R_{\text{нел. мин}}$, necessary for the calculation of concrete/specific/actual circuits, can be most simply determined in the points of intersection of objective parameter $R_{\text{нел}} = \varphi(U)$ and the approximating curve $R_{\text{нел}} = R_0 e^{-aU}$. The unknown values $R_{\text{нел}}$ for the real nonlinear cell/elements, utilized during the construction of the logarithmizing circuits, can be found on the given above experimental curve of dependence $R_{\text{нел}} = \varphi(U_{\text{нел}})$. The aforesaid is illustrated by Fig. 12.

Page 24.

Since by voltage U , applied to nonlinear cell/element and which determine the value of its resistor/resistance, is understood the intensive voltage of signal, removed from the resulting load impedance of amplifier instrument $Z_{\text{н. экв}}$,

$$\text{and } \left. \begin{aligned} U_1 &= U_{1\text{н}1} Y_{21} Z_{\text{н. экв}} \\ U_2 &= U_{2\text{н}2} Y_{21} Z_{\text{н. экв}} \end{aligned} \right\} \quad (15)$$

where U_{BX1} and U_{BX2} are the amplitudes of the voltage of input signal, which correspond to beginning and the end/lead of the logarithmic section of the amplitude characteristic of cascade/stage;

Y_{21} - the conductivity of the direct drive of amplifier instrument;

$Z_{H.BK2} = 1/(1/Z_H + 1/Z_{1.BK} + 1/Z_{BK})$ - the resulting constant value resistor/resistance of load circuit.

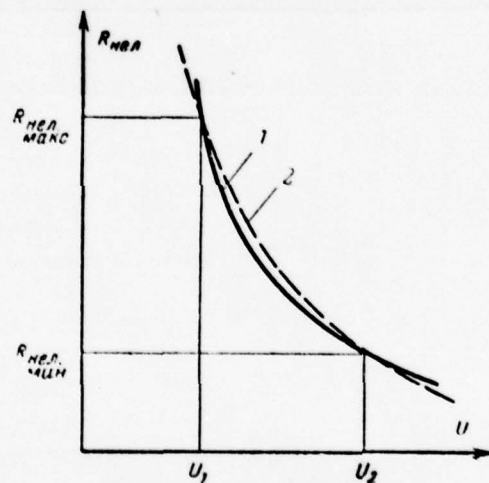

Fig. 12. Dependence of the resistor/resistance of the logarithmizing cell/element on of input signal level. 1 - experimental curve; 2 - ideal curve.

Page 25.

The conductivity of the direct drive of any amplifier instrument is complex quantity and in general form is determined as follows:

$$Y_{21} = G_{21} + jB_{21}, \quad (16)$$

where $G_{21} = S_y$ is equivalent slope/transconductance of the transient characteristic of instrument, i.e., dependence curve of the current, which takes place in the circuit of output electrode, from voltage on input or control electrode;

B_{21} is imaginary component of the composite conductivity of the direct drive of amplifier instrument, which has usually capacitive character, i.e., $B_{21} = j\omega C$.

It is not difficult to see that at comparatively low frequencies of component $j\omega C$ is small in comparison with S_y and it can be disregarded, in connection with this $Y_{21} \approx S_y$. Then for the initial and finite segments of logarithmic amplitude characteristic it is possible respectively to write:

$$R_{\text{нел. макс}} = \varphi_1(U_{\text{вх1}} S_y Z_{\text{н. экв}})$$

and

$$R_{\text{нел. мин}} = \varphi_2(U_{\text{вх2}} S_y Z_{\text{н. экв}}).$$

For convenience in the calculations of value $R_{\text{нел. макс}}$ and $R_{\text{нел. мин}}$ one

should determine in unity $Z_{н.э.кв.}$, namely:

$$\left. \begin{aligned} R_{нел. макс} &= b_1 Z_{н.э.кв.} \\ R_{нел. мин} &= b_2 Z_{н.э.кв.} \end{aligned} \right\} \quad (17)$$

Furthermore, for determining the dynamic range of amplifier stage from input signals it is necessary to utilize value

$$d_R = R_{нел. макс} / R_{нел. мин} = b_1 / b_2, \quad (18)$$

characterizing the limits of a change of the resistor/resistance of nonlinear cell/element in the range of the exponential section of static characteristic, and it is also necessary to know the permissible limits of a change in the output voltage of cascade/stage^{U_{ВЫХ.Н}} and $U_{ВЫХ.Л}$, which correspond to beginning and the end/lead of the logarithmic section of amplitude characteristic. The relation of these voltages determines the value of the dynamic range of cascade/stage according to the output signals

$$d_{ВЫХ} = U_{ВЫХ.Л} / U_{ВЫХ.Н}. \quad (19)$$

Now it is possible to pass to the derivation of the unknown expression for the simplest nonlinear cascade/stage, equivalent circuit of which is depicted on Fig. 13.

Page 26.

This circuit is real both for electron-tube and for transistor amplifier stages. Then in accordance with the theorem about equivalent generator can be determined isolating on nonlinear

cell/element stress, which is the output voltage of the cascade/stage:

$$U_{\text{ВЫХ}} = S_y U_{\text{ВХ}} \frac{Z_{\text{Н.ЭКВ}} R_{\text{Нел}}}{Z_{\text{Н.ЭКВ}} + R_{\text{Нел}}} \quad (20)$$

where

$$Z_{\text{Н.ЭКВ}} = 1 / (1/Z_{\text{ВВХ}} + 1/Z_{\text{Н}} + 1/Z_{\text{ВХ}}).$$

From expression (20) it follows that for determining the value of the dynamic range of amplifier stage from input signals ($d_{\text{ВХ}}$) it is necessary to know the type of nonlinear cell/elements - diodes, more precise the law of a change of the resistor/resistance of nonlinear cell/element depending on the applied to it voltage $R_{\text{Нел}} = \varphi(U)$, and the value of load impedance $Z_{\text{Н.ЭКВ}}$. After substituting into expression (20) of value $R_{\text{Нел.макс}}$ and $R_{\text{Нел.мин}}$, determined in accordance with (17), it is possible to find values $U_{\text{ВЫХ.Н}}$ and $U_{\text{ВЫХ.К}}$, the characteristic limits of a change in the amplitude of the output voltage:

$$\left. \begin{aligned} U_{\text{ВЫХ.Н}} &= S_y U_{\text{ВХ.Н}} \frac{Z_{\text{Н.ЭКВ}} b_1 Z_{\text{Н.ЭКВ}}}{Z_{\text{Н.ЭКВ}} + b_1 Z_{\text{Н.ЭКВ}}} = S_y U_{\text{ВХ.Н}} Z_{\text{Н.ЭКВ}} \frac{b_1}{1 + b_1}; \\ U_{\text{ВЫХ.К}} &= S_y U_{\text{ВХ.К}} \frac{Z_{\text{Н.ЭКВ}} b_2 Z_{\text{Н.ЭКВ}}}{Z_{\text{Н.ЭКВ}} + b_2 Z_{\text{Н.ЭКВ}}} = S_y U_{\text{ВХ.К}} Z_{\text{Н.ЭКВ}} \frac{b_2}{1 + b_2}. \end{aligned} \right\} \quad (21)$$

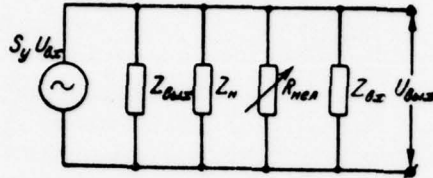

Fig. 13. Equivalent circuit of the simplest nonlinear cascade/stage.

Page 27.

Hence it is possible to find the value of the relation $U_{Bx,H}/U_{Bx,B}$, which determines the extent of the logarithmic section of the amplitude characteristic of cascade/stage, i.e., its dynamic range from input signals.

On the basis of the obtained above relationship/ratios can be written following expression for determining dynamic range from the input signals:

$$d_{\text{BXI}} = \frac{U_{\text{BXI}}}{U_{\text{BXI}}} = \frac{U_{\text{MAXI}} \frac{1}{S_Y Z_{\text{H.ЭН}}} \frac{1+b_2}{b_2}}{U_{\text{MAXI}} \frac{1}{S_Y Z_{\text{H.ЭН}}} \frac{1+b_1}{b_1}} = d_{\text{LXI}} \frac{b_1}{b_2} \frac{1+b_2}{1+b_1}. \quad (22)$$

Utilizing expression (18) and passing to logarithmic units, we obtain the expression, which can be used for the practical calculations:

$$d_{\text{BXI}} = 20 \lg \left[d_{\text{LXI}} d_R \frac{1 + \frac{1}{b_2}}{1 + \frac{1}{b_1}} \right], \text{ dB.} \quad (23)$$

Expression (23) makes it possible to connect the fundamental quantitative indices of amplifier stage (d_{BXI} and d_{MAXI}) with the parameters of load circuit, and, furthermore, it makes it possible to rate/estimate the effect of fixed resistors of load circuit on the effectiveness of the action of nonlinear cell/element. This is illustrated by Fig. 14-18, where are depicted the families of curve/graphs $d_{\text{BXI}} = \psi(1/b_2; d_R)$, constructed in accordance with (23) for different values d_{MAXI} . It is not difficult to see that the constructed curves make it possible to give the quantitative estimate/evaluation of a change in the value of the dynamic range of cascade/stage in input signals depending on the value of the resistor/resistance of the load circuit of amplifier cell/element $|Z_{\text{H.ЭН}}|$ and on the

properties of nonlinear cell/element (d_R).

By analyzing the constructed curve/graphs, it is possible to make the following conclusions:

1. The extent of the logarithmic section of amplitude characteristic, that determines the value of the dynamic range of cascade/stage according to output signals (d_{Bxi}), will be the greater, the more considerable the degree of a change in the resistor/resistance of nonlinear cell/element (i.e. the greater value d_R).

2. Value d_{Bxi} depends to a considerable extent on the constant value resistor/resistance of load circuit $Z_{H.9KB}$. Set/assuming for simplification $R_{\text{нел.эл}} = \text{const}$, we obtain, that with small values $Z_{H.9KB}$ (i.e. with $1/b \ll 1.0$, that corresponds to the case of amplifier with relatively wide passband) the dynamic range in input signals is small and in practice it does not depend on the parameters of nonlinear cell/element (there is in form the parameter d_R).

Page 28.

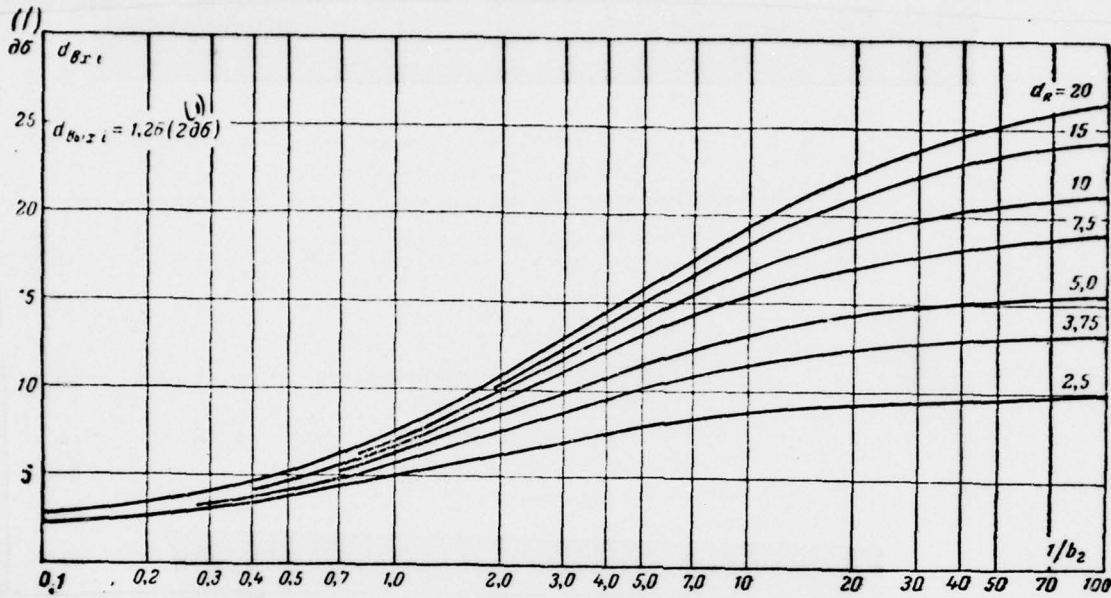

Fig. 14.

Key: (1) - dB.

Page 29.

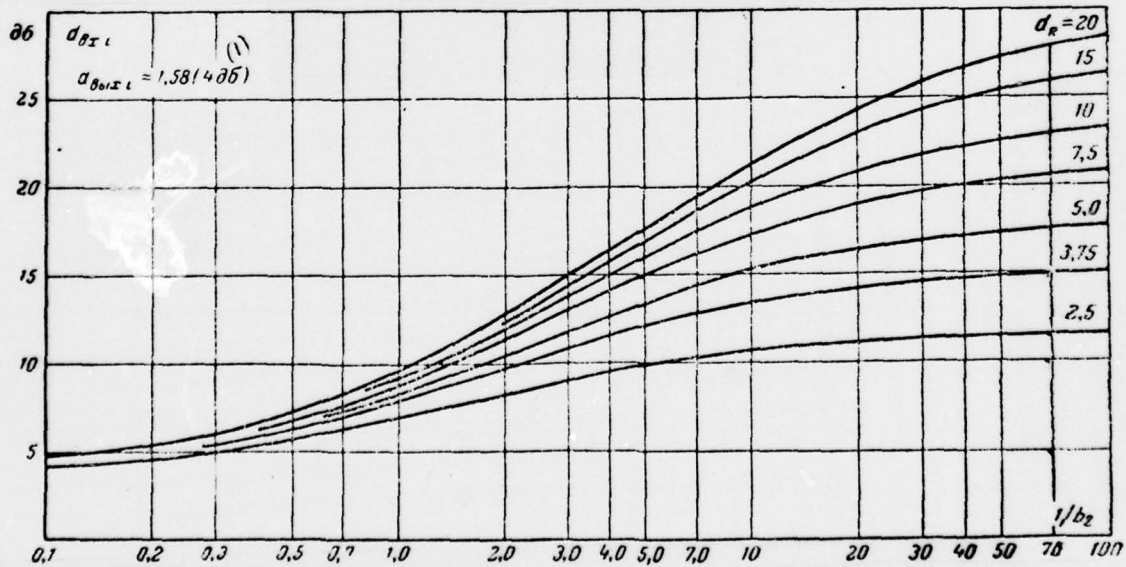

Fig. 15.

Key: (1) - dB.

Page 30.

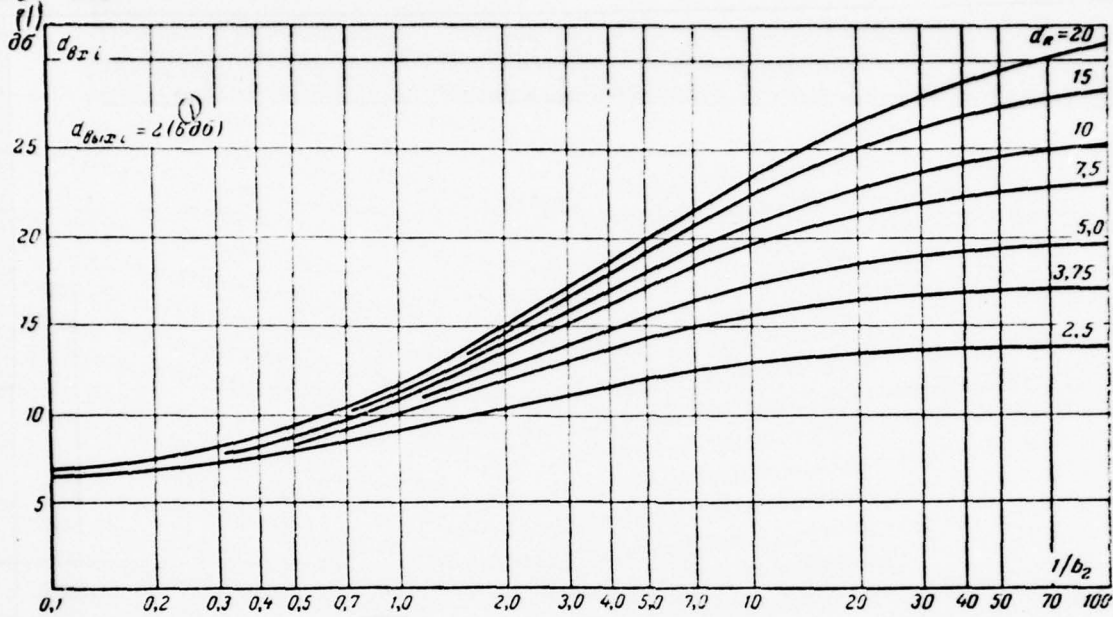

Fig. 16.

Key: (1) - dB.

Page 31.

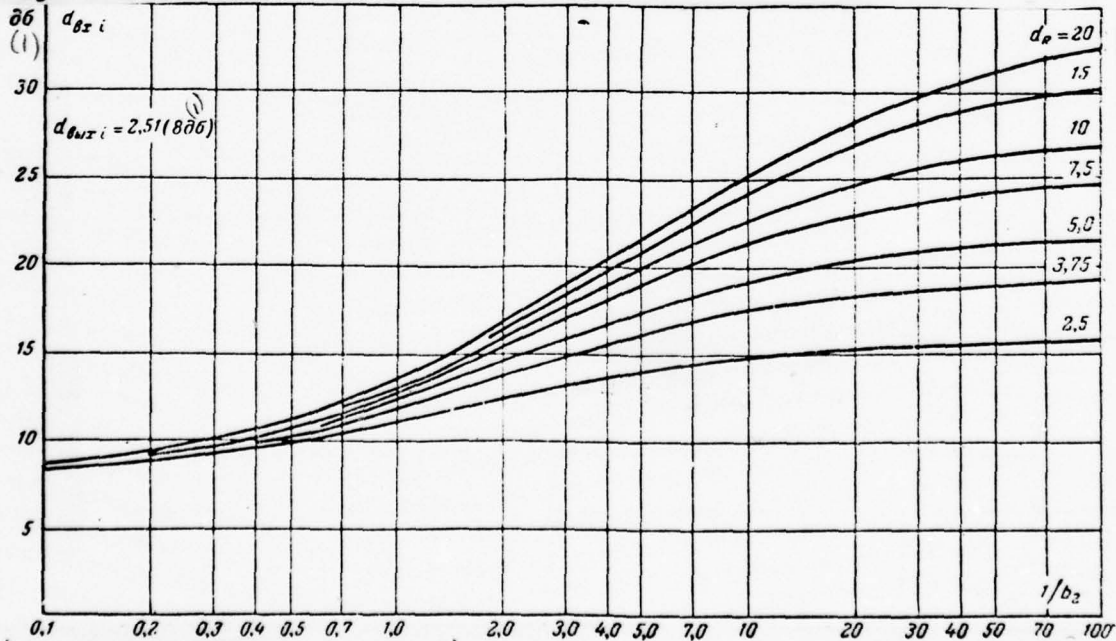

Fig. 17.

Key: (1) - dB.

Page 32.

This can be explained by the facts that the fixed resistor of load circuit, which has low value, strongly shunts nonlinear cell/element, lowering thereby its effectiveness. With the high values of resistor/resistance $Z_{H,3dB}$ (i.e. in narrow-band amplifier) the shunting of nonlinear cell/element insignificantly, thanks to which the dynamic range of amplifier at input signals substantially grow/rises and is determined exclusively by the properties of nonlinear cell/element, i.e., by the value of the parameter d_R . As can be seen from the presented curves, value d_{Bxi} narrow-band amplifier from value $Z_{H,3dB}$ in practice does not depend, and this is confirmed by the facts that beginning with $1/b_2 \gg 10-20$ curves $d_{Bxi} = \psi(1/b_2; d_R)$ go almost in parallel to the axis of abscissas.

The presented in Fig. 14-18 curve/graphs not only make it possible to examine in general form of the special feature/peculiarity of work of the logarithmizing cascade/stage, but also they make it possible to the certain degree to simplify

engineering scheme.

The obvious advantage of the proposed calculation method is that at its base lie/rest the curve/graphs (Fig. 14-18), constructed irrespectively of to the concrete/specific/actual type of amplifier cell/element (it can be tube or transistor), to the form of the circuit of interstage coupling circuit (aperiodic or oscillatory) and the type of the used nonlinear cell/element.

Engineering a logarithmic amplifier of the type in question can be carried out as follows:

1. We find the value of the resistor/resistance of load circuit $Z_{н.н.н.б.}$ we determine by usual methods the factor of amplification of cascade/stage and the width of its passband.

2. Is selected the type of nonlinear cell/element and is determined according to its characteristics of value $R_{нел.макс.}$, $R_{нел.мин.}$, d_R , and also value $\frac{1}{b_2} = \frac{Z_{н.н.н.б.}}{R_{нел.мин.}}$.

3. We are assigned by value $d_{в.н.х.и}$ (or we determine it from expression $D_{в.н.х.и} = n \ln K_0 + 1$ with $n=1$).

4. Through curve/graph, to the corresponding selected value $d_{в.н.х.и}$.

we find for the determined above values $1/b_2$ and d_R the value of dynamic range through input signals d_{BXi} one cascade/stage, and then also entire amplifier as a whole $D_{BX} = \sum_{i=1}^n d_{BXi}$ (here n - the number of logarithmizing cascade/stages).

Page 33.

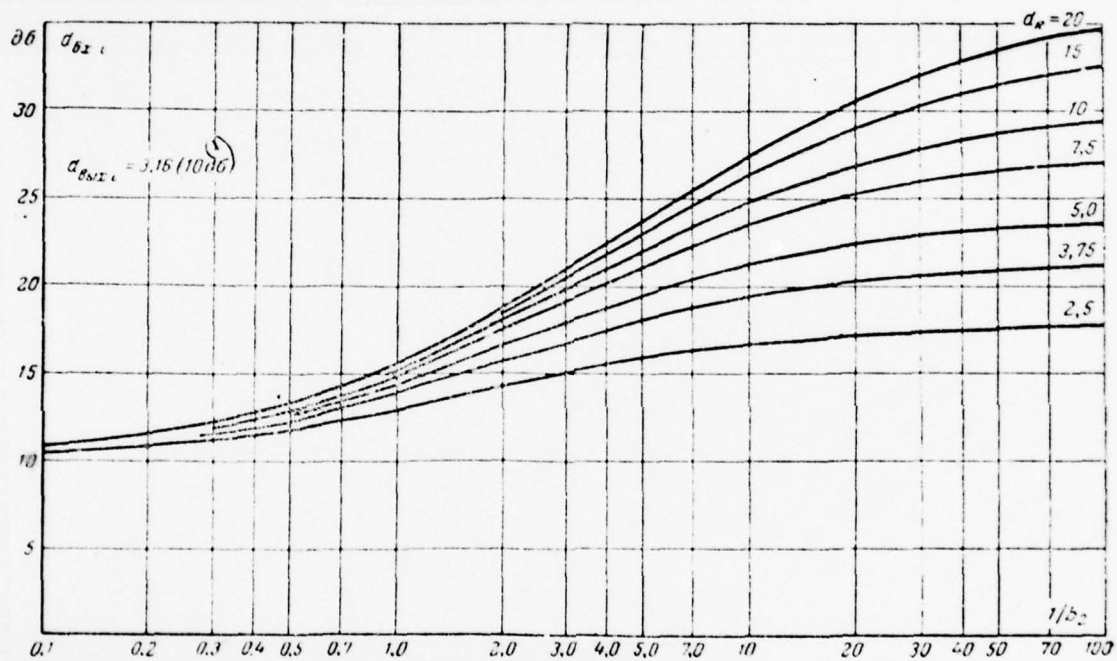

Fig. 18.

Key: (1). dB.

The proposed method of the analytical study of logarithmic amplifier with the shunting of load in terms of nonlinear cell/elements differs from the described in the appropriate literature methods first of all by its simplicity, which does not affect the accuracy of the calculation. In this case complex theoretical positions are led to simple formulas and the convenient in use curve/graphs, which make it possible to produce actually the synthesis of amplifier. It is necessary to note that the basic condition/positions of this calculation method are universal and can be used not only in logarithmic amplifiers of the type in question, but also in circuits with nonlinear feedback, or in other devices of those containing the nonlinear cell/elements whose resistor/resistance changes under the effect either of the amplified signal or signal AGC[APY].

In the subsequent sections conducted analytical investigation of the amplifier circuits, which contain the more complex types of the logarithmizing circuits, rather than the antiparallel connections of two semiconductor diodes.

Page 35.

4. Evaluation of the action of the resistor/resistance of linear resistor on the value of the dynamic range of cascade/stage at input signals.

For determining the degree of the effect of the resistor/resistance of the linear resistor, introduced into the logarithmizing circuit, on the value of the dynamic range of amplifier stage from input signals it is necessary first of all to write the appropriate analytical expression [derivation of this expression is analogous to the derivation of expression (23)]. In accordance with the presented in the preceding/previous section procedure of study it is assumed that the resistor/resistance of the logarithmizing circuit, which consists of series-connected nonlinear cell/element and linear resistor, varies from

$$R_1 = R_{\text{нел.макс}} + R_{\text{лин}}$$

to

$$R_2 = R_{\text{нел. нагрузки}} + R_{\text{линейн}}$$

(in the beginning and end/lead of the logarithmic section of amplitude characteristic respectively). Then, by utilizing a general method of the analysis of amplifier circuits with nonlinear load, it is possible to write expression for determining the dynamic range of amplifier stage from input signals.

It takes the form:

$$d_{\text{вхi}} = d_{\text{выхi}} \frac{(d_R + p/b_2) [(1+p)/b_2 + 1]}{(1+p/b_2) [(1+p)/b_2 + d_R]} \quad (24)$$

Here

$$p = R_{\text{линейн}}/R_{\text{н}}$$

Formula (24) can be rewritten in the form

$$\gamma = \frac{d_{\text{вхi}}}{d_{\text{выхi}}} = \frac{(d_R + p/b_2) [(1+p)/b_2 + 1]}{(1+p/b_2) [(1+p)/b_2 + d_R]} \quad (25)$$

where γ is the value, which determines the compression ratio of the dynamic range of signal of logarithmic cascade/stage.

From the given formulas it follows that with an increase of the resistor/resistance of linear resistor $R_{\text{линейн}}$ (or parameter p) the value of the dynamic range of amplifier stage in input signals decreases.

Physically this result is explained by the facts that the linear resistor, in any manner introduced into the logarithmizing circuit, in particular connected in series with nonlinear cell/element, attenuate/weakens the effect of the latter on the characteristics of schematic. In this case decreases the nonlinearity of amplitude characteristic and decreases the dynamic range of amplifier in input signals.

This can be illustrated by the design charts of the dependence of the contraction coefficient of the dynamic range of signal $\gamma = d_{\text{max}}/d_{\text{min}}$ of changes in the parameters of load circuit, namely: from value $1/b_2 = R_n/R_{\text{load}}$, $p = R_{\text{load}}/R_n$ and the type of nonlinear cell/element (i.e. the parameter d_n), constructed in accordance with expression (25) in Fig. 19.

Page 36.

Character the presented in Fig. 19 curves can be explained as follows. With the low values of the resistor/resistance of linear resistor R_{load} , i.e., at $p < 0.01$, the value of the dynamic range of amplifier in input signals (d_{max}), more precise than the contraction coefficient (γ), in practice does not depend on changes p and is determined exclusively by the relationship/ratio of values R_n - constant load impedance and R_{load} - the resistor/resistance of

nonlinear cell/element. But at the large values of p value γ is determined by two oppositely operating factors whose action with specific ratios between them is such, that the contraction coefficient, beginning with certain value of the parameter $1/b_2$, begins to decrease, that also it is possible to see on the presented curve/graphs. In connection with this during the design of real logarithmic amplifier it is very important to know such values $1/b_2$ and p , when value γ is close to maximum.

Figure 20 depicts the curves of the dependences of relation $1/b_2 = Z_{II}/R_{\text{неч. мин}}$ ^{with} $\gamma = d_{\text{вх. i}}/d_{\text{вх. i}} = \gamma_{\text{max}}$ ^{on} value p . Curves are constructed as follows. By equalizing the derivative $d\gamma/d(1/b_2)$ zero, from the obtained this equation

$$\frac{p(p+1)}{b_2^2} - d_R = 0 \quad (26)$$

it is possible to find the values $1/b_2$, which correspond to the maximum contraction coefficient γ at this value of p . The practical value of the presented in Fig. 19 curve/graphs lies in the fact that, by using them, it is possible to determine those parameters of the logarithmizing circuit, by which in each cascade/stage is provided the maximum value of dynamic range at input signals.

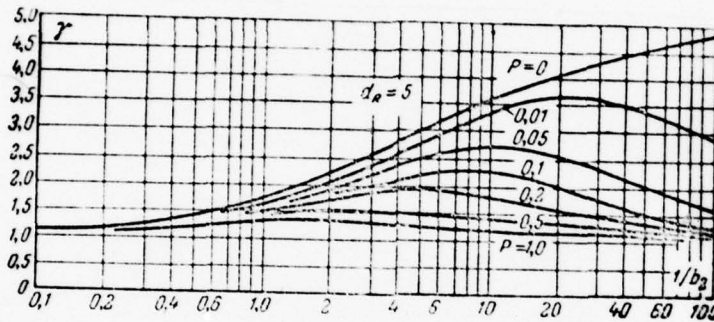

Fig. 19. Dependence of the contraction coefficient of dynamic range of the parameters of amplifier circuit.

Page 37.

Consequently, during the construction of multistage logarithmic amplifiers are open/disclosed the ways of the achievement of the required parameters at the minimum number of nonlinear cascade/stages. The obtained by calculation data are confirmed by the results of experimental check (Fig. 21). The experimental curves (amplitude characteristics of single-stage transistor logarithmic

video amplifier) sufficiently visually illustrate the action of linear resistor on the extent of the logarithmic section of the amplitude characteristic of amplifier, i.e., on the value of its dynamic range at input signals.

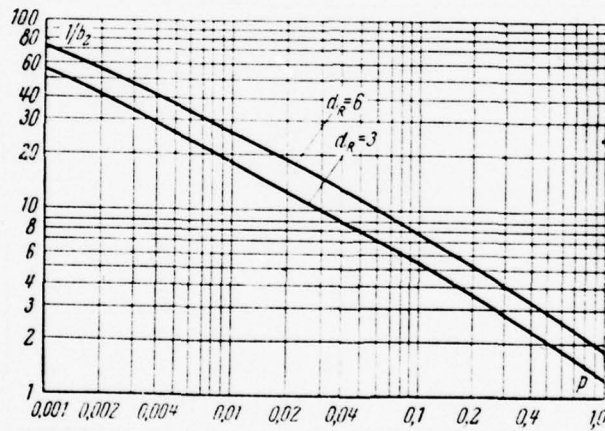

Fig. 20. Curve/graphs for determining the parameters of amplifier circuit.

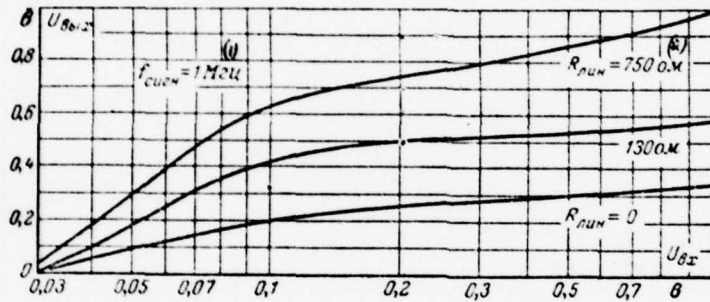

Fig. 21. Amplitude characteristics of nonlinear amplifier.

Key: (1) . MHz. (2) . ohm.

Page 38.

In conclusion it is necessary to note that to the dynamic range of amplifier at input signals exerts influence not only the extent of the logarithmic section of the volt-ampere characteristic of the nonlinear cell/element, which shunts load, but also the nonlinearity of amplifier instruments - transistors (see §11). Therefore it is possible to assert that the true value of the dynamic range of

amplifier stage from input signals is determined by the following expression:

$$d'_{nxi} = d_{nxi} + \Delta d, \quad (27)$$

where d_{nxi} is the dynamic range of cascade/stage at input signals, caused by the action of nonlinear cell/element;

Δd - the increment in the dynamic range at input signals, caused by the effect of the nonlinearity of the static characteristics of amplifier transistor.

By calculation to determine value Δd is sufficiently difficult in view of the complexity of analytical expressions. Experimental data show that an increase in the dynamic range in input signals because of the effect of the nonlinearity of transistors (Δd) reaches by 6-10 dB.

Furthermore, the presence in the composition of the logarithmizing circuit of linear resistor has a definite effect on the degree of the coincidence of real amplitude characteristic with ideal logarithmic law. However, the analytical determination of a change in the accuracy of logarithmic amplitude characteristic turns out to be impossible. This is explained by the facts that as nonlinear cell/elements are utilized the not fitted/not

adapted/unadapted for purposes logarithmic operations semiconductor diodes, and also by considerable technological scatter of the characteristics of the latter. Therefore both determination of the accuracy of logarithmic amplitude characteristic and the effect of linear resistor can be determined only by empiricism.

Page 39.

5. Diagram with nonlinear divider/denominator.

The logarithmic amplifiers, constructed with the application/use of the simplest diagrams of nonlinear compression (Fig. 22), do not make it possible to ensure the significant magnitude of dynamic range at input signals and have amplitude characteristics, with small degree of accuracy coinciding with ideal logarithmic curve. This is explained by the facts that, in the first place, the extent of the nonlinear section of the volt-ampere characteristic of the majority of the Soviet semiconductor diodes, used as nonlinear resistors, is comparatively small (coefficient $d_R=3\div 5$); in the second place, the nonlinear sections of volt-amperes characteristic have essential deviations from ideal logarithmic curve; thirdly, parameters of semiconductor diodes (in particular on initial - nonlinear section)

they have considerable scatter.

In order to remove (or at least to reduce to a minimum) the effect of the deficiency/lacks indicated, and consequently, to increase the dynamic range of amplifier in input signals and to raise the accuracy of logarithmic amplitude characteristic, can be recommended completely determined circuit solution.

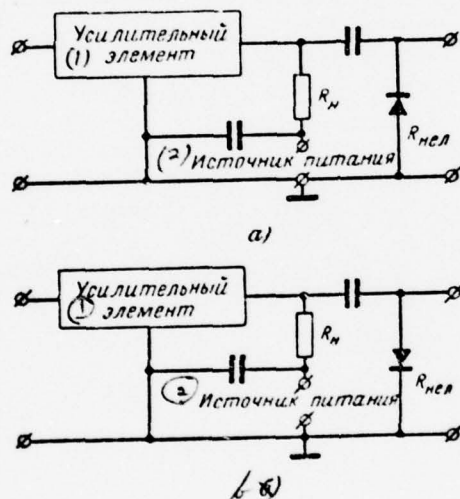

Fig. 22. Simple circuits of logarithmic amplifier. a) amplifier circuit for the signals of positive polarity; б) amplifier circuit for the signals of negative polarity.

Key: (1). Amplifier cell/element. (2). Power supply.

Page 40.

It is comprised in the complication of the logarithmizing circuit by the introduction of linear resistors (see §1) or by its execution in the form of the resistive four-pole, the transmission factor of which changes depending on of input signal level according to the necessary law.

The simplest and sufficiently widespread method, which makes it possible to solve the tasks indicated, is the switching on of nonlinear cell/element as one of the arms (in this case - parallel) of the resistive voltage divider. As can be seen from the given in Fig. 23a electrical circuit of logarithmic cascade/stage with nonlinear divider/denominator, the logarithmizing circuit is the passive network, the transmission factor of which depends on signal level.

We examine this circuit for the purpose of the explanation of its possibilities in the relation to the value of dynamic range at input signals.

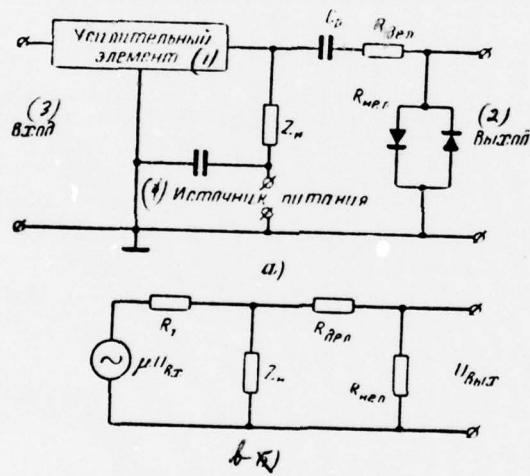

Fig. 23. Circuits of nonlinear cascade/stage with the voltage divider. a) generalized; b) is equivalent.

Key: (1). Amplification cell/element. (2). Output/yield; (3). Input.
 (4). Power supply.

Page 41.

By utilizing the equivalent circuit of nonlinear amplifier stage, depicted on Fig. 23b, it is possible to find output voltage from the following formula:

$$U_{\text{вых}} = Y_{21} U_{\text{вх}} \frac{Z_{\text{н}} R_{\text{нел}}}{Z_{\text{н}} + R_{\text{дел}} + R_{\text{нел}}}, \quad (28)$$

where Y_{21} is conductivity of the direct drive of amplifier instrument;

$Z_{\text{н}}$ - the resistor/resistance of the load circuit of amplifier instrument;

$R_{\text{нел}}$ - the resistor/resistance of the symmetrical nonlinear cell/element, carried out in the form of the antiparallel connection of two semiconductor diodes;

$R_{\text{дел}}$ is resistor/resistance of the fixed resistor, connected in the consecutive arm of the voltage divider.

For convenience in the further calculations one should determine $R_{\text{нел}}$ and $R_{\text{дел}}$ in units $Z_{\text{н}}$, namely:

$$R_{\text{дел}} = n Z_{\text{н}},$$

where n is any positive number;

$$R_{\text{нел}} = bZ_{\text{н}}$$

where coefficient b varies from b_1 , the corresponding to beginning exponential section of static characteristic $R_{\text{нел}} = \varphi(U)$ the diode, to b_2 which corresponds to the end/lead of this section.

The value of the output voltages, which correspond to beginning and the end/lead of the logarithmic section of amplitude characteristic, are respectively equal to:

$$\left. \begin{aligned} U_{\text{ВЫХ1}} &= Y_{21} U_{\text{ВХ1}} \frac{b_1 Z_{\text{н}}}{1+n+b_1}; \\ U_{\text{ВЫХ2}} &= Y_{21} U_{\text{ВХ2}} \frac{b_2 Z_{\text{н}}}{1+n+b_2}. \end{aligned} \right\} \quad (29)$$

Hence it is possible to find the dynamic range of amplifier stage from input signals. Its value is determined from the following expression:

$$\begin{aligned} d_{\text{ВХ}} &= \frac{U_{\text{ВХ2}}}{U_{\text{ВХ1}}} = \frac{U_{\text{ВЫХ2}}}{U_{\text{ВЫХ1}}} \frac{b_1}{b_2} \frac{1+n+b_2}{1+n+b_1} = \\ &= d_{\text{ВЫХ}} d_R \frac{1 + \frac{1+n}{b_2}}{d_R + \frac{1+n}{b_2}}. \end{aligned} \quad (30)$$

Directly from the analysis of the obtained expression it is possible to be convinced of the fact that the circuit of logarithmic operation, carried out in the form of the nonlinear voltage divider, provides wider dynamic range at input signals, than simple circuit (Fig. 22).

Page 42.

As it follows from curves, constructed according to expression (23) in Fig. 14-18, value d_{nxi} increases with an increase in the parameter $1/b_2$. In expression (30) value d_{nxi} is determined by parameter $1 + n/b_2$, i.e., other conditions being equal, dynamic range for input signals the amplification cascade/stage with nonlinear divider/denominator in load circuit it will be the greater, the greater the value of the resistor/resistance of resistor $R_{дел} = nZ_H$.

This increase d_{nxi} can be explained by the facts that the transmission factor of nonlinear four-pole - the resistive divider/denominator of the voltage, input of which enters the amplified signal, always less than unity. Therefore in divider/denominator occurs the supplementary weakening of the voltage of signal, whereupon the greater, the more powerful the signal, and therefore occurs the expansion of the region of logarithmic operation to the more considerable signal levels.

It is clear that as in this case for determining value it is possible to use the curve/graphs, presented in Fig. 14-18. Only instead of the coefficient $1/b_2$ one should substitute $(1+n)/b_2$.

During the construction of practical amplifier circuits it is necessary to keep in mind that the execution of the logarithmizing circuit in the form of the nonlinear voltage divider not always makes it possible to obtain large gain in the relation to value d_{nxi} in comparison with simple circuit. It is possible to show that the degree of an increase in the dynamic range in input signals in circuit with divider/denominator first of all depends on the properties of the used nonlinear cell/element, in particular on the value of the parameter $1/b_2$. Actually, the lesser value $R_{\text{нел.эле.}}$ i.e., than more $1/b_2$, with the facts to a lesser degree it changes the transmission factor of divider/denominator with a change in value n . This can be illustrated by the graph/diagrams of dependence $\frac{d_{nxi}}{d_{\text{нел.эле.}}} = \psi(n; 1/b_2; d_R)$, presented in Fig. 24-27. By examining curve/graphs, it is possible to make the conclusion that the application/use of a nonlinear divider/denominator turns out to be more effective in the wideband amplifiers: the wider the passband, that the more caused by divider/denominator increase d_{nxi} as compared with circuit without divider/denominator. This is explained by the facts that in the circuit in question the nonlinear cell/element is shunted not directly by the resistor/resistance of load circuit $Z_{\text{н}}$, but by total

resistance $Z_{II} + R_{дел.л} = Z_{II} (1+n)$.

Page 43.

It is clear that than more $R_{дел.л}$, that to a lesser degree is lowered the effectiveness of the logarithmizing cell/element because of shunting by its fixed resistor and the greater the extent of the logarithmic section of amplitude characteristic. With respect increases the value of the dynamic range of amplifier at input signals. Furthermore, introduction into the circuit of resistor $R_{дел.л}$ somewhat decreases the currents, which take place through diodes; as the final result this contributes to an increase in the reliability of the logarithmizing circuit and entire amplifier as a whole.

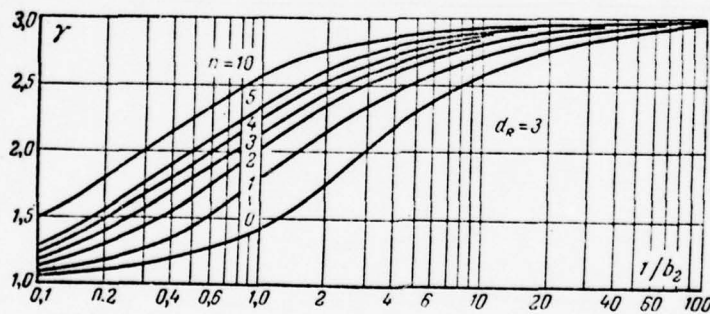

Fig. 24.

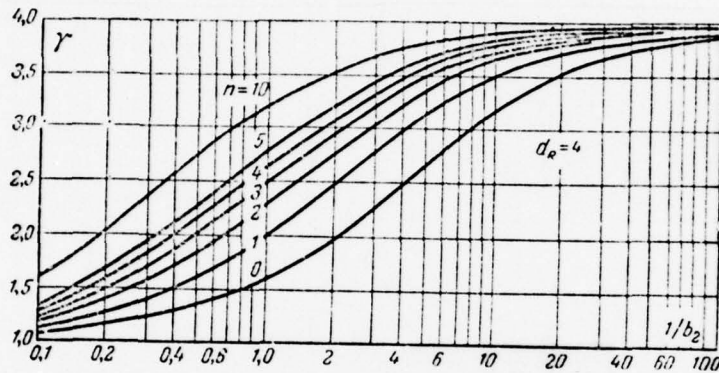

Fig. 25.

Page 44.

The results of the calculation - the curves of dependences $\gamma = \psi(n; 1/b_2; d_R)$ in Fig. 24-27 - show that during the introduction of nonlinear divider/denominator into the circuit of amplifier stage it is possible to expect an increase in the dynamic range of cascade/stage in input signals on 5-7 dB (with to values $n = 3-5$). Of course, by increasing n , i.e., the resistor/resistance of resistor $R_{дел.}$

it is possible to attain even larger growth d_{Bxi} . However, this one should make two reasons.

First of all, with $n > 5-7$ degree of an increase in the dynamic range of cascade/stage in input signals with an increase of n is considerably less than at the low values of n .

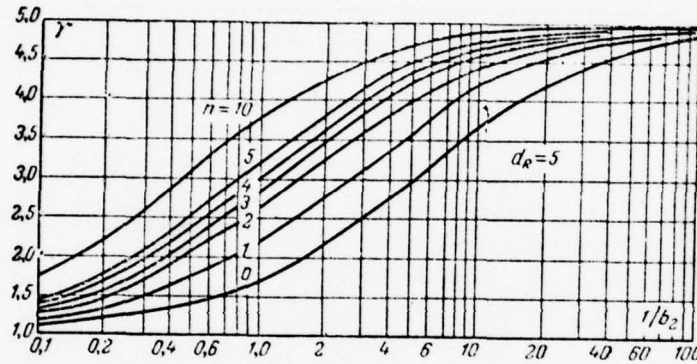

Fig. 26.

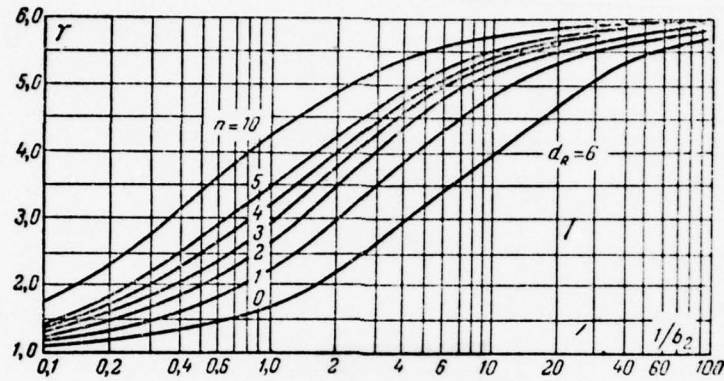

Fig 27.

Page 45.

In the second, an increase in the fixed resistor of divider ($R_{дел}$) leads to a decrease in the output voltage of cascade/stage. From the viewpoint of an increase d_{nxi} this property of the circuit in question is as has already been indicated above, advantage, since it makes it possible to expand the limits of logarithmic operation into the field

of the considerable signal levels and, therefore, makes it possible to raise the upper limit, with which occurs the overloading of cascade/stage. But during the amplification of the small due to amplitude voltages, when is not required any weakening of the amplified signal, the presence of divider/denominator leads to a decrease in the sensitivity, whereupon the greater, the greater the degree of division, i.e., the greater value n .

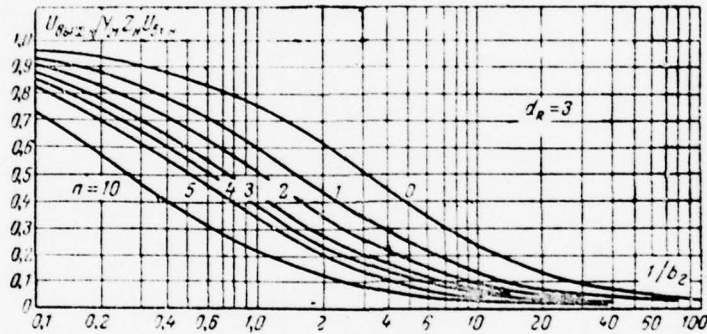

Fig. 28.

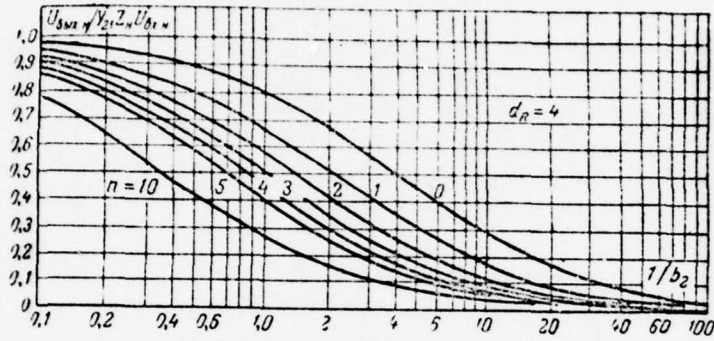

Fig 29.

Page 46.

The aforesaid is illustrated by the given in Fig. 28-31 graph/diagrams of the dependence of the standardized/normalized output voltage from the parameters of amplifier circuit

$$U_{BX.H} / Y_{21} Z_{II} U_{BX.H} = \psi(n; 1/b_2; d_n).$$

Therefore during the construction of the multistage logarithmic

computing circuits with the use of nonlinear divider/denominators one should, in the first place, select $R_{дел}$ from compromise considerations, namely:

$$R_{дел} \leq (3 \div 5) Z_{II}, \quad (31)$$

when a decrease in the output voltage of each cascade/stage comparatively small - not more than 2 times in comparison with simple circuit, and, in the second place, to introduce into amplifier one-two linear the cascade/stage of preliminary amplification, that make it possible to compensate for loss in amplification.

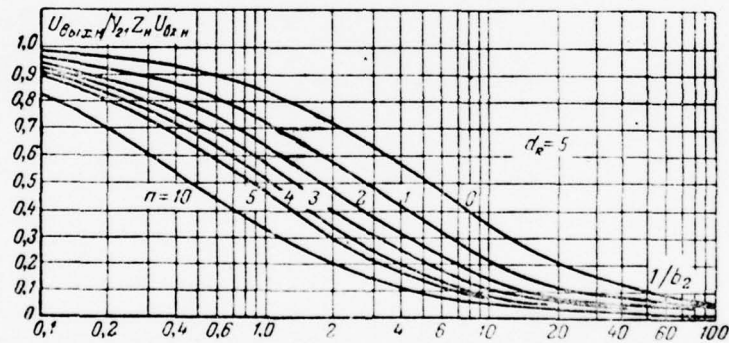

Fig 30.

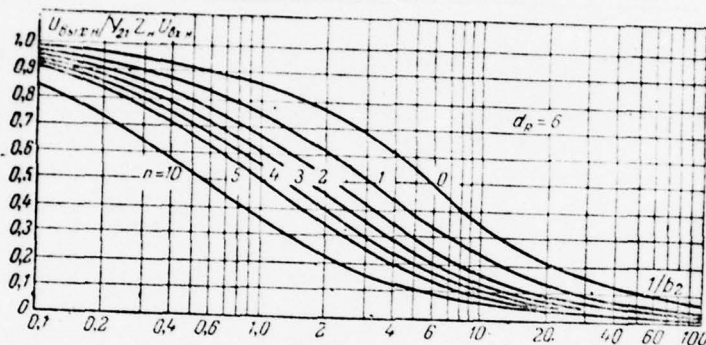

Fig. 31.

Page 47.

In conclusion to note which on the curve/graphs, presented in Fig. by 24-31, it is possible comparatively simply to produce the calculation of amplifier. Specifically, by knowing the value of the load of amplifier $Z_{H.}$ the type of the used nonlinear cell/element, dynamic range on output voltage $d_{B_{Mxi}}$, and also value $n = R_{де.т}/Z_{H.}$ which characterizes the degree of the division of voltage, on curve/graphs

it is possible to determine the contraction coefficient of the dynamic range of the amplified signal or the dynamic range of cascade/stage in input signals.

6. Special feature/peculiarities of the execution of the circuit of transistor logarithmic amplifier.

As it was shown above, nonlinear cell/element has the maximum effectiveness only when it insignificantly is shunted by the resistor/resistance of the load circuit of amplifier instrument. Consequently, for obtaining a maximally possible value of the dynamic range of logarithmic amplifier with input signals necessary to increase fixed resistor value loads, that shunts nonlinear cell/element. Therefore will increase the extent of the logarithmic section of the amplitude characteristic (and, consequently, the value of dynamic range) of both of each separate cascade/stage and entire amplifier as a whole.

If in vacuum-tube amplifiers an increase in the resistor/resistance value plate load it is virtually the only measure, which makes it possible to decrease the degree of the shunting of nonlinear cell/element by the effective resistance of linear networks, then in transistor amplifiers it is necessary to

bear in mind several such resistor/resistances. They include: the output resistance of amplifier transistor, the resistor/resistance of the resistor of load in the circuit of collector/receptacle and the entry impedance of the subsequent cascade/stage, which has sufficiently small value, especially if the transistor of the subsequent cascade/stage is included according to common-base circuit (order of hundreds or dozen ohm). The presence in the composition of the load circuit of the amplifier cell/element of several fixed resistors, the values of resistor/resistances of which are independent one from another, leads to the serious complication both of the process of the tuning of logarithmic amplifier and its electrical circuit.

Page 48.

In the general case during the tuning of transistor logarithmic amplifier it is necessary to perform three independent operations, which facilitate an increase in the effectiveness of nonlinear cell/element. Most important of these operations is that, that makes it possible to remove by-passing the entry impedance of the subsequent cascade/stage. This resistor/resistance it has in comparison with other components of the total resistance of load circuit the lowest value and on the strength of this to the greatest degree lowers the effectiveness of the action of the logarithmizing

cell/element during the direct connection of amplifier stages.

The task indicated can be solved in the best way by means of failure of the direct connection of nonlinear amplifier stages and introduction into the circuit of cascade/stage - between the logarithmizing circuit and the transistor of the subsequent cascade/stage - the separating matching cell/element with high input and low output resistance. As this cell/element is applied the emitter follower or, more precise, cascade/stage with the switching on of transistor according to common-collector connection; conventional designations of this circuit "OK". In this case nonlinear cell/element is shunted by the high entry impedance of emitter follower, determined following known expression (on the basis of the representation of transistor in the form of T-shaped replacement scheme):

$$(R_{BX})_{OK} \approx r_0 + \beta(r_e + R_e), \quad (32)$$

where r_0 is the distributed resistance of base;

r_e - the resistor/resistance of emitter junction;

R_e - the resistor/resistance of resistor in emitter circuit;

β is a factor of amplification of transistor in current.

On the basis of the aforesaid it is possible to propose the following construction of the cascade/stage of logarithmic amplifier, illustrated by circuit diagram depicted on Fig. 7. As can be seen from figure, the logarithmizing cascade/stage must consist of strictly amplifier stage, nonlinear cell/element (or in the general case from more complex than nonlinear value) and emitter follower - the decoupler, to output/yield of which is connected the input of the following logarithmizing cascade/stage, carried out according to analogous circuit.

Page 49.

In the multistage logarithmic amplifier, all cascade/stages of which are carried out in accordance with the proposed circuit, there can be comparatively easily they will achieve/reach wide dynamic range at input signals, i.e., is provided the sufficiently high effectiveness of logarithmic operation.

A deficiency/lack in the proposed method of the construction of the logarithmizing amplifier is that the factor of amplification of emitter follower in voltage is less than unity. This deficiency/lack, which leads to the determined weakening of the amplified signal,

acquires special importance if necessary to have for the composition of receiver the logarithmic amplifier, which possesses considerable amplification in linear conditions and the smallest possible overall sizes. With very stringent requirements for weight and overall sizes of the develop/processed assemblies the introduction into the logarithmizing cascade/stages of emitter followers enters into contradiction with the requirements indicated, since twice increases the number of active elements. Furthermore, emitter followers have poor frequency properties, which impedes, and now and then generally makes impossible their application/use in wideband amplifiers or in the amplifiers, inclined for comparatively high frequencies.

In connection with this as the untying cell/element is represented more advisable to utilize the cascade/stage, carried out with the switching on of transistor according to common-emitter connection, but when are accepted the measures to an increase in the entry impedance of this cascade/stage. This can be reached by known reception, namely: by the inclusion into the emitter circuit of the amplifier transistor of supplementary resistor R_0 (Fig. 32). Then the entry impedance of cascade/stage is determined from the following formula:

$$R_{вх.о.э} = R_{вх.тп} \parallel R_0, \quad (33)$$

where $R_0 = \frac{R_{01}R_{02}}{R_{01} + R_{02}}$ - the resistor/resistance of divider/denominator in

value grid priming to the base of transistor;

$R_{\text{вх.тп}} = R_0 + \beta(r_0 + R_0)$ the entry impedance of the transistor, connected according to circuit with common/general/total emitter.

Page 50.

Since the value of the resistor/resistance of the resistors, connected in the circuit of grid priming to base, usually is selected large, entry impedance of cascade/stage is determined by the entry impedance of transistor, i.e., $R_{\text{вх.о.с}} \approx R_{\text{вх.тп}}$, can reach the value of the order several dozen kilohm, but voltage amplification factor - several unity, that also is required.

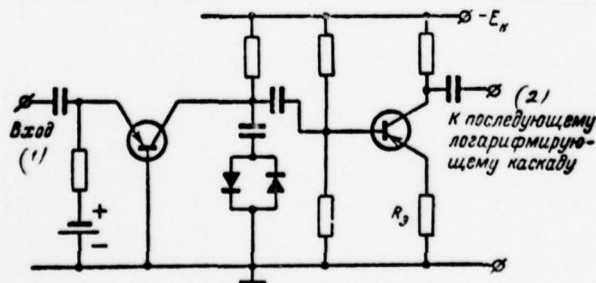

Fig. 32. Circuit of the logarithmizing cascade/stage.

Key: (1). Input. (2). To the subsequent logarithmizing cascade/stage.

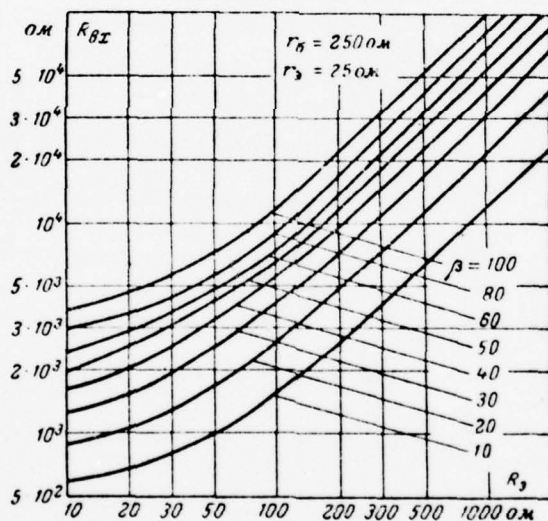

Fig. 33. Dependence of the entry impedance of cascade/stage on the value of the resistor/resistance of resistor in emitter circuit.

Page 51.

The curves of dependences $R_{bx} = \psi(R_{\alpha})$ for a standard transistor are represented in Fig. 33. It is necessary also to note, that the characteristics of the untying cascade/stage in different operating conditions and upon the exchange of transistors they will be the more stable, the greater value R_{α} . This fact acquires decisive importance when selecting the electrical circuit of the multistage logarithmic amplifier, which must enter in the composition of the equipment, intended for a work under conditions of the diverse mechanical and climatic effects of environment, and at the same time it must possess comparatively small overall sizes. This all the more important since the provision for a high stability of the characteristics of logarithmic amplifiers of the type in question is at present most essential of entire complex of the tasks, which must be solved in the process of production and tuning of these amplifiers.

As concerns the resistor/resistance of resistor in the circuit of the collector/receptacle of amplifier transistor, to its increase one should approach with considerably larger precaution, than an increase in the resistor/resistance of the resistor of the plate load of electron tube in analogous circuit. The experimental check of the

logarithmizing transistor cascade/stage, schematic diagram of which is given in Fig. 34, it showed that an increase in the resistor/resistance of resistor in the circuit of the collector/receptacle of amplifier transistor brings, as is evident from the amplitude characteristics of cascade/stage, depicted on Fig. 35, to completely opposite results - to decrease in the extent of the logarithmic section of amplitude characteristic and volume contraction of cascade/stage in input signals. This phenomenon can be explained as follows.

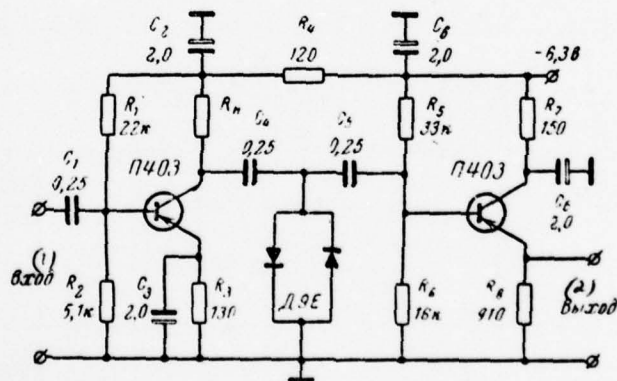

Fig. 34. Schematic diagram of the amplifier logarithmizing

cascade/stage.

Key: (1). Input. (2). Output/yield.

Page 52.

It is known that the dependence of the factor of amplification of transistor cascade/stage in voltage K_U from the current of emitter at the constant value of direct/constant voltage on collector/receptacle takes the form of the continuously growing curve. The family of such curves, taken for the different voltages on collector/receptacle, which artificially were supported by constants, is represented in Fig. 36. If we, however, do not take measures for the maintenance of the constancy of value U_K (that also occurs in real circuit), then curve $K_U = \psi(I_e)$ or, is more precise, $K_U = \psi(U_{BK})$ has more complex character. The form of the real dependence $K_U = \psi(I_e; U_K)$, presented in Fig. 36 by dotted curve, can be explained on the basis of the obvious principles of the work of amplifier circuits.

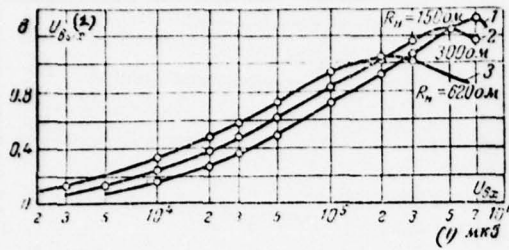

Fig. 35

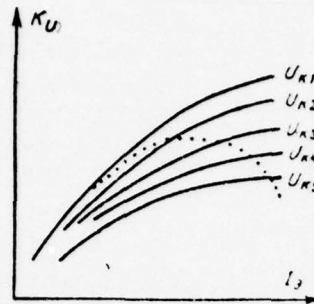

Fig. 36

Fig. 35. Amplitude characteristics of the logarithmizing cascade/stage. Input signal is a continuous oscillation/vibration with frequency $f_c = 1$ MHz.

Key: (1). μV . (2). output.

Fig. 36. Dependence of the amplification factor on the current of emitter at the different constant values of voltage on collector/receptacle. - true dependence $K_U = \Psi(I_3, U_{Kx})$; $U_{K1} > U_{K2} > U_{K3} > U_{K4} > U_{K5}$.

Page 53.

With an increase in the amplitude of input voltage grow/rises the current of the emitter of amplifier transistor, that is accompanied by an increase in the voltage drop across fixed resistor in the load circuit of collector/receptacle (also on the resistor of filter, if it is) and by a decrease in the stress level on collector/receptacle. This in turn, leads to the deferred-action increase in the voltage

amplification factor and with powerful signals - to the appearance of the falling/incident section in amplitude characteristic. Consequently, the more value R_{in} , the more the voltage drop across it i the fact at the smaller values of the amplitude of input voltage it begins the falling/incident section of amplitude characteristic, i.e., the torque/moment, with which $dU_{out}/dU_{in}=0$. Therefore for an increase in the extent of the logarithmic section of amplitude characteristic in transistor amplifiers (is in form a case of applying wideband amplifiers) one ought not to increase the constant load impedance of amplifier cell/element to most feasible values (in the same way as this it is made in vacuum-tube circuits). Certain decrease in the amplification factor, caused by the smaller value of the resistor/resistance of resistor in the circuit of collector/receptacle and undesirable when, at the input, the amplifier of weak signals is present, can be compensated for by simple boosting supply of power (E_R) on 3-4 v (Fig. 37).

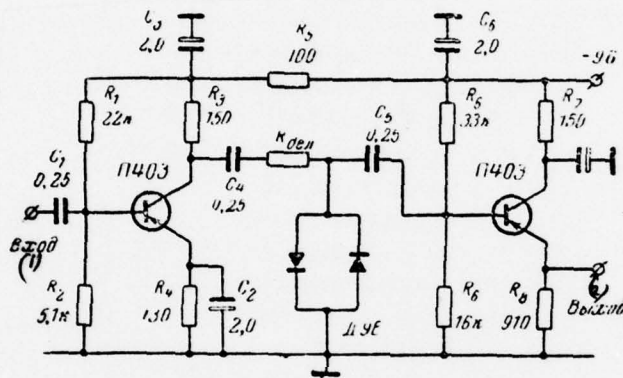

Fig. 37. Schematic diagram of the logarithmizing cascade/stage.

Key: (1). Input. (2). Output/yield.

Page 54.

On the effectiveness of this measure it is possible to judge from the comparison of the given in Fig. 35 and 38 amplitude characteristics of the logarithmizing amplifier stages (curve 1), these

characteristics are taken with $E = -6.3$ v and $E = -9$ V respectively. Unlike vacuum-tube amplifiers the increase in the source power of feed is not accompanied by deterioration in the thermal condition is narrow or by a noticeable increase in its overall sizes.

The made derivations testify to the presence of the fundamental difference between electron-tube and transistor logarithmic amplifiers. This difference is developed, in particular, in the fact that in the latter the task of the simultaneous achievement of wide passband and considerable dynamic range in input signals is not irresolvable. Of course, this problem into a given degree is solved in the electron-tube logarithmic computing circuits. However, in this case substantially grow/rise the difficulties both circuit and construction-engineering character.

One should note, for example, that in single-stage transistor amplifier without any special measures there can be achieved dynamic range on the order of 25 dB, whereas in electron-tube single-stage amplifier - only 15-20 dB. This is explained, in the first place, by the facts that the transistor is characterized considerably larger, rather than tube, by the value of the conductivity of direct drive Y_{21} and, therefore, provides larger gain per stage, but, in the second place, thereby that the static characteristics of transistor

possess the considerably larger degree of nonlinearity, the the anode-grid characteristics of electron tubes, whereupon with comparatively weak signals at input.

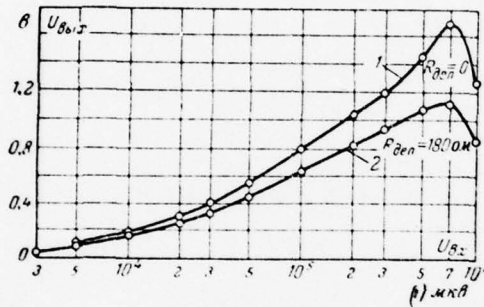

Fig. 38. Amplitude characteristics of the logarithmizing cascade/stage. Input signal is a continuous oscillation/vibration with frequency $f_c = 1$ MHz.

Key: (1). μV .

Page 55.

The reasons indicated cause the large extent of the logarithmic section of the amplitude characteristic of transistor amplifier in

comparison with electron-tube, other conditions being equal, in particular with the identical type of nonlinear cell/element. This increase in the extent of the logarithmic section of amplitude characteristic numerically is estimated at Δd [expression (27)], determined, of course, by empiricism. However, as can be seen from experimental data, the falling/incident section of amplitude characteristic, i. e., equality $dU_{\text{out}}/dU_{\text{in}}=0$, in single-stage transistor amplifier begins with voltages on input on the order of 0.7-0.8 v (Fig. 38), while in vacuum-tube amplifier this occurs with $U_{\text{in}}=7-8$ V. This is caused by the facts that the static characteristics of transistor have considerably smaller extent of linear section, rather than the characteristic of tube.

7. Frequency characteristic of transistor logarithmic amplifier.

During the total analysis of the logarithmic amplifier, made of the principle of the shunting of load as nonlinear cell/elements, it is necessary to keep in mind that for the majority used at present of the modification of amplifier (including for modification of the type in question) is characteristic the dependence of frequency properties on of the amplified signal level. This means that unlike linear amplifiers the description of the properties of logarithmic amplifier

AD-A065 856

FOREIGN TECHNOLOGY DIV WRIGHT-PATTERSON AFB OHIO
CALCULATION OF LOGARITHMIC AMPLIFIERS WITH NONLINEAR ELEMENTS I--ETC(U)
OCT 77 G M KRYLOV, A S KAKUNIN, V I PANOV
FTD-ID(RS)T-1829-77

F/G 9/5

UNCLASSIFIED

NL

2 OF 2
ADA
065856

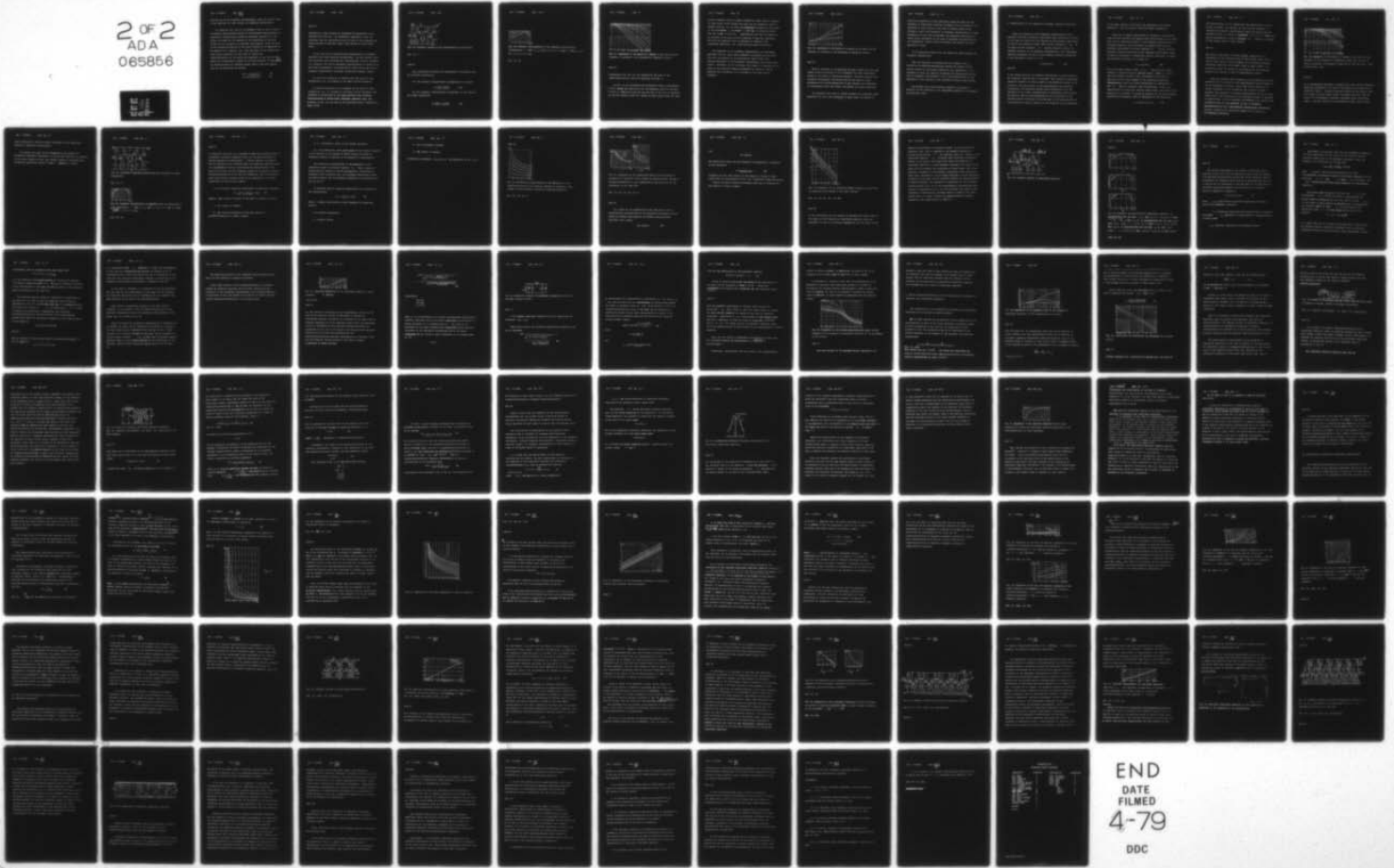

END
DATE
FILMED
4-79
DDC

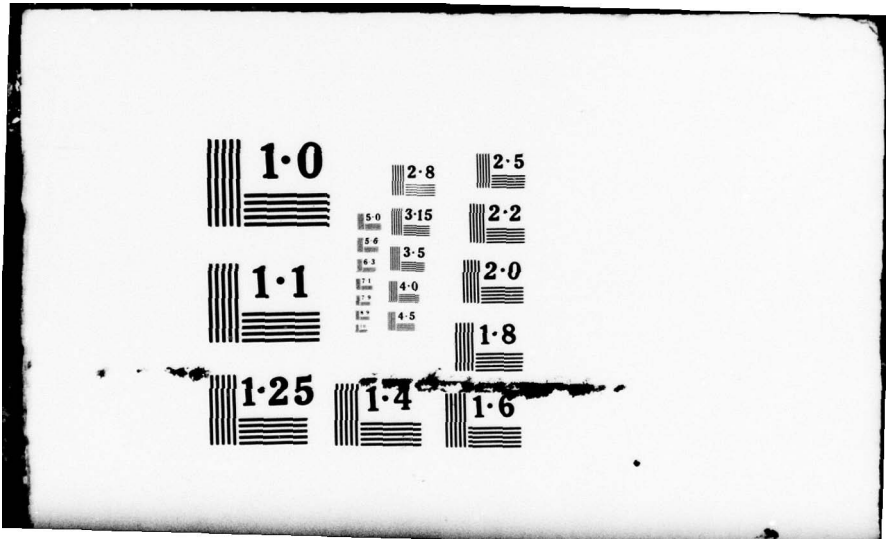

with the aid of the frequency characteristic, taken for certain value of the amplitude of input voltage, is completely insufficient.

In connection with this it is necessary first of all to stop at the special feature/peculiarities of the frequency characteristic of logarithmic cascade/stage, differing nonlinear amplifier from the linear and caused by the presence in the composition of the load circuit of the transistor of nonlinear cell/element. Since the value of the resistor/resistance of the latter depends on the amplitude of the applied to it voltage, i.e., from the level of the entering the input signal amplifier, in this case it changes the relationship/ratio of the active and reactance of load circuit they appear the corresponding changes in the form frequency $A(\omega)$ and phase ^{$\varphi(\omega)$} the characteristics of amplifier stage, which in the most general form are record/written as follows:

$$A(\omega) = \frac{1}{\sqrt{1 + [X_H/R_H(U_{BX})]^2}}; \quad (34)$$

$$\varphi(\omega) = \text{arctg} [X_H/R_H(U_{BX})]. \quad (35)$$

Page 56.

Specifically, these changes are developed the dependence of the bandwidth and time lag - the fundamental parameters, which are described from the quantitative point of view of the frequency and phase response of amplifier stage, from changes of input signal level.

In the work of the logarithmizing cascade/stage (is examined aperiodic type logarithmizing cascade/stage - the more general case, than resonance type logarithmizing cascade/stage, from the viewpoint of a change in the form of frequency characteristic) it proves to be that with an increase in the amplitude of input voltage the form of frequency characteristic undergoes considerable changes, namely:

a) occurs the expansion of passband into the range of high frequencies, i.e., an increase in the upper cut-off frequency;

b) occurs contraction in the passband in the range of lower frequencies, i.e., an increase in the lower cut-off frequency. The aforesaid is illustrated by the experimentally taken frequency characteristics of single-stage transistor amplifier (Fig. 39), presented in Fig. 40, and also by the calculated curves, depicted on Figs. 41-42.

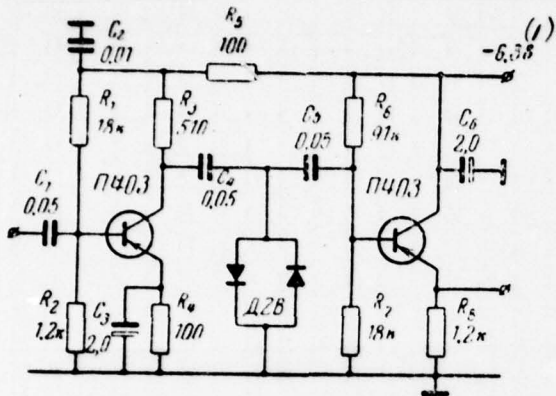

Fig. 39. Schematic diagram of the logarithmizing cascade/stage.

Key: (1) . V.

Page 57.

The curve/graphs indicated are constructed in accordance with the following expressions:

for the frequency characteristic of amplifier in the range

$$\Delta_n = \frac{f_{n, \text{мин}}}{f_{n, \text{макс}}} = \frac{1 + 1/b_2}{d_R + 1/b_2}; \quad (36)$$

for the frequency characteristic of amplifier in the range of the higher frequencies

$$\Delta_n = \frac{f_{n, \text{макс}}}{f_{n, \text{мин}}} = d_R \frac{1 + 1/b_2}{d_R + 1/b_2}. \quad (37)$$

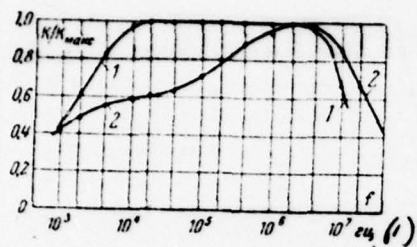

Fig. 40. Frequency characteristic of the simplest logarithmizing cascade/stage. 1 - with $U_{вх\ мин} = 10$ мВ; $K_{U\ макс} = 18$; $\Delta F_{0,7} = 3 \cdot 10^3 + 9.5 \cdot 10^6$ Hz; 2 - with $U_{вх\ макс} = 700$ мВ; $K_{U\ мин} = 1.85$; $\Delta F_{0,7} = 10^5 + 18 \cdot 10^6$ Hz.

Key: (1) . Hz.

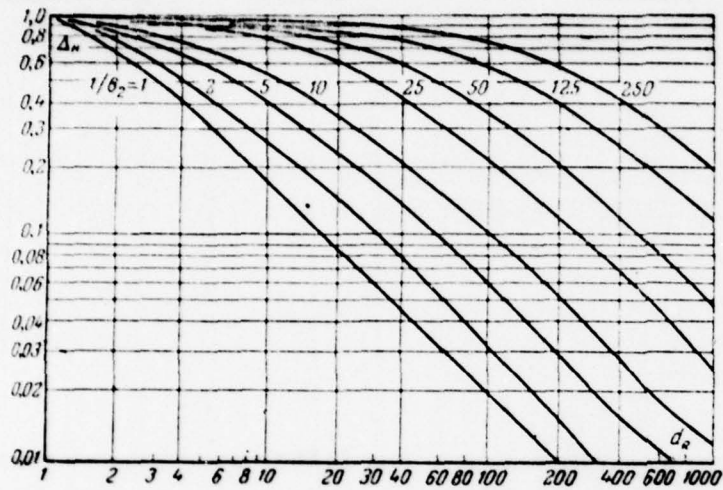

Fig. 41. Dependence of the degree of a change in the lower cut-off frequency of passband on the parameters of amplifier circuit.

Page 58.

[Expressions (36) and (37) are obtained on the basis of the common/general/total theory of amplifier circuits.]

On Fig. 41 are represented the calculated curves of dependences $\Delta_n = \psi(d_R)$. Curves are constructed for the different values of relation $1/b_2 = R_H/R_{ncr.min}$. From the figure one can see that in the work of amplifier in the wide dynamic range of a change of input signal level the lower

cut-off frequency does not remain constant in value. With an increase of input signal level changes the upper cut-off frequency, which is evident from Fig. 42, on which are represented theoretical the curves of the dependences Δ_n on values d_R and $1/b_2$. It should be noted that the curves $\Delta_n = \psi(d_R; 1/b_2)$ characterize not only the degree of an increase in the upper cut-off frequency of aperiodic amplifier, but also the expansion ratio of passband in resonance type logarithmic amplifier, i.e., they have more general character.

The expansion of the frequency characteristic of logarithmic amplifier into the range upper frequency is explained by the facts that with an increase of the amplitude of input voltage the resistor/resistance of the nonlinear cell/element, which shunts load circuit decreases. As it is obvious, this leads to a decrease in the value of the resulting resistor/resistance of collector load of amplifier and, therefore, to an increase in its upper cut-off frequency.

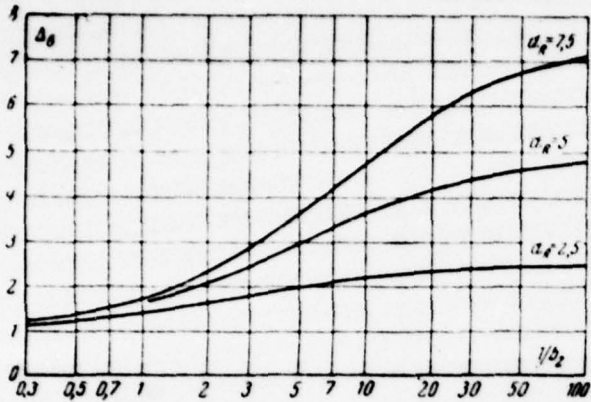

Fig. 42. Dependence of the degree of a change in the upper cut-off frequency of passband on the parameters of amplifier circuit.

Page 59.

With an increase of the amplitude of input voltage for this same reason occurs an increase in the "avalanche" of lower frequencies, caused by the effect of isolating capacitor. Isolating capacitor and nonlinear cell/element form during work in the range of lower frequencies the divider/denominator of the voltage, the coefficient of transmission which the lesser, the greater the signal amplitude.

In connection with this in transit through the logarithmic pulse amplifier will occur the distortion of their form, the degree of

distortion depending on pulse amplitude. Since the upper cut-off frequency of logarithmic amplifier increases with an increase of the amplitude of input signals, rise time of leading impulse front decreases. Since "the avalanche" of frequency characteristic at lower frequencies in this case grow/rises, the flat/plane apex/vertex of output pulse, determined by the form of frequency characteristic at low frequencies, obtains decay the greater, the greater the pulse amplitude at input.

In an appropriate manner will be changed the phase response of nonlinear cascade/stage.

When the expansion of passband and the connected with it distortion of momentum/impulse/pulse (during the passage of the latter through the logarithmic amplifier) are undesirable, it is necessary to raise the question concerning the stabilization of the form of frequency characteristic (is in form stabilization of the bandwidth) in all interval of the variation of input signal levels.

Are examined below some practical methods of providing a stability of the bandwidth in the logarithmic amplifiers of resonance and aperiodic types.

8. Stabilization of the passband of aperiodic transistor amplifier.

Under the stability of the frequency characteristic of the aperiodic nonlinear amplifier, which works under conditions of effect on its input of signal with the changing in wide dynamic range level, is implied the constancy either lower cut-off frequencies (f_n), or the upper cut-off frequency (f_H) — partial stability either the complete stability of the frequency characteristic, when logarithmic amplifier possesses the more or less constant bandwidth independent of the amplitude of input or, i.e.,

$$f_H - f_n = \Delta F \approx \text{const.} \quad (38)$$

Page 60.

In the present section are examined some methods of stabilization of the frequency characteristic of aperiodic type transistor logarithmic amplifier. Majority of them is based on the determined change in the circuit of the load circuit of the logarithmizing cascade/stage. Furthermore, the determined results gives introduction into the amplifier of the linear cascade/stages of preliminary amplification. The specific special feature/peculiarity of the majority of the possible circuit solutions is that the task of the stabilization of the bandwidth in certain interval of the variation in the amplitudes

of the input voltage in aperiodic type amplifier can be solved separately - for the range of lower and higher frequencies.

First let us examine some methods of providing a constancy of lower cut-off frequency and compare their effectiveness. It is known that certain stabilizing effect on the frequency characteristic of nonlinear amplifier exerts switching on consecutively with the nonlinear cell/element of linear resistor $R_{\text{лин}}$. In this case the resulting resistor/resistance of the nonlinear cell/element, which now must be considered as combination (series connection) of linear and nonlinear resistors, it is equal to:

$$R_{\text{нел.рез}} = R_{\text{нел}} + R_{\text{лин}} \quad (39)$$

But if with weak signals (with $U_{\text{вх}} < U_{\text{вх н}}$) the action of linear resistor in practice does not manifest itself, since $R_{\text{нел макс}} \gg R_{\text{нел мин}}$, then with powerful signals, which corresponds to the work of amplifier on the finite segment of the logarithmic amplitude characteristic, when the resistor/resistances of resistors $R_{\text{нел мин}}$ and $R_{\text{лин}}$ have an identical order of magnitude, a value $R_{\text{нел.рез}}$ substantially it grow/rises. Besides entire other, this leads to the weakening of the effect of isolating capacitor on the lower boundary amplification frequency, which is determined by the expression

$$f_{\text{н}} = 1/2\pi C_{\text{р}}(R_{\text{н}} + R_{\text{нел}} + R_{\text{лин}}). \quad (40)$$

And although when, in the composition, the logarithmizing circuit linear is present, the resistor of lower cut-off frequency of cascade/stage changes insignificantly, which one should from the presented in Fig. 43 curves of dependence $\Delta_n = \psi(p; 1/b_2; d_n)$, apply this method inexpediently, since an increase R_{min} leads to a decrease in the dynamic range in input signals.

Page 61.

The circuit realization of stated problem (provision for an independence of the bandwidth from of input signal level) must be such in order that any other parameter of the develop/processed logarithmic amplifier (but dynamic range at input signals - in particular) would not change its value during the corresponding change in the circuit of load or logarithmizing circuit.

From this viewpoint most rational is the introduction into the composition of the circuit of the logarithmizing network element of the low-frequency correction, which would afford possibility to remove "avalanche" at low frequencies and to ensure thereby a maximally flat passband of nonlinear cascade/stage for all of input signal level. This correction can be realized by means of switching on consecutively with the nonlinear cell/element of RC network that, as shown in Fig. 44. The presented in Fig. 45 frequency characteristics of that logarithmizing cascade/stage sufficiently visually illustrate the stabilizing effect of the circuit of low-frequency correction.

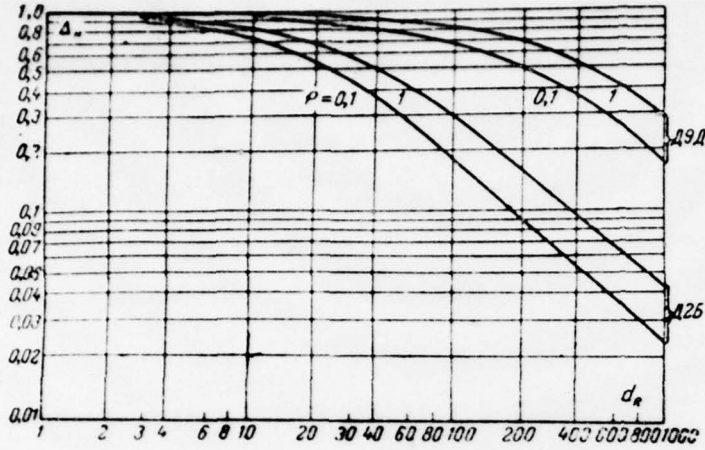

Fig. 43. Dependence of the degree of a change in the lower cut-off frequency on the parameters of amplifier circuit for the case of using as nonlinear cell/elements diodes of the type D9D ($1/b_2 = 200$) and D2B ($1/b_2 = 20$).

Page 62.

If in uncompensated amplifier a change of the lower cut-off frequency f_n comprises approximately two orders, then during the introduction of correction value f_n remains virtually constant in the dynamic range of a change of input signal levels. One should note also that the circuit of low-frequency correction indicated, after stabilizing value f_n in the interval of the variation of input signal levels

being investigated, does not affect the extent of the logarithmic section of amplitude characteristic.

As concerns the upper cut-off frequency of the passband of transistor logarithmic amplifiers, as can be seen from Fig. 45, value f_n in this case changes not more than double, whereas in analogous type vacuum-tube amplifiers change of value f_n composes 5-7 times.

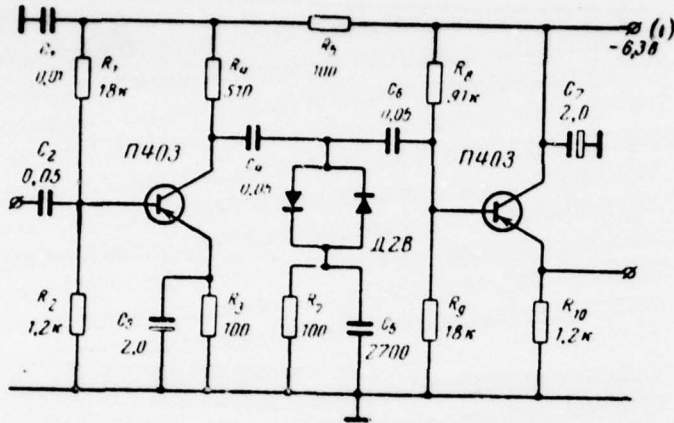

Fig. 44. Fundamental amplifier circuit with the correction of lower frequencies.

Key: (1) . V.

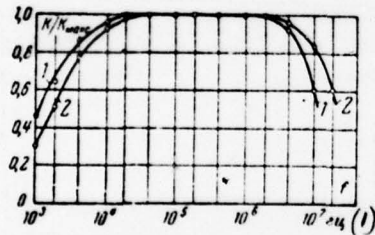

Fig. 45. Frequency characteristic of amplifier with the correction of

lower frequencies. 1 - with $U_{вх. макс} = 10$ мВ; $K_{г. макс} = 17$; $\Delta F_{0,7} = 4 \cdot 10^3 + 8.5 \cdot 10^4$ Hz; 2 - with

$U_{вх. макс} = 700$ мВ; $K_{г. макс} = 1.75$; $\Delta F_{0,7} = 2.7 \cdot 10^3 + 15 \cdot 10^4$ Hz.

Key: (1) . Hz.

Page 63.

In connection with this it is possible to make the conclusion that in logarithmic transistor amplifier (Fig. 44) the application/use of special measures of stabilization i_0 is not required. To explain this is possible by the following form. In transistor amplifier there is a supplementary factor, facilitating the stabilization of the value of the upper cut-off frequency, caused by the physical special feature/peculiarities of the work of transistors. With an increase of input signal level increases value two of components of the total capacitance of load circuit, namely:

- 1) the collector transition capacitance of amplifying transistor

$$C_{6,K} = \frac{C_0}{\sqrt[3]{U_K}} = \frac{C_0}{\sqrt[3]{E_K - I_0 R_K}} = \psi(U_{KX}), \quad (41)$$

where E_K — the voltage of battery of the feed of collector circuit;

I_0 — the current of emitter;

R_K — the resistor/resistance of the load circuit of collector/receptacle on direct current;

α is a transmission factor of the current decreases;

C_0 - the coefficient, which makes sense of the starting capacity of p-n junction in the absence of cutoff voltage and which is determined physical properties of the material of semiconductor.

The theoretical graph/diagrams of the dependence of the capacitance value of collector junction $C_{б.к}$ from a change in direct/constant voltage on collector/receptacle, constructed in accordance with expression (41), and analogous experimental curves for high-frequency and low-frequency transistors are represented on Fig. 46 and 47;

2) diffusion emitter transition capacitance the transistor of next cascade/stage

$$C_{д.диф} = \frac{1,21}{2\pi f_a} \frac{q}{kT} I_a = \psi(U_{вх}), \quad (42)$$

where f_a - current-amplification cutoff frequency in common-base circuit;

T is absolute temperature;

q - electron charge;

k - the Boltzmann constant;

I_0 - the current of emitter.

[Graphically dependence $C_{\text{эф}} = \psi(j_e, I_0)$ is represented on Fig. 48.]

Page 64.

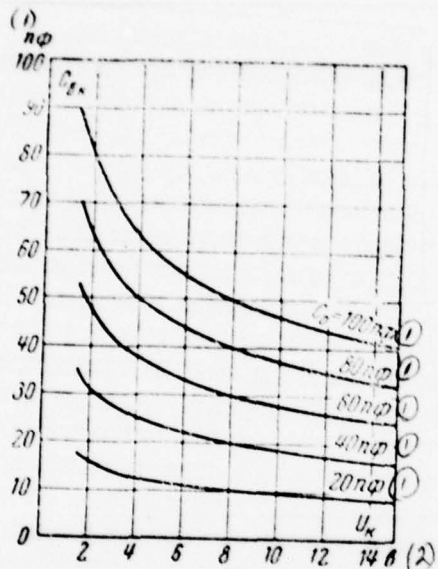

Fig. 46. Theoretical graph/diagrams of the dependence of the capacitance value of the collector junction of transistor from a change in direct/constant voltage on collector/receptacle.

Key: (1). pF. (2). V.

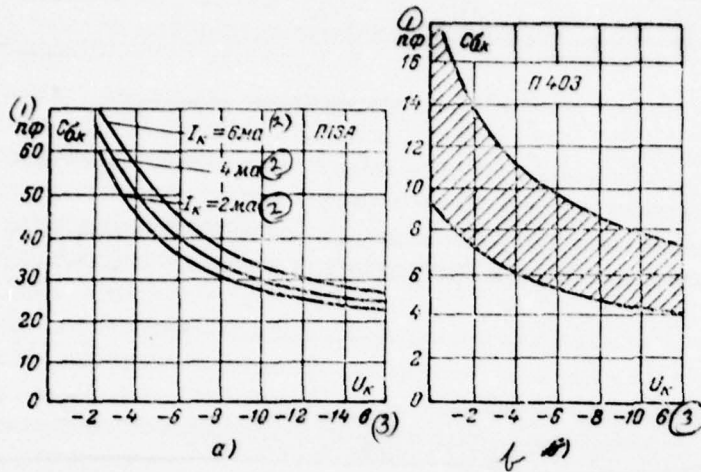

Fig. 47. Dependence of the capacitance value of the collector of transition of transistor from a change in direct/constant voltage on collector/receptacle. a) for transistors of the type P13A; b) for transistors of the type P403.

Key: (1). pF. (2). mA. (3). V.

Page 65.

As a result in the composition of the load circuit of the logarithmizing cascade/stage are two nonlinear cell/elements whose values are changed approximately on mutually reverse/inverse functional laws, namely:

$$R_{нез} = A/\psi_1(U_{вз}) \quad (43)$$

and

$$C_{\text{вс.н}} = B\psi_2(U_{\text{вх}}).$$

The respectively upper cut-off frequency of cascade/stage, determined by the expression

$$f_{\text{н}} = \frac{1}{2\pi AB\psi_2(U_{\text{вх}})/\psi_1(U_{\text{вх}})}, \quad (44)$$

increases not more than double, in the range of a change of input signal level of approximately 40 dB, i.e., functional factor $\psi_2(U_{\text{вх}})/\psi_1(U_{\text{вх}})$

remains virtually constant/invariable, that also is required for the solution of stated problem.

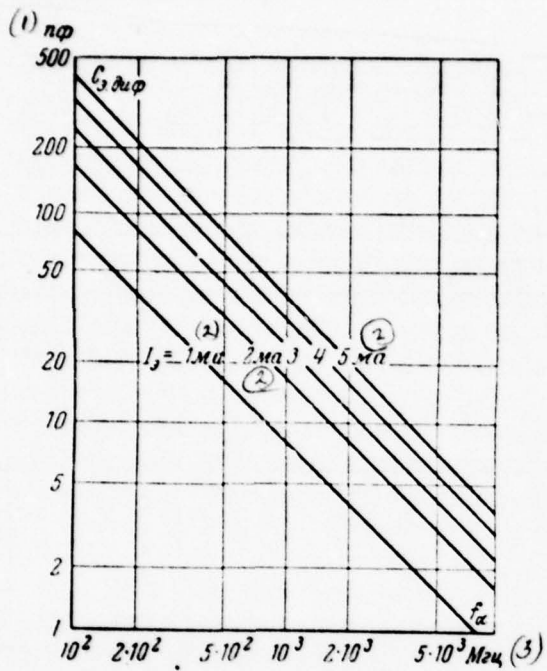

Fig. 48. Dependence of the diffusion emitter transition capacitance of transistor from changes in the input voltage.

Key: (1). pF. (2). mA. (3). MHz.

Page 66.

In this plan/layout for the problem is provided the stable value of the upper cut-off frequency of logarithmic amplifier stage can be considered as task of the mutual compensation for the effect of the

separate cell/elements of nonlinear circuit. As can be seen from expression (42), with an increase in the boundary frequency of current multiplication (f_*) the absolute limits of a change in the capacitance/capacity $C_{\text{в.днф}}$ decrease, which decreases stabilizing ability of the latter. This means that during the execution of logarithmic amplifier on high-frequency transistors the value of the upper cut-off frequency will grow/rise to larger degree than in the amplifier, assembled on low-frequency transistors other conditions being equal. Therefore it is not always possible to obtain sufficient stability of the upper cut-off frequency without the application/use of special measures. The aforesaid is illustrated by the frequency characteristics (Fig. 50) of the logarithmizing cascade/stage whose circuit is represented on Fig. 49. As is evident, the upper cut-off frequency of cascade/stage increased during a change in the input signal level 4.4. times (without the application/use of special measures of the stabilization of value f_*).

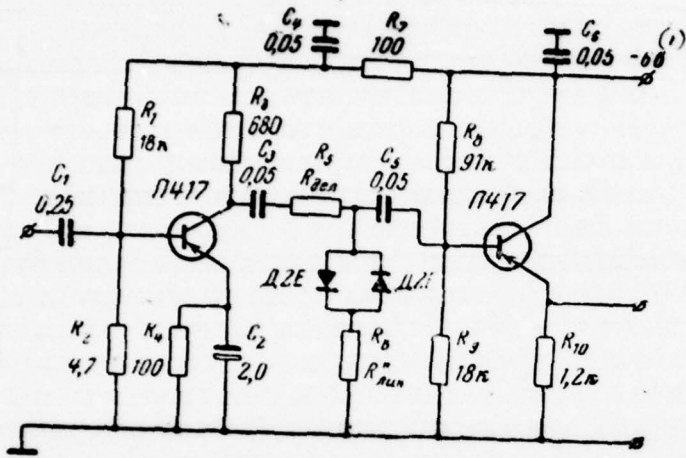

Fig. 49. Schematic diagram of logarithmic amplifier.

Page 67.

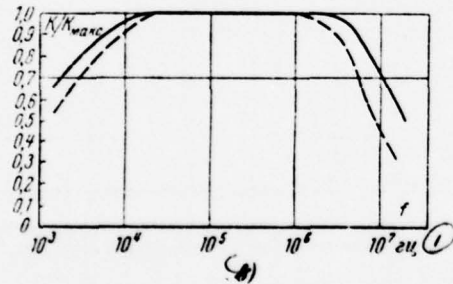
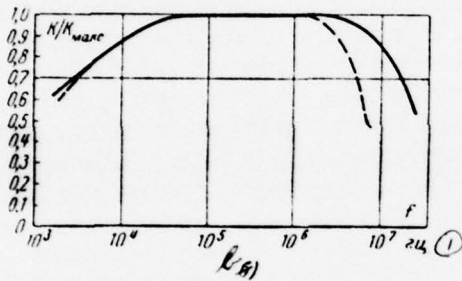
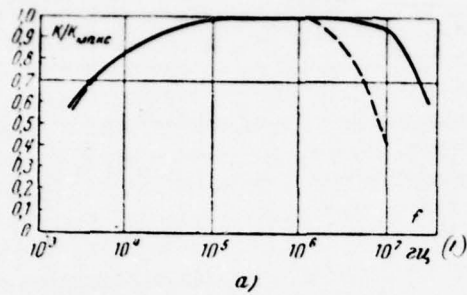

Fig. 50. Frequency characteristics of logarithmic amplifier. a)

characteristic for the case $R_{\text{пнн}}=750 \text{ ohm}$; $R_{\text{деп}}=0$; ---- $U_{\text{бз}}=0.01 \text{ V}$; $f_s=5 \text{ MHz}$;
 $K_{\text{макс}}=32$; — $U_{\text{бз}}=0.2$

Λ $U_{\text{бз}}=0.2 \text{ V}$; $f_s=22 \text{ MHz}$; $K_{\text{макс}}=5.75$; b) characteristic for the case $R_{\text{пнн}}=750$
 ohm ; $R_{\text{деп}}=1.5 \text{ kohm}$; ---- $U_{\text{бз}}=0.01 \text{ V}$; $f_s=5 \text{ MHz}$; $K_{\text{макс}}=24$; — $U_{\text{бз}}=0.2 \text{ V}$; $f_s=17$
 MHz ; $K_{\text{макс}}=3.6$; c) characteristic for the case $R_{\text{пнн}}=750 \text{ ohm}$; $R_{\text{деп}}=3$

kohm ; ---- $U_{\text{бз}}=0.01 \text{ V}$; $f_s=5 \text{ MHz}$; $K_{\text{макс}}=16$; — $U_{\text{бз}}=0.2 \text{ V}$; $f_s=10 \text{ MHz}$; $K_{\text{макс}}=2.9$.

Key: (1) . Hz.

Page 68.

The obtained difference in the results of experiment can be explained by the facts that the depicted on Fig. 44 and 49 circuits of logarithmic amplifiers are carried out on the different types of transistors. The amplifier whose circuit is represented in Fig. 44, is carried out on transistors of the type P403. It is known that the equivalent capacitance/capacity of load circuit in transistor aperiodic amplifier is defined as

$$C_{ЭНВ} = C_{Э.ДИФ} + C_{С.К} K_V + C_{МОУТ}, \quad (45)$$

where $C_{Э.ДИФ}$ - the diffusion transition capacitance of emitter - base of the subsequent transistor;

$C_{С.К}$ - transition capacitance the collector base of amplifier transistor; K_V - the factor of amplification of cascade/stage in voltage/stress;

$C_{МОУТ}$ - is wiring capacitance of interstage network.

Experimental calculations show that the fundamental component of the total capacitance of load circuit is the diffusion emitter transition capacitance of the subsequent transistor. Thus, for instance, for a transistor of the type P403

$$C_{\text{диф}} = \frac{S_0}{2\pi f_{\beta}} = \frac{0,7 \cdot 10^{-9}}{2\pi \cdot 0,7 \cdot 10^6} = 160 \text{ pF}$$

where $S_0 = \Delta I_0 / \Delta U_0$ — the slope/transconductance of input characteristic, determined according to the static characteristics of transistor $I_0 = \psi(U_{0.э})$ with $U_{к.э} = \text{const}$; $S_0 = 0,7 \text{ mA/V}$; $f_{\beta} = 0,7 \text{ MHz}$ — current-amplification cutoff frequency in common-emitter connection.

Capacitance value of passage collector base $C_{\text{б.к}} = 5 \text{ pF}$. Set/assuming $C_{\text{монт}} = 10 \text{ pF}$, the factor of amplification of cascade/stage in voltage/stress with weak signal on input $K_{\text{макс}} = 12$, the factor of amplification of cascade/stage in voltage/stress with powerful signal on input $K_{\text{мин}} = 3$, we determine the capacitance value $C_{\text{диф мин}}$ at weak signal at the input of the amplifier

$$C_{\text{диф мин}} = 160 + 5 \cdot 12 + 10 = 230 \text{ pF}$$

It is known that with an increase of the amplitude of input signal the diffusion emitter transition capacitance and the transition capacitance collector base grow/rise in value approximately double.

Consequently, with an increase of the input signal level

$$C_{\text{ЭКВ.МАКС}} = 160 \cdot 2 + 5 \cdot 2 \cdot 3 + 10 = 360 \text{ pF}$$

i.e. the equivalent capacitance/capacity of circuit will increase 1.57 times in comparison with $C_{\text{ЭКВ.МИН}}$. By this is explained the effect of the stabilization of the upper cut-off frequency in the amplifier, made on transistors of the type P403.

The diffusion emitter transition capacitance of transistors of the type P417 - on them is made the amplifier whose circuit is represented in Fig. 49- considerably less than of transistors of the type P403, and is equal to $C_{\text{в.э}} + C_{\text{т}} = 16 \text{ pF}$ (value $C_{\text{в.э}} + C_{\text{т}} = 16 \text{ pF}$ is obtained by calculation). Consequently, the equivalent capacitance/capacity of the load circuit of the logarithmizing cascade/stage under the conditions, analogous to that examined above, will be equal to:

$$C_{\text{ЭКВ.МИН}} = 16 + 5 \cdot 12 + 10 = 86 \text{ pF}$$

Page 69.

With an increase of input signal level the capacitance/capacity $C_{\text{ЭКВ}}$ will be equal to:

$$C_{\text{ЭКВ.МАКС}} = 16 \cdot 2 + 10 \cdot 3 + 10 = 72 \text{ pF}$$

i.e. capacitance value $C_{\text{нв}}$ decreased 1.2 times, and consequently, in this case the expansion of the passband of amplifier will be considerably more, rather than during the use of transistors of the type P403. The aforesaid sufficiently visually is illustrated by the frequency characteristics of amplifier, presented in Fig. 50.

On the basis of presented it is possible to make the conclusion that the need for the stabilization of the upper cut-off frequency for transistor amplifiers must be determined for each specific case (more precise, by the type of the used transistors).

When occurs an undesirable increase in the upper cut-off frequency, it is possible to use the connection/inclusion of the nonlinear resistance as arm of the resistive voltage divider in the manner that it is shown in Fig. 49.

Figure 50 depicts the frequency characteristics of amplifier; as is evident, the upper cut-off frequency in the range of a change in the input signal being investigated will increase in all 2 times (instead of 4-5 multiple increase in the upper cut-off frequency in circuit without resistor $R_{\text{дел}}$). In this case the dynamic range of amplifier stage at input signals because of the introduction of the nonlinear voltage divider grow/rises approximately to 30 dB (Fig. 51).

The stabilizing effect of the resistive voltage divider on the upper cut-off frequency to explain as follows.

Since fixed resistor of this divider/denominator is included between the isolating capacitor and the input electrode of the transistor of the subsequent cascade/stage, this divider/denominator is equivalent on the final effect of its action to circuit with the divided capacitance/capacities or to low-pass filter.

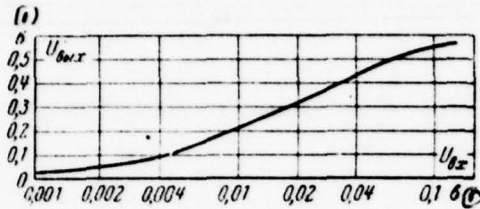

Fig. 51. Amplitude characteristic of logarithmic amplifier. Signal frequency $f_c = 500$ kHz.

Key: (1). V.

Page 70.

For this reason the execution of the logarithmizing circuit in the form of the resistive voltage divider makes it possible to considerably decrease the degree of an increase in the upper cut-off frequency depending on of the amplified signal level. The equivalent circuit of cascade/stage with nonlinear divider/denominator is represented in Fig. 52. On the basis of the theorem about equivalent generator can be written the expression for the standardized/normalized frequency characteristic of amplifier stage with the nonlinear voltage divider in the range of higher frequencies. It takes the form:

$$A(\omega) = \frac{1}{\sqrt{\left[1 - \omega^2 C_1 C_2 \frac{R_{\text{н}} R_{\text{неп}} R_{\text{дел}}}{R_{\text{н}} + R_{\text{неп}} + R_{\text{дел}}}\right]^2 + \left[\omega \frac{R_{\text{дел}} (C_2 R_{\text{неп}} + C_1 R_{\text{н}}) + R_{\text{неп}} R_{\text{н}} (C_1 + C_2)}{R_{\text{н}} + R_{\text{дел}} + R_{\text{неп}}}\right]^2}} \quad (46)$$

Set/assuming

$$R_{\text{дел}} = R_{\text{н}},$$

$$R_{\text{неп}} = b R_{\text{н}},$$

$$C_1 + C_2 = C_{\text{н}}.$$

where C_1 it is determined by the output interelectrode capacitance of amplifier instrument and by the wiring capacitance of the circuit of output electrode; it is accepted equal to $\gamma_1 C_{\text{н}}$; to C_2 it is determined by the input interelectrode capacitance of the amplifier instrument of the subsequent cascade/stage and by the wiring capacitance of the circuit of input electrode; it is accepted equal to $\gamma_2 C_{\text{н}}$;

$$\gamma_1 + \gamma_2 = 1.$$

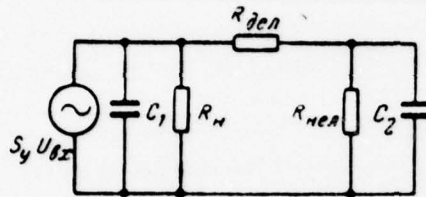

Fig. 52. Equivalent circuit of logarithmic cascade/stage with the nonlinear voltage divider.

Page 71.

In the general case both components of total capacitance are different, i.e., $\gamma_1 \neq \gamma_2$.

Taking into account the introduced designations expression (46) can be rewritten

$$A(\omega) = \frac{1}{\sqrt{\left[1 - \omega^2 C_n^2 R_n^2 \gamma_1 \gamma_2 \frac{bn}{1+n+b}\right]^2 + \left[\omega C_n R_n \frac{n(\gamma_2 b + \gamma_1) + b}{1+n+b}\right]^2}} \quad (47)$$

By set/assuming for simplification in calculation $C_1 = C_2$, i.e., $\gamma_1 = \gamma_2 = 0.5$, and by being given the nonuniformity of amplification within the limits of passband, equal to $1/\sqrt{2}$, it is possible to find the standardized/normalized value of the upper cut-off frequency as function of several values, which characterize the circuit of the load strictly of amplifier stage and the circuit of the nonlinear voltage divider, namely:

$$\omega_n C_n R_n = \psi(b, n) = \sqrt{\frac{-Y_2 + \sqrt{Y_2^2 + 4Y_1}}{2Y_1}} \quad (48)$$

where

$$Y_1 = \left[\frac{\gamma_1 \gamma_2 n b}{1 + n + b} \right]^2$$

and

$$Y_2 = \frac{[n(\gamma_2 b + \gamma_1) + b]^2 - 2\gamma_1 \gamma_2 n b (1 + n + b)}{(1 + n + b)^2}$$

they are the coefficients of the biquadratic equation

$$(\omega_b C_n R_n)^4 Y_1 + (\omega_b C_n R_n)^2 Y_2 - 1 = 0. \quad (49)$$

Figure 53 depicts theoretical the curves of the dependences of the upper cut-off frequency on value $b = R_{\text{нел}}/R_n$. Curves are constructed in accordance with expression (48) for different values $n = R_{\text{дел}}/R_n$.

Page 72.

From the presented curve/graphs it follows, that the more the resistance $R_{\text{дел}}$ (i.e. value n), that to a lesser degree it depends the upper cut-off frequency on changes in the value of nonlinear resistance - coefficient b , i.e., from changes of input signal level. Here for a comparison is given the curve of dependence $\omega_b C_n R_n = \psi(b)$ with $n = 0$, i.e., the simple circuit of logarithmic amplifier, made Be of the application/use of any circuits of the stabilization of the pass bandwidth.

Thus, and the results of experiment and theoretical curves (Fig. 53) completely confirm the effectiveness of the ^{indicated} method of stabilization f_n .

Furthermore, introduction into the circuit of the logarithmizing

circuit of linear resistor $R_{\text{лел}}$ contributes (as shown in §5) to an increase in the dynamic range of amplifier in input signals.

In conclusion it should be noted that the stabilization of the bandwidth of aperiodic type logarithmic amplifier it should be realized by all examined methods simultaneously, thanks to which not only to preserve, but also it is possible to increase the dynamic range of amplifier in input signals in comparison with the simplest circuit.

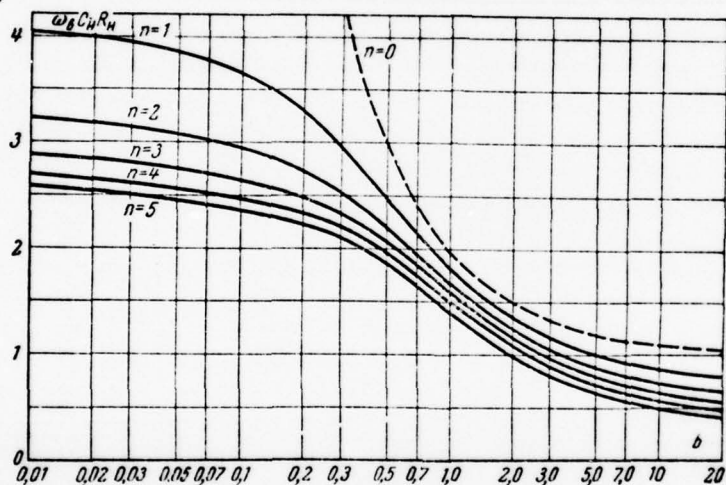

Fig. 53. Dependence of the standardized/normalized upper cut-off frequency of the passband of logarithmic amplifier on the parameters of its circuit.

From the analysis of the proposed circuit solutions it is

possible to see that some of them provide not only the stability of the bandwidth, but also an increase in the dynamic range in input signals. This is especially valuable from the viewpoint of the execution of the operations of construction-engineering character - the adjustment and the tuning of logarithmic amplifier.

9. Special features/peculiarities of the stabilization of passband in resonance type logarithmic amplifiers.

The stabilization of the bandwidth in resonance type logarithmic amplifiers can be realized by several methods.

One of these methods the introduction into the composition of the logarithmizing circuits of the linear resistors, stabilizing effect of which is described in §8, and also is illustrated by those presented in Fig. 54 calculated curves of the dependence of the relative expansion of the passband of the resonance logarithmizing cascade/stage

$$\delta_F = \Delta F_{\text{макс}}^{(1)} (\text{при } U_{\text{вх.макс}}) / \Delta F_{\text{мин}}^{(2)} (\text{при } U_{\text{вх}} = U_{\text{вх.мин}})$$

Key: (1) - with.

from values $1/b_2$ and $\rho = R_{\text{лин}}/R_{\text{н}}$; the curves are constructed for certain concrete/specific/actual type of the nonlinear cell/element, which is characterized by value $d_R = b_1/b_2 = 5$.

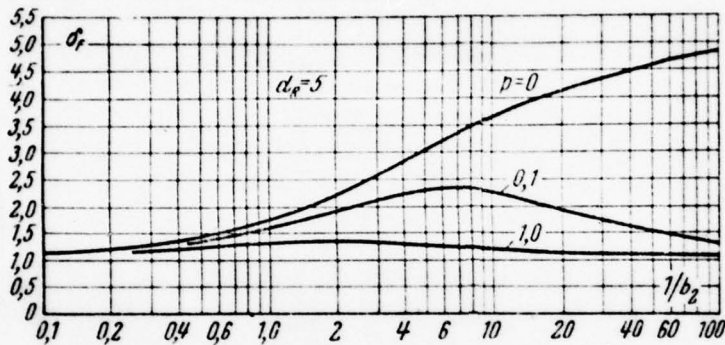

Fig. 54. Dependence of the expansion ratio of the passband of logarithmic amplifier on the parameters of its circuit.

Page 74.

From the given Fig. 54 curve/graphs shows that the introduction of linear resistor into the logarithmizing circuit of an amplifier of the type in question considerably lowers the expansion ratio of its passband during an increase of input signal levels. Presented in Fig. 55 the calculated curves of the dependences of the parameter $1/b_2 = Z_{in}/R_{\text{нел.мнн}}$

$$(1) \quad (\eta_{\text{пл}} \delta_F = \frac{\Delta F_{\text{Мак}}}{\Delta F_{\text{Мин}}} = \delta_{\text{Мак}})$$

Key: (1). with

on value p make it possible to graphically determine values $1/b_2$ and p , which correspond to the maximum expansion ratio of passband, and consequently, to select during the construction of amplifier those values $1/b_2$ and p , to which corresponds an insignificant change in the passband during an increase of input signal level.

Curves, depicted in Fig. 55, are constructed as follows. First must be determined derivative $d\delta_F/d(1/b_2)$: here

$$\delta_F = \frac{(1/b_2 + 1 + p/b_2)(d_R + p/b_2)}{(1/b_2 + d_R + p/b_2)(1 + p/b_2)} \quad (50)$$

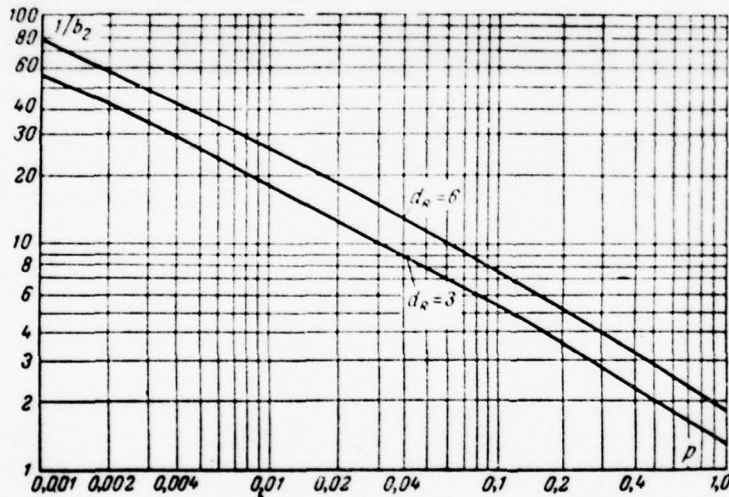

Fig. 55. Curve/graphs for determining the parameters of amplifier circuit.

Page 75.

Further expression for a derivative is equated zero, and from the

obtained in this case equation, which has the following form:

$$\frac{p(p+1)}{b_2^2} - d_R = 0, \quad (51)$$

can be obtained the values $1/b_2$, which correspond to the maximum values δ_r with this p .

However, as noted above, this method one ought not to apply as fundamental that reason, that an increase in the degree of the stabilization of passband (i.e. increase p) is accompanied by a decrease in the dynamic range of amplifier in input signals d_{Bxi} , that undesirably.

Thus, it is possible to assert that resonance type logarithmic amplifier, just as aperiodic type amplifier, made with the application/use of the simplest circuit of logarithmic operation, is characterized by the considerable expansion of passband. Quantitatively this expansion can be by the specific relationships, analogous obtained above for aperiodic type nonstabilized circuit.

The second method of stabilization of the bandwidth of logarithmic amplifiers of the type in question is the execution of the interstage circuits of communication/connection in the form the more or less compound circuits (Fig. 56), described by the differential equations of the fourth (and above) order. This is

caused by those by the known fact that the form of the frequency characteristic of circuit that nearer to ideal rectangle and that less depends on changes in the values of external resistor/resistances.

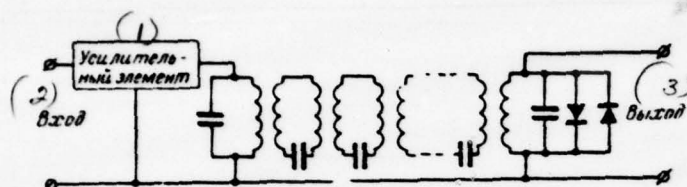

Fig. 56. Circuit of interstage coupling circuit with the large number of degrees of freedom, loaded to nonlinear cell/element.

Key: (1). Amplifier cell/element. (2). Input. (3). Output/yield.

Page 76.

Let us examine the special feature/peculiarities of the logarithmic amplifier, where as interstage networks are used circuits more complex, rather than simple resonant circuits. Specifically, is examined the amplifier with the use of the two-circuit body-fixed system; the generalized pattern of this amplifier stage is represented in Fig. 57.

The logarithmic selective amplifier made with the

application/use of two-circuit filters, possesses the property, which profitably differs it from tuned amplifier, namely: by the stability of the bandwidth during a change of input signal level. This can be explained as follows (is examined single cascade/stage). It is assumed that the frequency characteristic of cascade/stage because of the appropriate selection of the communication/connection between the ducts of filter takes the form of double-humped curve, the communication/connection only insignificantly exceeding critical, i. e., $k/d = \eta = 1.5-2$. It is clear that when, at the input, the amplifier stage of comparatively weak signals is present, the resistor/resistance of the nonlinear cell/elements, connected in the ducts of filter, has the maximum value and does not exert noticeable effect on the form of frequency characteristic. With an increase in the amplitude of input voltage circuit damping of filter (d) grow/rises, which leads to an increase in the bandwidth of amplifier. But simultaneously with this with an increase in circuit damping of filter occurs the corresponding decrease in the value of the factor of communication/connection $\eta = k/d$ to unit and less. Consequently, the frequency characteristic of cascade/stage will change its form, acquiring gradually the form of the single-humped curve whose width must decrease.

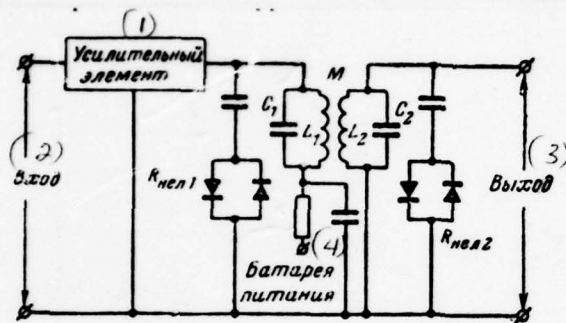

Fig. 57. Circuit of nonlinear two-circuit selective amplifier.

Key: (1). Amplifier cell/element. (2). Input. (3). Output/yield. (4). Power battery.

Page 77.

This means that the bandwidth of the logarithmizing amplifier stage with two-circuit filter is in this case the function of two variable values

$$\Delta F = \psi[R_{нел1}(U_{вх}); \eta(U_{вх})], \tag{52}$$

of which the first ($R_{нел1}$) it causes expansion, and the second (η) -

the contraction of passband with an increase in the amplitude of input signal; it is known that the lesser the value of the generalized coupling coefficient between the ducts (or the factor of communication/connection η), the narrower the bandwidth. At the appropriate selection of the parameters of the ducts of filter the action of these values can be mutually compensated for, thanks to which an absolute change in the bandwidth, equal to

$$\Delta F'' (\text{при } U_{\text{вх. макс}}) - \Delta F' (\text{при } U_{\text{вх. мин}}) = \delta F, \quad (53)$$

Key: (1) - with

it proves to be are very insignificant, i.e.,

$$\delta F \rightarrow 0.$$

For the analytical determination of the expansion ratio of the passband of amplifier one should investigate the expression for the frequency characteristic, which is determined by the frequency dependence of the transmission factor of two-circuit filter. The latter is described by the known expression

$$|K_{\Phi}| = \frac{k}{\sqrt{(d_1 d_{II} + k^2 - \gamma^2)^2 + \gamma^2 (d_1 + d_{II})^2}}. \quad (54)$$

Here k is a coupling coefficient between the ducts of filter; γ - relative detuning;

duct;

$$d_1 = \frac{\omega_p L}{R_{III} |1 + b|} - \text{the attenuation of the first}$$

$$d_{II} = \frac{\omega_p L}{R_{III} |1 + b|} - \text{the attenuation of the secondary circuit;}$$

R_{III} - the resistor/resistance of the resistors which shunt the ducts of filter.

Although both ducts are made with the application/use of identical on their ratings cell/elements, nevertheless $d_I \neq d_{II}$

Page 78.

This is explained by the facts that in the general case of the amplitude of the edge stresses of filter are different, i.e.,

$$U_{II} = \eta U_I, \quad (55)$$

where $\eta = \frac{k}{\sqrt{d_I d_{II}}}$ - the factor of communication/connection.

Consequently, the values of the resistor/resistances of the nonlinear cell/elements, connected in the composition of the first and secondary circuits of filter, are also different, namely:

$$\begin{aligned} R_{ne.II} < R_{ne.I}; \\ b_{II} < b_I. \end{aligned} \quad (56)$$

After designating by $\alpha_p = y/d_0$ the generalized detuning,

$$\begin{aligned} \frac{1 + b_I^2}{b_I} &= B_I; \\ \frac{1 + b_{II}^2}{b_{II}} &= B_{II}; \\ d_I &= d_0 B_I; \\ d_{II} &= d_0 B_{II}; \\ \eta_0 &= k/d_0; \end{aligned}$$

$d_0 = \omega_p L / R_{II}$ — circuit damping, determined with infinitesimal amplitude of the voltage of signal on the input of amplifier stage, can be written:

$$|K_\Phi| = \frac{\eta_0}{\sqrt{[B_1 B_{II} - \alpha_p^2 + \gamma_0^2]^2 + 4\alpha_p^2 [0.5(B_1 + B_{II})]^2}} \quad (57)$$

But in view of the fact that the two-circuit body-fixed system usually is fulfilled in the communication/connection between the ducts of filter, equal critical or insignificantly exceeding it, those i.e., $\eta_0 \cong 1$, with sufficient for practical calculations accuracy it is possible to count $U_{II} \cong U_I$ and $B_{II} \cong B_I = B$. Then the standardized/normalized frequency characteristic of filter is record/written in the following form:

$$|A(\omega)| \cong \frac{B^2 + \gamma_0^2}{\sqrt{(B^2 - \alpha_p^2 + \gamma_0^2)^2 + 4\alpha_p^2 \gamma_0^2}} \quad (58)$$

In accordance with expression (58) in Fig. 58 are constructed for

the different of input signal level, i.e., for different values of b , standardized/normalized frequency system performances.

Page 79.

Figure 58 shows that the bandwidth of the logarithmizing cascade/stage with two-circuit filter in the load circuit of amplifier cell/element remains by virtually the constant during change amplitude of input signal in more or less wide dynamic range.

The third method of stabilization of the bandwidth whose application/use is advisable in resonance type logarithmic amplifiers, is the introduction into the composition of the amplifier preliminary - forming frequency characteristic - band-pass filter or amplifier stages, the frequency characteristic of which differs in terms of the higher degree of squareness.

It is clear that the effectiveness of this method of stabilization the greater, the more considerable the difference in the bandwidth of the logarithmic amplifier and preliminary equipment/device, i.e., must be observed the condition

$$\Delta F_{\text{предл}} < \Delta F_{\text{мин}} \log^{(i)} (\text{при } U_{\text{вх}} = U_{\text{вх.мин}}), \quad (59)$$

Key: (i). With

where $\Delta F_{\text{предл}}$ - the bandwidth of linear preamplifier;

$\Delta F_{\text{мин.лог}}$ — the minimum bandwidth of logarithmic amplifier, determined on the minimum of input signal level.

The bandwidth ΔF_{pec} of the multistage selective amplifier, which is the series connection of two amplifiers — the preliminary linear amplifier, the bandwidth of which does not depend on changes in the level of the input signal

$$\Delta F_{\text{лин}} \neq \psi(U_{\text{вхл}});$$

and of the fundamental logarithmic amplifier, the bandwidth of which changes depending on of the input signal level

$$\Delta F_{\text{лог}} = \psi(U_{\text{вхл}}),$$

it is defined as certain resulting quantity, computed taking into account values $M_{\text{лин}}$ and $M_{\text{лог}}$.

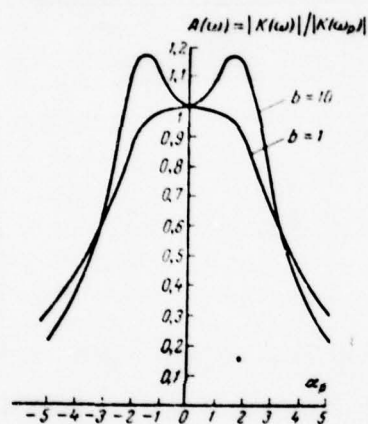

Fig. 58. Standardized/normalized frequency characteristics of two-circuit logarithmic amplifier.

Page 80.

For the purpose of the quantitative determination of the effect of the individual parts of the amplifier - linear and nonlinear - to the degree of a change in the resulting bandwidth ΔF_{res} the amplifier one should examine in the form of the simplified model, which

consists of two resonance quadrupoles, frequency characteristics of which are multiplied. Then the stabilizing effect of linear preamplifier can be illustrated given in Fig. 59 by the calculated curve of the dependence

$$\Delta F_{\text{рез}}/\Delta F_{\text{лин}} = \Psi(\Delta F_{\text{нед}}/\Delta F_{\text{лин}}).$$

From curve/graph it is evident, that the more value $q = \Delta F_{\text{нед}}/\Delta F_{\text{лин}}$, i.e. the more the width of the bandwidth of the logarithmic amplifier $\Delta F_{\text{нед}}$ in comparison with the bandwidth of preliminary linear amplifier $\Delta F_{\text{лин}}$, the lesser the width of the resulting passband $\Delta F_{\text{рез}}$ it differs from $\Delta F_{\text{лин}}$.

Besides the stabilization of the bandwidth of logarithmic amplifiers, the introduction into their composition of linear cascade/stages makes it possible to solve other problems, appearing during the practical construction of logarithmic amplifiers of the type in question and caused by the specific character of their work.

Thus, for instance, during the construction of logarithmic amplifier with wide (80-100 dB) dynamic range the input signals it is necessary to keep in mind that the effectiveness of logarithmic computing circuits turns out to be maximum only when noticeably are developed the properties of nonlinear cell/elements, i.e., with supply to the latter of powerful signals. But the signals of a more

or less significant level will be observed at the output only of certain stages (beginning with the second-third cascade/stage). But since in the first cascade/stages of the amplified signal level is comparatively small, the property of the nonlinear cell/elements, connected in the load circuit of these cascade/stages, they are developed very weakly and dynamic range of the amplifier practically does not increase relative to the input signals. Therefore to introduce the logarithmizing circuits into the first stages of amplifier it is represented unsuitable, and they usually work in linear conditions.

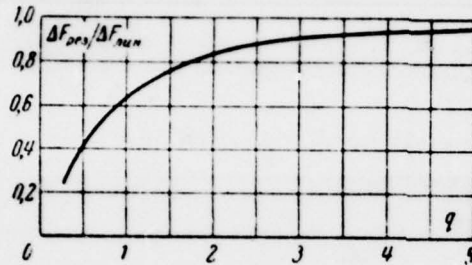

Fig. 59. Dependence of the resulting bandwidth of the series connection of linear and logarithmic selective amplifiers on the relationship/ratio of their passbands.

Page 81.

Thus, besides the provision for an in practice the constant and independent variable of a change of input signal levels bandwidth, the linear stages of preliminary amplification serve also for achievement of the necessary value of the amplification of the signals of weak level, and their presence in the composition of logarithmic amplifier contributes to an increase in the effectiveness of logarithmizing circuits, i.e., as the final result it leads to an increase in the dynamic range of amplifier in input signals.

Furthermore, the stabilization of the form of frequency characteristic (or, more precise, the bandwidth) in this type amplifiers it can be realized in by some other methods, in particular the partial shunting of oscillatory circuit by nonlinear cell/elements the so forth.

Are such the fundamental methods of the stabilization of the bandwidth in resonance type logarithmic amplifiers.

It is necessary to note that in a transistorized logarithmic amplifier of the resonance type, with a change in the level of the input signal a change in the resonance frequency occurs along with an expansion of the passband which is inherent to all nonlinear amplifiers. The latter is caused by the fact that with the operation of the amplifier in a broad dynamic range of change in the level of input signals the nonlinearity of the static characteristics of amplifier transistors is manifested. This, in turn, leads to a change in the operating conditions of the transistors on direct current and, consequently, to a change in the value of capacitances C_{CK} and $C_{сдиф}$ depending on the signal level.

As is known, the capacitance/capacities indicated into the composition of oscillatory circuit, in consequence of which during their change is changed the value of the resulting capacitance/capacity of duct and, consequently, also its resonance frequency. It is not difficult to see that the degree of a change in the latter is found in direct dependence on type the used during the construction of amplifier transistors, which are characterized by the low capacitance values of passages, and is great, if amplifier is assembled on low-frequency transistors.

On the basis of this it is possible to make the following conclusions:

1. During the production of resonance type transistor logarithmic amplifiers it is desirable to apply the new types of transistors, which possess the large value of cut-off frequency f_c and the respectively relatively low value of a change in the diffusion emitter transition capacitance. In this case will be reached the sufficiently high stability of resonance frequency both in the separate logarithmizing cascade/stages and in all amplifier as a whole in the work of the latter in the wide interval of the variation of input signal levels. The application/use above methods of the stabilization of the form of frequency characteristic indicated will make it possible to ensure the bandwidth, virtually independent variable of of input signal level.

Page 82.

2. Application/use in the amplifiers of the transistors of the old types in question, which possess low values f_p , one should restrict by the range of comparatively low frequencies (not more than 3-5 MHz), where is possible the use of sufficiently high capacitance values of oscillatory circuit C_{ROUT} . In this case changes of the resulting capacitance/capacity of duct, caused by undesirable changes in its separate components, will be small. As a result a change of the resonance frequency of amplifier during a change in the level input of the signal will be brought to the minimum.

10. Calculation of resonance of logarithmic cascade/stage.

The special feature/peculiarities of the calculation of the practical circuits of the resonance logarithmic amplifiers, made both on the tubes and on transistors (are in form only the those special feature/peculiarity of the calculation, which are connected with the

determination of the fundamental parameter of logarithmic amplifier - dynamic range from input signals), are caused by the need for the account of the entry impedance of amplifier instrument and detuning of cascade/stage.

Let us begin from the electron-tube resonance cascade/stage, where in the anode circuit of tube (on alternating current) in parallel to oscillatory circuit is included symmetrical nonlinear cell/element.

The common/general/total principles of the calculation of logarithmic amplifiers with nonlinear cell/elements in load circuits are presented in §3.

Therefore, the fundamental calculation formula is expression (23), suitable for the calculation both aperiodic and tuned amplifier. However, in the case in question this expression somewhat is modified, namely: value $R_{\text{нел.макс}}$ and $R_{\text{нел.мин}}$ corresponding to beginning and the end/lead of the logarithmic section of the amplitude characteristic of cascade/stage, they must be determined in the units

$$|Z_R| = \frac{R_{\text{нел.макс}}}{\sqrt{1 + \alpha_p^2}} \quad (60)$$

circuit; α_p - the generalized detuning; $R_{\text{eff}} = \frac{1}{\frac{1}{R} + \frac{1}{R_n} + \frac{1}{R_{\text{in}}}}$ - the resulting effective resistance of duct; R is resistor/resistance of the resistor, connected directly in duct or into the grid circuit of the tube of the subsequent cascade/stage; R_n is the resistor/resistance, caused by losses in inductance coil and the dielectrics of duct; R_{in} is the input impedance of a tube of the subsequent cascade/stage.

Consequently, the parameter $1/b_2$, which is one of the initial for determining value d_{in} , is calculated as follows:

$$\frac{1}{b_2} = \frac{|Z_r|}{R_{\text{in, min}}} = \frac{R_{\text{eff}}}{R_{\text{in, min}}} \frac{1}{\sqrt{1 + \alpha_p^2}} \quad (61)$$

It is not difficult to see that the value of the dynamic range of resonance cascade/stage at input signals depends not only on the value of the generalized detuning, but also on the frequency, for which is inclined oscillatory circuit. Actually, the component of the resulting effective resistance of duct R_n directly is determined by the frequency of tuning f_0 , namely:

$$R_n = \frac{1}{2\pi f_0 C_n d_n} \quad (62)$$

where C_n is a capacitance/capacity of oscillatory circuit; d_n - circuit damping, caused by losses in inductance coil and the dielectrics of duct (so-called its own circuit damping whose value ranges from 0.01 to 0.05).

Another component R_{sub} , caused by the input impedance of a tube of the subsequent cascade/stage, is defined as

$$R_{\text{ix}} \approx \frac{A}{f_0^2}, \quad (63)$$

where A is the constant coefficient, depending on the geometry of tube and mode of its operation on direct current and having value from $0.05 \cdot 10^{20}$ to $(1.0-1.5) \cdot 10^{20}$ ohm \cdot Hz.

Page 84.

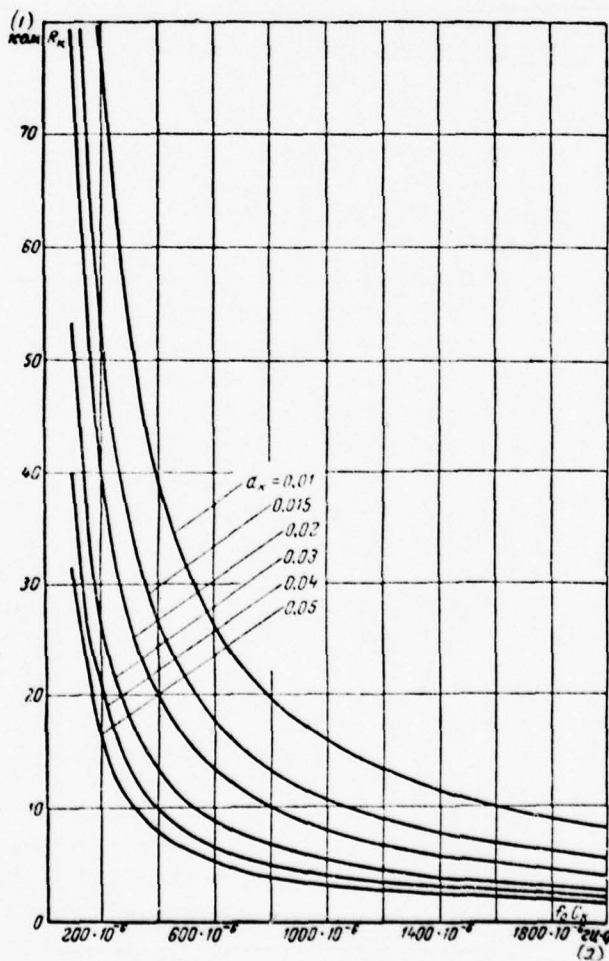

Fig. 60.

Fig. 60. Dependence of the internal resistance of the losses of oscillatory circuit on frequency.

Key: (1). $K\Omega$ (2). Hz•F.

Page 85.

For the facilitations of the calculation of value R_{int} in Fig. 60 and 61 are constructed the graph/diagrams of dependence $R_k = \Psi_1(j\omega C_k, d_k)$ and $R_{bx} = \Psi_2(j\omega, A)(f_0, \Lambda)$, designed in accordance with expressions (62) and (63) respectively. With the use of the curve/graphs indicated it is necessary to bear in mind that the fact that they are constructed irrespectively of the concrete/specific/actual types of oscillatory circuit and electron tube. This fact makes it possible to encompass with the proposed curves the virtually all used at present types of tube and ducts.

Thus, in the most general case, when the frequency of the tuning of amplifier stage does not coincide with the frequency of the amplified cascade/stage, i.e., occurs certain detuning, characterized by value α_p , the determination of the parameter $1/b_2$ can be produced with the aid of the curve/graphs, constructed on Fig. 62 in accordance with expression (61).

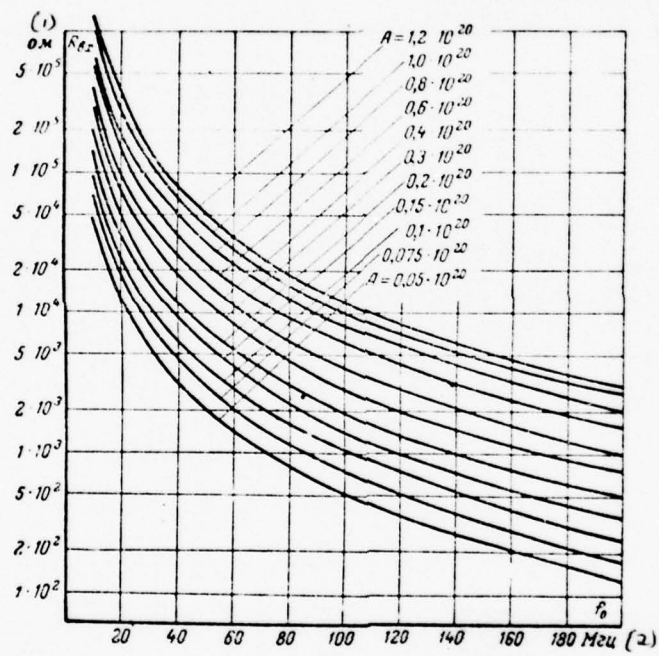

Fig. 61. Dependence of the input impedance of a tube on frequency.

Key: (1) . ohm. (2) . MHz.

Page 86.

In accordance with what has been said, the value of the dynamic range of the resonance logarithmizing cascade/stage at input signals can be found as follows:

1. Is determined necessary for providing the assigned values of the factor of amplification and bandwidth in the mode of the amplification of weak signals (more precise, in the work of cascade/stage on the linear section of amplitude characteristic) the value of the resistor/resistance

$$R_{\text{DNU}} = 1 / \left(\frac{1}{R} + \frac{1}{R_{\text{u}}} + \frac{1}{R_{\text{nx}}} \right).$$

The separate components of this resistor/resistance are determined with the aid of curve/graphs (Fig. 60 and 61).

If the design/projected amplifier is intended for a work in the range of the comparatively low frequencies, when resistor/resistances R_{u} and R_{nx} have the significant magnitude, as components $1/R_{\text{u}}$ and $1/R_{\text{nx}}$ it is possible to disregard, and then $R_{\text{DNU}} \approx R$.

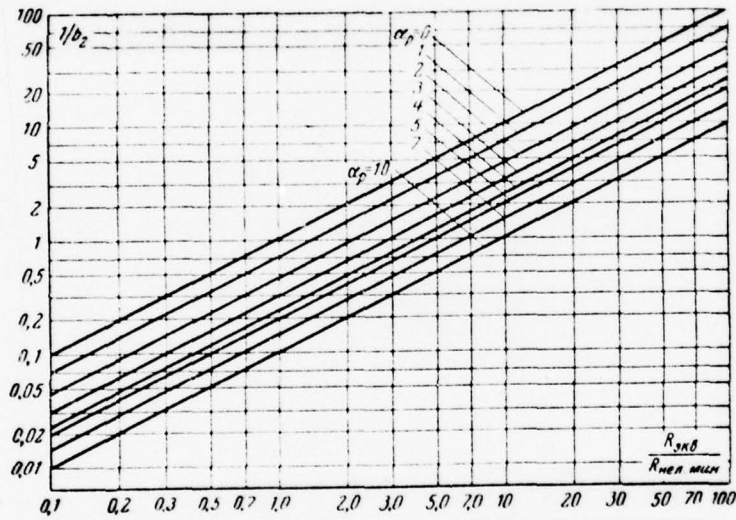

Fig. 62. Dependence of the equivalent resistance of oscillatory circuit with nonlinear load on detuning.

2. Is found the value of the generalized detuning a_p and from curve/graphs (Fig. 62) is determined for the obtained above value $R_{out}/R_{in, min}$ the value of the parameter $1/b_2$.

3. For the assigned values d_{max} , d_R and $1/b_2$ with the aid of the graphs presented in Fig. 14-18, is determined the value of the dynamic range of cascade/stage from input signals d_{in} .

Other parameters of amplifier, such as amplification factor and the bandwidth, can be designed in accordance with the methods, known from the theory of tuned amplifiers.

Let us examine now the special feature/peculiarities of the calculation of the resonance logarithmic amplifier, made on a transistor.

As is evident, the order of the calculation remains unchanged. It is natural that there is a difference in the calculation of the transistor amplifier, it is comprised in the account of the character of a change in the input and output resistance of amplifier instrument, i.e., difference bears only quantitative character. Actually, if representation in Fig. 61 curve/graphs are designed irrespectively of the concrete/specific/actual type of tube, the values R_{in} , found with the aid of to the type of tube, whereupon value found with the aid of these curve/graphs, closely coinciding with real values over a wide range of frequencies, then for transistors such universal curve/graphs cannot be constructed. Thus, for instance, for comparatively low frequencies, which do not exceed

(0.05-0.1) λ . when the input and output resistance are real values, it is possible to use the expressions, real for the T-shaped equivalent replacement scheme of transistor, namely:

$$\begin{aligned} R_{bx.o.g} &= r_g + r_g \left[1 - \frac{\alpha}{1 + Z_n Z_R} \right]; & (64) \\ R_{bx.o.o} &= r_g + r_g \left[1 + \frac{\alpha}{1 - \alpha + Z_n Z_R} \right]; \\ R_{bx.or} &= r_g + \beta [r_g + Z_n], \end{aligned}$$

where r_g, r_n, r_R - the parameters of replacement scheme; α - the transmission factor of the current of emitter; $\beta = \alpha/(1-\alpha)$; Z_n - the equivalent load impedance, and to construct according to these expressions curves, that make it possible to determine the value of the input and output resistance of cascade/stage for the more or less wide interval of the variation in the parameters of transistor and load circuit.

Page 88.

However, for the high frequencies, when all parameters of transistors become composite, the expressions indicated and, consequently, also the constructed in accordance with them curve/graphs no longer can be used. Formulas, recommended for determining the parameters of transistor at high frequencies, turn

out to be too bulky. In connection with this for practical calculations can be used experimentally obtained the curves of the dependences of the parameters of transistor on frequency. Some of such curves are represented in Fig. 63-64 for the connection/inclusion of amplifier transistor according to circuit with common/general/total base and in Fig. 65-66 for the connection/inclusion of amplifier transistor according to common-emitter connection.

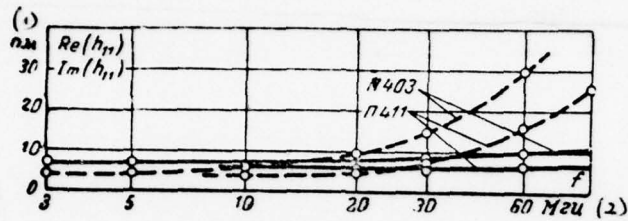

Fig. 63. Dependence of the real and imaginary components of the entry impedance of transistor on frequency with voltage on collector/receptacle $U_k = -5$ volts and the current of collector $I_k = 5$ mA. — — — real component; - - - - imaginary component.

Key: (1) - ohm. (2) - MHz.

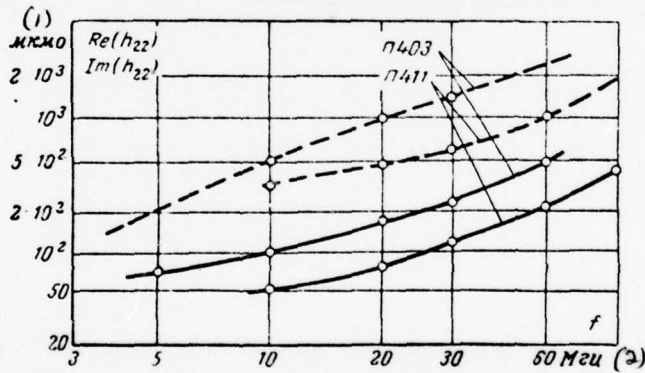

Fig. 64. Dependence of the real and imaginary components of the output conductance of transistor on frequency with voltage on collector/receptacle $U_k = -5$ volts and the current of collector/receptacle $I_k = 5$ mA. — — — real component; - - - - imaginary component.

Key: (1) - μ mo. (2) - MHz.

Page 89.

After on the proposed curve/graphs are determined values R_{ix} and R_{Bix} it is possible to perform further calculation according to the proposed procedure.

Let us note only that since during the construction of transistor tuned amplifiers it is necessary to take measures for providing a mode/conditions of agreement for power and decreases in the effect of input and output resistance on oscillatory circuit, is recommended the partial connection/inclusion of duct both from the collector/receptacle of amplifier transistor and from the base of the transistor of the subsequent cascade/stage. In connection with this value R_{ix} and R_{Bix} those which are introduced into the calculated relationship/ratios, one should determine taking into account the appropriate values of the coefficients of incorporation.

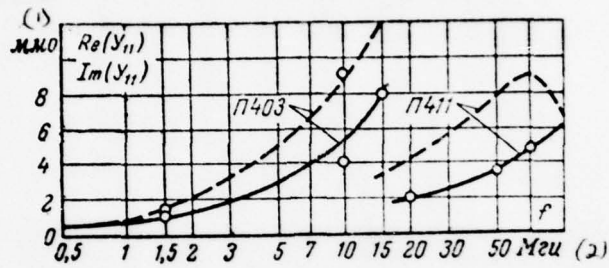

Fig. 65. Dependence of the real and imaginary components of the input admittance of transistor on frequency with the voltage from collector/receptacle $U_k = -5$ volts and the current of emitter $I_e = 1$ mA (for the transistor П403) and $U_k = -2$ volts and $I_e = 1$ mA (for the transistor П411). — — — real component; - - - - imaginary component.

Key: (1). mmho. (2). MHz.

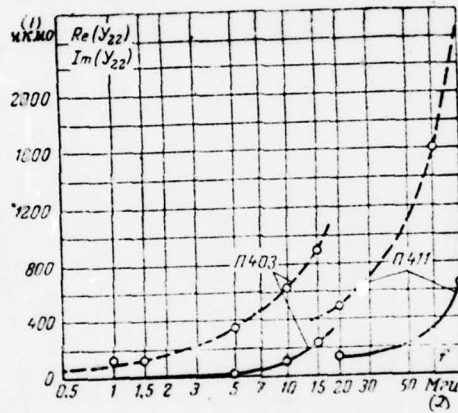

Fig. 66. Dependence of the real and imaginary components of the output conductance of transistor on frequency with $U_{\text{н}} = -5$ volts and $I_{\text{с}} = 1$ mA (for the transistor P403) and $U_{\text{н}} = -2$ volts and $I_{\text{с}} = 1$ mA (for the transistor P411). — — the real component; - - - - imaginary component.

Key: (1). μmho. (2). MHz.

The proposed calculation procedure is related to tuned amplifier. But if we in amplifier use the more compound circuits of interstage communication/connection, for example two-circuit filter, then in general form the calculation formulas turn out to be more complex. However, in logarithmic amplifiers the parameters of these circuits are selected so that the value of the factor of communication/connection would be equal critical to value, and consequently, resonance curve was single-humped. In this case the formulas for determining \bar{d}_{bxi} remain virtually without the change: in them is introduced only the coefficient which considers an increase in the back-out resistor of duct into $\sqrt{2}$ with the same width of the transmission band as in tuned amplifier.

11. Use of its own nonlinearity of transistors for the construction of logarithmic amplifiers.

The simplest and widespread method for the realization of logarithmic amplifiers is the introduction of nonlinear resistor into the load circuit of amplifier cell/element - transistor. Thus, in general form logarithmic amplifier stage is the combination of usual

linear amplifier and nonlinear cell/element, which possesses the volt-ampere characteristic of the necessary form in this or another range of stresses. As shown in the previous sections, the presence of nonlinear resistors to the certain degree complicates amplifier circuit, since it requires the acceptance of those or other measures for an increase in the degree of the coincidence of amplitude characteristic with ideal logarithmic law.

Therefore it is of interest to examine the following question: there is a possibility to carry out a logarithmic amplifier, without introducing into circuit special nonlinear elements? It proves to be that this is possible because of the use of nonlinear properties of amplifier instruments, in this case of transistors.

It is known that the transistor is especially nonlinear instrument and in the general case can be considered as active nonlinear four-pole, the transmission factor, input and output and output resistance of which are the nonlinear functions of currents and voltages. In this case the character of the nonlinearity of the parameters of transistor qualitatively differs from the character of the nonlinearity of the parameters of electron tube.

Examining the standard characteristics of transistors, it is not difficult to ascertain that that field, within limits of which the static characteristics can be considered linear, is very small. And, therefore, with any considerable signal amplitudes at the input of amplifier stage (order 0.1V) amplitude characteristic begins to differ from linear law to which the greater degree, the more powerful the input signal. This is illustrated by the given in Fig. 68 amplitude characteristic of selective transistor amplifier (Fig. 67).

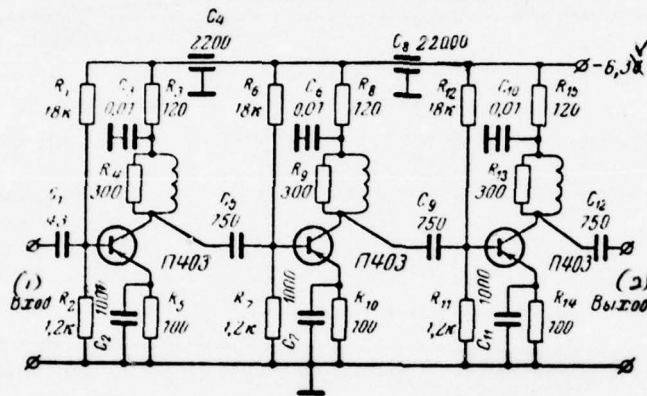

Fig. 67. Schematic diagram of three-stage tuned amplifier.

Key: (1). Input. (2). Output/yield.

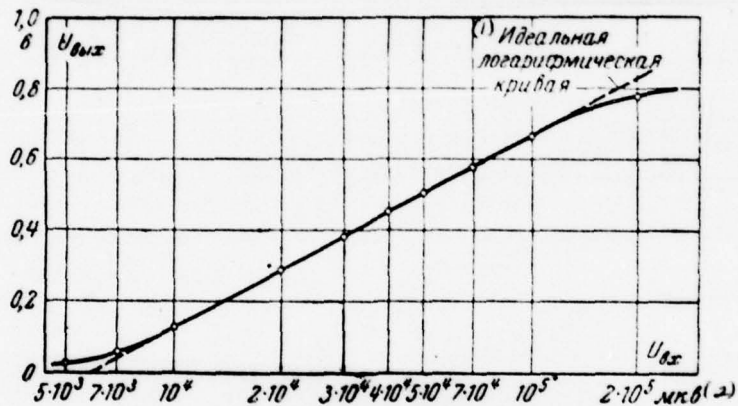

Fig. 68. Amplitude characteristic of tuned amplifier. Input signal is a continuous oscillation/vibration with frequency $f_c = 20$ MHz.

Key: (1). Ideal logarithmic curve. (2). μV .

Page 92.

As is evident, in the adopted semilogarithmic system of coordinates the characteristic is straight line (with very insignificant divergences) in dynamic range at input signals of approximately 30

dB. Furthermore, it proves to be that during a tenfold change in the amplitude of input signal - from 20 to 200 mV occurs the expansion of the passband of amplifier from 17 to 25 MHz, i.e., is observed the same effect as with the shunting of the load of transistor by nonlinear cell/elements. In actuality, so it there is. As is known, in multistage transistor amplifier the load circuit of each cascade/stage is shunted by the entry impedance of the subsequent transistor, equal at the incorporation of transistor according to common-emitter connection:

$$R_{\text{вх.о.в}} \approx r_0 + r_0 \left[1 + \frac{\alpha}{1 - \alpha + Z_{\text{в}} r_{\text{в}}} \right] \approx \beta r_0. \quad (65)$$

As is evident, the entry impedance in practice completely is determined by the resistor/resistance of passage emitter-base the physical processes, which occur in this passage (hole injection into the base of transistor), are analogous to processes in semiconductor diode, and the volt-ampere characteristic of emitter junction, which describes the process injection, is close to the volt-ampere characteristic of the diode, utilized as the basic type of nonlinear cell/element in logarithmic amplifiers of the type in question. Since the differential resistor/resistance of emitter junction is defined as

$$r_0 = kT/qI_0, \quad (66)$$

entry impedance of cascade/stage equally to:

$$R_{\text{вх.о.в}} \approx r_0 + \beta \frac{kT}{qI_0}. \quad (67)$$

Dependence $R_{n.o.}/\beta = \psi(I_e)$, being is constructed in the semilogarithmic system of coordinates (Fig. 69), has the form of straight line. Here are depicted (by dotted line) the characteristics of real transistors. As is evident, the latter coincide with described expression (43) of curve with very high accuracy up to the low values of entry impedance. With the high currents of emitter appear more or less considerable deviations from the idealized dependence, which is explained by the effect of the resistor/resistance of base r_b , which with the low currents of emitter can be disregarded.

During a change in the amplitude of input signal changes the current of the emitter of amplifier transistor and with respect is changed within sufficiently wide limits the resistance r_b . An example is the dependence of the entry impedance of the transistor P403 on the applied to junction voltage, presented in Fig. 70. This leads also to the fact that the resulting load impedance, equal to $R_{n.o.} = 1/(1/Z_n + 1/R_{n.o.})$

also decreases with an increase of the amplitude of input signal, that in turn, leads to decrease in nonlinear law and the coefficient of the amplification of cascade/stage.

The extent of the section of amplitude characteristic with positive slope/inclination and, consequently, also the dynamic range

of amplifier at input signals can be increased by changing the mode of transistors in direct current, this method in the form of the considerable nonlinearity of the static characteristics of transistors having more great possibilities, rather than in vacuum-tube amplifiers.

Page 93.

In conclusion it is necessary to note that such amplifiers should not be applied in the critical nodes of the radio-electronics equipment, where are required the high accuracy of functional transformation in the wide dynamic range of a change in the intensity of input signals, or the high stability of the parameters in all conditions of work. But, by speaking relative to the use of nonlinear properties of transistors, it is necessary to keep in mind that in conjunction with the known methods of logarithmic operation these properties give the determined effect. First, they contribute to an increase in the extent of the section of amplitude characteristic with positive slope/inclination, although it is obvious that the degree of this expansion cannot be determined by calculation, at least with the aid of known engineering formulas. From experimental data it follows that an increase in the dynamic range of amplifier in input signals can be 6-10 dB. In the second place, they make it possible to carry out a more or less satisfactory coupling of the individual sections of the amplitude characteristic of multistage logarithmic amplifier.

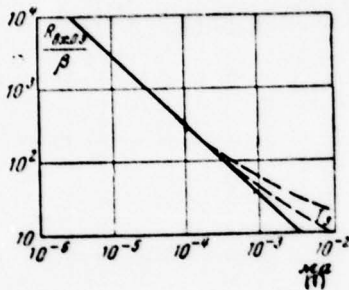

Fig. 69.

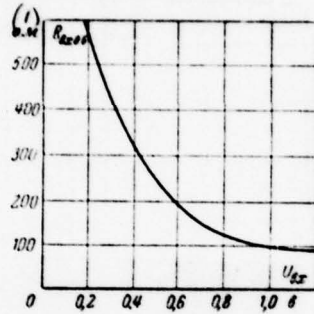

Fig. 70.

Fig. 69. The dependence of the standardized/normalized entry impedance of the transistor, connected according to common-emitter connection, from the current of emitter.

Key: (1) . mA.

Fig. 70. Dependence of entry impedance transistor, coupled according to circuit by common/general/total base, on input voltage. Transistor of the type P403: $I_{E, -5}$ mA; $U_{B, -5}$ volts

Key: (1) . ohm.

Page 94.

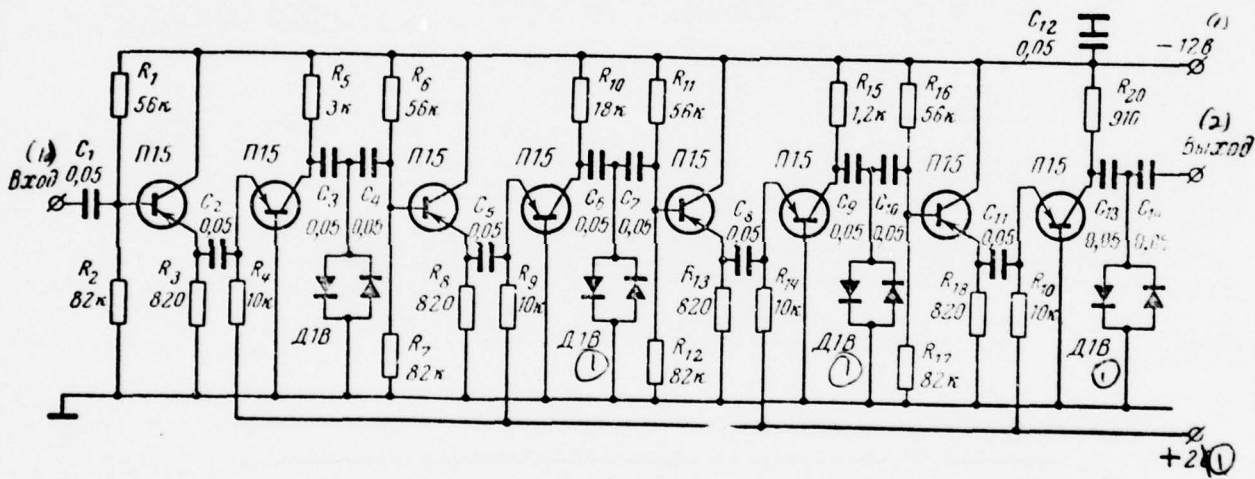

Fig. 71. Schematic diagram of four-stage logarithmic amplifier.

Key: (1). V. (1A). Input. (2). Output/yield.

Page 95.

12. Special feature/peculiarities of the *design* - technological execution of transistor logarithmic amplifiers.

The experimental check of logarithmic amplifiers showed that described into §6 the method of the construction the latter with use decouplers makes it possible to remove the undesirable shunting of nonlinear cell/element by the low by the entry impedance of the transistor of the subsequent cascade/stage and makes it possible of obtaining the considerable dynamic range of amplifier with input signals with the minimum number of cascade/stages. An example of this construction of multistage logarithmic amplifier is the depicted on Fig. 71 circuit. As is evident, the amplifier contains four amplifier stages, each of which consists of strictly the aperiodic amplifier, made on transistor with its incorporation according to common-base circuit of symmetrical nonlinear cell/element in load circuit on alternating current - the antiparallel connection of two semiconductor diodes and decoupling cell/element - emitter follower. In the circuit in question on amplifier transistors the supply voltage is fed from two sources. This measure considerably raises the stability of the fundamental characteristics of logarithmic amplifier. For this purpose amplifier transistors are included according to common-base circuit, which possesses in comparison with other circuit diagrams of transistor the highest stability. From the

experimentally removed amplitude characteristic of amplifier, presented in Fig. 72, it is possible to determine that the value of dynamic range at input signals is approximately 80 dB, whereupon the degree of the coincidence of objective parameter with ideal logarithmic curve is sufficiently high. Thus, is confirmed thought about the high quality of the proposed method of the construction of logarithmic amplifiers.

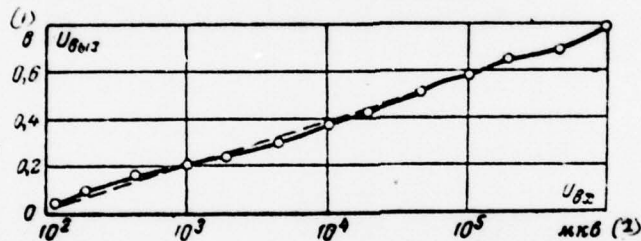

Fig. 72. Amplitude characteristic of four-stage logarithmic amplifier. — — — the amplitude characteristic of amplifier; - - - - ideal logarithmic curve. Input signal is a continuous oscillation/vibration with frequency $f_c = 200$ kHz.

Key: (1). V. (2). μ V.

Page 96.

Figure 73a shows the appearance of the experimental mock-up of the amplifier, made in accordance with schematic diagram in Fig. 71. Amplifier is made with the application/use of miniature/small parts (condenser/capacitors of the type MBM, resistors of the type OMLT and so forth). The nonlinear cascade/stages not only identical in the

relation to electrical circuit, but also are mounted according to identical assembly diagram (Fig. 73b).

Let us pause at the special feature/peculiarities of the execution of resonance type logarithmic amplifiers. As an example let us examine the amplifier, made with the application/use of the two-circuit body-fixed systems as interstage networks. Figure 74 depicts the circuit of transistor amplifier with the frequency of tuning $f_p = 8$ MHz.

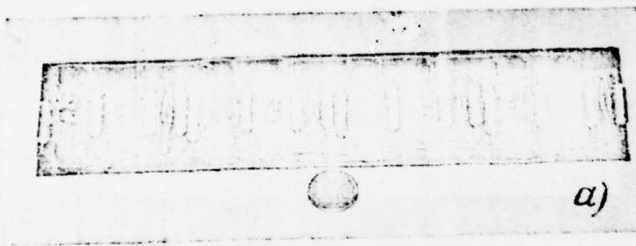

Fig 73 (a)

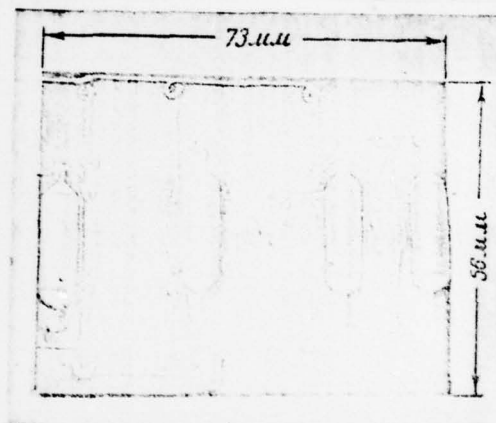

Fig 73 (b)

Fig. 73. Four-stage logarithmic amplifier. a) the appearance of amplifier; b) the appearance of one cascade/stage.

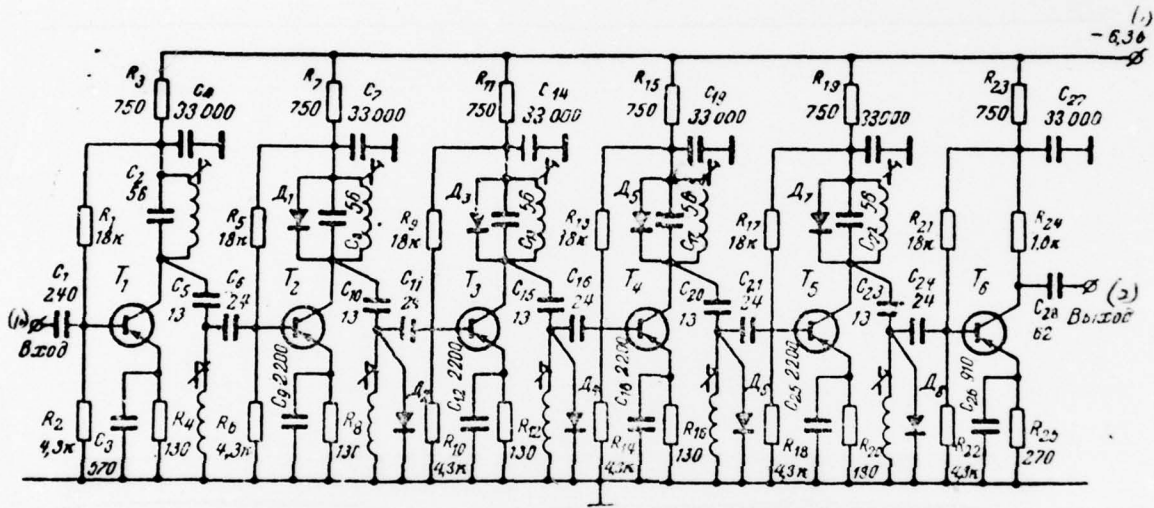

Fig. 74. Schematic diagram of selective logarithmic amplifier. \$T_1, T_2, \dots, T_6\$ - transistors of the type P416A; \$D_1, D_2, \dots, D_6\$ - semiconductor diodes of the type D9E.

Key: (1). V. (1A). Input. (2). Output/yield.

As is evident, in this amplifier the interstage network is made in the form of two-circuit system with the external capacitive coupling, which ensures obtaining the more stable under varied conditions operation of resonance curve, than in systems with transformer coupling. The special feature/peculiarity of the circuit in question is also that the secondary duct is made consecutive: besides capacitor and inductance coil, it contains input capacitance and the entry impedance of the transistor of the subsequent cascade/stage. The measure indicated provides, as is known, the condition of the optimum agreement for power and virtually removes the effect of the technological scatter of the parameters of transistor (entry impedance and input capacitance) on the characteristics of the interstage network of entire amplifier. As concerns nonlinear cell/elements, they are included in both ducts.

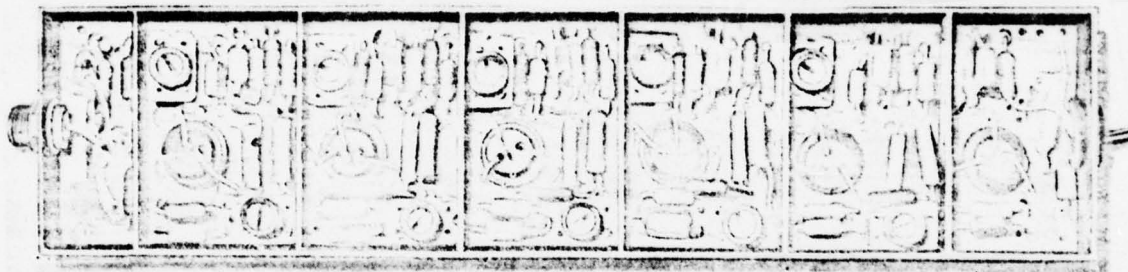

Fig. 75. The appearance of selective logarithmic amplifier.

Page 99.

Figure 75 gives the general view of the amplifier, prepared according to circuit in Fig. 74. As is evident, it is of miniature/small design with the high density of mounting.

All network elements are arranged/located on the printed board: each amplifier stage, in turn, it is arranged/located on the section of board, limited by the shielding partition/baffles (for the

prevention of the mutual effect of adjacent cascade/stages). The connection of amplifier into the common/general/total complex of equipment is realized through high-frequency couplings.

On the basis of presented it is possible to count that from structural/design point of view the amplifiers with nonlinear cell/elements in load circuits in essence are sufficiently simple and do not require the exaggerated number of supplementary parts (in comparison with usual linear amplifiers). Therefore the overall dimensions of nonlinear amplifiers are determined by the same factors that ^{and} the size/dimensions of linear amplifiers, and, as a rule, the complexity of the execution of mounting virtually does not grow/rise.

Comparing electron-tube and transistor logarithmic amplifiers with the shunting of load by nonlinear cell/elements, one should note the following important fact. In transistor amplifier is absent the undesirable combination of the strongly being heated amplifier instruments and temperature-sensitive nonlinear cell/elements, since transistors virtually do not isolate heat. There is not strongly heating parts, heat liberation from which could cause a change in the parameters of nonlinear cell/elements and connected with this changes in the characteristics of amplifier. Of course, the transistors are characterized considerably larger, rather than electron tubes, by the temperature dependence of the parameters. However, in this case it is

necessary to bear in mind following. First, the temperature compensation for transistor amplifier is realized with the aid of the parts, which determine the mode of the work of transistors on direct current, and usually do not require supplementary circuits. In the second place, transistor and nonlinear cell/element - semiconductor diode possess approximately the identical value of thermal inertia; consequently, is open/disclosed possibility by the comparatively simple methods to carry out a temperature compensation (for example, by the incorporation of thermistors).

Page 100.

Speaking about the reliability of transistor logarithmic amplifiers of the type in question, one should note the explicit advantage of the latter before vacuum-tube amplifiers, caused by the following reasons.

First, transistor itself is more reliable amplifier instrument, than electron tube.

In the second place, in transistor logarithmic amplifiers with the shunting of load in a number of cases is not required introductions into the circuit of the supplementary cell/elements, which stabilize the bandwidth (more precise, its high-frequency

section).

Thirdly, a temperature compensation in transistor amplifiers can be carried out by comparatively simple methods, which do not require the introduction of supplementary circuits.

As concerns the ways of an increase in the reliability of amplifiers of the type in question, they they do not differ from conventional (for example, the reliability of amplifier can be raised by a decrease in the number of its parts, by the application/use of nonlinear cell/elements, made in the form of parallel or antiparallel connection of semiconductor diodes, and so forth).

The proposed method of the construction of logarithmic amplifiers allows with the aid of one and the same cell/elements, introduced into the composition of load circuit, to carry out stabilization of the bandwidth, adjustment of the accuracy of logarithmic amplitude characteristic and extent of the logarithmic section of the amplitude characteristic of amplifier.

Conclusions. 1. In transistor logarithmic amplifiers with nonlinear cell/elements in load circuits the nonlinear cell/element is the unique specific part, which differs logarithmic amplifier from the linear. Therefore the selection of the type of nonlinear

cell/element and the determination of its operational conditions are the fundamental questions with analysis and the practical implementation of this type logarithmic amplifiers.

2. As the cell/elements, which possess nonlinear volt-ampere characteristic and which ensure obtaining logarithmic amplitude characteristic, in contemporary amplifiers are utilized the semiconductor diodes, transistors, and also electron tubes.

Page 101.

3. The fundamental index, which makes it possible to qualitatively rate/estimate the effectiveness of the work of logarithmic amplifier, is the value of dynamic range at input signals, determined by the extent of the logarithmic section of amplitude characteristic, i.e., by the parameters of load circuit and by the type of the used nonlinear cell/element. The proposed procedure of calculation of logarithmic amplifiers is universal and can be used during the calculation of circuits with nonlinear feedback, and also other equipment/devices, which contain the nonlinear cell/elements whose resistor/resistance changes under the effect either of the amplified signal or signal AGC.

4. Introduction into the nonlinear circuits of linear resistors

brings: to a decrease in the dynamic range of logarithmic amplifier - in the case of the incorporation of linear resistors consecutively with nonlinear cell/element;

to an increase in the dynamic range in input signals - in the case of the execution of the logarithmizing circuit in the form of the resistive voltage divider.

5. In transistor amplifiers (unlike the electron-tube) the problem of the simultaneous achievement of wide passband and considerable dynamic range in input signals is solved.

6. In transistor logarithmic amplifiers there is a supplementary factor, facilitating the stabilization of the value of the upper cut-off frequency and caused physical by the special feature/peculiarities of the work of transistors.

7. The nonlinear properties of transistors contribute to an increase in the extent of the section of amplitude characteristic with positive slope/inclination and make it possible to carry out a more precise coupling of the individual sections of the amplitude characteristic of multistage logarithmic amplifier.

8. It is shown, that the most advisable method of the

construction of transistor logarithmic amplifier is the execution of each nonlinear cascade/stage in the form of the combination of three circuits: linear amplifier stage, nonlinear logarithmizing circuit and untying cascade/stage.

Page 102.

9. From structural/design point of view the transistor amplifiers with nonlinear cell/elements in load circuits in essence are sufficiently simple and do not require the large number of supplementary parts (in comparison with usual linear amplifiers).

10. The examined method of the construction of logarithmic transistor amplifiers possesses the doubtless advantage; it allows with the aid of one and the same cell/elements, introduced into the composition of load circuit, to carry out stabilization of the bandwidth, adjustment of the accuracy of logarithmic amplitude characteristic and extent of the logarithmic section of the amplitude characteristic of amplifier.

11. The temperature compensation for transistor logarithmic amplifier is realized with the aid of the parts, which determine the mode of the work of transistors on direct current, and usually does not require the introduction of supplementary circuits, which makes

it possible to utilize transistor logarithmic amplifiers in miniature/small and miniature equipment.

REFERENCES.

1. V. M. Volkov, Logarithmic amplifier, the State Technical Press. *USSR, 1962.*
2. I. S. Gonorovskiy, Radio-engineering circuit and signals, publishing house the "Soviet radio", M., 1963.
3. A. P. Lukoshkin, Radar amplifiers with the large range of input signals, publishing house the "Soviet radio", M., 1964.
4. G. M. Krylov, Aperiodic nonlinear amplifier with stable passband, "radio mechanic", 1962, No 9.
5. G. M. Krylov, Features of logarithmic transistorized amplifiers, coll. "Semiconductor devices and their application/use", iss. 11, 1964.
6. N. I. Chistyakov, Radio receiving equipment, Svyaz'izdat, M., 1958.

DOC = 77182906

PAGE

~~56~~
184

7. G. M. Krylov, G. A. Smirnov, Transistorized amplifiers with automatic gain control, M. - L., publishing house "Energy", 1967.

Page 103. No typing.

~~XXXXXXXXXXXXXXXXXXXX~~

DISTRIBUTION LIST

DISTRIBUTION DIRECT TO RECIPIENT

ORGANIZATION	MICROFICHE	ORGANIZATION	MICROFICHE
A205 DMATC	1	E053 AF/INAKA	1
A210 DMAAC	2	E017 AF/RDXTR-W	1
B344 DIA/RDS-3C	8	E404 AEDC	1
C043 USAMIIA	1	E408 AFWL	1
C509 BALLISTIC RES LABS	1	E410 ADTC	1
C510 AIR MOBILITY R&D LAB/FIO	1	E413 ESD	2
C513 PICATINNY ARSENAL	1	FTD	
C535 AVIATION SYS COMD	1	CCN	1
██████████	█	ETID	3
C591 FSTC	5	NIA/PHS	1
C619 MIA REDSTONE	1	NICD	5
D008 NISC	1		
H300 USAICE (USAREUR)	1		
P005 ERDA	1		
P055 CIA/CRS/ADD/SD	1		
NAVORDSTA (50L)	1		
NASA/KSI	1		
AFIT/LD	1		