

AD-A079 542

AD

EN-79-02

TECHNICAL  
LIBRARY

**PERFORMANCE TESTING OF TWIST DRILLS  
ON AISI 4140 ALLOY STEEL**

C. H. KAHNG

JULY 1979

**TECHNICAL REPORT**



**DEPARTMENT OF MECHANICAL ENGINEERING  
MICHIGAN TECHNOLOGICAL UNIVERSITY**

DISTRIBUTION STATEMENT

Approved for public release; distribution unlimited.

**ENGINEERING DIRECTORATE  
ROCK ISLAND ARSENAL  
ROCK ISLAND, ILLINOIS 61299**

**DISTRIBUTION INSTRUCTIONS:**

Destroy this report when it is no longer needed. Do not return it to the originator.

**DISCLAIMER:**

The findings of this report are not to be construed as an official Department of the Army position unless so designated by other authorized documents.

REPORT DOCUMENTATION PAGE		READ INSTRUCTIONS BEFORE COMPLETING FORM
1. REPORT NUMBER EN-79-02	2. GOVT ACCESSION NO.	3. RECIPIENT'S CATALOG NUMBER
4. TITLE (and Subtitle) PERFORMANCE TESTING OF TWIST DRILLS ON AISI 4140 ALLOY STEEL		5. TYPE OF REPORT & PERIOD COVERED Technical Report--Final
		6. PERFORMING ORG. REPORT NUMBER
7. AUTHOR(s) C. H. Kahng		8. CONTRACT OR GRANT NUMBER(s) DAAF01-70-C-0303
9. PERFORMING ORGANIZATION NAME AND ADDRESS Dept. of Mechanical Engineering Michigan Technological University Houghton, Michigan 49931		10. PROGRAM ELEMENT, PROJECT, TASK AREA & WORK UNIT NUMBERS AMS Code 4932.06.6839
11. CONTROLLING OFFICE NAME AND ADDRESS CDR, Rock Island Arsenal ATTN: SARRI-ENM Rock Island, IL 61299		12. REPORT DATE July 1979
		13. NUMBER OF PAGES 109
14. MONITORING AGENCY NAME & ADDRESS (if different from Controlling Office)		15. SECURITY CLASS. (of this report) UNCLASSIFIED
		15a. DECLASSIFICATION/DOWNGRADING SCHEDULE
16. DISTRIBUTION STATEMENT (of this Report)  Approved for public release, distribution unlimited.		
17. DISTRIBUTION STATEMENT (of the abstract entered in Block 20, if different from Report)		
18. SUPPLEMENTARY NOTES		
19. KEY WORDS (Continue on reverse side if necessary and identify by block number)		
1. Machining	5. Drill accuracy	
2. Drilling	6. Hole accuracy	
3. Drill types	7. Drilling forces	
4. Alloy steel	8. Drill wear	
20. ABSTRACT (Continue on reverse side if necessary and identify by block number)		
<p>Performance testing of twist drills on AISI 4140 alloy steel was conducted by measurement of drill geometrics, drilling forces, drill wear, chip formation, and geometrical accuracy, and surface finish, of drilled holes. Major investigations were conducted using 1/2 inch diameter, H.S.S, taper-shank drills, of three manufactures, having six different, standard and special, geometrics. A dynamometer was designed and constructed to measure the drilling thrust, tongue and radial forces; and, effects of cutting conditions</p>		

## 20. ABSTRACT (cont.)

on drilling forces, and sources of force variations, were analyzed.

Drill wear was studied by photographs of wear progress. Wear on drill lips and chisel edges was visually detectable when using a cutting fluid; however, built-up-edge (BUE) predominated when drilling dry. An extensive study was made of drilled hole accuracies in size, straightness, roundness and concentricity. Criteria for determining and controlling drill life are discussed in terms of the measurements made, differences in drills, and drilling speeds.

## FOREWORD

This report was prepared by Dr. C. H. Kahng, Michigan Technological University, Houghton, Michigan, in compliance with contract DAAF01-70-C-0303, under the direction of the Engineering Directorate, Rock Island Arsenal, Rock Island, Illinois, with Mr. R. A. Kirschbaum as Project Engineer.

The author would like to thank Dr. G. L. Scofield, Professor and Head of the Department of Mechanical Engineering and Engineering Mechanics, Michigan Technological University, for his kind encouragement and help which made it possible for the completion of this project.

The major portion of this investigation was conducted at the Keweenaw Research Center, which made available a Radial Drilling Machine. I would like to thank the personnel of the center for their kind cooperation.

This project was carried out solely by the faculty and students of Michigan Technological University. Machine operation was conducted by Mr. John Carless and Mr. Fred Hoehn; drill inspection was performed by Mr. Tim Kinney; evaluation of data was conducted by Mr. Bob Campbell and Mr. Andy Kunos. The author would like to thank these students for their assistance, and would also like to thank Mr. H. C. Carlson, Teaching Aide, and Mr. D. A. Nivala, laboratory technician, who assisted in the manufacturing of instrumentation used in this investigation, and Ms. Janet Swem who typed this report.

This work was authorized as part of the Manufacturing Methods and Technology Program of the US Army Materiel Development and Readiness Command and was administered by the US Army Industrial Base Engineering Activity.

## TABLE OF CONTENTS

	<u>Page</u>
DD FORM 1473 .....	i
FOREWORD .....	iii
TABLE OF CONTENTS .....	iv
LIST OF TABLES .....	vi
LIST OF FIGURES .....	vii
1. INTRODUCTION .....	1
1-1. Background .....	1
1-2. Objectives .....	1
2. PREPARATION FOR THE STUDY .....	4
2-1. Drilling Machine .....	4
2-2. Work Materials .....	4
2-3. Drills .....	5
2-4. Instrumentation .....	5
3. INSPECTION OF ACCURACY OF DRILL GEOMETRY .....	7
3-1. Drill Geometry Nomenclature .....	7
3-2. Inspection of Drill Accuracy .....	8
4. DRILLING FORCES .....	12
4-1. Drill Force Characteristics .....	12
4-2. Radial Forces in Drilling .....	16
4-3. Design of Three Component Dynamometer .....	17
4-4. Effect of Cutting Condition on the Drilling Forces .....	19
4-5. Sources for Variation of Forces During Drilling .....	21
5. INVESTIGATION OF DRILL WEAR .....	23
5-1. Photographic Observation of the Progress of Drill Wear .....	23
5-2. Built-up Edge Occurrence in Dry Cutting .....	24
5-3. Investigation of Drill Wear When Drilling with Cutting Fluid .....	27
5-4. Feature of Wear on Inaccurately Ground Drills .....	33

	<u>Page</u>
6. SOURCES OF ERROR IN HOLE GEOMETRY .....	38
6-1. Evaluation of Accuracy of Drills in the Actual Drilling Stage .....	38
6-2. Straightness of Drilled Holes .....	41
6-3. Roundness of Drilled Holes .....	48
6-4. Dimensional Accuracy of Drilled Holes .....	50
7. CHIP FORMATION .....	54
7-1. Phenomenon of Chip Formation .....	54
7-2. Investigation of Chip Formation .....	55
8. SURFACE FINISH OF DRILLED HOLES .....	59
8-1. Characteristics .....	59
8-2. Effect of Cutting Fluid on Surface Finish .....	61
8-3. Effect of Cutting Speed on Surface Finish .....	62
8-4. Comparison of Obtained Surface Finish by Different Drills .....	63
9. DISCUSSION ON DRILL LIFE CRITERION .....	66
9-1. Definition of Drill Life .....	66
9-2. A "Screeching" Sound is Heard .....	67
9-3. The Chips Start to Stick in the Flute .....	67
9-4. An Increase in Drilling Force .....	67
9-5. Increased Wear on Margin .....	68
9-6. Wear on the Lip .....	70
9-7. Wear on the Chisel Edge .....	73
10. COMPARISON TEST OF VARIOUS SPECIAL DRILL GEOMETRIES .....	77
10-1. Special Drills Used in this Investigation .....	77
10-2. Drill Accuracy in the Rotating State .....	79
10-3. Drilling Forces .....	80
10-4. Chip Formation .....	82
10-5. Drill Wear .....	84
10-6. Surface Finish .....	88
10-7. Accuracy of Hole Geometry .....	89
10-8. Investigation of Burr Occurrence .....	95
10-9. Investigation of Accuracy of Location .....	96
11. CONCLUSIONS AND RECOMMENDATIONS .....	98
12. REFERENCES .....	100
13. DISTRIBUTION .....	

## LIST OF TABLES

<u>Table</u>	<u>Page</u>
1. Value of Shipments of Metal Cutting Tools by Class of Cutting Tool and Tool Material Type (1965).....	2
2. Chemical Composition of Workpiece Material.....	5
3. Result of Drill Inspection.....	11
4. Geometry of Special Drills.....	79
5. Error of Drill Geometry in Rotation.....	80
6. Max. Burr Height Obtained by Various Drill Geometries (Approximate Measurement).....	95

## LIST OF FIGURES

<u>Figure</u>	<u>Page</u>
1. Nomenclature of Twist Drill for Inspection.....	7
2. Accuracy of Drills Inspected.....	9
3. Force Vectors in Drilling Forces on Lip.....	12
4. Diagrams of Progress of Drilling Forces.....	14
5. Effect of Pilot Hole Diameter on Drilling Forces Under Various Feed Rates.....	14
6. Contribution of Margin to Drilling Forces.....	15
7. Force Vectors of Accurately and Inaccurately Ground Drills (Schematic).....	16
8. Effect of Relative Lip Height on Drill Forces.....	17
9. Three Components Dynamometer Designed by MTU.....	18
10. Schematic Illustration of Dynamometer and Workpiece Holder.....	18
11. Strain-Exaggerated, Three Component Measuring Table.....	19
12. Strain Gage Bridge Circuit of Three Components Dynamometer.....	19
13. Drilling Forces at Various Drilling Speeds and Feed Rates.....	20
14. Drilling Forces VS Feed Rate.....	21
15. Drilling Force VS Drill Diameter.....	21
16. Thrust and Torque Diagram Changed by the Increased Number of Drilled Holes.....	22
17. Device for Photography of Progress Wear.....	23
18. Photographed Chisel Edge and Lip of New Drill.....	23
19. Built-up Edge on the Chisel Edge and Lip After Drilling Under Dry Conditions (after 100 holes) Drill: HSS, 0.5 inch dia., Work: AISI 4140 Annealed, RPM: 110, Feed Rate: 0.005 ipr.....	24

LIST OF FIGURES (cont.)

<u>Figure</u>	<u>Page</u>
20. Maximum Height of Built-up Edge at Various Drilling Speeds.....	25
21. Schematic Illustration that Rake Angle (a) and Drilling Speed (b) are Varied.....	26
22. Progress of Wear on the Chisel and Lip.....	28
23a. Progress of Wear on the Chisel Edge and Lip Connected to Number of Drilled Holes.....	29
23b. BUE Protects the Wear of Lip and Chisel.....	30
24. Progress of Wear on the Chisel Edge and Lip (Schematic).....	31
25. Wearlands VS Number of Drilled Holes.....	31
26. Effect of Feed Rate on the Drill Wear.....	32
27. Examples of Inaccurately Ground Drills (8).....	33
28. Wear on the Lip of Inaccurately Ground Drill.....	36
29. Wear on the Chisel of Drill Which has Imperfect Centrality.....	36
30. Wear on Margin.....	37
31. Deflection of Arm Causing the Inaccuracy of the Drilled Hole.....	39
32. Runout Measurement of Different Points Spindle-Sleeve-Drill System.....	39
33. Proximeter Device.....	40
34. Example of Measurement by Proximeter.....	40
35. Measurement of Straightness of Drilled Hole (Schematic).....	42
36. Workpiece Holder Set-up.....	42
37. Straightness Measured in 5 Holes Drilled.....	43
38. Classification of Error in the Hole Geometry after Drilling.....	43

## LIST OF FIGURES (cont.)

<u>Figure</u>	<u>Page</u>
39. Frequency and Type of Hole Geometry with a Reed Rate of 0.0005 ipr.....	44
40. Frequency and Type of Hole Geometry with Feed Rate of 0.014 ipr.....	44
41. Frequency and Types of Holes Drilled on a Stiff Workpiece.....	45
42. Different Relative Lip Height of Several Drills.....	45
43. Effect of Relative Lip Height on Drill Force Diagram.....	46
44. Errors of Hole Geometry by Different Sleeve-Drill Combinations.....	46
45. Hole Geometries Produced by Different Slopes of the Workpiece Surface.....	47
46. The Straightness Errors Produced by the Sloped Workpiece Surface to the Axis of the Spindle.....	47
47. Roundness of Drilled Hole Measured at Different Position.....	49
48. Effect of Feed Rate on Roundness.....	50
49. Variations of Internal Diameter of Drilled Holes Drill: HSS, 0.5 in. Dia., Work: AISI 4140 Annealed, RPM: 110, Feed Rate: 0.009 ipr Cutting Fluid: None.....	52
50. Schematic Illustration of Reason for Oversize of Drilled Holes.....	53
51. Effect of Helix Angle on the Chip Flow and Force Components.....	55
52. Chips Being Emitted in Drilling and Different Types of Chip (Schematic).....	55
53. Comparison of Length of Chips Produced by Different Feed Rates.....	56
54. Relationship Between Chip Length and Feed Rate.....	56

LIST OF FIGURES (cont.)

<u>Figure</u>	<u>Page</u>
55. Chips Produced by Inaccurately Ground Drill.....	57
56. Chip Formation by Accurately Ground and Inaccurately Ground Drill (Schematic).....	57
57. Theoretical Surface Profile of Drilled Holes (Schematic).....	60
58. Schematic Illustration of Surface Profile Recording Device with Hydraulic Feed.....	60
59. Surface Roughness of Drilled Holes for Different Feed Rates.....	61
60. Surface Finish Using Cutting Fluid (a) and Dry Condition (b).....	62
61. Percentage Cumulative Frequency Comparing the Surface Roughness Effected by Cutting Fluid.....	62
62. Cumulative Percentage Frequency Curve of Surface Finish by Varied Drilling Speed.....	63
63. Surface Finish Generated by Different Drills at Same Condition, Drill: 0.5 inch, Work: 4140 RPM: 207, $f = 0.005$ ipr.....	64
64. Cumulative Percentage Frequency Curve of Surface Finish by Different Drills at Same Condition.....	64
65. Surface Roughness Profile Comparison Generated by Drills E and F, RPM = 207.....	65
66. Grooved Wear on the Margin.....	69
67. Reason for Oversize of Drilled Holes.....	69
68. Schematic Illustration of Wear on the Lips on Different Points of Drill Diameter (Schematic).....	71
69. Schematic Illustration of the Effect of Relief Angle on the Wear of Lip.....	71
70. Relationship Between Wear on Lip and Drilling Time.....	72
71. Drill Life Curve Based on Two Drill Life Criteria.....	73

LIST OF FIGURES (cont.)

<u>Figure</u>	<u>Page</u>
72. Relationship Between Wear on Chisel Edge and Drilling Time.....	74
73. Schematic Illustration of Wear Pattern.....	74
74. An Example of Wear Progress Related to No. of Holes Drilled.....	75
75. Special Drill Geometries.....	77
76. Drilling Forces VS Feed Rate by Different Special Drill Geometries.....	82
77. Effect of Feed Rate on Chip Formation a) Helical, b) Racon, c) Pyrcon.....	83
77. Effect of Feed Rate of Chip Formation d) Split e) Chip Breaker.....	84
78. Wear on Drills a) Helical, b) Racon.....	85
78. Wear on Drills c) Pyrcon, d) Split Point.....	86
78. Wear on Drills e) V.K. Point.....	87
79. Comparison of Wear in Different Special Drill Geometries.....	88
80. Surface Finish Comparison of Different Special Drills.....	89
81. Frequency and Type of Hole Geometry Produced a) Helical Point Drill, b) Racon Point Drill, c) Pyrcon Point, d) Split Point Drill.....	90
82. Roundness Measuring Record of the Hole Drilled a) Helical Point Drill, b) Racon Point Drill c) Roundness Measuring Record of the Hole Drilled - Pyrcon Drill.....	92
83. Effect of Feed Rate on the Roundness Using Different Drill Geometries.....	94
84. Accuracy of Hole Location Obtained by Two Drills.....	97

## INTRODUCTION

### 1-1. Background

The drilling process is one of the oldest and most widely used manufacturing operation. Billions of holes are drilled each year, and over 100 million drills are manufactured in the United States alone (1).

Statistics from 1965 show that the value of the shipment of twist drills ranks at the top of the various classes of cutting tools in the United States (Table 1). The total value of drills exceeds more than 110 million dollars annually. It is expected that 11 billion holes are drilled by twist drills under the assumption that one drill costs \$3.00 and one drill, drills 300 holes.

If, through development of the drilling process, the life of drills could be increased by even 10% and the hole geometry and location of holes improved, not only would industry save 11 million dollars but they would also benefit in the finishing processes used after drilling.

In a span of more than half a decade, numerous research works on drilling have been undertaken and hundreds of technical papers have been published. However, some publications described pure theoretical analysis on the drill and the drilling operation, and others presented fragmentary problems combined with an advertisement of a company's own products.

Galloway (2) has pointed out that the factors and parameters which are involved in drilling processes are very complex. In general, there are five main factors: drill, work, machine, drilling conditions, and cutting fluid, etc.

### 1-2. Objectives

Referring to Galloway's report (2), which was published in 1957, more than 1,000,000 holes were drilled for his investigation. It is impossible, therefore, to cover all

- 
- (1) Ernst, H. and Haggerty, W. A., The Spiral Point Drill - A New Concept in Drill Point Geometry, Trans. of ASME, 1957, pp. 1059-1072.
- (2) Galloway, D. F., Some Experiments on the Influence of various Factors on Drill Performance, Trans, of ASME, Feb., 1957, pp 191-231.

**TABLE 1.** Value of Shipments of Metal Cutting Tools  
by Class of Cutting Tool and Tool Material Type\* (1965)

Type of Cutting Tool	High Speed Steel	Carbide	Carbon Steel	Cast Alloy Ceramic and Diamond
Broaches	\$ 24,314,000	\$ 998,000	\$	\$
Twist Drills	102,406,000	7,270,000	1,618,000	
Gun Drills and Gun Reamers	1,122,000	4,064,000		
Spade Drills	1,963,000	605,000		
Combination Drills and Countersinks	7,048,000	368,000	(included with HSS)	
Counter Sinks	2,612,000	839,000		
Counter Bores	5,902,000	3,105,000		
Reamers	21,557,000	9,866,000	2,359,000	
Hobs	15,182,000			
Gear Shaper Cutters	7,859,000			
Gear Shaving Cutters	4,034,000			
End Mills	25,488,000	4,606,000		
Replaceable inserted blade cutters				
Non-indexible type	6,366,000	8,239,000		
Indexible insert type	994,000	5,567,000		
Form Relieved Cutters	6,360,000	458,000		
Slitting saws and screw slotting cutters	4,178,000	2,435,000		
Milling Cutters	19,860,000	4,605,000		
Taps	53,728,000	1,388,000	4,630,000	
Threading Dies	3,390,000	130,000	4,324,000	
Threading sets	1,462,000			
Chasers and Blades for Taps and Dies	12,342,000	242,000		
Single Point Tools	17,823,000	34,885,000		4,274,000
Circular Form Tools	4,338,000	1,718,000		
Blanks and Tips		52,570,000		187,000
Inserts, indexible types	400,000	38,414,000		559,000
Other inserts	1,368,000	7,142,000		375,000
Rotary Burrs and Files	1,090,000	3,572,000		
Other types not listed	10,290,000			
Thread Rolling Dies	9,855,000			
Tool Holders for Indexible Inserts	15,179,000			
	\$388,510,000	\$193,086,000	\$12,931,000	\$ 5,395,000

Source: U.S. Dept. of Commerce

factors in a limited study period.

This investigation was conducted using only one kind of work material, AISI 4140 steel, annealed. The drill used for this investigation was a HSS (M7), 0.5 inch diameter regular point, taper shank.

AISI 4140 steel, annealed, belongs to a group of high strength materials relatively hard to machine and published research data in drilling on this particular material are very limited. Therefore, the author felt that extensive experimental research in drilling of this material would be a valuable contribution for improvement in manufacturing, based on the original objective to determine the interrelated effects of drill elements and accuracies of these elements of drill performance. The aims of the study were as follows:

1. To evaluate the accuracy in geometry of drills from delivery stage.
2. To determine drilling forces when drilling 4140 steel.
3. To investigate the wear occurrence of drills under varying drilling conditions.
4. To discuss the effect of asymmetric grinding of the drill on drill wear.
5. To investigate drilled hole geometry from points of view of roundness, straightness, and dimensional accuracy.
6. To determine how various conditions in drilling are related and how they affect accuracy.
7. To investigate chip formation under varying drilling conditions.
8. To investigate the surface finish of the drilled hole.
9. To compare special drill geometries from the following points of view: drilling force, drill life, hole geometry and chip formation.
10. Conclusion.

The scope of this investigation is experimental only and an attempt was made to compare results with past publications. Also, this report was written so as to be easily understood by everyone in industry, taking into consideration, for instance, supervisors in charge of drilling operations.

## PREPARATION FOR THE STUDY

### 2-1. Drilling Machine

Since the accuracy of a machine tool influences the results of an investigation, the selection of the machine tool for this research project was made with careful consideration. The primary machine tool chosen for this study was a Cincinnati Gilbert Radial Drilling Machine, 5HP, RPM ranges 42 to 1500, and feed ranges 0.003 ipr to 0.020 ipr.

Considering the fact that the arm of the radial drill machine would be deflected because of thrust forces during drilling, the end of the arm was fixed to the base in order to eliminate this deflection. The runout of the spindle was carefully inspected statically and dynamically as the RPM was varied and was secured at a maximum of 0.001 inch. The Cincinnati Gilbert was used mainly for the investigation of drill life.

The second machine tool used was a Johansson's Radial Drill Machine, 5 HP, RPM range 60 to 900, and variable feed rate drives. The Johansson's machine was used mainly for investigation of the accuracy of the drilled hole and special drill geometry.

### 2-2. Work materials

According to the suggestion of Rock Island Arsenal, AISI 4140 Annealed was selected as the work material for this investigation.

Three different types of workpieces were prepared for this investigation:

- a) 4 inch x 4 inch x 4 inch blocks  
(For investigation of drill life and hole geometry)
- b) 1-1/16 inch dia. x 3 inch cylinders  
(For investigation of drilling forces, surface roughness and chip cure formation)
- c) 4 inch x 4 inch x 1 inch blocks  
(For investigation of through drilling and accuracy of hole location)

The chemical composition for each size workpiece is presented in the following table:

TABLE 2

Chemical Composition of Workpiece

<u>Size</u>	<u>C</u>	<u>Mn</u>	<u>P</u>	<u>S</u>	<u>Si</u>	<u>Cu</u>	<u>Ni</u>	<u>Cr</u>	<u>Mo</u>	<u>Sn</u>	<u>Al</u>
1-1 $\frac{1}{16}$											
Dia. Rd.	.36	.89	.008	.015	.28	.03	.07	.91	.20	.006	.05
4" x 1"	.45	.87	.010	.025	.25	.03	.02	.94	.20	.008	.044
4" x 4"	.41	.84	.008	.021	.26	.03	.02	.97	.18	.007	.05

Average hardness of material was measured as Rc30 or BHN212.

2-3. Drills

For this project several types of twist drills were used. However, the main investigation was conducted with standard, high speed steel, Grade M7, taper shank,  $\frac{1}{2}$  inch diameter drills.

Thirty drills were purchased from each of three different drill manufacturers.

For the advanced study of drilling performance, the following special drills were obtained:

- a) Chip breaker
- b) Helical
- c) Racon
- d) Pyrcon
- e) Split point
- f) V.K. point

Fifteen chip breakers and three of each type of the special drills were used for this project. The special drills, except the chip breaker, were pointed on Winslowmatic Grinders at Omark Industries, Arcadia, California, from where they were purchased.

2-4. Instrumentation

The following instrumentation was set up for this project:

- a) Tool Analyzer, Stocker & Yale, Model 11 MB

For inspection of drill geometry and dimension as well as to photograph the drill wear by using

an adapter for fixing a camera to the analyser.

b) Two Component Dynamometer

To measure torque and thrust during drilling.

c) Three Component Dynamometer

To measure torque, thrust and radial forces.

d) Straightness Measuring Instrument

To measure the straightness of the side of the drilled hole.

e) Proximeter

To measure the runout of drills mounted in the sleeve and spindle during rotation. By using two pick-ups it was possible to measure these runout simultaneously, both in the horizontal and vertical directions.

f) Profilometer

To measure surface finish of drilled holes.

g) Imparator

To measure the difference in diameter of drilled holes from initial diameter of drills.

h) Surface Profile Recorder

To record the profile of surface generated by drilling. For this purpose, a device was designed and manufactured at the beginning of this project. Later, a recorder, Surfcom-2B (Tokyo Seimitsu Co.), was adopted for precise evaluation.

i) Talyrond, Model 100

To measure roundness of drilled holes.

## INSPECTION OF ACCURACY OF DRILL GEOMETRY

### 3-1. Drill Geometry Nomenclature

The cutting elements of the twist drill contain three cutting edges: two lips which are primary cutting edges or main cutting edges, lying in parallel planes separated by the web thickness, and as the secondary edge, the chisel edge which is at the end of the web connecting the cutting edges.

The lips are the effective edges, each, in theory, contributing equally to the cutting action. The chisel, however, has a large negative rake angle which restricts chip flow and lacks any self-centering ability.

The drill factors of importance are the Helix angle  $\theta$ , The Point angle  $\rho$ , Lip relief angle  $\beta$ , the Web thickness  $W_t$ , Web centrality  $W_c$ , and the Diameter of the drill  $D_d$ .

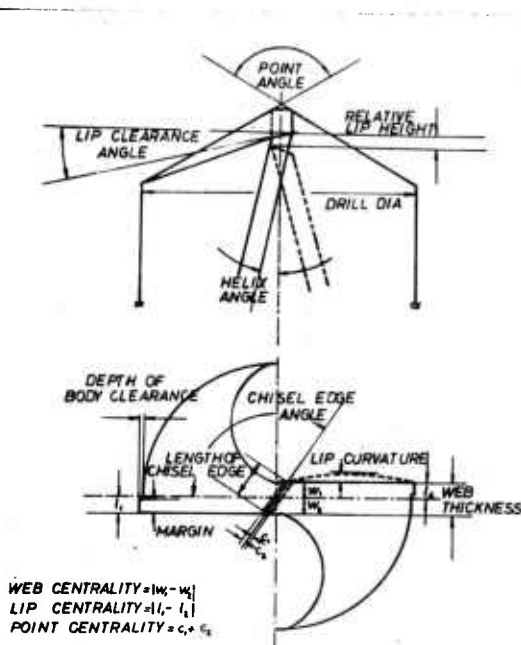

Fig. 1

Nomenclature of  
Twist Drill  
For Inspection

Fig. 1 shows the nomenclature of twist drill geometry and the definition of some possible inaccuracy in their critical points. It is obvious that the twist drill has a

complex geometry. Since obtainable accuracy in twist drill grinding has certain limits, there are allowable tolerances and various dimensions and elements which are most commonly used (3, 4). However, considering the fact that variation of the geometry and dimensions could cause performance differences in drilling, it is important to inspect each drill carefully and to classify and categorize each. This information will help to note the variation in twist drill grinding, and how geometry and dimensions of each drill can be varied in the commercially delivered state.

### 3-2. Inspection of Drill Accuracy

Recently, Kobayashi (5) introduced examples of the accuracy of drills manufactured by several companies throughout the world. His inspection was limited to so-called microdrills, cemented carbide drills 0.02 inch in diameter. The researcher found out that almost half of the drills have values of 0.004 inch in eccentricity and relative lip height.

However, there is no available data in regard to accuracy of drills in the practical drill diameter range.

In this investigation, each drill was carefully inspected, using a Stocker & Yale Model 11MB Tool Analyzer, which can be graduated in length measurement of 0.0001 inch and angle measurement of 15 minutes. For this purpose, an Inspection Chart was made up as shown in Table 3. The result of the inspection of 30 drills from three different manufacturers is summarized in Fig. 2. From this figure, the following variations are observed:

- a) Point angle - varies between  $11^{\circ}$  and  $13^{\circ}$ , which represents a range from  $-7^{\circ}$  to  $+13^{\circ}$  from the nominal standard of  $118^{\circ}$ .
- b) Lip clearance angle - 3 manufacturers produced drills with fairly close tolerances, maximum variation  $3^{\circ}$ .

---

(3) Tolerances for Twist Drills and Reamers, Metal Cutting Tool Institute, 1965.

(4) National Aerospace Standard, National Standards Association, Inc., 1969.

(5) Kobayashi, A. and Tsukada, T., Drilling of Multi-Layer Printed Circuit Board, Technical Paper MR71-202, 1971, Society of Manufacturing Engineers.

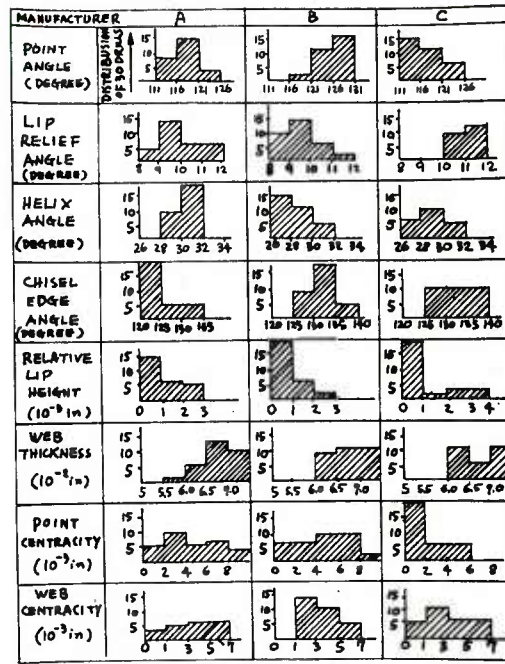

Fig. 2  
Accuracy of  
Drills Inspected

- c) Helix angle - ranges from 26° to 32°.
- d) Relative lip height - Compared with a tolerance of 0.004 inch after the U. S. Standard, the produced tolerances were satisfactory, they ranged within 0.0005 inch.
- e) Margin - ranges from 0.03 inch to 0.05 inch.
- f) Chisel edge angle - maximum range was 15°.
- g) Web thickness - ranges from 0.05 inch to 0.08 inch.
- h) Chisel edge length - varies from 0.07 inch to 0.009 inch.
- i) Point centricity in chisel edge - ranges from 0.03 inch to 0.010 inch.
- j) Lip curvature - maximum of 0.008 inch.
- k) Web centrality - large variation, which ranged from 0.001 inch to 0.008 inch, with a standard tolerance of 0.005 inch.
- l) Lip centrality - ranges from 0.006 inch to 0.087 inch.
- m) Diameter - ranges from 0.002 inch to 0.0004 inch, while standard shows +0.000 - 0.0010 inch.

The size of the sample is negligibly small compared to the total number of commercially available drills in this country. This result is only an indication in regard to the evaluation of the accuracy of drill grinding.

It is expected, deservedly so, that the variation of drill accuracy will be largely magnified when the drill is reground by the machine or by hand when it has reached the end of drill life.

The inspection data for beyond the second grinding was not conducted in this project.

TABLE 3  
Result of Drill Inspection

Drill Inspection	Drill Manufacturer			Tolerances after U.S. Standards
	A	B	C	
POINT ANGLE	113°~126°	116°~131	111°~126	118°±5°
LIP RELIEF ANGLE	8°~12°	8°~12°	10°~12	
HELIX ANGLE	28°~32°	26°~32°	26°~32°	
RELAT. LIP HEIGHT (in.)	0.001~ 0.004	0~ 0.003	0~ 0.005	0.004
MARGIN (in.)	0.040~ 0.057	0.040~ 0.045	0.038~ 0.050	
CHISEL EDGE ANGLE	120°~135°	125°~140°	125°~140°	
WEB THICKNESS (in.)	0.055~ 0.080	0.060~ 0.080	0.060~ 0.080	
CHISEL EDGE LENGTH (in.)	0.078~ 0.086	0.082~ 0.094	0.075~ 0.006	
POINT CENTRALITY CHISEL EDGE (in.)	0.003~ 0.010	0.003~ 0.009	0.003~ 0.006	
LIP CURVATURE (in.)	0.003~ 0.008	0.001~ 0.002	0~ 0.003	
WEB CENTRALITY (in.)	0~ 0.006	0.001~ 0.008	0~ 0.008	0.0050
LIP CENTRALITY (in.)	0~ 0.006	0.038~ 0.087	0.005~ 0.029	
DIAMETER = 0.5 (in.)	-0.0004~ -0.0003	-0.0003~ -0.0002	-0.0003~ -0.0002	+0.000 -0.0010

## DRILLING FORCES

### 4-1. Drill Force Characteristics

The forces acting in drilling can be classified as follows:

- a) Forces acting on both lips;
- b) Forces acting on the chisel edge;
- c) Forces acting in flute or friction on the margin.

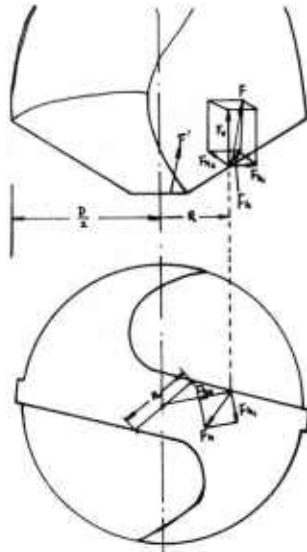

Fig. 3

Force Vectors  
in Drilling  
Forces on Lip

Fig. 3 shows the force vector on the lip. At a point located a distance  $R$  from the drill axis, a cutting force  $F$  occurs and its components in the horizontal and vertical directions are  $F_h$  and  $F_v$ , respectively. The force  $F_h$  can be divided into two forces,  $F_{h1}$  in a tangential direction and  $F_{h2}$  in a radial direction. If it is assumed that the two lips have perfect symmetry,  $F_{h2}$  at one lip will cancel  $F_{h2}$  at the other lip. Suppose  $F$  is a force acting on the chisel edge and its components in the horizontal and vertical directions are  $F_h$  and  $F_v$ , respectively, and the length of the chisel edge is  $r$ , then the moment  $M$  and thrust  $T$  can be expressed by the following equations:

$$M = 2 \int_0^r F'_h \cdot R \cdot dR + 2 \int_r^2 F_{h1} \cdot R \cdot dR + M_R$$

$$T = 2 \int_0^r F'_V \cdot dR + 2 \int_r^{\frac{D}{2}} F_V \cdot dR + T_R$$

The first term indicates the total forces on the chisel edge, the second shows the forces on the lip and the third indicates the total resistance caused by friction in the feed direction.

As the drill begins to plunge into the workpiece, the first point that contacts the workpiece is the chisel edge and the depth of the drill point into the material is

$$P_a = 0.5 D \times \cot \frac{\rho}{2}$$

and the actual cutting time needed for the depth  $P_a$  is

$$T_h = \frac{P_a}{f_o \cdot N} = \frac{0.5 D \cdot \cot \frac{\rho}{2}}{f_o \cdot N} = \frac{\pi \cdot 0.5 D^2 \cdot \cot \frac{\rho}{2}}{f_o \cdot V \cdot 12}$$

where  $N$  = RPM

$f$  = Feed Rate (ipr)

$V$  = Cutting speed (fpm)

$\rho$  = Point Angle

Since the chisel edge has a certain length - to - diameter ratio, ranging from 0.15 to 0.20, the thrust increases rapidly while torque increases almost linearly. The thrust caused by the chisel edge is so great that the additional thrust force caused by the lip can be neglected, even though the torque is mainly generated when the lip has penetrated into the workpiece. It can be seen from Fig. 4 that thrust and torque reach their peaks at different times and the time for the torque to stabilize is longer than the time for the thrust. In order to establish the relationship between the chisel edge, torque, and thrust, tests were conducted in such a way that the workpiece had a predrilled hole with a diameter slightly larger than the chisel edge length. As is indicated in Fig. 4, the thrust is reduced much more than the torque while the time for the forces to reach their peak values is also reduced. From this comparison test, it is clear that the chisel edge influence on thrust is large, but negligible on torque.

Drilling forces with varied diameter pilot holes and varied feed rates using 0.5 inch diameter H.S.S. drills are shown in Fig. 5a. It was surprising that the thrust caused by the chisel edge consisted of such a large proportion of the total force. As a feed rate of 0.009 ipr, 45% of the thrust was produced by the chisel edge. Conversely, the

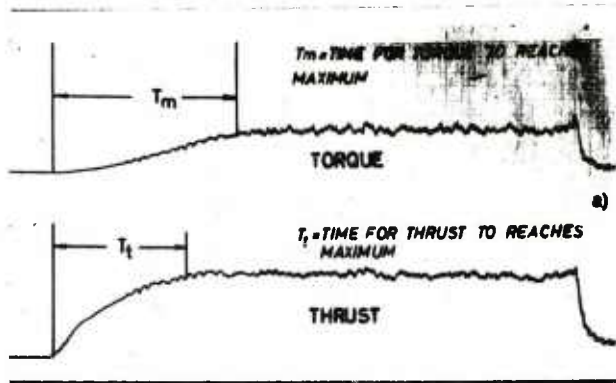
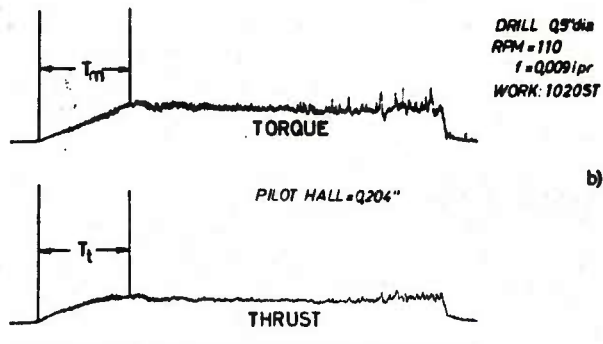

Fig. 4

Diagrams of Progress of Drilling Forces

- a) Drilling without predrilled hole
- b) Drilling in predrilled hole



torque obtained from the chisel edge was a relatively low portion of the total force. From Fig. 5b at feed rates of 0.009 ipr and 0.003 ipr, the proportion of total torque due to the chisel edge was only 20%.

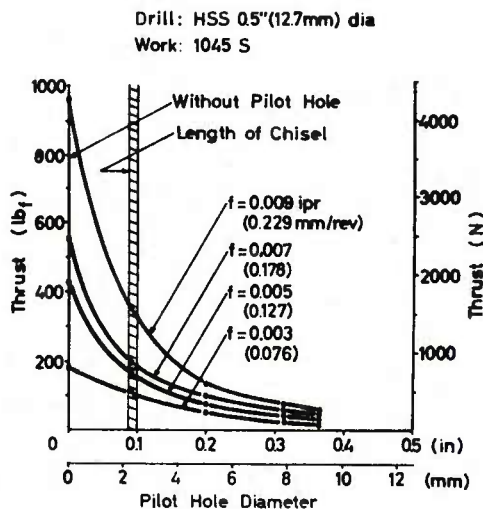

5a

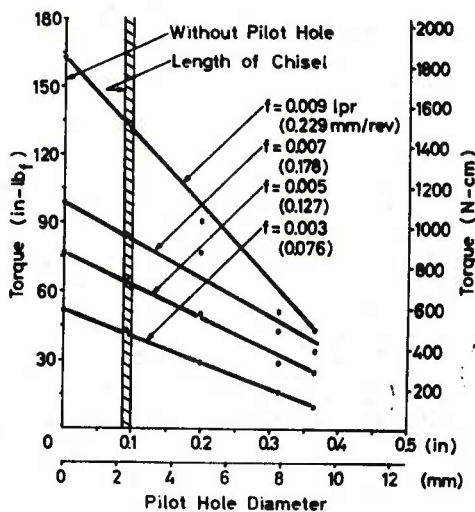

5b

Fig. 5: Effect of Pilot Hole Diameter on Drilling Forces Under Various Feed Rates

The influence of the margin on the total drilling forces was also sought. A workpiece, having a taper of  $45^\circ$  and an end diameter less than the drill diameter, was prepared. By drilling with a 0.5 inch diameter drill, the changing forces were recorded as shown in Fig. 6. At the point where the margin began to cut the workpiece, the thrust increased by more than 30% of the total thrust while torque showed no definitive change at the same point. Through this test, it was shown that the margin contributed a certain proportion of the drilling forces. Different feed rates, material, and drill size would be the main parameters which might affect the influence of the margin on drilling forces.

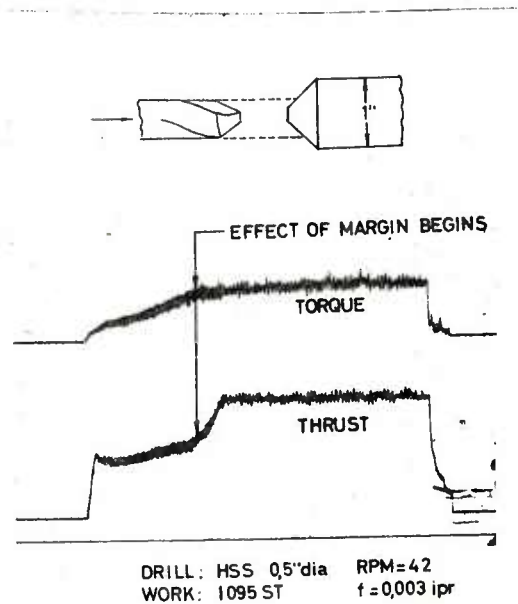

Fig. 6  
*Contribution of  
Margin to  
Drilling Forces*

It was found that no definite effect of depth of hole exists in drilling forces when drilling AISI 1020 steel.

The machine was adjusted to stop when the drill reached a hole depth of  $\frac{1}{4}$  inch,  $\frac{1}{2}$  inch, 1 inch,  $1\frac{1}{2}$  inch, and the drilling force diagrams were recorded. The difference of forces for each depth was negligible in the range of  $\frac{1}{4}$  to  $1\frac{1}{2}$  inch. This result refutes previous findings (6). The reason could be due to improvement in drill manufacturing which excludes the chip flow stocking difficulty. This subject will be discussed in more detail later in this chapter.

(6) Schallbrock, H., *Bohrarbeit und Bohrmaschine*, Carl Hanser Verlag, Munchen, 1951.

#### 4-2. Radial Forces in Drilling

As Pahlitzsch and Spur already discussed in their papers (7, 8), the radial force is important in the analysis of drilling forces from the viewpoint of oversize and geometrical accuracy of drilled holes.

The reason for the occurrence of radial forces can be explained by unbalanced resultant forces during drilling as shown in Fig. 7. Unbalanced drilling force is caused mainly by grinding the drill asymmetrically.

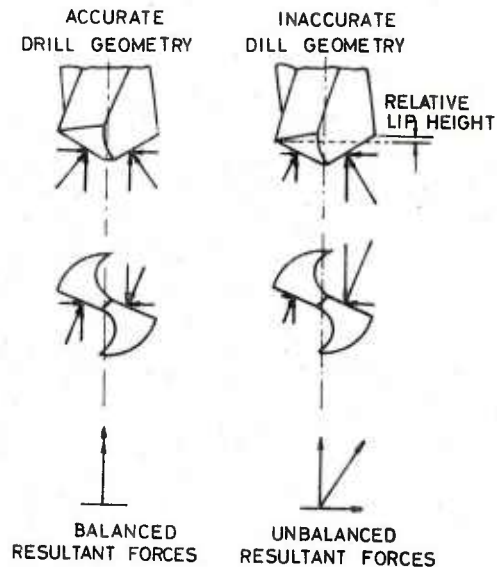

Fig. 7

*Force Vectors of  
Accurately and Inaccurately  
Ground Drills (Schematic)*

The radial force diagram obtained by the dynamometer, described below is introduced in Fig. 8. The radial force has a characteristic periodic motion and the magnitude will be equal to the amplitude of the radial force. If a radial force occurs during drilling, the drill produces a so-called "walk" and the drilled hole is oversized.

- (7) Spur, G., Messung und Bedeutung der Radialkräfte beim Bohren mit Spiralbohren, Microtecnic Vol. XV, No. 2, pp. 62-74.
- (8) Pahlitzsch, G. and Spur, G., Entstehung und Wirkang von Radialkräften beim Bohren mit Spiralbohren, Werkstattstechnik, Vol. 51 (1961), Heft 5., pp. 227-234.

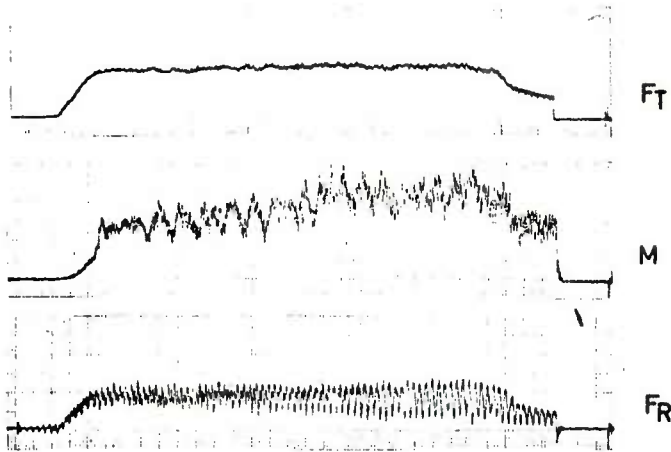

Fig. 8

Effect of Relative  
Lip Height  
on Drill Forces

#### 4-3. Design of Three Component Dynamometer

In order to study further details of drilling force characteristics when drilling, a three dimensional drilling force dynamometer was designed. The dynamometer was able to measure torque, thrust, and also radial forces. The dynamometer was a modification of one designed by Pahlitzsch and Spur (8). The dynamometer, Fig. 9, is shaped like a spoked wheel. The four spokes emanate from the center supporting column and terminate in a solid ring that connects the four spokes. A collet chuck for holding the workpieces was mounted on an aluminum plate which was fastened to the raised portions of the ring shown in Fig. 10.

The dynamometer was made from 6061-T6 Aluminum, which was chosen over steel because of its lower modulus of elasticity which allowed for a smaller size.

The forces were transmitted to the dynamometer through the chuck. The spokes were symmetrically located so that the forces were evenly divided among the spokes. The deflections of the spokes of the dynamometer due to the torque, thrust and radial forces, are shown in Fig. 11 a, b and c.

For measuring the torque and thrust, two strain gages were attached to each spoke (for each force) while for the radial force, four gages were attached to two opposite spokes - two gages on each spoke.

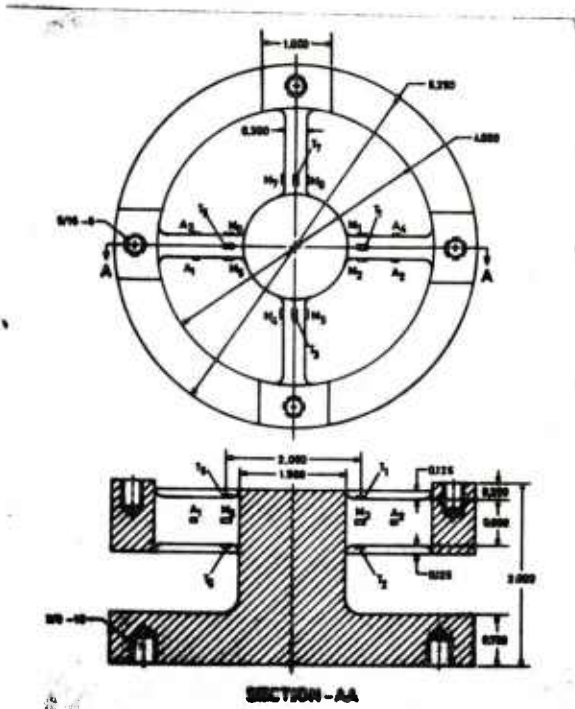

Fig. 9

Three Components  
Dynamometer Designed by MTU

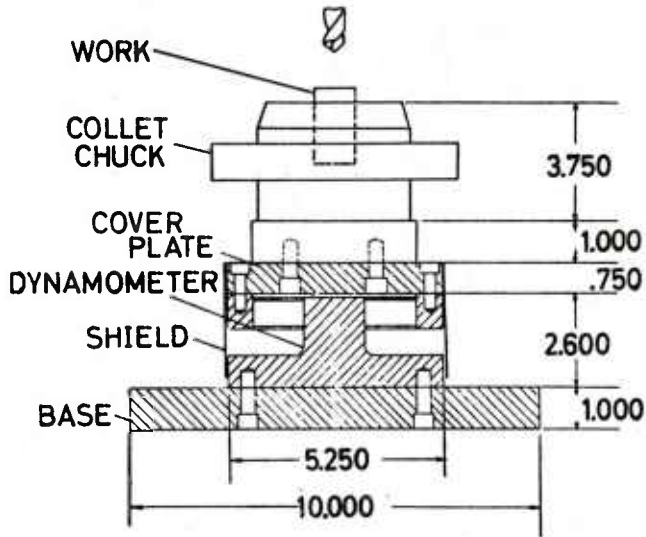

Fig. 10

Schematic Illustration  
of Dynamometer  
and Workpiece Holder

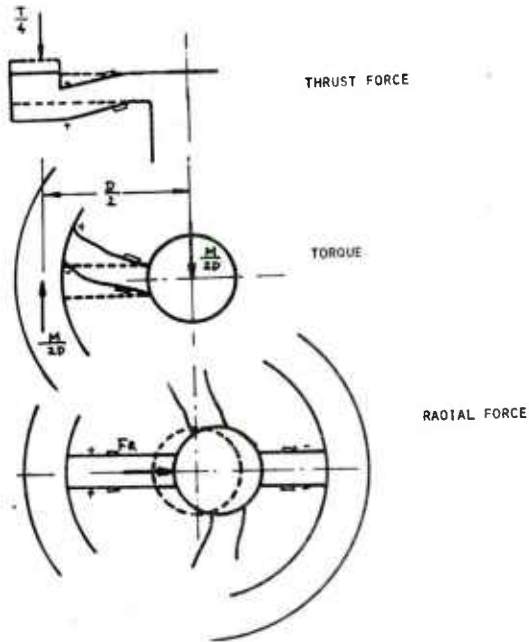

Fig. 11: Strain-Exaggerated, Three Component Measuring Table

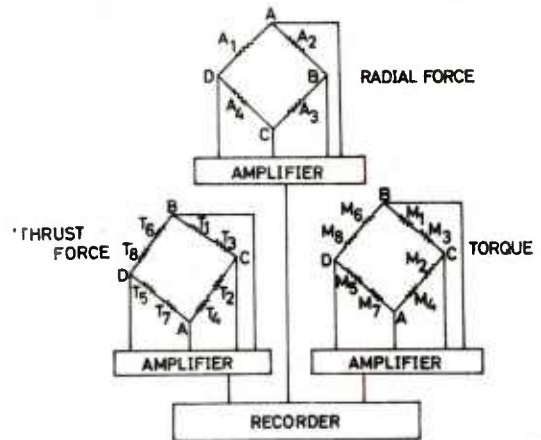

Fig. 12: Strain Gage Bridge Circuit of Three Components Dynamometer

Separate bridges were used for each of the three forces and they were recorded on a Sanborn Recorder and the arrangement of the strain gages in the bridges is shown in Fig. 12.

The strain gages were of the foil type with the following data:

- a) Gage Resistance = 120 ohms  $\pm$  0.2%
- b) Gage Factor = 2.00  $\pm$  1%
- c) Gage Grid Length - 0.062 in.
- d) Temperature compensated for Aluminum

The dynamometer was designed for a thrust force in the range of 400 to 1200 lbs. and torque in the range of 120 to 1200 in-lb.

#### 4-4. Effect of Cutting Condition on the Drilling Forces

Investigations on the turning of carbon steel, shows that the cutting forces vary as the speed varies from low to high. The cutting speed at which the cutting forces are at a maximum peak, indicate greatest built-up edge formation.

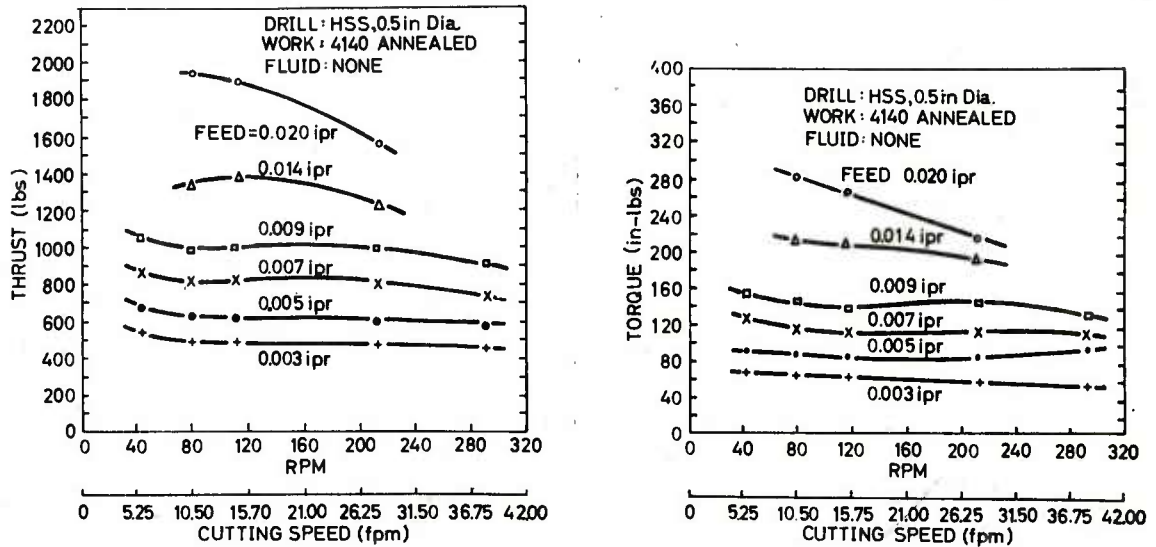

Fig. 13: Drilling Forces at Various Drilling Speeds and Feed Rates

In order to determine whether this could be expected in drilling 4140 Annealed Steel also, the drilling force was varied by changing the spindle speed. There are no definite indications in variation of cutting forces connected to cutting speed when cutting with several different feed rates (Fig. 13). However, at the feed rate of 0.020 ipr, both moment and thrust dropped with increased cutting speed. An explanation of this effect can be given only by a thorough investigation.

The effect of feed rate on torque and thrust is clearly shown in Fig. 14. With increased feed rate, both torque and thrust increase proportionately on log-log coordinates and the exponent was established to be 1.15 for thrust and 1.10 for torque.

Fig. 15 indicates the effect of drill diameter on torque and thrust and the exponent was 1.05 for thrust and 2.0 for torque.

The drilling force equation can be determined as follows:

$$\text{Torque } M = K_1 f^{1.10} D_d^{2.0}$$

$$\text{Thrust } T = K_2 f^{1.15} D_d^{1.05}$$

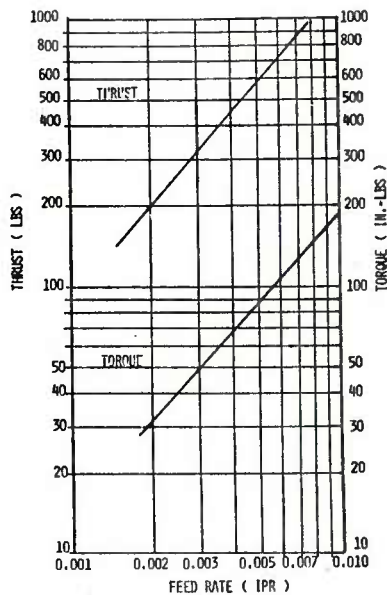

Fig. 14: Drilling Forces VS Feed Rate

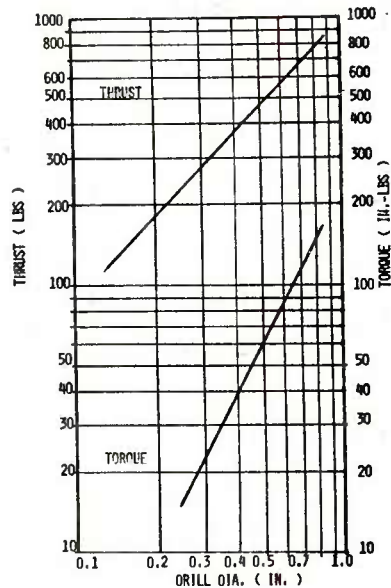

Fig. 15: Drilling Force VS Drill Diameter

where  $K_1$  and  $K_2$  may be called a "hardness class number" or "machinability factor" as Boston and et al (9) defined.

Compared with previous data for steel (9), it is felt that the drilling forces in 4140 steel are slightly larger.

#### 4-5. Sources for Variation of Forces During Drilling

A previously published paper (6) indicated that the drilling forces will increase when the drill comes to the end of its life. Several researchers suggested that an increased drilling force should be a criterion of drill life.

In this investigation, it was found that the force diagram of the freshly ground drills and the blunt drills are quite different and, in most cases, the newly ground drill produced a diagram that was clear with limited variation (Fig. 16a). However, by increasing the number of drilled holes, the forces definitely varied, especially the torque.

(9) Boston, O. W. and Oxford, C. J., Power Required to Drill Cast Iron and Steel, Trans. of ASME, Vol. 77, 1930, pp. 5-26.

As shown in Fig. 16b, after the 13th hole, the torque started to vary drastically at the depth of 1 inch in a total of 1.25 inch of penetration. This could be due to the fact that the chip flow at that condition of the drill was not smooth and caused the variation of torque. Once the variation of torque by a drill has occurred, the variation cannot be stopped and the magnitude of variation of torque is increased.

In Fig. 16c, it can be seen that, at the 96th hole, using the same drill and same conditions, the torque variation was intense, even though the thrust was steady. This phenomenon depends on the condition of chip flow and not the sharpness of drills. It was observed that with some drills there was no variation of torque from the first hole to the end of the drill life, while other drills showed the variation after several holes.

Through the measurement of thrust and torque, it can be determined whether the chip flows smoothly through the flute or with a jarring motion.

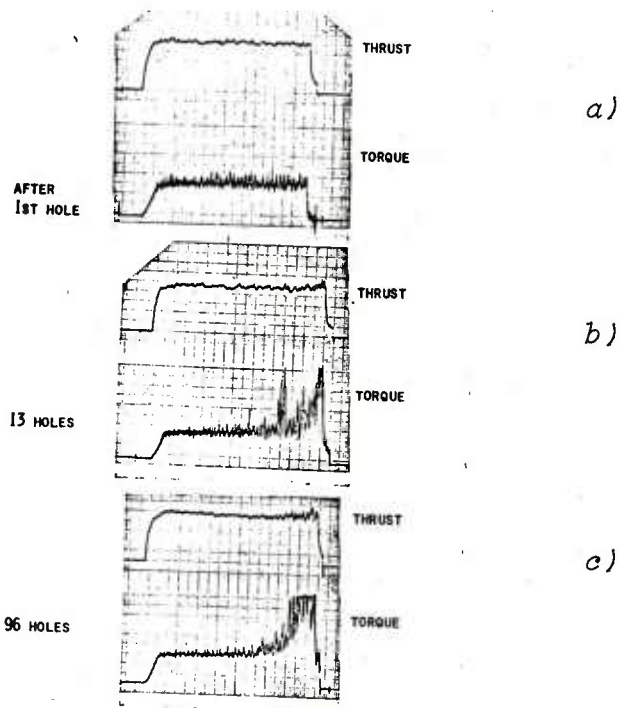

Fig. 16: Thrust and Torque Diagram Changed by the Increased Number of Drilled Holes

## INVESTIGATION OF DRILL WEAR

### 5-1. Photographic Observation of the Progress of Drill Wear

It is essential to study the tool wear phenomenon if a machinability study is required. Although many studies concerning tool wear with turning tools have been published, no intensive research on drill wear has been conducted.

In order to photographically observe drill wear and its progress, a special device was made, as indicated by the schematic illustration in Fig. 17, in which an adapter was fixed on the Tool Analyzer. Since the lens in the Tool Analyzer has a 20X magnification, the chisel edge could easily be photographed when the adapter was positioned opposite the drill. After rotating the adapter  $32^\circ$  (position B in Fig. 17), one side of the lip of the drill can be photographed and the other, when the adapter is rotated  $180^\circ$ . The photographs taken of the newly ground chisel edge and lips are shown in Fig. 18. In order to observe the progress of wear on the chisel edge and lips, the drills were observed after drilling a certain number of holes and then photographed.

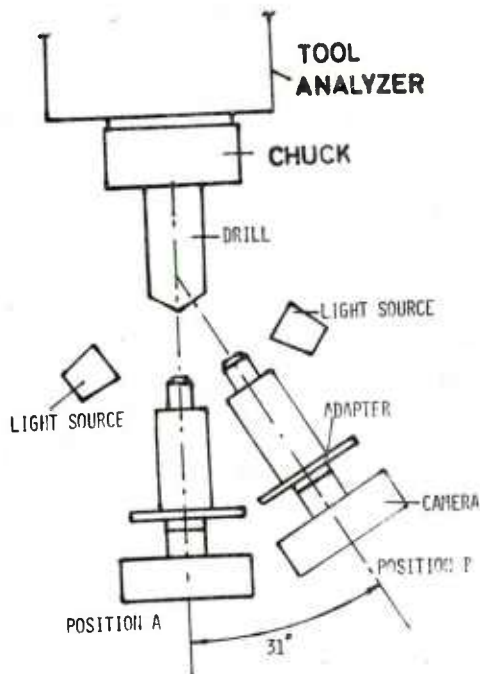

Fig. 17: Device for Photography of Progress of Wear

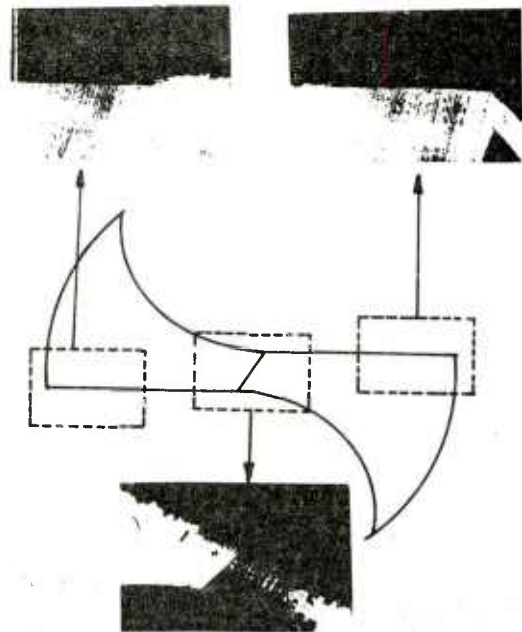

Fig. 18: Photographed Chisel Edge and Lip of New Drill

## 5-2. Built-up Edge Occurrence in Dry Cutting

As shown in Fig. 19, at an RPM of 110, equivalent to a cutting speed of 14.5 fpm and feed of 0.005 ipr, a built-up edge (BUE) was observed on both the lip and chisel edge after the first hole was drilled. After the tenth hole, the BUE was also observed on both lips and even after the 50th and 100th holes, the BUE had not disappeared from the lips and chisel edge.

After 100 holes, slight wear on the chisel edge was observed, because the lips were both protected by the BUE, while wear on the margin was easily recongized.

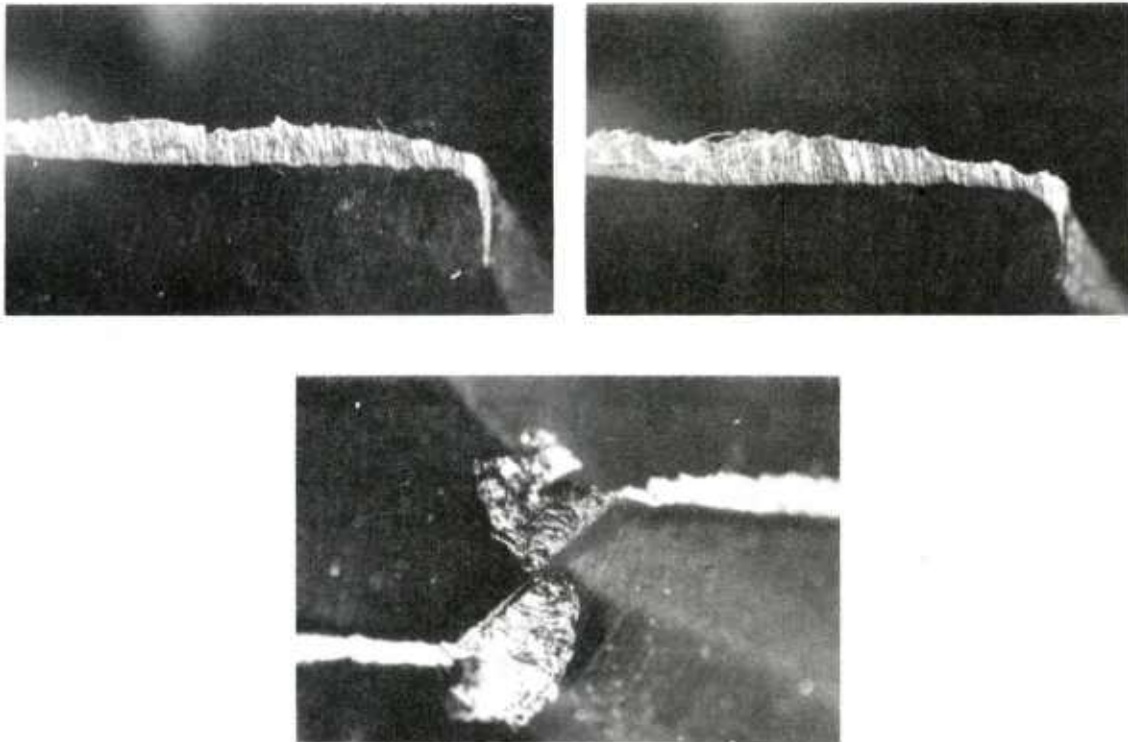

Fig. 19: *Built-up Edge on the Chisel Edge and Lip After Drilling Under Dry Conditions (after 100 holes) Drill: HSS, 0.5 inch dia., Work: AISI 4140 Annealed, RPM: 110, Feed Rate: 0.005 ipr.*

It was noticed that 4140 Steel, Annealed, has a remarkable affinity to BUE formation when dry drilling. According to literature (10, 11), BUE occurrences are usually influenced by the cutting temperature in the case of a turning operation and the cutting temperature is also a function of cutting speed. It is also considered likely that the changing of drilling condition may affect the occurrence of BUE.

In order to study the effect of drilling speed on BUE occurrence, RPM of the spindle was varied as follows: 42, 207, 289, 358, 574, 794. It was observed that the BUE remained on the drill edge from low to high cutting speeds. The maximum height of BUE ranged between 0.025 inch to 0.035 inch from 110 RPM to 794 RPM at a feed rate of 0.009 ipr (Fig. 20). It was found that at the lower feed rates the maximum height of BUE tends to be reduced slightly, but complete disappearance was not observed.

In order to determine whether an individual drill has any effect on BUE occurrence, numerous tests were undertaken. Several drills were selected from different drill manufacturers, and the conclusion was reached that BUE appearance is affected by cutting conditions rather than by drill

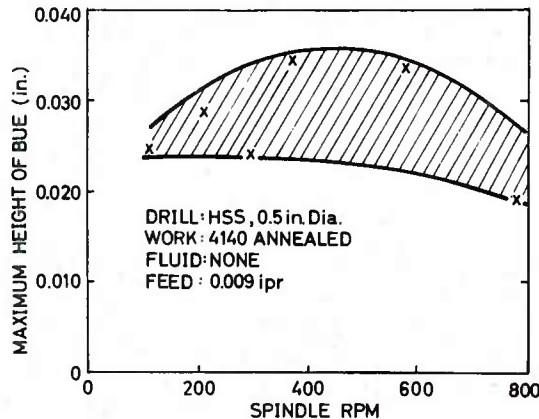

Fig. 20

Maximum Height of  
Built-Up Edge  
at Various Drilling Speeds

- (10) Opitz, H., Die Zerspannungsforschung als Beitrag zur Wirtschaftlichen Fertigung, C.I.R.P. Annalen, Band XII (1963), Heft 1., pp. 4-24.
- (11) Opitz, H., Gappish, M., Some Recent Research on the Wear Behavior of Carbide Cutting Tools, Advances in Machine Tool Design and Research (3rd MTDR, 1962), p. 43.

conditions. In dry drilling of 4140 Annealed Steel, BUE on the chisel and lip cannot be eliminated under the applied cutting conditions.

As shown in Fig. 21, the geometry of a drill differs greatly from that of a turning tool. The rake angle varies as described in several publications (12, 13) and each point on the lip does not have the same cutting speed because of the distance from the center to the respective point.

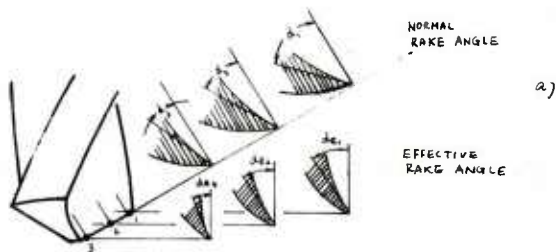

a)

Fig. 21

*Schematic Illustration that Rake Angle (a) and Drilling Speed (b) are Varied*

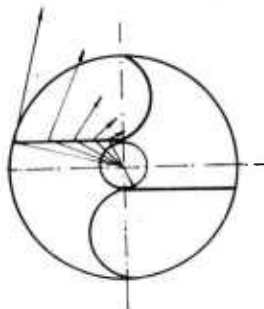

b)

(12) Kronenberg, M., Grundzüge der Zerspanungslehre (Zweiter Band), Springer-Verlag, 1963.

(13) Oxford, C. J., On the Drilling of Metals (1) Basic Mechanics of the Process, Trans. ASME, 1955, Feb., pp. 103-114.

Temperature distribution, however, on the drill lip is, unexpectedly, not distinguishable as many researchers (14, 15, 16,) have already introduced. The increase of cutting temperature affected by drilling conditions was not to any large degree what Nishida (17) investigated.

From the above mentioned explanation about drilling temperature, the reason for occurrence of BUE on chisel and lip can be given as follows:

1. Even though drilling conditions are greatly varied, the drilling temperature distribution on the chisel and lip have a limited range which is suited for micro-welding.
2. The drilling temperature will cause micro-welding of a metallic layer on the drill edge and BUE will occur.

### 5-3. Investigation of Drill Wear When Drilling with Cutting Fluid

In the Year 1930, Schlesinger (18) classified different types of drill wear. Since then, no one has attempted to study the drill wear phenomenon, while numerous publications on tool wear of turning tools are available.

In order to avoid BUE formation, a cutting fluid consisting of a 20:1 water soluble oil, Vantrol 450, produced by the Van Straaten Chemical Company, was used. The cutting fluid was supplied from two tubes which were spaced at 180°

- 
- (14) Kasahara, H. and Kinoshita, N., Experimental Studies of Cutting Temperatures of Drilling by Twist Drills, Report Institute Phys. Chem. Research Vol. 37, No. 3, 1961, pp. 177-185.
  - (15) DeVries, M. F., Saxena, V. K. and Wu, S. M., Temperature Distribution in Drilling, Trans. of ASME, J. Engg. Ind., 1968, pp. 231-238.
  - (16) Tsueda, M. et al, The Study of the Cutting Temperature in Drilling, (1) On the Measuring Method of Cutting Temperature, Trans. Japan Society of Mechanical Engineers, Vol. 27, No. 181 (1961), pp. 1423-1430.
  - (17) Nishida, S. and et al, Study on Drilling II - Lip Temperature, Journal of the Mechanical Laboratory of Japan, Vol. 8, No. 1 (1962), pp. 59-60.
  - (18) Schlesinger, G. and Kurrein, M., Das Bohren von Gusseisen in der Feinmechanik, Werkstattstechnik, Vol. 24 (1930), Heft 4, pp. 89-94.

and the cutting fluid flow was controlled in such a way that the cooling action on the workpiece and drill was sufficient.

As in dry cutting, the cutting speed was varied using five different speeds: 110, 207, 289, 385, and 574 RPM, while the feed was held constant at 0.005 ipr. During preliminary tests, the effect of using cutting fluid to eliminate BUE occurrence in the range of low to medium cutting speeds was determined. The progress of wear on the drill was carefully observed and photographed.

In Fig. 22 and Fig. 23a, the progress of wear on the drill can be seen by observing the increasing number of holes drilled, from 40 to 120. The cutting conditions were: RPM = 207, feed rate = 0.005 ipr, at penetration of 1.75 inch.

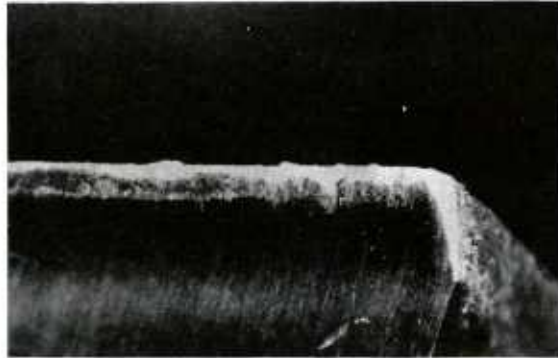

RPM = 207      f = 0.005 ipr

*After 40 Holes*

*Drill: HSS, 0.5 inch Diameter*

*Work: AISI 4140 Annealed*

*Cutting Fluid: Water Soluble Oil  
20:1*

*Fig. 22: Progress of Wear on the Chisel and Lip*

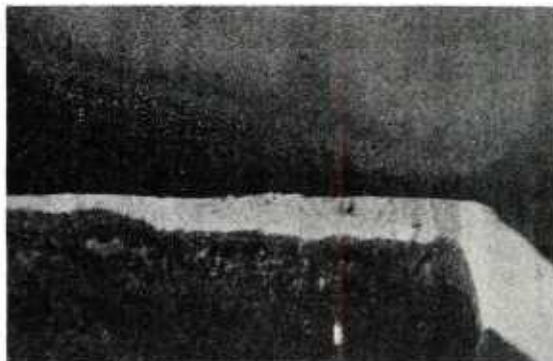

RPM = 207       $f = 0.005$  ipr

After 120 Holes

Drill: HSS, 0.5 inch Diameter  
Work: AISI 4140 Annealed  
Cutting Fluid: Water Soluble Oil  
20:1

Fig. 23a: Progress of Wear on the Chisel Edge and Lip Connected to Number of Drilled Holes

Three main areas of wear on a drill can be classified as follows:

- a) Chisel edge - With an increasing number of holes, the chisel edge developed wear in the form of two fans.
- b) Lip - A wearland on the lip developed in triangular form along the edge of the whole lip extending from chisel to margin, but both lips seldom had similar progress of wear. The lip curvature, web centrality and relative lip height are the most prominent reason for the difference of wear on both lips.
- c) Margin - At the point of junction between lip and margin, wear takes place in the form of a narrow triangle which developed upward. It was observed that as the error of drill axis centrality increased, the difference in wear on the two margins became noticeable.

At the 5th hole, wear on both lips and margin was visible. On the chisel edge, the line of the chisel edge length had disappeared and it began to develop wear in the form of a fan. At the 10th hole, the wear on the lip was starting to take the form of a belt. At the 20th and 36th holes, it was observed that wear of the belt form, on both lips was developed considerably and, also, the wear on the chisel edge started to fan further. The wear on both lips was almost the same.

Next, the cutting speed was increased to an RPM of 289. At the 80th hole, on one lip, a scratch type of wear was observed and also a small amount of BUE remained. At the 140th hole, a groove appeared in one margin.

The progress of drill wear was observed at an RPM of 385. At the 10th hole, a small BUE was produced on both lips. It was clearly noticeable, at the 144th hole, that the BUE protected the lip and at the 180th hole, BUE still remained on some parts of the lip.

Using the greatest speed, RPM = 574 ( $V = 75$  fpm), it was distinctly noticeable that BUE was produced on the lip and chisel edge. Due to the protection afforded by the BUE, wear on the lip and chisel were small, even after 200 holes were drilled (Fig. 23b).

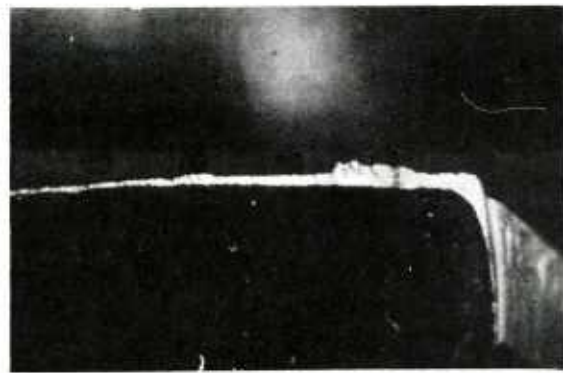
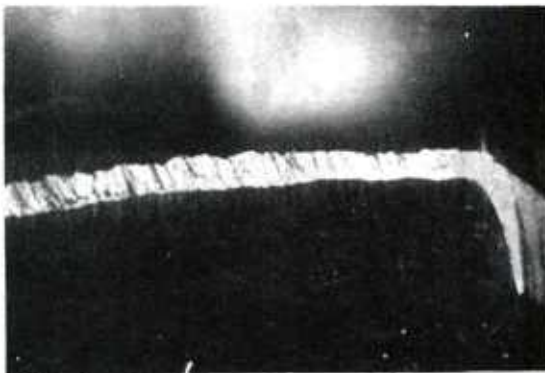

$f = 0.005$  ipr

*After 200 Holes*

*Drill: HSS, 0.5 inch Diameter*

*Work: AISI 4140 Annealed*

*Cutting Fluid: Water Soluble Oil 20:1*

*RPM: 574*



Fig. 23b: BUE Protects the Wear of Lip and Chisel

A schematic illustration of progress in wear on the chisel and lip can be plotted as shown in Fig. 24. It is important to note how the drilling condition was affected due to drill wear.

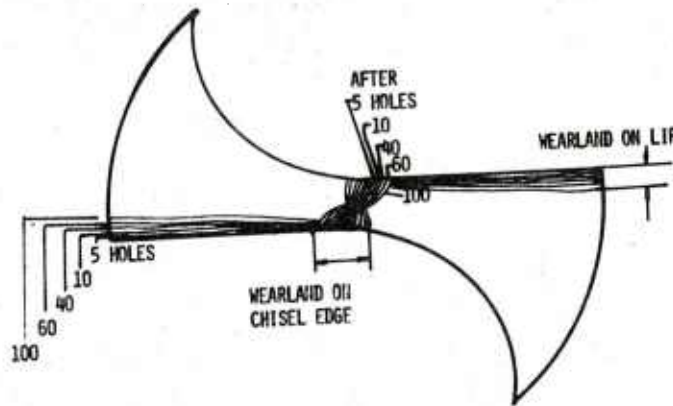

Fig. 24

Progress of Wear on the Chisel Edge and Lip (Schematic)

Based on the investigation, the wear land on the lip and chisel edge was tabulated and is plotted in Fig. 25 as a function of the number of drilled holes. The wearland on the lip developed almost proportionately with the increasing number of drilled holes. Also, the proportionality of wear on the chisel edge with the number of drilled holes is clearly indicated in the figure. As mentioned before, with the conditions: RPM - 574; feed rate  $f = 0.005$  ipr, BUE was developed, and in this figure, the maximum height of BUE is marked with the wearland on the lip.

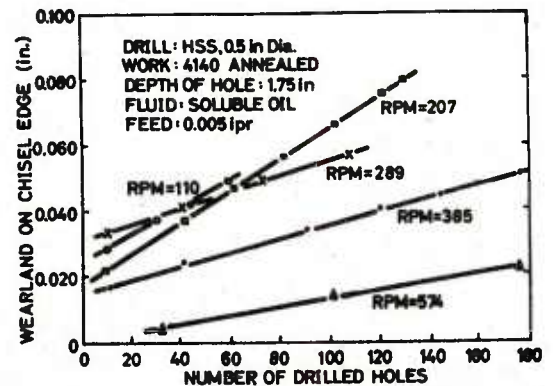
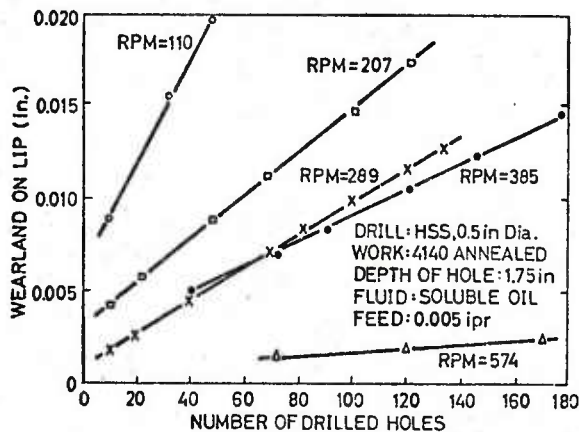

Fig. 25: Wearlands vs Number of Drilled Holes

This figure also shows that as speed is decreased, the wearland on both the chisel edge and lip becomes larger. This fact will be observed as being the reverse of the case in turning and milling. The reason for this could be explained by the fact that the cutting fluid affects the cooling of the tool and workpiece and consequently, the drilling temperature is dropped to a level where no induced affinity to BUE will take place. However, when there is an increase in drilling speed, there is also an increase in the drilling temperature, and with that, the occurrence of BUE protects the wear of lip and chisel.

Considering, first, the fact that the actual cutting time is in an inverse proportion to RPM of the spindle and, second, that drill wear on the lip is reduced as RPM is increased, the increase in cutting speed has a definite economic advantage. A detailed discussion on this point will be given in a later chapter (Chapter 9, Drill Life Criterion).

It was of interest to determine what effect feed rate had on drill wear. In Fig. 26 two different feed rates, 0.005 ipr and 0.009 ipr at 110 RPM, were compared in the progress of wear on both the chisel edge and lip. Increased feed rate showed definite decreased wear and also the actual cutting time was reduced. The reasons for this fact are the reduced cutting time, and the probability that increased drilling temperature will cause BUE occurrence which will decrease the wear on the drill.

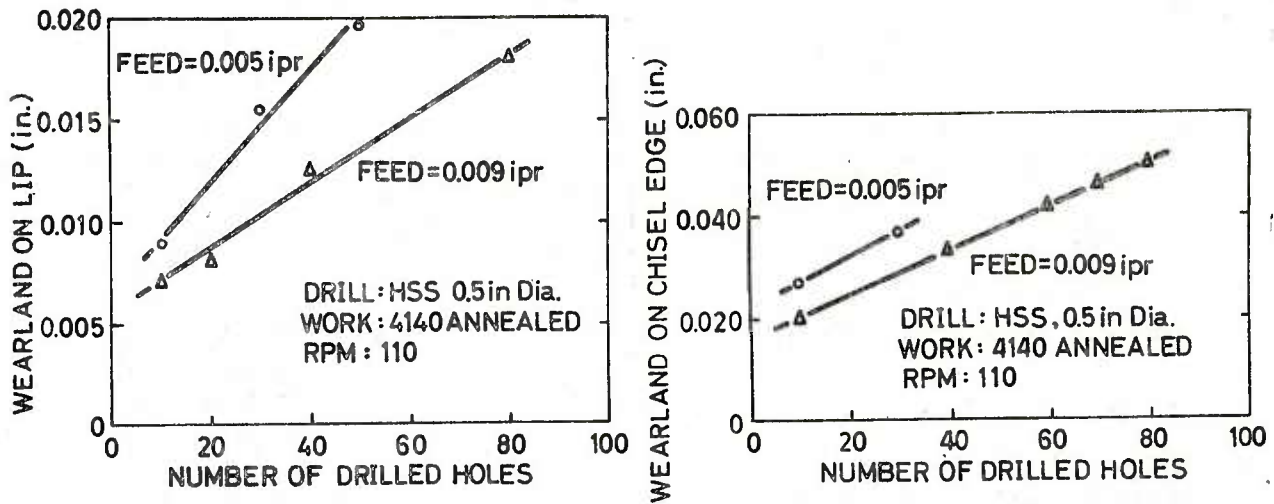

Fig. 26: Effect of Feed Rate on the Drill Wear

It is not justifiable to judge the effect of feed rate on wear by a comparison test of only two feed rates at one cutting speed. Therefore, it is suggested that a detailed investigation be conducted to determine the effect of feed rate on drill life and machining cost.

5-4. Feature of Wear on Inaccurately Ground Drills

Both the drill manufacturer and user desire to have the drill ground with the highest accuracy possible. However, in practice, it is almost impossible to grind a drill perfectly. With accurately ground drills, regardless of the point angle, the angles of the two cutting lips,  $\chi_1$  and  $\chi_2$  should be equal. Similarly, the length of the two lips,  $L_{H1}$  and  $L_{H2}$  should be equal (Fig. 27a). The point should be symmetrical and the difference in relative lip height should be kept to an absolute minimum. According to

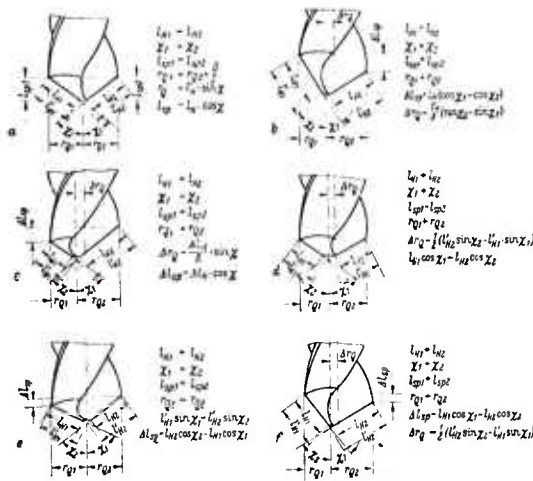

Fig. 27: Examples of Inaccurately Ground Drills (8)

literature (19), there are three cases which classify inaccurately ground drills:

- a) Lips of equal length but unequal angles.
- b) Lips of unequal length but equal angles.
- c) Lips of unequal length and unequal angles.

Pahlitzsch and Spur (8) described more details of possible errors in drill point grinding as shown in Fig. 27 b, c, d, e and f. The researchers suggested, through their extensive research on drilling, the following tolerances which would be acceptable, provided that the drills were ground symmetric:

$$L_{H_1} - L_{H_2} = 0.004 \text{ inch}$$
$$\chi_1 - \chi_2 = 0.33^\circ$$

In order to maintain the necessary accuracy of point angles, lip length, lip relief angle, and chisel edge angle, the use of machine point grinding is recommended. If one drill was ground inaccurately, the following errors would take place during drilling:

- a) Relative lip height error
- b) Off centerness of chisel edge

These errors are related to drill geometry and theoretically can be computed. The relative lip height can be determined from the following equation (2):

$$L_h = \frac{2 E_c}{\tan \chi}$$

where  $L_h$  is the relative difference in lip height,  $E_c$  is eccentricity of point grind, and  $\chi$  is half the point angle.

Haggerty (20) developed the following formula for relative lip height which can be determined from the web eccentricity, relief angle and helix angle:

$$L_h = W_c \cdot \tan \beta \left[ 1 + \frac{\sin \beta \cdot \sin \theta}{\sin (90 - \theta - \beta)} \right]$$

where  $W_c$  is web centricity,  $\beta$  is relief angle, and  $\theta$  is helix angle.

(19) Drilling Today's Materials, 1962, published by Metal Cutting Tool Institute.

(20) Haggerty, W. A., Effect of Point Geometry and Dimensional Asymmetry on Drill Performance, Int. Journal of Machine Tool Design and Research, Vol 1 (1961), pp. 41-58.

Practically speaking, the relative lip height can be measured with a dial indicator by rotating a drill sitting in a V-block.

An accurately pointed drill produces uniform chips with both lips because both lips extend to the periphery when their lip heights are equal. When the point is ground off-center, there is a difference in lip height which results in

- a) The chips being formed by lips which are not uniform.
- b) The unbalanced resultant force producing a radial force, which will cause an oversize in the drilled hole.

In the past, certain researchers, namely Galloway, Spur, Haggerty (2, 7, 20) investigated the effect of inaccuracy on drill life and oversize of drilled holes. However, no one has attempted to study the feature of wear on drills which were ground with errors.

In this investigation, several drills were purposely ground with errors, mainly in web centrality and relative lip height. Due to the non-uniformity described above, deformed chips tend to wind on the drill body which, therefore, makes it difficult to carry out the testing for a long enough time for wear on the drill to develop satisfactorily and to make a comparison for each drill.

Another difficulty, in this investigation, was that the lip started to chip frequently and finally broke due to insufficient chip flow. After several trials, it was concluded that with drills that exceeded reasonable error tolerance, it was impossible to carry out a drilling test up to the expected drill life.

A careful observation of wear was made on drills that were in the purchased state, and as shown in Fig. 28, the difference in relative lip height showed a different wearland after 72 holes. This can be explained by the fact that there are different chip thicknesses and therefore the degree of friction and cutting temperature could be different.

A drill which had a certain degree of error in web centrality was carefully investigated from the point of view of wear on the chisel edge. Due to the off center, the center of the drill shifts during drilling. By increasing drilling time, the wear on the chisel edge can be generated and after a certain time, the wear on the chisel edge is observed as shown in Fig. 29. It is clear that the pivot of the fan had moved as much as the original center had moved. It was noticed that by changing the relative position in the spindle sleeve and drill system,

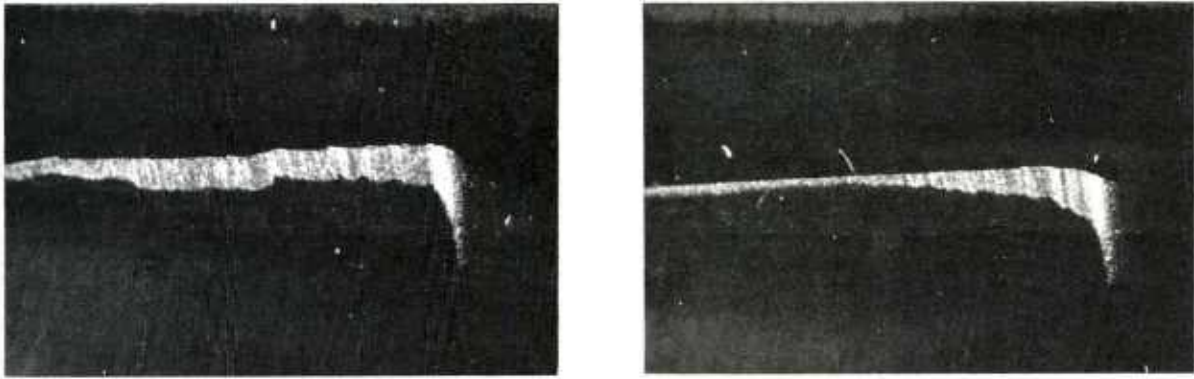

*Fig. 28: Wear on the Lip of Inaccurately Ground Drill*

the wear generated on the chisel edge became very irregular in shape, and was not of the fan type.

The runout of the drill greatly influences the wear on the margin. The runout of the drill forces one margin to act while the other margin plays a passive role. However, when the drill is deflected while penetrating into the workpiece, both margins produce wear to a different degree.

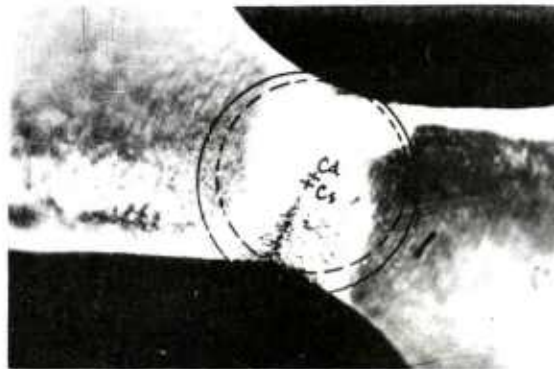

Cd: CENTER OF DRILL  
Cs: CENTER OF SPINDLE

*Fig. 29: Wear on the Chisel of Drill Which has Imperfect Centrality*

A typical wear pattern on the margin is introduced in Fig. 30, and as shown in this figure, it is difficult to expect that the two margins produce similar wear when the drill is run off center. Even when the center of the drill was lined up with the center of the spindle, wear on the two margins was observed to be different.

Due to the asymmetrical grinding of the drill, wear on the lips, chisel edge, and margin was observed to be non-uniform, and the grade of non-uniformity was related to the accuracy of the drill grinding.

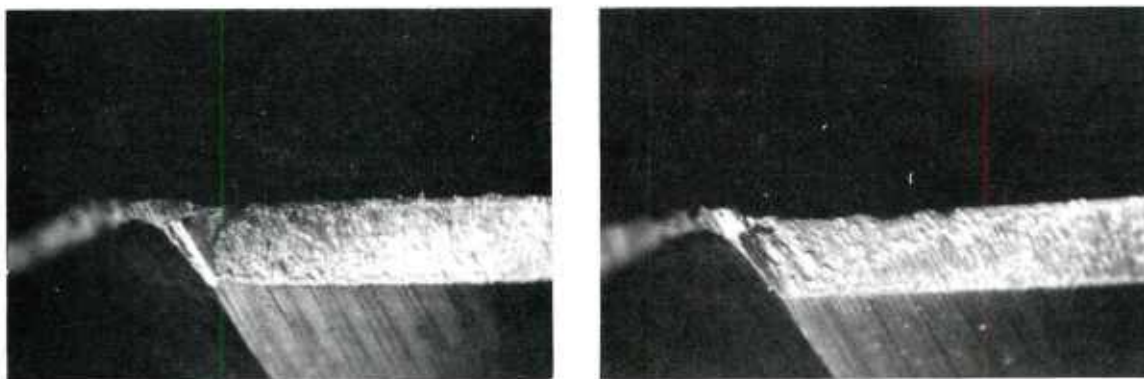

*Fig. 30: Wear on Margin*

## SOURCES OF ERROR IN HOLE GEOMETRY

### 6-1. Evaluation of Accuracy of Drills in the Actual Drilling Stage

The drilling process is usually not a final process in machining, and if the hole requires higher accuracy in hole geometry, it is common to ream and precision bore after drilling.

However, in the case of the hole being tapped, the drilled hole should be kept within a desired limit of accuracy. The following kinds of holes can be defined as having errors in the geometry and dimension (19):

- |                              |                       |
|------------------------------|-----------------------|
| a) Bell mouth (topped) holes | e) Oversize holes     |
| b) Out of round holes        | f) Stepped holes      |
| c) Bent or crooked holes     | g) Undersize holes    |
| d) Torn or scored holes      | h) Badly burred holes |

It is of common experience that most of the drilled holes belong to two categories, namely oversized holes and out of round holes. Oversize holes are the most common, therefore, drill diameters are made 0.001 inch smaller than the standardized diameter. Even though most of the drilled holes will be remachined, by processes such as reaming, boring, or tapping, it is desirable to obtain an accurate hole with regard to dimensional tolerances, roundness and straight sides.

Many researchers have pointed out that the accuracy of a drilled hole depends particularly on the quality of the machine tools themselves. Worn machine tools cannot obtain better accuracy than precision machine tools and thus, it was first necessary to investigate the accuracy of the machine tools.

As previously mentioned, the arm of the radial drilling machine was rigidly supported so that deflection of the arm during drilling was eliminated. Considering that the thrust force was more than 600 lbs. under general conditions, the deflection of the arm should be taken into account. If the stiffness and rigidity of the machine tool elements are not sufficient to avoid deflections, the taper and error of location of the drilled hole is caused as illustrated in Fig. 31.

After several measurements, the straightness of spindle feed confirmed that accuracy was within a 0.0001 inch.

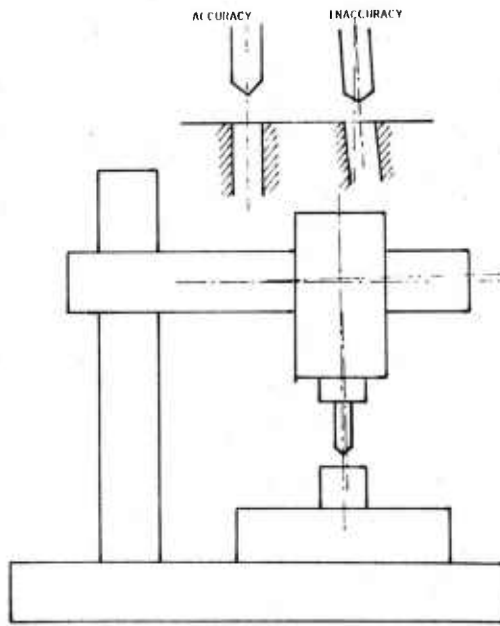
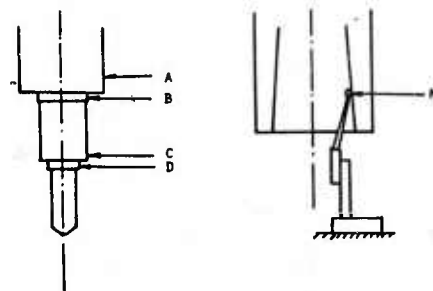

Fig. 31

Deflection of Arm Causing the Inaccuracy of the Drilled Hole



UNIT: IN

POINT DEGREE	A	B	C	D	M
0°	0	0	0	0	0
60°	+0.0005	+0.0002	+0.0002	+0.0001	-0.0005
120°	+0.0010	+0.0010	+0.0007	+0.0005	-0.0007
180°	+0.0015	+0.0015	+0.0010	+0.0010	-0.0010
240°	+0.0010	+0.0015	+0.0010	+0.0010	0
300°	+0.0005	+0.0005	+0.0002	+0.0001	+0.0002
MAXIMUM RUNOUT	0.0015	0.0015	0.0010	0.0010	0.0012

Fig. 32

Runout Measurement of Different Points Spindle-Sleeve-Drill System

The runout of the spindle was measured, both outside and inside of the spindle taper, with a dial gage and the result of which is shown in Fig. 32. The maximum runout of the spindle outside (Point A) and inside (Point M) stands at 0.0015 inch. The runout of the sleeve (Points B and C) and neck of the drill (Point D) at fitting conditions in the spindle were measured and it was concluded that the error of the sleeve and drill were negligibly small. The runout of the drill during drilling was mainly dependent upon the accuracy of the spindle runout when the combination spindle, sleeve, and drill was arranged in the proper fitting direction. However, in practice, no one considers what would be the best fitting combination of the above mentioned three parts and usually the sleeve is put in the spindle and the drill in the sleeve without any consideration that the selection of the combination of the three parts would have an effect. Even though the drill was accurately ground the actual accuracy during working was influenced by the accuracy of the spindle and sleeve.

In order to make a detailed inspection of the error during rotation at different points, the proximeter device was applied as illustrated in Fig. 33. The sensitivity of this instrument was such that a minimum of 0.0001 inch runout could be measured.

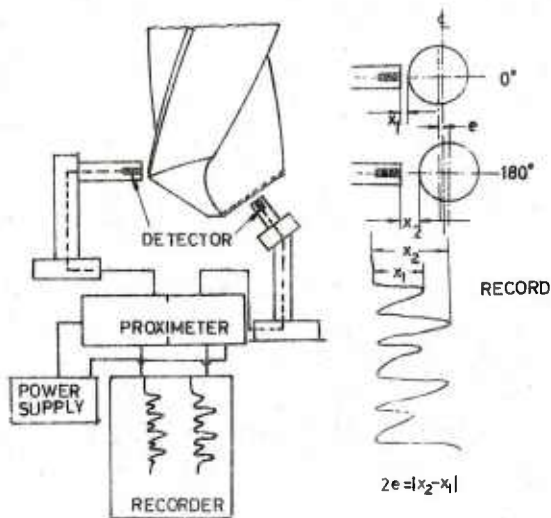

Fig. 33: Proximeter Device

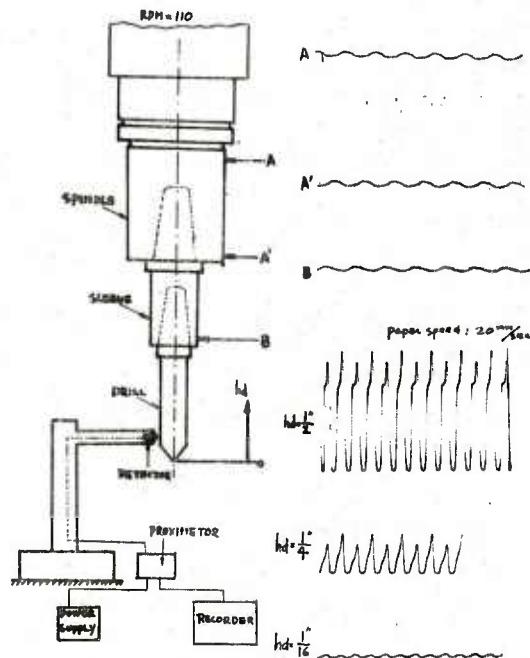

Fig. 34: Example of Measurement by Proximeter

Fig. 34 indicated an example of a record measured by a proximeter at different points in the spindle, sleeve and drill combination. From this figure, the following characteristics of the runout can be established:

- a) Runout of both points at the spindle (Point A and A') and sleeve (Point B) stands at 0.0012 inch.
- b) At 1/16 inch, 1/4 inch and 1/2 inch from the bottom of the drill, the indicated runouts are 0.0012 inch, 0.002 inch and 0.0024 inch respectively.

It was surprising that, with only a few exceptions, the runout at the end of the margin ranged between 0.0012 inch and 0.002 inch.

Considering that different combinations of sleeve and drill could change the magnitude of runout, the following combinations were inspected:

- |                    |      |                    |      |
|--------------------|------|--------------------|------|
| a) Sleeve position | 0°   | c) Sleeve position | 180° |
| Drill position     | 0°   | Drill position     | 0°   |
| b) Sleeve position | 0°   | d) Sleeve position | 180° |
| Drill position     | 180° | Drill position     | 180° |

The runouts of each position, especially the relative lip height, whose error ranged from 0.002 inch to 0.022 inch, were so different that no case had a similar figure. Considering this fact, it can be expected that the hole geometry and dimensional accuracy of a drilled hole can be variously affected.

In order to investigate the effect of runout of the drill on the error in hole geometry, all of the drills were inspected using the proximeter, and the findings recorded.

The effect of RPM on the runout of the spindle was investigated and it was confirmed that the spindle was well designed and that varying the RPM had no effect on the runout of the spindle, as is also usual in the turning lathe.

## 5-2. Straightness of Drilled Holes

For the measurement of the straightness on a side of a drilled hole, the set-up shown in Fig. 35 was used. The magnification of the instrument can be controlled by the range on the Sanborn Recorder and the gain on the amplifier. It was easy to measure the straightness with a sensitivity of 0.0001 inch, which this instrument has.

Considering the fact that the thrust forces reached more than 300 lbs. at a feed rate of 0.003 ipr, the stiffness of the workpiece fixture (holder) is expected to play a definite

part in the accuracy of the hole geometry.

The first investigation was conducted using a fixture which was mounted on a two-dimensional dynamometer which was designed in such a way that three octagonal rings of aluminum were mounted on the bottom plate and spaced  $120^\circ$  apart.

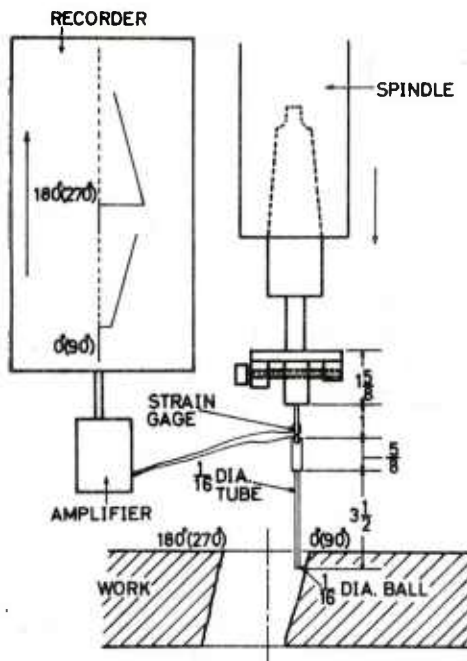

Fig. 35: Measurement of Straightness of Drilled Hole (Schematic)

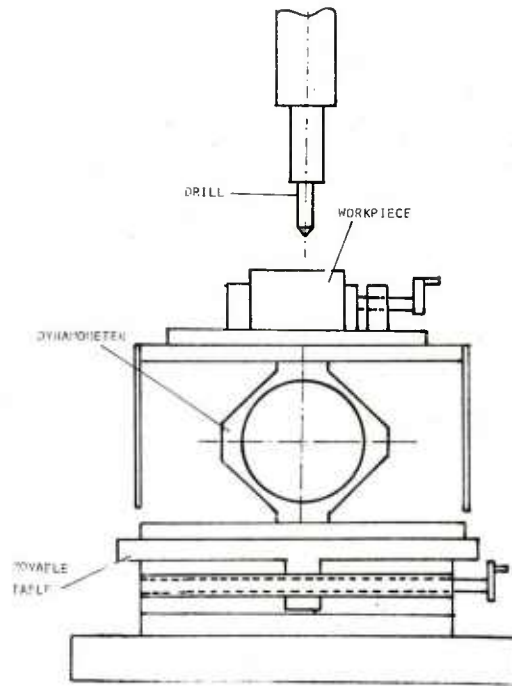

Fig. 36: Workpiece Holder Set-Up

When a drill plunges into the workpiece, the thrust and torque cause a strain in the octagonal ring which results in a slight deflection relative to the drill, and the amount of deflection will be proportional to the magnitude of the drilling forces.

The workpieces used for this project had the dimensions 4 inches x 4 inches x 4 inches. A total of 50 holes were drilled in opposing faces of the workpiece with a penetration of  $1\frac{3}{4}$  inches per hole. The workpieces were fixed in a vise, and the location of the hole being drilled was determined by the movable table with an accuracy of within  $\pm 0.001$  inch (Fig. 36). The stiffness of the dynamometer was measured as 100 lbs./0.001 inch in the center.

After drilling all the holes on one workpiece, the drill was replaced by the straightness measurement instrument, while the workpiece was kept held in the vise. The straightness measurements of the holes were made at  $0^\circ$ ,  $90^\circ$ ,  $180^\circ$  and

270° from the operator's position, while the spindle was raised and lowered to a depth of 1 inch.

Fig. 37 shows an example of the straightness measurements of 5 holes, when the drilling was conducted with the relatively small feed rate of 0.005 ipr under 110 RPM.

In general, the possible types of hole geometries can be classified as introduced in Fig. 38. The magnitude of error is established by the difference between the smallest diameter and the largest diameter.

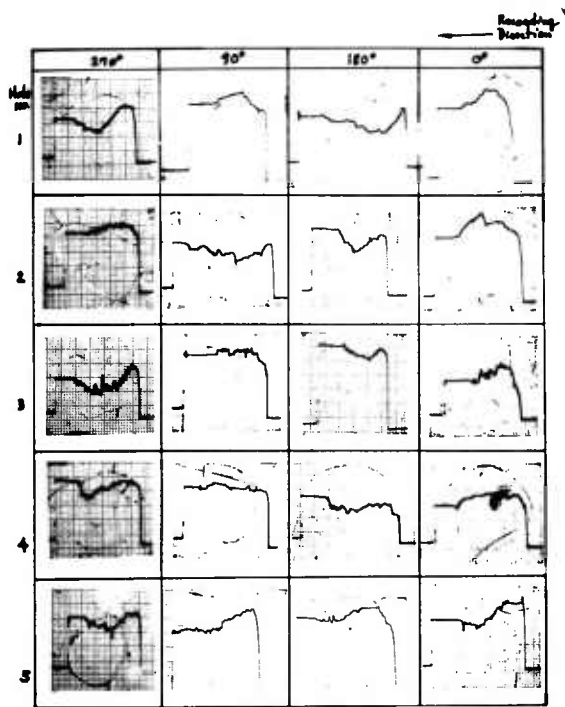

Fig. 37: Straightness Measured in 5 Holes Drilled

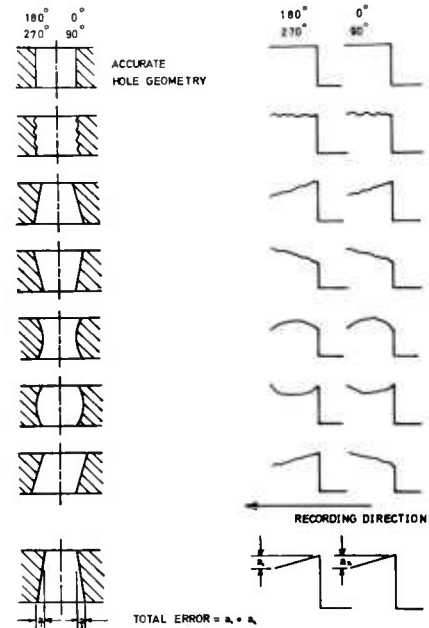

Fig. 38: Classifications of Error in the Hole Geometry after Drilling

The records of the 25 holes were classified and the error of each hole was placed in the appropriate column of Fig. 39. The figure shows that the most frequently obtained hole was slanted and the next was of the bell-mouth type which has smaller error compared with the first case. Only one hole was of the torn type which produced the least error in hole geometry. Maximum straightness errors of 0.008 inch and 0.006 inch were observed for the slanted and bell-mouth type holes respectively.

Interesting was the fact that in both directions of measurement, 0° - 180° and 90° - 270°, there were in most cases, similar magnitudes in the error.

This investigation showed that the various types of drilled holes were generated at random due to the instability of the workpiece holder during drilling.

The next investigation dealt with the effect of feed rate on the hole geometry when the workpiece was mounted on a fixture which was illustrated in Fig. 36. It is already known that increased feed rate will cause increased thrust and torque. The feed rate was increased from 0.005 ipr to 0.014 ipr with the rest of the parameters being kept constant. The characteristics of 15 holes are indicated in Fig. 40. The magnitude of error measured by more than 2 times when the feed rate was increased from 0.005 to 0.014 ipr.

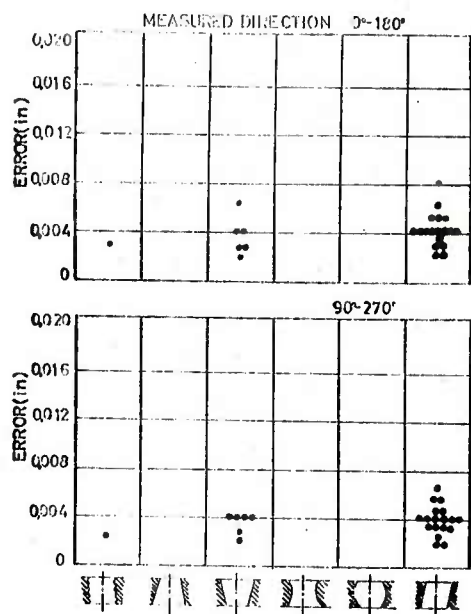

Fig. 39: Frequency and Type of Hole Geometry with a Feed Rate of 0.005 ipr

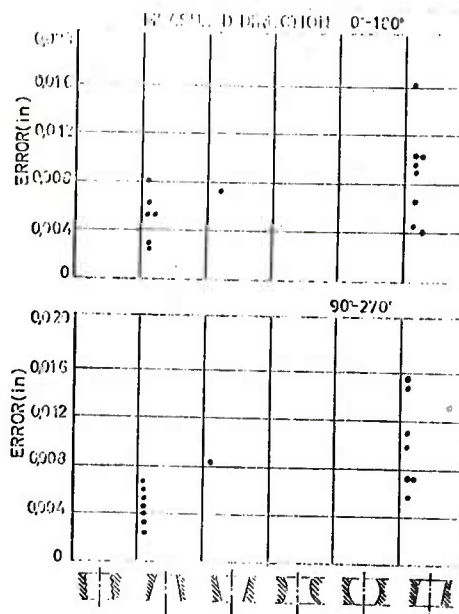

Fig. 40: Frequency and Type of Hole Geometry with Feed Rate of 0.014 ipr

In order to increase the stiffness of the workpiece holder, the dynamometer was removed from the modified table and the vise for fixing the workpiece was mounted directly on the table. The modified table had enough stiffness so that the drilling forces resulting from the general operating conditions would not have an effect on hole geometry.

The straightness measurement record of their hole geometries are shown in Fig. 41, which show that the hole geometries have improved a great deal.

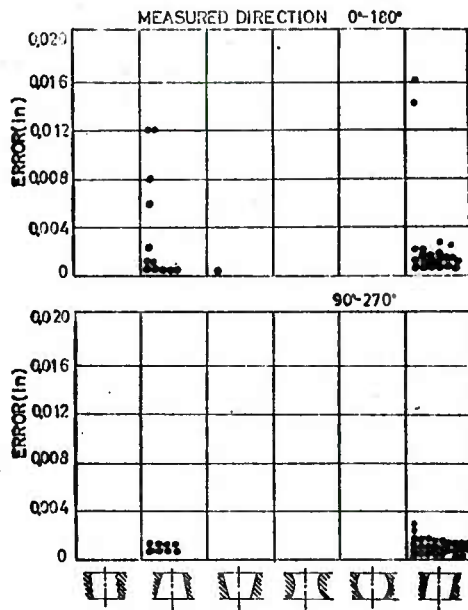

Fig. 41: Frequency and Types of Holes Drilled on a Stiff Workpiece Holder

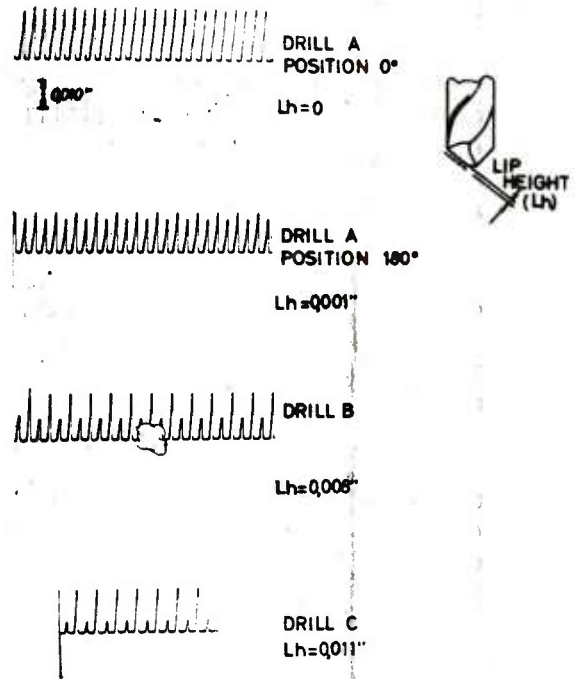

Fig. 42: Different Relative Lip Height of Several Drills

The above three typical investigations show the stiffness of the workpiece to play a large part in the generation of geometrical error, especially in the straightness of the side of a drilled hole. An interesting point in these investigations was the frequency of the type of hole geometry: the first was slanted and the second was bell mouth type (tapered). Since the drill for these investigations was selected as a symmetrically ground drill (both runout and relative lip height were negligibly small) it can be assumed that asymmetry of the drill can be neglected.

As reported above, the runout of the drill was dependent mainly upon the accuracy of the combination of spindle, sleeve and drill. In order to make a detailed inspection of the error during rotation at the margin and lip, the proximeter device was applied.

The most critical factor in asymmetry is likely to be the relative lip height. For example, Fig. 42 shows that when drill A is rotated 180° in the sleeve, the relative lip height changed from 0 inch to 0.001 inch. Two other drills,

B and C, also inspected in this manner had relative lip heights of 0.008 inch and 0.011 inch respectively.

To determine how the relative lip height affects the drilling force diagram, two extremely different drills (from Fig. 42) having relative lip heights of 0 inch and 0.011 inch were used. The force diagrams are shown in Fig. 43 for two feed rates,  $f = 0.005$  ipr and  $f = 0.009$  ipr. A comparison of both diagrams indicates that inaccurately ground drills lead to a variation in drilling forces, especially the torque and that the variation of forces were also affected by the feed rate, because increased feed rate increases the drilling forces.

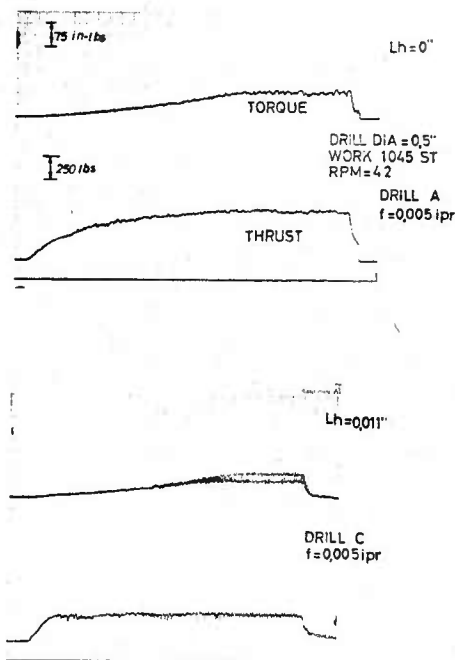

Fig. 43: Effect of Relative Lip Height on Drill Force Diagram

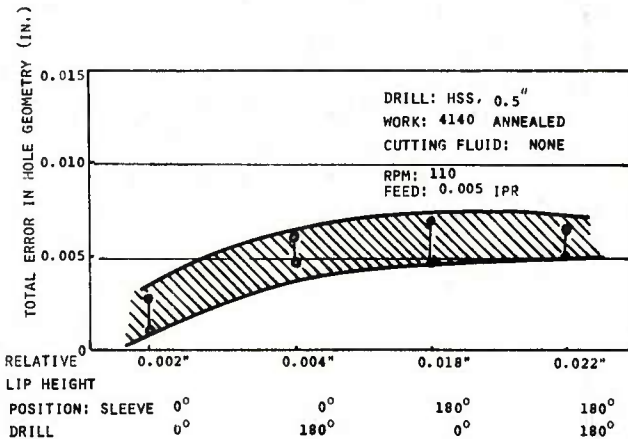

Fig. 44: Errors of Hole Geometry by Different Sleeve-Drill Combinations

Pahlitzsch and Spur (8) have already introduced the idea that an asymmetrically ground drill (or rotation of drill) results in a "walk" effect and results in an oversized hole.

It was interesting to observe how the error of rotation could affect hole geometry and this was done by drilling holes with various combinations of sleeve and drill direction. The straightness of each hole was carefully inspected and the results are presented in Fig. 44 where it was recognized that the relative lip height affected the total error of hole geometry in most cases.

The reason for this effect is explained as follows: the drill which is rotated accurately will generate symmetrical forces and moments in all directions, while the forces generated by a drill not rotating accurately are not symmetrical. Thus the magnitude of unbalance is related to the quality of hole geometry.

An attempt was made to establish the effect of a coolant on the accuracy of hole geometry, by keeping the same parameters as in dry drilling, except for the addition of cutting fluid. It was concluded that the coolant was not beneficial in obtaining accurate hole geometry while it was for the surface finish.

Gühring (21) mentioned that the type of hole, depth of hole, and also position of the hole in the workpiece affects the performance of the drill. Since the relative position of the workpiece surface to the drill could be considered a significant factor for the hole geometry, a block of workpiece material with a slope in the ratio of 0.5 inches to 4 inch was used as shown in Fig. 45.

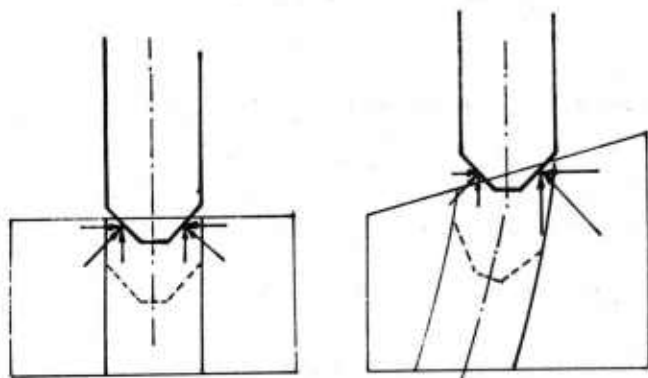

Fig. 45: Hole Geometries Produced by Different Slopes of the Workpiece Surface

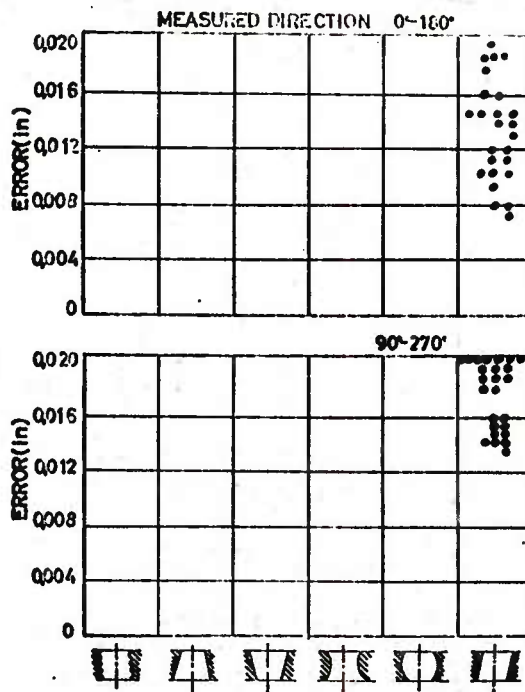

Fig. 46: The Straightness Errors Produced by the Sloped Workpiece Surface to the Axis of the Spindle

(21) Gühring, M., Auswahl and Einsatz von Bohrwerkzeugen, Industrieblatt, Sonderdruck, No. 9, 1964, pp. 1-11.

As is illustrated in the figure, the drilling forces do not act equally on both lips, thus one lip is affected a great deal more when the drill begins to cut the uneven surface of the workpiece. The asymmetric drilling force causes the deflection of drill body in one direction and the deflection will be maintained if the penetration begins.

Straightness measuring records and the evaluation of 20 holes were plotted in Fig. 46. It is shown that all holes have slanted forms and the total error ranged from 0.008 inch to 0.021 inch.

### 6-3. Roundness of Drilled Holes

Ständer (22) investigated the quality of drilled holes in terms of statistical evaluation and he classified three main forms of roundness produced by drilling: symmetric circle, irregular, and oval.

Due to the random nature of the roundness of drilled holes, a large number of tests and measurements were required for a definite conclusion. The roundness error in drilled holes will be caused mainly by the "walk" of drills during drilling.

Tsueda (23) investigated the walking phenomenon in drilling. His results were:

- a) As the feed rate increases, the walking decreases.
- b) The fixed feed rate where walking begins depends on the point angle and as the point angle decreases, the feed rate for walking decreases.
- c) At less than  $110^\circ$  of point angle, the walking disappears.
- d) No effect of RPM on walking was found.

Using special strain gage instrumentation, the researcher recorded the walking of the drill on an oscillograph and analyzed it as follows:

- a) At the beginning of drilling, when the drill

---

(22) Ständer, H., Bohrungsqualität beim Bohren mit Spiralbohren, Werkstatttechnik, Vol. 56 (1966), No. 11, pp. 546-554.

(23) Tsueda, M. and et al, On Walking Phenomenon of Drill, Transaction of Japan Society of Mechanical Engineers, Vol 27, 1961 No. 178, pp. 816-825.

plunges into the workpiece, no regular periodical recording was observed.

- b) However, after a short period, the periodical variation of record was seen which could indicate that "walking" of the drill has started.
- c) The number of corners in the drilled hole was picked as three, which can be assumed as the number of peaks in one period of record.
- d) When penetration of the drill is increased, the number of corners decreases during a short transitional period and then the number of corners increases to 5.
- e) After that, the number of corners remained steady.

In this investigation, a similar result was obtained, as shown in Fig. 47. In this figure, the Talyrond record at the top of the hole was observed as multi-cornered with roundness error of 0.0008 inch. Half-way between top and bottom, the hole had an increased number of corners, but the center of the hole shifted to a direction of  $110^{\circ}$ . The actual roundness error was reduced to 0.0005 inch. The surface finish on the bottom of the hole became rougher according to the record and the roundness error was 0.0005 inch. The center of the drilled hole moved again to a

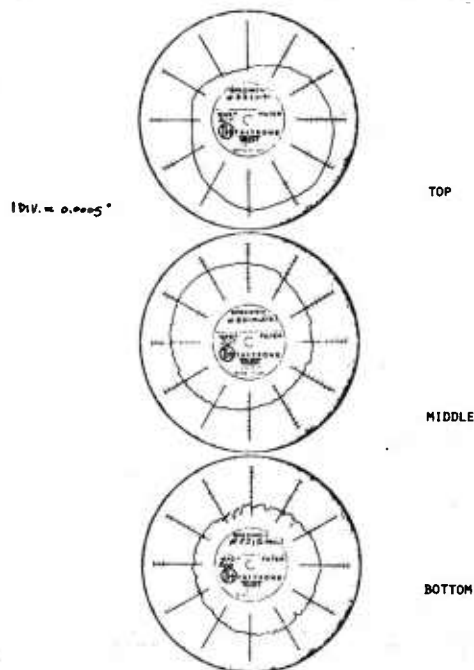

Fig. 47

*Roundness of Drilled  
Hole Measured  
at Different Position*

direction of  $135^{\circ}$ . The workpiece for this investigation was a 1-1/16 inch diameter bar and the face of the bottom was precisely ground so that the axis of the bar was perpendicular to the face of the bar.

Therefore, by taking Talyrond records on the top, middle and bottom (obtained by moving the stylus column), it can be assumed that each center of record indicates an alteration to the center of drilling.

The effect of feed rate on the roundness showed results opposite to those obtained by Tsueda. As shown in Fig. 48, both drill A and drill B had improved roundness error if the feed rate was increased from 0.005 ipr to 0.010 ipr, while using a coolant. However, in dry cutting, the superior roundness was obtained at the lower feed rates.

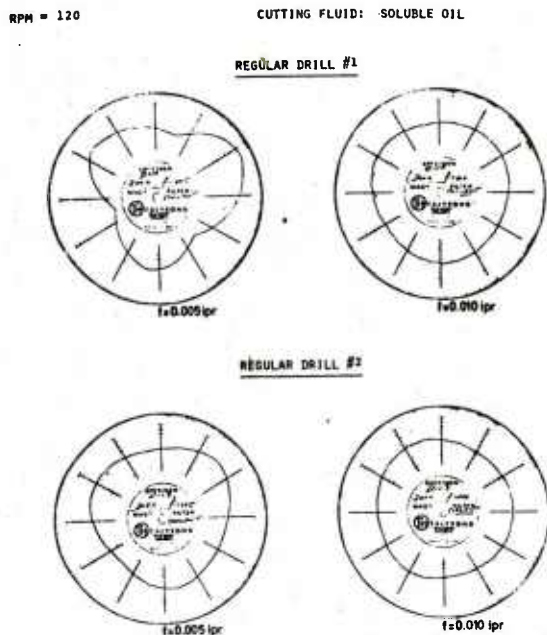

Fig. 48

*Effect of Feed  
Rate on Roundness*

Whether the accuracy of the drill grinding had any affect on the roundness of the drilled hole could not be ascertained due to the nature of the randomness of the results.

#### 6-4. Dimensional Accuracy of Drilled Holes

As previously mentioned, the drilled hole has a complex geometry. The straightness on the sides of the drilled holes had various appearances and roundness error varied with penetration. Consequently, the actual hole diameter is difficult

to define. First of all, it is difficult to determine which measurement represents the diameter of the drilled hole.

Ständer (22) drew the following conclusions on the obtained hole diameter:

- a) Effect of drilling condition is insignificant.
- b) Effect of drill diameter cannot be established.
- c) Effect of drill wear is small if wear is large.
- d) Effect of workpiece material increased in the order of light metal, steel and cast iron.

One research report (24) indicated that 6 different drill points gave some bell-mouthing due to the instability upon entry, but all eventually settled down to an oversize of less than about 0.002 inch, about 0.8% of the diameter. The effect of web eccentricity on the hole oversize was slight, while the relative lip height largely affected the oversize.

Spur (25) presented the effect of radial forces on the oversize, which was caused mainly by the relative lip height, while Haggerty (26) conducted a comparison test of twist drills with spiral drills and concluded that spiral drills were superior from the viewpoint of oversize. Other publications (27, 28) summarized the normal oversize encountered in drilling cast iron and steel under fairly good conditions without the use of guide bushings. In this case, the average oversize ranged from 0.002 inch to 0.008 inch with a drill of 1/2 inch diameter.

- 
- (24) Drill Points and Hole Size Metal Cuttings published by National Twist Drill and Tool Company, July 1964.
  - (25) Spur, G., Schnittkraftmessung beim Bohren mit Spiralbohren, Kurzberichte der Hochschulgruppe Fertigungstechnik der Technischen Hochschulen und Universitäten der Bundesrepublik Deutschland, 1969.
  - (26) Haggerty, W. A., Drill Symmetry - Effects on Hole Production, The Tool Engineer, June 15, 1960, pp. 83-86.
  - (27) Spizig, J. S., Bohrer genau and Schnell Schleifen, Werkstatt und Betrieb, Vol 104 (1971), No. 4, pp. 235-236.
  - (28) Oxford, C. J., Drilling Technology, Technical Paper, Vol. 58, No. 59, American Society of Tool Engineers, 1958.

The bore gage used for this investigation, which had a very sensitive comparator gaging device, indicated quite different values of diameters when the bore gage was moved to various depths of the hole, or rotated around the hole, even though the bore gage was held steady in a vertical direction. Therefore, it was necessary to measure at the same depth of hole and in the same direction to the two points on the bore gage in the hole in order to compare the accuracy of the drilled holes.

As the publication brought out, the oversize ranged from 0.002 inch to 0.008 inch or 0.8% of the drill diameter (24) which were similar to the results of this investigation.

It was interesting to determine how hole diameter varies with increased drilling time. Fig. 49 shows a plot of the variation of diameter of the drilled holes, in which the diameter of the first hole was considered as a intended diameter. From these figures, the effects of drilling speed on the variation of diameter was hard to establish. However, after 80 holes, the variation was a max. of  $\pm 0.004$  inch and min. of  $\pm$  of 0.002 inch.

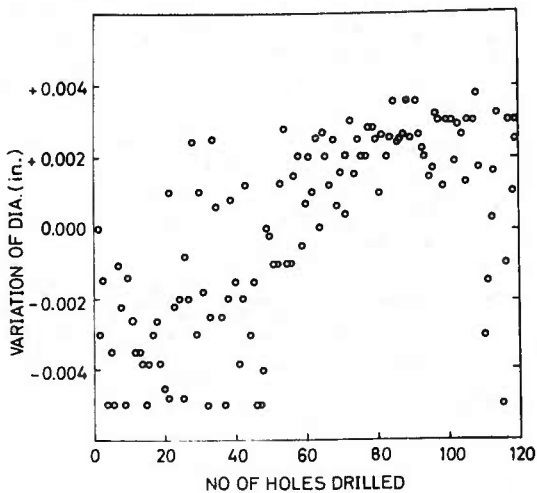

Fig. 49

*Variations of Internal  
Diameter of Drilled Holes  
Drill: HSS, 0.5 in. Dia.  
Work: AISI 4140 Annealed  
RPM: 110  
Feed Rate: 0.009 ipr  
Cutting Fluid: None*

No definite effect of coolant and drill accuracy on the hole diameter could be determined because the same drilling condition with the same drill produced diameters of a random nature.

Theoretically, the oversize of the hole can be analyzed as shown in Fig. 50. Actual hole diameter in a static condition will be determined by:

- a) Surface roughness
- b) Eccentricity of the drill itself
- c) Eccentricity of sleeve and spindle

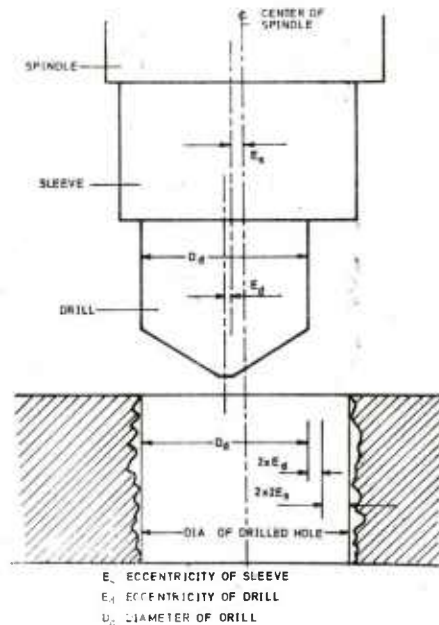

Fig. 50

*Schematic Illustration  
of Reason for  
Oversize of Drilled Holes*

It was interesting to note that both the eccentricity of the drill and spindle (and/or sleeve) can be cancelled and accurate hole dimensions obtained when the combination of the spindle, sleeve and drill are correct. Furthermore, it was also noted that the hole diameter will be increased more, in the case that

- a) the drill deflects due to lack of its own rigidity
- b) the workpiece leans toward one side due to lack of stiffness of workpiece holder.

The research report (24) pointed out, as the drill becomes shorter and more rigid, the accuracy and rigidity of the machine spindle chuck becomes more important. Also, accurate guide bushings are desirable, particularly with long, flexible drills.

## CHIP FORMATION

### 7-1. Phenomenon of Chip Formation

Chip formation in drilling is uniquely different from turning and other cutting methods. The chips generated by the drill will be restricted within the area between the drill flute and workpiece, and the chips will flow to the outside, while in other cutting methods the chips have no restriction.

If the chips clog during the drilling process, the drilling force will rapidly increase. Also, the supply of cutting fluid to the cutting part of the drill will be interrupted and this will cause an increase in the drilling temperature. Sometimes this imperfection in chip flow will cause a failure in the drill.

In 1928, Sachsenberg (29) made it possible to photograph chip formation during drilling with the help of specially designed instrumentation. The instrumentation consisted of a camera which rotated with the spindle using special lighting methods. He investigated the formation and flow of chips under various drilling conditions (helix angle, feed, workpiece).

The form of the drill point, flute, and helix angle all affected the chip formation to a large degree in every workmaterial investigated. The helix angle plays a decisive role in the chip flow from a drilled hole. As shown in Fig. 51, for small and large helix angles, chips strive to remain stationary due to friction on the side of the drilled hole rather than following the movement of the drill. However, the chip keeps moving because of the continuous rotation of flute. The appearance of chips on the rotating face of the flute can be caused by the force  $R$ , which can be divided into two components -  $N$  (normal to flute face) and  $S$  (same direction as the flute face). The component  $S$  contributes substantially to the chip flow and increases as the helix angle increases. The effect of  $S$ , however, will not be uniform with steel, cast iron, brass, light metals, etc., due to the different chip formation parameters, such as type of chip, ductility of material, diameter of chip coil, and friction coefficient of the particular material.

---

(29) Sachsenberg, E., Versuche mit Spiralbohren, Maschinenbau 7 (1928), pp. 905-911.

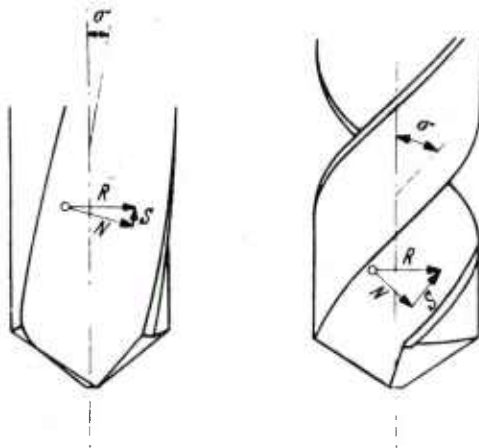

Fig 51: Effect of Helix Angle on the Chip Flow and Force Components

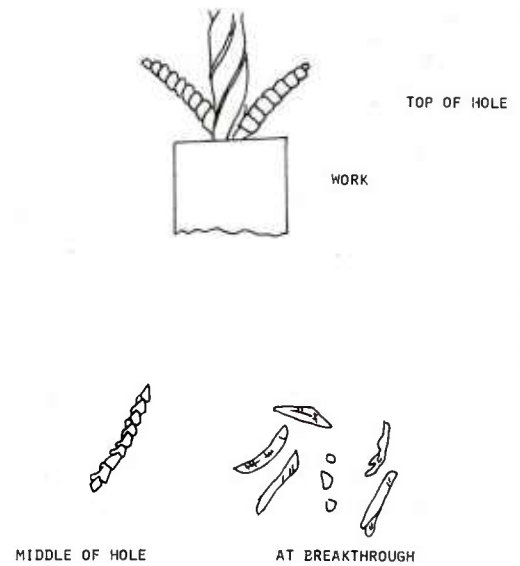

Fig. 52: Chips Being Emitted in Drilling and Different Types of Chip (Schematic)

In the evaluation of chip formation in drilling as well as turning, the description of the important characteristics of the chips (size, form, structure) must be applied. Drills may have one, two or more flutes, two being conventional. If a drill has two flutes, two lip edges produce a helicoidal formed chip for each. The chip can then be transferred through the flute and expelled as shown in Fig. 52.

It was observed that there are three different types of chips when drilling deep holes. When the drill penetrated the top of the hole, the chip formed was long and helicoidal. As the drill proceeded into the middle of the hole, the helicoid chip was broken and another type of chip, which was partly helicoid and partly broken, was produced. The third type of chip was broken and of irregular form.

## 7-2. Investigation of Chip Formation

The first chip formed was a helicoid, which was long and would wind on the drill and splash the cutting fluid on the operator. It was observed that the length of the helicoid chip was affected by the cutting condition and that the feed rate was the controlling factor for the length of the first type of chip.

Fig. 53 shows a comparison of the length of helicoid and other types of chips produced at different feed rates, and it is shown that at small feed rates, the length of the helicoid chip was larger. After extensive investigations, it was confirmed that the length of the chip was related to the feed rate as introduced in Fig. 54. In this figure, not only the first type of chip, but also the second, had some relation to the feed rate.

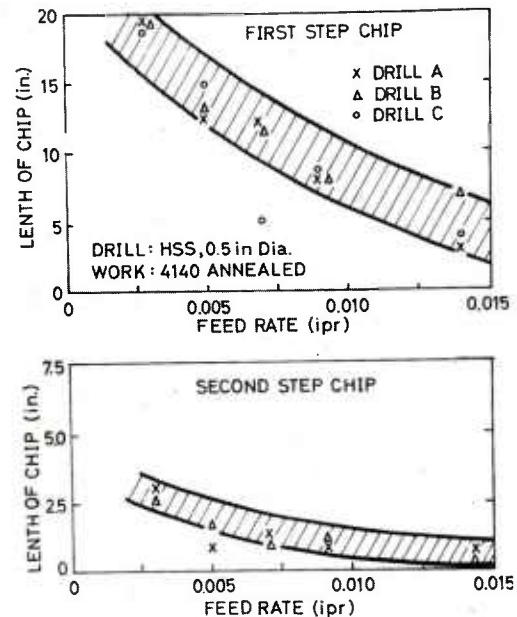
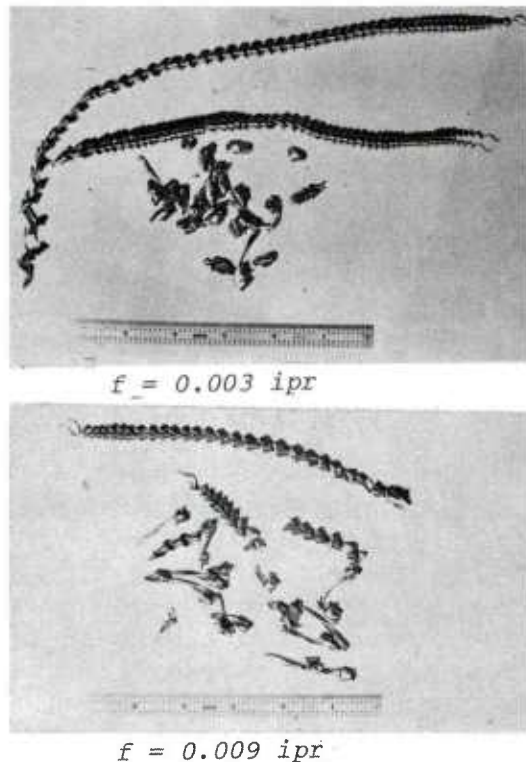

Fig. 53: Comparison of Length of Chips Produced by Different Feed Rates

Fig. 54: Relationship Between Chip Length and Feed Rate

The results were in agreement with the explanation of Spaans, et al (30). They stated that the fracture strain of the chips during cutting can be used as a quantitative criterion for "breakability", and, in general, the strain decreases somewhat with increasing feed. The effect of drilling speed on the length was not essential, and this fact can be traced back to Spaans' finding that the fracture strain of the chip was independent of the cutting speed.

(30) Spaans, C. and et al, The Breakability, An Aspect of the Machinability - A Computer - Simulation of Chip Formation, SME Technical Paper, MR71-154, 1971.

Often it was observed that the two chips emitted from the two flutes were quite different: One looks springy and long, while the other is unwound and short (Fig. 55). The reason for this can be explained by Fig. 56. Both lips are schematically illustrated in this figure. After one rotation of the drill, lip 2 moves in the direction of cutting for a distance of  $\pi D$  and removes chip 2, with the thickness corresponding to half of the feed rate ( $f/2$ ). The starting point of chip removal by lip 1 was a point which was ahead at a distance of  $\frac{\pi D}{2}$  from the starting point of lip 2. If

the drill is accurately ground (relative lip height is zero), both lips will remove the same thickness of chip. However, due to relative lip height not being zero, there will be some gap between the two lips which causes a difference in chip thickness during one rotation of the drill, i.e., one lip removes a thick chip while the other removes a thin chip. Naturally, the thin chip has a large fracture strain and this causes the long chip length.



Fig. 55: Chips Produced by Inaccurately Ground Drill

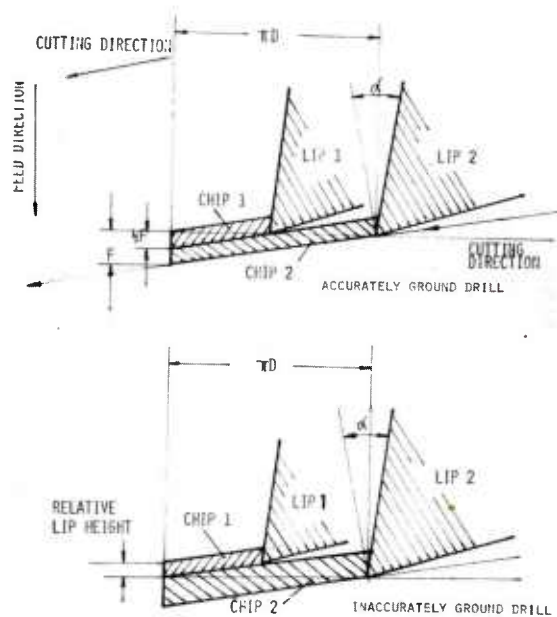

Fig. 56: Chip Formation by Accurately Ground and Inaccurately Ground Drill (Schematic)

The effect of using a coolant on the chip length was investigated. The results were found to be inconclusive since the chips resulting from the wet and dry cutting conditions were too similar.

Stoewer (31) suggested parameters with which the evaluation of chip formation and chip flow can be made. The coefficient of deformation,  $C_d$ , and the amount of space of the chip,  $N_{sc}$ , were obtained successfully through investigation with turning. These results can be also applied in drilling.

The coefficient of deformation can be determined by the broken or cross-sectioned chip. The  $C_d$  turns out to be the number of times the thickness of the actual chip compares to the theoretical thickness, namely  $\frac{S}{2}$  (half of feed rate).

The coefficient of deformation is unsuitable if it exceeds 3~6.

The amount of space of the chip,  $N_{sc}$ , can be related to the definition:

$$N_{sc} = \frac{\text{Required space for a broken chip}}{\text{Actual volume of work to be cut}}$$

The  $N_{sc}$  number obtained by turning ranged from 3 to 900. In drilling steel, the number ranged from 6 to 300. An optimal value should range between 15 and 90.

---

(31) Stoewer, H. J., Schneidversuche mit Gewindebohren auf Stahl, Stock-Zeitschrift, Vol 5 (1932), H. 2, pp. 31-42.

## SURFACE FINISH OF DRILLED HOLES

### 8-1. Characteristics

Surface finish in drilled holes was not considered to be important because drilling was not the final process. However, recently the surface finish obtained is receiving more attention in industry.

Pahlitzsch and Spur (32) investigated surface finish in steel with four different drill diameters, using a coolant (soluble oil in ratio 1:40) and obtained the following results:

- a) Surface roughness increases parabolically with cutting speed.
- b) The effect of feed rate on surface roughness became pronounced only at higher feed rates.
- c) Large variations in the measured roughness were observed.

Dubrov (33) found out that plastic-shanked drills improved surface finish compared to that obtained with regular shanked ones.

Due to the lack of published material in regard to surface roughness, its theoretical and statistical aspects were investigated.

Fig. 57 illustrates the theoretical surface roughness of a drilled hole. The roughness can be explained to be the peak to valley height ( $H_{\max}$ ) which can be affected by the point angle and especially by the feed rate.

As shown in the figure, the valley, which was generated by one corner of the drill, will be cut by the other corner and, theoretically, the maximum peak to valley height ( $H_{\max}$ ) will be reduced by one-half, assuming the drill is perfectly ground, i.e., no relative lip height, no centrality, and

- 
- (32) Pahlitzsch, G. and Spur, G., Untersuchungen über die Oberflächenraubeit der beim Bohren mit Spiralbohren Maschinenmark, Nr. 88, Nov. 1963, pp. 27-29.
  - (33) Dubrov, Yu. S. and et al, Surface Finish Using Plastic-Shanked Drills, Machine & Tooling, 1968, Vol 39. No. 8 pp. 39.

the rotation of the drill is assumed highly accurate. However, if the ground drill does not have accurate geometry or the wear on both corners is not similar, the surface will be rougher as compared to the ideal case.

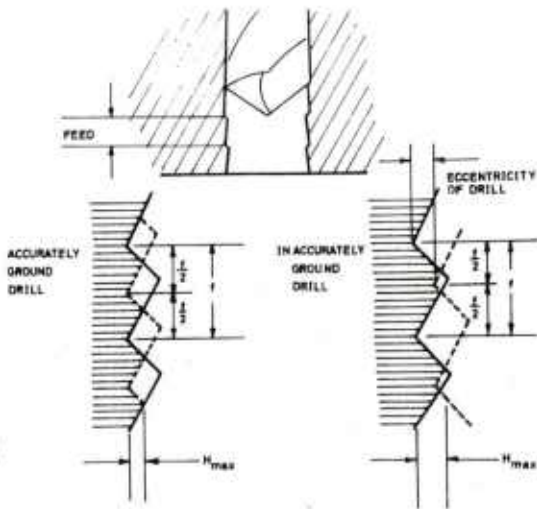

Fig. 57: Theoretical Surface Profile of Drilled Holes (Schematic)

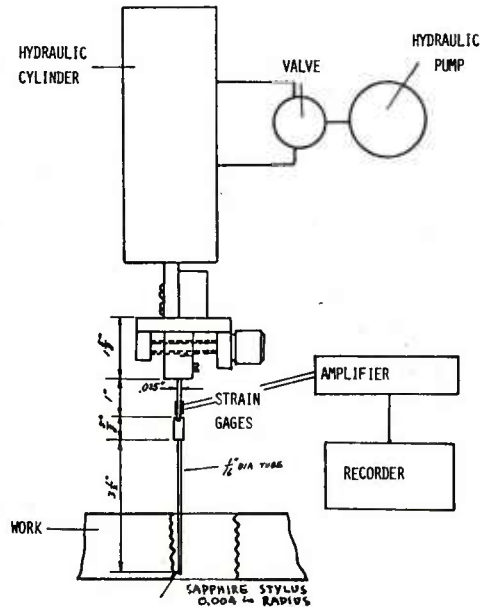
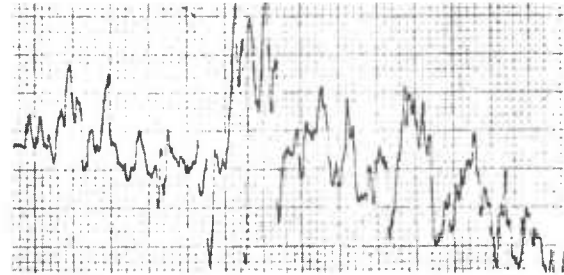
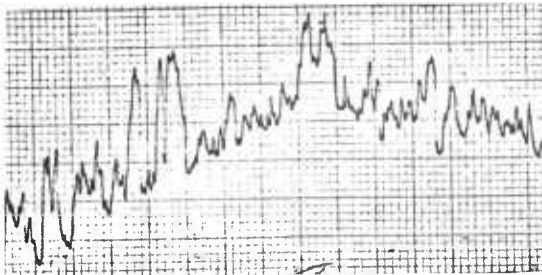
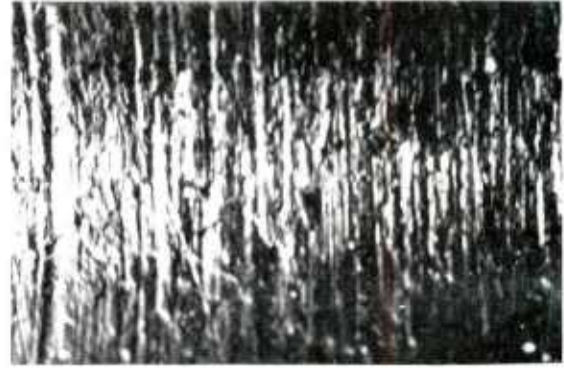
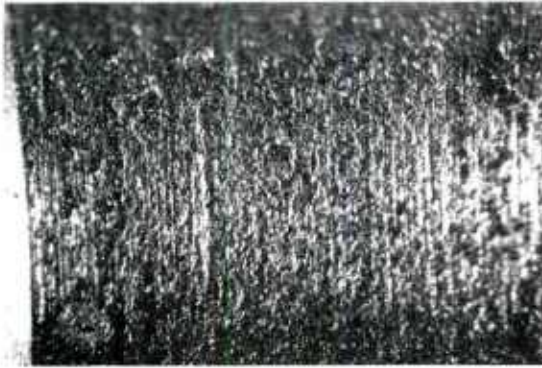

Fig. 58: Schematic Illustration of Surface Profile Recording Device with Hydraulic Feed

For experimental purposes, the feed rate was varied with constant drilling speed. The drill used in this investigation was inspected and found to have a negligible small error in the rotational accuracy. The workpiece was a round bar with 1-1/16 inch diameter. After drilling, the workpieces were cut in half and the surface of the drilled hole was photographed with a magnification of 4x. Also, a profile record of the drilled surfaces with varied feed rates was obtained. The profile recorder was specially designed for this investigation and the stylus of the recorder (Fig. 58) was a sapphire with a radius of 0.0005 inch. The profile was expected to be close to the actual roughness.

Fig. 59 shows both the photographs and the profile records obtained with various feed rates and dry cutting. They indicate that the profile has a random nature and no specific surface profile could be expected regularly.

At large feed rates, the irregularity of the surface roughness was intense and this could be caused by chipping when the chip moved through the flute.



RPM = 207       $f = 0.007$  ipr      · ·      RPM = 207       $f = 0.020$  ipr

Fig. 59: Surface Roughness of Drilled Holes for Different Feed Rates

## 8-2. Effect of Cutting Fluid on Surface Finish

It was expected that the use of a cutting fluid would improve the surface finish as compared to dry drilling.

Fig. 60 shows that drilling with a cutting fluid produced a steady range of surface roughness during drilling of 80 holes, while with dry drilling, the surface roughness varied drastically.

A comparison of the two tests was made in the graph of Percentage Cumulative Frequency in Fig. 61. The surface roughness produced by using a cutting fluid ranged from  $25\mu$  in. to  $130\mu$  in. and the dry drilling varied between  $105\mu$  in. to  $410\mu$  in. An average roughness height of  $70\mu$  in. was obtained using fluid and  $270\mu$  in. for drilling dry. This example was just a comparison of two processes. It is only possible to assert that the use of cutting fluid is advantageous, from the point of view of surface finish, compared with dry cutting.

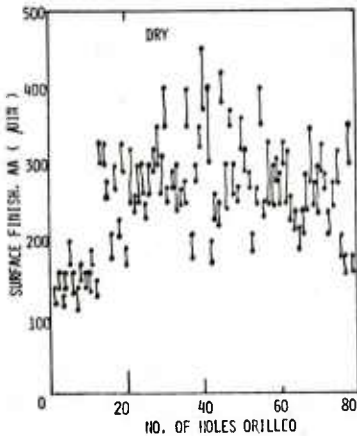
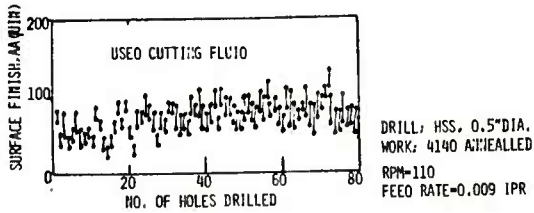

Fig. 60: Surface Finish Using Cutting Fluid (a) and Dry Condition (b)

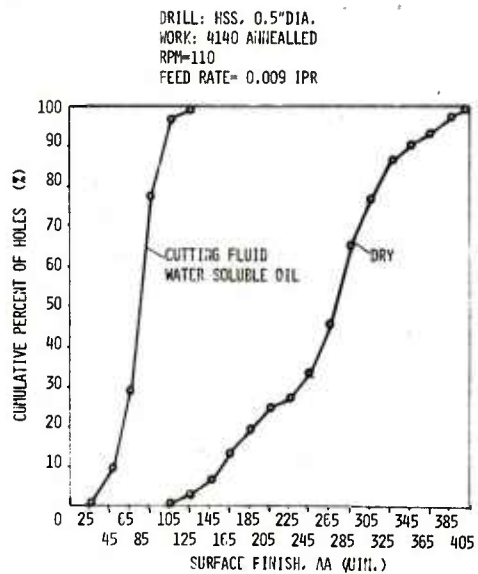

Fig. 61: Percentage Cumulative Frequency Comparing the Surface Roughness Effected by Cutting Fluid

### 8-3. Effect of Cutting Speed on Surface Finish

It was previously mentioned that a higher cutting speed (574 RPM) produced a BUE even though a cutting fluid was used. In order to study the effect of cutting speed on surface roughness, different cutting speeds were used and the roughness of all drilled holes was measured.

In order to make a comparison, four different speeds, 207, 289, 385 and 574 RPM, were compared after 100 holes were drilled in the cumulative percentage frequency curve as shown in Fig. 62. What this figure shows is that no meaningful trend in surface finish became noticeable until 574 RPM was reached. At that speed, the average roughness height obtained was more than  $80\mu$  in. and the variation of surface finish ranged between  $80$  and  $280\mu$  in. As already explained, all velocities below 574 RPM produced no BUE with a cutting fluid present. It appears, therefore, that in the case of BUE formation, the roughness obtained is much higher even though drill wear is greatly reduced.

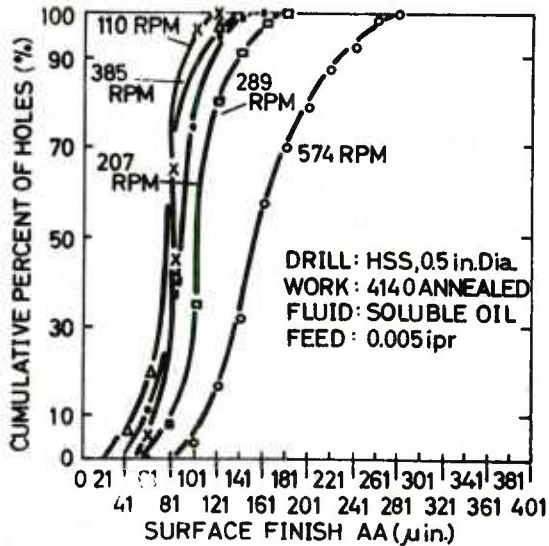

Fig. 62

Cumulative Percentage Frequency  
 Curve of Surface Finish  
 by Varied Drilling Speed

#### 3-4. Comparison of Obtained Surface Finish by Different Drills

Representative drills ground with high accuracy, by three drill manufacturers, were selected. The comparison test with the three drills was conducted under identical drilling conditions. The results of surface roughness obtained for each drill were plotted in Fig. 63. The roundness is shown to range randomly as the number of holes is increased. Interesting to note is the fact that the surface roughness keeps almost at the same level even when drill wear takes place.

In order to evaluate the data statistically, a cumulative percentage of holes relating to the obtained surface roughness is presented in Fig. 64.

It was hard to establish the superiority of any of the drills on the basis of surface quality. The average value varied only 15  $\mu$  in. in the arithmetic average roughness (AA) between manufacturers; however, the variation among drills from the same manufacturer was large.

For a detailed investigation of characteristics in surface roughness, two drills were chosen which were different with respect to their rotation. The error of rotation in the two points - lip and margin (corner) - were recorded on a proximeter. Drill E had a very accurate rotation at the lip, while error in the margin (corner) showed 0.013 inch. Drill F was less accurate in the lip (0.005 inch), but equally accurate

in the margin (0.013 inch).

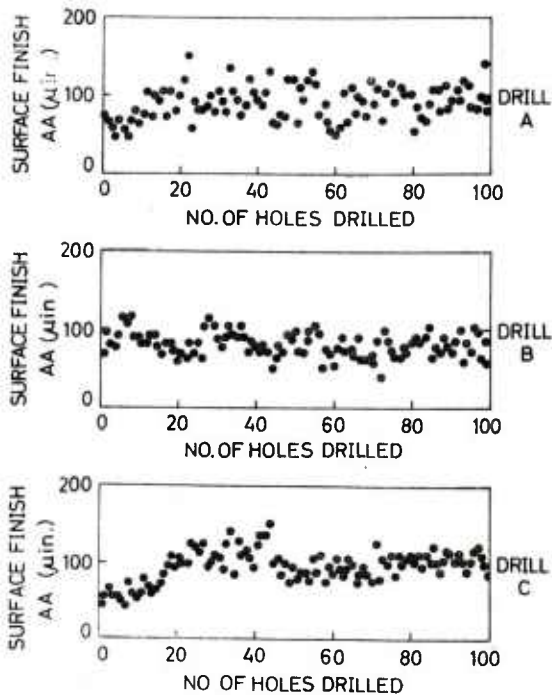

Fig. 63: Surface Finish Generated by Different Drills at Same Condition  
 Drill: 0.5 inch Work: 4140  
 RPM = 207  $f = 0.005$  ipr

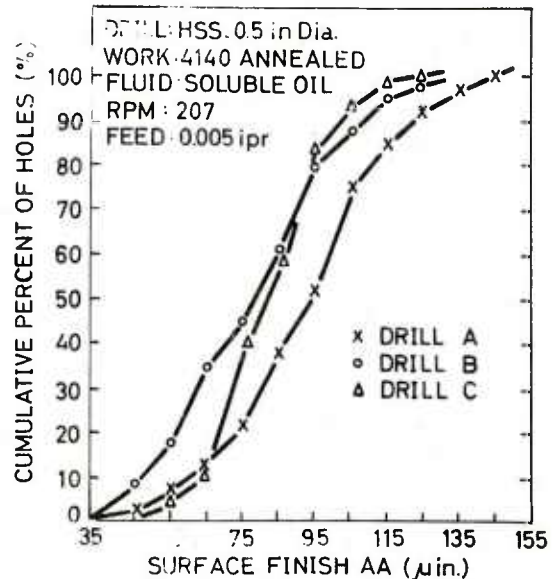

Fig. 64: Cumulative Percentage Frequency Curve of Surface Finish by Different Drills at Same Condition

The surface roughness profile of the two drills was carefully observed. Three different feed rates were run and each surface was recorded by the SURFCOM. It was confirmed again that the feed rate was an important factor in the generation of surface roughness. As the feed rate increased, the surface profile became rougher. However, between drill E and F, no definite difference, in the profile itself, was found.

The surface profile record of drill F indicated a large waviness at the feed rates of 0.003 ipr and 0.007 ipr while drill E generated reduced waviness at the same feed rates. Considering the fact that drill F was found to have a relative lip height of 0.005 inch while drill E was very accurate, it was determined that an increase in relative lip height could be the most important factor in the occurrence of radial force.

The surface profiles obtained under dry conditions were also presented in Fig. 65. Comparison with previous tests shows the effect of coolant on the surface profile to be very

remarkable. From the profile records it can be concluded that the surface roughness could be substantially improved when using coolant.

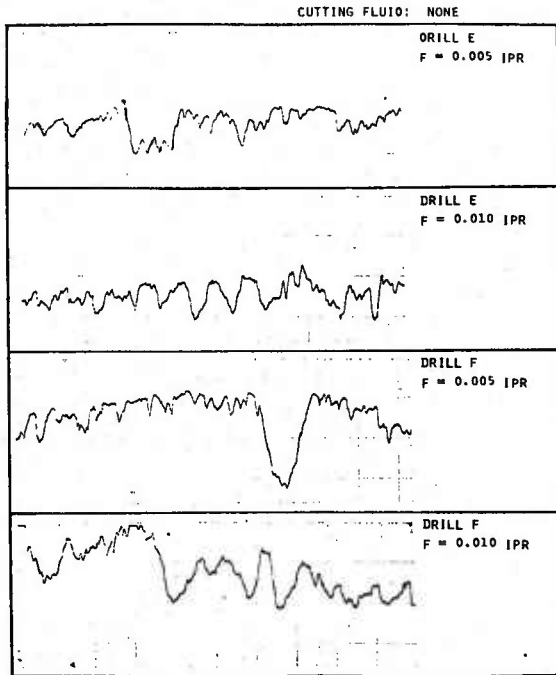

Fig. 65

*Surface Roughness Profile  
Comparison Generated by  
Drills E and F, RPM-207*

## DISCUSSION ON DRILL LIFE CRITERION

### 9-1. Definition of Drill Life

Tool life refers to the actual machining time between regrinding of the tool, not the total life of the tool before it is discarded.

Tool life is usually the most important of the three main machinability criteria from the standpoint of machining cost (34). For this reason, most machinability ratings of materials are based on tool life only. Generally, the common criteria for judging tool failure are as follows:

- |                        |                         |
|------------------------|-------------------------|
| a) Complete failure    | d) Finish failure       |
| b) Preliminary failure | e) Cutting-force change |
| c) Flank failure       |                         |

In judging tool life it is important that the tools are used only until they are worn to a point where regrinding is still economical. This has been found as a reasonably dependable criterion of tool failure for turning or other processes. However, there are no reasonable criteria for drill life judging.

Considering the recent developments in numerically controlled machining, a study on the drill life criterion is most significant because, in most cases, N/C does not allow individual interruption for the tool change.

In the past, various drill life criteria were suggested by many researchers. The factors which affect drill life are very complicated. Each factor does not have the same level of importance in drill life. In order to establish the effect of each factor, requires an extensive and precise investigation.

The following cases are considered regarding the time at which the operation is stopped and the drill is reconditioned.

- 9-2. A "screeching" sound is heard when the drill has produced a certain number of holes. The reason for this is that the margin is heavily worn or the friction between the margin and hole side produces the sound. In most such cases,

(34) Tool Engineers Handbook, 2nd Edition, ASTME, published by McGraw Hill, 1959.

heavy wear took place on one of the margins because of the eccentricity of drill in its rotation. In some cases, the sound is caused by chatter vibration which is due to the resonant frequency of the drill along with the frequency of vibration of the operation. Very often the sound stopped when the relative position of the drill in the spindle was changed. Often improvement of centrality through changing the combination of spindle sleeve and drill eliminated the sound. By changing the drilling conditions, the screeching can also be eliminated. It is not necessary to regrind the drill, still sharp on chisel and lip edges, only because the drill is noisy. For these reasons, this phenomenon cannot be recommended as drill life criterion.

- 9-3. The chips start to stick in the flute. The worn drill causes a hindrance to chip flow. The lip edge tears, rather than cuts, the chip and the non-helicoidal geometry of the chip may cause the chips to tend to stick in the flute. As discussed previously, the drill force diagram (especially the torque diagram) indicates when chip packing has started (see Fig. 16). This phenomenon could be a sign that the drill was not sharp enough for perfect drilling. The drill may continue to drill for a certain additional number of holes. However, after that, the drill should be removed from the operation and resharpened because the encumbered chip flow could be a reason for intense walk of a drill and may harm the surface finish. Sometimes, total failure of drill takes place when the chip has difficulty with the flow-out through the flute.

As already discussed, chip formation is mainly affected by feed rate. Through changing of drilling conditions (feed rate), improved chip flow could be obtained easily. Hence, this phenomenon cannot be counted as a reasonable drill life criterion.

- 9-4. An increase in drilling force may be due to the drill becoming dull. This criterion was most often discussed by several researchers and recommended as a satisfactory drill life criterion. These researchers, along with others, endeavored to assess drill life from torque, thrust and power readings, or some combination of these. Such methods have been thoroughly examined. The simplest method consisted of measuring the power input to the driving motor by a watt meter and assuming that the drill life would end when the power consumption had risen by a fixed amount, such as 10-15% above the initial value. Schlesinger (29) found that the normal fluctuations in power consumption due to varying losses in the machine and the inherent variations in the material being cut could easily exceed 15%, and accordingly, abandoned the method. He later used it in a modified form for tests on steel by running the tests for a longer period of time until the drilling had proceeded to such an extent as to incur an increase in power of approximately 30%.

Galloway (35) investigated several materials with this method, and the results with steel are presented as follows:

Type 1 drill	20 - 36 holes (min-max)
Type 2 drill	2 - 13 holes
Type 3 drill	24 - 33 holes
Type Special	76 -140 holes

As shown, the variation of drill life was so large (from 37% to 650%) that for all practical purposes, this criterion is not reasonable. In one of the investigations for this project, an increase of drilling forces was not experienced even though 200 holes were drilled and the drill had been found to wear at a certain rate. In another investigation, an increase of thrust from 600 lbs. to 800 lbs. and torque from 50 in-lbs. to 300 in-lbs. was obtained without an increase in the dullness of the drill. The increases represented 33% in thrust and 500% in torque. The reason for the increase of drilling forces is not directly related to the condition of the drill but involves many other factors, and it is difficult to determine the sources which change the drilling forces. In addition, for judging drill life by this method, the dynamometer and recorder would have to be used. As already discussed in this report, the lack of stiffness of a dynamometer causes error in geometrical accuracy. Also, the workpiece should be located symmetrically on the dynamometer in order to measure the forces accurately. Considering the inconvenience and imperfection of this method, it cannot be considered a suitable drill life criterion.

9-5. Increased wear on margin. The margin can be classified as one of three regions of wear on the drill, and this wear has been recommended as drill life criterion. In this investigation the wear on the margin was carefully observed and photographed. At the corner of the lip and margin, narrow lined wear began shortly after beginning drilling. The development of this lined wear was observed to progress rapidly, and after it was fully developed at the corner, the margin was chipped by friction between the drill and the hole (see Fig. 30).

This progress of wear on the margin had numerous types and is difficult to generalize. It was noticed that a groove in the form of a line began to develop after a certain cutting time. Only on a symmetrical drill was the development of similar grooves observed on both margins. With an increase in the number of drilled holes, a second groove began to be generated and the number of grooves increased according to

---

(35) Galloway, D. E. and Morton, I. S., Practical Drilling Tests, The Institution of Production Engineers, 1946.

the increase in the number of drilled holes. The time of groove inception and the regularity of appearance of the groove on the margin depends on the accuracy of the drill and the drilling condition.

The distance from the corner to the first groove and from the first to the second groove are identical with the feed rate applied to the drill, as shown in Fig. 66, and can thus be controlled accordingly.

The measurement of margin wear was not easy due to lack of discoloration in most cases. Theoretically, the wear on the margin should cause a reduction of drill diameter and this result should decrease the diameter of the drilled hole. However, in practice, no definite influence of the wear on the dimensional accuracy is presented. The reason for this can be given as follows.

The reason for the oversize of the drilled hole as analyzed in Fig. 67 is mainly the centrality of spindle, sleeve, and drill system, and the wear of the margin in the radial direction is so small that it can be neglected compared to the runout of the system.

It was found that, with an increasing number of holes, the variation of the diameter of a drilled hole barely changed, which leads to the assumption that the effect of

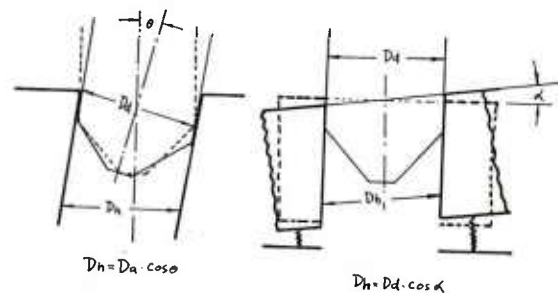
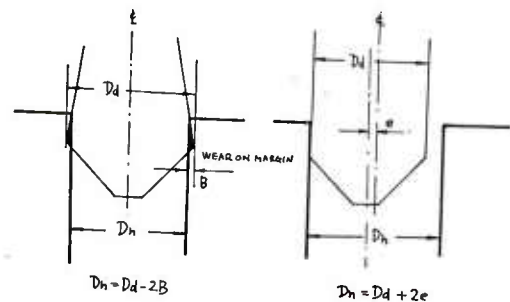
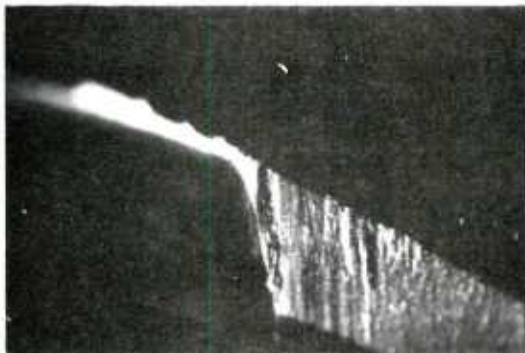
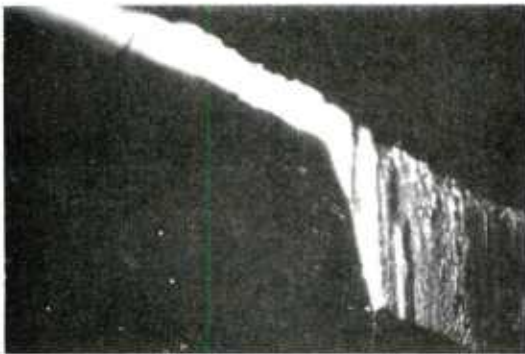

Fig. 66: Grooved Wear on the Margin

Fig. 67: Reason for Oversize of Drilled Holes

wear on the diameter of a drilled hole is negligible.

Based on the above discussion, the wear on the margin cannot be recommended as a suitable drill life criterion for the following reasons:

- a) In most cases, wear on the margin and type of wear depends on the centrality of the drill.
- b) The progress of wear on the margin has no definite relationship with drilling time.
- c) The relationship between drilling time and variation of hole diameter was caused mainly by the runout of spindle, sleeve and drill system, and no direct influence of drill wear on margin was determined.

9-6. Wear on the lip. The important parts of the drill point are those which are in contact with the work material, and the lip is one of the most effective. With increased cutting time, wear on the lip increases and this type of wear corresponds to flank wear in the turning operation, which is used as the tool life criterion.

Wear on the lip differs from flank wear in turning due to its geometrical features. The rake angle varies along the radius of the drill, thus, lip wear should develop in a triangular form, as shown in the schematic illustration in Fig. 68. A most important factor affecting lip wear is the relief angle (36). Fig. 69 illustrates how the relief angle affects lip wear. The relief angle was measured and was found to vary from  $9^{\circ}$  to  $14^{\circ}$  in this investigation. Since the relief angles varied in this range, a corresponding variation of lip wear could not be avoided.

As Kirschbaum (37) indicated, a standard point drill should be measured in this order: wear on lip, wear on chisel edge, and wear on margins. It was concluded that wearland on the lip should be the most ideal drill life criterion. However, special work materials (for example, 4140 annealed steel) may tend to have an affinity for a built-up edge formation in the range of drilling conditions generally used. It was hard to measure the wear on the lip because of the

---

(36) Cowie, R. J. and Pegler, J. O. M., Some Factors Affecting the Performance of Drills and Taps, Proceedings of the Conference on Technology of Engineering Manufacture, The Institution of Mechanical Engineers, London, March 1958.

(37) Kirschbaum, R. A., How to Measure Tool Wear, American Machinist, Feb. 26, 1968, pp. 105-106.

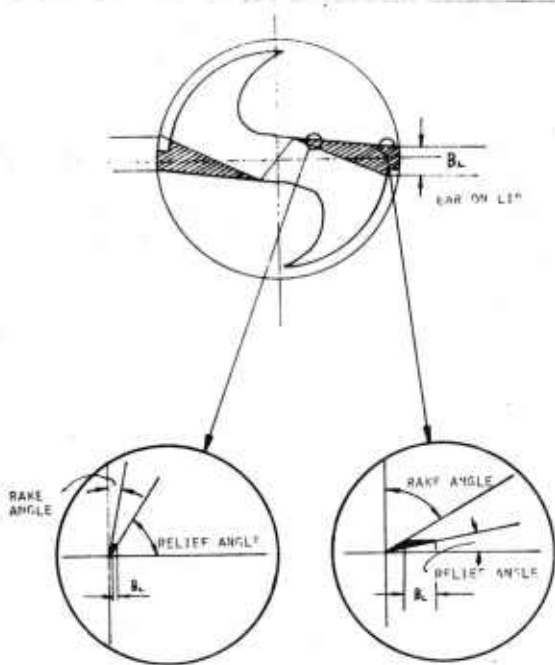

Fig. 68: Schematic Illustration of Wear on the Lips on Different Points of Drill Diameter (Schematic)

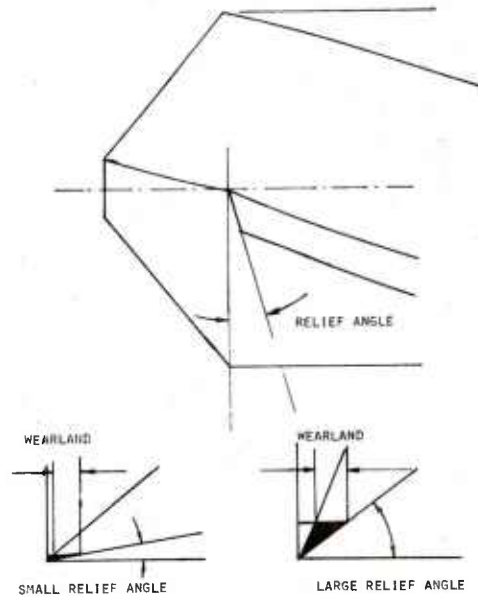

Fig. 69: Schematic Illustration of the Effect of Relief Angle on the Wear of Lip

protection by the BUE.

In a previous chapter, it was reported that the BUE appearance was random in nature and the length of BUE along the cutting lips and the maximum height of BUE were independent of the drilling speed and feed rate used. It was observed, after drilling 200 holes, that the BUE still had not disappeared from the lip, even though extreme wear on the margin and a certain amount on the chisel edge, were observed.

In the case of using cutting fluid, the wearland on the lip was clearly without BUE and the progress of the wearland with increased cutting time indicated an almost proportional relationship. The wearland-drilling time curve using various drilling speeds is introduced in Fig. 70. At 110, 207, and 289 RPM, the wear rates on the lip correspond well while at 385 and 574 RPM, there is no indication that the wearland would be a parameter of drilling time.

The drill life criterion was assumed to be a wearland of 0.010 inch on the lip. The drill life plotted against drilling speed is shown as a continuous line in Fig. 71. Two drill life curves are shown to lie parallel in this figure. The drill life curve on the left is the condition

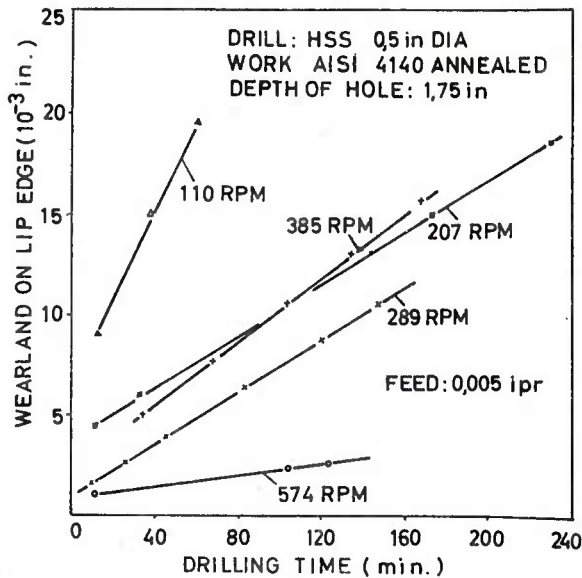

Fig. 70

Relationship Between Wear  
 on Lip  
 and Drilling Time

without BUE while the right curve involves BUE. It is interesting to note that as drilling speed increased, drill life increased, which is opposite to most other machining processes. Since the curves were obtained for 4140 steel, they cannot be applied in general without extensive investigation of other materials.

Many researchers suggested that the use of the total length of the hole wall (drilling length), which was generated by a drill, should be a drill life parameter. Schallbroch (38) suggested drill life as drilling length of 2000 mm (80 inches). The drilling speed which provides the drill life for the 2000 mm drilling length was defined as the drilling speed for the 2000 mm drilling length and was symbolized as  $V_L 2000$ . The researcher conducted a drilling experiment with numerous materials and concluded that the curve,  $V_L 2000$ , was related mainly to the material property, such as hardness, carbon content, etc. From the result of this project, a curve of drilling length against drilling speed was obtained. From this curve it can be concluded that larger drilling speeds produced more drilling length under the assumption that wearland of 0.010 inch on lip is drill life. However, it must be considered that the other parts which contact the work

(38) Schallbroch, H., Bohraibeit und Bohrmaschine, Carl Hanser Verlag, München, 1951.

(for example, the margin) will be more severely worn.

This drill life criteria is most popular in industry - they recommend a minimum amount of 0.060 inch to be taken off at the cutting end of the drill so that worn, chipped, or burned portions are removed (39).

However, drilling 4140 annealed steel with a cutting fluid or dry, presents a totally different phenomenon from the viewpoint of wear on the lip. Therefore, for the two cases, namely, with BUE and without BUE, two separate drill life criteria are recommended. For BUE formation, other parameters such as margin, could be a suitable life criterion, while for drilling with a cutting fluid, i.e. without BUE, the wearland on the lip can be taken as a drill life criterion. From this investigation, a wearland of between 0.015 inch to 0.020 inch is suggested as drill life.

9-7.

Wear on the chisel edge. Chisel edge wear is caused by plunging (and/or extrusion) rather than cutting. A schematic illustration of chisel edge wear is shown in Fig. 73. As can be seen in this figure, the wearland on the chisel edge is dependent on the point angles of chisel edge and of overall point.

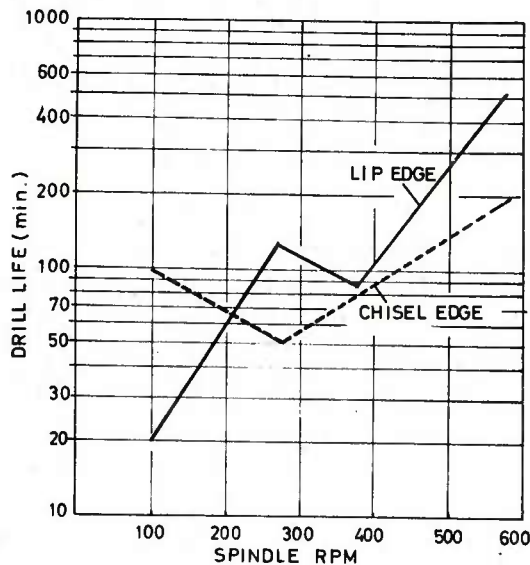

Fig. 71

Drill Life Curve  
Based on Two  
Drill Life criterions

(39) John Deere Manufacturing Processes Manual, Part A: Recommended Drill Reconditioning Procedure.

The progress of wearland on the chisel edge against drilling time is plotted in Fig. 72. A linear relationship between wear and number of holes exists for all RPM regardless of BUE formation.

The drill life curve for a wearland of 0.04 inch is presented as a dotted line in Fig. 71. Drill life decreased with increased drilling speed until BUE protection began, at which point drill life increased. As previously mentioned, the higher the drilling speed, the higher the cutting temperature, and the higher the temperature, the greater the affinity to BUE formation on the drill end. However, BUE on the chisel edge is a different phenomenon from BUE on the lip. Since the chisel edge plunges into the workpiece, the appearance and disappearance of BUE on the chisel edge will be repeated frequently. Therefore, the wear on the chisel edge is related closely to drilling time or drilling length.

The curve giving the relationship between drilling length and drilling speed was established where the drill life criterion was chosen as a 0.040 inch wearland for the chisel edge. From this curve, it is noted that the drill life curve can be considered in two phases. At first the

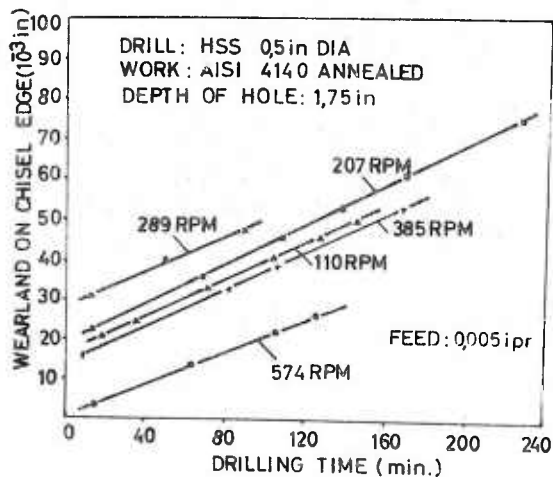

Fig. 72: Relationship Between Wear on Chisel Edge and Drilling Time

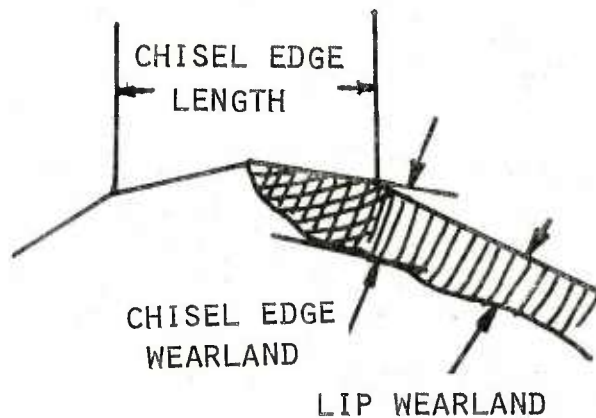

Fig. 73: Schematic Illustration of Wear Pattern

increase of drill life with drilling speed is indicated by a slight slope, then the slope increases abruptly. The point of intersection of the two resulting curves signifies that at this point BUE occurrence begins and wear on the chisel edge decreases so rapidly that the number of holes (or drilling length) is increased. Reviewing the drill wear study, and as shown in Fig. 73, a wearland on the lip developed in triangular form along the edge of the whole lip extending from chisel to margin. Both lips seldom had similar wear progress. The lip curvature, web centrality, and relative lip height were the most prominent causes of the difference in wear patterns on both lips.

With an increasing number of holes drilled, a form of two fans was developed at the chisel edge. At the point of junction between the lip and margin, wear took place in the form of a narrow triangle. The wear on the margin developed upward. It was observed that as the error in drill axis centrality increased, the difference in wear on the two margins became noticeable.

Figure 74 shows an example of wear progress compared to the number of holes drilled. As it was already explained, asymmetry of drill rotation causes different wear progress on both lips and margins, and it was observed that the wearland on both edges was dissimilar.

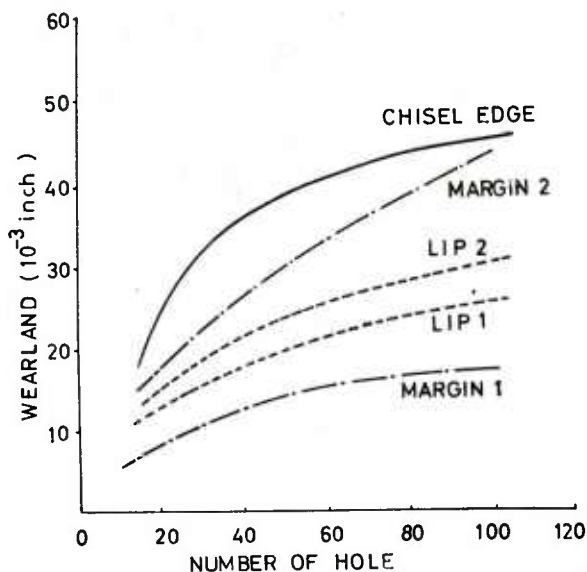

Fig. 74

An Example of Wear Progress Related to No. of Holes Drilled

Reviewing the above results, it appears that wear on the chisel edge would be a most reasonable drill life criterion. In addition, the measurement of chisel edge wear can be accomplished, not only by the toolmaker's microscope, but also eye measurement, if some optical instrument is not available. The wearland on the chisel edge was established at 0.040 inch, 4 times larger than the wearland on the lip which was assumed as drill life.

Considering all the advantages and disadvantages of the drill life criteria presented, the author wishes to recommend wear on the chisel edge as the drill life criterion.

However, it must be stressed that this recommendation is not necessarily applicable to all materials but the material used in this project or a similar material.

## COMPARISON TEST OF VARIOUS SPECIAL DRILL GEOMETRIES

### 10-1. Special Drills Used in this Investigation

In order to reduce the thrust caused by the chisel edge and to improve the cutting performance of drills, many different types had been employed. The main scope of the development consisted of thinning the chisel edge, which resulted in thrust reduction and increased drill life, i.e., an attempt to improve accuracy in drilling holes.

Recently, many new drill geometries were developed and introduced widely in industry. Although the manufacturers of these new drill geometries advertised the advantages of their products, no one attempted to carry out a comparison test with the different geometries.

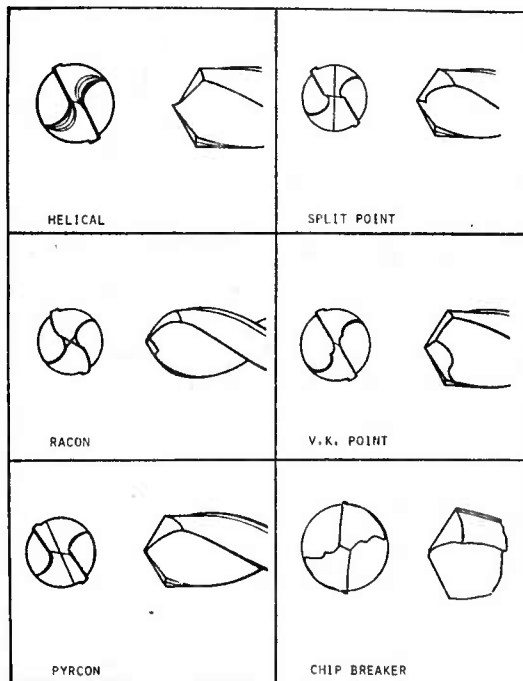

Fig. 75

*Special Drill Geometries*

In this investigation, the following new drill geometries were selected as shown in Fig. 75:

- |            |                       |
|------------|-----------------------|
| a) Helical | d) Split point        |
| b) Racon   | e) V.K. point         |
| c) Pyrcon  | f) Chip breaker drill |

All new drills were to be ground by a drill grinding machine which was specifically designed for them, since it

is impossible to obtain accuracy through hand grinding.

- a) Helical (or Spiral) drill was recommended because of its ability to reduce oversize, walk, and burrs and also, to increase accuracy of the hole geometry. Many research reports (40, 41, 42) were published in regard to the advantages of the helical drill and drill grinding machines.
- b) Racon drill was recommended because of its importance in industry where good surface finish, burr free holes, and long drill life are desired (43). Research results showed that there was a uniform stress concentration on the lips (44).
- c) Pyrcon drill was designed for reducing the thrust force, even with high rigidity of the drill.
- d) Split point (Crankshaft) was originally developed for drilling deep oil holes in automotive crankshafts. According to the literature (45), it has gained widespread use in many designs of drills used in a variety of ways, drilling soft and hard materials alike. The main advantage of this type of point comes in the large reduction of thrust and the positive rake cutting edge extending to the center of the drill. In many materials, this point will act as a chip breaker to produce small chips which can be readily ejected through the flutes. The split point minimized skidding or walking of the drill point when starting a hole. This distinct advantage can be recognized when talking about a portable drill or drill press work where bushings

- 
- (40) New Spiral Point Boosts Twist Drill Efficiency, The Iron Age, Oct. 17, 1957.
  - (41) Spiral vs. Chisel Point Drills, American Machinist, August 28, 1967.
  - (42) Wilson, G., et al, How Good Are Spiral Point Drills?, Machinery Sep. 1967, pp. 82-83.
  - (43) Naureckas, E. M., Development and Testing of the Radial Lip Drill, SME Technical Paper, MR69-420, 1969.
  - (44) Naureckas, E. M., and Gabrick, J., Photoelastic Techniques to Evaluate Cutting Forces During Drilling, SME Technical Paper, MR69-172, 1969.
  - (45) Howe, R. E., Editor, Producibility/Machinability of Space-Age and Conventional Materials, Society of Manufacturing Engineers, 1968.

cannot be used. The most common point angle would be  $135^{\circ}$ .

- e) V.K. (Lip correction) was designed for the drilling of plastics. The rake angle is  $0^{\circ}$  and the point angle  $140^{\circ}$ .
- f) Chip Breaker drill. There are many different types of chip breaker drills on the market. In this investigation, the type which contained a projection in the flute, as shown in Fig. 75(f) was used. Due to the reduction of curvature in the flute, the helically coiled chip should break down.

These special drills were purchased from the drill grinding machine manufacturer. The inspection chart for the six special drills, 0.5 inch diameter, are shown in Table 4.

TABLE 4

Geometry of Special Drills

	Helical	Racon	Pyrcon	Split	V.K. Point	Chip Breaker
Point angle (degree)	115	124	116	144	130	118
Helix angle (degree)	28	27	27	28	28	28
Margin (in.)	0.050	0.051	0.052	0.048	0.050	0.040
Chisel Edge Angle (degree)	130	129	143	144	125	140
Length of Chisel Edge (in.)	0.074	0.022	0.071	0.003	0.010	0.070

10-2. Drill Accuracy in the Rotating State

As previously discussed, the accuracy of drill rotation in a spindle sleeve and drill system affects the performance of the drill. Therefore, each drill was carefully inspected using a proximeter to determine the amount of runout at two points, namely lip and margin. Even if a drill of advanced geometry is strongly recommended by the manufacturer, the advantage is lost if the drill cannot assure its accuracy in rotation. The proximeter records which express the status of

the spindle-sleeve-drill system were recorded. The regular drill used in this comparison test was very accurate in relative lip height, and the accuracies are listed as follows: V.K. point, Regular, Helical, Split, Chip breaker, Pyrcon, and Racon. Runouts of the corner of the margin are as follows: V.K. point, Chip breaker, Split, Helical, Regular, Pyrcon, and Racon. The error in both the relative lip height and the runout of margin measured, when the drills were purchased, is introduced in Table 5.

TABLE 5  
Error of Drill Geometry in Rotation

	<u>Relative Lip Height</u>	<u>Runout of Margin</u>
Regular	0.0005 (in.)	0.012 (in.)
Helical	0.0015	0.011
Racon	0.0800	0.020
Pyrcon	0.0080	0.035
Split point	0.0050	0.006
V.K. point	0.0001	0.003
Chip breaker	0.0050	0.005

### 10-3. Drilling Forces

McKays (46) indicated that dynamometers have historically been used to measure the efficiency of the cutting-tool geometries. In this investigation, each drill point geometry was tested with a three dimensional dynamometer.

Cutting forces due to various drill types were recorded and compared. In the past, researchers (47) also evaluated the performance of the drill through drilling force diagrams.

(46) McKay, D. M., Using Standard Small Drills, American Machinist, April 19, 1971.

(47) Klein, H. H., Das Bohrschanbild als Kriterium der Bohrerform und-leistung, Werkstattstechnik und Maschinenbau, Vol. 47 (1957), Heft 11, pp. 597-603.

The drilling force characteristics of each drill geometry were investigated. The regular drill, which has a relative lip height of 0.0005 inch, produced a variation in torque to some extent, while thrust showed a steady process. Radial forces kept the same magnitude for the different feed rates.

The Helical drill, which was the most highly recommended one, also showed variations in torque. There was an indication of radial forces but it was also noticed that walking of the drill could be minimized.

The Racon point, having a relative lip height of 0.020 inch, showed the diagram characteristics which were rather surprising. Both torque and radial force diagrams varied largely; Pyrcon, Split, and Chip breaker showed almost similar pictures, while V.K. point generated a greatly varied torque and radial force.

From these investigations, the advanced drill geometries cannot be superior unless the spindle-sleeve-and-drill system are assured to be more accurate from the point of view of the force diagram.

Kang and et al (48) investigated drilling forces with high carbon steel and concluded that the drilling force exponent for feed rate was distinguishable in each drill geometry.

The thrust and torque of three different feed rates: 0.003, 0.005, and 0.007 ipr, were plotted when drilling 4140 Annealed Steel on log-log coordinates, as shown in Fig. 76. Each drill geometry indicated different magnitudes and exponents. The exponents of the feed rate obtained by this investigation were:

	<u>Thrust</u>	<u>Torque</u>
Helical	0.65	0.45
Racon	0.75	0.85
Pyrcon	0.65	0.60
Split	0.89	0.60
V.K.	0.95	0.90
Chip breaker	0.75	0.75
Regular	1.15	1.10

(48) Kang, T. H. and Carles, J.W., Cutting Force Analysis in Drilling, Technical Paper MR71-170 (1971), Society of Manufacturing Engineers.

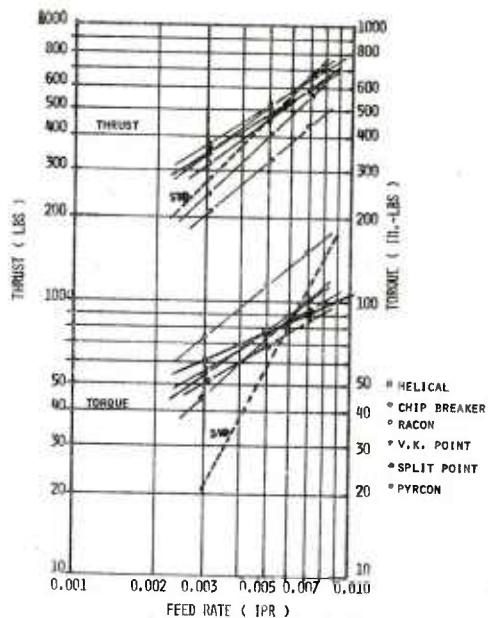

Fig. 76

Drilling Forces vs Feed Rate by Different Special Drill Geometries

All special drills have exponents smaller than those of regular twist drills. The explanation for this can be given only after extensive investigation on drilling forces.

#### 10-4. Chip Formation

As shown previously, the effect of feed rate on the chip length was very pronounced.

In varying feed rates, each drill geometry produced a different length and form of chip as shown in Fig. 77 a, b, c, d, and e. This investigation involved the use of a coolant. For Regular, Helical, Pyrcon, Split, and V.K. points, the chip lengths decreased as the feed was increased. However, the Racon point showed an opposite trend: with a small feed rate, well broken small chips were observed. At a feed rate of 0.010 ipr, the length of the chips were similar to the length generated by other drills at 0.003 ipr. The reason can be deduced from the fact that the radial lip, which is round and larger than the lip of the other drill geometries, can cut the chip uniformly and easily. The chip removed by the round lip could not coil unless the feed rate was increased.

The reason for the more pronounced BUE formation on the Racon and the V.K. point is as follows: Due to the large lip of the Racon and the zero degree rake angle of the V.K. point, the cutting temperatures were higher, even though the thrust force was reduced by web thinning. Thus, the affinity for BUE formation was higher than in the cases of the other special drills.

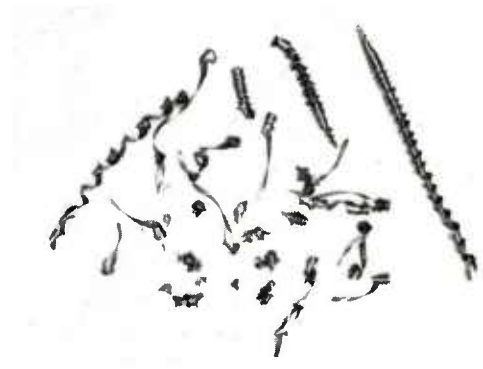

a)

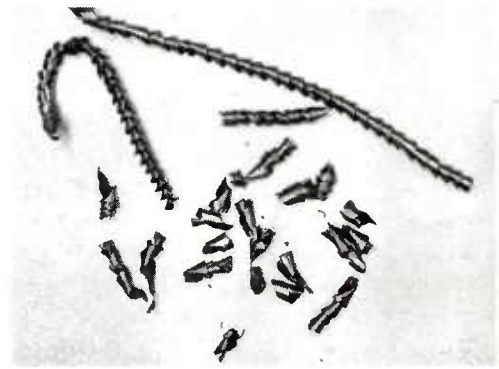

b)

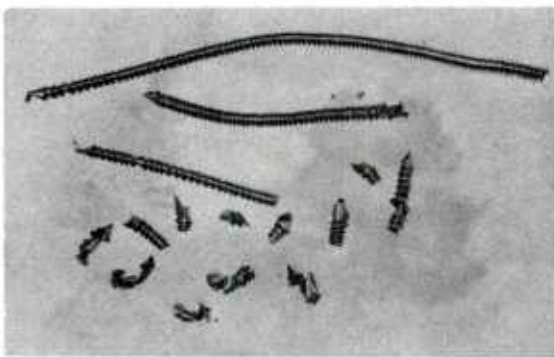

c)

$f = 0.005 \text{ ipr}$

$RPM = 300$

$f = 0.010 \text{ ipr}$

Fig. 77: Effect of Feed Rate on Chip Formation a) Helical b) Racon  
c) Pyrcon

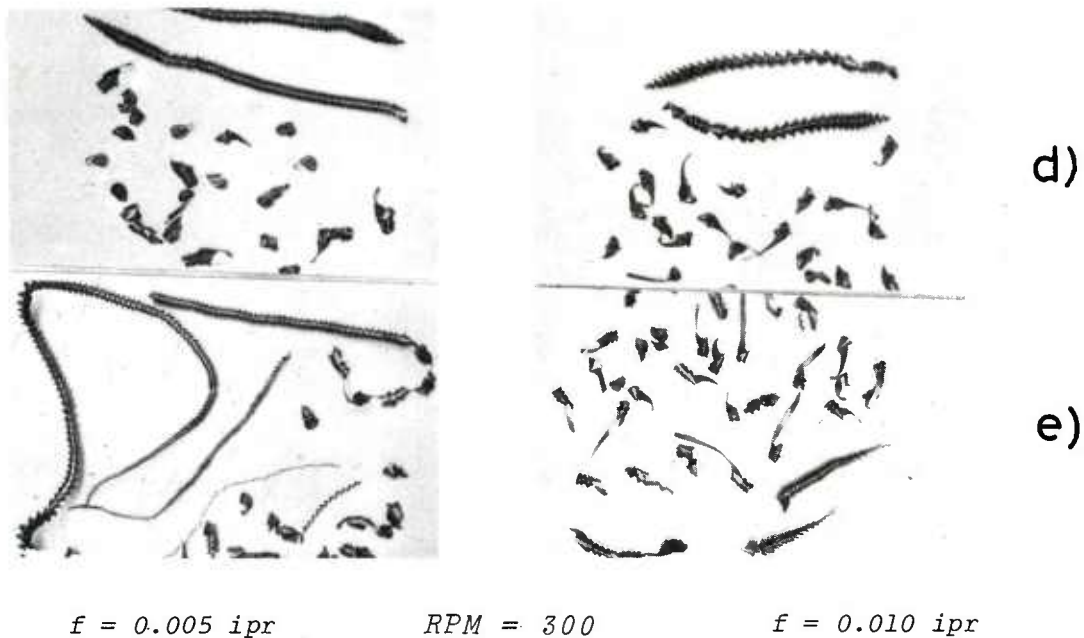

Fig. 77: Effect of Feed Rate of Chip Formation d) Split e) Chip Breaker

The Chip breaker drill was expected to produce an improved chip form. However, disappointingly, the length of the chips at low feed rates was longer than that of the regular drill and the others. However, at the feed rate of 0.007 ipr, the length of the chips were reduced more than for the other drill geometries. From this example investigation, it can be recognized that the Chip breaker drill can offer an advantage only in a limited drilling range. This kind of drill was so designed that the chip can be broken when the chip flows through the narrow flute.

The chip formation for other materials was found to be very different. The result of the investigation on other work materials will be explained at another opportunity.

#### 10-5. Drill Wear

The most essential aspect of the machinability testing was the investigation of drill wear. Similar to the regular drills, the special drills were photographed after a certain number of drilled holes.

It was interesting to study the BUE occurrence, since the drilling temperature might be lower due to improved drill geometry. Through this investigation, BUE occurrence was observed on all of the special drill geometries, namely, in large amounts on the lip and to a lesser degree on the chisel edge, when drilling under dry conditions.

Using a coolant, wear took place on the lip and also on the chisel edge. Fig. 78a shows progress of the wear on the Helical drill. The wear on the lip formed as a slender

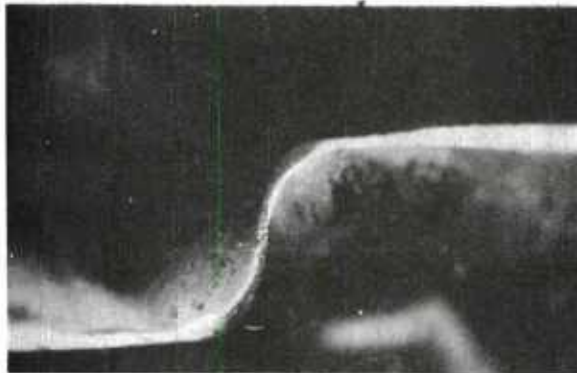
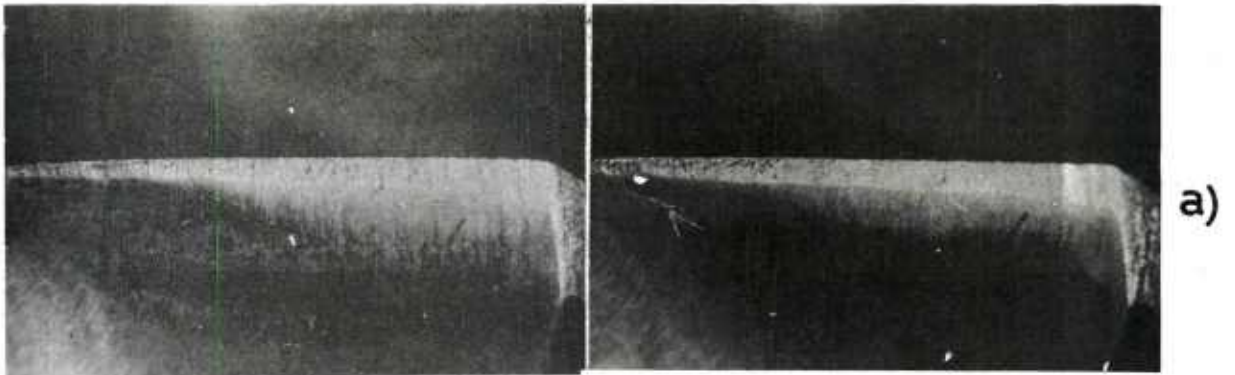

After 40 Holes  
RPM = 120  
f = 0.005 ipr

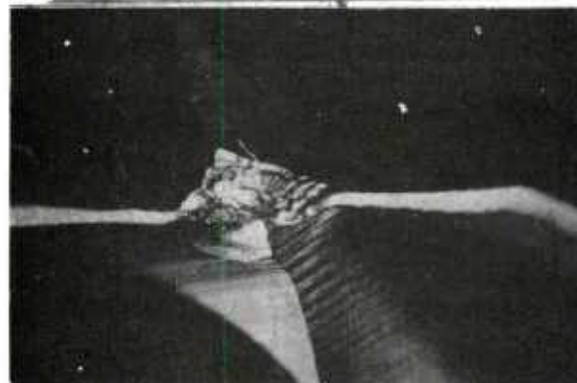
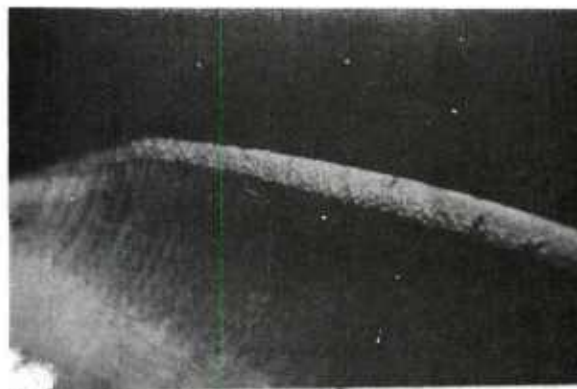

After 40 Holes  
RPM = 120  
f = 0.005 ipr

Fig. 78: Wear on Drills a) Helical b) Racon

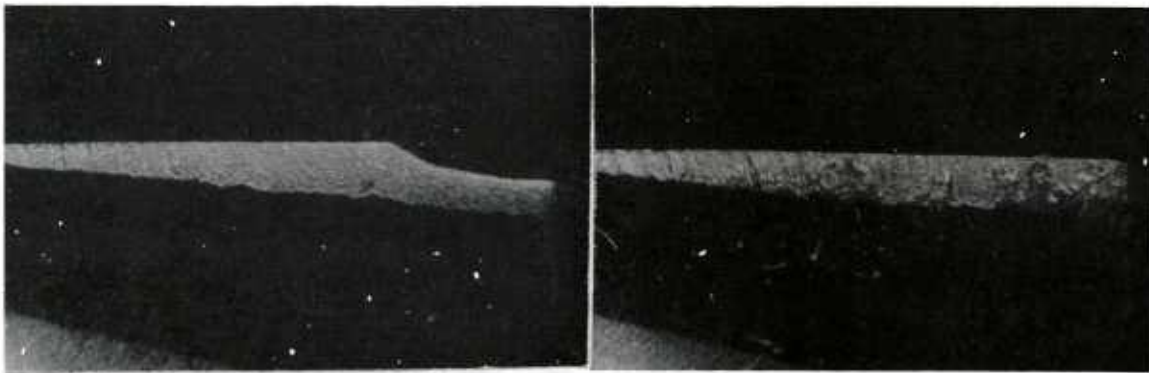

c)



After 20 Holes  
RPM = 120  
f = 0.005 ipr

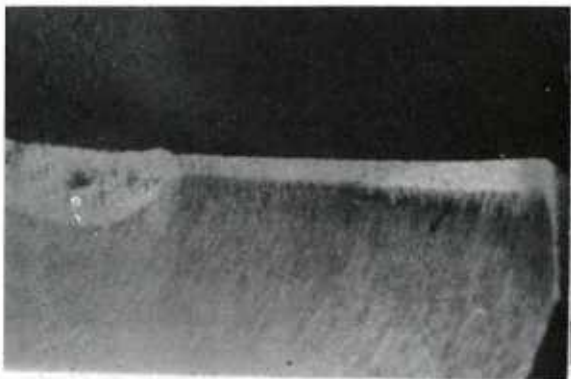

d)



After 20 Holes  
RPM = 120  
f = 0.005 ipr

Fig. 78: Wear on Drills c) Pyrcor d) Split Point

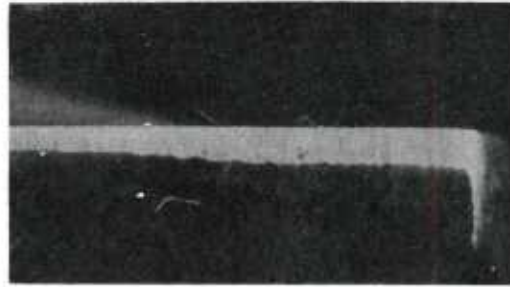
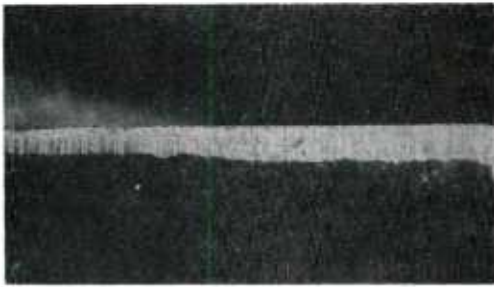

e)

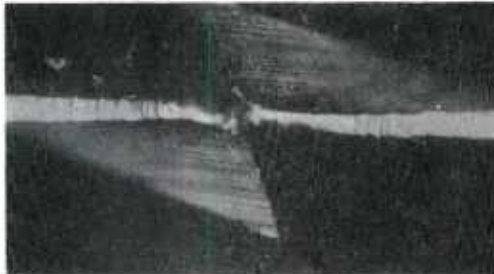

After 40 Holes  
RPM = 120,  $f = 0.005$  ipr

Fig. 73: Wear on Drills e) V.K. Point

triangle. On the chisel edge, wear was distributed uniformly along the chisel. Fig. 73b indicates the progress of wear on lip and chisel edge on the Racon. The wear on the lip was developed uniformly along both lips. However, after 40 holes, the chisel edge was damaged, as shown.

The progress of wear on the Pyrcon drill is shown in Fig. 78c. The wear on both lips and the chisel edge shows similarity with that of the regular drill. It was noted that after 40 holes, the corner of the lip was damaged.

Wear on the Split point can be seen in Fig. 78d, where its progress is indicated. After 5 holes, this drill was damaged on the lip closest to the chisel.

Wear progress for the V.K. point is shown in Fig. 78e. The wear on the lip showed a similar configuration as that of a regular drill. This chisel edge failed after 30 holes.

The wear on the chip breaker drill showed the same as that of the regular drill.

In Fig. 79 - the progress of wearland on the lip and chisel was plotted against the number of drilled holes. The largest lip wear was obtained by Pyrcon and the smallest was Racon drill. The largest chisel wear was by Pyrcon and the smallest was by the Helical drill after 40 holes. This figure was introduced only as an investigative example, because it is not desirable to determine drill performance in regard to drill life from this result. Reliable data can be obtained only after extensive investigation.

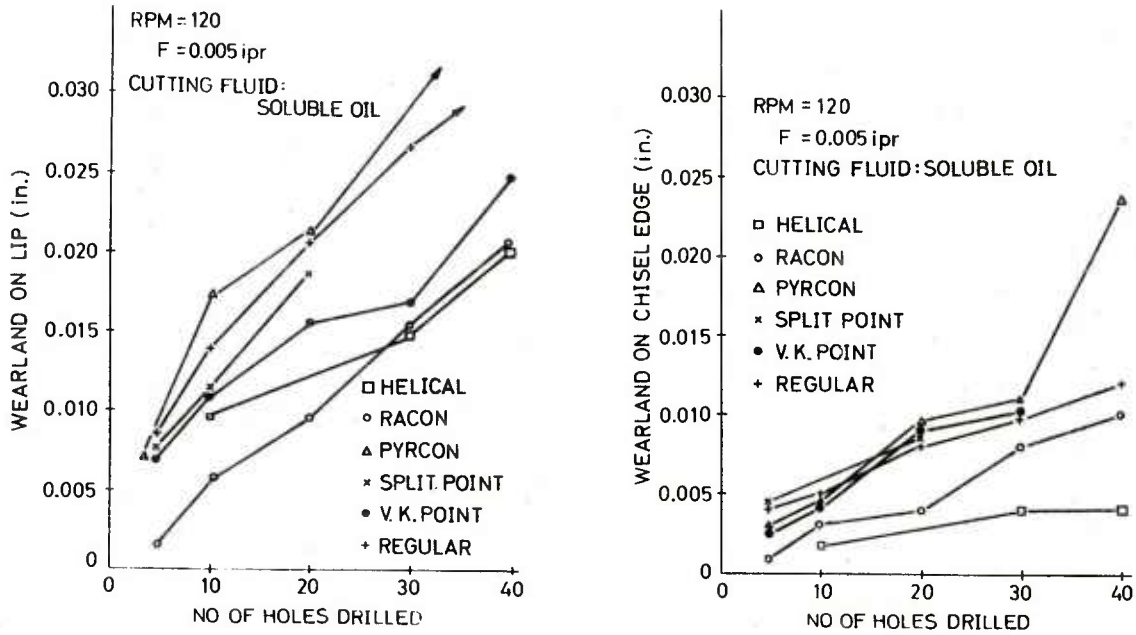

Fig. 79: Comparison of Wear in Different Special Drill Geometries

### 10-6. Surface Finish

Using the precision surface profile recorder SURFCOM, the surface roughness generated by the different drill geometries was analyzed. Due to differences in the geometry of the drills, chip formation, and contact with the workpiece, the characteristics of surface profile are expected to be distinguishable.

All drills generated rougher surfaces with increased feed rates except the Racon drill, which at a feed rate of 0.010 ipr, produced a roughness less than that obtained at smaller feed rates. The reason for this can be explained by the fact that the feed groove affects the total roughness value. The surface roughness varied greatly over a number of drilled holes. It was interesting to compare how the different drill geometries affect the variations if numerous holes are drilled in a series.

The average value of AA obtained by each drill geometry was plotted as shown in Fig. 80. As in the case of the regular drill, the variation of each drill geometry ranges approximately from 20  $\mu$  in. to 50  $\mu$  in. at the drilling condition of 120 RPM and feed rate of 0.007 ipr. This result does not permit any conclusion as to which drill geometry was the best. It was therefore concluded that

the obtainable surface roughness by the different special geometries were comparable to that of the regular drill geometry.

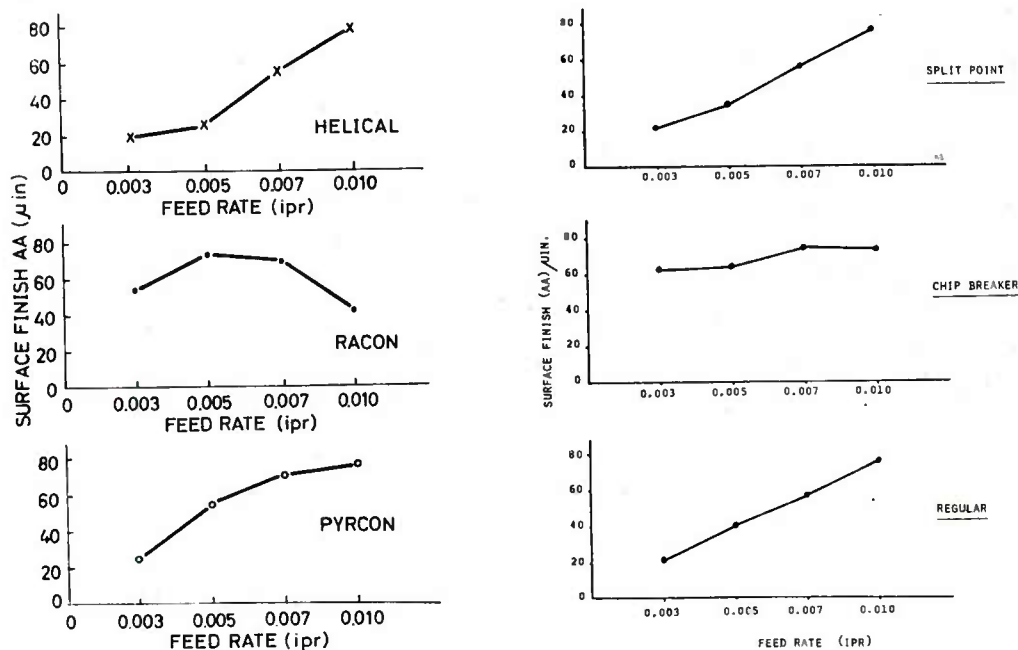

Fig. 80: Surface Finish Comparison of Different Special Drills

### 10-7. Accuracy of Hole Geometry

The procedure described in Chapter 4 was adopted in the straightness measurement of the side wall of the drilled holes. The investigation was conducted using the rigid work-piece holder described in the same chapter.

In Fig. 81a the characteristics of the straightness of 30 holes drilled by a Helical drill were introduced. The Helical drill, which was designed for the purpose of improvement of drilled hole size and long drill life, indicated distinct advantages with regard to hole geometry. Slanted holes were most frequently produced, instead of straight holes with waviness on the drilled surface. Surprisingly enough, the total error of the holes was much less than the regular drill. The average error was 0.003 inch while the regular drill average was 0.008 inch.

Fig. 81b presents the corresponding results for the Racon. The most frequently produced hole geometry for this drill geometry was the tapered hole (Bell mouth). The average error in geometry was twice as high as that of the

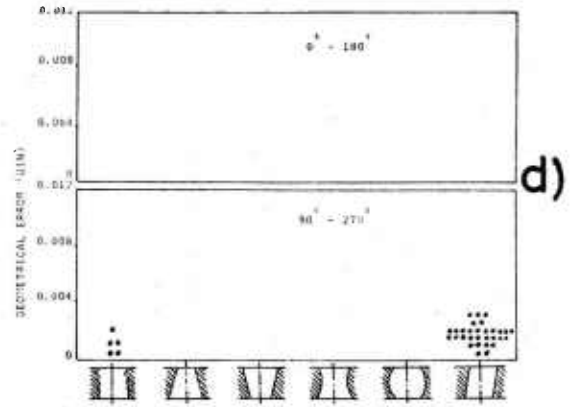
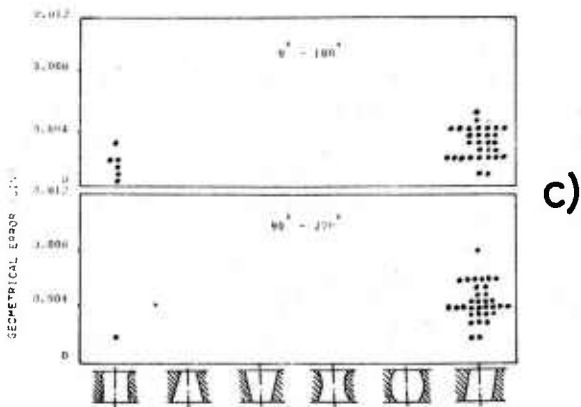
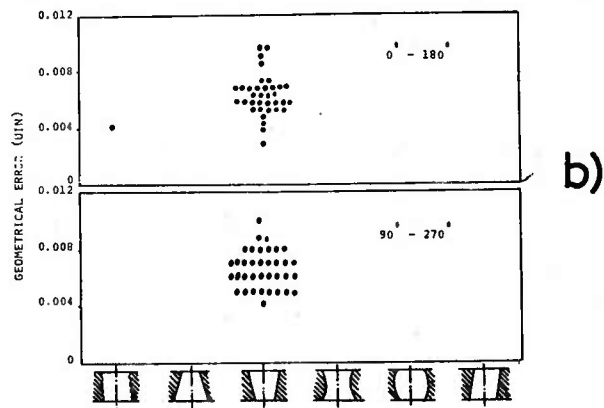
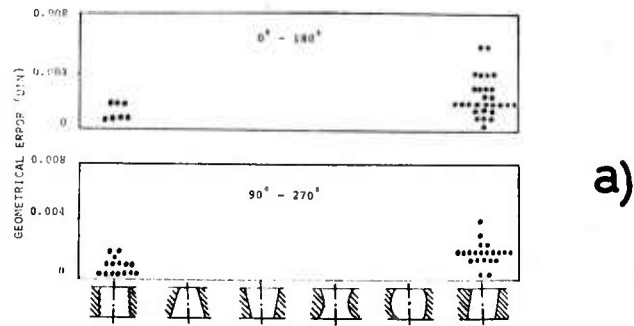

Fig. 81: Frequency and Type of Hole Geometry Produced  
 a) Helical Point Drill      c) Pyrcon Point  
 b) Racon Point Drill      d) Split Point Drill

Racon starts to plunge into the work, the effect of "walking" causes a larger hole. By increasing the penetration, the walking effect was reduced. This would be the reason why the "bell mounth" form was most frequent with this type of drill.

The Pyrcon point obtained better hole geometry as shown in Fig. 81c. The average error was approximately 0.004 inch and the "slanted" hole was most frequently formed.

Similar results were obtained also by the Split point, Fig. 81d.

The V.K. point and the Chip breaker indicated similar trends and results as Split and Pyrcon. The reason for the error in straightness experienced with the regular drill geometry has already been discussed in Chapter 4. The error in straightness was also attributed to some lack of stiffness in the work piece holder.

As opposed to straightness, the roundness of the hole is expected to be affected by the drill geometry. Work-pieces of 1-1/16 inch. dia. were fixed rigidly on the base of the table, and different drill geometries were used to drill holes. The roundness of the holes was measured by the Talyrond and recorded at three points: top, middle and bottom. These measuring points were located approximately 1/8 inch, 1/2 inch and 1 inch from the entrance of the hole respectively.

Each special drill geometry used for this investigation was inspected as shown in Chapter 4.

The roundness error of the Helical point is shown in Fig. 82a. Due to the errors in relative lip height and runout of margin, the drill walked after a short period when the drill started to operate. The error of roundness was measured as 0.002 inch. From this record it is clear that the difference between the maximum diameter and the minimum diameter would be two times the roundness error, or 0.004 inch.

At the middle point, the roundness error was 0.007 inch and at the bottom, was less than 0.005 inch.

The Racon point drill, which has a relative lip height and runout of margin of 0.080 inch and 0.020 inch respectively, showed unsatisfactory results in the roundness error as shown in Fig. 82b. At the top of the hole, where the walking of the drill was supposed to be greatest, there was an error of roundness in the form of a maple leaf, amounting to 0.006 inch. At the middle, the roundness error was reduced to 0.001 inch. The bottom of the hole showed an error slightly increased to 0.0015 inch.

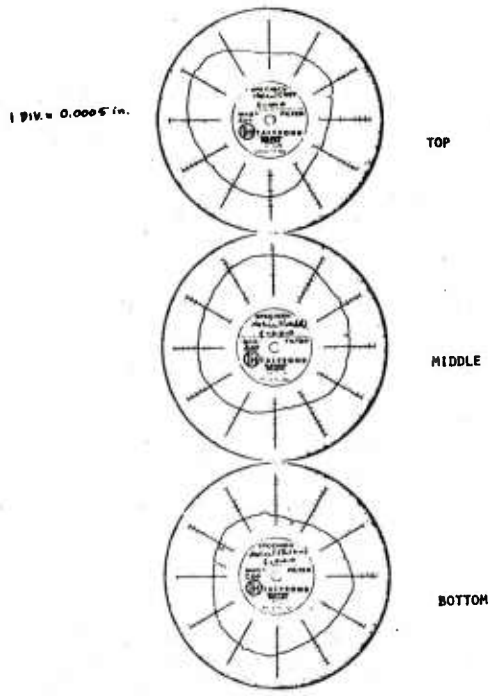

a)

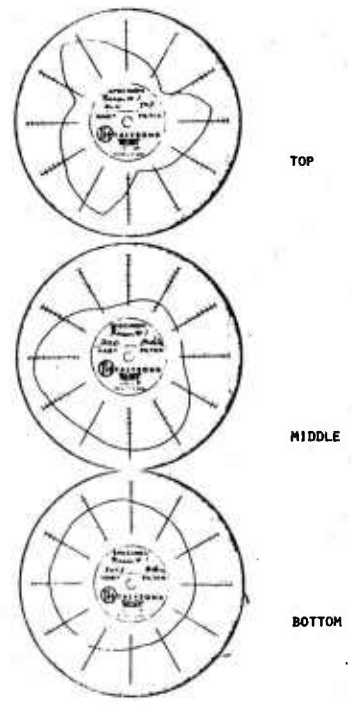

b)

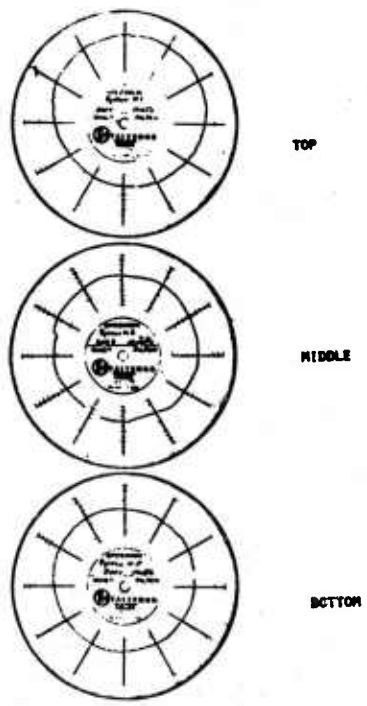

c)

Fig. 82: Roundness Measuring Record of the Hole Drilled  
 a) Helical Point Drill      c) Roundness Measuring Record of  
 b) Racon Point Drill      the Hole Drilled - Pyrcan Drill

The reason for the unusual hole geometry can be explained as follows: The Racon has less rigidity on the end of the drill. Moreover, the point grinding involved a large inaccuracy in the relative lip height (error of 0.080 inch) and runout of margin (error of 0.020 inch). Due to drill spindle axis eccentricity, the drill was forced to twist, causing a deflection of the drill. After a rotation of approximately  $120^{\circ}$ , the drill released by the softer work material, instantly returned to the initial position, and the deflection was repeated. The angle of  $120^{\circ}$  corresponds to the state of maximum deflection, and the roundness error formed the three cornered shape.

The magnitude of the angle which indicates the maximum deflection is affected by the drilling speed and the length of the drills.

The Pyrcon drill, which has a relatively larger chisel edge length than other drill geometries, was classified as a rigid drill. This kind of drill generates very accurate roundness (Fig. 82c). At the top of the hole, the error was less than 0.005 inch and at the bottom, the error indicated was less than 0.002 inch.

The comparison of the roundness errors of all drill types was introduced in Fig. 83. Two different feed rates, 0.005 ipr and 0.010 ipr, were applied; and, the measured Talyrond records, which were measured at the middle point of the hole, were compared. The increased feed rate, i.e. increased drilling force, affected the deflection of the drill, which was caused by the inaccurate drill point grinding.

Two regular drills, which had different point grinding accuracies, were tested. Drill A had a relative lip height of 0.002 inch and drill B of 0.001 inch. Drill B was superior to drill A in roundness tests at a feed rate of 0.005 ipr. However, after drilling with a feed rate of 0.010 ipr, similar errors in roundness were obtained by the two drills. The roundness of Helical, Pyrcon, and Split Point improved by increasing the feed rate from 0.005 ipr to 0.010 ipr. However, Racon and Chip breaker did not follow this trend.

Due to inaccuracy of drill point grinding in three drill geometries, the effect of feed rate could be disregarded.

RPM = 120

CUTTING FLUID: SOLUBLE OIL

REGULAR

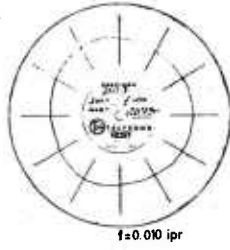

RACON

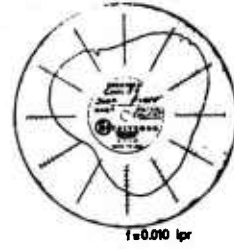

HELICAL



PYRCON

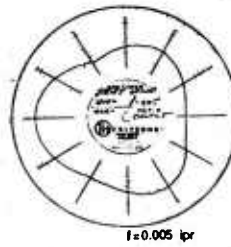

SPLIT POINT

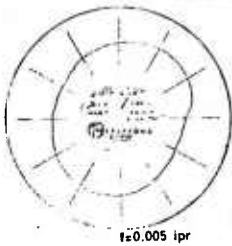

CHIP BREAKER

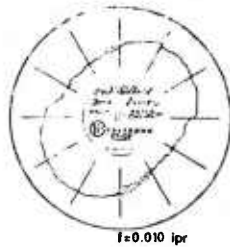

Fig. 83

*Effect of Feed Rate  
on the Roundness  
Using Different  
Drill Geometries*

10-8. Investigation of Burr Occurrence

It is most desirable to eliminate burrs, since their removal is costly. In order to investigate the effects of drill geometry on burr occurrence, a special workpiece was prepared. The workpiece, having dimensions of 4 inch x 4 inch x 7/8 inch, was ground flat on both surfaces. Holes were drilled with different drill types using two feed rates, 0.005 ipr and 0.010 ipr. After the holes were drilled, the burr occurrence at the entrance and the exit was observed.

The following table presents the measurement of burr height.

TABLE 6

Max. Burr Height Obtained by Various Drill Geometries (Approximate Measurement)

Entrance of Hole

<u>Drill Geometry</u>	<u>Feed = 0.005 ipr</u>	<u>Feed = 0.010 ipr</u>
Helical	0.005 (in.)	0.005 (in.)
Racon	0.015	0.015
Pyrcon	0.002	0.001
Split Point	0.001	0.001
Chip Breaker	0.001	0.001
Regular A	Negligible	0.001
Regular B	Negligible	Negligible

Exit of Hole

<u>Drill Geometry</u>	<u>Feed = 0.005 ipr</u>	<u>Feed = 0.010 ipr</u>
Helical	0.026 (in.)	0.016 (in.)
Racon	0.035	0.014
Prycon	0.010	0.008
Split Point	0.002	0.002
Chip Breaker	0.020	0.015
Regular A	0.002	0.001
Regular B	0.001	Negligible

It was noted that extensive burr formation occurred at the exit in general. The Racon left the largest burr on both surfaces, entrance and exit. Naturally, this effect cannot be generalized since this drill was initially inaccurately ground with relative lip height of 0.020 inch.

The results for Helical, Pyrcon, Split, and also the Chip breaker drills were not better than that of the regular

drill ground with high accuracy. The burr occurrence was dependent upon the state of rotation when the drill enters and exits from the work.

If the accuracy of the drill rotation was assured, "walking" did not occur, and the chip was removed perfectly, then, no burrs remained. However, since the accuracy of drill rotation was less than perfect, the chip was not perfectly cut but deformed, and the burr remained.

From the results of this investigation it can be concluded that the burr occurrence was mainly governed by the rotating accuracy of the drill no matter which kind of drill geometry was used.

#### 10-9. Investigation of Accuracy of Location

It was essential to secure the location of the drilled hole if a number of holes were to be drilled, and the distance between the holes was important.

The accuracy of hole location is affected by the drill geometry and the performance of the drill itself. The accuracy of the moving table was assumed to be perfect.

In order to measure the distance the table moved, a special device was designed and constructed. Using a block gage and a dial gage, the accuracy of table movement was determined to be within 0.0001 inch. A set of four holes was drilled in line, each by two different geometry drills with a distance between the holes of 0.8250 inch, adjusted by the device described above. After drilling, the distance between each hole was inspected by a Toolmakers's Microscope which was accurate to 0.0001 inch.

The results of this investigation are presented in Fig. 84. Only two drill geometries were introduced since it was felt that this investigation would be more reliable. The regular drill, having an accurately ground drill end, showed a surprising location error. However, most locations on the top and bottom plates were obtained in very close tolerances, i.e., the straightness of the hole was perfect. The locations of the Chip breaker holes were scattered, and the difference between bottom and top ranged from 0.002 inch to 0.006 inch.

The accuracy of hole location is affected by many factors, such as stiffness of spindle-adapter-drill system and table moving accuracy. In addition, the combined factors, namely straightness, accuracy of hole diameter, and roundness, are expected to determine the accuracy of positioning of a drilled hole.

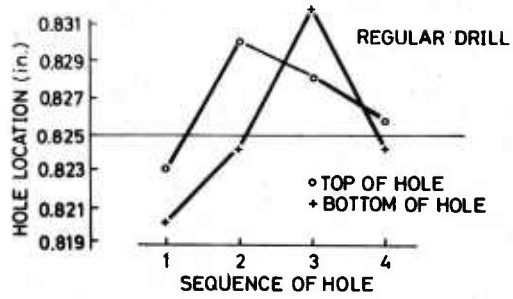
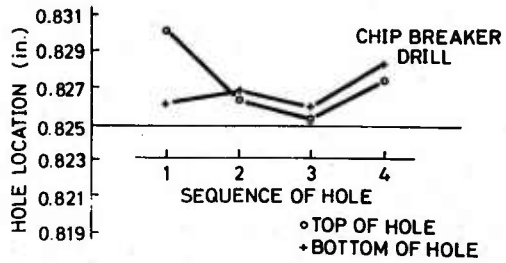

Fig. 84

Accuracy of Hole Location  
Obtained by Two Drills



## CONCLUSIONS AND RECOMMENDATIONS

The performances of twist drills including various special drill geometries were investigated. The drill diameter was constant at 0.5 inch and 4140 annealed steel was used as the work-material throughout this project. Reviewing the results obtained in the investigation, the following conclusions can be made:

1. Commercially available drills from different manufacturers were carefully inspected using a Tool Analyzer and it turned out that the dimensions exceed the tolerances established in the American Standards on Twist Drills and Reamers.

2. The characteristics of thrust and torque were described. The larger portion of thrust was caused by the chisel edge. The feed rate and diameter of the drill had considerable influence, while the effect of cutting speed was negligible.

3. A three-component dynamometer was designed for the study of thrust, torque, and radial force. The occurrence of radial forces was due mainly to asymmetrical grinding of the drills.

4. Variation in forces during drilling, especially torque, can be caused by stacking of chip flow.

5. A built-up edge (BUE) occurred on the lip and the chisel edge when drilling 4140 annealed steel under dry conditions. The maximum height of built-up edge on the lip was virtually constant as drilling speed was varied.

6. BUE occurrence can be eliminated by using a cutting fluid except at higher cutting speeds. The cause for BUE occurrence is the cutting temperature, which induces an affinity to micro-welding a metallic layer on the lip.

7. The progress of wear on the lip and chisel edge was photographed at various drilling speeds and the relationship of wearland to drilling time was established.

8. Wear on inaccurately ground drills showed different forms of wearland on both lips.

9. The working accuracy of the drill was affected by the spindle-sleeve-drill system, not only by the grinding accuracy of the drill itself. Several types of holes were discussed and a straightness measuring instrument was designed for inspection of straightness of the sides of drilled holes.

10. The error in straightness was mainly caused by the imperfect stiffness of the workpiece holder (fixture). The other reason for the error in straightness was the slope of the workpiece surface to the axis of the spindle.

11. The error in roundness was investigated and it was found that the roundness of drilled holes was random.

12. Accuracy of the hole diameter will be determined by various factors: straightness of the hole side, surface roughness, and eccentricity of spindle-sleeve-drill systems. The effect of wear on the margin should be negligibly small.

13. The chip length was affected by the feed rate, while the effect of drilling speed was negligibly small. Asymmetrically ground drills caused different length chips.

14. Surface roughness of the drilled hole was discussed, and, it was concluded that cutting with a fluid improved the surface roughness compared to dry cutting. Profile records for different feed rates were obtained. By applying a percent cumulative frequency, a comparison of surface finish under various drilling conditions was made. The superiority of any drill on the basis of surface finish was hard to establish.

15. The various possible drill life criteria were discussed; and, it was recommended that chisel edge wear should be the most reasonable criterion for the determination of drill life, when drilling 4140 annealed steel or similar materials.

16. Various special drill geometries were compared from the point of view of drilling forces, chip formation, wear, straightness and roundness.

Drilling forces were so different that the exponent of feed rate ranged very widely. Chip formation by the Racon drill was unique and the chip length showed results opposite to those of the regular drill. Chips produced by Chip breaker drills showed a benefit only in a limited range of drilling conditions.

17. Burr occurrence was investigated for different drill geometries; and, the conclusion reached was that the regular drill provides the best results, if the drill is ground accurately.

18. The performance of different drill geometries cannot be compared meaningfully unless the investigation is extensive and statistical.

## REFERENCES

1. Ernst, H, and Haggerty, W. A., The Spiral Point Drill - A New Concept in Drill Point Geometry, Trans. of ASME, 1957, pp. 1059-1072.
2. Galloway, D. F., Some Experiments on the Influence of various Factors on Drill Performance, Trans, of ASME, Feb., 1957, pp 191-231.
3. Tolerances for Twist Drills and Reamers, Metal Cutting Tool Institute, 1965.
4. National Aerospace Standard, National Standards Association, Inc., 1969.
5. Kobayashi, A. and Tsukada, T., Drilling of Multi-Layer Printed Circuit Board, Technical Paper MR71-202, 1971, Society of Manufacturing Engineers.
6. Schallbrock, H., Bohrarbeit und Bohrmaschine, Carl Hanser Verlag, Munchen, 1951.
7. Spur, G., Messung und Bedeutung der Radialkräfte beim Bohren mit Spiralbohren, Microtecnic Vol. XV, No. 2, pp. 62-74.
8. Pahlitzsch, G. and Spur, G., Entstehung und Wirkand von Radialkräften beim Bohren mit Spiralbohren, Werkstattstechnik, Vol. 51 (1961), Heft 5., pp. 227-234.
9. Boston, O. W. and Oxford, C. J., Power Required to Drill Cast Iron and Steel, Trans. of ASME, Vol. 77, 1930, pp. 5-26.
10. Opitz, H., Die Zerspanungsforschung als Beitrag zur Wirtschaftlichen Fertigung, C.I.R.P. Annalen, Band XII (1963), Heft 1., pp. 4-24.
11. Opitz, H., Gappish, M., Some Recent Research on the Wear Behavior of Carbide Cutting Tools, Advances in Machine Tool Design and Research (3rd MTDR, 1962), p. 43.
12. Kronenberg, M., Grundzüge der Zerspanungslehre (Zweiter Band), Springer-Verlag, 1963.
13. Oxford, C. J., On the Drilling of Metals (1) Basic Mechanics of the Process, Trans. ASME, 1955, Feb., pp. 103-114.
14. Kasahara, H. and Kinoshita, N., Experimental Studies of Cutting Temperatures of Drilling by Twist Drills, Report Institute Phys. Chem. Research Vol. 37, No. 3, 1961, pp. 177-185.
15. DeVries, M. F., Saxena, V. K. and Wu, S. M., Temperature Distribution in Drilling, Trans. of ASME, J. Engg. Ind., 1968, pp. 231-238.

16. Tsueda, M. et al, The Study of the Cutting Temperature in Drilling, (1) On the Measuring Method of Cutting Temperature, Trans. Japan Society of Mechanical Engineers, Vol. 27, No. 181 (1961), pp. 1423-1430.
17. Nishida, S. and et al, Study on Drilling II - Lip Temperature, Journal of the Mechanical Laboratory of Japan, Vol. 8, No. 1 (1962), pp. 59-60.
18. Schlesinger, G. and Kurrein, M., Das Bohren von Gusseisen in der Feinmechanik, Werkstattstechnik, Vol. 24 (1930), Heft 4, pp. 89-94.
19. Drilling Today's Materials, 1962, published by Metal Cutting Tool Institute.
20. Haggerty, W. A., Effect of Point Geometry and Dimensional Asymmetry on Drill Performance, Int. Journal of Machine Tool Design and Research, Vol 1 (1961), pp. 41-58.
21. " Guhring, M., Auswahl and Einsatz von Bohrwerkzeugen, Industrieblatt, Sonderdruck, No. 9, 1964, pp. 1-11.
22. " Ständer, H., Bohrungsqualität beim Bohren mit Spiralbohren, Werkstattstechnik, Vol. 56 (1966), No. 11, pp. 546-554.
23. Tsueda, M. and et al, On Walking Phenomenon of Drill, Transaction of Japan Society of Mechanical Engineers, Vol 27, 1961 No. 178, pp. 816-825.
24. Drill Points and Hole Size Metal Cuttings published by National Twist Drill and Tool Company, July 1964.
25. Spur, G., Schnittkraftmessung beim Bohren mit Spiralbohren, Kurzberichte der Hochschulgruppe Fertigungstechnik der Technischen Hochschulen und Universitäten der Bundesrepublik Deutschland, 1969.
26. Haggerty, W. A., Drill Symmetry - Effects on Hole Production, The Tool Engineer, June 15, 1960, pp. 83-86.
27. Spizig, J. S., Bohrer genau and Schnell Schleifen, Werkstatt und Betrieb, Vol 104 (1971), No. 4, pp. 235-236.
28. Oxford, C. J., Drilling Technology, Technical Paper, Vol. 58, No. 59, American Society of Tool Engineers, 1958.
29. Sachsenberg, E., Versuche mit Spiralbohren, Maschinenbau 7 (1928), pp. 905-911.
30. Spaans, C. and et al, The Breakability, An Aspect of the Machinability - A Computer - Cimulation of Chip Formation, SME Technical Paper, MR71-154, 1971.

31. Stoewer, H. J., Schneidversuche mit Gewindebohren auf Stahl, Stock-Zeitschrift, Vol 5 (1932), H. 2, pp. 31-42.
32. Pahlitzsch, G. and Spur, G., Untersuchungen über die Oberflächenrauheit der beim Bohren mit Spiralbohren Maschinenmark, Nr. 88, Nov. 1963, pp. 27-29.
33. Dubrov, Yu. S. and et al, Surface Finish Using Plastic-Shanked Drills, Machine & Tooling, 1968, Vol 39. No. 8, pp. 39
34. Tool Engineers Handbook, 2nd Edition, ASTME, published by McGraw Hill, 1959.
35. Galloway, D. E. and Morton, I. S., Practical Drilling Tests, The Institution of Production Engineers, 1946.
36. Cowie, R. J. and Pegler, J. O. M., Some Factors Affecting the Performance of Drills and Taps, Proceedings of the Conference on Technology of Engineering Manufacture, The Institution of Mechanical Engineers, London, March 1958.
37. Kirschbaum, R. A., How to Measure Tool Wear, American Machinist, Feb. 26, 1968, pp. 105-106.
38. Schallbroch, H., Bohrabeit und Bohrmaschine, Carl Hanser Verlag, München, 1951.
39. John Deere Manufacturing Processes Manual, Part A: Recommended Drill Reconditioning Procedure.
40. New Spiral Point Boosts Twist Drill Efficiency, The Iron Age, Oct. 17, 1957.
41. Spiral vs. Chisel Point Drills, American Machinist, August 28, 1967.
42. Wilson, G., et al, How Good Are Spiral Point Drills?, Machinery Sep. 1967, pp. 82-83.
43. Naureckas, E. M., Development and Testing of the Radial Lip Drill, SME Technical Paper, MR69-420, 1969.
44. Naureckas, E. M., and Gabrick, J., Photoelastic Techniques to Evaluate Cutting Forces During Drilling, SME Technical Paper, MR69-172, 1969.
45. Howe, R. E., Editor, Producibility/Machinability of Space-Age and Conventional Materials, Society of Manufacturing Engineers, 1968.
46. McKay, D. M., Using Standard Small Drills, American Machinist, April 19, 1971.

47. Klein, H. H., Das Bohrschanbild als Kriterium der Bohrerform und-leistung, Werkstattstechnik und Maschinenbau, Vol. 47 (1957), Heft 11, pp. 597-603.
48. Kang, T. H. and Carles, J.W., Cutting Force Analysis in Drilling, Technical Paper MR71-170 (1971), Society of Manufacturing Engineers.

DISTRIBUTION

Copies

A. Department of Defense

Defense Documentation Center  
ATTN: TIPDR  
Cameron Station  
Alexandria, VA 22314

12

B. Department of the Army

Commander  
US Army Materiel Development and Readiness Command  
ATTN: DRCMT  
5001 Eisenhower Avenue  
Alexandria, VA 22333

1

Commander  
US Army Materiel Development and Readiness Command  
Scientific and Technical Information Team - Europe  
ATTN: DRXST-STL, Dr. Richard B. Griffin  
APO New York 09710

1

Commander  
US Army Armament Materiel Readiness Command  
ATTN: DRSAR-RDP  
      DRSAR-SC  
      DRSAR-QAE  
      DRSAR-IRW  
Rock Island, IL 61299

1

1

1

1

Commander  
US Army Armament Research & Development Command  
ATTN: DRDAR-PMP, Mr. Donald J. Fischer  
Dover, NJ 07801

1

Director  
US Army Materials and Mechanics Research Center  
ATTN: DRXMR-M  
Watertown, MA 02172

2

Commander  
US Army Maintenance Management Center  
ATTN: DRXMD-A  
Lexington, KY 40507

1

Commander  
US Army Electronics Research and Development Command  
ATTN: DRSEL-PA-E  
Fort Monmouth, NJ 07703

1

DISTRIBUTION

Copies

Commander  
US Army Missile Research and Development Command  
ATTN: DRDMI  
Redstone Arsenal, AL 35809 1

Commander  
US Army Tank-Automotive Materiel Readiness Command  
ATTN: DRSTA-Q  
Warren, MI 48090 1

Commander  
US Army Tank-Automotive Research and Development Command  
ATTN: DRDAR-UL 1  
DRDTA-RKA 1  
Warren, MI 48090

Commander  
US Army Aviation Research and Development Command  
ATTN: DRDAV-EXT 1  
P.O. Box 209  
St. Louis, MO 63166

Commander  
US Army Troop Support and Aviation Materiel Readiness Command  
ATTN: DRSTS-PLE 1  
4300 Goodfellow Blvd.  
St. Louis, MO 63120

Commander  
Ballistic Research Laboratories  
ATTN: DRXBR-X 1  
Aberdeen Proving Ground, MD 21005

Commander  
Harry Diamond Laboratories  
ATTN: DRXDO-RCD 1  
2800 Powder Mill Road  
Adelphi, MD 20783

Commander  
New Cumberland Army Depot  
ATTN: SDSNC-QA 1  
New Cumberland, PA 17070

Commander  
Pueblo Army Depot Activity  
ATTN: DRXPU 1  
Pueblo, CO 81001

DISTRIBUTION

Copies

Commander  
Red River Army Depot  
ATTN: SDSRR-QA  
Texarkana, TX 75501

1

Commander  
Sacramento Army Depot  
ATTN: SDSSA-QA  
Sacramento, CA 95813

1

Commander  
Seneca Army Depot  
ATTN: SDSSE-R  
Romulus, NY 14541

1

Commander  
Sharpe Army Depot  
ATTN: SDSSH-QE  
Lathrop, CA 95330

1

Commander  
Sierra Army Depot  
ATTN: SDSSI-DQA  
Herlong, CA 96113

1

Commander  
Tobyhanna Army Depot  
ATTN: SDSTO-Q  
Tobyhanna, PA 18466

1

Director  
US Army Industrial Base Engineering Activity  
ATTN: DRXIB-MT  
Rock Island Arsenal  
Rock Island, IL 61299

2

Director  
USDARCOM Intern Training Center  
ATTN: SDSRR-QA  
Red River Army Depot  
Texarkana, TX 75501

1

Commander  
US Army Tropic Test Center  
ATTN: STETC-TD  
Drawer 942  
Fort Clayton, Canal Zone

1

DISTRIBUTION

Copies

Commander  
Anniston Army Depot  
ATTN: SDSAN-QA  
Anniston, AL 36202

1

Commander  
Corpus Christi Army Depot  
ATTN: SDSCC-MEE  
Mail Stop 55  
Corpus Christi, TX 78419

1

Commander  
Fort Wingate Army Depot Activity  
ATTN: DRXFW  
Gallup, NM 87301

1

Commander  
Letterkenny Army Depot  
ATTN: SDSLE  
Chambersburg, PA 17201

1

Commander  
Lexington-Blue Grass Army Depot Activity  
ATTN: SDSLX  
Lexington, KY 40507

1

Commander  
Tooele Army Depot  
ATTN: SDSTE-QA  
Tooele, UT 84074

1

Commander  
Holston Army Ammunition Plant  
ATTN: SARHO  
Kingsport, TN 37660

1

Commander  
Indiana Army Ammunition Plant  
ATTN: SARIN  
Charleston, IN 47111

1

Commander  
Iowa Army Ammunition Plant  
ATTN: SARIO  
Middletown, IA 52601

1

DISTRIBUTION

Copies

Commander  
Joliet Army Ammunition Plant  
ATTN: SARJO  
Joliet, IL 60434

1

Commander  
Lone Star Army Ammunition Plant  
ATTN: SARLS  
Texarkana, TX 75501

1

Commander  
Louisiana Army Ammunition Plant  
ATTN: SARLA  
P.O. Box 30058  
Shreveport, LA 71161

1

Commander  
Milan Army Ammunition Plant  
ATTN: SARMI  
Milan, TN 38358

1

Commander  
Radford Army Ammunition Plant  
ATTN: SARRA  
Radford, VA 24141

1

Commander  
Riverbank Army Ammunition Plant  
ATTN: SARRB  
Riverbank, CA 95367

1

Commander  
Scranton Army Ammunition Plant  
ATTN: SARSC  
Scranton, PA 18501

1

Commander  
Twin Cities Army Ammunition Plant  
ATTN: SARTC  
New Brighton, MN 55112

1

Commander  
Volunteer Army Ammunition Plant  
ATTN: SARVO-T  
P.O. Box 6008  
Chattanooga, TN 37401

1

DISTRIBUTION

Copies

C. Department of the Navy

Commander  
US Navy Materiel Industrial Resources Office  
ATTN: Code 044, CPT L. C. Dictmar  
Code 227  
Philadelphia, PA 19112

1  
1

D. Department of the Air Force

Commander  
Air Force Materials Laboratory  
ATTN: LTM  
Wright-Patterson AFB, OH 45433

1

DISTRIBUTION LIST UPDATE

- - - FOR YOUR CONVENIENCE - - -

Government regulations require the maintenance of up-to-date distribution lists for technical reports. This form is provided for your convenience to indicate necessary changes or corrections.

If a change in our mailing lists should be made, please check the appropriate boxes below. For changes or corrections, show old address *exactly* as it appeared on the mailing label. Fold on dotted lines, tape or staple the lower edge together, and mail.

Remove Name From List

Change or Correct Address

Old Address:

Corrected or New Address:

COMMENTS

---

---

---

---

---

Date: \_\_\_\_\_ Signature: \_\_\_\_\_

Technical Report #