

AD-A091 460

AIR FORCE INST OF TECH WRIGHT-PATTERSON AFB OH F/G 8/13
SAMPLE SIZE EFFECTS USING THE NGI DIRECT SIMPLE SHEAR APPARATUS--ETC(U)
MAY 79 M D CARROLL

UNCLASSIFIED

AFIT-CI-79-184T

NL

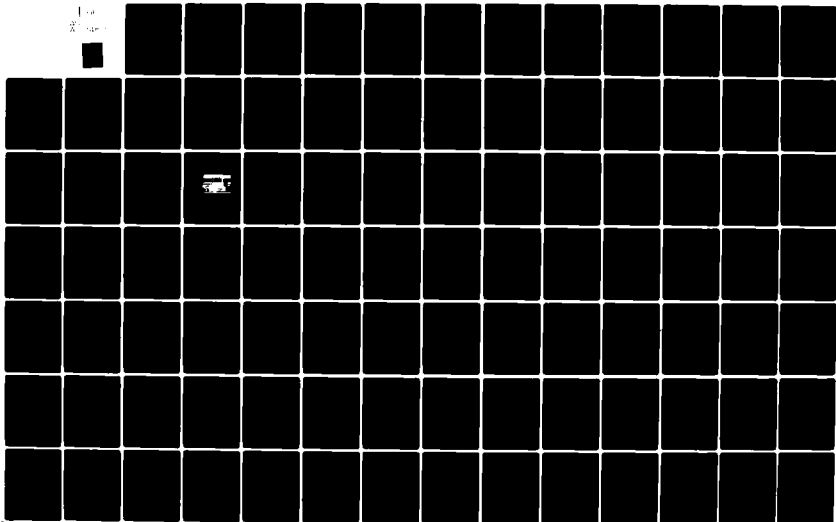

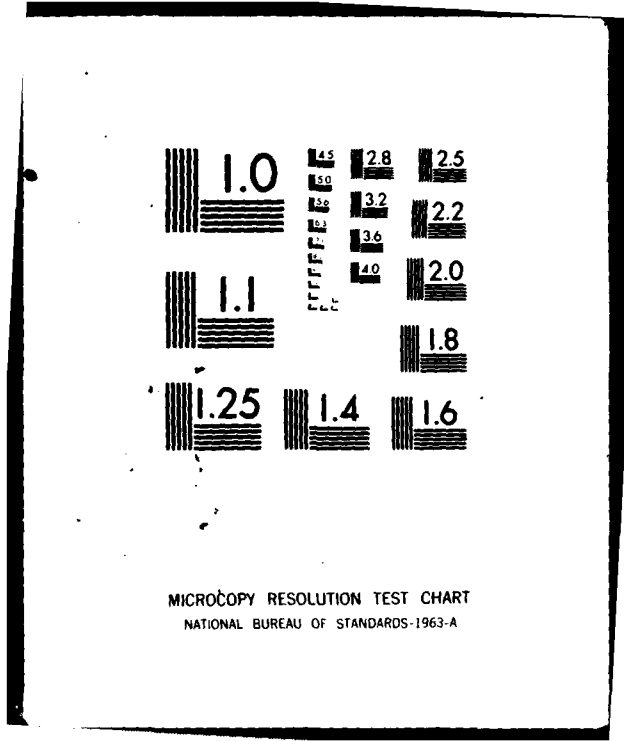

MICROCOPY RESOLUTION TEST CHART
NATIONAL BUREAU OF STANDARDS-1963-A

AD A091460

LEVEL II

180
①
B S

SAMPLE SIZE EFFECTS USING THE
NGI DIRECT SIMPLE SHEAR APPARATUS

by

Michael D. Carroll

A Thesis Submitted to the Graduate
Faculty of Rensselaer Polytechnic Institute
in Partial Fulfillment of the
Requirements of the Degree of
MASTER OF SCIENCE

Major Subject: Civil Engineering

Approved by:

Thomas F. Zimmie 5/9/79
Thomas F. Zimmie, Thesis Adviser

DTIC
ELECTE
NOV 12 1980
S D
E

DDC FILE COPY

Rensselaer Polytechnic Institute
Troy, New York

DISTRIBUTION STATEMENT A
Approved for public release
Distribution Unlimited

MAY 1979

80 10 16 095

14

UNCLASS

SECURITY CLASSIFICATION OF THIS PAGE (When Data Ent)

AFIT-CT REPORT DOCUMENTATION PAGE

READ INSTRUCTIONS BEFORE COMPLETING FORM

1. REPORT NUMBER 79-184T		2. GOVT ACCESSION NO. AD A091460		3. RECIPIENT'S CATALOG NUMBER	
4. TITLE (and Subtitle) Sample Size Effects Using The NGI Direct Simple Shear Apparatus,		5. TYPE OF REPORT & PERIOD COVERED			
7. AUTHOR(S) Michael D. Carroll		8. CONTRACT OR GRANT NUMBER(s)			
9. PERFORMING ORGANIZATION NAME AND ADDRESS Student at: Rensselaer Polytechnic Institute		10. PROGRAM ELEMENT, PROJECT, TASK AREA & WORK UNIT NUMBERS			
11. CONTROLLING OFFICE NAME AND ADDRESS AFIT/NR WPAFB OH 45433		12. REPORT DATE 11 May 1979		13. NUMBER OF PAGES 132	
14. MONITORING AGENCY NAME & ADDRESS (if different from Controlling Office)		15. SECURITY CLASS. (of this report)		15a. DECLASSIFICATION/DOWNGRADING SCHEDULE	
16. DISTRIBUTION STATEMENT (of this Report) Approved for public release; distribution unlimited					
17. DISTRIBUTION STATEMENT (of this Report) (Block 20, if different from Report) APPROVED FOR PUBLIC RELEASE Fredric C. Lynch FREDRIC C. LYNCH, Major, USAF Director of Public Affairs 23 SEP 1980					
18. SUPPLEMENTARY NOTES Approved for public release; IAW AFR 190-17 Air Force Institute of Technology (ATC) Wright-Patterson AFB, OH 45433					
19. KEY WORDS (Continue on reverse side if necessary and identify by block number)					
20. ABSTRACT (Continue on reverse side if necessary and identify by block number) Attached					

10

9

12 142

012200

SECURITY CLASSIFICATION OF THIS PAGE(When Data Entered)

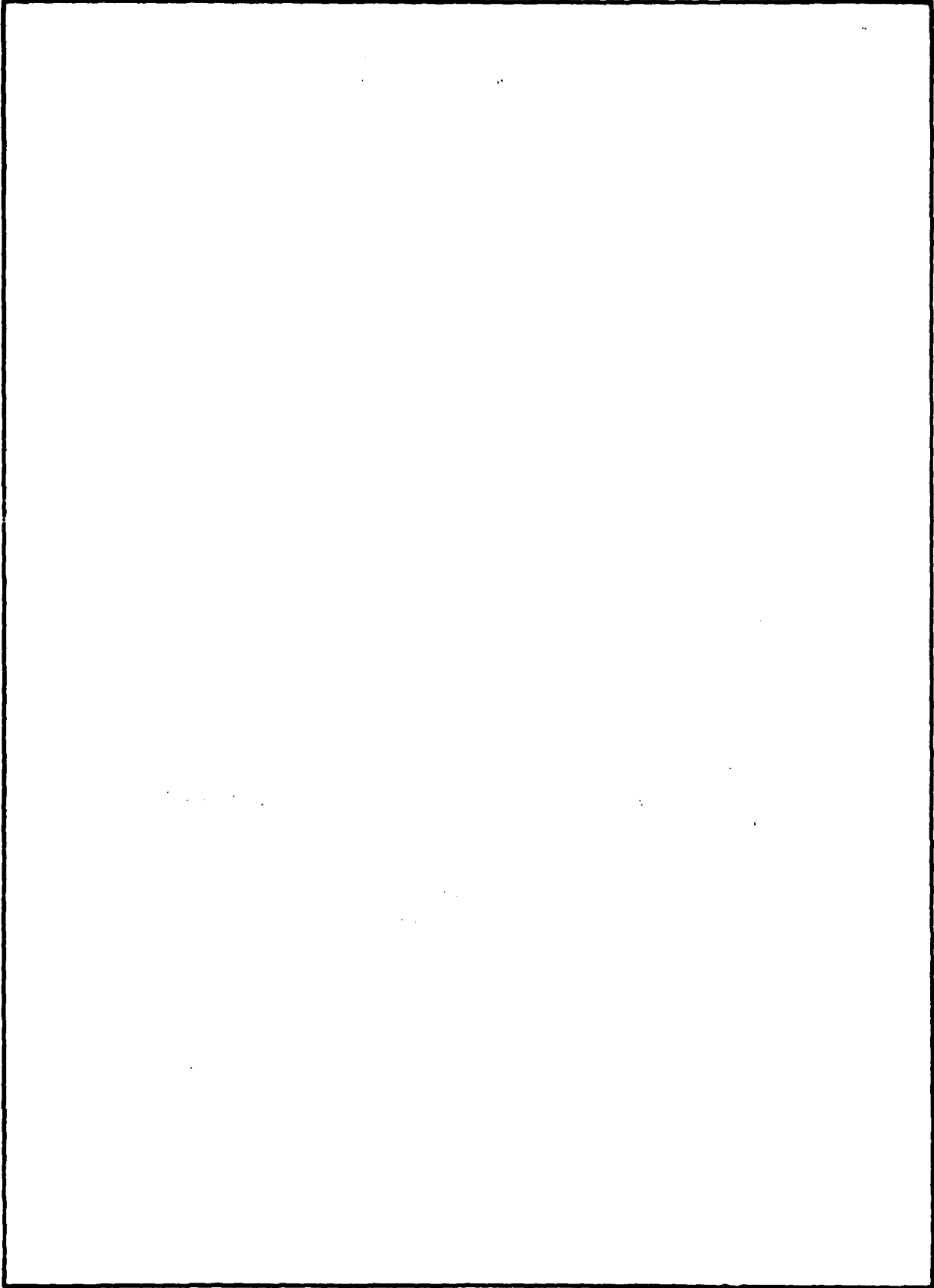

SECURITY CLASSIFICATION OF THIS PAGE(When Data Entered)

SAMPLE SIZE EFFECTS USING THE
NGI DIRECT SIMPLE SHEAR APPARATUS

by

Michael D. Carroll

Sponsored by the National Science Foundation
Directorate for Applied Science and
Research Applications (ASRA)

GRANT No. ~~PFR76-14220~~
(FORMERLY ~~ENV76-14220~~)
and
GRANT NO. PFR78-18743

INTERIM REPORT

MAY 1979

Department of Civil Engineering
Rensselaer Polytechnic Institute
Troy, NY 12181

Accession For	
NTIS GRA&I	<input checked="" type="checkbox"/>
DDC TAB	<input type="checkbox"/>
Unannounced	<input type="checkbox"/>
Justification	<input type="checkbox"/>
By _____	
Distribution/	
Availability Codes	
Dist.	Avail and/or special
A	

TABLE OF CONTENTS

	PAGE
ACKNOWLEDGEMENT	v
FOREWORD	vii
ABSTRACT	viii
1. INTRODUCTION	1
A. Background	1
B. Stress Conditions	3
2. EQUIPMENT	11
A. Shear Apparatus	11
B. Trimming Apparatus	19
C. Reinforced Rubber Membranes	19
D. Data Acquisition	22
E. Equipment Calibration	23
Proving Ring Load Cells	23
Load Cell	24
LVDT	24
Friction	24
False Deformation	24
3. TESTING SPECIFICS	27
A. Soil	27
Gulf of Alaska Clay	27
Gulf of Mexico Clay	28
Sample Preparation	28
B. Test Procedures	32
4. TEST RESULTS AND ANALYSIS	34
A. Introduction	34
B. Static Test Comparisons	39
C. Sample Cross Section Size Comparison for Cyclic Tests	48
D. Sample Height Comparisons for Cyclic Tests	57
5. DISCUSSION AND CONCLUSIONS	78
A. Discussion	78
B. Summary	81

	PAGE
6. LITERATURE CITED	84
APPENDIX A - ADDITIONAL DATA	87
A. Static Test Comparisons	88
B. Comparison of Sample Cross-Sectional Size for Cyclic Tests	95
C. Comparison of Sample Heights for Cyclic Tests	102
APPENDIX B - SAMPLE PREPARATION -- Step by Step Procedures . . .	121
APPENDIX C - INSTRUCTIONS FOR THE USE OF THE NORWEGIAN GEOTECHNICAL INSTITUTE DIRECT SIMPLE SHEAR DEVICE -- A Step by Step Approach	126
APPENDIX D - CALIBRATION OF STRAIN GAUGE EQUIPPED MEMBRANES FOR THE NORWEGIAN GEOTECHNICAL INSTITUTE DIRECT SIMPLE SHEAR DEVICE -- A User's Approach	132

ACKNOWLEDGEMENT

This investigation was in response to previous research completed by Dr. Thomas F. Zimmie and Mr. Carsten H.L. Floess (24). As the author of this report, I would like to express my appreciation to Dr. Zimmie, my adviser on this project, for his comments and directioning which was, indeed, invaluable. I would also like to thank Mr. Floess who afforded me large amounts of his time and knowledge. His assistance truly made this investigation possible. Further, Figures 1 through 8 and Table 1 were directly adapted from a report on the above mentioned investigation (24). Likewise, the structuring of this report as a whole was based on the same.

I would also like to thank Mrs. Betty Alix for assisting in proofing and for typing this report.

Appreciation is also expressed to the United States Geological Survey for providing the undisturbed offshore marine samples with appropriate geotechnical data used in this study.

I do not wish to forget all the researchers and authors whose previous works assisted me in mine.

Most sincerely, I would like to thank my wife, Kathy, who stuck with me all the way and whose typing of the enclosed graphs and the drafts of the narrative was indispensable.

Funds for this project were provided by a grant from the National Science Foundation, Grant No. PFR76-14220 (formerly ENV76-14220), sponsored by the Earthquake Engineering Program for the Directorate for Applied Science and Research Applications (ASRA) (formerly RANN).

The principal investigator of this project was Thomas F. Zimmie, Associate Professor, Civil Engineering.

Dr. S.C. Liu was the initial Program Manager for the research project whereas Dr. W. Hakala was the Program Manager for the latter portion of the project.

Please note that although the project is sponsored by the National Science Foundation, any opinions, findings, conclusions and/or recommendations expressed by this publication are those of the authors and do not necessarily reflect the view of NSF.

FOREWORD

Realizing the importance of the undrained cyclic shear strength of soils, particularly marine clays, this report sets out to analyze and hopefully improve the use and the interpretation of results of the Norwegian Geotechnical Institute direct simple shear device modified for cyclic loading. Specifically, the text quantifies the effects of variations in sample size. Part 1 of this text summarizes the need for this information and covers stress conditions necessary for the interpretation of results.

Equipment used in this investigation is discussed in Part 2, while testing procedures and soil characteristics are discussed in Part 3. Part 4 discusses and analyzes the test results with respect to variation in sample size and soils. Part 5 completes the body of this text by drawing conclusions from the results and summarizing.

Appendix A is a collection of additional data not analyzed in the body of the report.

Details of testing procedures are presented in Appendix B through D, so further investigation can utilize experiences obtained during this research. Sample preparation is discussed in Appendix B, instructions for cyclic and static shearing procedures with the Norwegian Geotechnical Institute direct simple shear device are given in Appendix C, and Appendix D covers the calibration of strain gauged equipped reinforced membranes used to measure lateral strains.

ABSTRACT

↙ The contents of this report include a comparison of direct simple shear test results for variations in sample size and for two different soils. Soils tested were undisturbed samples of Gulf of Alaska and Gulf of Mexico clays. Testing was performed on the Norwegian Geotechnical Institute Direct Simple Shear Device and included both static and cyclic loading applications. The emphasis was on cyclic loading results.

The parameters varied were sample cross section and sample height. Two cross-sectional sizes and three heights are compared.

Test data included lateral strain measurements from which horizontal normal stresses and subsequently K_0 values were calculated. These calculations and results are discussed as affected by sample size, with special attention to K_0 values. $K_{pul=0}$

The main conclusions from this investigation were: K_0 is affected by changes in height; the smaller cross-sectional sample size produces higher static and cyclic shear strain resistance, but a much greater degree of scatter; and sample height had little obvious and consistent effects on cyclic shear results. ↙

Appended are detailed step by step instructions on the use of the Norwegian Geotechnical Institute direct simple shear device in both static and cyclic functions; the use of the Norwegian Geotechnical Institute sample trimming apparatus; and methods for calibrating the Norwegian Geotechnical Institute calibrated reinforced membranes using calibration cylinders.

PART I

INTRODUCTION

A. Background

In recent years, the importance of soil strength characteristics under cyclic loading has become recognized and accepted. Increasingly, designers have sought to incorporate these characteristics in their analyses. A recent notable example is the controversy concerning the possible shutdown of the Indian Point Nuclear Power Plant in southern New York* (1) .

Actually, cyclic loadings are quite common, effecting all geographical areas. These loads can take the form of wind and wave action, traffic activity, blasting, pile driving, machinery vibrations, and of course, earthquakes.

The failure of soil resulting from cyclic loading is a common destructive mechanism. Earthquake damage to every conceivable structure, including pipelines, buildings, and dams, have at times been attributed to soil failures. For many structures, such as pipelines, the effects of dynamic soil strains cause more failures than any other single force (22). Besides the relative frequent occurrence of soil failure when exposed to cyclic loading, the results of such failures can also be catastrophic as well. Failure of earth gravity structures, such as dams, embankments and retaining walls, have resulted in losses of both life and property far

*The Indian Point Power Plant reactors are situated within 1 km of a major branch of the Ramapo fault system, a branch previously thought inactive. More people (21 million) live within 80 km of this nuclear power plant than any other in the U.S.

exceeding acceptable limits.

With petroleum interest in offshore areas heightening, knowledge of soil strength characteristics is essential. Oil drilling platform structures are particularly susceptible to soil failure from cyclic loadings, both because of the physical characteristics of the platforms, and because of the sensitive soil often found beneath the platform (2,7,14,18,24).

Often failures occur because of rapid increases in stress from seismic accelerations by loss of soil strength and increased pore pressures. An extreme form of this type of failure, where the soil essentially loses all of its strength, is called "liquefaction" (20). Much of the research designed to study this mode of soil strength deterioration has been limited to cohesionless soils. There has been much less accomplished in the way of studying clays and other fine grained soils for these conditions (24).

Increasingly, direct simple shear devices are being utilized to study fine grained soil characteristics, particularly under cyclic loading conditions. This report concentrates on the more effective use of the Norwegian Geotechnical Institute (NGI) direct simple shear device. The NGI device is an accepted and appropriately sophisticated apparatus for the measurement of cyclic strength characteristics of fine grained cohesive soils.

Recently, an investigation was completed by Zimmie and Floess (24) using the NGI direct simple shear apparatus and associated sample trimming

equipment, on Gulf of Alaska and Concord Blue Clays. One problem encountered was the inability to obtain exact or consistent sample heights. In all, nine Gulf of Alaska samples were tested with heights ranging from 1.40 cm to 1.91 cm and a mean, variance and standard deviation of 1.69 cm, 0.0142 cm and 0.1193 cm, respectively. Twenty-one Concord Blue samples were tested with heights ranging from 1.42 to 2.05 cm, and a mean, variance, and standard deviation of 1.73 cm, 0.0371 cm, and 0.1927 cm, respectively. The recommended height was 1.5 cm (8). The purpose of this research was to investigate the effects of variations.

Specifically, this research was directed to the study of soil sample size and the refinement of sample preparation and cyclic testing procedures. An analysis of the former is contained within the body of this report while the latter two are appended. To a lesser degree, strength characteristics of undisturbed clay samples of the Gulf of Alaska and the Gulf of Mexico were studied and compared.

The NGI direct simple shear device, modified for cyclic loading capabilities, has been used by a number of researchers for cyclic loading studies (24). Overall it is an excellent device, although it does have some limitations (23). This device, with modifications, allows for repetitive loadings in alternate directions in an attempt to more closely simulate in situ cyclic loading conditions, such as for earthquakes.

B. Stress Conditions

The NGI direct simple shear device subjects a cylindrical sample of soil to a shearing displacement of the top of the sample relative to

the bottom. Normal compressive stresses can be applied parallel to the sample vertical axis, and a reinforced rubber membrane restrains the lateral expansion of the soil. Such a pattern of loading involves distributions of stress that are not symmetrical about the axis of the cylinder (13,16). The lack of complementary shear stresses on the vertical sides of the sample, coupled with the relatively small sample size, complicates stress and strain assumptions, since in a small sample no element will be far from the boundary conditions (24).

Figure 1 shows the stress conditions imposed on a soil element in the field, and on the boundaries of the NGI direct simple shear sample (24). The lack of complementary vertical shear stresses are illustrated. Although not ideal, it has been concluded (13,16,21) that the distribution of stresses on the NGI sample is better than in conventional direct shear devices. Lucks et al (13) found, for NGI direct simple shear samples, that approximately 70 percent of the sample (the center 70 percent) exhibits fairly uniform stress conditions, while stress concentrations at the edges were quite local. Roscoe (17), in his analysis of a Cambridge simple shear sample, found that though the magnitude of shear stress is zero at the outer edges, the shear stress increases rapidly with distance from the outside boundaries and is quite uniform in the middle third of the upper and lower boundaries of the sample for small strains. For larger strains these assumptions were felt to be reasonable.

Considering the above, this study of sample size was initiated to investigate the effects of nonuniform stress distributions on experimental

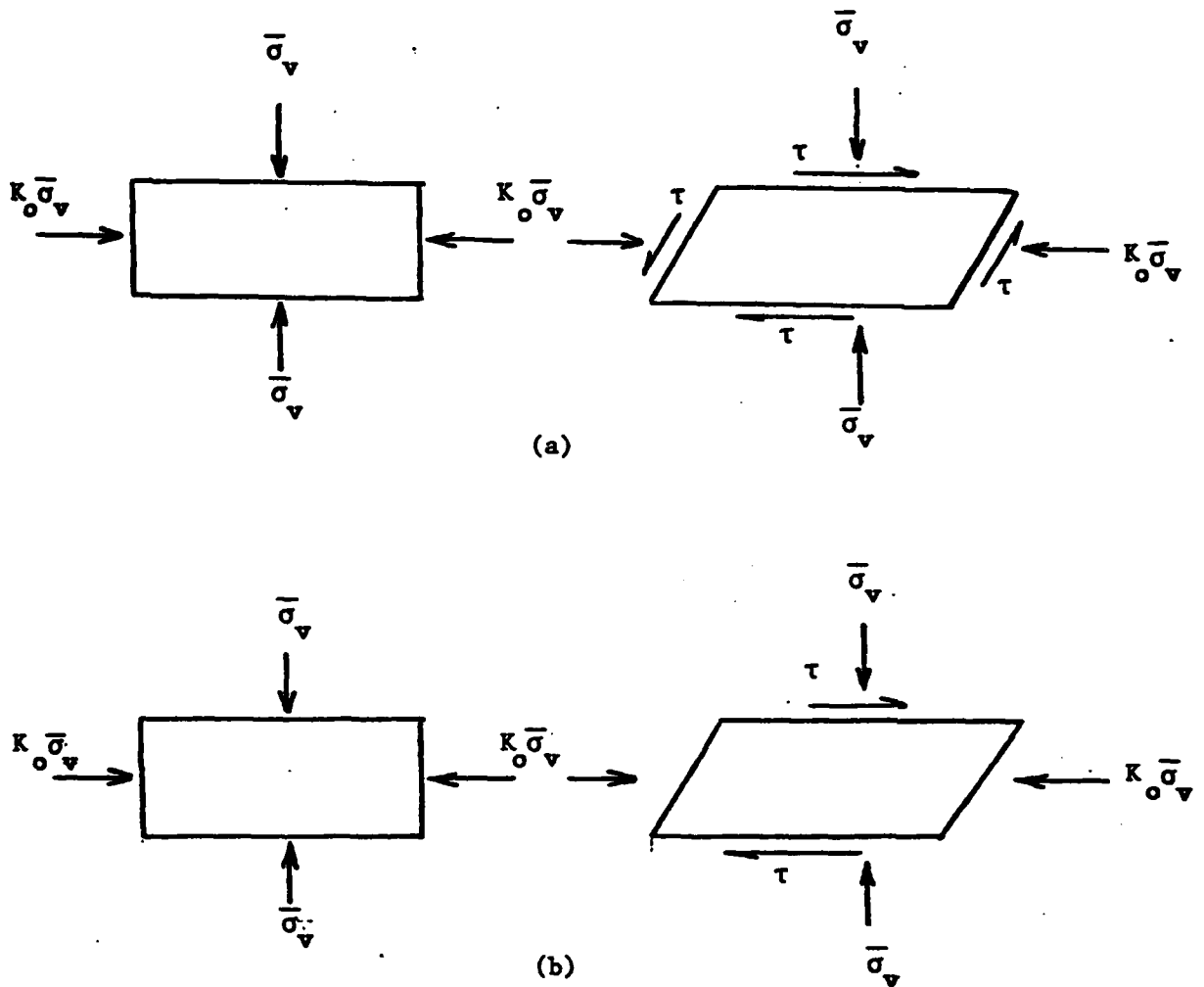

FIGURE 1. (a) APPLIED STRESS CONDITIONS ON AN IN-SITU SOIL ELEMENT
 (b) APPLIED STRESS CONDITIONS ON A NGI DIRECT SIMPLE SHEAR SOIL SAMPLE

results that assume a uniform stress.

Consolidated constant volume (CCV) static and cyclic tests were performed. Samples were tested after application of stress histories resulting in normally consolidated specimens.

Three stresses were measured during testing. The vertical normal stress and the horizontal shearing stress were directly monitored. Horizontal normal stresses were computed from lateral strains measured by strain gauge equipped reinforced membranes. Changes in normal vertical stress, necessary to maintain a constant volume during testing, were equated to the changes in excess hydrostatic pore pressures which would have occurred in undrained testings.

Since the reinforced rubber membranes maintain the sample at essentially a constant cross-sectional area, constant volume tests were conducted by adjusting the normal vertical load to keep the sample height constant.

The following assumptions were necessary for the interpretation of test results (24):

- Undrained conditions were simulated in the NGI direct simple shear device by maintaining a constant sample volume.
- Measured changes in vertical normal stress were equal to pore pressures which would have been generated in an undrained test.
- All measured normal stresses were effective stresses.
- Stresses acting on an infinitesimal element at the center of the sample were uniform and complementary.
- Vertical shearing stresses were equal to the horizontal shearing stresses.

Figure 2 illustrates the measured stresses acting on the NGI direct simple shear sample and the assumed stresses acting on an infinitesimal element at the center of the sample (24).

As explained in an earlier report by Zimmie and Floess (24), by utilizing the three measured stresses, a Mohr's circle of stress can be drawn for the soil element at any stage during the test as shown in Figure 3. The variables indicated in the figure can be determined from the geometry of the Mohr's circle along with the known values of the vertical effective normal stresses $\bar{\sigma}_v$, the horizontal effective normal stress $\bar{\sigma}_h$, and the horizontal shear stress τ_h , as follows:

$$\bar{p} = \frac{\bar{\sigma}_v + \bar{\sigma}_h}{2} = \frac{\bar{\sigma}_1 + \bar{\sigma}_3}{2}$$

$$q = \left(\frac{(\bar{\sigma}_v - \bar{\sigma}_h)^2}{4} + \tau_h^2 \right)^{1/2} = \frac{\bar{\sigma}_1 - \bar{\sigma}_3}{2}$$

where \bar{p} and q define the uppermost point of the Mohr's circle or the effective stress point. The major and minor effective principal stresses are $\bar{\sigma}_1$ and $\bar{\sigma}_3$.

$$\phi_m = \sin^{-1} \left(\frac{q}{\bar{p}} \right)$$

where ϕ_m is the mobilized friction angle of the soil,

$$\theta_p = \tan^{-1} \left(\frac{\tau_h}{\frac{(\bar{\sigma}_v - \bar{\sigma}_h)}{2} + q} \right)$$

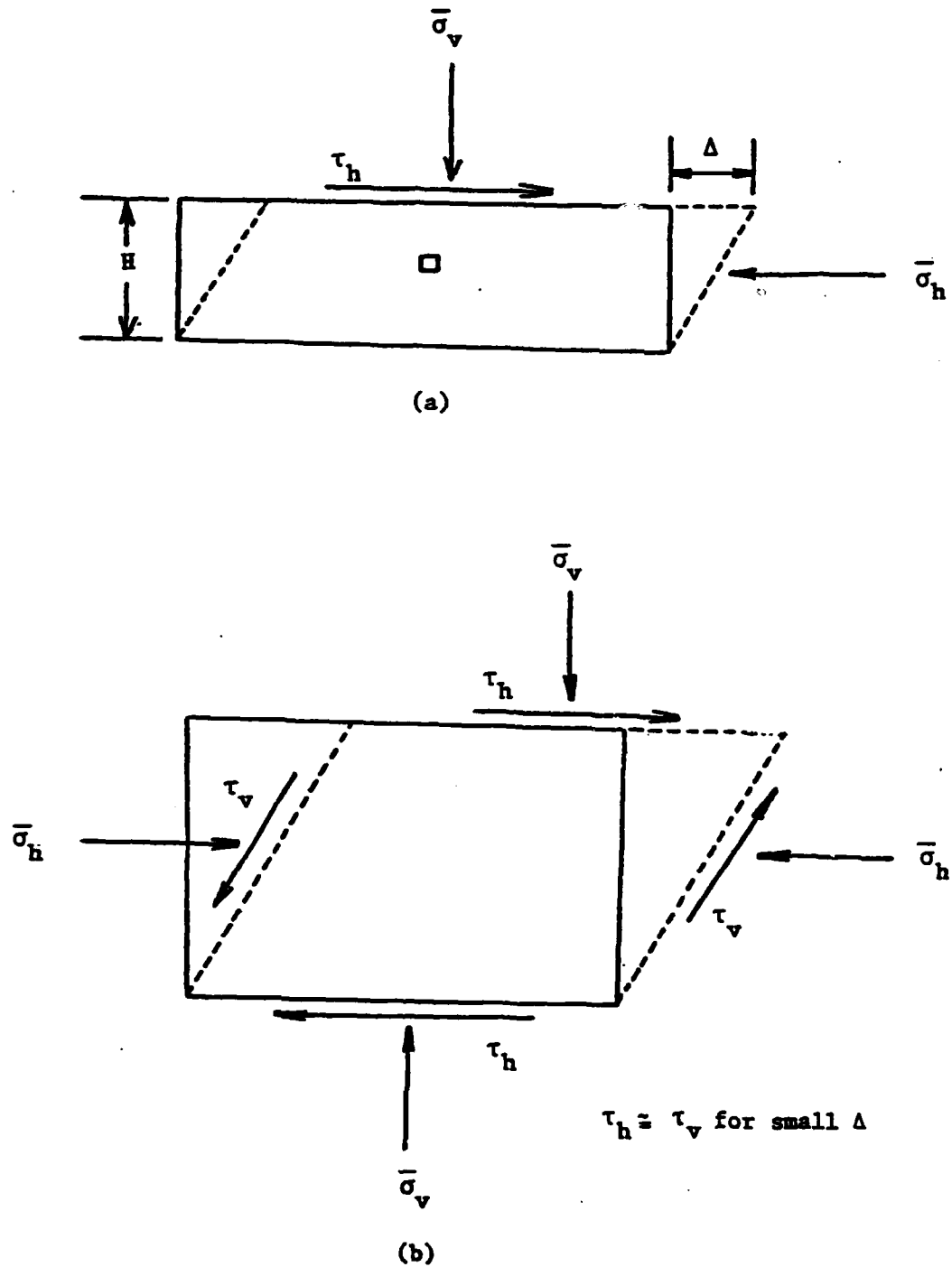
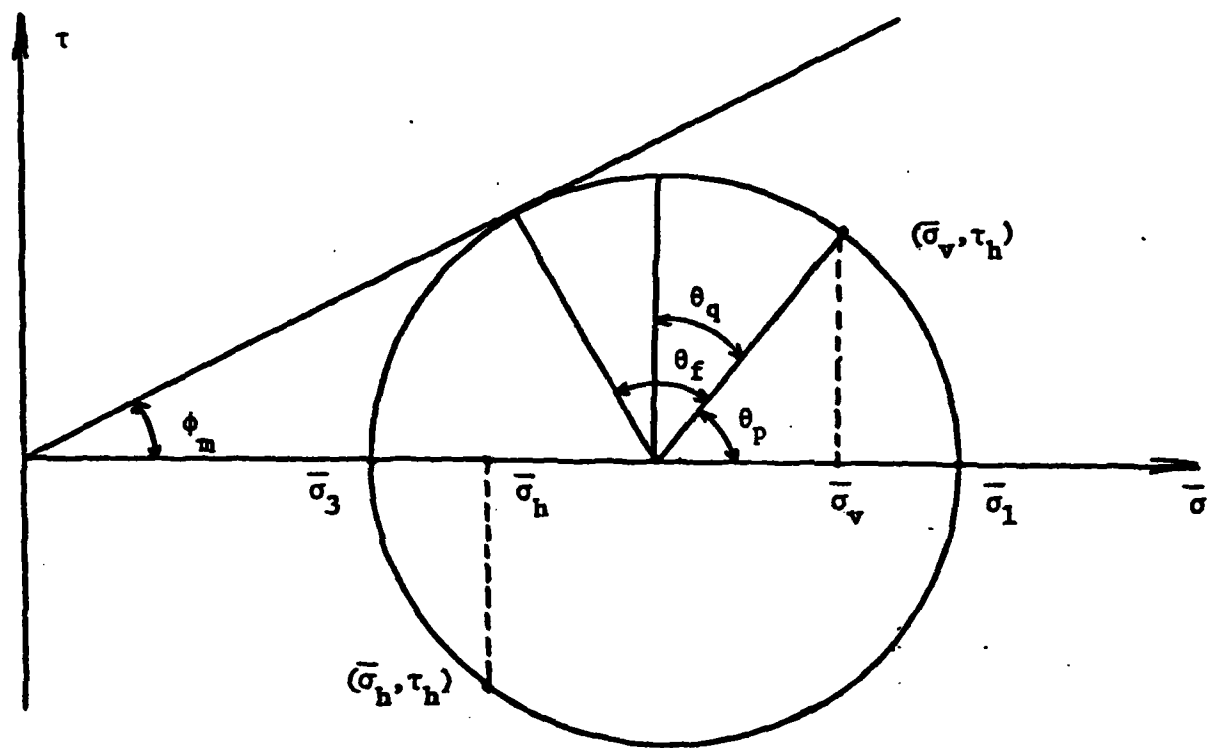

FIGURE 2. (a) MEASURED BOUNDARY STRESSES ACTING ON THE NGI DIRECT SIMPLE SHEAR SAMPLE
 (b) ASSUMED STRESS CONDITIONS ACTING ON AN ELEMENT FROM THE CENTER OF THE SAMPLE



$$\bar{p} = \frac{\bar{\sigma}_v + \bar{\sigma}_h}{2} = \frac{\bar{\sigma}_1 + \bar{\sigma}_3}{2}$$

$$q = \left[\frac{(\bar{\sigma}_v - \bar{\sigma}_h)^2}{4} + \tau_h^2 \right]^{1/2} = \frac{\bar{\sigma}_1 - \bar{\sigma}_3}{2}$$

$$\phi_m = \sin^{-1} \left(\frac{q}{p} \right)$$

$$\theta_p = \tan^{-1} \left[\frac{\tau_h}{\frac{(\bar{\sigma}_v - \bar{\sigma}_h)}{2} + q} \right]$$

$$\theta_q = 45 - \theta_p$$

$$\theta_f = 45 + \frac{\phi_m}{2} - \theta_p$$

$$\bar{\sigma}_1 = \bar{p} + q$$

$$\bar{\sigma}_3 = \bar{p} - q$$

FIGURE 3. MOHR'S CIRCLE OF STRESS FOR A SOIL ELEMENT AT THE CENTER OF THE NGI DIRECT SIMPLE SHEAR SAMPLE

where θ_p is the angle between the horizontal plane and the plane on which the major principal stress acts,

$$\theta_q = 45 - \theta_p$$

where θ_q is the angle between the horizontal plane and the plane on which the maximum shear stress acts,

$$\theta_f = 45 + \frac{\phi_m}{2} - \theta_p$$

where θ_f is the angle between the horizontal plane and the plane of maximum obliquity, and

$$\bar{\sigma}_1 = \bar{p} + q$$

$$\bar{\sigma}_3 = \bar{p} - q$$

Note that the above equations are valid for no cohesion, i.e., $c = 0$.

All tests performed during this study were analyzed on the basis of the assumptions and equations presented here. Actual test results are presented in Part 4.

PART 2
EQUIPMENT

The Norwegian Geotechnical Institute (NGI) direct simple shear apparatus, model number 4, modified for cyclic loading capabilities, was used for this investigation. The device was developed by NGI and manufactured by Geonor. Detailed discussions of this apparatus and associated equipment are available (8,24). This report will attempt to summarize the above, deviating where appropriate for the portrayal of this investigation. Moreover, fully detailed laboratory procedures are appended.

The basic principle of this device is to apply a shearing force to a cylindrical soil sample, confined in the radial direction by a wire reinforced rubber membrane, so as to cause a shearing displacement of the top of the sample relative to the bottom. The reinforcement of the membrane allows for a constant cross-sectional area during consolidation and shearing. As shearing occurs the upper and lower ends of the sample are maintained parallel to each other.

Consolidation is performed by applying a vertical normal stress to the sample while allowing drainage. During shearing, a constant volume is maintained by varying the vertical normal stress, thus simulating undrained shear conditions.

A. Shear Apparatus

The NGI direct simple shear device consists of the sample assembly, the vertical loading unit, and the horizontal loading unit. Figure 4

shows the sample assembly, Figure 5 presents the shearing apparatus without cyclic loading modifications, and Figure 6 shows it with cyclic loading capabilities.

The sample assembly consists of the pedestal, upper cap, lower cap, wire reinforced rubber membrane, and O-rings. At this point sample height and cross section are defined since they were the sample size variables studied in this investigation. The height and diameter are shown in Figure 4, where the cross section is the circular area. The sample assembly unit is available in either the standard 50 cm² sample cross section or 17.81 cm² cross section (1.875 inch diameter). These two sample sizes constituted the variation of cross-sectional area. The sample heights for this study were varied from 10 to 25 millimeters (a height of 15 millimeters is recommended).

The upper and lower caps have recesses for porous stones, and were equipped with drainage tubes which were connected to an external water source. The O-rings provided a water tight seal between the wire reinforced rubber membrane and the caps.

The vertical loading unit consists of the base, the tower, the 10:1 lever arm, the proving ring load gauge, the piston, the sliding shear box, the vertical dial gauge, and the adjusting mechanism. A counter-weight balances the weight of the lever arm, the proving ring load gauge, the piston, the sliding shear box, and the top cap.

The horizontal loading unit for static strain controlled testing includes the electric motor and gear box, the proving ring load gauge,

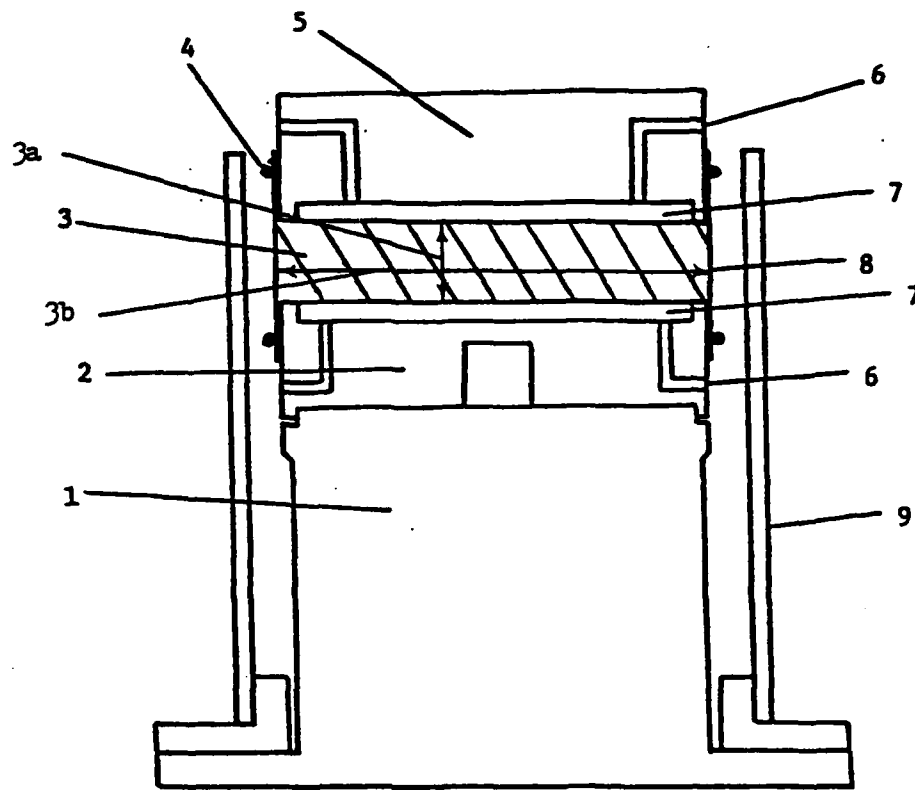

- | | |
|--------------------|-------------------------------|
| 1. Pedestal | 6. Drainage Tube |
| 2. Lower Cap | 7. Porous Stone |
| 3. Sample | 8. Reinforced Rubber Membrane |
| a. Sample Height | 9. Plastic Cylinder |
| b. Sample Diameter | |
| 4. O-Ring | |
| 5. Upper Cap | |

FIGURE 4. THE NGI DIRECT SIMPLE SHEAR DEVICE
SAMPLE ASSEMBLY

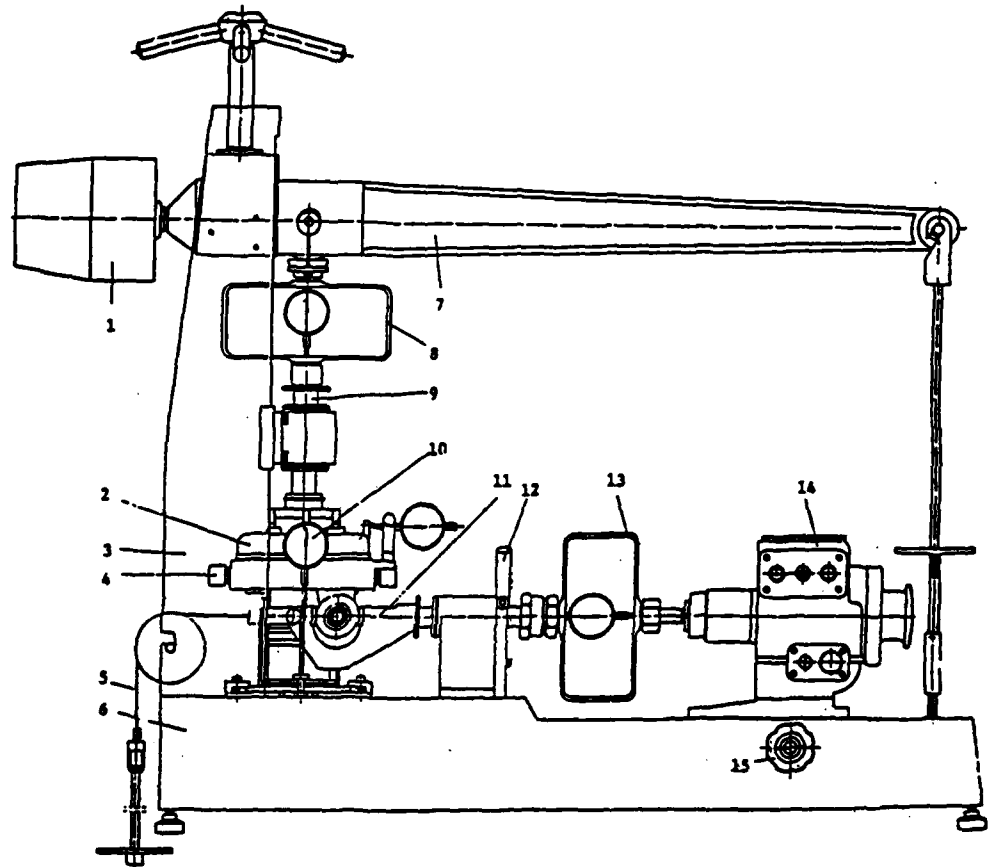

(Adapted from Ref. 8)

FIGURE 5. THE NGI DIRECT SIMPLE SHEAR DEVICE

1. Counter Weight
2. Sliding Shear Box
3. Tower
4. Lugs
5. Hanger
6. Base
7. Lever Arm
8. Proving Ring Load Gauge
9. Piston
10. Vertical Dial Gauge
11. Connection Fork
12. Locking Clamp
13. Proving Ring Load Gauge
14. Electric Motor and Gear Box
15. Adjusting Mechanism

FIGURE 5. (CONTINUED)

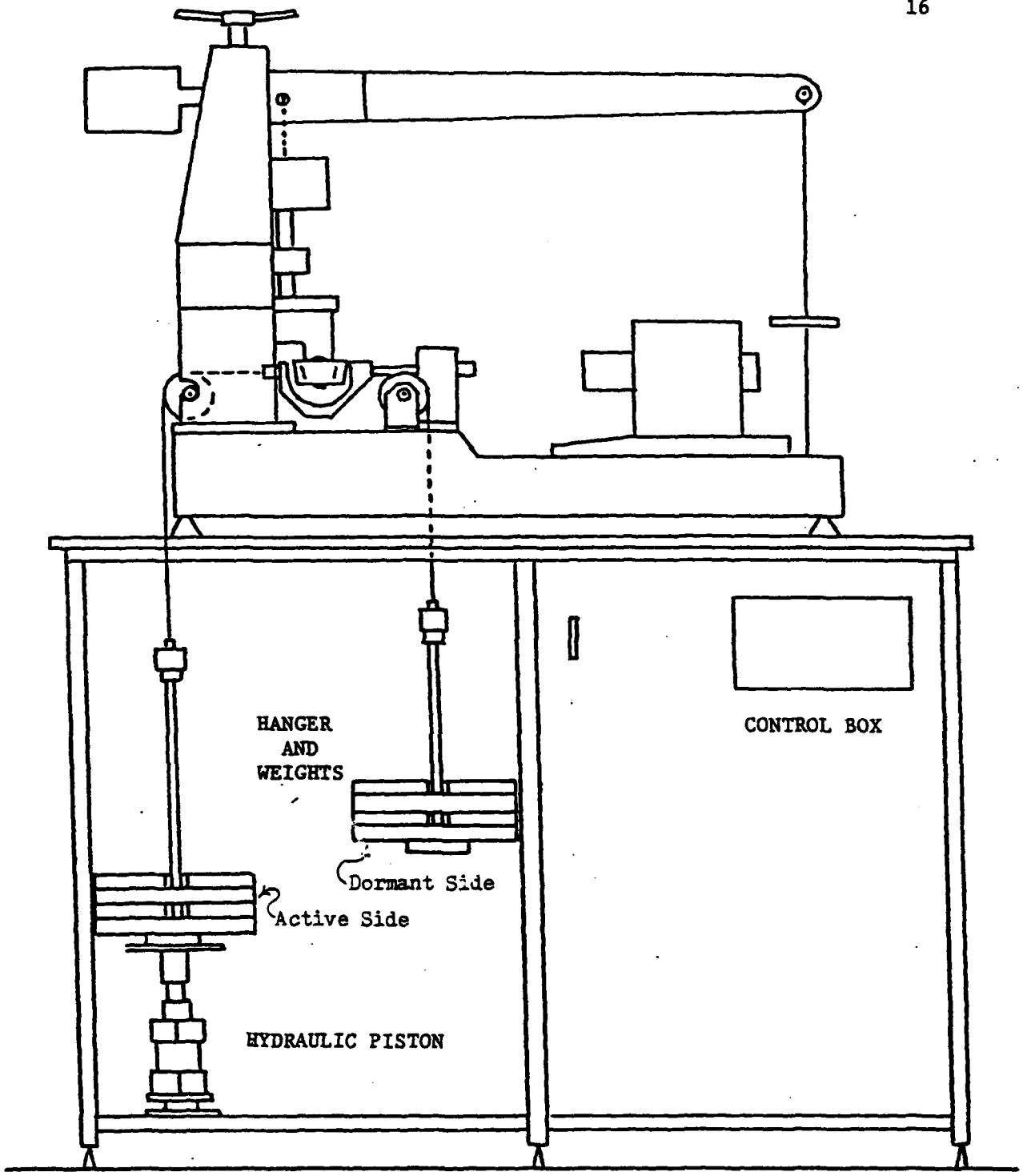

FIGURE 6. NGI DIRECT SIMPLE SHEAR DEVICE WITH MODIFICATIONS FOR CYCLIC LOADING CAPABILITIES

the horizontal piston, the locking clamp, the connection fork, the sliding shear box, and the horizontal dial gauge. A constant rate of shear strain is applied to the sample by the gear box and electric motor. The gear box has a stepless speed adjustment with a range of 10 minutes per mm to 300 minutes per mm of travel. For this investigation 75 minutes per mm was used during static testing.

With cyclic loading modifications, stress controlled tests with a square wave loading were performed. The cyclic loading mechanism is illustrated in Fig. 6. The hydraulic piston travels up and down at controlled frequencies. Weight hangers were attached by wires to the connection fork. The hanger which would come into and out of contact with the piston will be referred to as the active side hanger. When the piston was in the down position, the active side hanger and weights hung free; when the piston was up, it supported this weight. Providing that exactly twice as much weight (including the weight of the hanger) hung from the active side as from the dormant side, equal shear forces were alternately transmitted in opposite directions to the sample. Thus, the mechanism induced a stress controlled square wave loading on the sample.

Zimmie and Floess (24) observed that shear strains were generally larger on the active side as opposed to the dormant side. This is attributed to the impact loading of the active weight as it is relieved of support by the piston. This is an inherent problem with this loading system, and a compensational reduction of weight was administered to produce approximately symmetric shear strains. A weight reduction

equivalent to 0.005 kg/cm^2 shearing stress was found appropriate and used for stresses in the range (0.07 kg/cm^2 to 0.08 kg/cm^2) applied to samples of this investigation. As some data obtained from Zimmie and Floess' research is in this report, the reduction is the same as used by them.

The control unit for cyclic loadings consists of a counter and a timer. Half period frequencies from 1 to 99 seconds were possible. For this investigation the period was maintained at 10 seconds. The timer controlled a 4-way solenoid operated air valve that actuated the piston motion.

The connection between the top cap of the sample assembly and the lower part of the sliding shear box was made by two adjustable lugs. The lugs were brought into contact with the cap by means of two allen-head screws. The sample was sheared by moving the top cap while holding the bottom cap and the pedestal stationary.

The fine adjustments in the vertical load, needed to maintain constant volume conditions, were made by the adjusting mechanism. After consolidation, the lever arm was pinned to the adjusting mechanism, providing the desired consolidation stress. Once pinned into position, the vertical load was changed by controlled movements of the lever arm upwards and downwards. This was accomplished by rotating a worm gear connected to the adjusting knob.

B. Trimming Apparatus

The trimming apparatus was designed for use with the soft sensitive clays that are common in Scandinavia. The basic design principles are that the sample should be completely and rigidly supported at all times, with a minimum of handling.

The trimming apparatus consists of a base, and a set of three yokes. The base has two vertical columns on which the yokes slide. The yokes are positionable at any point on the columns.

The first yoke used in the trimming procedure guides a stainless steel cutting cylinder. It contains provisions for attaching the lower sample assembly cap to the bottom of the sample. The second yoke acts as a guide for attaching the upper cap to the sample. The final yoke acts as the guide for the reinforced rubber membrane expander. When vacuum is applied to the expander, the diameter of the reinforced rubber membrane inserted within the yoke is increased. The membrane is then mounted on the sample with a minimum of disturbance.

Proper use of the trimming apparatus ensures that the sample stands vertical, and the ends will be horizontal and parallel. A photograph of the trimming apparatus is shown in Figure 7.*

C. Reinforced Rubber Membranes

The calibrated reinforced rubber membranes used for the measurement of lateral stress were manufactured by Geonor. These membranes, shown in Figure 7, operate on a strain gauge principle; the change in resis-

*A more detailed discussion of sample preparation is appended.

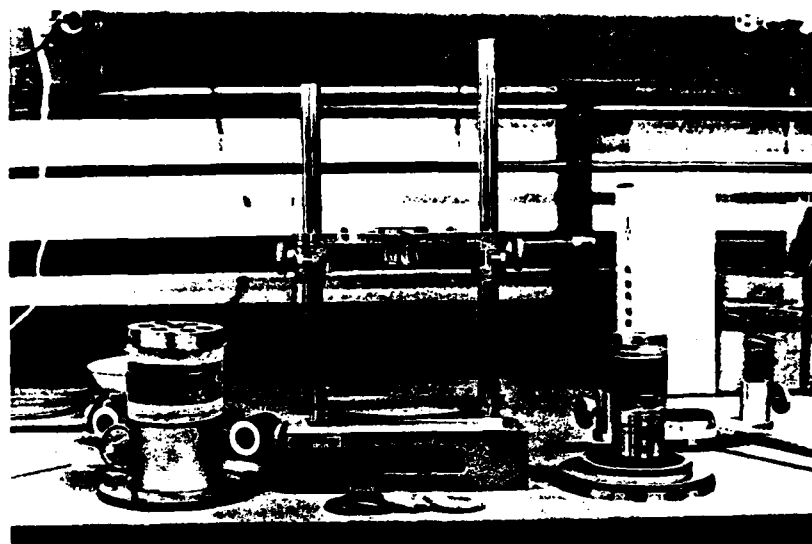

FIGURE 7. NGI TRIMMING APPARATUS AND REINFORCED RUBBER MEMBRANES

tance of the wire windings is measured. The entire height of the wire reinforcement windings is 3 cm; the middle centimeter acts as the strain gauge. These membranes are calibrated by applying known hydrostatic stresses and by measuring the resulting change in resistance. The resistance changes are measured by a strain gauge indicator calibrated directly in micro-inches per inch. Calibration of the 50 cm² sample membranes were completed by Geonor, while the smaller diameter sample membranes were calibrated at Rensselaer Polytechnic Institute explicitly for this investigation.*

The active strain monitoring wire and the remaining membrane reinforcement had the same physical properties. They consisted of constantan wire with a diameter of .15 mm, a Young's Modulus E of 1.55×10^6 kg/cm², and a tensile strength of 5,800 kg/cm². The wires were wound at 20 turns per centimeter of height. The rubber material was natural latex. The membranes were manufactured in two sizes, the standard 50 cm² size and the 1.875 in. (4.76 cm) diameter size. The recommended maximum lateral stress for these membranes is 1.4 kg/cm².

The membranes provided adequate lateral strength to maintain a constant cross-sectional area during consolidation and shear. The wire reinforcement was very slightly deformed as the lateral stress increased, producing only minor error (8). In addition, the membranes also allowed for vertical strains in the sample during consolidation and shearing.

*A more detailed discussion of membrane calibration is appended.

The resistance of the standard size reinforced rubber membranes to shear has been determined to be small (11).

Difficulties can be encountered in the use of these calibrated membranes. During this investigation, water came into contact with the active wire of one membrane resulting in a partial short circuit. Consequently, decreasing resistance and erroneous microstrain readings were obtained. It is essential that the rubber material (butyl latex or neoprene) used for these membranes form a watertight seal around the active wire. Additionally, two other tests were performed without the ability to monitor lateral strains, since total malfunction of the strain gauge capabilities of these membranes occurred.

Because temperature variations can result in resistance changes that can be mistaken for changes in lateral stress, a matching "dummy" membrane and the active membrane were connected in a bridge arrangement to compensate for temperature changes. The active and dummy membranes were placed as close to each other as possible (within one foot). Under these conditions, microstrain readings were not affected by small temperature changes.

D. Data Acquisition

To facilitate data acquisition, some modifications were made to the direct simple shear apparatus as supplied by Geonor.

The vertical load proving ring was replaced by a Schaevitz FTD-1U-200 load cell. This load cell had a capacity of 200 lb (90.5 kg) in tension or compression. The linearity and resolution were better than .2% and .1%, respectively.

A Hewlett Packard 7DCDT-050 Linear Variable Differential Transformer (LVDT) was used for measurement of horizontal displacements. The range of this LVDT was $\pm .050$ in. (1.27 mm). This range provided excellent resolution at small strains. The LVDT was connected in series with the original dial gauge by a special aluminum mounting block. Horizontal displacements could therefore, be measured by either the LVDT or by the dial gauge. Typically, the LVDT and the dial gauge were used together, providing a convenient crosscheck at all times.

Both the LVDT and the load cell had integral signal conditioning for DC operation; both were powered by separate constant DC voltage power supplies. The voltage outputs of the LVDT and the load cell, plus the square wave loading pattern were recorded on a Gould Brush 2400 four channel recorder. Microstrain readings from the calibrated reinforced rubber membranes were measured by a BLH 120C strain gauge indicator.

The data for each individual test was put into computer files. The data was processed and reduced at RPI's Interactive Computer Graphics Center. Appropriate plots were then produced and were used in developing the data graphs in this report.

E. Equipment Calibration

Proving Ring Load Cells

Proving ring load cells with ranges of 50, 100, 200, 400, and 800 kg were supplied and calibrated by Geonor. All were linear throughout their ranges.

Load Cell

The Schaevitz load cell used for measurement of vertical load was calibrated directly on the direct simple shear apparatus. While supporting the bottom of the sliding shear box, loads were applied to the load cell through the lever arm, and the corresponding voltages measured. The voltage output was linear throughout its range.

LVDT

The Hewlett Packard LVDT used for measurement of horizontal displacements was also calibrated on the direct simple shear apparatus. Voltage outputs were recorded for displacements measured by the dial gauge. The voltage output was linear for ± 3.0 mm displacement.

Friction

Friction in the vertical load unit and the horizontal load unit originated primarily in the ball bearing bushings. This friction was measured by the 50 kg proving ring load cell and by the Schaevitz load cell. It was found to be negligible.

False Deformation

Vertical deformations of the soil sample were measured between two reference points, the top half of the sliding shear box and the base. Because the parts of the direct simple shear apparatus between these two points deformed under the action of a vertical stress, it was important to distinguish this deformation from the deformation of the sample itself,

especially since constant volume tests were performed.

These false deformations were measured by inserting a steel dummy sample between the sample caps. Vertical loads were incrementally applied until consolidation loads were reached, and then unloaded while vertical deflections were measured and recorded.

It was assumed most of the vertical deformation was due to the seating and compression of the porous stones. Hence, the same porous stones were maintained in their same relative positions for each test.

Average deformation curves for loading and unloading were obtained for the consolidation history used for each sample size (50 cm² and 17.81 cm² cross-sectional sample sizes). An example is shown in Figure 8 for 50 cm² diameter samples normally consolidated to .510 kg/cm².

During constant volume testing, the equipment deformation curve was entered as the appropriate change in vertical normal stress was reached, and the normal load was then further compensated to adjust the sample height for the expected equipment deformations. Thus, sample volume remained constant.

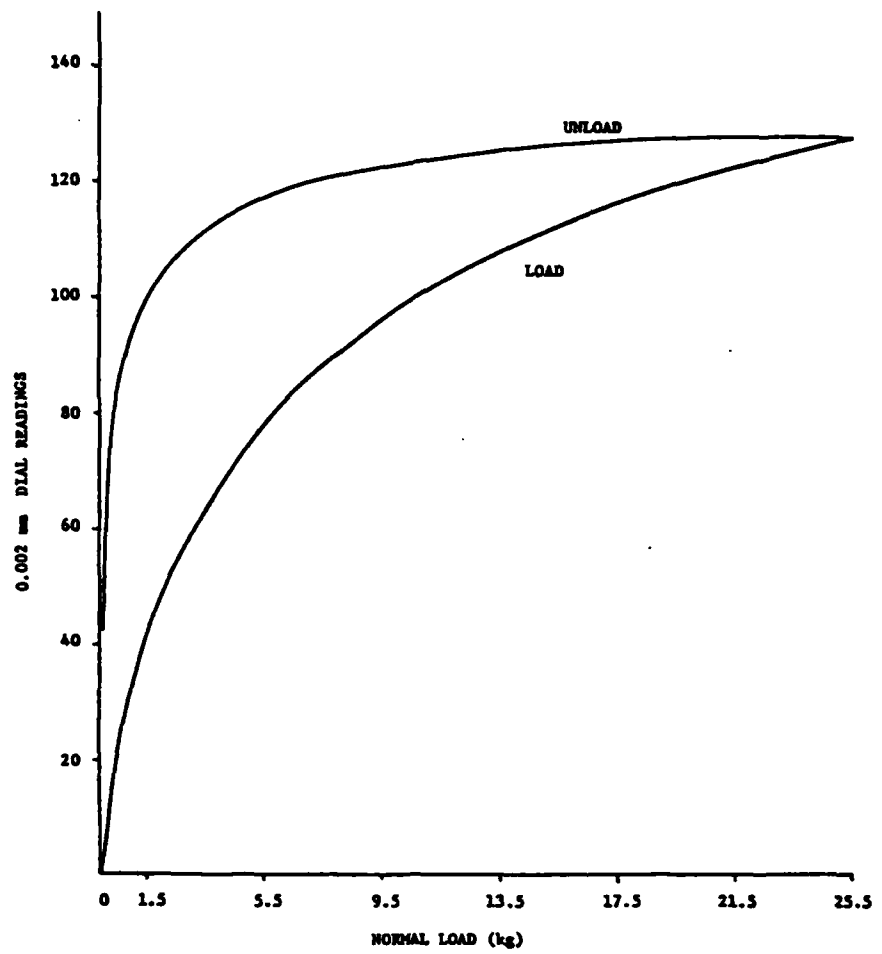

FIGURE 8. EXAMPLE OF EQUIPMENT DEFORMATION CURVES FOR THE 50 cm² SAMPLE SIZE WITH CONSOLIDATION TO .510 kg/cm².

PART 3
TESTING SPECIFICS

A. SOIL

The soils tested in this investigation were stored in an environmentally controlled room. The room was maintained at 3° C and 97 to 99 percent humidity to simulate in situ conditions and preserve the sample undisturbed. The two clays used were core samples from the Gulf of Alaska and Gulf of Mexico.

Because of the sensitivity of marine clays, special care was taken to control sample disturbance. As discussed by Berre, et al (3), core sample size is an important parameter in obtaining consistent testing results. A 95 mm core sample was recommended. The core sample size for both soils used in this investigation was four inches, approximately equivalent. Although studying variations in consolidation test results, the data of Berre, et al (3) also suggested the smaller the specimen size in testing the greater the variation of results. This aspect will be considered later as it applies to the results of this study.

Gulf of Alaska Clay

The clay samples used in this study were obtained from the Copper River prodelta area in the Gulf of Alaska (5,9,24), and provided by the United States Geological Survey. Development of pore pressures leading to liquefaction has been a major cause of instability of these submarine slopes. Complicated by the intense seismic activity in this

area and the common occurrence of storms with large waves (6), the determination of the behavior of these submarine soils under cyclic loading became important.

Table 1 portrays the geotechnical data for this soil.

Gulf of Mexico Clay

The core sample of Gulf of Mexico Clay was taken at a location approximately 175 miles southeast of Houston, Texas and approximately 225 miles due east of Corpus Christi, Texas by the U.S. Geological Survey, Corpus Christi office. The ocean depth at this point was approximately 1000 feet. The top five feet of the core sample, minus the top seven inches of surface crust, was received from the U.S.G.S. The first specimen used for this investigation was approximately seven inches down from the top of the sample core received or about 14 inches below the ocean floor. The last specimen tested from this core was an additional 20 inches deeper.

Table 2 includes the geotechnical data for this soil.

Soil Preparation*

Specimens were sliced from the sample cores stored in the environmental room described previously, and moved to a second environmentally controlled room. This second room was maintained at 20° C and approximately 92 percent humidity. While sample drying was still prevented in this room, the temperature was more conducive for personnel during the trimming operations.

*Sample preparations are discussed in greater detail in Appendix B.

GULF OF ALASKA SAMPLES

SITE: COPPER RIVER PRODELTA
 TYPE: 4" DIAMETER UNDISTURBED CORES

GEOTECHNICAL DATA

WATER CONTENT	57 - 65 %
LIQUID LIMIT	48 %
PLASTIC LIMIT	25 %
SPECIFIC GRAVITY	2.84
* ϕ	24°
SENSITIVITY (FALL CONE)	4.0
CONSOLIDATION HISTORY	UNDERCONSOLIDATED
% SAND	1
% SILT	34
% CLAY	65
* SEDIMENTATION RATE	10-15 m/1000 years

* Data obtained from Hampton, et al (9).

TABLE 1. GEOTECHNICAL DATA FOR THE GULF OF ALASKA CLAY

GULF OF MEXICO SAMPLES

SITE: 225 MILES EAST OF CORPUS CHRISTI, TEXAS

TYPE: 4" DIAMETER UNDISTURBED CORES

GEOTECHNICAL DATA

WATER CONTENT	100 - 120 %
LIQUID LIMIT	105 %
PLASTIC LIMIT	30 %
SPECIFIC GRAVITY	2.71
SENSITIVITY (FALL CONE)	2.50
CONSOLIDATION HISTORY	NORMALLY CONSOLIDATED
% SAND	2
% SILT	28
% CLAY	70

TABLE 2. GEOTECHNICAL DATA FOR THE GULF OF MEXICO CLAY

The trimming apparatus, as supplied by Geonor, was designed for undisturbed preparation of samples to be used in the NGI direct simple shear device. The procedures prescribed by Geonor (8) for trimming were followed in general. However, some improvements to these procedures for the soils tested were employed.* The average trimming time was approximately 75 minutes.

From the leftover trimmings, four water content samples were taken, and undrained shear strength was measured by using the Swedish fall cone method. The shear strengths were too low for the use of either pocket penetrometers or torvane devices. Although sensitivity values were supplied by the U.S.G.S. with the core samples, further tests during this investigation confirmed the U.S.G.S. values.

Initial vertical sample heights, although difficult to obtain with a great deal of precision, were previously selected and purposely produced. Geonor recommends an initial height of 15 mm for both the standard 50 cm² sample size and the smaller 1.875 in. diameter size. To determine the sensitivity of cyclic test results to variations from this recommended height, three sample heights were selected for study; one at the recommended height, one 10 mm, and one 25 mm. Trimming limitations prevented the production of samples shorter than approximately 10 mm, thus 10 mm was used as the lower height limit. The actual heights obtained were not always 10 mm, 15 mm, or 25 mm, but varied due to accuracy limitations in the trimming process. Nevertheless, the actual heights were close to the desired values. Static tests were performed with a height at or near the recommended height (15 mm).

*Sample preparations are discussed in greater detail in Appendix B.

B. Test Procedures

After sample trimming was completed, the sample was carefully moved from the environmentally controlled room to the NGI direct simple shear apparatus for consolidation and shearing. The sample was now sealed in its membrane, thus sample drying was not a problem. Drainage hoses leading to water supplies were connected to the upper and lower caps of the sample. A sea water solution (obtained from a local aquarium supply store) was used as the water supply. The water was circulated through the caps and the enclosed porous stones to flush out any air which may have been trapped during the trimming process.

The sample was next clamped to the direct simple shear device. The sliding shear box was brought into contact with the top of the sample, and the normal load lever arm was leveled. A small weight (10 grams) was placed at the end of the lever arm to ensure contact between the sample and the shear box. The initial vertical dial reading was recorded. The calibrated membrane was connected to a strain gauge indicator, and after one hour (to allow for temperature stabilization and equipment warm up) an initial reading on the strain gauge indicator was taken. Consolidation was begun.

Consolidation loads were applied in increments similar to the standard laboratory consolidation test. The time between each load increment was approximately twice the time for 100 percent primary consolidation. The

final consolidation load was applied for a minimum of 24 hours. The sample was then ready for shearing.

All shear tests were run as constant volume tests. Changes in vertical stress in the sample necessary to maintain a constant height was equated to the change in excess pore pressures which would have occurred in an undrained test (16).

Static tests were performed at a sufficiently slow rate to minimize strain rate effects. Typically, static tests were performed in seven hours. Stress controlled cyclic tests were performed at a frequency of 0.1 Hz with a square wave loading application. This frequency was selected primarily to simulate storm wave loading applications. Fluctuations in pore pressure per cycle were not measured but were monitored by observing changes in height and lateral strains. The change in pore pressure per cycle was not excessive. Permanent pore pressure build up was measured as the change in vertical normal stress necessary to maintain a constant height. Because cyclic loading causes slight fluctuations in the vertical height dial readings, the mean height was used for measurements.

Lateral strains, changes in vertical normal stress, horizontal shear stress, and cycles (or time, as applicable) were monitored. The vertical stress was adjusted to maintain a constant sample height, including corrections for false deformations as discussed previously.

PART 4

TEST RESULTS AND ANALYSIS

A. Introduction

Testing was designed to study the effects of sample size on the results obtained for cyclic loading of clays using the NGI direct simple shear device. A schedule was followed such that three categories were tested. The categories allowed for the comparison of two different clays, two sample cross-sectional sizes, and three variations in sample height. Specifically, the first category tested was three standard size (50 cm^2) Gulf of Alaska clay samples, the second tested was three standard size Gulf of Mexico clay samples, and last four small size (17.81 cm^2 cross-sectional) Gulf of Mexico samples were tested. Each category was composed of three separate cyclic tests for the selected initial sample heights of 10 mm, 15 mm, and 25 mm.

Static tests were performed for each category, at the recommended height (15 mm), prior to cyclic testing. Although the static test data for the three categories were analyzed and compared, the major purpose of the static tests were to establish a static strength as a base to determine the cyclic stresses to be used. All cyclic tests were run at 50 percent of the tested static shear strength for each category. Fifty percent was chosen after analyzing data on the Gulf of Alaska clay from a previous investigation. At this level the Gulf of Alaska clay reached test terminating strains (about 20 percent) after approximately 150 cycles (24).

A total of 13 tests are included in the succeeding presentation and are cataloged in Table 3. Of these, three are static tests -- one Gulf of Alaska standard sample size, and two Gulf of Mexico -- one standard sample size, and one 17.81 cm² cross-sectional sample; and ten are cyclic -- three Gulf of Alaska standard sample size at the selected various heights, and seven Gulf of Mexico -- three standard sample size and four small sample size, similarly at the selected various heights. The following discussion of the results will progress in the order: 1) static test, comparing sample cross-sectional size and soils; 2) cyclic test, comparing sample cross-sectional size; and 3) cyclic test, comparing the various heights. Additional data from these tests, not included in the body of this text, is appended.

After consolidation, K_o values were calculated for all samples using lateral strain measurements. This was accomplished for each consolidation loading interval and the K_o from the last interval used for the purposes of this investigation. Values obtained are contained in Table 1. The equations used were:

$$\Delta\sigma_h = \frac{(\Delta\epsilon_m)k}{1 - \epsilon_a}$$

and,

$$K_o = \frac{\Delta\sigma_h}{\Delta\sigma_v}$$

where: $\Delta\epsilon_m$ is the change in microstrain reading for the loading interval, k is the calibration factor for the membrane strain gauge, ϵ_a is the vertical strain of the specimen, $\Delta\sigma_v$ is the change in normal vertical stress, and $\Delta\sigma_h$ is the calculated change in normal horizontal stress.

1	2	BUILDING IN					CONSOLIDATION								14
		3	4	5	6	7	8	9	10	11	12	13			
Test No.	A ² cm ²	w %	e	H _i cm	S _u kg/cm ²	S _t	σ_{vo} kg/cm ²	τ_{ho} kg/cm ²	σ_{vm} kg/cm ²	OCR	H _f cm	v %	K _o		
GOA02S	50	58.0	1.65	1.64	.039	-	.510	0.0	.510	1.0	1.48	9.7	.492		
MEX01S	50	111.3	3.03	1.46	.053	-	.510	0.0	.510	1.0	1.20	17.6	.446		
MEX06S	17.8	123.7	3.37	1.71	.055	2.73	.510	0.0	.510	1.0	1.43	16.3	.490		
GOA06C	50	64.8	1.84	1.64	.024	-	.510	0.0	.510	1.0	1.40	14.8	.490		
GOA11C	50	64.9	1.84	2.10	.027	3.50	.510	0.0	.510	1.0	1.82	13.2	.490		
GOA12C	50	64.8	1.84	1.02	.034	-	.510	0.0	.510	1.0	0.86	15.1	.490		
MEX02C	50	117.9	3.21	1.72	.055	-	.510	0.0	.510	1.0	1.41	18.0	.446		
MEX09C	50	129.7	3.53	2.00	.038	-	.510	0.0	.510	1.0	1.62	19.0	.439		
MEX04C	50	126.8	3.44	1.09	.047	-	.510	0.0	.510	1.0	0.85	21.5	.453		
MEX05C	17.8	124.5	3.39	1.70	.053	2.42	.510	0.0	.510	1.0	1.42	16.8	.554		
MEX07C	17.8	122.1	3.32	1.84	.048	-	.510	0.0	.510	1.0	1.50	18.4	.592		
MEX08C	17.8	126.7	3.45	1.09	.025	-	.510	0.0	.510	1.0	0.89	18.6	.487		
MEX09C	17.8	132.9	3.62	2.40	.026	-	.510	0.0	.510	1.0	1.89	21.1	.608		

TABLE 3. SUMMARY OF TESTS - GULF OF ALASKA AND GULF OF MEXICO CLAYS

COLUMN	EXPLANATION
1.	Test Number
2.	Sample Cross-Sectional Area: 50cm^2 = standard size 17.8cm^2 = small size
3.	Water Content of Trimmings
4.	Void Ratio of Trimmings
5.	Sample Height
6.	Undrained Shear Strength (Swedish Fall Cone)
7.	Sensitivity (Swedish Fall Cone)
8.	Vertical Consolidation Stress
9.	Static Shear Stress (Horizontal Applied)
10.	Maximum Consolidation Stress
11.	Overconsolidation Ratio
12.	Sample Height Following Consolidation
13.	Vertical Strain
14.	K_o - Calculated From Consolidation Strains
15.	Cyclic Shear Stress (Horizontal Applied)
16.	Cyclic Shear Stress as a Percent of Static Strength
17.	Number of Cycles Tested
18.	Shear Strain at N Cycles
19.	Pore Pressure at N Cycles
20.	Frequency of Loading
21.	Static Undrained Shear Strength (Peak of Stress-Strain Curve)
22.	Shear Strain at Peak of Stress-Strain Curve
23.	Pore Pressure at Peak of Stress-Strain Curve
24.	Strain Rate
25.	Water Content of Sample (After Test)
26.	Void Ratio of Sample (After Test)

TABLE 3. (CONTINUED)

A relationship between K_o and size is apparent in Table 3. The calculated K_o values for the Gulf of Mexico samples tended to be directly proportional to sample height. Additionally, the 17.81 cm² cross-sectional samples tended to have higher K_o values than the larger 50 cm² samples. Other investigations of stress conditions occurring in simple shear test samples indicated neither horizontal normal stresses nor vertical normal stresses acting on the samples were distributed uniformly (10,21). The nonuniformity was found to depend on sample size (height and diameter), the amount of vertical displacement, and the percent of membrane wire reinforcement (21). This nonuniformity of stress could cause disproportionate lateral strains in different size (height or diameter) samples. Another possibility could be small eccentricities in vertical loading caused by less than absolutely vertical samples resulting in greater moment effects on the smaller diameter and taller samples.

Nonetheless, all calculated K_o values for the Gulf of Mexico samples were quite close, ranging from 0.44 to 0.60, with a mean of 0.50. Only two Gulf of Alaska samples possessed the correct recorded data to facilitate the calculation of K_o , therefore, the average K_o value obtained by Zimmie and Floess (24) in tests on the same soil were used in this study.

B. Static Test Comparisons

The stress strain curves for the three static tests are shown in Figure 9. The shear stress was normalized by dividing by the consolidation stress σ_{vo} . These curves are consistent with existing literature

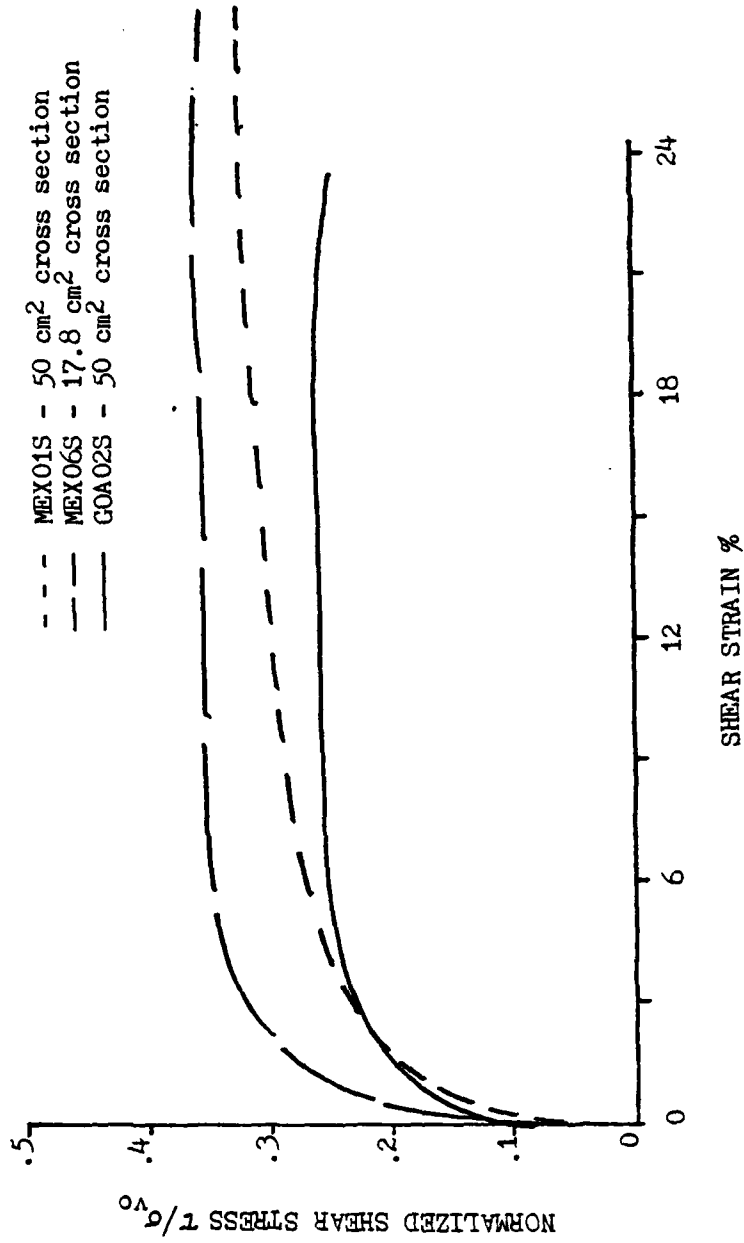

FIGURE 9 . STRESS-STRAIN CURVES COMPARED FOR STATIC TESTS PERFORMED ON GULF OF ALASKA CLAY AND GULF OF MEXICO CLAY FOR BOTH STANDARD AND SMALL DIAMETER SAMPLES

(12,15,24). The smaller Gulf of Mexico sample required more stress per strain or, in other words, was stronger than the larger Gulf of Mexico sample.

Figure 10 is a plot of normalized pore pressure against percent of shear strain. This plot did not act in exactly the opposite manner from the stress-strain curve, as might be expected from effective stress principles. The pore pressure was higher in the small size Gulf of Mexico sample than in the large, although the small sample had a higher shear strength in Figure 9. Differences between the two sample sizes were small in both figures (Figures 9 and 10). The pore pressure differences between the Gulf of Alaska clay and Gulf of Mexico clay were predictable from effective stress theory after having observed Figure 9.

The normalized shear modulus versus shear strain curves are presented in Figure 11. The difference between the three are relatively small but the small size Gulf of Mexico sample was slightly higher than the other two, and the Gulf of Alaska sample was slightly lower. Shen et al (21), indicated shear modulus results from the NGI device tend to be lower than the soils real modulus.

The stress paths for a $\tau - \sigma$ plot for the three tests are shown in Figure 12. The failure line, K_f , for 20 percent* strain and 3 percent strain were nearly identical for the small Gulf of Mexico sample and the standard Gulf of Alaska sample. From the slope of this line an angle of internal friction, ϕ , for the two samples was calculated to be 30°

*The K_f line at 20 percent strain was calculated and shown because shearing forces started to drop off near this strain and the test was shortly terminated. The three percent strain was thought to be a more practical strain value for working failure.

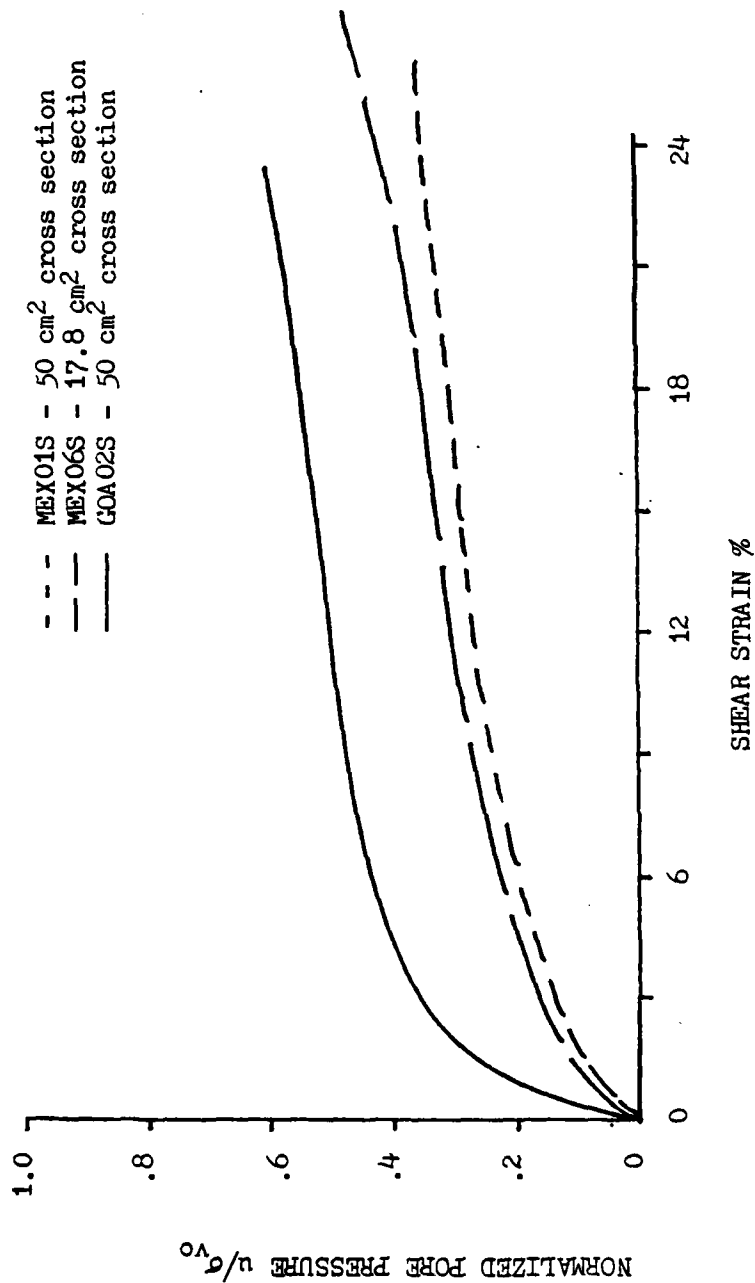

FIGURE 10. PORE PRESSURE - STRAIN CURVES COMPARED FOR STATIC TESTS PERFORMED ON GULF OF ALASKA CLAY AND GULF OF MEXICO CLAY FOR BOTH STANDARD AND SMALL DIAMETER SAMPLES

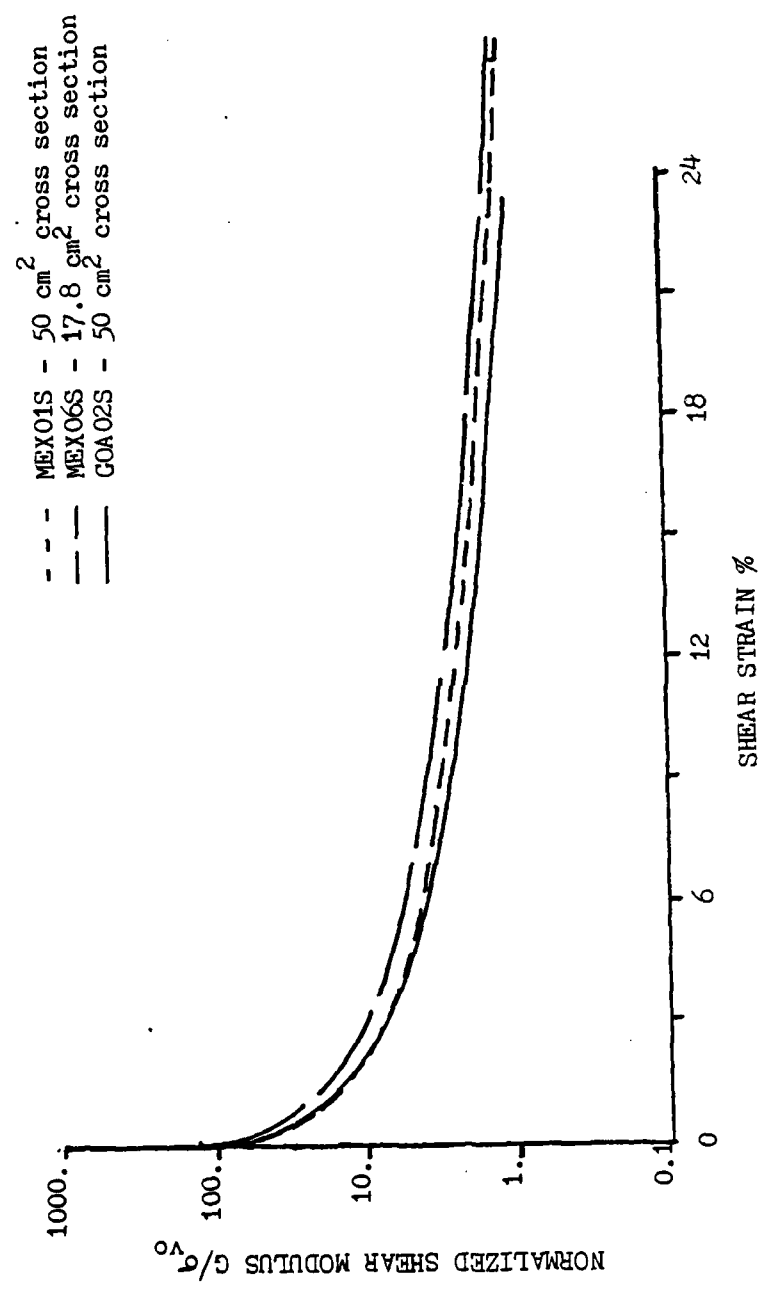

FIGURE 11. NORMALIZED SHEAR MODULUS DATA COMPARED FOR STATIC TESTS PERFORMED ON GULF OF ALASKA CLAY AND GULF OF MEXICO CLAY FOR BOTH STANDARD AND SMALL DIAMETER SAMPLES

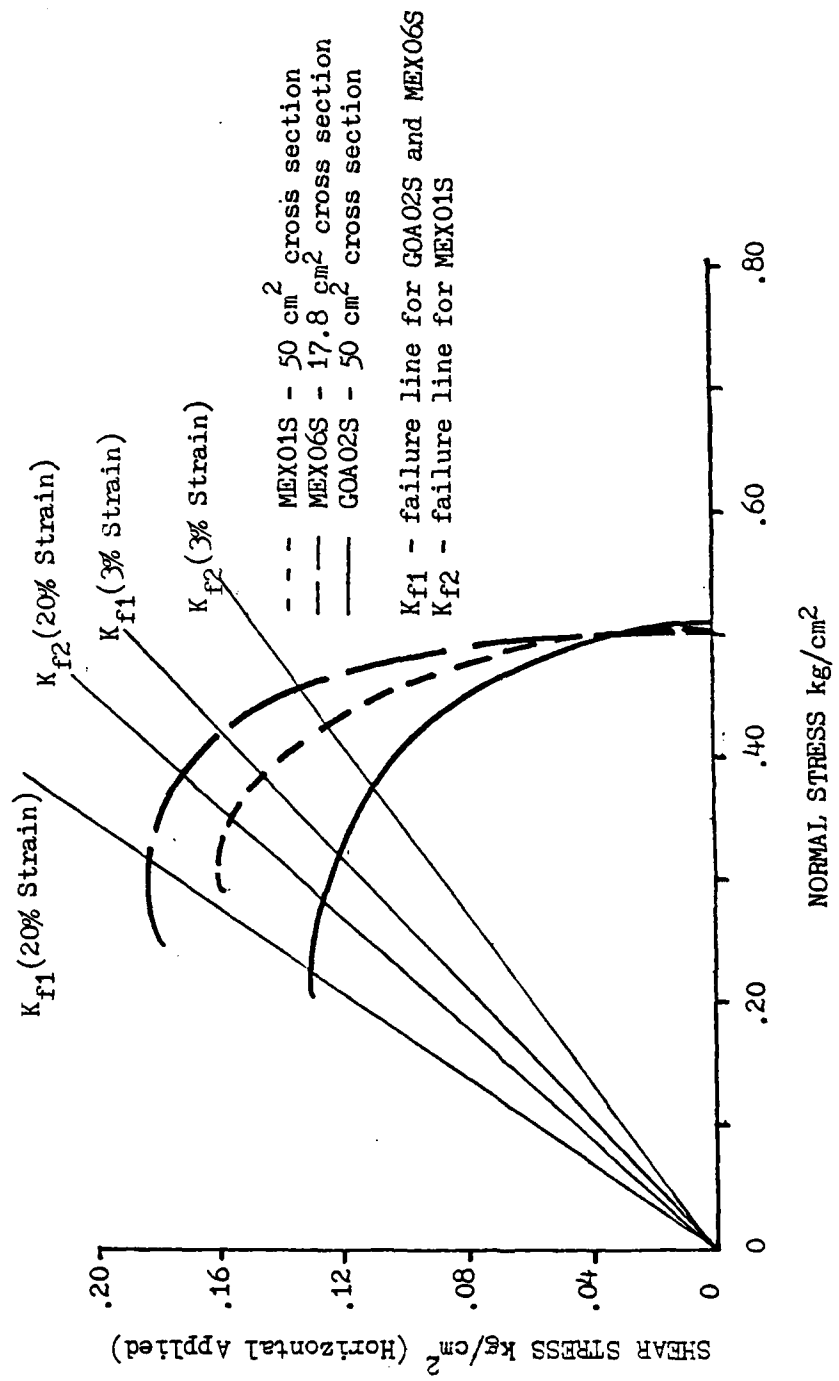

FIGURE 12. "STRESS PATHS" COMPARED FOR STATIC TESTS PERFORMED ON GULF OF ALASKA CLAY AND GULF OF MEXICO CLAY FOR BOTH STANDARD AND SMALL DIAMETER SAMPLES

for 20 percent strain and 20° for 3 percent strain. The standard size Gulf of Mexico sample was calculated to have a 26° friction angle for 20 percent strain and 17° for 3 percent strain.

The $p - q$ stress plots in Figure 13, for the two Gulf of Mexico samples are quite similar, and the plot for the Gulf of Alaska sample is lower. Connecting the $p - q$ points associated with 20 percent and 3 percent strain resulted in K_f lines for the respective strains. Calculating ϕ angles for these lines resulted in considerably higher values than obtained from the results shown in Figure 12 where it was assumed that the horizontal plane is the theoretical plane of failure. The ϕ values obtained from the $p - q$ plots were all quite close, the average being 40° for 20 percent strain and 30° for three percent strain. These results are consistent with values obtained by Zimmie and Floess (24).

The ratios of horizontal normal stress to vertical normal stress are exhibited in Figure 14. The ratio, beginning at the initial lateral stress ratio, K_o , increases throughout the test. The plots increased in an opposite manner to the stress-strain plots and similar to the pore pressure-strain plots. While the ratio remained below 0.6 for the standard size Gulf of Mexico sample and below 1.0 for the other Gulf of Mexico sample, it increased rapidly and exceeded 1.0 for the Gulf of Alaska sample. The values for normal horizontal stress were obtained from lateral strain measurements.

The ratio σ_3/σ_1^* also starting at K_o , decreased throughout the tests

*Values for σ_1 and σ_3 are based on the assumptions and equations presented in section B, "Stress Conditions", Part 1 of this report, and by Zimmie and Floess (24).

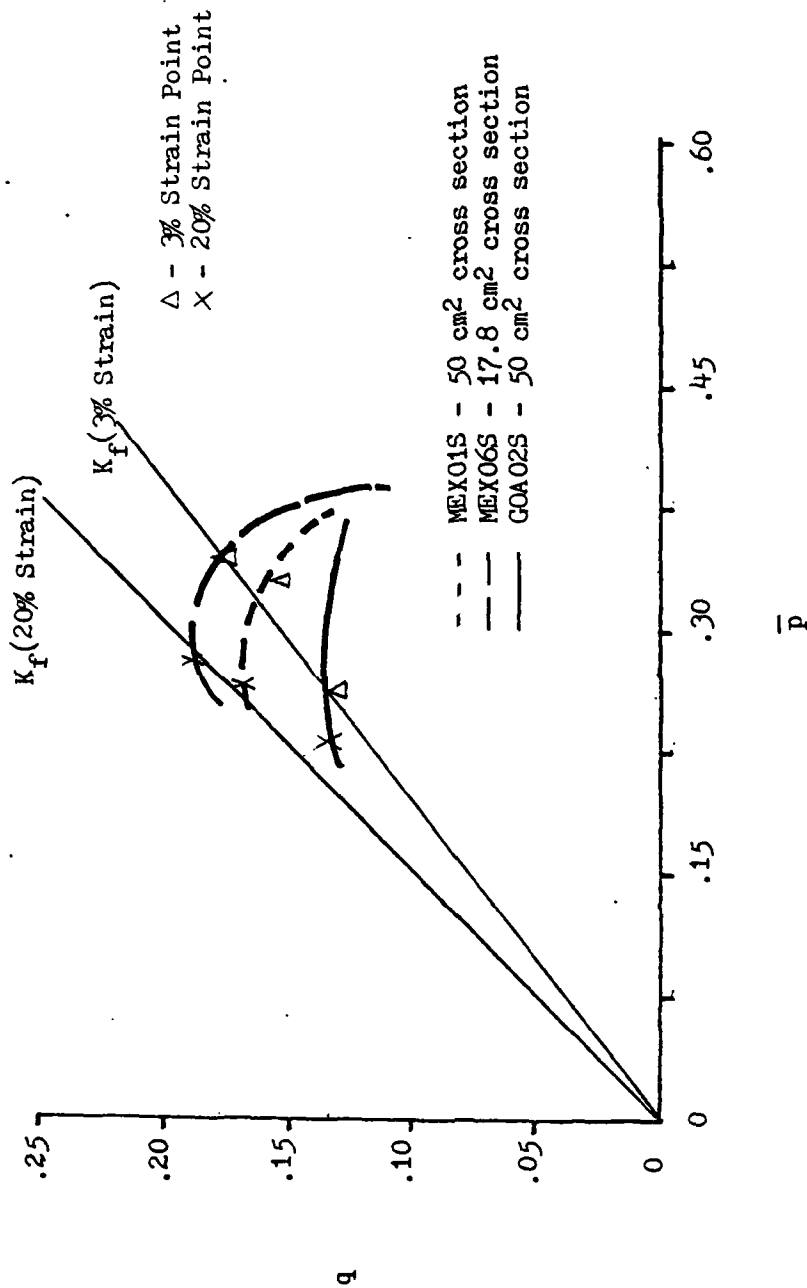

FIGURE 13. \bar{p} - q STRESS PLOTS COMPARED FOR STATIC TESTS PERFORMED ON GULF OF ALASKA CLAY AND GULF OF MEXICO CLAY FOR BOTH STANDARD AND SMALL DIAMETER SAMPLES

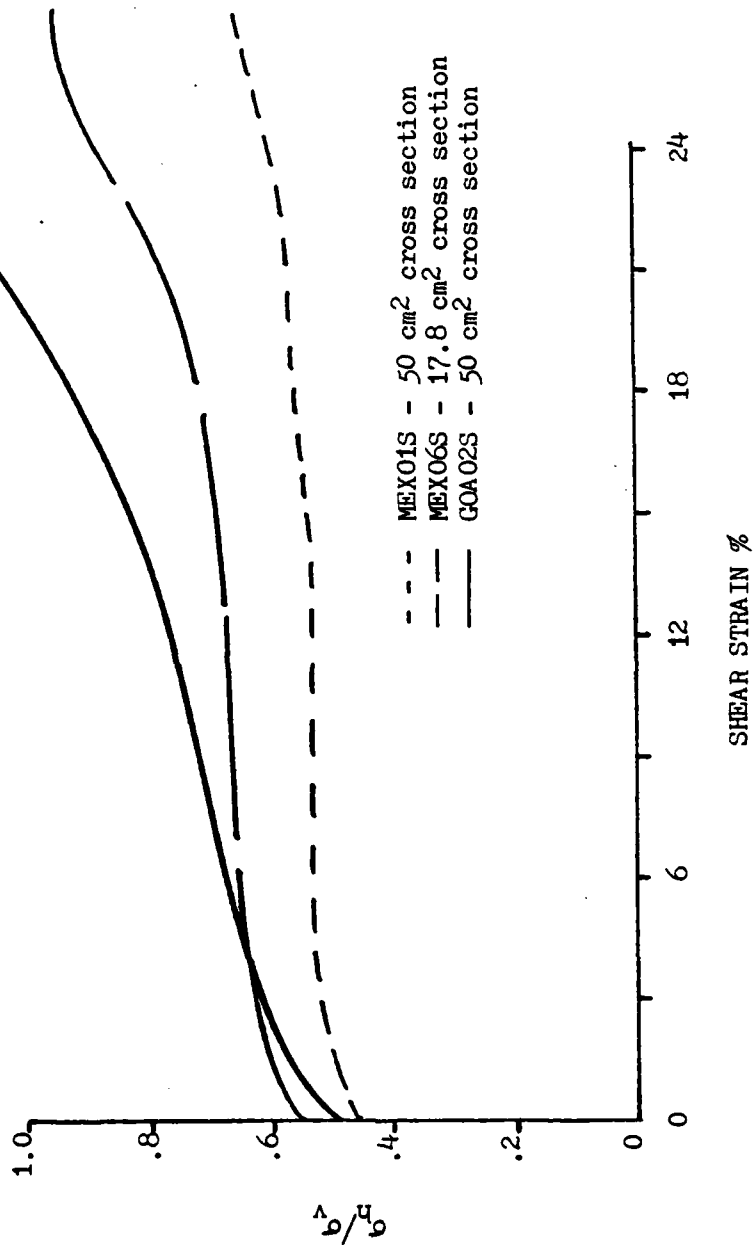

FIGURE 14. THE RATIO OF HORIZONTAL NORMAL STRESS TO VERTICAL NORMAL STRESS VS. SHEAR STRAIN COMPARED FOR STATIC TESTS PERFORMED ON GULF OF ALASKA CLAY AND GULF OF MEXICO CLAY FOR BOTH STANDARD AND SMALL DIAMETER SAMPLES

but the three plots are very similar, as shown in Figure 15.

It appears that if the initial K_0 values (discussed in section A of Part 4) for the Gulf of Mexico samples were equal, as would be expected, little difference would have existed between their plots in the $p - q$, σ_h/σ_v , and σ_3/σ_1 graphs. This would indicate the static results for the two sample sizes are compatible.

C. Sample Cross Section Size Comparison for Cyclic Tests

Cyclic tests were carried out at a frequency of 0.1 Hz, using 50 percent of the static shear strength for the cyclic shearing stress. The plots shown in this section utilize an average of the test results from various sample heights tested for each of the sample size groups.

Cyclic shear strain versus the number of loading cycles is plotted on Figure 16.* Shear strains given are one-half the peak-to-peak shear strain. The Gulf of Mexico samples were far more resistant to cyclic loading than the Gulf of Alaska samples. This appears reasonable, considering the lower static shear strength of the Gulf of Alaska soil, plus its higher sensitivity. A difference between the two Gulf of Mexico sample sizes was observed. The smaller cross-sectional sample size yielded less per cycle than the larger. This was consistent in the seven Gulf of Mexico samples tested (three standard size samples and four smaller size samples) shown in later graphs. A possibility that could account for part of this apparent strength difference is differences in resistance to shear of the two reinforced membrane sizes. The smaller membrane may offer more resistance than the larger membranes.

*After the first few cycles, shear strains were about 1/2%. Therefore, it falsely appears that Fig. 16, 22, 23, 24 do not pass through zero percent strain.

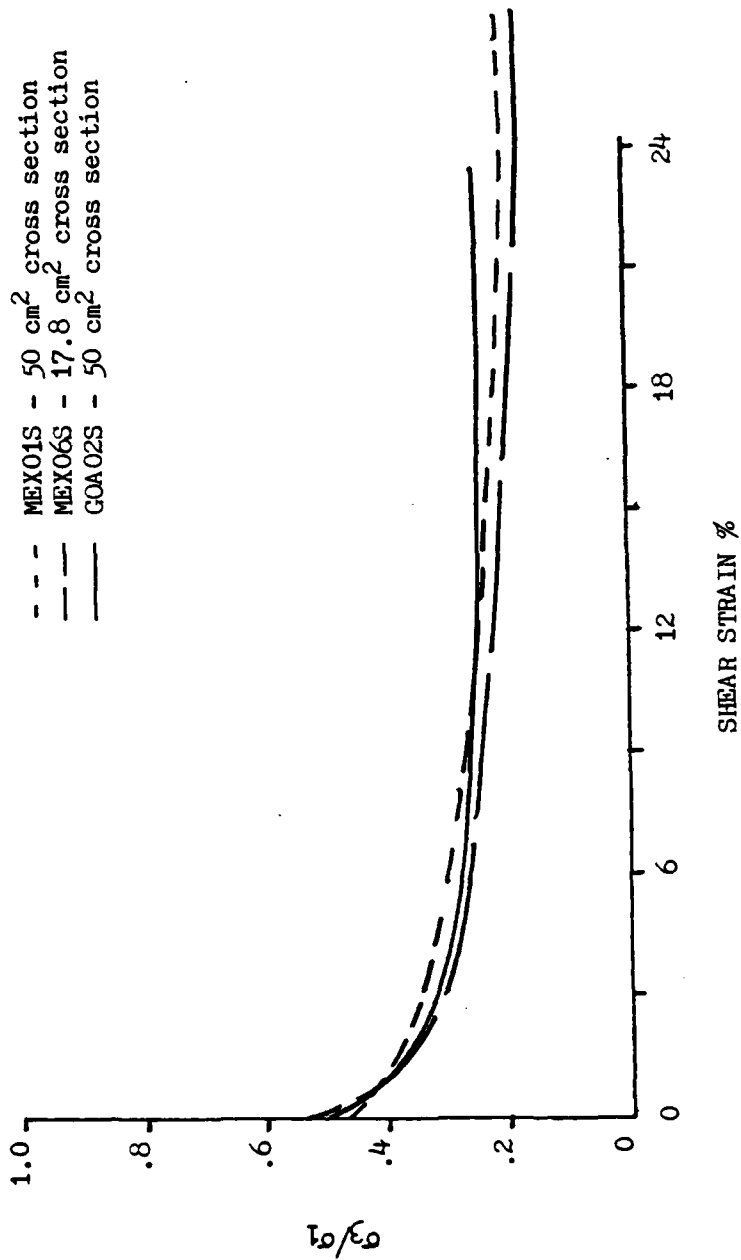

FIGURE 15. THE RATIO σ_3/σ_1 VS. SHEAR STRAIN COMPARED FOR STATIC TESTS PERFORMED ON GULF OF ALASKA CLAY AND GULF OF MEXICO CLAY FOR BOTH STANDARD AND SMALL DIAMETER SAMPLES

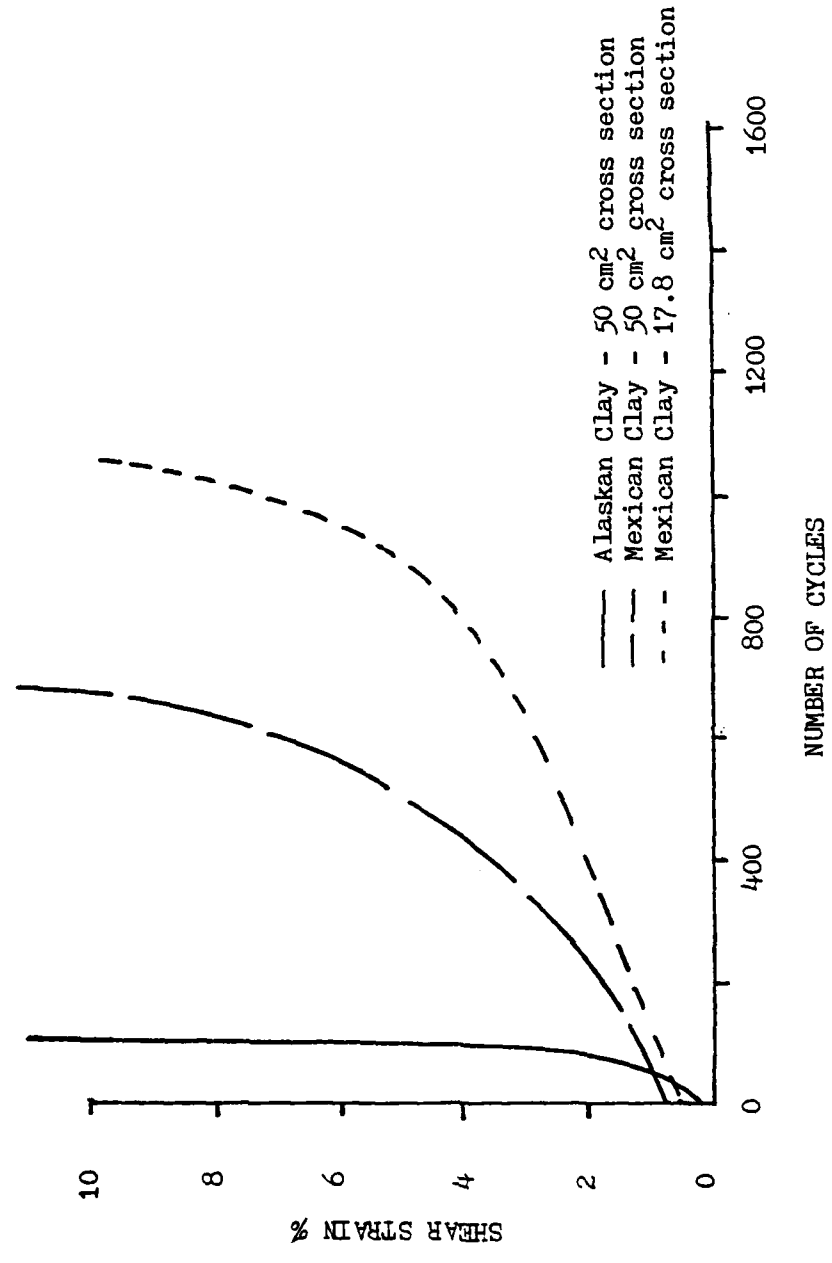

FIGURE 16. AVERAGE SHEAR STRAIN VS. NUMBER OF CYCLES COMPARED FOR CYCLIC TESTS PERFORMED ON GULF OF ALASKA CLAY AND GULF OF MEXICO CLAY FOR BOTH STANDARD AND SMALL DIAMETER SAMPLES

Pore pressure versus number of cycles, illustrated in Figure 17, is consistent with the above in respect to the comparison of Gulf of Alaska soil to Gulf of Mexico soil. However, the Gulf of Mexico standard cross-sectional sample size would have been expected to exhibit greater pore pressures per cycle, relative to the smaller size sample, accounting for its more rapid loss of strength.

The shear modulus (Figure 18) for both Gulf of Mexico sample sizes are nearly identical. The Gulf of Alaska soil exhibited a higher initial shear modulus which decreased more rapidly with the number of cycles than did the Gulf of Mexico clay.

The $p - q$ diagrams in Figure 19 have the same basic shapes. The smaller size Gulf of Mexico sample fell below the others and barely crossed the three percent strain K_f line from the static test. This is contrary to results obtained by Zimmie and Floess (24), who found the three percent cyclic shear strains to fall near or on the three percent static K_f line.

The ratio of σ_h/σ_v (Figure 20) is similar for the two standard samples but the shape of the curve is almost the mirror image of the small sample which reached 1.0 by test termination. Until failure became imminent, all three curves maintained nearly K_0 conditions. Near failure, the ratio of σ_h/σ_v increased for the small sample, while the ratio decreased for the two standard size samples.

The plot of the ratio σ_3/σ_1 is contained in Figure 21. The small sample exhibited a ratio higher than the two standard size samples. The three curves are similar in shape with the ratio staying relatively

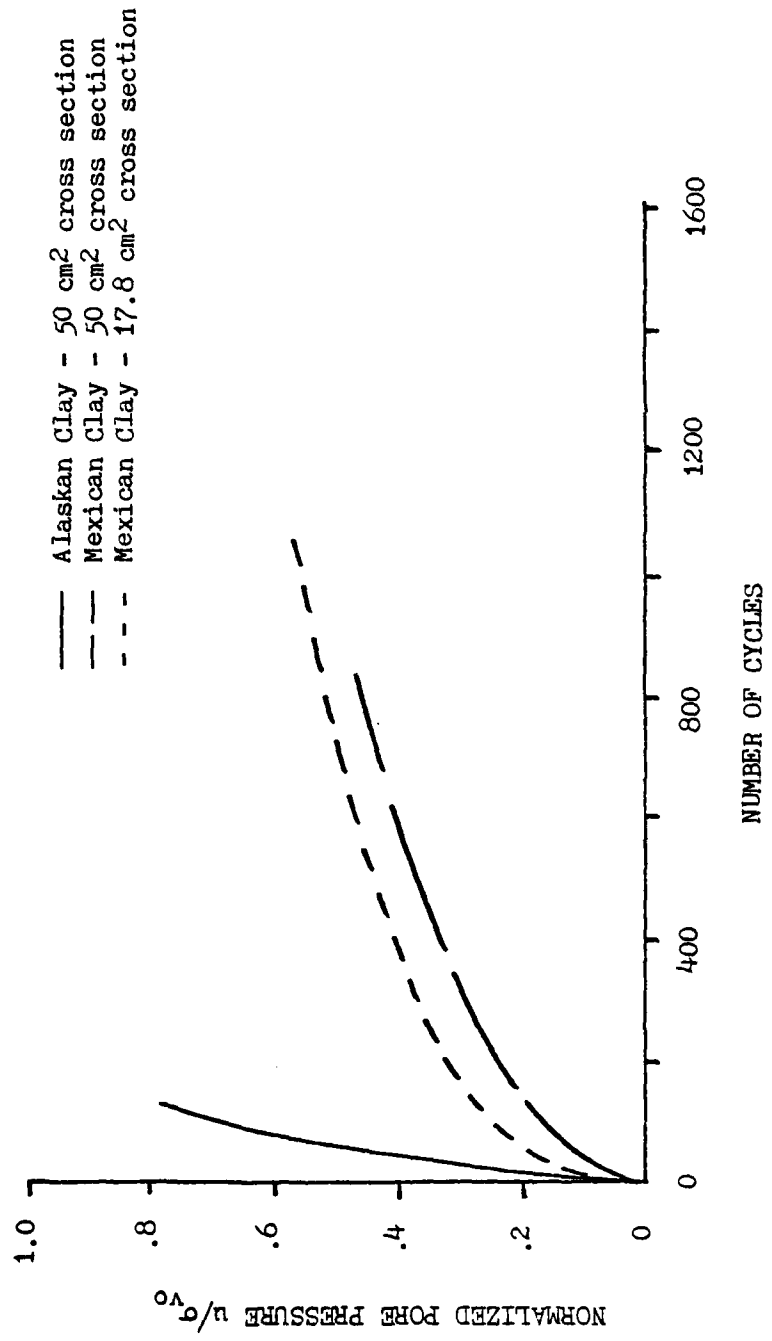

FIGURE 17. AVERAGE PORE PRESSURE VS. NUMBER OF CYCLES COMPARED FOR CYCLIC TESTS PERFORMED ON GULF OF ALASKA CLAY AND GULF OF MEXICO CLAY FOR BOTH STANDARD AND SMALL DIAMETER SAMPLES

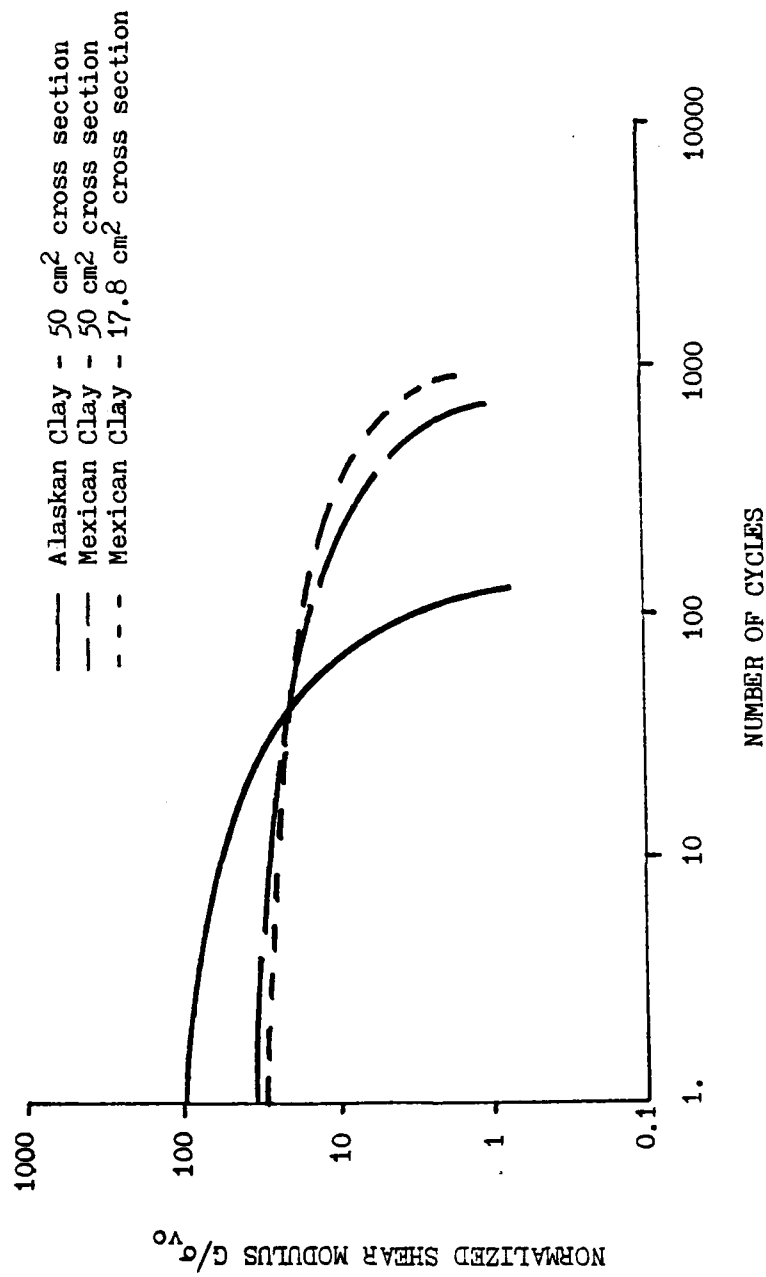

FIGURE 18. AVERAGE SHEAR MODULUS VS. NUMBER OF CYCLES COMPARED FOR CYCLIC TESTS PERFORMED ON GULF OF ALASKA CLAY AND GULF OF MEXICO CLAY FOR BOTH STANDARD AND SMALL DIAMETER SAMPLES

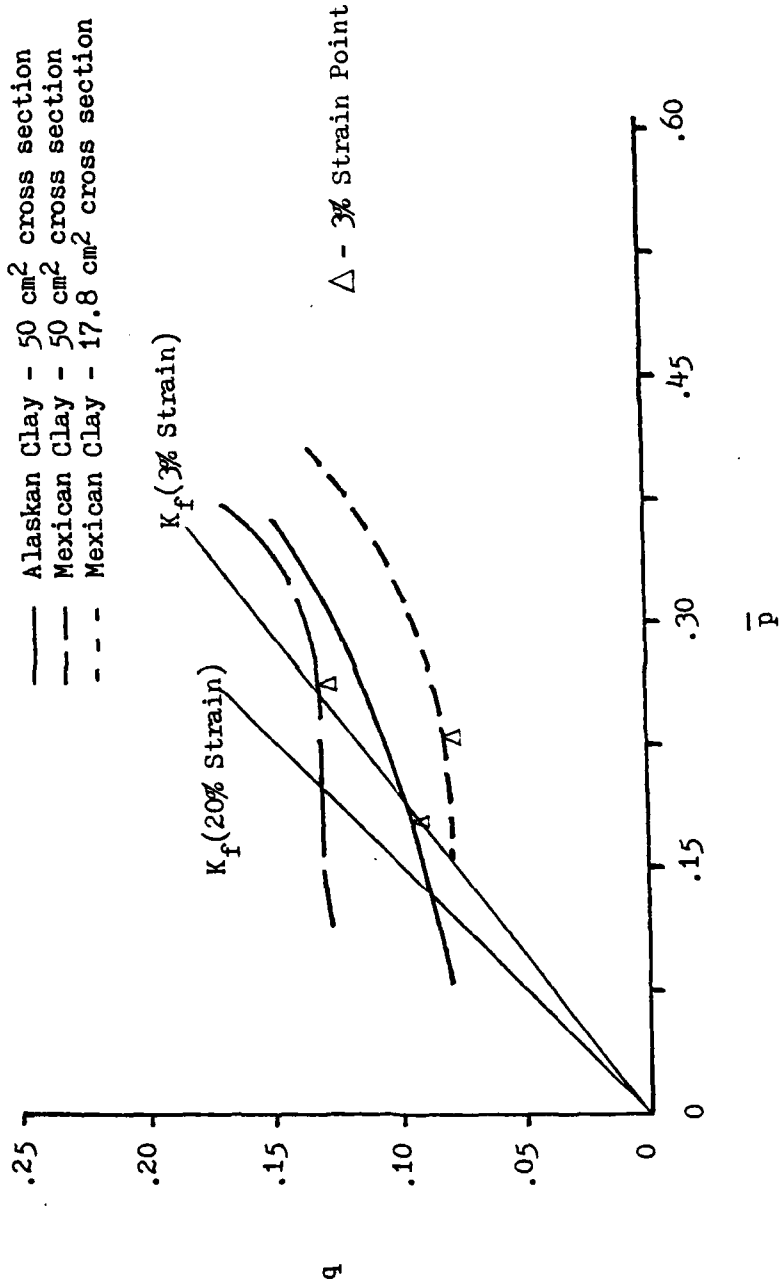

FIGURE 19. AVERAGE STRESS PLOT COMPARED FOR CYCLIC TESTS PERFORMED ON GULF OF ALASKA CLAY AND GULF OF MEXICO CLAY FOR BOTH STANDARD AND SMALL DIAMETER SAMPLES

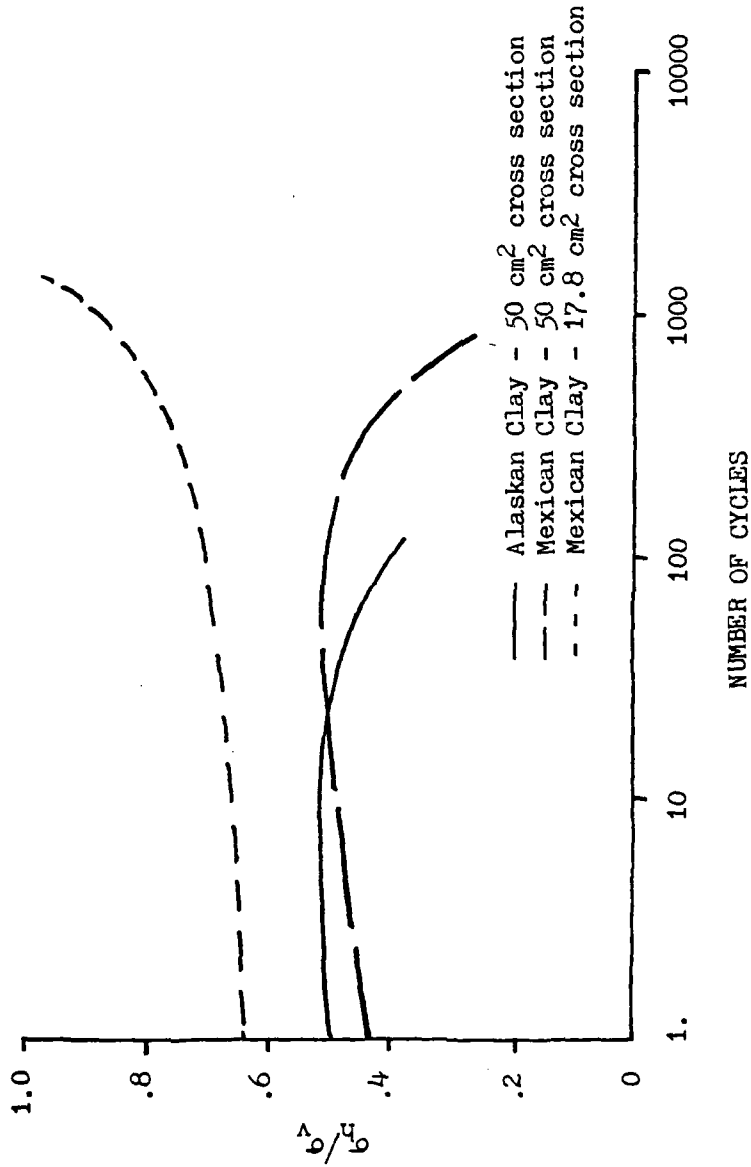

FIGURE 20. THE AVERAGE RATIO OF HORIZONTAL NORMAL STRESS TO VERTICAL NORMAL STRESS VS. NUMBER OF CYCLES COMPARED FOR CYCLIC TESTS PERFORMED ON GULF OF ALASKA CLAY AND GULF OF MEXICO CLAY FOR BOTH STANDARD AND SMALL DIAMETER SAMPLES

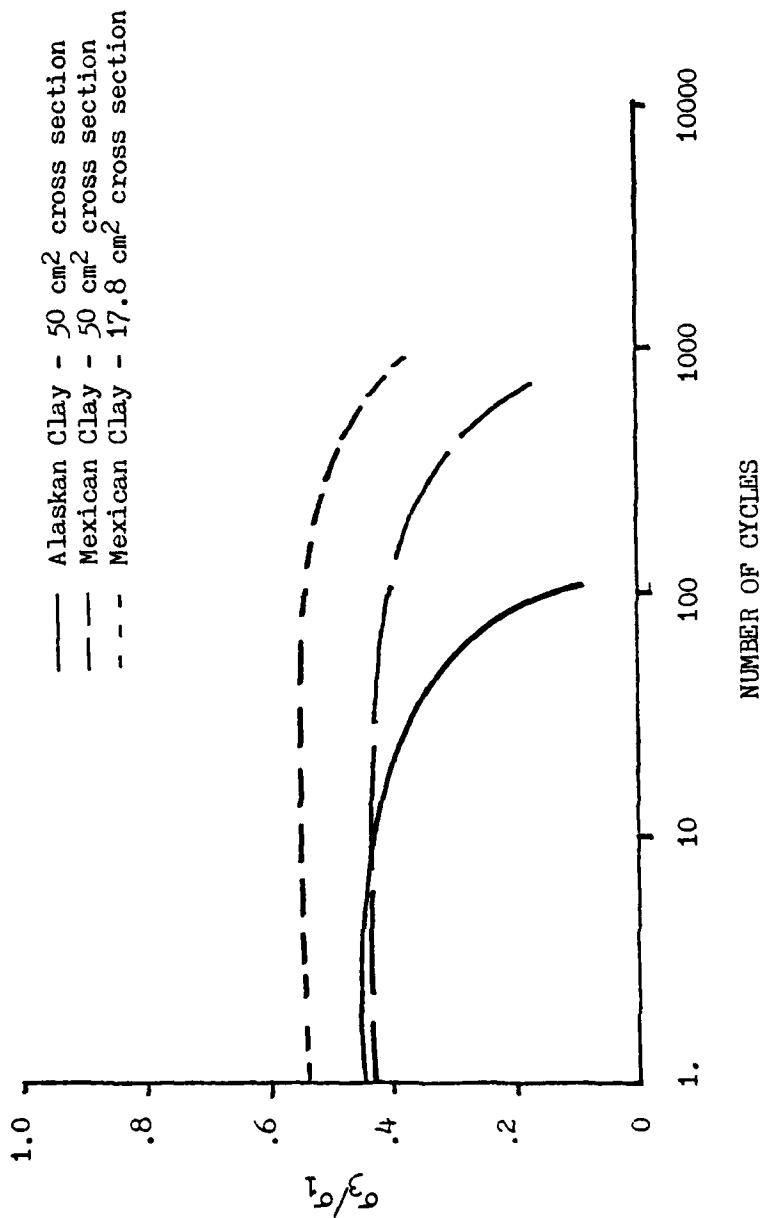

FIGURE 21 . THE AVERAGE RATIO σ_3/σ_1 VS. NUMBER OF CYCLES COMPARED FOR CYCLIC TESTS PERFORMED ON GULF OF ALASKA CLAY AND GULF OF MEXICO CLAY FOR BOTH STANDARD AND SMALL DIA-METER SAMPLES

level until failure approaches.

As in the static test, if the initial K_0 for the Gulf of Mexico samples were equal, the $p - q$, σ_h/σ_v , and σ_3/σ_1 plots would probably have been more identical for a large portion of the test. The difference in direction at failure of the σ_h/σ_v ratio plots for the two sample sizes is unexplained.

D. Sample Height Comparisons for Cyclic Tests

The following is a presentation of the results of individual tests as a function of sample height. As explained earlier, three sample heights (approximately 10 mm, 15 mm, and 25 mm) were compared. Since trimming imprecisions restricted the ability to obtain samples at exactly precise heights, the actual heights varied somewhat. Actual sample heights are noted on each graph.

All remaining graphs are plotted in the following sequence - the Gulf of Alaska standard size samples are plotted on the first graph of each group, the standard size Gulf of Mexico samples are plotted on the second graph, and the small Gulf of Mexico sample size is plotted on the last graph of each group.

Figures 22 through 24 compare the percent of shear strain to number of cycles. Where differences were apparent, as in Figure 22 and 24, the shortest sample tended to fail more rapidly. As sample height was varied the results of the tests on standard size samples shown in Figures 22 and 23 were quite consistent, but the plots of the small size samples (17.8 cm² cross section), in Figure 24, were much more scattered. Similar results for consolidation test samples were observed by Berre et al (3).

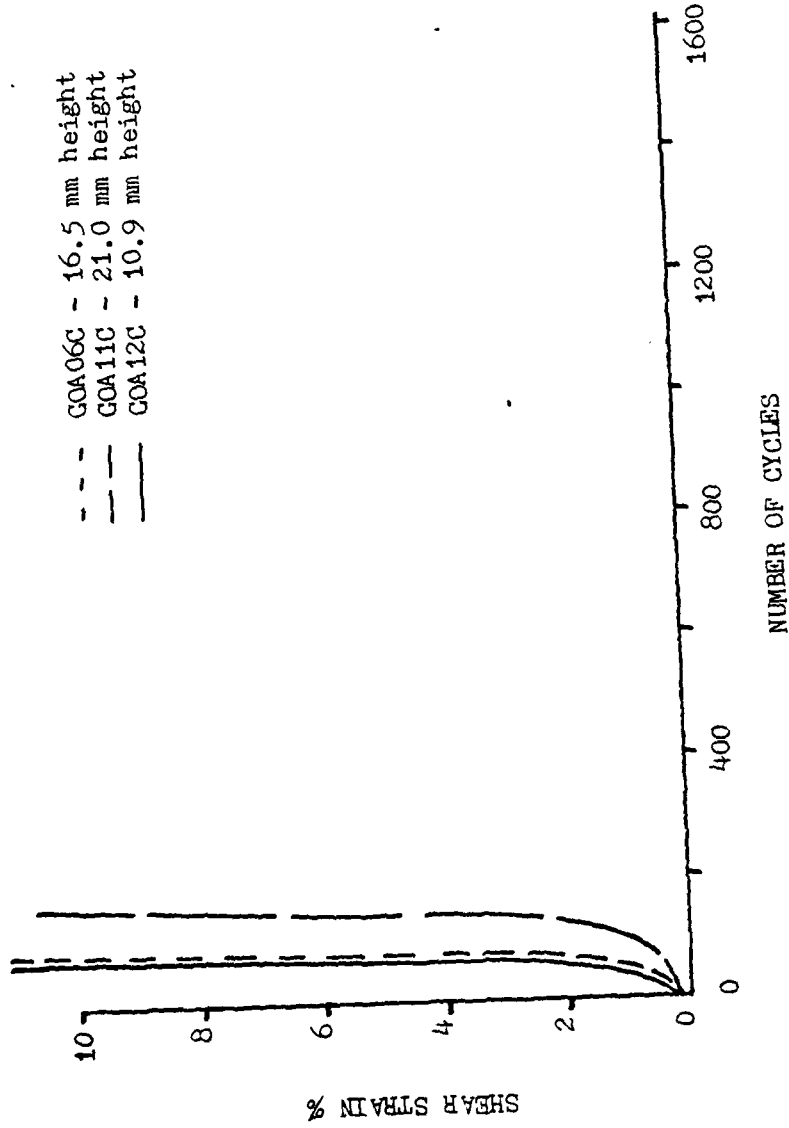

FIGURE 22. SHEAR STRAIN VS. NUMBER OF CYCLES COMPARED FOR TESTS ON 50 cm² CROSS SECTIONAL AREA GULF OF ALASKA CLAY SAMPLES OF VARYING HEIGHTS

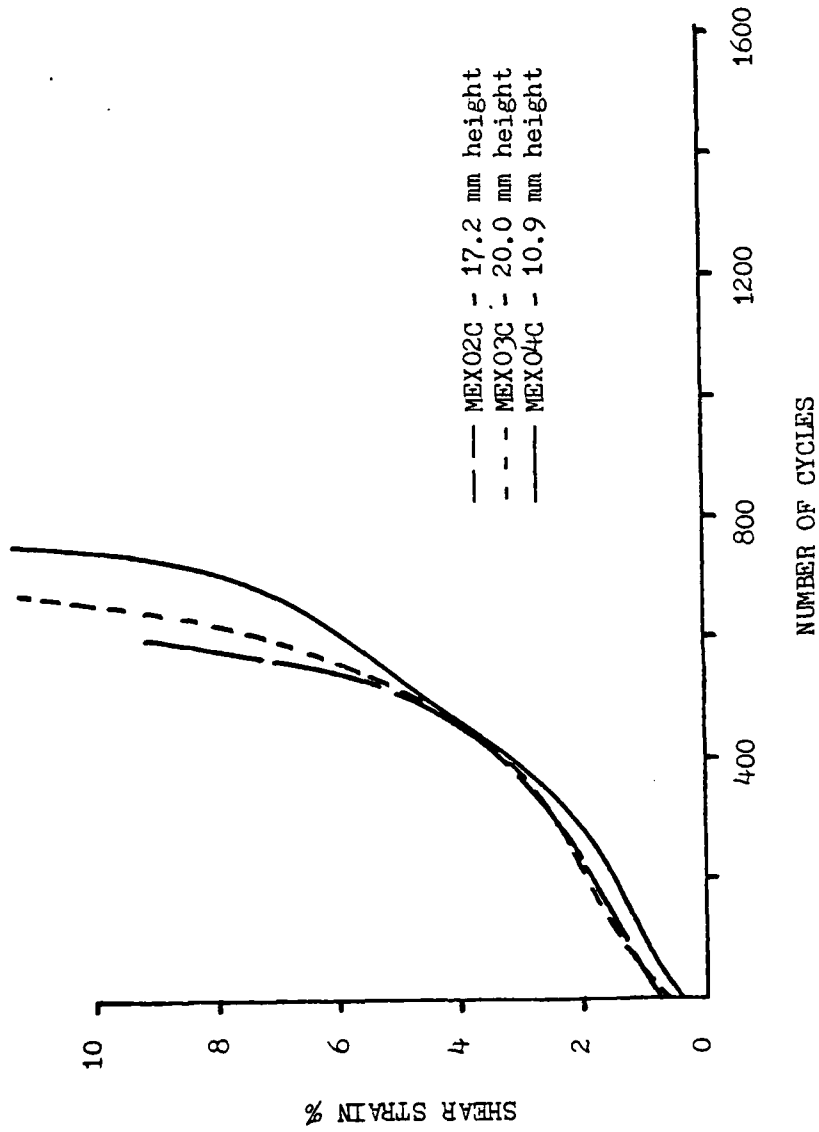

FIGURE 23. SHEAR STRAIN VS. NUMBER OF CYCLES COMPARED FOR TESTS ON 50 cm² GROSS SECTIONAL AREA GULF OF MEXICO CLAY SAMPLES OF VARYING HEIGHTS

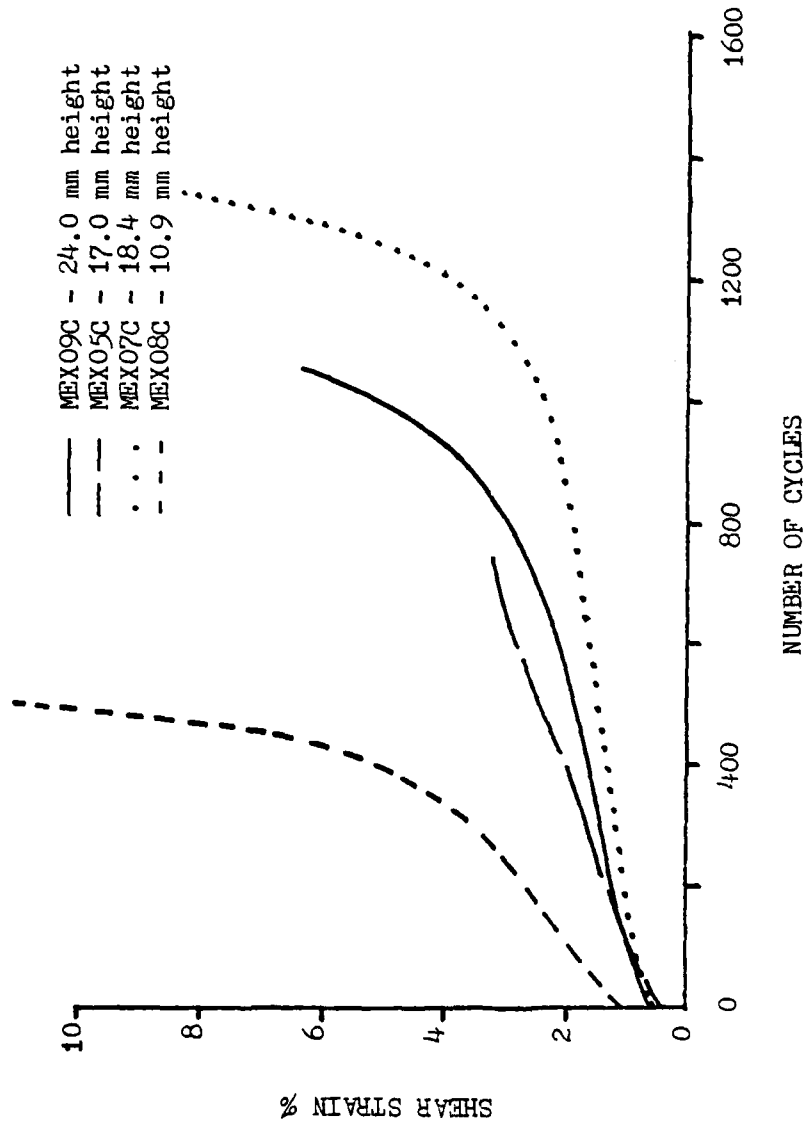

FIGURE 24. SHEAR STRAIN VS. NUMBER OF CYCLES COMPARED FOR TESTS ON 17.8 cm² CROSS SECTIONAL AREA GULF OF MEXICO CLAY SAMPLES OF VARYING HEIGHTS

As expected larger diameter soil samples yield more consistent results and are preferred in practice.

Pore pressures in Figures 25 to 27 behaved as one might expect, with larger build ups of pore pressure for the tests that failed more rapidly. The scatter in Figure 26 is greater than that for the tightly grouped strain versus cycles plots of Figure 23.

The shear modulus plots of Figures 28, 29, and 30 were well grouped with the exception of the short sample of Figure 30. The 10.9 mm height, 17.8 cm² cross section Gulf of Mexico sample also exhibited the greatest rate of strain and largest pore pressures for its sample size group.

Figures 31 through 33 represent the p - q stress path plots for these tests. The p - q plots coincide quite closely in Figure 31 despite height variations. Figure 32, if K_0 was adjusted, would become more closely grouped. In Figure 33 the plots are all of similar shape, and converge at failure. If this figure was adjusted for K_0 the plots would still remain closely grouped. The three percent shear strain points from cyclic tests are indicated by the apex of the triangles. No consistency with the static failure lines ($K_f = 3$ percent) is evidenced in any of the three graphs. In Figure 33 three of the four paths never cross the three percent static failure line. Even shifts in the paths due to adjustments in K_0 would not change this situation significantly.

Presented next, in Figures 34, 35 and 36, are the ratios of σ_h/σ_v for the ten tests. If, as in Figure 34, all plots started with equal K_0 values, the grouping of these curves would be very tight, again, with the exception of test MEX08C (shortest height-small diameter Gulf of

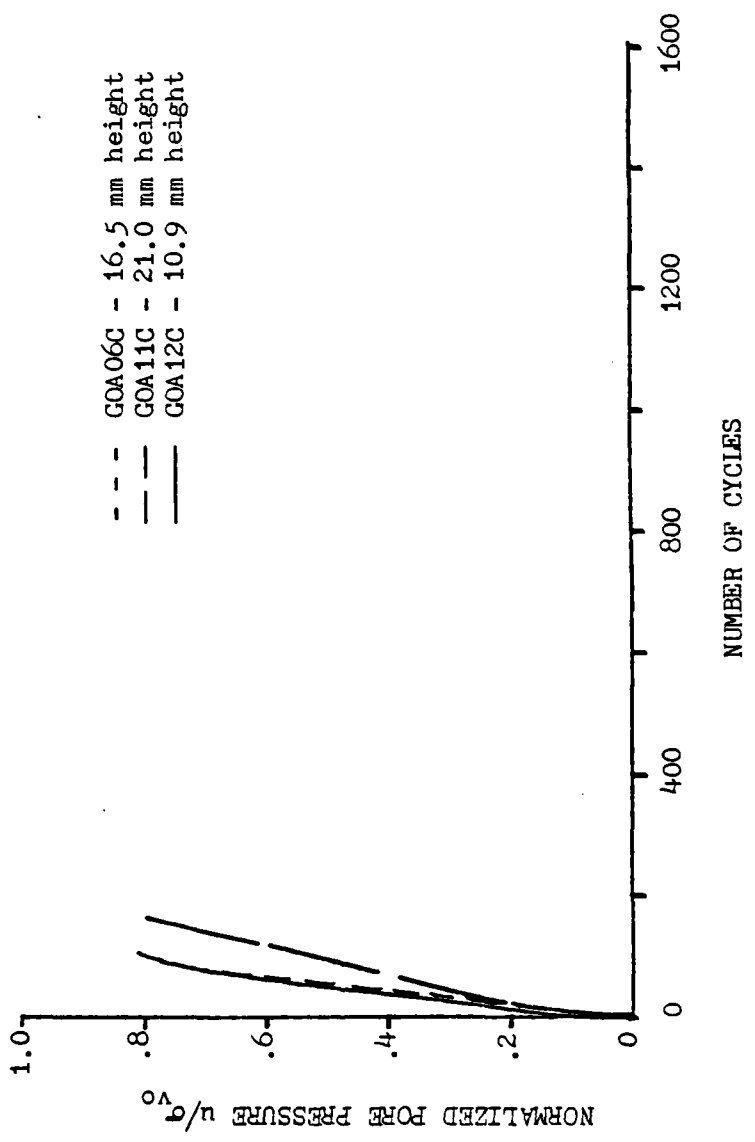

FIGURE 25. PORE PRESSURE VS. NUMBER OF CYCLES COMPARED FOR TESTS ON 50 cm² CROSS SECTIONAL AREA GULF OF ALASKA CLAY SAMPLES OF VARYING HEIGHTS

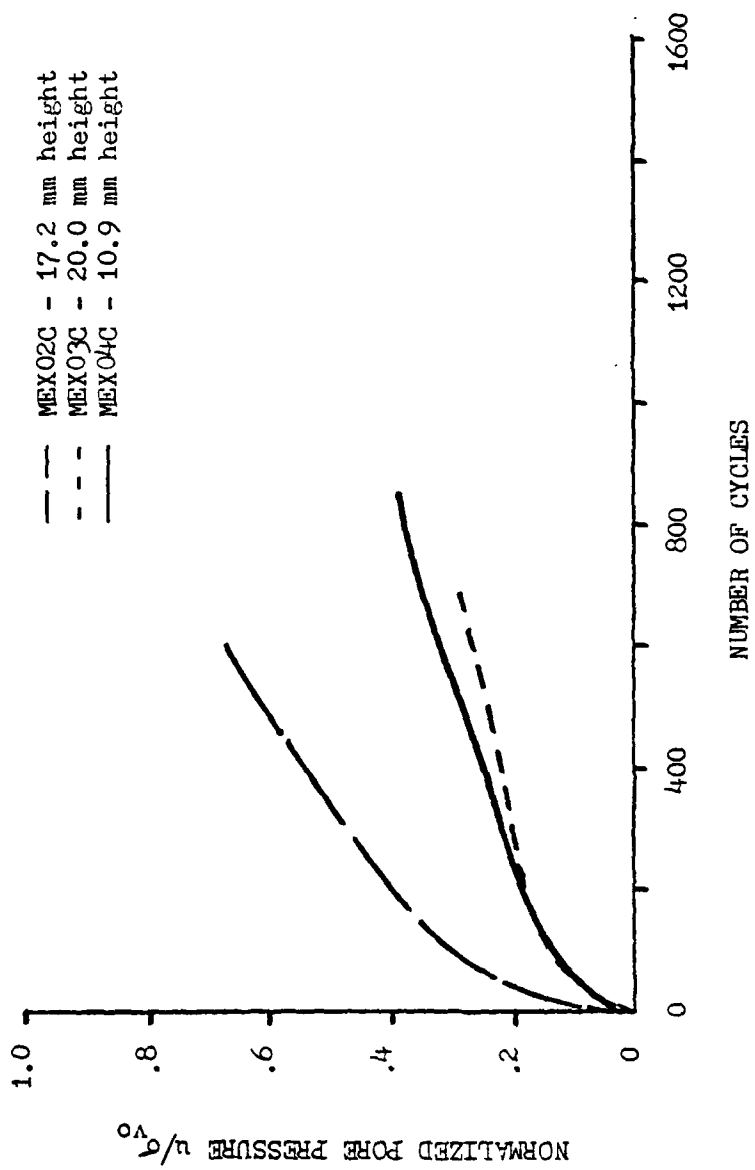

FIGURE 26. PORE PRESSURE VS. NUMBER OF CYCLES COMPARED FOR TESTS ON 50 cm² CROSS SECTIONAL AREA GULF OF MEXICO CLAY SAMPLES OF VARYING HEIGHTS

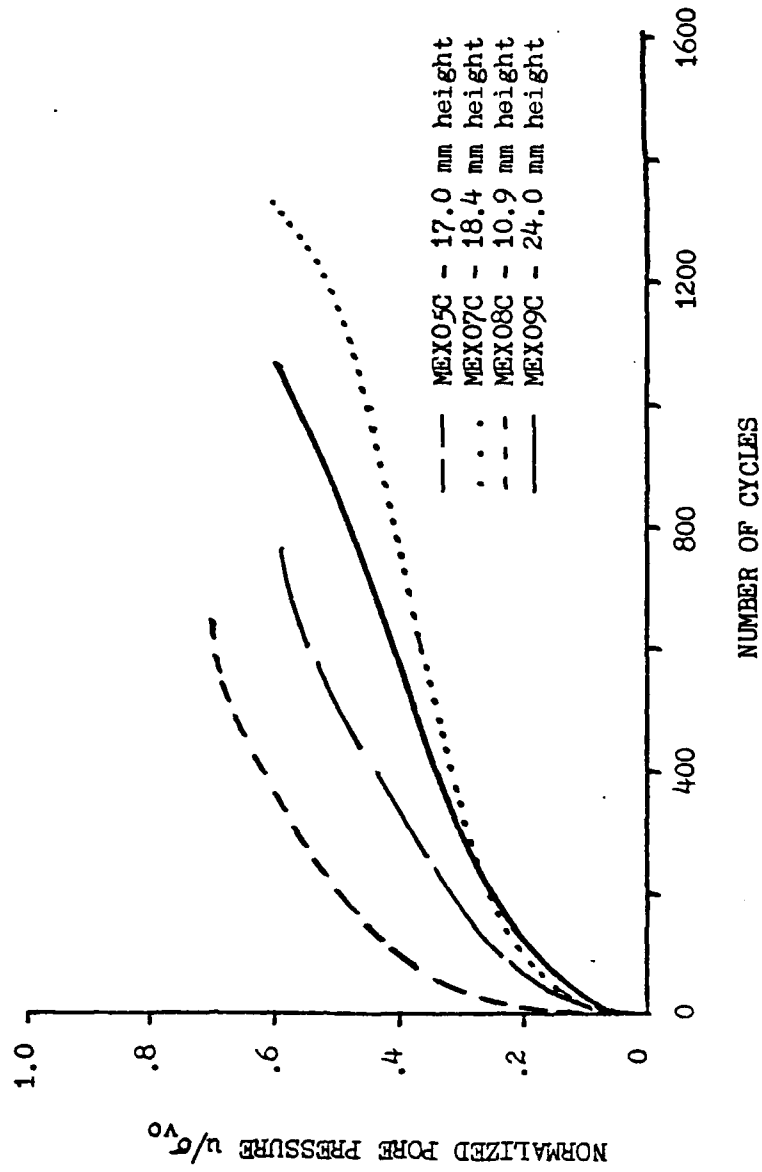

FIGURE 27. PORE PRESSURE VS. NUMBER OF CYCLES COMPARED FOR TESTS ON 17.8 cm² CROSS SECTIONAL AREA GULF OF MEXICO CLAY SAMPLES OF VARYING HEIGHTS

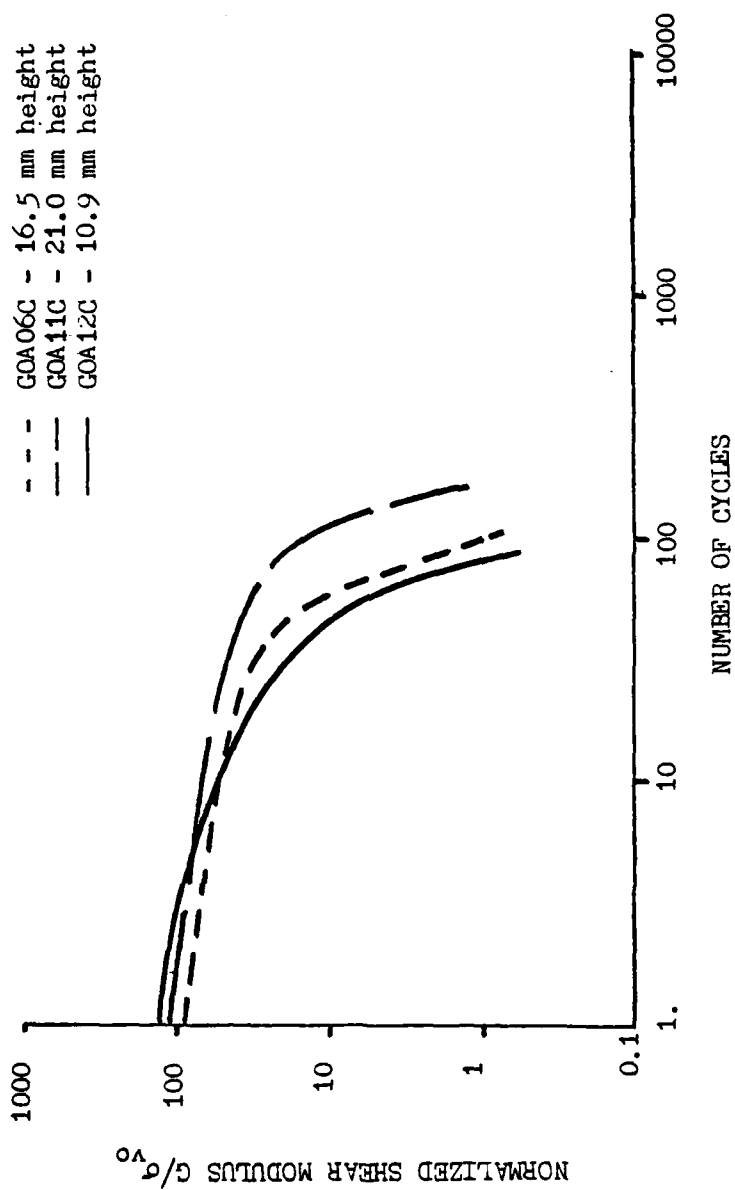

FIGURE 28. SHEAR MODULUS VS. NUMBER OF CYCLES COMPARED FOR TESTS PERFORMED ON 50 cm² CROSS SECTIONAL AREA GULF OF ALASKA CLAY SAMPLES OF VARYING HEIGHTS

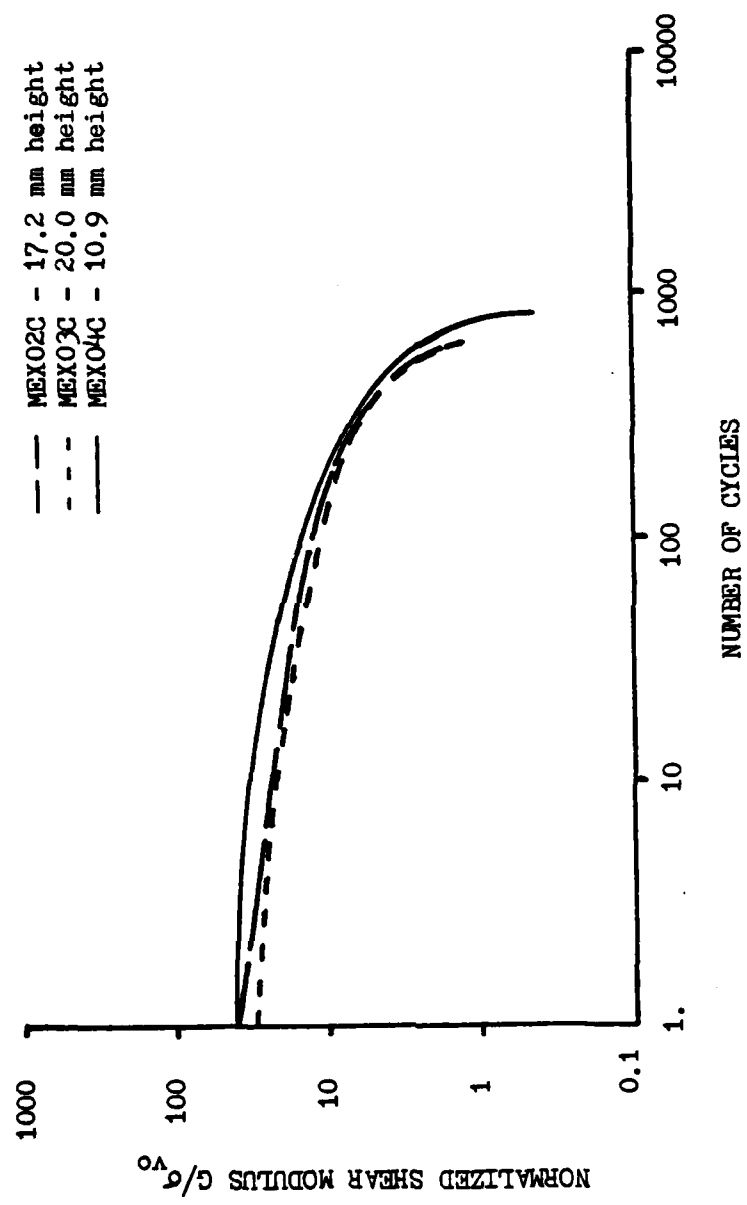

FIGURE 29. SHEAR MODULUS VS. NUMBER OF CYCLES COMPARED FOR TESTS PERFORMED ON 50 cm² CROSS SECTIONAL AREA GULF OF MEXICO CLAY SAMPLES OF VARYING HEIGHTS

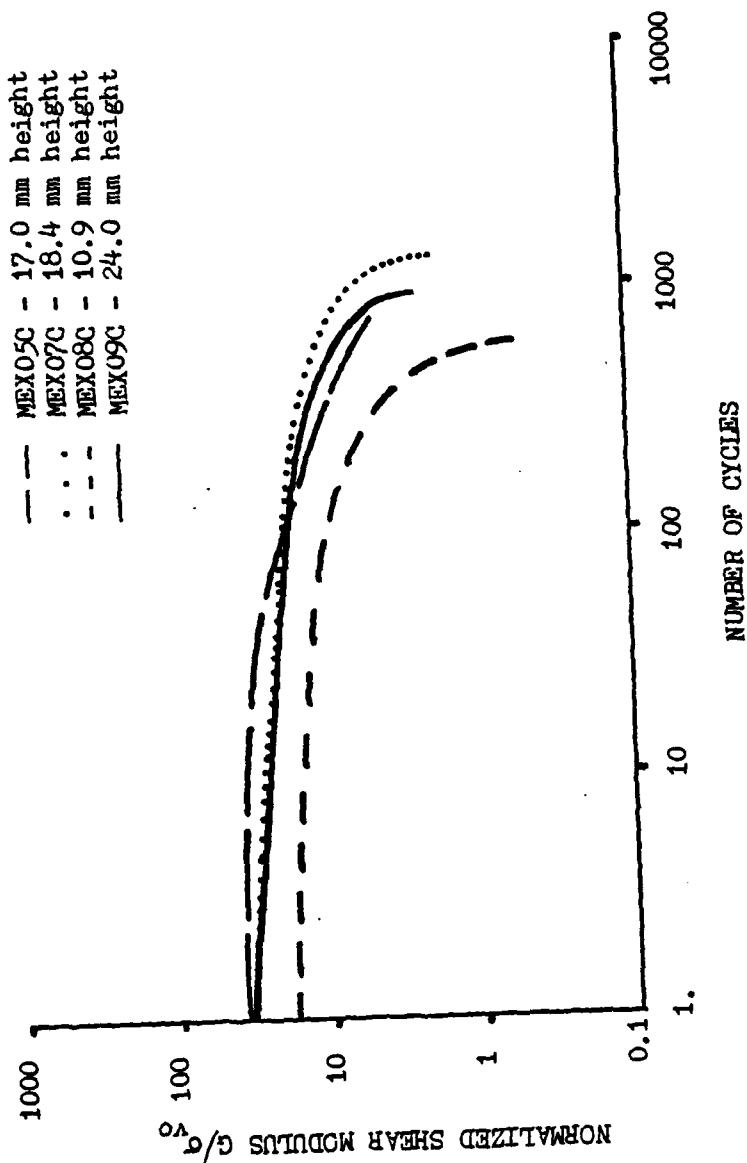

FIGURE 30. SHEAR MODULUS VS. NUMBER OF CYCLES COMPARED FOR TESTS
 PERFORMED ON 17.8 cm^2 CROSS SECTIONAL AREA GULF OF
 MEXICO CLAY SAMPLES OF VARYING HEIGHTS

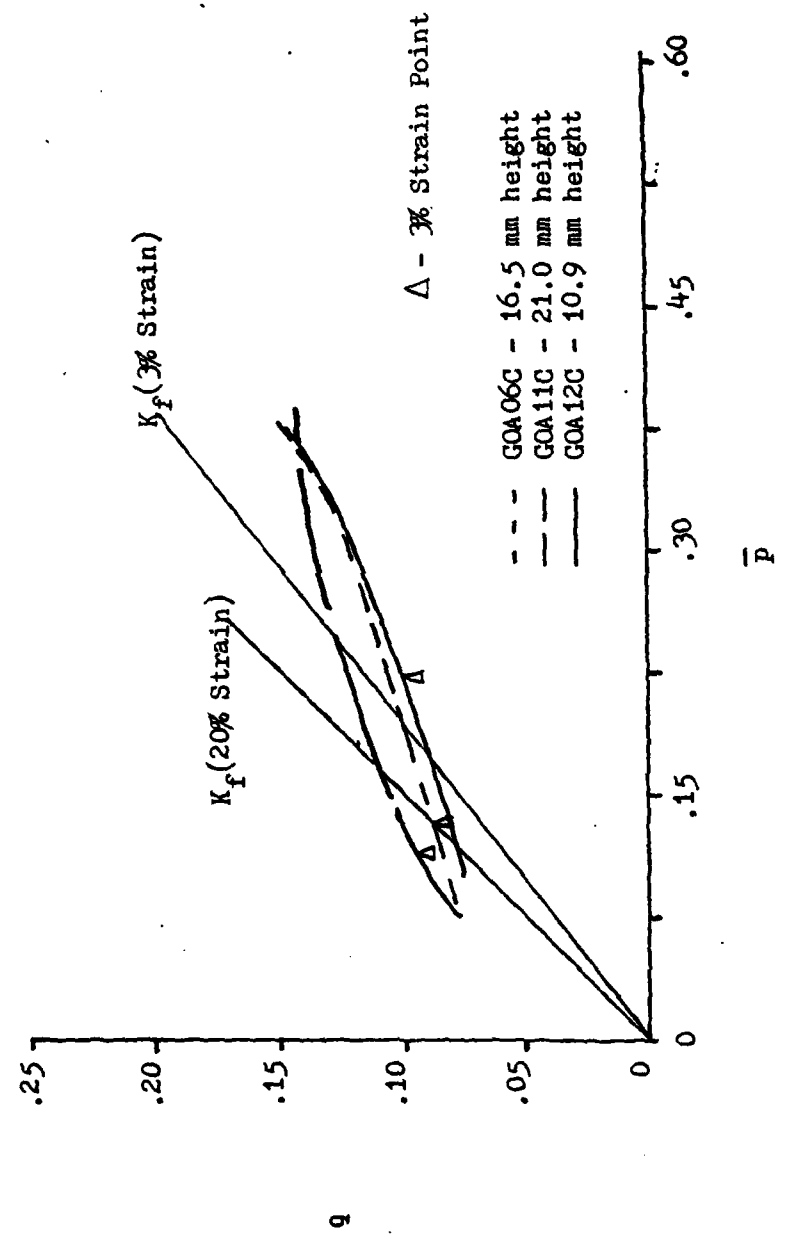

FIGURE 31. STRESS PLOT COMPARED FOR CYCLIC TESTS ON 50 cm² CROSS SECTIONAL AREA GULF OF ALASKA CLAY SAMPLES OF VARYING HEIGHTS

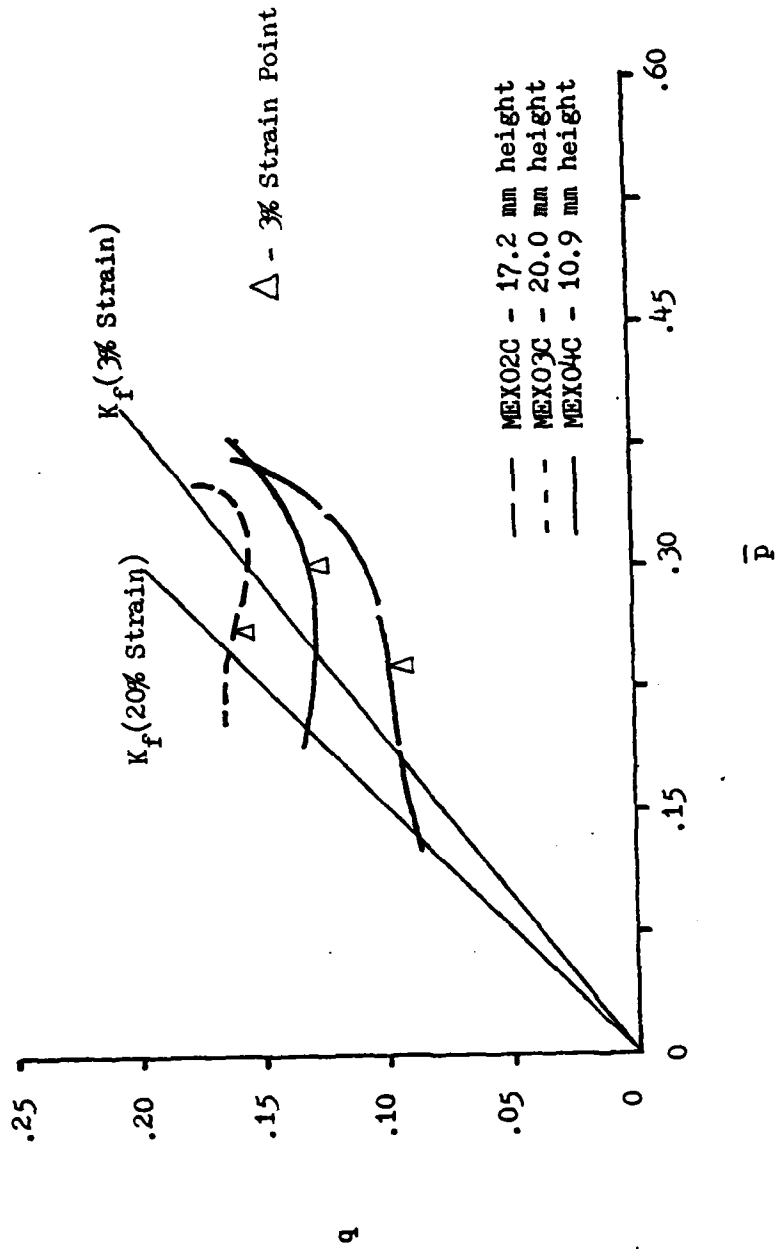

FIGURE 32. STRESS PLOT COMPARED FOR CYCLIC TESTS ON 50 cm² CROSS SECTIONAL AREA GULF OF MEXICO CLAY SAMPLES OF VARYING HEIGHTS

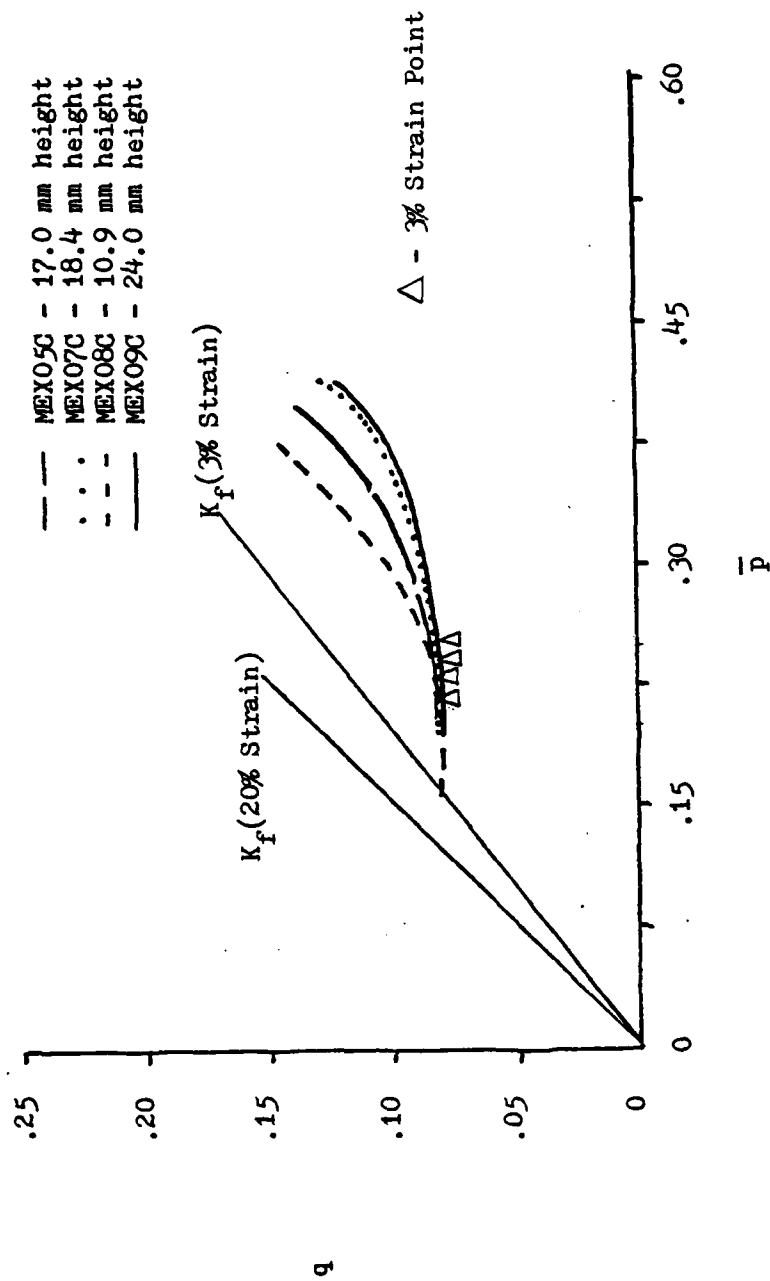

FIGURE 33. STRESS PLOT COMPARED FOR CYCLIC TESTS ON 17.8 cm² CROSS SECTIONAL AREA GULF OF MEXICO CLAY SAMPLES OF VARYING HEIGHTS

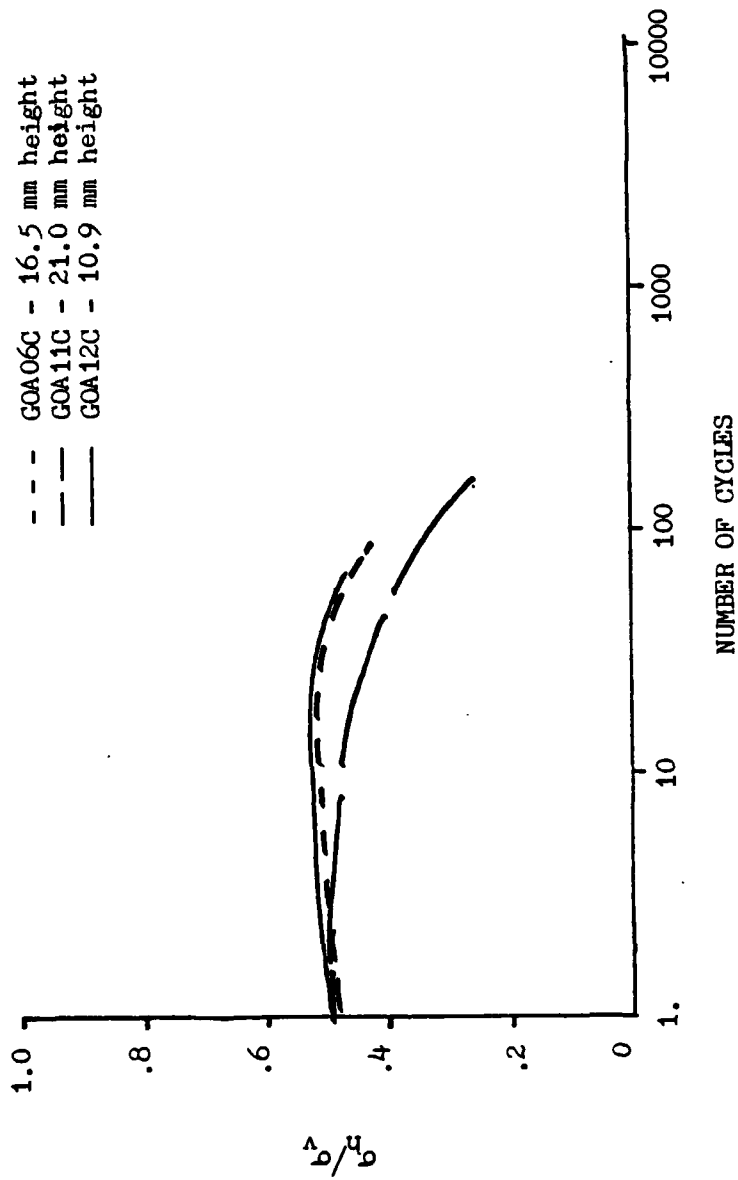

FIGURE 34. THE RATIO OF HORIZONTAL NORMAL STRESS TO VERTICAL NORMAL STRESS VS. NUMBER OF CYCLES COMPARED FOR TESTS ON 50 cm² CROSS SECTIONAL AREA GULF OF ALASKA CLAY SAMPLES OF VARYING HEIGHTS

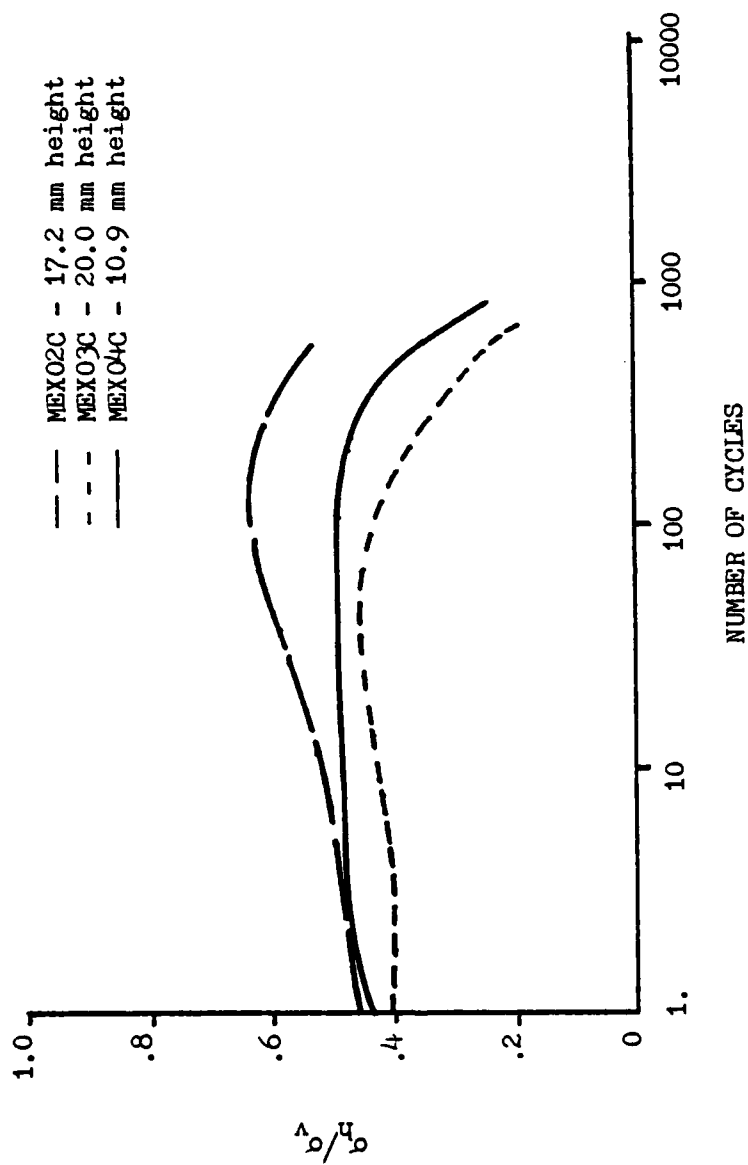

FIGURE 35. THE RATIO OF HORIZONTAL NORMAL STRESS TO VERTICAL NORMAL STRESS VS. NUMBER OF CYCLES COMPARED FOR TESTS ON 50 cm² CROSS SECTIONAL AREA GULF OF MEXICO CLAY SAMPLES OF VARYING HEIGHTS

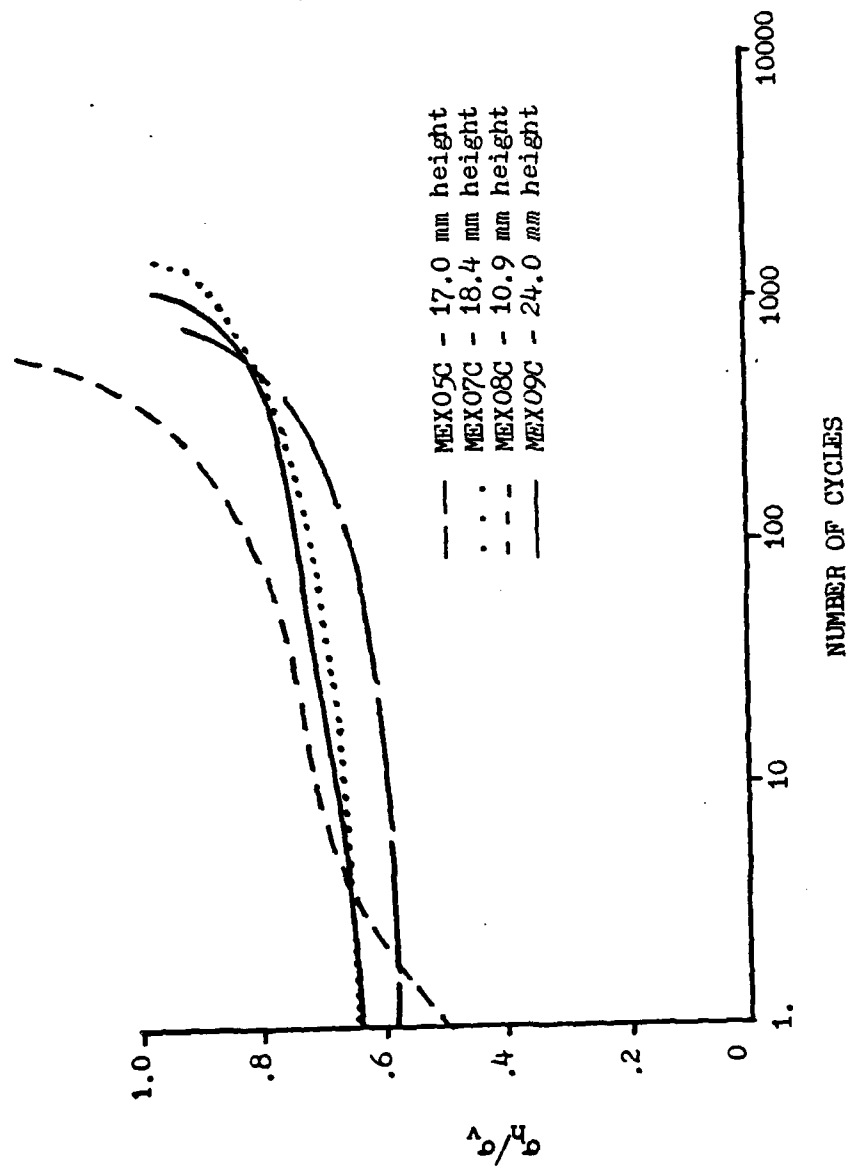

FIGURE 36 THE RATIO OF HORIZONTAL NORMAL STRESS TO VERTICAL NORMAL STRESS VS. NUMBER OF CYCLES COMPARED FOR TESTS ON 17.8 cm² CROSS SECTIONAL AREA GULF OF MEXICO CLAY SAMPLES OF VARYING HEIGHTS

Mexico sample).

The ratios σ_3/σ_1 , in Figures 37 to 39, are grouped quite closely. Adjusting K_0 values would produce somewhat more consistent plots in Figures 38 and 39.

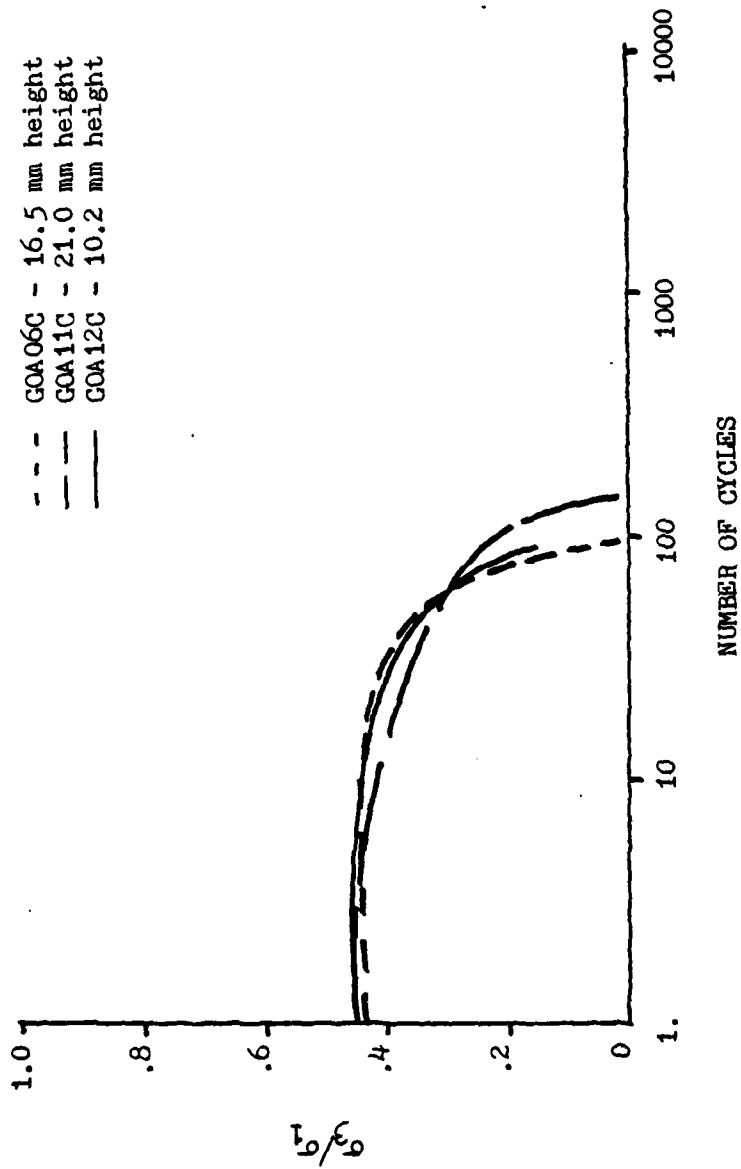

FIGURE 37. THE RATIO σ_3/σ_1 VS. NUMBER OF CYCLES COMPARED FOR TESTS ON 50 cm² CROSS SECTIONAL AREA GULF OF ALASKA CLAY SAMPLES OF VARYING HEIGHTS

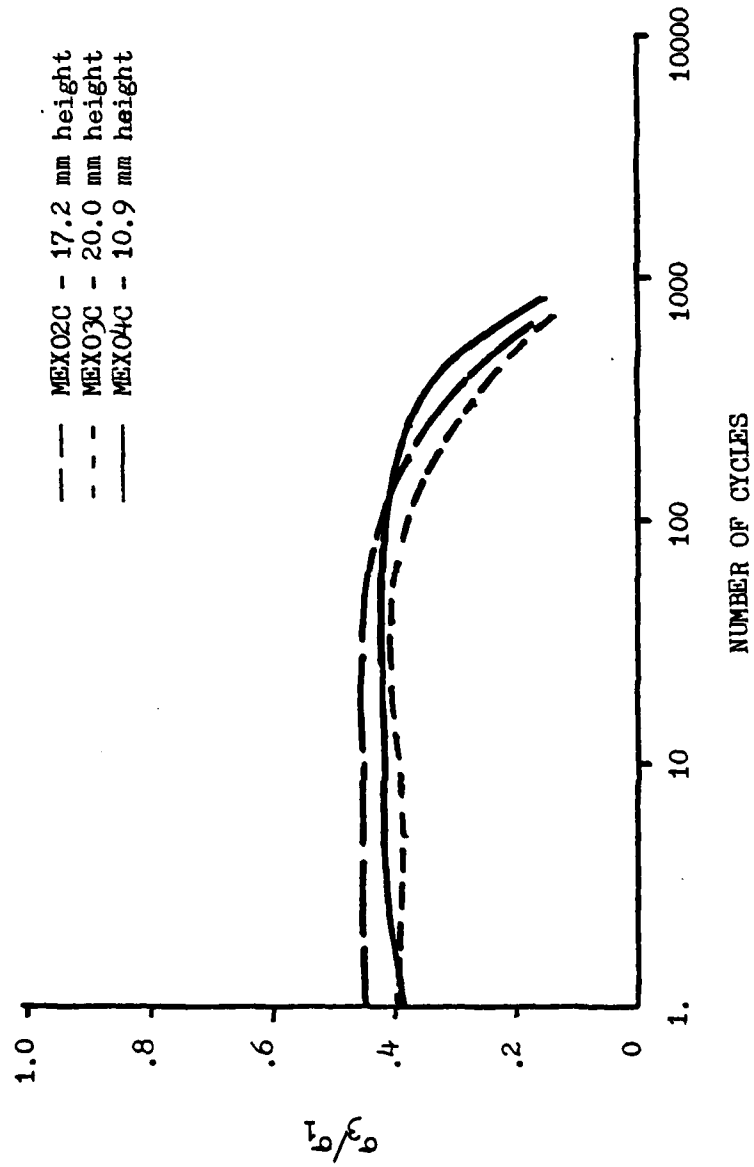

FIGURE 38. THE RATIO σ_3/σ_1 VS. NUMBER OF CYCLES COMPARED FOR TESTS ON 50 cm² CROSS SECTIONAL AREA GULF OF MEXICO CLAY SAMPLES OF VARYING HEIGHTS

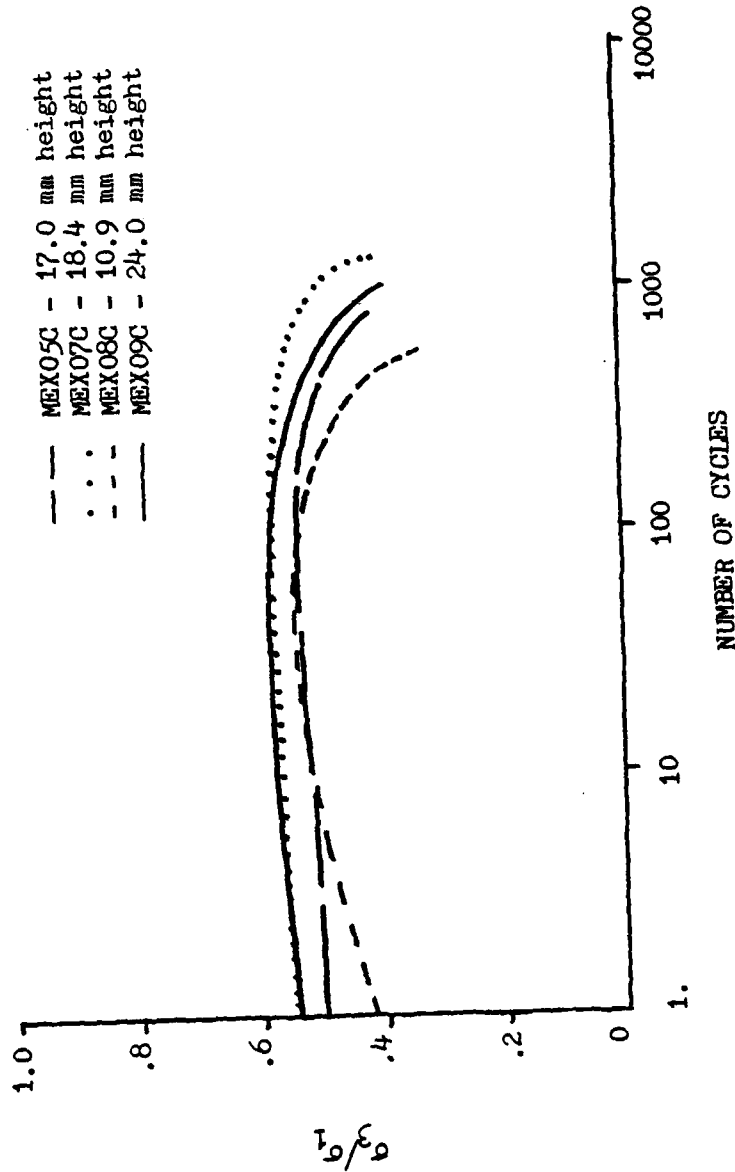

FIGURE 39. THE RATIO σ_3/σ_1 VS. NUMBER OF CYCLES COMPARED FOR TESTS ON 17.8 cm² GROSS SECTIONAL AREA GULF OF MEXICO CLAY SAMPLES OF VARYING HEIGHTS

PART 5

DISCUSSION AND CONCLUSIONS

A. Discussion

The purpose of this investigation was to study sample size effects on cyclic and static shear tests performed on clays, using the Norwegian Geotechnical Institute direct simple shear device. To a lesser degree undrained strength characteristics of Gulf of Alaska and Gulf of Mexico clays were investigated and compared. To accomplish these goals the Gulf of Mexico samples tested were of two diameters and three different heights. The middle height was at or near the 15 mm recommended by Geonor (8). Gulf of Alaska samples were restricted to one diameter but varied in height. Static tests for the Gulf of Alaska soil and for both diameters of the Gulf of Mexico samples were conducted using the recommended height. All tests were run as consolidated constant volume tests to simulate undrained conditions. All were consolidated to the same vertical normal stress. Lateral strains were measured, and horizontal normal stresses calculated. All cyclic tests were performed with cyclic stresses equal to 50 percent of the static strengths obtained. K_0 values were calculated by using lateral strains measured during consolidation of the samples.

During the static tests, normal vertical stress, horizontal shear stress, horizontal shear strains, and lateral strains were monitored and recorded. During cyclic tests the same was true, however, the horizontal

shear stress was constant, since the tests were constant stress tests. Using these known and measured values, and with the assumptions and equations presented in Part 1 of this text, calculations were performed to obtain the data presented in Part 4.

One effect of sample size noticed was the direct relation of the calculated K_o values to sample heights for the Gulf of Mexico samples*. The mean values were 0.446 for the large diameter sample and 0.554 for the small diameter sample. For the large diameter samples the value ranged from 0.439 to 0.453 for the shortest and tallest samples, respectively. For the small diameter sample the range was 0.487 to 0.608 for the shortest and tallest samples, respectively. The variances and standard deviations were: large diameter samples -- $s_x^2 = 0.0001$, $s_x = 0.01$; for the small diameter samples -- $s_x^2 = 0.0032$, and $s_x = 0.056$. The K_o values are fairly well grouped considering the variabilities normally associated with soil investigations and seem reasonable for the soil tested. The use of lateral strain measurement may offer a viable method of obtaining K_o for future studies, but adjustments will be necessary to compensate for differences due to height variations.

Static tests comparing sample cross-sectional variations showed the smaller diameter sample was slightly more resistant to shear than the 50 cm² sample. However, only one test was run for each size, and normal experimental variations could easily account for the difference.

* K_o values for the Gulf of Alaska soil were not calculated during this investigation because of lack of recorded data. Instead, the average K_o value obtained by Zimmie and Floess (24) was used.

Differences in cross-sectional sample size for cyclic tests were more defined, at least for resistance to shear strain per cycle. Concurrent with static test results, the smaller sample was more durable. However, the disparity in strength was considerably greater with the small sample, averaging almost twice as many cycles for strains of three percent or greater. This is a significant difference and perhaps partly attributable to greater support from sample membranes. Ladd and Edgers (11) found the resistance of the membranes to shear increased with increasing shear strain and with decreasing normal loads. The normal load required was much less for the small diameter samples to maintain a vertical normal stress equal to the larger cross section samples. The resistance of standard sample size membranes were measured to be less than $.01 \text{ kg/cm}^2$ for stresses up to $.3 \text{ kg/cm}^2$. Small membranes were not tested by Ladd and Edgers (11).

Additionally, the smaller samples evidenced much more scatter of results than did the larger samples, although sample heights were varied equally. This is consistent with data obtained on consolidation tests by Berre et al (3).

Intuitively, one might expect that shear strain resistance would be inversely proportional to sample height and pore pressure build up would be directly proportional to sample height, since the greater the distance to the drainage surfaces the greater the pore pressures are likely to be (3,4). Additionally, a larger moment could be developed as sample height increases, resulting from the greater distances between shearing surfaces. However, the data indicates random variation in test results due to differences in sample height.

Common to the three categories (static test, cyclic test with sample cross section varied, and cyclic test with sample height varied) discussed, was the effect of the calculated K_0 value. Where this value was used in calculations to obtain data plots, it was noticed that if the K_0 value had been equal for all samples, the plots would have compared much more consistently. Obtaining K_0 as was done in this investigation could be of value, but the effects of sample height must be considered.

The Gulf of Alaska clay was somewhat weaker than the Gulf of Mexico clay under static loading conditions (approximately 20 percent) but was far less resistant to shear strains during cyclic loadings. After only one-sixth the number of loading cycles of the 50 cm² Gulf of Mexico samples, the Gulf of Alaska samples evidenced equal or even higher strains. Pore pressures built up at a much faster rate in the Gulf of Alaska samples, indicating a reduction in effective stress. Comparisons have been made of a direct relationship of soil sensitivity values and behavior under cyclic loading (19). This relation is apparent for the two soils tested as the sensitivity value for the Gulf of Alaska soil was 4.0, nearly twice the 2.5 value for the Gulf of Mexico clay.

B. Summary

The findings of this investigation suggest some effects of sample size on results obtained from the use of the Norwegian Geotechnical Institute direct simple shear device. The following list summarizes these findings:

- K_0 values calculated using measured lateral strains were directly proportional to sample height and inversely proportional to sample diameter. The calculated values for the large diameter samples ranged from 0.439 to 0.453, with a mean value of 0.446 and a variance and standard deviation of 0.0001 and 0.01, respectively. The small diameter samples yielded values varying from 0.487 to 0.608 with a mean of 0.554 and a variance and standard deviation of 0.0032 and 0.056, respectively.
- During static testing the smaller diameter sample showed 10 to 15 percent more resistance to shear strain than the larger sample.
- In cyclic loading the smaller sample was significantly more resistant to shear strain per cycle than the larger sample. (Approximately twice as resistant).
- The smaller sample showed less repeatability of results with greater scatter of test results.
- No evidence was obtained to suggest that variations in sample height will effect cyclic shear resistance.
- Adjusting K_0 values would produce more consistent plots of $p - q$ stress paths, and σ_h/σ_v and σ_3/σ_1 ratios for samples of the same soil.

In brief, K_0 is effected by changes in height; the smaller cross-sectional sample size produces higher static and cyclic shear strain resistance, but a much greater degree of scatter; and sample height had little obvious and consistent effects on cyclic shear results.

The comparison of the behavior of the Gulf of Alaska clay with that of the Gulf of Mexico clay illustrated a relation of soil sensitivity to cyclic strength. Consistent with other investigations (19), the soil with the higher sensitivity value showed much less resistance to cyclic shearing stresses. In addition, although the static shear strength of the Gulf of Alaska sample was less than 20 percent below the static shear strength of the 50 cm² Gulf of Mexico sample, it was almost six times less resistant to shear strains under cyclic conditions.

PART 6

LITERATURE CITED

1. Aggarwal, Y.P., and Sykes, L.R. (1978), "Earthquake, Faults, and Nuclear Power Plants in Southern New York and Northern New Jersey", Science Magazine, Vol. 200, pp. 425-429.
2. Andersen, K.G. (1976), "Behavior of Clay Subjected to Undrained Cyclic Loading", Proc. International Conf. on the Behavior of Offshore Structures, Norwegian Institute of Technology, Trondheim, Vol. 1, pp. 392-403.
3. Berre, T., Schjetne, D., and Sollie, S. (1969), "Sampling Disturbance of Soft Marine Clays", Proc. Seventh International Conf. on Soil Mechanics and Foundation Engineering, Mexico City, pp. 417-420.
4. Berre, T., Iversen, K. (1972), "Oedometer Tests with Different Specimen Heights on a Clay Exhibiting Large Secondary Compression", Geotechnique, Vol. 22, No. 1, pp. 53-70.
5. Carlson, P.R. (1976), "Submarine Faults and Slides that Disrupt Surficial Sedimentary Units, Northern Gulf of Alaska", U.S. Geological Survey, Open File Report 76-294, Menlo Park, California.
6. Danielson, E.F., Burt, W.V., and Rattray, M., Jr. (1957), "Intensity and Frequency of Severe Storms in the Gulf of Alaska", Transactions, American Geophysical Union, Vol. 38, No. 1, pp. 44-49.
7. Fischer, J.A., Koutsoftas, D.C., and Lu, T.D. (1976), "The Behavior of Marine Soils Under Cyclic Loading", Proc., International Conf. on the Behavior of Offshore Structures, Norwegian Institute of Technology, Trondheim, Vol. 2, pp. 407-417.
8. Geonor (1968), "Description and Instruction for Use of Direct Simple-Shear Apparatus Model h-12", Geonor A/S, Oslo.
9. Hampton, M.A., Bouma, A.H., Carlson, P.R., Molina, B.F., and Clukey, E.C. (1978), "Quantitative Study of Slope Instability in the Gulf of Alaska", Proc., 10th Offshore Technology Conf., Houston, pp. 2307-2318.
10. Hvorslev, M.J., and Daufman, R.I. (1952), "Torsion Shear Apparatus and Testing Procedures", USAE Waterways Experiment Station, Bulletin No. 38, May.

11. Ladd, C.C., and Edgers, L. (1972), "Consolidated Undrained Direct-Simple Shear Tests on Saturated Clays", Soils Publication No. 284, Dept. of Civil Engineering, Massachusetts Institute of Technology, Cambridge, Massachusetts.
12. Lee, K.L., and Focht, J.A. (1976), "Strength of Clay Subjected to Cyclic Loading", Marine Geotechnology, Vol. 1, No. 3, pp. 165-185.
13. Lucks, A.S., Christian, J.T., Brandow, G.E., and Hoeg, D. (1972), "Stress Conditions in NGI Simple Shear Test", J. Soil Mech. and Found. Div., ASCE, Vol. 98, No. SMI, pp. 155-160.
14. Mitchell, R.J., Tsui, K.K., and Sangrey, D.A. (1973), "Failure of Submarine Slopes Under Wave Action", Proc., 13th International Conf. on Coastal Eng., Vol. 1.
15. Norwegian Geotechnical Institute (1975), "Research Project, Repeated Loading on Clay: Summary and Interpretation of Test Results", NGI Report: 74037-9, Oct. 1975, Oslo.
16. Prevost, J.H., and Hoeg, K. (1976), "Reanalysis of Simple Shear Soil Testing", Canadian Geotechnical Journal, Vol. 13, pp. 418-429.
17. Roscoe, K.H. (1953), "An Apparatus for the Application of Simple Shear to Soil Samples", Proc., 3rd ICSMFE, Zurich, Vol. 1, pp. 186-191.
18. Rowe, R.W. (1975), "Displacement and Failure Modes of Model Offshore Gravity Platforms Founded on Clay", Offshore Europe 1975, Aberdeen, Scotland, Conf. Paper OE-75 218.1.
19. Sangrey, D.A., Castro, G., Poulos, S.J., and France, J.W. (1978), "Cyclic Loadings of Sands, Silts and Clays", Proc., Earthquake Engineering and Soil Dynamics, ASCE Specialty Conf., Pasadena, pp. 836-851.
20. Seed, H.B. (1976), "Evaluation of Soil Liquefaction Effects on Level Ground During Earthquakes", Liquefaction Problems in Geotechnical Engineering, ASCE, National Convention, Philadelphia, pp. 1-104.
21. Shen, C.K., Herrmann, L.R., and Sadigh, K. (1978), "Analysis of Cyclic Simple Shear Test Data", Proc., Earthquake Engineering and Soil Dynamics, ASCE Specialty Conf., Pasadena, pp. 864-874.

22. Wang, L.R., and O'Rourke, M.J., "An Overview of Buried Lifeline Earthquake Engineering", Seismic Vulnerability, Behavior and Design of Underground Piping Systems (SVBDUPS Project), Technical Report No. 1A, January, 1978, Rensselaer Polytechnic Institute, Department of Civil Engineering.
23. Woods, R.D. (1978), "Measurement of Dynamic Soil Properties", Proc., Earthquake Engineering and Soil Dynamics, ASCE Specialty Conf., Pasadena, pp. 91-178.
24. Zimmie, T.F. and Floess, C.H.L. (1979), "Simple Shear Behavior of Fine Grained Soils Subjected to Earthquake and Other Repeated Loading", National Science Foundation Directorate for Applied Science and Research Applications (ASRA), Final Report, March, 1979, Rensselaer Polytechnic Institute, Department of Civil Engineering.

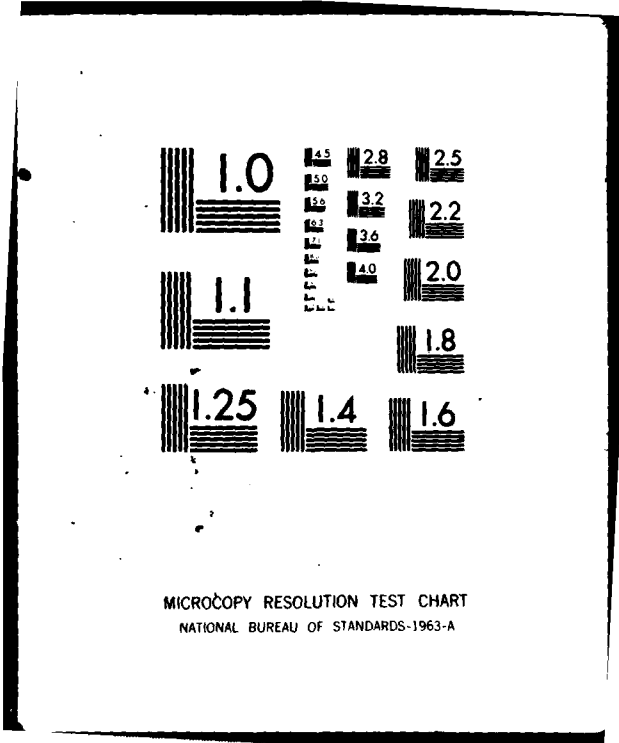

MICROCOPY RESOLUTION TEST CHART
NATIONAL BUREAU OF STANDARDS-1963-A

A. Static Test Comparisons

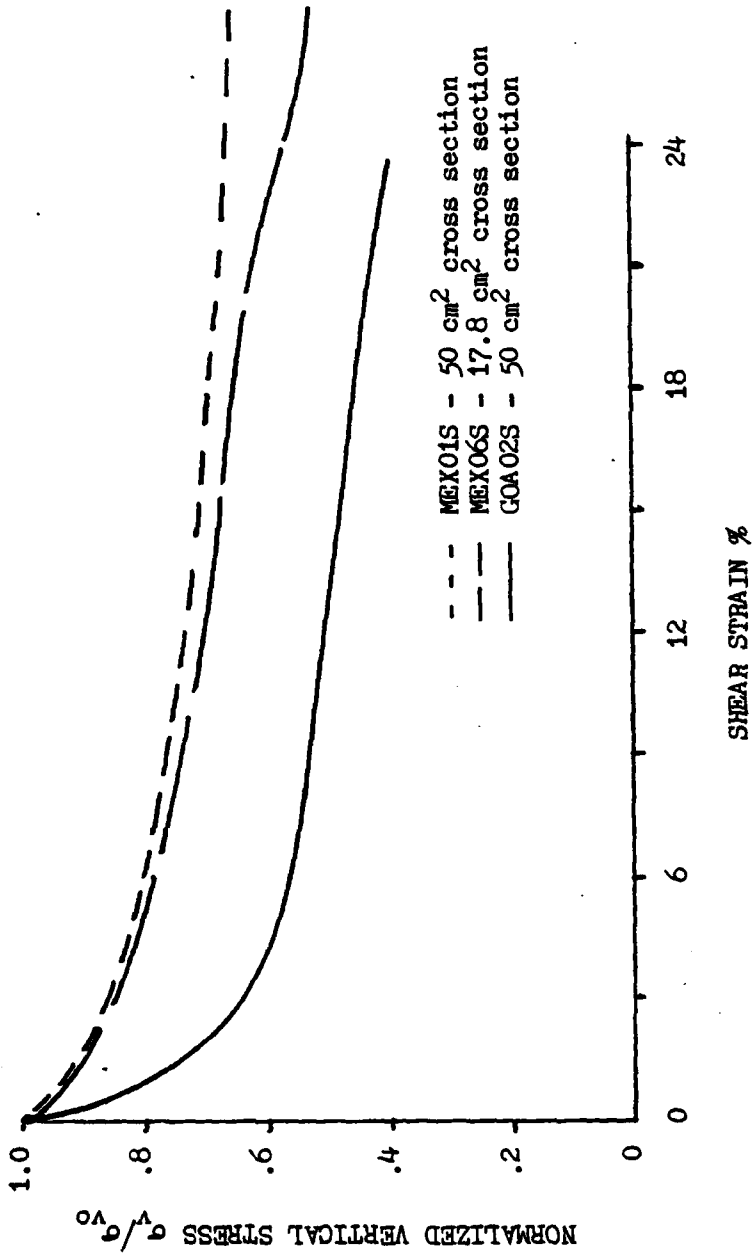

FIGURE 40. NORMALIZED VERTICAL STRESS VS. SHEAR STRAIN COMPARED FOR STATIC TESTS PERFORMED ON GULF OF ALASKA CLAY AND GULF OF MEXICO CLAY FOR BOTH STANDARD AND SMALL DIAMETER SAMPLES

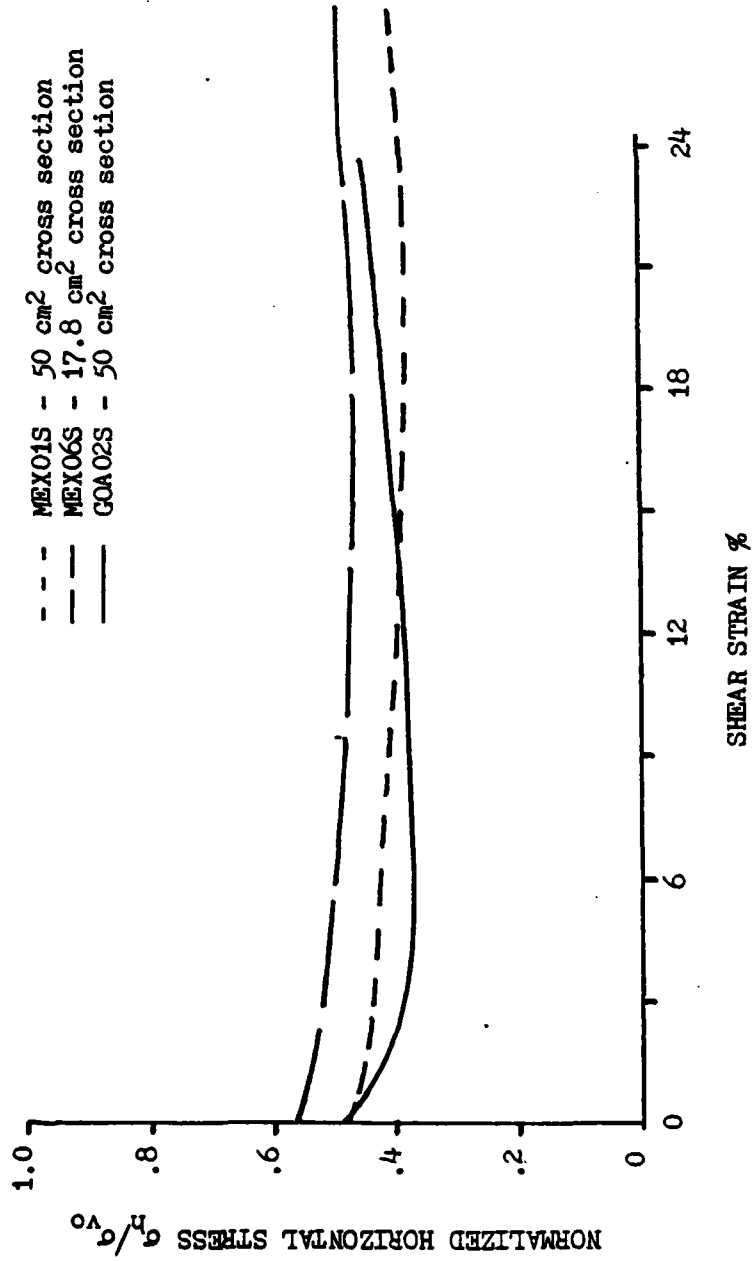

FIGURE 41. NORMALIZED HORIZONTAL (LATERAL) STRESS VS. SHEAR STRAIN
 COMPARED FOR STATIC TESTS PERFORMED ON GULF OF ALASKA
 CLAY AND GULF OF MEXICO CLAY FOR BOTH STANDARD AND SMALL
 DIAMETER SAMPLES

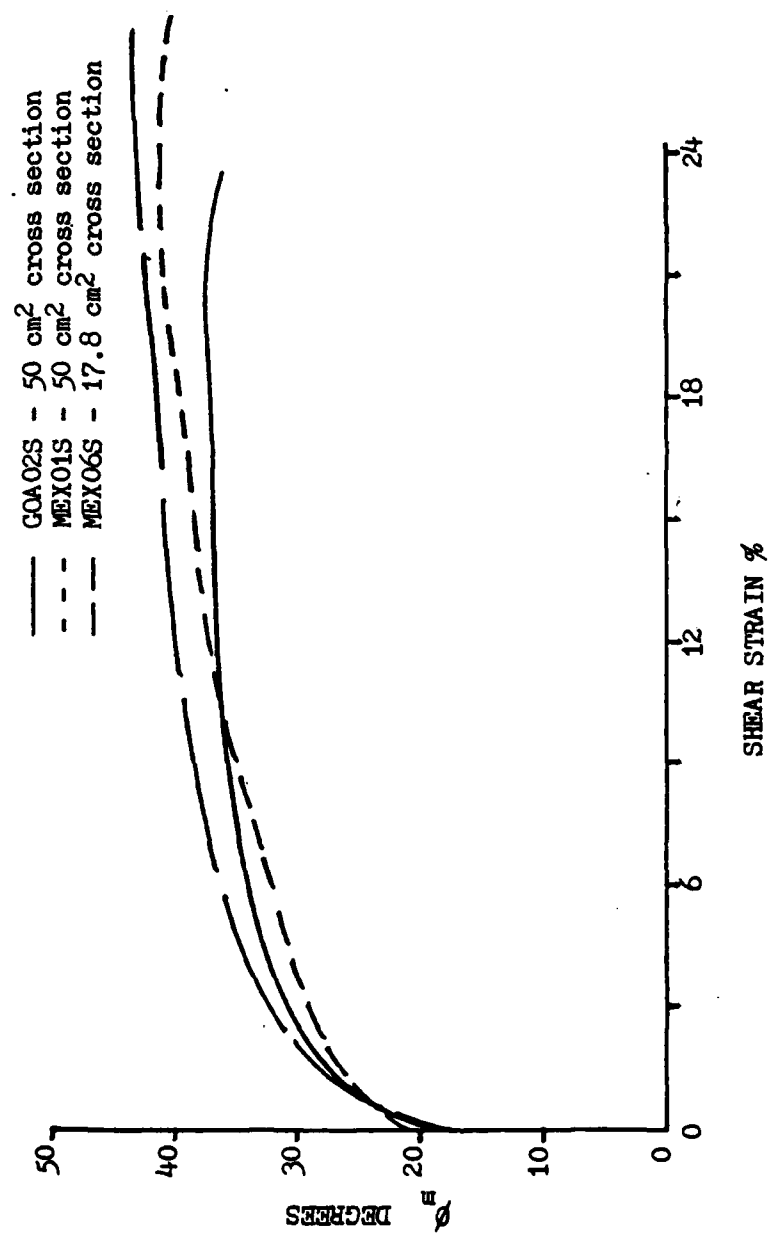

FIGURE 42. MOBILIZED ANGLE OF INTERNAL FRICTION VS. SHEAR STRAIN COMPARED FOR STATIC TESTS PERFORMED ON GULF OF ALASKA CLAY AND GULF OF MEXICO CLAY FOR BOTH STANDARD AND SMALL DIAMETER SAMPLES

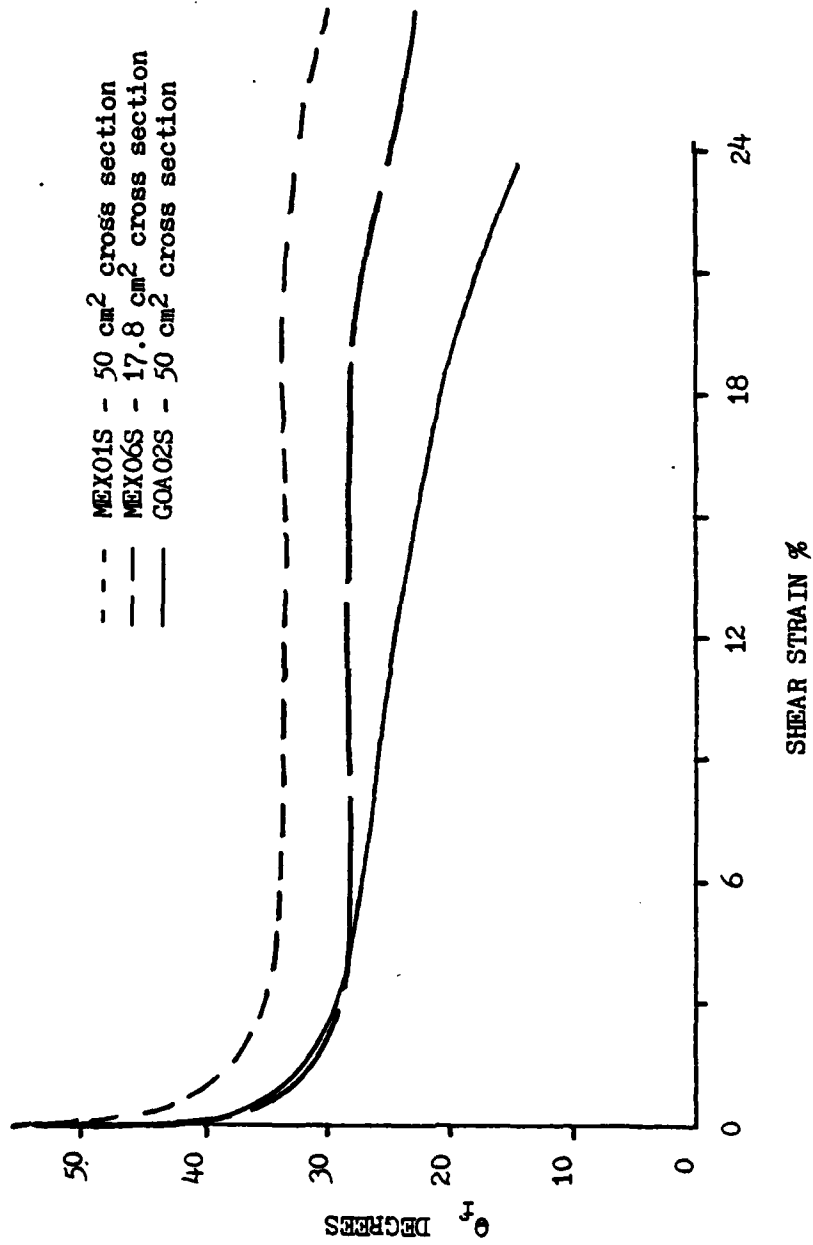

FIGURE 43. THE ANGLE BETWEEN THE HORIZONTAL PLANE AND THE PLANE ON WHICH THE MAXIMUM OBLIQUITY VS. SHEAR STRAIN COMPARED FOR STATIC TESTS PERFORMED ON GULF OF ALASKA CLAY AND GULF OF MEXICO CLAY FOR BOTH STANDARD AND SMALL DIAMETER SAMPLES

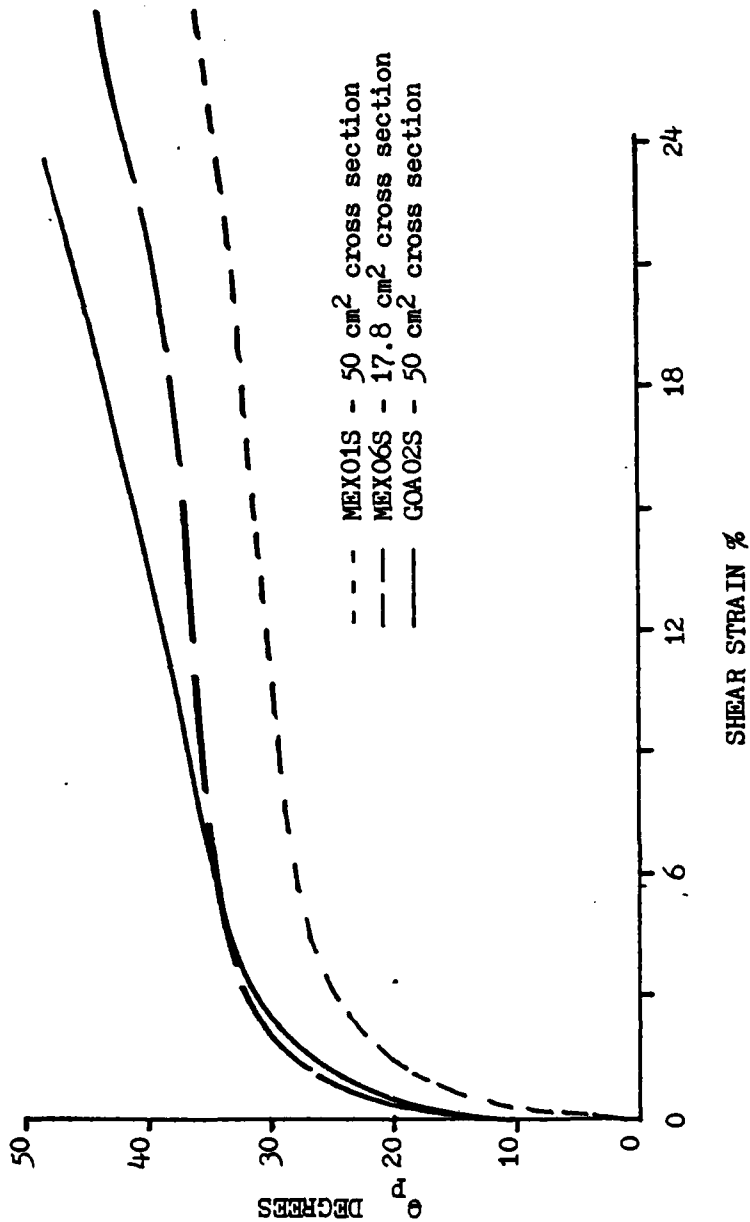

FIGURE 44. THE ANGLE BETWEEN THE HORIZONTAL PLANE AND THE PLANE ON WHICH THE MAXIMUM PRINCIPAL STRESS ACTS VS. SHEAR STRAIN COMPARED FOR STATIC TESTS PERFORMED ON GULF OF ALASKA CLAY AND GULF OF MEXICO CLAY FOR BOTH STANDARD AND SMALL DIAMETER SAMPLES

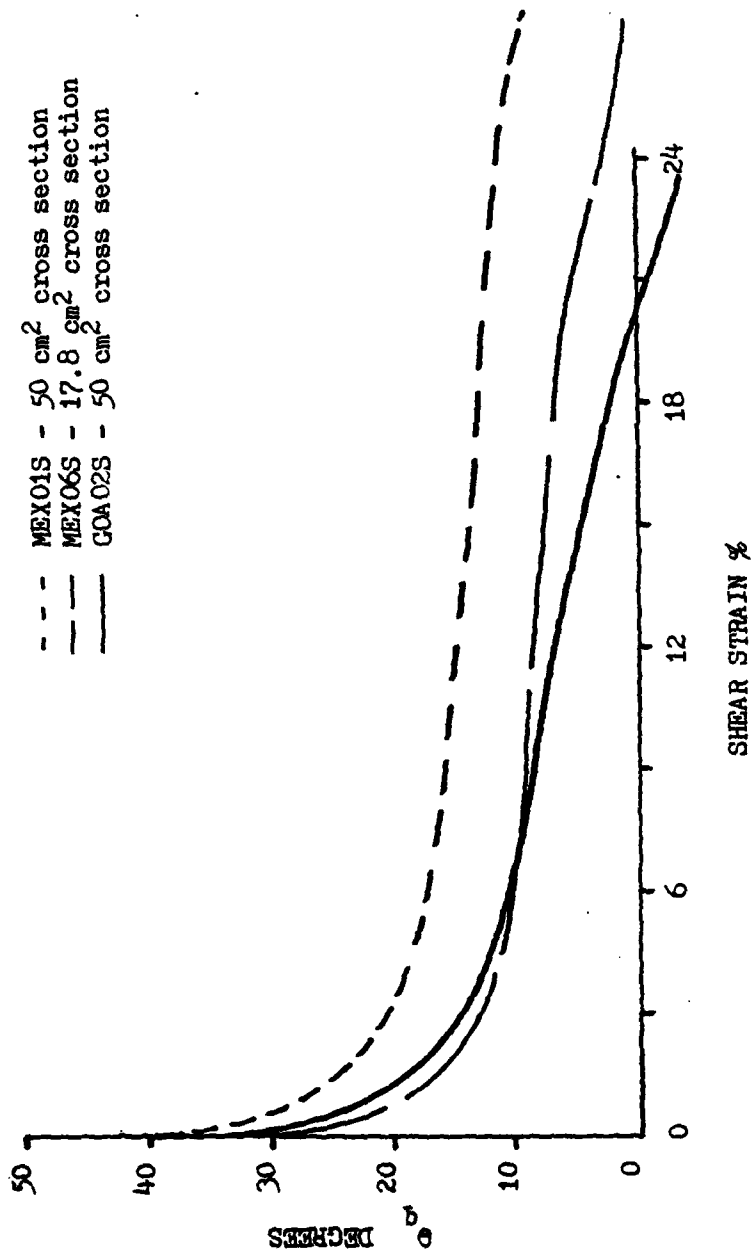

FIGURE 45. THE ANGLE BETWEEN THE HORIZONTAL PLANE AND THE PLANE ON WHICH THE MAXIMUM SHEAR STRESS ACTS VS. SHEAR STRAIN COMPARED FOR STATIC TESTS PERFORMED ON GULF OF ALASKA CLAY AND GULF OF MEXICO CLAY FOR BOTH STANDARD AND SMALL DIAMETER SAMPLES

B. Comparison of Sample Cross-Sectional Size for Cyclic Tests

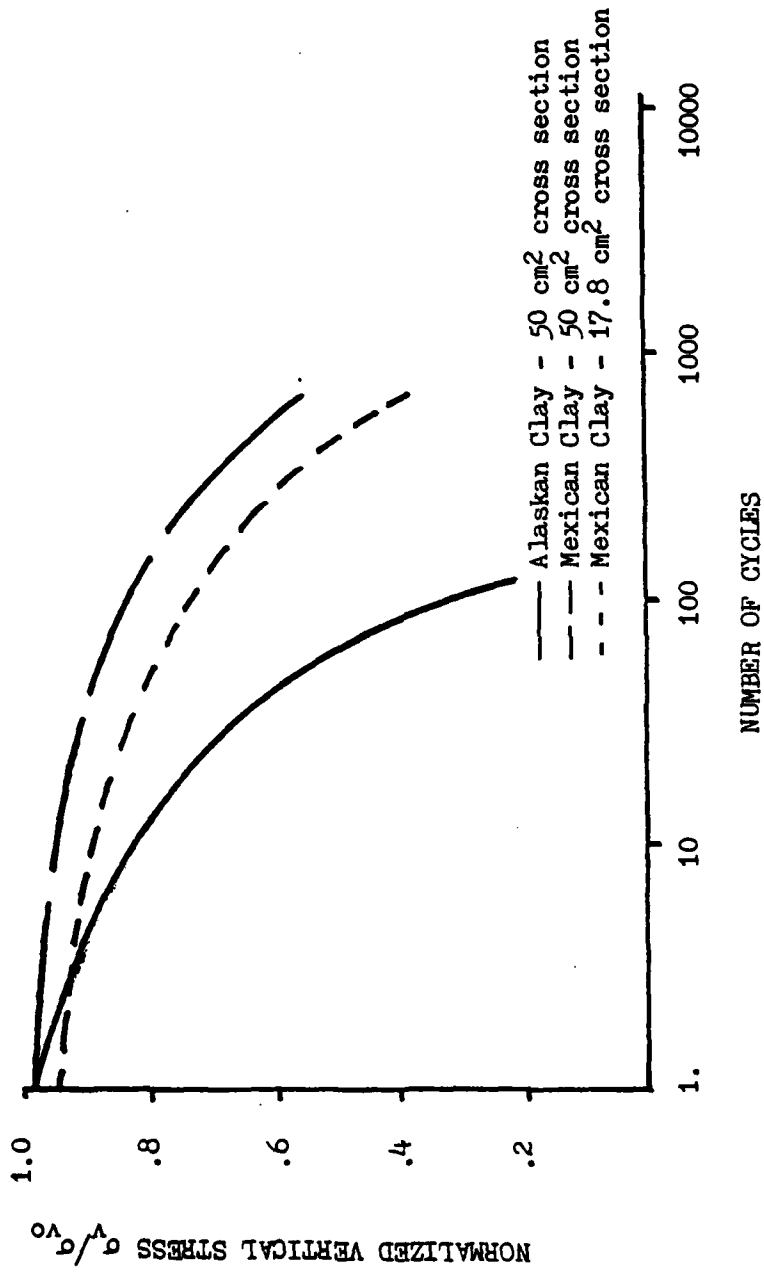

FIGURE 46. AVERAGE VERTICAL STRESS VS. NUMBER OF CYCLES COMPARED FOR CYCLIC TESTS PERFORMED ON GULF OF ALASKA CLAY AND GULF OF MEXICO CLAY FOR BOTH STANDARD AND SMALL DIAMETER SAMPLES

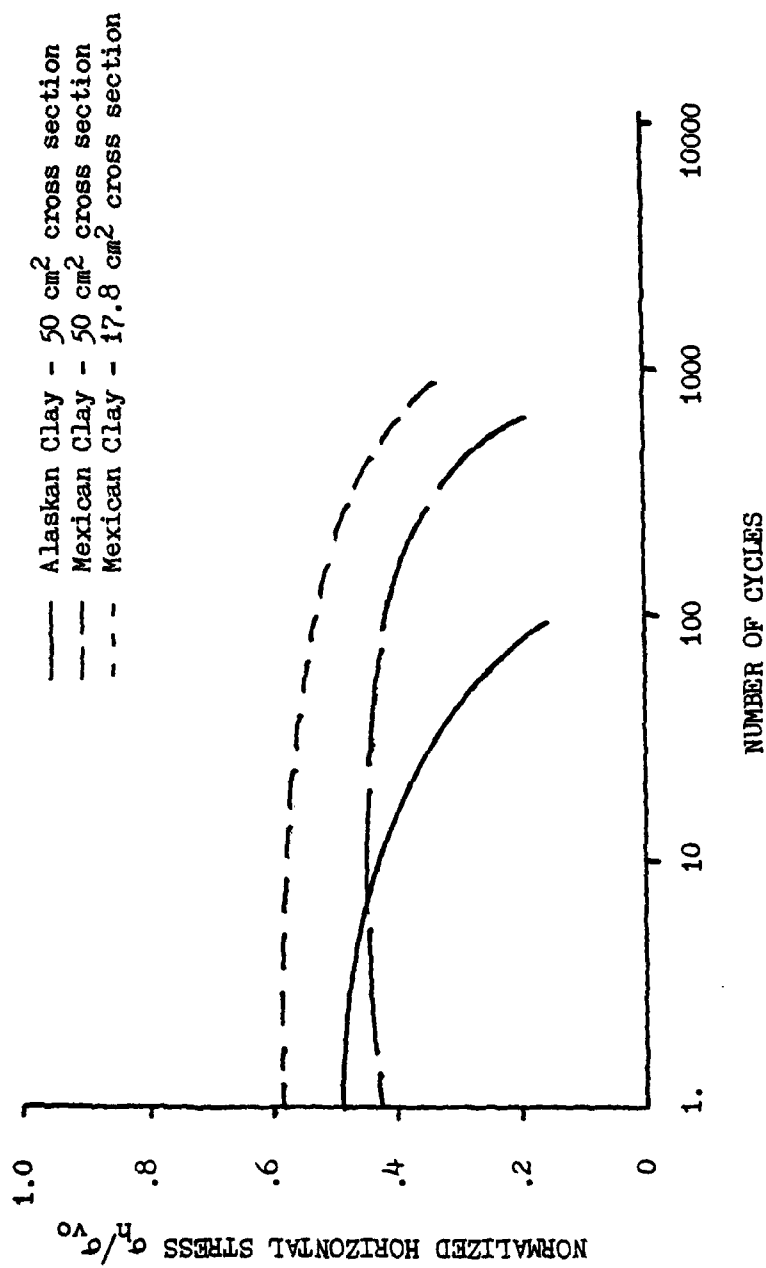

FIGURE 47. AVERAGE HORIZONTAL STRESS VS. NUMBER OF CYCLES COMPARED FOR CYCLIC TESTS PERFORMED ON GULF OF ALASKA CLAY AND GULF OF MEXICO CLAY FOR BOTH STANDARD AND SMALL DIAMETER SAMPLES

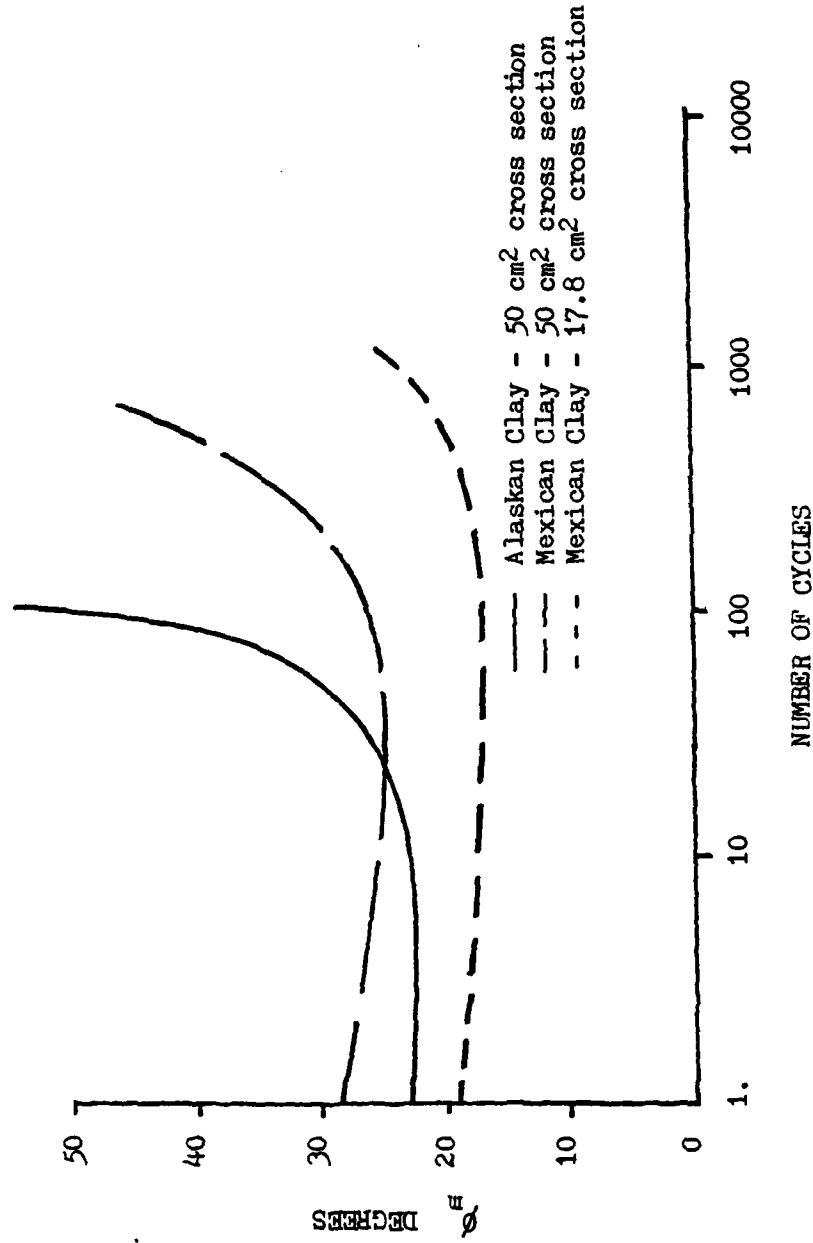

FIGURE 48. AVERAGE MOBILIZED ANGLE OF INTERNAL FRICTION VS. NUMBER OF CYCLES COMPARED FOR CYCLIC TESTS PERFORMED ON GULF OF ALASKA CLAY AND GULF OF MEXICO CLAY FOR BOTH STANDARD AND SMALL DIAMETER SAMPLES

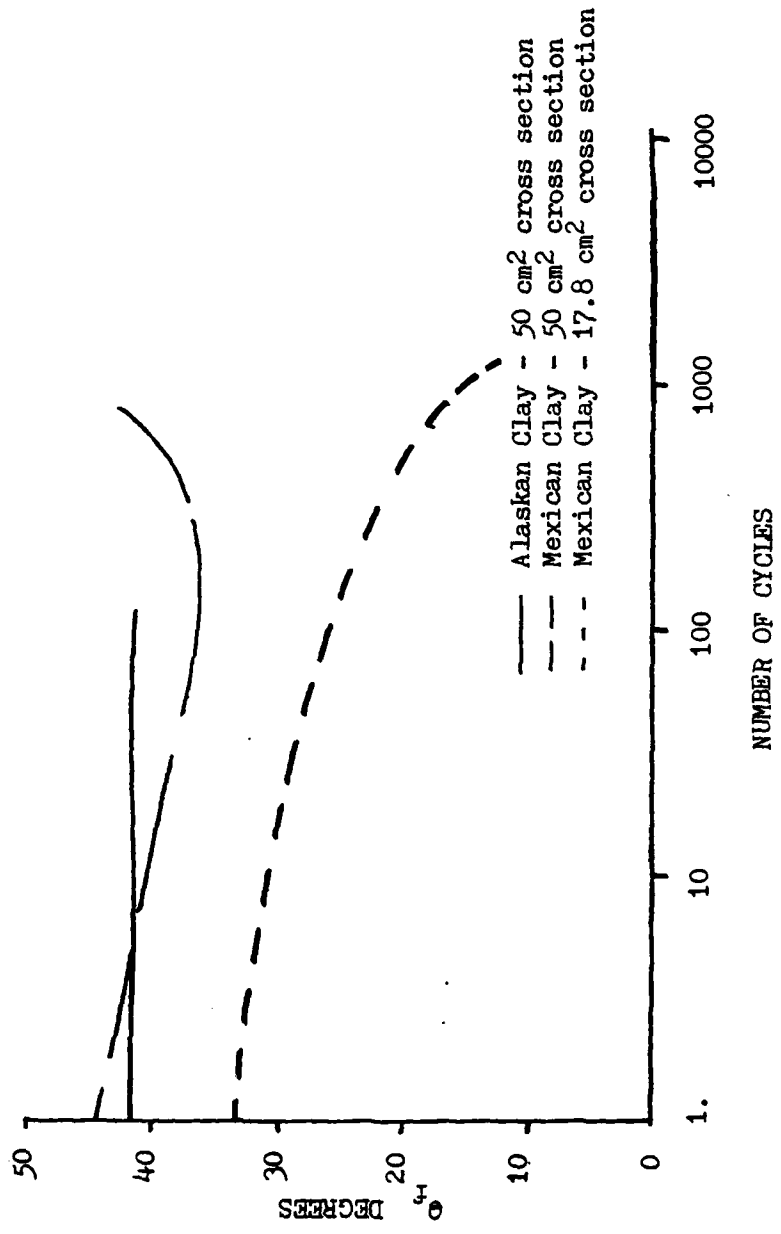

FIGURE 49. THE AVERAGE ANGLE BETWEEN THE HORIZONTAL PLANE AND THE PLANE OF MAXIMUM OBLIQUITY VS. NUMBER OF CYCLES COMPARED FOR CYCLIC TESTS PERFORMED ON GULF OF ALASKA CLAY AND GULF OF MEXICO CLAY FOR BOTH STANDARD AND SMALL DIAMETER SAMPLES

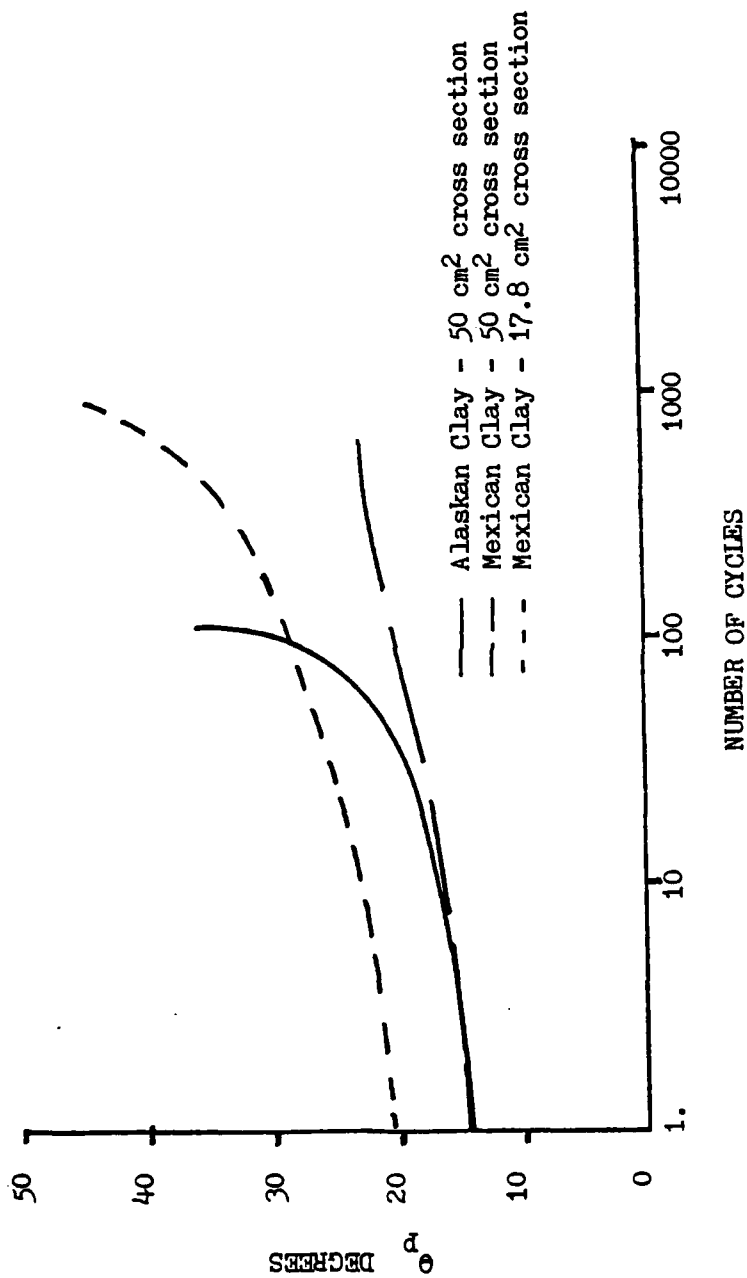

FIGURE 50. THE AVERAGE ANGLE BETWEEN THE HORIZONTAL PLANE AND THE MAJOR PRINCIPAL PLANE VS. NUMBER OF CYCLES COMPARED FOR CYCLIC TESTS PERFORMED ON GULF OF ALASKA CLAY AND GULF OF MEXICO CLAY FOR BOTH STANDARD AND SMALL DIAMETER SAMPLES

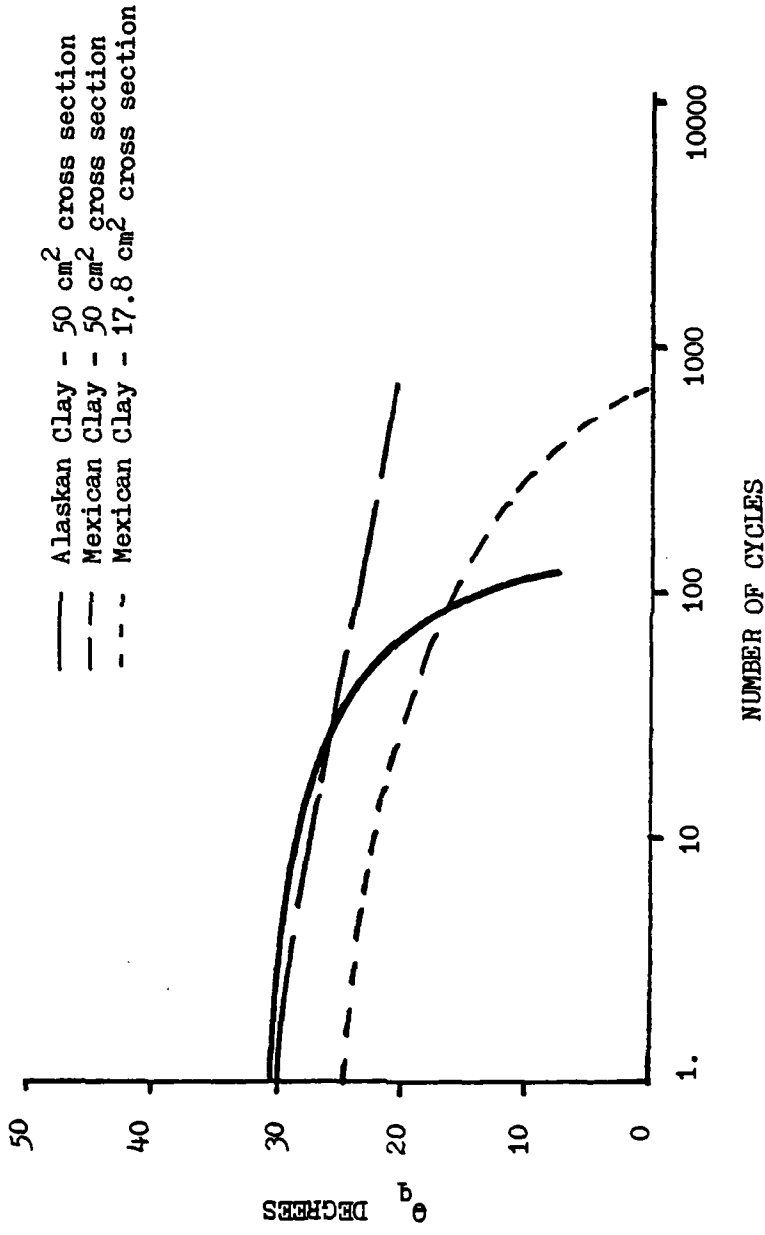

FIGURE 51. THE AVERAGE ANGLE BETWEEN THE HORIZONTAL PLANE AND THE PLANE ON WHICH THE MAXIMUM SHEAR STRESS ACTS VS. NUMBER OF CYCLES COMPARED FOR CYCLIC TESTS PERFORMED ON GULF OF ALASKA AND GULF OF MEXICO CLAY FOR BOTH STANDARD AND SMALL DIAMETER SAMPLES

C. Comparison of Sample Heights for Cyclic Tests

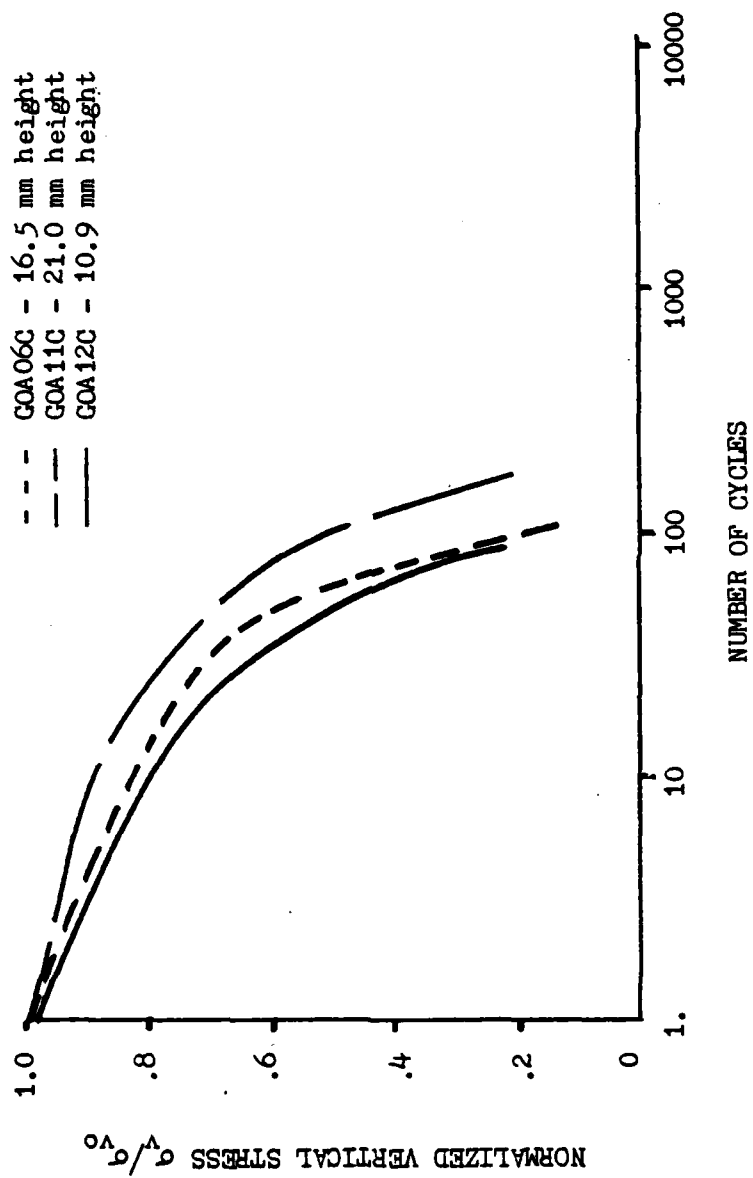

FIGURE 52. VERTICAL STRESS VS. NUMBER OF CYCLES COMPARED FOR TESTS ON 50 cm² CROSS SECTIONAL AREA GULF OF ALASKA CLAY SAMPLES OF VARYING HEIGHTS

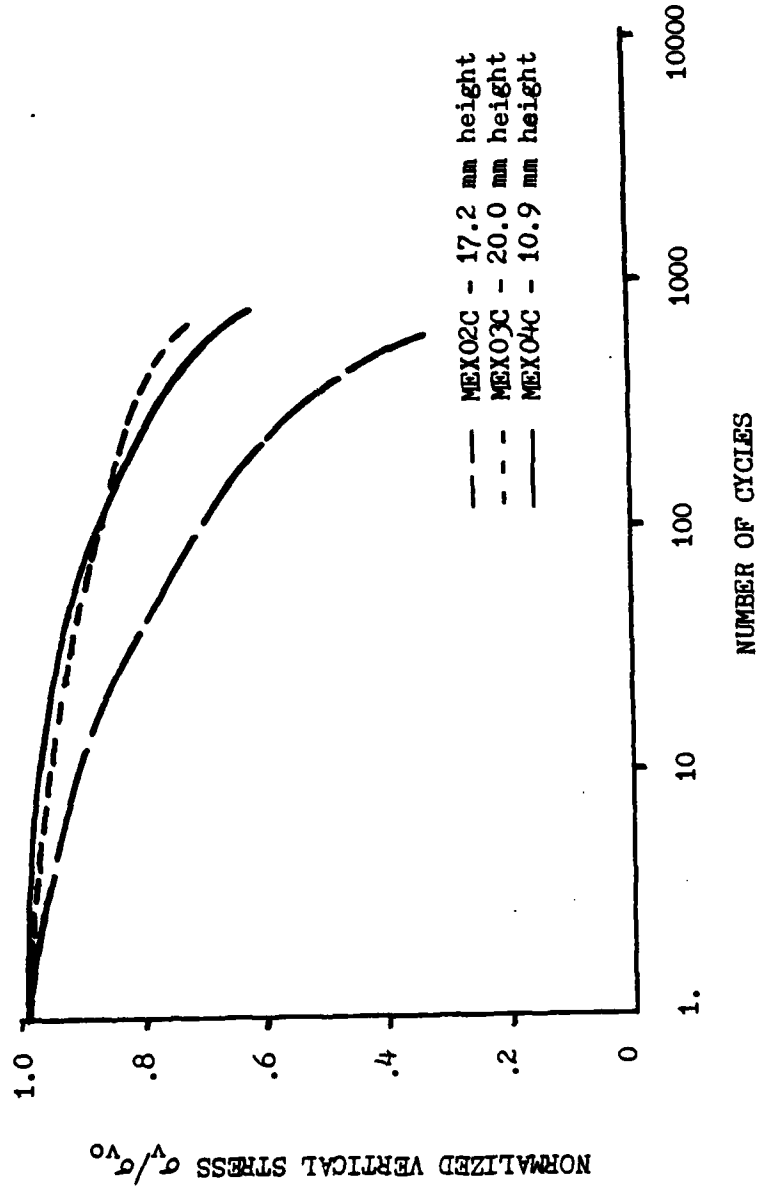

FIGURE 53. VERTICAL STRESS VS. NUMBER OF CYCLES COMPARED FOR TESTS ON 50 cm² CROSS SECTIONAL AREA GULF OF MEXICO CLAY SAMPLES OF VARYING HEIGHTS

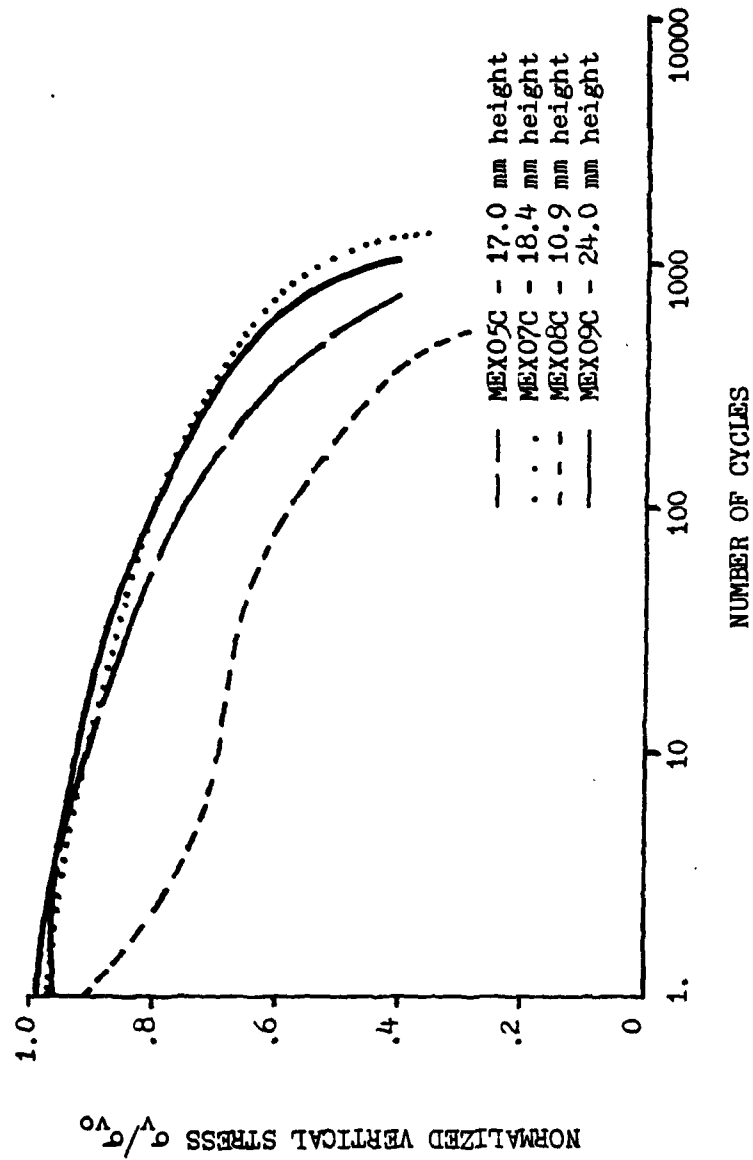

FIGURE 54. VERTICAL STRESS VS. NUMBER OF CYCLES COMPARED FOR TESTS ON 17.8 cm^2 CROSS SECTIONAL AREA GULF OF MEXICO CLAY SAMPLES OF VARYING HEIGHTS

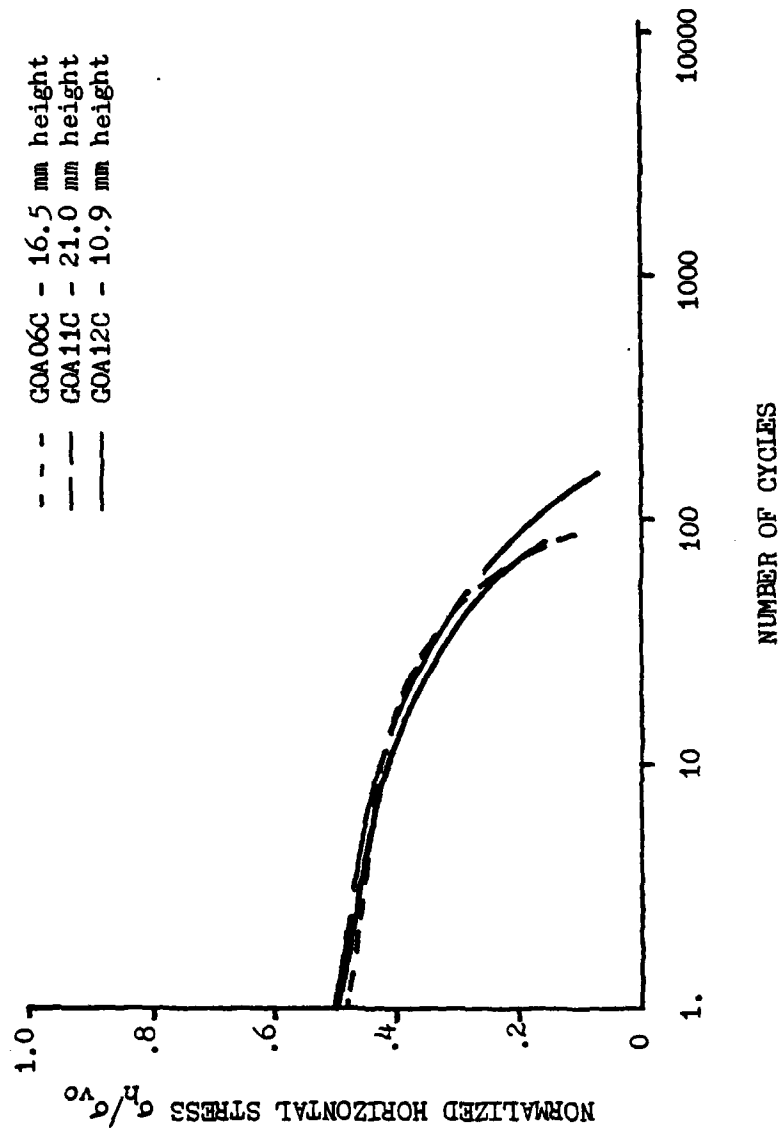

FIGURE 55. HORIZONTAL STRESS VS. NUMBER OF CYCLES COMPARED FOR TESTS ON 50 cm² CROSS SECTIONAL AREA GULF OF ALASKA CLAY SAMPLES OF VARYING HEIGHTS

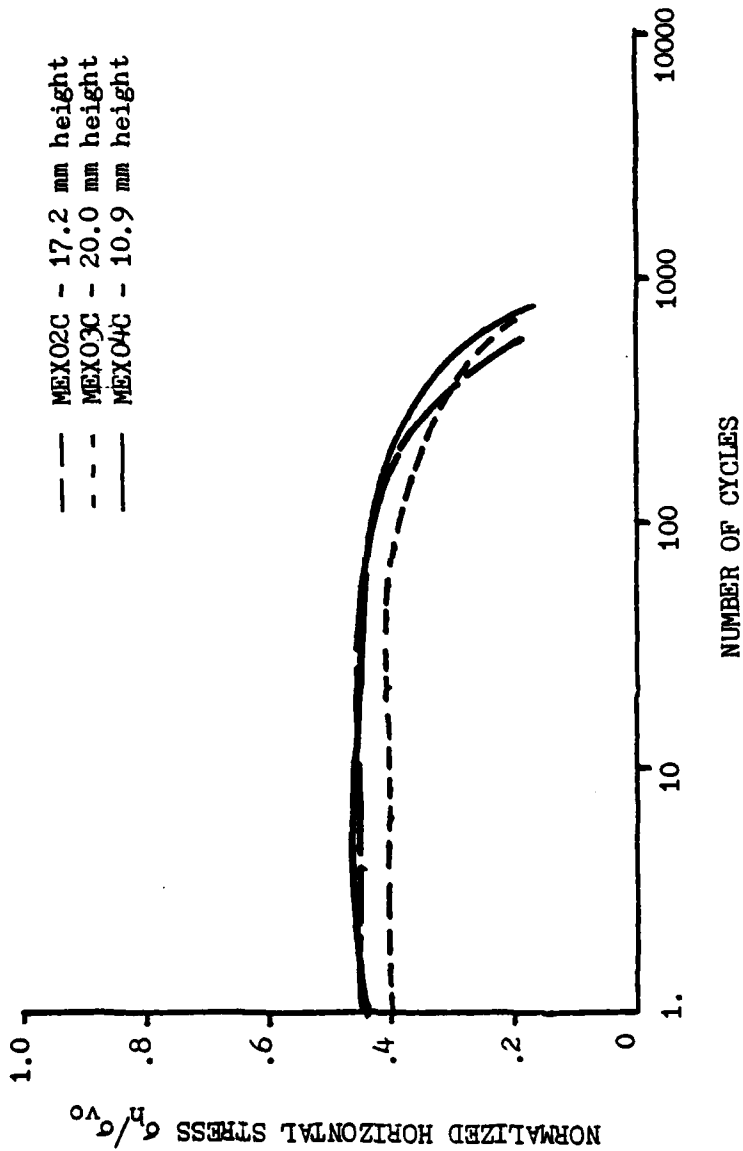

FIGURE 56. HORIZONTAL STRESS VS. NUMBER OF CYCLES COMPARED FOR TESTS ON 50 cm² CROSS SECTIONAL AREA GULF OF MEXICO CLAY SAMPLES OF VARYING HEIGHTS

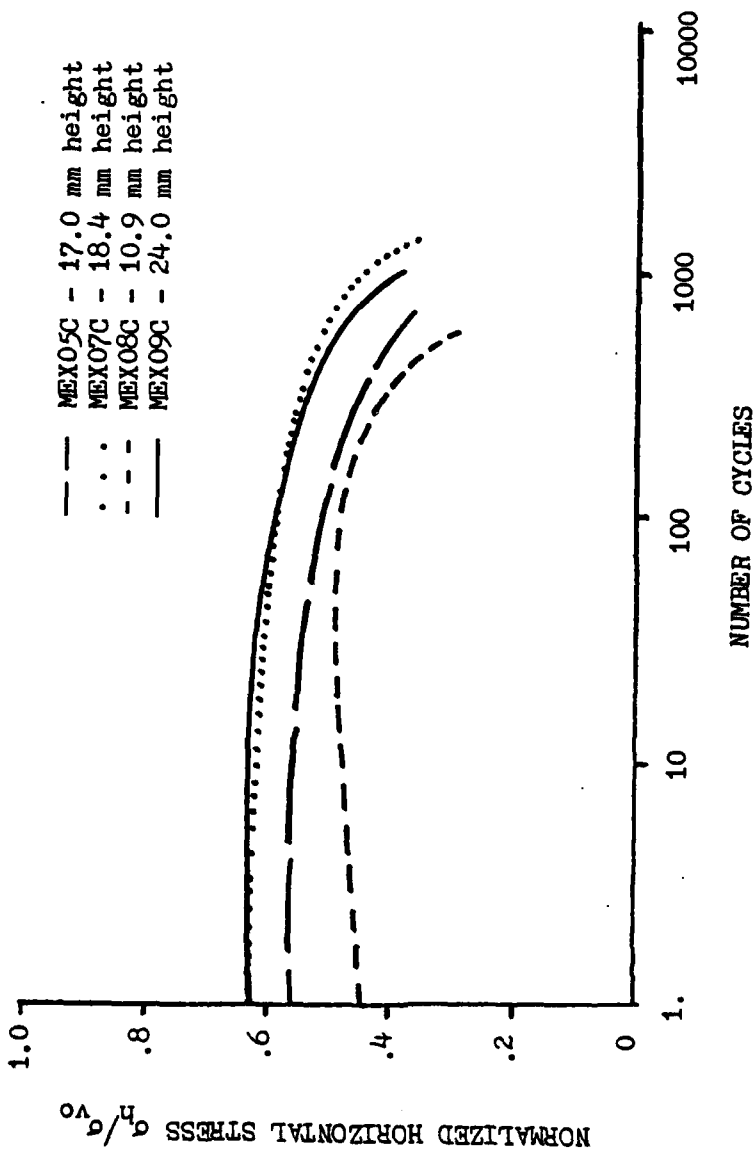

FIGURE 57. HORIZONTAL STRESS VS. NUMBER OF CYCLES COMPARED FOR TESTS ON 178 cm² CROSS SECTIONAL AREA GULF OF MEXICO CLAY SAMPLES OF VARYING HEIGHTS

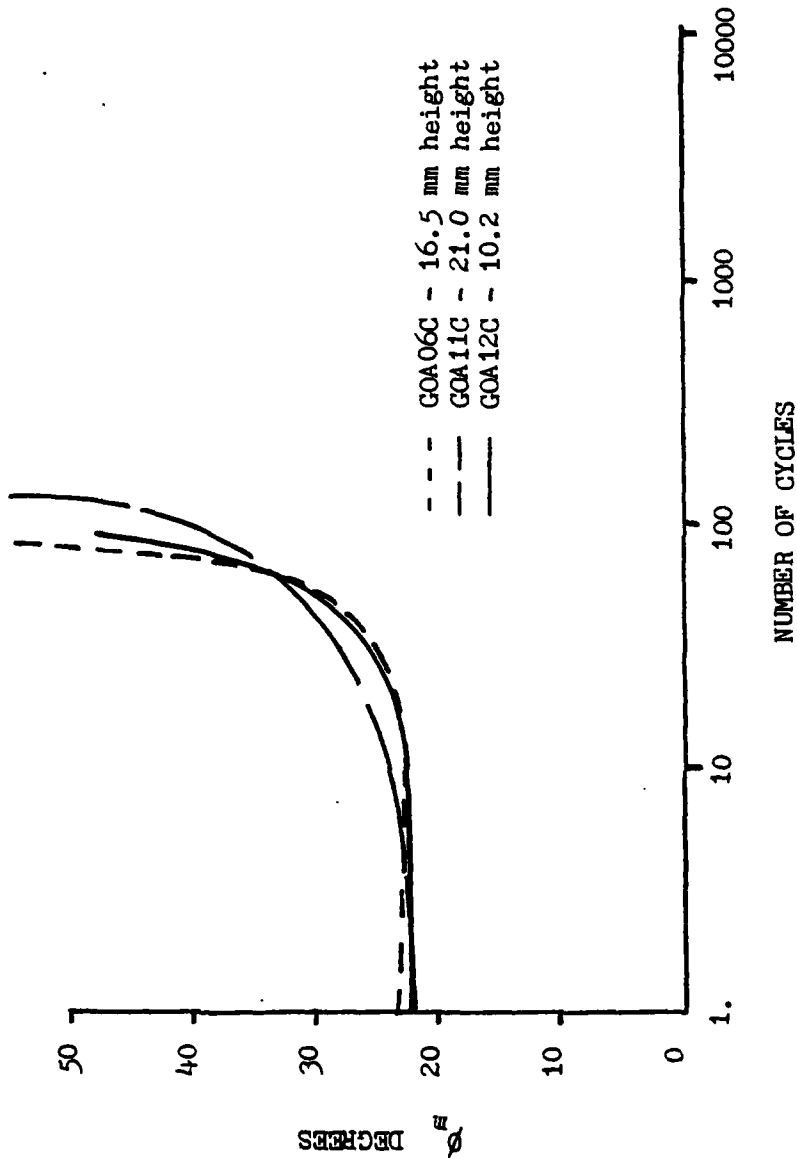

FIGURE 58. MOBILIZED ANGLE OF INTERNAL FRICTION VS. NUMBER OF CYCLES COMPARED FOR TESTS ON 50 cm² CROSS SECTIONAL AREA GULF OF ALASKA CLAY SAMPLES OF VARYING HEIGHTS

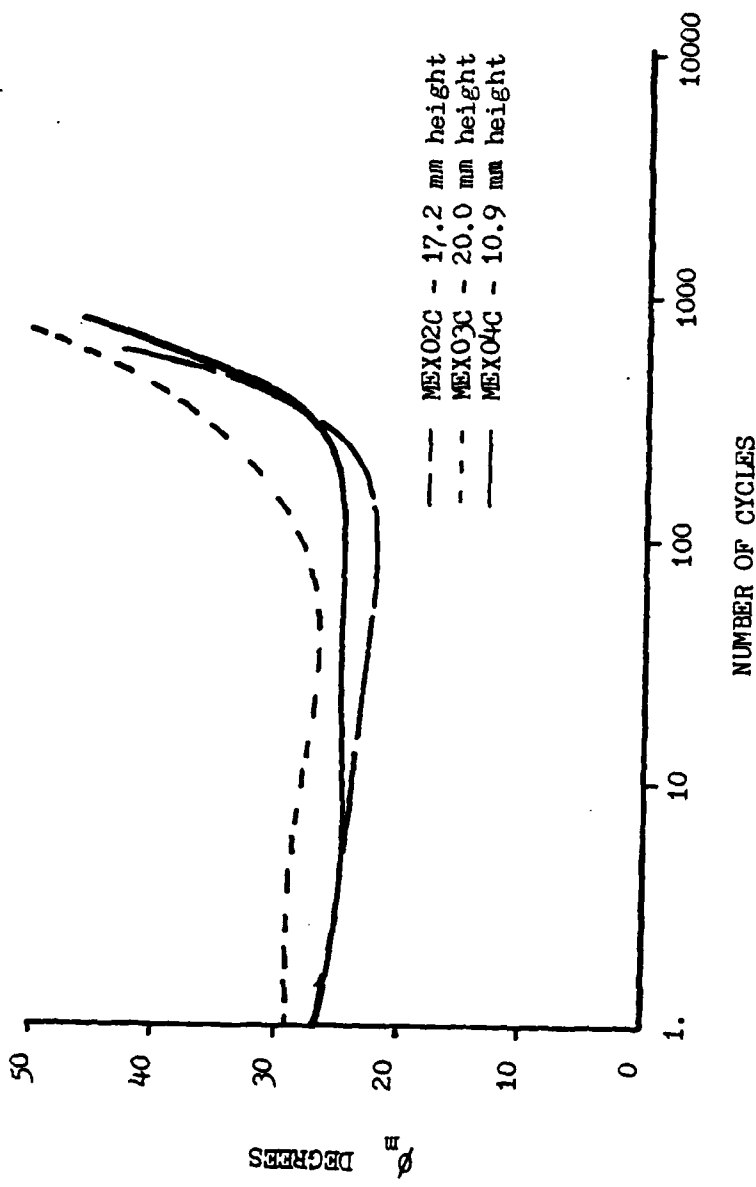

FIGURE 59. MOBILIZED ANGLE OF INTERNAL FRICTION VS. NUMBER OF CYCLES COMPARED FOR TESTS ON 50 cm² CROSS SECTIONAL AREA GULF OF MEXICO CLAY SAMPLES OF VARYING HEIGHTS

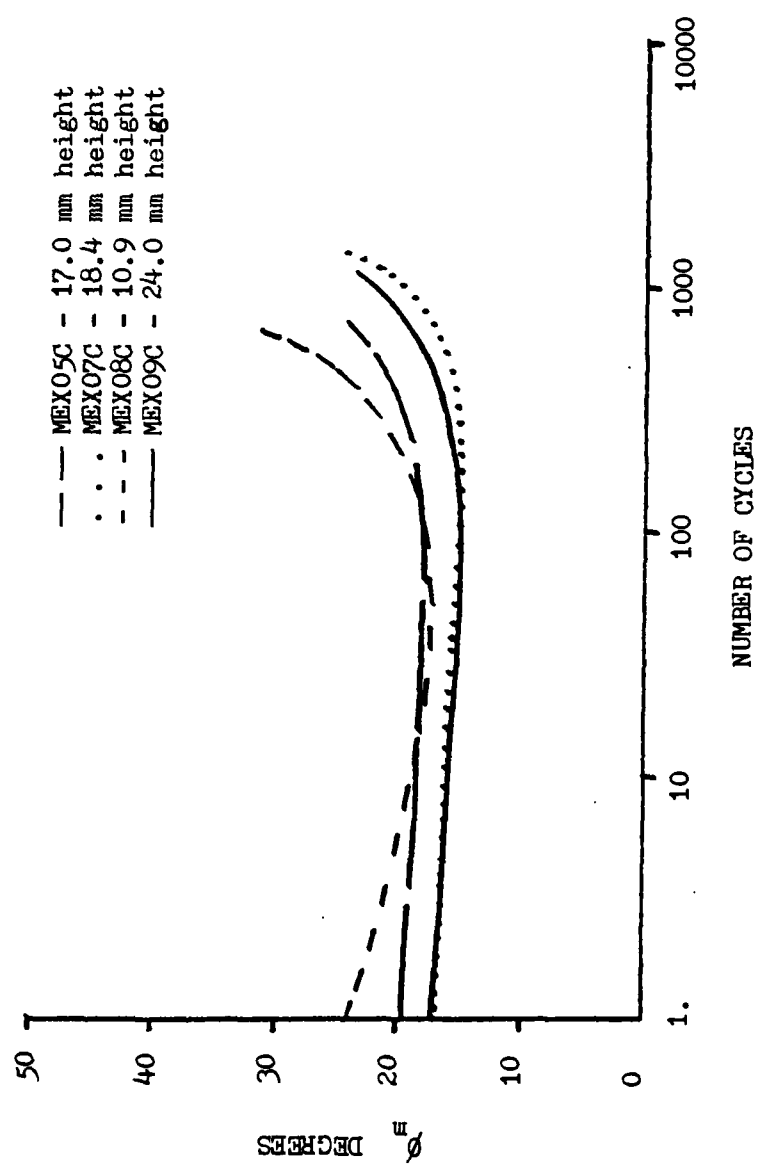

FIGURE 60. MOBILIZED ANGLE OF INTERNAL FRICTION VS. NUMBER OF CYCLES COMPARED FOR TESTS ON 17.8 cm² CROSS SECTIONAL AREA GULF OF MEXICO CLAY SAMPLES OF VARYING HEIGHTS

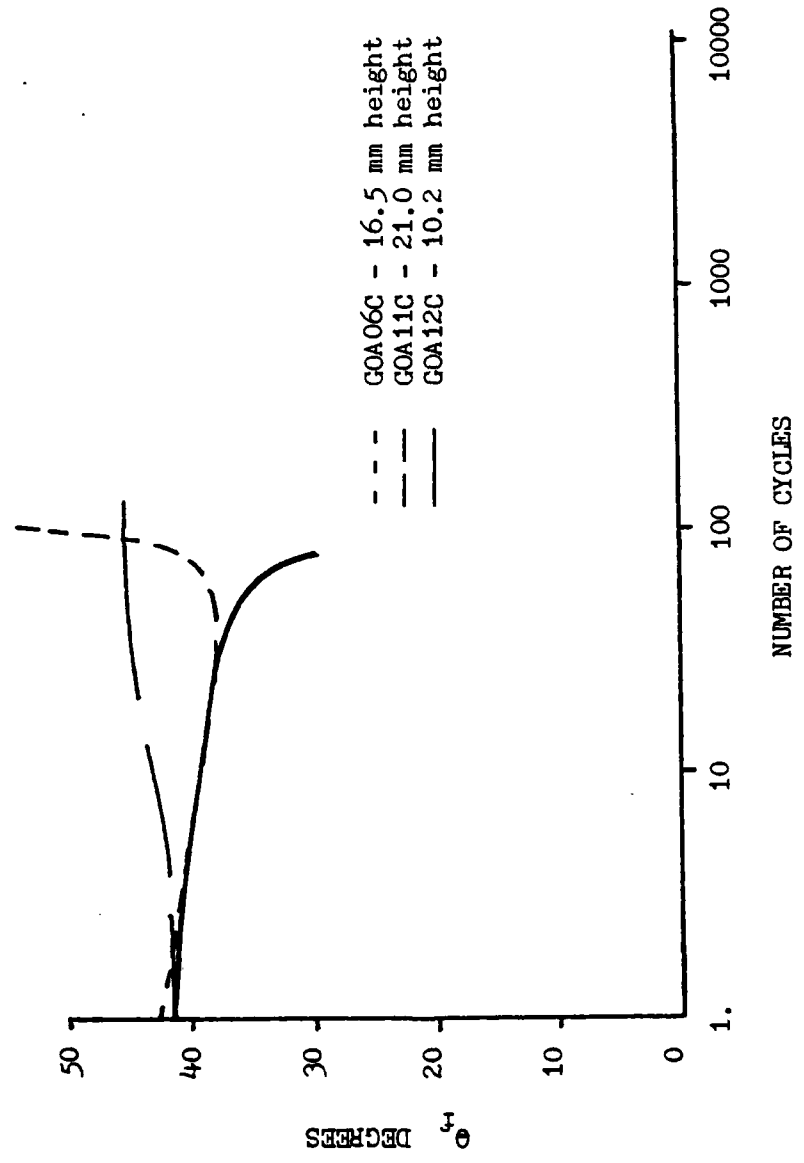

FIGURE 61. THE ANGLE BETWEEN THE HORIZONTAL PLANE AND THE PLANE OF MAXIMUM OBLIQUITY VS. NUMBER OF CYCLES COMPARED FOR TESTS ON 50cm² CROSS SECTIONAL AREA GULF OF ALASKA CLAY SAMPLES OF VARYING HEIGHTS

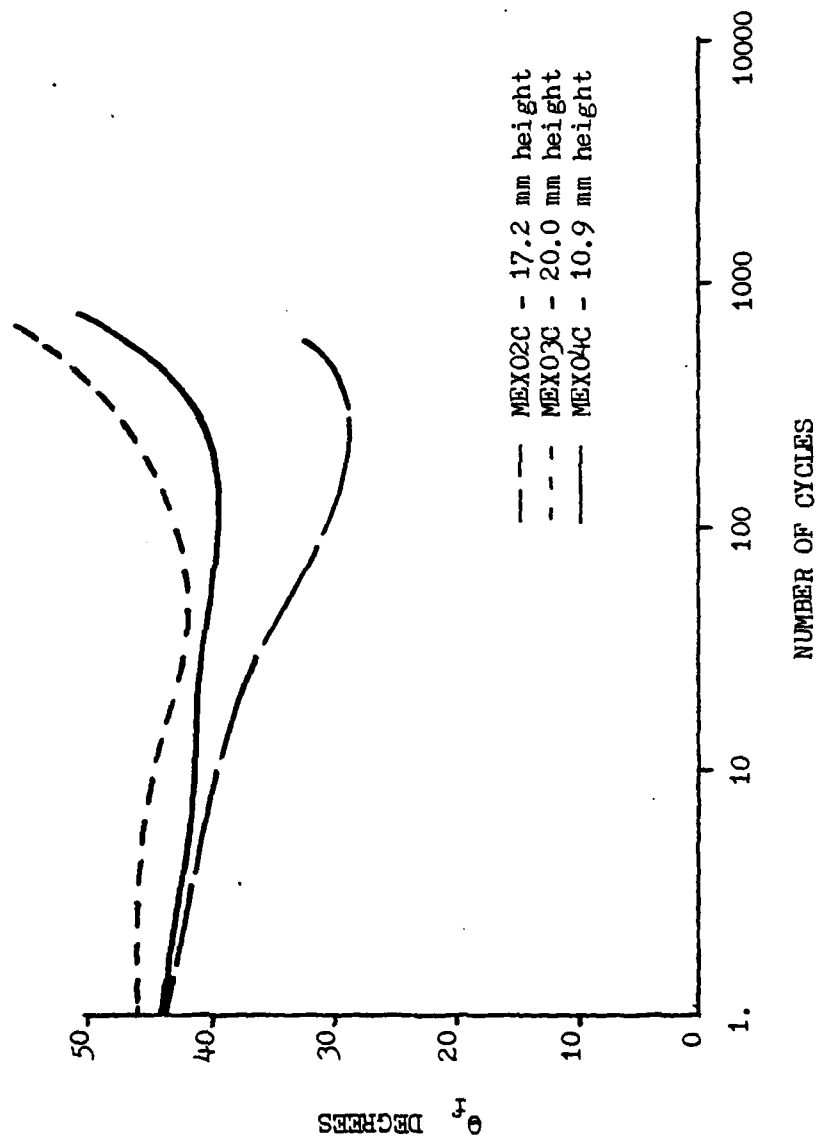

FIGURE 62. THE ANGLE BETWEEN THE HORIZONTAL PLANE AND THE PLANE OF MAXIMUM OBLIQUITY VS. NUMBER OF CYCLES COMPARED FOR TESTS ON 50 cm² CROSS SECTIONAL AREA GULF OF MEXICO CLAY SAMPLES OF VARYING HEIGHTS

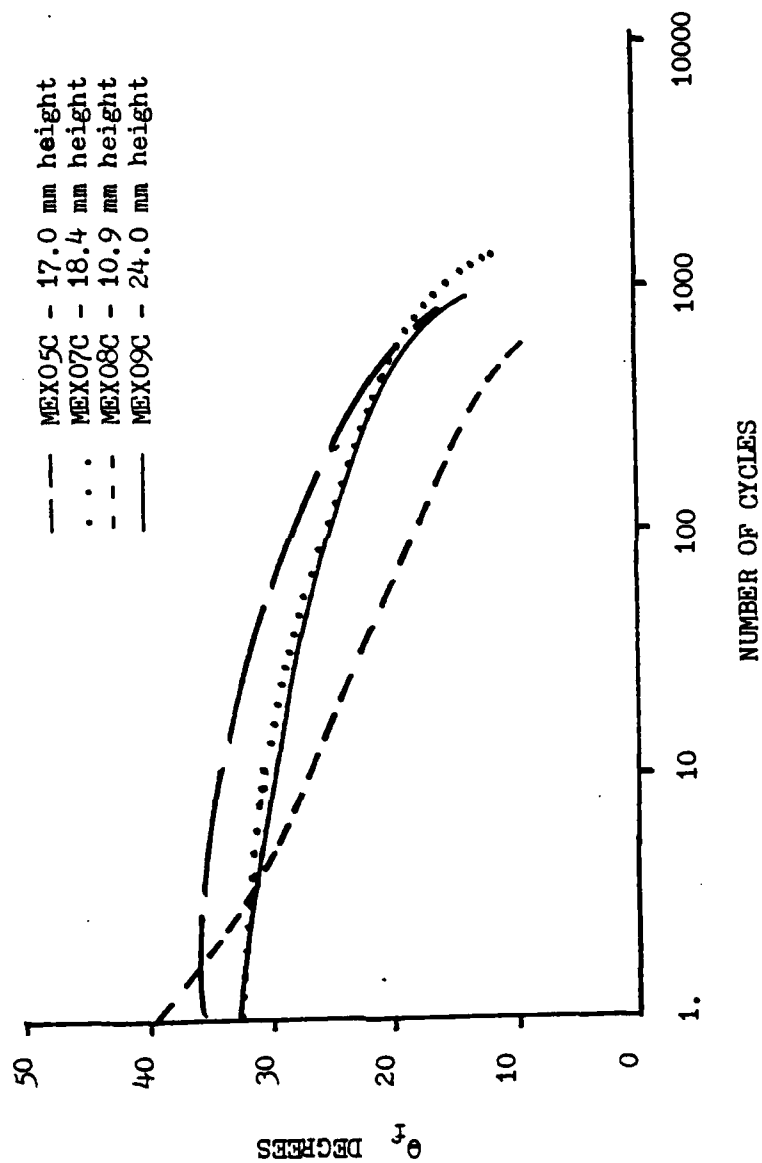

FIGURE 63. THE ANGLE BETWEEN THE HORIZONTAL PLANE AND THE PLANE OF
 MAXIMUM OBLIQUITY VS. NUMBER OF CYCLES COMPARED FOR TESTS
 ON 17.8 cm² CROSS SECTIONAL AREA GULF OF MEXICO CLAY SAM-
 PLES OF VARYING HEIGHTS

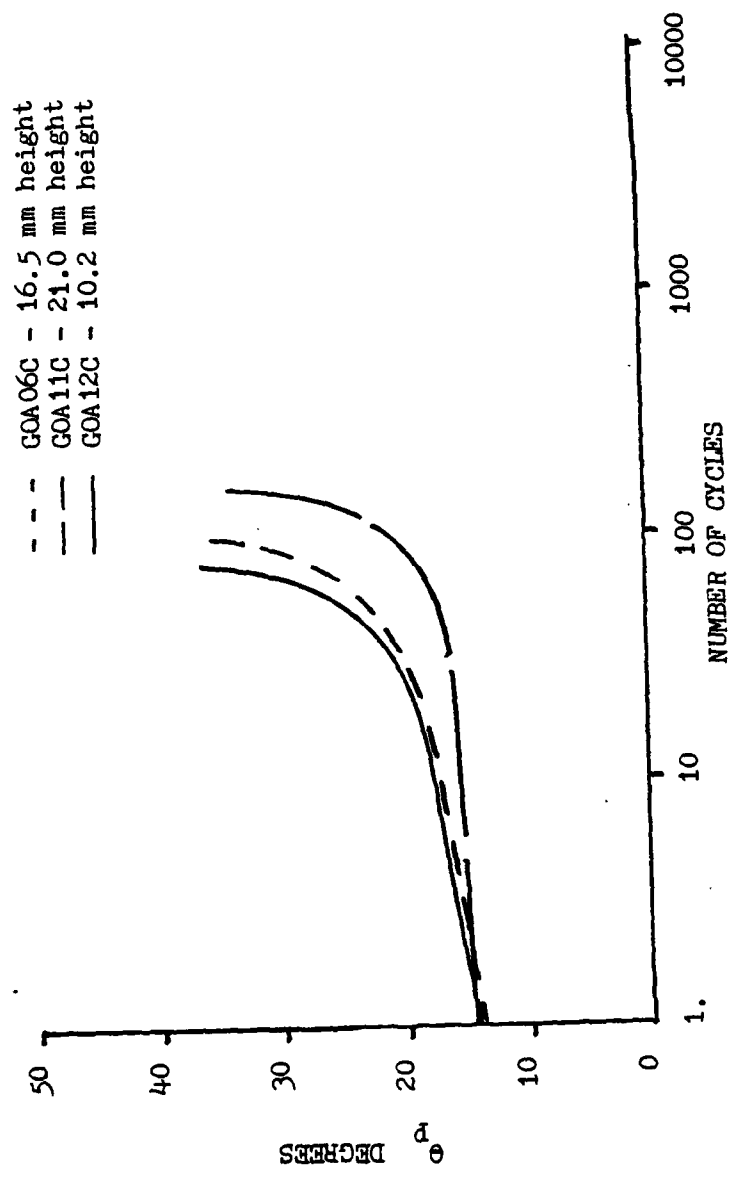

FIGURE 64. THE ANGLE BETWEEN THE HORIZONTAL PLANE AND THE MAJOR PRINCIPAL PLANE VS. NUMBER OF CYCLES COMPARED FOR TESTS ON 50 cm² CROSS SECTIONAL AREA GULF OF ALASKA CLAY SAMPLES OF VARYING HEIGHTS

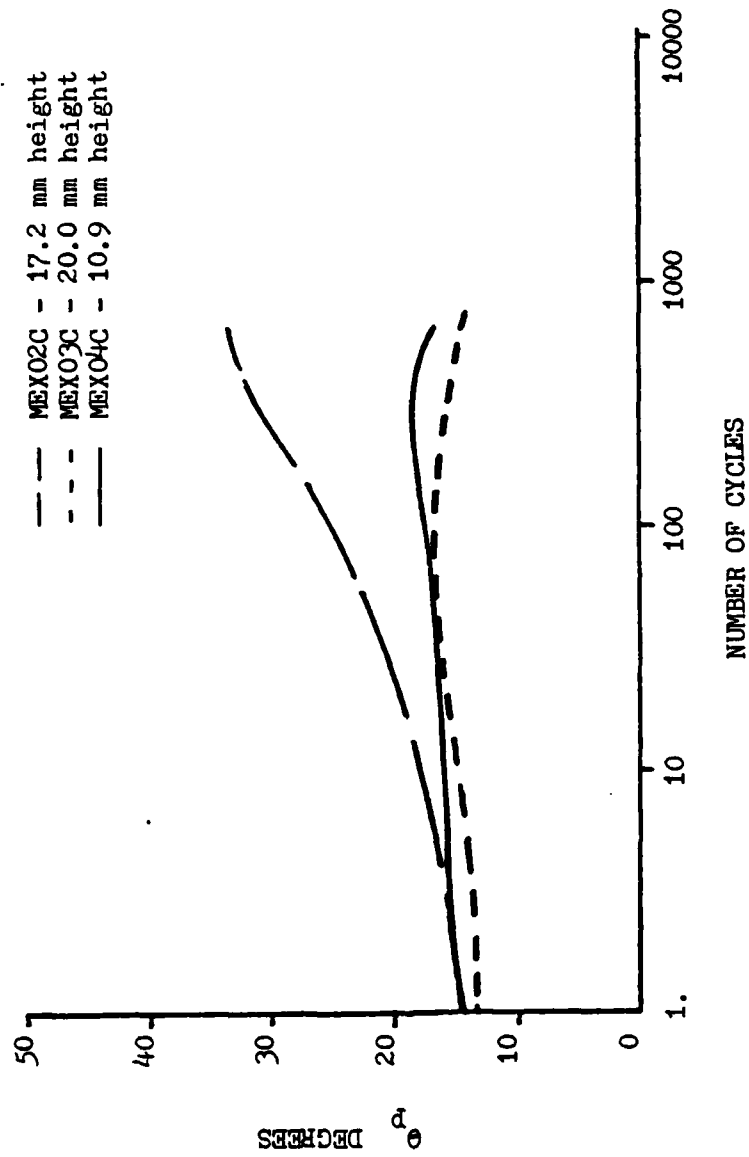

FIGURE 65. THE ANGLE BETWEEN THE HORIZONTAL PLANE AND THE MAJOR PRINCIPAL PLANE VS. NUMBER OF CYCLES COMPARED FOR TESTS ON 50 cm² CROSS SECTIONAL AREA GULF OF MEXICO CLAY SAMPLES OF VARYING HEIGHTS

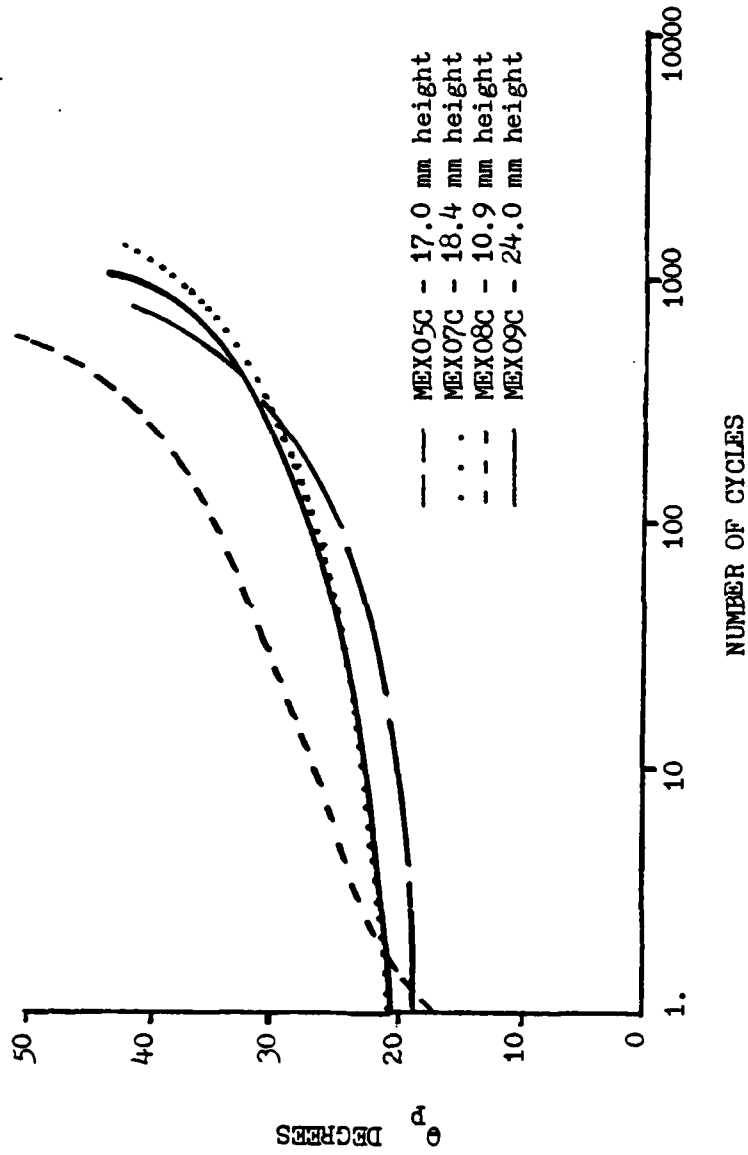

FIGURE 66. THE ANGLE BETWEEN THE HORIZONTAL PLANE AND THE MAJOR PRINCIPAL PLANE VS. NUMBER OF CYCLES COMPARED FOR TESTS ON 17.8 cm^2 CROSS SECTIONAL AREA GULF OF MEXICO CLAY SAMPLES OF VARYING HEIGHTS

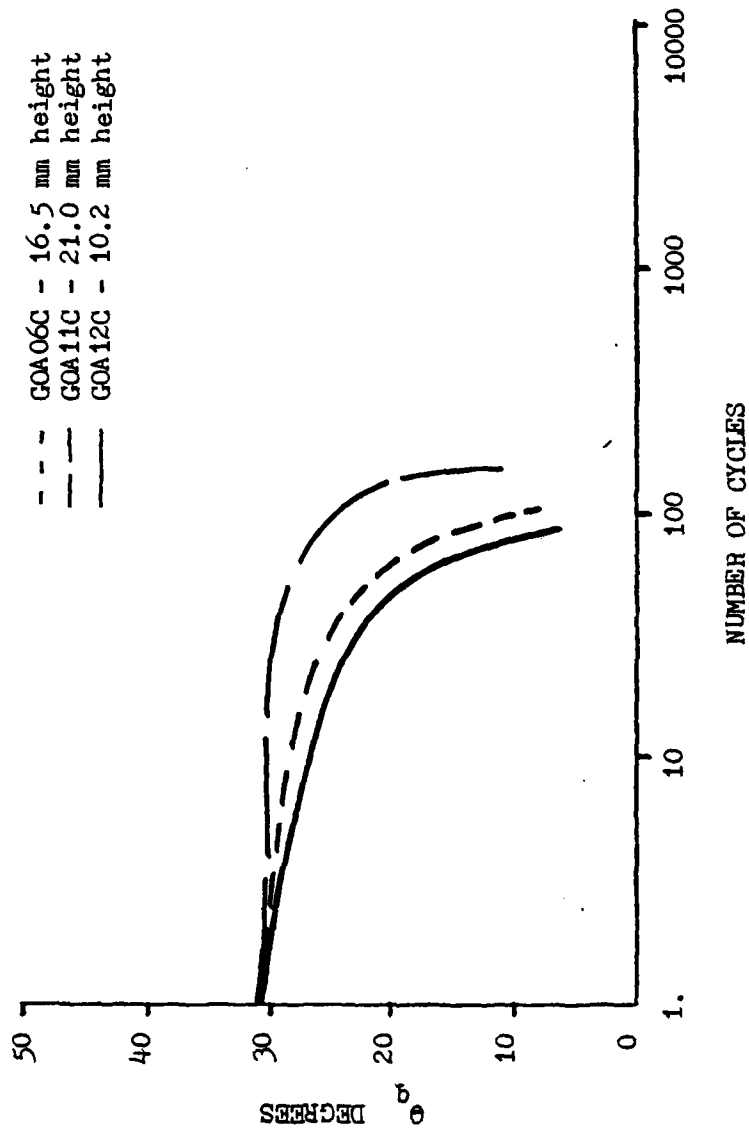

FIGURE 67. THE ANGLE BETWEEN THE HORIZONTAL PLANE AND THE PLANE ON WHICH THE MAXIMUM SHEAR STRESS ACTS VS. NUMBER OF CYCLES COMPARED FOR TESTS ON 50cm² CROSS SECTIONAL AREA GULF OF ALASKA CLAY SAMPLES OF VARYING HEIGHTS

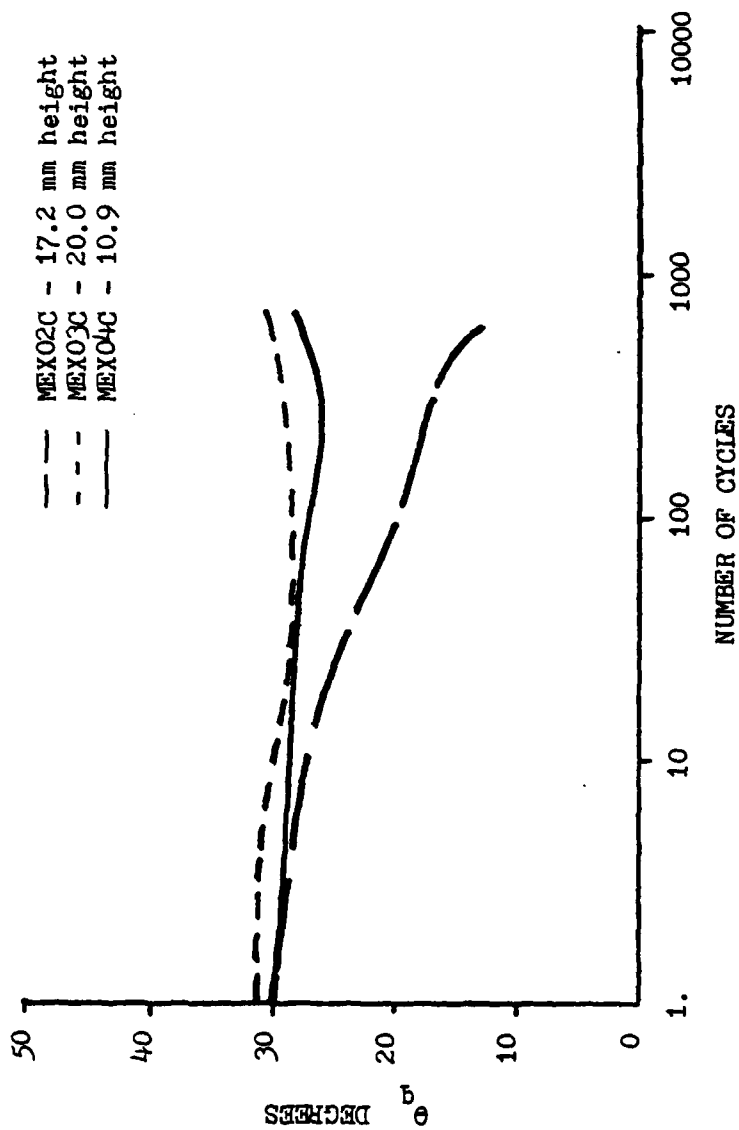

FIGURE 68. THE ANGLE BETWEEN THE HORIZONTAL PLANE AND THE PLANE ON WHICH THE MAXIMUM SHEAR STRESS ACTS VS. NUMBER OF CYCLES COMPARED FOR TESTS ON 50 cm² CROSS SECTIONAL AREA GULF OF MEXICO CLAY SAMPLES OF VARYING HEIGHTS

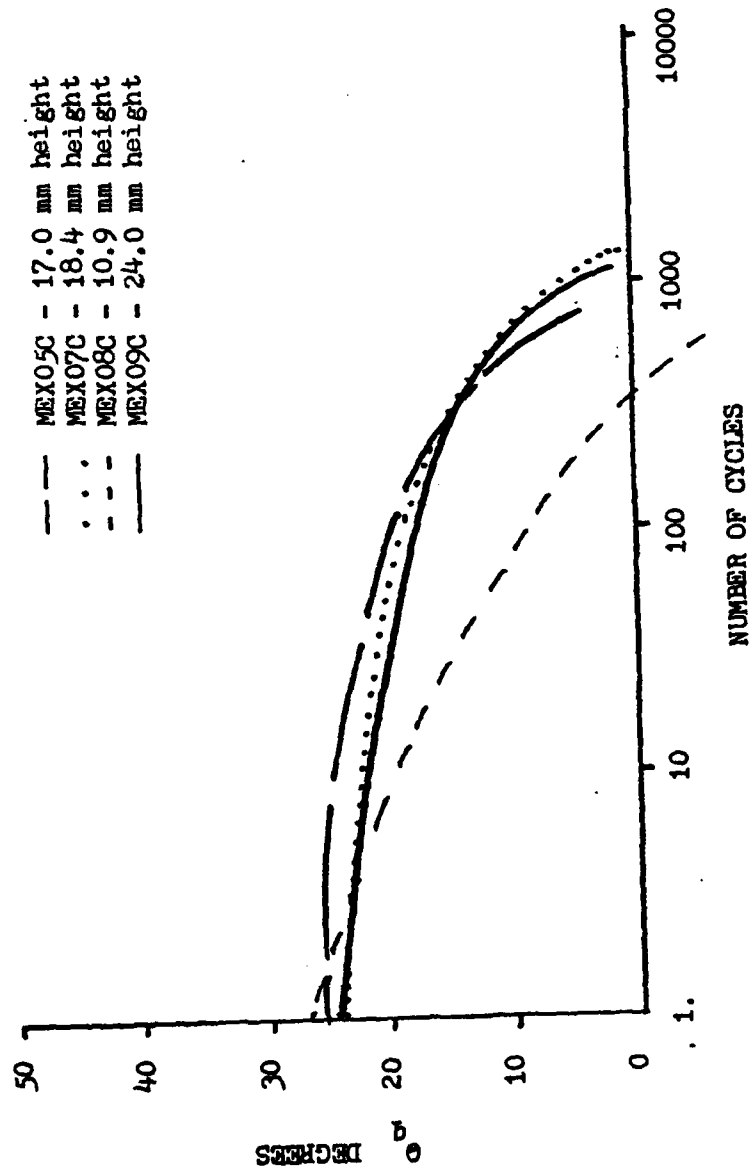

FIGURE 69. THE ANGLE BETWEEN THE HORIZONTAL PLANE AND THE PLANE ON WHICH THE MAXIMUM SHEAR STRESS ACTS VS. NUMBER OF CYCLES COMPARED FOR TESTS ON 17.8 cm² CROSS SECTIONAL AREA GULF OF MEXICO CLAY SAMPLES OF VARYING HEIGHTS

APPENDIX B

SAMPLE PREPARATION -- STEP BY STEP PROCEDURES

The study of soil requires the ability to analyze specimens in conditions simulating as closely as possible those encountered under real conditions. Maintaining soil samples undisturbed through storage, sample preparation, and eventual testing is of utmost importance. The marine soft clays studied during this research required extreme care so as not to disturb their structures.

During the course of finalizing and then further refining the sample preparation procedures to be discussed, it became acutely obvious that sample preparation is not only a science but an art.

These instructions are written with the user in mind. It is assumed he has access to the Geonor Manual, "Description and Instruction for Use of the Direct Simple-Shear Apparatus - Model h-12" or is at least aware of all the soil trimming equipment. A great deal of the procedures listed here are based directly on the above mentioned Geonor Manual and should be so noted.

Before the soil can be touched, all trimming equipment and other apparatus must be readied so as not to subject the soil to prolonged times for drying. These preparations include the oiling, with silicon oil, of all NGI sample trimming equipment to include the columns of the base but not to include the membrane expander unit. Also two small spatulas, a very thin metal cutting plate, and a wire saw should be oiled. Four

water content dishes should be cleaned, dried and weighed. The membrane should be mounted in the membrane expander. After applying a vacuum, ensure that the interior of the membrane is smooth. The inside of the membrane should then be oiled. Filter paper should be cut to barely cover the porous stone*. The bottom sample cap (called filter holder by Geonor) should be mounted in the mounting ring. The ring is used to ensure that the lower sample cap and the top of the cutting cylinder are flush. Be certain that the cap remains concentric while tightening the ring screws. A saturated filter stone with filter paper should now be installed in the lower cap. The trimming base should be positioned where it will be used for trimming, the pedestal placed on the base and the upper cap on the pedestal. A circular glass plate is now positioned on top of the upper cap.

At this point the sample may be obtained.

The soils were stored in an environmentally controlled room, sealed in the core tube in which they were obtained. Approximately four centimeters of soil is jacked slowly out of the top of the tube. A wire saw is then used to cut through the cross section of the extended soil. After passing once or twice through the soil, the saw is passed through again, followed directly behind with the oiled, thin metal plate. The specimen will now be resting on the metal plate and is immediately transported to the environmental room for the trimming.

*Any filter paper protruding past the sample cap will bind the trimming apparatus.

Once in the trimming room, the glass plate on the pedestal is placed on the upper side of the sample. The sample is gently flipped, the glass is now on the down side (in other words, the sample is turned upside-down, opposite to in situ conditions). The glass with sample is replaced on the pedestal. The thin metal cutting plate is gently and carefully slid off the sample top.

The cutting yoke is now positioned on the base's columns, cutting edge down. The yoke is pressed down gently, pausing to allow for trimming of excess soil from the sides with the oiled spatulas. Some of the soil trimmings are used for water content measurements. This process is continued until the cutting edge comes in contact with the glass at the bottom.

The top surface is now trimmed using a wire saw. The top should be smooth and even with the cutting yoke's top surface. If a sufficiently thick slice is removed it can be salvaged for fall cone shear strength testing.

The mounting ring with bottom cap and porous stone are now placed on the top of the sample, ensuring correct seating, with drainage holes facing forward. The mounting ring is then clamped to the cutting yoke. Once again, care must be taken to tighten the screws so the mounting ring remains concentric.

The cutting yoke with sample is now gently removed from the base, the glass plate sealing the bottom. The top sample cap is removed from the pedestal. The expander yoke with membrane is mounted, vacuum applied, and lowered to the bottom of the base. Note that the yoke should be

mounted with the longer part of the bushings upward.

Mount the cutting yoke on the columns with the cutting edge upward and the drainage holes of the sampling cap facing forward. The upper sample cap is lowered down gently until the lower filter cap rests firmly on the pedestal.

The lower sample cap is then released from the mounting ring. The cutting yoke is pushed downward until approximately 15 mm of soil is exposed. A slice is made with the wire saw, through the soil, even with the cutting yoke's edge. A second pass of the saw is made while carefully lifting the glass plate, with soil adhered, until the soil is freed. This slice of soil is of sufficient height for fall cone testing. A water content is also taken. This procedure usually leaves the sample with a jagged top surface so the cutting yoke should be pressed down about 1 mm. The remaining soil is trimmed from the top with the wire saw until a smooth even surface is obtained.

The porous stone and filter paper are placed in the top sample cap. It is clamped to the upper yoke which is then mounted and locked on the columns of the base. The cap is lowered by the center rod and seated on the sample with the drainage holes facing forward. It is clamped into place by the lever vise of the upper yoke.

The cutting yoke is raised above the upper sample cap's top. The sample is now laterally unsupported.

The vacuum is applied to the membrane expander and the expander yoke is raised to position the membrane. The membrane reinforcement should be

centered on the sample. The vacuum is then released. The membrane is slid onto the upper and lower sample caps.

The three yokes are removed and the upper yoke replaced to keep the sample stable. The initial sample height is now measured.

The O-rings are positioned on the non-reinforced portions of the membranes so as to complete a tight seal between membrane and sample caps.

The sample is now ready for transport to the NGI direct simple shear device.

After cleaning, all equipment should be oiled with silicon oil.

APPENDIX C

INSTRUCTIONS FOR THE USE OF THE NORWEGIAN GEOTECHNICAL INSTITUTE DIRECT SIMPLE SHEAR DEVICE - A STEP-BY-STEP APPROACH

The following is a list, in chronological order, of recommended steps for the accomplishment of static and cyclic shearing tests as performed on the Rensselaer Polytechnic Institute modified Norwegian Geotechnical Institute direct simple shear device. These steps are as they were executed during the tests of this investigation. The list is based on the Geonor instruction manual (8) and the recommendations of Mr. Carsten Floess, who completed the data acquisition modifications.

It will be assumed readers of these instructions are familiar with the device and have access to the Geonor instruction manual (8). Reference to the body of this report, specifically Part 2 - "Equipment", will assist the reader with unfamiliar terms.

Steps for Static and Cyclic Direct Simple Shear Test on the NGI Device

1. Set timer in recorder - 1 minute intervals for static
- 100 second intervals for cyclic.
(See "Operating Manual 2400 Series", pg. 3.4)
2. Place pins in sliding shear box. Pins must move freely up and down while the lever arm is level. This can best be accomplished by moving the sliding box via the hand crank on the static shearing motor (the proving ring must be in and the loading clamp must be open).

- c 3. Hook up dormant side hanger (right side).
- s 4. Take the slack out of the horizontal shear assembly.
Hand crank the shearing motor until the dial in the proving ring moves continually and smoothly. Then back it off slightly and zero gauge.
5. Lock the locking clamp.
6. Raise the lever arm as high as it goes. This requires turning the hand crank on top of the vertical assembly all the way counterclockwise.
7. Ensure the water level is appropriate in the water supply containers.
8. Open the top sample cap confining lugs all the way.
9. Cut sample. (See Appendix B, this text).
10. Sample is brought out and the base is attached to the NGI shear device.
11. With upper yoke still in place (stabilizing sample assembly) attach drainage hoses.
12. Raise one side of water supply well above sample top and lower the other. Allow one-half hour for the water to leach all air bubbles out. Level water containers at a height slightly above the sample top.
13. Take upper yoke off.
14. Slide sample into testing position.

c - for cyclic tests only

s - for static tests only

15. Clamp bottom of sample assembly in place. Note, a small aluminum foil gasket is placed on one side of the bottom clamp for the larger sample size assembly to eliminate excess sliding.
16. Position the lever arm. It should be brought down so the shearing box is in contact with the upper sample cap while the lever arm is approximately 3 or 4 degrees above horizontal.
- c 17. Hook up left side hanger.
18. Put a 5 or 10 gram weight on the lever arm's hanger.
19. Record vertical dial reading.
20. Hook up calibrated membranes (dummy and active) to strain gauge indicator.
21. After one-half hour take initial microstrain readings.
22. Place first consolidation load interval on.
23. Repeat as required taking microstrain and vertical dial readings at the end of each interval.
24. After the last interval is placed, allow 24 hours until next step.
25. Turn power supplies and recorder on. Allow one-half hour warm up time.
26. Take vertical dial and microstrain readings.
27. Turn sensitivity and filter knobs on recorder, for each amplifier in use, to the right.

c - for cyclic tests only

s - for static tests only

28. Zero recorder dial needles with top knobs.
Note: volts to off position.
- c 29. Turn #1 amplifier to .1 x 100 and position needle 3.2 cm to the left.
30. Set #3 amplifier to .025 x 1 and zero suppression.
(See "Operating Manual 2400 Series").
31. Place pin in normal load hanger, being careful not to disturb sample.
32. Start taking weights off lever arm hanger adjusting the vertical position of the lever arm with the adjusting mechanism to maintain the recorder needle at zero (you must turn knob clockwise).
33. Take pins out of sliding shear box.
34. Clamp upper sample cap with lugs.
- s 35. Unlock shear locking clamp.
- s 36. Set #2 amplifier to .025 x 1 and zero suppression.
- c 37. Set #2 amplifier to .025 x 1 and zero chart needles with the LVDT adjusting nuts. (Note: zero suppression mode must be off.) This step requires patience.
38. Zero all dials (vertical deformation, horizontal shear displacement, and horizontal shear force) and recheck all needle zeros.
39. Run paper down.
- s 40. Set chart speed to 5 + 100 (.05 mm/sec).

c - for cyclic tests only

s - for static tests only

- s 41. Set voltage selectors to .5 volts on #2 and #3 amplifier.
- s 42. Turn shear generator to on.
- s 43. Put left-right switch on generator to left.
- s 44. Turn generator top lever arm counterclockwise.
- s 45. Select generator speed. (This investigation used 5.5 on the dial which is 75 min/mm.)
- s 46. After five minutes check for slack. If proving ring dial has not moved yet, crank the generator by hand up to, but not past, 5 on the proving ring dial.

Return the generator motor back to automatic mode.
- s 47. Take readings every five minutes recording shear force dial, shear displacement dial, and microstrain readings.
- c 48. Set chart speed to 25 + 100 (.25 mm/sec).
- c 49. Set voltage selector to 1 volt on the #2 and #3 amplifier.
- c 50. Put weights on cyclic shearing hangers. Must have been previously calculated to deliver desired stresses.
- c 51. Set pump timer to half the desired period time.
- c 52. Push counter button to zero counter.
- c 53. Turn air supply to piston pump on.
- c 54. Plug in pump solenoid to AC supply.
- c 55. Turn pump to on position.
- c 56. When the piston is in the up position unlock shearing locking clamp.
- c 57. Record microstrain readings at the first cycle and then every five cycles thereon.

c - for cyclic tests only

s - for static tests only

58. Maintain vertical dial at correct reading by referring to false deformation charts and monitoring vertical load changes. This is done by adjusting the Adjusting Mechanism.
59. Change voltage selectors upward as necessary.
- s 60. When failure is reached the shear force levels off and begins to drop. Displacements should be between 300 and 350 on the horizontal displacement dial. Do not exceed 450.
- s 61. Shut generator motor off, then hand crank until sample is vertical.
- c 62. Termination of testing at full scale needle deflections while in the 10 v range (.1 x 100) is usually acceptable.
- c 63. Shut air off, turn pump switch to off, and remove weights.
64. Run paper down and shut equipment off.
65. Open the lugs, releasing the upper sample cap.
66. Raise the lever arm all the way.
67. Unclamp sample bottom, and disconnect strain gauge wires.
68. Remove the sample assembly.
69. Dismember the sample assembly and remove the sample from the membrane.
70. Take a water content of the sample.
- c 71. Unplug the solenoid.
72. Clean up - You are done.

c - for cyclic tests only

s - for static tests only

APPENDIX D
CALIBRATION OF STRAIN GAUGE EQUIPPED MEMBRANES
FOR THE NORWEGIAN GEOTECHNICAL INSTITUTE
DIRECT SIMPLE SHEAR DEVICE - A User's Approach

The calibration of the strain gauge equipped membranes supplied by Geonor were accomplished on calibration cylinders, also supplied by Geonor. The procedure which is about to be presented assumes a certain degree of familiarity with the membranes and the cylinder. This Appendix is based primarily on a letter from Geonor to Dr. Thomas Zimmie and on experience obtained during the course of this project.

Procedure

The membrane, which is to be calibrated, is mounted on the expander yoke, part of the trimming apparatus, and expanded by a vacuum. The interior should be smooth as if it were to be used on a sample. The membrane is slid over the calibration cylinder. The midheight of the membrane reinforcement must be positioned at the midheight of the cylinder. This will ensure the active part of the windings have the lateral stress applied to them. The windings should be straight and horizontal.

The membrane is placed where it is to be calibrated. The strain gauge leads of the membrane are attached to the microstrain indicator device through a bridge which includes a dummy membrane for temperature

compensation. The microstrain indicator should be turned on and allowed to warm up for one-half hour during which the membranes will adjust to the temperature.

A known pressure must be applied to the interior of the calibration cylinder to expand its membrane and cause lateral stress to be transmitted to the strain gauge membrane being calibrated. The source of this pressure can be either water or air, air being recommended. This step was accomplished by connecting a hose to the top of the calibration cylinder from the backpressure air supply of an Anteus Consolidometer located at the Rensselaer Polytechnic Institute soils laboratory. The air supply to the consolidometer must be turned on, then the main air pressure chamber is opened until about 45 psi is registered on its dial. The back pressure chamber may now be opened and pressure is applied to the calibration cylinder and membrane under test. The back pressure dial is read directly in psi.

The pressure is increased in small intervals and microstrain readings recorded. After a sufficiently high pressure (15 to 20 psi) the pressure is decreased in the same intervals and the microstrains are again recorded.

A number of tests should be run on each membrane to be calibrated, and the average values plotted on a microstrain reading versus pressure graph. The slope of this curve in the form of microstrain per kg is the calibration factor for the tested membrane.

Although several runs should be made for each membrane and the average used, experience has shown the readings obtained are very closely repeated.