

LEVEL II

12

construction
engineering
research
laboratory



United States Army
Corps of Engineers
...Serving the Army
...Serving the Nation

TECHNICAL REPORT M-296
June 1981

AD A102754

EMI/RFI SHIELDING EFFECTIVENESS EVALUATION OF
BOLT-TOGETHER SHIELDED ROOMS IN LONG-TERM AGING

9 Final repts

DTIC
ELECTED
AUG 12 1981

FILE COPY

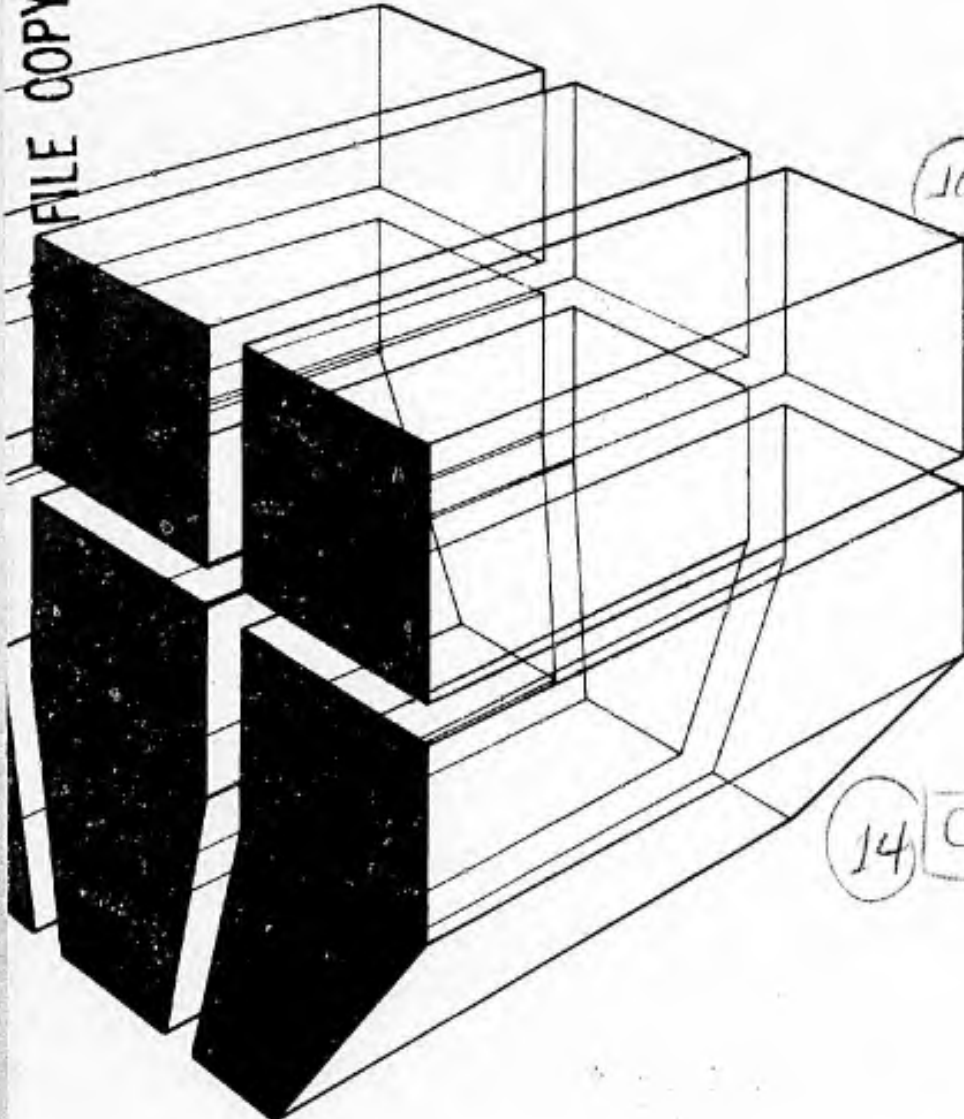

10 by
Raymond B. G/McCormack

12 144

16 4A762717A746

17 AD

14 CERL-TR-M-296



Approved for public release; distribution unlimited.

405279 81 8 12 026

JOB

The contents of this report are not to be used for advertising, publication, or promotional purposes. Citation of trade names does not constitute an official indorsement or approval of the use of such commercial products. The findings of this report are not to be construed as an official Department of the Army position, unless so designated by other authorized documents.

***DESTROY THIS REPORT WHEN IT IS NO LONGER NEEDED
DO NOT RETURN IT TO THE ORIGINATOR***

UNCLASSIFIED

SECURITY CLASSIFICATION OF THIS PAGE (When Data Entered)

REPORT DOCUMENTATION PAGE		READ INSTRUCTIONS BEFORE COMPLETING FORM
1. REPORT NUMBER CERL-TR-M-296	2. GOVT ACCESSION NO. AD-A102754	3. RECIPIENT'S CATALOG NUMBER
4. TITLE (and Subtitle) EMI/RFI SHIELDING EFFECTIVENESS EVALUATION OF BOLT-TOGETHER SHIELDED ROOMS IN LONG-TERM AGING	5. TYPE OF REPORT & PERIOD COVERED FINAL	
	6. PERFORMING ORG. REPORT NUMBER	
7. AUTHOR(s) R. G. McCormack	8. CONTRACT OR GRANT NUMBER(s)	
9. PERFORMING ORGANIZATION NAME AND ADDRESS U.S. ARMY CONSTRUCTION ENGINEERING RESEARCH LABORATORY P.O. Box 4005, Champaign, IL 61820	10. PROGRAM ELEMENT, PROJECT, TASK AREA & WORK UNIT NUMBERS 4A762719AT40-AO-015	
11. CONTROLLING OFFICE NAME AND ADDRESS	12. REPORT DATE June 1981	
	13. NUMBER OF PAGES 139	
14. MONITORING AGENCY NAME & ADDRESS (if different from Controlling Office)	15. SECURITY CLASS. (of this report) Unclassified	
	15a. DECLASSIFICATION/DOWNGRADING SCHEDULE	
16. DISTRIBUTION STATEMENT (of this Report) Approved for public release; distribution unlimited.		
17. DISTRIBUTION STATEMENT (of the abstract entered in Block 20, if different from Report)		
18. SUPPLEMENTARY NOTES Copies are obtainable from the National Technical Information Service Springfield, VA 22151		
19. KEY WORDS (Continue on reverse side if necessary and identify by block number) electromagnetic shielding radiofrequency interference shielded rooms		
20. ABSTRACT (Continue on reverse side if necessary and identify by block number) This report presents the results of a laboratory evaluation of elec- tromagnetically shielded rooms that represent the state of the art in demount- able, bolt-together shielded rooms. First, the initial shielding effective- ness was measured; next, the rooms were housed for a 3-year "aging" period in a laboratory area whose environment was controlled during working hours for human comfort. Additional evaluations included a study of how easily the rooms could be assembled, a comparison of shielding effectiveness when dif-		

(over)

BLOCK 20 CONTINUED

ferent seam bolt torques were used, and a comparison of particleboard and plywood panel cores.

The study results show that significant degradation of shielding effectiveness occurs with aging, so periodic maintenance will be necessary if optimum shielding is required.

A

FOREWORD

This investigation was performed for the Directorate of Military Programs, Office of the Chief of Engineers (OCE), under Project 4A762719AT40, "Mobility, Soils, and Weapons Effects"; Technical Area AO, "Weapons Effects and Protective Structures"; Work Unit O15, "Laboratory Evaluation of EMP/EMI Shielding Enclosures Performance and Design Standards." The applicable QCR is 3.05.003. The OCE Technical Monitor was Mr. S. Berkowitz, DAEN-MCE-U.

This investigation was performed by the Engineering and Materials Division (EM) of the U.S. Army Construction Engineering Research Laboratory (CERL). Dr. R. Quattrone is Chief of EM.

Appreciation is expressed to Messrs. P. H. Nielsen and M. J. Pollock of CERL for their contributions to this study.

COL L. J. Circeo is Commander and Director of CERL, and Dr. L. R. Shaffer is Technical Director.

Accession For	
NTIS GRA&I	<input checked="" type="checkbox"/>
DTIC TAB	<input type="checkbox"/>
Unannounced	<input type="checkbox"/>
Justification	
By _____	
Distribution/ _____	
Availability Codes	
Dist	Avail and/or Special
A	

CONTENTS

DD FORM 1473	1
FOREWORD	3
LIST OF TABLES AND FIGURES	5
1 INTRODUCTION.....	7
Background	
Objective	
Scope	
Approach	
Mode of Technology Transfer	
2 DESCRIPTION OF TEST SAMPLES.....	9
All-Weld Sheet Steel Rooms	
Demountable	
Current Suppliers	
3 ASSEMBLY OF TEST SAMPLES.....	12
4 TEST METHODS.....	13
Location of Test Points	
Test Equipment Used	
Environmental Exposure	
Shielding Degradation Versus Aging	
5 SUMMARY OF TEST DATA.....	17
Shielding Effectiveness Versus Torque on Seam Bolts	
Shielding Effectiveness Versus Aging	
Comparison of Shielding Effectiveness Versus Aging for Plywood Versus Particleboard	
6 CONCLUSIONS.....	19
REFERENCES	20
TABLES AND FIGURES	21
APPENDIX A: Shielding Effectiveness Test Data Analysis	43
APPENDIX B: Shielding Effectiveness Data for Particleboard and Plywood-Cored Panels	93
APPENDIX C: Shielding Effectiveness Test Data	127
DISTRIBUTION	

TABLES

<u>Number</u>		<u>Page</u>
1	Current Suppliers of Shielded Rooms	21
2	Assembly Time for LMI Cell-Type Room	22
3	Assembly Time for Ark Single-Shield Room	22
4	Assembly Time for Lindgren Double Electrically Isolated Room	23
5	Test Equipment List	23
6	Test Equipment Use	24
7	Mean Shielding Effectiveness for All Points: June 1980	24
8	Plywood Versus Particleboard Comparison of Shielding Effectiveness	25

FIGURES

1	Typical Demountable Enclosure Shielding Effectiveness Versus Frequency Claimed by Manufacturer	26
2	Typical Panel-Joining Hardware for Cell-Type Rooms	26
3	Typical Panel-Joining Details for Double Electrically Isolated Enclosures	27
4	Typical Panel-Joining Hardware for Single-Shield Lindsay Structure	27
5	Typical Seam-Joining Hardware for True Cell-Type Room	27
6	Single-Shield Test Module	28
7	Cell-Type Test Module	28
8	Double Electrically Isolated Test Module	29
9	Hatch and Hatch Cover for Single-Shield Room	29
10	Hatch and Hatch Cover for Cell-Type Room	30
11	Hatch and Hatch Cover for Double Electrically Isolated Room	30
12	Test Point Locations	31

FIGURES (Cont'd)

<u>Name</u>	<u>Page</u>	
13	Relative Antenna Orientations for Testing Wall and Corner Seams	32
14	Temperature and Humidity in the Testing Area for a Typical Week in Spring	33
15	Temperature and Humidity in the Testing Area for a Typical Week in Summer	34
16	Temperature and Humidity in the Testing Area for a Typical Week in Autumn	35
17	Temperature and Humidity in the Testing Area for a Typical Week in Winter	36
18	Shielding Effectiveness Versus Frequency for Three-Fourths and Full-Rated Torque	37
19	Mean Shielding Effectiveness for All Test Points for the June 1980 Test	38
20	Comparison of the Shielding Effectiveness of the Three Room Types Versus Aging (10 kHz Frequency)	39
21	Comparison of the Shielding Effectiveness of the Three Rooms Versus Aging (50 kHz Frequency)	39
22	Comparison of the Shielding Effectiveness of the Three Room Types Versus Aging (200 kHz Frequency)	40
23	Comparison of the Shielding Effectiveness of the Three Room Types Versus Aging (1 MHz Frequency)	40
24	Comparison Between Particleboard- and Plywood-Cored Panels Versus Aging (10 kHz)	41
25	Comparison of Plywood and Particleboard-Cored Panels Versus Aging (50 kHz)	41
26	Comparison Between Plywood and Particleboard-Cored Panels Versus Aging (200 kHz)	42
27	Comparison of Plywood and Particleboard-Cored Panels Versus Aging (1 MHz)	42
A1	Graphical Key for Appendix A	44
B1	Graphical Key for Appendix B	94

EMI/RFI SHIELDING EFFECTIVENESS EVALUATION OF BOLT-TOGETHER SHIELDED ROOMS IN LONG-TERM AGING

1 INTRODUCTION

Background

The U.S. Army requires the use of electromagnetic shielding in many military construction projects. This shielding may be necessary for several reasons, including:

1. Protection of sensitive electronic equipment from damage or upset from electromagnetic pulse (EMP).
2. Prevention of compromising emanations which may yield secret information to enemy detection systems.
3. Containment of electromagnetic interference (EMI) which may cause other electronic systems to malfunction.
4. Protection of sensitive equipment from incoming EMI emanating from any source, including lightning, static electricity discharge, high-power radio, radar, television, or jamming transmitters.
5. Provision of a clean electromagnetic environment for experimentation and for analysis, troubleshooting, and maintenance testing of sensitive electronic equipment.

Some examples of shielded structures include weapon control facilities (e.g., the SAFEGUARD Anti-Ballistic Missile facilities), underground secure command centers, secure communications facilities, command and control center buildings on military bases, electronic maintenance shops, and electronic research and development facilities.

Shielding of large buildings or facilities from EMP, EMI, or TEMPEST* can be provided in three ways: (1) completely lining the entire facility or major selected portions of it, (2) using shielded modules to house the sensitive electronic equipment where required, and (3) completely shielding each piece of electronic equipment and all its related cabling.

Approaches (1) and (2) have been used extensively. Approach (3) is generally not practical, since it requires redesign of many of a building's electronic equipment components.

Cost-effectiveness comparisons of approaches (1) and (2) depend on several factors, including the number of locations within the facility. If approach (2) is the most cost-effective and is technically suitable, two

* TEMPEST is not an acronym, but a code name generally applied to secure communication networks wherein compromising emanations must be controlled to a suitably low level.

options are possible: (1) modules with all welded, soldered, or brazed seams, and (2) prefabricated, demountable, bolt-together rooms. Either option may have significant advantages, depending on the specific application. The demountable module is more flexible, since it can be disassembled and moved in smaller components; however, this type of module generally provides less initial shielding and requires greater maintenance, because shielding effectiveness degrades with aging.

Objective

The primary objectives of this study are (1) to identify the state of the art of modular, demountable, shielded rooms, (2) to investigate how easily these modules can be assembled, and (3) to study the aging characteristics of these modules in typical facilities with environments controlled for human comfort in order to determine their maintenance requirements. The secondary objectives of this study are to generally evaluate modular, bolt-together shielded rooms and to compare plywood and particleboard-cored panels.

Scope

This study has addressed only bolt-together rooms which use galvanized steel as the shielding membranes. The rooms tested were standard, commercially available types embodying the general principles of all commonly used seam-joining designs. Parametric studies of all possible seam-joining designs are beyond the scope of this study. The dual-shield rooms have been limited to either plywood or particleboard-cored panels. The modules have been designed to eliminate leakage around doors or penetrations in order to insure that the data taken are from seams only.

Approach

The state of the art of modular, demountable shielded rooms was determined through a literature search, contact with other government agencies, and contact with manufacturers. Then, three test modules representing the state of the art were tested and evaluated. The evaluation for ease of assembly primarily measured assembly time and noted any problems encountered and any necessary re-work. The evaluation also measured shielding effectiveness versus torquing of seam bolts. After manufacturer's torque was reached, an initial shielding effectiveness test was done for each room. This test was followed by 3 years of aging during which the rooms were periodically evaluated for degradation.

Mode of Technology Transfer

The information contained herein will impact on TM 5-855-5, Nuclear Electromagnetic Pulse Protection.

2 DESCRIPTION OF TEST SAMPLES

A state-of-the-art survey has shown that three general construction types of demountable, electromagnetically shielded enclosures are commercially available:

1. Single shield
2. Cell type
3. Double electrically isolated (DEI).

Any of these may have either screen wire or continuous metal sheet shield materials. The single-shield type uses only one shield membrane, whereas the cell type and the DEI type use dual-shield membranes separated by a nonelectrically conducting core (such as plywood or particleboard). The cell type and DEI differ electrically, in that one shield is isolated electrically from the other in the DEI. In the cell type, the panel-joining hardware makes electrical connection at each through-bolt or continuously around each panel edge. Thus, each panel becomes a cell with electrical connection between shield membranes around the panel edges. In the DEI room, the panels use dual-shield membranes and panel-joining hardware, which assure that there is no electrical contact between the inner- and outer-shield membranes. Usually, a single through-bolt connects the inner membrane to the outer membrane at one point.

According to manufacturers, the typical shielding effectiveness of demountable enclosures is at least 100 dB through most of the frequency range for magnetic fields. Figure 1 is a typical curve of advertised shielding effectiveness.

The electrical quality of the seams determines the performance of the demountable enclosure within most of the frequency range of interest, with low seam resistance being important. Therefore, the metal mating surfaces between panels must be clean, corrosion-free, galvanically similar, and with uniform contact pressure in order to maintain the advertised shielding level. Numerous factors may reduce conductivity across the joint. Elevated temperature and humidity can cause corrosion. Dirt tends to penetrate the seams. Humidity variations cause the plywood or particleboard to expand and contract, which can reduce contact pressure and increase seam resistance. This expansion and contraction can eventually loosen the clamping bolts. In disassembly and reassembly, it is easily possible to damage, bend, or warp panels, thereby causing shielding degradation. To maintain optimum enclosure performance, maintenance is generally required, which may consist of disassembly, cleaning, and reassembly or bolt tightening.

Thus, several factors must be considered when selecting a shielded room. Following is a summary of advantages and disadvantages of each type of room.

All-Weld Sheet Steel Rooms

Advantages

1. Higher shielding performance
2. Less affected by adverse environments
3. No seam maintenance required
4. Less subject to ground shock.

Disadvantages

1. Cannot be disassembled
2. Generally more costly.

Demountable

Advantages

1. Can be disassembled for moving
2. Lower initial cost
3. No particular construction skills required.

Disadvantages

1. Shielding effectiveness tends to decrease with age
2. Seam maintenance required
3. Lower initial shielding performance.

Current Suppliers

Table 1 lists current suppliers of standard, commercially available, shielded rooms, most of which are the demountable type. The all-welded rooms may be built at the factory and transported to the user's site, except for the larger rooms, which must be built on-site. The list of suppliers is derived from the 1980 issue of ITEM (Interference Technology Engineers Master).¹

Figures 2, 3, and 4 illustrate the three basic construction types for bolt-together rooms: (1) cell-type, (2) double electrically isolated (DEI), and (3) single-shield. Although these drawings are representative, some variations may exist in the actual hardware used for panel joining. For example, in Figure 2, the panel joining hardware for the cell-type is electrically

¹ Products and Services Index, Interference Technology Engineers Master (ITEM)
(R&B Enterprises, 1980), p 204.

connected by the through-bolts, providing a noncontinuous electrical contact around each cell. Another manufacturer uses a square cross-section steel extrusion at the seam joint, as shown in Figure 5, to obtain a true cell-type construction. However, when the test modules were selected for this study, this type of construction was not commercially available.

Figures 6, 7, and 8 show the modules selected for testing. The manufacturers of these modules are Ark Electronics Corporation, Erik A. Lindgren and Associates, and Lectro-Magnetics, Inc. Dimensions of these modules are:

1. Single-Shield (Ark) - 8 x 8 x 8 ft (2.4 x 2.4 x 2.4 m)
2. Cell-type (Lectro-Magnetics) - 8 x 8 x 8 ft (2.4 x 2.4 x 2.4 m)
3. Double electrically isolated (Lindgren) - 7 x 7 x 8 ft high (2.1 x 2.1 x 2.4 m).

Each module used standard panels, hardware, powerline filtering, and honeycomb air filters.

To prevent leakage through doors from influencing the shielding data, standard shielded doors were not used. Instead, each room was equipped with a small hatch (Figures 9, 10, and 11) with a gasketed bolt-on cover for personnel and equipment access.

An additional feature of the cell-type room was that two of its walls used plywood-cored panels, and two walls used particleboard-cored panels. The module was assembled so that walls of similar material were adjacent; i.e., the north and west walls were plywood-cored, and the south and east walls were particleboard-cored. Referring to Figure 12, the panels bounded by test points 1 through 28 had plywood cores, while the panels bounded by test points 29 through 56 had particleboard cores. Separate data for the two core types are plotted on pages 95 through 126.

3 ASSEMBLY OF TEST SAMPLES

Each room selected for testing was shipped by the manufacturer to CERL as a kit, with all parts supplied. One objective of the program was to determine how easily the rooms could be assembled. Rooms were assembled by two workmen with extensive experience in building maintenance and setting up large experimental construction systems. Each workman was skilled in the use of hand tools and in the operations required for room assembly.

Assembly times were determined by a third person who observed the work, defined it in specific steps, and timed the amount of labor required for each step. A television camera and videotape recorder provided a permanent record of the assembly work. In addition, movies were made of representative portions of the assembly process.

Each room was assembled on a pre-constructed wood plank base placed on the concrete floor of the laboratory area and then allowed to age for 3 years. Care was taken to insure that no specific advantages made assembly of any room easier. The order of assembly is not believed to be a significant factor affecting the amount of time required, because the designs are substantially different, and assembly methods learned on one room could not necessarily be applied to another room. One factor affecting time of assembly was found to be the clarity and adequacy of instructions provided by the manufacturer.

The rooms were assembled in the following order:

1. Cell-type
2. Single-shield
3. Double electrically isolated.

Generally, the assembly operations were somewhat difficult, especially for the single-shield and the cell-type rooms. The problems encountered with both types of rooms could be solved by improving dimensional tolerances on the panels and hardware and by providing stops to insure proper insertion depth of the panel into the panel-joining hardware. Initial shielding tests showed that the room's shielding quality depended on how well all the hardware mated during the assembly process. A seam leak detector was used in the initial evaluation, and extremely leaky points were readjusted to insure proper fit. Tables 2, 3, and 4 give the assembly time in man-minutes required for each room.

4 TEST METHODS

The test methods used to measure shielding effectiveness were similar to the techniques described in test standards such as MIL-STD-285, IEEE 299, and NSA 65-6,² although not identical to any of these. The methods actually used were copied from shielding effectiveness measurement methods used in the acceptance testing of the SAFEGUARD Anti-Ballistic Missile Facility.³

The basic test approach involved the use of a transmitter and a receiver (with antennas for each) for each test frequency. A reference reading was taken, with the transmitting and receiving antennas spaced a pre-determined distance apart. Shielding measurements were then made by placing the antennas this same distance apart (plus shield thickness), but with the transmitting antenna outside the shield module and the receiving antenna inside the module. Shielding effectiveness was defined as follows:

$$S = \frac{\log_{10} V_{\text{ref}}}{\log_{10} V_2} \quad [\text{Eq 1}]$$

where:

S = Shielding effectiveness in dB

V_{ref} = Indicated receiver voltage level without shield

V_2 = Indicated receiver voltage level with shield between antennas.

The test frequencies used and type of field generated were:

f1	10 kHz	H-field
f2	50 kHz	H-field
f3	200 kHz	H-field
f4	1 MHz	H-field
f5	30 MHz	H-field
f6	450 MHz	E-field
f7	2.5 GHz	plane wave
f8	9.5 GHz	plane wave

² Military Standard, Attenuation Measurements for Enclosures, Electromagnetic Shielding, for Electronic Test Purposes, Method of, MIL-STD-285 (Department of the Army, 25 June 1956); Proposed IEEE Recommended Practice for Measurement of Shielding Effectiveness of High Performance Shielding Enclosures, IEEE-299 (Institute of Electrical and Electronic Engineers [IEEE], June 1969); National Security Agency Specification for R. F. Shielded Enclosures for Communications Equipment: General Specifications, NSA 65-6 (National Security Agency, 30 October 1964).

³ H. E. Atkins, R. E. Evans, B. J. Gay, H. L. Holt, and A. R. Wright, Safe-guard Tactical Ground Facilities EMP/RFI Facilities Acceptance Construction/Installation Test Plan -- Grand Forks (The Boeing Company, January 1972).

At frequencies f1 and f2, 2-ft (.6-m)-diameter, multi-turn, nonelectrostatically shielded loop antennas were used in a co-axial orientation, with 2-ft (.6-m) spacing for reference reading.

At frequencies f3, f4, and f5, the antennas* used were electrostatically shielded, 1-ft (.3-m)-diameter loops, with matching networks. Tests at these three frequencies were also done with a 2-ft (.6-m) antenna spacing to obtain the reference and co-axial antenna orientation.

At frequency f6, dipole antennas without reflectors were used with a horizontally polarized electric field. Reference readings were taken with antenna spacings of 2 m. Considerable variation in reading was encountered at this frequency because of reflected signals and standing waves within the test areas. Therefore, an effort was made to average these variations when taking reference readings.

At the plane wave frequencies f7 and f8, horn antennas were used for both transmitting and receiving. An isolator was used between the transmitting horn and the signal source to prevent excessive transmitter mismatch due to the shield being directly in front of the horn antenna.

The horn antennas were spaced 2 m from each antenna leading edge. Waveguide to co-axial adapters were used on the horn antennas, and low-loss co-axial cable was used to maximize measurement range.

For all frequencies, test location points on the shielded rooms were as shown in Figure 12, with a total of 56 points plus the door. At each test point, the transmitting antenna was hand-held in a fixed position with a dielectric spacing rod to insure correct spacing from the shield. Where possible, the transmitting antenna was spaced directly out from the test point with its centerline perpendicular to the room wall (see Figure 13). At corners, the antenna centerline was held parallel with the shield room diagonal (corner to corner), as shown in Figure 13.

At each test point, the receiving antenna was moved** about while the measurement was taken; the maximum signal represented shielding effectiveness. The distance over which the receiving antenna was moved was limited to about half the distance toward the next test point along the seam or seams being tested.

Location of Test Points

Figure 12 shows the location of test points for a side of a room. All four sides of each room had similar test point locations, but were numbered differently. All corner test points were shared by two room sides, so there were 14 points per side, 56 test points (plus the door) for each room.

* The loop antennas were manufactured by Empire Devices Corp. under model number LP-105.

**In moving the antenna, its spacing was maintained at the specified distance from the seam. The movement was in a plane parallel to the wall being tested. In the case of corners, specified distance was maintained while moving the antenna up and down and radially back and forth relative to the corner.

Previous testing⁴ had shown that measured shielding effectiveness will vary significantly if defects are more than 2 ft (.6 m) (laterally) away from antenna locations. For this study, the maximum room dimensions were 8 ft (2.4 m), so with the test point pattern selected, the test points were spaced a maximum of 8/5 ft (.48 m) apart. Therefore, a defect along a seam could never be more than 4/5 ft (.24 m) from a test point. This assured that this aspect of the testing would be thorough.

Test Equipment Used

Table 5 lists representative equipment used in the shielding effectiveness tests, and Table 6 lists the uses of this equipment. There is some duplication in these tables, because the same types of receivers and transmitting equipment were not used for each test. Because of how the test is conducted, different equipment types may be used without compromising data accuracy, as long as equipment linearity and attenuator accuracy are assured through a regular equipment calibration program.

Environmental Exposure

The three test rooms were assembled during April 1977. Initial tests were done in May and June, and further tests were conducted at 6-month intervals. The last test was completed in June 1980.

The rooms had not been moved or disturbed since their original assembly. The area where they were aged is a large laboratory controlled for human comfort. To conserve energy, air conditioning was turned off on all weekends and during some evenings. During most of the aging period, a temperature and humidity recorder provided a record of the environmental exposure. Figures 14 through 17 show typical chart records for a week during each of the four seasons.

Shielding Degradation Versus Aging

The effects of aging under various environmental conditions must be well understood in order to develop a methodology for selecting a shielding approach appropriate for specific applications. Since development of such a methodology is a goal of the current program, existing information on shielded room degradation with aging was examined. This investigation included a search of the literature, contact with manufacturers, and contact with recognized experts in the field.

⁴ H. E. Atkins, R. E. Evans, B. J. Gray, H. L. Holt, and A. R. Wright, Safeguard Tactical Ground Facilities, EMP/RFI Facilities Acceptance Construction/Installation Test Plan -- Grand Forks (The Boeing Company, January 1972).

This investigation revealed that very little usable data exists. Three manufacturers were contacted;⁵ two make both demountable and all-welded rooms, and one makes only demountable rooms. None of the three knew of any test data that would verify shielding performance versus the effects of aging. Those who make both types of rooms feel that the demountable type has few applications, because it may degrade in a relatively short time after assembly and therefore entail higher maintenance costs. The third manufacturer claims that the demountable type is adequate for most applications and experiences very little degradation with aging.

Telephone contact was made with several TEMPEST test and support groups. These teams do not often test demountable shielded facilities, but do use portable demountable shielded enclosures. They are not aware of data on degradation of shielding versus aging.

Other contacts⁶ were made with experts from the Illinois Institute of Technology Research Institute, U.S. Army Electronics Command, the Naval Civil Engineering Laboratory, the Naval Avionics Facility, and Collins Radio Group. None of the people contacted knew of any useful data on the shielding degradation of demountable enclosures versus aging.

⁵ FONECONs between Ray McCormack (CERL) and T. Anderson (Eric A. Lindgren and Associates, Inc., Chicago, IL) 3 August 1976; F. Nichols (Lectro-Magnetics, Inc., Los Angeles, CA) 4 August 1976; D. Hanson (Electro-Magnetic Filter Co., Palo Alto, CA) 4 August 1976.

⁶ FONECONs between Ray McCormack (CERL) and CPT D. Bosco (TEMPEST Team Security Detachment, Region 3, Fort Sam Houston, TX) 10 August 1976; J. J. O'Neil (U.S. Army Electronics Command) 5 August 1976; TEMPEST Staff Advisor, 6 August 1976; I. Mendel (Illinois Institute of Technology Research Institute) 10 August 1976; D. B. Clark and J. Brooks (Naval Civil Engineering Laboratory, Port Heuneme, CA) 11 August 1976; D. Fassberg (Naval Avionics Group, Indianapolis, IN) 5 August 1976; R. B. Cowdell (Collins Radio Group, Newport Beach, CA) 12 August 1976.

5 SUMMARY OF TEST DATA

Shielding Effectiveness Versus Torque on Seam Bolts

To show the effect of pressure on the panel-joining seams, two tests were done on the cell-type room: the first with the seam bolts at three-fourths of the manufacturer's recommended torque, and the second with full recommended torque. Figure 18 plots the results of this test; the curves shown represent the average of all 56 test points.

One problem that occurred in applying the required torque was that starting torque with the wrench was greater than rotational torque once the bolt started to turn. Thus, in the initial tightening, the three-fourths torque setting was reached with no apparent problem. However, in re-tightening to full-rated torque, it was necessary to exceed the full rate on some bolts to reach the point where the bolts would start to turn. Thus, the full-rated torque, as stated, is a rotational torque and not a starting torque.

The data in Figure 18 show an obvious improvement in shielding effectiveness for the higher-torque condition except for the measurements taken at 30 MHz. At this frequency, the shielding effectiveness for both three-fourths and full torque was beyond the dynamic measurement range of the equipment used, so the results are indeterminate.

Shielding Effectiveness Versus Aging

The shielding effectiveness of the three rooms was measured seven times during the 3-year testing period. Since there were test points plus the door in each test, and eight frequencies, a total of 3192 measurements were taken.

A considerable amount of nonrepeatability was noted when the test measurements were made at the higher frequencies. This resulted partially from the standing waves and signal reflections occurring both inside and outside the room during tests and partly from slight variations in operator technique. Because of the lack of repeatability, a computer program was used to help analyze the data. This computer analysis statistically summarized the data by calculating the mean of all data points for a room at each frequency and the standard deviation of each data set. The analysis also automatically plotted points for the mean values versus aging. These plots show the percentage of shielding effectiveness values within an applicable set of ranges such as 0 to 60 dB, 0 to 70 dB, 0 to 80 dB, etc. Therefore, a family curve that rises versus aging indicates a degradation of shielding effectiveness with aging. Appendix A provides plots summarizing all data taken.

Figures 19 through 23 present a more concise summary of the shielding effectiveness versus aging data.

Table 7 provides the mean shielding effectiveness for all rooms for the June 1980 test. These data are plotted in Figure 19. This information indicates little difference between the rooms except at 10 kHz, where the single-shield room provides significantly lower shielding, and at microwave frequencies, where the double electrical isolation appears to be better.

Figures 20 through 23 show the mean values of shielding effectiveness versus aging for frequencies of 10 kHz, 50 kHz, 200 kHz, and 1 MHz. As expected, the single-shield room, which does not use a wood separator, experienced less degradation.

Tabulated data showing the shielding effectiveness versus aging for each test point and for frequencies of 200 kHz and 2.5 GHz are presented in Appendix B.

Comparison of Shielding Effectiveness Versus Aging for Plywood Versus Particleboard

The cell-type room was built with two complete adjacent walls (four panels) having plywood cores and two complete adjacent walls having particleboard cores. Appendix C presents a computerized data printout comparing these different panel types. Figures 24 through 27 summarize these results. Two conclusions are implied from these curves: (1) the particleboard-cored panels in this room had slightly greater shielding effectiveness in the initial test, and (2) the shielding effectiveness degradation versus aging for the particleboard core is smaller. The reason for this demonstrated superiority is not fully understood, but is assumed to be affected by the expansion and contraction characteristics of the two material types. Table 8 provides data for the particleboard- versus plywood-cored panels.

6 CONCLUSIONS

The following conclusions have been reached as a result of this study:

1. The state of the art in demountable, bolt-together shielded room construction is exemplified by three basic construction types: (1) single-shield, (2) cell, and (3) double electrically isolated.

2. The demountable modules can be assembled with relative ease and do not require highly skilled labor for successful assembly.

3. Shielding effectiveness tests indicate somewhat low values of shielding effectiveness at a few isolated points within each room type where there are problems in proper mating of the panel-joining hardware; these areas require careful re-work and re-test after initial assembly if optimum shielding effectiveness is to be obtained.

4. The aging results show a definite trend of shielding degradation versus aging; this indicates a need for periodic maintenance if optimum shielding is required. This conclusion is clearly demonstrated by Figure 22, which shows degradations averaging 15 dB for the three rooms, for magnetic fields at 200 kHz.

5. The single-shield room that does not have plywood or particleboard integral to the panels experiences less degradation versus aging. This point is clearly illustrated in Figures 24 through 27, which show an average of 7 dB greater shielding degradation for the plywood cored panels.

6. Particleboard is superior to plywood as a panel core, both in shielding capability and in stability with aging.

REFERENCES

Atkins, H. E., R. E. Evans, B. J. Gray, H. L. Holt, and A. R. Wright, Safe-guard Tactical Ground Facilities EMP/RFI Facilities Acceptance Construction/ Installation Test Plan -- Grand Forks (The Boeing Company, January 1972).

Military Standard, Attenuation Measurements for Enclosures, Electromagnetic Shielding, for Electronic Test Purposes, Method of, MIL-STD-285 (Department of the Army, 25 June 1956).

National Security Agency Specification for R. F. Shielded Enclosures for Communications Equipment: General Specifications, NSA 65-6 (National Security Agency, 30 October 1964).

Products and Services Index, Interference Technology Engineers Master (ITEM) (R&B Enterprises, 1980), p 204.

Proposed IEEE Recommended Practice for Measurement of Shielding Effectiveness of High Performance Shielding Enclosures, IEEE-299 (Institute of Electrical and Electronic Engineers [IEEE], June 1969).

Table 1

Current Suppliers of Shielded Rooms

<u>Supplier</u>	<u>Type of Prefabricated Room</u>	
	<u>Demountable</u>	<u>All-Welded</u>
Filtron 9812 Independence Ave. Chatsworth, CA 91311	X	
Erik A. Lindgren and Assoc., Inc. 4514-17 North Ravenswood Ave. Chicago, IL 60640	X	
Lectro-Magnetics, Inc. 6056 West Jefferson Blvd. Los Angeles, CA 90016	X	X
Universal Shielding Corp. 45 S. Service Road Plainview, NY 11803	X	
Emerson and Cuming, Inc. Canton, MA 02021	X	
Ray Proof Corporation 50 Keeler Ave. Norwalk, CT 06856	X	X
Ark Electronics Corporation 1325 Industrial Hwy. South Hampton, PA 18966	X	
Electro-Magnetic Filter Company 4083 Transport St. Palo Alto, CA 94303	X	X
McDonald Associates 933 6th St. Santa Monica, CA 90403	X	X
R. F. Superior Shields, Inc. 123 Marcus Blvd. Hauppauge, NY 11787	X	X
All-Shield Enclosures 45 Bond St. Westbury, NY 11590	X	
Shieldtron 5401 Burnet Ave. Van Nuys, CA 91411	X	
Specialty Engineering Construction 2115 Brandford Pacoima, CA 91311	X	

Table 2
 Assembly Time for LMI Cell-Type Room

<u>Step</u>	<u>Time Req'd (min)</u>	<u>No. of Men</u>	<u>Man-Minutes</u>
Uncrate	15	2	30
Read Directions	12	2	24
Lay Out Parts	10	2	20
Assemble Floor Panels	12	2	24
Assemble Corner Clamps	7	2	14
Install Wall Panels	134	2	268
Install Ceiling Panels	92	2	184
Install Lead Foil	130	1	<u>130</u>
		TOTAL	979
		Man-Minutes	

Table 3
 Assembly Time for Ark Single-Shield Room

<u>Step</u>	<u>Time Req'd (min)</u>	<u>No. of Men</u>	<u>Man-Minutes</u>
Uncrate and Read Directions	36	2	72
Lay Out Floor Parts	48	2	96
Install Corner Parts	74	2	148
Install Ceiling Framing	113	2	226
Install Ceiling Panels	69	2	138
Install Tensioners	271	2	542
Torque Bolts	135	1	135
Install Floor Interior	75	1	<u>75</u>
		TOTAL	1432
		Man-Minutes	

Table 4

Assembly Time for Lindgren Double Electrically Isolated Room

<u>Step</u>	<u>Time Req'd (min)</u>	<u>No. of Men</u>	<u>Man-Minutes</u>
Uncrate	10	2	20
Read Directions	5	2	10
Lay Out Floor Panels	2	2	4
Install Walls	43	2	86
Install Floor Panels	6	2	12
Install Ceiling Panels	11	2	22
Install All Bolts	45	2	90
Torque Bolts	75	2	150
		TOTAL	394
		Man-Minutes	

Table 5

Test Equipment List

<u>Identifier</u>	<u>Type</u>	<u>Manufacturer</u>	<u>Model No.</u>
R1	Receiver	Electro-Metrics	EMC-25
R2	Receiver	Stoddard	NM-12AT
R3	Receiver	Empire Devices	NF-105
R4	Receiver	AILTECH	NM-65T
R5	Spectrum Analyzer	AILTECH	707-10
A1	Antenna	CERL	2 Diam. Multi-turn loop
A2	Antenna	Empire Devices	LP-105
A3	Antenna	Empire Devices	DM-105-T3
A4	Antenna	Stoddard	AT-255/URM-17
A5	Antenna (Horn)	Norda 56 x 1	
A6	Antenna (Horn)	DeMorna-Bonerdi	DBL-520
I1	Isolator	Sperry	044 S2
I2	Isolator	Rantec	IX-310
S1	Source	Hewlett-Packard	8601A
S2	Source	Wavetek	147
S3	Source	Hewlett-Packard	694B
S4	Source	AILTECH	445
S5	Source	NARDA	18500B
T1	Power Amp	ENI	310L
T2	Power Amp	Bogen	310L

Table 6
Test Equipment Use

<u>Frequency</u>	<u>Field Type</u>	<u>Equipment-Used Identifiers</u>
10 kHz	H	R1,R2,R3,S2,TS,A1,A1
50 kHz	H	R1,R2,R3,S2,T2,A1,A1
200 kHz	H	R1,R2,R3,S3,T1,A2,A2
1 MHz	H	R1,R3,S3,T1,A2,A2
30 MHz	H	R1,R3,S3,T1,A2,A2
450 MHz	Plane wave	R1,R4,S4,A3,A4
2.5 GHz	Plane wave	R4,S4,A6,A6
9.5 GHz	Plane wave	R4,S5,A5,A5

Table 7
Mean Shielding Effectiveness for All Points: June 1980

<u>Frequency</u>	<u>Shielding Effectiveness (dB)</u>		
	<u>Ark</u>	<u>Lindgren</u>	<u>LMI</u>
10 kHz	57.4	72.02	77.80
50 kHz	84.36	84.64	84.71
200 kHz	96.98	96.68	92.77
1 MHz	103.48	106.20	101.16
30 MHz	111.34	114.79	114.75
450 MHz	96.00	76.45	87.86
2.4 GHz	72.52	94.09	75.48
7 GHz	64.05	73.48	57.66

Table 8

Plywood Versus Particleboard Comparison of Shielding Effectiveness*

Freq.	Plywood			Particleboard		
	1st Trial	7th Trial	Change	1st Trial	7th Trial	Change
10 kHz	92.2	70.2	22.0	96.0	84.0	12.0
50 kHz	101.1	81.3	19.8	105.9	88.2	17.9
200 kHz	105.8	85.3	20.5	115.9	100.3	15.6
7 MHz	108.5	97.0	11.5	109.5	105.4	4.1
30 MHz	100.0	113.7	-13.7	100.0	115.8	-15.8
450 MHz	97.4	86.4	11.0	98.6	89.3	9.3
2.4 GHz	71.6	74.1	-2.5	81.2	76.9	4.3
7 GHz	75.1	56.0	19.1	74.2	59.3	14.9
Average shielding change:			10.96	7.8		

*Note: All measurements in dB

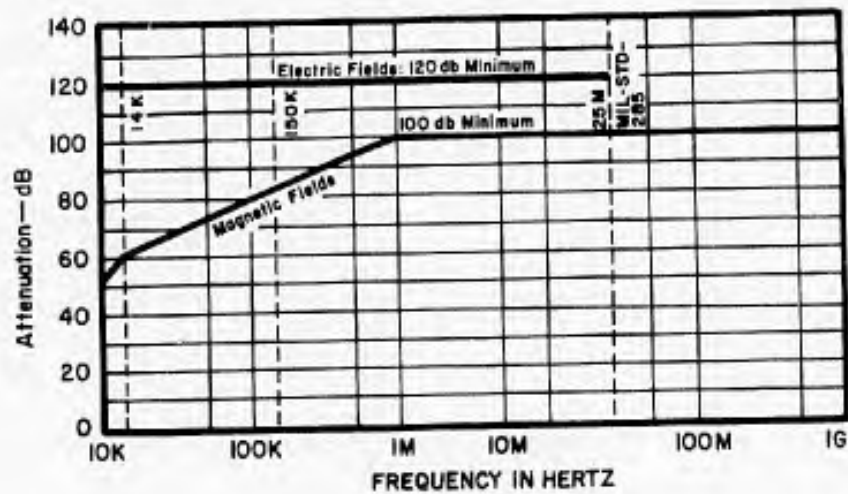

Figure 1. Typical demountable enclosure shielding effectiveness versus frequency claimed by manufacturer.

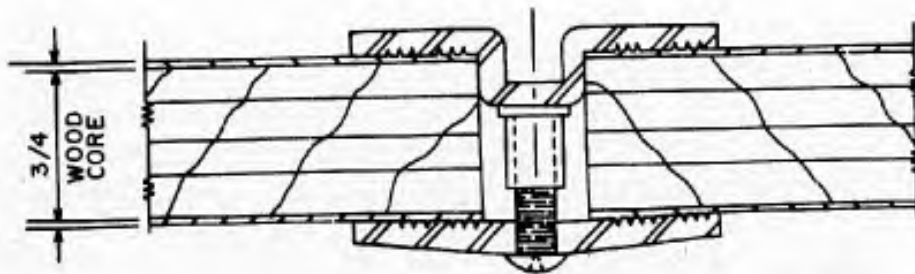

Figure 2. Typical panel-joining hardware for cell-type rooms.

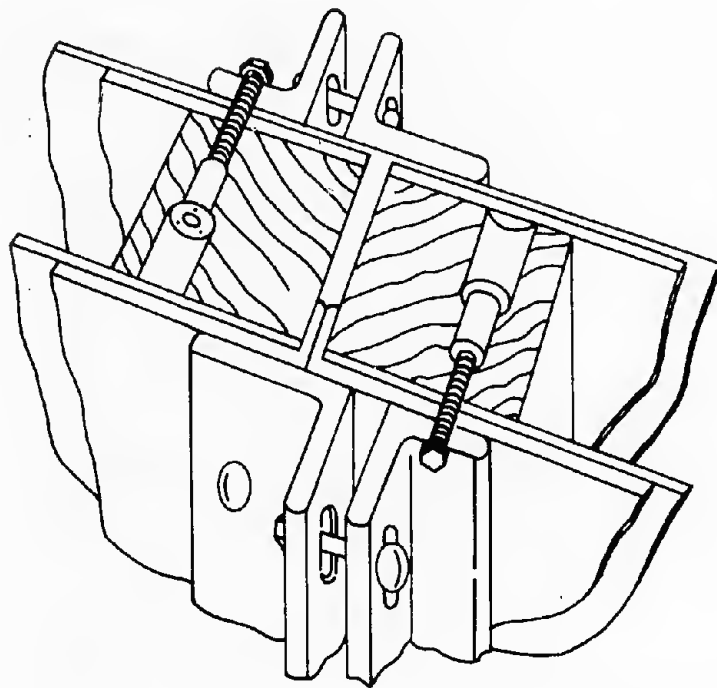

Figure 3. Typical panel-joining details for double electrically isolated enclosures.

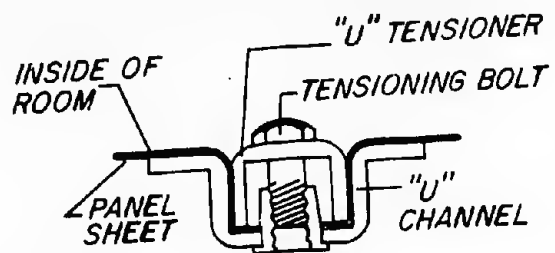

Figure 4. Typical panel-joining hardware for single-shield Lindsay structure.

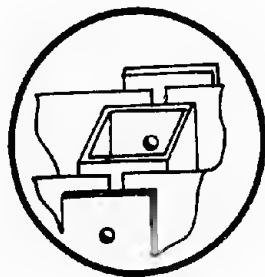

Figure 5. Typical seam-joining hardware for true cell-type room.

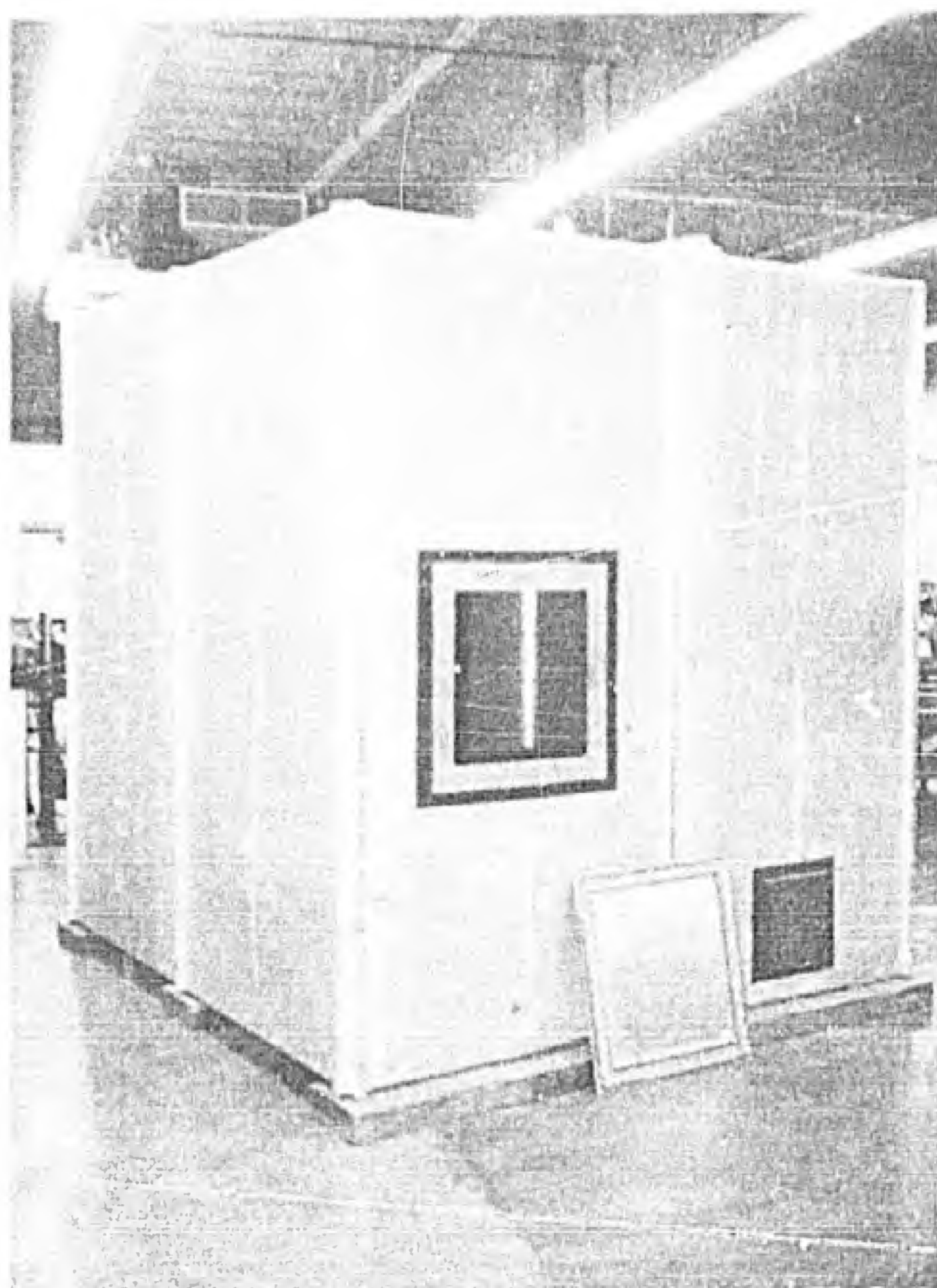

Figure 6. Single-shield test module.

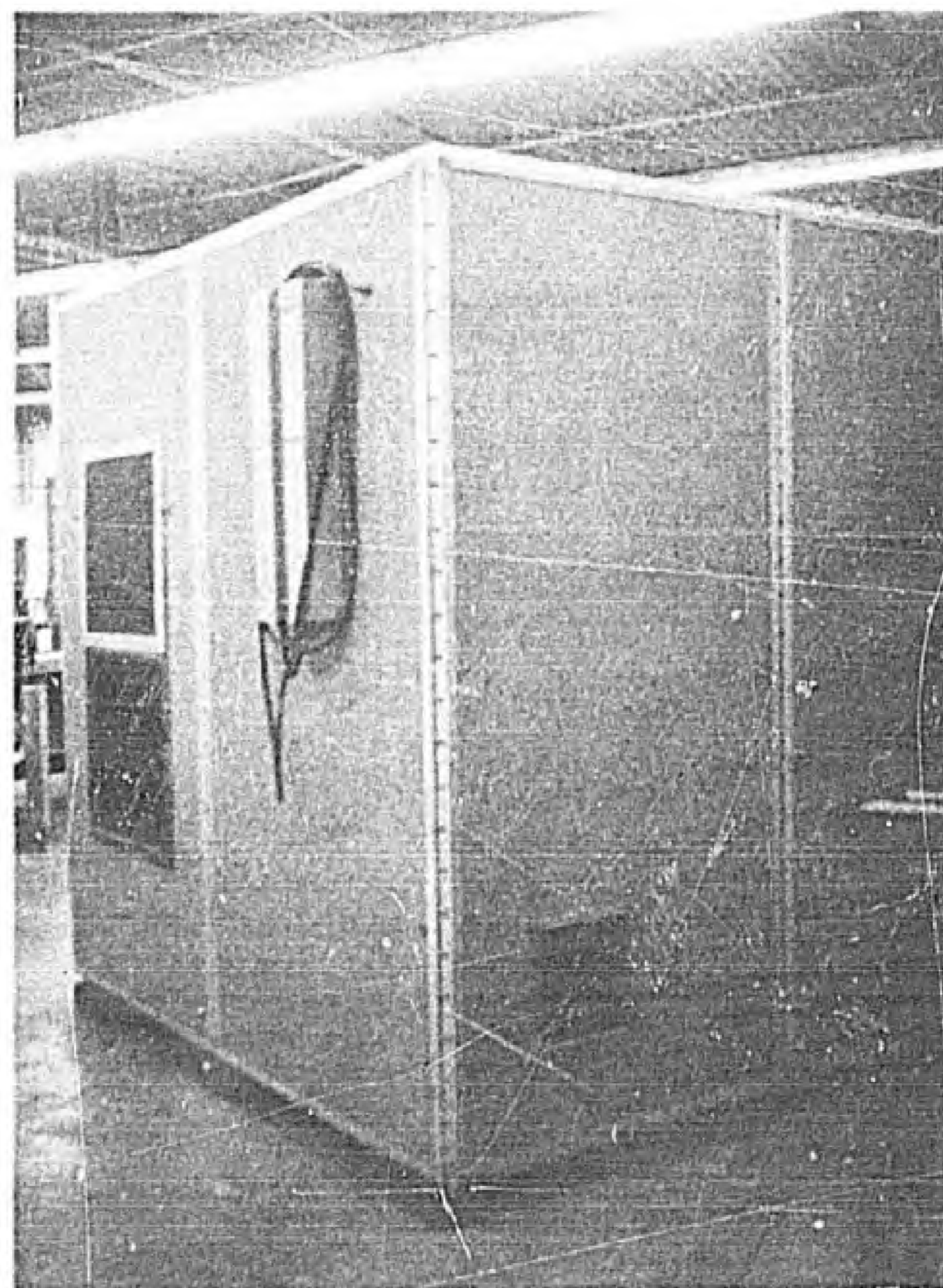

Figure 7. Cell-type test module.

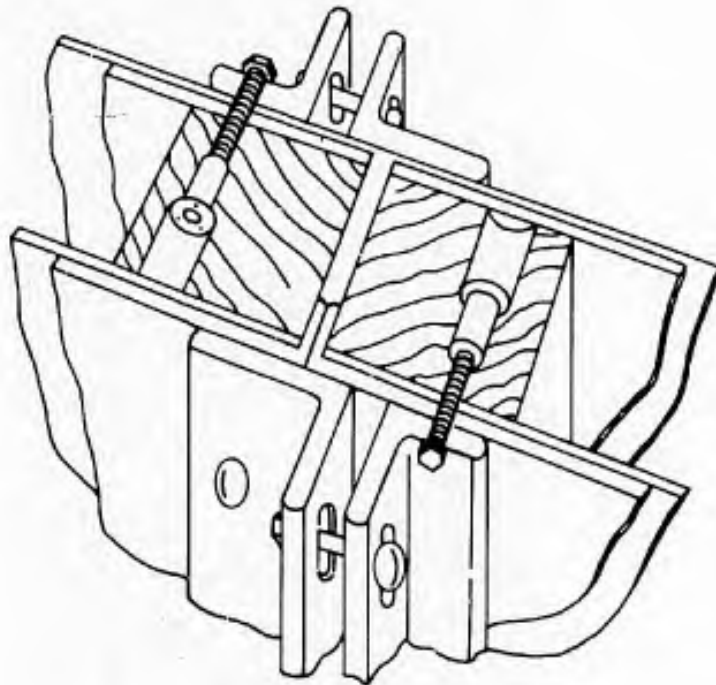

Figure 3. Typical panel-joining details for double electrically isolated enclosures.

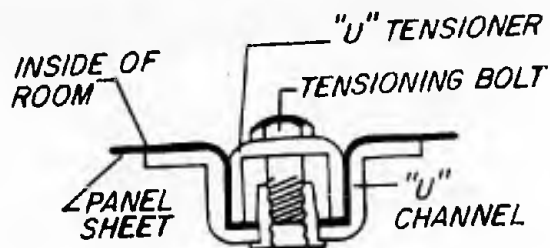

Figure 4. Typical panel-joining hardware for single-shield Lindsay structure.



Figure 5. Typical seam-joining hardware for true cell-type room.

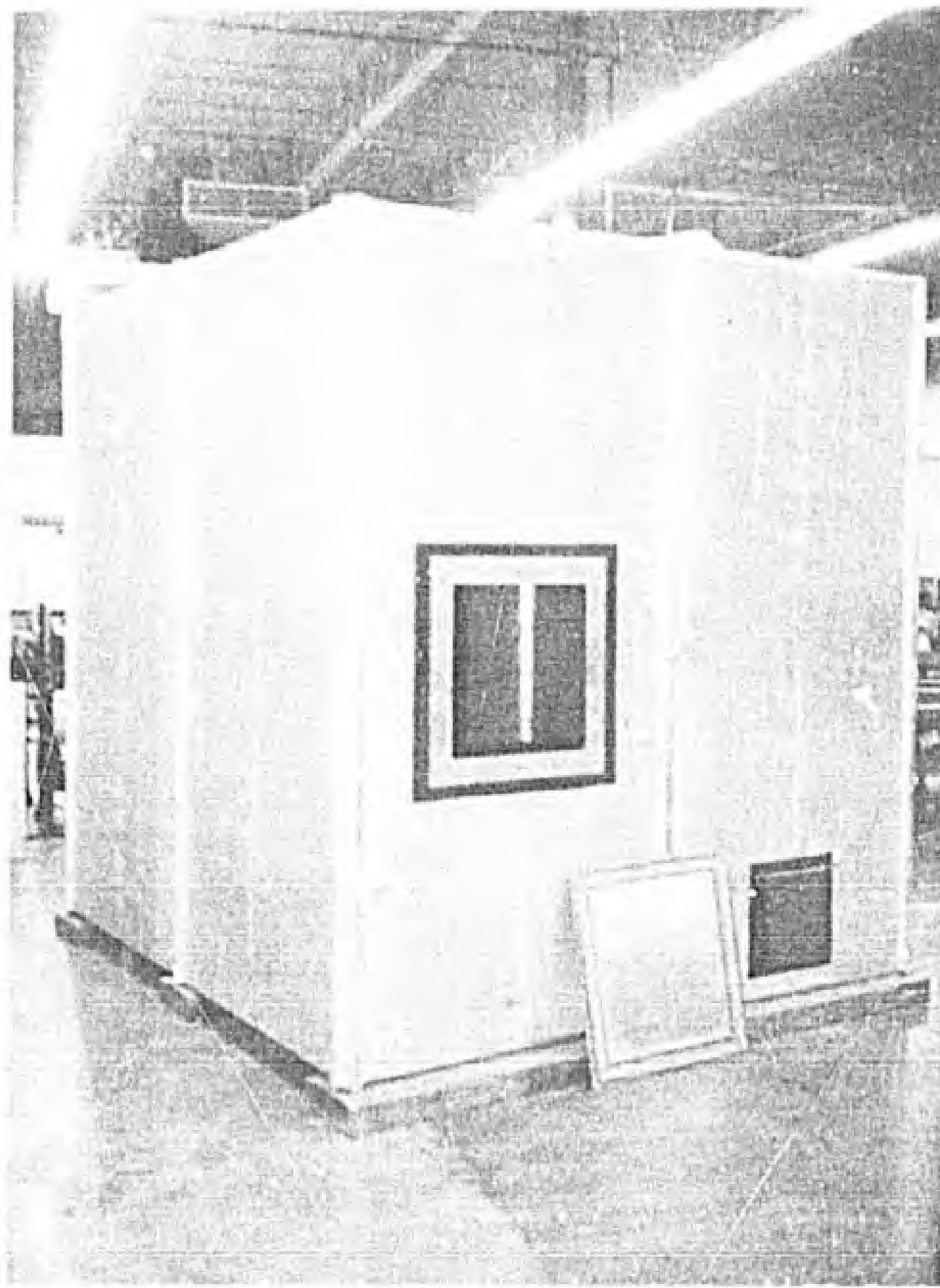

Figure 6. Single-shield test module.

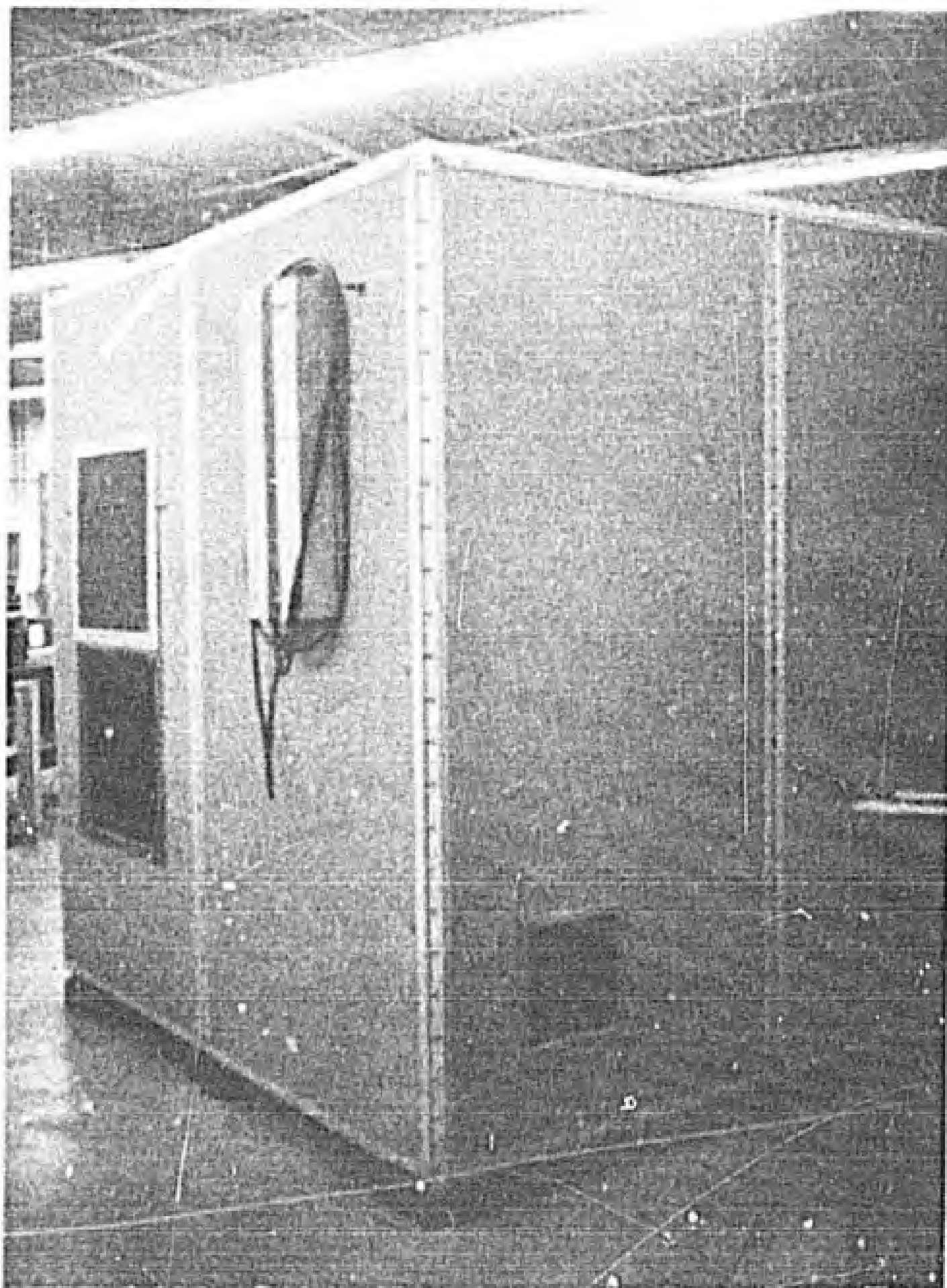

Figure 7. Cell-type test module.

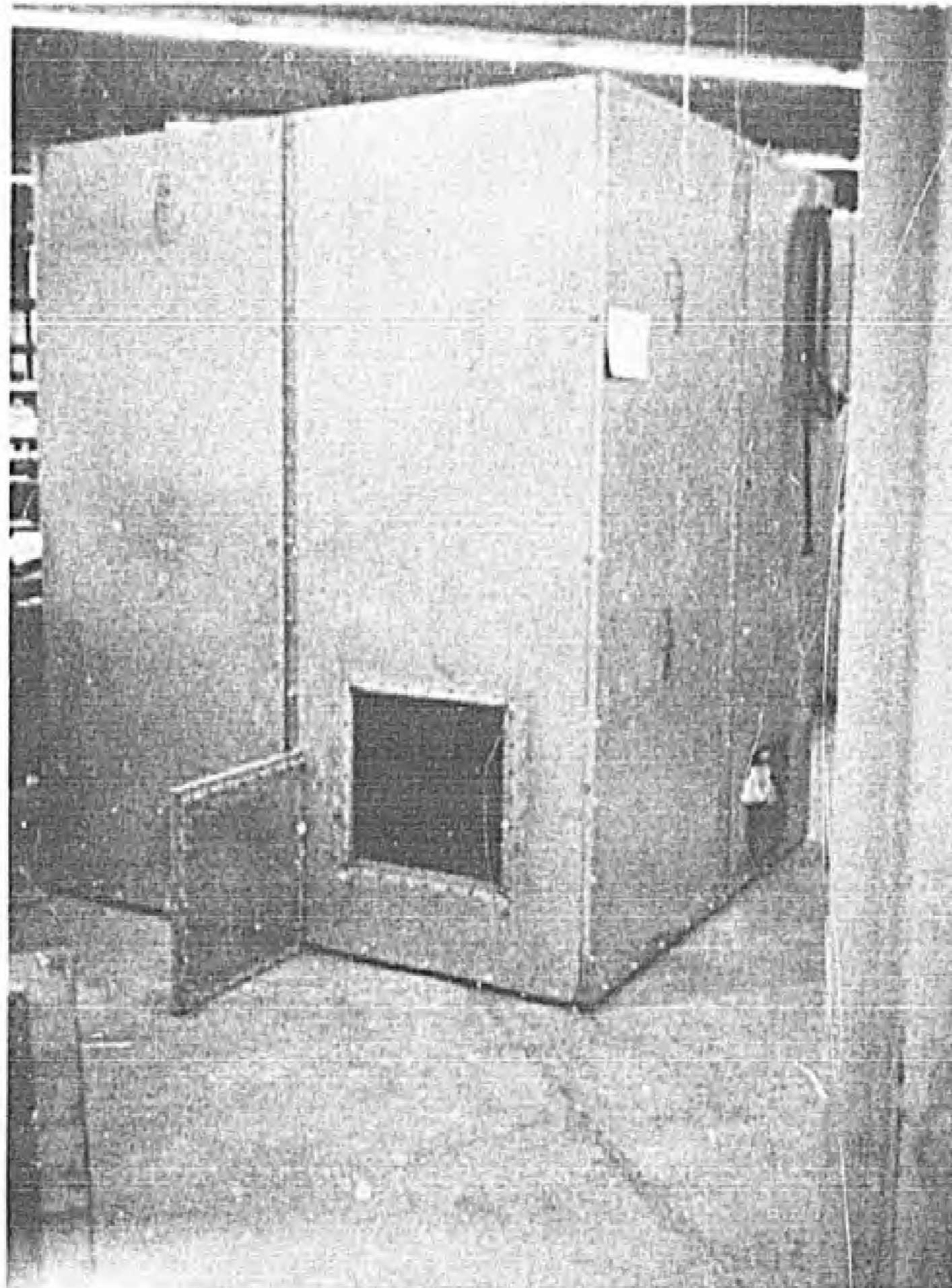

Figure 8. Double electrically isolated test module.

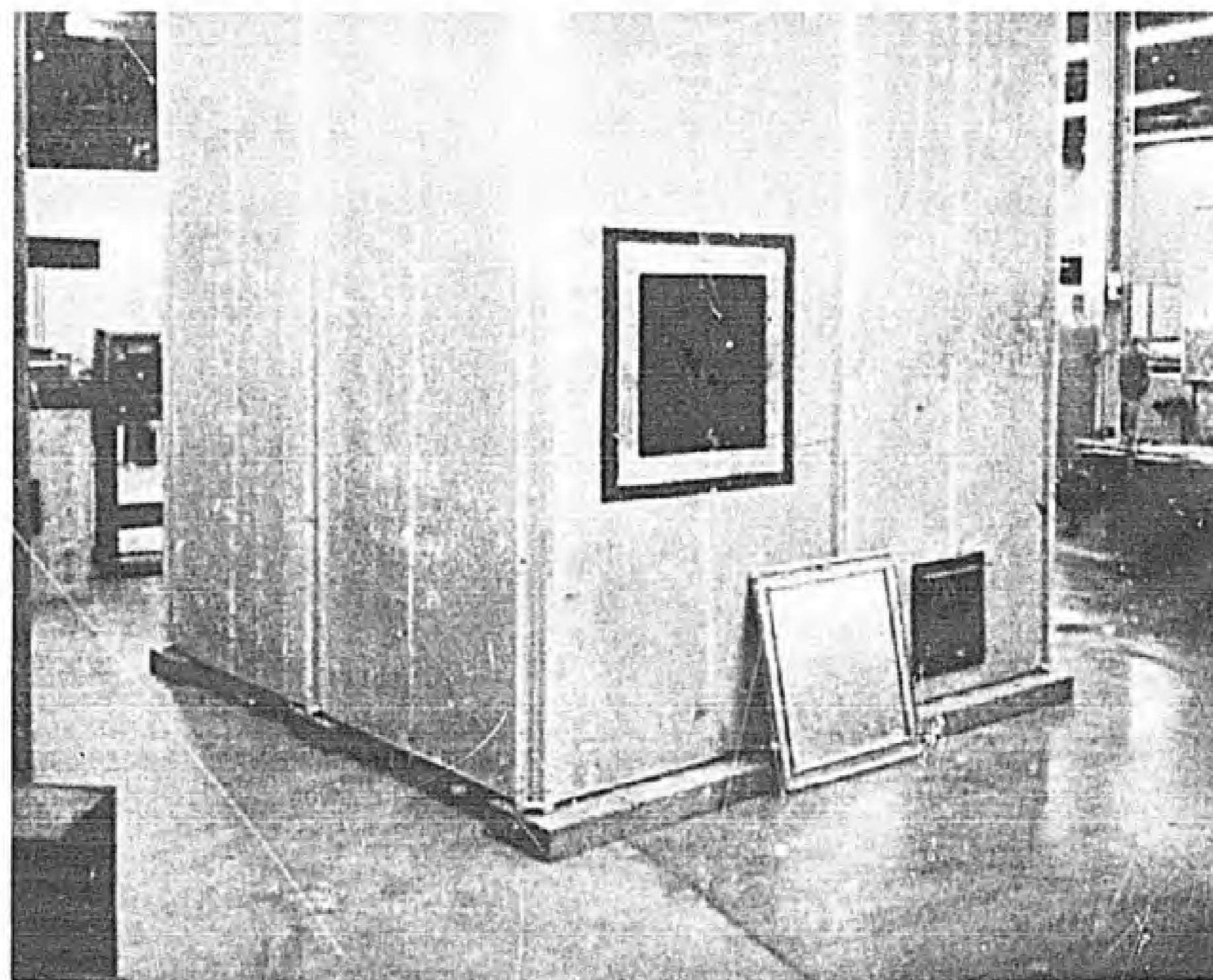

Figure 9. Hatch and hatch cover for single-shield room.

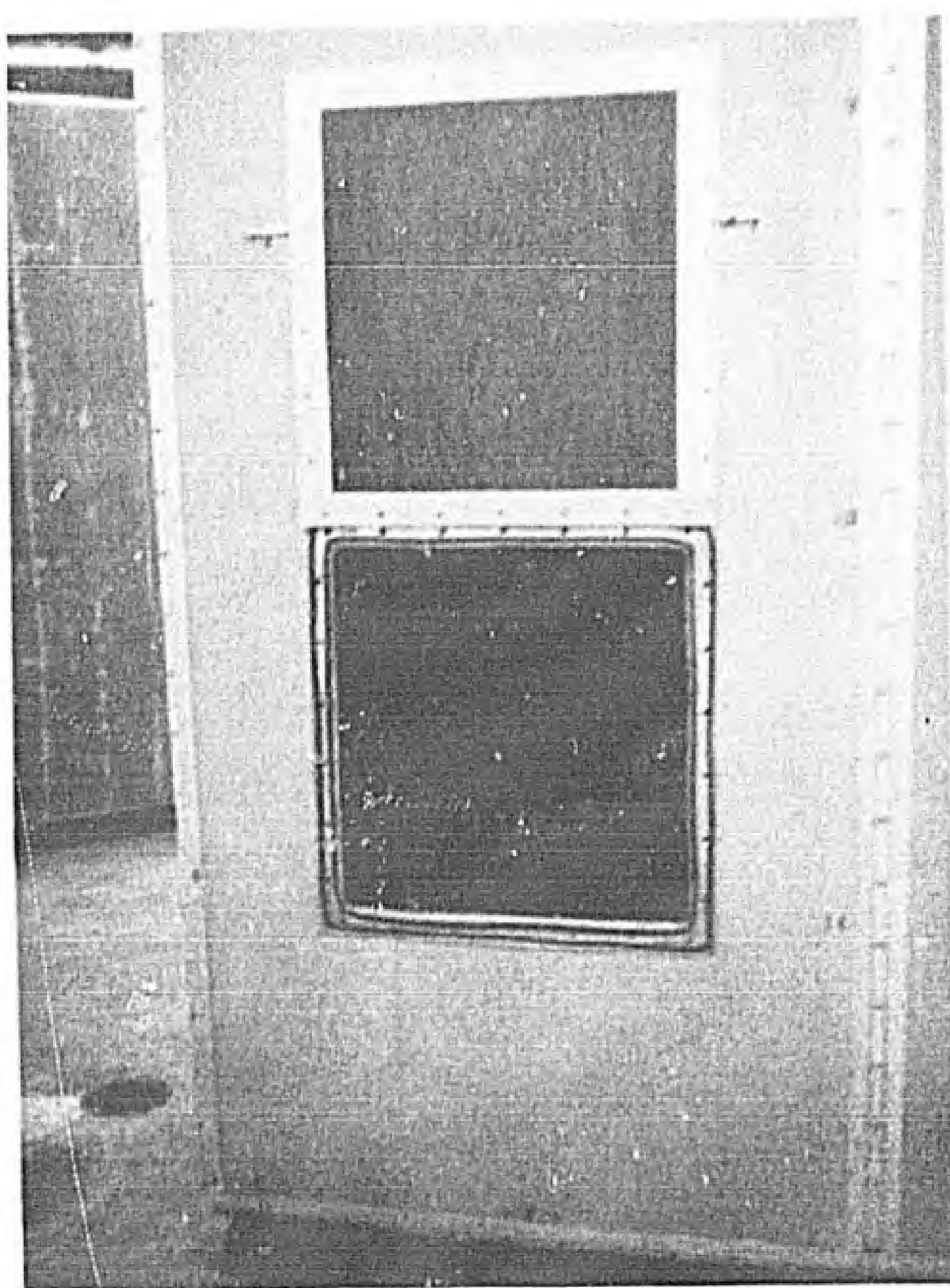

Figure 10. Hatch and hatch cover for cell-type room.

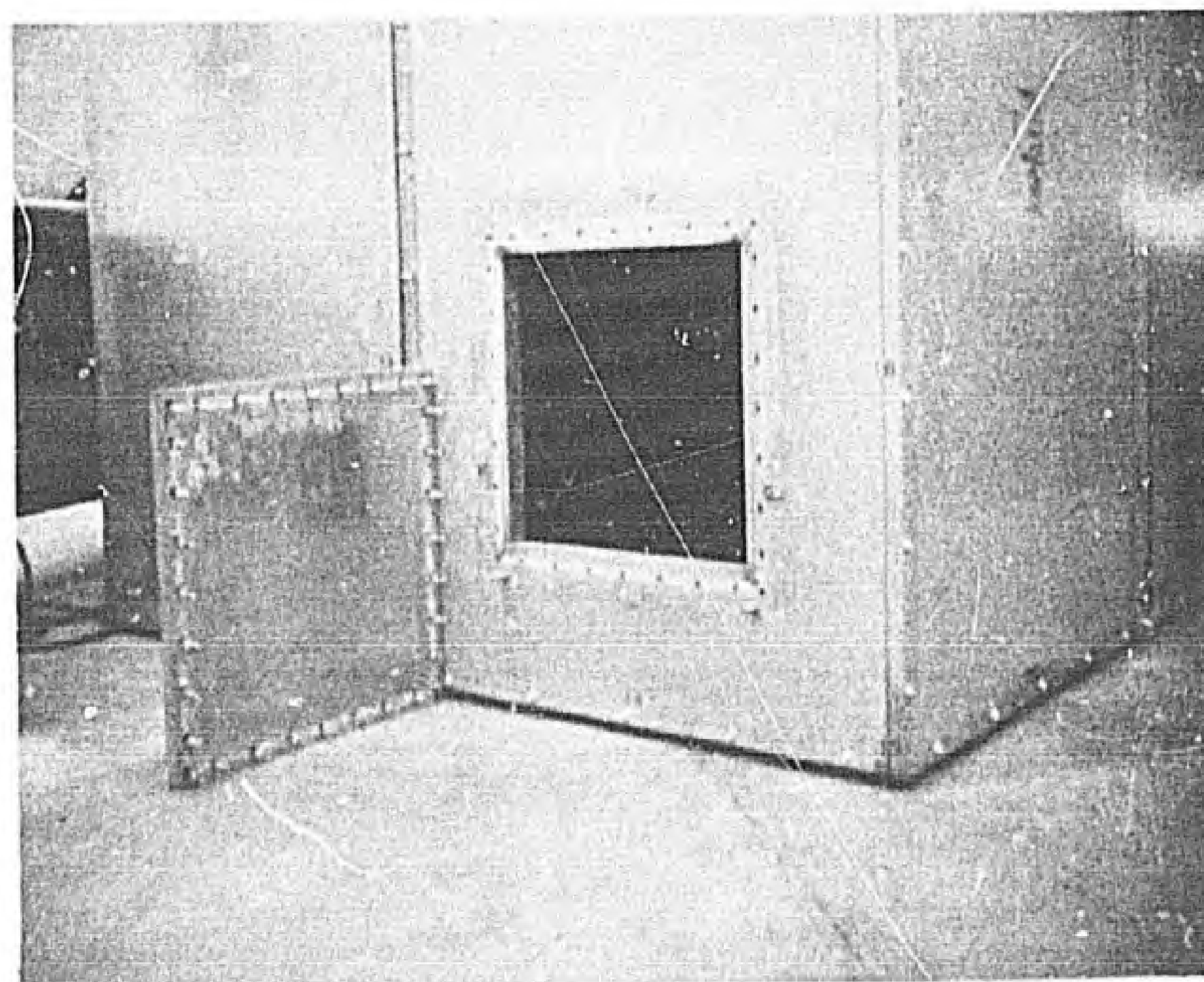

Figure 11. Hatch and hatch cover for double electrically isolated room.

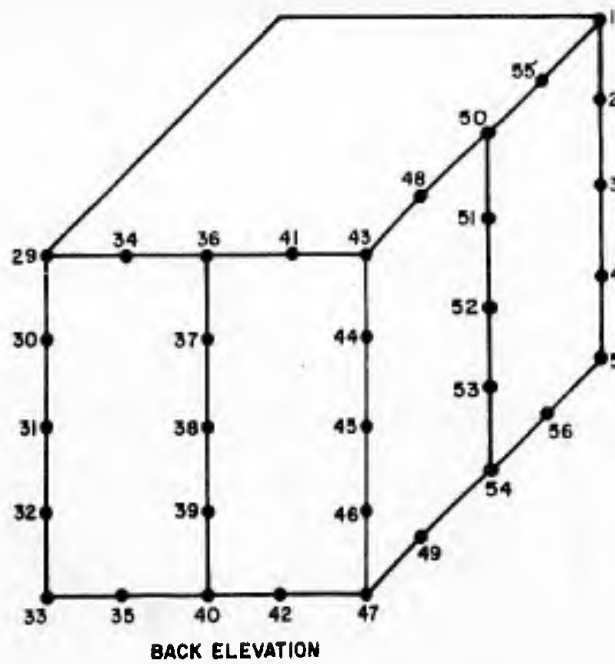
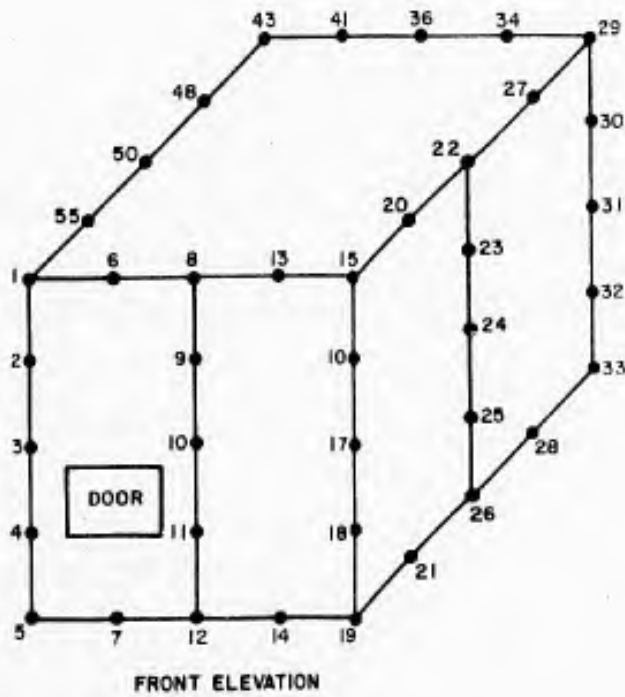

Figure 12. Test point locations.

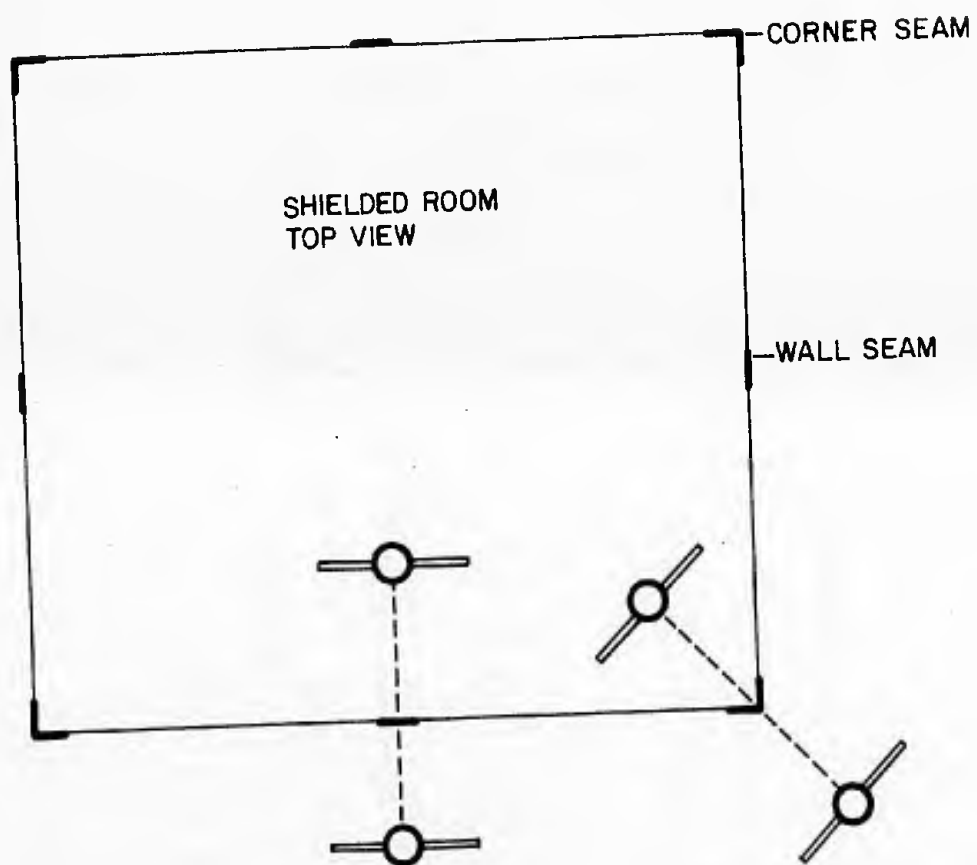

Figure 13. Relative antenna orientations for testing wall and corner seams.

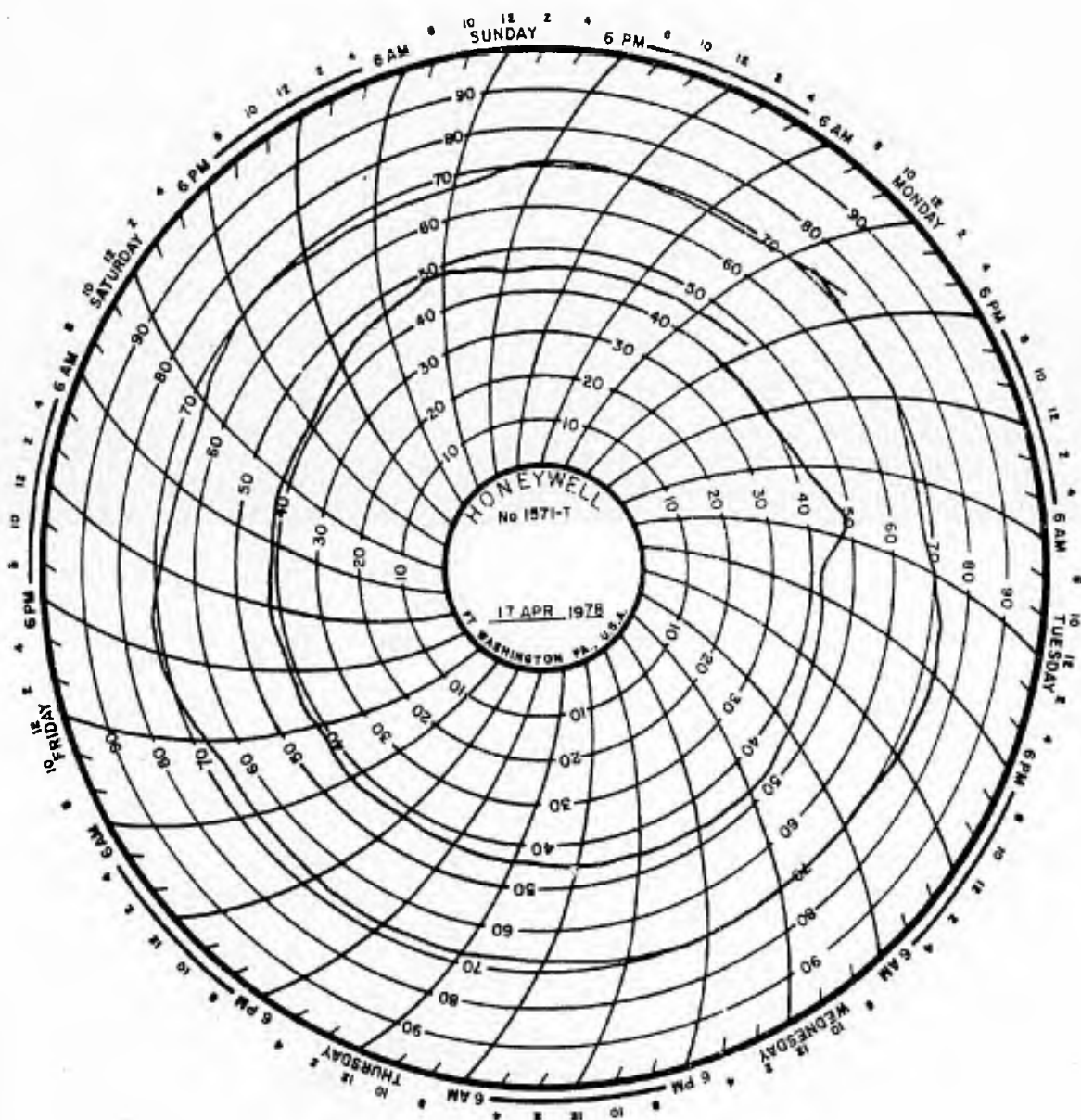

Figure 14. Temperature and humidity in the testing area for a typical week in spring.

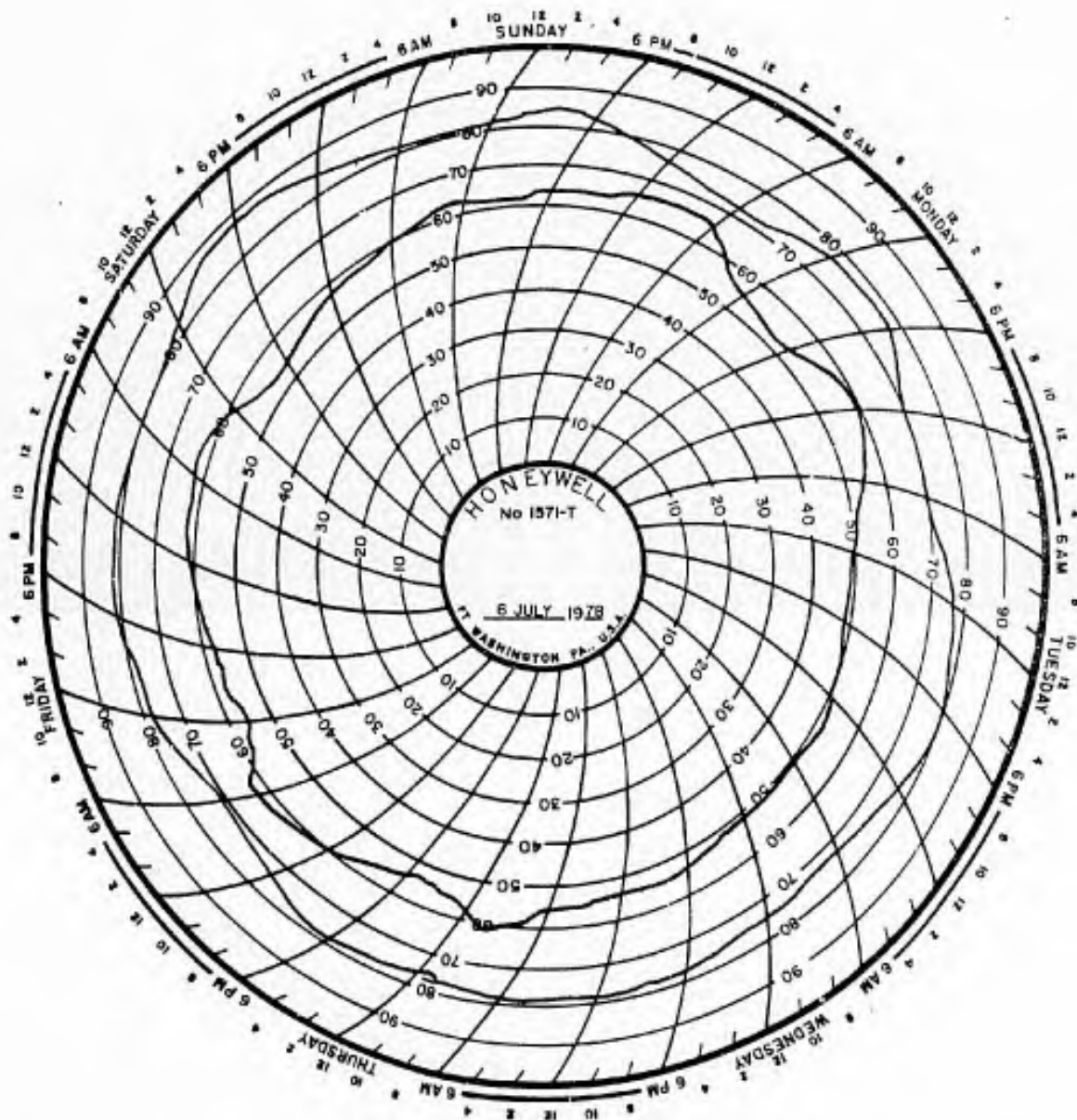

Figure 15. Temperature and humidity in the testing area for a typical week in summer.

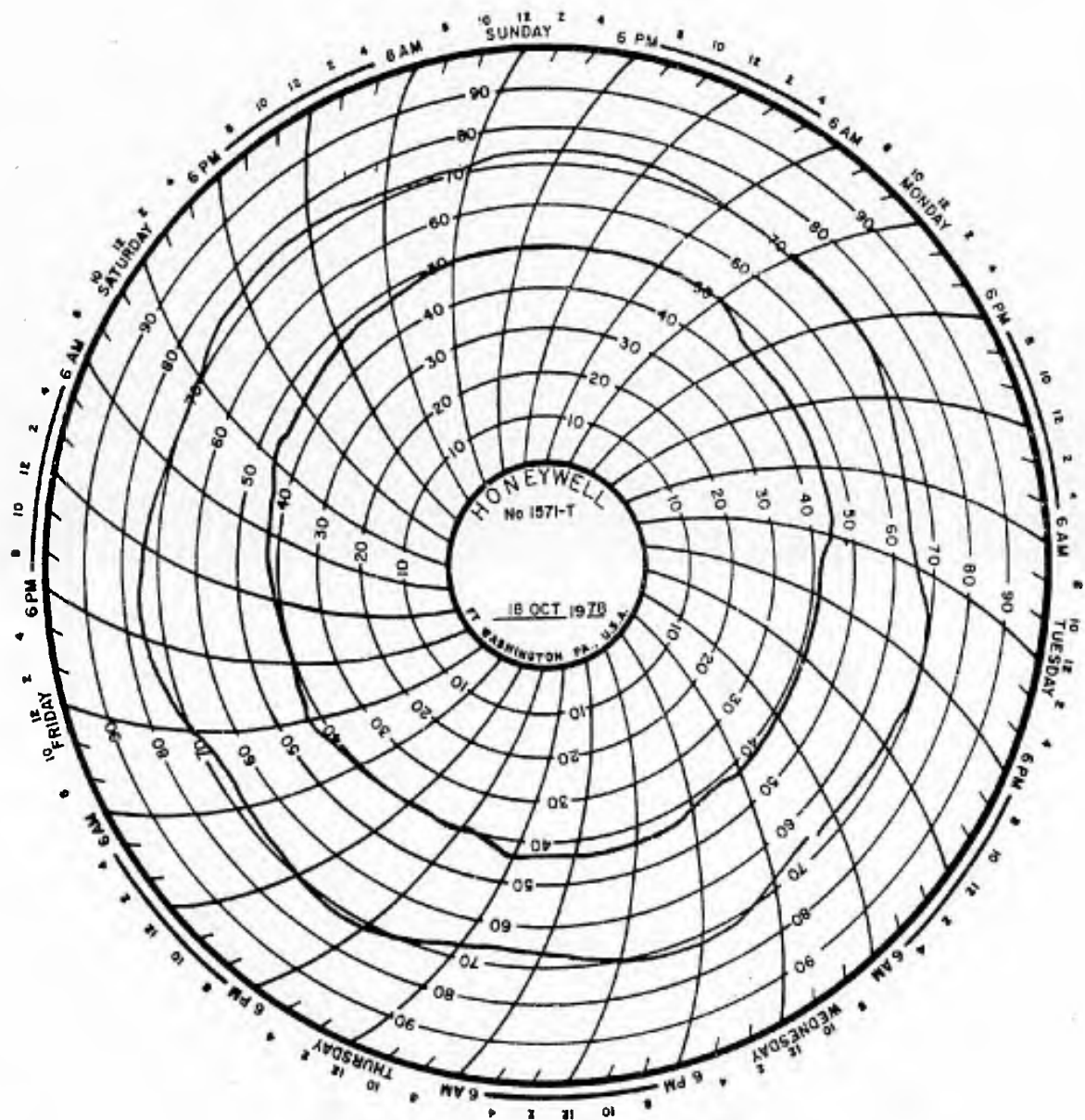

Figure 16. Temperature and humidity in the testing area for a typical week in autumn.

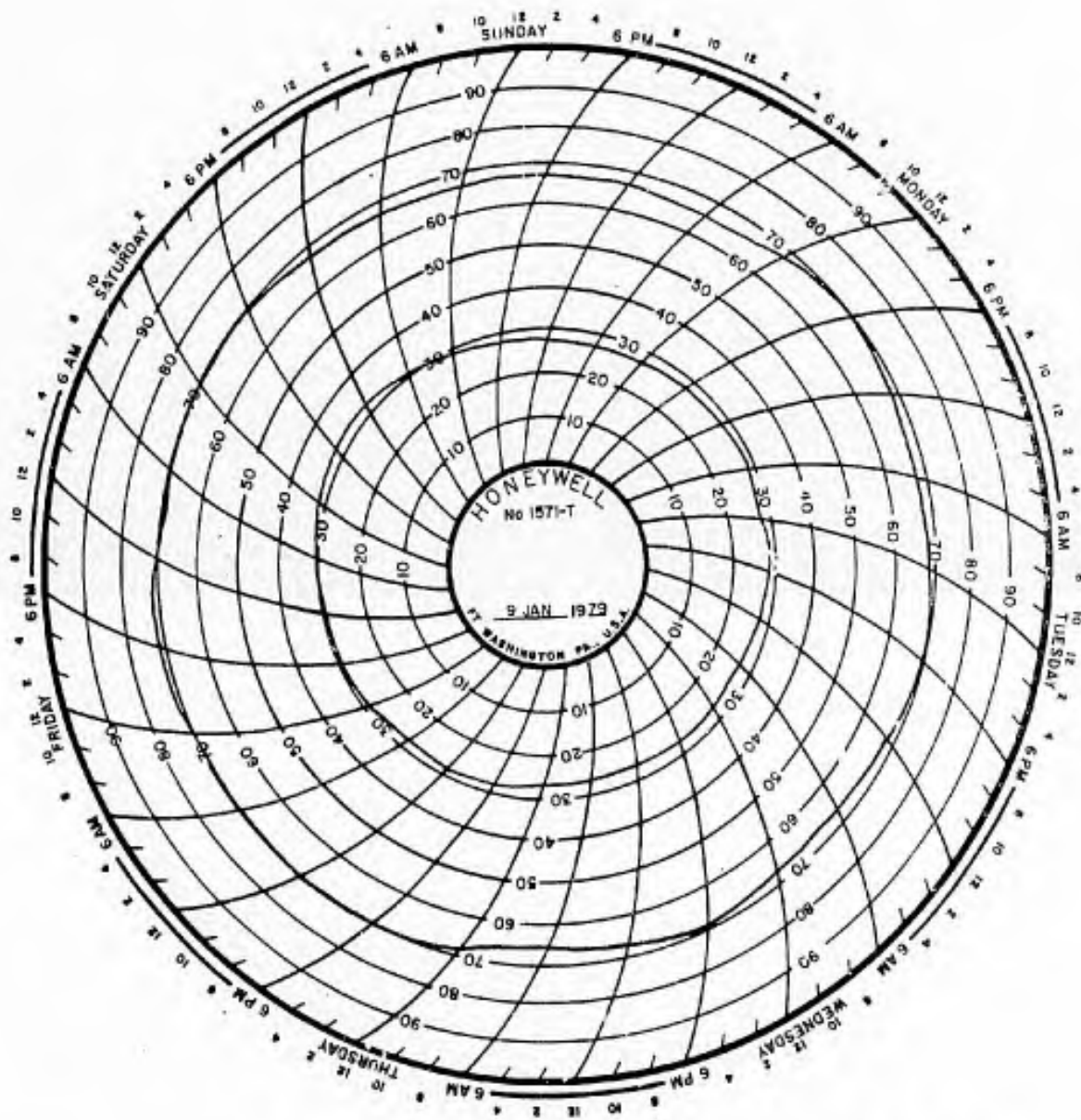

Figure 17. Temperature and humidity in the testing area for a typical week in winter.

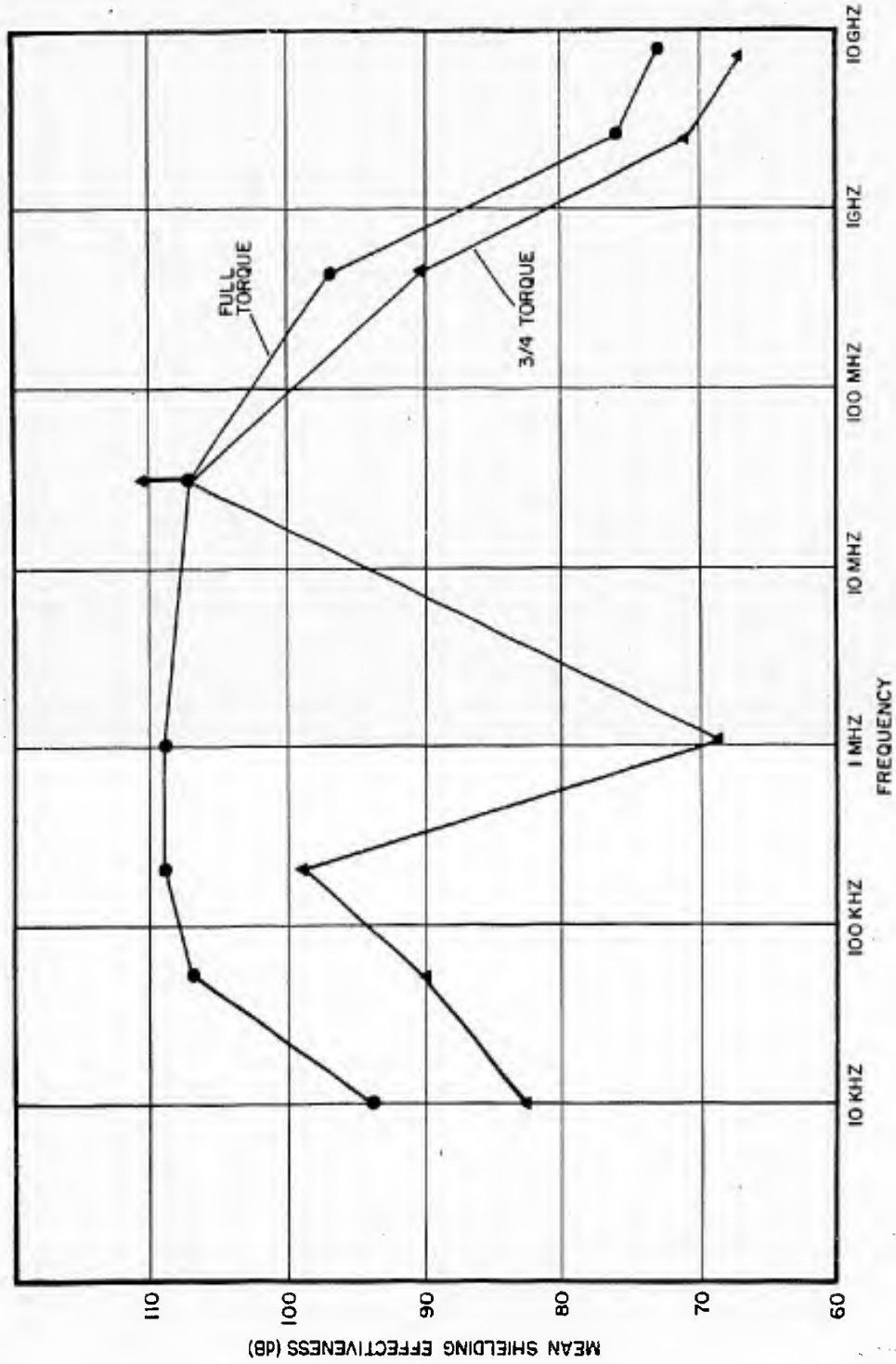

Figure 18. Shielding effectiveness versus frequency for three-fourths and full-rated torque.

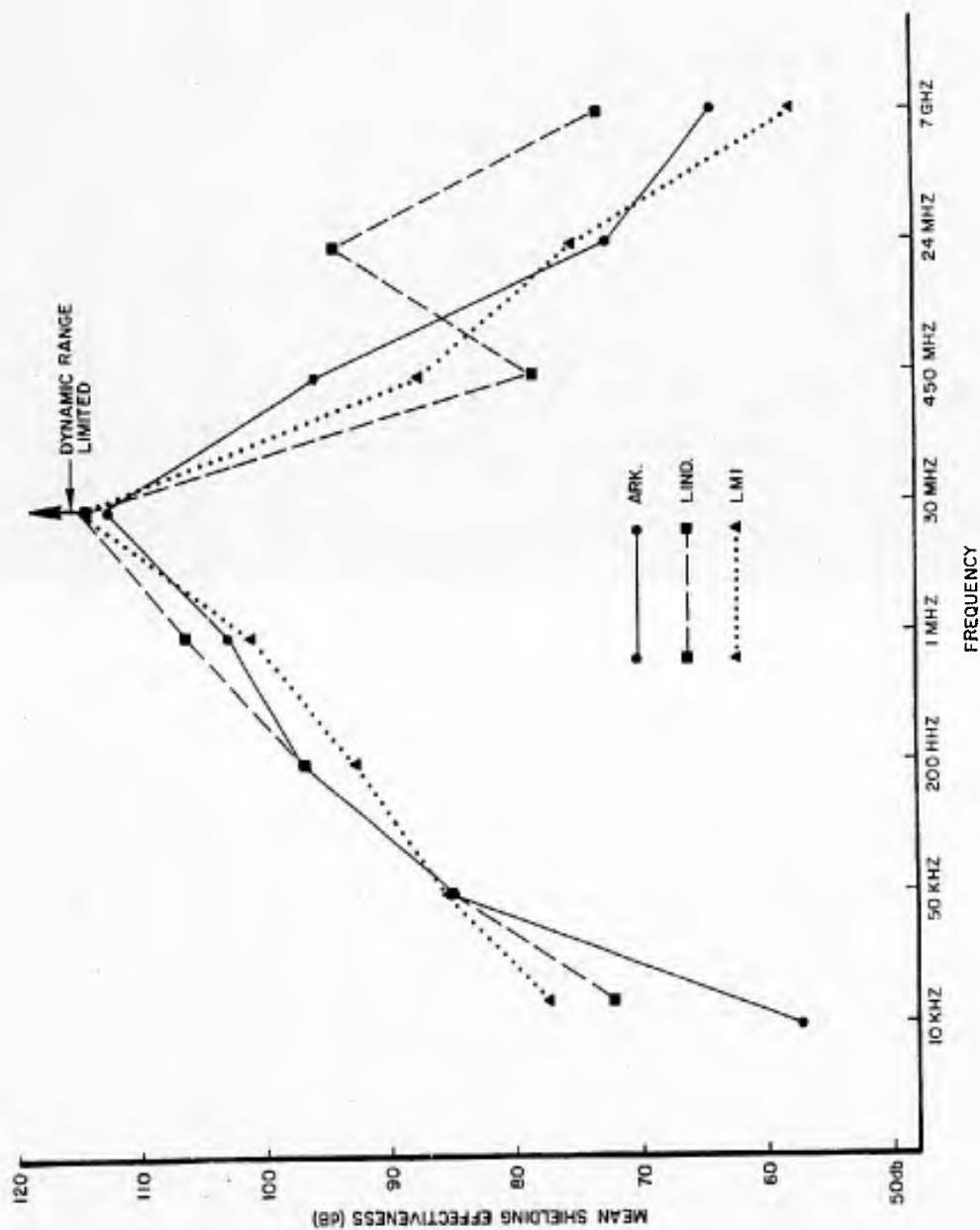

Figure 19. Mean shielding effectiveness for all test points for the June 1980 test.

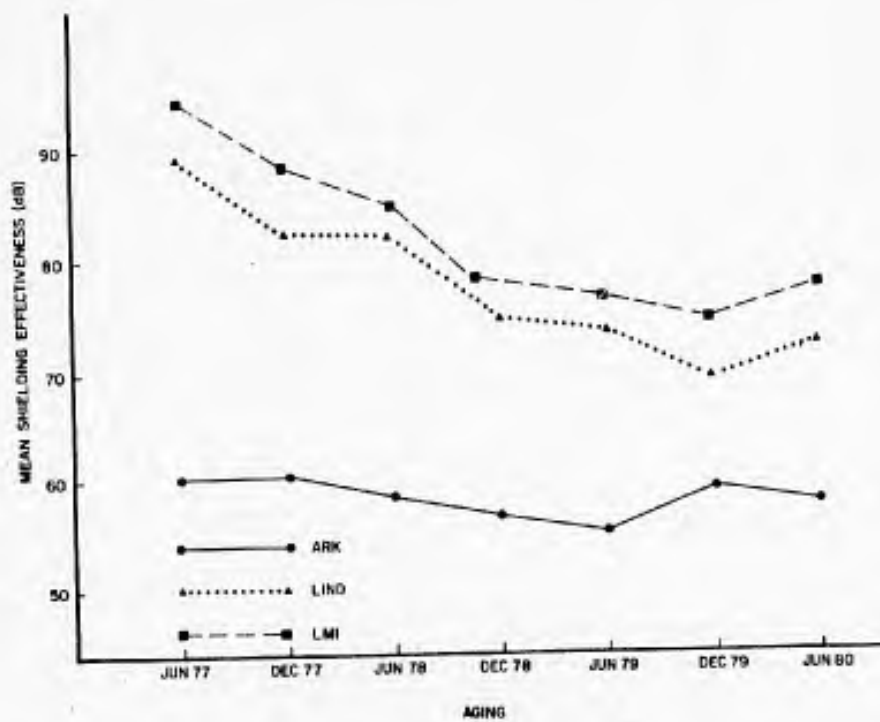

Figure 20. Comparison of the shielding effectiveness of the three room types versus aging (10 kHz frequency).

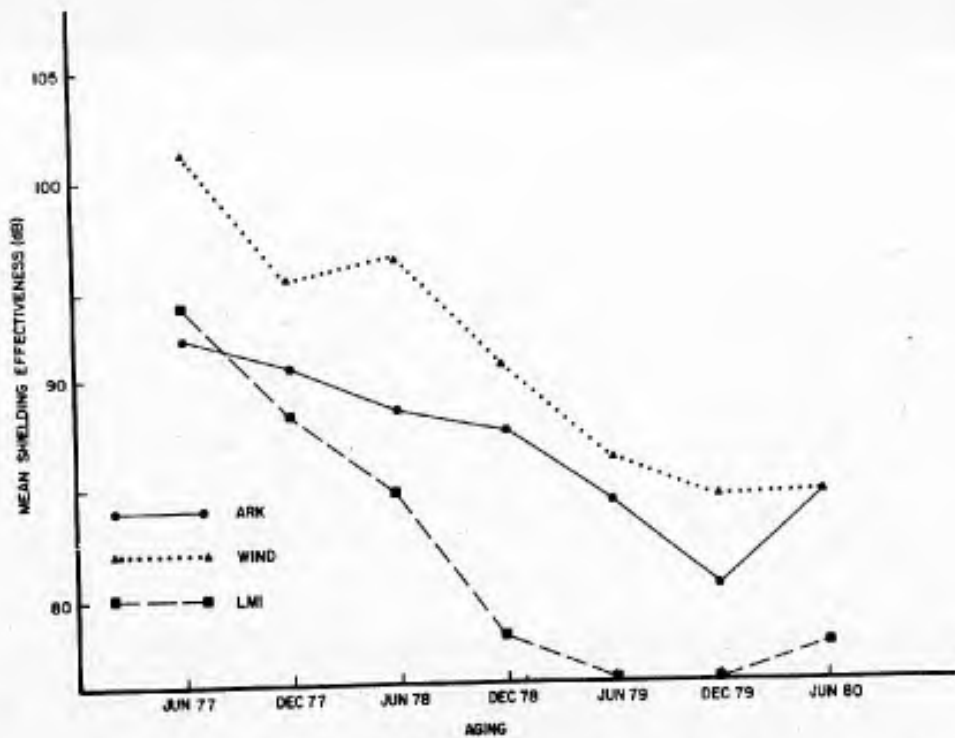

Figure 21. Comparison of the shielding effectiveness of the three rooms versus aging (50 kHz frequency).

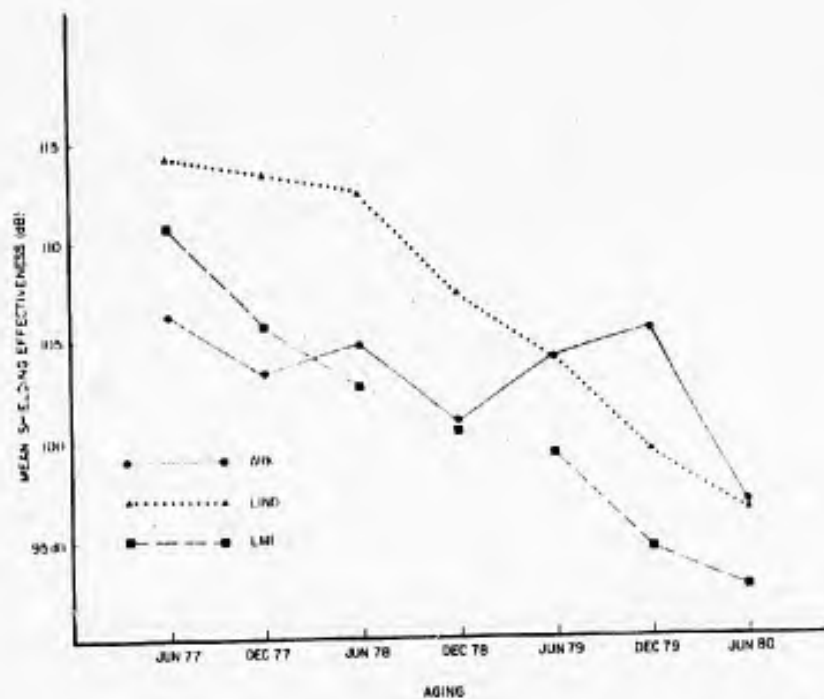

Figure 22. Comparison of the shielding effectiveness of the three room types versus aging (200 kHz frequency).

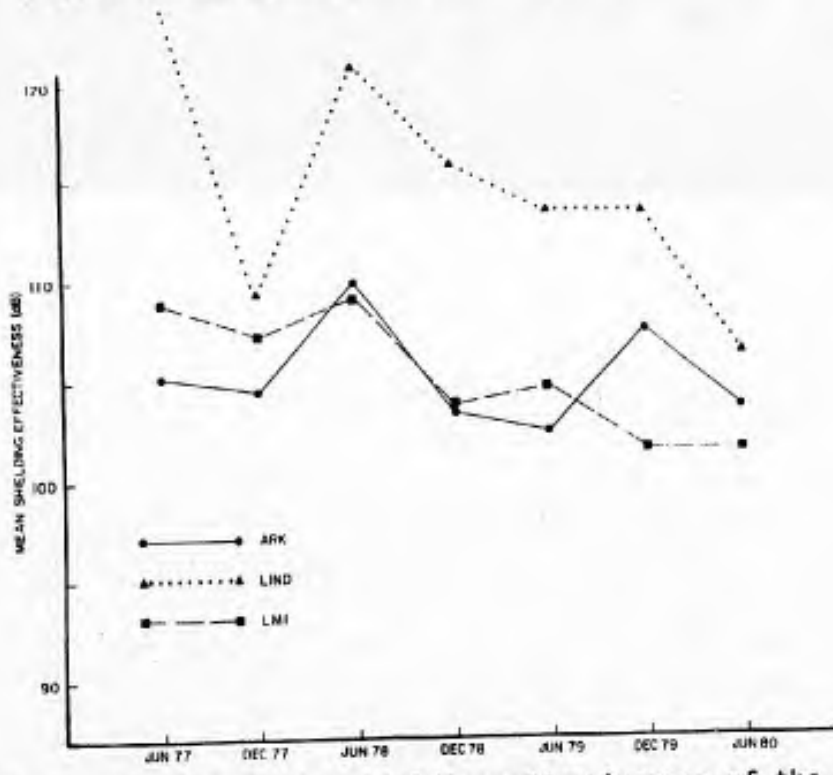

Figure 23. Comparison of the shielding effectiveness of the three room types versus aging (1 MHz frequency).

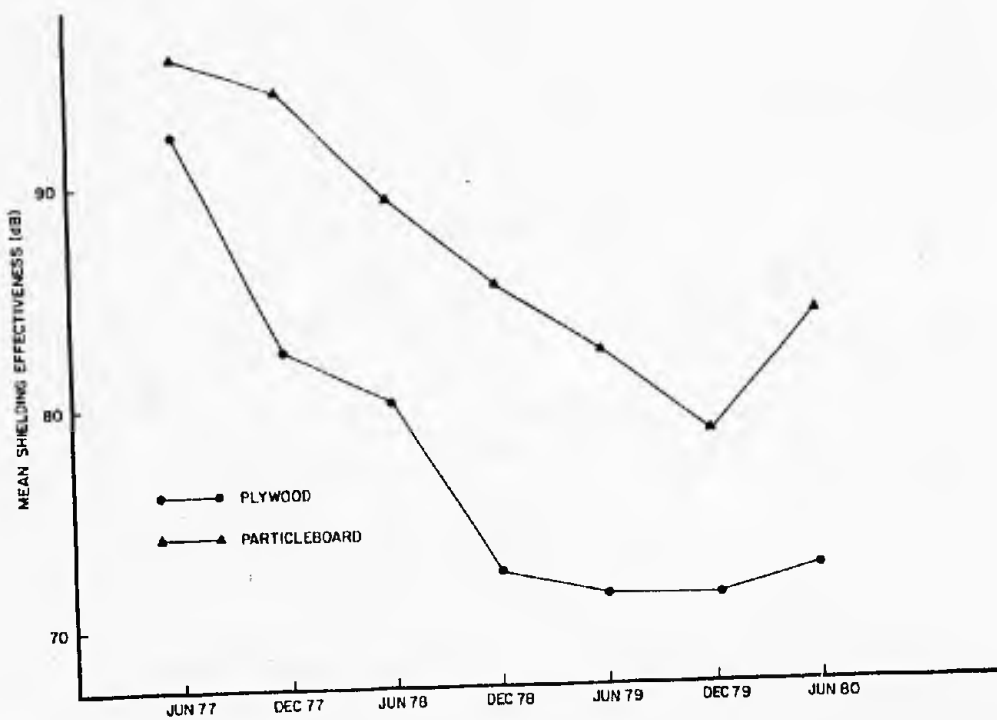

Figure 24. Comparison between particleboard and plywood-cored panels versus aging (10 kHz).

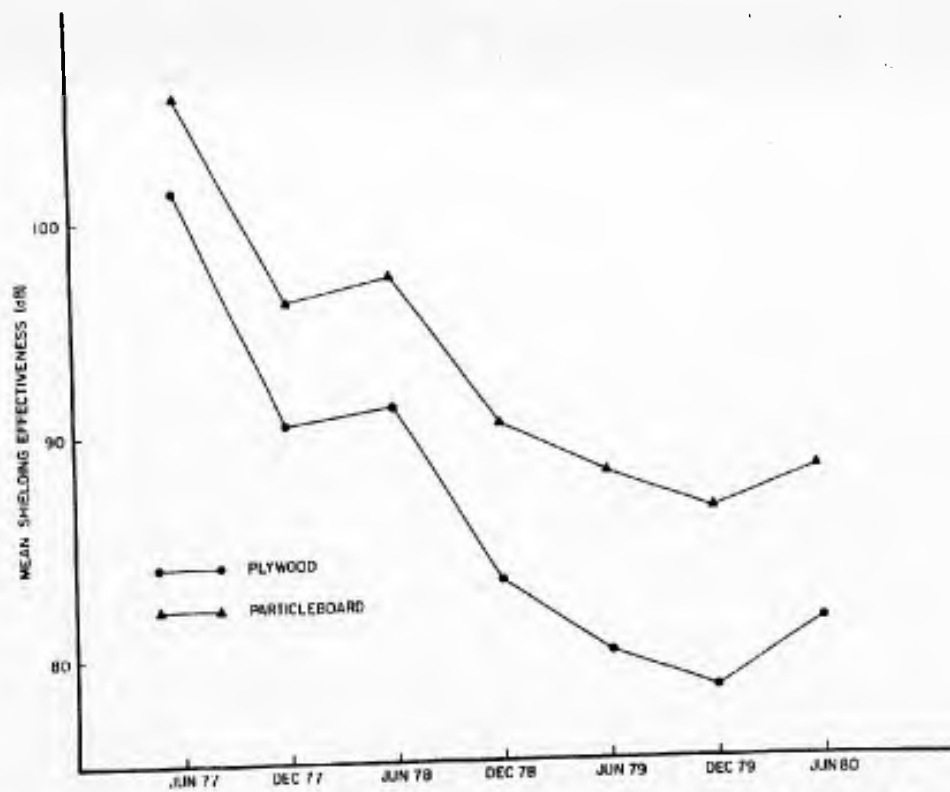

Figure 25. Comparison of plywood and particleboard-cored panels versus aging (50 kHz).

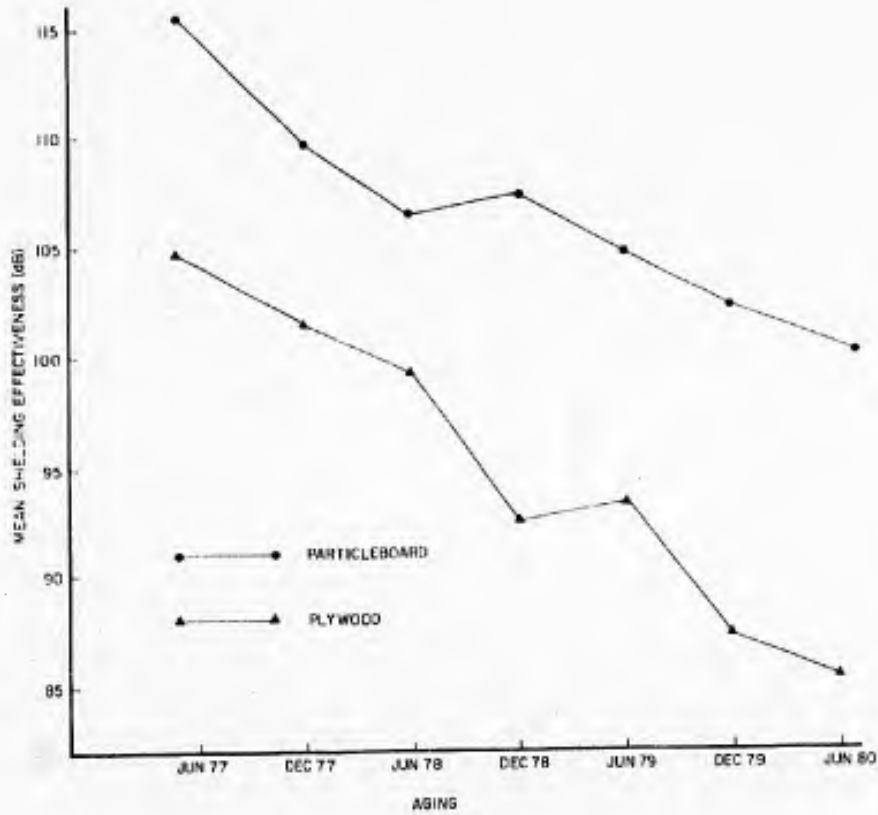

Figure 26. Comparison between plywood and particleboard-cored panels versus aging (200 kHz).

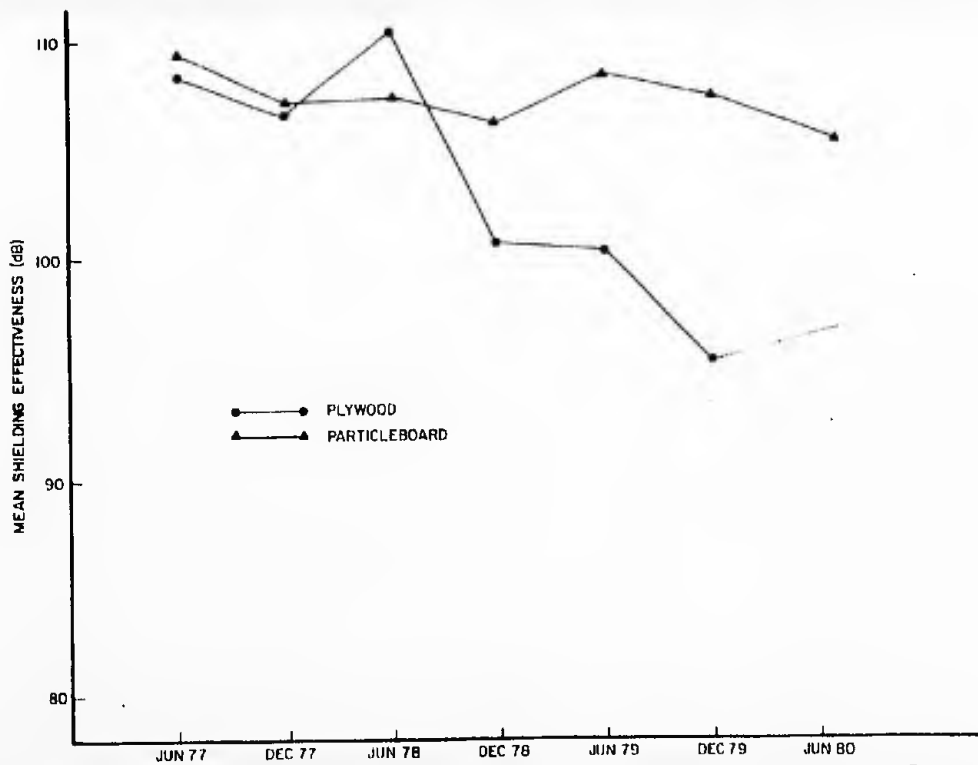

Figure 27. Comparison of plywood and particleboard-cored panels versus aging (1 MHz).

APPENDIX A:

SHIELDING EFFECTIVENESS TEST DATA ANALYSIS

This appendix presents the results of the computerized analysis of all test data taken during this study.

The families of curves presented show the shielding effectiveness versus aging trends for each room studied. In addition, each graph shows, for each interval test, the number of test points within dynamic range, the mean of points included, and the standard deviation of these points. Figure A1 provides a graphical key as an aid in interpreting the data.

The computerized graphs shown present shielding effectiveness versus aging for averages of the test points indicated in Figure 12. For each room and frequency, two graphs are presented. The first excludes out-of-range data from the average, while the second includes all data points. Out-of-range data are shielding effectiveness data where the measurement range of the equipment used is less than the actual shielding effectiveness at the point being measured. At some frequencies there are no out-of-range data points and the two consecutive graphs are identical.

The numbers within the graphed lines represent the range (in decibels) of shielding effectiveness. Thus the curves show the percentage of the test points which fall within the range identified. For example, on p 45 the number "2" represents the range from 0 to 60 dB. The December 1977 (DEC 77) test shows 70 percent of all test points being between 0 and 60 dB, while only about 3 percent are between 0 and 50 dB and all are within 0 and 90 dB. A rising trend versus aging in the curve families thus shows a decrease in average shielding effectiveness.

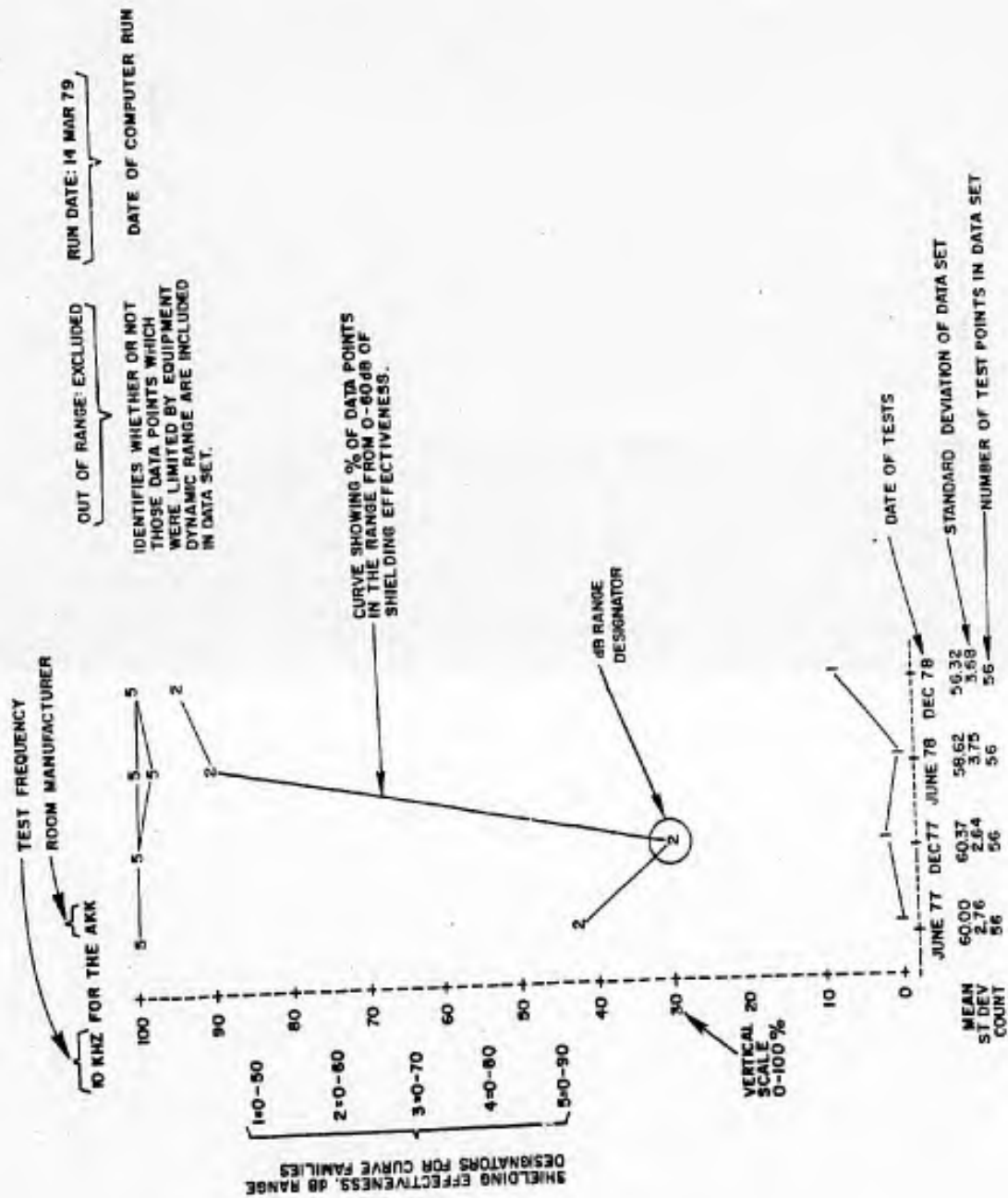
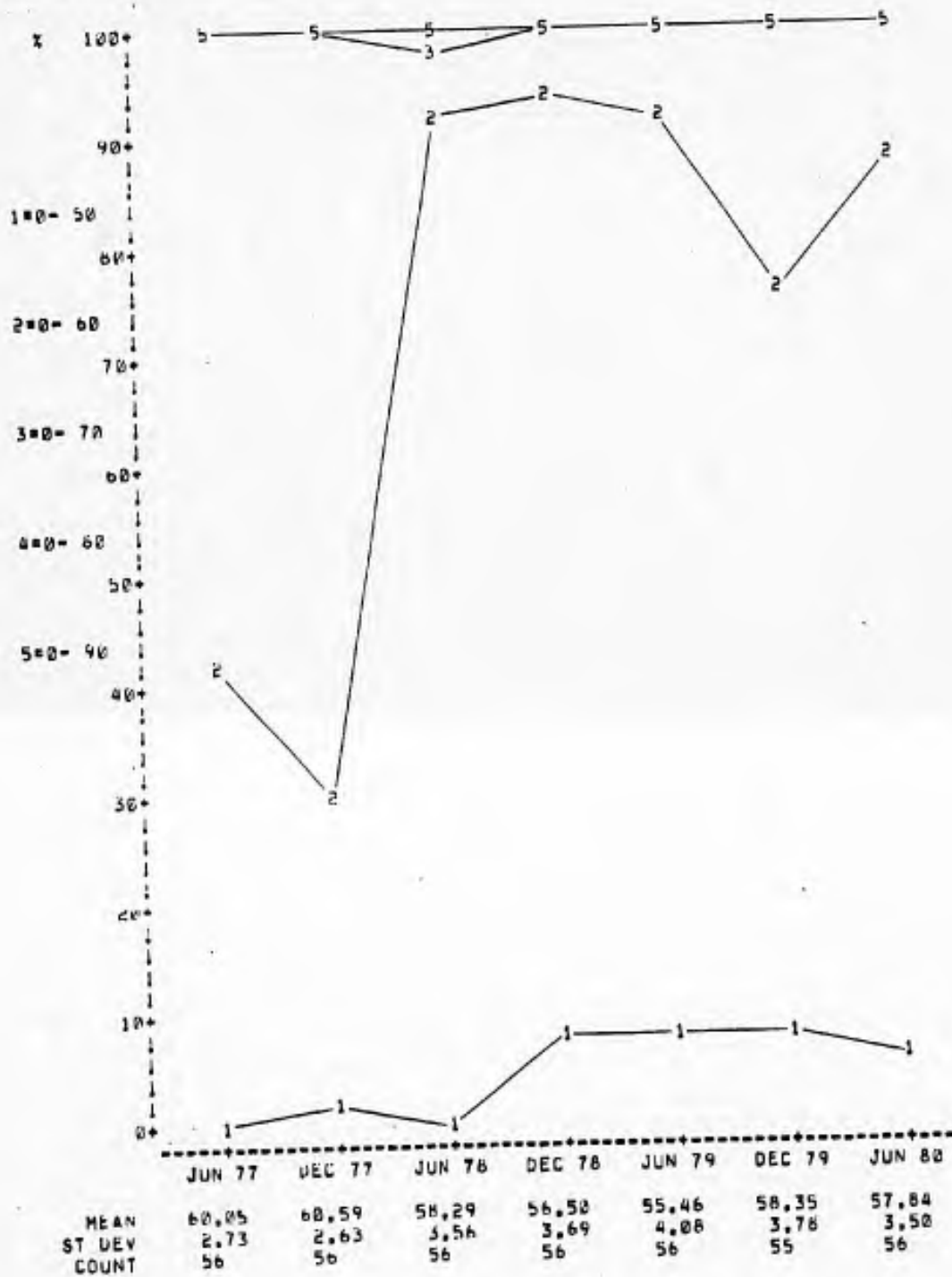

Figure A1. Graphical key for Appendix A.

10 KHZ FOR THE ARK
OUT OF RANGE: EXCLUDED

RUN DATE:



10 KM2 FOR THE ARK
OUT OF RANGE: INCLUDED

RUN DATE:

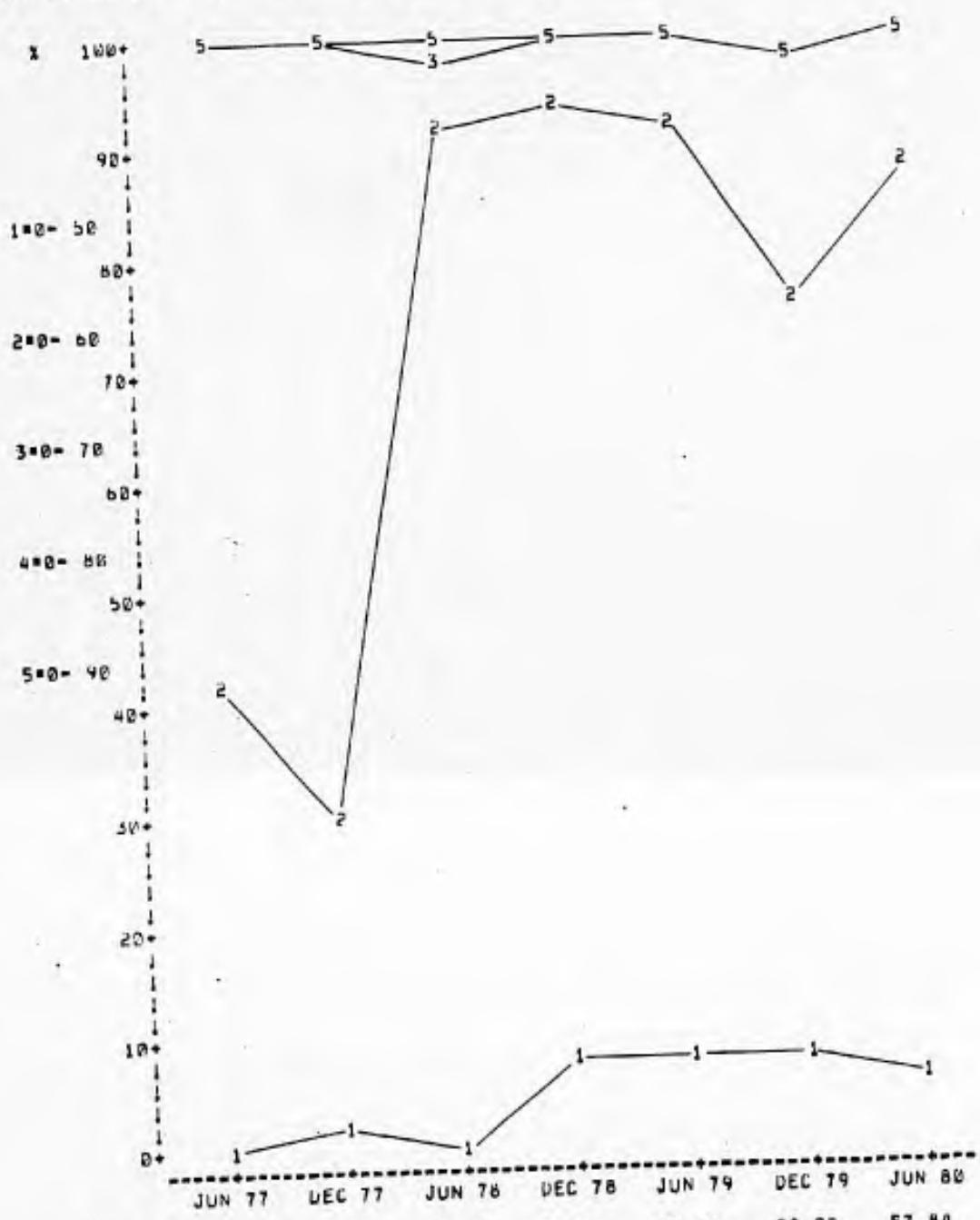

	JUN 77	DEC 77	JUN 78	DEC 78	JUN 79	DEC 79	JUN 80
MEAN	60.05	60.59	58.29	56.50	55.46	58.98	57.84
ST DEV	2.73	2.63	3.56	3.69	4.08	6.06	3.50
COUNT	56	56	56	56	56	56	56

50KHZ FOR THE ARK
OUT OF RANGE: EXCLUDED

RUN DATE:

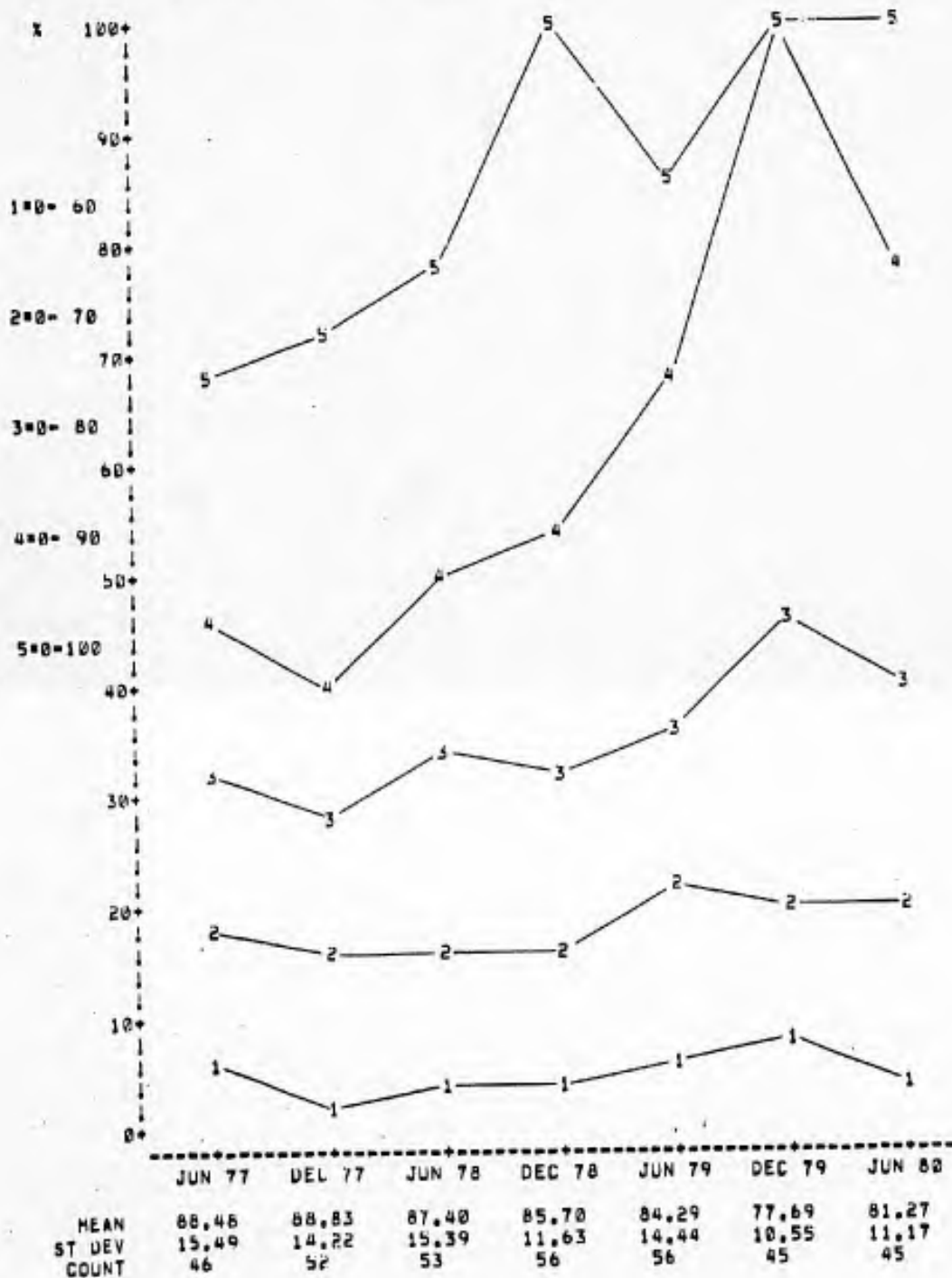

50KHZ FOR THE ANK
OUT OF RANGE: INCLUDED

RUN DATE:

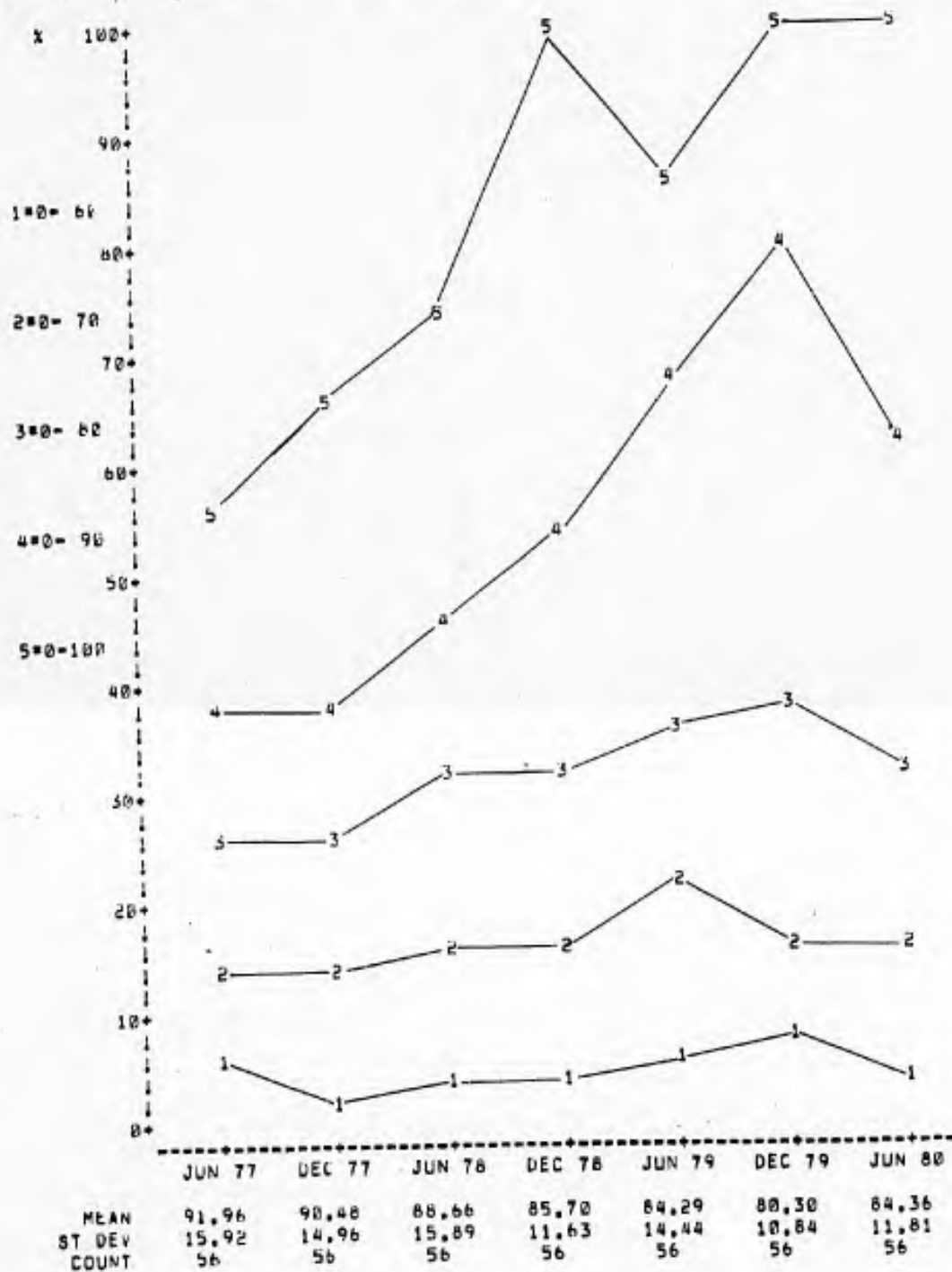

200 KHZ FOR THE ANK
OUT OF RANGE: EXCLUDED

RUN DATE:

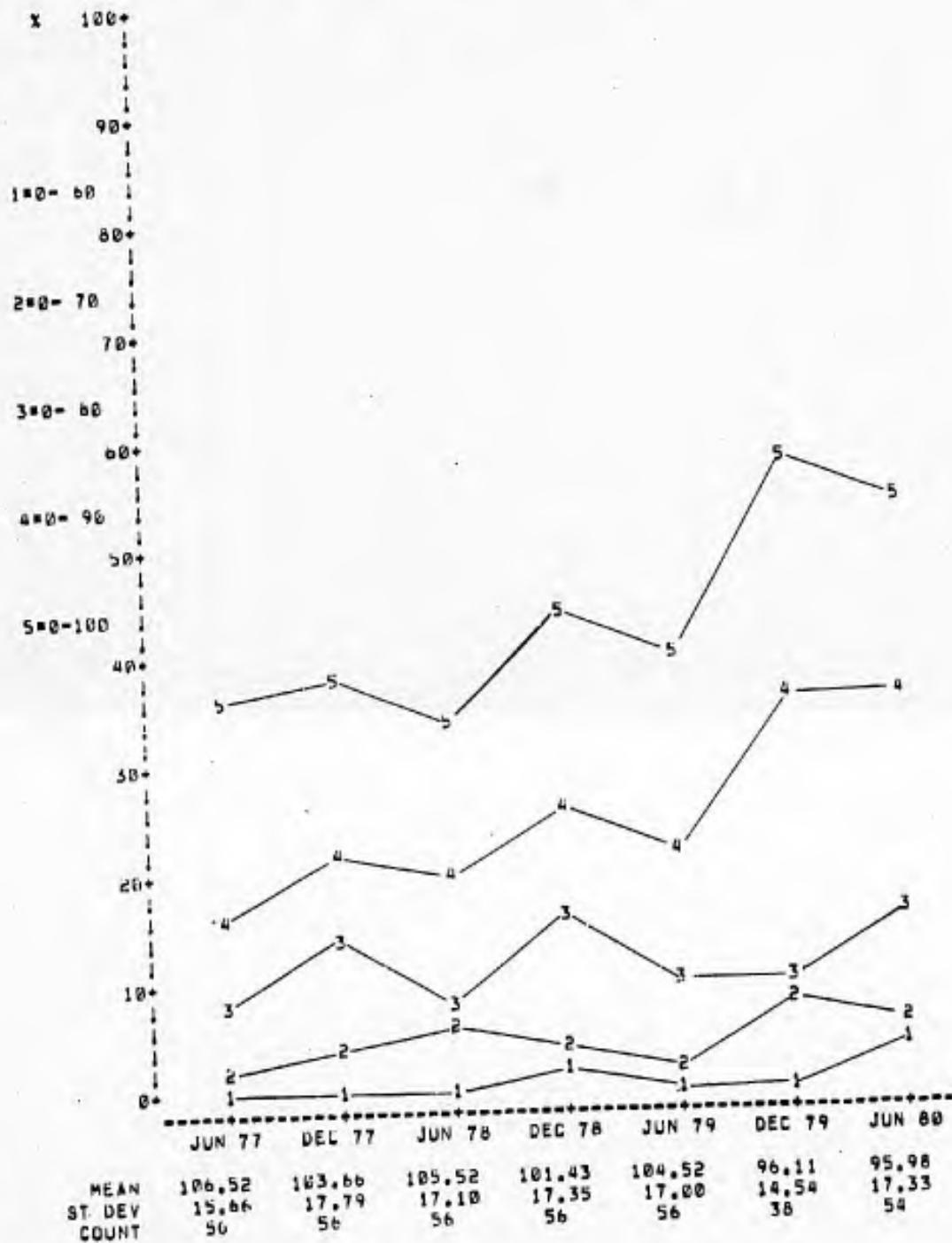

200 KHZ FOR THE AMK
OUT OF RANGE: INCLUDED

RUN DATE:

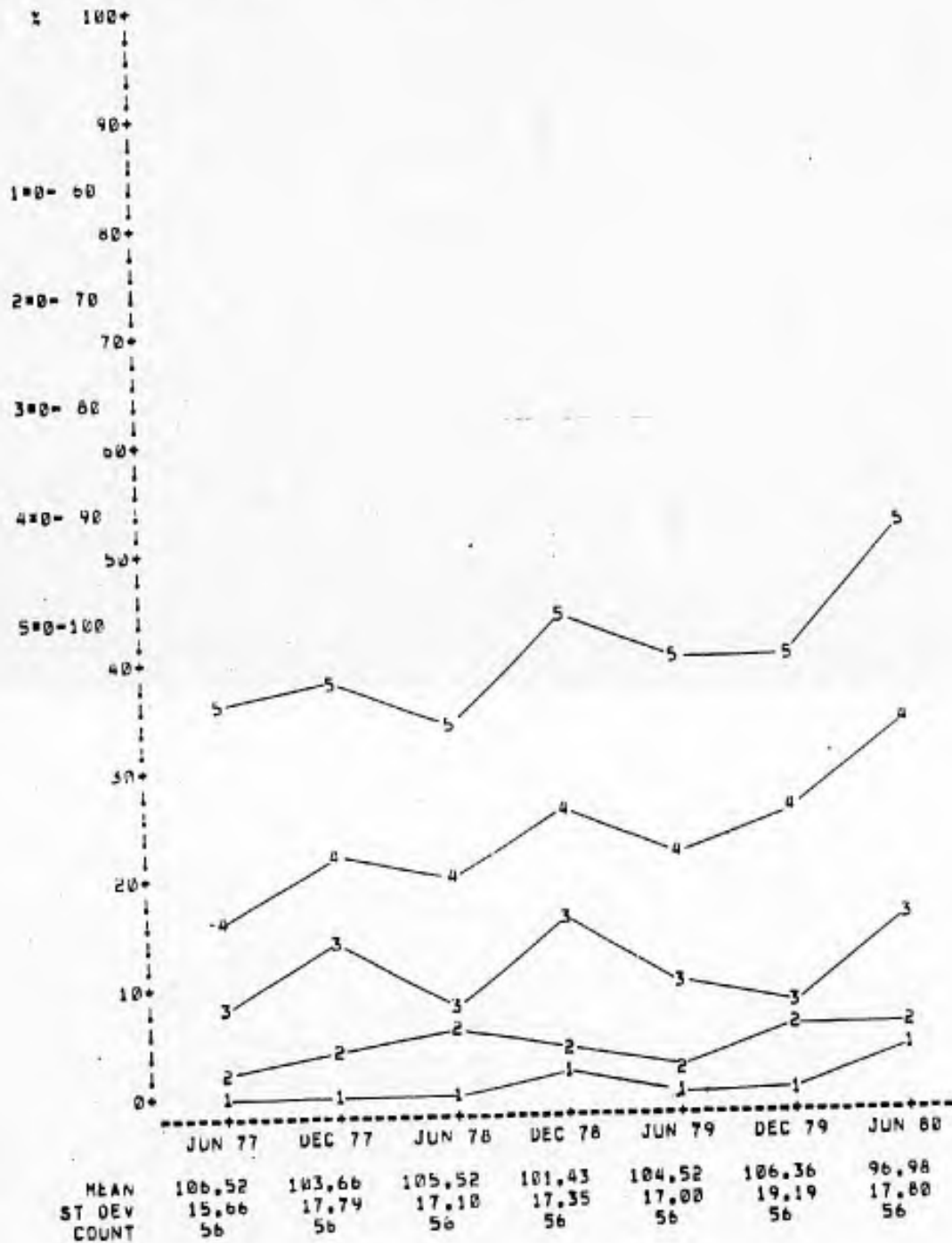

1 MHZ FOR THE ARK
OUT OF RANGE: EXCLUDED

RUN DATE:

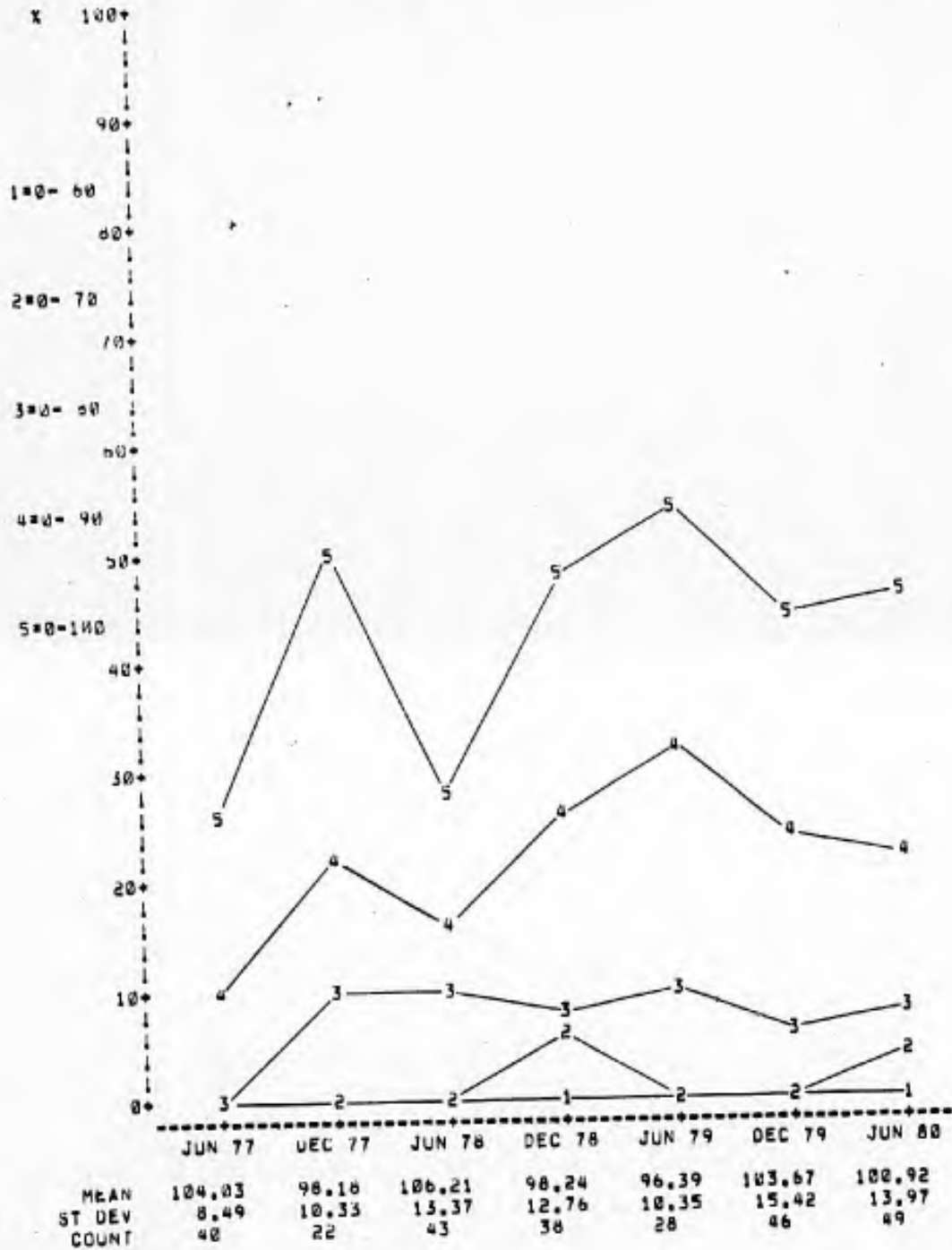

1 MHZ FOR THE ANK
OUT OF RANGE: INCLUDED

RUN DATE:

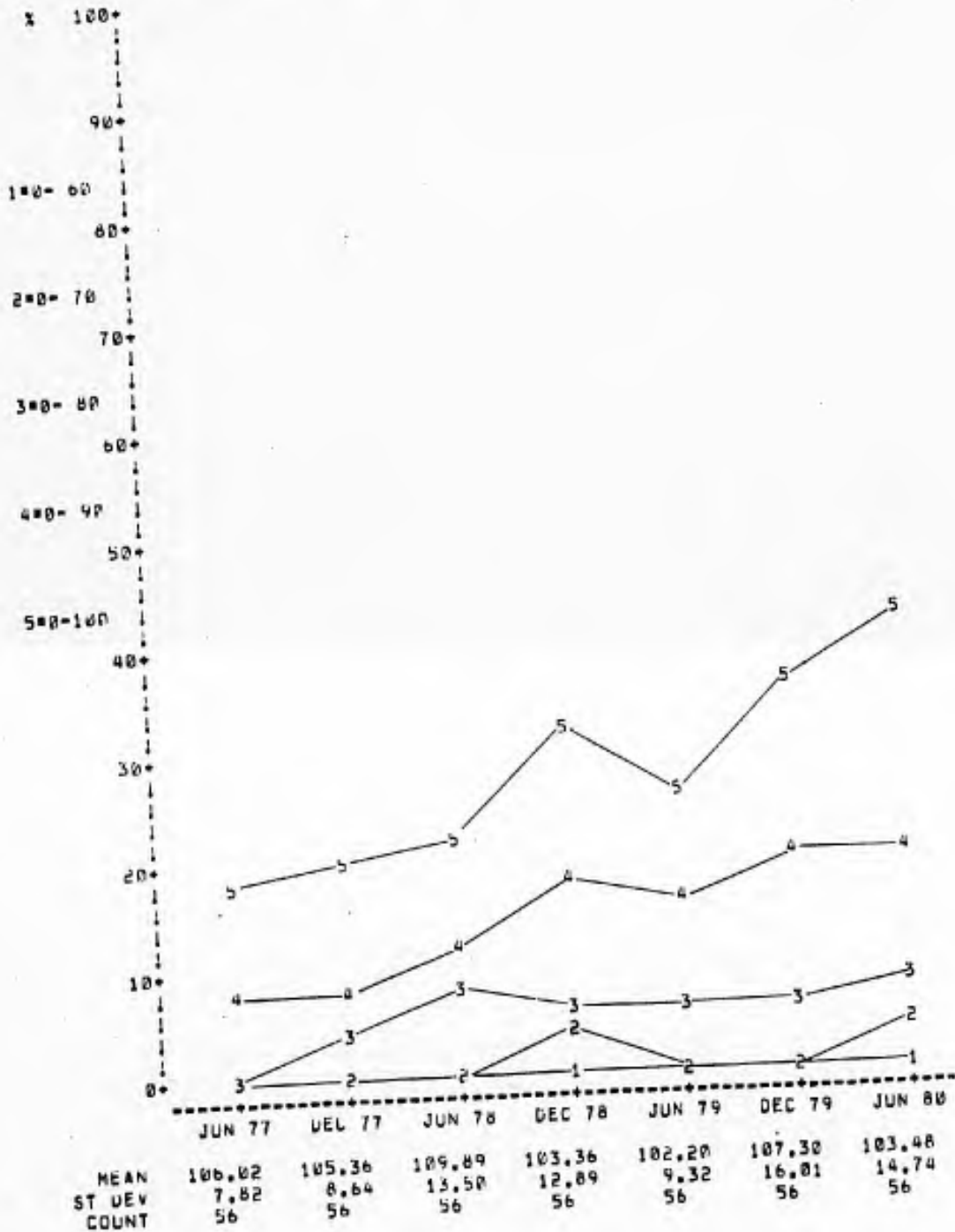

30 MHZ FOR THE ARK
 OUT OF RANGE: EXCLUDED

RUN DATE:

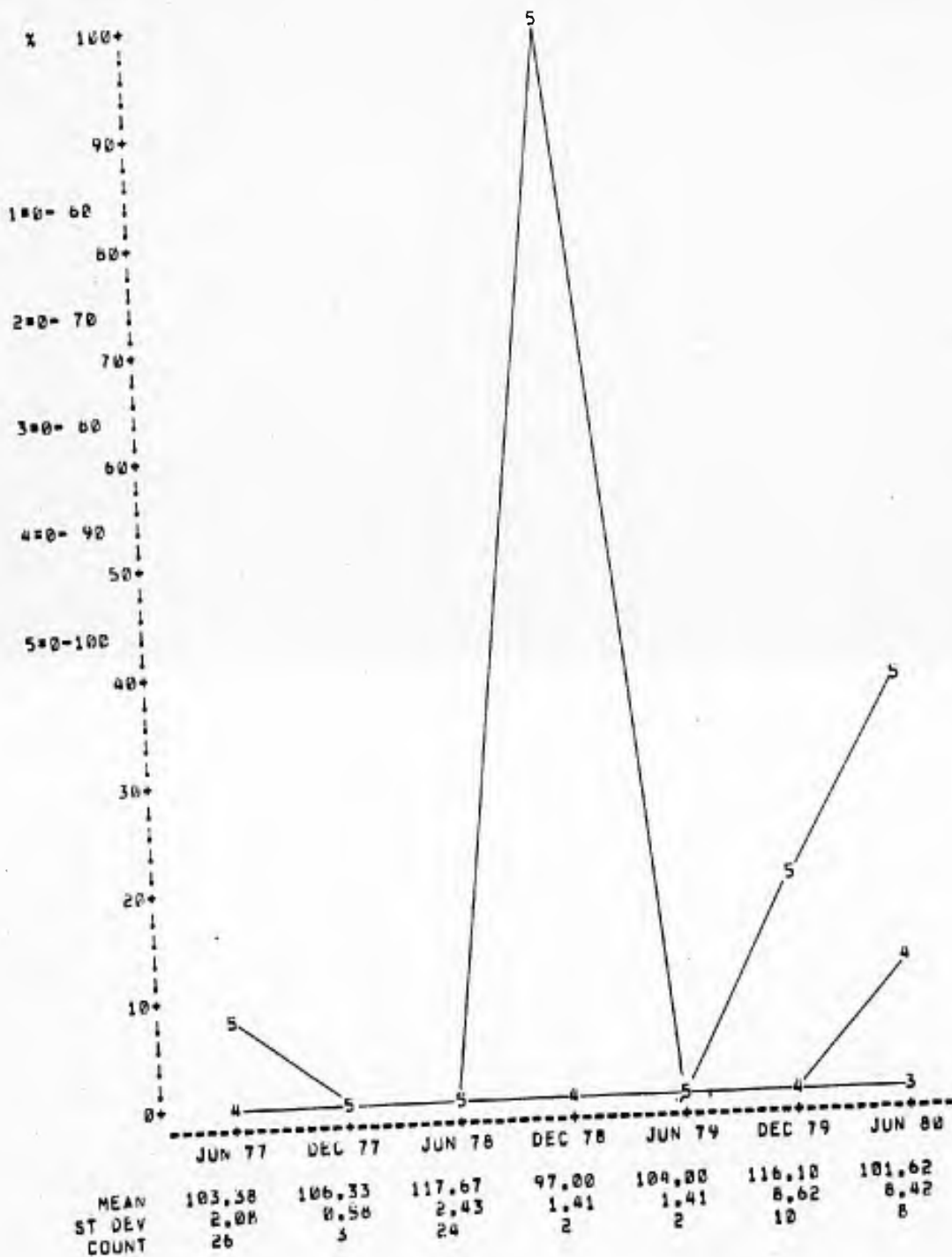

30 MHZ FOR THE APK
 OUT OF RANGE: INCLUDED

RUN DATE:

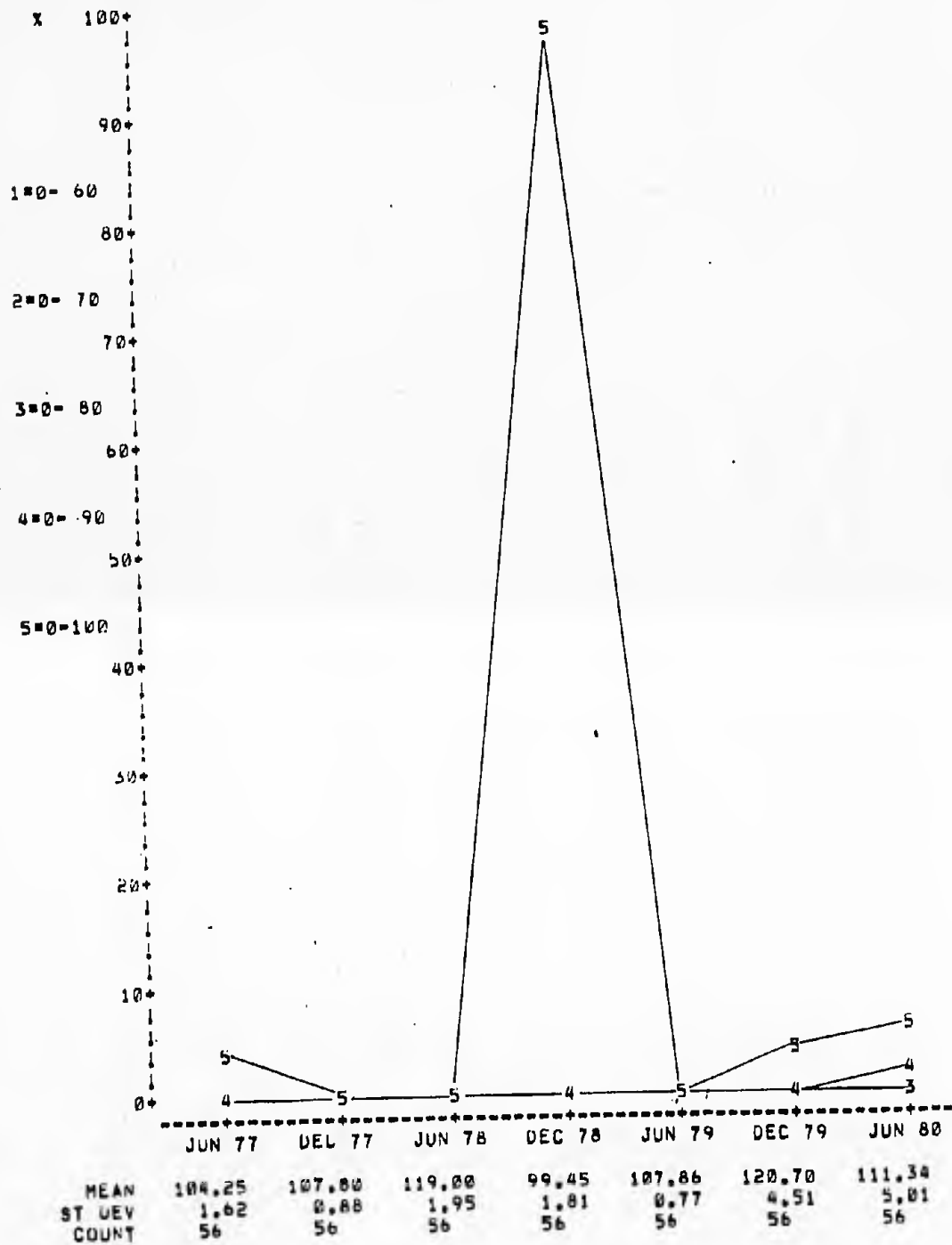

450 MHZ FOR THE ARK
OUT OF RANGE: EXCLUDED

RUN DATE:

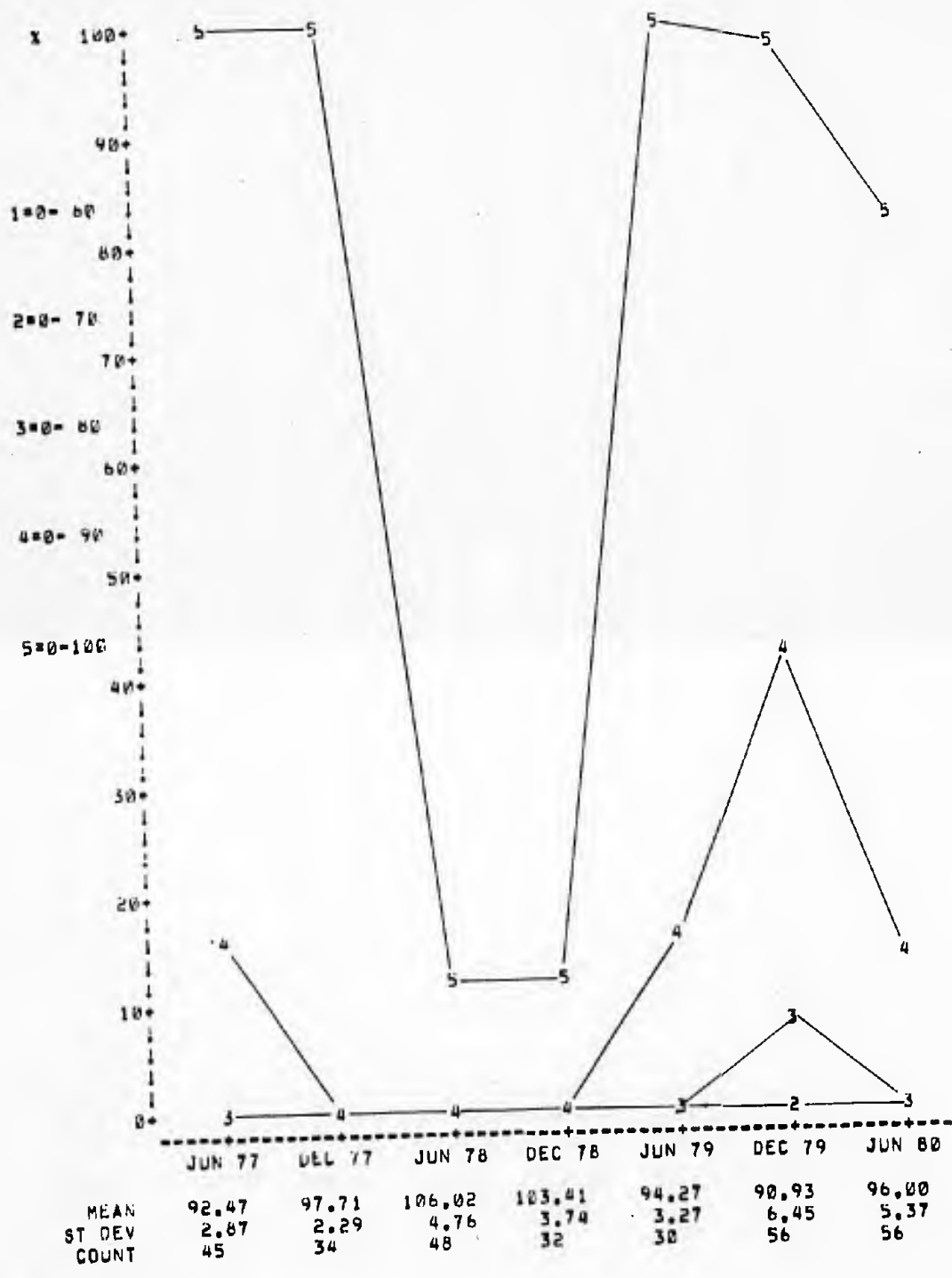

450 MHZ FOR THE ARK
OUT OF RANGE: INCLUDED

RUN DATE:

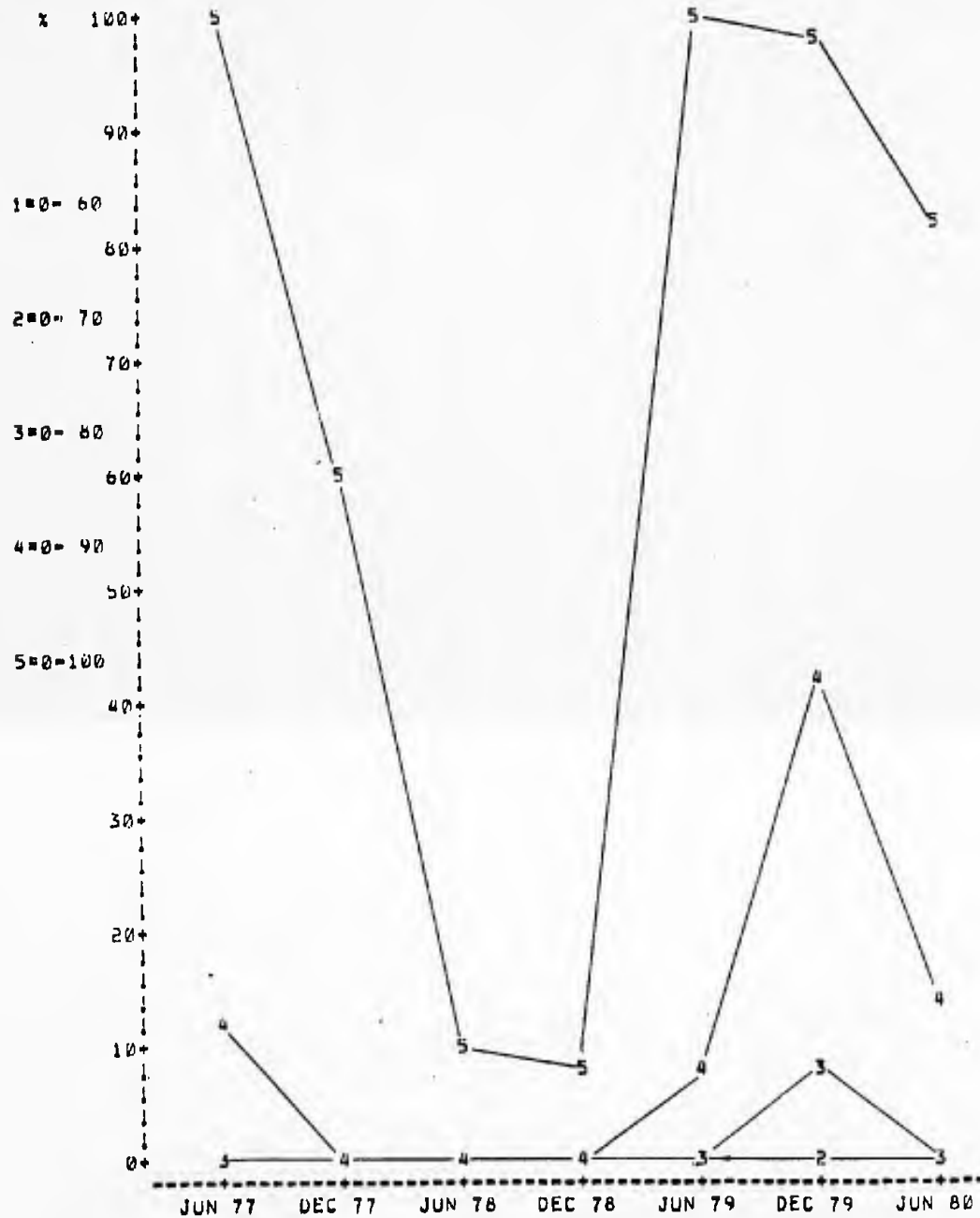

	JUN 77	DEC 77	JUN 78	DEC 78	JUN 79	DEC 79	JUN 80
MEAN	93.16	99.00	106.87	108.37	96.12	90.93	96.00
ST DEV	2.93	2.40	4.88	6.43	3.13	6.45	5.37
COUNT	56	56	56	56	56	56	56

2.4 GHZ FOR THE ARK
OUT OF RANGE: EXCLUDED

RUN DATE:

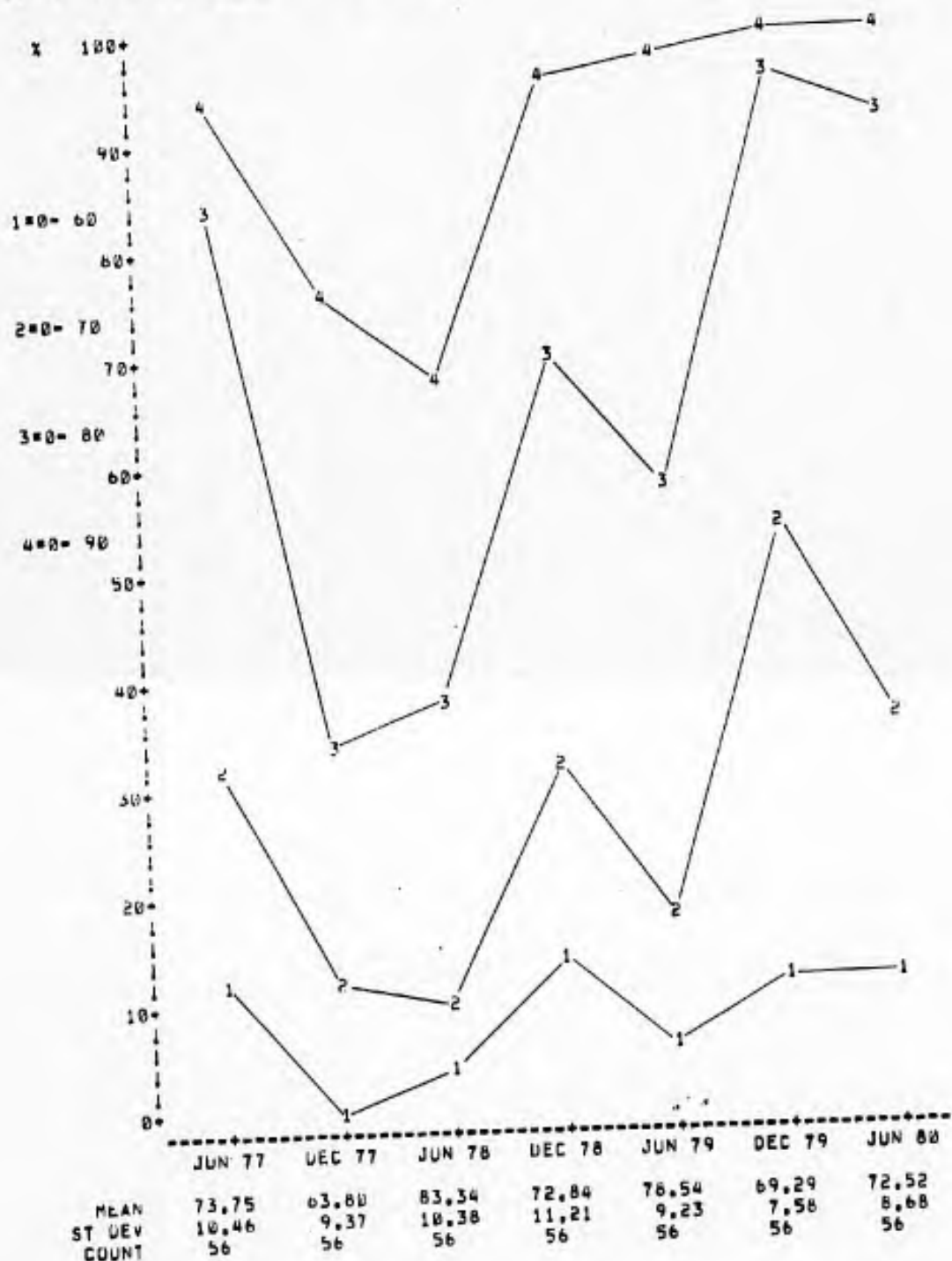

2.4 GHZ FOR THE ARK
OUT OF RANGE: INCLUDED

RUN DATE:

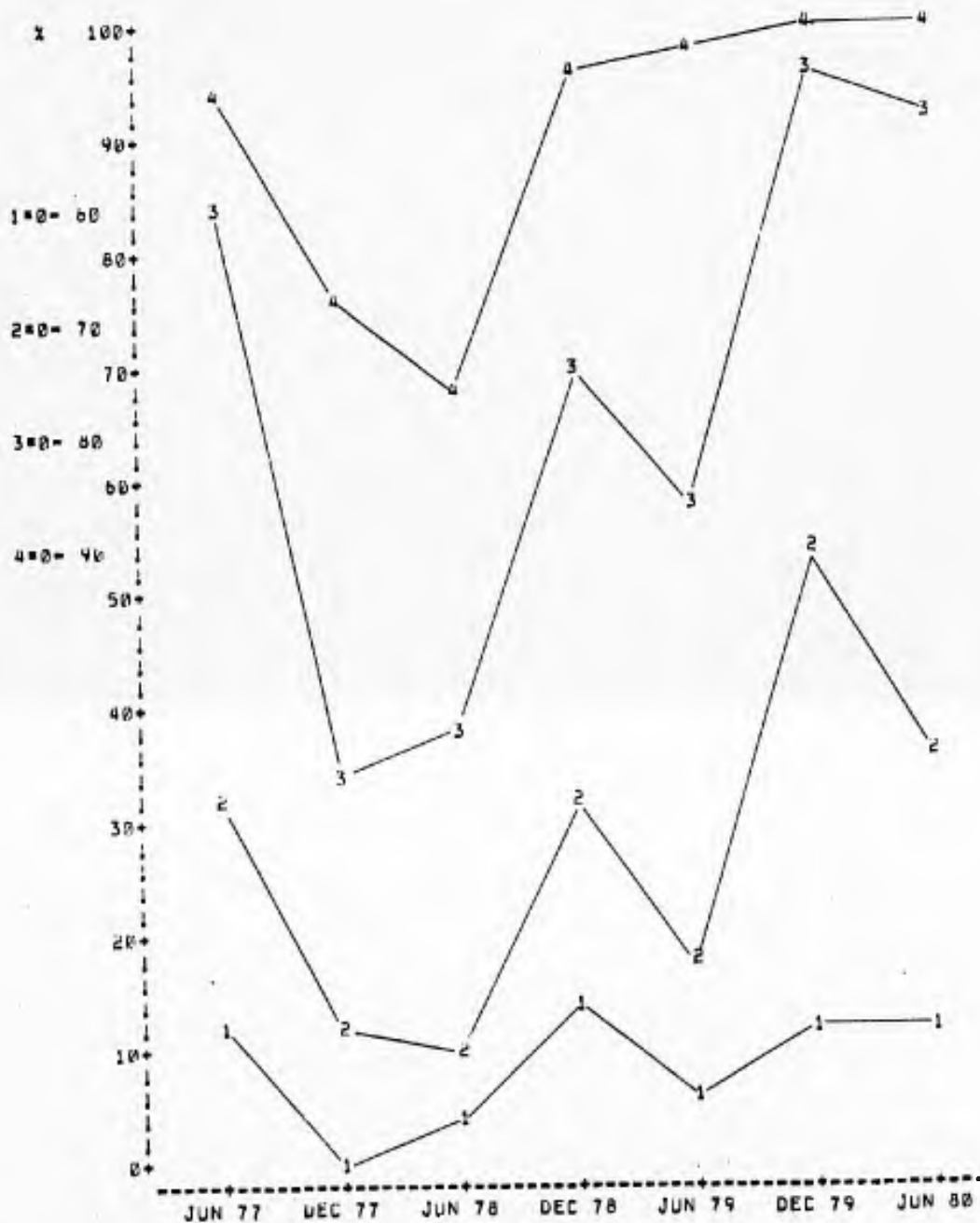

	JUN 77	DEC 77	JUN 78	DEC 78	JUN 79	DEC 79	JUN 80
MEAN	73.75	83.80	83.34	72.84	78.54	69.29	72.52
ST DEV	10.46	9.37	10.38	11.21	9.23	7.58	8.68
COUNT	56	56	56	56	56	56	56

7 GHZ FOR THE ARK
OUT OF RANGE: EXCLUDED

RUN DATE:

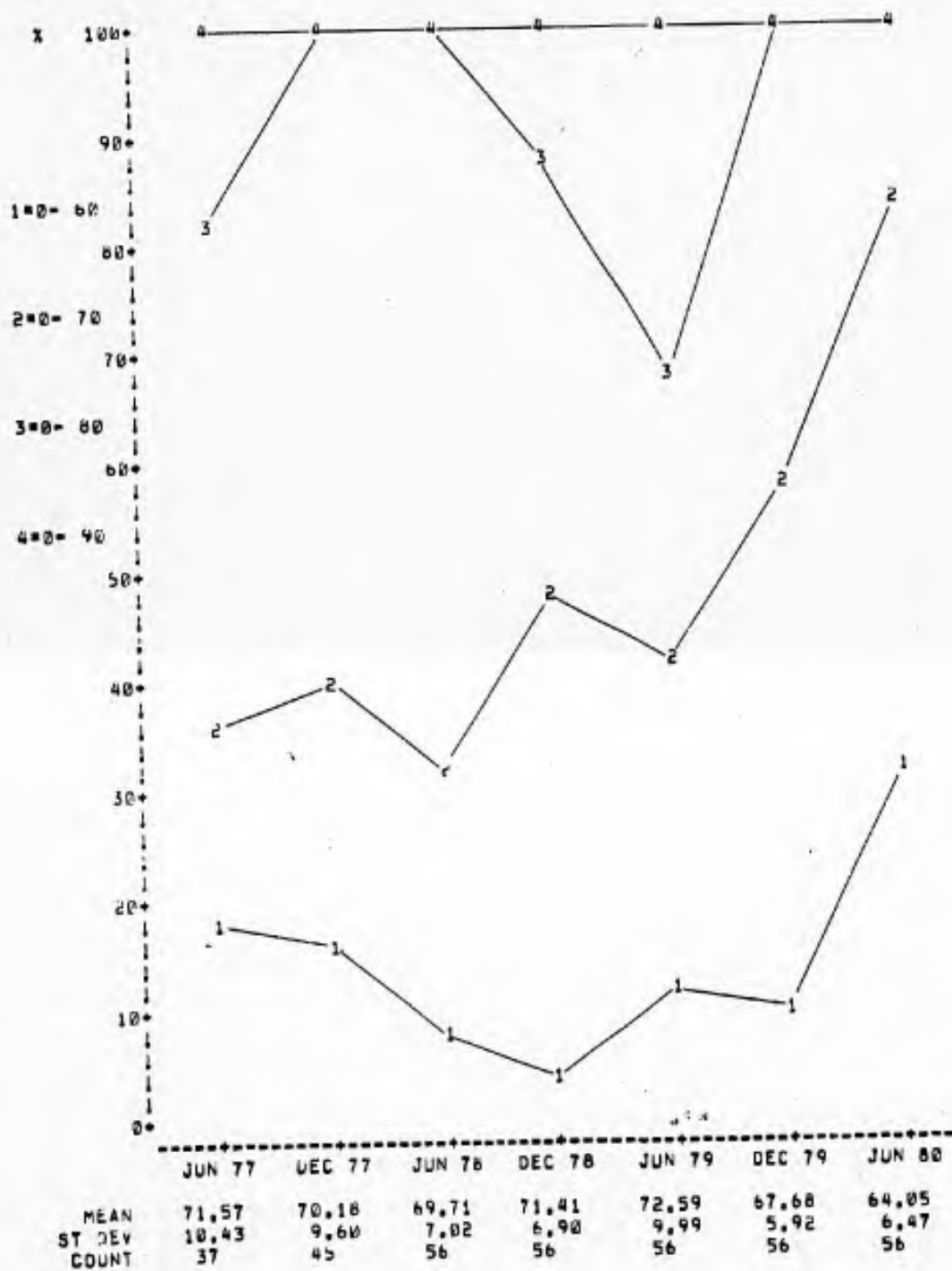

7 GHZ FOR THE ARK
OUT OF RANGE: INCLUDED

RUN DATE:

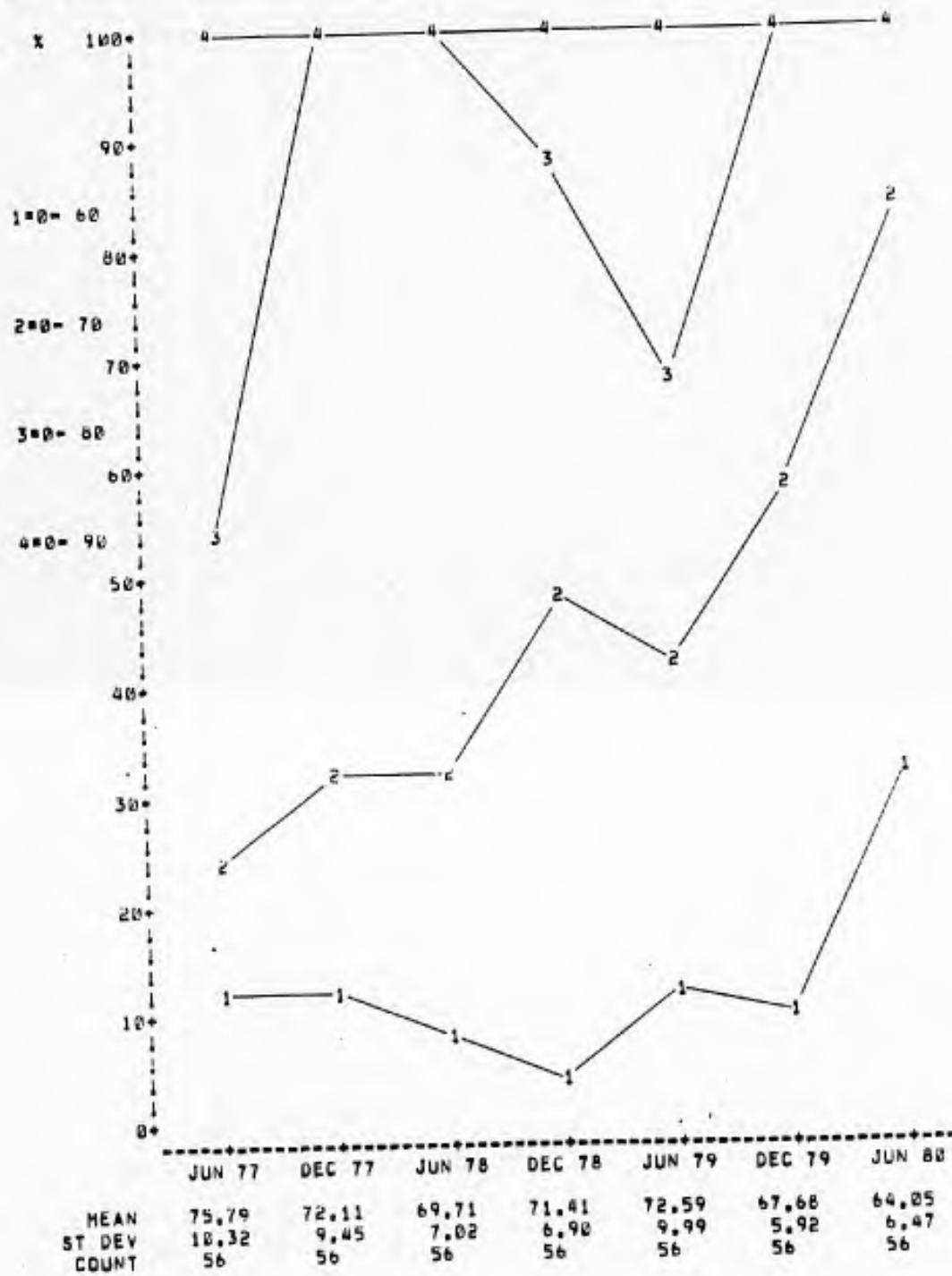

10 KHZ FOR THE LINDGREN
OUT OF RANGE: EXCLUDED

RUN DATE:

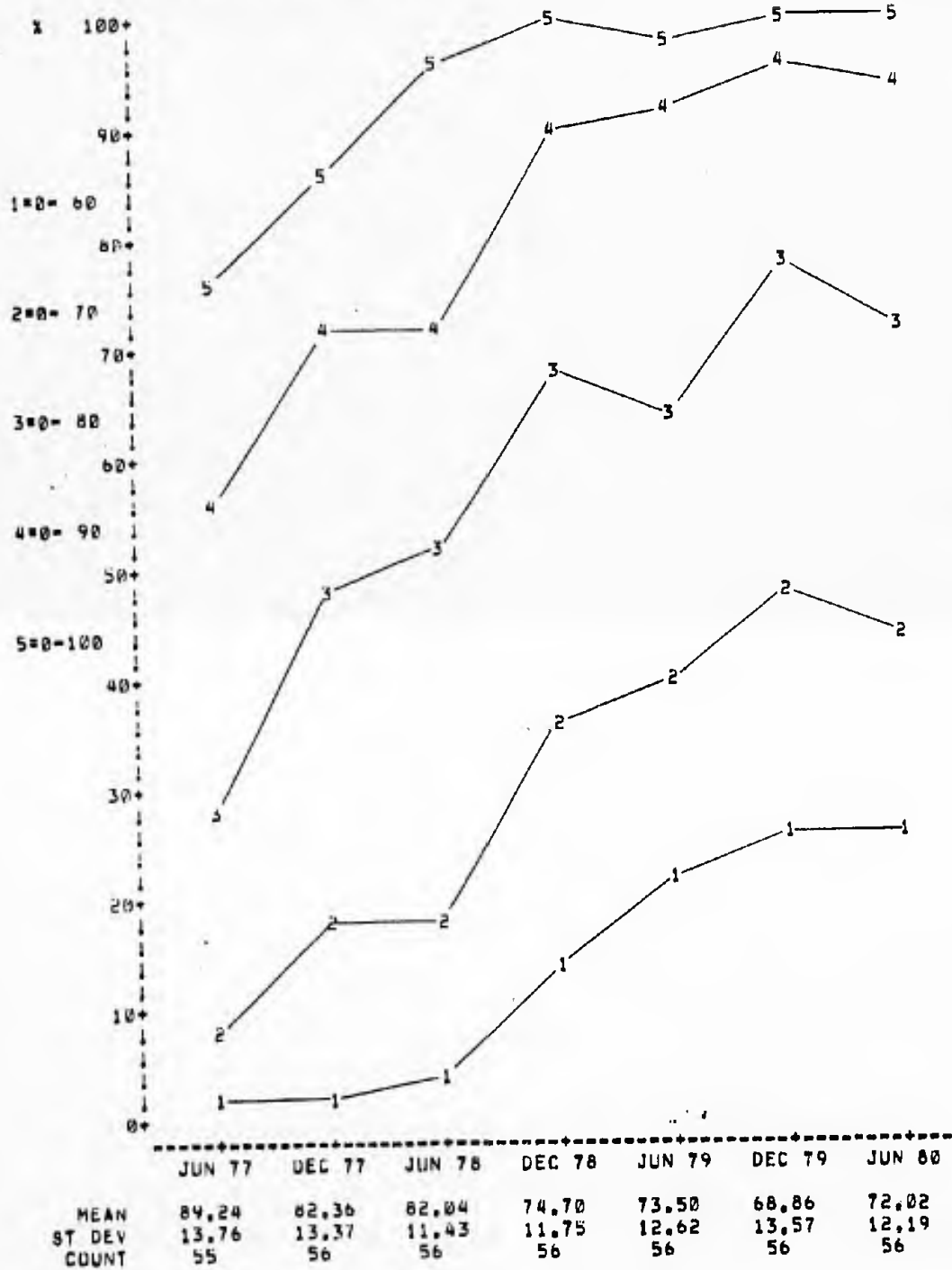

10 KHZ FOR THE LINDGREN
OUT OF RANGE: INCLUDED

RUN DATE:

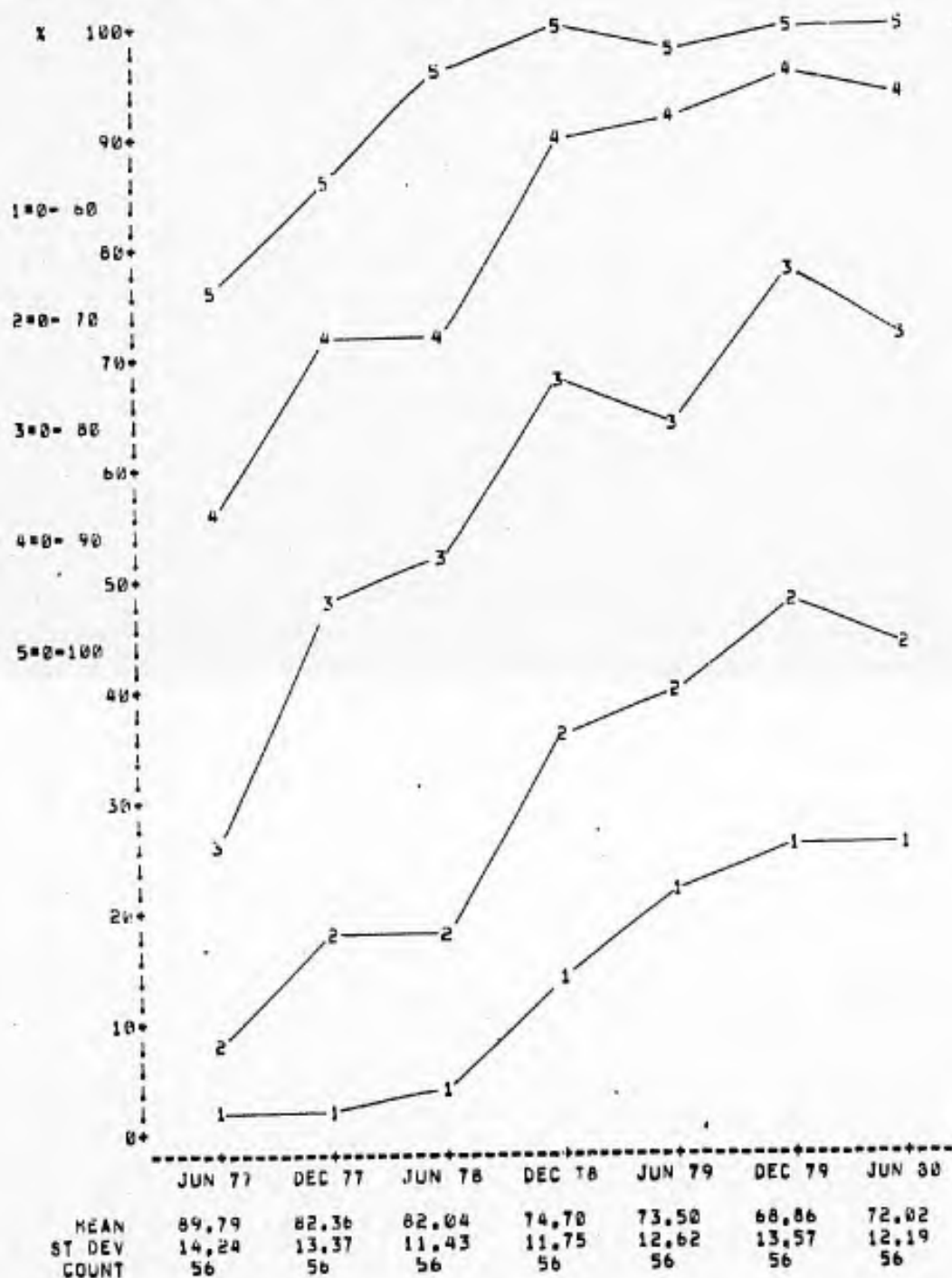

50 KHZ FOR THE LINDGREN
OUT OF RANGE: EXCLUDED

RUN DATE:

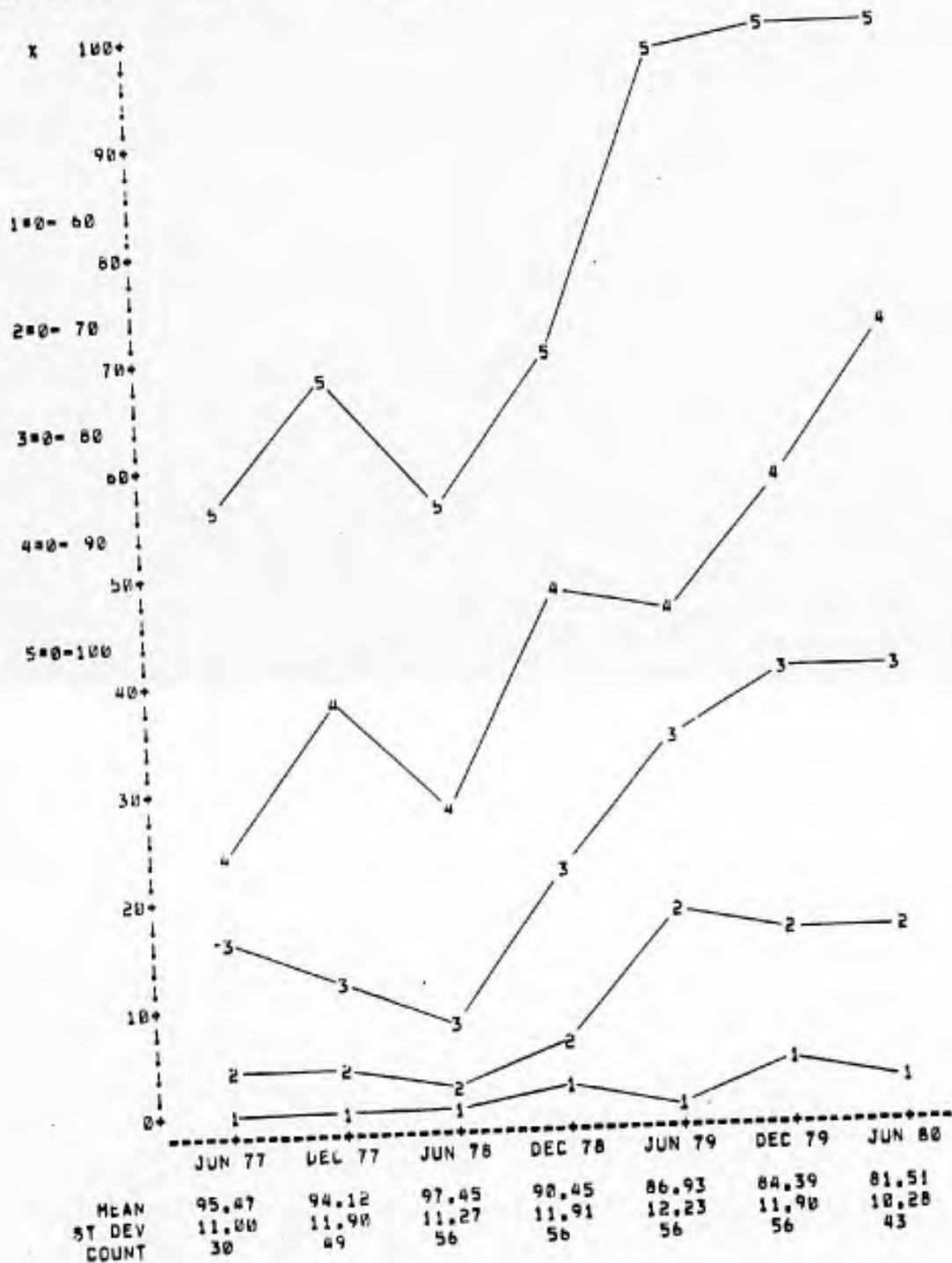

50 KHZ FOR THE LINDGREN
OUT OF RANGE: INCLUDED

RUN DATE:

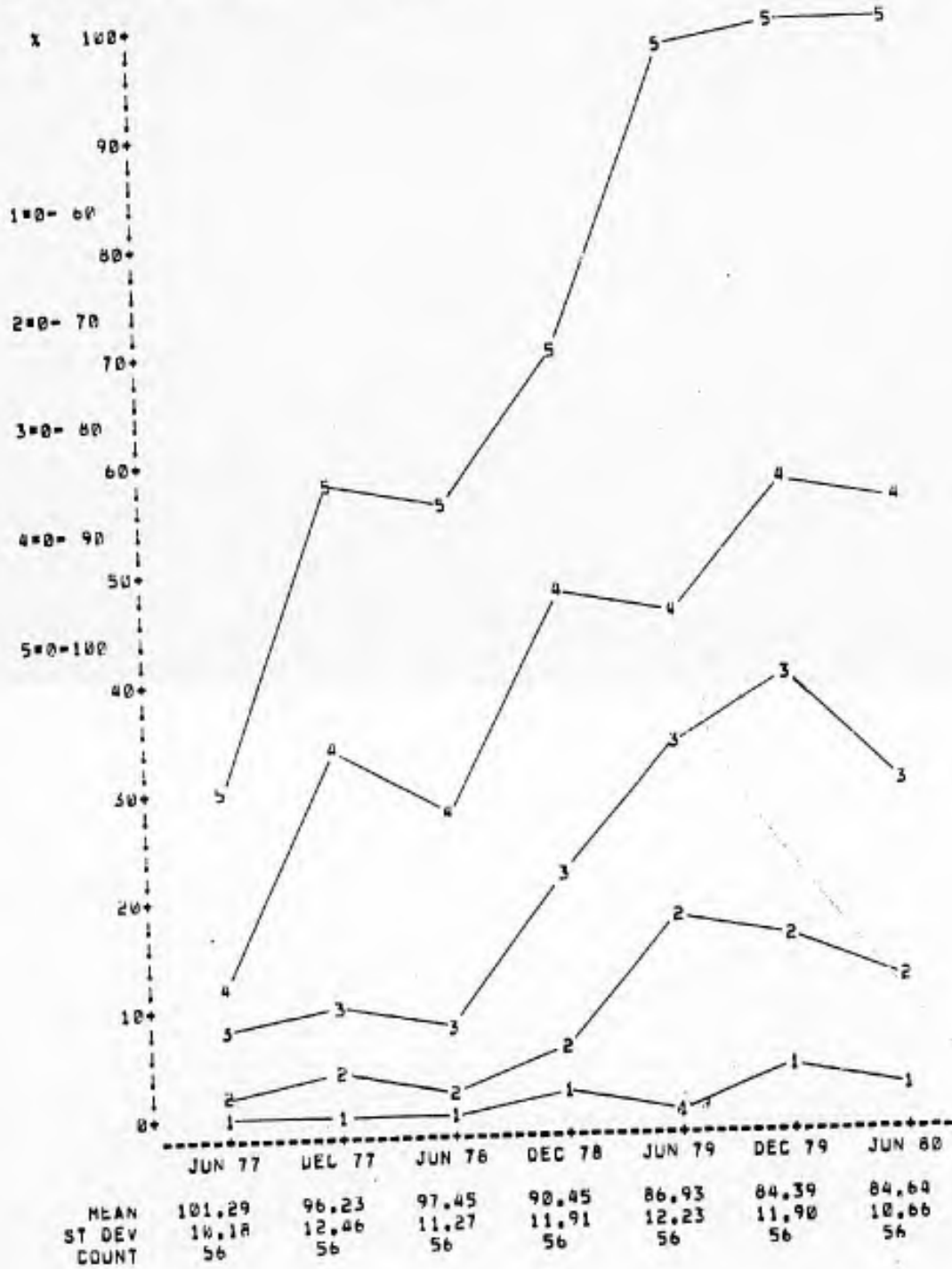

200 KHZ FOR THE LINGHEN
OUT OF RANGE: EXCLUDED

RUN DATE:

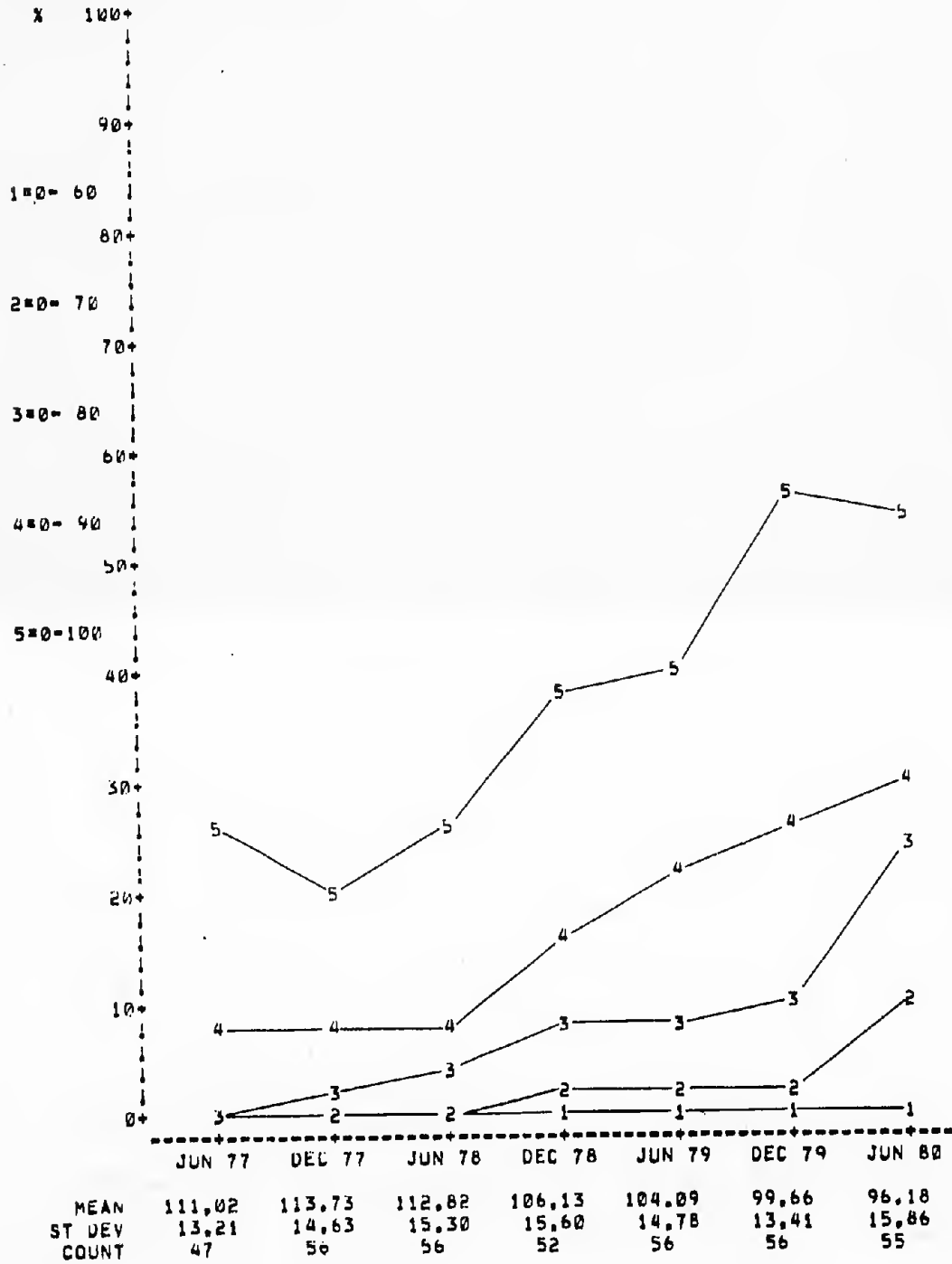

200 KHZ FOR THE LINDGREN
OUT OF RANGE: INCLUDED

RUN DATE:

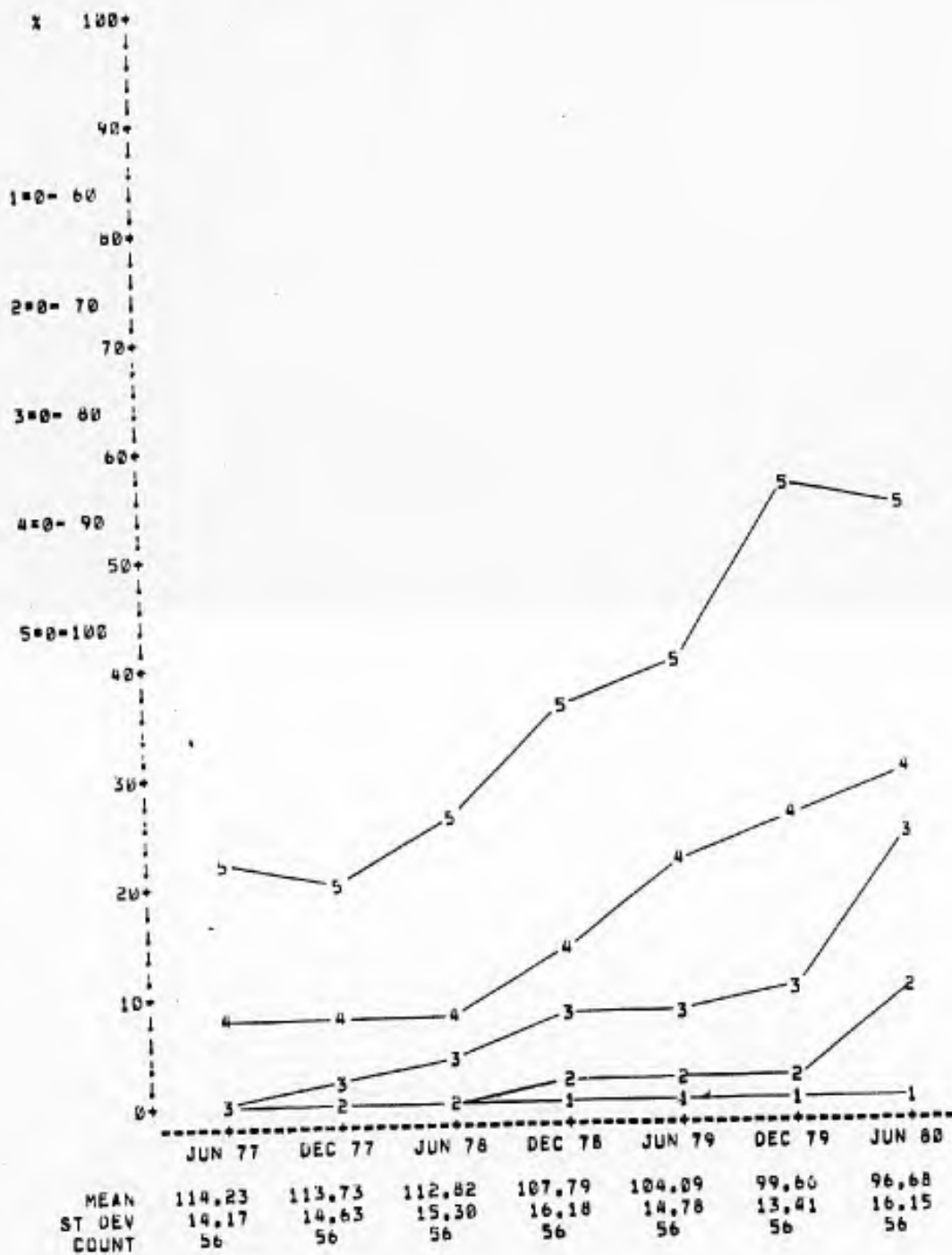

1 MHZ FOR THE LINDGREN
OUT OF RANGE: EXCLUDED

RUN DATES:

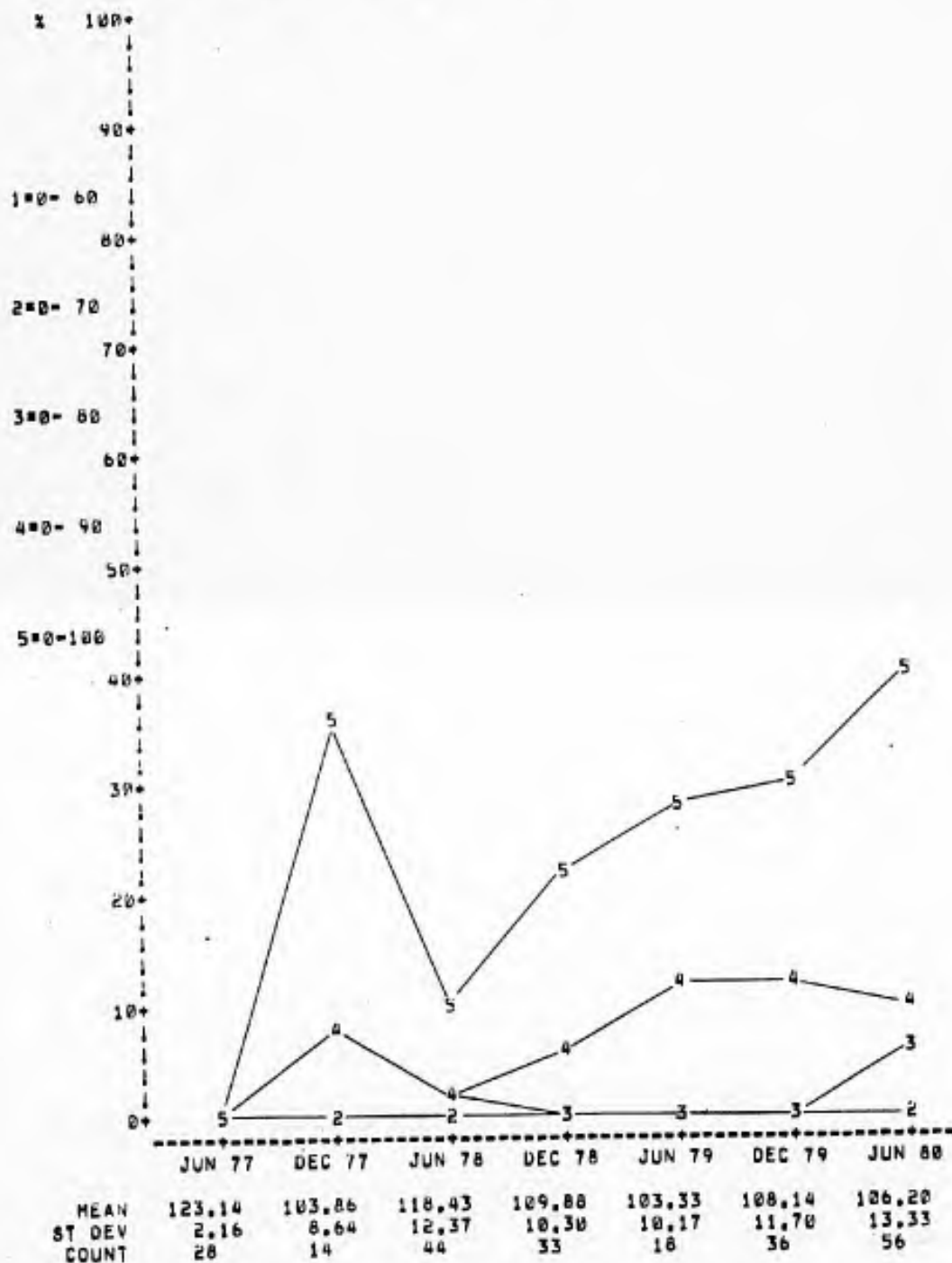

1 MHZ FOR THE LINDGREN
OUT OF RANGE: INCLUDED

RUN DATE:

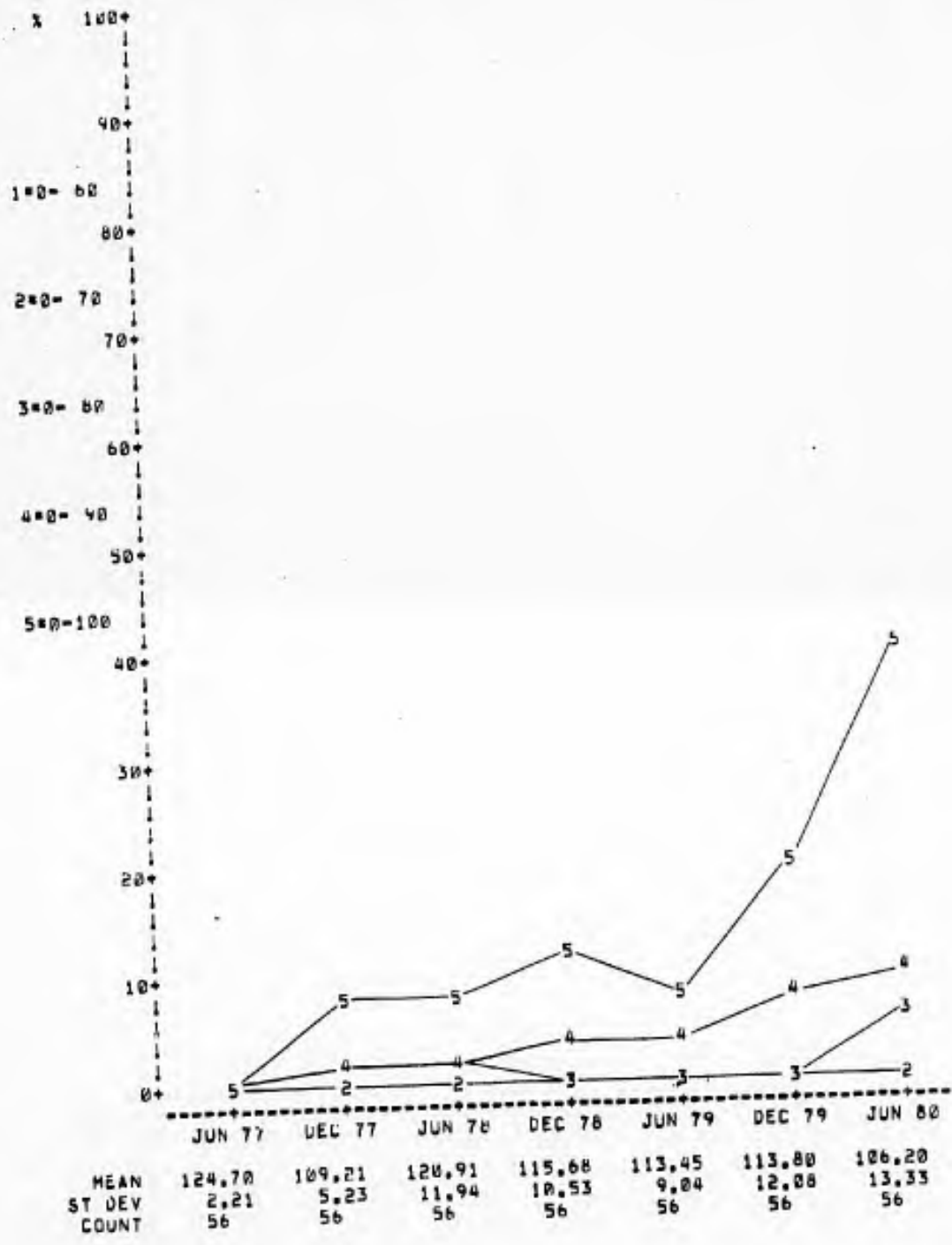

30 MHZ FOR THE LINDGREN
OUT OF RANGE EXCLUDED

RUN DATE:

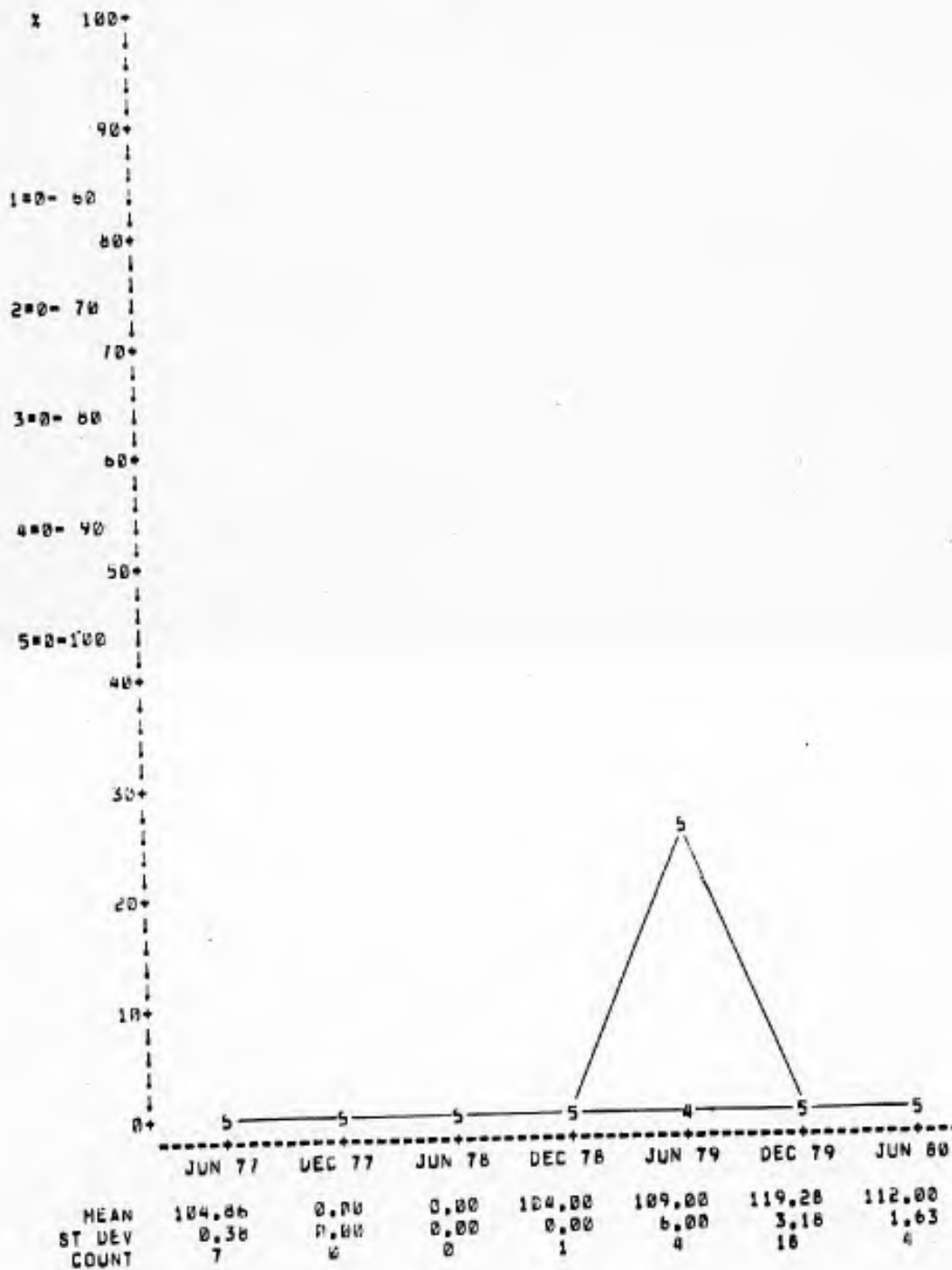

30 MHZ FOR THE LINDGREN
OUT OF RANGE: INCLUDED

RUN DATE:

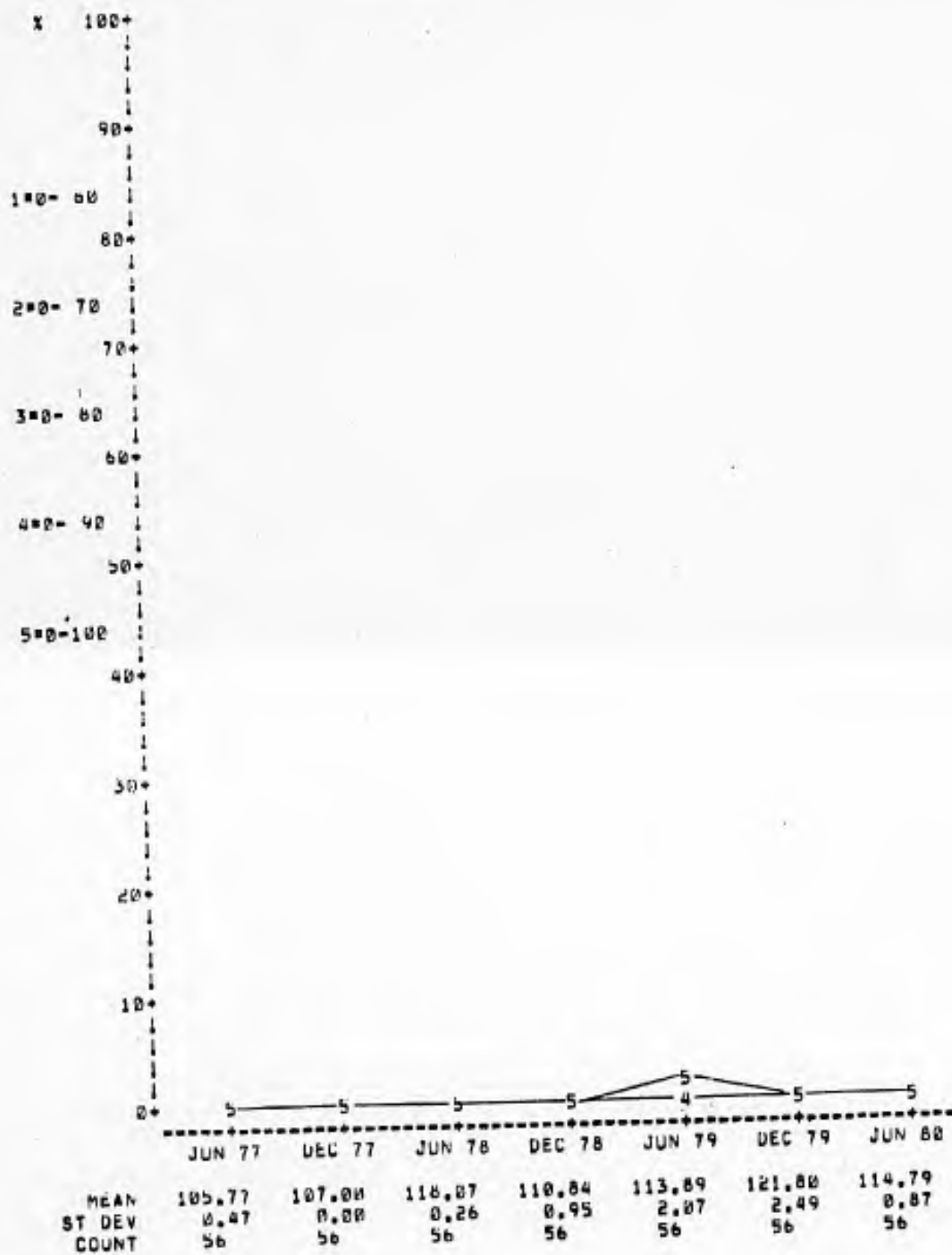

450 MHZ FOR THE LINDGREN
OUT OF RANGE: EXCLUDED RUN DATE:

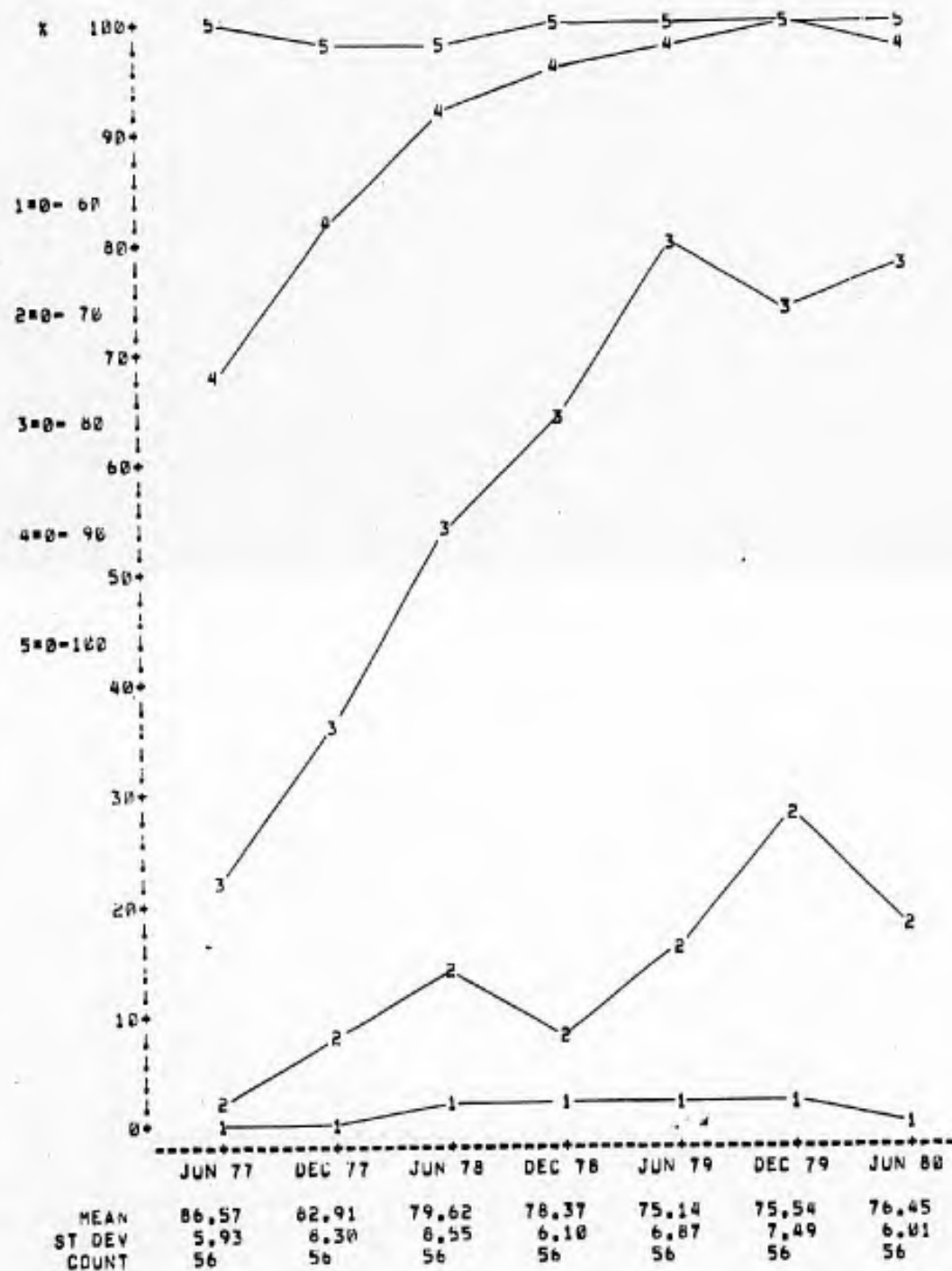

450 MHZ FOR THE LINUGKEN
OUT OF RANGE: INCLUDED RUN DATE:

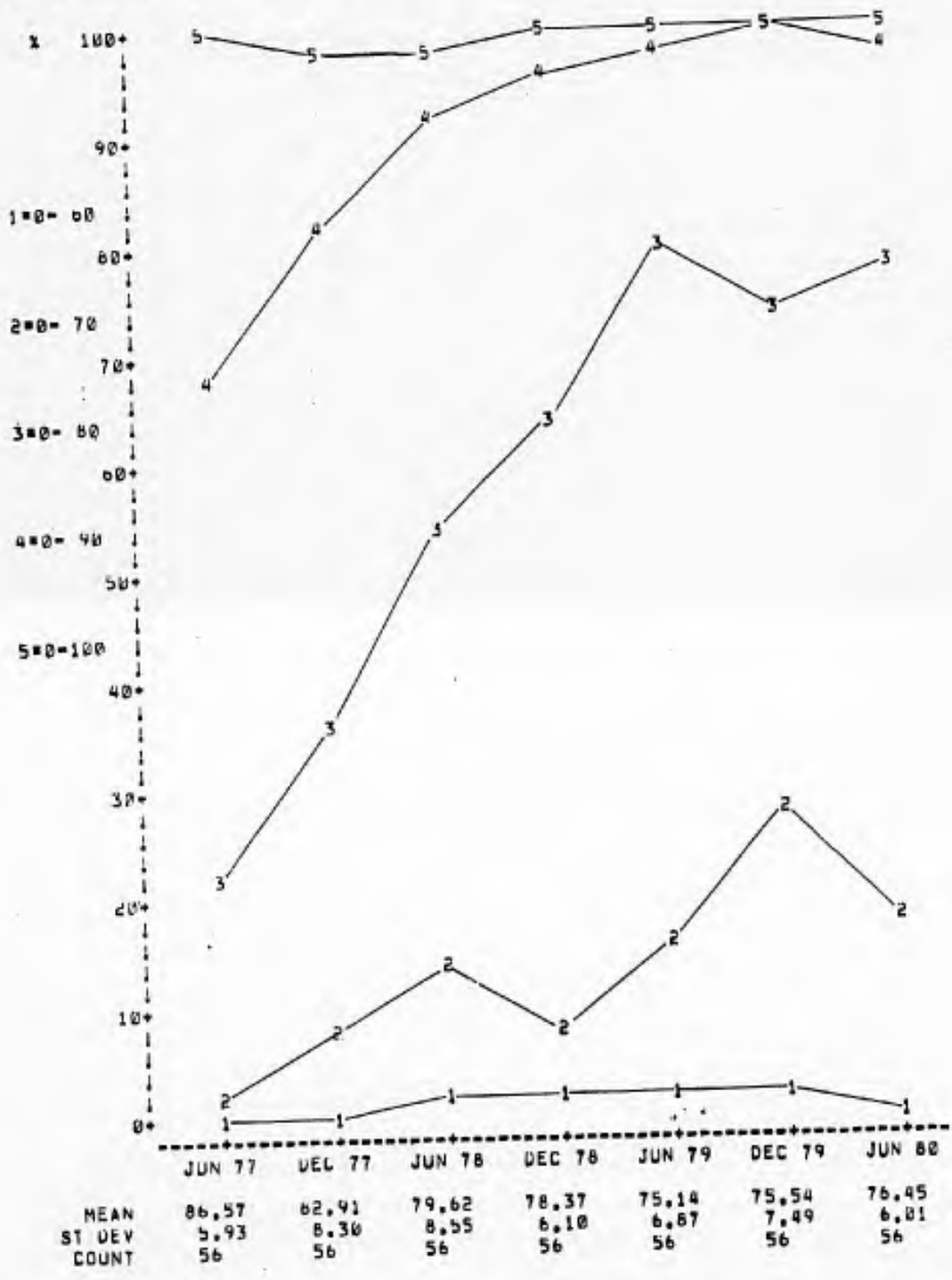

2.4 GHZ FOR THE LINDGREN
OUT OF RANGE: EXCLUDED RUN DATES

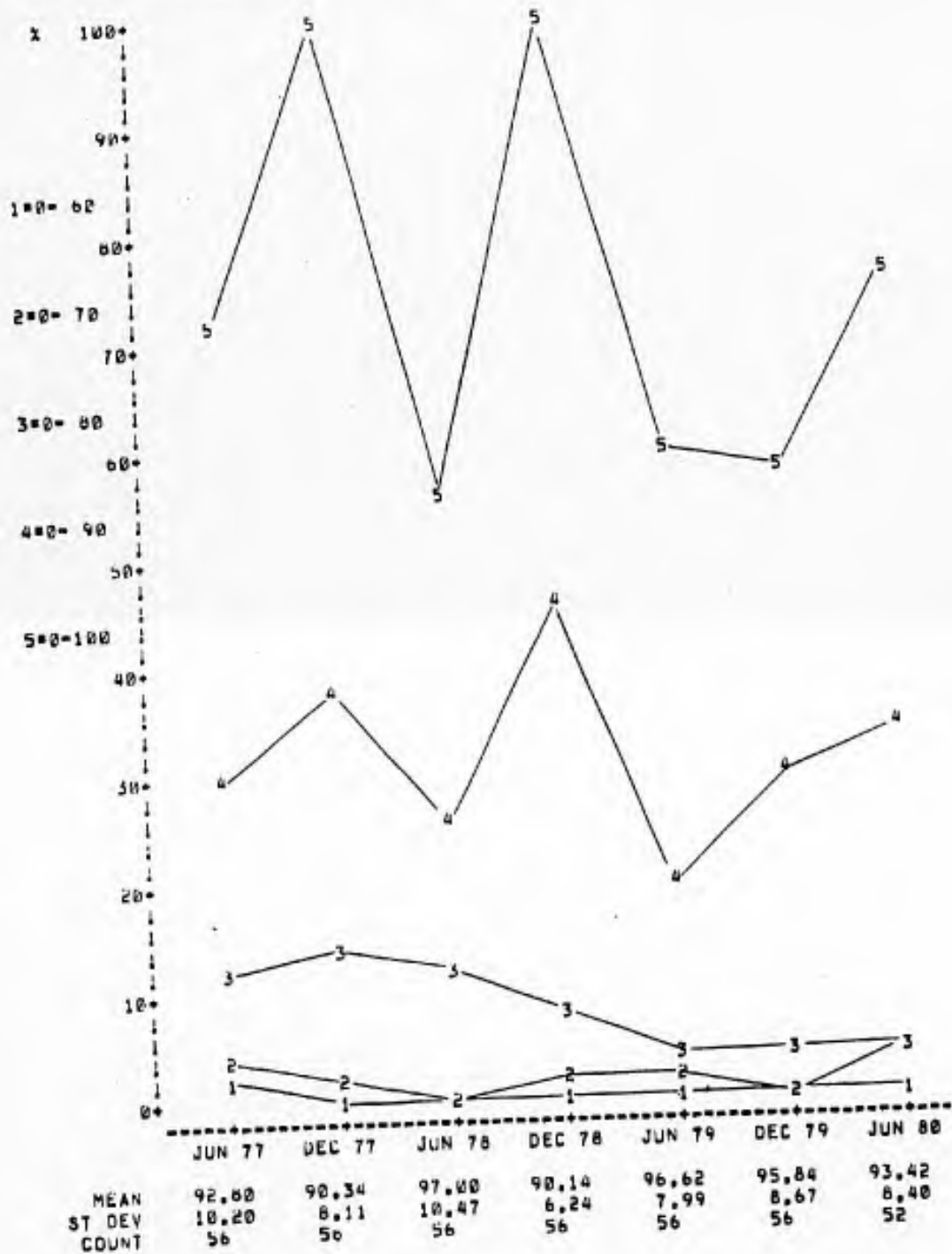

2.4 GHZ FOR THE LINDGREN
OUT OF RANGE: INCLUDED

RUN DATE:

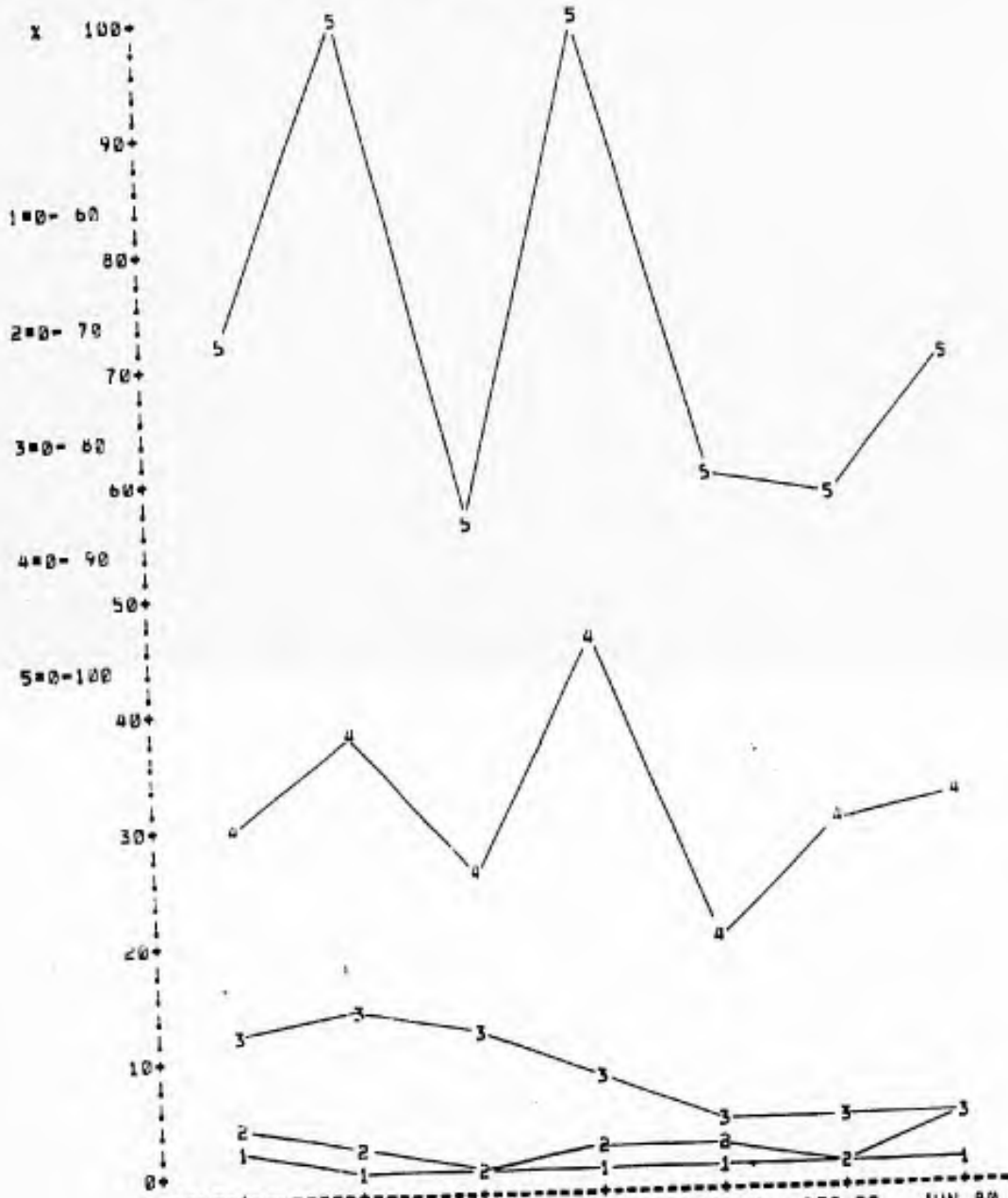

	JUN 77	DEC 77	JUN 78	DEC 78	JUN 79	DEC 79	JUN 80
MEAN	92.88	90.34	97.00	98.14	96.62	95.84	94.89
ST DEV	10.20	8.11	10.47	6.24	7.99	8.67	8.44
COUNT	56	56	56	56	56	56	56

7 GHZ FOR THE LINDGREN
OUT OF RANGE! EXCLUDED

RUN DATE:

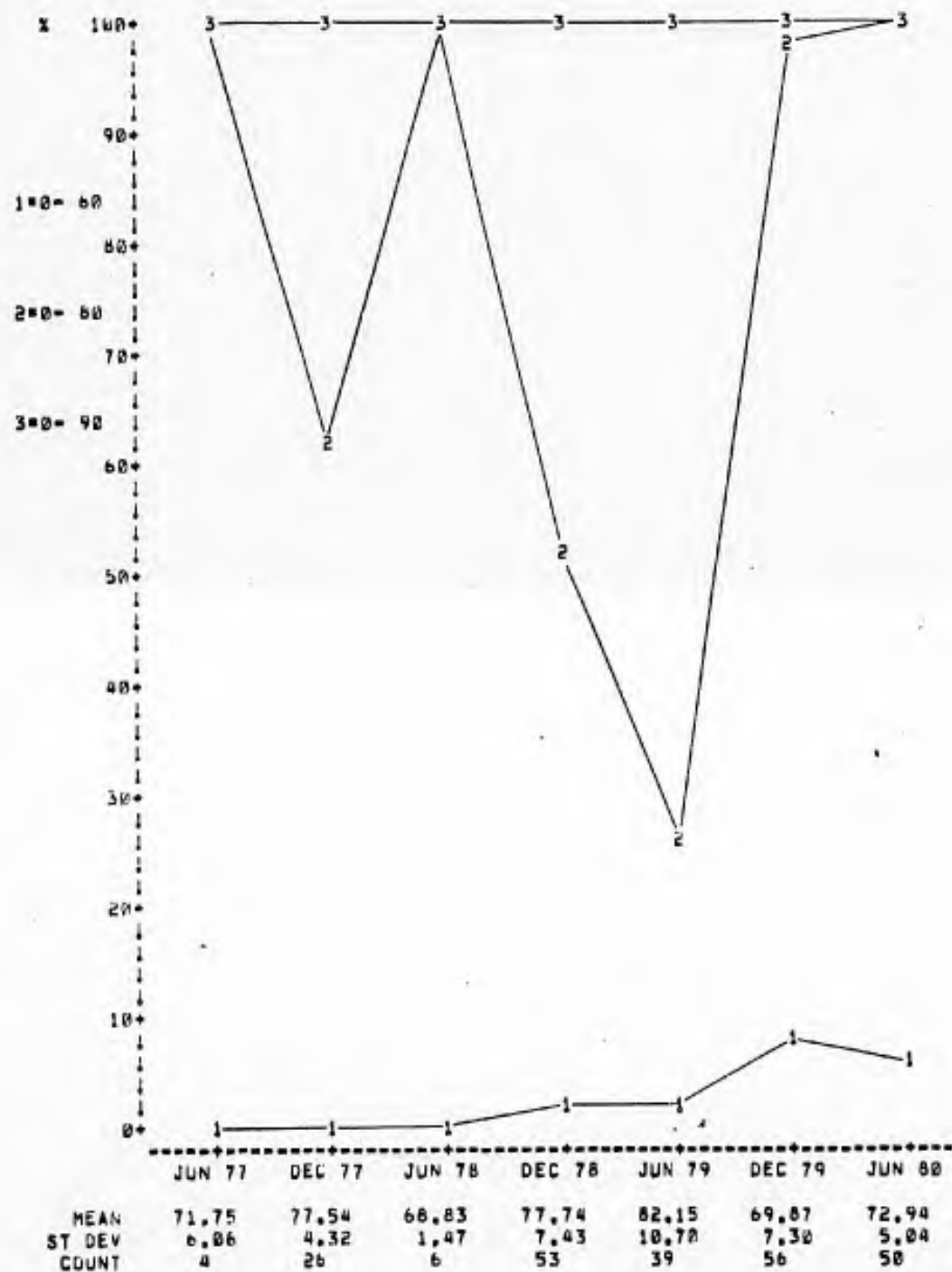

7 GHZ FOR THE LINDGREN
OUT OF RANGE: INCLUDED

PUN DATE:

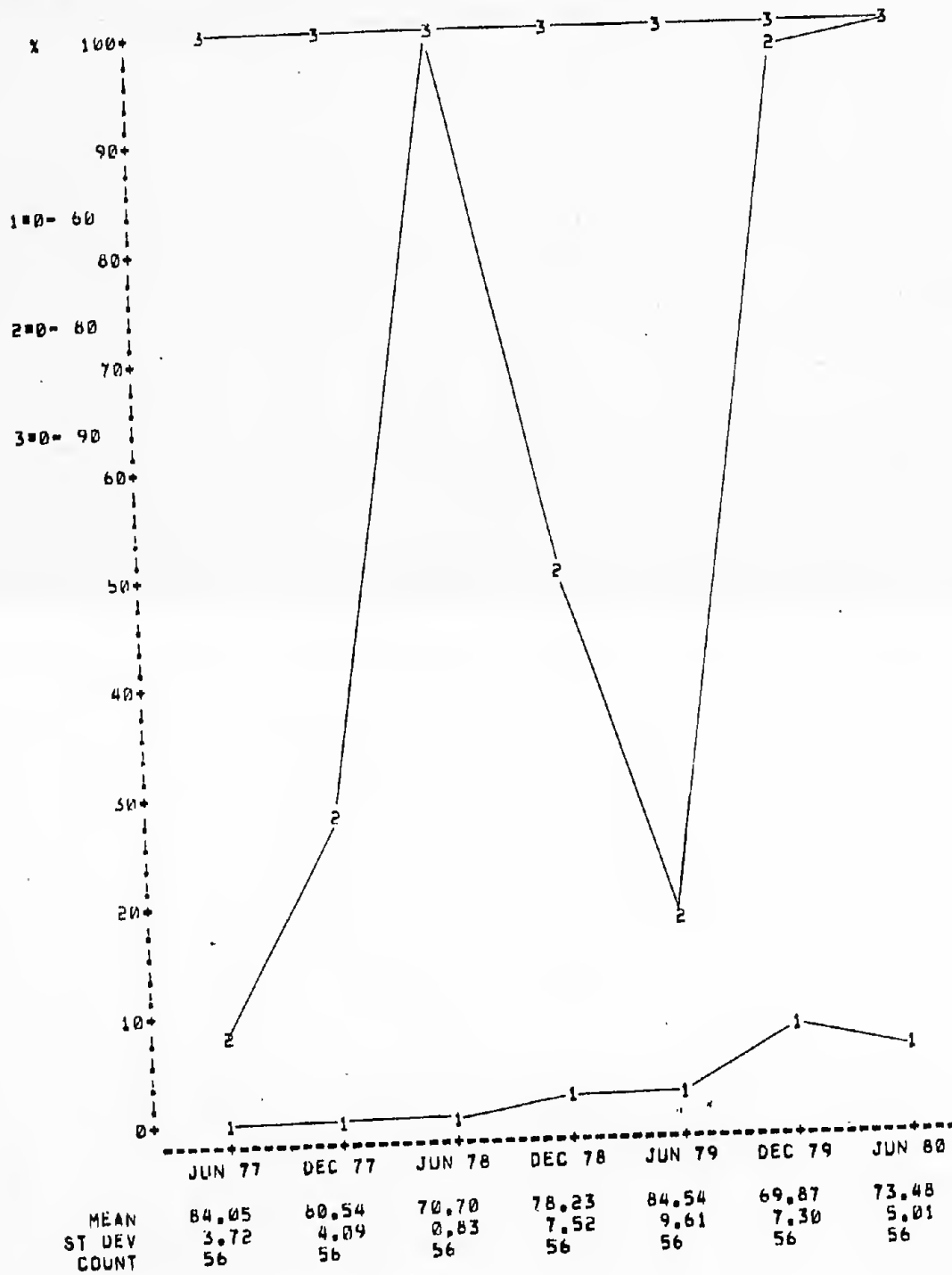

	JUN 77	DEC 77	JUN 78	DEC 78	JUN 79	DEC 79	JUN 80
MEAN	84.05	80.54	70.70	78.23	84.54	69.87	73.48
ST DEV	3.72	4.04	0.83	7.52	9.61	7.30	5.01
COUNT	56	56	56	56	56	56	56

10 KHZ FOR THE LMI
OUT OF RANGE: EXCLUDED

RUN DATE:

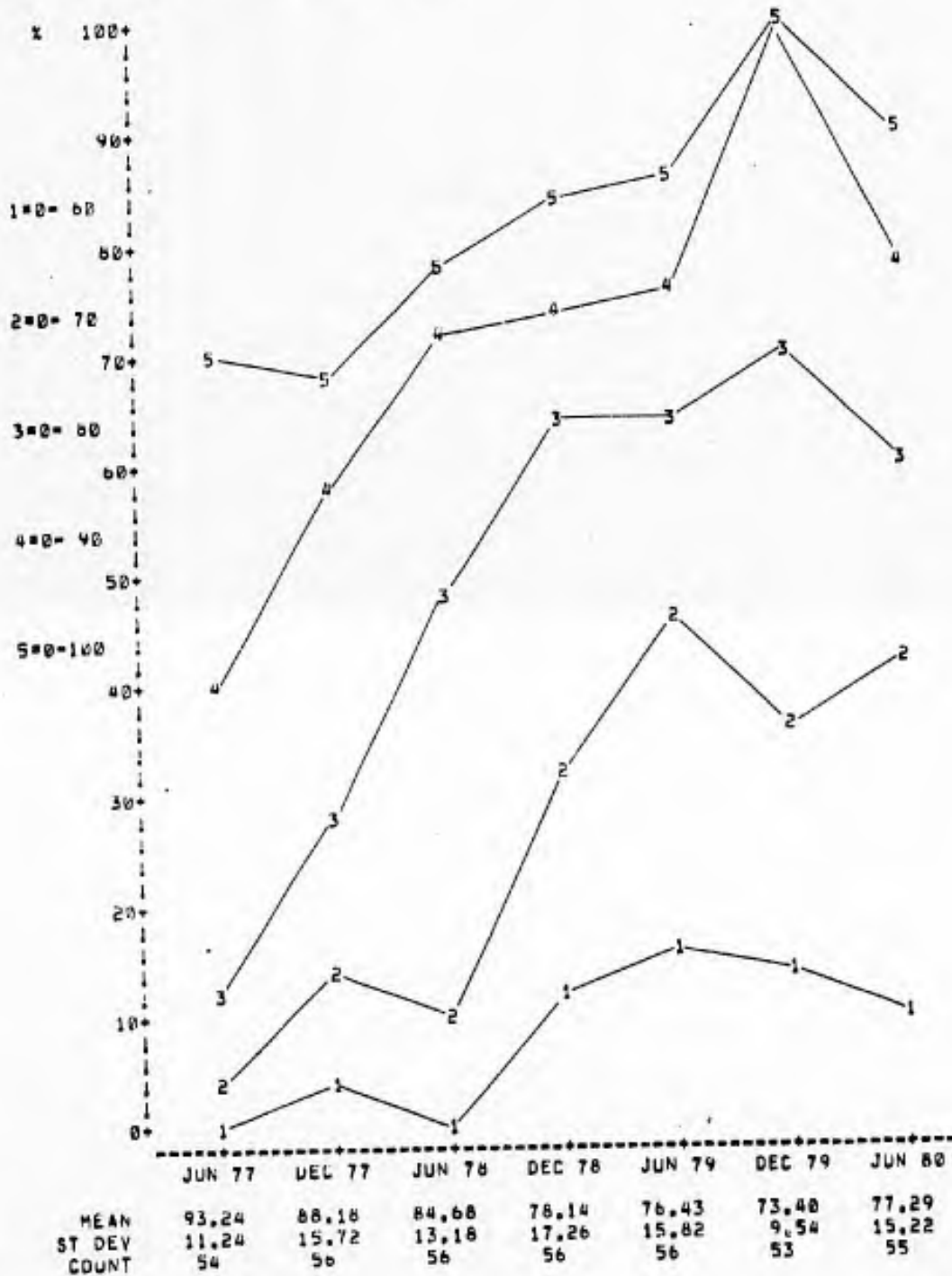

10 KHZ FOR THE LMI
OUT OF RANGE: INCLUDED

RUN DATES:

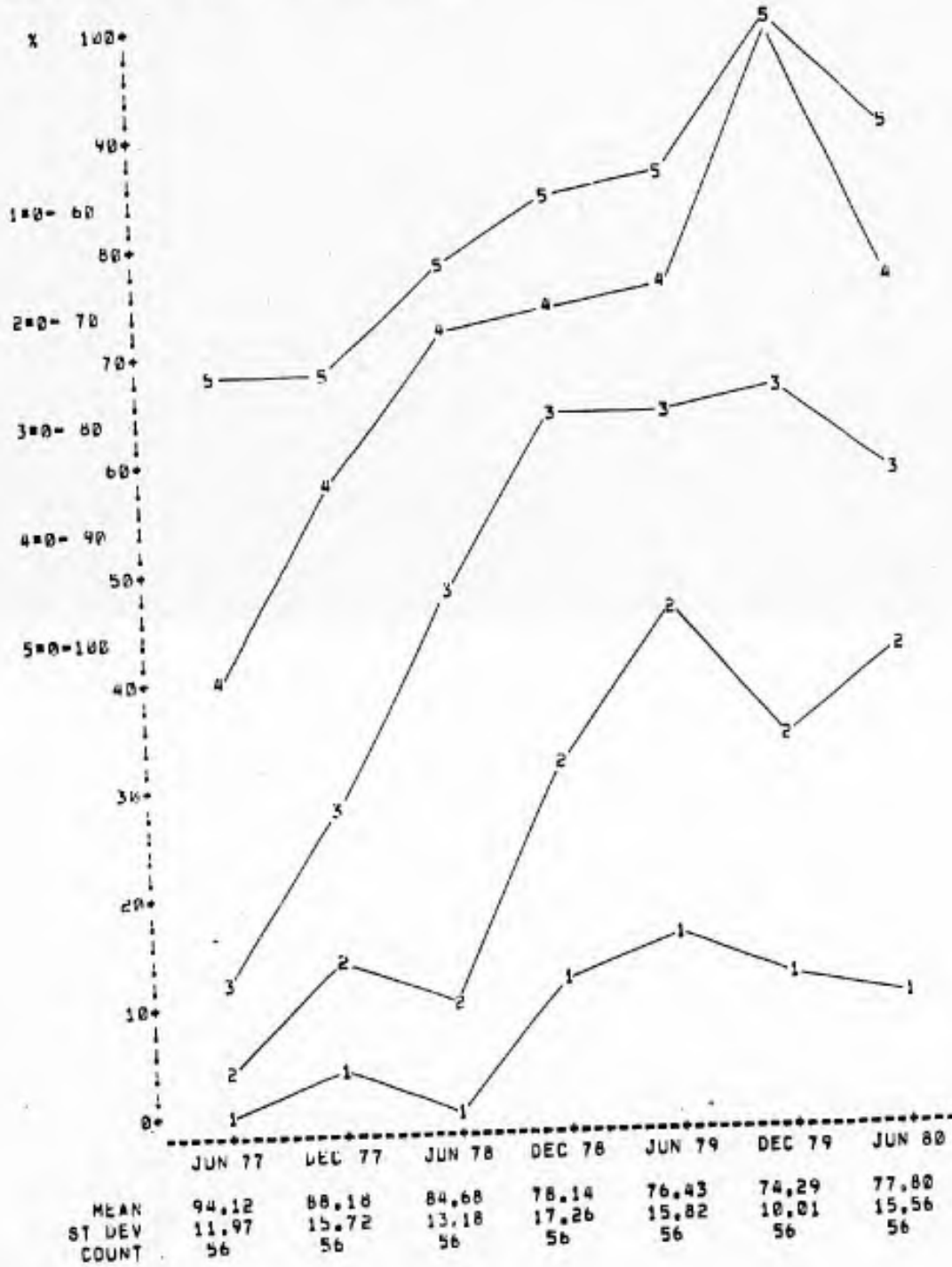

50 KHZ FOR THE LM1
OUT OF RANGE1 EXCLUDED

RUN DATE:

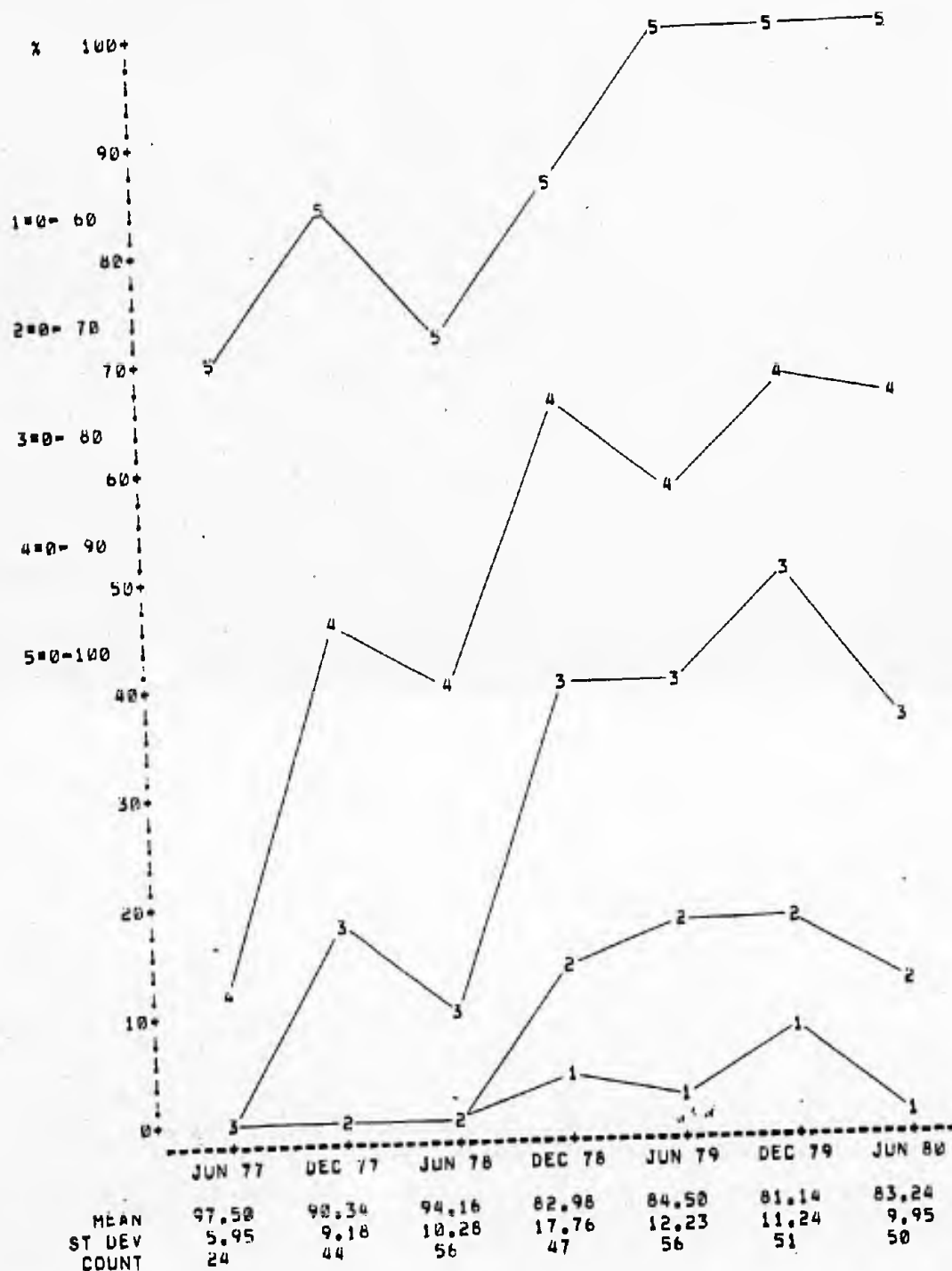

50 KHZ FOR THE LHI
OUT OF RANGE: INCLUDED

RUN DATE:

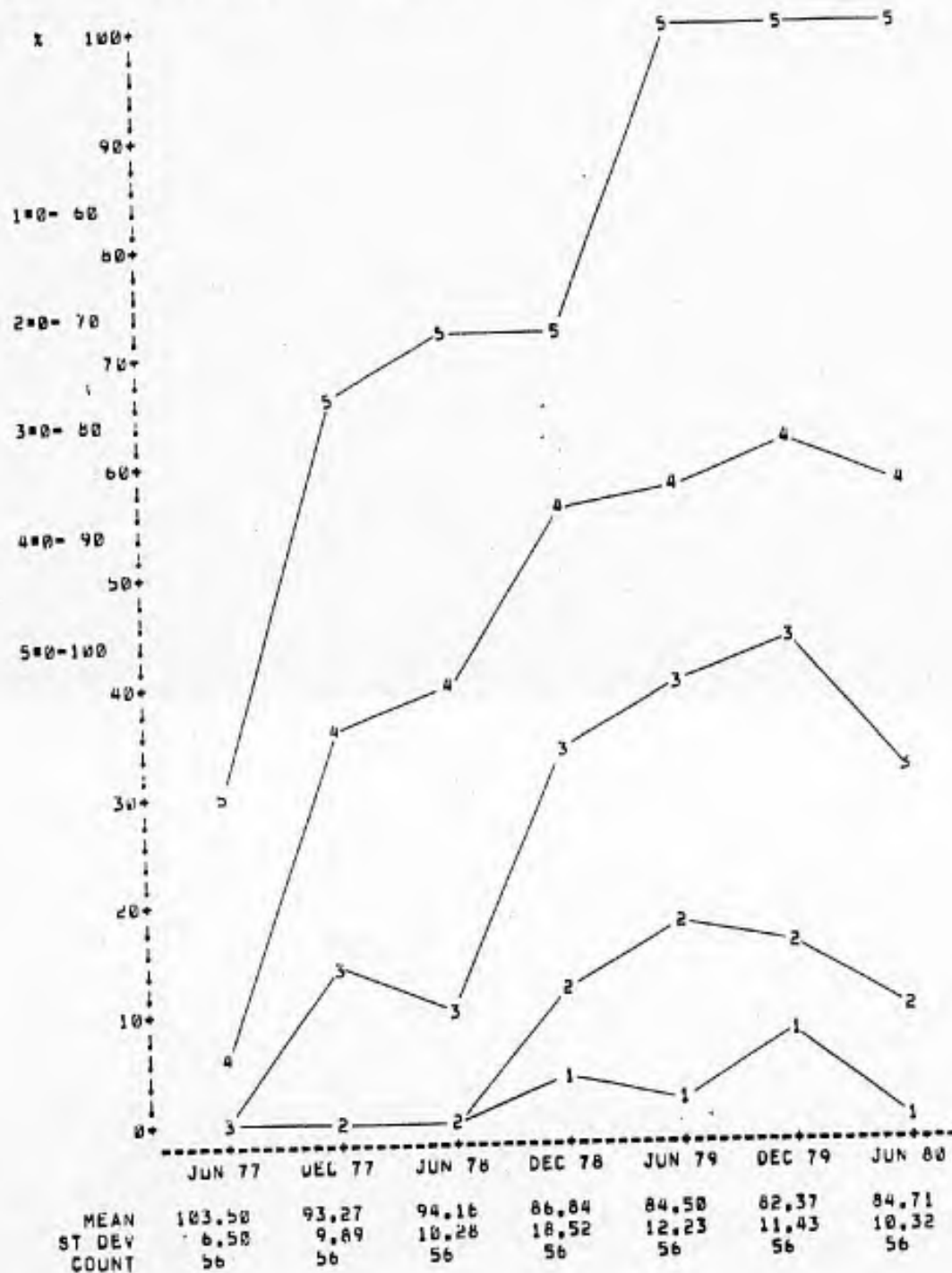

200 KMZ FOR THE LMI
 OUT OF RANGE: EXCLUDED

RUN DATE:

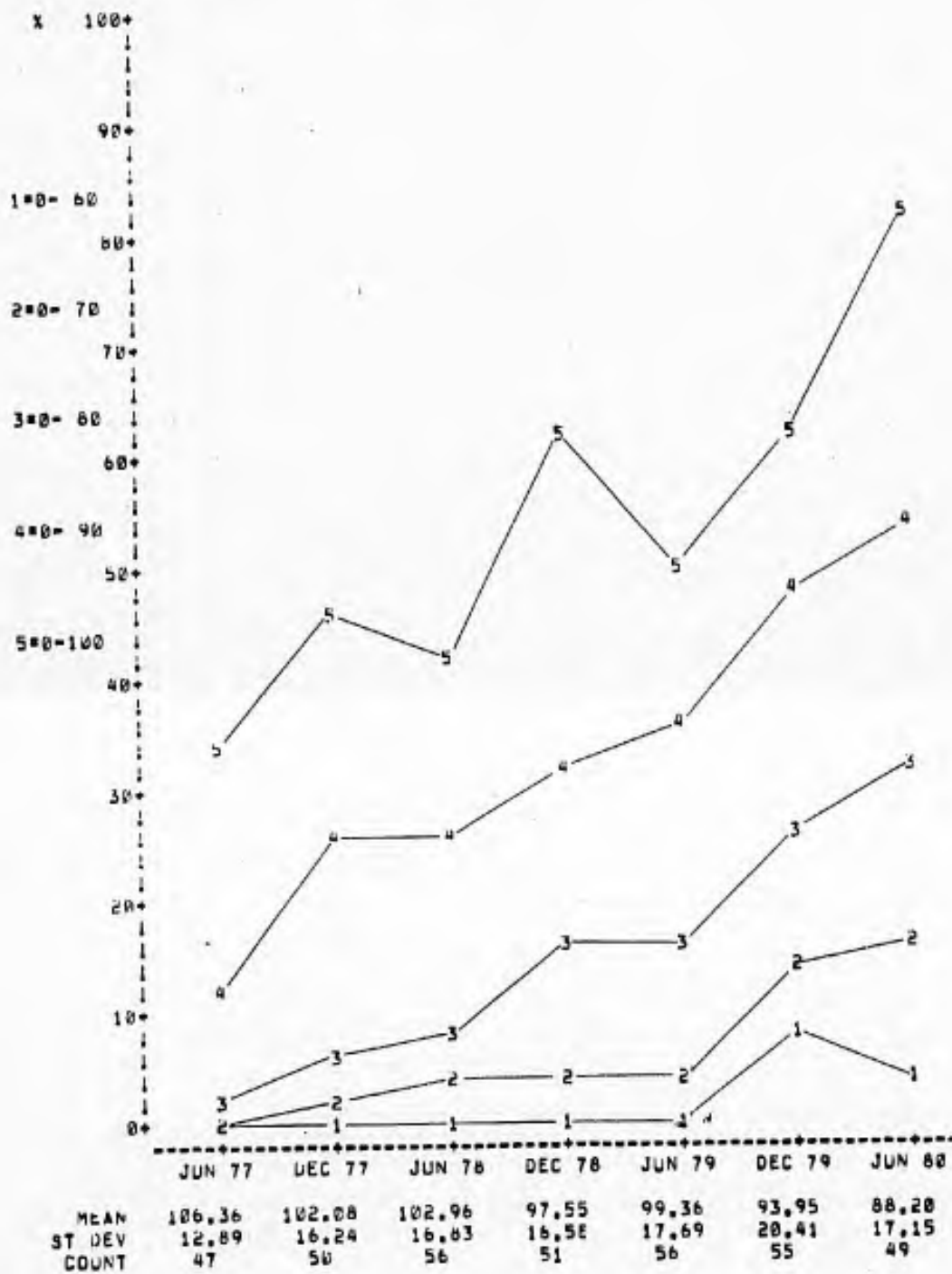

200 KHZ FOR THE LNI
OUT OF RANGE: INCLUDED

RUN DATE:

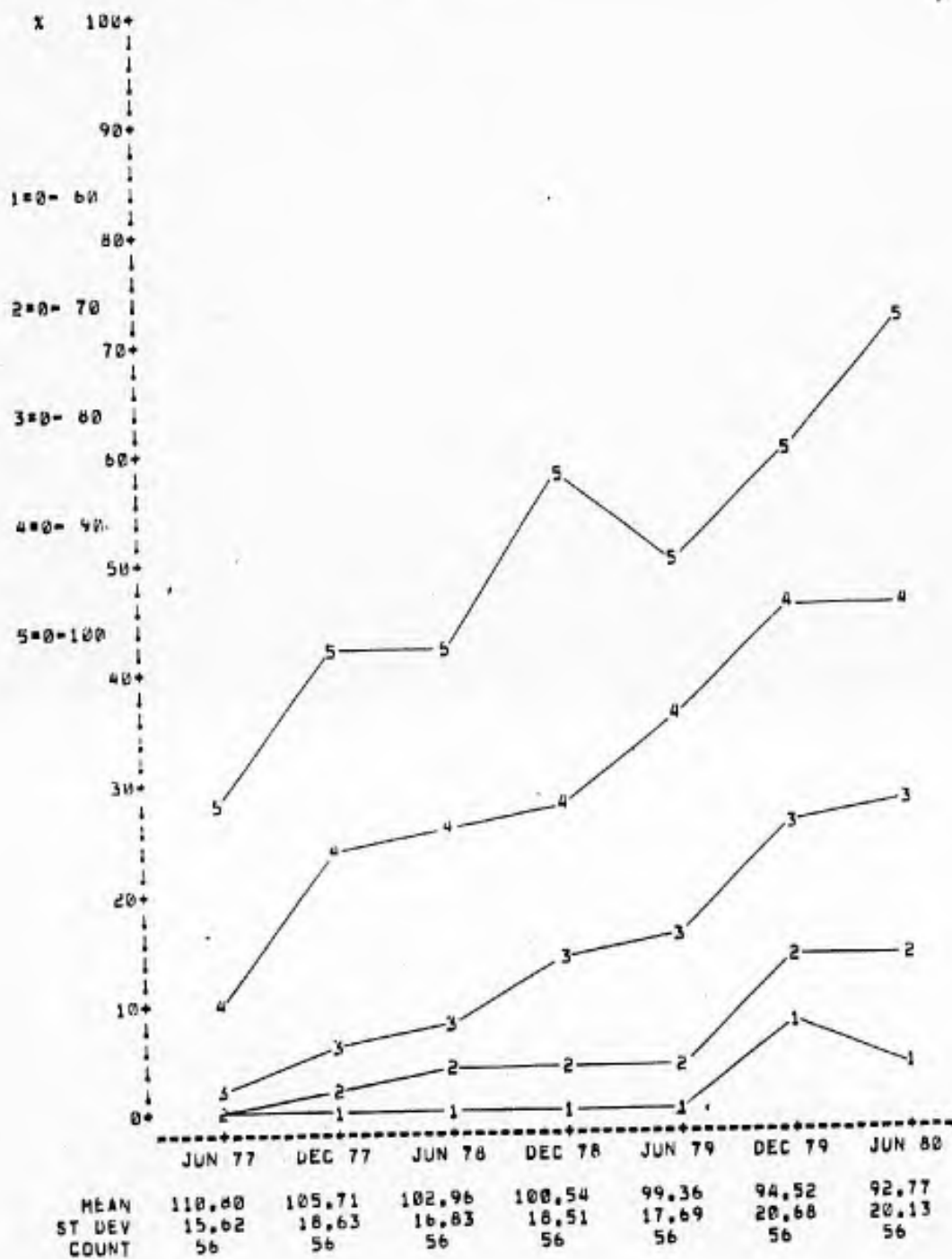

1 MHZ FOR THE LMI
OUT OF RANGE: EXCLUDED

RUN DATE:

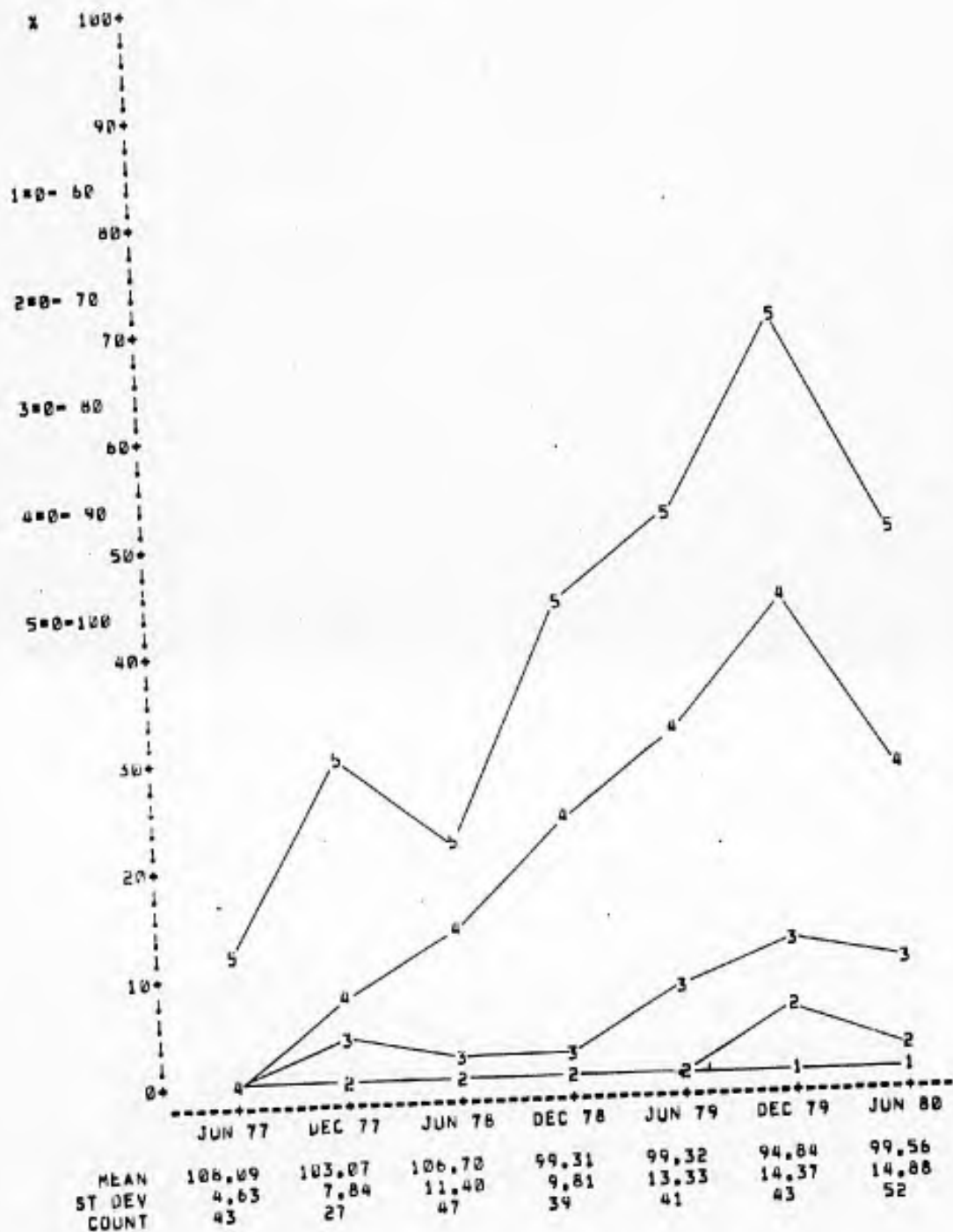

1 MHZ FOR THE LMI
OUT OF RANGE: INCLUDED

RUN DATE:

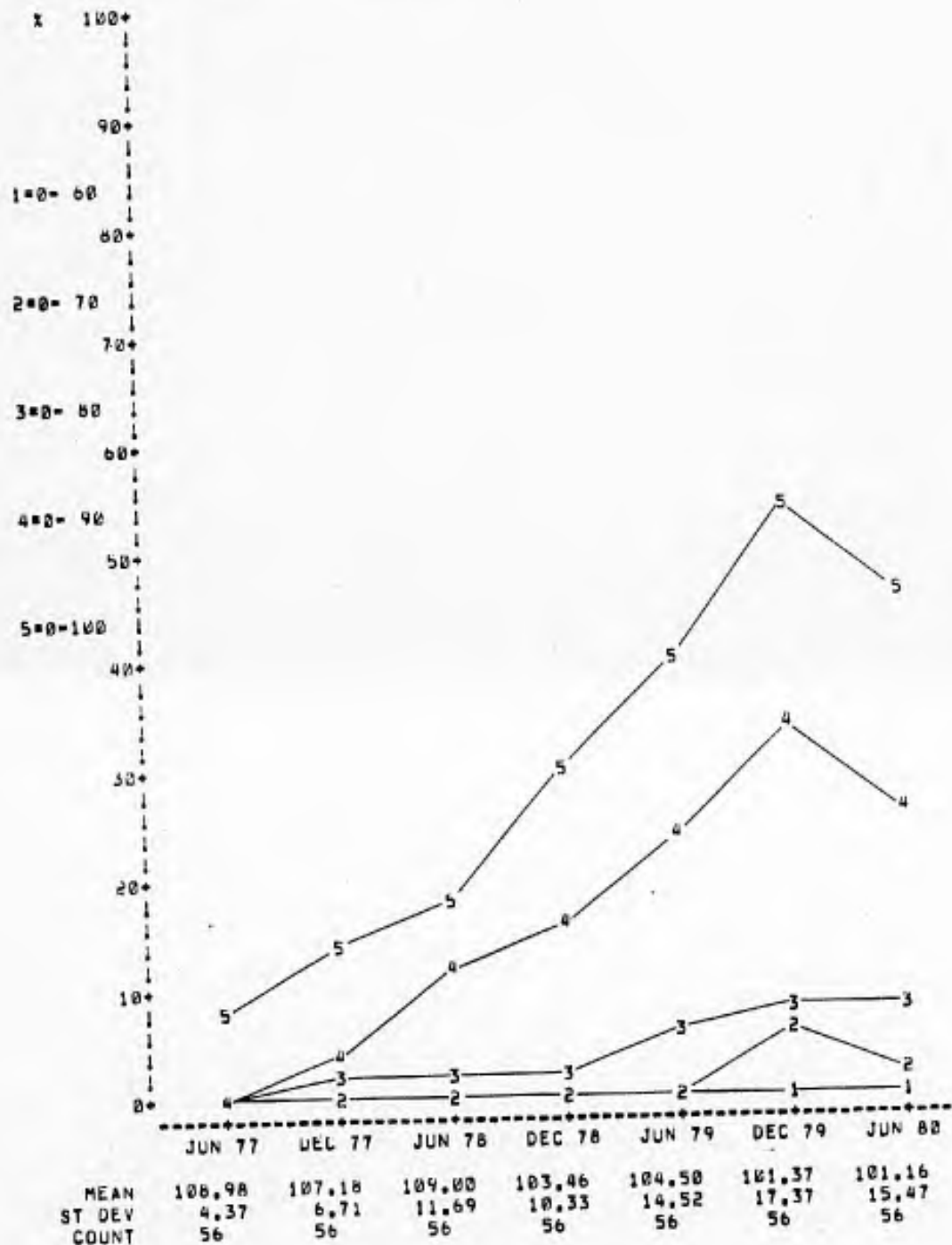

30 MHZ FOR THE LMI
OUT OF RANGE: EXCLUDED

RUN DATE:

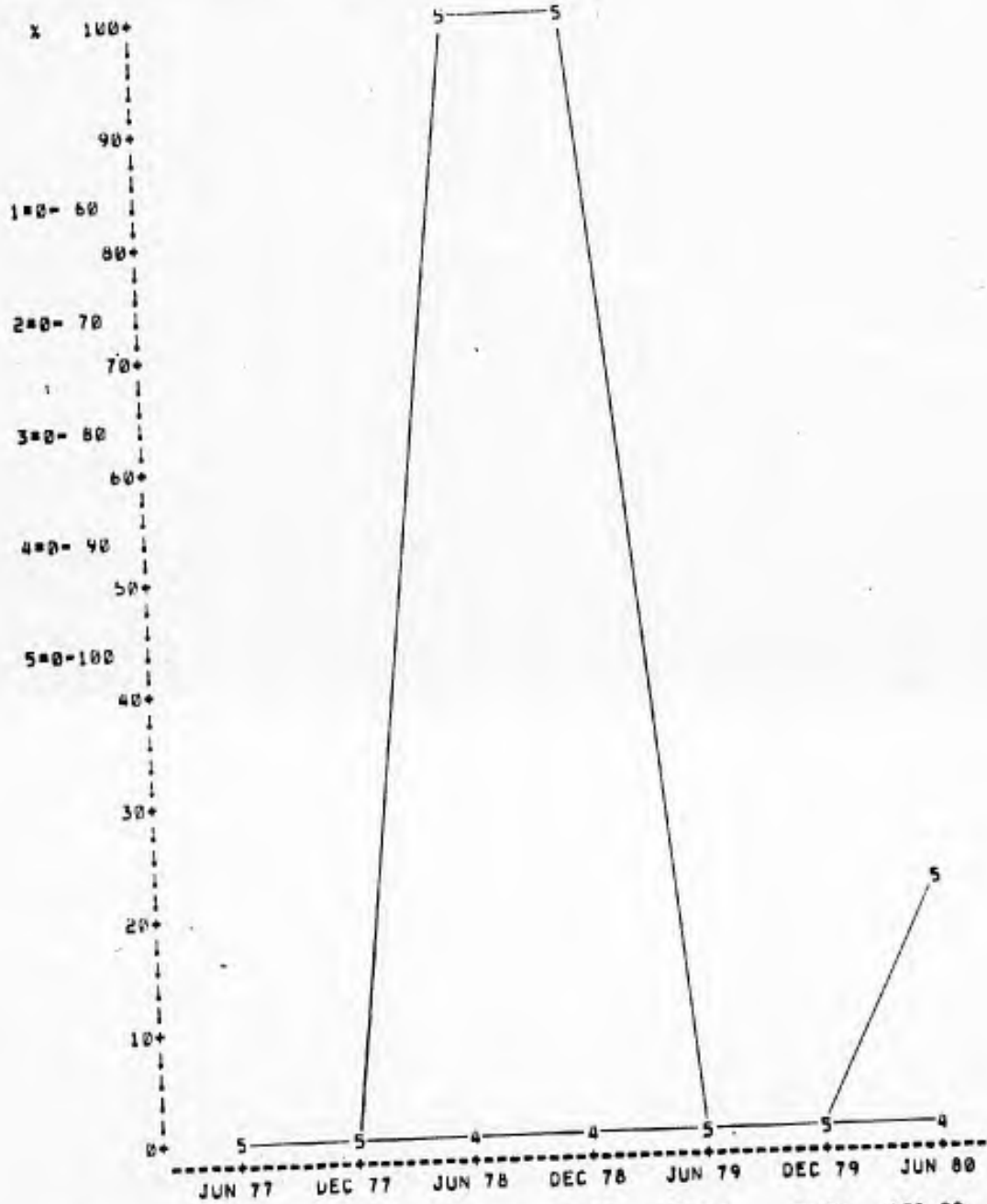

	JUN 77	DEC 77	JUN 78	DEC 78	JUN 79	DEC 79	JUN 80
MEAN	0.00	0.00	98.00	97.50	110.54	0.00	106.22
ST DEV	0.00	0.00	1.41	0.71	3.07	0.00	6.57
COUNT	0	0	2	10	13	0	9

30 MHZ FOR THE LMI
 OUT OF RANGE: INCLUDED

RUN DATE:

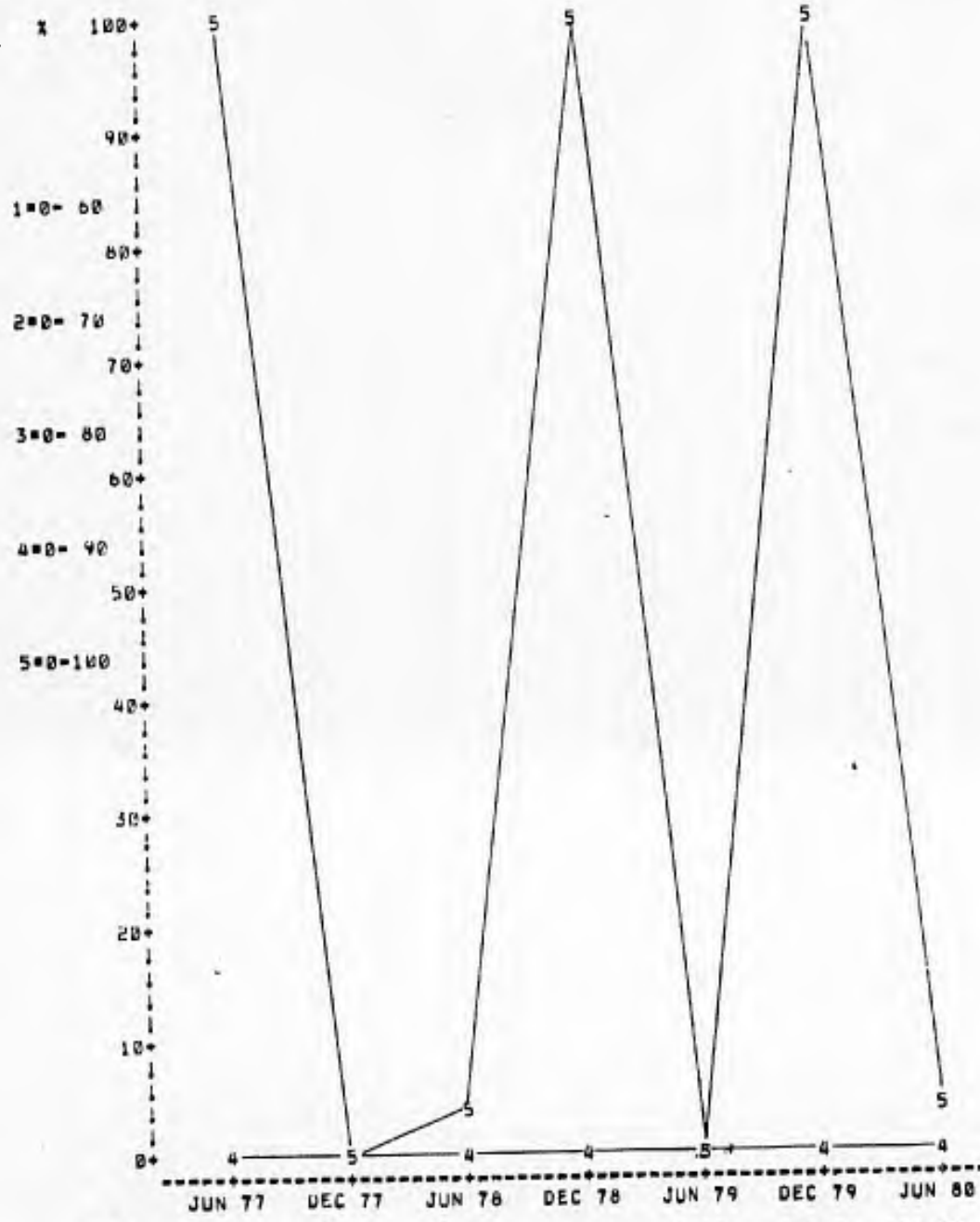

	JUN 77	DEC 77	JUN 78	DEC 78	JUN 79	DEC 79	JUN 80
MEAN	100.00	109.00	105.34	99.02	113.20	98.00	114.75
ST DEV	0.00	0.00	1.52	0.86	2.06	0.00	3.82
COUNT	56	56	56	56	56	56	56

450 MHZ FOR THE LMI
OUT OF RANGE: EXCLUDED

RUN DATE:

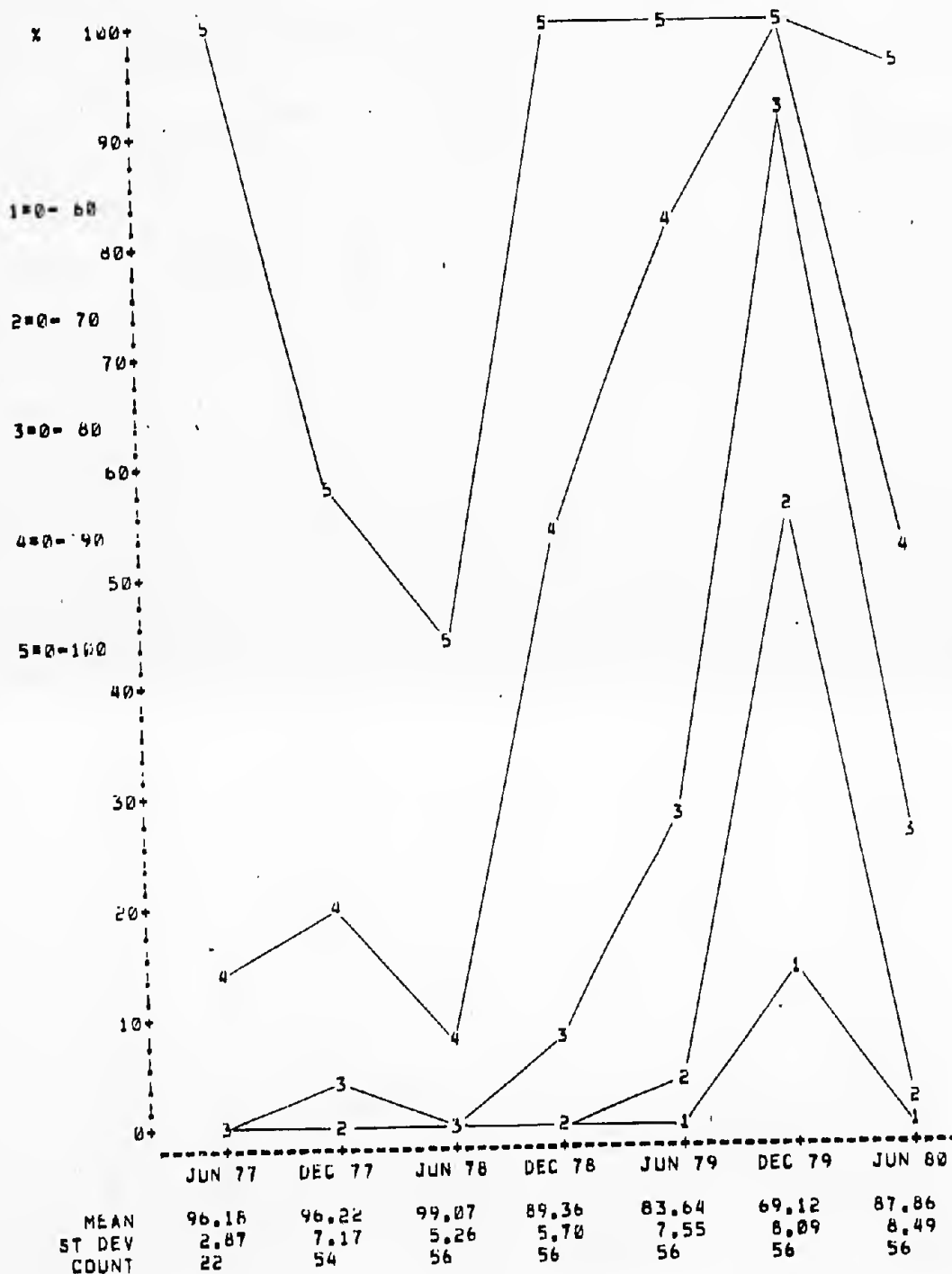

450 MHZ FOR THE LMI
OUT OF RANGE: INCLUDED

RUN DATE:

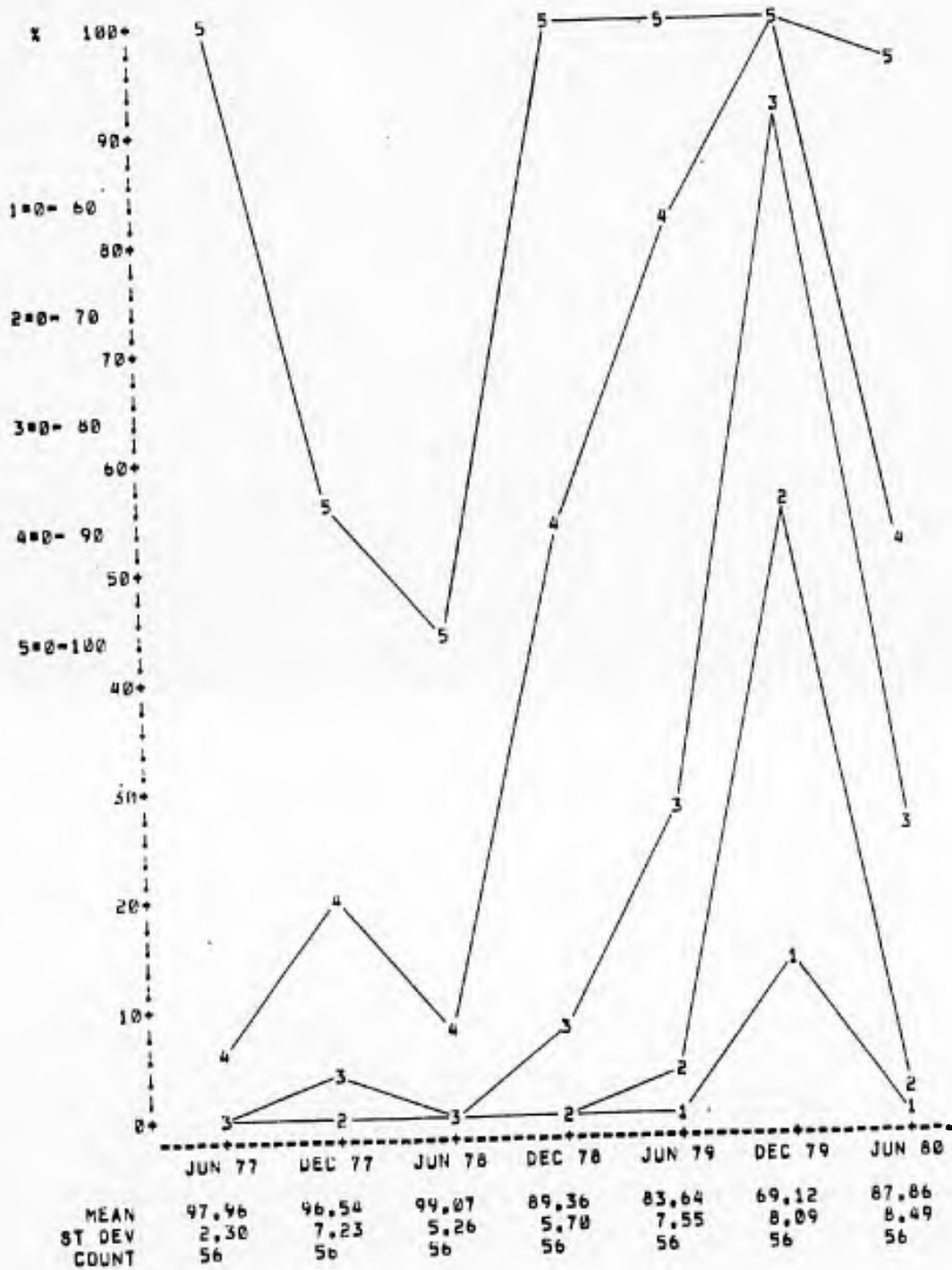

2.4 GHZ FOR THE LMI
OUT OF RANGE: EXCLUDED

RUN DATE:

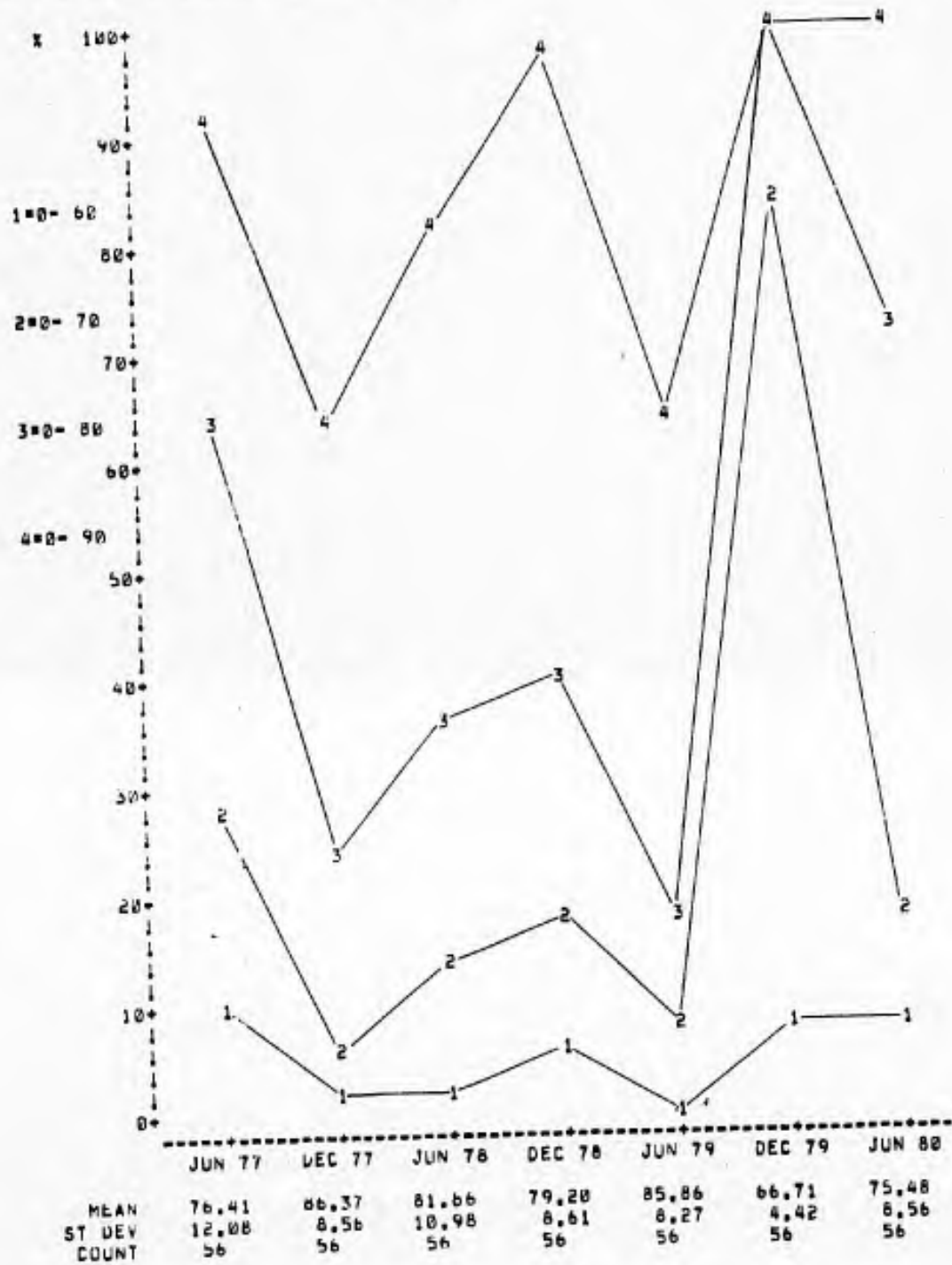

2.4 GHZ FOR THE LMI
OUT OF RANGE: INCLUDED

RUN DATE:

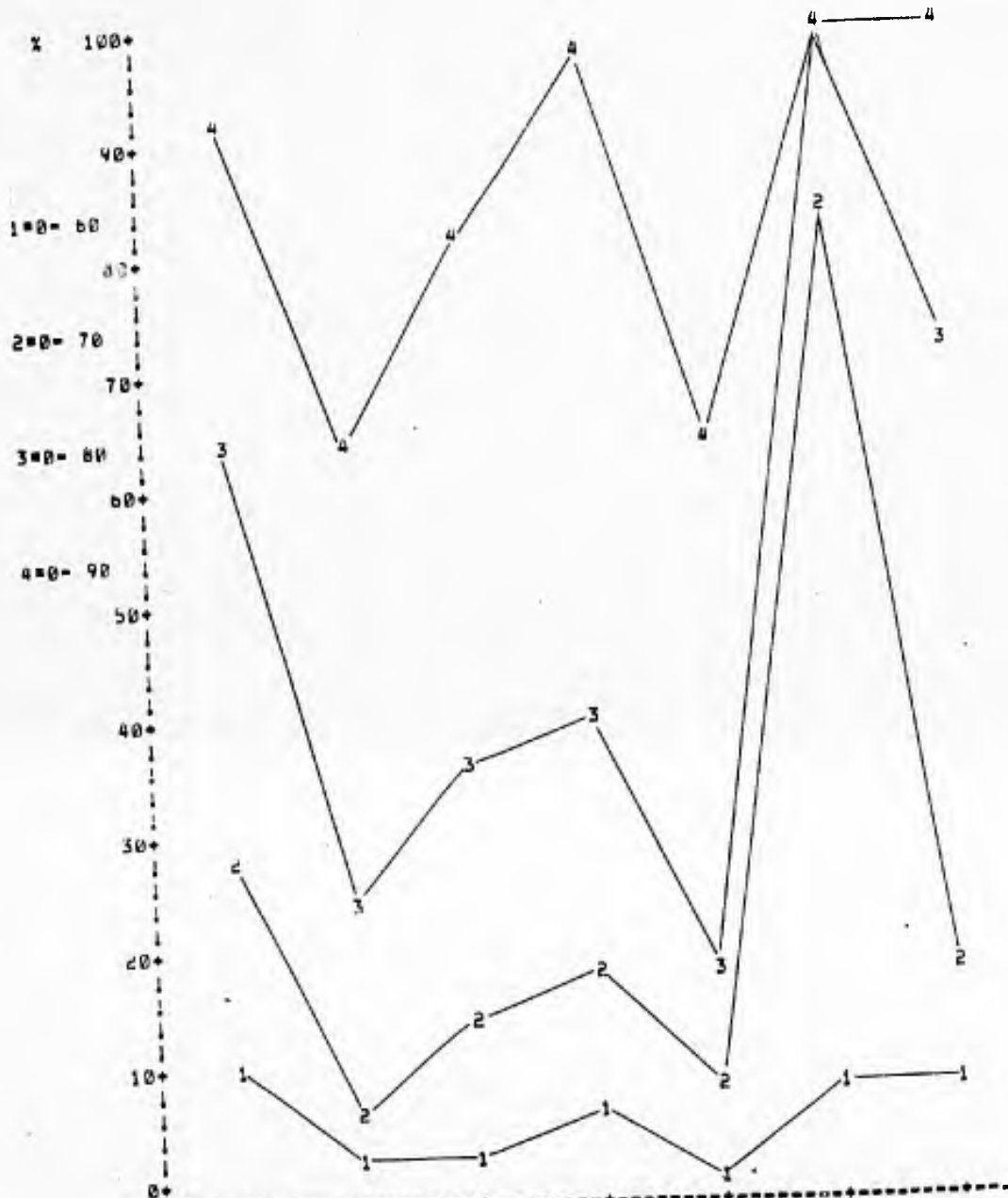

	JUN 77	DEC 77	JUN 78	DEC 78	JUN 79	DEC 79	JUN 80
MEAN	76.41	66.37	81.86	79.20	85.86	66.71	75.48
ST DEV	12.08	8.56	10.98	8.61	8.27	4.42	8.56
COUNT	56	56	56	56	56	56	56

7 GHZ FOR THE LMI
OUT OF RANGE: EXCLUDED

RUN DATE:

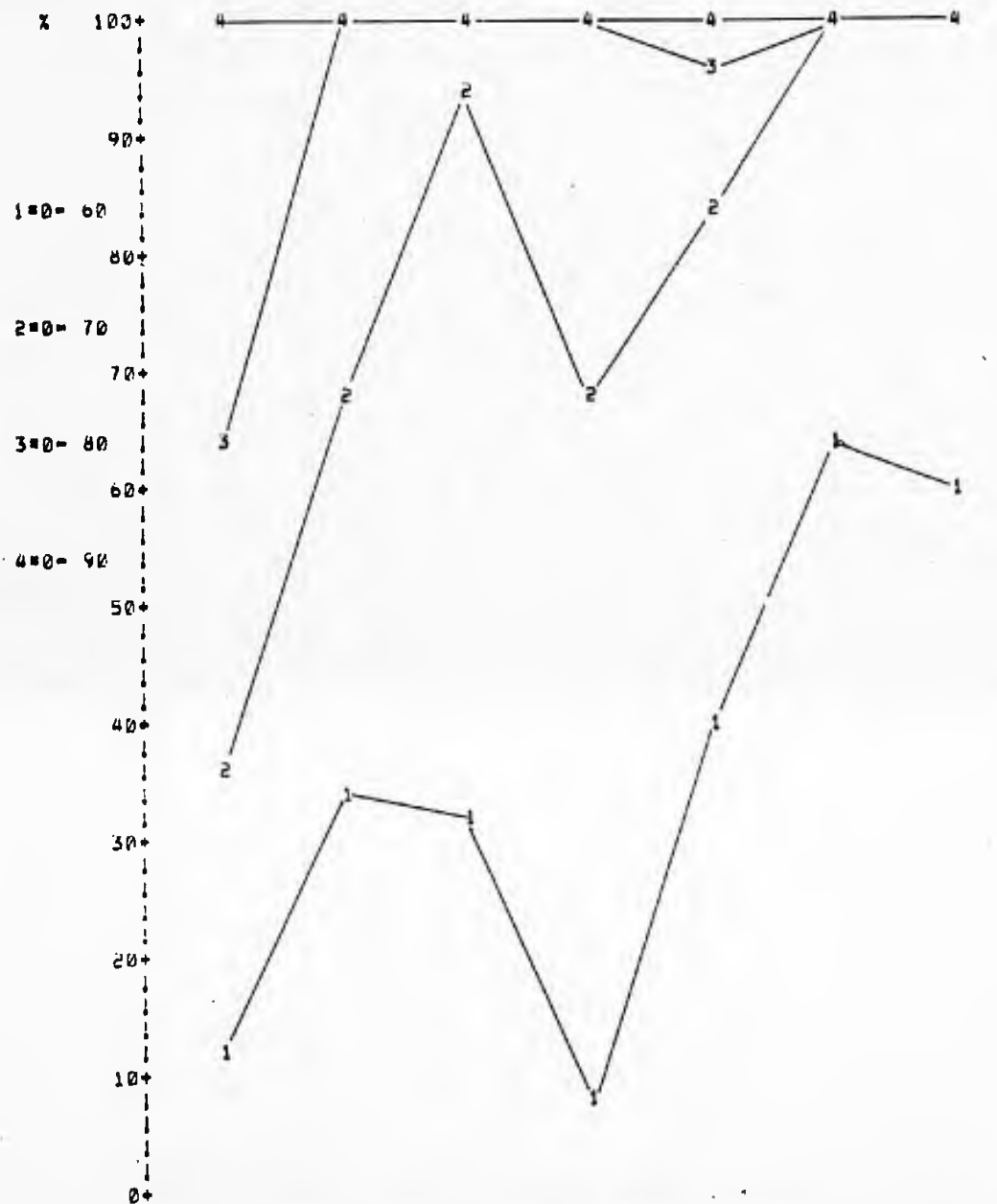

	JUN 77	DEC 77	JUN 78	DEC 78	JUN 79	DEC 79	JUN 80
MEAN	73.81	63.68	62.14	67.34	64.48	57.52	57.66
ST DEV	11.22	11.59	11.72	6.02	8.13	6.28	7.10
COUNT	53	56	56	56	56	56	56

7 GHz FOR THE LMI
OUT OF RANGE: INCLUDED

RUN DATE:

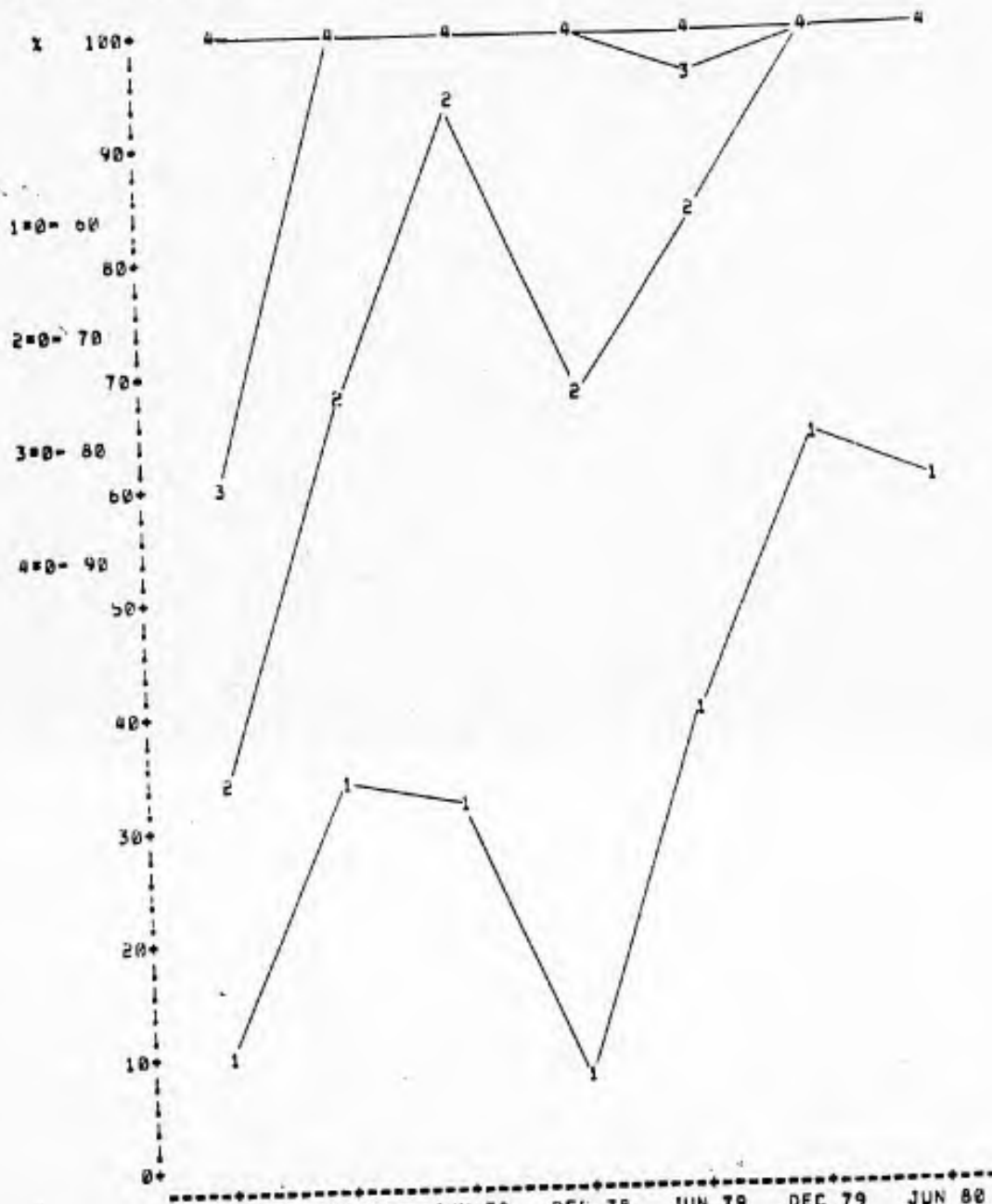

	JUN 77	DEC 77	JUN 78	DEC 78	JUN 79	DEC 79	JUN 80
MEAN	74.68	63.68	62.14	67.34	64.48	57.52	57.66
ST DEV	11.51	11.54	11.72	6.82	8.13	6.28	7.10
COUNT	56	56	56	56	56	56	56

APPENDIX B:

SHIELDING EFFECTIVENESS DATA FOR PARTICLEBOARD- AND PLYWOOD-CORED PANELS

The graphs in this appendix show shielding effectiveness versus aging for the two different panel core material types (particleboard and plywood).

The cell-type test module was fabricated using two different types of panels -- one with a 3/4-in. (19-mm) plywood core separating the two steel sheets, and the other with a 3/4-in. (19-mm) particleboard core. Two adjacent walls had plywood cores and two had particleboard cores. The data presented allow a comparison of shielding degradation versus aging for each type. Figure B1 is a graphical key aid for interpreting the data.

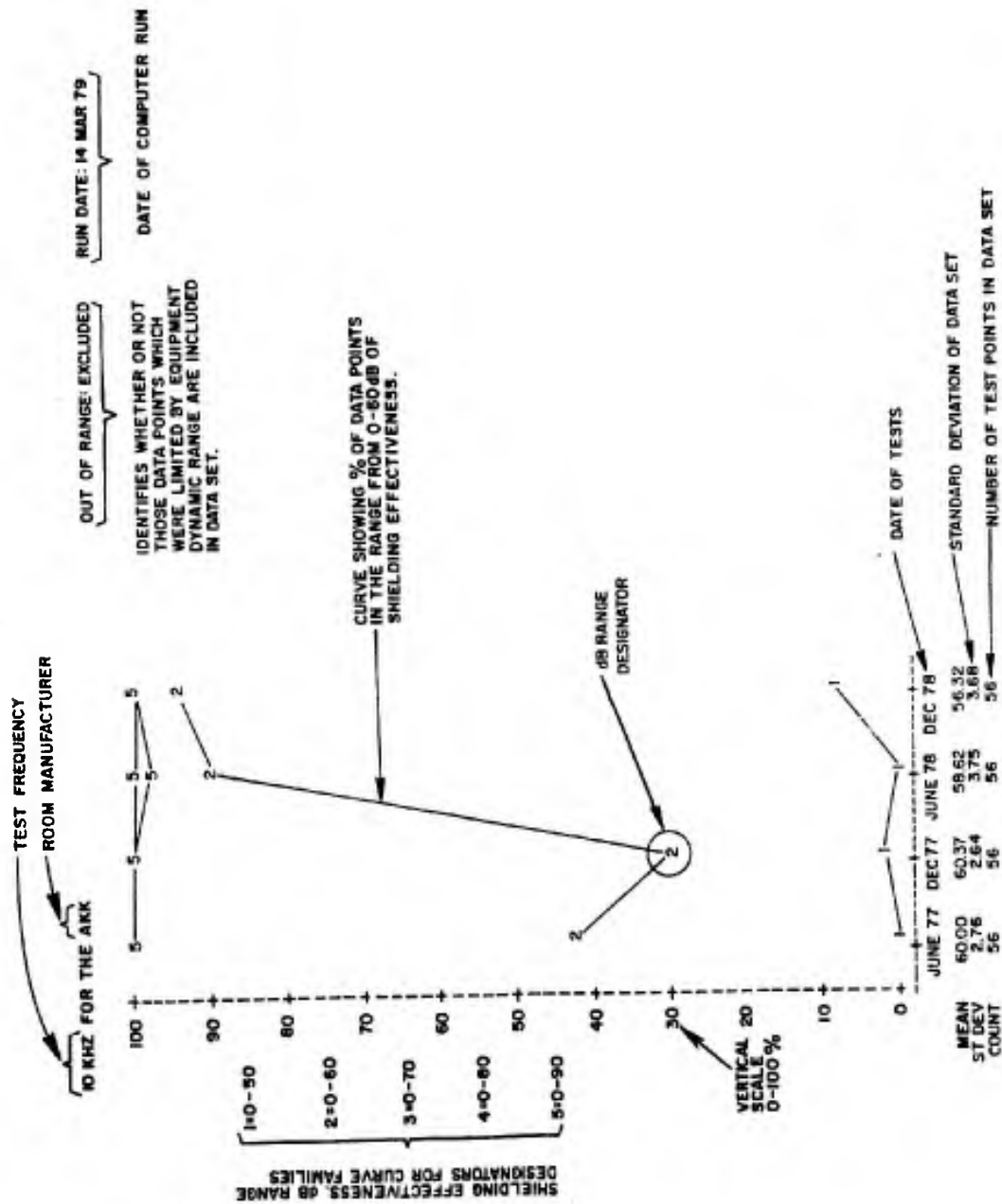
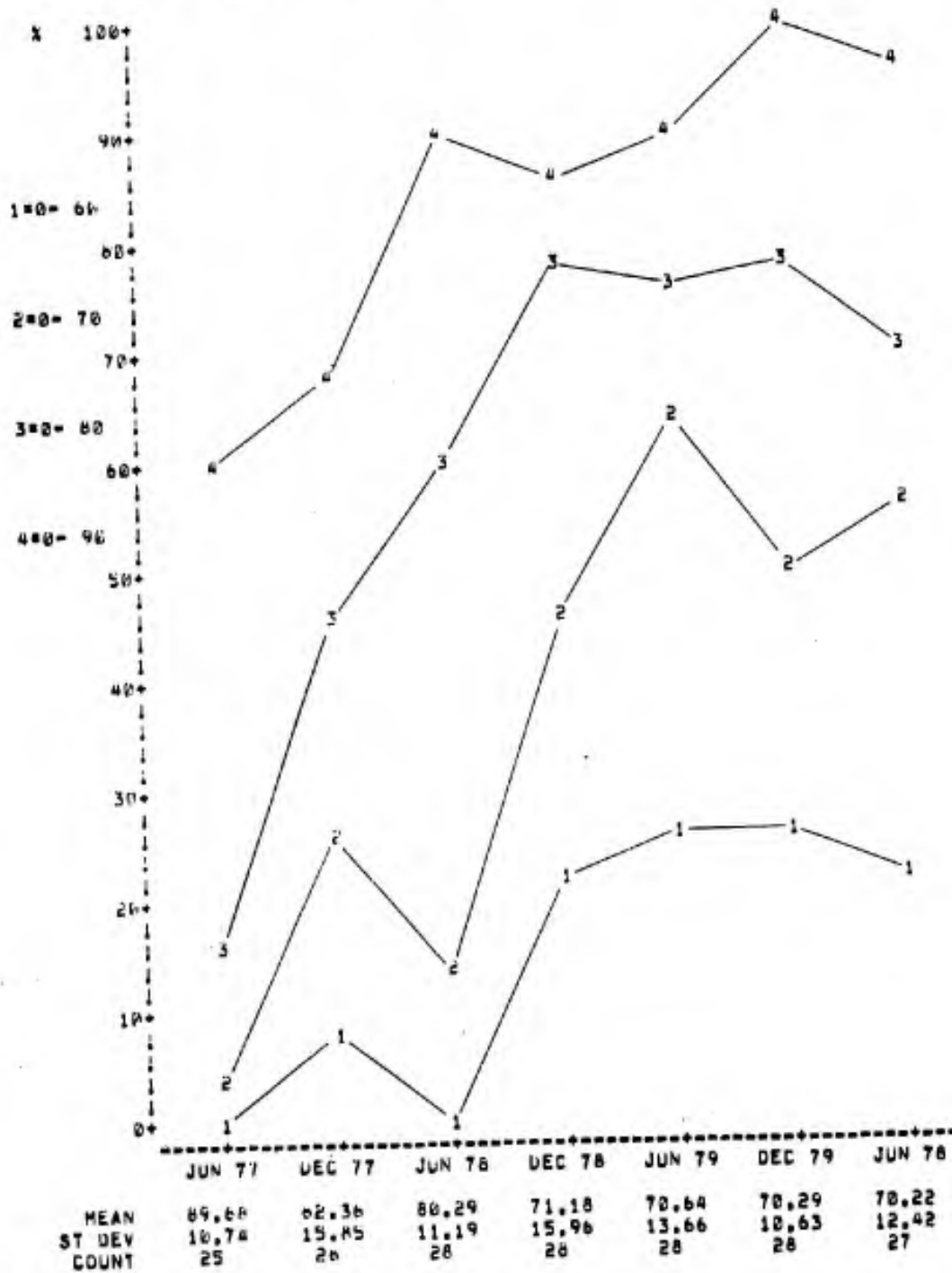

Figure B1. Graphical key for Appendix B.

10 KHZ FOR THE L11
OUT OF RANGE: EXCLUDED

RUN GATE:



10 KHZ FOR THE LMI
OUT OF RANGE: INCLUDED

RUN DATE:

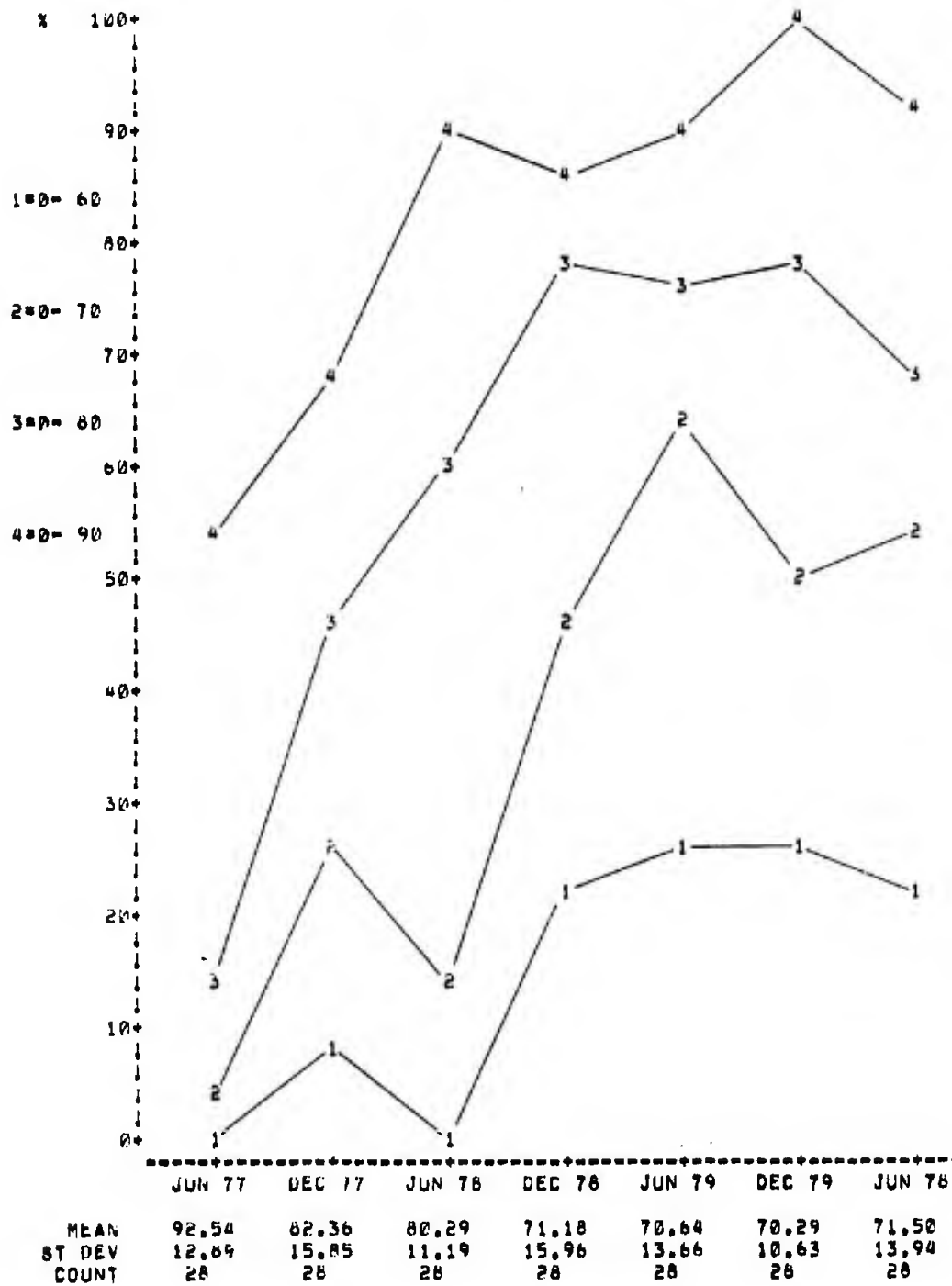

50 KHZ FOR THE LM1
OUT OF RANGE: EXCLUDED RUN DATE:

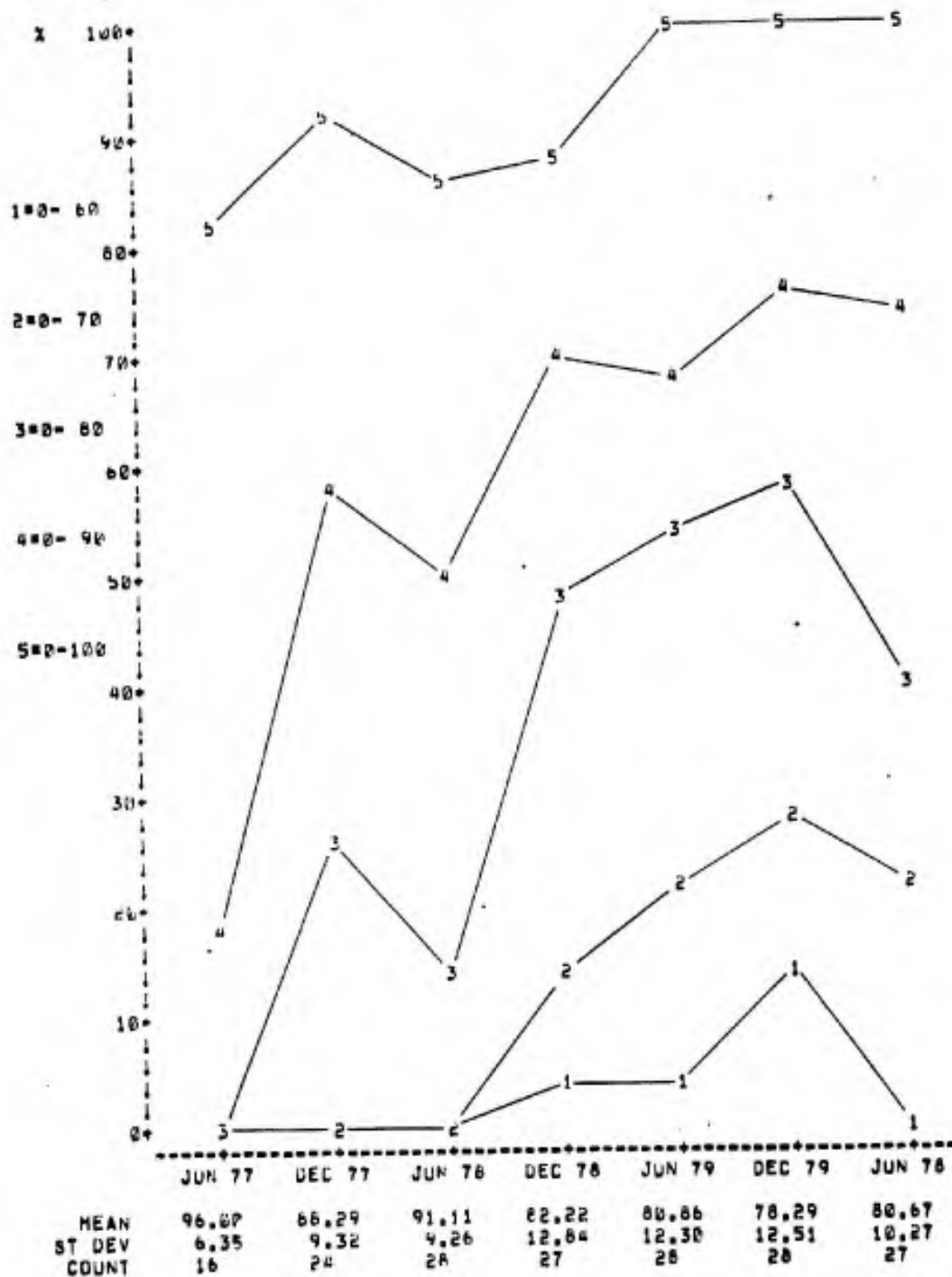

50 KHZ FOR THE L11
OUT OF RANGE: INCLUDED

RUN DATE:

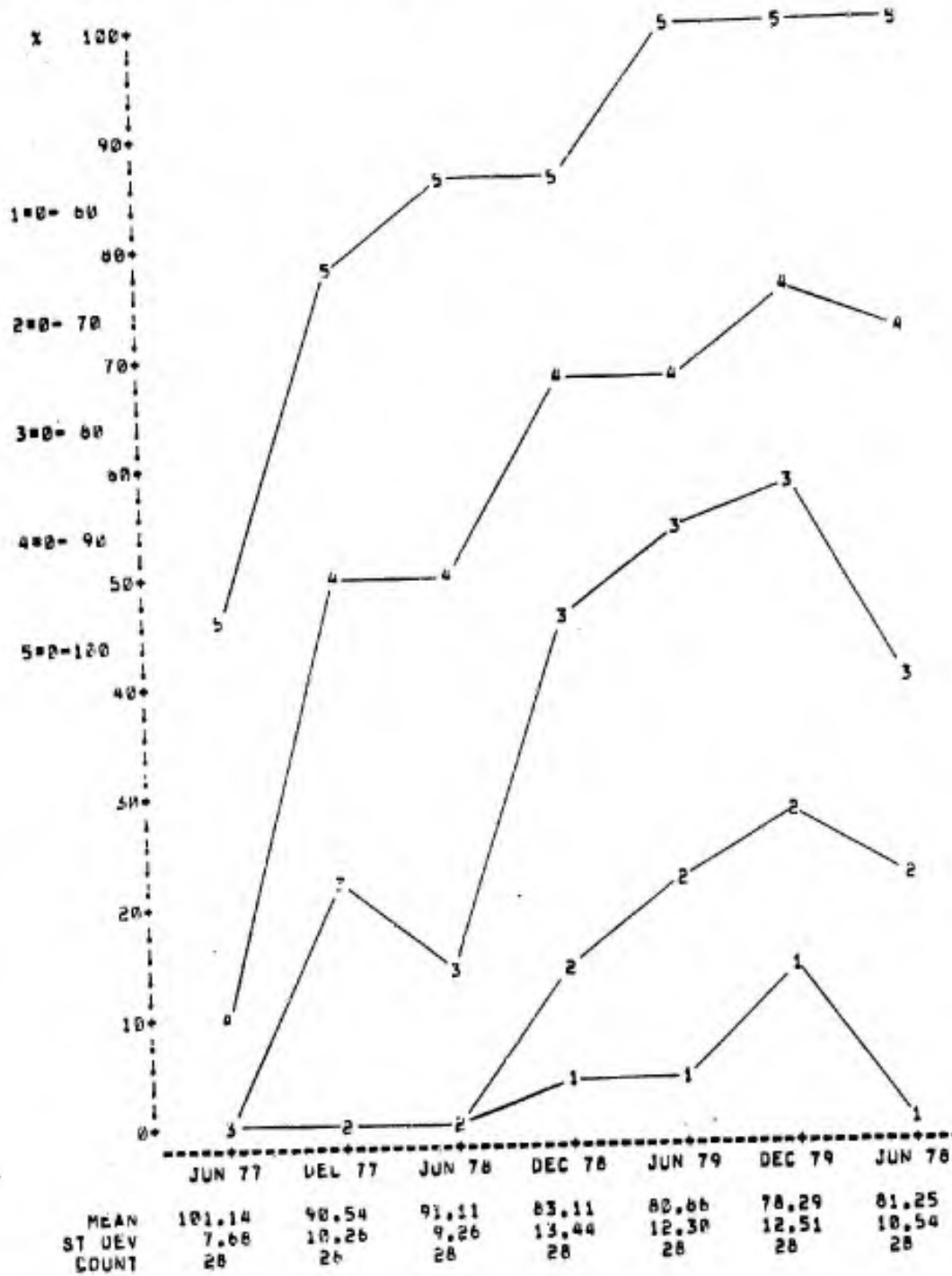

200 KHZ FOR THE LHI
OUT OF RANGE! EXCLUDED

RUN DATE:

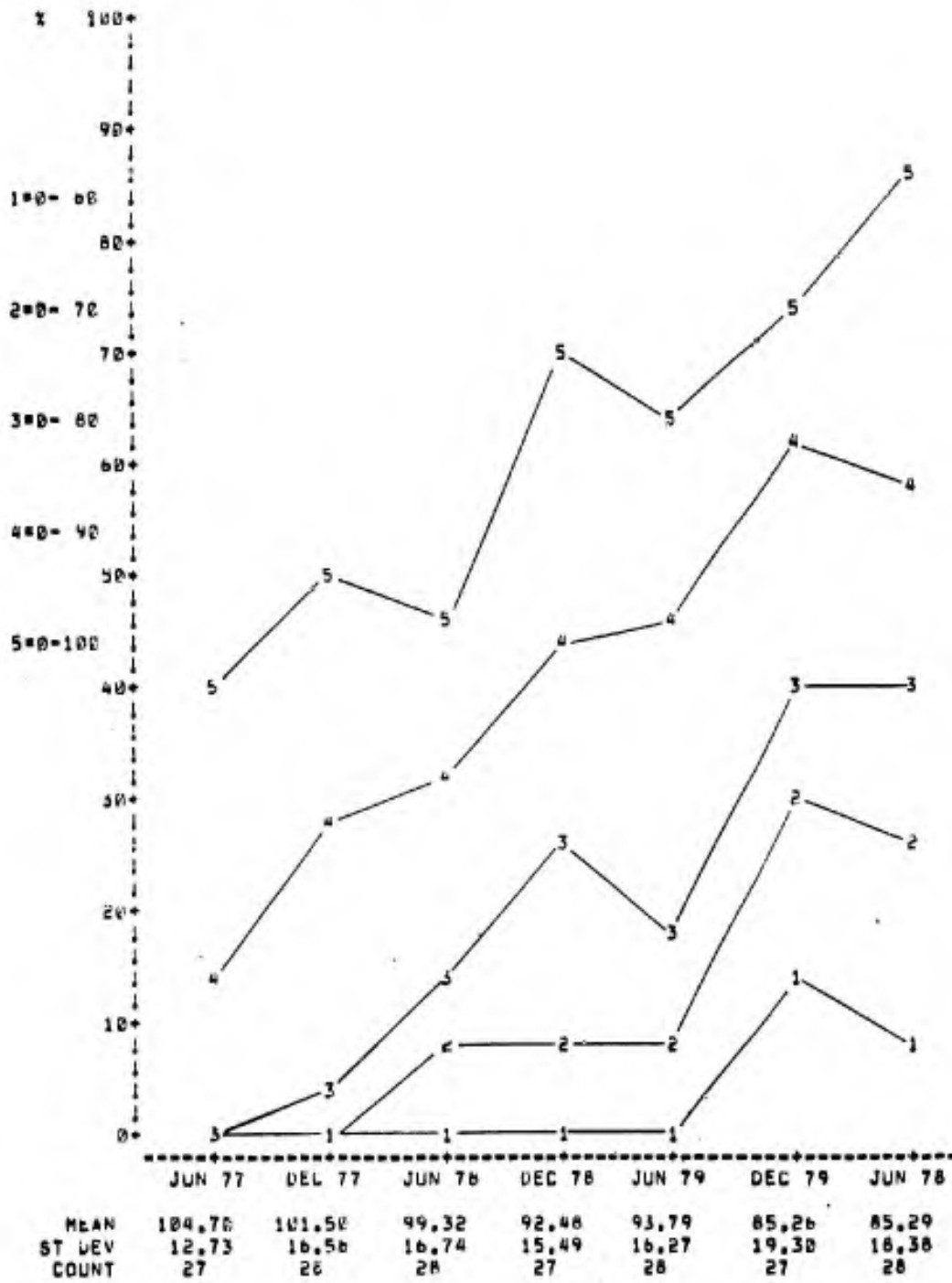

	JUN 77	DEL 77	JUN 78	DEC 78	JUN 79	DEC 79	JUN 78
MEAN	104.70	101.50	99.32	92.48	93.79	85.26	85.29
ST DEV	12.73	16.56	16.74	15.49	16.27	19.30	16.38
COUNT	27	26	28	27	28	27	28

200 KHZ FOR THE LMI
OUT OF RANGE: INCLUDED

RUN DATE:

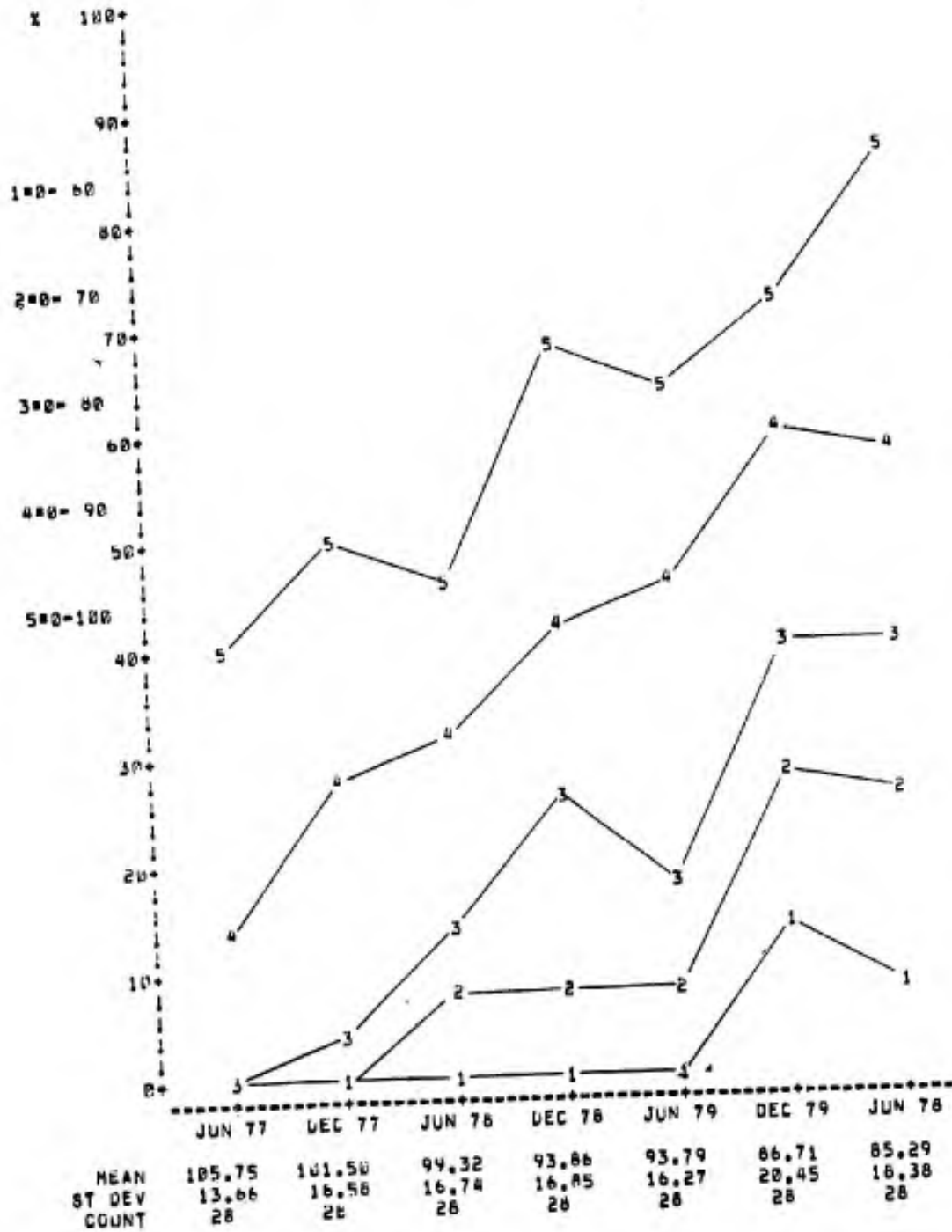

1 MHZ FOR THE LMI
OUT OF RANGE EXCLUDED

RUN DATE:

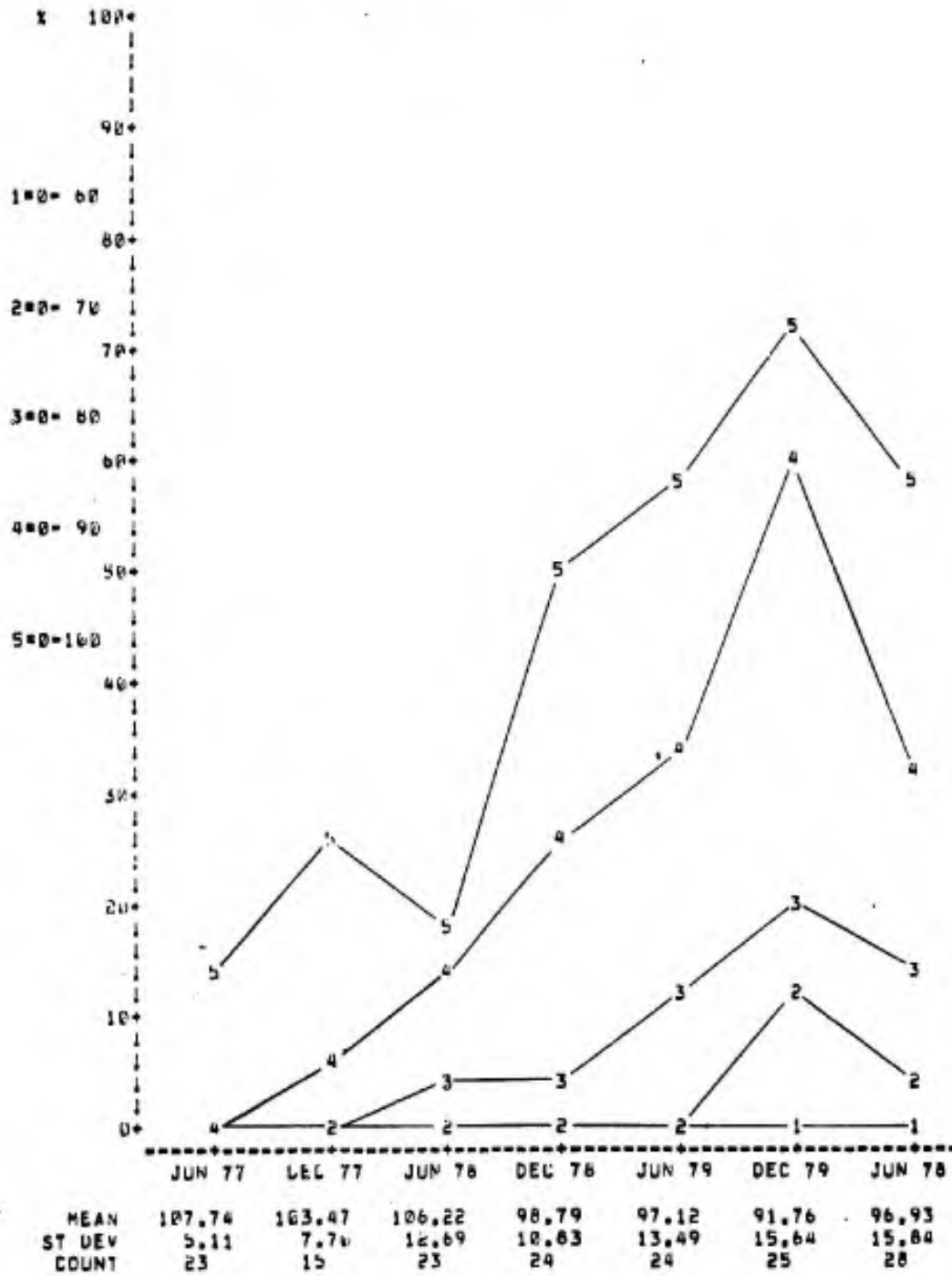

1 MHZ FOR THE LMI
OUT OF RANGE: INCLUDED

RUN DATE:

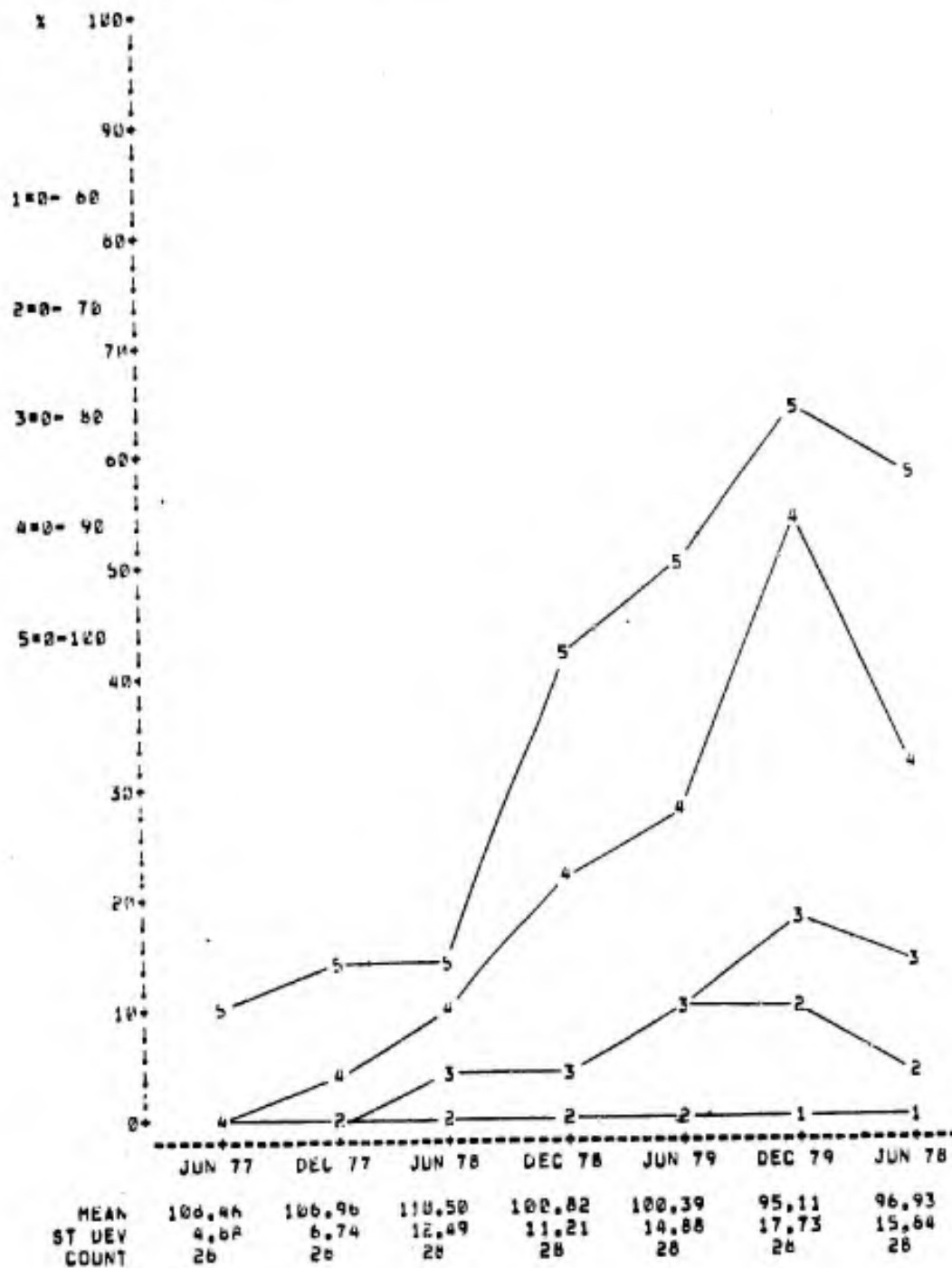

30 MHZ FOR THE LPI
OUT OF RANGE: EXCLUDED

RUN DATE:

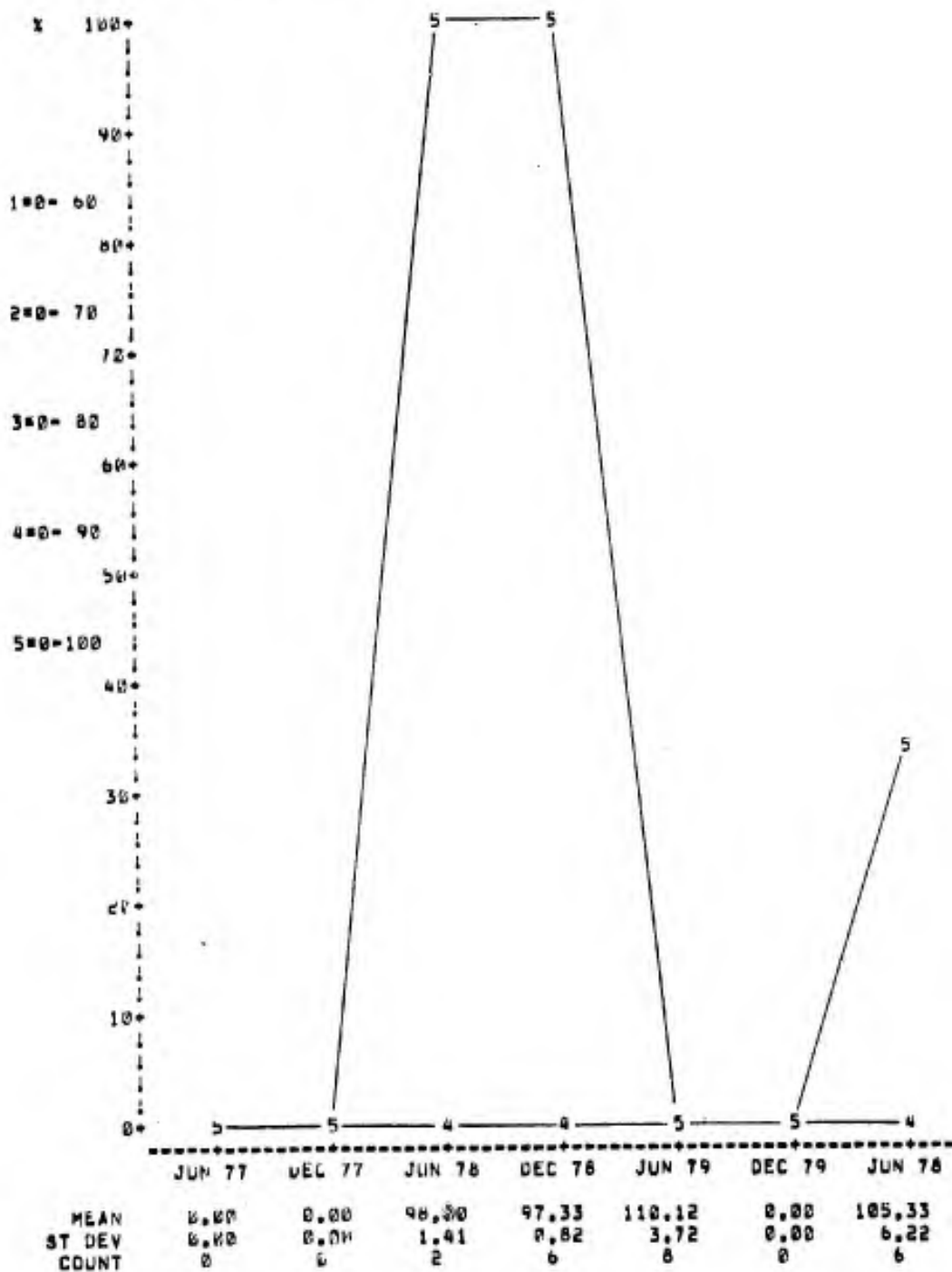

30 MHZ FOR THE LMI
OUT OF RANGE: INCLUDED

RUN DATE:

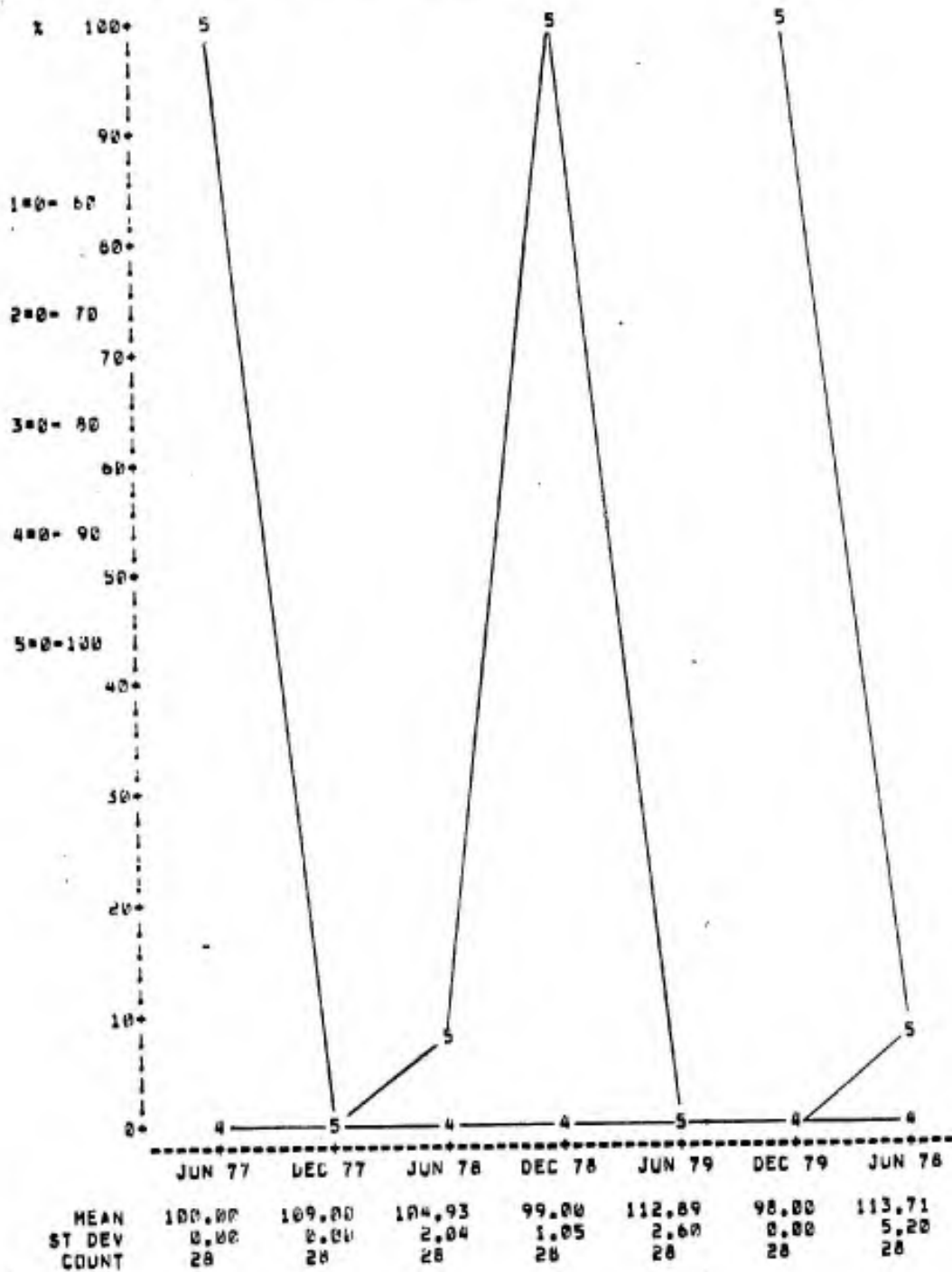

450 MHZ FOR THE LMI
OUT OF RANGE: EXCLUDED

RUN DATE:

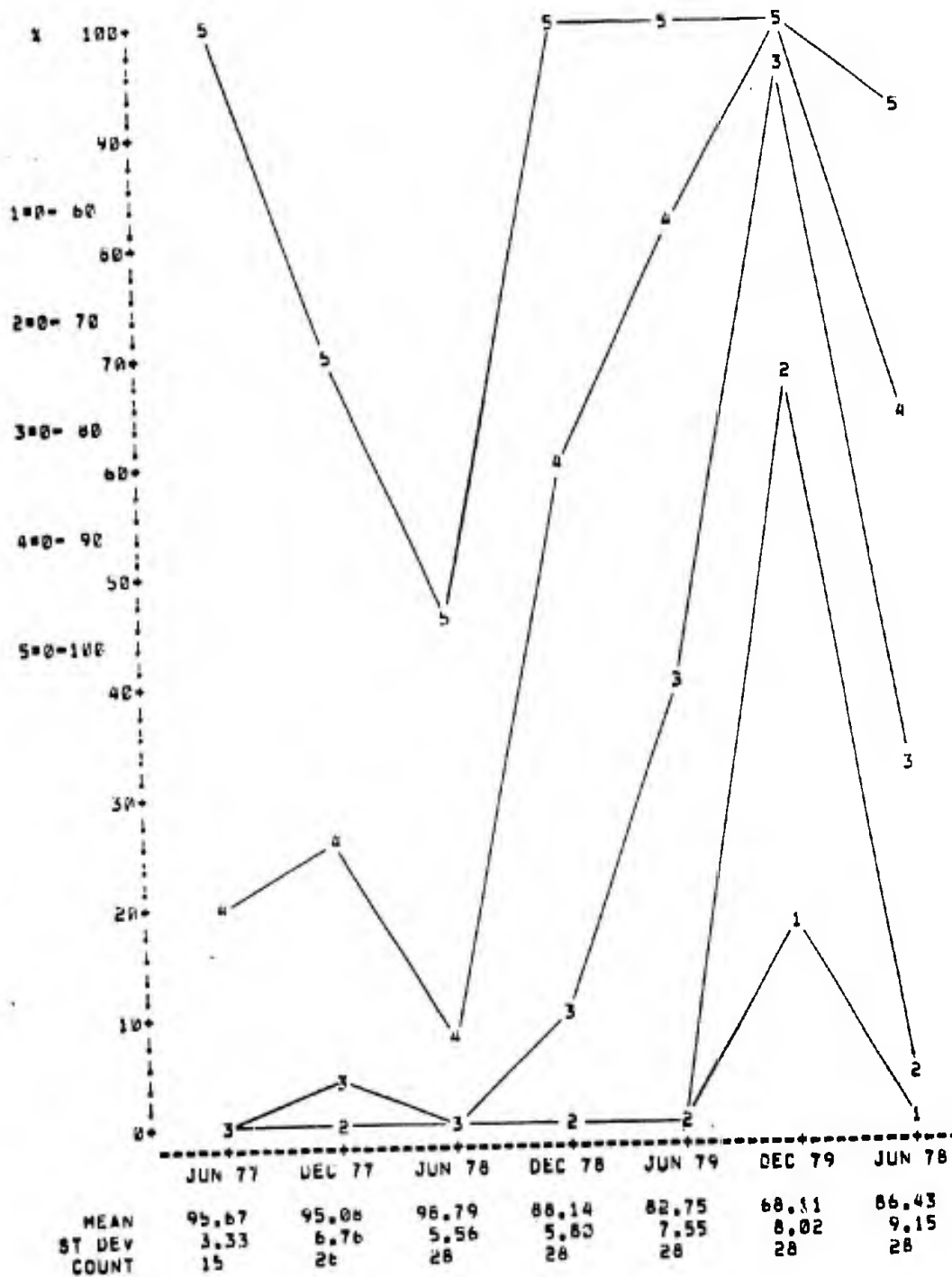

450 MHZ FOR THE LPI
OUT OF RANGE: INCLUDED

RUN DATE:

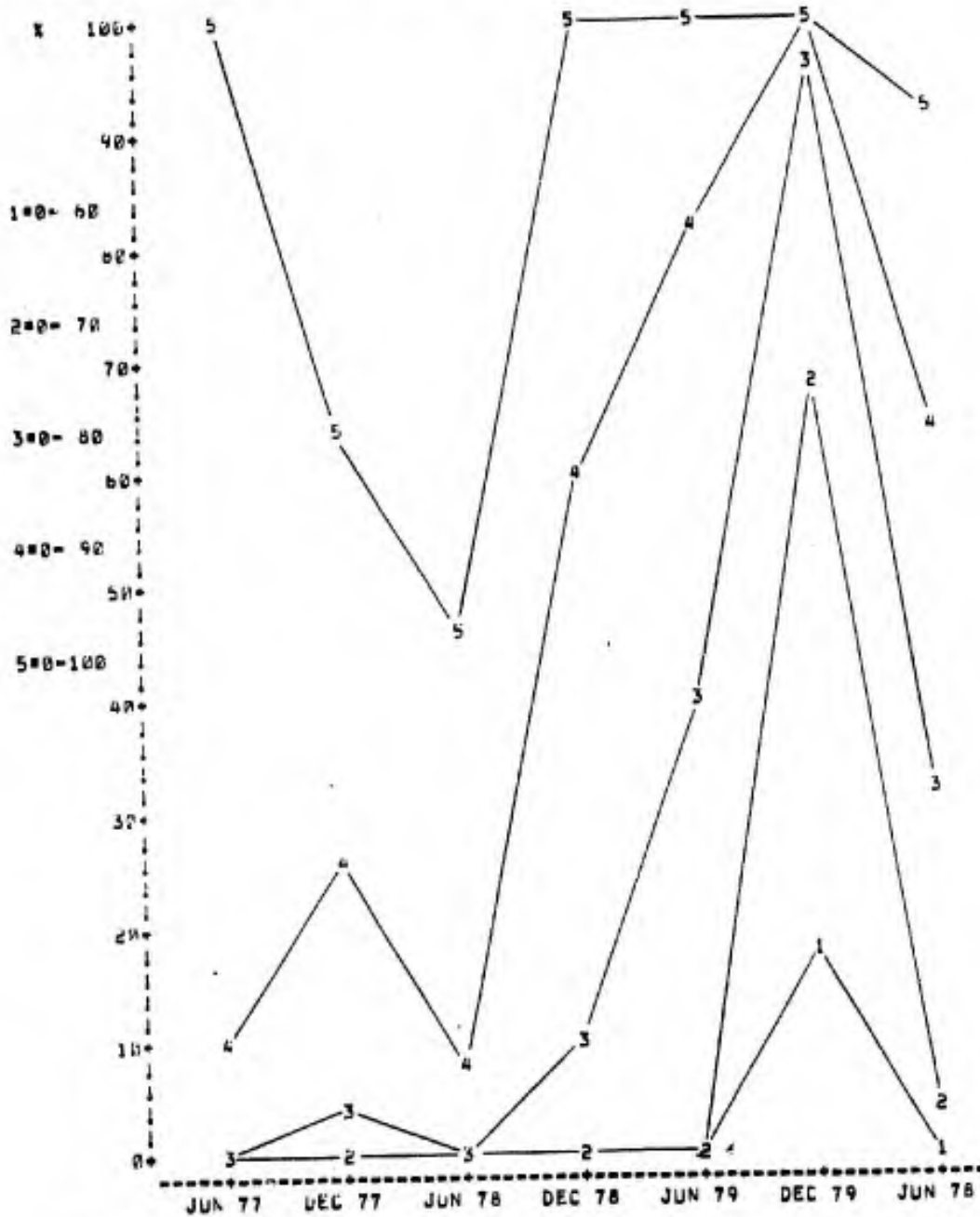

	JUN 77	DEC 77	JUN 78	DEC 78	JUN 79	DEC 79	JUN 78
MEAN	97.36	95.79	98.79	88.14	82.75	68.11	86.43
ST DEV	3.85	7.80	5.56	5.80	7.55	8.02	9.15
COUNT	28	26	26	28	28	28	28

2.4 GHZ FOR THE LMI
 OUT OF RANGE: EXCLUDED RUN DATE:

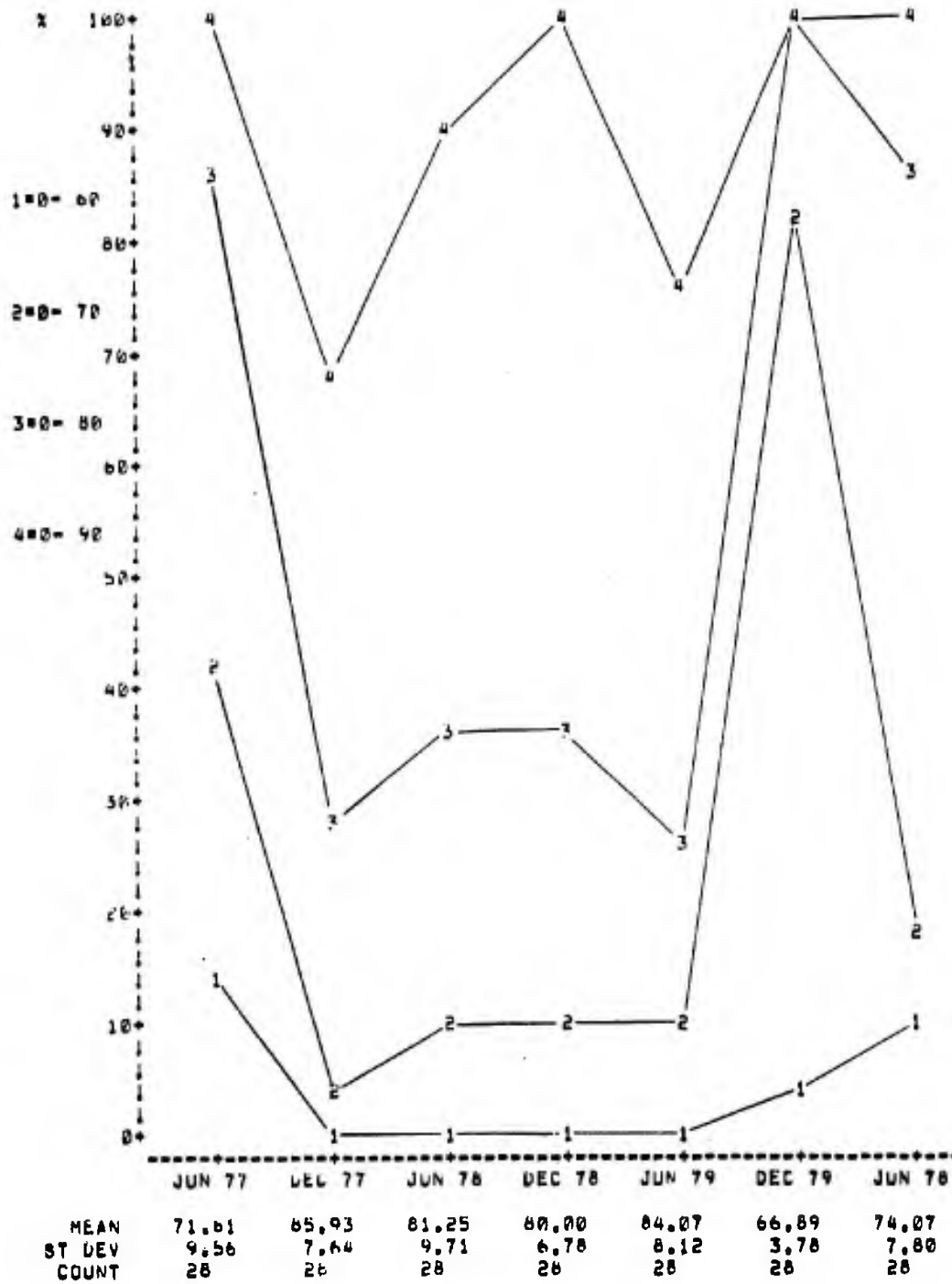

2.4 GHZ FOR THE LMI
OUT OF RANGE: INCLUDED

RUN DATE:

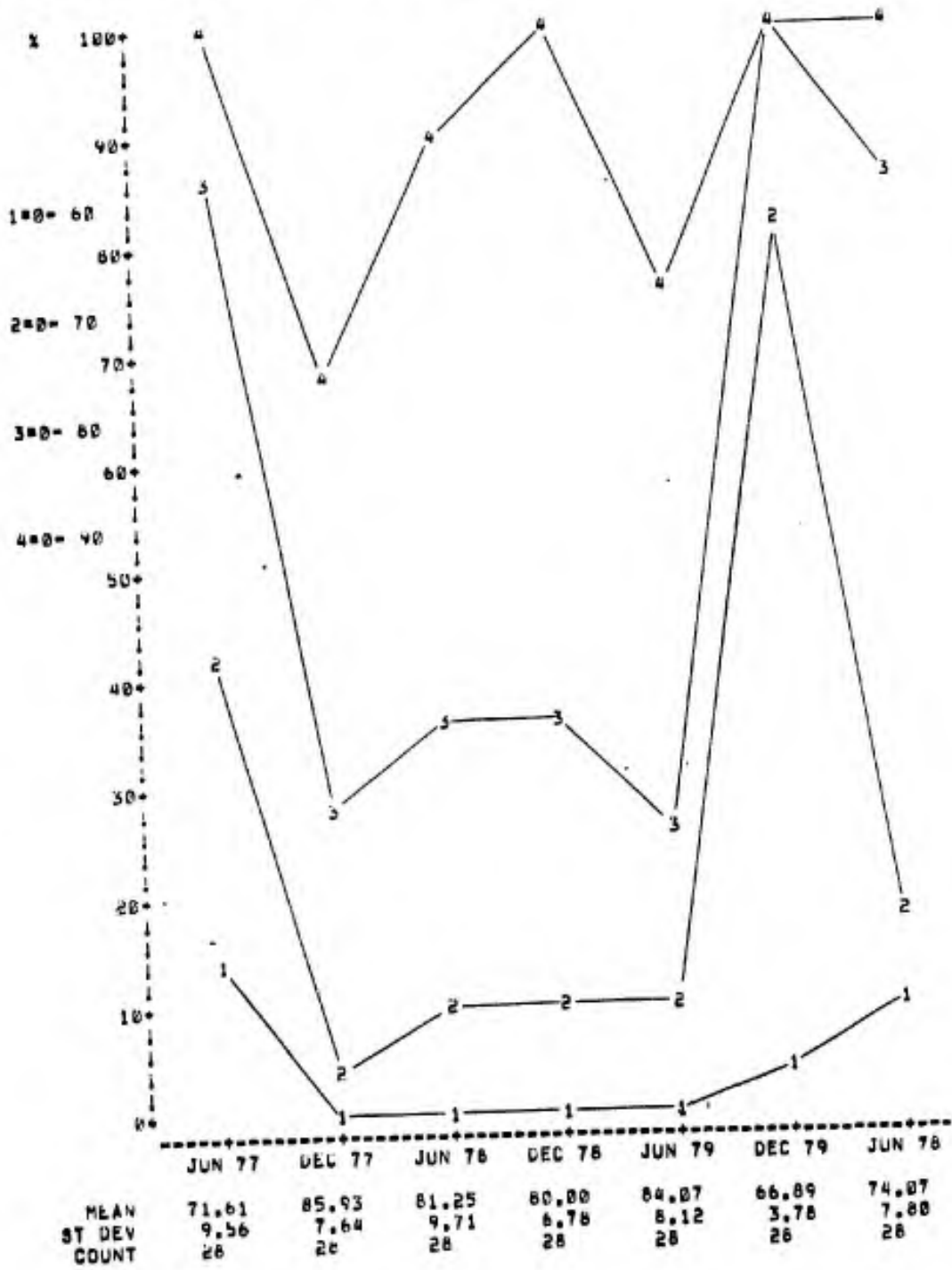

	JUN 77	DEC 77	JUN 78	DEC 78	JUN 79	DEC 79	JUN 78
MEAN	71.61	85.93	81.25	80.80	84.07	66.89	74.07
ST DEV	9.56	7.64	9.71	6.78	8.12	3.78	7.88
COUNT	28	28	28	28	28	28	28

7 GHZ FOR THE LMT
OUT OF RANGE: EXCLUDED

RUN DATES:

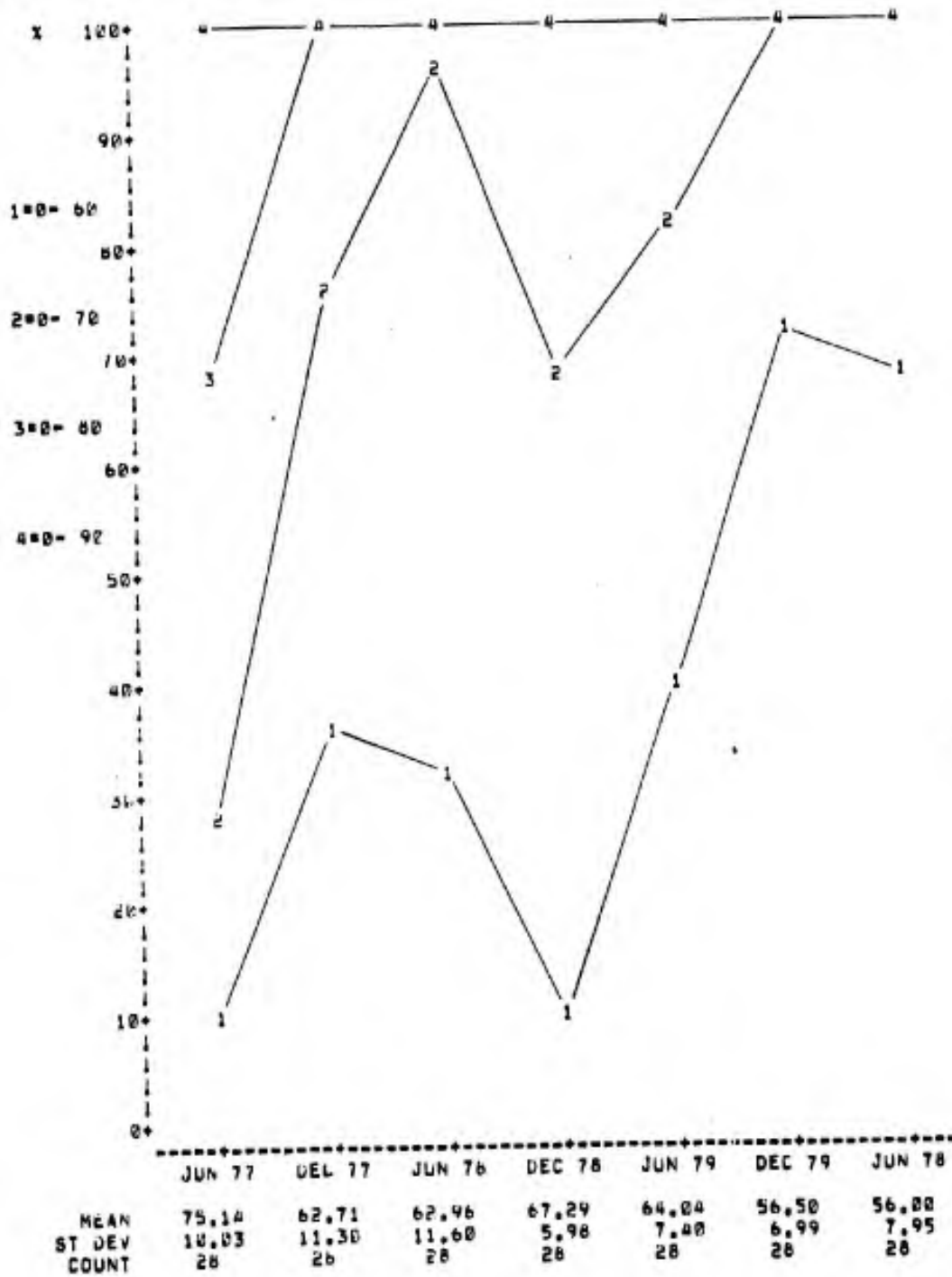

7 GHz FOR THE LM1
OUT OF RANGE: INCLUDED:

RUN DATE:

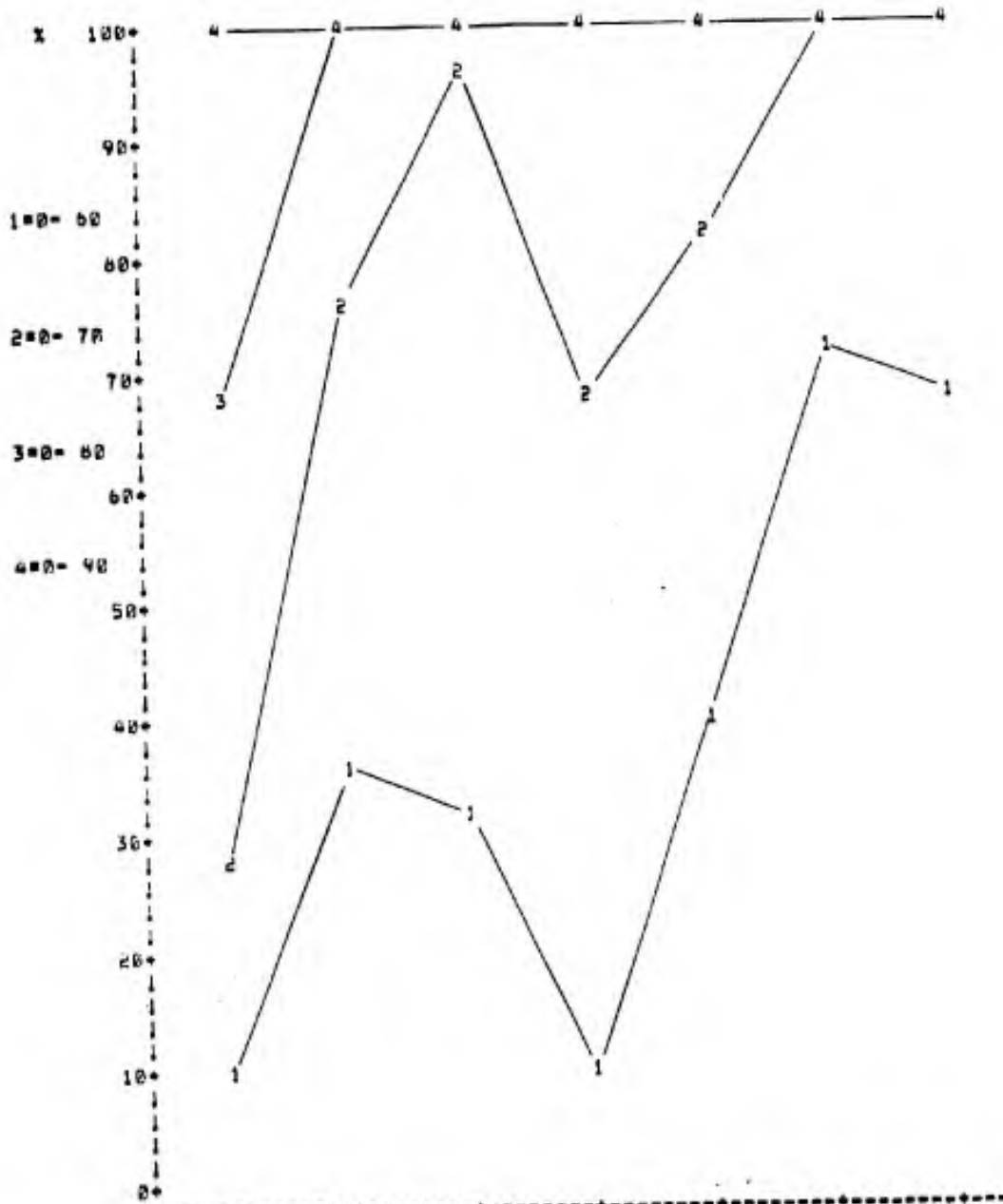

	JUN 77	DEC 77	JUN 78	DEC 78	JUN 79	DEC 79	JUN 78
MEAN	75.14	62.71	62.96	67.29	64.04	56.58	56.08
ST DEV	10.03	11.36	11.68	5.98	7.48	6.99	7.95
COUNT	28	26	28	28	28	26	28

10 KHZ FOR THE LMI
OUT OF RANGE: EXCLUDED

RUN DATES:

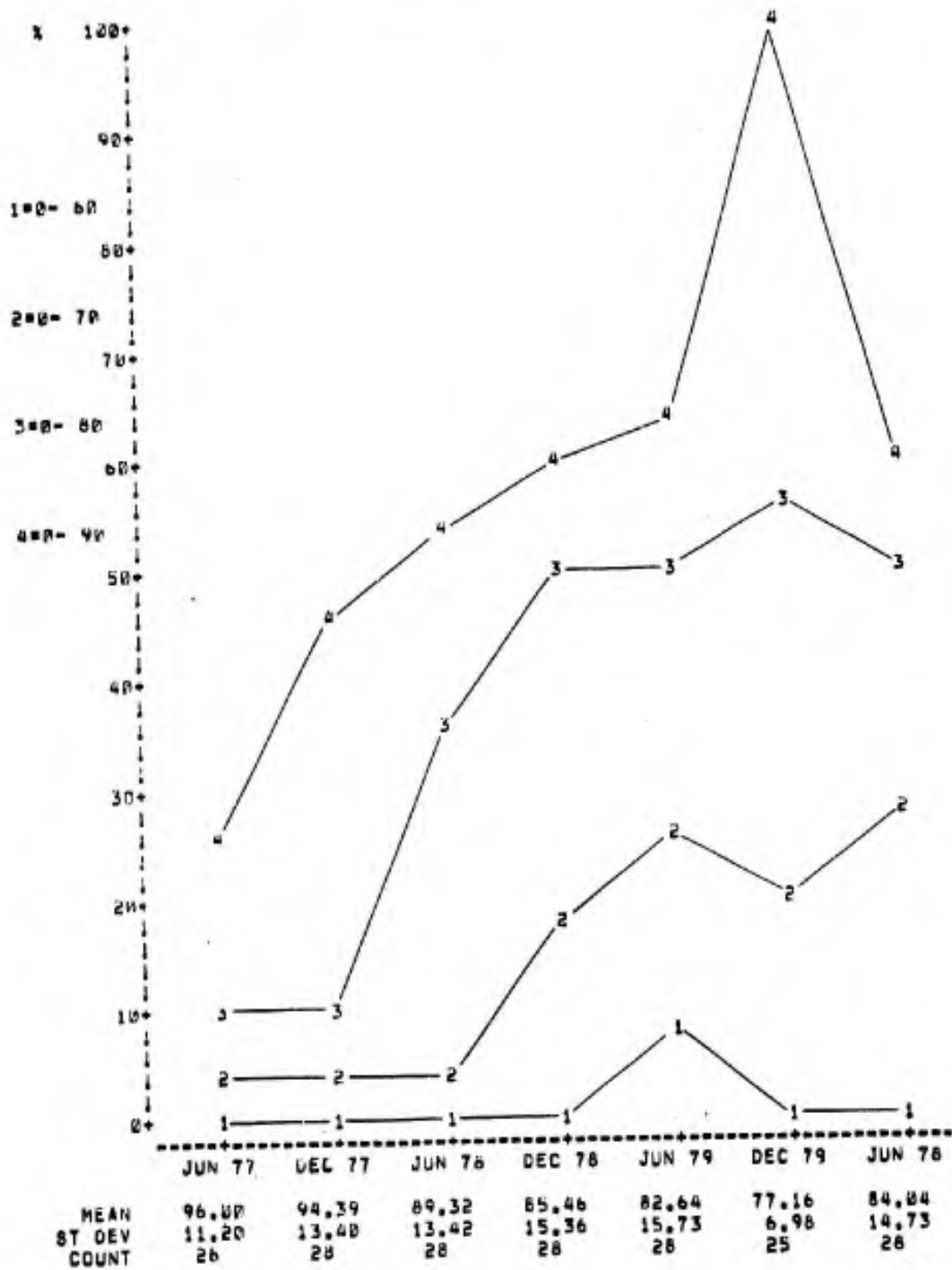

10 KHZ FOR THE LPI
OUT OF RANGE! INCLUDED

RUN DATE:

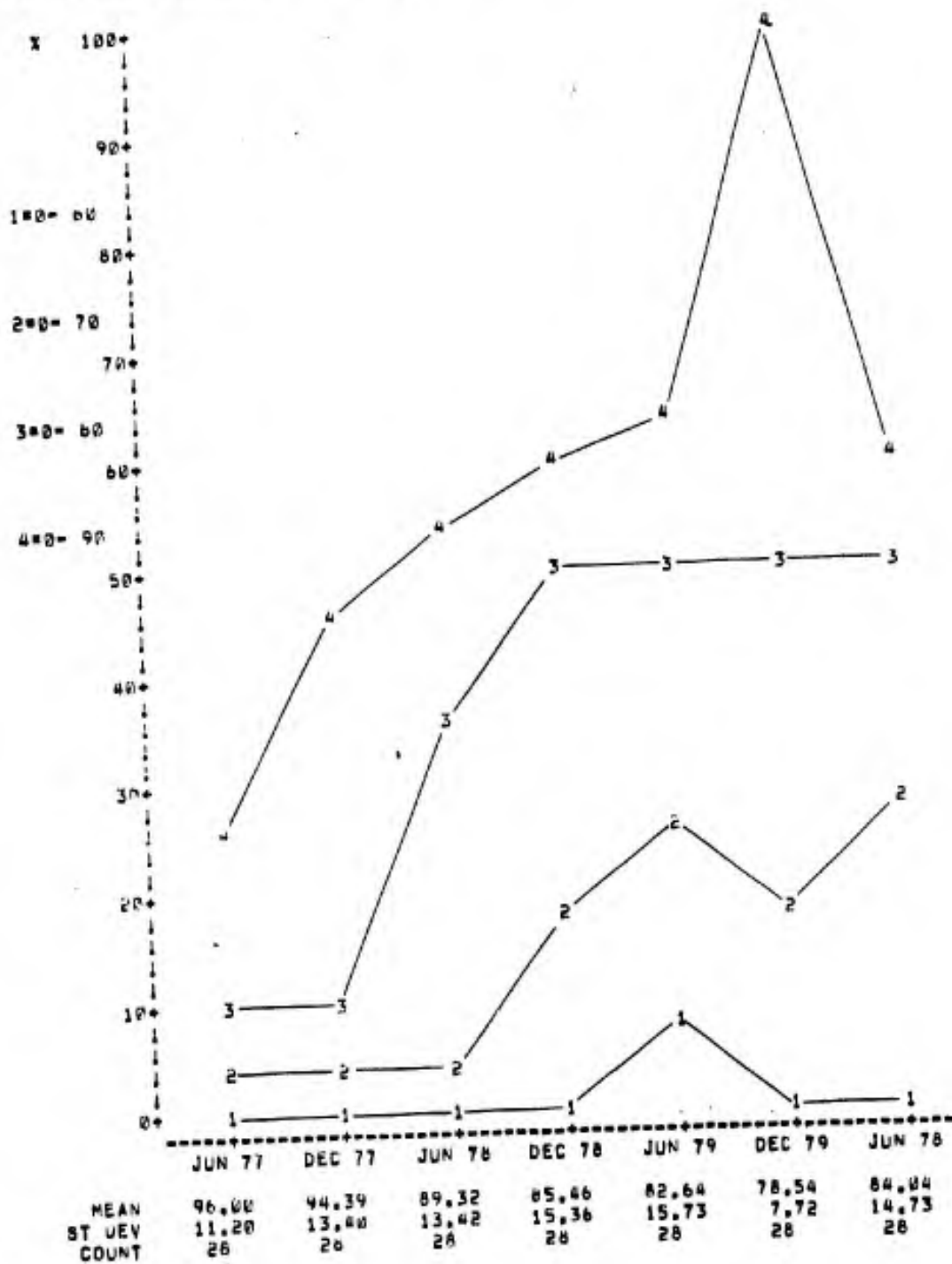

50 KHZ FOR THE LM1
OUT OF RANGE: EXCLUDED

RUN DATE:

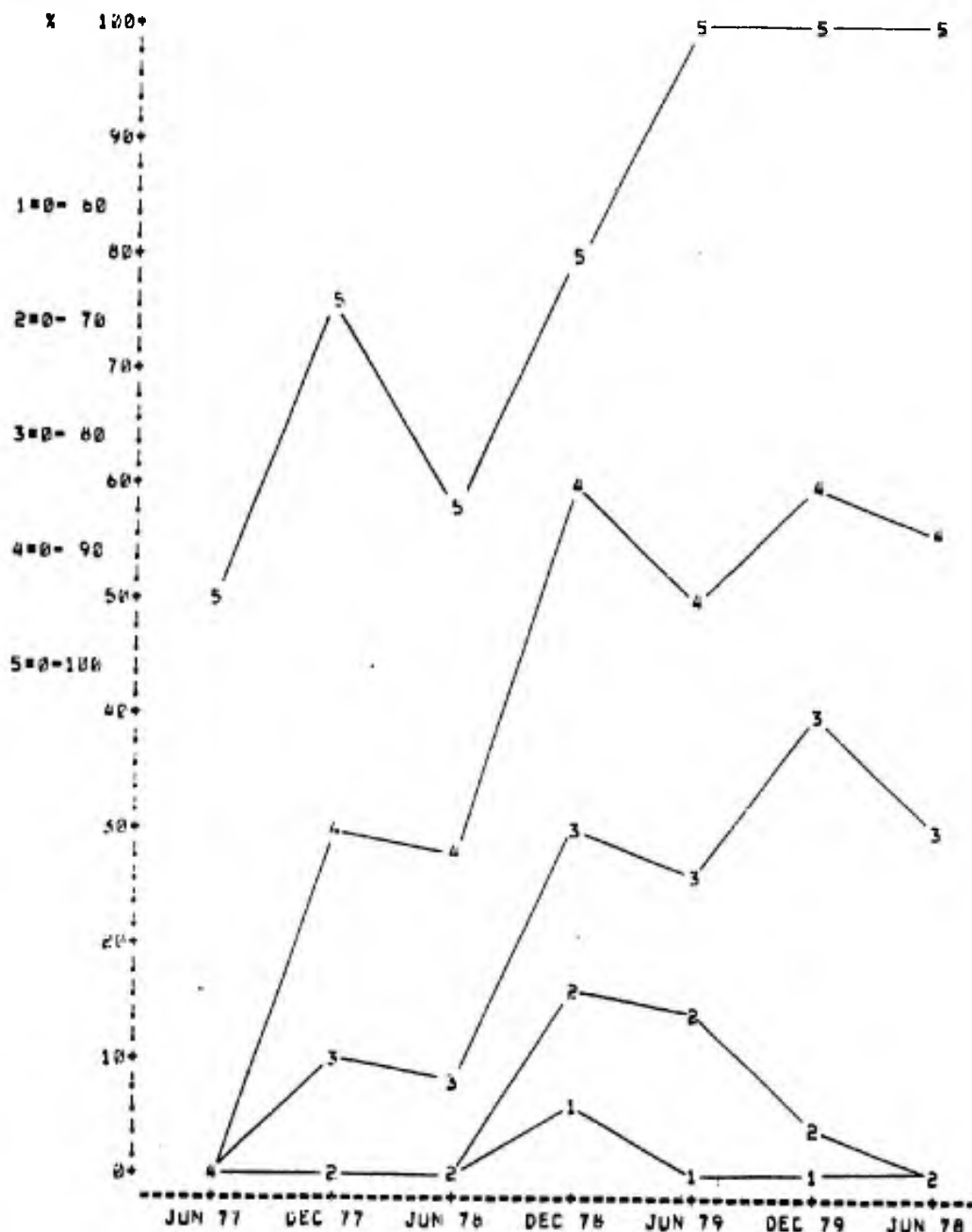

	JUN 77	DEC 77	JUN 78	DEC 78	JUN 79	DEC 79	JUN 78
MEAN	100.50	92.80	97.21	84.00	86.14	84.61	86.26
ST DEV	3.82	8.59	10.50	23.14	11.22	8.48	8.64
COUNT	6	20	28	20	28	23	23

50 KHZ FOR THE LMI
OUT OF RANGE: INCLUDED

RUN DATES:

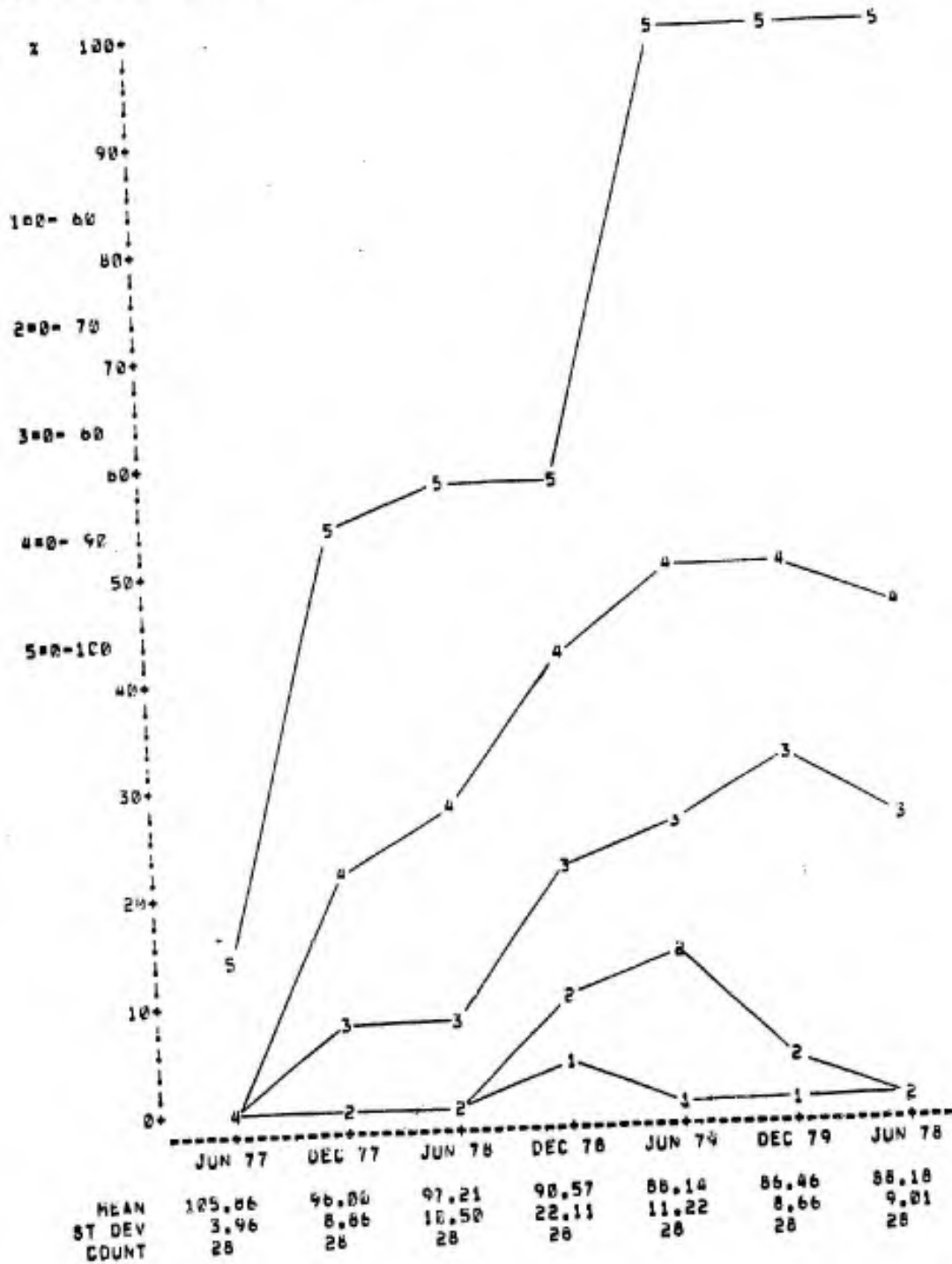

200 KHZ FOR THE LMI
OUT OF RANGE! EXCLUDED

RUN DATE:

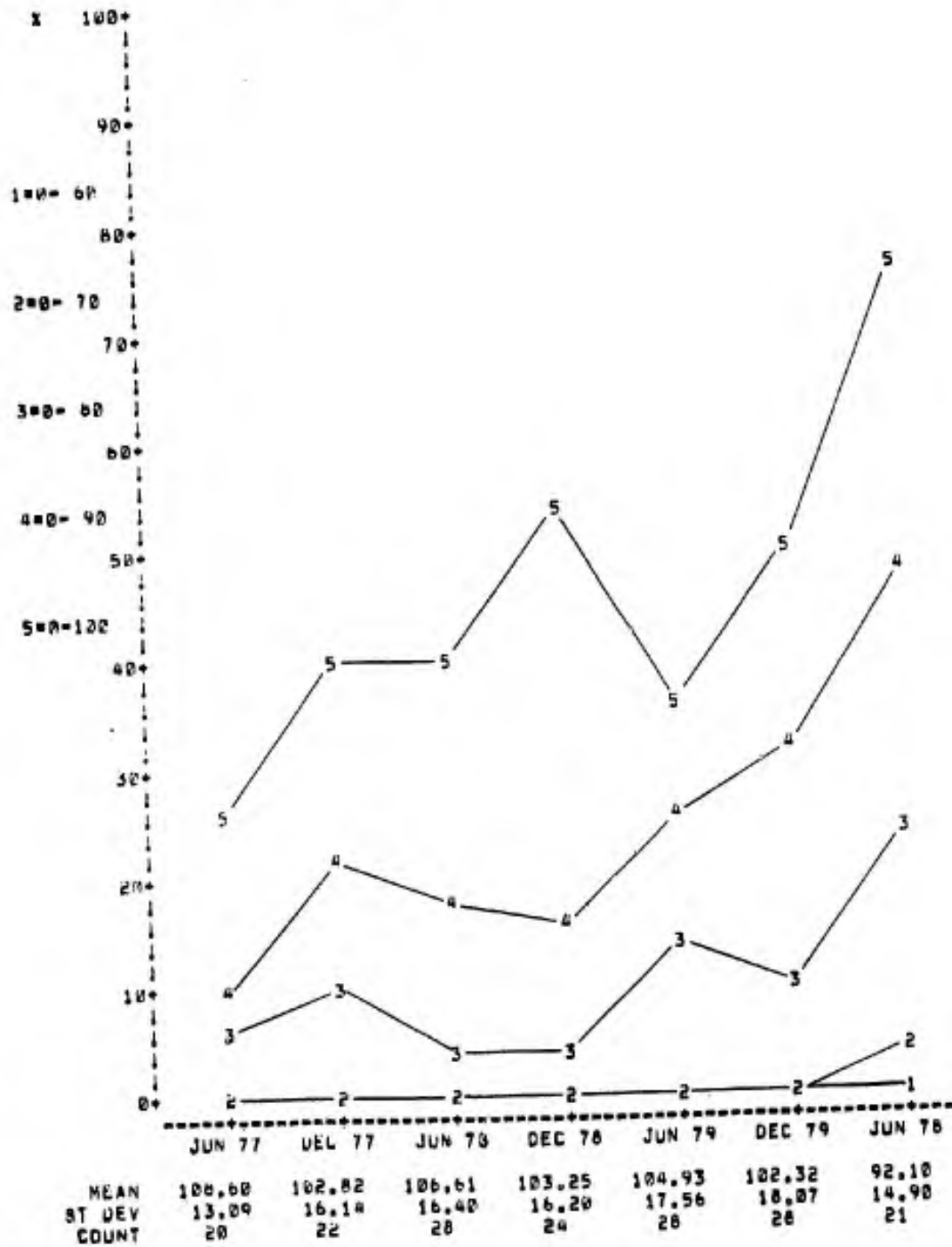

200 KHZ FOR THE LMI
OUT OF RANGE: INCLUDED

RUN DATE:

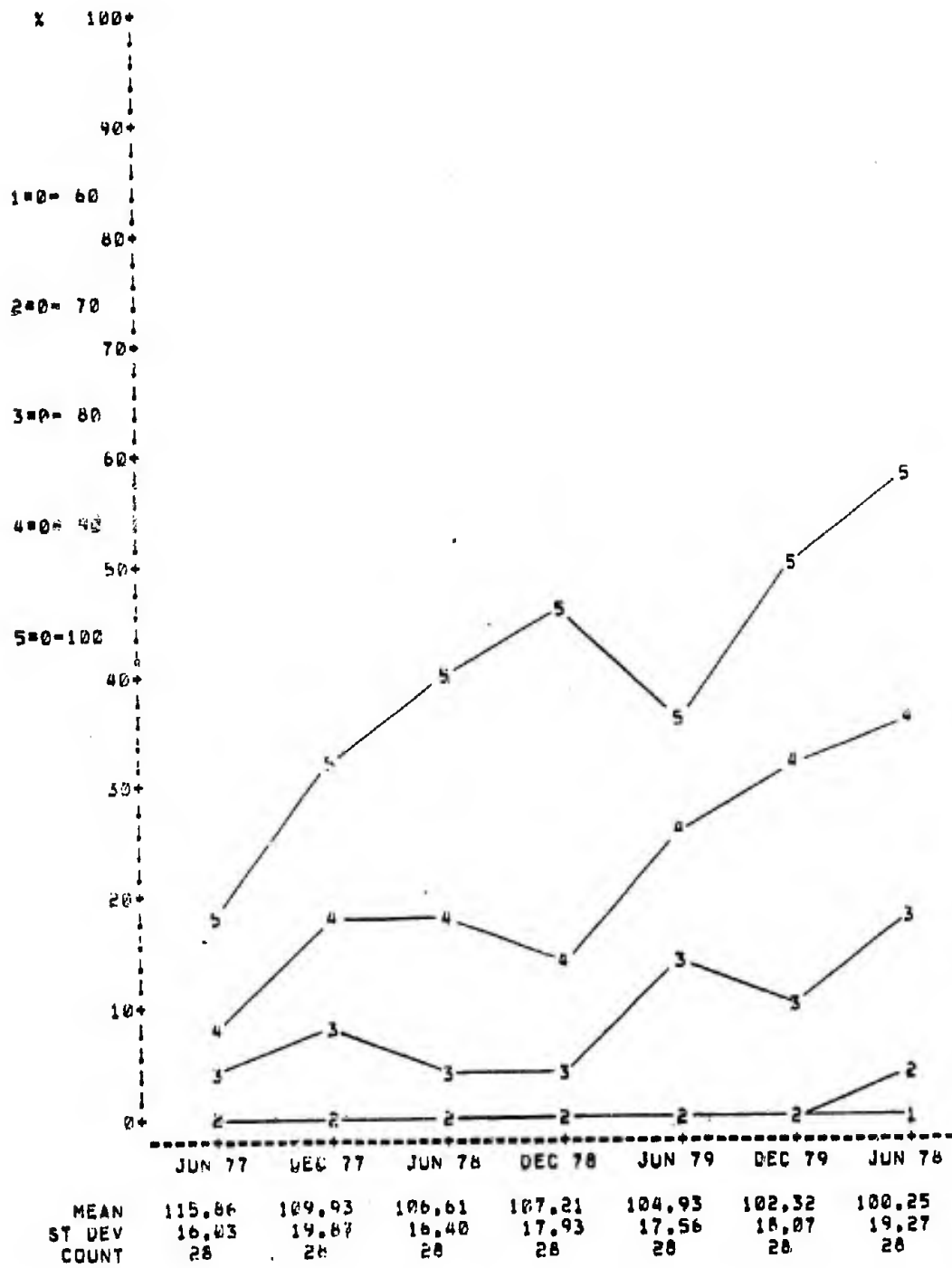

1 MHZ FOR THE LMI
OUT OF RANGE EXCLUDED

RUN DATES

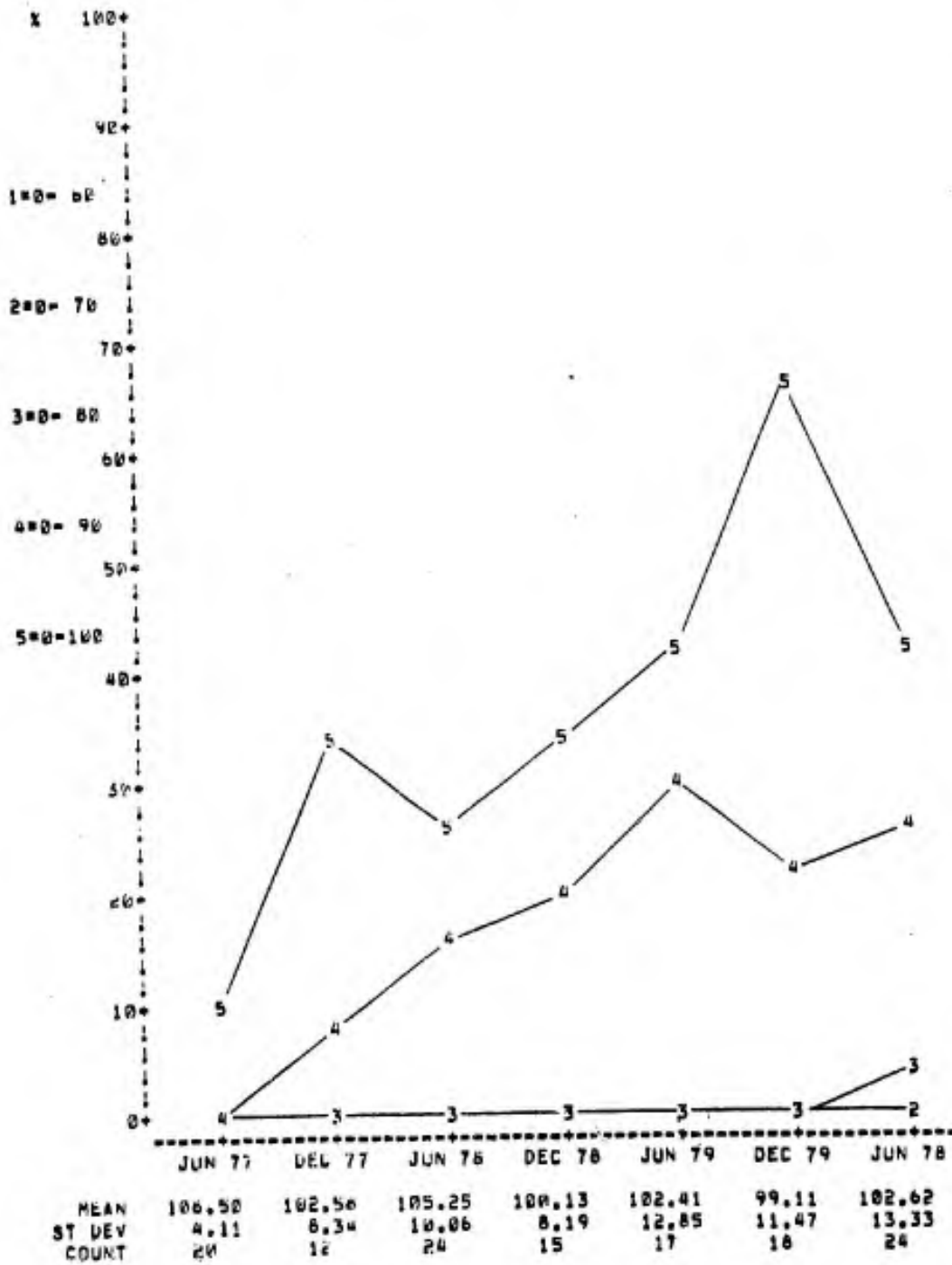

1 MHZ FOR THE LNI
OUT OF RANGE: INCLUDED

RUN DATES:

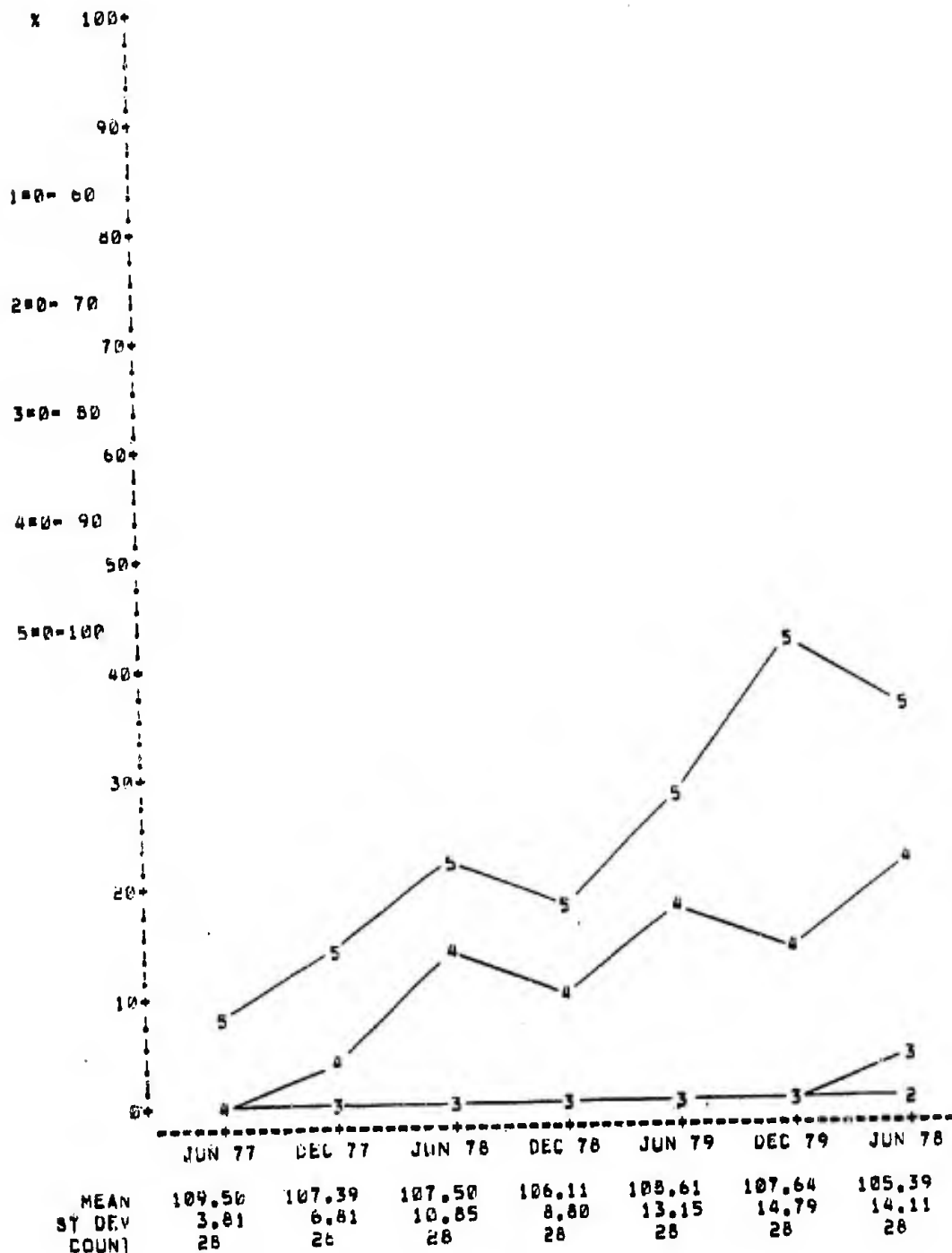

30 MHZ FOR THE LMI
OUT OF RANGE: EXCLUDED

RUN DATE:

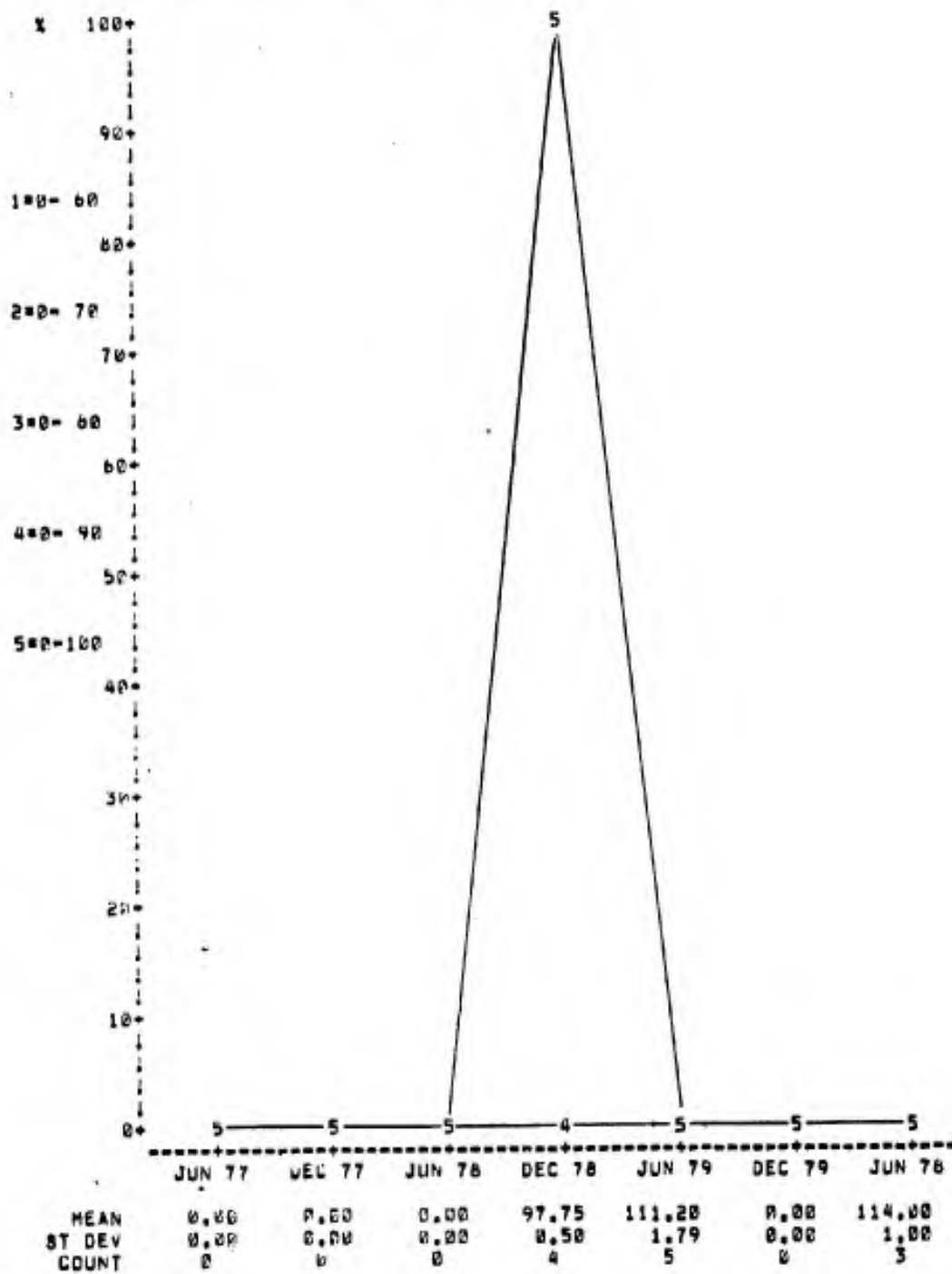

30 MHZ FOR THE LMI
OUT OF RANGE: INCLUDED

RUN DATE:

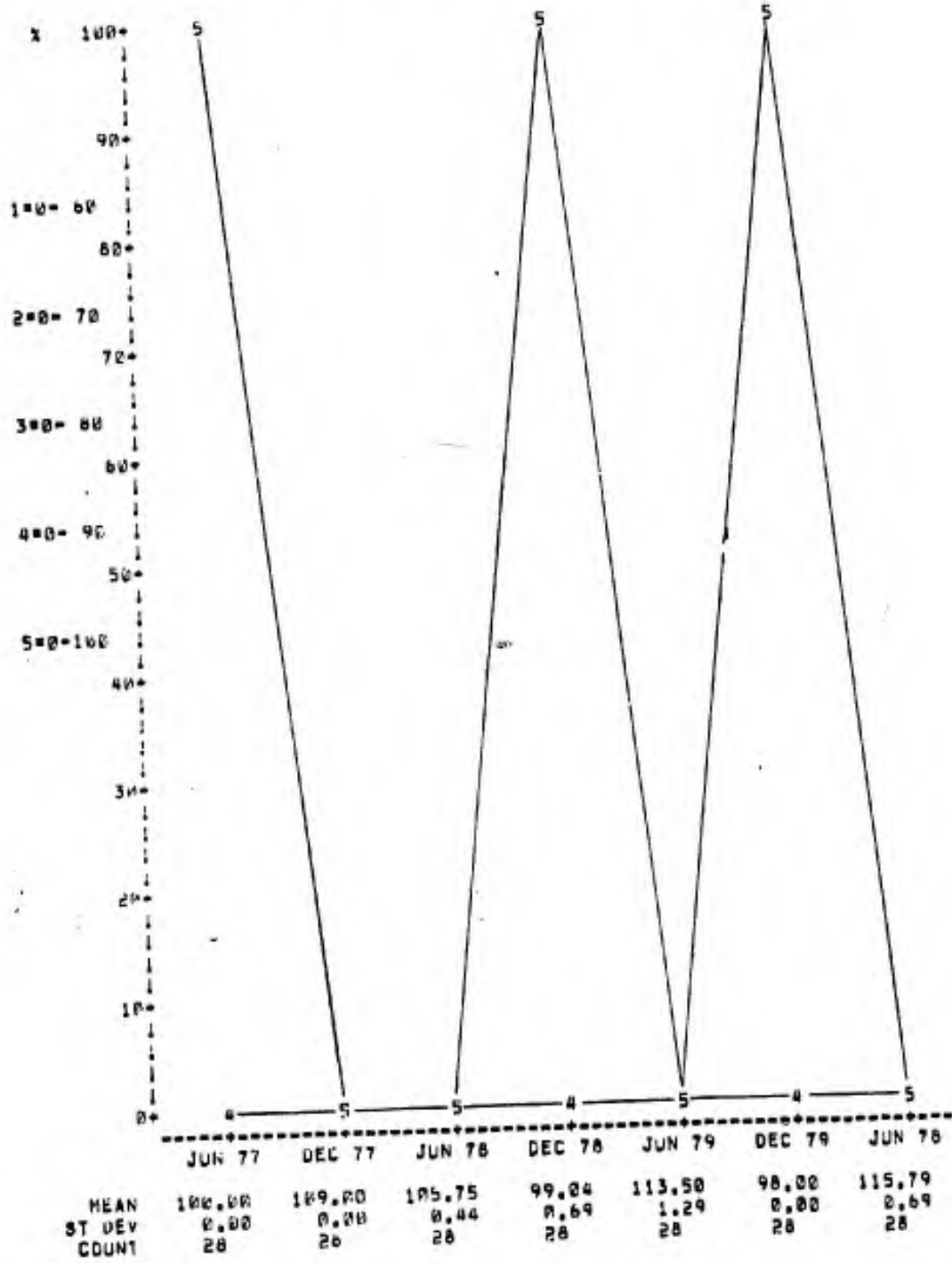

450 MMZ FOR THE LMI
 OUT OF RANGE: EXCLUDED

RUN DATE:

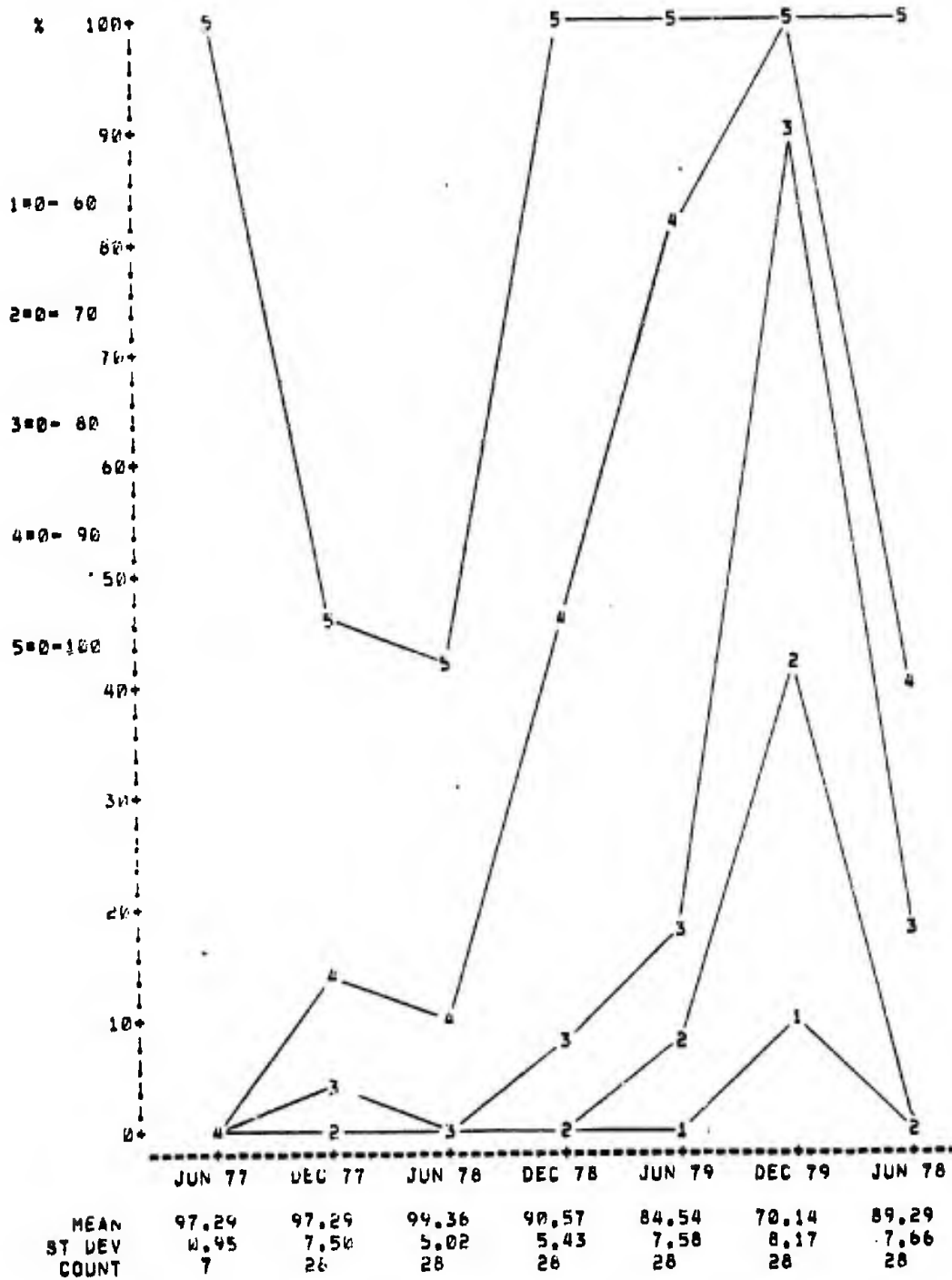

450 MHZ FOR THE LMI
 OUT OF RANGE: INCLUDED

RUN DATE:

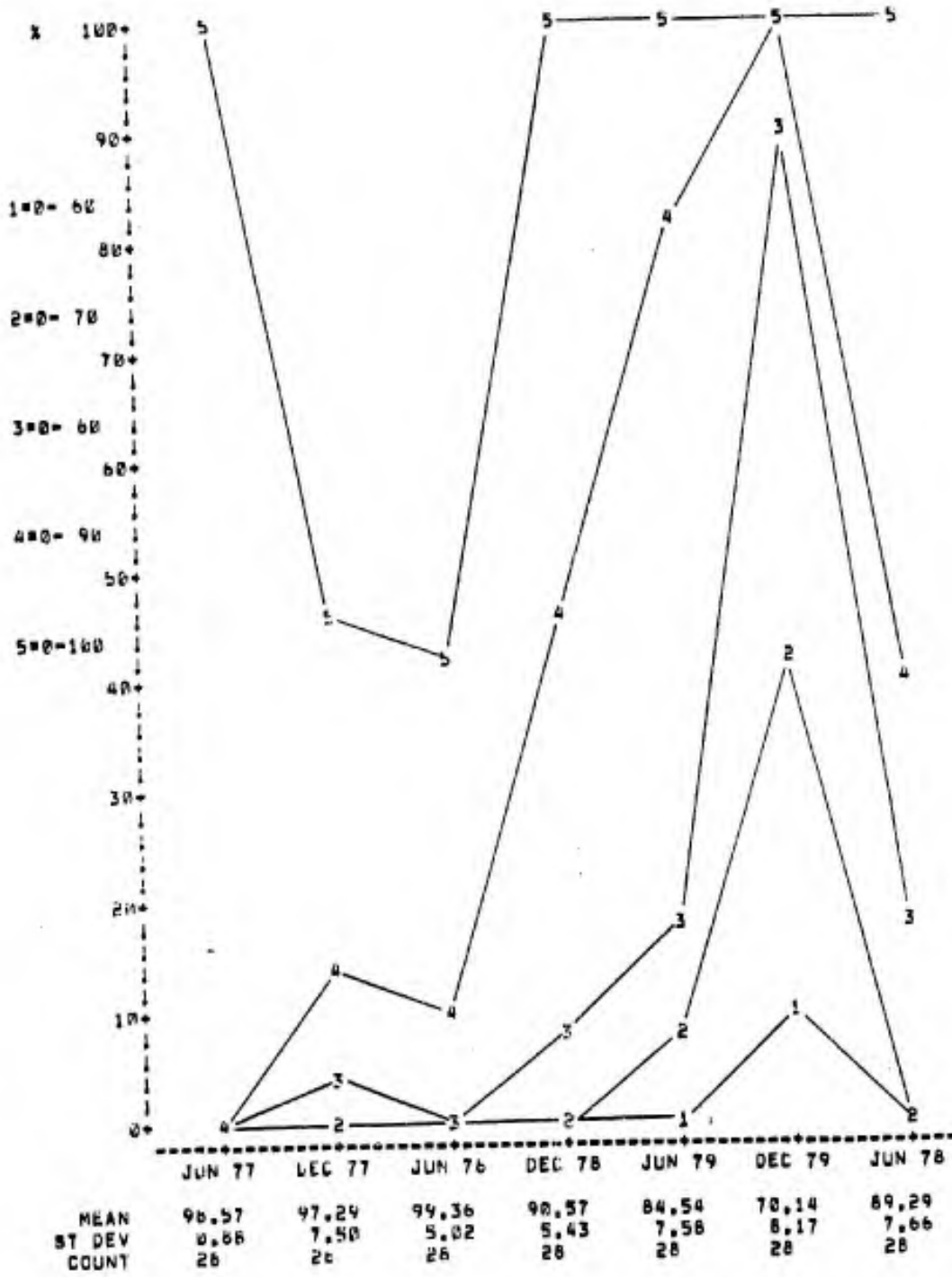

2.4 GHz FOR THE LMI
 OUT OF RANGE: EXCLUDED

RUN DATE:

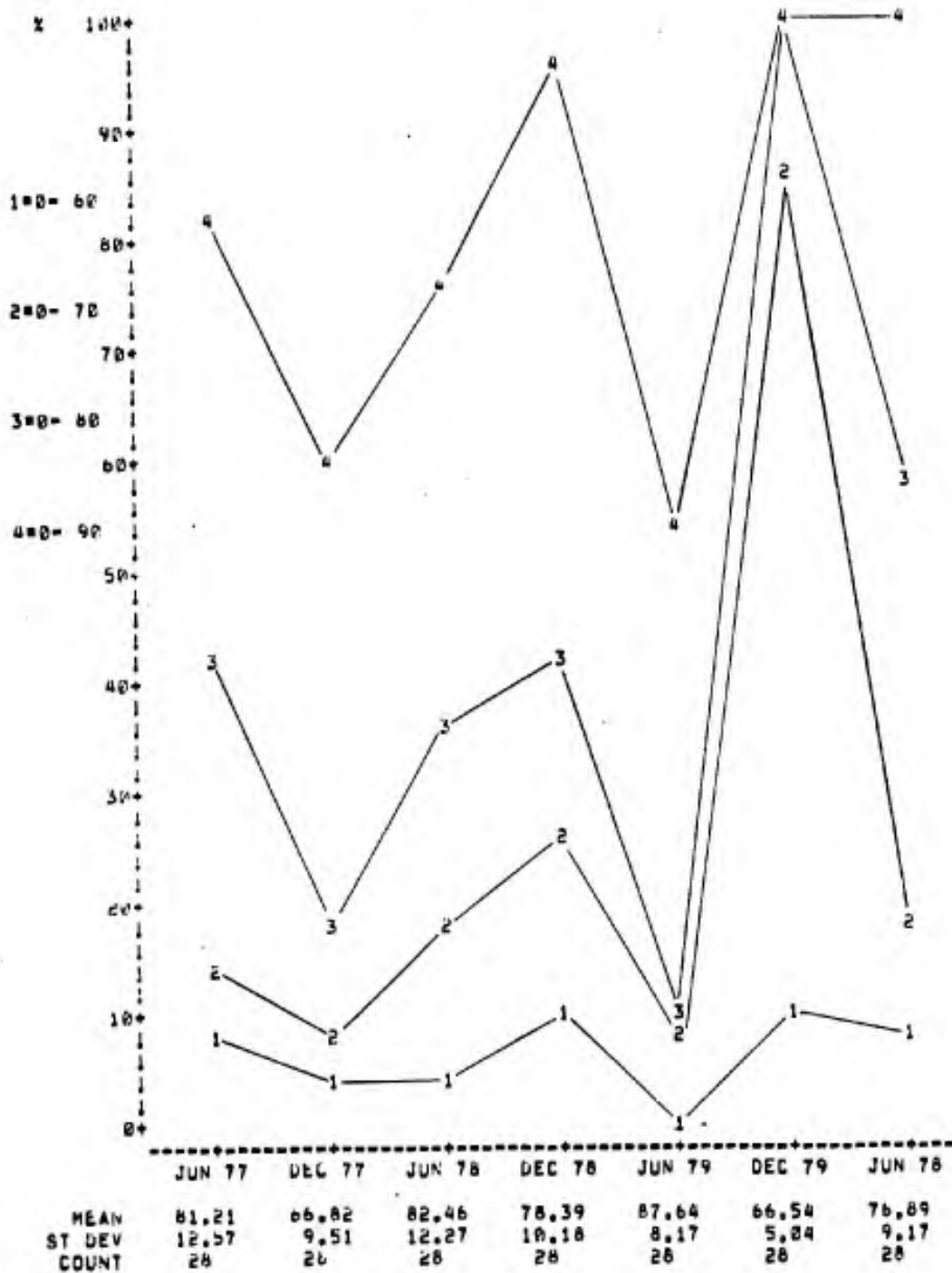

2.4 GHz FOR THE LPT
OUT OF RANGE: INCLUDEL

RUN DATE:

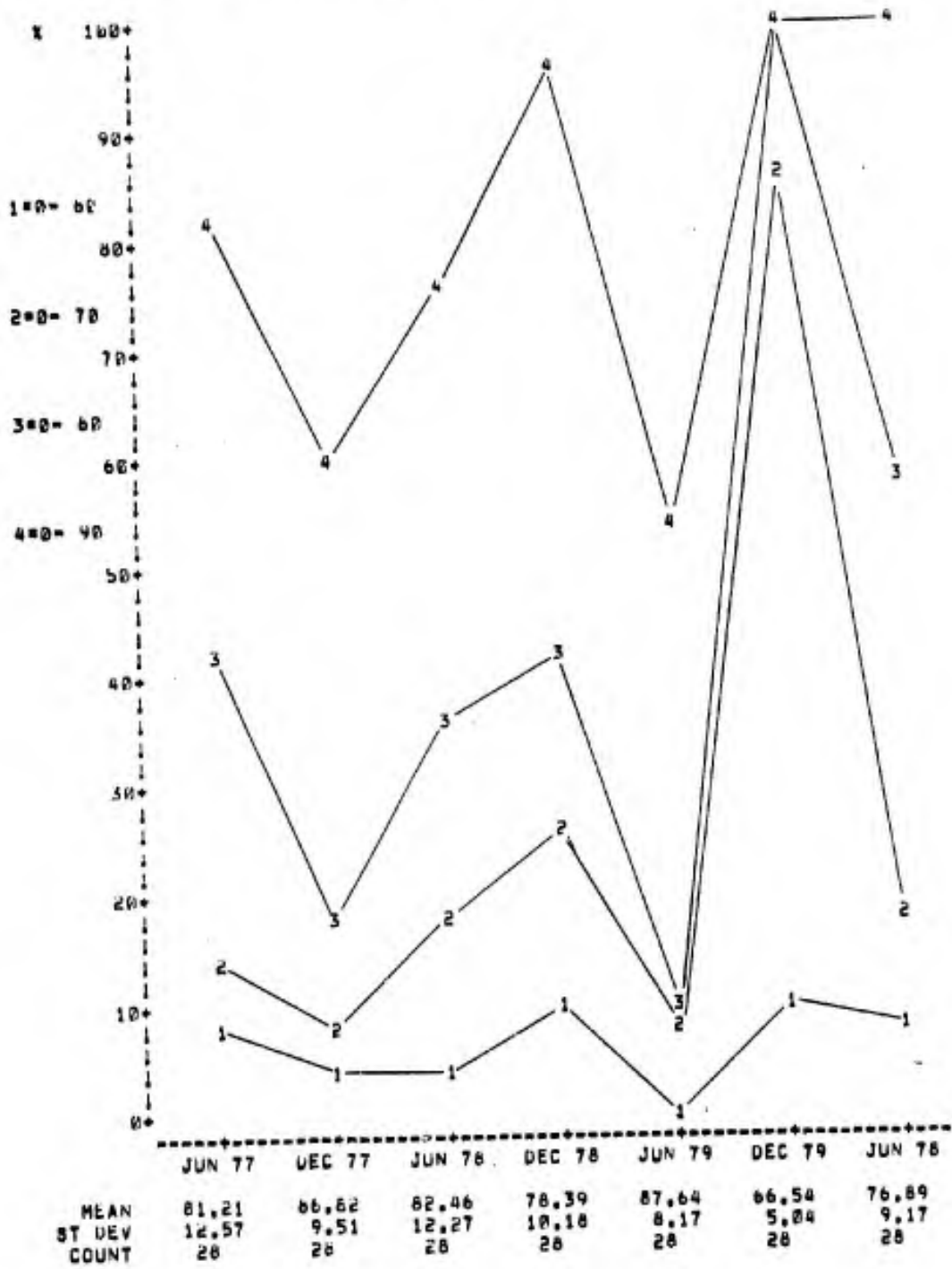

7 GHz FOR THE LMI
 OUT OF RANGE: EXCLUDED RUN DATE:

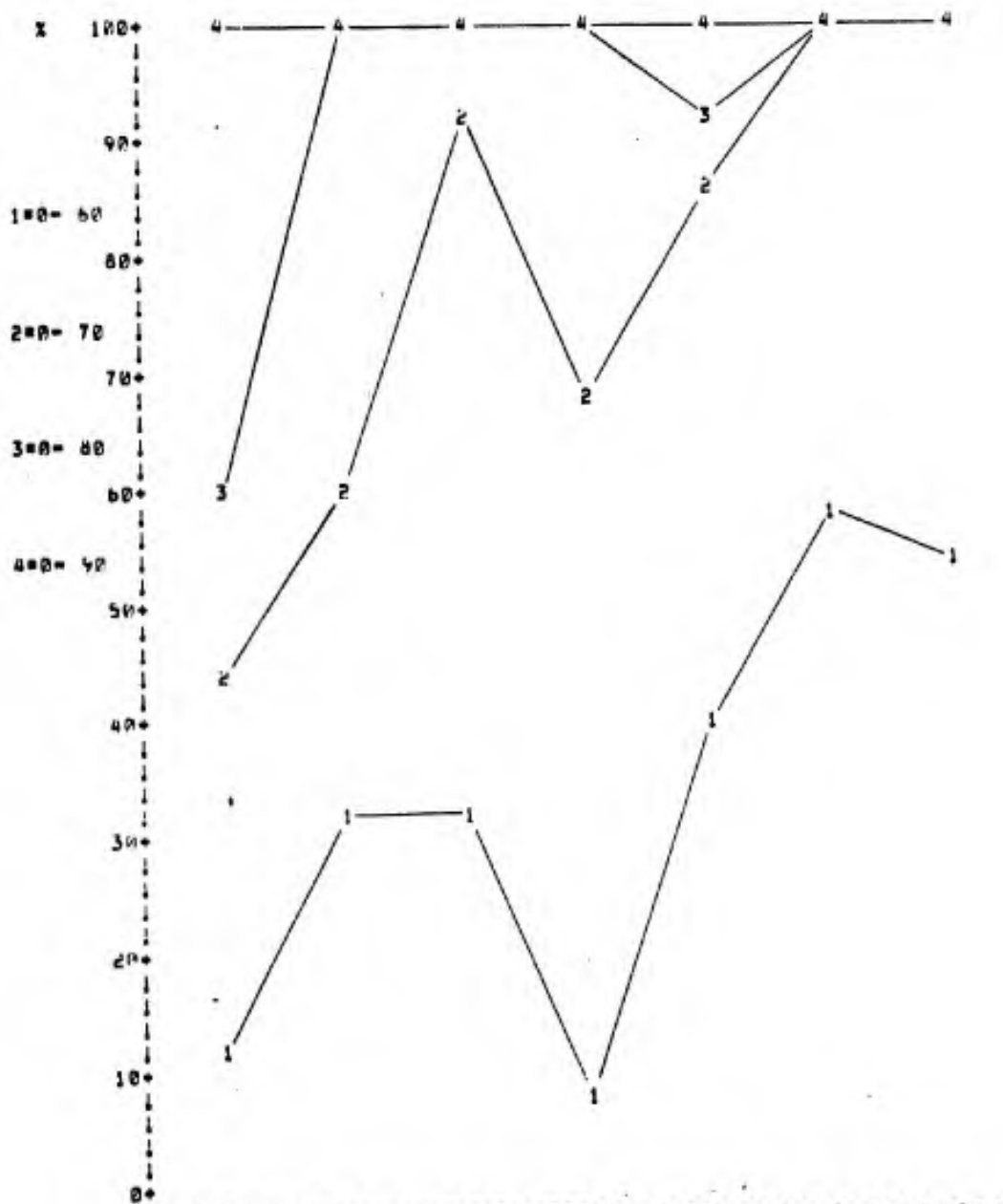

	JUN 77	DEC 77	JUN 78	DEC 78	JUN 79	DEC 79	JUN 78
MEAN	72.32	64.64	61.32	67.39	64.93	58.54	59.32
ST DEV	12.45	12.00	12.00	6.16	8.91	5.41	5.82
COUNT	25	28	28	28	28	28	28

7 GHZ FOR THE LMI
OUT OF RANGE: INCLUDED

RUN DATE:

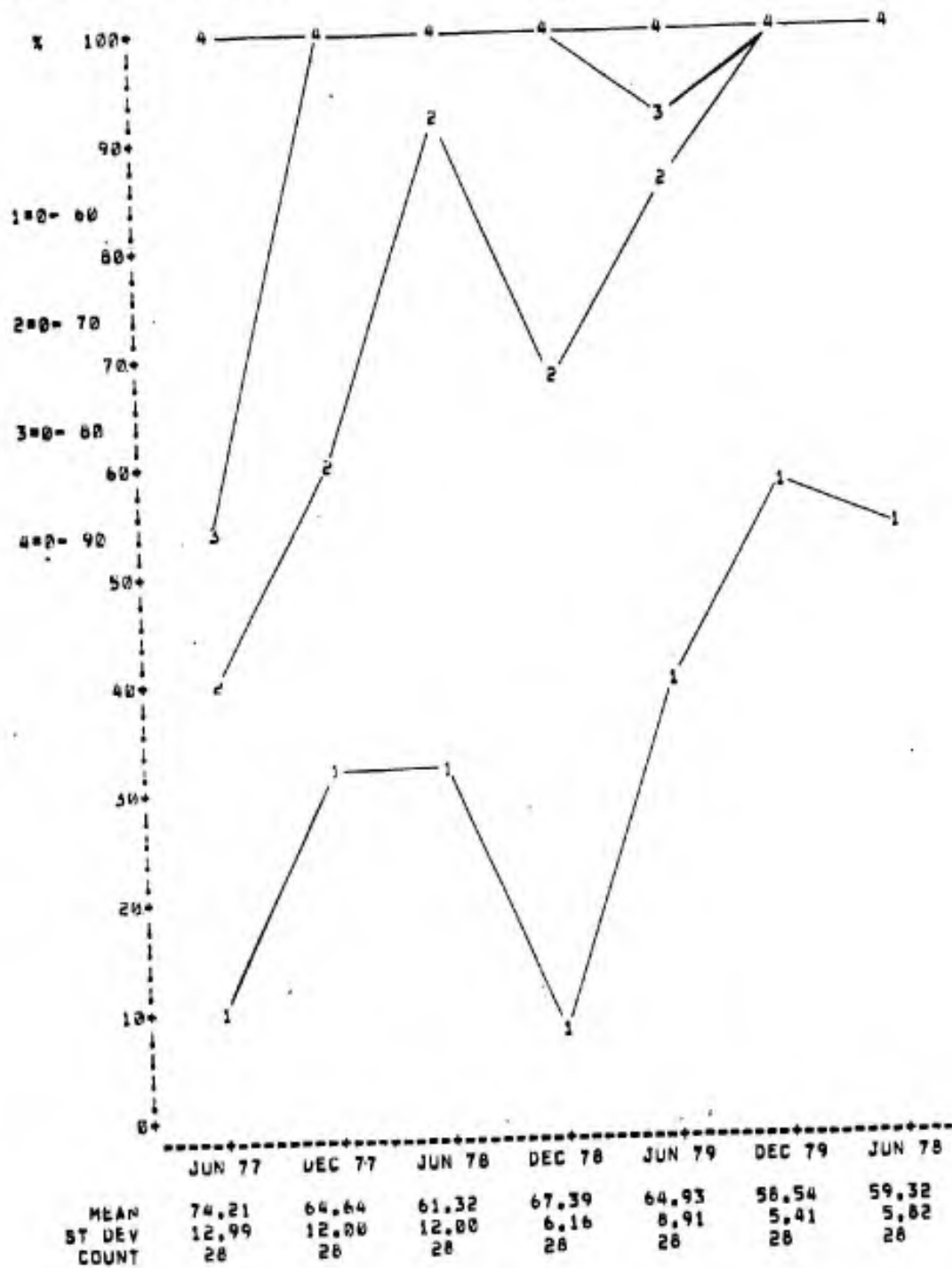

APPENDIX C:

SHIELDING EFFECTIVENESS TEST DATA

This appendix presents tabular data showing the actual measured values of shielding effectiveness for each room and each test interval at frequencies of 200 kHz and 2.5 GHz.

SHIELDED MODULE TEST RESULTS, SHIELDING EFFECTIVENESS

Test Point	Room Ark		Frequency 200 kHz				
	Jun 77	Dec 77	Jun 78	Dec 78	Jun 79	Dec 79	Jun 80
1	109	96	92	90	89	99	105
2	104	81	84	85	82	82	99
3	84	71	80	74	74	73	71
4	79	71	70	75	73	70	73
5	96	82	84	88	86	88	109
6	114	114	114	111	112	110	102
7	115	111	108	108	106	98	111
8	114	109	110	109	107	104	97
9	116	107	114	112	104	99	110
10	99	93	94	91	90	92	85
11	98	95	95	89	92	93	83
12	104	101	105	100	100	88	93
13	119	119	120	115	115	128	102
14	104	112	110	106	105	91	81
15	109	104	104	104	101	128	94
16	99	93	98	96	96	128	81
17	82	76	82	76	78	70	83
18	69	71	73	71	74	68	68
19	99	95	95	92	96	84	82
20	109	121	120	117	121	128	112
21	113	113	111	110	111	104	103
22	119	119	123	119	120	128	117
23	126	132	130	121	132	128	124
24	133	132	129	121	137	128	122
25	129	133	134	121	134	116	124
26	114	117	123	111	116	104	107
27	122	127	130	119	130	128	121
28	123	127	131	119	129	124	123
29	97	97	97	96	100	128	88
30	99	97	103	101	105	128	94
31	79	77	92	77	93	82	71
32	88	87	94	86	98	84	77
33	109	107	110	107	109	108	99
34	109	107	100	96	101	104	89
35	122	122	123	117	122	116	118
36	108	113	114	110	118	128	102
37	130	127	130	120	125	128	121
38	124	115	116	110	116	112	109
39	109	106	109	100	107	106	107
40	103	102	108	98	102	86	97
41	119	119	121	119	121	128	113
42	100	96	103	91	97	86	82
43	106	96	94	89	93	128	87
44	90	82	86	79	91	84	77
45	83	77	84	74	84	82	74

SHIELDED MODULE TEST RESULTS, SHIELDING EFFECTIVENESS

Test Point	Room Ark		Frequency 200 kHz				
	Jun 77	Dec 77	Jun 78	Dec 78	Jun 79	Dec 79	Jun 80
46	93	102	108	99	97	98	95
47	91	87	86	82	88	83	81
48	110	105	110	123	108	128	103
49	115	112	114	129	113	94	101
50	77	70	70	64	68	128	54
51	118	115	110	102	110	111	98
52	122	117	110	113	118	105	98
53	122	116	111	114	121	109	109
54	124	120	124	120	121	117	116
55	72	70	67	58	78	128	51
56	126	122	120	122	120	112	117
Door	96	83	84	81	78	84	90
Worst Point SE	18 69	50,55 70	55 67	55 58	50 68	18 68	55 51

SHIELDED MODULE TEST RESULTS, SHIELDING EFFECTIVENESS

Room Ark Frequency 2.4 GHz

Test Point	Jun 77	Dec 77	Jun 78	Dec 78	Jun 79	Dec 79	Jun 80
1	72	72	76	65	72	65	70
2	80	79	78	73	74	67	74
3	78	95	83	67	86	64	79
4	74	82	89	80	84	62	76
5	78	94	87	75	88	76	79
6	75	82	78	77	86	74	75
7	88	98	98	79	88	74	85
8	78	89	79	65	76	74	73
9	80	94	84	73	88	70	79
10	80	93	91	81	90	72	82
11	78	90	92	81	86	67	80
12	92	96	99	85	86	64	77
13	74	84	94	79	86	66	76
14	78	98	91	85	86	68	85
15	60	80	76	55	70	66	68
16	66	85	82	73	74	63	75
17	86	88	85	61	86	64	80
18	82	97	101	73	78	66	69
19	80	84	91	73	86	77	77
20	60	70	81	62	76	72	63
21	80	79	93	81	80	73	81
22	54	68	74	45	60	58	53
23	62	80	70	55	68	65	65
24	64	88	96	63	82	67	69
25	68	82	85	55	76	69	67
26	74	93	92	77	80	76	71
27	48	69	60	53	54	55	50
28	76	81	78	79	80	65	69
29	64	68	64	55	62	60	60
30	70	81	74	81	72	75	75
31	76	80	92	73	74	80	68
32	78	82	82	71	74	73	79
33	82	90	80	81	80	77	79
34	66	79	80	69	72	68	74
35	92	97	94	91	90	85	79
36	76	76	85	72	76	65	73
37	80	87	84	81	82	73	79
38	80	89	94	85	76	80	80
39	88	90	91	85	80	77	84
40	80	96	93	91	90	75	80
41	64	81	72	70	78	59	66
42	93	99	98	84	92	82	80
43	60	68	68	74	88	54	57
44	84	74	71	74	72	68	70
45	78	85	88	88	80	72	77

SHIELDED MODULE TEST RESULTS, SHIELDING EFFECTIVENESS

Room Ark Frequency 2.4 GHz

Test Point	Jun 77	Dec 77	Jun 78	Dec 78	Jun 79	Dec 79	Jun 80
46	80	89	87	83	86	79	73
47	76	91	96	81	88	80	79
48	52	63	52	57	50	50	47
49	78	95	81	75	86	77	77
50	48	63	66	45	64	54	56
51	64	78	80	62	70	67	69
52	66	82	72	78	70	73	66
53	74	84	80	71	80	76	71
54	78	82	89	77	82	73	77
55	62	74	82	65	70	64	60
56	76	81	89	90	88	65	79
Door	72	95	96	83	86	68	79
Worst Point							
SE	50	48,50	48	22,50	48	48	48
	48	63	52	45	50	50	47

SHIELDED MODULE TEST RESULTS, SHIELDING EFFECTIVENESS

Room Lindgren

Frequency 200 kHz

Test Point	Jun 77	Dec 77	Jun 78	Dec 78	Jun 79	Dec 79	Jun 80
1	118	118	120	114	98	103	111
2	115	128	125	128	122	126	120
3	92	118	132	104	120	107	105
4	111	114	120	102	116	107	109
5	107	123	136	>129	112	120	106
6	127	115	124	120	118	102	107
7	125	131	132	>130	122	114	122
8	94	92	80	78	69	81	66
9	99	84	94	78	79	77	69
10	96	94	100	94	90	98	90
11	88	86	91	88	86	76	78
12	87	94	95	98	96	90	83
13	>131	135	124	120	120	100	111
14	109	107	107	97	96	95	78
15	120	111	106	98	106	93	99
16	128	115	110	108	108	108	104
17	112	114	111	114	108	95	93
18	126	108	108	98	88	88	76
19	97	93	98	96	86	89	73
20	108	111	102	96	104	86	97
21	114	107	111	102	104	88	96
22	87	134	71	68	72	68	68
23	113	106	106	102	104	110	96
24	130	135	135	128	121	126	110
25	115	113	121	108	106	100	99
26	81	80	83	75	74	80	70
27	105	99	100	98	99	98	96
28	111	107	115	120	116	93	104
29	118	119	110	117	116	104	111
30	109	109	98	111	99	100	99
31	128	118	113	116	107	108	99
32	109	106	111	110	100	94	97
33	113	112	111	114	92	108	92
34	127	129	132	128	120	110	111
35	>131	134	130	128	122	124	123
36	94	107	95	86	83	89	74
37	100	90	90	87	82	78	68
38	108	98	98	92	87	89	85
39	117	110	117	116	108	100	103
40	113	119	115	116	112	99	101
41	>131	134	133	126	122	107	116
42	>131	133	133	>129	122	118	122
43	129	127	118	107	96	103	104
44	130	118	115	116	104	106	98
45	>131	120	121	118	104	108	105

SHIELDED MODULE TEST RESULTS, SHIELDING EFFECTIVENESS

Room Lindgren

Frequency 200 kHz

Test Point	Jun 77	Dec 77	Jun 78	Dec 78	Jun 79	Dec 79	Jun 80
46	>131	124	125	126	108	110	103
47	>131	128	130	127	116	117	112
48	>131	135	130	>129	122	102	121
49	127	129	126	121	121	97	108
50	105	102	105	82	86	80	67
51	115	108	119	97	100	86	80
52	112	106	108	97	106	98	87
53	123	125	121	115	118	100	92
54	98	97	97	91	94	128	78
55	>131	135	133	123	122	106	111
56	128	125	127	120	120	94	110
Door		125	120	108	108	99	85
Worst Point	26	26	22	22	8	22	8
SE	81	80	71	68	69	68	66

SHIELDED MODULE TEST RESULTS, SHIELDING EFFECTIVENESS

Room Lindgren

Frequency 2.4 GHz

Test Point	Jun 77	Dec 77	Jun 78	Dec 78	Jun 79	Dec 79	Jun 80
1	91	93	89	87	96	88	94
2	94	93	102	89	100	94	94
3	104	97	99	92	102	100	101
4	101	97	99	97	100	104	101
5	100	97	108	97	98	102	101
6	93	81	84	89	92	88	93
7	103	99	106	98	102	102	103
8	78	73	77	84	86	82	86
9	104	72	94	89	100	96	100
10	101	97	102	96	104	102	102
11	102	96	108	95	104	105	103
12	98	97	108	97	105	107	104
13	80	85	78	86	84	83	88
14	103	98	107	95	104	107	102
15	83	84	83	82	90	97	88
16	94	88	88	87	94	102	89
17	98	91	99	92	94	94	94
18	95	96	107	91	100	103	95
19	96	97	108	89	102	101	103
20	81	79	80	87	88	94	81
21	100	95	106	94	100	99	101
22	71	73	76	79	82	85	81
23	85	79	93	87	92	94	86
24	93	88	96	86	92	97	90
25	88	89	102	90	94	104	97
26	97	98	106	92	101	103	98
27	56	69	76	67	74	84	69
28	96	97	105	88	98	94	97
29	74	77	75	75	68	71	68
30	86	81	91	83	88	84	83
31	82	83	92	87	92	83	84
32	88	93	106	90	99	101	81
33	94	97	99	91	102	102	95
34	86	76	76	82	90	80	81
35	94	97	104	93	96	103	100
36	70	87	81	85	86	82	89
37	94	89	97	80	100	96	90
38	94	96	97	95	101	102	96
39	94	97	105	95	102	104	98
40	96	96	107	95	104	98	97
41	78	92	88	91	86	88	93
42	101	97	107	96	105	104	100
43	88	85	97	84	94	99	94
44	101	92	98	90	98	85	95
45	96	90	99	93	104	89	101

SHIELDED MODULE TEST RESULTS, SHIELDING EFFECTIVENESS

Room Lindgren

Frequency 2.4 GHz

Test Point	Jun 77	Dec 77	Jun 78	Dec 78	Jun 79	Dec 79	Jun 80
46	101	93	102	93	104	100	100
47	104	91	99	91	104	89	102
48	86	93	88	87	92	85	84
49	104	99	107	95	100	105	102
50	96	95	99	93	102	93	98
51	101	96	107	97	104	103	99
52	102	98	108	96	103	106	102
53	102	98	108	98	103	102	102
54	104	98	108	98	105	106	102
55	98	83	95	95	96	90	90
56	98	97	106	98	105	106	104
Door	101	97	108	95	104	101	100
Worst Point							
SE	22	22	22	27	27	29	29
	71	73	76	67	74	71	68

SHIELDED MODULE TEST RESULTS, SHIELDING EFFECTIVENESS

Test Point	Room LMI		Frequency 200 kHz				
	Jun 77	Dec 77	Jun 78	Dec 78	Jun 79	Dec 79	Jun 80
1	104	89	77	71	71	70	69
2	119	112	103	102	101	93	94
3	86	93	105	77	76	57	55
4	96	94	96	85	85	67	60
5	81	68	64	63	63	60	61
6	109	111	105	107	105	102	95
7	100	108	105	95	97	81	68
8	109	113	105	110	110	102	91
9	126	130	126	119	118	101	111
10	106	102	118	83	83	60	72
11	99	103	111	84	89	58	70
12	109	97	111	97	98	84	91
13	89	89	78	80	81	85	81
14	109	94	102	97	97	94	93
15	88	83	69	67	68	64	62
16	96	84	88	80	83	85	79
17	>134	125	124	123	123	123	123
18	104	89	90	91	89	79	83
19	99	82	82	80	85	79	81
20	116	103	94	90	92	90	86
21	102	93	89	91	85	74	79
22	104	127	105	102	108	126	95
23	116	111	108	103	101	102	99
24	130	130	124	121	119	123	122
25	132	131	126	>131	124	118	117
26	96	86	84	90	80	69	72
27	106	104	98	95	104	99	97
28	96	91	94	94	91	83	82
29	86	81	76	89	71	83	71
30	116	103	101	93	96	94	94
31	>134	129	125	129	124	124	124
32	104	88	96	91	88	83	82
33	79	77	81	96	81	76	77
34	98	106	102	103	106	102	98
35	112	99	103	103	101	96	98
36	114	123	110	99	113	96	90
37	>134	>136	126	>131	124	130	124
38	>134	>136	126	>131	124	130	124
39	>134	>136	126	>131	124	118	119
40	129	106	122	119	123	96	100
41	116	102	98	98	101	95	96
42	109	97	96	92	90	89	89
43	100	87	86	82	79	82	64
44	115	102	100	93	98	89	86
45	>134	>136	126	>131	124	110	124

SHIELDED MODULE TEST RESULTS, SHIELDING EFFECTIVENESS

Test Point	Room RMI		Frequency 200 kHz				
	Jun 77	Dec 77	Jun 78	Dec 78	Jun 79	Dec 79	Jun 80
46	132	116	118	119	112	110	109
47	100	91	82	79	75	74	73
48	124	116	111	111	115	118	116
49	104	96	92	94	92	107	89
50	104	127	111	111	105	115	110
51	>134	>136	126	129	124	128	124
52	>134	>136	126	131	124	130	124
53	>134	133	126	131	124	122	124
54	109	102	112	111	113	106	105
55	119	104	97	94	108	85	91
56	102	77	84	81	79	77	77
Door	88	101	106	80	76	66	69
Worst Point SE	33 79	5 68	15 69	5 63	5 63	3 57	3 55

SHIELDED MODULE TEST RESULTS, SHIELDING EFFECTIVENESS

Test Point	Room LMI		Frequency 2.4 GHz				
	Jun 77	Dec 77	Jun 78	Dec 78	Jun 79	Dec 79	Jun 80
1	71	82	75	74	75	70	75
2	76	92	87	81	93	74	80
3	76	94	94	84	89	64	80
4	80	90	71	81	87	64	65
5	65	78	67	72	73	59	53
6	76	92	89	86	89	70	82
7	78	84	89	87	85	65	76
8	73	92	87	83	87	73	79
9	86	96	91	87	93	67	80
10	86	94	104	89	93	72	72
11	88	86	87	81	81	66	75
12	58	78	71	63	67	70	60
13	67	88	77	79	87	67	74
14	72	82	86	78	79	70	75
15	44	70	61	68	67	72	60
16	63	80	73	85	85	65	71
17	70	92	83	90	91	66	83
18	68	78	73	83	79	62	74
19	58	72	63	65	67	64	61
20	76	90	82	83	87	70	71
21	78	98	84	79	85	66	79
22	70	85	82	77	83	65	75
23	74	77	84	81	91	65	83
24	70	90	85	82	95	64	79
25	72	90	85	84	93	72	85
26	68	92	89	83	85	65	76
27	60	74	73	73	81	64	73
28	82	90	83	82	87	62	80
29	42	58	43	52	63	51	47
30	54	70	68	58	81	63	52
31	78	88	80	84	91	71	85
32	70	74	69	68	83	65	77
33	66	72	61	64	81	63	68
34	72	82	65	70	87	67	67
35	82	96	80	79	87	63	83
36	76	98	91	77	89	68	82
37	90	92	86	86	97	70	84
38	90	98	95	85	99	65	83
39	94	92	94	86	93	68	84
40	84	92	98	80	89	65	80
41	94	88	87	86	93	60	84
42	84	90	91	84	89	61	79
43	76	74	72	69	77	70	74
44	88	92	87	83	89	68	81
45	74	89	85	91	93	68	81

SHIELDED MODULE TEST RESULTS, SHIELDING EFFECTIVENESS

Room LMI Frequency 2.4 GHz

Test Point	Room LMI		Frequency 2.4 GHz				
	Jun 77	Dec 77	Jun 78	Dec 78	Jun 79	Dec 79	Jun 80
46	86	92	89	79	81	75	80
47	76	88	79	59	69	70	70
48	84	90	88	81	93	70	79
49	88	92	89	84	91	68	80
50	80	86	82	82	83	67	79
51	96	90	95	85	93	70	85
52	80	95	90	90	95	75	85
53	88	98	91	87	97	73	83
54	90	88	85	79	89	60	81
55	96	85	90	81	91	65	81
56	96	82	79	86	91	64	76
Door	96	95	94	87	95	70	76
Worst Point SE	15 44	15,30 70	29 43	47 59	29 63	29 51	29 47

CERL DISTRIBUTION

Chief of Engineers
 ATTN: Tech Monitor
 ATTN: DAEN-ASI-L (2)
 ATTN: DAEN-CCP
 ATTN: DAEN-CW
 ATTN: DAEN-CWE
 ATTN: DAEN-CWM-R
 ATTN: DAEN-CWO
 ATTN: DAEN-CWP
 ATTN: DAEN-MP
 ATTN: DAEN-MPC
 ATTN: DAEN-MPE
 ATTN: DAEN-MPO
 ATTN: DAEN-MPR-A
 ATTN: DAEN-RD
 ATTN: DAEN-ROC
 ATTN: DAEN-RDM
 ATTN: DAEN-RM
 ATTN: DAEN-ZC
 ATTN: DAEN-ZCE
 ATTN: DAEN-ZCI
 ATTN: DAEN-ZCM

US Army Engineer Districts
 ATTN: Library

Alaska
 Al Batln
 Albuquerque
 Baltimore
 Buffalo
 Charleston
 Chicago
 Detroit
 Far East
 Fort Worth
 Galveston
 Huntington
 Jacksonville
 Japan
 Kansas City
 Little Rock
 Los Angeles
 Louisville
 Memphis
 Mobile
 Nashville
 New Orleans
 New York
 Norfolk
 Omaha
 Philadelphia
 Pittsburgh
 Portland
 Riyadh
 Rock Island
 Sacramento
 San Francisco
 Savannah
 Seattle
 St. Louis
 St. Paul
 Tulsa
 Vicksburg
 Walla Walla
 Wilmington

US Army Engineer Divisions
 ATTN: Library

Europe
 Huntsville
 Lower Mississippi Valley
 Middle East
 Middle East (Rear)
 Missouri River
 New England
 North Atlantic
 North Central
 North Pacific
 Ohio River
 Pacific Ocean
 South Atlantic
 South Pacific
 Southwestern

Waterways Experiment Station
 ATTN: Library

Cold Regions Research Engineering Lab
 ATTN: Library

US Government Printing Office
 Receiving Section/Depository Copies (2)

Defense Technical Information Center
 ATTN: DDA (12)

Engineering Societies Library
 New York, NY

FESA, ATTN: Library

ETL, ATTN: Library

Engr. Studies Center, ATTN: Library

Inst. for Water Res., ATTN: Library

Army Instl. and Major Activities (CONUS)

DARCOM - Dir., Inst., & Svcs.
 ATTN: Facilities Engineer
 ARRAOCOM
 Aberdeen Proving Ground
 Army Matls. and Mechanics Res. Ctr.
 Corpus Christi Army Depot
 Harry Diamond Laboratories
 Dugway Proving Ground
 Jefferson Proving Ground
 Fort Monmouth
 Letterkenny Army Depot
 Natick Research and Dev. Ctr.
 New Cumberland Army Depot
 Pueblo Army Depot
 Red River Army Depot
 Redstone Arsenal
 Rock Island Arsenal
 Savanna Army Depot
 Sharpe Army Depot
 Seneca Army Depot
 Tobyhanna Army Depot
 Tooele Army Depot
 Watervliet Arsenal
 Yuma Proving Ground
 White Sands Missile Range

FORSCOM

FORSCOM Engineer, ATTN: AFEN-FE
 ATTN: Facilities Engineers
 Fort Buchanan
 Fort Bragg
 Fort Campbell
 Fort Carson
 Fort Devens
 Fort Drum
 Fort Hood
 Fort Indiantown Gap
 Fort Irwin
 Fort Sam Houston
 Fort Lewis
 Fort McCoy
 Fort McPherson
 Fort George G. Meade
 Fort Ord
 Fort Polk
 Fort Richardson
 Fort Riley
 Presidio of San Francisco
 Fort Sheridan
 Fort Stewart
 Fort Wainwright
 Vancouver Bks.

TRADOC

HQ, TRADOC, ATTN: ATEN-FE
 ATTN: Facilities Engineer
 Fort Belvoir
 Fort Benning
 Fort Bliss
 Carlisle Barracks
 Fort Chaffee
 Fort Dix
 Fort Eustis
 Fort Gordon
 Fort Hamilton
 Fort Benjamin Harrison
 Fort Jackson
 Fort Knox
 Fort Leavenworth
 Fort Lee
 Fort McClellan
 Fort Monroe
 Fort Rucker
 Fort Sill
 Fort Leonard Wood

INSCOM - Ch, Instl. Div.
 ATTN: Facilities Engineer
 Vint Hill Farms Station
 Arlington Hall Station

WESTCOM

ATTN: Facilities Engineer
 Fort Shafter

MDW

ATTN: Facilities Engineer
 Cameron Station
 Fort Lesley J. McNair
 Fort Myer

HSC

HQ USAHSC, ATTN: HSLO-F
 ATTN: Facilities Engineer
 Fitzsimons Army Medical Center
 Walter Reed Army Medical Center

USACC

ATTN: Facilities Engineer
 Fort Huachuca
 Fort Ritchie

MTMC

HQ, ATTN: MTMC-SA
 ATTN: Facilities Engineer
 Oakland Army Base
 Bayonne MOT
 Sunny Point MOT

US Military Academy

ATTN: Facilities Engineer
 ATTN: Dept of Geography &
 Computer Science

USAES, Fort Belvoir, VA

ATTN: ATZA-DTE-EM
 ATTN: ATZA-DTE-SU
 ATTN: Engr. Library

Chief Inst. Div., I&SA, Rock Island,

USA ARRCOM, ATTN: Dir., Instl & Svcs
 TARCOM, Fac. Div.
 TECOM, ATTN: DRSTE-LG-F
 TSARCOM, ATTN: STSAS-F
 NARAD COM, ATTN: DRDNA-F
 AMMRC, ATTN: DRXMR-WE

HQ, XVIII Airborne Corps and
 Ft. Bragg
 ATTN: AFZA-FE-EE

HQ, 7th Army Training Command
 ATTN: AETTG-DEH (5)

HQ USAREUR and 7th Army
 ODGS/Engineer
 ATTN: AEAEN-EH (4)

V Corps
 ATTN: AETVDEH (5)

VII Corps
 ATTN: AETSDEH (5)

21st Support Command
 ATTN: AEREH (5)

US Army Berlin
 ATTN: AEBA-EN (2)

US Army Southern European Task Force
 ATTN: AESE-ENG (5)

US Army Installation Support Activity
 Europe
 ATTN: AEUES-RP

8th USA, Korea
 ATTN: EAPE
 Cdr, Fac Engr Act (8)
 AFE, Yongsan Area
 AFE, 20 Inf Div
 AFE, Area II Spt Det
 AFE, Cp Humphreys
 AFE, Pusan
 AFE, Taegu

DLA ATTN: DLA-WI

USA Japan (USARJ)
 Ch, FE Div, AJEM-FE
 Fac Engr (Honshu)
 Fac Engr (Okinawa)

ROR/US Combined Forces Command
 ATTN: EUSA-HHC-CFC/Engr

416th Engineer Command
 ATTN: Facilities Engineering

Norton AFB
 ATTN: AFRCE-MX/DEE

EMS Team Distribution

USA ARRADCOM
ATTN: DRDAR-LCA-OK

Director of Facilities Engineering
Miami, FL 34004

USA Liaison Detachment
ATTN: Library
New York, NY 10007

Chief of Engineers
ATTN: DAEN-MPO-B
ATTN: DAEN-MPZ-A
ATTN: DAEN-MPR
ATTN: DAEN-RDL
ATTN: DAEN-MPO-U

Airports and Const. Services Dir.
Technical Info. Reference Centre
Ottawa, Ontario
Canada K1A 0N8

Aberdeen Proving Ground, MD 21005
ATTN: AMXHE

Ft. Belvoir, VA 22060
ATTN: Learning Resources Center
ATTN: ATSE-TD-TL (2)
ATTN: Kingman Bldg., Library
ATTN: Canadian Liaison Officer (2)

Ft. Leavenworth, KS 66027
ATTN: ATZLCA-SA

US Army Foreign Science & Tech. Center
ATTN: Charlottesville, VA 22901
ATTN: Far East Office

Ft. Monroe, VA 23651
ATTN: ATEN-AD (3)
ATTN: ATEN-FE-BG (2)
ATTN: ATEN-FE-W

Ft. Lee, VA 23801
ATTN: DRXMC-D (2)

Ft. McPherson, GA 30330
ATTN: AFEN-CD

USA-WES
ATTN: C/Structures

6th US Army
ATTN: AFKC-EN

7th US Army
ATTN: AETTM-HRD-EHD

HQ, Combined Field Army (ROK/US)
ATTN: CFAR-EN

US Army Engineer District
New York
ATTN: Chief, Design Br.
Pittsburgh
ATTN: Chief, Engr Div
Philadelphia
ATTN: Chief, NAPEN-D
Baltimore
ATTN: Chief, Engr Div
Norfolk
ATTN: Chief, NAOEN-M
ATTN: Chief, NAOEN-D
Huntington
ATTN: Chief, ORHED-D
Wilmington
ATTN: Chief, SAWEN-DS
ATTN: Chief, SAWEN-D
Charleston
ATTN: Chief, Engr Div
Savannah
ATTN: Chief, SASAS-L
Jacksonville
ATTN: Const Div
ATTN: Design Br., Structures Sec.
Mobile
ATTN: Chief, SAMEN-D
ATTN: Chief, SAMEN-C
Nashville
ATTN: Chief, CRNED-D
Memphis
ATTN: Chief, LMED-DT
ATTN: Chief, LMED-DM

US Army Engineer District
Vicksburg
ATTN: Chief, Engr Div
Louisville
ATTN: Chief, Engr Div
Detroit
ATTN: Chief, NCEED-T
St. Paul
ATTN: Chief, ED-D
Chicago
ATTN: Chief, NCCED-DS
Rock Island
ATTN: Chief, Engr Div
ATTN: Chief, NCRED-D
St. Louis
ATTN: Chief, ED-D
Kansas City
ATTN: Chief, Engr Div
Omaha
ATTN: Chief, Engr Div
New Orleans
ATTN: Chief, LMNED-DG
Little Rock
ATTN: Chief, Engr Div
Tulsa
ATTN: Chief, Engr Div
Fort Worth
ATTN: Chief, SWFED-D
Galveston
ATTN: Chief, SWGAS-L
ATTN: Chief, SWGED-DS
ATTN: Chief, SWGED-DM
Albuquerque
ATTN: Chief, Engr Div
Los Angeles
ATTN: Chief, SPLED-D
San Francisco
ATTN: Chief, Engr Div
Sacramento
ATTN: Chief, SPKED-D
Far East
ATTN: Chief, Engr Div
Portland
ATTN: Chief, DB-6
ATTN: Chief, DB-3
Seattle
ATTN: Chief, NPSCO
ATTN: Chief, EN-DB-EM
ATTN: Chief, EN-DB-ST
ATTN: Chief, NPSEN-PL-WC
Walla Walla
ATTN: Chief, Engr Div
Alaska
ATTN: Chief, NPASA-R

US Army Engineer Division
New England
ATTN: Chief, NEDED-T
Middle East (Rear)
ATTN: Chief, MEDED-T
North Atlantic
ATTN: Chief, NADEN-T
South Atlantic
ATTN: Chief, SADEN-TS
ATTN: Chief, SADEN-TE/TM
Huntsville
ATTN: Chief, HNDED-CS
ATTN: Chief, HNDED-ME
ATTN: Chief, HNDED-SR
Ohio River
ATTN: Chief, Engr Div
North Central
ATTN: Chief, Engr Div
Missouri River
ATTN: Chief, MRDED-T
Southwestern
ATTN: Chief, SWDED-TS
ATTN: Chief, SWDED-TM
South Pacific
ATTN: Chief, SPDED-TG
Pacific Ocean
ATTN: Chief, Engr Div
ATTN: Chief, FM&S Branch
ATTN: Chief, PODED-D
North Pacific
ATTN: Chief, Engr Div

AF/PREEU
Bolling AFB, DC 20332

AFESC/PRT
Tyndall AFB, FL 32403

AFE, Camp Humphreys
APO San Francisco 96721

McClellan AFB, CA 95652
2852 APG/DE

Tinker AFB, OK 73145
2854 ABG/DEEE

Patrick AFB, FL 32925
ATTN: XRQ

Little Rock AFB
ATTN: 314/DEEE

Naval Air Systems Command
ATTN: Library
WASH DC 20360

NAVFAC/Code O4
Alexandria, VA 22332

Naval Training Equipment Command
ATTN: Technical Library
Orlando, FL 32813

Port Hueneme, CA 93043
ATTN: Library (Code L08A)
ATTN: Morell Library

WASH DC
ATTN: Bldg. Research Advisory Board
ATTN: Library of Congress (2)
ATTN: Dept. of Transportation Library
ATTN: Transportation Research Board

AFWL/DES
Kirtland AFB, NM 87117

APO, New York, NY 09055
Chief, Land & Msl. Instl. Section

WASH DC 20305
Chief, Electronic Vulnerability Div.

CERCOM, Ft Monmouth
ATTN: DRSEL-LE-SS

Tyndall AFB
ATTN: AFESC-RDCF

Hanscom AFB, MA 01731
ATTN: HQ AFSC
ATTN: ESD/OCR-3

HND-ED-FD
Huntsville Engineering Division

SHAPE, Survivability Section, CCB
Operations Division, SHAPE
APO New York 09055

AFWL-DYC
Kirtland AFB

ASD/ENAMA
Wright-Patterson AFB, OH 45433

RADC/RBES
Griffiss AFB

AFWAL/MLSE
Wright-Patterson AFB, OH 45433

NARADCOM/DRDNA-UST
USA Natick Labs

USMC, CMC, HQMC
WASH DC

Harry Diamond Laboratories
ATTN: DELHD-NW-E
ATTN: DELHD-NW-EA
ATTN: DELHD-NW-EC
ATTN: DELHD-HW-ED
ATTN: DELHD-NW-EE

Defense Nuclear Agency
WASH DC 20305
ATTN: DNA-RAEE
ATTN: DNA-STRA
ATTN: DNA-ODST

McCormack, Raymond G.

EMI/RFI shielding effectiveness evaluation of bolt-together shielded rooms in long-term aging. -- Construction Engineering Research Laboratory ; available from NTIS, 1981.

139 p. (Technical report ; M-296)

1. Electromagnetic interference. 2. Shielding (electricity). I. Title.
II. Series: U.S. Army Construction Engineering Research Laboratory. Technical report ; M-296.