

USAAVRADCOM-TR-81-D-21B

AD A111106

LEVEL III



12

A110312

ADVANCED CONCEPTS FOR COMPOSITE STRUCTURE JOINTS
AND ATTACHMENT FITTINGS

Volume II - Design Guide

J. V. Alexander and R. H. Messinger
Hughes Helicopters
Division of Summa Corporation
Culver City, CA 90230

DTIC
ELECTED
S FEB 19 1982
E

November 1981

Final Report for Period July 1977 - February 1981

DTIC FILE COPY

Approved for public release;
distribution unlimited.

Copy (s) of this report may not
permit fully legible reproduction

Prepared for
APPLIED TECHNOLOGY LABORATORY
U. S. ARMY RESEARCH AND TECHNOLOGY LABORATORIES (AVRADCOM)
Fort Eustis, Va. 23604

82 02 18 006

A 1

APPLIED TECHNOLOGY LABORATORY POSITION STATEMENT

This report consists of two volumes and identifies all design considerations, testing, and cost analysis pertinent to composite joints and fittings attachments. The approach used in this program was to identify generic types of joints and fittings applicable to helicopter composite primary structures; the design emphasized reliability and cost effectiveness. The technology developed in this program has been incorporated in the design of new major composite components such as tail sections, and the foundation for future R&D work has been laid.

Mr. Nick Calapodas of the Aeronautical Technology Division served as project engineer for this effort.

DISCLAIMERS

The findings in this report are not to be construed as an official Department of the Army position unless so designated by other authorized documents.

When Government drawings, specifications, or other data are used for any purpose other than in connection with a definitely related Government procurement operation, the United States Government thereby incurs no responsibility nor any obligation whatsoever; and the fact that the Government may have formulated, furnished, or in any way supplied the said drawings, specifications, or other data is not to be regarded by implication or otherwise as in any manner licensing the holder or any other person or corporation, or conveying any rights or permission, to manufacture, use, or sell any patented invention that may in any way be related thereto.

Trade names cited in this report do not constitute an official endorsement or approval of the use of such commercial hardware or software.

DISPOSITION INSTRUCTIONS

Destroy this report when no longer needed. Do not return it to the originator.

DISCLAIMER NOTICE

THIS DOCUMENT IS BEST QUALITY PRACTICABLE. THE COPY FURNISHED TO DTIC CONTAINED A SIGNIFICANT NUMBER OF PAGES WHICH DO NOT REPRODUCE LEGIBLY.

UNCLASSIFIED

SECURITY CLASSIFICATION OF THIS PAGE (When Data Entered)

REPORT DOCUMENTATION PAGE		READ INSTRUCTIONS BEFORE COMPLETING FORM
1. REPORT NUMBER USAAVRADCOM-TR-81-D-21B	2. GOVT ACCESSION NO. AD-A111106	3. RECIPIENT'S CATALOG NUMBER
4. TITLE (and Subtitle) ADVANCED CONCEPTS FOR COMPOSITE STRUCTURE JOINTS AND ATTACHMENT FITTINGS - VOLUME II: Design Guide	5. TYPE OF REPORT & PERIOD COVERED Final Report Jul 1977 - Feb 1981	
	6. PERFORMING ORG. REPORT NUMBER HH 80-402	
7. AUTHOR(s) J. V. Alexander and R. H. Messinger	8. CONTRACT OR GRANT NUMBER(s) DAAJ02-77-C-0076	
9. PERFORMING ORGANIZATION NAME AND ADDRESS Hughes Helicopters, Inc. Centinela and Teale Streets Culver City, California 90230	10. PROGRAM ELEMENT, PROJECT, TASK AREA & WORK UNIT NUMBERS 62209A IL262209AH76 00 228 EK	
11. CONTROLLING OFFICE NAME AND ADDRESS Applied Technology Laboratory U. S. Army Research and Technology Laboratories (AVRADCOM), Fort Eustis, Virginia 23604	12. REPORT DATE November 1981	
	13. NUMBER OF PAGES 272	
14. MONITORING AGENCY NAME & ADDRESS (if different from Controlling Office)	15. SECURITY CLASS. (of this report) Unclassified	
	15a. DECLASSIFICATION/DOWNGRADING SCHEDULE	
16. DISTRIBUTION STATEMENT (of this Report) Approved for public release; distribution unlimited.		
17. DISTRIBUTION STATEMENT (of the abstract entered in Block 20, if different from Report)		
18. SUPPLEMENTARY NOTES Volume II of a two-volume report.		
19. KEY WORDS (Continue on reverse side if necessary and identify by block number) Attachment Fittings Fabrication Nondestructive Inspection Composite Fittings Helicopters Strength Design Joints Weight Wet Filament Winding		
20. ABSTRACT (Continue on reverse side if necessary and identify by block number) The purpose of this program was to develop the technology of applying fiber-reinforced composite materials to helicopter joints and attachment fittings that permit disassembly of major components. A generic design methodology approach was used to make the data developed applicable to ongoing and future helicopter programs.		

DD FORM 1 JAN 73 1473 EDITION OF 1 NOV 65 IS OBSOLETE

UNCLASSIFIED

SECURITY CLASSIFICATION OF THIS PAGE (When Data Entered)

UNCLASSIFIED

SECURITY CLASSIFICATION OF THIS PAGE(When Data Entered)

A detail design, analysis, and testing program was carried out on the three joint and fitting concepts selected: wrapped tension fittings, gear box attachment fittings, and seat attachment fittings.

The scope of the study included analytical design tools, including finite element computer analysis; fabrication techniques, with special emphasis on weight and cost effectiveness considerations; structural integrity testing, including static, dynamic, failsafe/safe-life, and ballistic tolerance considerations; and nondestructive inspection (NDI) techniques.

This volume contains the analytical and experimental results of the laminated angle bracket study and the Design Guide, which covers each type of joint or fitting tested.

1
B

UNCLASSIFIED

SECURITY CLASSIFICATION OF THIS PAGE(When Data Entered)

SUMMARY

This report was prepared by Hughes Helicopters, Inc. (HHI), Culver City, California 90230, for the Applied Technology Laboratory, U.S. Army Research and Technology Laboratories (AVRADCOM), Fort Eustis, Virginia 23604, under Contract DAAJ02-77-C-0076.

The purpose of this program was to develop the necessary methodology for applying fiber-reinforced composite materials to helicopter joint and attachment fitting designs that permit disassembly of major components.

For this program, primary joints and fittings representative of high-performance helicopters (the YAH-64 in particular) were selected for evaluation. A generic design methodology approach was used to make the data that was developed applicable to ongoing and future helicopter programs.

The objective of this program was to develop basic concepts for competitive helicopter joints and fittings using composite materials. These materials must be capable of being readily integrated into composite components and attached to other components, both composite and metal, such that the weight and cost effectiveness of the advanced composite component is an improvement over the baseline metallic component alternatives.

All detail design and fabrication aspects of the three advanced composite joint and fitting types that were fabricated and tested during this contracted effort are documented in this report, along with the analytical and experimental results of the laminated angle bracket study.



Accession For	
NTIS GRA&I	<input checked="" type="checkbox"/>
DTIC TAB	<input type="checkbox"/>
Unannounced	<input type="checkbox"/>
Justification	
By _____	
Distribution/	
Availability Codes	
Dist	Avail and/or Special
A	27

TABLE OF CONTENTS

	<u>Page</u>
SUMMARY	3
LIST OF ILLUSTRATIONS	8
LIST OF TABLES	12
INTRODUCTION.	14
DESIGN PROPERTIES	19
Composite Allowables	19
Angle Allowables	21
DRAWING PREPARATION.	24
Ply Orientation	24
Stacking Sequence	24
FUSELAGE-TAILBOOM JOINT (TYPE A)	27
Design Criteria	27
Stress Analysis	29
Fabrication Methods	29
SPAR BOX-RIB JOINT (TYPE D)	31
Design Criteria	31
Stress Analysis	31
Fabrication Methods	33

TABLE OF CONTENTS (CONT)

	<u>Page</u>
COPILOT SEAT FITTING (TYPE K)	35
Design Criteria	35
Stress Analysis	35
Fabrication Methods	37
INSPECTION METHODS	38
COST/WEIGHT TRADE STUDY	39
FINITE ELEMENT ANALYSIS	41
Angle Bracket Model	41
Individual Joint Models	41
BIBLIOGRAPHY	52
<u>APPENDIXES</u>	
A COMPOSITE MATERIAL ALLOWABLES	53
B ANGLE BRACKET STUDY	69
C C-1 MODEL PREPROCESSOR PROGRAM LISTING	123
D C-1 PREPROCESSOR FLOWCHART	138
E C-1 MODEL PREPROCESSOR PROGRAM OUTPUT	144
F C-1 MODEL PREPROCESSOR PROGRAM BULK DATA LISTING	162
G C-1 PLOT RUN DATA DECK SETUP AND UNDEFORMED PLOTS	168
H C-1 SOLUTION RUN OUTPUT	173
I C-2 MODEL PREPROCESSOR PROGRAM LISTING	190

TABLE OF CONTENTS (CONT)

	<u>Page</u>
J C-2 PREPROCESSOR FLOWCHART	192
K C-2 MODEL PREPROCESSOR PROGRAM OUTPUT	195
L C-2 PLOT RUN OUTPUT AND UNDEFORMED PLOTS	198
M SINGLE STRIP NASTRAN OUTPUT	216
N ACRONYM DEFINITIONS	241
O STRESS ANALYSIS	242

LIST OF ILLUSTRATIONS

<u>Figure</u>		<u>Page</u>
1	Fuselage-Tailboom Joint	15
2	Spar Box-Rib Joint	16
3	Copilot Seat Fitting	17
4	Joint and Fitting Design Flowchart	18
5	Fiber Orientation	21
6	Angle Joint Allowable Loads	22
7	Fiber Orientation Reference Axis	24
8	Stacking Sequence	25
9	Ply Sequence Schematic	26
10	Final Detail Design: Type A	28
11	Manufacturing Steps: Type A	30
12	Final Detail Design: Type D	32
13	Manufacturing Steps: Type D	34
14	Final Detail Design: Type K	36
15	Manufacturing Steps: Type K	37
16	Break-Even Partitioning of Composite Fittings	39
17	Cost vs Weight Relationship of Composite Fittings	40

LIST OF ILLUSTRATIONS (CONT)

<u>Figure</u>		<u>Page</u>
18	Typical Laminated Angle Bracket	42
19	NASTRAN Model C-1	43
20	NASTRAN Model C-2	44
21	Normalized Shear Stress vs Bracket Angle and Width	45
22	NASTRAN Model of Joint Type A (Top View)	46
23	NASTRAN Model of Joint Type A (Side View)	47
24	NASTRAN Model of Joint Type D (Top View)	48
25	NASTRAN Model of Joint Type D (Side View)	49
26	NASTRAN Model of Joint Type K (Front and Side Views)	50
27	NASTRAN Model of Joint K (Internal Loads)	51
B-1	"Bathtub" Tension Fitting	69
B-2	Turning the Corner	71
B-3	Internal Loads in the Corner Region	73
B-4	Laminate Geometry	74
B-5	Angle Bracket Subdivision	76
B-6	Single-Layer Model	77
B-7	Two-Stage Computer Analysis Flowchart	79
B-8	C-1 Coordinate Systems	81
B-9	Grid Point and Element ID Numbers	83

LIST OF ILLUSTRATIONS (CONT)

<u>Figure</u>		<u>Page</u>
B-10	C-1 Boundary Conditions	88
B-11	Rotation of Axis	90
B-12	Load Conditions	91
B-13	Sample Input Data for Multilayer C-1 Model Preprocessor Run	94
B-14	Critical Strip Model	96
B-15	Sample Ten-Strip Model	98
B-16	Tangential Stress Versus Bend Angle Along the Centerline Strip: Uniform Tension Load Case	99
B-17	Tangential Stress Versus Angle Width: Uniform Tension Load Case	100
B-18	Interlaminar Shear Stress Versus Bend Angle: Uniform Tension Load Case	101
B-19	Interlaminar Shear Stress Versus Angle Width: Uniform Tension Load Case	102
B-20	Normal Stress Versus Bend Angle: Uniform Tension Load Case	103
B-21	Normal Stress Versus Angle Width: Uniform Tension Load Case	104
B-22	Laminated Centerline Strip of the Ten-Strip Test Model	105
B-23	Interlaminar Shear Stress Versus Bend Angle: Uniform Tension Load Case	106
B-24	Interlaminar Shear Stress Through the Laminate Thickness at $\theta = 5$ and 75 degrees: Uniform Tension Load Case	107

LIST OF ILLUSTRATIONS (CONT)

<u>Figure</u>		<u>Page</u>
B-25	Normal Stress Along the Bend Angle: Uniform Tension Load Case	108
B-26	Normal Stress Through the Laminate Thickness at $\theta = 5$ and 75 degrees: Uniform Tension Load Case	109
B-27	Interlaminar Shear Stress Versus Bend Angle: Uniform Clockwise Couple Load Case	110
B-28	Normal Stress Versus Bend Angle: Uniform Clockwise Couple Load Case	111
B-29	Tangential Stress Versus Bend Angle for Varying Thickness-to-Bend Radius Ratios: Uniform Tension Load Case	113
B-30	Tangential Stress Versus Bend Angle for Varying Stacking Sequences: Uniform Tension Load Case	114
B-31	Interlaminar Shear Stress Versus Bend Angle for Varying Thickness-to-Bend Radius Ratios: Uniform Tension Load Case	115
B-32	Interlaminar Shear Stress Versus Bend Angle for Varying Stacking Sequences: Uniform Tension Load Case	116
B-33	Four Stacking Sequences	117
B-34	Interlaminar Shear Stress for Varying Stacking Sequences Through the Laminate Thickness	117
B-35	Test Setup	120
B-36	Fracture Progression in Typical Composite Angle	121
B-37	Ultimate Allowable Loads Versus Thickness	122

LIST OF TABLES

<u>Table</u>		<u>Page</u>
1	Sample Stacking Sequence	25
A-1	Graphite Composite Properties.	55
A-2	Graphite Moduli (VF = 0.55)	56
A-3	Graphite Moduli (VF = 0.60)	57
A-4	Graphite Strength Allowables (VF = 0.55).	58
A-5	Graphite Strength Allowables (VF = 0.60).	59
A-6	Graphite Poisson's Ratio and Thermal Expansion (VF = 0.55)	60
A-7	Graphite Poisson's Ratio and Thermal Expansion (VF = 0.60)	61
A-8	Kevlar 49 Composite Properties.	62
A-9	Kevlar 49 Moduli (VF = 0.55).	63
A-10	Kevlar 49 Moduli (VF = 0.60).	64
A-11	Kevlar 49 Strength Allowables (VF = 0.55)	65
A-12	Kevlar 49 Strength Allowables (VF = 0.60)	66
A-13	Kevlar 49 Poisson's Ratio and Thermal Expansion (VF = 0.55)	67
A-14	Kevlar 49 Poisson's Ratio and Thermal Expansion (VF = 0.60)	68

LIST OF TABLES (CONT)

<u>Table</u>		<u>Page</u>
B-1	Input Parameter Names	86
B-2	Parametric Analysis.	112
B-3	Angle Tension Test Specimens	119

INTRODUCTION

The purpose of this design guide is to document all detail design and fabrication aspects of three advanced composite joint and fitting types that were investigated under the Advanced Concepts for Composite Structure Joints and Attachment Fittings Program (Contract DAAJ02-77-C-0076). The three joint and fitting types analyzed are:

- a. Type A — Fuselage-Tailboom Joint (Figure 1)
- b. Type D — Spar Box-Rib Joint (Figure 2)
- c. Type K — Copilot Seat Fitting (Figure 3)

The steps involved in the design, fabrication, and testing of the three joint and fitting types are illustrated in flowchart form in Figure 4. During the initial screening and evaluation phase of the program, the configurations and critical applied loads of the metal baseline joints were identified. Design concepts, composite materials, and fabrication methods selected according to structural efficiency, cost, and weight considerations were incorporated into the preliminary design drawings. Preliminary hand analyses of the joints were then carried out using conservative design allowables obtained from the existing data base.

A small number of each joint and fitting type were fabricated for tool proofing and subsequent testing by nondestructive methods (hammer tapping and harmonic analysis). Each joint and fitting was then tested statically, and Types A and D were also fatigue tested. The results of these experiments were compared with the analytical predictions discussed in Volume I of this report.

A cost effectiveness study was carried out to relate cost and weight differences between the composite joints and their baseline metal counterparts.

Finite element modeling consisted of a NASTRAN analysis to determine critical interlaminar shear properties in the radius of a general angle bracket, and NASTRAN models were prepared for each individual joint.

The experience and data gained from fabrication, testing, and modeling of these joints were used to finalize the detail design drawings. Accessibility, simplicity, environmental protection, weight, cost, and interchangeability were the factors weighed most heavily.

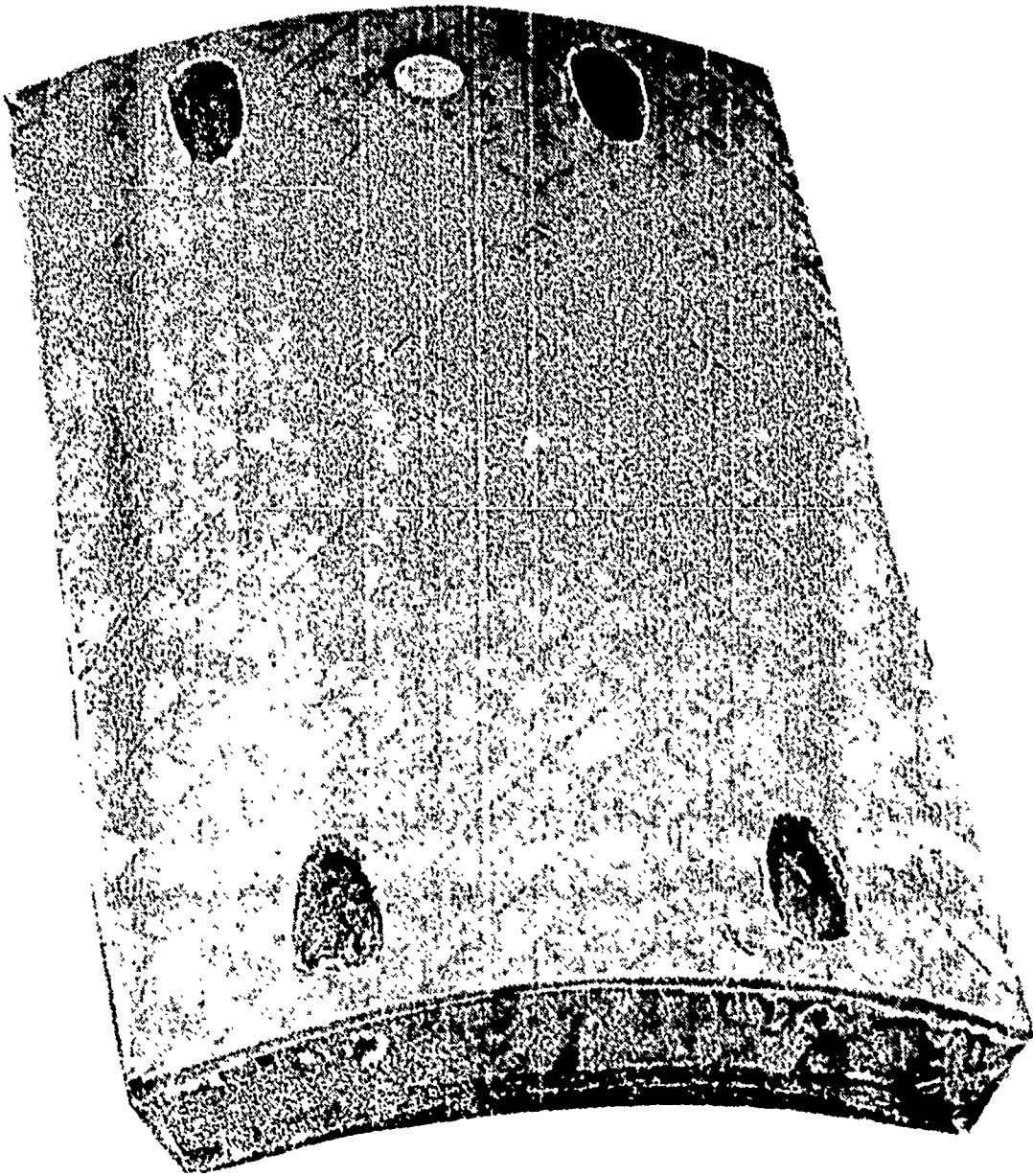
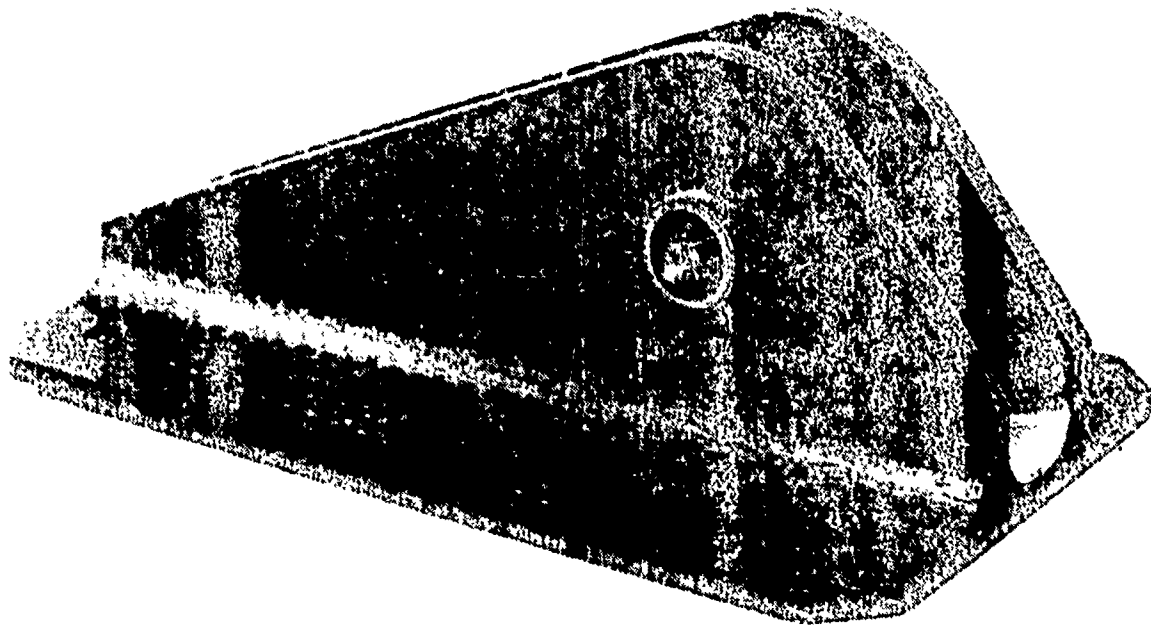

Figure 1. Fuselage-Tailboom Joint

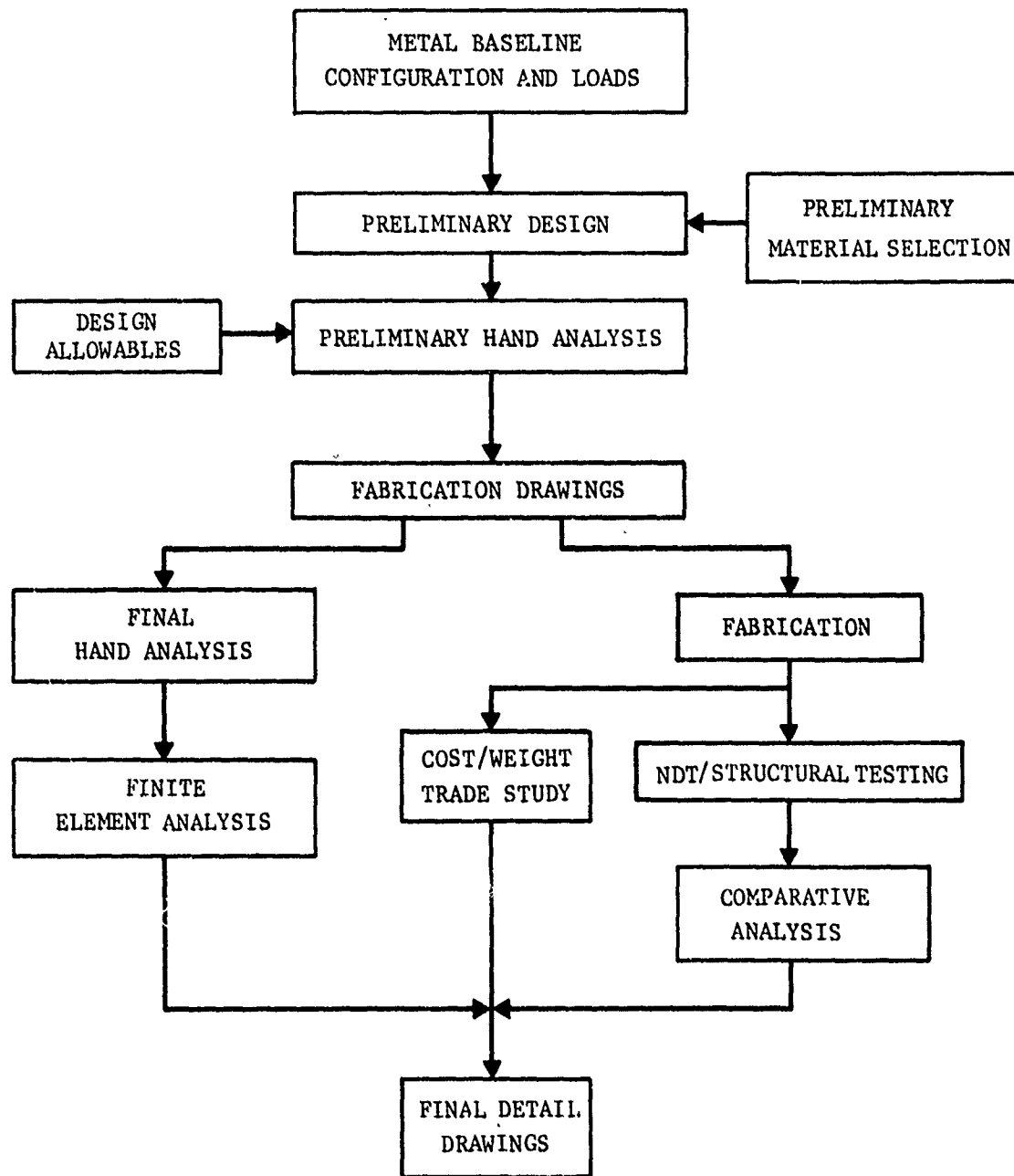

Figure 2. Spar Box-Rib Joint



2
F

Figure 3. Copilot Seat Fitting



2
B

Figure 4. Joint and Fitting Design Flowchart

DESIGN PROPERTIES

The composite material allowables and angle properties in this report are given for Kevlar 49 aramid fiber and Thornel T300 graphite fiber impregnated with an epoxy resin system obtained from Applied Plastics Co., Inc. (2434 resin/2347 hardener). These materials have been qualified to HHI material specifications.

Either the wet filament winding or hand layup technique can be used according to HHI process specifications. The cure cycle for this resin system is:

- a. 4 hr at 140°F ±10°F
- b. 2 hr at 170°F ±10°F
- c. 2 hr at 250°F ±10°F

COMPOSITE ALLOWABLES

The graphite and Kevlar composite allowables used in the design analyses of the joints were developed during previous work using advanced composite materials¹ and are reproduced in Appendix A. Laminate moduli, strength, and other physical property values are given as a function of fiber angle for fiber volume ratios of 0.55 and 0.60. The laminates are constructed of symmetric angle plied layers of ±α (alpha) orientation. Fiber, resin, and composite input data terms are defined as:

AF (AR) = Fiber (resin) coefficient of thermal expansion,
in./in./°F

AFT = Fiber transverse coefficient of thermal
expansion, in./in./°F

EF (ER) = Fiber (resin) elastic modulus, psi

EFT = Fiber transverse elastic modulus, psi

¹ Goodall, R. E., ADVANCED TECHNOLOGY HELICOPTER LANDING GEAR, Hughes Helicopters, Division of Summa Corporation; USAAMRDL Technical Report 77-27, Eustis Directorate, U. S. Army Air Mobility Research and Development Laboratory, Fort Eustis, Virginia, April 1977.

FCU = Fiber or composite ultimate compressive strength, psi

FSU = Resin ultimate shear strength, psi

FTU = Fiber or composite ultimate tensile strength, psi

GF = Fiber shear modulus, psi

RHO = Composite density, lb/ft³

RHOF (RHOR) = Fiber (resin) density, lb/ft³

UF (UR) = Fiber (resin) Poisson's ratio (dimensionless)

VF (VR) = Fiber (resin) volume, percent

WF (WR) = Fiber (resin) weight, percent

Composite properties are abbreviated as follows:

ALPHA = Fiber angle, deg

AX = Coefficient of thermal expansion, X direction, in./in./°F

AY = Coefficient of thermal expansion, Y direction, in./in./°F

EX = Elastic modulus, X direction, psi

EY = Elastic modulus, Y direction, psi

FXCU = Ultimate compressive strength, X direction, psi

FXTU = Ultimate tensile strength, X direction, psi

FXY = Ultimate shear strength, psi

FYCU = Ultimate compressive strength, Y direction, psi

FYTU = Ultimate tensile strength, Y direction, psi

GXY = Shear modulus, psi

UXY = Poisson's ratio, perpendicular to X direction
(dimensionless)

UYX = Poisson's ratio, perpendicular to Y direction
(dimensionless)

Fiber orientation with respect to the longitudinal (X) and transverse(Y) directions of the composite component is defined in Figure 5. The longitudinal direction is usually aligned with the primary load path of the component.

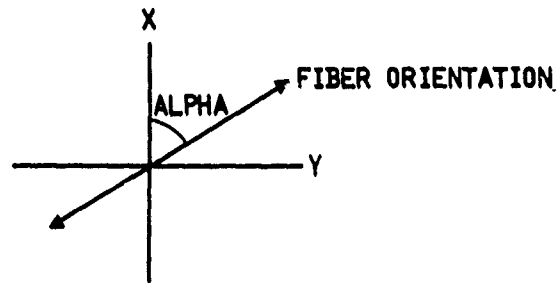

Figure 5. Fiber Orientation

The rule of mixtures method can be used with the property tables given in Appendix A to determine the laminate properties of any one type of fiber. For example, in a $(0/\pm 45/90)_s$ graphite laminate with $VF = 0.55$, the longitudinal (X direction) elastic modulus is

$$\begin{aligned} EX (\text{laminate}) &= \frac{2(18.91 \times 10^6) + 4(2.039 \times 10^6) + 2(9.106 \times 10^5)}{8} \\ &= 5.975 \times 10^6 \text{ psi} \end{aligned}$$

ANGLE ALLOWABLES

The simple turn-the-corner angle design shown at the bottom of Figure 6 can be used in many cases in which composite components must be capable of disassembly. One-inch-wide T300 graphite, Kevlar 49, E-glass, and

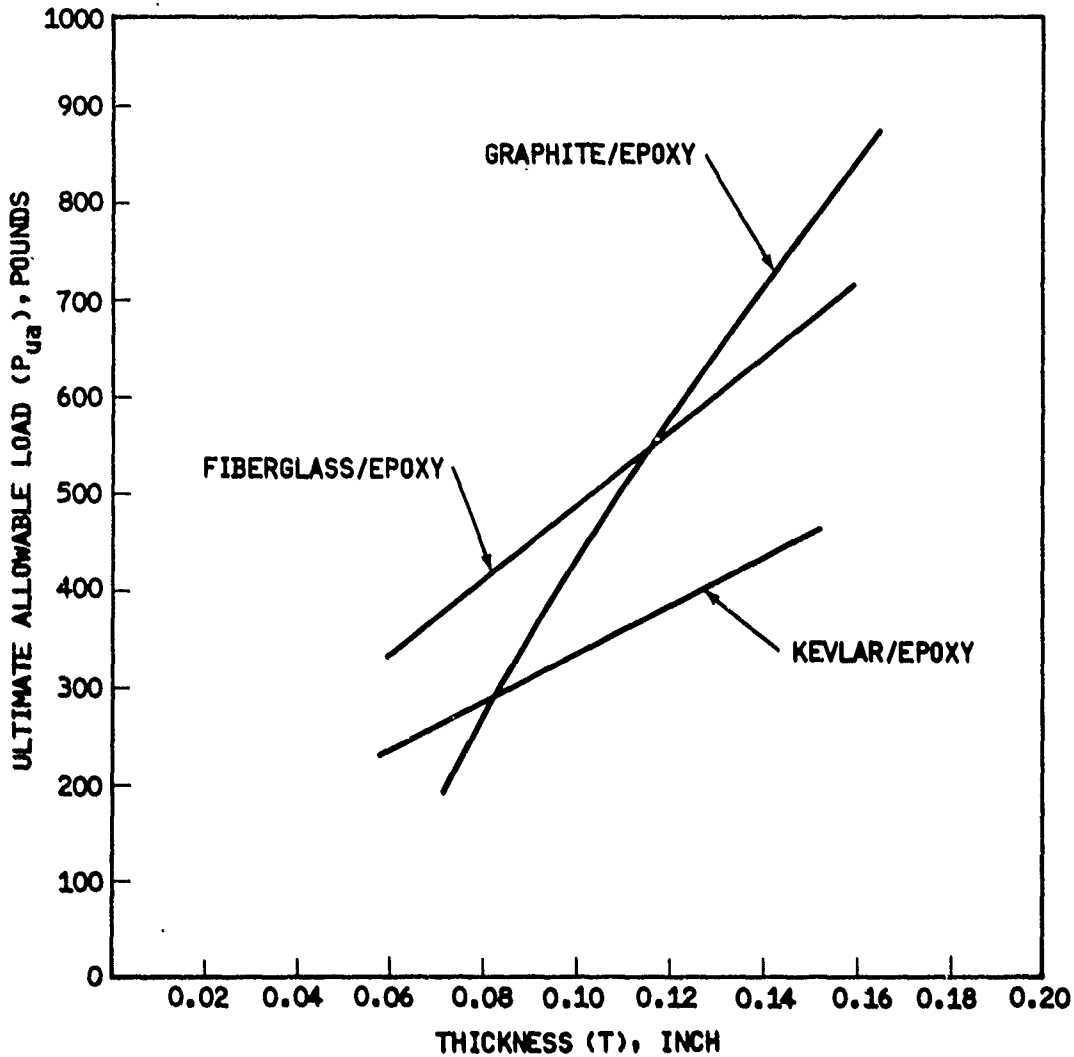

FIBERGLASS, GRAPHITE/EPOXY, OR TEDLAR
WASHER, 0.2 IN. ID, 1/2 TO 3/4 IN. OD,
TYP TWO PLACES, 1/32 TO 3/32 IN. THICK

NAS 620 OR EQUIVALENT
NO. 10 PLAIN STEEL WASHER,
TYP TWO PLACES

NAS 1103 OR EQUIVALENT
NO. 10-32 HEX HEAD BOLTS
WITH 1/4 TO 1/2 IN. GRIP;
NAS 671-10 OR EQUIVALENT
PLAIN HEX NUTS TO BE
TORQUED TO 26 IN.-LB

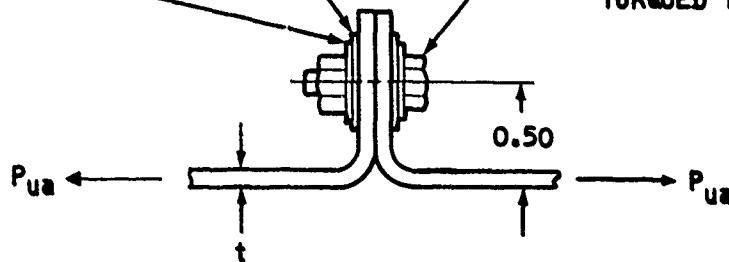

Figure 6. Angle Joint Allowable Loads

S-glass angle joints with repetitions of the (0/±45/90) layup sequence were fabricated and tested to determine their allowable ultimate strengths. Preliminary results of these tests are given below:

- a. The corners of thinner angles straighten out elastically for a distance of up to two or three times their initial radii. Next the matrix fails in delamination, and finally the fibers fracture at ultimate load.
- b. The concept of yield strength being two-thirds of ultimate strength is not transferable from metals to composites. Permanent set may occur anywhere from 75 percent (thin angles) to 90 percent of ultimate strength (thicker angles).
- c. Thick sections are more ductile than thin ones.
- d. Allowable load versus thickness in composite angles is shown in Figure 6 for an eccentricity of 0.5 inch. Composite angles of varying eccentricity and thickness must be tested before nomographs similar to those already well-established for aluminum can be developed.

DRAWING PREPARATION

A number of common industry practices are used in the detail design drawings to describe the composite components of the three joint and fitting types.

PLY ORIENTATION

The reference fiber orientation of a composite component is shown in Figure 7. The 0-degree direction is defined as the longitudinal, lengthwise, or major load direction of the component.

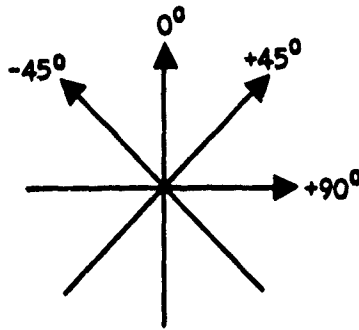

Figure 7. Fiber Orientation Reference Axis

STACKING SEQUENCE

The stacking sequence of any number of plies can be represented by giving the orientation of each ply or group of plies, separated by slashes, braces, and brackets according to a conventional system of notation. The stacking sequence of Detail 5 of Joint Type K is shown in Figure 8 as an example.

A stacking sequence table such as the one shown in Table 1 can be placed on the engineering drawing to help organize the stacking sequence and orientation of any relatively complex composite component.

A large-scale schematic detail of the component should be provided along with the stacking sequence table. In the cross section shown in Figure 9, each ply is drawn and appropriately identified so that ply dropoffs can be clearly defined. The minimum distance between ply dropoffs is 0.2 inch. The maximum thickness of each dropoff is 0.030 inch, which is approximately equivalent to two plies of fabric.

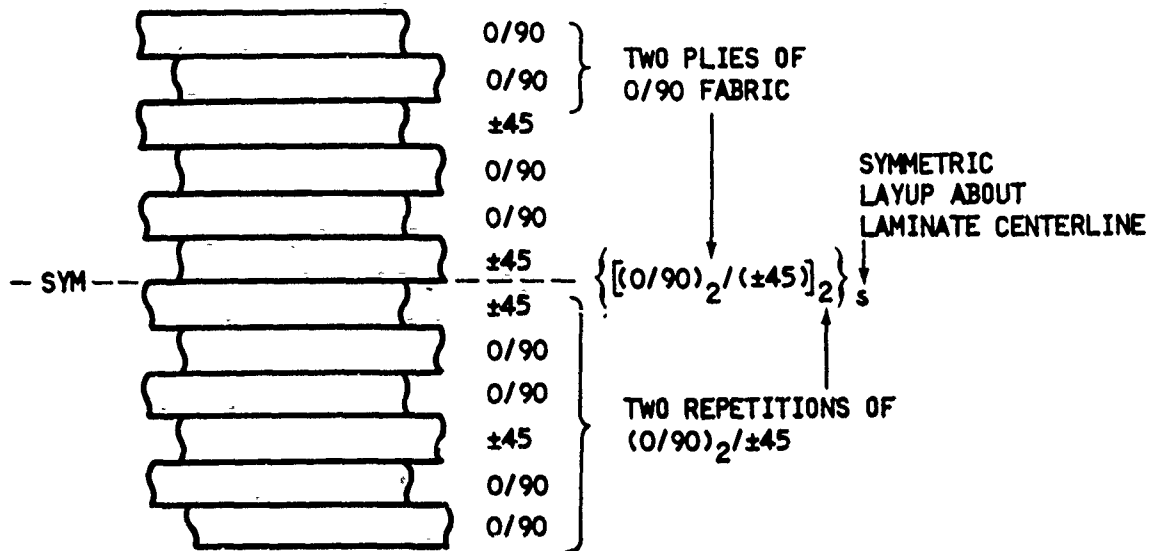

Figure 8. Stacking Sequence

TABLE 1. SAMPLE STACKING SEQUENCE

PLY NO.	PLY ORIENTATION	MATERIAL	PLY THICKNESS
P1	±45	⑦ ⑧	0.0135
P2	±45		0.0135
P3	0		0.007
P4	0		
P5	0		
P6	0		
P7	0		
P8	0		0.007
P9	±45		0.0135
P10	0		0.007
P11	0		
P12	0		
P13	0		
P14	0		
P15	0		0.007
P16	±45		0.0135
P17	±45	⑦ ⑧	0.0135

NOTE: ⑦ AND ⑧ REFER TO THE GENERAL NOTES ON THE ENGINEERING DRAWING IN QUESTION

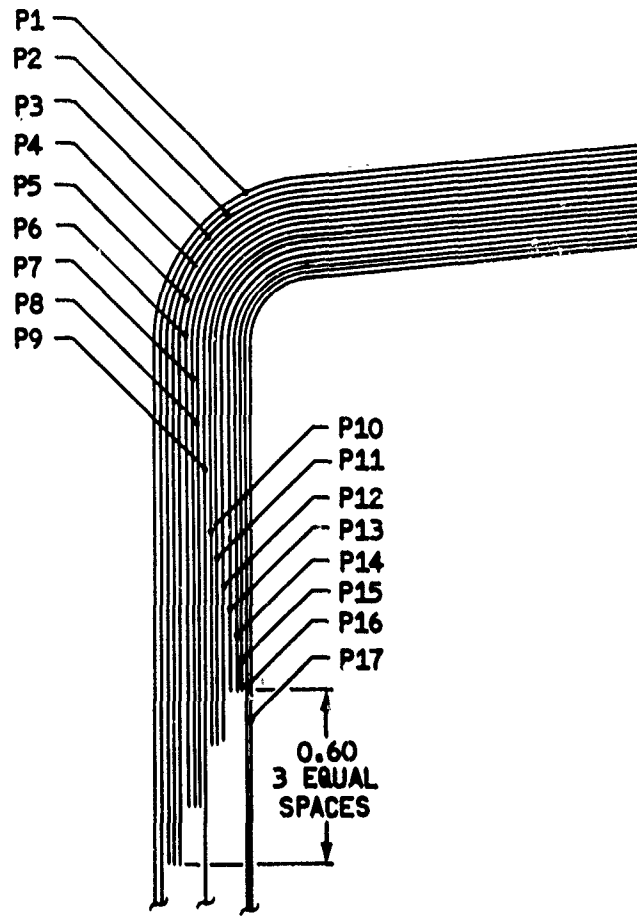

Figure 9. Ply Sequence Schematic

FUSELAGE-TAILBOOM JOINT (TYPE A)

Joint Type A represents the attachment of a composite helicopter tailboom to a forward fuselage. This tension bolt design includes steel fittings within a graphite/Kevlar hybrid channel, which is joined to the graphite/Kevlar hybrid skins of the sandwich structure.

The composite fuselage-tailboom joint incorporates design concepts and manufacturing techniques to minimize weight and cost while efficiently carrying ultimate loads. The final detail design of the test panel that incorporates this joint is shown in Figure 10.

DESIGN CRITERIA

The process of evaluating and comparing numerous design concepts and carrying out the final detail design was controlled by the following criteria:

- a. **Loads** - Flight condition loads transferred across the fuselage-tailboom joint must be efficiently carried by either a tension bolt fitting or shear splice. The tension bolt concept was chosen to permit direct interchangeability with an existing metal tailboom.
- b. **Accessibility** - Given the tension bolt concept, the composite tailboom should be attached from the outside. Access holes must therefore be provided in the skin or other integral fitting.
- c. **Simplicity** - The wet-filament-winding/cocuring fabrication process eliminates much time and effort normally spent in secondary bonding or mechanical fastening of precured parts. Wet filament winding is especially applicable to fabrication of cylindrical structures such as tailbooms.
- d. **Environmental protection** - Exterior helicopter components such as fuselage-tailboom joints are designed for improved environmental resistance in accordance with established HHI process specifications. External steel parts such as the -3 fitting are plated by various methods approved for aircraft structures. Non-metallic external parts such as the -9 inner or -11 outer skins are primed before they are painted according to specification.

STRESS ANALYSIS

In the hand stress analysis of Joint Type A, the following loads and stresses were determined:

- a. Critical ultimate loads due to crashworthiness conditions
- b. Local -5 channel reaction load intensities in tension and compression
- c. Fiber stresses in $\pm 15^\circ$ graphite and $\pm 45^\circ$ Kevlar
- d. Shear stresses between the -5 channel and the outer facesheet
- e. Lamina strains
- f. Honeycomb sandwich buckling and wrinkling
- g. Bending of the -3 fitting

FABRICATION METHODS

Joint Type A was fabricated to simulate the methods used to fabricate a composite tailboom, and so the inner and outer skins and the 0° plies of the -5 channel were fabricated using the wet filament winding method. The -5 channel was laid up manually on a male tool, using the 0° plies mentioned above and the $\pm 45^\circ$ Kevlar fabric, and then staged in a vacuum bag. The channel was trimmed, assembled with honeycomb core, and cocured with the skins. Pressure during cure was provided by hoop-wound filaments (90°) rather than by vacuum bag or autoclave to avoid collapsing the mandrel. No film adhesive was used because the skins were wound with sufficient resin to create filleting in the core. The fabrication sequence is shown in Figure 11.

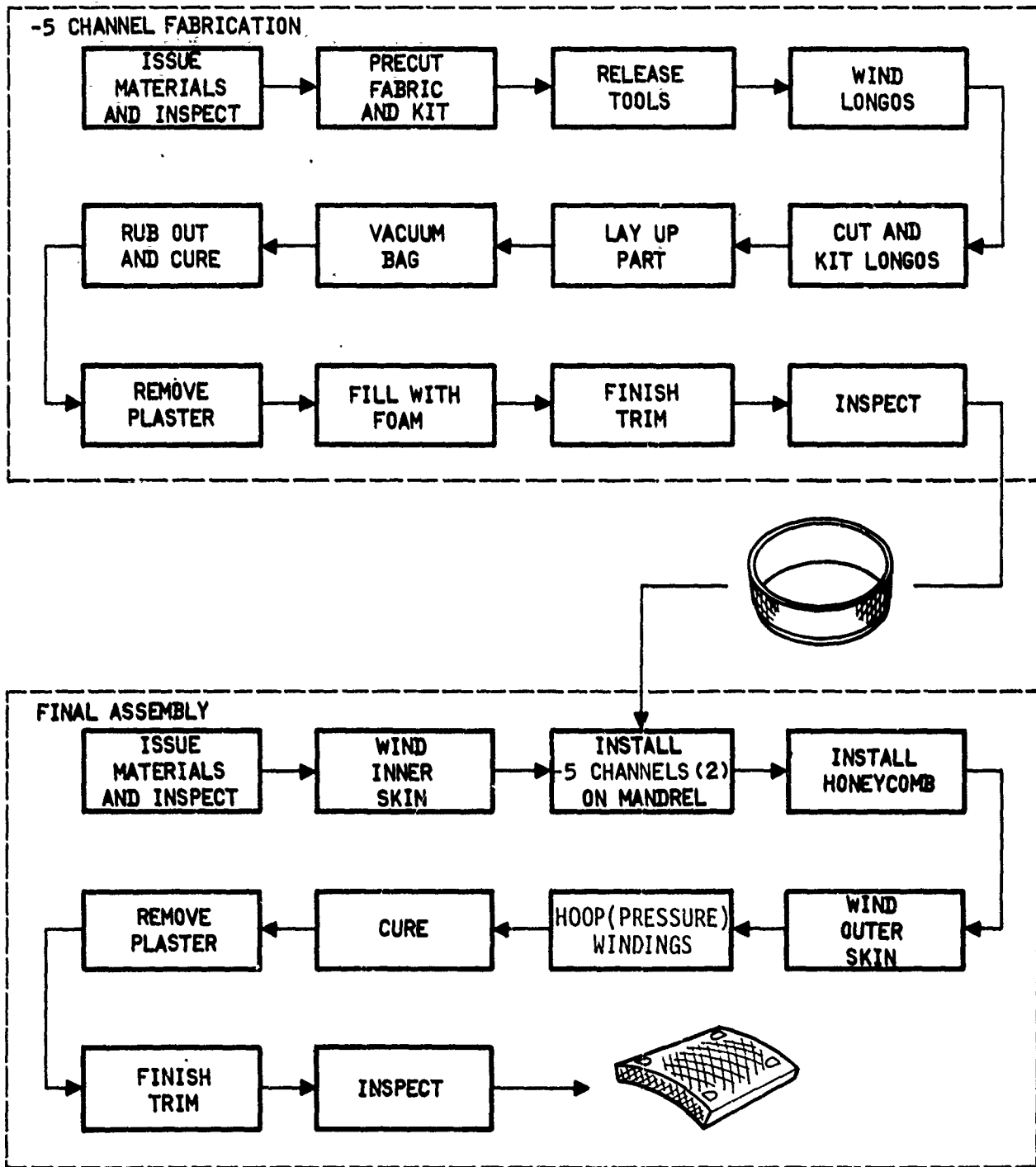

Figure 11. Manufacturing Steps: Type A

SPAR BOX-RIB JOINT (TYPE D)

The composite spar box-rib joint was designed to replace its metal equivalent in a helicopter vertical stabilizer. This joint includes a rib that secures the attach fittings and carries the shear induced by coupled applied loads from the tail rotor. In addition, corner spar caps are cocured into the sandwich box structure to carry longitudinal bending loads. The detail drawing of Joint Type D is shown in Figure 12.

DESIGN CRITERIA

Detail design of the final concept was controlled by the following criteria:

- a. Loads - Critical tension and compression loads from the tail rotor strike condition that are applied to the fittings must be transferred through the rib to the box structure in shear. The rib provides stability to the metal fittings.
- b. Cost - Wet filament winding was chosen as the fabrication method to minimize the cost of the spar box structure. The fitting design was simplified to minimize machining and assembly costs.
- c. Environmental protection - The gearbox attach fitting includes two internal 4140 steel fittings that require a finish system for bonding and environmental protection, and the external graphite/epoxy skin of a composite vertical stabilizer spar is primed and painted, both in accordance with approved aircraft process specifications.

STRESS ANALYSIS

In the hand stress analysis of Joint Type D, the following were determined:

- a. Critical loads at the tail rotor gearbox attachment fittings
- b. Section properties
- c. Internal forces (shear flows in spar box walls and internal ribs)
- d. Shear tear-out of lug through composite skins

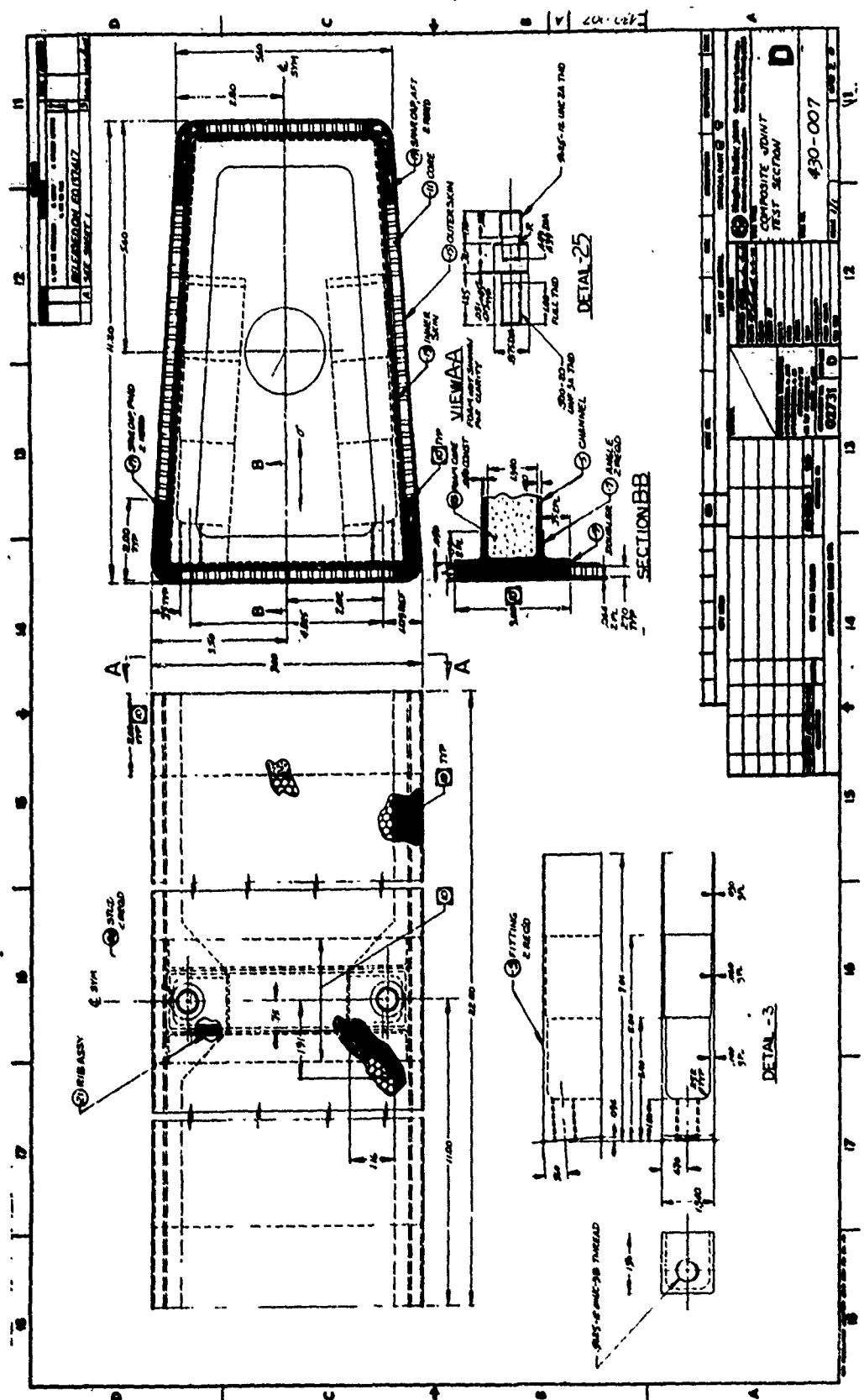
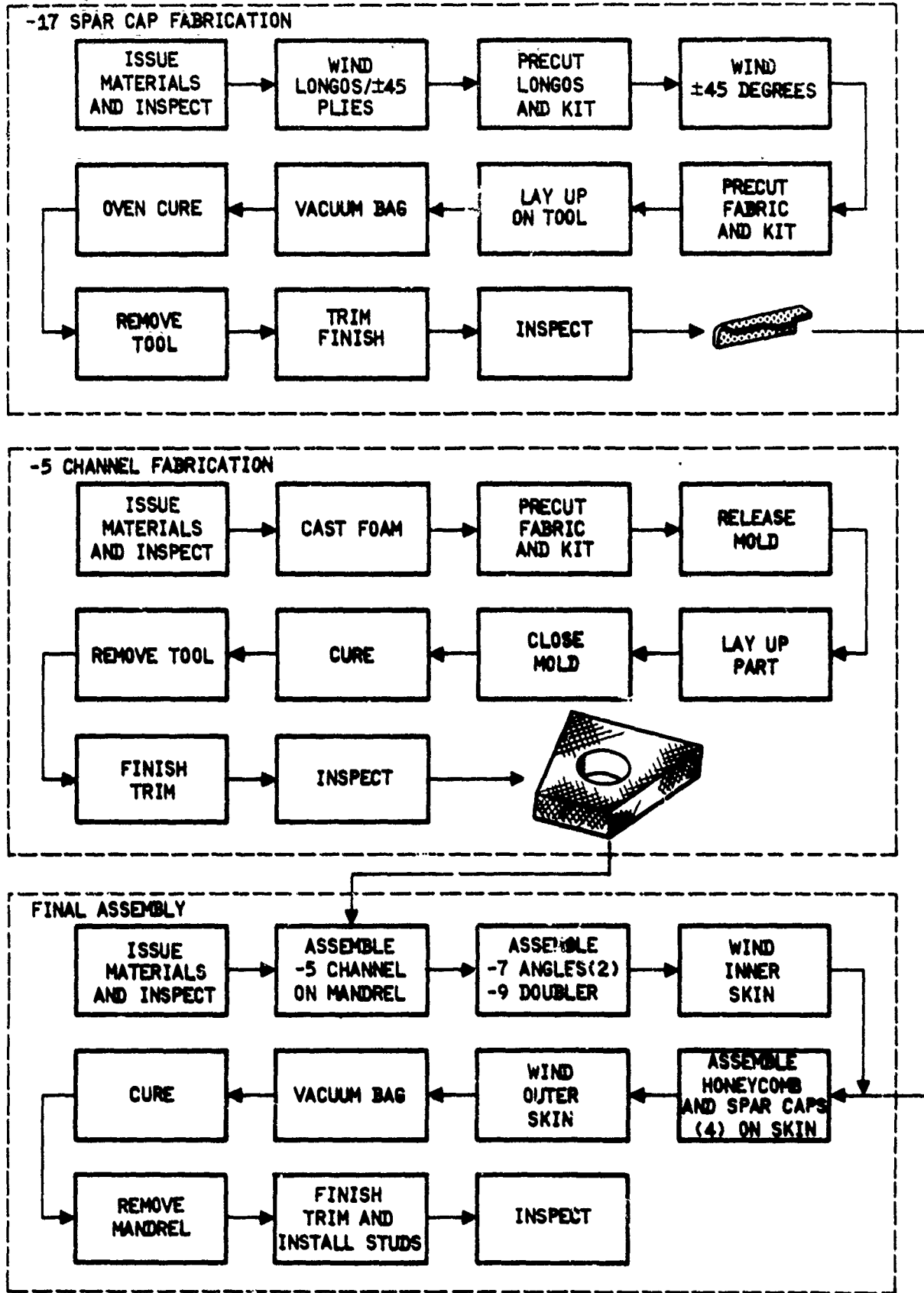

Figure 12. Final Detail Design: Type D

- e. Shear between steel fitting and graphite rib
- f. Rib stability

FABRICATION METHODS

Fabrication of Joint Type D simulated the methods to be used during production. The plies for the four -17 spar caps were wet filament wound on a drum mandrel, cut into patterns, and laid up on a male tool. Each part was staged under vacuum and trimmed before final assembly. The -5 internal rib was laid up with graphite fabric over a foam core and staged in a female die mold. The rib was then assembled into the spar mandrel prior to winding of the inner skin. Honeycomb core was placed on the mandrel, and then the outer skin was wound. These fabrication steps are shown in Figure 13.



3
B

Figure 13. Manufacturing Steps: Type D

COPILOT SEAT FITTING (TYPE K)

The copilot seat fitting design, derived from the metal seat attachment fitting design, utilizes the turn-the-corner angle concept to carry (mainly) tension loads. The final design drawing is shown in Figure 14.

DESIGN CRITERIA

Detail design of the final concept was controlled by the following criteria:

- a. Configuration - The substitution of composite materials for metals was the primary change in this design because the seat fitting configuration and its location could not be changed significantly. Space limitations also limited the design alternatives.
- b. Loads - Interlaminar shear stress in the corner of the composite angles due to lug pullout loads was an omnipresent factor during the design phase.
- c. Cost - Manual layup of fabric provided the most cost-effective fabrication technique. Wet filament winding of the plies could not be justified due to the low material requirement.
- d. Environmental protection - Since the copilot seat fitting is inside the helicopter, no finish is required.

STRESS ANALYSIS

The composite layup sequence was determined by lug shearout stresses in the following stress analysis procedure:

- a. Critical vertical, horizontal, and lateral applied loads
- b. Internal loads and bolt reactions
- c. Composite tensile stresses, allowing for bolt hole concentration factors
- d. Composite angle strength (see Figure 6)
- e. Lug bearing and shearout stresses

FABRICATION METHODS

Joint Type K was fabricated by laying up preimpregnated graphite fabric on four aluminum blocks; these were then assembled for cocuring. Three fittings were cut and trimmed from the cured assembly, and bushings were installed. The fabrication process is shown in Figure 15.

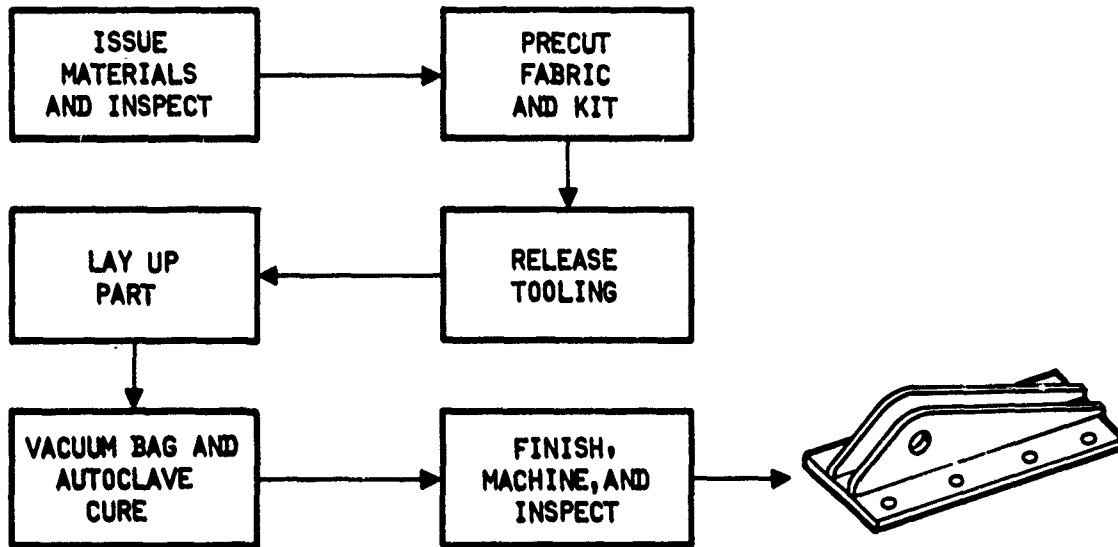

Figure 15. Manufacturing Steps: Type K

INSPECTION METHODS

In manufacturing these joints and fittings, as many components as possible are cocured during a single cycle. While this method of assembly has significant advantages from a manufacturing standpoint, it makes it impossible to individually inspect the various components that make up an assembly. The types of defects that can degrade the performance of composite structures are:

- a. Delaminations
- b. Unbonded areas
- c. Porosity or voids
- d. Resin-rich or resin-starved areas
- e. Geometry of internal details
- f. Thick bondlines
- g. Position and bond of metal inserts
- h. Foreign object inclusions

The importance of these defects varies with their size and location in relation to the size and geometry of the particular joint or fitting design in which they occur. Assurance that the finished part has been fabricated free of internal defects and has the proper internal geometry can only be obtained using nondestructive inspection techniques.

These techniques include the hammer tapping method, in which a small hammer is used to tap the surface of the composite component. The flat sound produced by tapping over an unbonded area or void is easily detected, even by an untrained ear, and an experienced inspector can readily determine and mark the boundaries of the unbonded area or void. Subsequent tapping can determine the growth of an unbonded area if it occurs.

The Shurtronics harmonic bond tester operates by physically transmitting high-frequency vibrations into bonded materials and monitoring the resulting acoustical response with a small hand-held transducer. The instrument is calibrated with a sample specimen of the same materials and layup as the part under examination, with known defects built in for reference. With the instrument calibrated for a known density and thickness, a reduction in local thickness caused by an unbonded area or other defect results in an amplitude or phase change in the received signal. Liquid coupling is not required for testing, and the probe can easily be used in any position.

COST/WEIGHT TRADE STUDY

The cost effectiveness of each composite fitting design was measured by considering the individual weight reductions afforded by switching to composites and the cost increments vis-a-vis the metal baseline. To differentiate between cost effective and cost ineffective designs, the cost differences and the weight reductions were plotted in Figure 16. The population of cost-vs-efficiency points is divided into two domains by the cost effectiveness break-even lines, with cost-effective designs residing above and to the left of the lines. Cost-effective designs possess features that add value (in the form of weight reduction) that more than offsets the extra expense. The slope of the break-even line is determined by the value of eliminating a pound of structure from a helicopter without altering its structural performance.

The cost of saving weight can also be portrayed by plotting part weight versus total cost (Figure 17).

The relationship between the cost and weight of composite fittings implies that the total cost per pound is \$174 for Joint Type D, \$329 for Type A, and \$593 for Type K. The \$300-per-pound line is added to the graph for comparison.

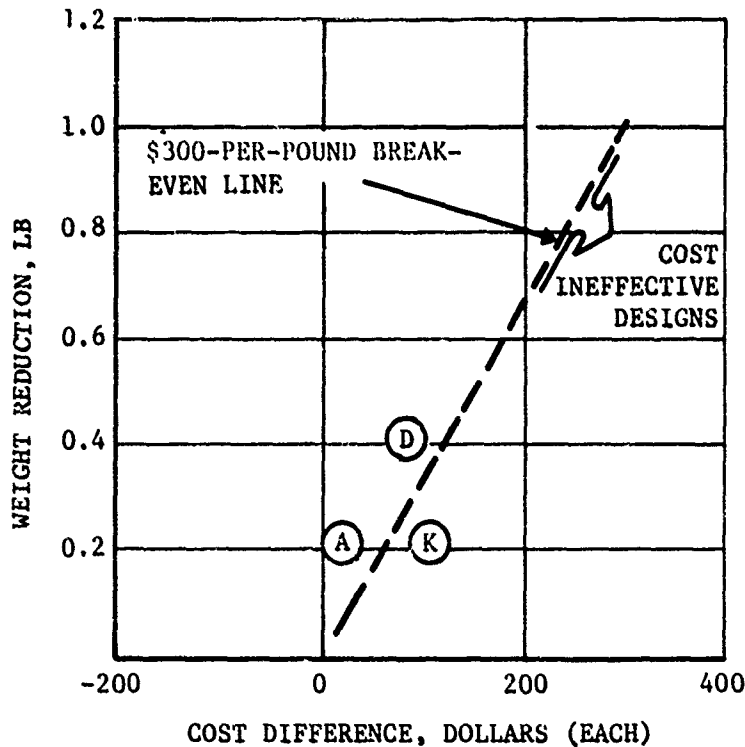

Figure 16. Break-Even Partitioning of Composite Fittings

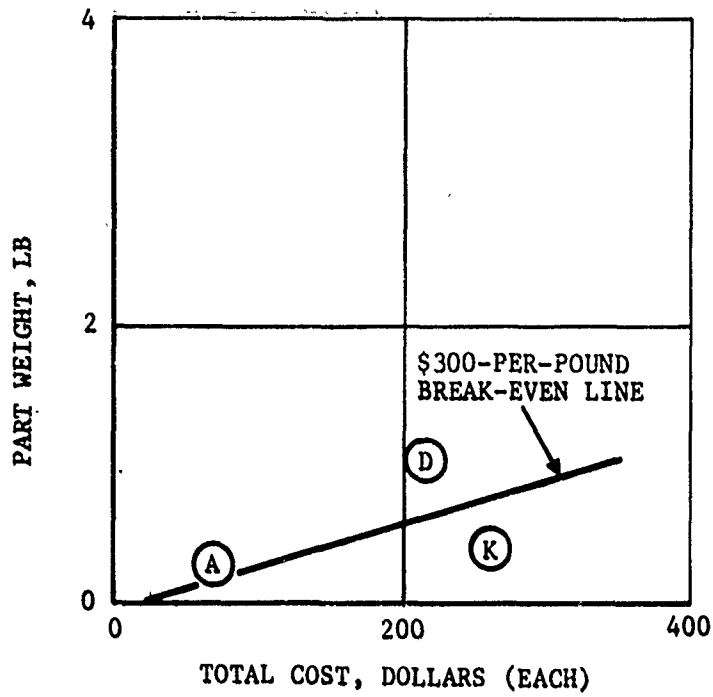

Figure 17. Cost vs Weight Relationship of Composite Fittings

FINITE ELEMENT ANALYSES

ANGLE BRACKET MODEL

Finite element models C-1 and C-2 were developed to predict the interlaminar shear present in the radius of an angle (Figure 18). Using the half-symmetrical C-1 model (Figure 19), variations in washer diameter, washer distance from the bend, lamina orientation, lamina thickness, and bend radius-to-thickness ratio can be investigated. Using the C-2 one-strip model, variations in stacking sequence can be analyzed (Figure 20).

To minimize computer costs, the analysis was conducted in two stages. The bracket was first analyzed as a single-layer (solid laminate), multistrip structure (C-1 model) to identify the critical strip and the corresponding boundary conditions. In the second stage of the analysis, the critical strip was further divided into many discrete layers (C-2 model), to represent the actual laminated structure, and analyzed in terms of the boundary conditions obtained from the C-1 model to identify interlaminar stresses.

It is possible to conduct many parametric analyses using the C-1 and C-2 models. Figure 21 shows the relationship between normalized shear stress (defined as interlaminar shear stress τ_{xy} divided by net tension stress σ_0) and the width of the angle bracket. It should be noted that, since the interlaminar shear stress in composite components ranges from 1,000 to 5,000 pounds per square inch, the net tension stress is limited to $\tau_{xy}/2.5$, or 400 to 2,000 pounds per square inch. Actual test results, however, indicate higher allowables.

INDIVIDUAL JOINT MODELS

NASTRAN models were developed for Joint Types A, D, and K. Instead of developing one three-dimensional model for each type, a pair of two-dimensional models was constructed to minimize development time. The models for Joint Types A, D, and K are shown in Figures 22 through 27. Orthotropic plates, with appropriate mechanical properties, are used in all instances.

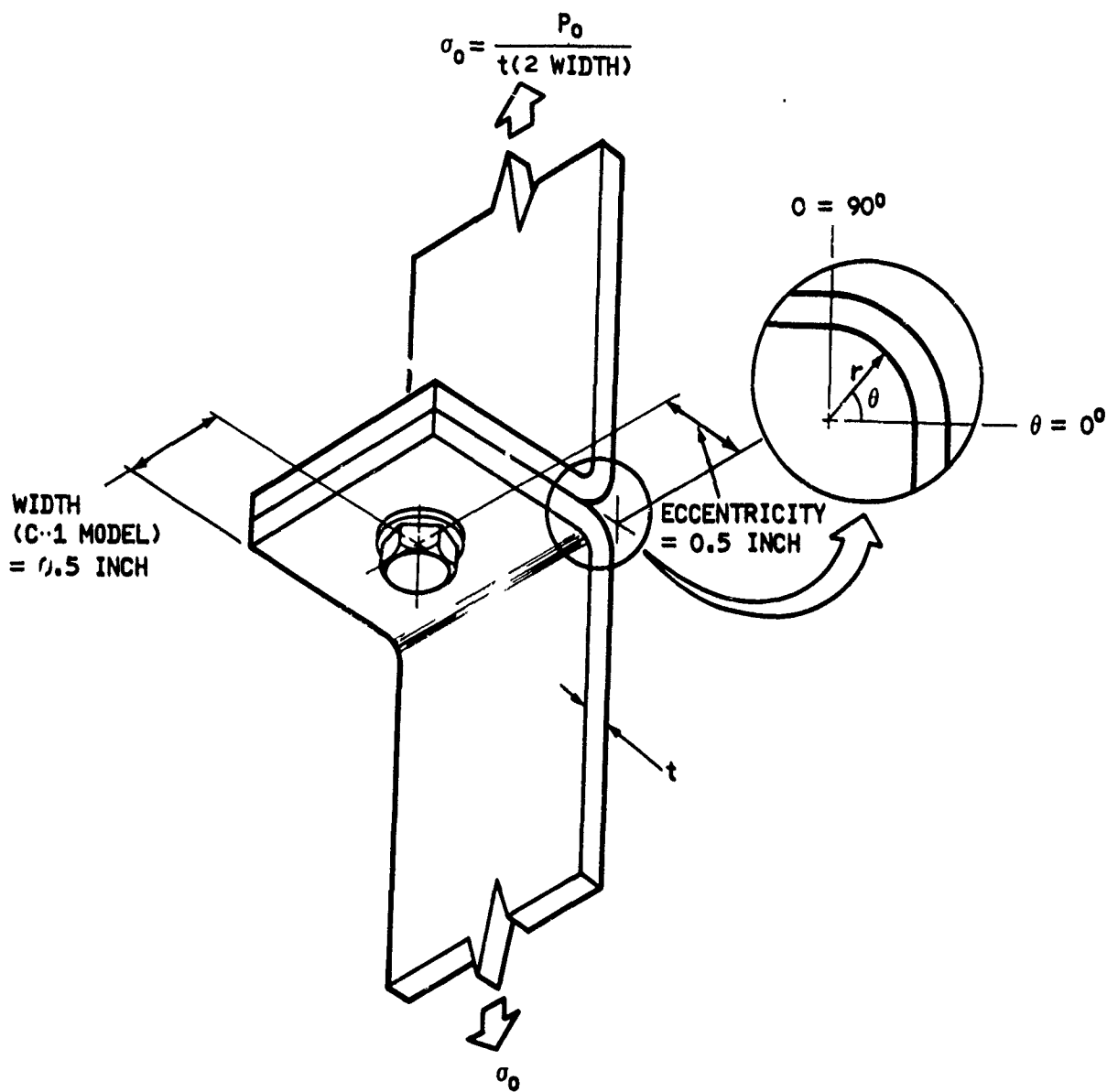

Figure 18. Typical Laminated Angle Bracket

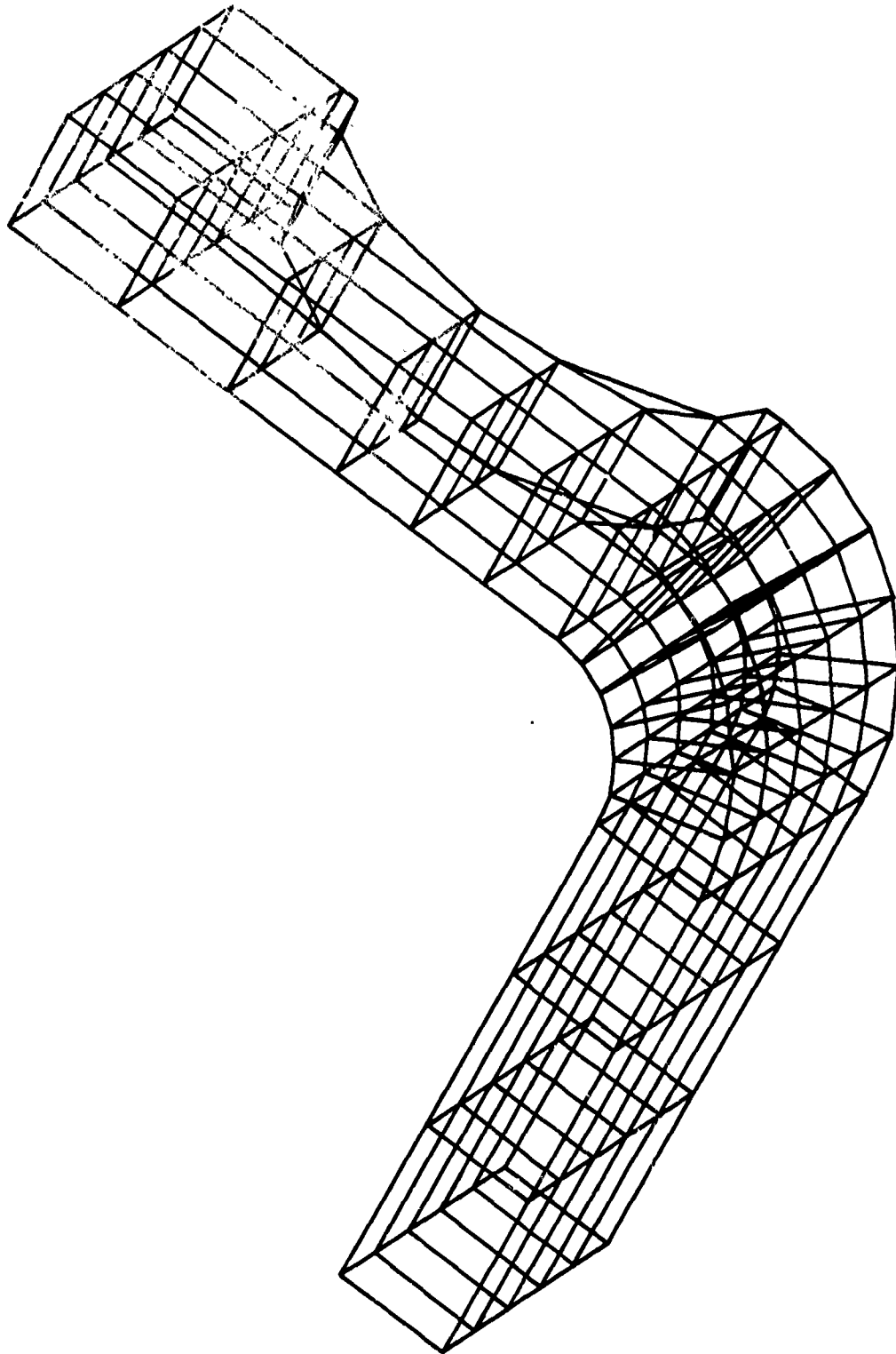

Figure 19. NASTRAN Model C-1

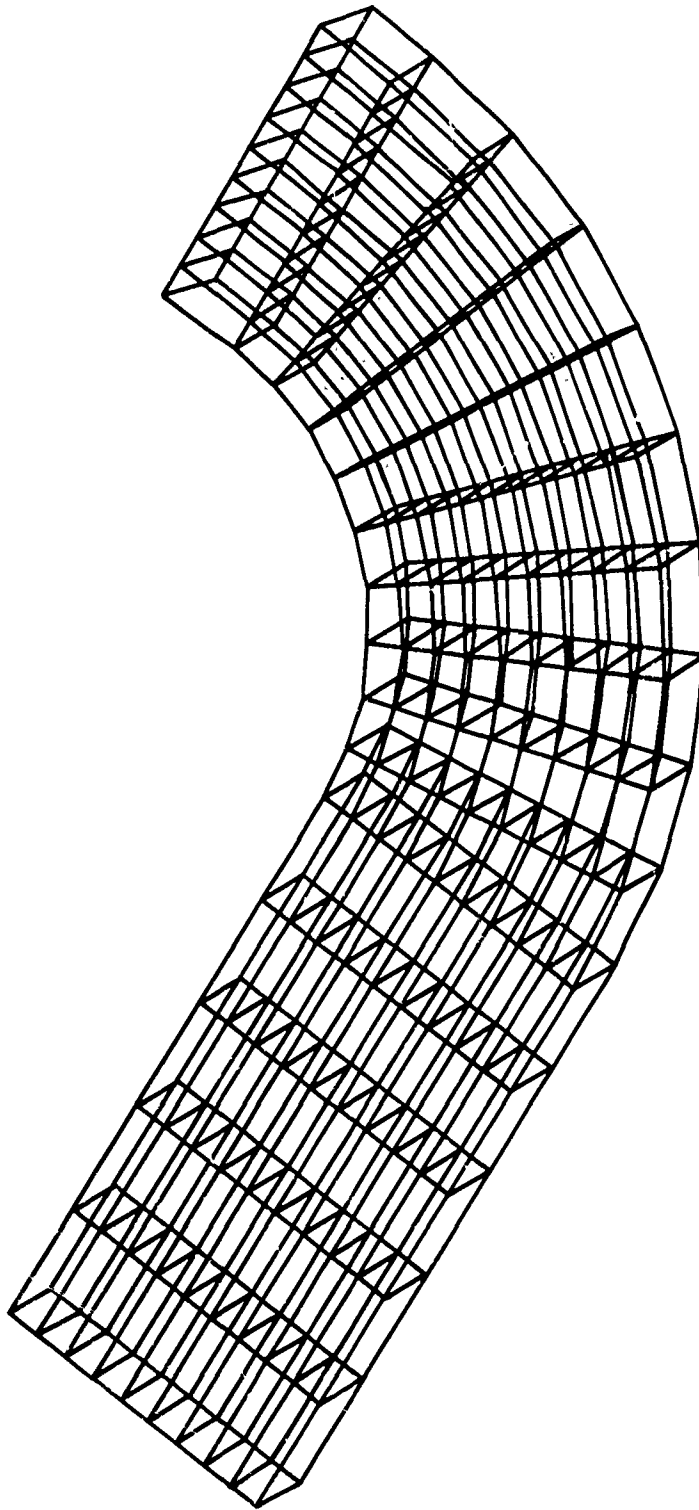

Figure 20. NASTRAN Model C-2

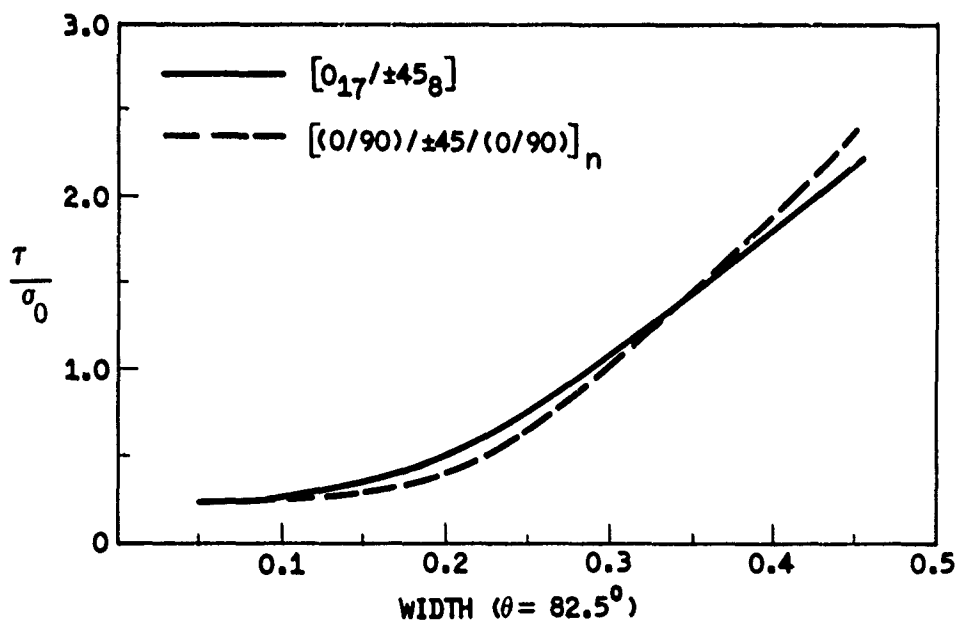
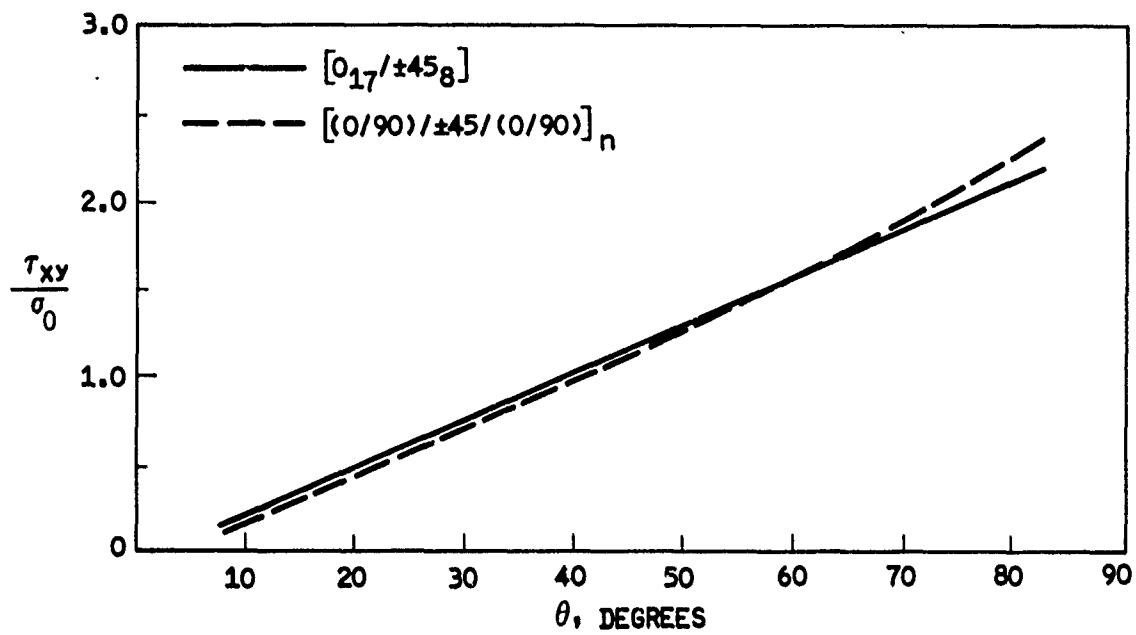

Figure 21. Normalized Shear Stress vs Bracket Angle and Width

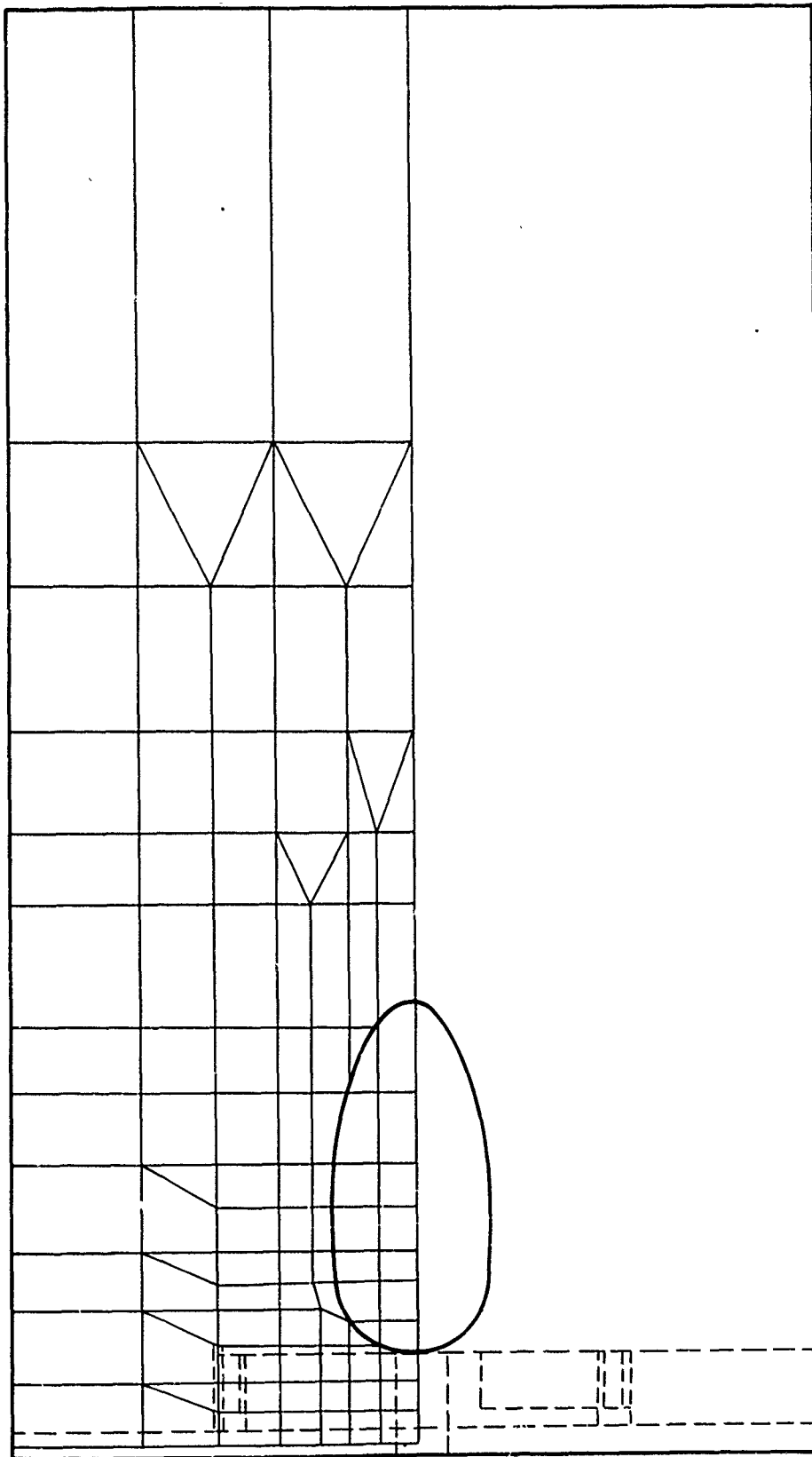
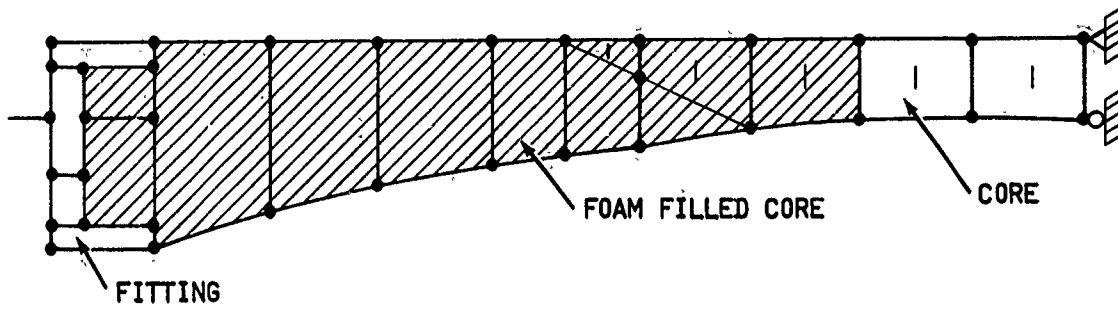
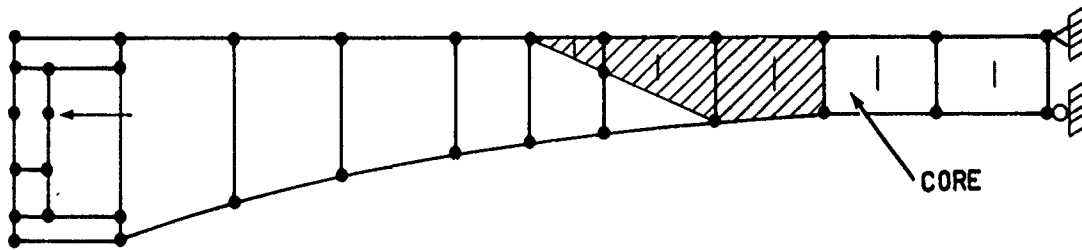

Figure 22. NASTRAN Model of Joint Type A (Top View)



SECTION B-B OF DRAWING No. 430-009 (Figure 10)



SECTION A-A OF DRAWING No. 430-009 (Figure 10)

Figure 23. NASTRAN Model of Joint Type A (Side View)

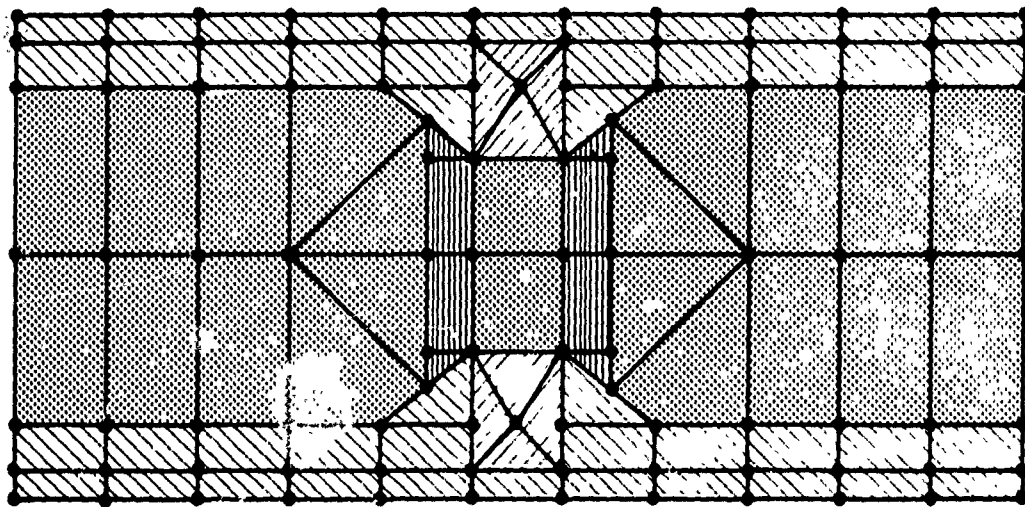





-  GRAPHITE SPAR ELEMENTS
-  4130 STEEL FITTING
-  HONEYCOMB SANDWICH
-  RIBS

Figure 24. NASTRAN Model of Joint Type D (Top View)





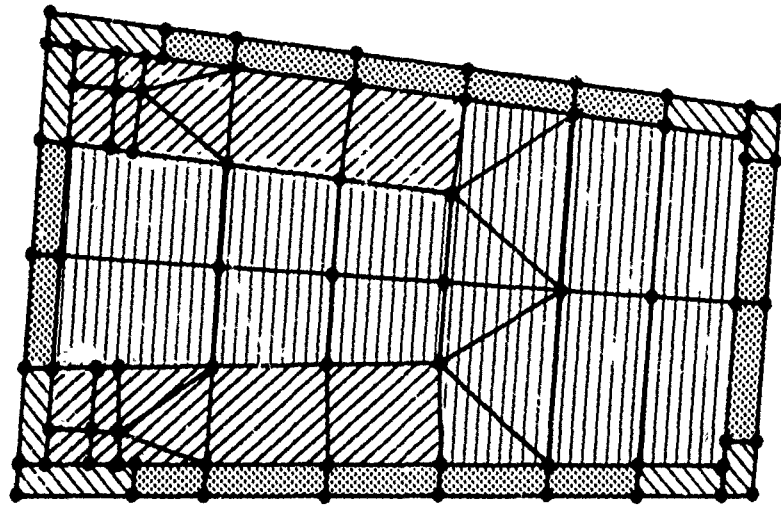

-  GRAPHITE SPAR ELEMENTS
-  4130 STEEL FITTING
-  HONEYCOMB SANDWICH
-  RIBS

Figure 25. NASTRAN Model of Joint Type D (Side View)



4
B

Figure 26. NASTRAN Model of Joint Type K (Front and Side Views)

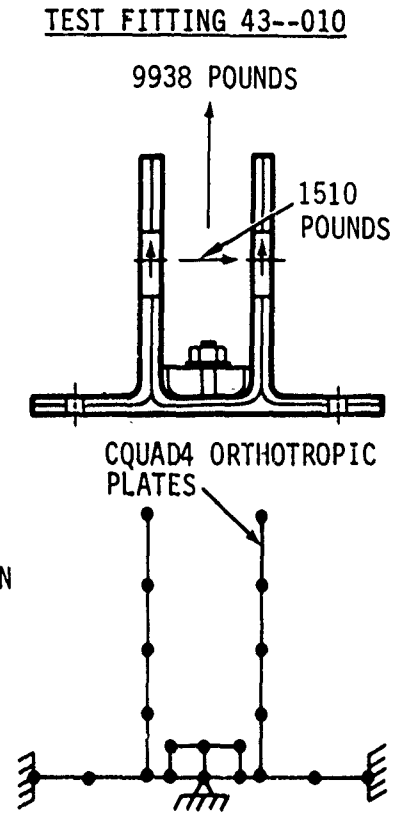
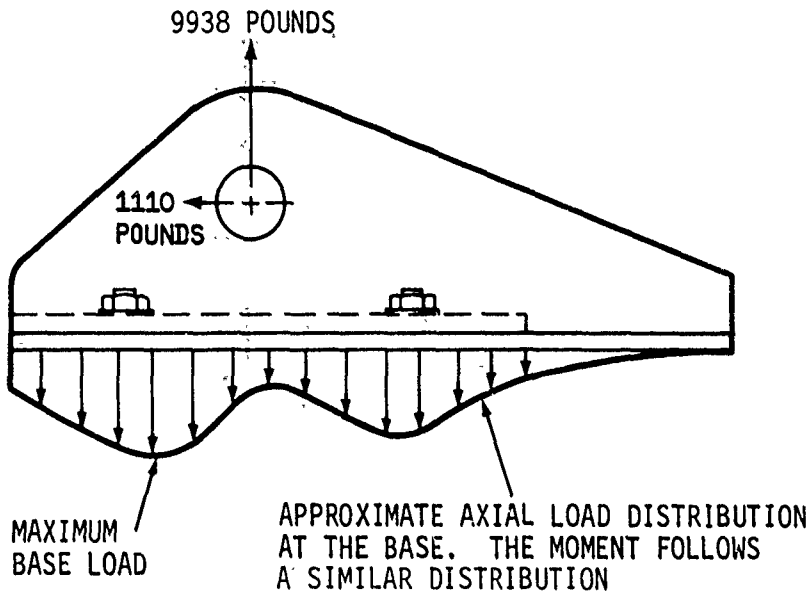
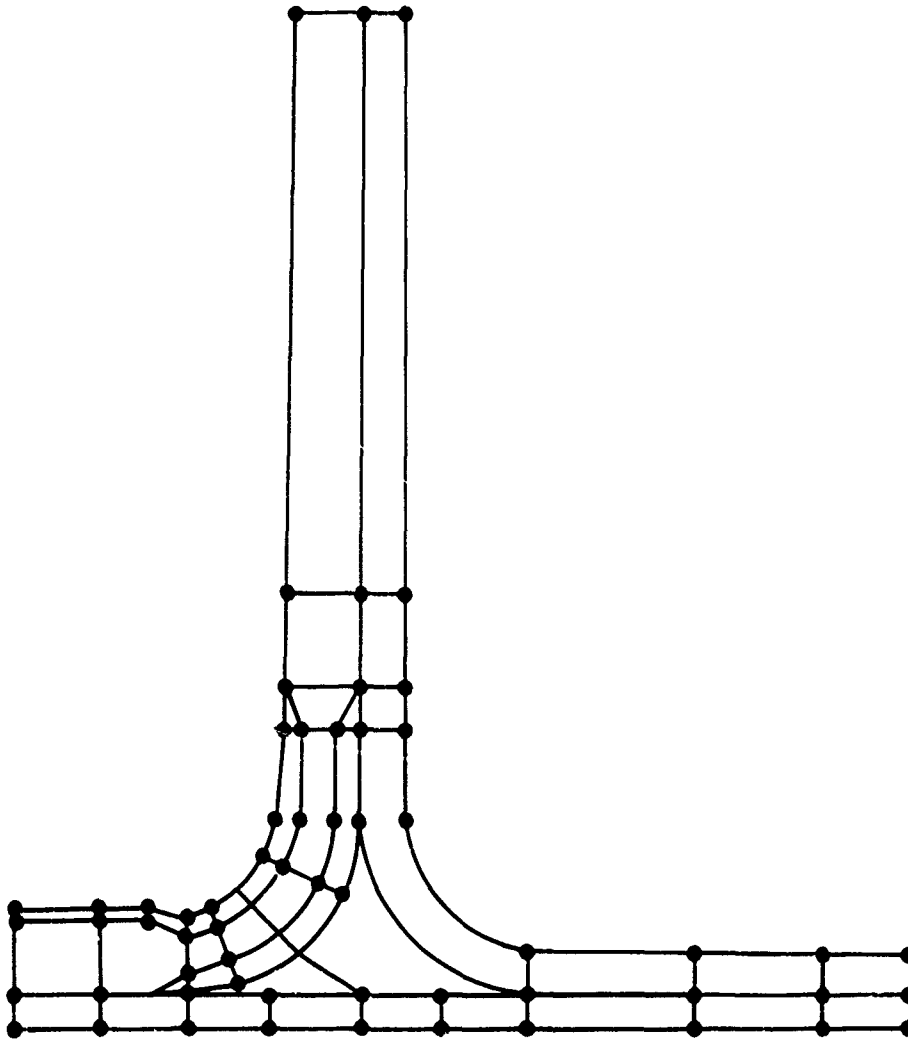

Figure 27. NASTRAN Model of Joint Type K
(Internal Loads)

BIBLIOGRAPHY

Advanced Composite Design Guide, AFFDL-DG-76-9, Volumes I and II,
Wright-Patterson Air Force Base, Ohio, July 1973.

Engineering Design Handbook: Joining of Advanced Composites, DARCOM-
P-706-316, U.S. Army Materiel Development and Readiness Command,
Alexandria, Virginia, March 1978.

Jones, R.M., "Mechanics of Composite Materials," Scripta, Washington,
D. C., 1975.

APPENDIX A

COMPOSITE MATERIAL ALLOWABLES

The graphite and Kevlar composite allowables used in the design analyses documented in this report are given in Tables A-1 through A-14. Laminate moduli, strength, and other physical property values are given as a function of fiber angle for fiber volumes of 0.55 and 0.60. Fiber, resin, and composite input data terms are defined as:

AF (AR) = Fiber (resin) coefficient of thermal expansion,
in./in./°F

AFT = Fiber transverse coefficient of thermal
expansion, in./in./°F

EF (ER) = Fiber (resin) elastic modulus, psi

EFT = Fiber transverse elastic modulus, psi

FCU = Fiber or composite ultimate compressive
strength, psi

FSU = Resin ultimate shear strength, psi

FTU = Fiber or composite ultimate tensile strength, psi

GF = Fiber shear modulus, psi

RHO = Composite density, lb/ft³

RHOF (RHOR) = Fiber (resin) density, lb/ft³

UF (UR) = Fiber (resin) Poisson's ratio (dimensionless)

VF (VR) = Fiber (resin) volume, percent

WF (WR) = Fiber (resin) weight, percent

Composite properties are abbreviated as follows:

ALPHA = Fiber angle, deg

AX = Coefficient of thermal expansion, X direction,
in. /in. /°F

AY = Coefficient of thermal expansion, Y direction,
in. /in. /°F

EX = Elastic modulus, X direction, psi

EY = Elastic modulus, Y direction, psi

FXCU = Ultimate compressive strength, X direction, psi

FXTU = Ultimate tensile strength, X direction, psi

FX Y = Ultimate shear strength, psi

FYCU = Ultimate compressive strength, Y direction, psi

FYTU = Ultimate tensile strength, Y direction, psi

GXY = Shear modulus, psi

UXY = Poisson's ratio, perpendicular to X direction
(dimensionless)

UYX = Poisson's ratio, perpendicular to Y direction
(dimensionless)

TABLE A-1. GRAPHITE COMPOSITE PROPERTIES

FIBER PROPERTIES		RESIN PROPERTIES		COMPOSITE PROPERTIES
VF = 0.5500	EF = 3.400E+07	VR = 0.4500	ER = 4.700E+05	RHO = 0.0535
WF = 0.6536	EFT = 1.300E+06	WR = 0.3464	AR = 4.000E-05	FTU = 178750.0
RHOF = 0.0636	GF = 3.500E+06	RHUF = 0.0412	UR = 0.3500	FCU = 118250.0
FTU = 325000.0	AF = -2.400E-07	FSU = 8000.0		FSU = 8000.0
FCU = 215000.0	AFT = 2.960E-06			
UF = 0.2200				
FIBER PROPERTIES		RESIN PROPERTIES		COMPOSITE PROPERTIES
VF = 0.6000	EF = 3.400E+07	VR = 0.4000	ER = 4.700E+05	RHO = 0.0546
WF = 0.6984	EFT = 1.300E+06	WR = 0.3016	AR = 4.000E-05	FTU = 195000.0
RHOF = 0.0636	GF = 3.500E+06	RHOF = 0.0412	UR = 0.3500	FCU = 129000.0
FTU = 325000.0	AF = -2.400E-07	FSU = 8000.0		FSU = 8000.0
FCU = 215000.0	AFT = 2.960E-06			
UF = 0.2288				

TABLE A-2. GRAPHITE MODULI (VF = 0.55)

ALPHA	EX	EY	GXY
0.00	1.891E+07	9.108E+05	5.665E+05
1.00	1.890E+07	9.107E+05	5.717E+05
2.00	1.886E+07	9.111E+05	5.873E+05
3.00	1.879E+07	9.119E+05	6.133E+05
4.00	1.869E+07	9.129E+05	6.494E+05
5.00	1.856E+07	9.143E+05	6.956E+05
6.00	1.839E+07	9.160E+05	7.515E+05
7.00	1.819E+07	9.180E+05	8.170E+05
8.00	1.795E+07	9.204E+05	8.917E+05
9.00	1.767E+07	9.231E+05	9.753E+05
10.00	1.734E+07	9.263E+05	1.067E+06
11.00	1.697E+07	9.299E+05	1.167E+06
12.00	1.655E+07	9.339E+05	1.275E+06
13.00	1.609E+07	9.385E+05	1.389E+06
14.00	1.559E+07	9.435E+05	1.510E+06
15.00	1.504E+07	9.492E+05	1.637E+06
16.00	1.445E+07	9.555E+05	1.769E+06
17.00	1.383E+07	9.624E+05	1.905E+06
18.00	1.319E+07	9.701E+05	2.045E+06
19.00	1.253E+07	9.786E+05	2.189E+06
20.00	1.185E+07	9.880E+05	2.335E+06
21.00	1.117E+07	9.984E+05	2.483E+06
22.00	1.049E+07	1.010E+06	2.632E+06
23.00	9.826E+06	1.022E+06	2.781E+06
24.00	9.175E+06	1.036E+06	2.930E+06
25.00	8.547E+06	1.051E+06	3.078E+06
26.00	7.844E+06	1.068E+06	3.224E+06
27.00	7.371E+06	1.087E+06	3.388E+06
28.00	6.830E+06	1.107E+06	3.508E+06
29.00	6.323E+06	1.130E+06	3.645E+06
30.00	5.849E+06	1.154E+06	3.777E+06
31.00	5.410E+06	1.181E+06	3.903E+06
32.00	5.004E+06	1.211E+06	4.024E+06
33.00	4.630E+06	1.244E+06	4.139E+06
34.00	4.286E+06	1.281E+06	4.246E+06
35.00	3.972E+06	1.321E+06	4.346E+06
36.00	3.685E+06	1.365E+06	4.438E+06
37.00	3.424E+06	1.414E+06	4.522E+06
38.00	3.187E+06	1.468E+06	4.596E+06
39.00	2.971E+06	1.527E+06	4.662E+06
40.00	2.775E+06	1.593E+06	4.718E+06
41.00	2.697E+06	1.665E+06	4.764E+06
42.00	2.436E+06	1.745E+06	4.800E+06
43.00	2.291E+06	1.834E+06	4.826E+06
44.00	2.159E+06	1.932E+06	4.842E+06
45.00	2.039E+06	2.048E+06	4.847E+06

TABLE A-3. GRAPHITE MODULI (VF = 0.60)

ALPHA	EX	EY	GXY
0.00	2.059E+07	9.451E+05	6.343E+05
1.00	2.057E+07	9.453E+05	6.400E+05
2.00	2.053E+07	9.439E+05	6.569E+05
3.00	2.045E+07	9.470E+05	6.850E+05
4.00	2.035E+07	9.485E+05	7.242E+05
5.00	2.020E+07	9.504E+05	7.742E+05
6.00	2.002E+07	9.528E+05	8.348E+05
7.00	1.980E+07	9.556E+05	9.058E+05
8.00	1.954E+07	9.590E+05	9.887E+05
9.00	1.924E+07	9.628E+05	1.077E+06
10.00	1.838E+07	9.672E+05	1.177E+06
11.00	1.848E+07	9.722E+05	1.205E+06
12.00	1.802E+07	9.778E+05	1.402E+06
13.00	1.752E+07	9.840E+05	1.526E+06
14.00	1.698E+07	9.989E+05	1.657E+06
15.00	1.637E+07	9.985E+05	1.794E+06
16.00	1.573E+07	1.002E+06	1.937E+06
17.00	1.906E+07	1.016E+06	2.065E+06
18.00	1.435E+07	1.026E+06	2.237E+06
19.00	1.363E+07	1.038E+06	2.392E+06
20.00	1.290E+07	1.058E+06	2.551E+06
21.00	1.216E+07	1.063E+06	2.711E+06
22.00	1.143E+07	1.078E+06	2.873E+06
23.00	1.071E+07	1.094E+06	3.834E+06
24.00	1.001E+07	1.112E+06	3.196E+06
25.00	9.332E+06	1.131E+06	3.356E+06
26.00	8.687E+06	1.152E+06	3.515E+06
27.00	8.066E+06	1.175E+06	3.670E+06
28.00	7.484E+06	1.200E+06	3.822E+06
29.00	6.937E+06	1.227E+06	3.970E+06
30.00	6.427E+06	1.257E+06	4.113E+06
31.00	5.957E+06	1.290E+06	4.250E+06
32.00	5.514E+06	1.326E+06	4.381E+06
33.00	5.110E+06	1.366E+06	4.505E+06
34.00	4.778E+06	1.409E+06	4.622E+06
35.00	4.398E+06	1.456E+06	4.738E+06
36.00	4.086E+06	1.508E+06	4.830E+06
37.00	3.801E+06	1.565E+06	4.920E+06
38.00	3.542E+06	1.627E+06	5.001E+06
39.00	3.306E+06	1.696E+06	5.072E+06
40.00	3.091E+06	1.771E+06	5.133E+06
41.00	2.895E+06	1.854E+06	5.183E+06
42.00	2.718E+06	1.845E+06	5.222E+06
43.00	2.556E+06	2.045E+06	5.250E+06
44.00	2.409E+06	2.155E+06	5.267E+06
45.00	2.276E+06	2.276E+06	5.273E+06

TABLE A-4 GRAPHITE STRENGTH ALLOWABLES (VF = 0.55)

ALPHA	FXTU	FYTU	FXCU	FYCU	FX Y
0.00	178750.0	0.0	118250.0	5673.3	4408.0
1.00	178296.6	6.5	118173.7	5674.2	4676.8
2.00	176949.2	26.1	117942.9	5677.0	4968.8
3.00	174744.6	58.8	117551.5	5681.7	5286.4
4.00	171741.7	104.7	116990.0	5688.4	5631.7
5.00	168017.3	163.8	116245.3	5697.1	6007.3
6.00	183661.7	236.3	115301.9	5707.8	6415.6
7.00	158773.6	322.3	114142.1	5720.7	6859.3
8.00	153454.8	422.1	112747.4	5735.9	7341.1
9.00	147806.4	535.7	111099.6	5753.5	7863.5
10.00	141924.5	663.5	109182.3	5773.6	8429.4
11.00	135898.0	805.6	106982.1	5796.4	9041.2
12.00	129806.1	962.5	104490.5	5822.2	9701.4
13.00	123718.0	1134.4	101705.1	5851.1	10412.3
14.00	117691.9	1321.7	98630.9	5883.3	11175.9
15.00	111775.8	1524.7	95281.4	5919.2	11993.7
16.00	106807.8	1744.0	91678.4	5959.1	12866.8
17.00	100417.4	1979.9	87852.4	6003.3	13796.0
18.00	95025.9	2233.0	83841.0	6052.2	14780.9
19.00	89848.3	2503.9	79688.1	6106.3	15820.9
20.00	84893.6	2793.2	75441.5	6165.9	16914.2
21.00	80166.4	3101.4	71150.6	6231.6	18058.1
22.00	75667.3	3429.3	66864.8	6304.1	19248.9
23.00	71394.2	3777.7	62630.6	6383.9	20481.8
24.00	67342.5	4147.4	58490.4	6471.8	21750.9
25.00	63505.9	4539.2	54480.7	6568.6	23049.1
26.00	59877.0	4954.1	50631.9	6675.1	24368.6
27.00	56447.3	5393.0	46967.4	6792.4	25700.1
28.00	53208.2	5857.2	43504.1	6921.5	27033.9
29.00	50150.4	6347.6	40252.5	7063.7	28359.4
30.00	47264.6	6865.6	37217.8	7220.2	29665.7
41.00	44541.9	7412.5	34400.0	7392.7	30941.7
32.00	41973.1	7989.7	31795.8	7582.6	32176.2
33.00	39549.6	8598.7	29398.5	7792.0	33358.7
34.00	37262.9	9241.3	27199.2	8022.7	34479.0
35.00	35105.2	9919.1	25187.4	8277.1	35527.9
36.00	33068.6	10634.0	23351.6	8557.8	36497.2
37.00	31146.0	11388.1	21680.0	8867.4	37379.6
38.00	29330.5	12183.6	20160.5	9209.2	38169.2
39.00	27615.7	13022.7	18781.1	9586.5	38861.1
40.00	25995.5	13908.0	17530.3	10003.3	39451.7
41.00	24464.1	14842.1	16397.0	10463.7	39937.9
42.00	23016.3	15828.0	15371.0	10972.5	40317.8
43.00	21647.1	16868.7	14442.5	11534.9	40590.0
44.00	20351.8	17967.5	13602.5	12156.5	40753.6
45.00	19126.0	19127.9	12842.7	12843.9	40808.2

TABLE A-5. GRAPHITE STRENGTH ALLOWABLES (VF = 0.60)

ALPHA	FXTU	FYTU	FXCU	FYCU	FXU
0.00	195000.0	0.0	129000.0	5902.6	4928.4
1.00	194519.1	7.3	128917.1	5903.9	5228.6
2.00	193089.4	29.3	128666.3	5907.9	5554.8
3.00	190748.9	68.0	128240.7	5914.6	5906.8
4.00	187558.2	117.4	127629.4	5924.0	6289.6
5.00	183597.0	183.8	126617.8	5936.3	6704.9
6.00	178958.5	265.1	125788.1	5951.4	7155.5
7.00	173745.4	361.6	124520.7	5969.5	7644.1
8.00	163264.0	473.5	122994.9	5990.7	8173.6
9.00	162020.2	601.6	121190.4	6015.1	8746.9
10.00	155715.4	744.3	119089.3	6043.0	9366.8
11.00	149243.4	903.6	116677.2	6074.5	10036.2
12.00	142688.9	1079.8	113945.3	6109.8	10757.9
13.00	136125.9	1272.5	110892.0	6149.2	11534.1
14.00	129617.5	1482.6	107524.1	6192.9	12367.2
15.00	123216.8	1710.3	103857.6	6241.3	13259.0
16.00	116963.3	1956.2	99918.1	6294.6	14210.7
17.00	118892.3	2220.7	95740.1	6353.4	15223.2
18.00	105027.2	2504.5	91366.3	6418.0	16296.3
19.00	99385.5	2808.2	86845.3	6488.8	17429.2
20.00	93978.6	3132.5	82229.6	6566.5	18620.1
21.00	88811.0	3478.0	77573.4	6651.6	19866.2
22.00	83886.2	3845.6	72929.5	6744.6	21163.2
23.00	79202.2	4236.0	68348.0	6846.4	22506.2
24.00	74755.1	4650.3	63873.5	6957.8	23888.4
25.00	70538.9	5089.3	59544.5	7079.5	25302.2
26.00	66546.1	5554.0	55392.2	7212.6	26738.6
27.00	62768.5	6045.7	51440.8	7358.2	28187.7
28.00	59196.9	6565.5	47707.1	7517.3	29638.5
29.00	55821.9	7114.7	44201.3	7691.4	31079.4
30.00	52633.8	7694.7	40928.2	7881.8	32498.3
31.00	49623.1	8306.9	37887.1	8090.2	33883.0
32.00	46780.3	8952.9	35073.8	8318.4	35221.3
33.00	44096.2	9634.5	32480.9	8568.3	36501.7
34.00	41561.7	10353.3	30098.6	8842.1	37713.1
35.00	39168.4	11111.5	27915.6	9142.2	38845.8
36.00	36908.0	11911.1	25919.7	9471.4	39890.9
37.00	34772.8	12754.2	24098.1	9832.6	40841.1
38.00	32755.4	13643.3	22438.2	10229.1	41690.1
39.00	30848.7	14581.1	20927.3	10664.6	42433.1
40.00	29046.2	15570.1	19553.3	11143.2	43066.4
41.00	27341.8	16613.4	18304.6	11669.3	43587.2
42.00	25729.7	17714.1	17170.2	12247.9	43993.8
43.00	24204.3	18875.7	16140.1	12884.6	44284.9
44.00	22760.6	20101.7	15204.8	13585.3	44459.7
45.00	21393.9	21396.1	14355.4	14356.7	44518.0

TABLE A-6. GRAPHITE POISSON'S RATIO AND THERMAL EXPANSION (VF = 0.55)

ALPHA	UXY	UYX	AX	AY
0.00	0.2785	0.0134	2.100E-07	1.716E-05
1.00	0.2841	0.0137	2.055E-07	1.716E-05
2.00	0.3009	0.0145	1.919E-07	1.713E-05
3.00	0.3287	0.0160	1.692E-07	1.709E-05
4.00	0.3872	0.0179	1.377E-07	1.704E-05
5.00	0.4160	0.205	9.739E-08	1.696E-05
6.00	0.4745	0.0236	4.847E-08	1.687E-05
7.00	0.5420	0.0274	-8.815E-09	1.677E-05
8.00	0.6176	0.0317	-7.420E-08	1.664E-05
9.00	0.7001	0.0366	-1.474E-07	1.650E-05
10.00	0.7883	0.0421	-2.279E-07	1.635E-05
11.00	0.8806	0.0483	-3.154E-07	1.617E-05
12.00	0.9754	0.0550	-4.094E-07	1.598E-05
13.00	1.0709	0.0625	-5.093E-07	1.576E-05
14.00	1.1663	0.0785	-6.143E-07	1.553E-05
15.00	1.2569	0.0793	-7.239E-07	1.528E-05
16.00	1.3427	0.0888	-8.371E-07	1.502E-05
17.00	1.4223	0.989	-9.531E-07	1.473E-05
18.00	1.4936	0.1099	-1.071E-06	1.442E-05
19.00	1.5554	0.1215	-1.189E-06	1.409E-05
20.00	1.6068	0.1340	-1.307E-06	1.374E-05
21.00	1.6472	0.1472	-1.423E-06	1.337E-05
22.00	1.6762	0.1613	-1.535E-06	1.298E-05
23.00	1.6941	0.1763	-1.643E-06	1.257E-05
24.00	1.7011	0.1921	-1.744E-06	1.214E-05
25.00	1.6978	0.2089	-1.836E-06	1.169E-05
26.00	1.6852	0.2266	-1.918E-06	1.122E-05
27.00	1.6640	0.2453	-1.988E-06	1.074E-05
28.00	1.6354	0.2651	-2.043E-06	1.023E-05
29.00	1.6004	0.2859	-2.082E-06	9.711E-06
30.00	1.5601	0.3078	-2.103E-06	9.176E-06
31.00	1.5154	0.3309	-2.102E-06	8.627E-06
32.00	1.4572	0.3552	-2.079E-06	8.068E-06
33.00	1.4165	0.3808	-2.031E-06	7.499E-06
34.00	1.3640	0.4076	-1.956E-06	6.923E-06
35.00	1.3103	0.4357	-1.852E-06	6.343E-06
36.00	1.2561	0.4653	-1.718E-06	5.761E-06
37.00	1.2017	0.4962	-1.553E-06	5.181E-06
38.00	1.1477	0.5287	-1.354E-06	4.605E-06
39.00	1.0944	0.5627	-1.122E-06	4.037E-06
40.00	1.0428	0.5982	-8.562E-07	3.480E-06
41.00	0.9907	0.6353	-5.562E-07	2.938E-06
42.00	0.9408	0.6740	-2.227E-07	2.412E-06
43.00	0.3923	0.7144	1.437E-07	1.907E-06
44.00	0.0454	0.7564	5.417E-07	1.425E-06
45.00	0.8001	0.8001	9.698E-07	9.691E-07

TABLE A-7. GRAPHITE POISSON'S RATIO AND THERMAL EXPANSION (VF = 0.60)

ALPHA	UXY	UYX	AX	AY
0.00	0.2720	0.0125	1.275E-07	1.575E-05
1.00	0.2779	0.0128	1.233E-07	1.574E-05
2.00	0.2954	0.0136	1.106E-07	1.572E-05
3.00	0.3243	0.0150	9.004E-08	1.568E-05
4.00	0.3844	0.0170	6.113E-08	1.562E-05
5.00	0.4152	0.0195	2.421E-08	1.554E-05
6.00	0.4760	0.0226	-2.052E-08	1.545E-05
7.00	0.5460	0.0263	-7.283E-08	1.534E-05
8.00	0.6243	0.0306	-1.324E-07	1.521E-05
9.00	0.7098	0.0355	-1.990E-07	1.507E-05
10.00	0.8005	0.0410	-2.721E-07	1.491E-05
11.00	0.8954	0.0471	-3.513E-07	1.473E-05
12.00	0.9926	0.0539	-4.361E-07	1.453E-05
13.00	1.0901	0.0612	-5.260E-07	1.432E-05
14.00	1.1059	0.0693	-6.202E-07	1.409E-05
15.00	1.2732	0.0780	-7.181E-07	1.384E-05
16.00	1.3649	0.0874	-8.188E-07	1.357E-05
17.00	1.4444	0.0975	-9.215E-07	1.328E-05
18.00	1.5151	0.1083	-1.025E-06	1.298E-05
19.00	1.5759	0.1199	-1.129E-06	1.265E-05
20.00	1.6257	0.1323	-1.232E-06	1.231E-05
21.00	1.6642	0.1455	-1.332E-06	1.195E-05
22.00	1.6912	0.1595	-1.429E-06	1.158E-05
23.00	1.7868	0.1743	-1.520E-06	1.118E-05
24.00	1.7115	0.1901	-1.605E-06	1.077E-05
25.00	1.7059	0.2067	-1.683E-06	1.035E-05
26.00	1.6911	0.2243	-1.750E-06	9.905E-06
27.00	1.6679	0.2429	-1.806E-06	9.449E-06
28.00	1.6374	0.2625	-1.850E-06	8.981E-06
29.00	1.6007	0.2832	-1.878E-06	8.501E-06
30.00	1.5589	0.3050	-1.890E-06	8.010E-06
31.00	1.5129	0.3279	-1.884E-06	7.511E-06
32.00	1.4637	0.3520	-1.858E-06	7.005E-06
33.00	1.4121	0.3774	-1.811E-06	6.493E-06
34.00	1.3589	0.4040	-1.741E-06	5.979E-06
35.00	1.3047	0.4828	-1.646E-06	5.463E-06
36.00	1.2500	0.4614	-1.526E-06	4.950E-06
37.00	1.1954	0.4921	-1.379E-06	4.440E-06
38.00	1.1413	0.5243	-1.205E-06	3.936E-06
39.00	1.0878	0.5581	-1.002E-06	3.442E-06
40.00	1.0354	0.5934	-7.719E-07	2.958E-06
41.00	0.9842	0.6363	-5.129E-07	2.489E-06
42.00	0.9744	0.6688	-2.258E-07	2.036E-06
43.00	0.8861	0.7089	8.896E-08	1.602E-06
44.00	0.8393	0.7568	4.304E-07	1.188E-06
45.00	0.7942	0.7843	7.975E-07	7.969E-07

TABLE A-8. KEVLAR 49 COMPOSITE PROPERTIES

FIBER PROPERTIES	RESIN PROPERTIES	COMPOSITE PROPERTIES
VF = 0.5500 EF = 1.900E+07 WF = 0.6085 EFT = 1.000E+06 RHOF = 0.0524 GF = 3.000E+05 FTU = 325000.0 AF = -3.440E-06 FCU = 70000.0 AFT = 3.000E-05 UF = 0.2200	VR = 0.4500 ER = 4.700E+05 WR = 0.3915 AR = 4.800E-05 RHOR = 0.0412 UR = 0.3500 FSU = 8000.0	RHO = 0.0474 FTU = 178750.0 FCU = 38500.0 FSU = 8000.0
FIBER PROPERTIES	RESIN PROPERTIES	COMPOSITE PROPERTIES
VF = 0.6000 EF = 1.900E+07 WF = 0.6561 EFT = 1.000E+06 RHOF = 0.0524 GF = 3.000E+05 FTU = 325000.0 AF = 3.440E-06 FCU = 70000.0 AFT = 3.000E-05 UF = 0.2200	VR = 0.4000 ER = 4.700E+05 WR = 0.3439 AR = 4.000E-05 RHOR = 0.0412 UR = 0.3500 FSU = 8.000.0	RHO = 0.0479 FTU = 195000.0 FCU = 42000.0 FSU = 8000.0

TABLE A-9. KEVLAR 49 MODULI (VF = 0.55)

ALPHA	EX	EY	GXY
0.00	1.066E+07	7.847E+05	2.349E+05
1.00	1.065E+07	7.845E+05	2.380E+05
2.00	1.563E+07	7.840E+05	2.472E+05
3.00	1.859E+07	7.830E+05	2.626E+05
4.00	1.053E+07	7.817E+05	2.840E+05
5.00	1.046E+07	7.800E+05	3.113E+05
6.00	1.037E+07	7.779E+05	3.444E+05
7.00	1.026E+07	7.755E+05	3.832E+05
8.00	1.012E+07	7.727E+05	4.274E+05
9.00	9.968E+06	7.696E+05	4.768E+05
10.00	9.791E+06	7.661E+05	5.312E+05
11.00	9.589E+06	7.623E+05	5.904E+05
12.00	9.364E+06	7.582E+05	6.540E+05
13.00	9.113E+06	7.538E+05	7.217E+05
14.00	8.838E+06	7.491E+05	7.932E+05
15.00	8.538E+06	7.441E+05	8.682E+05
16.00	8.215E+06	7.389E+05	9.483E+05
17.00	7.871E+06	7.335E+05	1.027E+06
18.00	7.509E+06	7.279E+05	1.110E+06
19.00	7.131E+06	7.221E+05	1.195E+06
20.00	6.741E+06	7.162E+05	1.282E+06
21.00	6.343E+06	7.102E+05	1.369E+06
22.00	5.942E+06	7.042E+05	1.457E+06
23.00	5.541E+06	6.983E+05	1.546E+06
24.00	5.145E+06	6.924E+05	1.634E+06
25.00	4.758E+06	6.867E+05	1.721E+06
26.00	4.384E+06	6.812E+05	1.808E+06
27.00	4.025E+06	6.761E+05	1.893E+06
28.00	3.685E+06	6.714E+05	1.976E+06
29.00	3.365E+06	6.674E+05	2.057E+06
30.00	3.066E+06	6.640E+05	2.135E+06
31.00	2.790E+06	6.614E+05	2.210E+06
32.00	2.535E+06	6.599E+05	2.281E+06
33.00	2.303E+06	6.597E+05	2.349E+06
34.00	2.092E+06	6.608E+05	2.413E+06
35.00	1.902E+06	6.537E+05	2.472E+06
36.00	1.732E+06	6.686E+05	2.526E+06
37.00	1.580E+06	6.758E+05	2.576E+06
38.00	1.445E+06	6.857E+05	2.620E+06
39.00	1.326E+06	6.987E+05	2.659E+06
40.00	1.221E+06	7.152E+05	2.692E+06
41.00	1.130E+06	7.358E+05	2.719E+06
42.00	1.050E+06	7.610E+05	2.740E+06
43.00	9.813E+05	7.915E+05	2.756E+06
44.00	9.219E+05	8.279E+05	2.765E+06
45.00	8.711E+05	8.712E+05	2.768E+06

TABLE A-10. KEVLAR 49 MODULI (VF = 0.60)

ALPHA	EX	EY	GXY
0.00	1.159E+07	8.053E+05	2.412E+05
1.00	1.158E+07	8.051E+05	2.445E+05
2.00	1.155E+07	8.045E+05	2.546E+05
3.00	1.151E+07	8.036E+05	2.713E+05
4.00	1.145E+07	8.022E+05	2.947E+05
5.00	1.137E+07	8.005E+05	3.245E+05
6.00	1.127E+07	7.983E+05	3.606E+05
7.00	1.114E+07	7.958E+05	4.029E+05
8.00	1.100E+07	7.930E+05	4.511E+05
9.00	1.083E+07	7.898E+05	5.050E+05
10.00	1.083E+07	7.862E+05	5.644E+05
11.00	1.0412E+07	7.823E+05	6.289E+05
12.00	0.106E+07	7.782E+05	6.983E+05
13.00	9.886E+06	7.735E+05	7.721E+05
14.00	9.5812E+06	7.687E+05	8.582E+05
15.00	9.249E+06	7.636E+05	9.319E+05
16.00	8.891E+06	7.553E+05	1.017E+06
17.00	8.509E+06	7.527E+05	1.105E+06
18.00	8.107E+06	7.469E+05	1.196E+06
19.00	7.688E+06	7.410E+05	1.288E+06
20.00	7.256E+06	7.349E+05	1.303E+06
21.00	6.816E+06	7.288E+05	1.478E+06
22.00	6.373E+06	7.226E+05	1.575E+06
23.00	5.9322E+06	7.165E+05	1.671E+06
24.00	5.497E+06	7.105E+05	1.767E+06
25.00	5.073E+06	7.046E+05	1.863E+06
26.00	4.664E+06	6.990E+05	1.957E+06
27.00	4.273E+06	6.938E+05	2.050E+06
28.00	3.903E+06	6.893E+05	2.140E+06
29.00	3.556E+06	6.848E+05	2.228E+06
30.00	3.233E+06	6.813E+05	2.314E+06
31.00	2.935E+06	6.787E+05	2.395E+06
32.00	2.662E+06	6.772E+05	2.473E+06
33.00	2.413E+06	6.769E+05	2.547E+06
34.00	2.188E+06	6.782E+05	2.617E+06
35.00	1.986E+06	6.812E+05	2.681E+06
36.00	1.805E+06	6.864E+05	2.740E+06
37.00	1.644E+06	6.939E+05	2.794E+06
38.00	1.501E+06	7.042E+05	2.843E+06
39.00	1.375E+06	7.177E+05	2.885E+06
40.00	1.265E+06	7.349E+05	2.921E+06
41.00	1.169E+06	7.563E+05	2.951E+06
42.00	1.085E+06	7.826E+05	2.974E+06
43.00	1.013E+06	8.143E+05	2.991E+06
44.00	9.506E+05	8.524E+05	3.001E+06
45.00	8.975E+05	8.975E+05	3.004E+06

TABLE A-11. KEVLAR 49 STRENGTH ALLOWABLES (VF = 0.55)

ALPHA	FXTU	FYTU	FXCU	FYCU	FX Y
0.00	178750.0	0.0	38500.0	2818.7	1413.4
1.00	178134.2	4.8	38474.8	2818.0	1498.5
2.00	176310.4	19.2	38398.7	2816.1	1596.7
3.00	173347.7	43.3	38270.3	2812.7	1709.5
4.00	169353.7	77.0	38087.3	2808.1	1838.6
5.00	164465.9	120.5	37846.7	2802.2	1985.6
6.00	158839.9	173.9	37544.7	2795.0	2152.4
7.00	152638.8	237.2	37176.8	2786.5	2340.7
8.00	146023.3	310.6	36738.3	2776.7	2552.3
9.00	139143.7	394.3	36224.1	2765.8	2789.0
10.00	132134.6	488.5	35629.2	2753.6	3052.2
11.00	125111.4	593.3	34949.3	2740.3	3343.6
12.00	118169.7	708.9	34180.4	2726.0	3664.3
13.00	111385.2	835.7	33320.0	2710.5	4015.3
14.00	104815.7	974.0	32367.0	2694.1	4397.2
15.00	98502.7	1123.9	31322.3	2676.7	4810.2
16.00	92473.9	1286.0	30188.9	2658.5	5253.8
17.00	86746.1	1460.5	28972.5	2639.6	5727.2
18.00	81326.6	1647.8	27681.1	2620.0	6228.8
19.00	76215.9	1848.5	26325.4	2599.9	6756.5
20.00	71409.1	2062.9	24918.4	2579.3	7307.5
21.00	66897.6	2291.6	23474.7	2558.6	7878.3
22.00	62669.8	2535.1	22010.3	2537.8	8465.0
23.00	58712.6	2794.1	20541.8	2517.1	9063.1
24.00	55011.8	3069.2	19085.8	2496.8	9667.8
25.00	51552.6	3361.1	17657.8	2477.2	10273.9
26.00	48320.3	3670.6	16272.2	2458.4	10876.3
27.00	45300.4	3998.4	14941.5	2441.0	11469.6
28.00	42478.7	4345.6	13675.9	2425.2	12048.9
29.00	39841.8	4712.9	12483.3	2411.5	12609.5
30.00	37376.9	5101.4	11369.1	2400.4	13147.0
31.00	35071.8	5512.3	10336.7	2392.5	13657.5
32.00	32915.2	5946.6	9387.3	2388.3	14138.0
33.00	30896.5	6405.8	8520.4	2388.7	14585.9
34.00	29006.0	6891.1	7734.0	2394.4	14999.0
35.00	27234.3	7404.1	7025.0	2406.4	15376.2
36.00	25573.0	7946.3	6389.4	2425.7	15716.5
37.00	24014.4	8519.4	5822.7	2453.6	16019.5
38.00	22551.1	9125.4	5320.1	2491.2	16285.2
39.00	21176.5	9766.3	4876.4	2540.3	16513.9
40.00	19884.3	10444.2	4486.7	2602.4	16706.1
41.00	18669.0	11161.4	4146.0	2679.4	16862.3
42.00	17525.2	11920.6	3849.7	2773.6	16983.0
43.00	16448.1	12724.4	3593.2	2887.2	17068.8
44.00	15433.3	13575.9	3372.4	3022.9	17120.1
45.00	14476.7	14478.2	3183.4	3183.7	17137.2

S
F

TABLE A-12. KEVLAR 49 STRENGTH ALLOWABLES (VF = 0.60)

ALPHA	FXTU	FYTU	FXCU	FYCU	FXY
0.00	0.0	0.0	42000.0	2904.8	1460.9
1.00	194288.9	4.9	41972.5	2904.1	1550.0
2.00	192184.6	19.8	41889.3	2902.1	1652.9
3.00	188771.6	44.6	41748.9	2898.6	1771.3
4.00	184181.1	79.3	41548.7	2893.8	1906.9
5.00	178579.5	124.2	41284.9	2887.7	2061.8
6.00	172154.1	179.2	40953.1	2880.3	2237.6
7.00	165099.2	244.4	40548.1	2871.5	2436.5
8.00	157604.1	320.1	40064.4	2861.4	2660.5
9.00	149843.9	406.4	39496.0	2850.1	2911.3
10.00	141973.1	503.4	38837.2	2837.6	3191.0
11.00	134122.3	611.4	36002.6	2823.0	3501.3
12.00	126397.4	730.6	37227.9	2809.0	3843.5
13.00	118880.9	861.4	36270.2	2793.0	4219.0
14.00	111633.6	1003.9	35200.1	2776.0	4628.5
15.00	104898.0	1158.5	34042.9	2758.1	5072.4
16.00	98100.8	1325.6	32778.4	2739.3	5550.5
17.00	91856.4	1505.6	31421.2	2719.7	6062.1
18.00	85969.1	1698.8	29981.1	2699.4	6605.7
19.00	80435.8	1905.8	28470.6	2678.6	7179.0
20.00	75248.0	2127.0	26904.9	2657.4	7779.4
21.00	70393.1	2362.9	25301.0	2636.0	8403.0
22.00	65856.3	2614.3	23677.4	2614.4	9045.8
23.00	61620.7	2881.6	22653.1	2593.0	9702.8
24.00	57669.2	3165.6	20446.6	2572.1	10368.8
25.00	53984.0	3467.0	18875.6	2551.7	11038.0
26.00	50547.7	3786.5	17355.8	2532.3	11704.6
27.00	47343.6	4125.2	15900.6	2514.3	12362.7
28.00	44355.2	4483.8	14521.0	2497.9	13006.6
29.00	41567.4	4863.3	13225.1	2483.7	13630.6
30.00	38965.5	5264.9	12018.3	2472.2	14229.9
31.00	36536.0	5689.7	10903.5	2464.0	14800.1
32.00	34266.2	6138.8	9881.5	2459.7	15337.2
33.00	32144.4	6613.8	8950.9	2460.1	15838.2
34.00	30159.6	7115.9	8109.2	2466.1	16300.7
35.00	28301.7	7646.8	7352.2	2478.5	16723.1
36.00	26561.6	8208.2	6675.4	2498.6	17104.3
37.00	24930.5	8801.8	6073.4	2527.6	17443.7
38.00	23400.7	9429.7	5540.5	2566.8	17741.4
39.00	21964.8	10093.9	5071.2	2617.8	17997.5
40.00	20616.3	10796.8	4659.7	2682.5	18212.7
41.00	19348.9	11540.8	4300.6	2762.9	18387.5
42.00	18156.9	12328.7	3988.8	2861.1	18522.6
43.00	17035.3	13163.4	3719.3	2979.7	18618.7
44.00	15979.3	14047.9	3487.6	3121.6	18676.0
45.00	14984.3	14985.9	3289.6	3289.9	18695.1

S
B

TABLE A-13. KEVLAR 49 POISSON'S RATIO AND THERMAL EXPANSION (VF = 0.55)

ALPHA	UXY	UYX	AX	AY
0.00	0.2785	0.205	-2.578E-06	2.844E-05
1.00	0.2824	0.208	-2.587E-06	2.843E-05
2.00	0.2942	0.217	-2.613E-06	2.843E-05
3.00	0.3138	0.232	-2.656E-06	2.841E-05
4.00	0.3410	0.0253	-2.716E-06	2.840E-05
5.00	0.3757	0.0280	-2.794E-06	2.838E-05
6.00	0.4178	0.0313	-2.889E-06	2.835E-05
7.00	0.4668	0.0353	-3.002E-06	2.831E-05
8.00	0.5224	0.0399	-3.132E-06	2.827E-05
9.00	0.5841	0.0451	-3.279E-06	2.822E-05
10.00	0.6513	0.0510	-3.445E-06	2.816E-05
11.00	0.7233	0.0575	-3.627E-06	2.809E-05
12.00	0.7991	0.0647	-3.828E-06	2.802E-05
13.00	0.8777	0.0726	-4.045E-06	2.792E-05
14.00	0.9580	0.0812	-4.280E-06	2.782E-05
15.00	1.0387	0.0905	-4.532E-06	2.770E-05
16.00	1.1184	0.1006	-4.800E-06	2.756E-05
17.00	1.1958	0.1114	-5.085E-06	2.739E-05
18.00	1.2694	0.1230	-5.384E-06	2.721E-05
19.00	1.3379	0.1355	-5.698E-06	2.700E-5
20.00	1.4001	0.1487	-6.024E-06	2.676E-05
21.00	1.4547	0.1629	-6.361E-06	2.649E-05
22.00	1.5010	0.1779	-6.707E-06	2.618E-05
23.00	1.5383	0.1939	-7.059E-06	2.582E-05
24.00	1.5662	0.2108	-7.413E-06	2.542E-05
25.00	1.5845	0.2287	-7.767E-06	2.497E-05
26.00	1.5934	0.2476	-8.114E-06	2.446E-05
27.00	1.5932	0.2676	-8.449E-06	2.388E-05
28.00	1.5845	0.2887	-8.764E-06	2.323E-05
29.00	1.5679	0.3109	-9.052E-06	2.251E-05
30.00	1.5442	0.3344	-9.304E-06	2.170E-05
31.00	1.5142	0.3590	-9.507E-06	2.079E-05
32.00	1.4789	0.3850	-9.652E-06	1.979E-05
33.00	1.4392	0.4122	-9.723E-06	1.869E-05
34.00	1.3957	0.4408	-9.708E-06	1.749E-05
35.00	1.3495	0.4708	-9.591E-06	1.618E-05
36.00	1.3011	0.5023	-9.357E-06	1.477E-05
37.00	1.2513	0.5352	-8.992E-06	1.325E-5
38.00	1.2006	0.5697	-8.483E-06	1.165E-05
39.00	1.1495	0.6056	-7.820E-06	9.969E-06
40.00	1.0984	0.6432	-6.995E-06	8.228E-06
41.00	1.0477	0.6823	-6.005E-06	6.448E-06
42.00	0.9978	0.7230	-4.852E-06	4.654E-06
43.00	0.9487	0.7652	-3.546E-06	2.874E-06
44.00	0.9008	0.8090	-2.098E-06	1.136E-06
45.00	0.8542	0.8543	-5.289E-07	-5.316E-07

TABLE A-14. KEVLAR 49 POISSON'S RATIO AND THERMAL EXPANSION (VF = 0.60)

ALPHA	UXY	UYX	AX	AY
0.00	0.2720	0.0189	-2.735E-06	2.821E-05
1.00	0.2762	0.0192	-2.744E-06	2.820E-05
2.00	0.2887	0.201	-2.770E-06	2.620E-05
3.00	0.3095	0.0216	-2.813E-06	2.819E-05
4.00	0.3384	0.0237	-2.874E-06	2.817E-05
5.00	0.3734	0.0264	-2.952E-06	2.815E-05
6.00	0.4201	0.0298	-3.047E-06	2.812E-05
7.00	0.4722	0.0337	-3.160E-06	2.808E-05
8.00	0.5313	0.0383	-3.291E-06	2.804E-05
9.00	0.5969	0.0435	-3.439E-06	2.799E-05
10.00	0.6683	0.0494	-3.605E-06	2.794E-05
11.00	0.7447	0.0559	-3.768E-06	2.787E-05
12.00	0.8251	0.0632	-3.989E-06	2.779E-05
13.00	0.9084	0.0711	-4.208E-06	2.770E-05
14.00	0.9933	0.0797	-4.444E-06	2.760E-05
15.00	1.0784	0.0890	-4.697E-06	2.748E-05
16.00	1.1623	0.991	-4.967E-06	2.734E-05
17.00	1.2434	0.1100	-5.253E-06	2.718E-05
18.00	1.3203	0.1216	-5.554E-06	2.699E-05
19.00	1.3914	0.1341	-5.870E-06	2.679E-05
20.00	1.4554	0.1474	-6.198E-06	2.655E-05
21.00	1.5113	0.1616	-6.538E-06	2.633E-05
22.00	1.5580	0.1767	-6.887E-06	2.597E-05
23.00	1.5951	0.1927	-7.242E-06	2.562E-05
24.00	1.6220	0.2097	-7.601E-06	2.522E-05
25.00	1.6387	0.2276	-7.958E-06	2.477E-05
26.00	1.6455	0.2466	-8.310E-06	2.426E-05
27.00	1.6428	0.2667	-8.650E-06	2.368E-05
28.00	1.6312	0.2880	-8.971E-06	2.303E-05
29.00	1.6115	0.3103	-9.265E-06	2.231E-05
30.00	1.5846	0.3339	-9.523E-06	2.150E-05
31.00	1.5514	0.3587	-9.733E-06	2.060E-05
32.00	1.5129	0.3849	-9.884E-06	1.960E-05
33.00	1.4700	0.4123	-9.963E-06	1.850E-05
34.00	1.4235	0.4412	-9.954E-06	1.729E-05
35.00	1.3744	0.4715	-9.844E-06	1.598E-05
36.00	1.3234	0.5032	-9.616E-06	1.456E-05
37.00	1.2711	0.5365	-9.257E-06	1.305E-05
38.00	1.2181	0.5714	-8.753E-06	1.144E-05
39.00	1.1649	0.6078	-8.093E-06	9.751E-06
40.00	1.1120	0.6459	-7.271E-06	8.003E-06
41.00	1.0596	0.6856	-6.281E-06	6.215E-06
42.00	1.0081	0.7270	-5.128E-06	4.413E-06
43.00	0.9577	0.7700	-3.819E-06	2.625E-06
44.00	0.9085	0.8146	-2.367E-06	3.792E-07
45.00	0.8609	0.8609	-7.920E-07	-7.947E-07

APPENDIX B

ANGLE BRACKET STUDY

Tension fittings, frequently referred to as "bathtub" fittings (Figure B-1), provide an effective method of transferring axial load across removable helicopter joints. This type of fitting is commonly fabricated from metals whose strength and stiffness are essentially the same in all directions (i. e., they are isotropic and homogeneous).

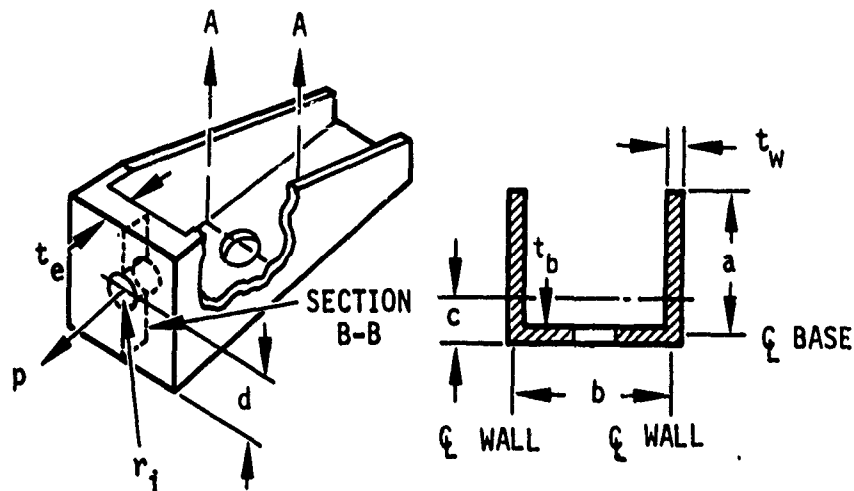

Figure B-1. "Bathtub" Tension Fitting

The design and fabrication of similar fittings from reinforced composites present several problems that do not arise in the design of metal fittings:

- The strength and stiffness of composite materials depend on fiber orientation.
- The bearing and shear strengths of composites are low in comparison with their unidirectional tensile strength and the tensile strength of metals.

- The three-dimensional state of stress that exists in composite fittings complicates the analysis of these structures.
- The failure modes of composites are different from those of metals.

A major problem in designing attachment fittings using reinforced composites is "turning the corner." A simple example is the bolted angle bracket shown in Figure B-2. In bolted angle brackets, a tension load applied to one leg of the angle is reacted by a shear load in the other leg. As a result of the inherent eccentricity, a bending moment is present in both legs and, in particular, in the radius of the angle. In composites, the transfer of the load from tension in one leg to shear in the other and the transfer of the bending moment around the corner limit the strength of the fitting because composites possess nonuniform properties. The situation is complicated by several discontinuities:

- The tension bolt-washer interface
- The turn-the-corner problem
- The load distribution around the hole
- The material behavior

This problem had to be solved in order to design effective composite tension fittings. An analytical solution was required, along with experimental data to verify the accuracy of the analysis.

METHODOLOGY

The nature of the stress field in the corner of an angle bracket was investigated using several theoretical methods including classical two-dimensional thin laminate theory, thick laminated plate theory, and cylindrical shell theory. Results obtained using the two-dimensional classical theory were comparable with parametric study results obtained using finite element models C-1 and C-2.

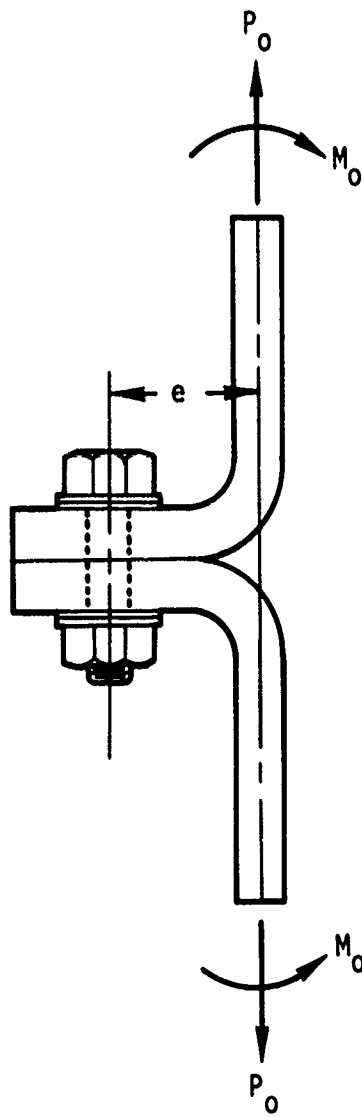

P_o = APPLIED TENSION LOAD

M_o = MOMENT DUE TO ECCENTRICITY e

Figure B-2. Turning the Corner

When a pure axial tension load is applied to an angle bracket (Figure B-3), the internal axial, shear, and moment loads vary as a function of the bend angle θ . These loads are simply:

$$N_{\theta} = N_0 \cos \theta$$

$$S_{\theta} = N_0 \sin \theta$$

$$M_{\theta} = N_0 \bar{R} (1 - \cos \theta)$$

where the distance to the center of the laminate is $\bar{R} = R_0 + t/2$. At high values of θ , the shear and moment loads will create critical interlaminar shear and transverse tensile stresses. These effects will be discussed with the NASTRAN results.

The reduced stiffnesses of an orthotropic lamina in a flat composite plate are:

$$Q_{11} = \frac{E_1}{1 - \nu_{12} \nu_{21}}$$

$$Q_{12} = \frac{\nu_{12} E_2}{1 - \nu_{12} \nu_{21}} = \frac{\nu_{21} E_1}{1 - \nu_{12} \nu_{21}}$$

$$Q_{22} = \frac{E_2}{1 - \nu_{12} \nu_{21}}$$

$$Q_{66} = G_{12}$$

where

E_1, E_2 = Young's moduli in one and two directions, respectively

ν_{ij} = Poisson's ratio for transverse strain in the j -direction when stressed in the i -direction

G_{12} = shear modulus in the 1-2 plane

- N_{θ} = NORMAL STRESS
- S_{θ} = SHEAR STRESS
- M_{θ} = MOMENT
- R_o = INSIDE RADIUS
- \bar{R} = AVERAGE RADIUS
- N_o = APPLIED LOAD
- t_k = THICKNESS OF k^{th} LAMINA
- h_k = DISTANCE FROM AVERAGE RADIUS TO k^{th} LAMINA

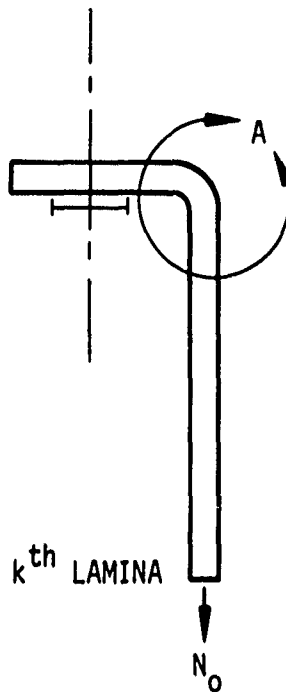

DETAIL A

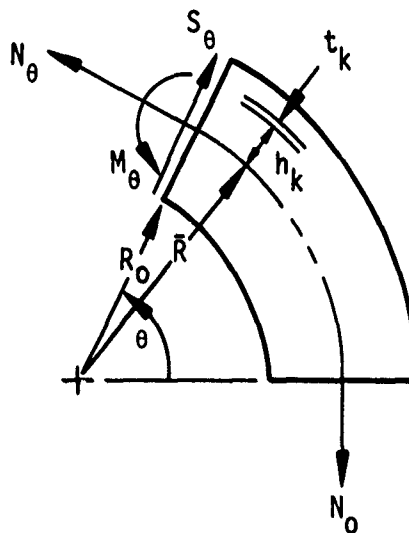

Figure B-3. Internal Loads in the Corner Region

Laminated bending stiffnesses are defined as

$$D_{ij} = \frac{1}{3} \sum_{k=1}^N (\bar{Q}_{ij})_k (h_k^3 - h_{k-1}^3)$$

where Q_{ij} are the reduced stiffnesses when transformed to a rotated x-y axis and h_k is defined in Figure B-4.

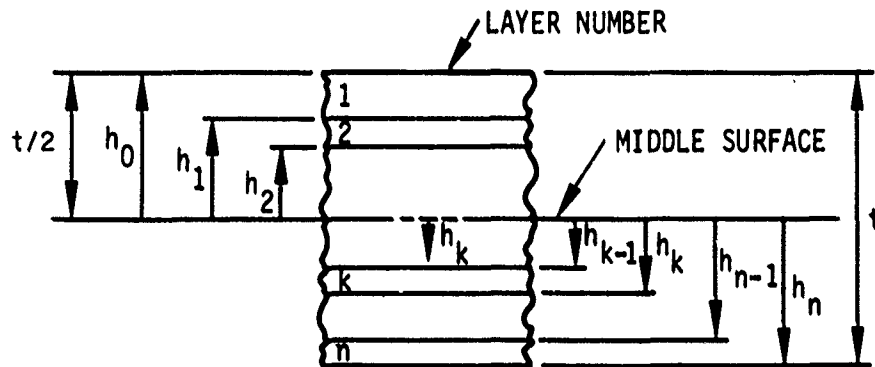

Figure B-4. Laminate Geometry

The normalized tangential stress in the corner of an angle bracket is

$$\frac{\sigma_{\theta}^k}{\sigma_0} = \left\{ \frac{t (R_0 + t/2) [1 - \cos \theta] (h_k + t_k/2)}{D_{\theta\theta}} + \frac{\cos \theta}{Q_{\theta\theta}} \right\} Q_{\theta\theta}^k$$

where $D_{\theta\theta}$ and $Q_{\theta\theta}$ are equal to D_{11} and Q_{11} , respectively, and $\sigma_0 = N_0/t$. At θ equal to 0 degrees, there is no bending stress component, as expected.

Similarly, the normalized interlaminar shear stress in the corner region was evaluated as

$$\frac{\tau_{r\theta}^k}{\sigma_0} = \frac{t \sin \theta}{2G_{r\theta}} \left[\left(\frac{t}{2} \right)^2 - \left(h_k + t_k/2 \right)^2 \right] G_{r\theta}^k$$

where $G_{r\theta}$ is the laminate shear modulus using the radial coordinate system. Given a particular lamina, the value of $\tau_{r\theta}^k/\sigma_0$ varies as a function of $\sin \theta$.

Despite the relative simplicity of these equations, the results show excellent agreement with results obtained using the NASTRAN C-1 and C-2 preprocessor models developed for this contracted effort.

FINITE ELEMENT MODEL

Modeling Considerations

The finite element model of the angle bracket to be investigated was designed in accordance with the following considerations:

- Since the geometry of the bracket fitting and the applied loads are both symmetrical, it is necessary to analyze only half of the bracket, using appropriate boundary constraints.
- To avoid using a dense mesh and yet obtain reliable results in critical parts of the bracket (parts with high stress/strain gradients), higher-order isoparametric solid elements (HEXA, PENTA) are employed.
- For modeling purposes, the bracket is subdivided into four parts (Figure B-5) such that each part can be independently provided with a mesh size appropriate to its stress/strain gradients.
- The mesh size for each bracket part is chosen so as to lend itself to automatic resolution into discrete strips and automatic numbering by appropriate preprocessors.
- To obtain the magnitude of the interlaminar stresses, several layers of elements are provided across the thickness of the bracket to represent the actual laminated construction.
- The bracket is subdivided along its width into a reasonable number of uniform strips such that it is convenient to identify critical zones and, when desirable, possible to extract and subject individual strips to detailed interlaminar analysis (Figure B-6).

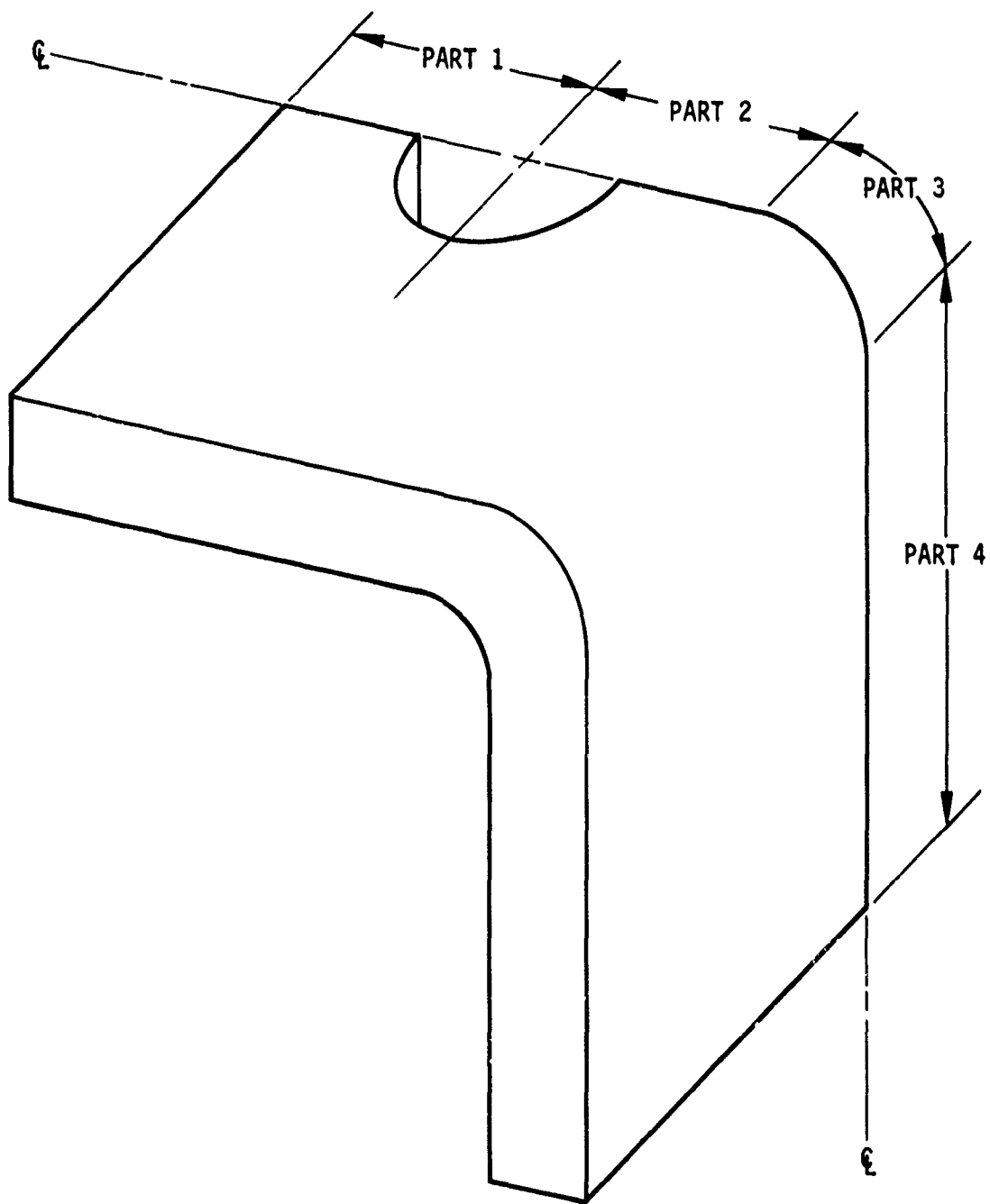

Figure B-5. Angle Bracket Subdivision

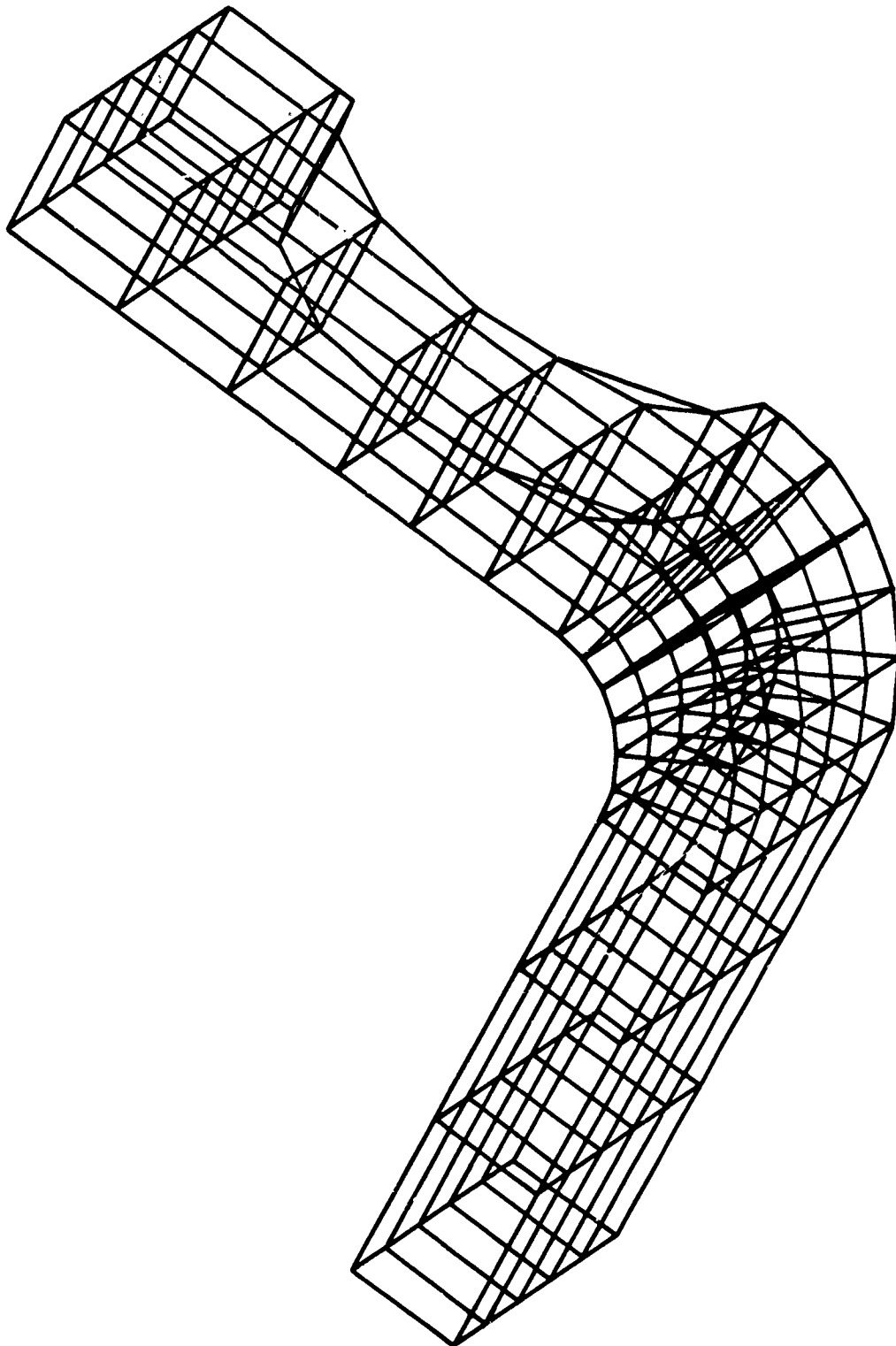

Figure B-6. Single-Layer Model

Preprocessors

To minimize computer cost, it was decided to develop two FORTRAN preprocessor programs (C-1 and C-2) capable of automatically forming the finite element meshes for a given bracket and generating the associated Bulk Data decks (Figure B-7).

In the first stage of the analysis, the C-1 preprocessor idealizes the whole (half-symmetrical) bracket into either a single- or a multilayer model with a given number of strips across the width of the bracket. A full model NASTRAN can then be conducted.

The C-2 preprocessor simply extracts that part of the C-1 model output that is associated with a specific critical strip so that a single strip NASTRAN can be conducted.

Parametric studies can be run using either the output of the full model NASTRAN analysis after a C-1 run or the output of the single strip NASTRAN after a C-2 run.

Note that a separate C-1 run is made for the specific multilayer construction of the angle in question before the second stage of the analysis (the C-2 run) is conducted.

Step-by-Step NASTRAN Procedure

The steps involved in determining the magnitude of the interlaminar stresses in any given composite bracket by this two-stage procedure are as follows:

- List the dimensions of the bracket, the dimensions of the elements for all four regions, and the equivalent solid laminate material properties.
- Execute the C-1 preprocessor model, entering the above information as input, to obtain the bulk data for a single-layer, multistrip model run.
- Supplement the C-1 output with appropriate Executive Control and Case Control decks and the required additional Bulk Data cards to make a data check and plot run with identification numbers for grid points and elements.
- Modify the above deck to conduct the full model NASTRAN for the solid laminate bracket.

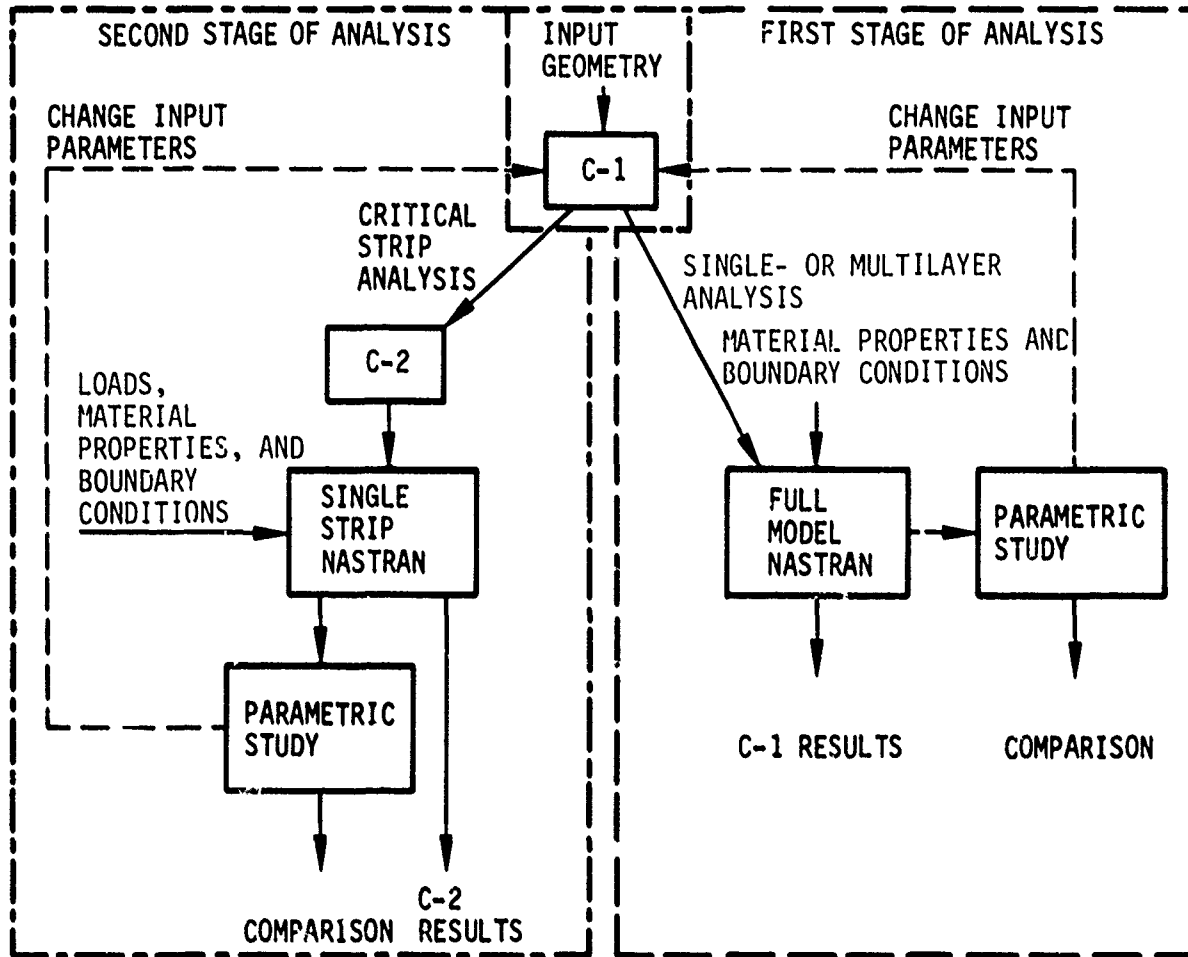

Figure B-7. Two-Stage Computer Analysis Flowchart

- Examine the results to identify regions of high stress/strain gradients and select the critical strip to investigate interlaminar behavior.
- Rerun the C-1 preprocessor model for a multilayered mesh that represents the actual laminated construction.
- Execute the C-2 preprocessor model to extract the multilayer bulk data for the critical strip, using the results of the second C-1 model run as input.
- Supplement the C-2 output with the necessary Executive Control, Case Control, and Bulk Data cards to make a data check and plot run with elements and grid points labeled.
- Modify the above deck to perform the final single strip NASTRAN to obtain interlaminar stress results within the critical strip.

FULL MODEL C-1 PREPROCESSOR

The C-1 preprocessor first analyzes the portion of the bracket to the left of the centerline of the washer and then, in a similar manner, the portion to the right of the centerline up to the tangent line where the bend starts. Particular care is taken to ensure that the grid points accurately trace the circular washer circumference and that the appropriate wedge-shaped elements (PENTAs) are provided in combination with the solid (HEXA) elements near the circumference. The cylindrical part of the bracket is then modeled using diverging HEXA elements and, finally, the loaded leg (Part 4) is idealized using the rectangular HEXA elements.

The program is capable of modeling up to 25 layers across the thickness of the bracket.

Coordinate Systems

In order to locate the grid points, to obtain a printout of node displacements along desired directions, and to account for specific material orientations, five coordinate systems are employed (Figure B-8). These coordinate systems are defined by NASTRAN CORD2 Bulk Data cards, and their ID numbers are appropriately referenced when the related GRID and PSOLID cards are input. These five coordinate systems are:

- The basic rectangular coordinate system, with its origin placed directly below the left rear corner of the angle such that the xyz

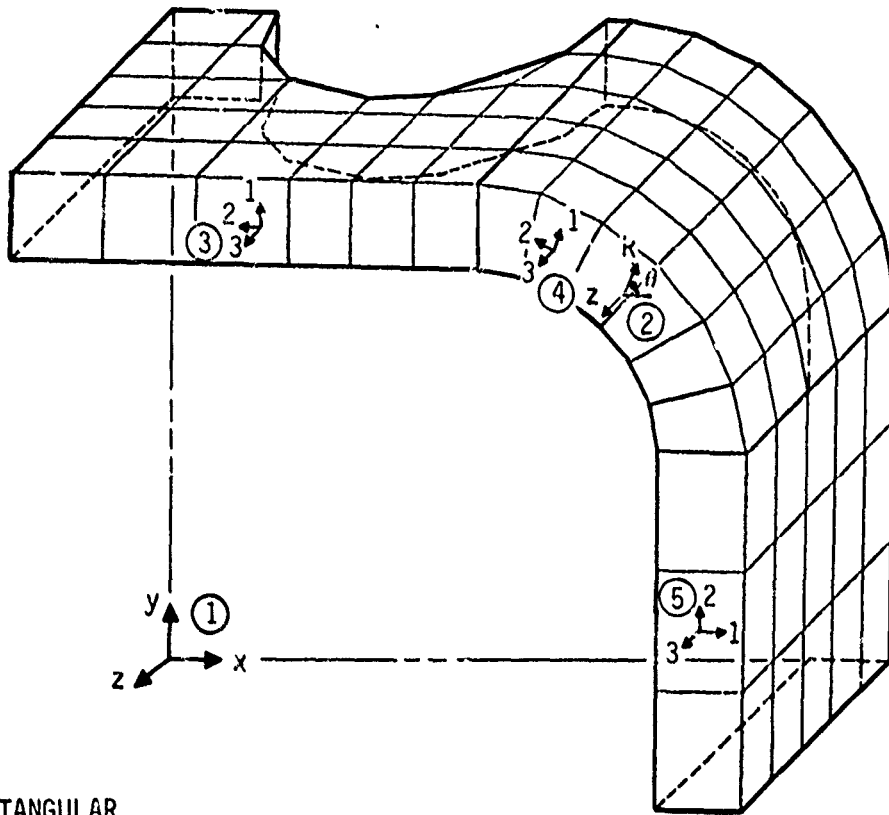

BASIC RECTANGULAR
COORDINATE SYSTEM ①

LOCAL CYLINDRICAL COORDINATE
SYSTEM ② USED TO LOCATE GRID POINTS
ON CYLINDRICAL PART OF BRACKET

THREE LOCAL COORDINATE SYSTEMS USED TO DEFINE
ANISOTROPIC MATERIAL PROPERTIES OF SOLID ELEMENTS
THAT CONSTITUTE PARTS 1 AND 2 ③ , PART 3 ④ ,
AND PART 4 ⑤

Figure B-8. C-1 Coordinate Systems

coordinates of all grid points have positive values. The grid points of all the flat regions (Parts 1, 2, and 4) are located with reference to this system, which is directed by an appropriate entry in Field 3 of the GRID card. The displacements, degrees of freedom, and constraints at all grid points are also defined with reference to this basic coordinate system by making a corresponding entry in Field 7 of the appropriate GRID cards.

- A local cylindrical coordinate system (defined with reference to the basic system described above) used for locating the grid points on the cylindrical part of the bracket. Field 3 of the corresponding GRID cards defines this system.
- Three local coordinate systems (also established with reference to the basic system) used to define the anisotropic material properties of the solid elements constituting Parts 1 and 2, Part 3, and Part 4, respectively, of the bracket. Systems 3 and 5, which are rectangular, correspond to the flat parts, and System 4, which is cylindrical, pertains to the curved part.

These systems are referenced on the appropriate PSOLID card, which in turn references the corresponding MAT9 card. The orientation of these systems was selected such that Direction 1 is consistently normal to and radiating out of all elements of the bracket. All laminae composing the bracket are thus parallel to Plane 2-3 of the related material coordinate system at all locations. This orientation, which is dictated by the geometry of the cylindrical part, allows the material properties of any continuous lamina to be defined in a consistent manner.

6
B

The NASTRAN program prints out the element stresses in directions parallel to the corresponding material coordinate systems.

Grid Point and Element Numbering Schemes

The C-1 preprocessor model lays out the mesh and assigns identification numbers for the grid points and elements at the top and bottom of each layer, as illustrated (for a single-layer model) in Figure B-9. First, the grid points on the bottom surface of Part 1 are numbered, starting from the washer centerline and proceeding in a sweeping fashion in the -x direction toward the free edge. The numbers are assigned consecutively, starting with 1. The program then moves to the top surface (in the +y direction), increments the ID numbers by 10,000, and assigns grid point IDs in the same manner as for the bottom surface.

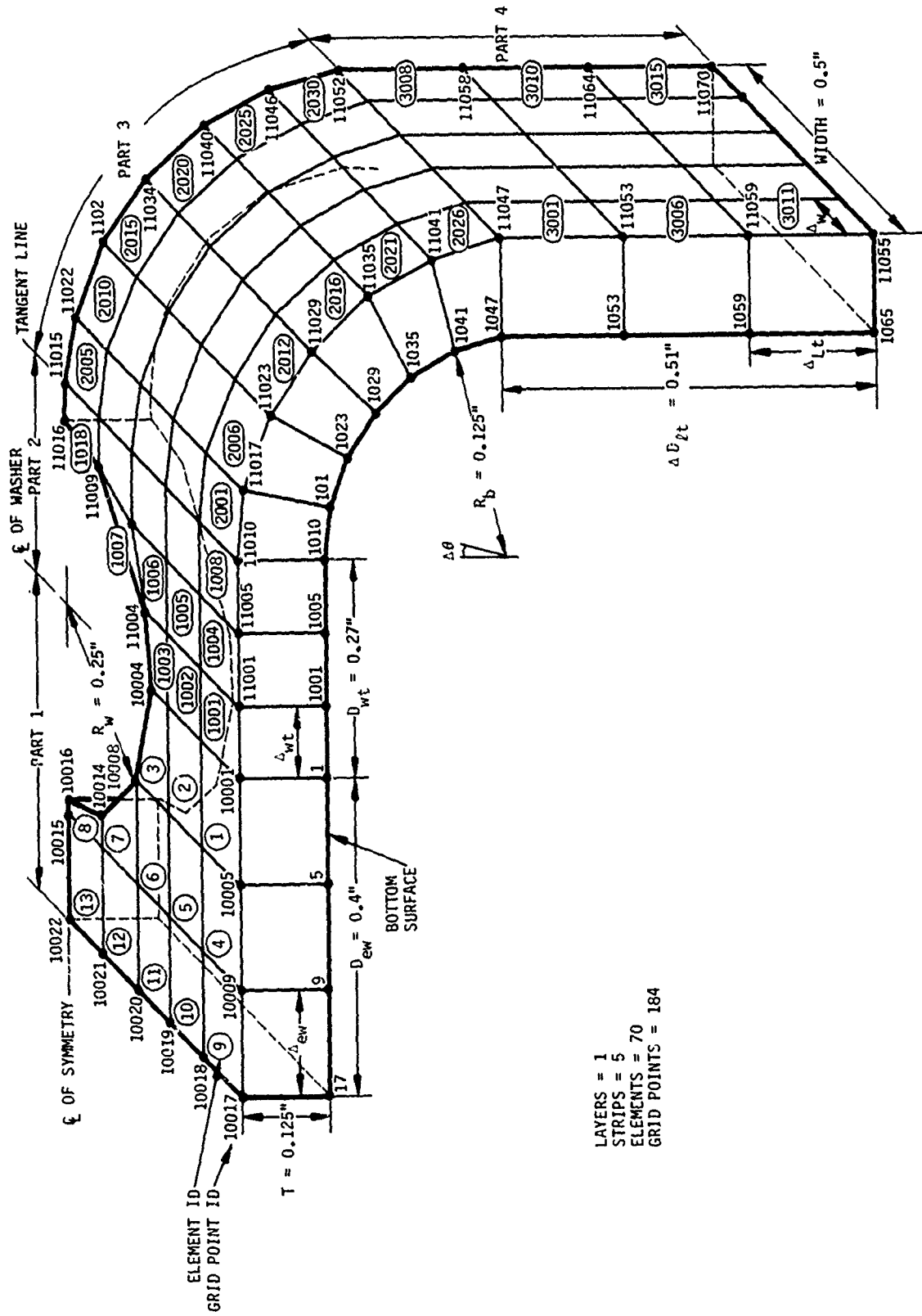

Figure B-9. Grid Point and Element ID Numbers

For models with more than one layer, the program moves up one layer at a time until it reaches the top surface. The elements for Part 1 are numbered following the same general directions as for the grid point numbering.

After the grid points and elements of Part 1 have been numbered, the program provides grid point IDs for the bottom surface of Part 2, starting with number 1001 and moving from the washer centerline to the tangent line. The numbers of the nodes one layer higher are incremented by 10,000, and the element IDs start with 11,001.

The grid points for Parts 3 and 4 are given numbers consecutive with those assigned to Part 2. The element numbers for Part 3 start with 2001 and those for Part 4 start with 3001.

The ID numbers given to grid points near the washer should be carefully noted because that area is numbered according to a modified scheme to account for the circular boundary and the wedge-shaped elements required to model it.

C-1 Input Data

The user essentially specifies the basic dimensions of the bracket and the desired fineness of the mesh by giving the number of divisions along the three axes for each of the four parts of the bracket. The required input parameters are defined as:

Width (W) = Width of the modeled half-symmetrical bracket, which remains uniform over all four parts.

Δ_w = Typical element dimension in the width direction, also uniform over all four parts.

Thickness (T_i) = Thickness of the i^{th} lamina, entered as T(1), (T2), ..., T(n), starting from the bottom.

Layers = Number of laminae making up the total thickness. Up to 25 layers may be specified (Default = 1).

D_{ew} = Distance from the free transverse edge to the center of the washer defining the limits of Part 1.

Δ_{ew} = Typical element dimension in the D_{ew} direction. Along with Δ_w , this parameter establishes the mesh density in Part 1.

R_w = Radius of washer or circular opening in the model.

D_{wt} = Distance from the center of the washer to the tangent line defining the limits of Part 2.

Δ_{wt} = Typical element dimension in the D_{wt} direction. Along with Δ_w , this parameter establishes the mesh density in Part 2.

R_b = Inside radius of the cylindrical part (bend radius).

Δ_θ = Typical angle (in degrees) subtended by the radial faces of the converging elements of the cylindrical part. Along with Δ_w , this parameter establishes the mesh density in Part 3.

D_{lt} = Distance from the transverse loaded edge to the closest tangent line. This parameter defines the limits of Part 4.

Δ_{lt} = Typical element dimension in the D_{lt} direction. Along with Δ_w , this parameter establishes the mesh density in Part 4.

Tolerance = This parameter controls the element dimensions while fitting the elements in around the circumference of the washer. It defines the minimum length to which the side of an element may be reduced, or the maximum length to which an element may be increased to meet the circular boundary.

Actual data input to the C-1 preprocessor consists of the names of the parameters (Table B-1) and their respective values, entered in free format and in free order. Lines 898 through 901 of the program listing, presented as Appendix C, constitute an example of user data input (this example corresponds to the bracket illustrated in Figure B-9). An echo of the input parameters is printed along with the run output.

A comprehensive flow chart showing the sequence of program operations is given in Appendix D.

TABLE B-1. INPUT PARAMETER NAMES

Input Parameters	Parameter Names
Width	WIDTH
Δ_w	DELTAX
Thickness T(i)	T(i)
Layers	LAYERS
D_{ew}	HT2
Δ_{ew}	DELT2
R_w	RADIUS
D_{wt}	LEGX1
Δ_{wt}	DELTAY
R_b	BEND
Δ_θ	DELTAT
D_{lt}	LEGY
Δ_{lt}	DELTAZ
Tolerance	TOLER

Job Control Statements

The first part of the C-1 model JCL (job control list) is a command to execute FORTRAN programs, and the second part specifies the disposition of the output (save or dispose). The JCL for the source program listing shown in Appendix C is valid for the IBM 360/370 computer. Lines 1 and 2 show the user ID and the Execute FORTRAN command. Lines 895 through 897 specify that Tape Unit 7 be saved and catalogued on on-line disk pack WYLBUR. Tape Unit 7 contains the NASTRAN Bulk Data card images, which are to be used for the subsequent stress analysis run.

Typical C-1 Output

The program produces three types of output: an echo of the input parameters, error messages, and the Bulk Data cards CHEXA, CPENTA, GRID, and CORD2C, printed in 8-column NASTRAN format. The first two types of output are written on Tape Unit 6 and are printed along with the preprocessor run, and the bulk data is written on Tape Unit 7 and saved on an on-line disk pack to be supplemented with additional data for the subsequent NASTRAN run. Appendix E shows the C-1 model preprocessor program output, and Appendix F presents the bulk data generated by the program.

FULL MODEL NASTRAN

To conduct a full model NASTRAN, the Bulk Data cards generated by the C-1 preprocessor model must be supplemented by appropriate Executive Control, Case Control, and Bulk Data cards defining the boundary conditions, material properties, and loading.

Boundary Conditions

Figure B-10 shows the constraints imposed on the bracket:

- The top edge of the free transverse side is restrained from motion in the vertical direction ($U_2 = 0$).
- The washer boundary (circular opening) is assumed to be rigidly constrained ($U_1 = U_2 = U_3 = 0$) along both the top and the bottom edges.
- Since only half the bracket is modeled (because of structural and loading symmetry), appropriate boundary conditions ($U_3 = 0$) are imposed on all grid points along the face of symmetry.

All these constraints are effected by including additional SPC1 cards in the Bulk Data deck and the corresponding SPC card in the Case Control deck. Since HEXA and PENTA elements relate only to the translational degrees of freedom (1, 2, and 3), the GRDSET card is used to constrain all the rotational degrees of freedom (4, 5, and 6) and thus prevent the singularity problem.

CONSTRAINED AT CENTERLINE FOR SYMMETRY

WASHER BOUNDARY FIXED

EDGE CONSTRAINED NORMALLY

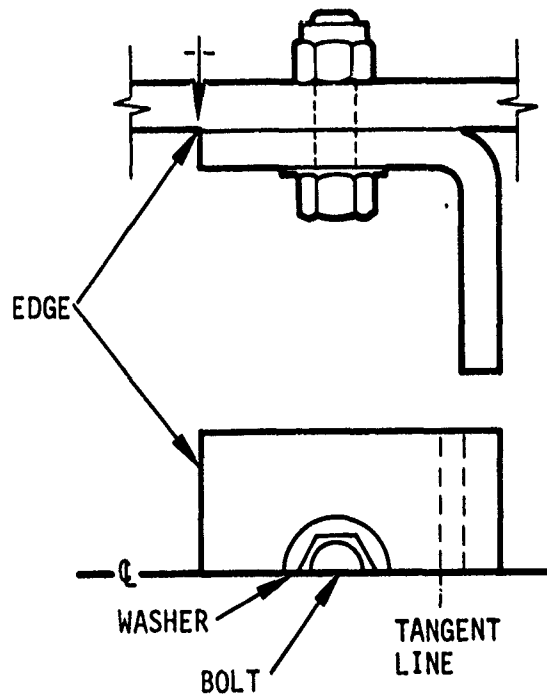

Figure B-10. C-1 Boundary Conditions

Material Properties

The bracket construction is defined by including PSOLID and MAT9 cards in the Bulk Data deck. The appropriate material coordinate system is input on the PSOLID card, and a symmetric 6 by 6 material property matrix G_{ij} is input on the MAT9 card to define the anisotropic properties of the solid, isoparametric elements. For the laminated bracket, the G_{ij} matrix is defined as

$$[G_{ij}] = \begin{bmatrix} \frac{(1 - \nu_{23}\nu_{32})E_{11}}{\nu} & \frac{(\nu_{21} + \nu_{23}\nu_{31})E_{11}}{\nu} & \frac{(\nu_{31} + \nu_{12}\nu_{32})E_{11}}{\nu} & 0 & 0 & 0 \\ & \frac{(1 - \nu_{31}\nu_{13})E_{22}}{\nu} & \frac{(\nu_{32} + \nu_{12}\nu_{31})E_{22}}{\nu} & 0 & 0 & 0 \\ & & \frac{(1 - \nu_{12}\nu_{21})E_{33}}{\nu} & 0 & 0 & 0 \\ & & & G_{12} & 0 & 0 \\ & \text{SYMMETRIC} & & & G_{23} & 0 \\ & & & & & G_{31} \end{bmatrix}$$

where

$$\nu = 1 - \nu_{12}\nu_{21} - \nu_{23}\nu_{32} - \nu_{31}\nu_{13} - 2\nu_{12}\nu_{23}\nu_{31}$$

for the k^{th} lamina

$$[\bar{G}^k] = [T^k]^{-1} [G^k] [T^k]$$

where

$$[T^k] = \begin{bmatrix} 1 & 0 & 0 & 0 & 0 & 0 \\ 0 & m^2 & n^2 & 0 & 2mn & 0 \\ 0 & n^2 & m^2 & 0 & -2mn & 0 \\ 0 & 0 & 0 & m & 0 & -n \\ 0 & -mn & mn & 0 & (m^2 - n^2) & 0 \\ 0 & 0 & 0 & n & 0 & m \end{bmatrix}$$

and

$$m = \cos \theta$$

$$n = \sin \theta$$

where the transformation matrix T^k for the k^{th} lamina define a rotation about the x axis as illustrated in Figure B-11.

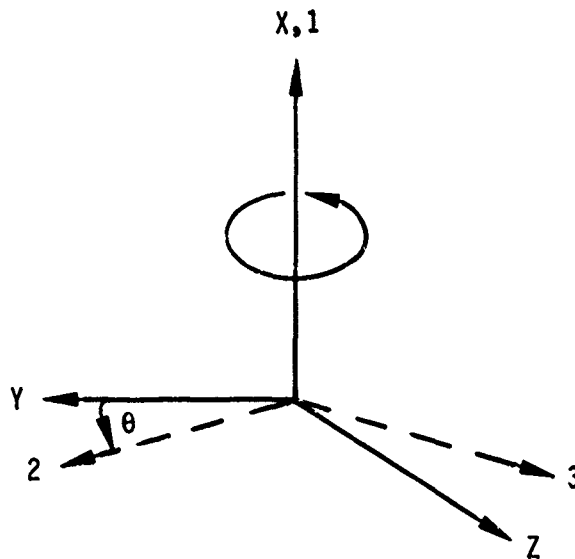

Figure B-11. Rotation of Axis

Applied Loads

Two load conditions were imposed on the C-1 bracket model:

- A uniformly distributed tension load across the loaded transverse edge (Figure B-12a)
- A uniformly distributed clockwise couple across the edge to compensate for eccentric tensile loads (Figure B-12b)



Figure B-12. Load Conditions

These loads are applied by including FORCE cards in the Bulk Data deck and the corresponding LOAD cards in the Case Control deck.

Bandwidth (Wavefront) Optimization

It is advisable, especially for large models, to employ a bandwidth or wavefront minimization subroutine to make optimal use of computer resources. With the MSC NASTRAN program, this is accomplished by using a NASTRAN preprocessor card (parameter PREOPT = 1).

C-1 Data Check and Plot Run

Before making a solution run, it is desirable to examine the preprocessor-produced finite element model by making a data check and plot run using several carefully selected points. Appendix G shows the NASTRAN data deck setup for making a data check and plot run and the undeformed structure plots produced.

Care should be taken to save the plot files by inputting the proper job control statements.

NASTRAN C-1 Solution Run

To make a NASTRAN solution run, the following cards must be added to the Bulk Data deck generated by the C-1 preprocessor:

- NASTRAN wavefront optimization card (PREOPT = 1)
- Executive Control deck
- Case Control deck
- Additional Bulk Data cards:
 - CORD2R cards to define the material coordinate systems
 - GRDSET cards to constrain the redundant degrees of freedom (4, 5, and 6)
 - FORCE cards for the two loading cases
 - MAT9 material properties cards
 - PSOLID cards for the various groups of solid elements
 - SPC1 cards to impose the necessary boundary conditions
 - ENDDATA card

The printout from a NASTRAN solution run, including an echo of the completed input data decks, is presented in Appendix H. This output corresponds to the bracket model shown in Figure B-9.

SINGLE STRIP C-2 PREPROCESSOR

The C-2 model preprocessor was developed to postprocess the data generated by the C-1 preprocessor model. Its function is to extract the bulk data for a particular strip out of the multilayered full bracket model.

The user specifies the sequence number of the desired strip (parameter ISTRIP), starting from the free edge, and the total number of strips (parameter ISTRPS) that comprise the bracket model. The grid point and element ID numbers previously assigned are retained for the C-2 run.

The program reads the C-1 bulk data generated for the full bracket model and identifies and outputs the GRID, CHEXA, and CPENTA cards (the CORD2R cards are also extracted) for all layers belonging to the desired strip, which terminates at the washer opening. The corresponding part of the model on the other side of the washer opening is assumed to have no significant influence on the results because the washer is assumed to completely restrain the bracket along its circular boundary.

The C-2 model preprocessor program consists of approximately 120 FORTRAN statements (see Appendix I for the program listing). A detailed flowchart that explains the logic and sequence of program operations is presented in Appendix J.

Figure B-13 illustrates the "multilayer" input data required for the separate C-1 run necessary to produce the major input data for the C-2 preprocessor model.

Job Control Statements

The C-2 model preprocessor has a two-part JCL similar to that of the C-1 preprocessor. The first part contains the user ID and the Execute FORTRAN command, and the second part specifies the disposition of the output (save or dispose). The C-2 JCL also manages two tape units: Unit 1 (input) contains, in card format, the bulk data generated by the C-1 preprocessor for the full (multilayer, multistrip) bracket model, and Unit 2 (output) stores the bulk data extracted for the critical strip and later outputs it for NASTRAN analysis. Lines 113 through 116 of the program listing (Appendix I) show some of the job control statements, and line 117 specifies the desired strip number and the total number of strips in the bracket model. On-line disk pack WYLBUR is employed to read the specified Bulk Data cards and write the selected Data cards.

The program designates Tape Units 5 and 6 as the current input and output units, in the usual fashion.

Typical C-2 Output

This program produces two types of output: an echo of the input parameters, which is written on Tape Unit 6 and printed along with the preprocessor run, and Bulk Data cards CHEXA, CPENTA, GRID, and CORD2C, printed in typical 8-column NASTRAN format. (Note that the program assigns a PID (property ID) value of 1, 2, or 3 on the CHEXA and CPENTA cards for the bottom layer and increments by 10 for each subsequent layer above.) This bulk data is written on Tape Unit 2 (input) and saved on on-line disk pack

&PARAMS

T(1) = 0.01, T(2) = 0.01, T(3) = 0.01, T(4) = 0.01, T(5) = 0.01, T(6) = 0.01,
T(7) = 0.005, T(8) = 0.01, T(9) = 0.01, T(10) = .01, T(11) = .01, T(12) = .01,
T(13) = .01, LAYERS = 13, WIDTH = 0.5, HT2 = 0.4, RADIUS = 0.25, DELTY2 = 0.20,
LEGX1 = 0.27, DELTAY = 0.09, BEND = 0.125, DELTAT = 15.0, LEGY = 0.17,
DELTAZ = 0.17, DELTAX = 0.1, TOLER = 0.015
& END

NOTES:

1. COLUMN 1 MUST BE BLANK FOR ALL PARAM CARDS.
2. &PARAMS IS ENTERED IN COLUMNS 2-8 AND &END IN COLUMNS 2-5.
3. THE VALUES OF PARAMETERS HAVE FORMAT F8.4; THUS, THERE SHOULD BE NO MORE THAN THREE DIGITS TO THE LEFT OF THE DECIMAL AND NO MORE THAN FOUR DIGITS TO THE RIGHT.
4. ALL 13 PARAMETERS AND ONE THICKNESS PER LAYER MUST BE SPECIFIED; THE DEFAULT VALUE FOR LAYERS EQUALS 1.

Figure B-13. Sample Input Data for Multilayer
C-1 Model Preprocessor Run

WYLBUR, as previously described, and additional data is appended for the subsequent NASTRAN run. The program listing and output are shown in Appendix K.

SINGLE STRIP NASTRAN

In order to conduct a single strip NASTRAN, the Bulk Data cards generated by the C-2 model preprocessor must be supplemented with suitable Executive Control and Case Control decks and Bulk Data cards that define the boundary conditions and material properties.

Boundary Conditions

Three types of boundary conditions must be imposed:

- The grid points lying on the exposed surfaces (top and bottom) must be subjected to the same constraints as they were during the C-1 model analysis. These constraints are effected by including the appropriate SPC (or SPC1) and GRDSET cards.
- The rest of the grid points on exposed surfaces, which were unconstrained during the C-1 model analysis, are subjected to the same finite displacements (T1, T2, T3) as during the corresponding C-1 model analysis. This condition is effected by including the appropriate SPC cards.
- The interior grid points newly produced by the multilayered construction are interlinked to the exterior grid points by continuous RSPLINE elements along all the straight lines across the thickness of the bracket. It was assumed that RSPLINE elements would provide a more realistic boundary condition for the single strip analysis (than MPC or RBE elements), and the few test runs carried out confirmed this assumption.

Note that no loads need be applied for this analysis; the model is deformed under the influence of displacement boundary conditions.

Material Properties

The number of MAT9 cards required equals the number of types of layers that comprise the angle bracket. The number of PSOLID cards required equals the number of sets of PID values assigned to the various CHEXA and CPENTA elements by the C-1 preprocessor program. Three groups of PID values corresponding to three parts of the angle bracket are shown in Figure B-14.

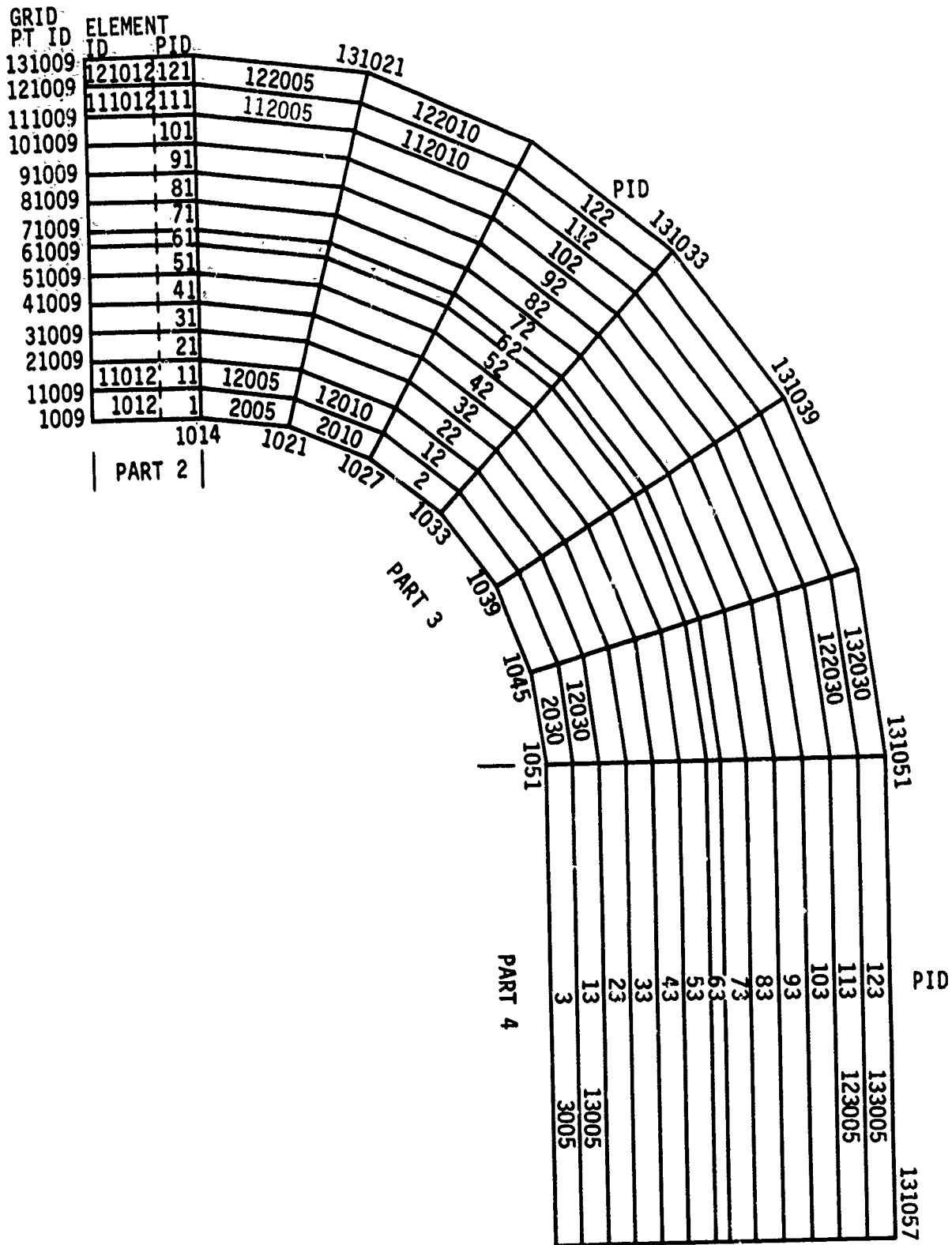

Figure B-14. Critical Strip Model

Dummy Elements

Since all grid points in the single strip model are subjected to either a single- or multipoint constraint, NASTRAN would be unable to initiate execution without a valid A-SET matrix. Three CBAR elements are input to define the additional grid points required.

C-2 Data Check and Plot Run

The output produced by a NASTRAN data check and plot run and the undeformed plots produced are shown in Appendix L.

NASTRAN C-2 Solution Run

To conduct a NASTRAN solution run, the bulk data generated by the C-2 model preprocessor must be supplemented with the following cards:

- NASTRAN wavefront optimization card (PREOPT = 1)
- Executive Control deck
- Case Control deck
- Additional Bulk Data cards:
 - CORD2R cards to define the material coordinate systems
 - GRDSET cards to constrain the redundant degrees of freedom (4, 5, and 6)
 - Additional GRID, CBAR, PBAR, and MAT1 cards to provide for the required dummy elements
 - MAT9 material properties cards
 - PSOLID cards for the various groups of solid elements
 - SPC, SPC1, and RSPLINE cards to impose the necessary boundary conditions
 - ENDDATA card

Part of the printout from a NASTRAN C-2 solution run, including an echo of the completed input data checks, is presented in Appendix M. This example corresponds to the angle bracket shown in Figure B-9.

NASTRAN RESULTS

Throughout this study T300 graphite/5208 epoxy was used for the test case. The stacking sequence $[0_{\#}/45_{\#}/0_{\#}]$ was used, where the symbol # stands for crossplied fabric. Two load cases were examined: a uniform tension load and a uniform clockwise couple. The sample ten-strip model executed by the NASTRAN plotter is shown in Figure B-15. The following geometries were used:

T_i = thickness of the i^{th} lamina (0.14 inch TYP)

R_b = bend radius (0.125 inch)

R_w = washer radius (0.219 inch)

D_{wt} = distance from the center of the washer to the tangent line (0.249 inch)

D_{ew} = distance from the free transverse edge to the center of the washer (0.40 inch)

D_{lt} = distance from the transverse loaded edge to the closest tangent line (0.249 inch)

Width = width of the modeled half-symmetrical bracket (1.0 inch)

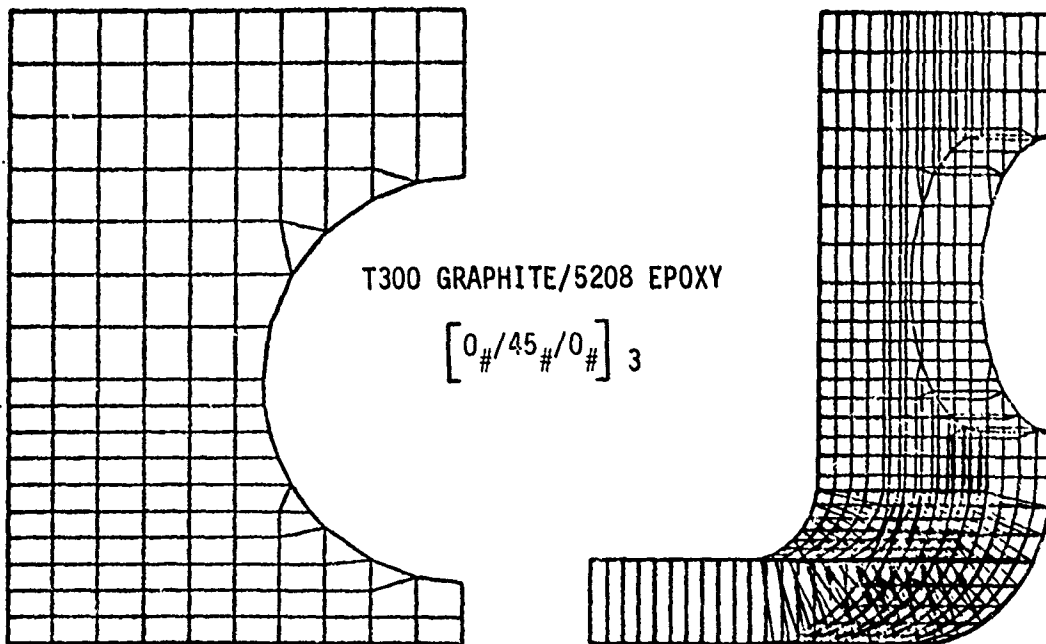

Figure B-15. Sample Ten-Strip Model

Using the C-1 model preprocessor, the NASTRAN data output from the uniform tension load case was plotted in such a way that it could easily be compared with data derived from mathematical theory.

In Figure B-16 the tangential stress σ_y/σ_0 is plotted versus bend angle along the centerline strip; it is most critical at the inner surface and its gradient peaks at $\theta = 75$ to 85 degrees. Interlaminar shear stress is also expected to be most critical at this location. (All stresses plotted in these figures have been normalized.)

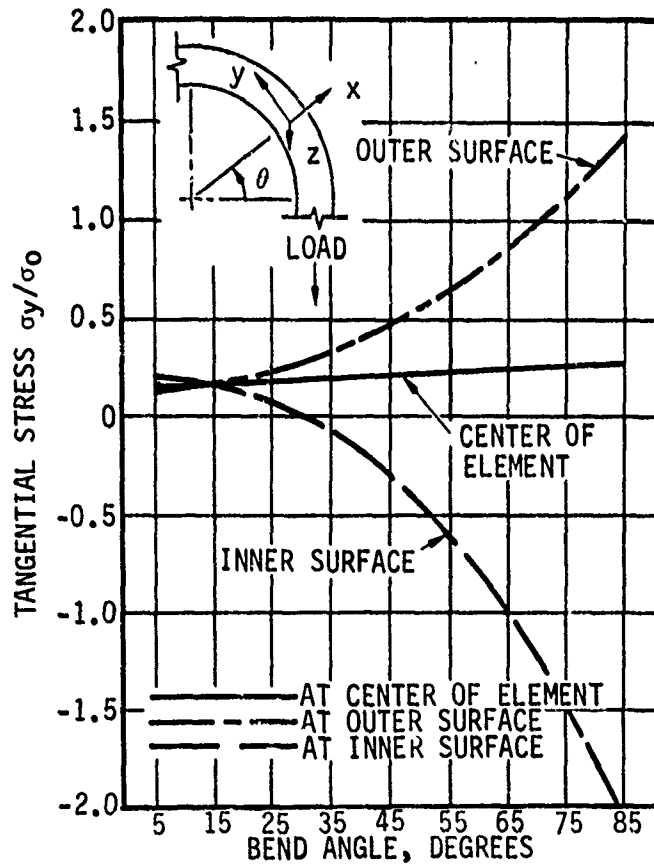

Figure B-16. Tangential Stress Versus Bend Angle Along the Centerline Strip: Uniform Tension Load Case

In Figure B-17 this same stress is plotted versus angle width at $\theta = 85$ degrees (angle of maximum stress). This stress and its gradient (slope) appear to peak at the inner surface and closest to the centerline of the angle.

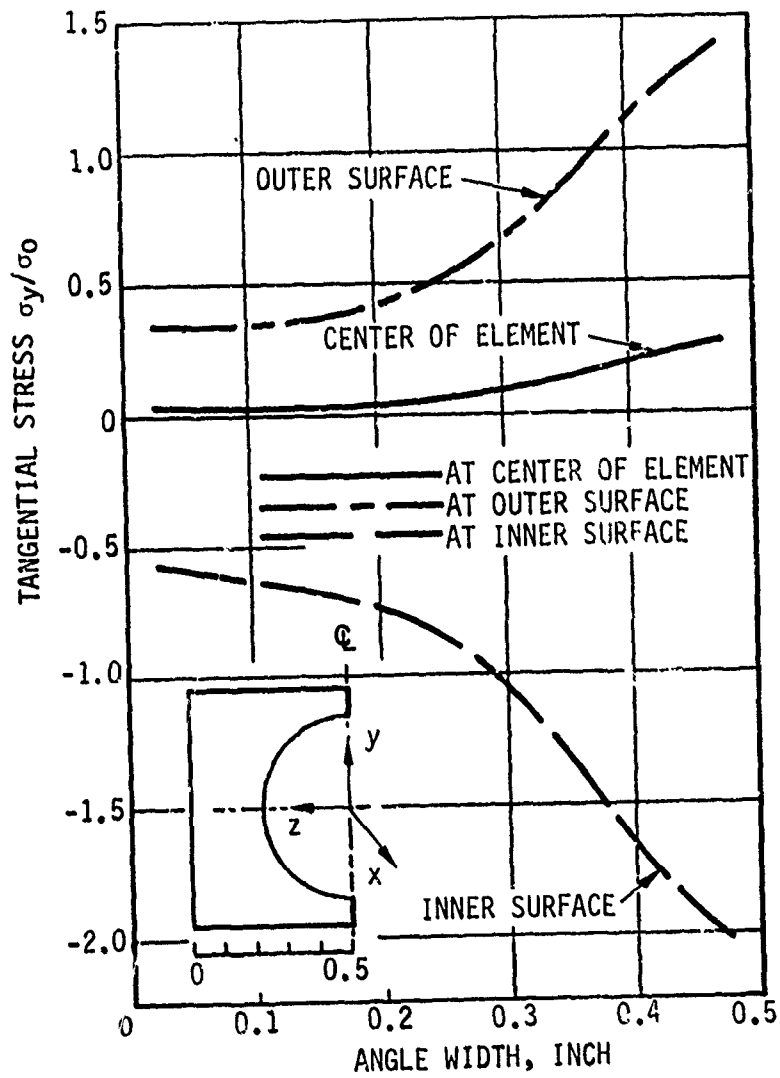

Figure B-17. Tangential Stress Versus Angle Width: Uniform Tension Load Case

In Figure B-18 the interlaminar shear stress τ_{xy}/σ_0 is plotted versus bend angle. The shear stress reaches a maximum at $\theta = 85$ to 90 degrees and remains relatively constant across the thickness of the laminate as evidenced by the positive correlation of the curves.

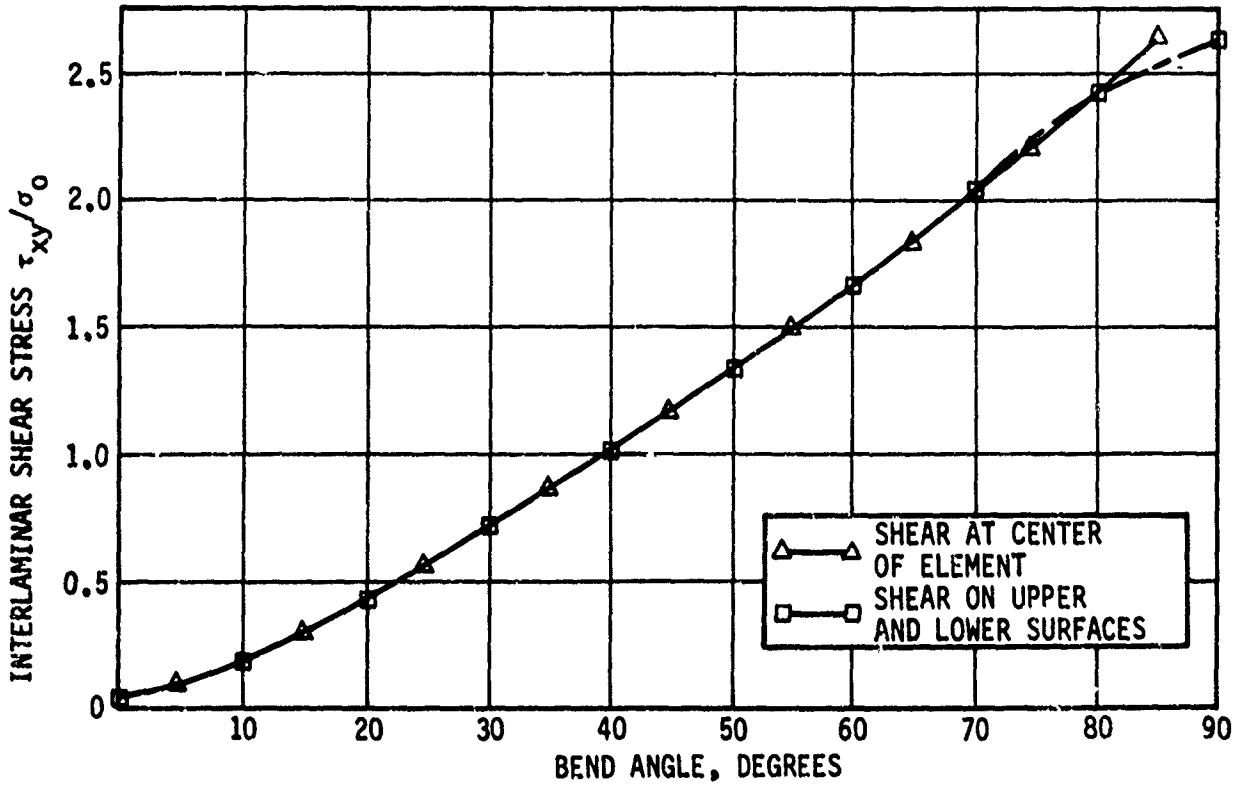

Figure B-18. Interlaminar Shear Stress Versus Bend Angle: Uniform Tension Load Case

In Figure B-19 this same stress is plotted versus angle width at the angles indicated. At $\theta = 5$ degrees, the stress is maximum at the edge of the angle and decreases toward the centerline. At all other angles, the stress increases to a maximum at the centerline. The transverse shear strength τ_{xz} is directly proportional to the interlaminar shear strength.

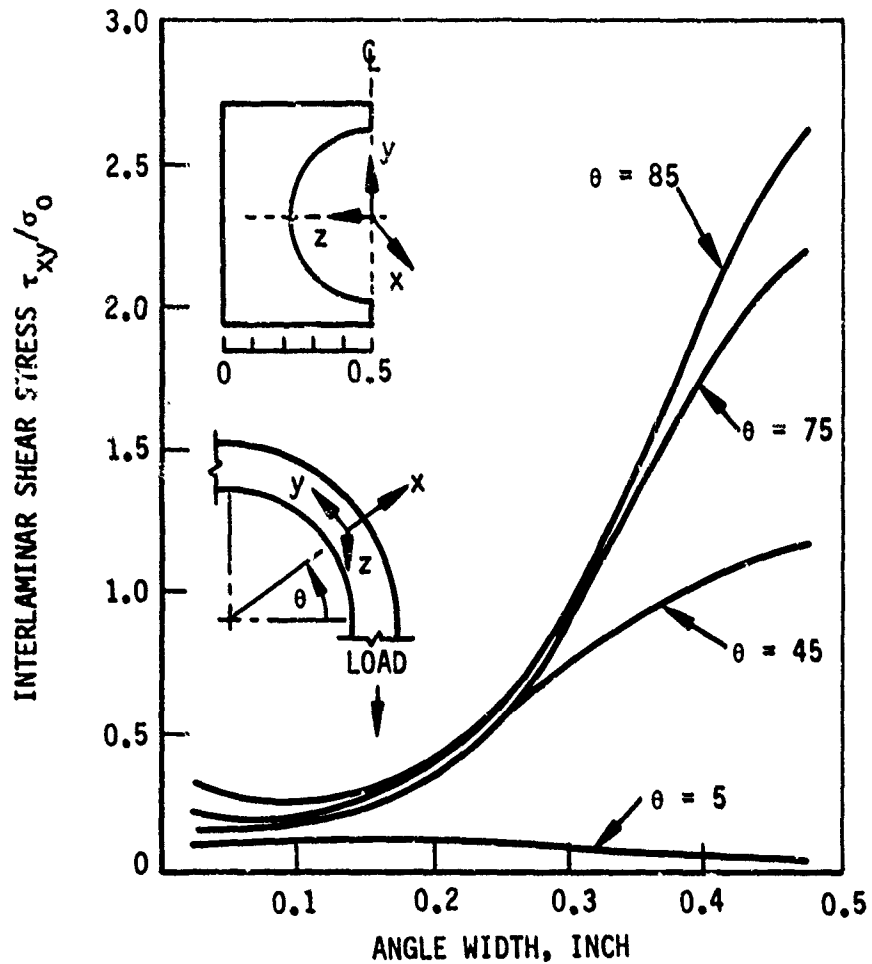

Figure B-19. Interlaminar Shear Stress Versus Angle Width: Uniform Tension Load Case

The normal stress (normal to the laminate surface) σ_x/σ_0 is plotted versus bend angle in Figure B-20. In general, this is a compression field; however, at bend angles up to $\theta = 15$ degrees a low-magnitude tension field is present near the centerline of the angle (Figure B-21). Interlaminar tension can only occur in the flat area between the applied load and the bend angle, acting perpendicular to the applied load.

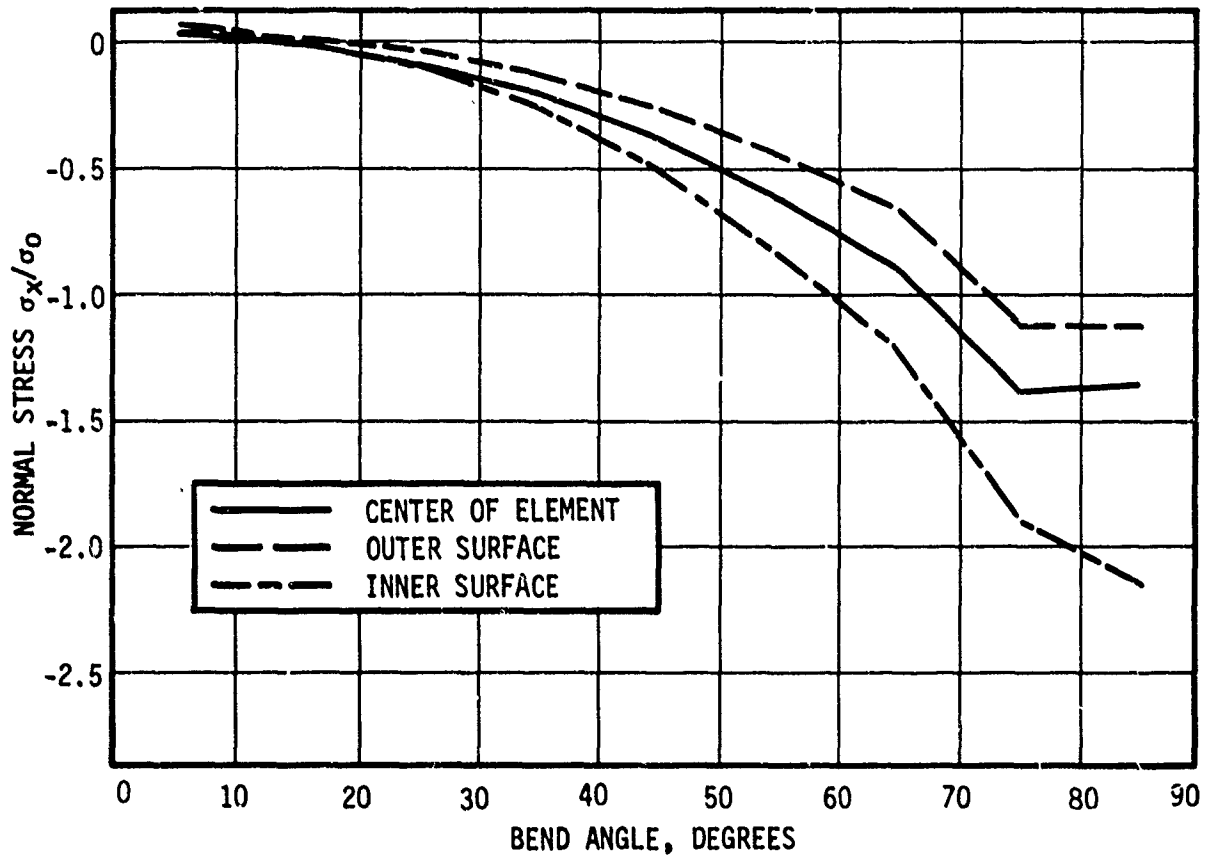

Figure B-20. Normal Stress Versus Bend Angle:
Uniform Tension Load Case

Up to this point the C-1 model has been used to study the displacement/load distribution by measuring the stresses and their gradients. In reducing the data, the study was focused on the areas of primary interest, the locations at which a delamination could begin.

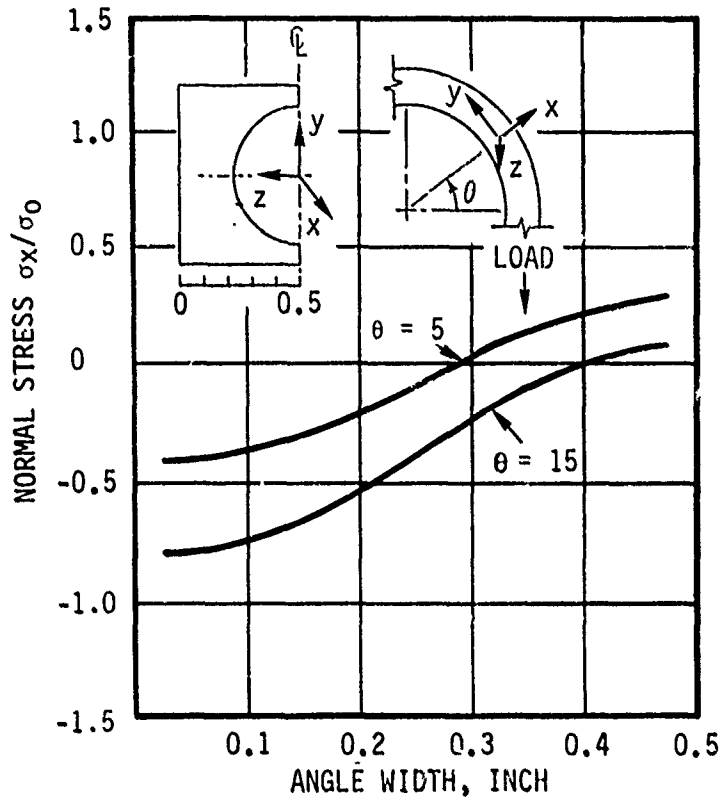

Figure B-21. Normal Stress Versus Angle Width: Uniform Tension Load Case

To determine the magnitude of the interlaminar stresses, a C-2 run was executed on the centerline strip of the ten-strip test model (see Figure C-22). Interlaminar stress analyses can be carried out on any layer or, in some cases, the entire model can be analyzed layer by layer. In some instances more than one lamina of the same type with the same orientation are lumped together into a single layer to reduce computer costs.

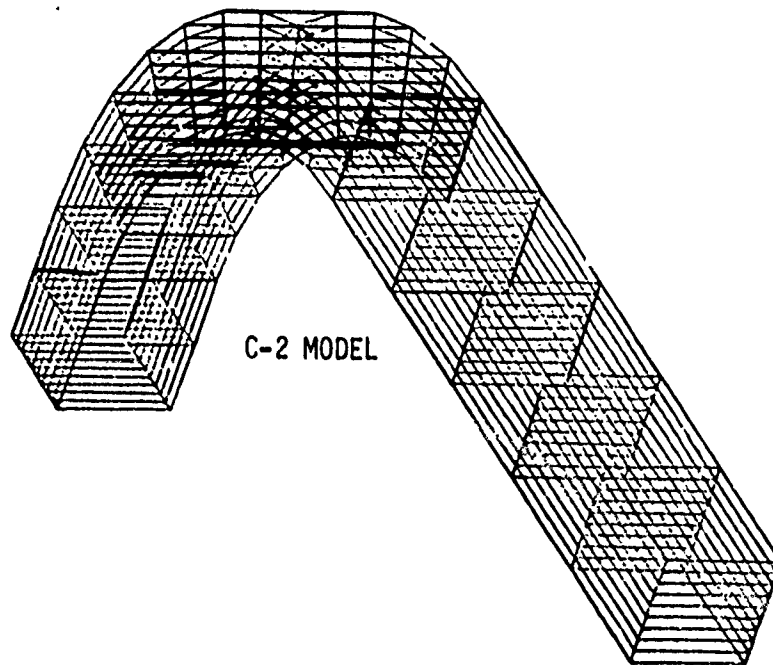

Figure B-22. Laminated Centerline Strip of the Ten-Strip Test Model

The interlaminar shear stress τ_{xy}/σ_0 along the bend angle is shown for all nine laminae in Figure B-23. The lamina nearest the inner surface is identified as L0, the next is L1, and the lamina nearest the outer surface is L8. Zero-degree crossplied fabric laminae are represented by the even numbers (and zero), and the 45-degree crossplied fabric laminae are represented by the odd numbers. The interlaminar shear stress peaks between the L0 and L1 laminae at $\theta = 75$ degrees.

$$\left(\frac{\tau_{xy}}{\sigma_0}\right)^{L0, L1} = \left[\left(\frac{\tau_{xy}}{\sigma_0}\right)^{L0} + \left(\frac{\tau_{xy}}{\sigma_0}\right)^{L1} \right] / 2$$

$$\left(\frac{\tau_{xy}}{\sigma_0}\right)^{L0, L1} = [5.40 + 3.64] / 2 = 4.52$$

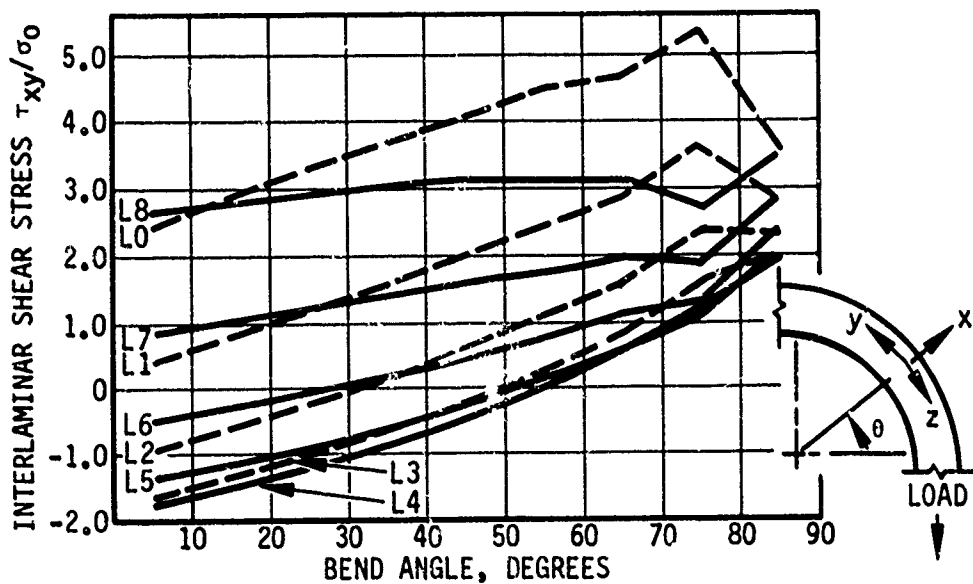

Figure B-23. Interlaminar Shear Stress Versus Bend Angle: Uniform Tension Load Case

In Figure B-24 the interlaminar shear stress through the laminate thickness is shown at $\theta = 5$ and 75 degrees. These stresses are very nearly equal at the outer surface.

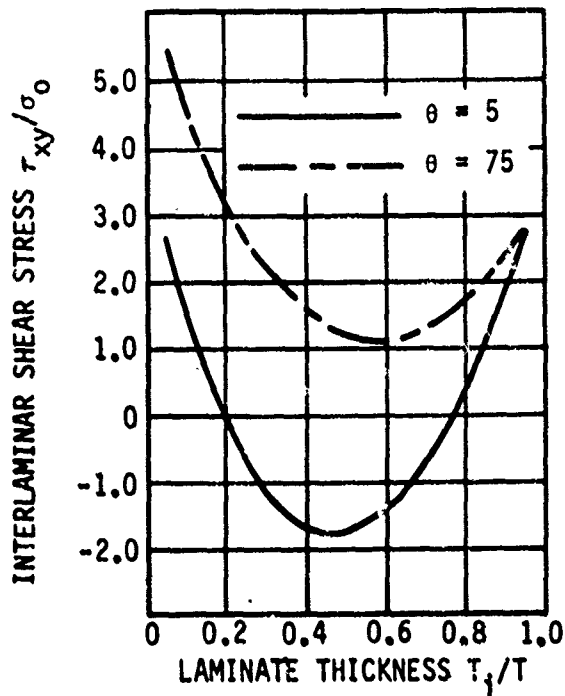

Figure B-24. Interlaminar Shear Stress Through the Laminate Thickness at $\theta = 5$ and 75 degrees: Uniform Tension Load Case

Normal stress along the bend angle is shown in Figure B-25. This stress is chiefly in compression, but it is in tension up to about $\theta = 15$ degrees. In the flat region up to $\theta = 0$ degrees, this stress is maximum and is

$$\left(\frac{\sigma_x}{\sigma_0}\right) = 0.1333$$

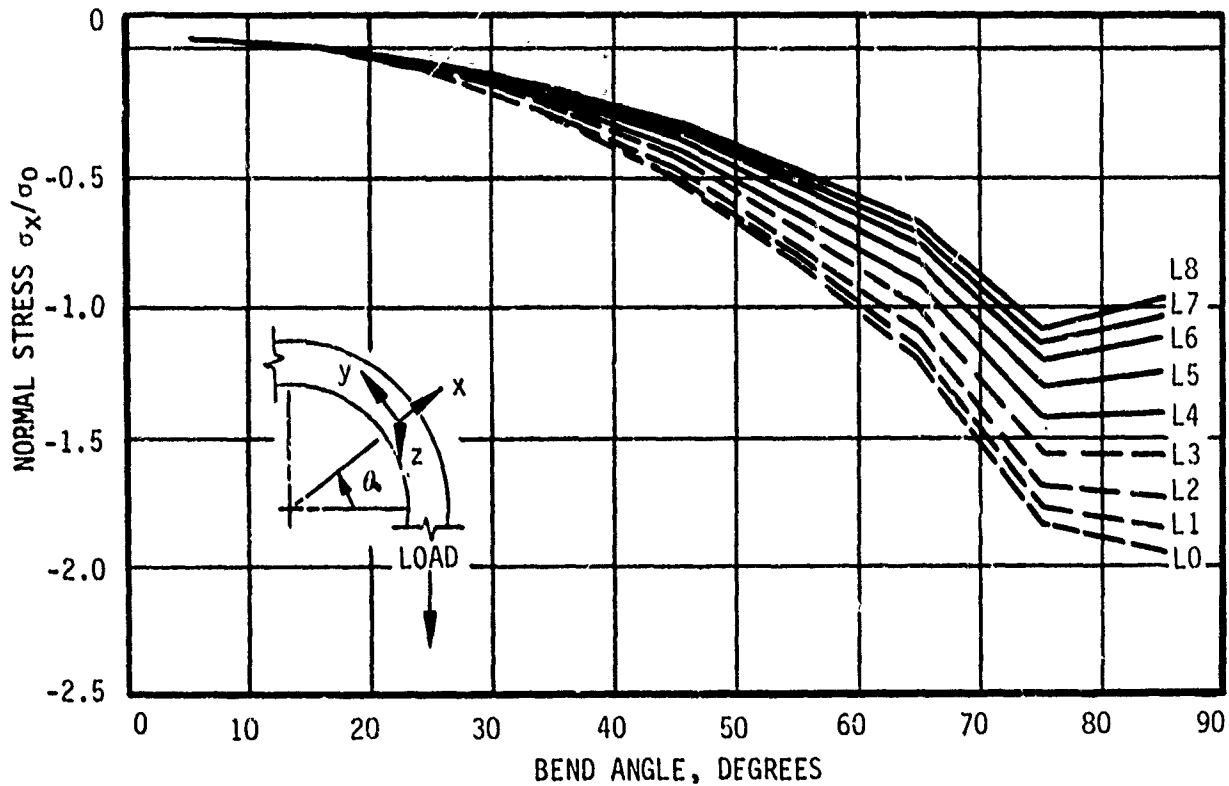

Figure B-25. Normal Stress Along the Bend Angle:
Uniform Tension Load Case

Normal stress along the centerline strip is shown at $\theta = 5$ and 75 degrees in Figure B-26. At $\theta = 5$ degrees this stress is an interlaminar tension with a magnitude of approximately 0.05.

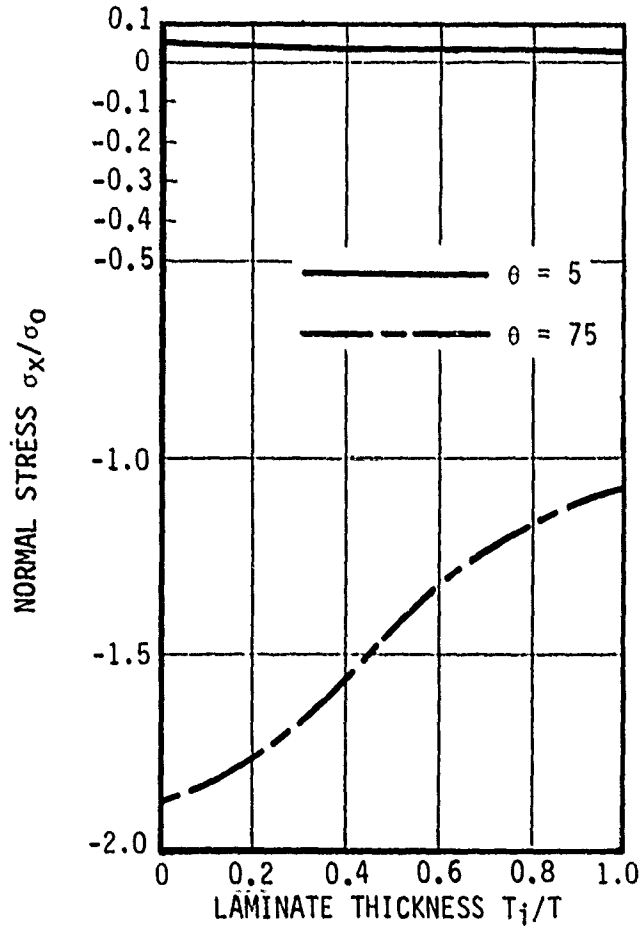

Figure B-26. Normal Stress Through the Laminate Thickness at $\theta = 5$ and 75 degrees: Uniform Tension Load Case

Uniform clockwise couple load cases were also run using the C-2 preprocessor model. Interlaminar shear stresses are plotted versus bend angle in Figure B-27. This stress, which peaks at $\theta = 0$ to 5 degrees, has a magnitude of

$$\left(\frac{\tau_{xy}}{\sigma_0}\right)^{L0, L1} = (0.446 + 1.580) / 2 = 1.013$$

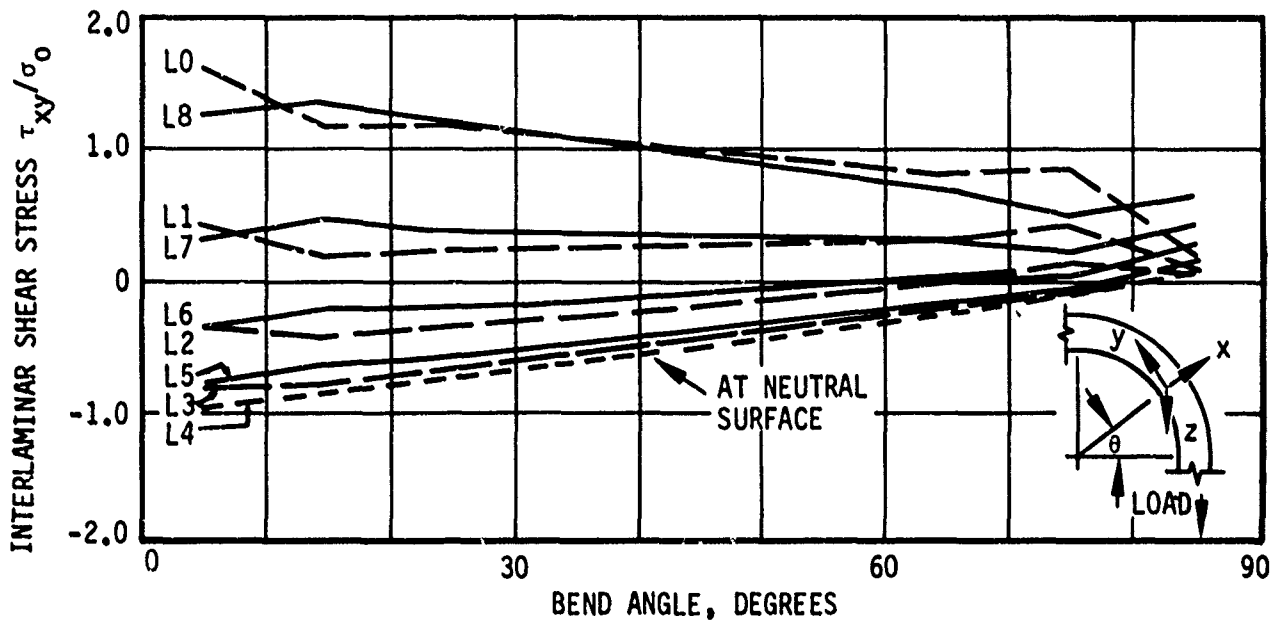

Figure B-27. Interlaminar Shear Stress Versus Bend Angle: Uniform Clockwise Couple Load Case

Normal stress is plotted versus bend angle in Figure B-28. This stress, a compression field, is rather uniform all along the bend angle.

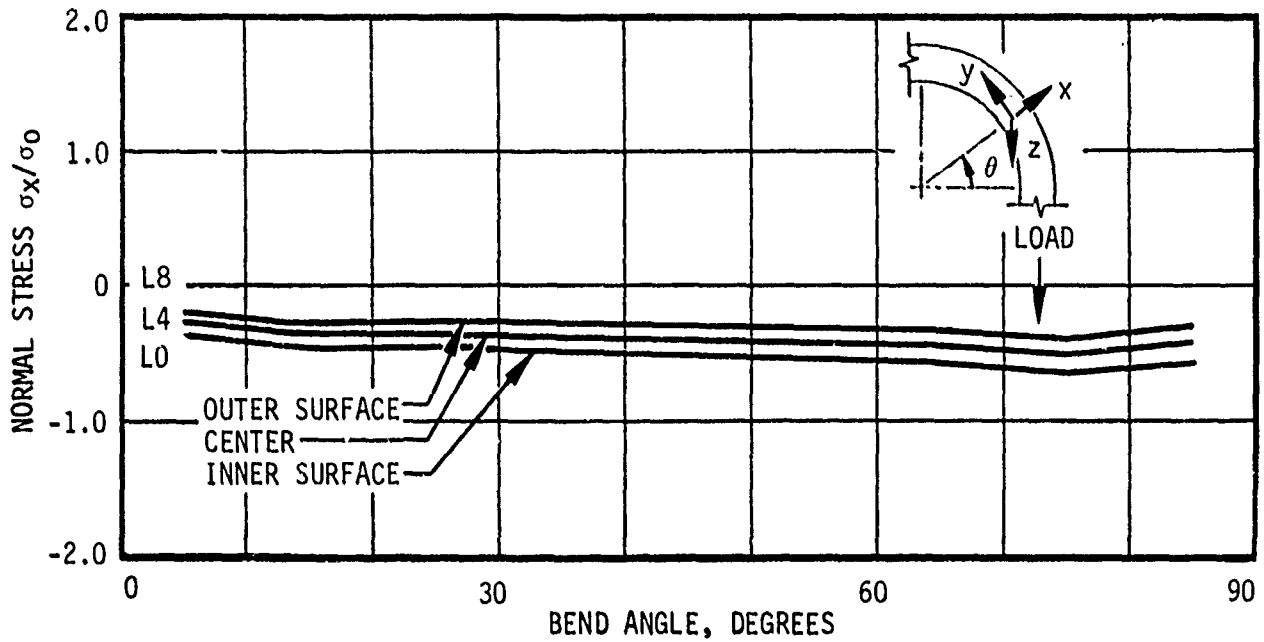

Figure B-28. Normal Stress Versus Bend Angle: Uniform Clockwise Couple Load Case

PARAMETRIC STUDIES

Parametric studies were conducted using the C-1 preprocessor model to determine the influence of various design parameters (Table B-2). The finite element model used for these studies varied somewhat from that described previously; five strips were used instead of ten. This coarser grid gave results comparable with those obtained using the ten-strip model, at one-fourth the cost in computer time.

The parametric study was based on the behavior of the in-plane tangential stress gradient $\partial\sigma_y/\partial(r\theta)$ and the interlaminar shear stress τ_{xy} , which determines interlaminar shear stress recovery. Tangential stress σ_y/σ_0 is plotted versus bend angle for varying thickness-to-bend radius ratios in Figure B-29. It can be seen that the tangential stress gradient decreases with increasing thickness-to-bend radius ratio; therefore, the larger the laminate thickness and the lower the bend radius, the smaller the interlaminar shear stress.

TABLE B-2. PARAMETRIC ANALYSIS

Run Number	Bend Radius, inch	Thickness, inch	Washer Radius, inch	Stacking Sequence	D_{lw} , inch	D_{wt} , inch	$\Delta\theta$, degrees	D_{et} , inch
1	0.25	0.125	0.25	$[0_{17}/\pm 45_8]$	0.4	0.27	15	0.51
2	0.50	↓	↓	↓	↓	↓	↓	↓
3	0.125	↓	0.219	$[0_{\#}/\pm 45_{\#}/0_{\#}]_3$	↓	0.249	↓	0.249
4	↓	↓	0.25	$[0_{17}/\pm 45_8]$	↓	0.27	↓	0.51
5	↓	0.25	↓	↓	↓	↓	↓	↓
6	↓	0.50	↓	↓	↓	↓	↓	↓
7	↓	0.125	↓	$[0_9/\pm 45_{16}]$	↓	↓	↓	↓
8	↓	↓	↓	$[0_{13}/\pm 45_{12}]$	↓	↓	↓	↓
9	↓	↓	↓	$[0]$	↓	↓	↓	↓
10	↓	↓	↓	$[\pm 45]$	↓	↓	↓	↓

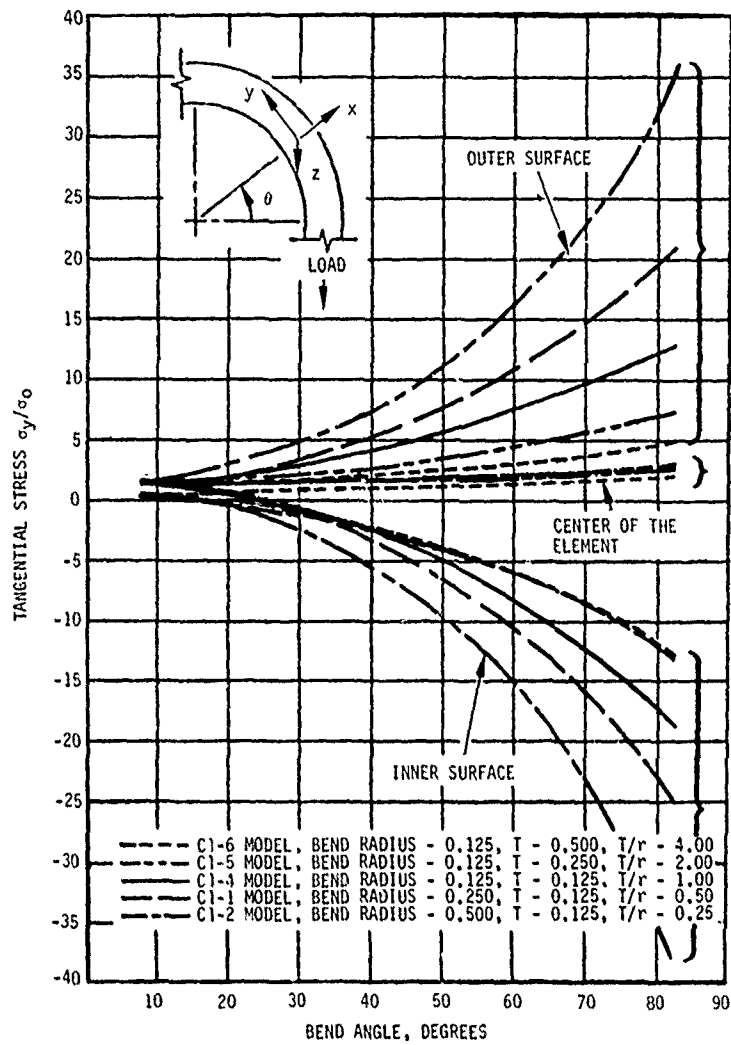

Figure B-29. Tangential Stress Versus Bend Angle for Varying Thickness-to-Bend Radius Ratios: Uniform Tension Load Case

Tangential stress is plotted versus bend angle for varying stacking sequences (with all laminae 0.125 inch thick) in Figure B-30. This stress and its gradient peak at the inner surface ($\theta = 75$ to 85 degrees). The slope of the gradient is lowest for a 0-degree laminate and highest for a ± 45 -degree laminate; however, tangential stress itself is highest for a 0-degree laminate. All other stacking sequences fall in between the extremes. A laminate may be chosen based on these curves, but the minimum thickness for a given application may depend on other, more important criteria.

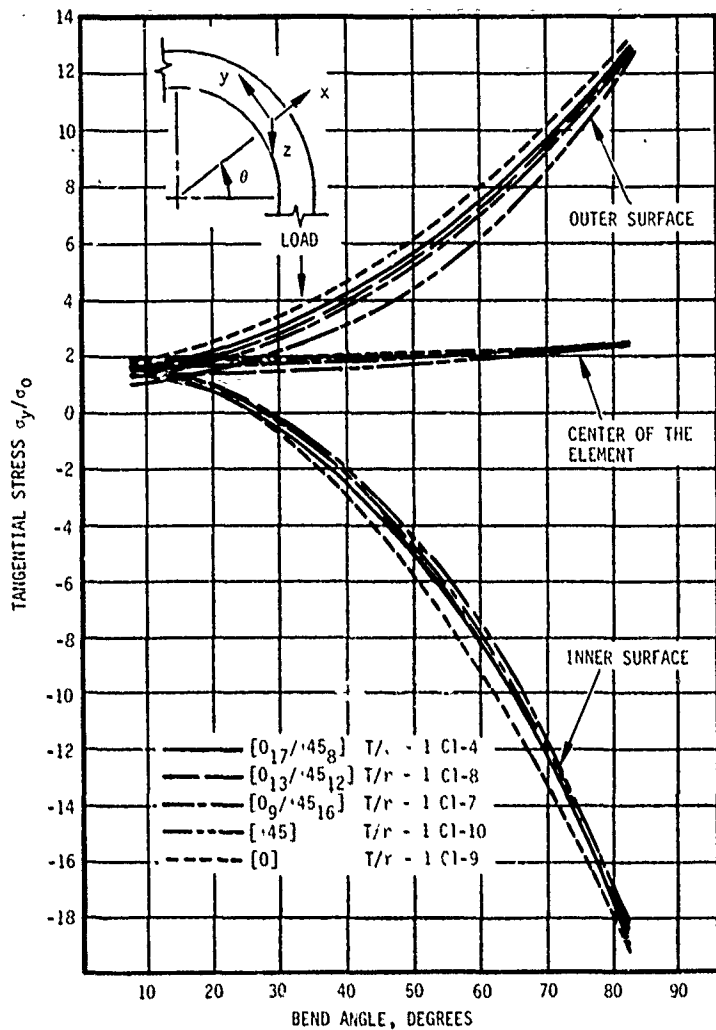

Figure B-30. Tangential Stress Versus Bend Angle for Varying Stacking Sequences: Uniform Tension Load Case

Interlaminar shear stress is plotted versus bend angle as a function of thickness-to-bend radius ratio in Figure B-31. At a bend angle of 90 degrees, this stress decreases with increasing thickness-to-bend radius ratio. For a ratio of 1, the stress varies linearly along the bend angle and, up to about 77 degrees, is the highest shown (note that the gradient is minimal at 77 degrees). For most design purposes, therefore, the thickness-to-bend radius ratio should be as high as possible.

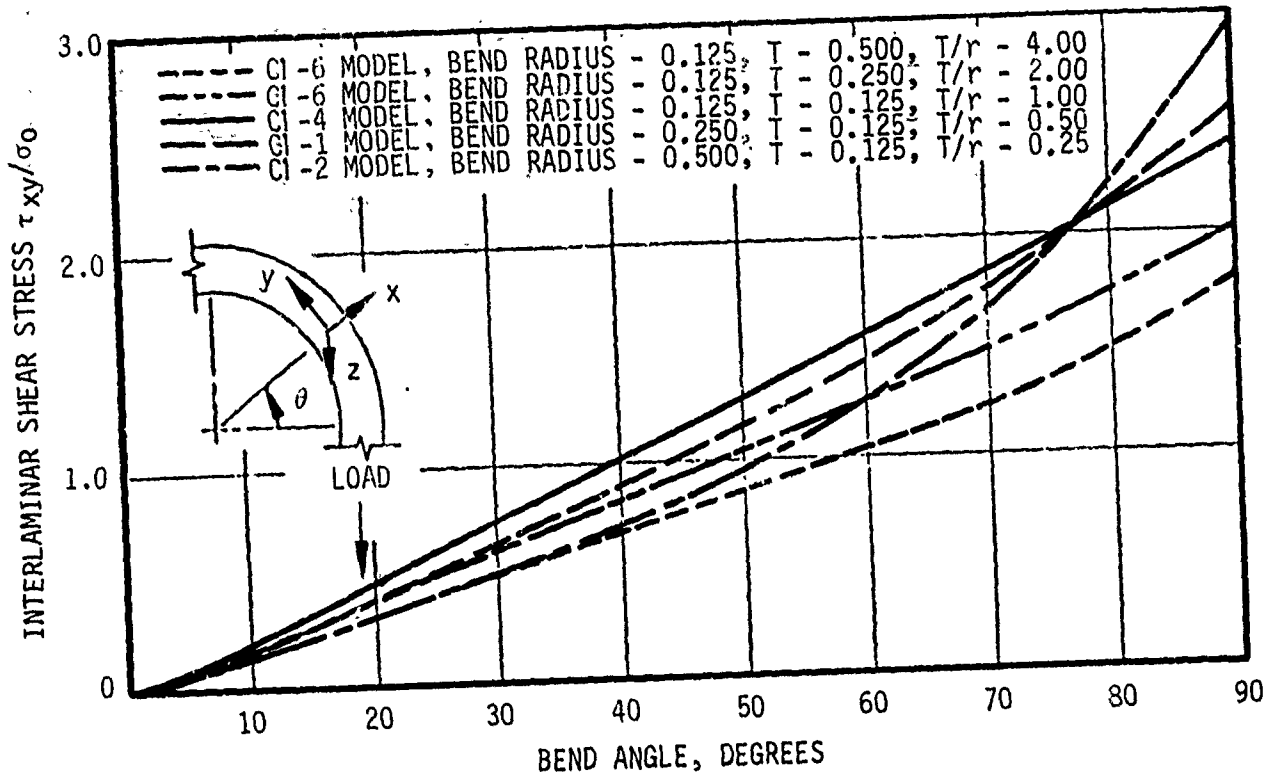

Figure B-31. Interlaminar Shear Stress Versus Bend Angle for Varying Thickness-to-Bend Radius Ratios: Uniform Tension Load Case

Interlaminar shear stress τ_{xy}/σ_0 is plotted versus bend angle in Figure B-32. For bend angles between 0 and 77 degrees, the shear stress is highest for a 0-degree laminate and lowest for a ± 45 -degree laminate, with the 0/ ± 45 degree laminates falling in between. For bend angles between 77 and 85 degrees, the order reverses such that the peak shear stress, which occurs at $\theta = 85$ degrees, is highest for a ± 45 -degree laminate and lowest for a 0-degree laminate.

For the $[0_{13}/\pm 45_{12}]$ laminate, which corresponds to the quasi-isotropic laminate, the interlaminar shear stress gradient is constant throughout the range.

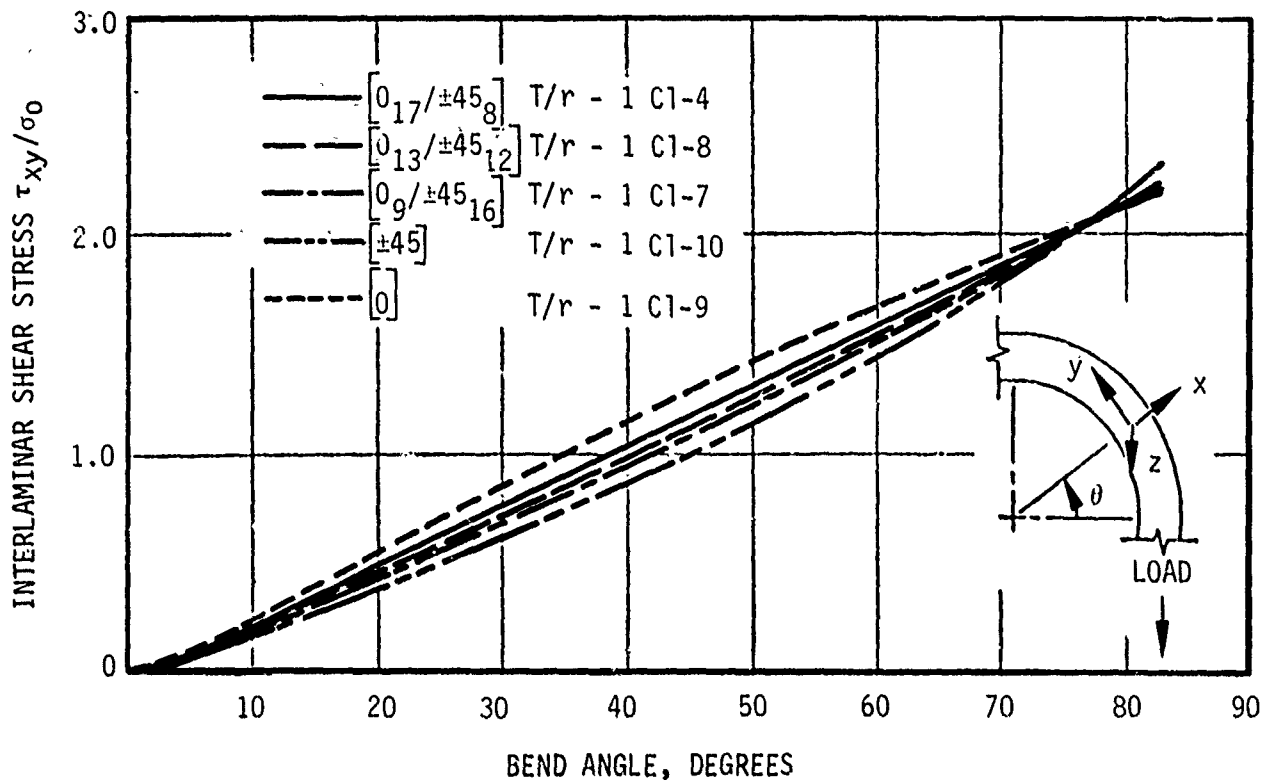

Figure B-32. Interlaminar Shear Stress Versus Bend Angle for Varying Stacking Sequences; Uniform Tension Load Case

A C-2 model analysis was performed to determine the influence of the lamina stacking sequence on interlaminar stresses. The model consisted of a 25-ply laminate of T300 graphite/5208 epoxy. The critical strip, which was extracted from the previous ten-strip C-1 model, was 0.1 inch wide. Four stacking sequences were studied (Figure B-33).

Interlaminar shear stress is plotted across the laminate thickness for the four stacking sequences in Figure B-34. Interlaminar shear stress is independent of the stacking sequence over most of the laminate thickness; in fact the only discernible difference among the four stacking sequences occurs near the outer surface, where Sequence 3 appears to show a slightly lower stress value.

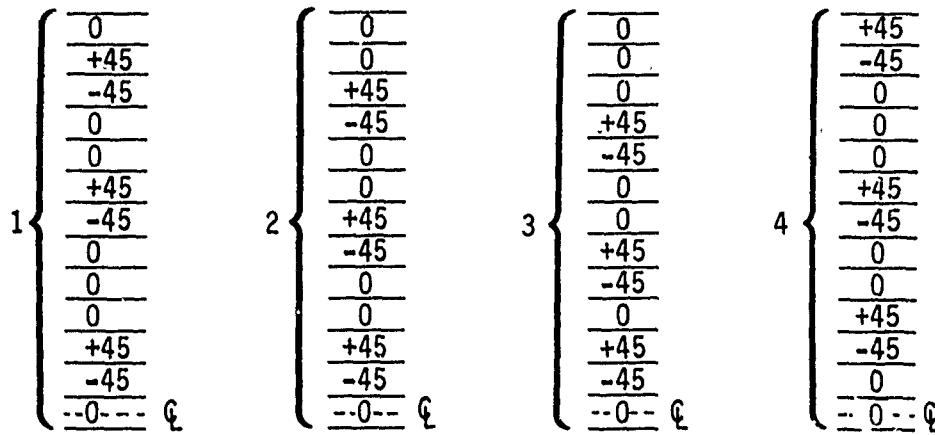

Figure B-33. Four Stacking Sequences

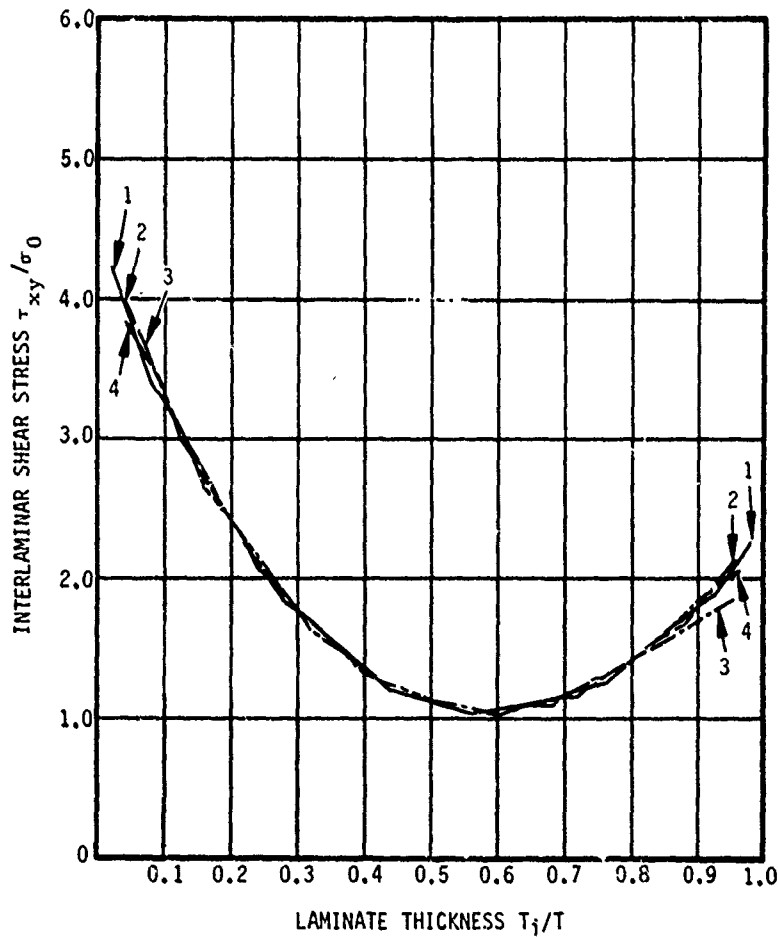

Figure B-34. Interlaminar Shear Stress for Varying Stacking Sequences Through the Laminate Thickness

To verify the importance of the type of laminae used (fabric or tape), a comparison was made between the four configurations shown in Figure B-33 and a $[0\#/45\#/0\#]$ laminate. The fabric laminate coincides with the others for laminates between 0.5 and 0.65 inch thick; however, for all other thicknesses it is subjected to much higher interlaminar shear stress levels. This indicates that the choice of material would be tape.

It should be noted, however, that mixing is very important in keeping the stresses uniformly distributed throughout the laminate thickness. Stress gradients are highly sensitive to induced singularities due to any severe change in laminae properties within a laminate.

EXPERIMENTAL TESTS

The graphite, Kevlar 49, S-glass, and E-glass composite angle specimens described in Table B-3 were fabricated and tested after 3 to 4 days in the normal laboratory environment. The tension test setup for these 1-inch-wide specimens is shown in Figure B-35.

Both incipient local matrix failure by delamination in the outer plies of the corner region and ultimate filament fracture were recorded. Initial matrix delaminations were audible and were measured as sudden changes in the slope of the load-deflection curve. These changes of slope were recorded in two ways:

- Displacement from top of grip to mid-bolt head (Delta 1)
- Test machine head travel (Delta 2)

As shown in Figure B-35, Delta 2 readings have more than twice the magnitude of the Delta 1 readings in the elastic range. Delta 1 readings were recorded continuously and automatically, and Delta 2 readings were taken (from the gauges) every 20 pounds for the -1, -3, and -5 specimens and every 40 pounds for the -2, -4, and -6 specimens.

The typical sequence of events in fracture failures is illustrated in Figure B-36. The corners of thinner angles straighten out elastically for a distance of up to two or three times their initial radii. Next the matrix fails in delamination, and finally the fibers fracture at ultimate load.

TABLE B-3. ANGLE TENSION TEST SPECIMENS

Panel No.	Quantity Made	Fiber Type	Supplier Designation	Ply Thickness, inch	Stacking Sequence	Cured Thickness, inch
1	8	Graphite	Hexcel F3T-584, Gr/F-250	0.0125	$[(0/90)/(\pm 45)/(0/90)]_3$	0.078
2	8	Graphite	Narmco Rigidite, T300/5208	0.014	$[(0/90)/(\pm 45)/(0/90)]_5$	0.205
3	8	Kevlar 49	Hexcel 181, Kevlar 49/F-155	0.0095	Same as 1	0.085
4	8	Kevlar 49	Narmco 281, Kevlar 49/5208	0.009	Same as 2	0.124
5	8	S-glass	Hexcel 181, S2-glass/F-155	0.0095	Same as 1	0.084
6	8	E-glass	Narmco 7781, E-glass/5208	0.010	Same as 2	0.156

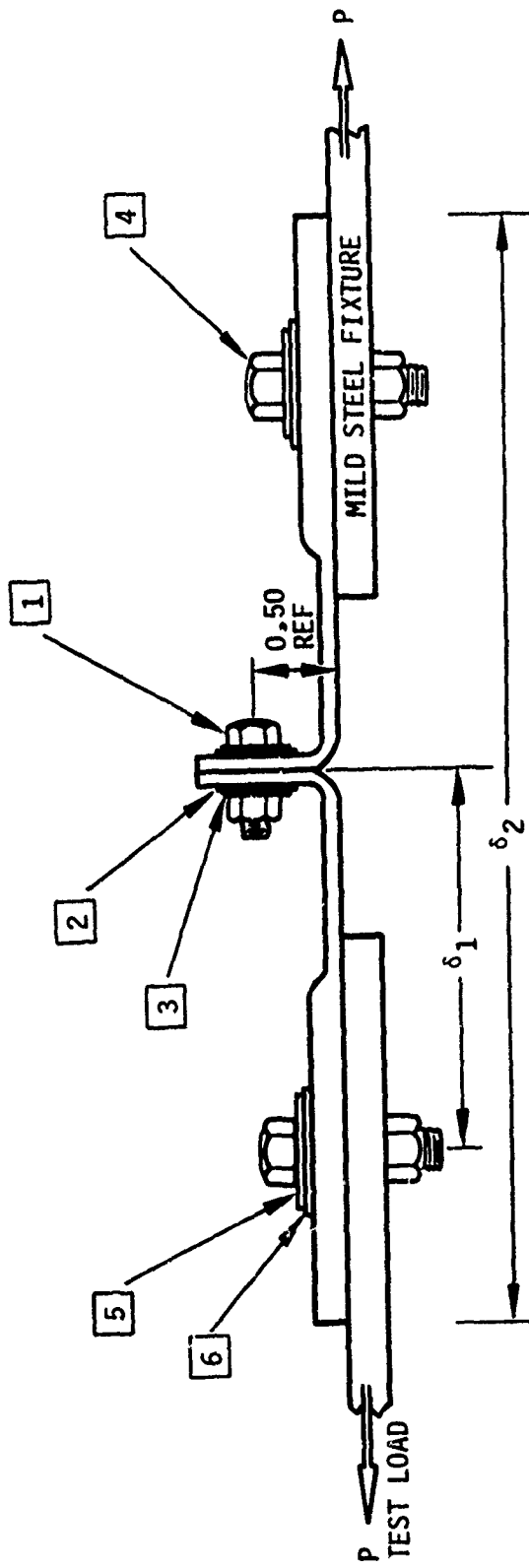

- 1 NAS 1103 OR NAS 1223-4 OR EQUIVALENT NO. 10-32 HEX HEAD BOLTS WITH 1/2- TO 1/2-INCH GRIP; NAS 671-10 OR NAS 1021 OR EQUIVALENT PLAIN HEX NUTS TO BE TORQUED TO 26 IN.-LB
- 2 FIBERGLASS, GRAPHITE/EPOXY, TEFLON, OR TEDLAR WASHER, 0.2-INCH ID, 1/2- TO 3/4-INCH OD IN 2 PLACES, 1/32- TO 3/32-INCH THICK
- 3 NAS 620 OR EQUIVALENT NO.10 ID STEEL PLAIN WASHER, TYP OF 2 PLACES
- 4 1/4-20 OR 1/4-28 BOLT AND NUT, TORQUED TO 3/4 OF ALLOWABLE, TYP OF 2 PLACES
- 5 PLAIN STEEL WASHER 6 FIBERGLASS, GRAPHITE/ EPOXY, OR GLASS/TEFLON WASHER

Figure B-35. Test Setup

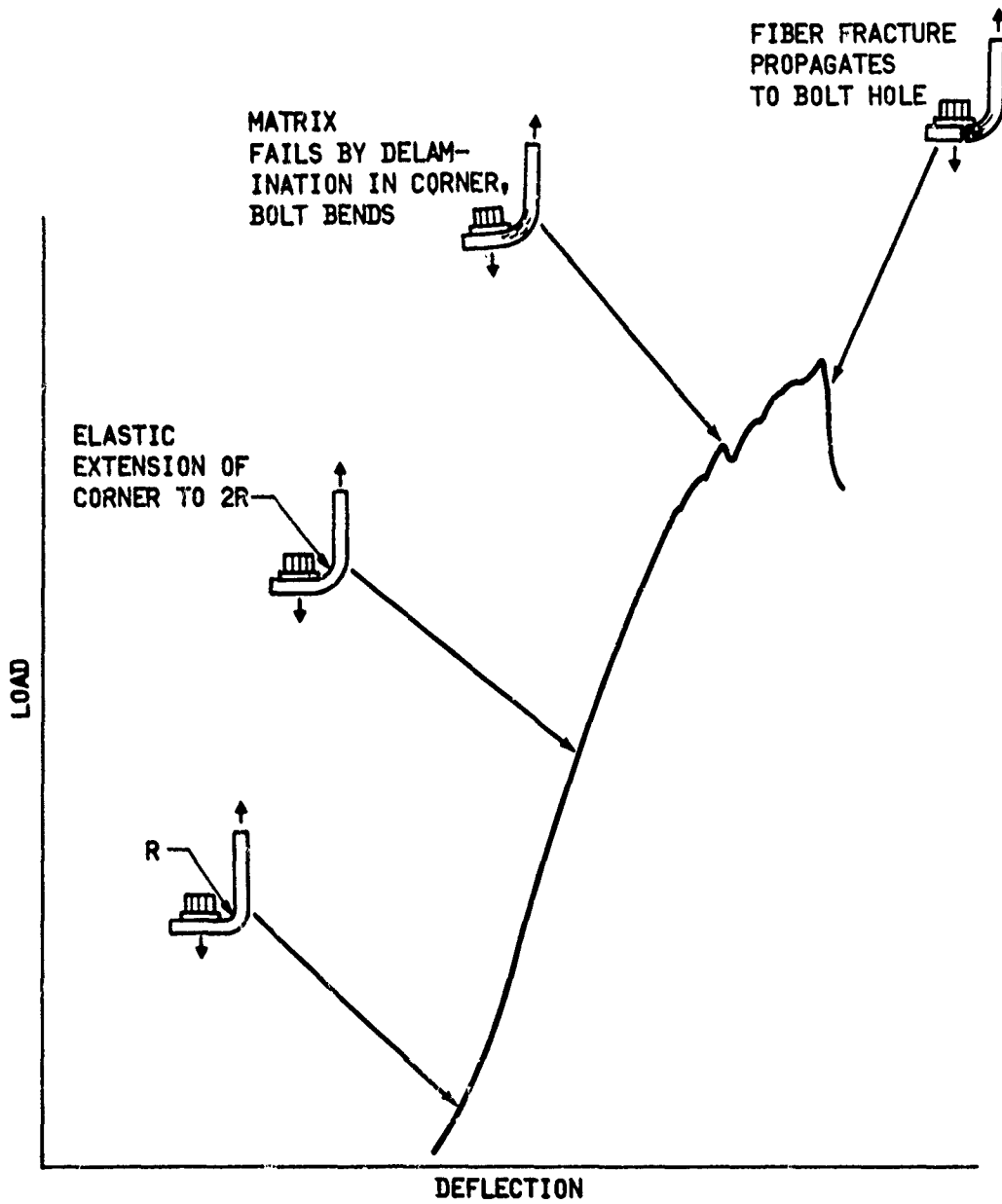

Figure B-36. Fracture Progression in Typical Composite Angle

The concept of yield strength being two-thirds of ultimate strength is not transferable from metals to composites. Permanent set may occur anywhere from 75 percent (thin angles) to 90 percent of ultimate strength (thicker angles).

Thick sections are more ductile than thin ones.

Allowable load versus thickness in composite angles is shown in Figure B-37 for an eccentricity of 0.5 inch. A similar curve for 2024-T3 aluminum has been added for comparison. With respect to angle allowables, only graphite is similar to aluminum.

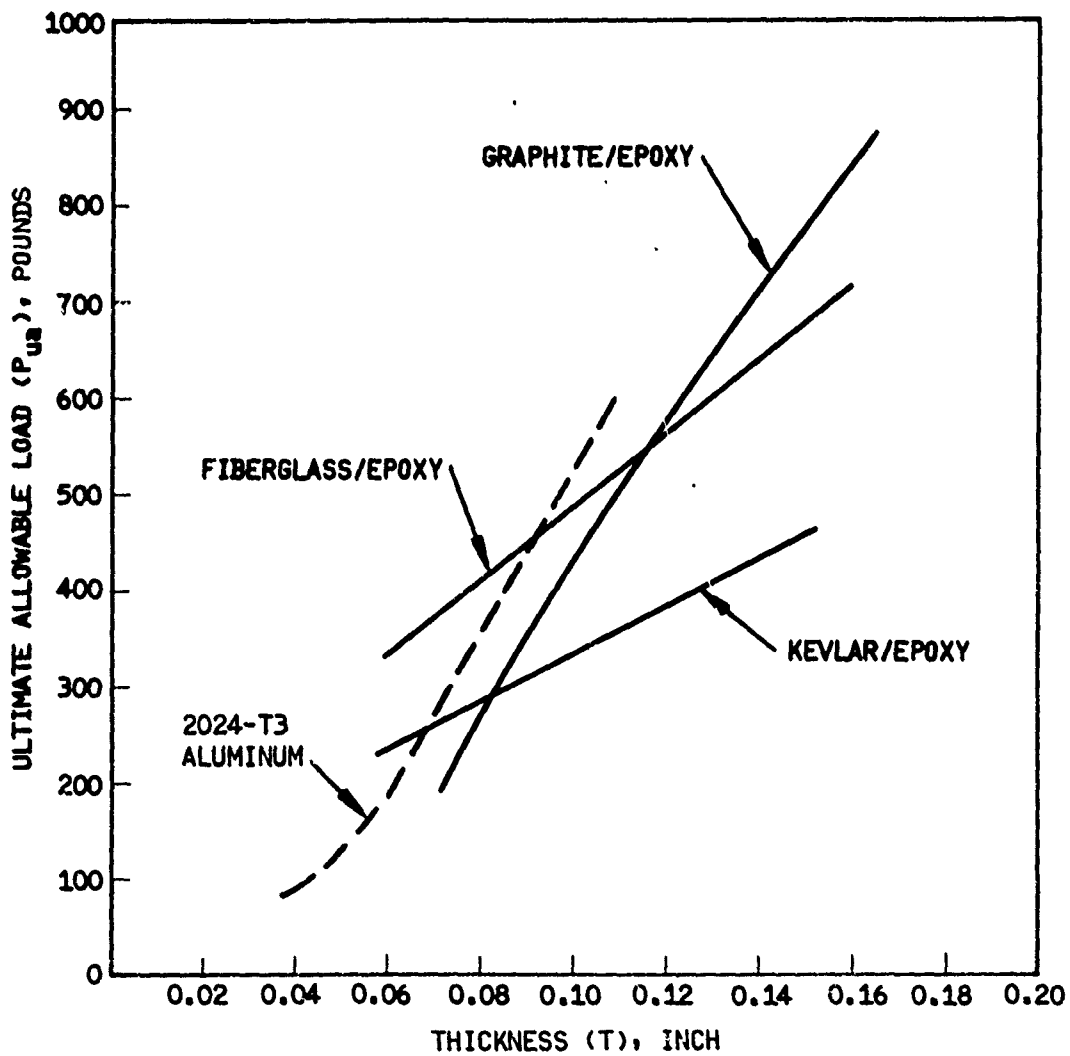

Figure B-37. Ultimate Allowable Loads Versus Thickness

APPENDIX C

C-1 MODEL PREPROCESSOR PROGRAM LISTING

```

1. // JOB (900004,,048),PRE91278,CLASS=B -----
2. //STEP1 EXEC FORTHCLG
3.   DIMENSION LAST(1000),ICUR(1000),IG(8)
4.   REAL*8 LEGX1,LEGY,WIDTH,RADIUS,DELTAY,DELTAX,T(26),TOLER,X,Y(26),
5.   *PION4,XSAVE,YSAVE,ANGLE,DIST,XLAST,YLAST,DELTAT,YY,XX,DELT2,
6.   *BEND,THETA,Z(26),DELTAZ,R(26),HT2,XMOD1,XXMOD,XMOD(26),
7.   *YMOD(26),ZMOD,ZMOD2(26),THMOD,LEGX,LEGXP1,LEGY
8.   NAMELIST /PARAMS/ LEGX1,LEGY,WIDTH,RADIUS,DELTAX,DELTAY,T,
9.   *TOLER,DELTAT,BEND,DELTAZ,LAYERS,
10.  *DELT2,HT2
11.  DATA IGRID/1/,JGRID/10001/,ICONT/0/,JCUR/0/,JLAST/0/,IEL/1/
12.  DATA LEGX1,LEGY,WIDTH,RADIUS,DELTAX,DELTAY,TOLER/7*0.0/
13.  DATA T/26*0.0/
14.  DATA DELTAT,BEND/2*0.0/,DELTAZ/0.0/,LAYERS/0/,DELT2/0.0/
15.  DATA HT2/0.0/
16. C
17. C
18. C THIS PROG IS FOR GENERATING BULK DATA FOR THE FULL BRACKET
19. C AND IS CALLED PRE-PROCESSOR FOR C1 MODEL -----
20. C
21. C READ IN PARAMETERS
22. C READ(5,PARAMS)
23. C IF(LAYERS.EQ.0)LAYERS=1
24. C ECHO PARAMETERS
25. C WRITE(6,0)LEGX1,LEGY,WIDTH,RADIUS,DELTAY,DELTAX,DELTAT,BEND,
26. C *TOLER,DELTAZ,LAYERS,DELT2,HT2
27. C @PARAMETER ECHO',/,,'OLEGX1= ',T13,F8.4,/,
28. C * LEGY= ',T13,F8.4,/,,' WIDTH= ',
29. C *T13,F8.4,/,,' RADIUS= ',T13,F8.4,/,,' DELTA-Y= ',T13,F8.4,/,
30. C *' DELTA-X= ',T13,F8.4,/,,' DELTA-T= ',T13,F8.4,/,,' BEND= ',T13,F8.4
31. C *',/,,' TOLERANCE= ',F8.4,/,,' DELTA-Z=',T13,
32. C *F8.4,/,,' LAYERS=',T13,18,/,,' DELTAY2=',T13,F8.4,/,,' HEIGHT2=',
33. C *T13,F8.4)
34. C DO 996 I=1,LAYERS
35. C WRITE(6,997) I,T(I)
36. 997 FORMAT(' LAYER-',I2,' THICKNESS=',F8.4)
37. 998 CONTINUE
38. C 1 FORMAT('GRID ',I8,8X,3F8.4)
39. C IF(LAYERS.GT.25)GO TO 900
40. C INITIALIZE CONSTANTS
41. C LAYERG=LAYERS+1
42. C Z(I)=LEGY+BEND
43. C DO 35 I=2,LAYERG
44. C Z(I)=Z(I-1)+T(I-1)
45. C 35 CONTINUE
46. C IEND2=0
47. C PION4=3.14159/4.
48. C IPSOL=1
49. C
50. C
51. C GENERATE PIECE BEFORE FIRST PIECE(MODEL CHANGE 5/8/78)
52. C
53. C
54. C
55. C START AT THE LOWER LEFTHAND CORNER
56. C THEN MOVE TO THE RIGHT UNTIL WE HIT THE CUTOUT
57. C Y(1)=0.0
58. C 430 X=WIDTH

```

```

59. C   GENERATE FAR LEFT GRID POINT
60.     YY=-Y(1)
61. C   TRANSFORMING FROM ORIGINAL TO MODIFIED RECT COORD SYSTEM
62.     XXMOD=YY+HT2
63.     YMOD(1)=Z(1)
64.     ZMOD=X
65.     WRITE(7,1)IGRID,XXMOD,YMOD(1),ZMOD
66.     DD 495 I=2,LAYERG
67.     YMOD(1)=Z(1)
68.     WRITE(7,1)JGRID,XXMOD,YMOD(1),ZMOD
69.     JGRID=JGRID+10000
70. 495 CONTINUE
71. C   STORE GRID ID
72.     JCUR=JCUR+1
73.     ICUR(JCUR)=IGRID
74. C   INCREMENT GRID ID
75.     IGRID=IGRID+1
76.     JGRID=JGRID+10000
77. C   MOVE TO THE LEFT
78. 490 X=X-DELTA
79. C   SAVE X AND Y
80.     XSAVE=X
81.     YSAVE=Y(1)
82.     IF(Y(1).EQ.0.0)XX=X
83. C   ARE WE PAST THE 45?
84.     ANGLE=DATAN(Y(1)/X)
85.     IF(ANGLE.GT.PION/4)GO TO 540
86. C   BELOW THE 45
87. C   FIND DISTANCE FROM CUTOUT
88.     IF(Y(1).GT.RADIUS)GO TO 550
89.     DIST=X-DSORT(RADIUS**2-Y(1)**2)
90. C   ARE WE WITHIN TOLERANCE FROM THE CUTOUT
91.     IF(DIST.LE.TOLER)GO TO 480
92.     GO TO 550
93. C   ABOVE THE 45
94. 540 IF(X.GT.RADIUS)GO TO 550
95.     DIST=Y(1)-DSORT(RADIUS**2-X**2)
96.     IF(DIST.LE.TOLER)GO TO 560
97. C   NOT AT THE CUTOUT YET SO GENERATE NORMAL GRID POINT
98. 550 YY=-Y(1)
99. C   TRANSFORMING FROM ORIGINAL TO MODIFIED RECT COORD SYSTEM
100.    XXMOD=YY+HT2
101.    YMOD(1)=Z(1)
102.    ZMOD=X
103.    WRITE(7,1)IGRID,XXMOD,YMOD(1),ZMOD
104.    DD 555 I=2,LAYERG
105.    YMOD(1)=Z(1)
106.    WRITE(7,1)JGRID,XXMOD,YMOD(1),ZMOD
107.    JGRID=JGRID+10000
108. 555 CONTINUE
109. C   STORE GRID ID
110.    JCUR=JCUR+1
111.    ICUR(JCUR)=IGRID
112. C   INCREMENT GRID ID'S
113.    IGRID=IGRID+1
114.    JGRID=JGRID+10000
115. C   IF THIS IS THE FIRST LINE OF GRIDS, DON'T GENERATE CONNECTIONS
116.    IF(Y(1).EQ.0.0)GO TO 490
117. C   MAKE SURE WE HAVE A POINT NEXT TO THIS ONE
118.    IF(JCUR.GT.JLAST)GO TO 560
119. C   GENERATE QUAD ELEMENT

```

```

120. C FIRST SET UP GRID POINT ORDER
121. 590 IG(1)=ICUR(JCUR)
122. IG(2)=ICUR(JCUR-1)
123. IG(3)=LAST(JCUR-1)
124. IG(4)=LAST(JCUR)
125. IG(5)=IG(1)+10000
126. IG(6)=IG(2)+10000
127. IG(7)=IG(3)+10000
128. IG(8)=IG(4)+10000
129. JEL=IEL
130. JPSOL=JPSOL
131. DO 565 J=1,LAYERS
132. IF(J.EQ.1) GO TO 567
133. JEL=JEL+10000
134. JPSOL=JPSOL+10
135. DO 566 K=1,8
136. IG(K)=IG(K)+10000
137. 566 CONTINUE
138. C PUNCH CONNECTION CARD
139. 567 WRITE(7,2)JEL,JPSOL,(IG(I),I=1,6),JCONT
140. C INCREMENT CONTINUATION FIELD
141. JCONT=JCONT
142. JCONT=JCONT+1
143. C PUNCH CONTINUATION OF CONNECTION CARD
144. WRITE(7,3)JCONT,IG(7),IG(8)
145. 565 CONTINUE
146. C INCREMENT ELEMENT ID
147. IEL=IEL+1
148. C KEEP GOING TILL WE HIT THE CUTOUT
149. GO TO 490
150. C IF WE DON'T HAVE A POINT NEXT TO THIS ONE PUT ONE ON THE CURVE
151. 58C YY=DSQRT(RADIUS**2-X**2)
152. C TRANSFORMING FROM ORIGINAL TO MODIFIED RECT COORD SYSTEM
153. XXMOD=YY+HT2
154. YMOD(1)=Z(1)
155. ZMOD=X
156. WRITE(7,1)IGRID,XXMOD,YMOD(1),ZMOD
157. DO 585 I=2,LAYERC
158. YMOD(I)=Z(I)
159. WRITE(7,1)JGRID,XXMOD,YMOD(I),ZMOD
160. JGRID=JGRID+10000
161. 585 CONTINUE
162. C STORE GRID ID
163. JLAST=JLAST+1
164. LAST(JLAST)=IGRID
165. C INCREMENT GRID ID
166. IGRID=IGRID+1
167. JGRID=JGRID+10000
168. GO TO 590
169. C
170. C WE'VE HIT THE CUTOUT, SO GENERATE
171. C A GRID POINT ON THE CURVE OF THE CUTOUT
172. C WE'RE ABOVE THE 45, SO MOVE IN THE Y-DIRECTION
173. 560 Y(1)=DSQRT(RADIUS**2-X**2)
174. GO TO 570
175. C WE'RE BELOW THE 45 SO MOVE IN THE X-DIRECTION
176. 480 X=DSQRT(RADIUS**2-Y(1)**2)
177. 570 YY=-Y(1)
178. C TRANSFORMING FROM ORIGINAL TO MODIFIED RECT COORD SYSTEM
179. XXMOD=YY+HT2
180. YMOD(1)=Z(1)

```

```

181.      ZMOD=X
182.      WRITE(7,1)IGRID,XXMOD,YMOD(1),ZMOD
183.      DO 575 I=2,LAYERG
184.      YMOD(I)=Z(I)
185.      WRITE(7,1)JGRID,XXMOD,YMOD(1),ZMOD
186.      JGRID=JGRID+10000
187. 575 CONTINUE
188. C      STORE GRID ID
189.      JCUR=JCUR+1
190.      ICUR(JCUR)=IGRID
191. C      INCREMENT GRID ID'S
192.      IGRID=IGRID+1
193.      JGRID=JGRID+10000
194. C      IF THIS IS THE FIRST LINE OF GRIDS, DON'T GENERATE CONNECTIONS
195.      IF(Y(1).EQ.0.0)GO TO 530
196. C      DID WE CROSS A LINE OF GRIDS?
197.      IF(XSAVE.NE.XLAST)GO TO 500
198. C      WE DIDN'T CROSS A LINE OF GRIDS SO
199. C      GENERATE A QUAD ELEMENT
200. C      FIRST SET UP THE GRID ORDER
201.      IG(1)=ICUR(JCUR)
202.      IG(2)=ICUR(JCUR-1)
203.      IG(3)=LAST(JCUR-1)
204.      IG(4)=LAST(JCUR)
205.      IG(5)=IG(1)+10000
206.      IG(6)=IG(2)+10000
207.      IG(7)=IG(3)+10000
208.      IG(8)=IG(4)+10000
209.      JEL=IEL
210.      JPSOL=JPSOL
211.      DO 576 J=1,LAYERS
212.      IF(J.EQ.1)GO TO 578
213.      JPSOL=JPSOL+10
214.      JEL=JEL+10000
215.      DO 577 K=1,8
216.      IG(K)=IG(K)+10000
217. 577 CONTINUE
218. C      PUNCH CONNECTION CARD
219. 578 WRITE(7,2)JEL,JPSOL,(IG(I),I=1,6),ICONT
220. C      INCREMENT CONTINUATION FIELD
221.      JCONT=ICONT
222.      ICONT=ICONT+1
223. C      PUNCH CONTINUATION OF CONNECTION CARD
224.      WRITE(7,3)JCONT,IG(7),IG(8)
225. 576 CONTINUE
226. C      INCREMENT ELEMENT ID
227.      IEL=IEL+1
228.      GO TO 530
229. C
230. C      WE CROSSED A LINE OF GRIDS SO WE NEED A TRIANGULAR
231. C      ELEMENT INSTEAD OF A QUAD ELEMENT
232. C      FIRST SET UP THE GRID ORDER
233. 500 IG(1)=ICUR(JCUR-1)
234.      IG(2)=LAST(JCUR-1)
235.      IG(3)=ICUR(JCUR)
236.      IG(4)=IG(1)+10000
237.      IG(5)=IG(2)+10000
238.      IG(6)=IG(3)+10000
239.      JEL=IEL
240.      JPSOL=JPSOL
241.      DO 505 J=1,LAYERS

```

```

242.     IF(J.EQ.1) GO TO 507
243.     JPSOL=JPSOL+10
244.     JEL=JEL+10000
245.     DO 506 K=1,6
246.     IG(K)=IG(K)+10000
247. 506 CONTINUE
248. C   PUNCH CONNECTION CARD
249. 507 WRITE(7,4)JEL,JPSOL,(IG(I),I=1,6)
250.     4 FORMAT('CPENTA ',8I8)
251. 505 CONTINUE
252. C   INCREMENT ELEMENT ID
253.     IEL=IEL+1
254. C   SAVE LAST X AND Y VALUES
255. 530 YLAST=YSAVE
256.     XLAST=XSAVE
257. C   NOW MOVE CURRENT GRIDS TO LAST GRIDS
258.     DO 510 I=1,JCUR
259.     LAST(I)=ICUR(I)
260. 510 CONTINUE
261.     JLAST=JCUR
262. C   RESET CURRENT GRID COUNTER
263.     JCUR=0
264. C   MOVE UP A LINE
265.     IF(ANGLE.GT.PION/4)Y(1)=YSAVE
266.     Y(1)=Y(1)+DELT Y2
267. C   ARE WE AT THE TOP OF THE CUTOUT?
268.     IF(Y(1).LT.(RADIUS+TOLER))GO TO 430
269. C   START GOING UP IN THE Y-DIRECTION UNTIL WE HIT THE TOP
270. C   START AT THE LEFT EDGE
271.     Y(1)=Y(1)-DELT Y2
272.     GO TO 475
273. 420 X=WIDTH
274. C   GENERATE NEXT LINE OF GRID POINTS
275.     IEND=0
276. 440 YY=Y(1)
277. C   TRANSFORMING FROM ORIGINAL TO MODIFIED RECT COORD SYSTEM
278.     XXMOD=YY+HT2
279.     YMOD(I)=Z(I)
280.     ZMOD=X
281.     WRITE(7,1)IGRID,XXMOD,YMOD(I),ZMOD
282.     GO 445 I=2,LAYERG
283.     YMOD(I)=Z(I)
284.     WRITE(7,1)JGRID,XXMOD,YMOD(I),ZMOD
285.     JGRID=JGRID+10000
286. 445 CONTINUE
287. C   SAVE GRID ID'S FOR ELEMENT CONNECTIONS
288.     JCUR=JCUR+1
289.     ICUR(JCUR)=IGRID
290. C   INCREMENT GRID ID'S
291.     IGRID=IGRID+1
292.     JGRID=JGRID+10000
293. C   SEE IF THERE IS A POINT NEXT TO THIS ONE
294.     IF (JCUR.GT.JLAST)GO TO 452
295. C   MOVE TO THE RIGHT ONE INCREMENT AND REPEAT
296. 451 X=X-DELT X
297.     IF(X.GT.TOLER)GO TO 440
298. C   MAKE SURE WE GET THE RIGHT EDGE
299.     IF(IEND.EQ.1)GO TO 450
300.     X=0.0
301.     IEND=1
302.     GO TO 440

```

```

303. C
304. C   GENERATE ELEMENT CONNECTIONS
305. C
306.   450 DD 460 I=2,JLAST
307. C   FIRST SET UP THE GRID POINT ORDER
308.     IG(1)=ICUR(I)
309.     IG(2)=ICUR(I-1)
310.     IG(3)=LAST(I-1)
311.     IG(4)=LAST(I)
312.     IG(5)=IG(1)+10000
313.     IG(6)=IG(2)+10000
314.     IG(7)=IG(3)+10000
315.     IG(8)=IG(4)+10000
316.     JEL=IEL
317.     JPSOL=IPSOL
318.     DD 455 K=1,LAYERS
319.     IF(K.EQ.1) GO TO 457
320.     JEL=JEL+10000
321.     JPSOL=JPSOL+10
322.     DD 456 L=1,8
323.     IG(L)=IG(L)+10000
324.   456 CONTINUE
325. C   PUNCH CONNECTION CARD
326.   457 WRITE(7,2)JEL,JPSOL,(IG(J),J=1,6),ICONT
327. C   INCREMENT CONTINUATION FIELD
328.     JCONT=ICONT
329.     ICONT=ICONT+1
330. C   PUNCH CONTINUATION OF CONNECTION CARD
331.     WRITE(7,3)JCONT,IG(7),IG(8)
332.     2 FORMAT('CHEXA ',818,'+',17)
333.     3 FORMAT('+',17,218)
334.   455 CONTINUE
335. C   INCREMENT ELEMENT ID
336.     IEL=IEL+1
337.   460 CONTINUE
338. C   MOVE CURRENT LINE OF GRIDS TO LAST LINE
339.     DD 470 I=1,JCUR
340.     LAST(I)=ICUR(I)
341.   470 CONTINUE
342.     JLAST=JCUR
343. C   MAKE CURRENT LINE EMPTY
344.     JCUR=0
345. C   MOVE UP A LINE
346.   475 Y(1)=Y(1)+DELTY2
347. C   HAVE WE HIT THE TOP YET?
348.     IF(Y(1).LT.(HT2-TOLER))GO TO 420
349.     IF(IEND2.EG.1)GO TO 600
350.     IEND2=1
351.     Y(1)=HT2
352.     GO TO 420
353. C   IF WE DON'T HAVE A POINT NEXT TO THIS ONE PUT ONE ON THE CURVE
354.   452 YY=DSORT(RADIUS**2-X**2)
355. C   TRANSFORMING FROM ORIGINAL TO MODIFIED RECT COORD SYSTEM
356.     XXMOD=YY+HT2
357.     YMOD(1)=Z(1)
358.     ZMOD=X
359.     WRITE(7,1)IGRID,XXMOD,YMOD(1),ZMOD
360.     DD 453 I=2,LAYERG
361.     YMOD(I)=Z(I)
362.     WRITE(7,1)JGRID,XXMOD,YMOD(I),ZMOD
363.     JGRID=JGRID+10000

```

```

364. 453 CONTINUE
365. C STORE GRID ID
366. JLAST=JLAST+1
367. LAST(JLAST)=IGRID
368. C INCREMENT GRID ID
369. IGRID=IGRID+1
370. JGRID=IGRID+10000
371. GO TO 451
372. 600 IGRID=(IGRID/1000+1)*1000+1
373. JGRID=IGRID+10000
374. IEL=(IEL/1000+1)*1000+1
375. XLAST=XX
376. IEND2=0
377. C
378. C
379. C GENERATE FIRST PIECE WITH CUTOUT IN IT
380. C
381. C
382. C
383. C START AT THE LOWER LEFTHAND CORNER
384. C THEN MOVE TO THE RIGHT UNTIL WE HIT THE CUTOUT
385. Y(1)=DELTAY
386. 30 X=WIDTH
387. C GENERATE FAR LEFT GRID POINT
388. C TRANSFORMING FROM ORIGINAL TO MODIFIED RECT COORD SYSTEM
389. XMOD(1)=Y(1)+HT2
390. YMOD(1)=Z(1)
391. ZMOD=X
392. WRITE(7,1)IGRID,XMOD(1),YMOD(1),ZMOD
393. DO 95 I=2,LAYERG
394. YMOD(I)=Z(I)
395. WRITE(7,1)JGRID,XMOD(1),YMOD(I),ZMOD
396. JGRID=JGRID+10000
397. 95 CONTINUE
398. C STORE GRID ID
399. JCUR=JCUR+1
400. ICUR(JCUR)=IGRID
401. C IF FIRST LINE OF GRIDS PICK UP GRID # FOR LAST LINE
402. IF(Y(1).EQ.DELTAY)LAST(JCUR)=MOD(IGRID,1000)
403. IF(Y(1).EQ.DELTAY)JLAST=JCUR
404. C INCREMENT GRID ID
405. IGRID=IGRID+1
406. JGRID=IGRID+10000
407. C MOVE TO THE LEFT
408. 90 X=X-DELTAX
409. C SAVE X AND Y
410. XSAVE=X
411. YSAVE=Y(1)
412. C ARE WE PAST THE 45?
413. ANGLE=DATAN(Y(1)/X)
414. IF(ANGLE.GT.PION/4)GO TO 140
415. C BELOW THE 45
416. C FIND DISTANCE FROM CUTOUT
417. IF(Y(1).GT.RADIUS)GO TO 150
418. DIST=X-DSQRT(RADIUS**2-Y(1)**2)
419. C ARE WE WITHIN TOLERANCE FROM THE CUTOUT
420. IF(DIST.LE.TOLER)GO TO 80
421. GO TO 150
422. C ABOVE THE 45
423. 140 IF(X.GT.RADIUS)GO TO 150
424. DIST=Y(1)-DSQRT(RADIUS**2-X**2)

```

9
F

```

425.     IF(DIST.LE.TOLER)GO TO 160
426. C   NOT AT THE CUTOUT YET SO GENERATE NORMAL GRID POINT
427. C   TRANSFORMING FROM ORIGINAL TO MODIFIED RECT COORD SYSTEM
428. 150 XMOD(1)=Y(1)+HT2
429.     YMOD(1)=Z(1)
430.     ZMOD=X
431.     WRITE(7,1)IGRID,XMOD(1),YMOD(1),ZMOD
432.     DO 155 I=2,LAYERG
433.     YMOD(1)=Z(1)
434.     WRITE(7,1)JGRID,XMOD(1),YMOD(1),ZMOD
435.     JGRID=JGRID+10000
436. 155 CONTINUE
437. C   STORE GRID ID
438.     JCUR=JCUR+1
439.     ICUR(JCUR)=IGRID
440. C   IF FIRST LINE OF GRIDS, PICK UP GRID # FOR LAST LINE
441.     IF(Y(1).EQ.DELTAY)LAST(JCUR)=MOD(IGRID,1000)
442.     IF(Y(1).EQ.DELTAY)JLAST=JCUR
443. C   INCREMENT GRID ID'S
444.     IGRID=IGRID+1
445.     JGRID=JGRID+10000
446. C   MAKE SURE WE HAVE A POINT NEXT TO THIS ONE
447.     IF(JCUR.GT.JLAST)GO TO 180
448. C   GENERATE QUAD ELEMENT
449. C   FIRST SET UP GRID POINT ORDER
450. 190 IG(1)=LAST(JCUR)
451.     IG(2)=LAST(JCUR-1)
452.     IG(3)=ICUR(JCUR-1)
453.     IG(4)=ICUR(JCUR)
454.     IG(5)=IG(1)+10000
455.     IG(6)=IG(2)+10000
456.     IG(7)=IG(3)+10000
457.     IG(8)=IG(4)+10000
458.     JEL=JEL
459.     JPSOL=JPSOL
460.     DO 165 J=1,LAYERS
461.     IF(J.EQ.1) GO TO 167
462.     JEL=JEL+10000
463.     JPSOL=JPSOL+10
464.     DO 166 K=1,8
465.     IG(K)=IG(K)+10000
466. 166 CONTINUE
467. C   PUNCH CONNECTION CARD
468. 167 WRITE(7,2)JEL,JPSOL,(IG(1),I=1,6),JCONT
469. C   INCREMENT CONTINUATION FIELD
470.     JCONT=JCONT
471.     JCONT=JCONT+1
472. C   PUNCH CONTINUATION OF CONNECTION CARD
473.     WRITE(7,3)JCONT,IG(7),IG(8)
474. 165 CONTINUE
475. C   INCREMENT ELEMENT ID
476.     JEL=JEL+1
477. C   KEEP GOING TILL WE HIT THE CUTOUT
478.     GO TO 90
479. C   IF WE DON'T HAVE A POINT NEXT TO THIS ONE PUT ONE ON THE CURVE
480. 180 YY=+DSORT(RADIUS**2-X**2)
481. C   TRANSFORMING FROM ORIGINAL TO MODIFIED RECT COORD SYSTEM
482.     XXMOD=YY+HT2
483.     YMOD(1)=Z(1)
484.     ZMOD=X
485.     WRITE(7,1)IGRID,XXMOD,YMOD(1),ZMOD

```

9
B

```

486.      DO 185 I=2,LAYERG
487.      YMOD(1)=Z(1)
488.      WRITE(7,1)JGRID,XXMOD,YMOD(1),ZMOD
489.      JGRID=JGRID+10000
490. 185 CONTINUE
491. C      STORE GRID ID
492.      JLAST=JLAST+1
493.      LAST(JLAST)=IGRID
494. C      INCREMENT GRID ID
495.      JGRID=JGRID+1
496.      JGRID=JGRID+10000
497.      GO TO 190
498. C
499. C      WE'VE HIT THE CUTOUT, SO GENERATE
500. C      A GRID POINT ON THE CURVE OF THE CUTOUT
501. C      WE'RE ABOVE THE 45, SO MOVE IN THE Y-DIRECTION
502. 160 Y(1)=DSQRT(RADIUS**2-X**2)
503.      GO TO 170
504. C      WE'RE BELOW THE 45 SO MOVE IN THE X-DIRECTION
505. 80 X=DSQRT(RADIUS**2-Y(1)**2)
506. C      TRANSFORMING FROM ORIGINAL TO MODIFIED RECT COORD SYSTEM
507. 170 XMOD(1)=Y(1)*HI2
508.      YMOD(1)=Z(1)
509.      ZMOD=X
510.      WRITE(7,1)JGRID,XMOD(1),YMOD(1),ZMOD
511.      DO 175 I=2,LAYERG
512.      YMOD(1)=Z(1)
513.      WRITE(7,1)JGRID,XMOD(1),YMOD(1),ZMOD
514.      JGRID=JGRID+10000
515. 175 CONTINUE
516. C      STORE GRID ID
517.      JCUR=JCUR+1
518.      ICUR(JCUR)=IGRID
519. C      IF FIRST LINE OF GRIDS, PICK UP GRID # FOR LAST LINE
520.      IF(Y(1).EQ.DELTAY)LAST(JCUR)=MOD(IGRID,1000)
521.      IF(Y(1).EQ.DELTAY)JLAST=JCUR
522. C      INCREMENT GRID ID'S
523.      IGRID=IGRID+1
524.      JGRID=JGRID+10000
525. C      DID WE CROSS A LINE OF GRIDS?
526.      IF(XSAVE.NE.XLAST)GO TO 100
527. C      WE DIDN'T CROSS A LINE OF GRIDS SO
528. C      GENERATE A QUAD ELEMENT
529. C      FIRST SET UP THE GRID ORDER
530.      IG(1)=LAST(JCUR)
531.      IG(2)=LAST(JCUR-1)
532.      IG(3)=ICUR(JCUR-1)
533.      IG(4)=ICUR(JCUR)
534.      IG(5)=IG(1)+10000
535.      IG(6)=IG(2)+10000
536.      IG(7)=IG(3)+10000
537.      IG(8)=IG(4)+10000
538.      JEL=IEL
539.      JPSOL=IPSDL
540.      DO 176 J=1,LAYERS
541.      IF(J.EQ.1)GO TO 178
542.      JPSOL=JPSOL+10
543.      JEL=JEL+10000
544.      DO 177 K=1,8
545.      IG(K)=IG(K)+10000
546. 177 CONTINUE

```

```

547. C PUNCH CONNECTION CARD
548. 178 WRITE(7,2)JEL,JPSOL,(IG(I),I=1,6),ICONT
549. C INCREMENT CONTINUATION FIELD
550. JCONT=ICONT
551. ICONT=ICONT+1
552. C PUNCH CONTINUATION OF CONNECTION CARD
553. WRITE(7,3)JCONT,IG(7),IG(8)
554. 176 CONTINUE
555. C INCREMENT ELEMENT ID
556. IEL=IEL+1
557. GO TO 130
558. C
559. C WE CROSSED A LINE OF GRIDS SO WE NEED A TRIANGULAR
560. C ELEMENT INSTEAD OF A QUAD ELEMENT
561. C FIRST SET UP THE GRID ORDER
562. 100 IG(1)=LAST(JCUR-1)
563. IG(2)=ICUR(JCUR-1)
564. IG(3)=ICUR(JCUR)
565. IG(4)=IG(1)+10000
566. IG(5)=IG(2)+10000
567. IG(6)=IG(3)+10000
568. JEL=IEL
569. JPSOL=JPSOL
570. DO 105 J=1,LAYERS
571. IF(J.EQ.1) GO TO 107
572. JPSOL=JPSOL+10
573. JEL=JEL+10000
574. DO 106 K=1,6
575. IG(K)=IG(K)+10000
576. 106 CONTINUE
577. C PUNCH CONNECTION CARD
578. 107 WRITE(7,4)JEL,JPSOL,(IG(I),I=1,6)
579. 105 CONTINUE
580. C INCREMENT ELEMENT ID
581. IEL=IEL+1
582. C SAVE LAST X AND Y VALUES
583. 130 YLAST=YSAVE
584. XLAST=XSAVE
585. C NOW MOVE CURRENT GRIDS TO LAST GRIDS
586. DO 110 I=1,JCUR
587. LAST(I)=ICUR(I)
588. 110 CONTINUE
589. JLAST=JCUR
590. C RESET CURRENT GRID COUNTER
591. JCUR=0
592. C MOVE UP A LINE
593. IF(ANGLE.GT.PION/4)Y(1)=YSAVE
594. Y(1)=Y(1)+DELTAY
595. C ARE WE AT THE TOP OF THE CUTOFF?
596. IF(Y(1).LT.(RADIUS+TOLER))GO TO 30
597. C START GOING UP IN THE Y-DIRECTION UNTIL WE HIT THE TOP
598. C START AT THE LEFT EDGE
599. Y(1)=Y(1)-DELTAY
600. GO TO 75
601. 20 X=WIDTH
602. C GENERATE NEXT LINE OF GRID POINTS
603. IEND=0
604. C TRANSFORMING FROM ORIGINAL TO MODIFIED RECT COORD SYSTEM
605. 40 XMOD(1)=Y(1)+HTZ
606. YMOD(1)=Z(1)
607. ZMOD=X

```

```

608.      WRITE(7,1)IGRID,XMOD(1),YMOD(1),ZMOD
609.      DO 45 I=2,LAYERG
610.      YMOD(I)=Z(I)
611.      WRITE(7,1)JGRID,XMOD(1),YMOD(1),ZMOD
612.      JGRID=JGRID+10000
613.      45 CONTINUE
614.  C      SAVE GRID ID'S FOR ELEMENT CONNECTIONS
615.      JCUR=JCUR+1
616.      ICUR(JCUR)=IGRID
617.  C      INCREMENT GRID ID'S
618.      IGRID=IGRID+1
619.      JGRID=JGRID+10000
620.  C      SEE IF THERE IS A POINT NEXT TO THIS ONE
621.      IF (JCUR.GT.JLAST)GO TO 52
622.  C      MOVE TO THE RIGHT ONE INCREMENT AND REPEAT
623.      51 X=X-DELTA
624.      IF(X.GT.TOLER)GO TO 40
625.  C      MAKE SURE WE GET THE RIGHT EDGE
626.      IF(IEND.EQ.1)GO TO 50
627.      X=0.0
628.      IEND=1
629.      GO TO 40
630.  C
631.  C      GENERATE ELEMENT CONNECTIONS
632.  C
633.      50 DO 60 I=2,JLAST
634.  C      FIRST SET UP THE GRID POINT ORDER
635.      IG(1)=LAST(I)
636.      IG(2)=LAST(I-1)
637.      IG(3)=ICUR(I-1)
638.      IG(4)=ICUR(I)
639.      IG(5)=IG(1)+10000
640.      IG(6)=IG(2)+10000
641.      IG(7)=IG(3)+10000
642.      IG(8)=IG(4)+10000
643.      JEL=IEL
644.      JPSOL=IPSOL
645.      DO 55 K=1,LAYERS
646.      IF(K.EQ.1) GO TO 57
647.      JEL=JEL+10000
648.      JPSOL=JPSOL+10
649.      DO 56 L=1,8
650.      IG(L)=IG(L)+10000
651.      56 CONTINUE
652.  C      PUNCH CONNECTION CARD
653.      57 WRITE(7,2)JEL,JPSOL,(IG(J),J=1,6),JCONT
654.  C      INCREMENT CONTINUATION FIELD
655.      JCONT=JCONT
656.      JCONT=JCONT+1
657.  C      PUNCH CONTINUATION OF CONNECTION CARD
658.      WRITE(7,3)JCONT,IG(7),IG(8)
659.      55 CONTINUE
660.  C      INCREMENT ELEMENT ID
661.      IEL=IEL+1
662.      60 CONTINUE
663.  C      MOVE CURRENT LINE OF GRIDS TO LAST LINE
664.      DO 70 I=1,JCUR
665.      LAST(I)=ICUR(I)
666.      70 CONTINUE
667.      JLAST=JCUR
668.  C      MAKE CURRENT LINE EMPTY

```

```

669.      JCUR=0
670. C    MOVE UP A LINE
671.      75 Y(1)=Y(1)+DELTAY
672. C    HAVE WE HIT THE TOP YET?
673.      IF(Y(1).LT.(LEGX1-TOLER))GO TO 20
674.      IF(IEND2.EQ.1)GO TO 200
675.      IEND2=1
676.      Y(1)=LEGX1
677.      GO TO 20
678. C    IF WE DON'T HAVE A POINT NEXT TO THIS ONE PUT ONE ON THE CURVE
679.      52 YY=+DSORT(RADIUS**2-X**2)
680. C    TRANSFORMING FROM ORIGINAL TO MODIFIED RECT COORD SYSTEM
681.      XXMOD=YY+HT2
682.      YMOD(1)=Z(1)
683.      ZMOD=X
684.      WRITE(7,1)IGRID,XXMOD,YMOD(1),ZMOD
685.      DO 53 I=2,LAYERC
686.      YMOD(I)=Z(I)
687.      WRITE(7,1)JGRID,XXMOD,YMOD(1),ZMOD
688.      JGRID=JGRID+10000
689.      53 CONTINUE
690. C    STORE GRID ID
691.      JLAST=JLAST+1
692.      LAST(JLAST)=IGRID
693. C    INCREMENT GRID ID
694.      IGRID=IGRID+1
695.      JGRID=JGRID+10000
696.      GO TO 51
697. C
698. C
699. C    END OF FIRST PIECE
700. C
701. C
702. C
703. C    GENERATE THE 90-DEGREE BEND
704. C
705. C    FIRST ESTABLISH A CYLINDRICAL CO-ORDINATE SYSTEM
706.      200 X=0.0
707.      LEGX=HT2+LEGX1
708.      LEGXP1=LEGX*1.
709.      LEGY=LEGY
710.      WRITE(7,201)LEGX,LEGY,LEGX,LEGY,ICONT
711.      201 FORMAT('CORD2C ',5X,'100',8X,2F8.4,5X,'0.0',2F8.4,5X,'1.0',
712.      *17)
713.      JCONT=ICONT
714.      ICONT=ICONT+1
715.      WRITE(7,202)JCONT,LEGXP1,LEGY
716.      202 FORMAT(' ',17,2F8.4,5X,'0.0')
717. C    SET INITIAL VALUES
718.      IPSOL=IPSOL+1
719.      R(1)=BEND
720.      DO 205 I=2,LAYERC
721.      R(I)=R(I-1)-T(I-1)
722.      205 CONTINUE
723.      THETA=DELTA?
724.      IEL=((IEL/1000)+1)*1000+1
725.      IEND2=0
726.      250 IEND=0
727.      Z(1)=C.0
728. C    TRANSFORMING FROM ORIGINAL TO MODIFIED CYLINDRICAL COORD SYSTEM
729.      220 THMOD=90.-THETA

```

```

730.      ZMOD2(1)=WIDTH-Z(1)
731.      WRITE(7,203)IGRID,R(1),THMOD,ZMOD2(1)
732. 203  FORMAT('GRID',18,5X,'100',3F8.4)
733.      DO 225 I=2,LAYERG
734.      WRITE(7,203)JGRID,R(I),THMOD,ZMOD2(1)
735.      JGRID=JGRID+10000
736. 225  CONTINUE
737.      JCUR=JCUR+1
738.      ICUR(JCUR)=IGRID
739.      IGRID=IGRID+1
740.      JGRID=JGRID+10000
741.      Z(1)=Z(1)+DELTAX
742.      IF(Z(1).LT.(WIDTH-TOLER))GO TO 220
743. C     MAKE SURE WE GET THE EDGE
744.      IF(IEND.EQ.1)GO TO 210
745.      Z(1)=WIDTH
746.      IEND=1
747.      GO TO 220
748. C     GENERATE CONNECTIONS
749. 210  DO 230 I=2,JCUR
750. C     SET UP THE GRID POINT ORDER
751.      IG(1)=LAST(I)
752.      IG(2)=LAST(I-1)
753.      IG(3)=ICUR(I-1)
754.      IG(4)=ICUR(I)
755.      IG(5)=IG(1)+10000
756.      IG(6)=IG(2)+10000
757.      IG(7)=IG(3)+10000
758.      IG(8)=IG(4)+10000
759.      JEL=IEL
760.      JPSOL=JPSOL
761.      DO 215 K=1,LAYERS
762.      IF(K.EQ.1)GO TO 217
763.      JEL=JEL+10000
764.      JPSOL=JPSOL+10
765.      DO 216 L=1,8
766.      IG(L)=IG(L)+10000
767. 216  CONTINUE
768. C     PUNCH CONNECTION CARD
769. 217  WRITE(7,2)JEL,JPSOL,(IG(J),J=1,6),JCONT
770. C     INCREMENT CONTINUATION
771.      JCONT=JCONT
772.      JCONT=JCONT+1
773. C     PUNCH CONTINUATION OF CONNECTION CARD
774.      WRITE(7,3)JCONT,IG(7),IG(8)
775. 215  CONTINUE
776. C     INCREMENT ELEMENT ID
777.      IEL=IEL+1
778. 230  CONTINUE
779. C     MOVE CURRENT GRIDS TO LAST GRIDS
780.      DO 240 I=1,JCUR
781.      LAST(I)=ICUR(I)
782. 240  CONTINUE
783.      JLAST=JCUR
784.      JCUR=0
785. C     INCREMENT ANGLE
786.      THETA=THETA+DELTAT
787.      IF(THETA.LT.89.99995)GO TO 250
788.      IF(IEND2.EQ.1)GO TO 241
789.      IEND2=1
790.      THETA=90.

```

```

791.      GO TO 250
792. C
793. C      END OF 90 DEGREE BEND
794. C
795. C
796. C
797. C      START OF BOTTOM PIECE(NO CUTOUT)
798. C
799. C
800. C      INITIALIZE CONSTANTS
801. 241 IEL=((IEL/1000)+1)*1000+1
802.      IEND2=0
803.      IPSOL=IPSOL+1
804.      Y(1)=LEGX1+BEND
805.      DO 245 I=2,LAYERG
806.      Y(I)=Y(I-1)+T(I)-1
807. 245 CONTINUE
808. C      START GOING DOWN IN THE Z-DIRECTION UNTIL WE HIT THE BOTTOM
809. C      START AT THE LEFT EDGE
810.      Z(1)=LEGY-DELTAZ
811. 320 X=WIDTH
812. C      GENERATE NEXT LINE OF GRID POINTS
813.      IEND=0
814. C      TRANSFORMING FROM ORIGINAL TO MODIFIED RECT COORD SYSTEM
815. 340 XMOD(1)=Y(1)+HT2
816.      YMOD(1)=Z(1)
817.      ZMOD=X
818.      WRITE(7,1)IGRID,XMOD(1),YMOD(1),ZMOD
819.      DO 345 I=2,LAYERG
820.      XMOD(I)=Y(I)+HT2
821.      WRITE(7,1)JGRID,XMOD(I),YMOD(I),ZMOD
822.      JGRID=JGRID+10000
823. 345 CONTINUE
824. C      SAVE GRID ID'S FOR ELEMENT CONNECTIONS
825.      JCUR=JCUR+1
826.      ICUR(JCUR)=IGRID
827. C      INCREMENT GRID ID'S
828.      IGRID=IGRID+1
829.      JGRID=JGRID+10000
830. C      MOVE TO THE RIGHT ONE INCREMENT AND REPEAT
831.      X=X+DELTAZ
832.      IF(X.GT.TOLER)GO TO 340
833. C      MAKE SURE WE GET THE RIGHT EDGE
834.      IF(IEND.EQ.1)GO TO 350
835.      X=0.0
836.      IEND=1
837.      GO TO 340
838. C
839. C      GENERATE ELEMENT CONNECTIONS
840. C
841. 350 DO 360 I=2,JLAST
842. C      FIRST SET UP THE GRID POINT ORDER
843.      IG(1)=LAST(I)
844.      IG(2)=LAST(I-1)
845.      IG(3)=ICUR(I-1)
846.      IG(4)=ICUR(I)
847.      IG(5)=IG(1)+10000
848.      IG(6)=IG(2)+10000
849.      IG(7)=IG(3)+10000
850.      IG(8)=IG(4)+10000
851.      JEL=IEL

```

```

852.      JPSOL=JPSOL
853.      DD 355 K=1,LAYERS
854.      IF(K.EQ.1)GO TO 357
855.      JEL=JEL+10000
856.      JPSOL=JPSOL+10
857.      DD 356 L=1,8
858.      IG(L)=IG(L)+10000
859. 356 CONTINUE
860. C    PUNCH CONNECTION CARD
861. 357 WRITE(7,2)JEL,JPSOL,{IG(J),J=1,6},ICONT
862. C    INCREMENT CONTINUATION FIELD
863.      JCONT=ICONT
864.      ICONT=ICONT+1
865. C    PUNCH CONTINUATION OF CONNECTION CARD
866.      WRITE(7,3)JCONT,IG(7),IG(8)
867. 355 CONTINUE
868. C    INCREMENT ELEMENT ID
869.      IEL=IEL+1
870. 360 CONTINUE
871. C    MOVE CURRENT LINE OF GRIDS TO LAST LINE
872.      DD 370 I=1,JCUR
873.      LAST(I)=ICUR(I)
874. 370 CONTINUE
875.      JLAST=JCUR
876. C    MAKE CURRENT LINE EMPTY
877.      JCUR=0
878. C    MOVE UP A LINE
879.      Z(1)=Z(1)-DELTAZ
880. C    HAVE WE HIT THE BOTTOM YET?
881.      IF(Z(1).GT.TOLER)GO TO 320
882.      IF(IEND2.EQ.1)GO TO 120
883.      IEND2=1
884.      Z(1)=0.0
885.      GO TO 320
886. C    WERE DONE WHEN
887. C    SO DUMP THE BUFFER
888. 120 ENDFILE 7
889. C    AND GET THE HELL OUT
890.      STOP
891.      900 WRITE(6,901)
892.      901 FORMAT('***ERROR*** TOO MANY LAYERS SPECIFIED')
893.      STOP
894.      END
895. //GO.FT07FO01 DD DSN=CN900004.SSS.C16BLKXF,UNIT=WYLBUR,DISP=(,CATLG),
896. // SPACE=(TRK,(10,10),RLSE),DCB=(RECFM=FB,LRECL=80,BLKSIZE=3120) } JCL
897. //GO.SYSIN DD *
898. &PARAMS LEGX1=0.27,LEGY=0.51,WIDTH=0.5,RADIUS=0.25,DELTAY=0.09,
899. DELTAX=0.1,TOLER=0.015,DELTAT=15.0,BEND=0.125,
900. T(1)=0.125,
901. DELTAZ=0.17,LAYERS=1,DELT2=0.1330,HT2=0.4
902. &END } INPUT DATA

```

(ALSO SEE FIGURE B-13)

APPENDIX D

C-1 PREPROCESSOR FLOWCHART

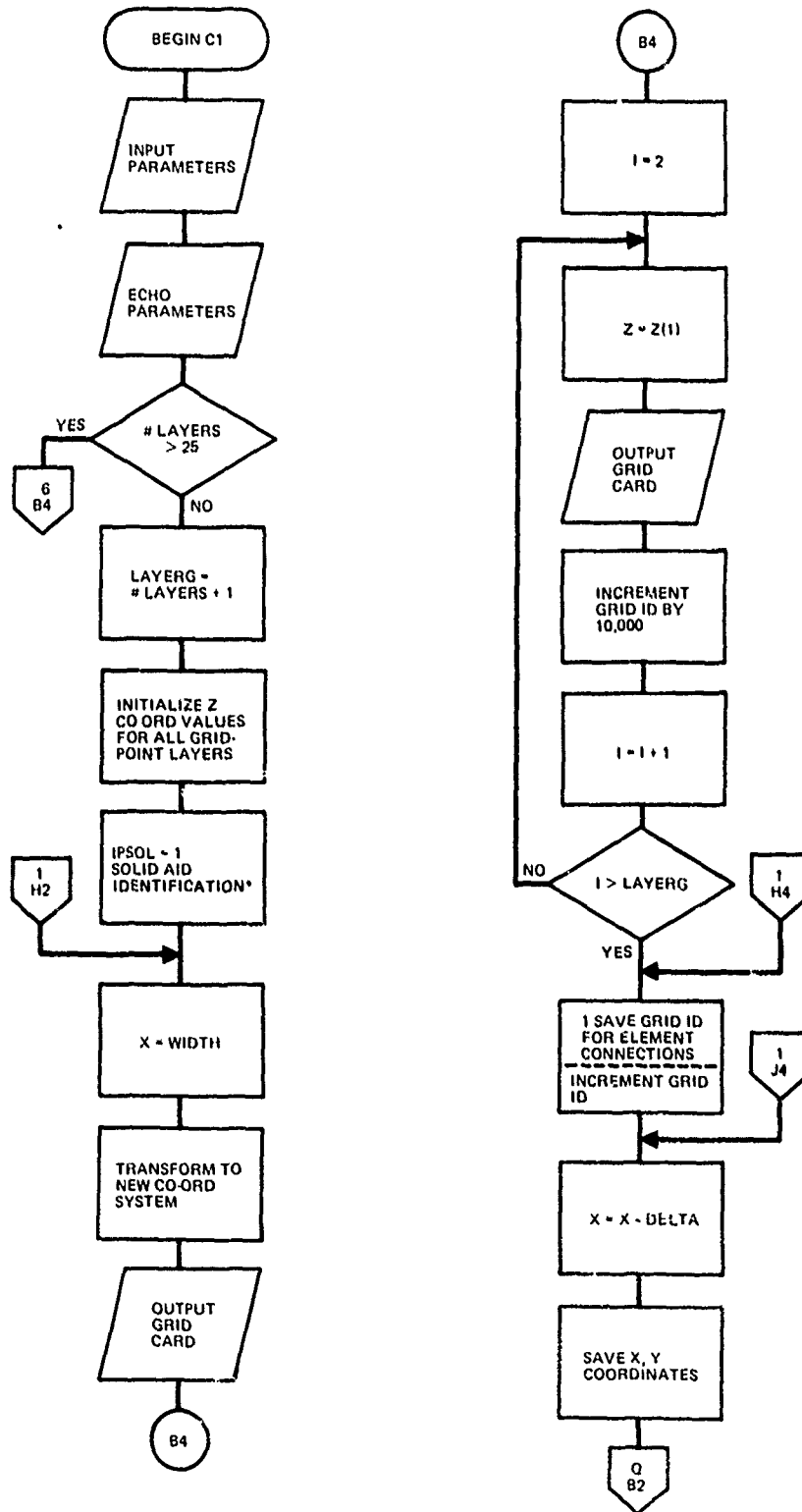

C-1 PREPROCESSOR

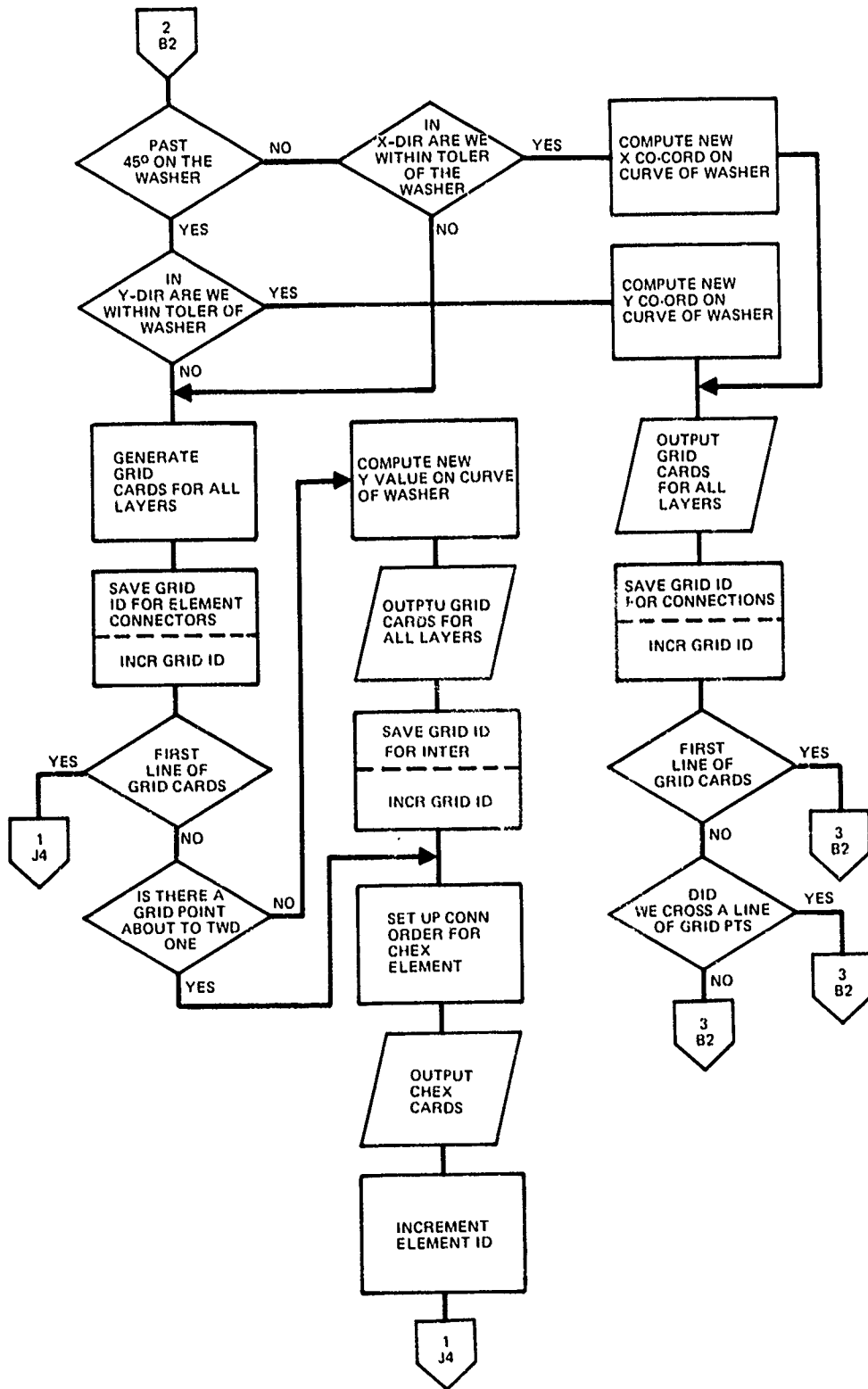

C-1 PREPROCESSOR

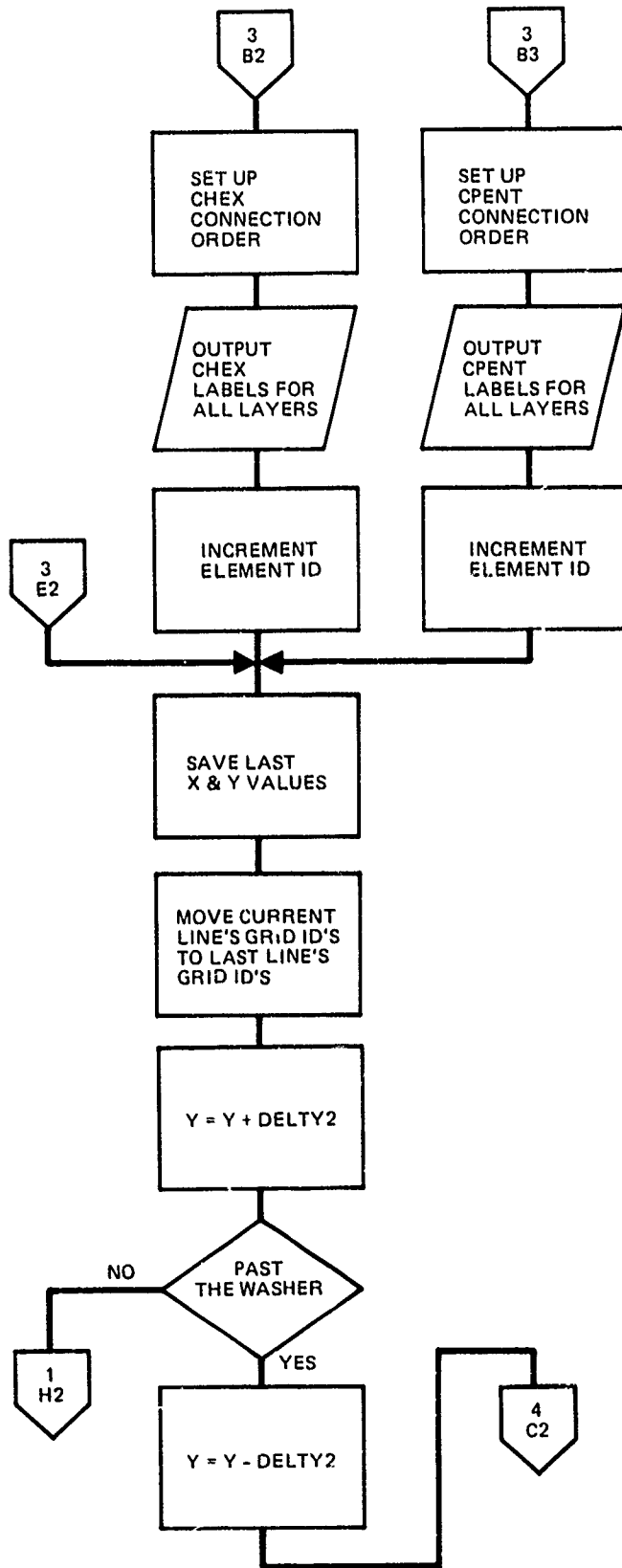

C-1 PREPROCESSOR

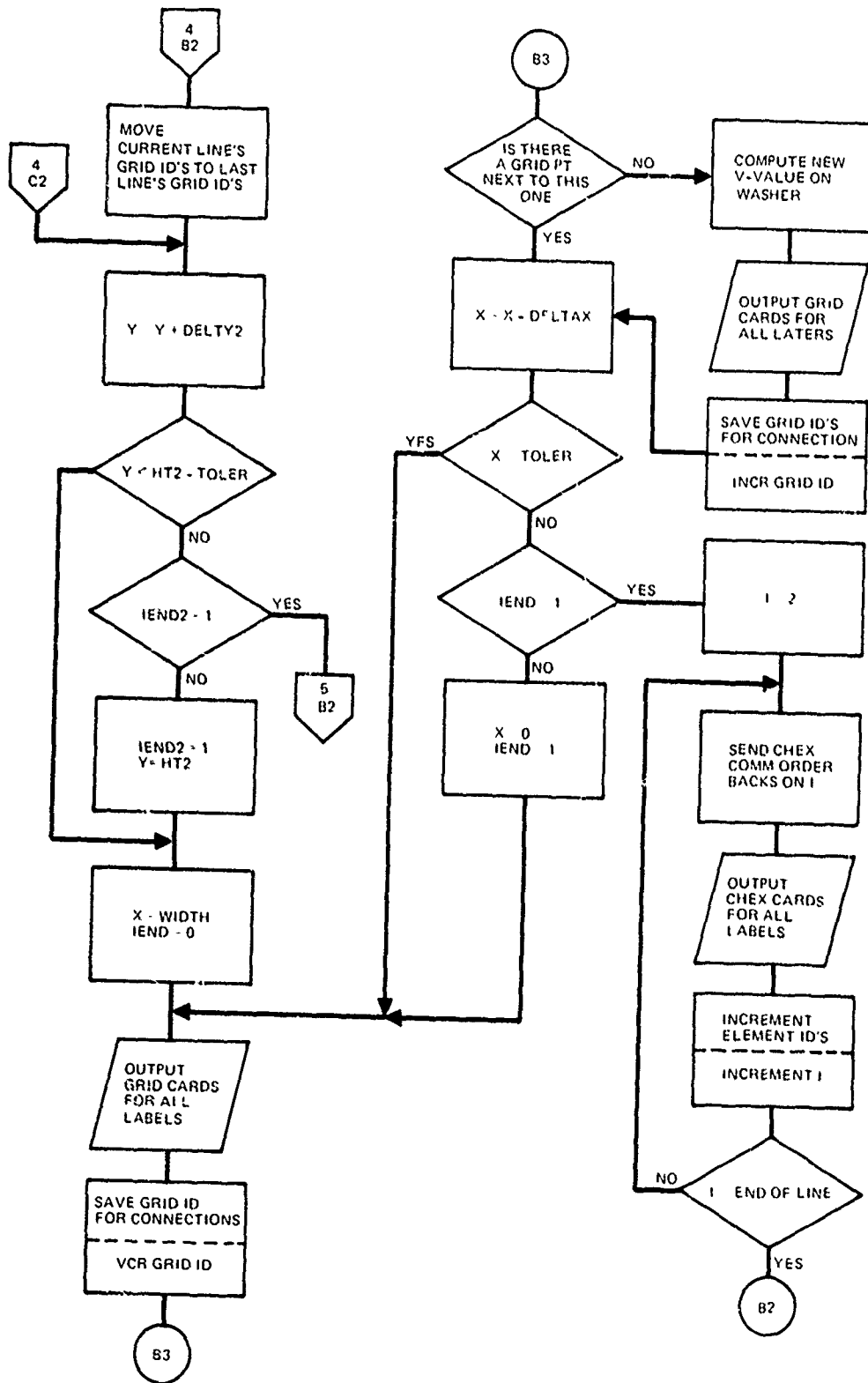

C-1 PREPROCESSOR

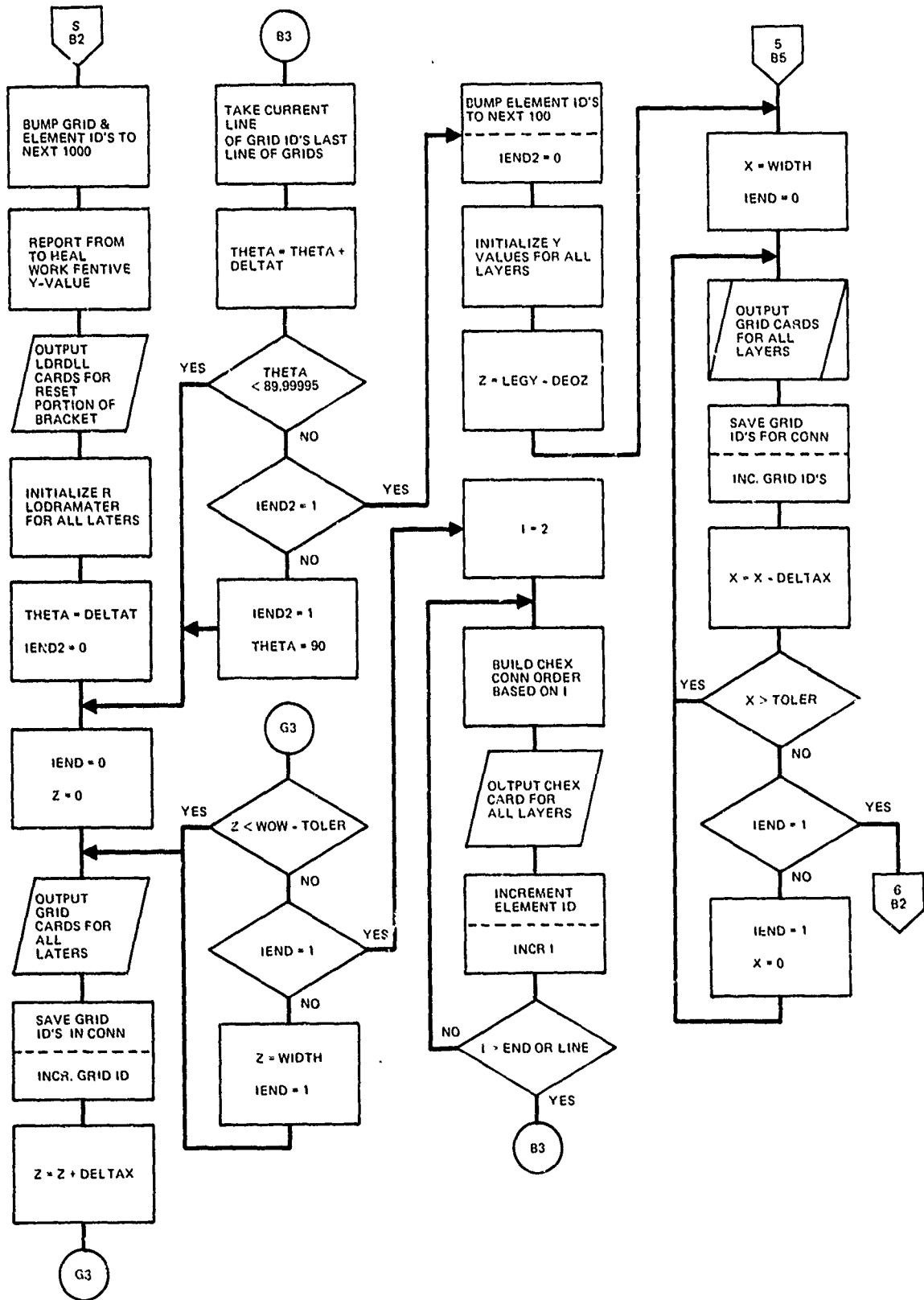

C-1 PREPROCESSOR

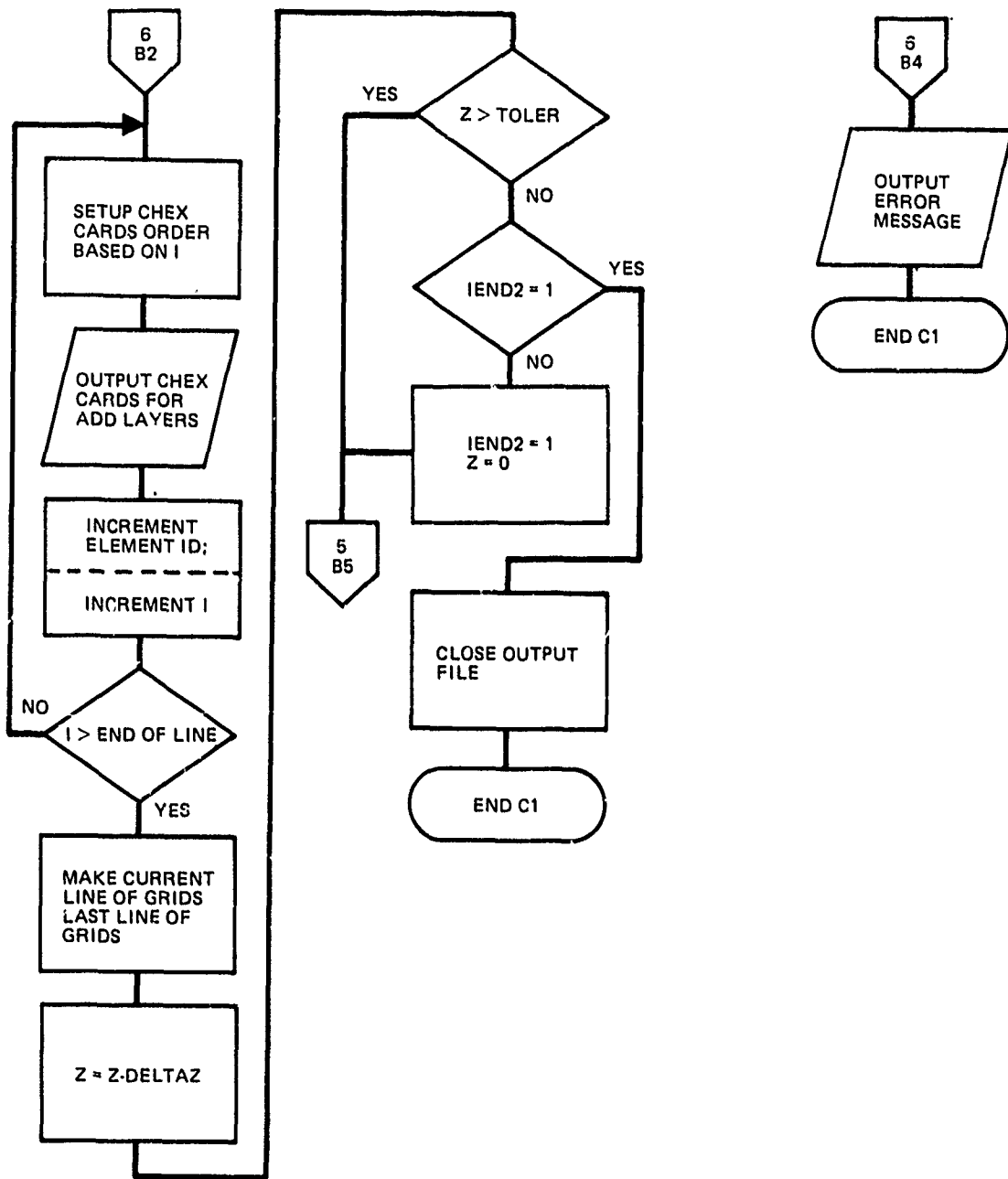

APPENDIX E

C-1 MODEL PREPROCESSOR PROGRAM OUTPUT

LEVEL 21.8 (JUN 74)

05/360 FORTRAN H

```

COMPILER OPTIONS - NAME= MAIN,OPT=01,LINECNT=56,SIZE=0000K,
SOURCE,EBCDIC,NOLIST,NODECK,LOAD,MAP,NOEDIT,NOID,XREF
ISN 0002     DIMENSION LAST(1000),ICUR(1000),IG(8)
ISN 0003     REAL*8 LEGX1,LEGY,WIDTH,RADIUS,DELTAY,DELTAX,T(26),TOLER,X,Y(26)
              *PION4,XSAVE,YSAVE,ANGLE,DIST,XLAST,YLAST,DELTAT,YY,XX,DELT2,
              *BEND,THETA,Z(26),DELTAZ,R(26),HT2,XMOD1,XXMOD,XMOD(26),
              *YMOD(26),ZMOD,ZMOD2(26),THMOD,LEGX,LEGXP1,LEGY
ISN 0004     NAMELIST /PARAMS/_LEGX1,LEGY,WIDTH,RADIUS,DELTAX,DELTAY,DEL
              *TOLER,DELTAT,BEND,DELTAZ,LAYERS,
              *DELT2,HT2
ISN 0005     DATA IGRID/1/,JGRID/10001/,ICONT/0/,JCUR/0/,JLAST/0/,IEL/1/
ISN 0006     DATA LEGX1,LEGY,WIDTH,RADIUS,DELTAX,DELTAY,TOLER/7*0.0/
ISN 0007     DATA T/26*0.0/
ISN 0008     DATA DELTAT,BEND/2*0.0/,DELTAZ/0.0/,LAYERS/0/,DELT2/0.0/
ISN 0009     DATA HT2/0.0/

C
C
C   THIS PRGM IS FOR GENERATING BULK DATA FOR THE FULL BRACKET
C   AND IS CALLED PRE-PROCESSOR FOR C1 MODEL
C
C   READ IN PARAMETERS
ISN 0010     READ(5,PARAMS)
ISN 0011     IF(LAYERS.EQ.0)LAYERS=1
C   ECHO PARAMETERS
ISN 0013     WRITE(6,8)LEGX1,LEGY,WIDTH,RADIUS,DELTAY,DELTAX,DELTAT,BEND,
              *TOLER,DELTAZ,LAYERS,DELT2,HT2
ISN 0014     8 FORMAT('1PARAMETER ECHO',/, 'OLEGX1= ',T13,F8.4,/,
              *' LEGY= ',T13,F8.4,/, ' WIDTH= ',
              *T13,F8.4,/, ' RADIUS= ',T13,F8.4,/, ' DELTA-Y= ',T13,F8.4,/,
              *' DELTA-X= ',T13,F8.4,/, ' DELTA-T= ',T13,F8.4,/, ' BEND= ',T13,F8.
              *',/, ' TOLERANCE= ',F8.4,/, ' DELTA-Z=',T13,
              *F8.4,/, ' LAYERS=',T13,18,/, ' DELTAY2=',T13,F8.4,/, ' HEIGHT2=',
              *T13,F8.4)
ISN 0015     DO 998 I=1,LAYERS
ISN 0016     WRITE(6,997) I,T(I)
ISN 0017     997 FORMAT(' LAYER-',12,' THICKNESS=',F8.4)
ISN 0018     998 CONTINUE
ISN 0019     1 FORMAT('GRID _ _ _ ',18,8X,3F8.4)
ISN 0020     IF(LAYERS.GT.25)GO TO 900
C   INITIALIZE CONSTANTS
ISN 0022     LAYERG=LAYERS+1
ISN 0023     Z(1)=LEGY+BEND
ISN 0024     DO 35 I=2,LAYERG
ISN 0025     Z(I)=Z(I-1)+T(I-1)
ISN 0026     35 CONTINUE
ISN 0027     IEND2=0
ISN 0028     PION4=3.14159/4.
ISN 0029     IPSOL=1

C
C
C   GENERATE PIECE BEFORE FIRST PIECE (MODEL CHANGE 576/78)
C
C
C

```

```

C START AT THE LOWER LEFTHAND CORNER
C THEN MOVE TO THE RIGHT UNTIL WE HIT THE CUTOUT
ISN 0030 Y(1)=0.0
ISN 0031 430 X=WIDTH
C GENERATE FAR LEFT GRID POINT
ISN 0032 YY=-Y(1)
C TRANSFORMING FROM ORIGINAL TO MODIFIED RECT COORD SYSTEM
ISN 0033 XXMOD=YY+HT2
ISN 0034 YMOD(1)=Z(1)
ISN 0035 ZMOD=X
ISN 0036 WRITE(7,1)IGRID,XXMOD,YMOD(1),ZMOD
ISN 0037 DD 495 I=2,LAYERG
ISN 0038 YMOD(1)=Z(1)
ISN 0039 WRITE(7,1)JGRID,XXMOD,YMOD(1),ZMOD
ISN 0040 JGRID=JGRID+10000
ISN 0041 495 CONTINUE
C STORE GRID ID
ISN 0042 JCUR=JCUR+1
ISN 0043 ICUR(JCUR)=IGRID
C INCREMENT GRID ID
ISN 0044 IGRID=IGRID+1
ISN 0045 JGRID=JGRID+10000
C MOVE TO THE LEFT
ISN 0046 490 X=X-DELTA
C SAVE X AND Y
ISN 0047 XSAVE=X
ISN 0048 YSAVE=Y(1)
ISN 0049 IF(Y(1).EQ.0.0)XX=X
C ARE WE PAST THE 45?
ISN 0051 ANGLE=DATAN(Y(1)/X)
ISN 0052 IF(ANGLE.GT.PION/4)GO TO 540
C BELOW THE 45
ISN 0054 C FIND DISTANCE FROM CUTOUT
ISN 0056 IF(Y(1).GT.RADIUS)GO TO 550
DIST=X-DSORT(RADIUS**2-Y(1)**2)
C ARE WE WITHIN TOLERANCE FROM THE CUTOUT
ISN 0057 IF(DIST.LE.TOLER)GO TO 480
ISN 0059 GO TO 550
C ABOVE THE 45
ISN 0060 540 IF(X.GT.RADIUS)GO TO 550
ISN 0062 DIST=Y(1)-DSORT(RADIUS**2-X**2)
ISN 0063 IF(DIST.LE.TOLER)GO TO 560
C NOT AT THE CUTOUT YET SO GENERATE NORMAL GRID POINT
ISN 0065 550 YY=-Y(1)
C TRANSFORMING FROM ORIGINAL TO MODIFIED RECT COORD SYSTEM
ISN 0066 XXMOD=YY+HT2
ISN 0067 YMOD(1)=Z(1)
ISN 0068 ZMOD=X
ISN 0069 WRITE(7,1)IGRID,XXMOD,YMOD(1),ZMOD
ISN 0070 DD 555 I=2,LAYERG
ISN 0071 YMOD(1)=Z(1)
ISN 0072 WRITE(7,1)JGRID,XXMOD,YMOD(1),ZMOD
ISN 0073 JGRID=JGRID+10000
ISN 0074 555 CONTINUE

```

10
F

```

C   STORE GRID ID
ISN 0075 JCUR=JCUR+1
ISN 0076 ICUR(JCUR)=IGRID
C   INCREMENT GRID ID'S
ISN 0077 IGRID=IGRID+1
ISN 0078 JGRID=IGRID+10000
C   IF THIS IS THE FIRST LINE OF GRIDS, DON'T GENERATE CONNECTIONS
ISN 0079 IF(Y(1).EQ.0.0)GO TO 490
C   MAKE SURE WE HAVE A POINT NEXT TO THIS ONE
ISN 0081 IF(JCUR.GT.JLAST)GO TO 580
C   GENERATE QUAD ELEMENT
C   FIRST SET UP GRID POINT ORDER
ISN 0083 590 IG(1)=ICUR(JCUR)
ISN 0084 IG(2)=ICUR(JCUR-1)
ISN 0085 IG(3)=LAST(JCUR-1)
ISN 0086 IG(4)=LAST(JCUR)
ISN 0087 IG(5)=IG(1)+10000
ISN 0088 IG(6)=IG(2)+10000
ISN 0089 IG(7)=IG(3)+10000
ISN 0090 IG(8)=IG(4)+10000
ISN 0091 JEL=IEL
ISN 0092 JPSOL=IPSOL
ISN 0093 DO 565 J=1,LAYERS
ISN 0094 IF(J.EQ.1) GO TO 567
ISN 0096 JEL=JEL+10000
ISN 0097 JPSOL=JPSOL+10
ISN 0098 DO 566 K=1,8
ISN 0099 IG(K)=IG(K)+10000
ISN 0100 566 CONTINUE
C   PUNCH CONNECTION CARD
ISN 0101 567 WRITE(7,2)JEL,JPSOL,(IG(1),1=1.0).ICONT
C   INCREMENT CONTINUATION FIELD
ISN 0102 JCONT=ICONT
ISN 0103 ICONT=ICONT+1
C   PUNCH CONTINUATION OF CONNECTION CARD
ISN 0104 WRITE(7,3)JCONT,IG(7),IG(8)
ISN 0105 565 CONTINUE
C   INCREMENT ELEMENT ID
ISN 0106 IEL=IEL+1
C   KEEP GOING TILL WE HIT THE CUTOUT
ISN 0107 GO TO 490
C   IF WE DON'T HAVE A POINT NEXT TO THIS ONE PUT ONE ON THE CURVE
ISN 0108 580 YY=-DSQRT(RADIUS**2-X**2)
C   TRANSFORMING FROM ORIGINAL TO MODIFIED RECT COORD SYSTEM
ISN 0109 XXMOD=YY+HT2
ISN 0110 YMOD(1)=Z(1)
ISN 0111 ZMOD=X
ISN 0112 WRITE(7,1)IGRID,XXMOD,YMOD(1),ZMOD
ISN 0113 DO 585 I=2,LAYERG
ISN 0114 YMOD(I)=Z(I)
ISN 0115 WRITE(7,1)JGRID,XXMOD,YMOD(I),ZMOD
ISN 0116 JGRID=JGRID+10000
ISN 0117 585 CONTINUE
C   STORE GRID ID

```

10
B

```

ISN 0118      JLAST=JLAST+1
ISN 0119      LAST(JLAST)=IGRID
C             INCREMENT GRID ID
ISN 0120      IGRID=IGRID+1
ISN 0121      JGRID=IGRID+10000
ISN 0122      GO TO 590

C
C             WE'VE HIT THE CUTOUT, SO GENERATE
C             A GRID POINT ON THE CURVE OF THE CUTOUT
C             WE'RE ABOVE THE 45, SO MOVE IN THE Y-DIRECTION
ISN 0123      560 Y(1)=DSORT(RADIUS**2-X**2)
ISN 0124      GO TO 570
C             WE'RE BELOW THE 45 SO MOVE IN THE X-DIRECTION
ISN 0125      480 X=DSORT(RADIUS**2-Y(1)**2)
ISN 0126      570 YY=-Y(1)
C             TRANSFORMING FROM ORIGINAL TO MODIFIED RECT COORD SYSTEM
ISN 0127      XXMOD=YY+HT2
ISN 0128      YMOD(1)=Z(1)
ISN 0129      ZMOD=X
ISN 0130      WRITE(7,1)IGRID,XXMOD,YMOD(1),ZMOD
ISN 0131      DO 575 I=2,LAYERG
ISN 0132      YMOD(I)=Z(I)
ISN 0133      WRITE(7,1)JGRID,XXMOD,YMOD(1),ZMOD
ISN 0134      JGRID=JGRID+10000
ISN 0135      575 CONTINUE
C             STORE GRID ID
ISN 0136      JCUR=JCUR+1
ISN 0137      ICUR(JCUR)=IGRID
C             INCREMENT GRID ID'S
ISN 0138      IGRID=IGRID+1
ISN 0139      JGRID=JGRID+10000
C             IF THIS IS THE FIRST LINE OF GRIDS, DON'T GENERATE CONNECTIONS
ISN 0140      IF(Y(1).EQ.0.0)GO TO 530
C             DID WE CROSS A LINE OF GRIDS?
ISN 0142      IF(XSAVE.NE.XLAST)GO TO 500
C             WE DIDN'T CROSS A LINE OF GRIDS SO
C             GENERATE A QUAD ELEMENT
C             FIRST SET UP THE GRID ORDER
ISN 0144      IG(1)=ICUR(JCUR)
ISN 0145      IG(2)=ICUR(JCUR-1)
ISN 0146      IG(3)=LAST(JCUR-1)
ISN 0147      IG(4)=LAST(JCUR)
ISN 0148      IG(5)=IG(1)+10000
ISN 0149      IG(6)=IG(2)+10000
ISN 0150      IG(7)=IG(3)+10000
ISN 0151      IG(8)=IG(4)+10000
ISN 0152      JEL=IEL
ISN 0153      JPSOL=IPSOI
ISN 0154      DO 576 J=1,LAYERS
ISN 0155      IF(J.EQ.1)GO TO 578
ISN 0157      JPSOL=JPSOL+10
ISN 0158      JEL=JEL+10000
ISN 0159      DO 577 K=1,8
ISN 0160      IG(K)=IG(K)+10000

```

```

ISN 0161 577 CONTINUE
ISN 0162 C PUNCH CONNECTION CARD
ISN 0162 578 WRITE(7,2)JEL,JPSOL,(IG(I),I=1,6),ICONT
C INCREMENT CONTINUATION FIELD
ISN 0163 JCONT=ICONT
ISN 0164 ICONT=ICONT+1
C PUNCH CONTINUATION OF CONNECTION CARD
ISN 0165 WRITE(7,3)JCONT,IG(7),IG(8)
ISN 0166 576 CONTINUE
C INCREMENT ELEMENT ID
ISN 0167 IEL=IEL+1
ISN 0168 GO TO 530

C
C WE CROSSED A LINE OF GRIDS SO WE NEED A TRIANGULAR
C ELEMENT INSTEAD OF A QUAD ELEMENT
C FIRST SET UP THE GRID ORDER
ISN 0169 500 IG(1)=ICUR(JCUR-1)
ISN 0170 IG(2)=LAST(JCUR-1)
ISN 0171 IG(3)=ICUR(JCUR)
ISN 0172 IG(4)=IG(1)+10000
ISN 0173 IG(5)=IG(2)+10000
ISN 0174 IG(6)=IG(3)+10000
ISN 0175 JEL=IEL
ISN 0176 JPSOL=JPSOL
ISN 0177 DO 505 J=1,LAYERS
ISN 0178 IF(J.EQ.1) GO TO 507
ISN 0180 JPSOL=JPSOL+10
ISN 0181 JEL=JEL+10000
ISN 0182 DO 506 K=1,6
ISN 0183 IG(K)=IG(K)+10000
ISN 0184 506 CONTINUE
C PUNCH CONNECTION CARD
ISN 0185 507 WRITE(7,4)JEL,JPSOL,(IG(I),I=1,6)
ISN 0186 4 FORMAT('CPENTA ',818)
ISN 0187 505 CONTINUE
C INCREMENT ELEMENT ID
ISN 0188 IEL=IEL+1
C SAVE LAST X AND Y VALUES
ISN 0189 530 YLAST=YSAVE
ISN 0190 XLAST=XSAVE
C NOW MOVE CURRENT GRIDS TO LAST GRIDS
ISN 0191 DO 510 I=1,JCUR
ISN 0192 LAST(I)=ICUR(I)
ISN 0193 510 CONTINUE
ISN 0194 JLAST=JCUR
C RESET CURRENT GRID COUNTER
ISN 0195 JCUR=0
C MOVE UP A LINE
ISN 0196 IF(ANGLE.GT.PIDW4)Y(1)=YSAVE
ISN 0198 Y(1)=Y(1)+DELTY2
C ARE WE AT THE TOP OF THE CUTOUT?
ISN 0199 IF(Y(1).LT.(RADIUS+TOLER))GO TO 430
C START GOING UP IN THE Y-DIRECTION UNTIL WE HIT THE TOP
C START AT THE LEFT EDGE

```

```

ISN 0201      Y(1)=Y(1)-DELTY2
ISN 0202      GO TO 475
ISN 0203      420 X=WIDTH
C             GENERATE NEXT LINE OF GRID POINTS
ISN 0204      IEND=0
ISN 0205      440 YY=-Y(1)
C             TRANSFORMING FROM ORIGINAL TO MODIFIED RECT COORD SYSTEM
ISN 0206      XXMOD=YY*HT2
ISN 0207      YMOD(1)=Z(1)
ISN 0208      ZMOD=X
ISN 0209      WRITE(7,1)IGRID,XXMOD,YMOD(1),ZMOD
ISN 0210      DO 445 I=2,LAYERG
ISN 0211      YMOD(I)=Z(I)
ISN 0212      WRITE(7,1)JGRID,XXMOD,YMOD(I),ZMOD
ISN 0213      JGRID=JGRID+10000
ISN 0214      445 CONTINUE
C             SAVE GRID ID'S FOR ELEMENT CONNECTIONS
ISN 0215      JCUR=JCUR+1
ISN 0216      ICUR(JCUR)=IGRID
C             INCREMENT GRID ID'S
ISN 0217      IGRID=IGRID+1
ISN 0218      JGRID=JGRID+10000
C             SEE IF THERE IS A POINT NEXT TO THIS ONE
ISN 0219      IF (JCUR.GT.JLAST)GO TO 452
C             MOVE TO THE RIGHT ONE INCREMENT AND REPEAT
ISN 0221      451 X=X-DELTA
ISN 0222      IF(X.GT.TOLER)GO TO 440
C             MAKE SURE WE GET THE RIGHT EDGE
ISN 0224      IF(IEND.EQ.1)GO TO 450
ISN 0226      X=0.0
ISN 0227      IEND=1
ISN 0228      GO TO 440
C
C             GENERATE ELEMENT CONNECTIONS
C
ISN 0229      450 DO 460 I=2,JLAST
C             FIRST SET UP THE GRID POINT ORDER
ISN 0230      IG(1)=ICUR(I)
ISN 0231      IG(2)=ICUR(I-1)
ISN 0232      IG(3)=LAST(I-1)
ISN 0233      IG(4)=LAST(I)
ISN 0234      IG(5)=IG(1)+10000
ISN 0235      IG(6)=IG(2)+10000
ISN 0236      IG(7)=IG(3)+10000
ISN 0237      IG(8)=IG(4)+10000
ISN 0238      JEL=IEL
ISN 0239      JPSOL=IPSDL
ISN 0240      DO 455 K=1,LAYERS
ISN 0241      IF(K.EQ.1) GO TO 457
ISN 0243      JEL=JEL+10000
ISN 0244      JPSOL=JPSOL+10
ISN 0245      DO 456 L=1,8
ISN 0246      IG(L)=IG(L)+10000
ISN 0247      456 CONTINUE

```

```

ISN 0248 C PUNCH CONNECTION CARD
457 WRITE(7,2)JEL,JPSOL,(IG(J),J=1,6),ICONT
C INCREMENT CONTINUATION FIELD
ISN 0249 JCONT=ICONT
ISN 0250 ICONT=ICONT+1
C PUNCH CONTINUATION OF CONNECTION CARD
ISN 0251 WRITE(7,3)JCONT,IG(7),IG(8)
ISN 0252 2 FORMAT('CHEXA',2I8,'+',I7)
ISN 0253 3 FORMAT('+',I7,2I8)
ISN 0254 455 CONTINUE
C INCREMENT ELEMENT ID
ISN 0255 IEL=IEL+1
ISN 0256 460 CONTINUE
C MOVE CURRENT LINE OF GRIDS TO LAST LINE
ISN 0257 DO 470 I=1,JCUR
ISN 0258 LAST(I)=ICUR(I)
ISN 0259 470 CONTINUE
ISN 0260 JLAST=JCUR
C MAKE CURRENT LINE EMPTY
ISN 0261 JCUR=0
C MOVE UP A LINE
ISN 0262 475 Y(1)=Y(1)+DELT2
C HAVE WE HIT THE TOP YET?
ISN 0263 IF(Y(1).LT.(MT2-TOLER))GO TO 420
ISN 0265 IF(IEND2.EQ.1)GO TO 600
ISN 0267 IEND2=1
ISN 0268 Y(1)=MT2
ISN 0269 GO TO 420
C IF WE DON'T HAVE A POINT NEXT TO THIS ONE PUT ONE ON THE CURVE
ISN 0270 452 YY=-DSORT(RADIUS**2-X**2)
C TRANSFORMING FROM ORIGINAL TO MODIFIED RECT COORD SYSTEM
ISN 0271 XXMOD=YY+MT2
ISN 0272 YMOD(1)=Z(1)
ISN 0273 ZMOD=X
ISN 0274 WRITE(7,1)IGRID,XXMOD,YMOD(1),ZMOD
ISN 0275 DO 453 I=2,LAYERG
ISN 0276 YMOD(I)=Z(I)
ISN 0277 WRITE(7,1)JGRID,XXMOD,YMOD(1),ZMOD
ISN 0278 JGRID=JGRID+10000
ISN 0279 453 CONTINUE
C STORE GRID ID
ISN 0280 JLAST=JLAST+1
ISN 0281 LAST(JLAST)=IGRID
C INCREMENT GRID ID
ISN 0282 IGRID=IGRID+1
ISN 0283 JGRID=IGRID+10000
ISN 0284 GO TO 451
ISN 0285 600 IGRID=(IGRID/1000+1)*1000+1
ISN 0286 JGRID=IGRID+10000
ISN 0287 IEL=(IEL/1000+1)*1000+1
ISN 0288 XLAST=XX
ISN 0289 IEND2=0
C
C

```

```

C      GENERATE FIRST PIECE WITH CUTOUT IN IT
C
C
C
C      START AT THE LOWER LEFTHAND CORNER
C      THEN MOVE TO THE RIGHT UNTIL WE HIT THE CUTOUT
ISN 0290      Y(1)=DELTAY
ISN 0291      30 X=WIDTH
C      GENERATE FAR LEFT GRID POINT
C      TRANSFORMING FROM ORIGINAL TO MODIFIED RECT COORD SYSTEM
ISN 0292      XMOD(1)=Y(1)+HT2
ISN 0293      YMOD(1)=Z(1)
ISN 0294      ZMOD=X
ISN 0295      WRITE(7,1)IGRID,XMOD(1),YMOD(1),ZMOD
ISN 0296      DO 95 I=2,LAYERG
ISN 0297      YMOD(I)=Z(I)
ISN 0298      WRITE(7,1)JGRID,XMOD(1),YMOD(1),ZMOD
ISN 0299      JGRID=JGRID+10000
ISN 0300      95 CONTINUE
C      STORE GRID ID
ISN 0301      JCUR=JCUR+1
ISN 0302      ICUR(JCUR)=IGRID
C      IF FIRST LINE OF GRIDS PICK UP GRID # FOR LAST LINE
ISN 0303      IF(Y(1).EQ.DELTAY)LAST(JCUR)=MOD(IGRID,1000)
ISN 0305      IF(Y(1).EQ.DELTAY)JLAST=JCUR
C      INCREMENT GRID ID
ISN 0307      IGRID=IGRID+1
ISN 0308      JGRID=JGRID+10000
C      MOVE TO THE LEFT
ISN 0309      90 X=X-DELTAX
C      SAVE X AND Y
ISN 0310      XSAVE=X
ISN 0311      YSAVE=Y(1)
C      ARE WE PAST THE 45?
ISN 0312      ANGLE=ATAN(Y(1)/X)
ISN 0313      IF(ANGLE.GT.PION/4)GO TO 140
C      BELOW THE 45
C      FIND DISTANCE FROM CUTOUT
ISN 0315      IF(Y(1).GT.RADIUS)GO TO 150
ISN 0317      DIST=X-DSORT(RADIUS**2-Y(1)**2)
C      ARE WE WITHIN TOLERANCE FROM THE CUTOUT
ISN 0318      IF(DIST.LE.TOLER)GO TO 80
ISN 0320      GO TO 150
C      ABOVE THE 45
ISN 0321      140 IF(X.GT.RADIUS)GO TO 150
ISN 0323      DIST=Y(1)-DSORT(RADIUS**2-X**2)
ISN 0324      IF(DIST.LE.TOLER)GO TO 160
C      NOT AT THE CUTOUT YET SO GENERATE NORMAL GRID POINT
C      TRANSFORMING FROM ORIGINAL TO MODIFIED RECT COORD SYSTEM
ISN 0326      150 XMOD(1)=Y(1)+HT2
ISN 0327      YMOD(1)=Z(1)
ISN 0328      ZMOD=X
ISN 0329      WRITE(7,1)IGRID,XMOD(1),YMOD(1),ZMOD
ISN 0330      DO 155 I=2,LAYERG

```

```

ISN 0331      YMOD(1)=Z(1)
ISN 0332      WRITE(7,1)JGRID,XXMOD(1),YMOD(1),ZMOD
ISN 0333      JGRID=JGRID+10000
ISN 0334 155  CONTINUE
                STORE GRID ID
ISN 0335      JCUR=JCUR+1
ISN 0336      ICUR(JCUR)=IGRID
                IF FIRST LINE OF GRIDS, PICK UP GRID # FOR LAST LINE
ISN 0337      IF(Y(1).EQ.DELTAY)LAST(JCUR)=MOD(IGRID,1000)
ISN 0339      IF(Y(1).EQ.DELTAY)JLAST=JCUR
                INCREMENT GRID ID'S
ISN 0341      IGRID=IGRID+1
ISN 0342      JGRID=JGRID+10000
                MAKE SURE WE HAVE A POINT NEXT TO THIS ONE
ISN 0343      IF(JCUR.GT.JLAST)GO TO 180
                GENERATE QUAD ELEMENT
                FIRST SET UP GRID POINT ORDER
ISN 0345 190  IG(1)=LAST(JCUR)
ISN 0346      IG(2)=LAST(JCUR-1)
ISN 0347      IG(3)=ICUR(JCUR-1)
ISN 0348      IG(4)=ICUR(JCUR)
ISN 0349      IG(5)=IG(1)+10000
ISN 0350      IG(6)=IG(2)+10000
ISN 0351      IG(7)=IG(3)+10000
ISN 0352      IG(8)=IG(4)+10000
ISN 0353      JEL=IEL
ISN 0354      JPSOL=JPSOL
ISN 0355      DO 165 J=1,LAYERS
ISN 0356      IF(J.EQ.1) GO TO 167
ISN 0358      JEL=JEL+10000
ISN 0359      JPSOL=JPSOL+10
ISN 0360      DO 166 K=1,8
ISN 0361      IG(K)=IG(K)+10000
ISN 0362 166  CONTINUE
                PUNCH CONNECTION CARD
ISN 0363 167  WRITE(7,2)JEL,JPSOL,(IG(1),I=1,6),ICONT
                INCREMENT CONTINUATION FIELD
ISN 0364      JCONT=ICONT
ISN 0365      ICONT=ICONT+1
                PUNCH CONTINUATION OF CONNECTION CARD
ISN 0366      WRITE(7,3)JCONT,IG(7),IG(8)
ISN 0367 165  CONTINUE
                INCREMENT ELEMENT ID
ISN 0368      IEL=IEL+1
                KEEP GOING TILL WE HIT THE CUTOUT
ISN 0369      GO TO 90
                IF WE DON'T HAVE A POINT NEXT TO THIS ONE PUT ONE ON THE CURVE
ISN 0370 180  YY=+DSQRT(RADIUS**2-X**2)
                TRANSFORMING FROM ORIGINAL TO MODIFIED RECT COORD SYSTEM
ISN 0371      XXMOD=YY+HT2
ISN 0372      YMOD(1)=Z(1)
ISN 0373      ZMOD=X
ISN 0374      WRITE(7,1)IGRID,XXMOD,YMOD(1),ZMOD
ISN 0375      DO 185 I=2,LAYERG

```

```

ISN 0376      YMOD(1)=Z(1)
ISN 0377      WRITE(7,1)JGRID,XXMOD,YMOD(1),ZMOD
ISN 0378      JGRID=JGRID+10000
ISN 0379      185 CONTINUE
C             STORE GRID ID
ISN 0380      JLAST=JLAST+1
ISN 0381      LAST(JLAST)=IGRID
C             INCREMENT GRID ID
ISN 0382      IGRID=IGRID+1
ISN 0383      JGRID=IGRID+10000
ISN 0384      GO TO 190
C
C             WE'VE HIT THE CUTOUT, SO GENERATE
C             A GRID POINT ON THE CURVE OF THE CUTOUT
C             WE'RE ABOVE THE 45, SO MOVE IN THE Y-DIRECTION
ISN 0385      160 Y(1)=DSQRT(RADIUS**2-X**2)
ISN 0386      GO TO 170
C             WE'RE BELOW THE 45 SO MOVE IN THE X-DIRECTION
ISN 0387      80 X=DSQRT(RAD2US**2-Y(1)**2)
C             TRANSFORMING FROM ORIGINAL TO MODIFIED RECT COORD SYSTEM
ISN 0388      170 XMOD(1)=Y(1)+HT2
ISN 0389      YMOD(1)=Z(1)
ISN 0390      ZMOD=X
ISN 0391      WRITE(7,1)IGRID,XMOD(1),YMOD(1),ZMOD
ISN 0392      DO 175 I=2,LAYERG
ISN 0393      YMOD(I)=Z(I)
ISN 0394      WRITE(7,1)JGRID,XMOD(I),YMOD(I),ZMOD
ISN 0395      JGRID=JGRID+10000
ISN 0396      175 CONTINUE
C             STORE GRID ID
ISN 0397      JCUR=JCUR+1
ISN 0398      ICUR(JCUR)=IGRID
C             IF FIRST LINE OF GRIDS, PICK UP GRID # FOR LAST LINE
ISN 0399      IF(Y(1).EQ.DELTAY)LAST(JCUR)=MOD(IGRID,1000)
ISN 0401      IF(Y(1).EQ.DELTAY)JLAST=JCUR
C             INCREMENT GRID ID'S
ISN 0403      IGRID=IGRID+1
ISN 0404      JGRID=IGRID+10000
C             DID WE CROSS A LINE OF GRIDS?
ISN 0405      IF(XSAVE.NE.XLAST)GO TO 100
C             WE DIDN'T CROSS A LINE OF GRIDS SO
C             GENERATE A QUAD ELEMENT
C             FIRST SET UP THE GRID ORDER
ISN 0407      IG(1)=LAST(JCUR)
ISN 0408      IG(2)=LAST(JCUR-1)
ISN 0409      IG(3)=ICUR(JCUR-1)
ISN 0410      IG(4)=ICUR(JCUR)
ISN 0411      IG(5)=IG(1)+10000
ISN 0412      IG(6)=IG(2)+10000
ISN 0413      IG(7)=IG(3)+10000
ISN 0414      IG(8)=IG(4)+10000
ISN 0415      JEL=IEL
ISN 0416      JPSOL=IPSOL
ISN 0417      DO 176 J=1,LAYERS

```

```

ISN 0418      IF(J.EQ.1)GO TO 178
ISN 0420      JPSQL=JPSQL+10
ISN 0421      JEL=JEL+10000
ISN 0422      DD 177 K=1.8
ISN 0423      IG(K)=IG(K)+10000
ISN 0424      177 CONTINUE
C             PUNCH CONNECTION CARD
ISN 0425      178 WRITE(7,2)JEL,JPSQL,(IG(I),I=1,6),JCONT
C             INCREMENT CONTINUATION FIELD
ISN 0426      JCONT=JCONT
ISN 0427      JCONT=JCONT+1
C             PUNCH CONTINUATION OF CONNECTION CARD
ISN 0428      WRITE(7,3)JCONT,IG(7),IG(8)
ISN 0429      176 CONTINUE
C             INCREMENT ELEMENT ID
ISN 0430      IEL=IEL+1
ISN 0431      GO TO 130
C
C             WE CROSSED A LINE OF GRIDS SO WE NEED A TRIANGULAR
C             ELEMENT INSTEAD OF A QUAD ELEMENT
C             FIRST SET UP THE GRID ORDER
ISN 0432      100 IG(1)=LAST(JCUR-1)
ISN 0433      IG(2)=ICUR(JCUR-1)
ISN 0434      IG(3)=ICUR(JCUR)
ISN 0435      IG(4)=IG(1)+10000
ISN 0436      IG(5)=IG(2)+10000
ISN 0437      IG(6)=IG(3)+10000
ISN 0438      JEL=IEL
ISN 0439      JPSQL=JPSQL
ISN 0440      DD 105 J=1,LAYERS
ISN 0441      IF(J.EQ.1) GO TO 107
ISN 0443      JPSQL=JPSQL+10
ISN 0444      JEL=JEL+10000
ISN 0445      DD 106 K=1.6
ISN 0446      IG(K)=IG(K)+10000
ISN 0447      106 CONTINUE
C             PUNCH CONNECTION CARD
ISN 0448      107 WRITE(7,4)JEL,JPSQL,(IG(I),I=1,6)
ISN 0449      105 CONTINUE
C             INCREMENT ELEMENT ID
ISN 0450      IEL=IEL+1
C             SAVE LAST X AND Y VALUES
ISN 0451      130 YLAST=YSAVE
ISN 0452      XLAST=XSAVE
C             NOW MOVE CURRENT GRIDS TO LAST GRIDS
ISN 0453      DD 110 I=1,JCUR
ISN 0454      LAST(I)=ICUR(I)
ISN 0455      110 CONTINUE
ISN 0456      JLAST=JCUR
C             RESET CURRENT GRID COUNTER
ISN 0457      JCUR=0
C             MOVE UP A LINE
ISN 0458      IF(ANGLE.GT.PION/4)Y(1)=YSAVE
ISN 0460      Y(1)=Y(1)+DELTAY

```

```

C ARE WE AT THE TOP OF THE CUTOUT?
ISN 0461 IF(Y(1).LT.(RADIUS+TOLER))GO TO 30
C START GOING UP IN THE Y-DIRECTION UNTIL WE HIT THE TOP
C START AT THE LEFT EDGE
ISN 0463 Y(1)=Y(1)-DELTAY
ISN 0464 GO TO 75
ISN 0465 20 X=WIDTH
C GENERATE NEXT LINE OF GRID POINTS
ISN 0466 IEND=0
C TRANSFORMING FROM ORIGINAL TO MODIFIED RECT COORD SYSTEM
ISN 0467 40 XMOD(1)=Y(1)+HTZ
ISN 0468 YMOD(1)=Z(1)
ISN 0469 ZMOD=X
ISN 0470 WRITE(7,1)IGRID,XMOD(1),YMOD(1),ZMOD
ISN 0471 DO 45 I=2,LAYERG
ISN 0472 YMOD(I)=Z(I)
ISN 0473 WRITE(7,1)JGRID,XMOD(1),YMOD(1),ZMOD
ISN 0474 JGRID=JGRID+10000
ISN 0475 45 CONTINUE
C SAVE GRID ID'S FOR ELEMENT CONNECTIONS
ISN 0476 JCUR=JCUR+1
ISN 0477 ICUR(JCUR)=IGRID
C INCREMENT GRID ID'S
ISN 0478 IGRID=IGRID+1
ISN 0479 JGRID=JGRID+10000
C SEE IF THERE IS A POINT NEXT TO THIS ONE
ISN 0480 IF (JCUR.GT.JLAST)GO TO 52
C MOVE TO THE RIGHT ONE INCREMENT AND REPEAT
ISN 0482 51 X=X-DELTAX
ISN 0483 IF(X.GT.TOLER)GO TO 40
C MAKE SURE WE GET THE RIGHT EDGE
ISN 0485 IF(IEND.EQ.1)GO TO 50
ISN 0487 X=0.0
ISN 0488 IEND=1
ISN 0489 GO TO 40
C
C GENERATE ELEMENT CONNECTIONS
C
ISN 0490 50 DO 60 I=2,JLAST
C FIRST SET UP THE GRID POINT ORDER
ISN 0491 IG(1)=LAST(I)
ISN 0492 IG(2)=LAST(I-1)
ISN 0493 IG(3)=ICUR(I-1)
ISN 0494 IG(4)=ICUR(I)
ISN 0495 IG(5)=IG(1)+10000
ISN 0496 IG(6)=IG(2)+10000
ISN 0497 IG(7)=IG(3)+10000
ISN 0498 IG(8)=IG(4)+10000
ISN 0499 JEL=IEL
ISN 0500 JPSQL=IPSQL
ISN 0501 DO 55 K=1,LAYERS
ISN 0502 IF(K.EQ.1) GO TO 57
ISN 0504 JEL=JEL+10000
ISN 0505 JPSQL=JPSQL+10

```



```

C      GENERATE THE 90-DEGREE BEND
C
C      FIRST ESTABLISH A CYLINDRICAL CO-ORDINATE SYSTEM
ISN 0544 200 X=0.0
ISN 0545      LEGX=HT2+LEGX1
ISN 0546      LEGXP1=LEGX+1.
ISN 0547      LEGY=LEGY
ISN 0548      WRITE(7,201)LEGX,LEGY,LEGX,LEGY,ICONT
ISN 0549 201 FORMAT('CORD2C ',5X,'100',8X,2F8.4,5X,'0.0',2F8.4,5X,'1.0+',
*17)
ISN 0550      JCONT=ICONT
ISN 0551      ICONT=ICONT+1
ISN 0552      WRITE(7,202)JCONT,LEGXP1,LEGY
ISN 0553 202 FORMAT('+',17,2F8.4,5X,'0.0')
C      SET INITIAL VALUES
ISN 0554      IPSOL=IPSOL+1
ISN 0555      R(1)=BEND
ISN 0556      DO 205 I=2,LAYERG
ISN 0557      R(I)=R(I-1)+T(I-1)
ISN 0558 205 CONTINUE
ISN 0559      THETA=DELTA T
ISN 0560      IEL=(IEL/1000)+1)*1000+1
ISN 0561      IEND2=0
ISN 0562 250 IEND=0
ISN 0563      Z(1)=0.0
C      TRANSFORMING FROM ORIGINAL TO MODIFIED CYLINDRICAL COORD SYSTEM
ISN 0564 220 THMOD=90.-THETA
ISN 0565      ZMOD2(1)=WIDTH-Z(1)
ISN 0566      WRITE(7,203)IGRID,R(1),THMOD,ZMOD2(1)
ISN 0567 203 FORMAT('GRID ',18,5X,'100',3F8.4)
ISN 0568      DO 225 I=2,LAYERG
ISN 0569      WRITE(7,203)JGRID,R(I),THMOD,ZMOD2(1)
ISN 0570      JGRID=JGRID+10000
ISN 0571 225 CONTINUE
ISN 0572      JCUR=JCUR+1
ISN 0573      ICUR(JCUR)=IGRID
ISN 0574      IGRID=IGRID+1
ISN 0575      JGRID=JGRID+10000
ISN 0576      Z(1)=Z(1)+DELTA X
ISN 0577      IF(Z(1).LT.(WIDTH-TOLER))GO TO 220
C      MAKE SURE WE GET THE EDGE
ISN 0579      IF(IEND.EQ.1)GO TO 210
ISN 0581      Z(1)=WIDTH
ISN 0582      IEND=1
ISN 0583      GO TO 220
C      GENERATE CONNECTIONS
ISN 0584 210 DO 230 I=2,JCUR
C      SET UP THE GRID POINT ORDER
ISN 0585      IG(1)=LAST(I)
ISN 0586      IG(2)=LAST(I-1)
ISN 0587      IG(3)=ICUR(I-1)
ISN 0588      IG(4)=ICUR(I)
ISN 0589      IG(5)=IG(1)+10000
ISN 0590      IG(6)=IG(2)+10000

```

```

ISN 0591      IG(7)=IG(3)+10000
ISN 0592      IG(8)=IG(4)+10000
ISN 0593      JEL=IEL
ISN 0594      JPSOL=IPSO
ISN 0595      DO 215 K=1,LAYERS
ISN 0596      IF(K.EQ.1)GO TO 217
ISN 0598      JEL=JEL+10000
ISN 0599      JPSOL=JPSOL+10
ISN 0600      DO 216 L=1,8
ISN 0601      IG(L)=IG(L)+10000
ISN 0602      216 CONTINUE
C             PUNCH CONNECTION CARD
ISN 0603      217 WRITE(7,2)JEL,JPSOL,(IG(J),J=1,6),ICONT
C             INCREMENT CONTINUATION
ISN 0604      JCONT=ICONT
ISN 0605      ICONT=ICONT+1
C             PUNCH CONTINUATION OF CONNECTION CARD
ISN 0606      WRITE(7,3)JCONT,IG(7),IG(8)
ISN 0607      215 CONTINUE
C             INCREMENT ELEMENT ID
ISN 0608      IEL=IEL+1
ISN 0609      230 CONTINUE
C             MOVE CURRENT GRIDS TO LAST GRIDS
ISN 0610      DO 240 I=1,JCUR
ISN 0611      LAST(I)=ICUR(I)
ISN 0612      240 CONTINUE
ISN 0613      JLAST=JCUR
ISN 0614      JCUR=0
C             INCREMENT ANGLE
ISN 0615      THETA=THETA+DELTAT
ISN 0616      IF(THETA.LT.89.99995)GO TO 250
ISN 0618      IF(IEND2.EQ.1)GO TO 241
ISN 0620      IEND2=1
ISN 0621      THETA=90.
ISN 0622      GO TO 250
C
C             END OF 90 DEGREE BEND
C
C
C
C             START OF BOTTOM PIECE(NO CUTOUT)
C
C
C             INITIALIZE CONSTANTS
ISN 0623      241 IEL=((IEL/1000)+1)*1000+1
ISN 0624      IEND2=0
ISN 0625      IPSOL=IPSO+1
ISN 0626      Y(1)=LEGX1+BEND
ISN 0627      DO 245 I=2,LAYERG
ISN 0628      Y(I)=Y(I-1)+Y(I-1)
ISN 0629      245 CONTINUE
C             START GOING DOWN IN THE Z-DIRECTION UNTIL WE HIT THE BOTTOM
C             START AT THE LEFT EDGE
ISN 0630      Z(1)=LEGY-DELTAZ

```

```

ISN 0631 320 X=WIDTH
C GENERATE NEXT LINE OF GRID POINTS
ISN 0632 IEND=0
C TRANSFORMING FROM ORIGINAL TO MODIFIED RECT COORD SYSTEM
ISN 0633 340 XMOD(1)=Y(1)+HT2
ISN 0634 YMOD(1)=Z(1)
ISN 0635 ZMOD=X
ISN 0636 WRITE(7,1)IGRID,XMOD(1),YMOD(1),ZMOD
ISN 0637 DO 345 I=2,LAYERG
ISN 0638 XMOD(I)=Y(I)+HT2
ISN 0639 WRITE(7,1)JGRID,XMOD(I),YMOD(1),ZMOD
ISN 0640 JGRID=JGRID+10000
ISN 0641 345 CONTINUE
C SAVE GRID ID'S FOR ELEMENT CONNECTIONS
ISN 0642 JCUR=JCUR+1
ISN 0643 ICUR(JCUR)=IGRID
C INCREMENT GRID ID'S
ISN 0644 IGRID=IGRID+1
ISN 0645 JGRID=JGRID+10000
C MOVE TO THE RIGHT ONE INCREMENT AND REPEAT
ISN 0646 X=X-DELTA
ISN 0647 IF(X.GT.TOLER)GO TO 340
C MAKE SURE WE GET THE RIGHT EDGE
ISN 0649 IF(IEND.EQ.1)GO TO 350
ISN 0651 X=0.0
ISN 0652 IEND=1
ISN 0653 GO TO 340
C
C GENERATE ELEMENT CONNECTIONS
C
ISN 0654 350 DO 360 I=2,JLAST
C FIRST SET UP THE GRID POINT ORDER
ISN 0655 IG(1)=LAST(I)
ISN 0656 IG(2)=LAST(I-1)
ISN 0657 IG(3)=ICUR(I-1)
ISN 0658 IG(4)=ICUR(I)
ISN 0659 IG(5)=IG(1)+10000
ISN 0660 IG(6)=IG(2)+10000
ISN 0661 IG(7)=IG(3)+10000
ISN 0662 IG(8)=IG(4)+10000
ISN 0663 JEL=IEL
ISN 0664 JPSOL=IPSQL
ISN 0665 DO 355 K=1,LAYERS
ISN 0666 IF(K.EQ.1)GO TO 357
ISN 0668 JEL=JEL+10000
ISN 0669 JPSOL=JPSOL+10
ISN 0670 DO 356 L=1,8
ISN 0671 IG(L)=IG(L)+10000
ISN 0672 356 CONTINUE
C PUNCH CONNECTION CARD
ISN 0673 357 WRITE(7,2)JEL,JPSOL,(IG(J),J=1,6),ICONT
C INCREMENT CONTINUATION FIELD
ISN 0674 JCONT=ICONT
ISN 0675 ICONT=ICONT+1

```

```

C      PUNCH CONTINUATION OF CONNECTION CARD
ISN 0676 - WRITE(7,3)JCONT,IG(Z),IG(8)
ISN 0677 355 CONTINUE
C      INCREMENT ELEMENT ID
ISN 0678 IEL=IEL+1
ISN 0679 360 CONTINUE
C      MOVE CURRENT LINE OF GRIDS TO LAST LINE
ISN 0680 DD 370 J=1,JCUR
ISN 0681 LAST(I)=ICUR(I)
ISN 0682 370 CONTINUE
ISN 0683 JLAST=JCUR
C      MAKE CURRENT LINE EMPTY
ISN 0684 JCUR=0
C      MOVE UP A LINE
ISN 0685 Z(I)=Z(I)-DELTAZ
C      HAVE WE HIT THE BOTTOM YET?
ISN 0686 IF(Z(I).GT.TOLER)GO TO 320
ISN 0688 IF(IEND2.EQ.1)GO TO 120
ISN 0690 IEND2=1
ISN 0691 Z(I)=0.0
ISN 0692 GO TO 320
C      WERE DONE WHEN
C      SO DUMP THE BUFFER
ISN 0693 120 ENDFILE 7
C      AND GET THE HELL OUT
ISN 0694 STOP
ISN 0695 900 WRITE(6,901)
ISN 0696 901 FORMAT('***ERROR*** TOO MANY LAYERS SPECIFIED')
ISN 0697 STOP
ISN 0698 END

```

PARAMETER ECHO

LEGX1= 0.2700
LEGY= 0.5100
WIDTH= 0.5000
RADIUS= 0.2500
DELTA-Y= 0.0900
DELTA-X= 0.1000
DELTA-T= 15.0000
BEND= 0.1250
TOLERANCE= 0.0150
DELTA-Z= 0.1700
LAYERS= 1
DELTAY2= 0.1330
HEIGHT2= 0.4000
LAYER- 1 THICKNESS= 0.1250

11
F

APPENDIX F

C-1 MODEL PREPROCESSOR PROGRAM BULK DATA LISTING

BULK DATA GENERATED BY C-1 PREPROCESSOR

1.	GRID	1		0.4000	0.6350	0.5000					
2.	GRID	10001		0.4000	0.7600	0.5000					
3.	GRID	2		0.4000	0.6350	0.4000					
4.	GRID	10002		0.4000	0.7600	0.4000					
5.	GRID	3		0.4000	0.6350	0.3000					
6.	GRID	10003		0.4000	0.7600	0.3000					
7.	GRID	4		0.4000	0.6350	0.2500					
8.	GRID	10004		0.4000	0.7600	0.2500					
9.	GRID	5		0.2670	0.6350	0.5000					
10.	GRID	10005		0.2670	0.7600	0.5000					
11.	GRID	6		0.2670	0.6350	0.4000					
12.	GRID	10006		0.2670	0.7600	0.4000					
13.	CHEXA	1	1								
14.	*	0	10001	10002			2	10006	10005*	0	
15.	GRID	7		0.2670	0.6350	0.3000					
16.	GRID	10007		0.2670	0.7600	0.3000					
17.	CHEXA	2	1								
18.	*	1	10002	10003			3	10007	10006*	1	
19.	GRID	8		0.2670	0.6350	0.2117					
20.	GRID	10008		0.2670	0.7600	0.2117					
21.	CHEXA	3	1								
22.	*	2	10003	10004			4	10008	10007*	2	
23.	GRID	9		0.1340	0.6350	0.5000					
24.	GRID	10009		0.1340	0.7600	0.5000					
25.	GRID	10		0.1340	0.6350	0.4000					
26.	GRID	10010		0.1340	0.7600	0.4000					
27.	GRID	11		0.1340	0.6350	0.3000					
28.	GRID	10011		0.1340	0.7600	0.3000					
29.	GRID	12		0.1340	0.6350	0.2000					
30.	GRID	10012		0.1340	0.7600	0.2000					
31.	GRID	13		0.1340	0.6350	0.1000					
32.	GRID	10013		0.1340	0.7600	0.1000					
33.	GRID	14		0.1709	0.6350	0.1000					
34.	GRID	10014		0.1709	0.7600	0.1000					
35.	GRID	15		0.1340	0.6350	0.0					
36.	GRID	10015		0.1340	0.7600	0.0					
37.	GRID	16		0.1500	0.6350	0.0					
38.	GRID	10016		0.1500	0.7600	0.0					
39.	CHEXA	4	1								
40.	*	3	10005	10006	10	5	6	10010	10009*	3	
41.	CHEXA	5	1								
42.	*	4	10006	10007	11	6	7	10011	10010*	4	
43.	CHEXA	6	1								
44.	*	5	10007	10008	12	7	8	10012	10011*	5	
45.	CHEXA	7	1								
46.	*	6	10008	10014	13	8	14	10013	10012*	6	
47.	CHEXA	8	1								
48.	*	7	10014	10016	15	13	14	16	10015	10013*	7
49.	GRID	17		0.0	0.6350	0.5000					
50.	GRID	10017		0.0	0.7600	0.5000					
51.	GRID	18		0.0	0.6350	0.4000					
52.	GRID	10018		0.0	0.7600	0.4000					
53.	GRID	19		0.0	0.6350	0.3000					
54.	GRID	10019		0.0	0.7600	0.3000					
55.	GRID	20		0.0	0.6350	0.2000					
56.	GRID	10020		0.0	0.7600	0.2000					
57.	GRID	21		0.0	0.6350	0.1000					
58.	GRID	10021		0.0	0.7600	0.1000					

11
B

59.	GRID	22		0.0	0.6350	0.0						
60.	GRID	10022		0.0	0.7600	0.0						
61.	CHEXA	9	1	18	17	9	10	10018	10017*	8		
62.	CHEXA	10009	10010	1			11	10019	10018*	9		
63.	CHEXA	10	1	19	18	10	12	10020	10019*	10		
64.	CHEXA	9	10010	10011	1		13	10021	10020*	11		
65.	CHEXA	11	1	20	19	11	15	10022	10021*	12		
66.	CHEXA	10	10011	10012	1							
67.	CHEXA	12	1	21	20	12						
68.	CHEXA	11	10012	10013	1							
69.	CHEXA	13	1	22	21	13						
70.	CHEXA	12	10013	10015								
71.	GRID	1001		0.4900	0.6350	0.5000						
72.	GRID	11001		0.4900	0.7600	0.5000						
73.	GRID	1002		0.4900	0.6350	0.4000						
74.	GRID	11002		0.4900	0.7600	0.4000	1002	10002	10001*	13		
75.	CHEXA	1001	1	2	1	1001						
76.	CHEXA	13	11002									
77.	GRID	1003		0.4900	0.6350	0.3000						
78.	GRID	11003		0.4900	0.7600	0.3000	1003	10003	10002*	14		
79.	CHEXA	1002	1	3	2	1002						
80.	CHEXA	14	11003									
81.	GRID	1004		0.4900	0.6350	0.2332						
82.	GRID	11004		0.4900	0.7600	0.2332	1004	10004	10003*	15		
83.	CHEXA	1003	1	4	3	1003						
84.	CHEXA	15	11004									
85.	GRID	1005		0.5800	0.6350	0.5000						
86.	GRID	11005		0.5800	0.7600	0.5000						
87.	GRID	1006		0.5800	0.6350	0.4000						
88.	GRID	11006		0.5800	0.7600	0.4000	1006	11002	11001*	16		
89.	CHEXA	1004	1	1002	1001	1005						
90.	CHEXA	16	11006									
91.	GRID	1007		0.5800	0.6350	0.3000						
92.	GRID	11007		0.5800	0.7600	0.3000	1007	11003	11002*	17		
93.	CHEXA	1005	1	1003	1002	1006						
94.	CHEXA	17	11007									
95.	GRID	1008		0.5800	0.6350	0.2000						
96.	GRID	11008		0.5800	0.7600	0.2000	1008	11004	11003*	18		
97.	CHEXA	1006	1	1004	1003	1007						
98.	CHEXA	18	11008									
99.	GRID	1009		0.6291	0.6350	0.1000						
100.	GRID	11009		0.6291	0.7600	0.1000	11004	11008	11009*			
101.	CPENTA	1007	1	1004	1006	1009						
102.	GRID	1010		0.6700	0.6350	0.5000						
103.	GRID	11010		0.6700	0.7600	0.5000						
104.	GRID	1011		0.6700	0.6350	0.4000						
105.	GRID	11011		0.6700	0.7600	0.4000						
106.	GRID	1012		0.6700	0.6350	0.3000						
107.	GRID	11012		0.6700	0.7600	0.3000						
108.	GRID	1013		0.6700	0.6350	0.2000						
109.	GRID	11013		0.6700	0.7600	0.2000						
110.	GRID	1014		0.6700	0.6350	0.1000						
111.	GRID	11014		0.6700	0.7600	0.1000						
112.	GRID	1015		0.6700	0.6350	0.0						
113.	GRID	11015		0.6700	0.7600	0.0						
114.	GRID	1016		0.6500	0.6350	0.0						
115.	GRID	11016		0.6500	0.7600	0.0	1011	11006	11005*	19		
116.	CHEXA	1008	1	1004	1005	1010						
117.	CHEXA	10	11010	11011			1012	11007	11006*	20		
118.	CHEXA	1009	1	1007	1006	1011						
119.	CHEXA	20	11011	11012								

120.	CHEXA	1010	1	1008	1007	1012	1013	11008	11007*	21
121.	+	21 11012	11013							
122.	CHEXA	1011	1	1009	1008	1013	1014	11009	11008*	22
123.	+	22 11013	11014							
124.	CHEXA	1012	1	1010	1009	1014	1015	11010	11009*	23
125.	+	23 11014	11015							
126.	CHEXA	100		0.6700	0.5100	0.0	0.6700	0.5100	1.0*	24
127.	+	24 1.6700	0.5100	0.0						
128.	GRID	1017	100	0.1250	75.0000	0.5000				
129.	GRID	11017	100	0.2500	75.0000	0.5000				
130.	GRID	1016	100	0.1250	75.0000	0.4000				
131.	GRID	11016	100	0.2500	75.0000	0.4000				
132.	GRID	1019	100	0.1250	75.0000	0.3000				
133.	GRID	11019	100	0.2500	75.0000	0.3000				
134.	GRID	1020	100	0.1250	75.0000	0.2000				
135.	GRID	11020	100	0.2500	75.0000	0.2000				
136.	GRID	1021	100	0.1250	75.0000	0.1000				
137.	GRID	11021	100	0.2500	75.0000	0.1000				
138.	GRID	1022	100	0.1250	75.0000	0.0				
139.	GRID	11022	100	0.2500	75.0000	0.0				
140.	CHEXA	2001	2	1011	1010	1017	1018	11011	11010*	25
141.	+	25 11017	11018							
142.	CHEXA	2002	2	1012	1011	1016	1019	11012	11011*	26
143.	+	26 11018	11019							
144.	CHEXA	2003	2	1013	1012	1019	1020	11013	11012*	27
145.	+	27 11019	11020							
146.	CHEXA	2004	2	1014	1013	1020	1021	11014	11013*	28
147.	+	28 11020	11021							
148.	CHEXA	2005	2	1015	1014	1021	1022	11015	11014*	29
149.	+	29 11021	11022							
150.	GRID	1023	100	0.1250	60.0000	0.5000				
151.	GRID	11023	100	0.2500	60.0000	0.5000				
152.	GRID	1024	100	0.1250	60.0000	0.4000				
153.	GRID	11024	100	0.2500	60.0000	0.4000				
154.	GRID	1025	100	0.1250	60.0000	0.3000				
155.	GRID	11025	100	0.2500	60.0000	0.3000				
156.	GRID	1026	100	0.1250	60.0000	0.2000				
157.	GRID	11026	100	0.2500	60.0000	0.2000				
158.	GRID	1027	100	0.1250	60.0000	0.1000				
159.	GRID	11027	100	0.2500	60.0000	0.1000				
160.	GRID	1028	100	0.1250	60.0000	0.0				
161.	GRID	11028	100	0.2500	60.0000	0.0				
162.	CHEXA	2006	2	1016	1017	1023	1024	11016	11017*	30
163.	+	30 11023	11024							
164.	CHEXA	2007	2	1019	1018	1024	1025	11019	11018*	31
165.	+	31 11024	11025							
166.	CHEXA	2008	2	1020	1019	1025	1026	11020	11019*	32
167.	+	32 11025	11026							
168.	CHEXA	2009	2	1021	1020	1026	1027	11021	11020*	33
169.	+	33 11026	11027							
170.	CHEXA	2010	2	1022	1021	1027	1028	11022	11021*	34
171.	+	34 11027	11028							
172.	GRID	1029	100	0.1250	45.0000	0.5000				
173.	GRID	11029	100	0.2500	45.0000	0.5000				
174.	GRID	1030	100	0.1250	45.0000	0.4000				
175.	GRID	11030	100	0.2500	45.0000	0.4000				
176.	GRID	1031	100	0.1250	45.0000	0.3000				
177.	GRID	11031	100	0.2500	45.0000	0.3000				
178.	GRID	1032	100	0.1250	45.0000	0.2000				
179.	GRID	11032	100	0.2500	45.0000	0.2000				
180.	GRID	1033	100	0.1250	45.0000	0.1000				

161.	GRID	11033	100	0.2500	45.0000	0.1000					
162.	GRID	1034	100	0.1250	45.0000	0.0					
163.	GRID	11034	100	0.2500	45.0000	0.0					
164.	CHEXA	2011	2	1024	1023	1029	1030	11024	11023+		35
165.	+	35 11029	11030								
166.	CHEXA	2012	2	1025	1024	1030	1031	11025	11024+		36
167.	+	36 11030	11021								
168.	CHEXA	2013	2	1026	1025	1031	1032	11026	11025+		37
169.	+	37 11031	11032								
190.	CHEXA	2014	2	1027	1026	1032	1033	11027	11026+		38
191.	+	38 11032	11023								
192.	CHEXA	2015	2	1028	1027	1033	1034	11028	11027+		39
193.	+	39 11033	11034								
194.	GRID	1035	100	0.1250	30.0000	0.5000					
195.	GRID	11035	100	0.2500	30.0000	0.5000					
196.	GRID	1036	100	0.1250	30.0000	0.4000					
197.	GRID	11036	100	0.2500	30.0000	0.4000					
198.	GRID	1037	100	0.1250	30.0000	0.3000					
199.	GRID	11037	100	0.2500	30.0000	0.3000					
200.	GRID	1038	100	0.1250	30.0000	0.2000					
201.	GRID	11038	100	0.2500	30.0000	0.2000					
202.	GRID	1039	100	0.1250	30.0000	0.1000					
203.	GRID	11039	100	0.2500	30.0000	0.1000					
204.	GRID	1040	100	0.1250	30.0000	0.0					
205.	GRID	11040	100	0.2500	30.0000	0.0					
206.	CHEXA	2016	2	1030	1029	1035	1036	11030	11029+		40
207.	+	40 11035	11036								
208.	CHEXA	2017	2	1031	1030	1036	1037	11031	11030+		41
209.	+	41 11036	11037								
210.	CHEXA	2018	2	1032	1031	1037	1038	11032	11031+		42
211.	+	42 11037	11038								
212.	CHEXA	2019	2	1033	1032	1038	1039	11033	11032+		43
213.	+	43 11038	11039								
214.	CHEXA	2020	2	1034	1033	1039	1040	11034	11033+		44
215.	+	44 11039	11040								
216.	GRID	1041	100	0.1250	15.0000	0.5000					
217.	GRID	11041	100	0.2500	15.0000	0.5000					
218.	GRID	1042	100	0.1250	15.0000	0.4000					
219.	GRID	11042	100	0.2500	15.0000	0.4000					
220.	GRID	1043	100	0.1250	15.0000	0.3000					
221.	GRID	11043	100	0.2500	15.0000	0.3000					
222.	GRID	1044	100	0.1250	15.0000	0.2000					
223.	GRID	11044	100	0.2500	15.0000	0.2000					
224.	GRID	1045	100	0.1250	15.0000	0.1000					
225.	GRID	11045	100	0.2500	15.0000	0.1000					
226.	GRID	1046	100	0.1250	15.0000	0.0					
227.	GRID	11046	100	0.2500	15.0000	0.0					
228.	CHEXA	2021	2	1036	1035	1041	1042	11036	11035+		45
229.	+	45 11041	11042								
230.	CHEXA	2022	2	1037	1036	1042	1043	11037	11036+		46
231.	+	46 11042	11043								
232.	CHEXA	2023	2	1038	1037	1043	1044	11038	11037+		47
233.	+	47 11043	11044								
234.	CHEXA	2024	2	1039	1038	1044	1045	11039	11038+		48
235.	+	48 11044	11045								
236.	CHEXA	2025	2	1040	1039	1045	1046	11040	11039+		49
237.	+	49 11045	11046								
238.	GRID	1047	100	0.1250	0.0	0.5000					
239.	GRID	11047	100	0.2500	0.0	0.5000					
240.	GRID	1048	100	0.1250	0.0	0.4000					
241.	GRID	11048	100	0.2500	0.0	0.4000					

242.	GRID	1044	100	0.1250	0.0	0.2000															
243.	GRID	11045	100	0.2500	0.0	0.3000															
244.	GRID	1050	100	0.1250	0.0	0.2000															
245.	GRID	11040	100	0.2500	0.0	0.2000															
246.	GRID	1051	100	0.1250	0.0	0.1000															
247.	GRID	11051	100	0.2500	0.0	0.1000															
248.	GRID	1052	100	0.1250	0.0	0.0															
249.	GRID	11052	100	0.2500	0.0	0.0															
250.	CHIXA	2024	2	1042		1041	1047	1048	11042	11041+	50										
251.	+	50	11047	11048																	
252.	CHIXA	2027	2	1043		1042	1048	1049	11043	11042+	51										
253.	+	51	11048	11049																	
254.	CHIXA	2028	2	1044		1043	1049	1050	11044	11043+	52										
255.	+	52	11049	11050																	
256.	CHIXA	2029	2	1045		1044	1050	1051	11045	11044+	53										
257.	+	53	11050	11051																	
258.	CHIXA	2030	2	1046		1045	1051	1052	11046	11045+	54										
259.	+	54	11051	11052																	
260.	GRID	1053		0.7950	0.3400	0.5000															
261.	GRID	11053		0.9200	0.3400	0.5000															
262.	GRID	1054		0.7950	0.3400	0.4000															
263.	GRID	11054		0.9200	0.3400	0.4000															
264.	GRID	1055		0.7950	0.3400	0.3000															
265.	GRID	11055		0.9200	0.3400	0.3000															
266.	GRID	1056		0.7950	0.3400	0.2000															
267.	GRID	11056		0.9200	0.3400	0.2000															
268.	GRID	1057		0.7950	0.3400	0.1000															
269.	GRID	11057		0.9200	0.3400	0.1000															
270.	GRID	1058		0.7950	0.3400	0.0															
271.	GRID	11058		0.9200	0.3400	0.0															
272.	CHIXA	3001	3	1048		1047	1053	1054	11048	11047+	55										
273.	+	55	11053	11054																	
274.	CHIXA	3002	3	1049		1048	1054	1055	11049	11048+	56										
275.	+	56	11054	11055																	
276.	CHIXA	3003	3	1050		1049	1055	1056	11050	11049+	57										
277.	+	57	11055	11056																	
278.	CHIXA	3004	3	1051		1050	1056	1057	11051	11050+	58										
279.	+	58	11056	11057																	
280.	CHIXA	3005	3	1052		1051	1057	1058	11052	11051+	59										
281.	+	59	11057	11058																	
282.	GRID	1059		0.7950	0.1700	0.5000															
283.	GRID	11059		0.9200	0.1700	0.5000															
284.	GRID	1060		0.7950	0.1700	0.4000															
285.	GRID	11060		0.9200	0.1700	0.4000															
286.	GRID	1061		0.7950	0.1700	0.3000															
287.	GRID	11061		0.9200	0.1700	0.3000															
288.	GRID	1062		0.7950	0.1700	0.2000															
289.	GRID	11062		0.9200	0.1700	0.2000															
290.	GRID	1063		0.7950	0.1700	0.1000															
291.	GRID	11063		0.9200	0.1700	0.1000															
292.	GRID	1064		0.7950	0.1700	0.0															
293.	GRID	11064		0.9200	0.1700	0.0															
294.	CHIXA	3006	3	1054		1053	1059	1060	11054	11053+	60										
295.	+	60	11059	11060																	
296.	CHIXA	3007	3	1055		1054	1060	1061	11055	11054+	61										
297.	+	61	11060	11061																	
298.	CHIXA	3008	3	1056		1055	1061	1062	11056	11055+	62										
299.	+	62	11061	11062																	
300.	CHIXA	3009	3	1057		1056	1062	1063	11057	11056+	63										
301.	+	63	11062	11063																	
302.	CHIXA	3010	3	1058		1057	1063	1064	11058	11057+	64										

303.	*	64	11065	11064	0.7950	0.0	0.5000				
304.	GH II		1065		0.9200	0.0	0.3000				
305.	GH II		11066		0.7950	0.0	0.4000				
306.	GH II		11066		0.9200	0.0	0.4000				
307.	GH II		1067		0.7950	0.0	0.3000				
308.	GH II		11067		0.9200	0.0	0.3000				
309.	GH II		1068		0.7950	0.0	0.2000				
310.	GH II		11068		0.9200	0.0	0.2000				
311.	GH II		1069		0.7950	0.0	0.1000				
312.	GH II		11069		0.9200	0.0	0.1000				
313.	GH II		1070		0.7950	0.0	0.0				
314.	GH II		11070		0.9200	0.0	0.0				
315.	GH XA		3011	3	1060	1059	1065	1066	11060	11059+	65
316.	*	65	11065	11065							
317.	GH XA		3012	3	1061	1060	1066	1067	11061	11060+	66
318.	*	66	11066	11067							
319.	GH XA		3013	3	1062	1061	1067	1068	11062	11061+	67
320.	*	67	11067	11068							
321.	GH XA		3014	3	1063	1062	1068	1069	11063	11062+	68
322.	*	68	11068	11069							
323.	GH XA		3015	3	1064	1063	1069	1070	11064	11063+	69
324.	*	69	11069	11070							

APPENDIX G

C-1 PLOT RUN DATA DECK SETUP AND UNDEDORMED PLOTS

```

1. // JOB (900004,,048,300),PLOTG14,CLASS=C -----
2. //RUN EXEC NAST46,PTAPE=WYLBUR,PLOT=WYL302,
3. // PLOTDSN='CX900004,SSS.PLOTG14',PLOTPGM=PLOT936,
4. //      W1=1,KON360=12K,PBUF=141,FBUFF=400,R=299K
5. ID MODEL C1,PLOTG14 -----
6. SOL 24
7. TIME 5 -----
8. DIAG 8,14
9. ALTER 23 $ -----
10. EXIT $ -----
11. ENDALTER -----
12. CEND
13. TITLE = PRE-PROCESSOR PRODUCED GEOMETRY (MODEL C14) -----
14. OUTPUT (PLOT)
15. PLOTTER NASTRAN MODEL D,0- -----
16. SET 1 = 1 THRU 1072 EXCLUDE GRID POINTS 1001 THRU 1103
17. SET 2 = 2001 THRU 2090 -----
18. SET 3 = 3001 THRU 3050
19. SET 4 = ALL -----
20. $
21. $ PLOT MESH I -----
22. $
23. AXES Y,X,MZ -----
24. VIEW 0,,0,,0.
25. PTITLE=PART I WITH WASHER; TOP VIEW -----
26. FIND SCALE SET 1 ORIGIN 1
27. PLOT SET 1 ORIGIN 1 LABEL ELEMENTS -----
28. PLOT SET 1 ORIGIN 1 LABEL GRIDS
29. $
30. AXES Z,X,Y -----
31. VIEW 0,,0,,0.
32. PTITLE=FULL BRACKET; VIEW 0,0,0 -----
33. FIND SCALE SET 4 ORIGIN 6
34. PLOT SET 4 ORIGIN 6 -----
35. $
36. $ PLOT MESHES I,II, AND III -----
37. $
38. AXES Z,X,Y -----
39. VIEW -10,,20,,-30.
40. PTITLE=FULL BRACKET; 3-D VIEW -10,20,-30 -----
41. FIND SCALE SET 4 ORIGIN 5
42. PLOT SET 4 ORIGIN 5 -----
43. BEGIN BULK -----
.
.
.
(BULK DATA) -----
.
.
.
ENDDATA

```

8/11/78
 TOP VIEW - MESH 1 WITH WASHER

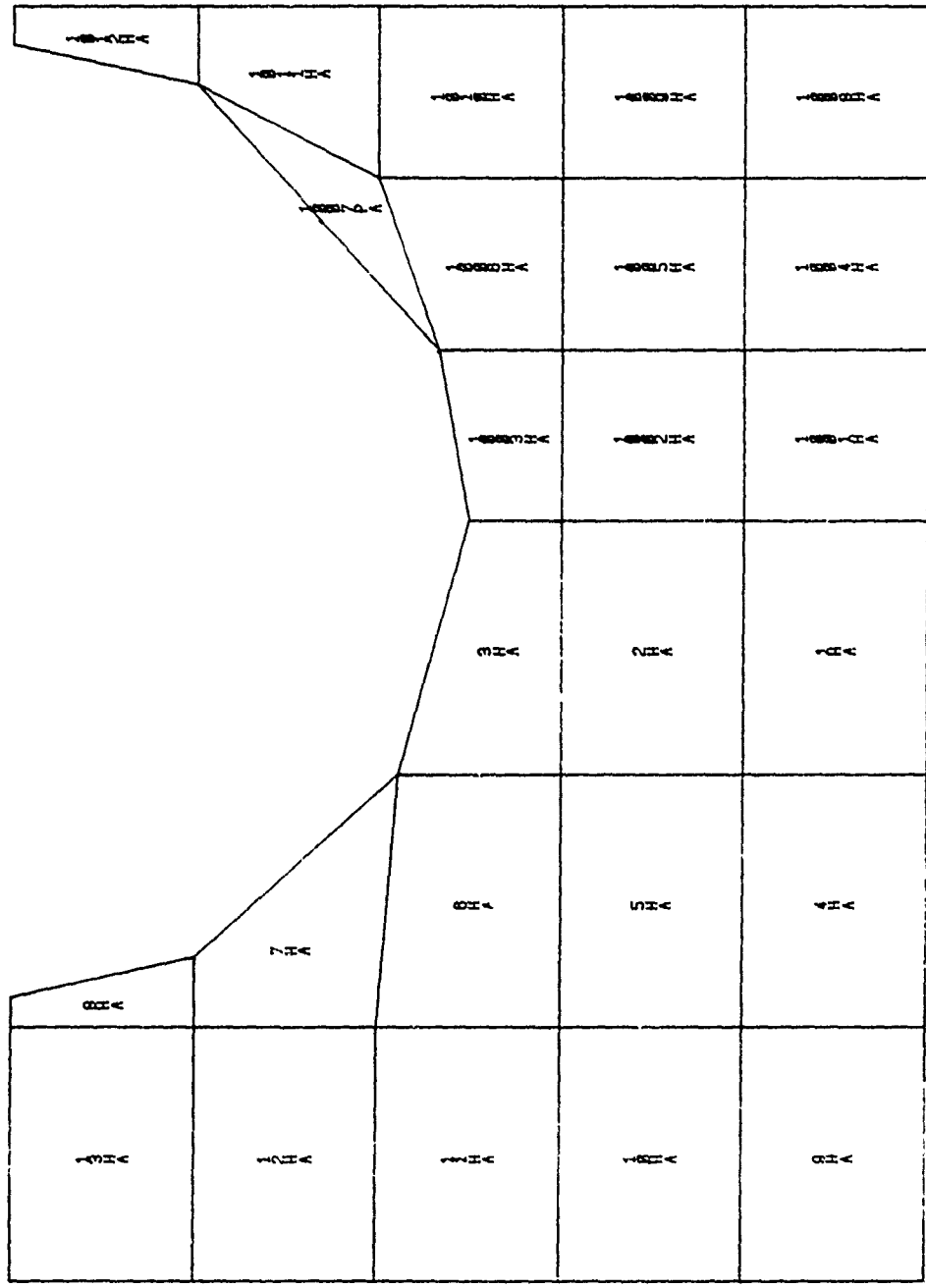

PRE-PROCESSOR PRODUCED BULK DATA
 UNDEFORMED SHAPE

2
TOP VIEW 8/11/78
- 4PCS 1 WITH WASHER

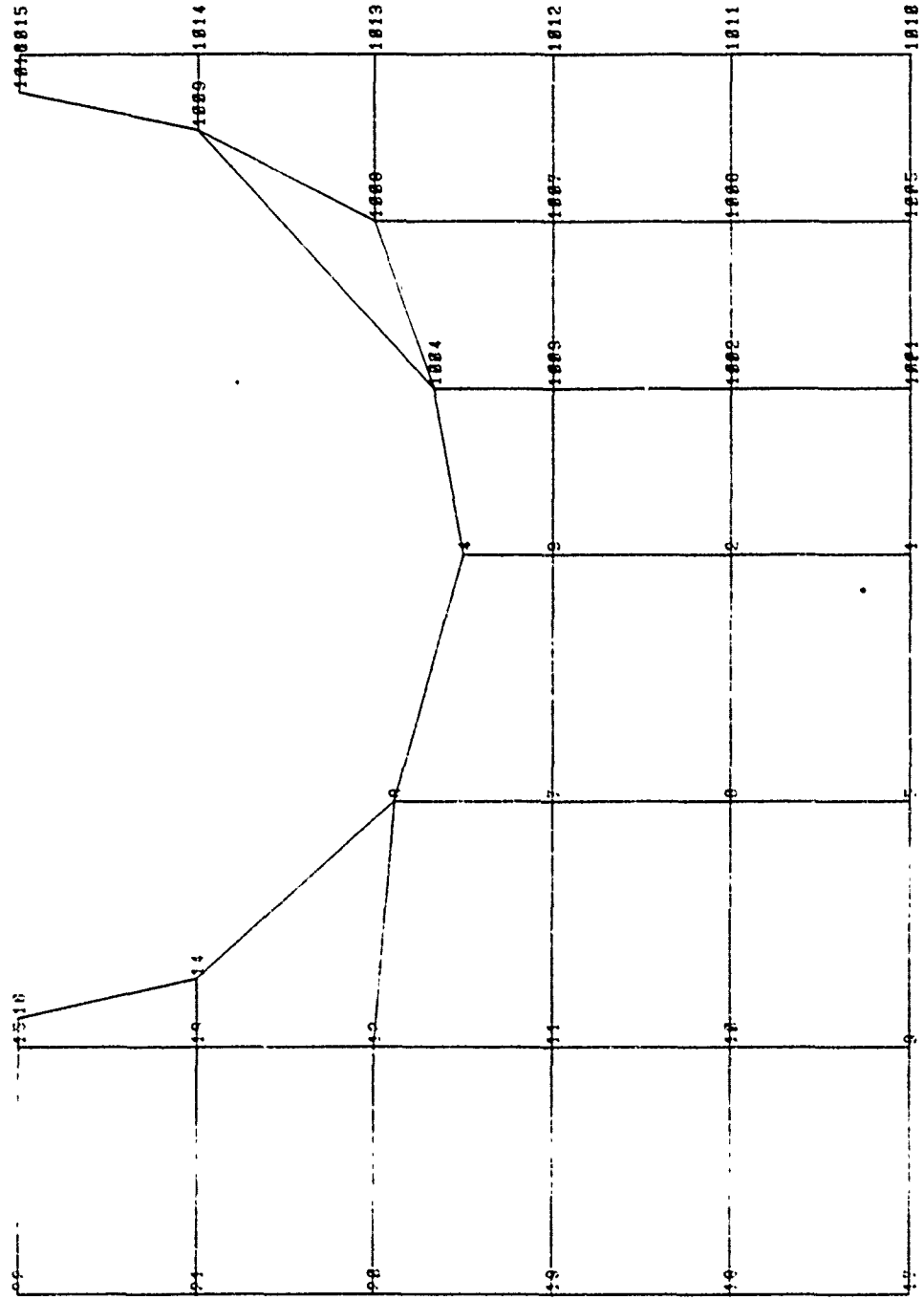

PRE-PROCESSOR PRODUCED BULK DATA
UNDEFORMED SHAPE

8/11/78
REVISION 1.11, AND III - S.C.B. VIEW

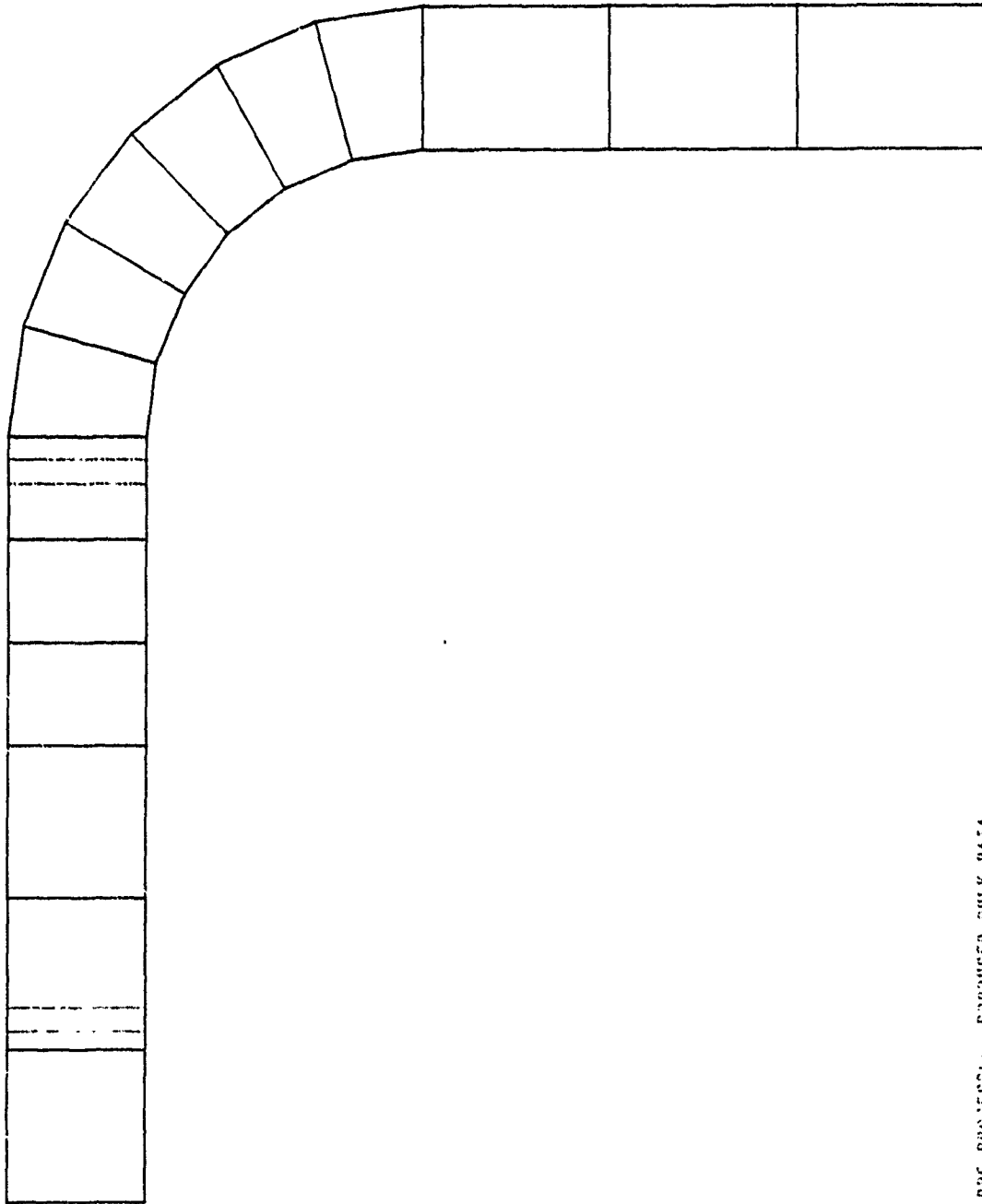

PRE-PRECAST CONCRETE BULK DATA
UNREFORMED SHAPE

4
REVISED 9/11/78
REVISED 1.11. AND III -12.28.-28 VIEW

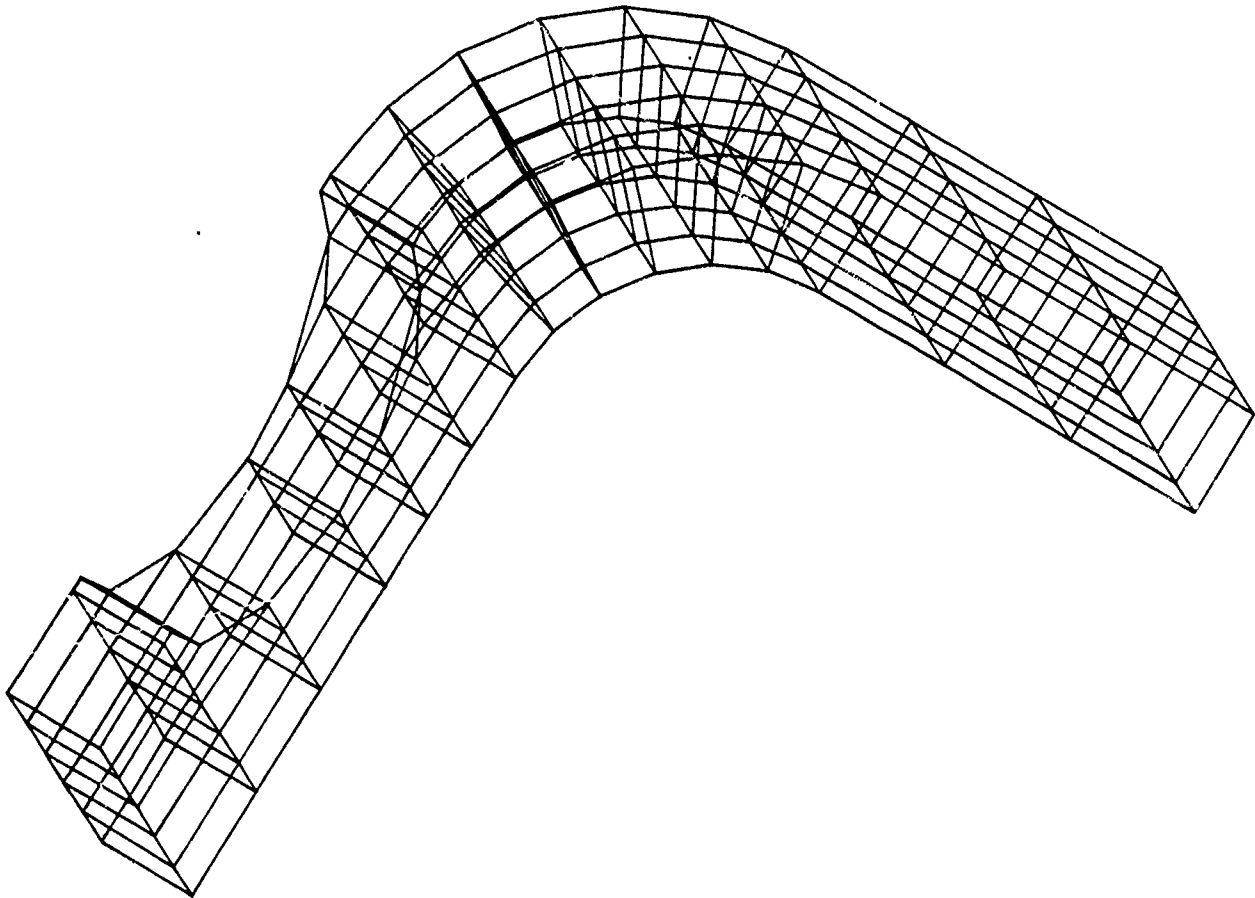

PRE-PROCESSOR PRODUCED BULK DATA
UNDEFORMED SHAPE

COMPOSIT BRACKET MODEL C18 (PHASE 2)
PA19 M052 (C113)745(121), BR *.125, T *.125

SEPTEMBER 7, 1978 NASTMAN 3/11/78

CASE CONTROL DECK ECHO

CARD
COUNT

1 TITLE * COMPOSIT BRACKET MODEL C18 (PHASE 2)
2 SUBTITLE * MAT9 M052 (C113)745(121), BR *.125, T *.125
3 SPC * 9
4 \$
5 SUBCASE 1 * DOWNWARD LOAD ALONG ONE LINE
6 LOAD * 1
7 \$
8 SUBCASE 2 * DOWNWARD LOAD ALONG OTHER LINE
9 LOAD * 2
10 \$
11 SUBCASE 3
12 SUBTITLE * UNIFORM PULL
13 SUBSEC * 1.0, 1.0
14 DLOAD * ALL
15 DISPL * ALL
16 STRESS * ALL
17 SPFCNCE * ALL
18 ESE * ALL
19 CFFCNCE * ALL
20 \$
21 SUBCASE 4
22 SUBTITLE * COUPLE DUE TO ECCENTRICITY (CLOCKWISE)
23 SUBSEC * -1.0, 1.0
24 DLOAD * ALL
25 DISPL * ALL
26 STRESS * ALL
27 SPFCNCE * ALL
28 ESE * ALL
29 CFFCNCE * ALL
30 BEGIN BULK

CARD COUNT	S O R T E D B U L K D A T A E C H U												
	1	2	3	4	5	6	7	8	9	10			
1-	CHEXA	1	1	6	5	1	6	2	10006	10005	*	10	0
2-		010001	10002										
3-	CHEXA	2	1	7	6	2	3	10007	10006	*		1	
4-		110002	10003										
5-	CHEXA	3	1	8	7	3	4	10008	10007	*		2	
6-		210003	10004										
7-	CHEXA	4	1	10	9	5	6	10010	10009	*		3	
8-		310005	10006										
9-	CHEXA	5	1	11	10	6	7	10011	10010	*		4	
10-		410006	10007										
11-	CHEXA	6	1	12	11	7	8	10012	10011	*		5	
12-		510007	10008										
13-	CHEXA	7	1	13	12	8	14	10013	10012	*		6	
14-		610008	10014										
15-	CHEXA	8	1	15	14	14	16	10015	10014	*		7	
16-		710014	10016										
17-	CHEXA	9	1	18	17	9	10	10018	10017	*		8	
18-		810009	10010										
19-	CHEXA	10	1	19	18	10	11	10019	10018	*		9	
20-		910010	10011										
21-	CHEXA	11	1	20	19	11	12	10020	10019	*		10	
22-		1010011	10012										
23-	CHEXA	12	1	21	20	12	13	10021	10020	*		11	
24-		1110012	10013										
25-	CHEXA	13	1	22	21	13	15	10022	10021	*		12	
26-		1210013	10014										
27-	CHEXA	1001	1	2	1	1001	1002	10002	10001	*		13	
28-		1311001	11002										
29-	CHEXA	1002	1	3	2	1002	1003	10003	10002	*		14	
30-		1411002	11003										
31-	CHEXA	1003	1	4	3	1003	1004	10004	10003	*		15	
32-		1511003	11004										
33-	CHEXA	1004	1	1002	1001	1005	1006	11002	11001	*		16	
34-		1611005	11006										
35-	CHEXA	1005	1	1003	1002	1006	1007	11003	11002	*		17	
36-		1711006	11007										
37-	CHEXA	1006	1	1004	1003	1007	1008	11004	11003	*		18	
38-		1811007	11008										
39-	CHEXA	1008	1	1006	1005	1010	1011	11006	11005	*		19	
40-		1911010	11011										
41-	CHEXA	1009	1	1007	1006	1011	1012	11007	11006	*		20	
42-		2011011	11012										
43-	CHEXA	1010	1	1008	1007	1012	1013	11008	11007	*		21	
44-		2111012	11013										
45-	CHEXA	1011	1	1009	1008	1013	1014	11009	11008	*		22	
46-		2211013	11014										
47-	CHEXA	1012	1	1016	1005	1014	1015	11016	11009	*		23	
48-		2311014	11015										
49-	CHEXA	2001	2	1011	1010	1017	1018	11011	11010	*		25	
50-		2511017	11018										

SHORTER BULK DATA LCHU

CARU LUUNT	1	2	3	4	5	6	7	8	9	10	11
51-	CHEXA	2002	2	1012	1011	1010	1019	11012	11011	*	26
52-	* 2611018	11019	2	1013	1012	1019	1020	11013	11012	*	27
53-	CHEXA	2003	2	1014	1013	1020	1021	11014	11013	*	28
54-	* 2711019	11020	2	1015	1014	1021	1022	11015	11014	*	29
55-	CHEXA	2004	2	1016	1015	1022	1023	11016	11015	*	30
56-	* 2811020	11021	2	1017	1016	1023	1024	11017	11016	*	31
57-	CHEXA	2005	2	1018	1017	1024	1025	11018	11017	*	32
58-	* 2911021	11022	2	1019	1018	1025	1026	11019	11018	*	33
59-	CHEXA	2006	2	1020	1019	1026	1027	11020	11019	*	34
60-	* 3011022	11023	2	1021	1020	1027	1028	11021	11020	*	35
61-	CHEXA	2007	2	1022	1021	1028	1029	11022	11021	*	36
62-	* 3111023	11024	2	1023	1022	1029	1030	11023	11022	*	37
63-	CHEXA	2008	2	1024	1023	1030	1031	11024	11023	*	38
64-	* 3211024	11025	2	1025	1024	1031	1032	11025	11024	*	39
65-	CHEXA	2009	2	1026	1025	1032	1033	11026	11025	*	40
66-	* 3311025	11026	2	1027	1026	1033	1034	11027	11026	*	41
67-	CHEXA	2010	2	1028	1027	1034	1035	11028	11027	*	42
68-	* 3411026	11027	2	1029	1028	1035	1036	11029	11028	*	43
69-	CHEXA	2011	2	1030	1029	1036	1037	11030	11029	*	44
70-	* 3511027	11028	2	1031	1030	1037	1038	11031	11030	*	45
71-	CHEXA	2012	2	1032	1031	1038	1039	11032	11031	*	46
72-	* 3611028	11029	2	1033	1032	1039	1040	11033	11032	*	47
73-	CHEXA	2013	2	1034	1033	1040	1041	11034	11033	*	48
74-	* 3711029	11030	2	1035	1034	1041	1042	11035	11034	*	49
75-	CHEXA	2014	2	1036	1035	1042	1043	11036	11035	*	50
76-	* 3811030	11031	2	1037	1036	1043	1044	11037	11036	*	51
77-	CHEXA	2015	2	1038	1037	1044	1045	11038	11037	*	52
78-	* 3911031	11032	2	1039	1038	1045	1046	11039	11038	*	53
79-	CHEXA	2016	2	1040	1039	1046	1047	11040	11039	*	54
80-	* 4011032	11033	2	1041	1040	1047	1048	11041	11040	*	55
81-	CHEXA	2017	2	1042	1041	1048	1049	11042	11041	*	56
82-	* 4111033	11034	2	1043	1042	1049	1050	11043	11042	*	57
83-	CHEXA	2018	2	1044	1043	1050	1051	11044	11043	*	58
84-	* 4211034	11035	2	1045	1044	1051	1052	11045	11044	*	59
85-	CHEXA	2019	2	1046	1045	1052	1053	11046	11045	*	60
86-	* 4311035	11036	2	1047	1046	1053	1054	11047	11046	*	61
87-	CHEXA	2020	2	1048	1047	1054	1055	11048	11047	*	62
88-	* 4411036	11037	2	1049	1048	1055	1056	11049	11048	*	63
89-	CHEXA	2021	2	1050	1049	1056	1057	11050	11049	*	64
90-	* 4511037	11038	2	1051	1050	1057	1058	11051	11050	*	65
91-	CHEXA	2022	2	1052	1051	1058	1059	11052	11051	*	66
92-	* 4611038	11039	2	1053	1052	1059	1060	11053	11052	*	67
93-	CHEXA	2023	2	1054	1053	1060	1061	11054	11053	*	68
94-	* 4711039	11040	2	1055	1054	1061	1062	11055	11054	*	69
95-	CHEXA	2024	2	1056	1055	1062	1063	11056	11055	*	70
96-	* 4811040	11041	2	1057	1056	1063	1064	11057	11056	*	71
97-	CHEXA	2025	2	1058	1057	1064	1065	11058	11057	*	72
98-	* 4911041	11042	2	1059	1058	1065	1066	11059	11058	*	73
99-	CHEXA	2026	2	1060	1059	1066	1067	11060	11059	*	74
100-	* 5011042	11043	2	1061	1060	1067	1068	11061	11060	*	75

CAKUP	CLUM1	1	2	3	4	5	6	7	8	9	10
101-	CHEXA	2027	2	1043	1042	1048	1045	11043	11042	51	
102-	•	5111046	11049								
103-	CHEXA	2028	2	1044	1043	1049	1050	11044	11043	52	
104-	•	5211049	11050								
105-	CHEXA	2029	2	1045	1044	1050	1051	11045	11044	53	
106-	•	5311050	11051								
107-	CHEXA	2030	2	1046	1045	1051	1052	11046	11045	54	
108-	•	5411051	11052								
109-	CHEXA	3001	3	1048	1047	1053	1054	11048	11047	55	
110-	•	5511054	11054								
111-	CHEXA	3002	3	1049	1048	1054	1055	11049	11048	56	
112-	•	5611054	11055								
113-	CHEXA	3003	3	1050	1049	1055	1056	11050	11049	57	
114-	•	5711055	11056								
115-	CHEXA	3004	3	1051	1050	1056	1057	11051	11050	58	
116-	•	5811056	11057								
117-	CHEXA	3005	3	1052	1051	1057	1058	11052	11051	59	
118-	•	5911057	11058								
119-	CHEXA	3006	3	1054	1053	1059	1060	11054	11053	60	
120-	•	6011059	11060								
121-	CHEXA	3007	3	1055	1054	1060	1061	11055	11054	61	
122-	•	6111060	11061								
123-	CHEXA	3008	3	1056	1055	1061	1062	11056	11055	62	
124-	•	6211061	11062								
125-	CHEXA	3009	3	1057	1056	1062	1063	11057	11056	63	
126-	•	6311062	11063								
127-	CHEXA	3010	3	1058	1057	1063	1064	11058	11057	64	
128-	•	6411063	11064								
129-	CHEXA	3011	3	1060	1059	1065	1066	11060	11059	65	
130-	•	6511065	11066								
131-	CHEXA	3012	3	1061	1060	1066	1067	11061	11060	66	
132-	•	6611066	11067								
133-	CHEXA	3013	3	1062	1061	1067	1068	11062	11061	67	
134-	•	6711067	11068								
135-	CHEXA	3014	3	1063	1062	1068	1069	11063	11062	68	
136-	•	6811068	11069								
137-	CHEXA	3015	3	1064	1063	1069	1070	11064	11063	69	
138-	•	6911069	11070								
139-	CUMD2R	100		.6700	.5100	.0	.6700	.5100	1.0	24	
140-	•	241.6700	.5100	.0							
141-	CUMD2R	50		.0	.76	0.0	.0	.76	.1	CUMD2R	
142-	•	0	.4	0.0							
143-	CUMD2R	1007	1	1004	1004	1004	11004	11008	11004		
144-	•	1065	0	-2.5	.0	1.0	.0				
145-	FORCE	1	1066	0	-5.0	.0	1.0	.0			
146-	•	1067	0	-5.0	.0	1.0	.0				
147-	FORCE	1	1068	0	-5.0	.0	1.0	.0			
148-	•	1069	0	-5.0	.0	1.0	.0				
149-	FORCE	1	1070	0	-2.50	.0	1.0	.0			
150-	•	11069	0	-2.50	.0	1.0	.0				

12
1

S U B R I E L B U L K D A T A E C H U											
CARD		1	2	3	4	5	6	7	8	9	10
151-	FORCE	2		11066	0	-5.0	.0	1.0	.0		
152-	FORCE	2		11067	0	-5.0	.0	1.0	.0		
153-	FORCE	2		11068	0	-5.0	.0	1.0	.0		
154-	FORCE	2		11069	0	-5.0	.0	1.0	.0		
155-	FORCE	2		11070	0	-2.5	.0	1.0	.0		
156-	CRUSIT								456		
157-	GRID	1			.4000	.6350	.5000				
158-	GRID	2			.4000	.6350	.4000				
159-	GRID	3			.4000	.6350	.3000				
160-	GRID	4			.4000	.6350	.2500				
161-	GRID	5			.2667	.6350	.5000				
162-	GRID	6			.2667	.6350	.4000				
163-	GRID	7			.2667	.6350	.3000				
164-	GRID	8			.2667	.6350	.2119				
165-	GRID	9			.1334	.6350	.5000				
166-	GRID	10			.1334	.6350	.4000				
167-	GRID	11			.1334	.6350	.3000				
168-	GRID	12			.1334	.6350	.2000				
169-	GRID	13			.1334	.6350	.1000				
170-	GRID	14			.1709	.6350	.1000				
171-	GRID	15			.1334	.6350	.0				
172-	GRID	16			.1500	.6350	.0				
173-	GRID	17			.0	.6350	.5000				
174-	GRID	18			.0	.6350	.4000				
175-	GRID	19			.0	.6350	.3000				
176-	GRID	20			.0	.6350	.2000				
177-	GRID	21			.0	.6350	.1000				
178-	GRID	22			.0	.6350	.0				
179-	GRID	1001			.4900	.6350	.5000				
180-	GRID	1002			.4900	.6350	.4000				
181-	GRID	1003			.4900	.6350	.3000				
182-	GRID	1004			.4900	.6350	.2332				
183-	GRID	1005			.5800	.6350	.5000				
184-	GRID	1006			.5800	.6350	.4000				
185-	GRID	1007			.5800	.6350	.3000				
186-	GRID	1008			.5800	.6350	.2000				
187-	GRID	1009			.6251	.6350	.1000				
188-	GRID	1010			.6700	.6350	.5000				
189-	GRID	1011			.6700	.6350	.4000				
190-	GRID	1012			.6700	.6350	.3000				
191-	GRID	1013			.6700	.6350	.2000				
192-	GRID	1014			.6700	.6350	.1000				
193-	GRID	1015			.6700	.6350	.0				
194-	GRID	1016			.6500	.6350	.0				
195-	GRID	1017	100		.1250	75.0000	.5000				
196-	GRID	1018	100		.1250	75.0000	.4000				
197-	GRID	1019	100		.1250	75.0000	.3000				
198-	GRID	1020	100		.1250	75.0000	.2000				
199-	GRID	1021	100		.1250	75.0000	.1000				
200-	GRID	1022	100		.1250	75.0000	.0				

12
B

SORTED BLOCK DATA ECHO

CARD		1	2	3	4	5	6	7	8	9	10
COUNT											
201-	GRID	1023	100	.1250	60.0000	.5000					
202-	GRID	1024	100	.1250	60.0000	.4000					
203-	GRID	1025	100	.1250	60.0000	.3000					
204-	GRID	1026	100	.1250	60.0000	.2000					
205-	GRID	1027	100	.1250	60.0000	.1000					
206-	GRID	1028	100	.1250	60.0000	.0					
207-	GRID	1029	100	.1250	45.0000	.5000					
208-	GRID	1030	100	.1250	45.0000	.4000					
209-	GRID	1031	100	.1250	45.0000	.3000					
210-	GRID	1032	100	.1250	45.0000	.2000					
211-	GRID	1033	100	.1250	45.0000	.1000					
212-	GRID	1034	100	.1250	45.0000	.0					
213-	GRID	1035	100	.1250	30.0000	.5000					
214-	GRID	1036	100	.1250	30.0000	.4000					
215-	GRID	1037	100	.1250	30.0000	.3000					
216-	GRID	1038	100	.1250	30.0000	.2000					
217-	GRID	1039	100	.1250	30.0000	.1000					
218-	GRID	1040	100	.1250	30.0000	.0					
219-	GRID	1041	100	.1250	15.0000	.5000					
220-	GRID	1042	100	.1250	15.0000	.4000					
221-	GRID	1043	100	.1250	15.0000	.3000					
222-	GRID	1044	100	.1250	15.0000	.2000					
223-	GRID	1045	100	.1250	15.0000	.1000					
224-	GRID	1046	100	.1250	15.0000	.0					
225-	GRID	1047	100	.1250	.0	.5000					
226-	GRID	1048	100	.1250	.0	.4000					
227-	GRID	1049	100	.1250	.0	.3000					
228-	GRID	1050	100	.1250	.0	.2000					
229-	GRID	1051	100	.1250	.0	.1000					
230-	GRID	1052	100	.1250	.0	.0					
231-	GRID	1053		.7950	.3400	.5000					
232-	GRID	1054		.7950	.3400	.4000					
233-	GRID	1055		.7950	.3400	.3000					
234-	GRID	1056		.7950	.3400	.2000					
235-	GRID	1057		.7950	.3400	.1000					
236-	GRID	1058		.7950	.3400	.0					
237-	GRID	1059		.7950	.1700	.5000					
238-	GRID	1060		.7950	.1700	.4000					
239-	GRID	1061		.7950	.1700	.3000					
240-	GRID	1062		.7950	.1700	.2000					
241-	GRID	1063		.7950	.1700	.1000					
242-	GRID	1064		.7950	.1700	.0					
243-	GRID	1065		.7950	.0	.5000					
244-	GRID	1066		.7950	.0	.4000					
245-	GRID	1067		.7950	.0	.3000					
246-	GRID	1068		.7950	.0	.2000					
247-	GRID	1069		.7950	.0	.1000					
248-	GRID	1070		.7950	.0	.0					
249-	GRID	10001		.4000	.7000	.5000					
250-	GRID	10002		.4000	.7000	.4000					

SORTED BULK DATA ECHO

CARD		1	2	3	4	5	6	7	8	9	10
251-	GRID	10003			.4000	.7600	.3000				
252-	GRID	10004			.4000	.7600	.2500				
253-	GRID	10005			.2667	.7600	.5000				
254-	GRID	10006			.2667	.7600	.4000				
255-	GRID	10007			.2667	.7600	.3000				
256-	GRID	10008			.2667	.7600	.2115				
257-	GRID	10009			.1334	.7600	.5000				
258-	GRID	10010			.1334	.7600	.4000				
259-	GRID	10011			.1334	.7600	.3000				
260-	GRID	10012			.1334	.7600	.2000				
261-	GRID	10013			.1334	.7600	.1000				
262-	GRID	10014			.1709	.7600	.1000				
263-	GRID	10015			.1334	.7600	.0				
264-	GRID	10016			.1500	.7600	.0				
265-	GRID	10017			.0	.7600	.5000				
266-	GRID	10018			.0	.7600	.4000				
267-	GRID	10019			.0	.7600	.3000				
268-	GRID	10020			.0	.7600	.2000				
269-	GRID	10021			.0	.7600	.1000				
270-	GRID	10022			.0	.7600	.0				
271-	GRID	11001			.4900	.7600	.5000				
272-	GRID	11002			.4900	.7600	.4000				
273-	GRID	11003			.4900	.7600	.3000				
274-	GRID	11004			.4900	.7600	.2332				
275-	GRID	11005			.5800	.7600	.5000				
276-	GRID	11006			.5800	.7600	.4000				
277-	GRID	11007			.5800	.7600	.3000				
278-	GRID	11008			.5800	.7600	.2000				
279-	GRID	11009			.6291	.7600	.1000				
280-	GRID	11010			.6700	.7600	.5000				
281-	GRID	11011			.6700	.7600	.4000				
282-	GRID	11012			.6700	.7600	.3000				
283-	GRID	11013			.6700	.7600	.2000				
284-	GRID	11014			.6700	.7600	.1000				
285-	GRID	11015			.6700	.7600	.0				
286-	GRID	11016			.6500	.7600	.0				
287-	GRID	11017	100		.2500	75.0000	.5000				
288-	GRID	11018	100		.2500	75.0000	.4000				
289-	GRID	11019	100		.2500	75.0000	.3000				
290-	GRID	11020	100		.2500	75.0000	.2000				
291-	GRID	11021	100		.2500	75.0000	.1000				
292-	GRID	11022	100		.2500	75.0000	.0				
293-	GRID	11023	100		.2500	60.0000	.5000				
294-	GRID	11024	100		.2500	60.0000	.4000				
295-	GRID	11025	100		.2500	60.0000	.3000				
296-	GRID	11026	100		.2500	60.0000	.2000				
297-	GRID	11027	100		.2500	60.0000	.1000				
298-	GRID	11028	100		.2500	60.0000	.0				
299-	GRID	11029	100		.2500	45.0000	.5000				
300-	GRID	11030	100		.2500	45.0000	.4000				

S Q R T L D B L C K D A T A E C H O

CARD	CLUNT	1	2	3	4	5	6	7	8	9	10
301-	GRID	11031	100	.2500	45.0000	.3000					
302-	GRID	11032	100	.2500	45.0000	.2000					
303-	GRID	11033	100	.2500	45.0000	.1000					
304-	GRID	11034	100	.2500	45.0000	.0					
305-	GRID	11035	100	.2500	30.0000	.5000					
306-	GRID	11036	100	.2500	30.0000	.4000					
307-	GRID	11037	100	.2500	30.0000	.3000					
308-	GRID	11038	100	.2500	30.0000	.2000					
309-	GRID	11039	100	.2500	30.0000	.1000					
310-	GRID	11040	100	.2500	30.0000	.0					
311-	GRID	11041	100	.2500	15.0000	.5000					
312-	GRID	11042	100	.2500	15.0000	.4000					
313-	GRID	11043	100	.2500	15.0000	.3000					
314-	GRID	11044	100	.2500	15.0000	.2000					
315-	GRID	11045	100	.2500	15.0000	.1000					
316-	GRID	11046	100	.2500	15.0000	.0					
317-	GRID	11047	100	.2500	.0	.5000					
318-	GRID	11048	100	.2500	.0	.4000					
319-	GRID	11049	100	.2500	.0	.3000					
320-	GRID	11050	100	.2500	.0	.2000					
321-	GRID	11051	100	.2500	.0	.1000					
322-	GRID	11052	100	.2500	.0	.0					
323-	GRID	11053		.9200	.3400	.5000					
324-	GRID	11054		.9200	.3400	.4000					
325-	GRID	11055		.9200	.3400	.3000					
326-	GRID	11056		.9200	.3400	.2000					
327-	GRID	11057		.9200	.3400	.1000					
328-	GRID	11058		.9200	.3400	.0					
329-	GRID	11059		.9200	.1700	.5000					
330-	GRID	11060		.9200	.1700	.4000					
331-	GRID	11061		.9200	.1700	.3000					
332-	GRID	11062		.9200	.1700	.2000					
333-	GRID	11063		.9200	.1700	.1000					
334-	GRID	11064		.9200	.1700	.0					
335-	GRID	11065		.9200	.0	.5000					
336-	GRID	11066		.9200	.0	.4000					
337-	GRID	11067		.9200	.0	.3000					
338-	GRID	11068		.9200	.0	.2000					
339-	GRID	11069		.9200	.0	.1000					
340-	GRID	11070		.9200	.0	.0					
341-	MAT9	100		1.792+6	4.682+5	4.558+5	.0	.0	.0	1.414+7	ELAS201
342-	ELAS201	2.794+6	.0	.0	.0	.0	4.104+6	.0	.0	.0	ELAS202
343-	ELAS202	6.330+5	.0	.0	.0	2.472+6	.0	6.160+5			
344-	PSOLID	1	100	50							
345-	PSOLID	2	100	100							
346-	PSOLID	3	100	0							
347-	SEQCP	1	43	2	46	3	30	4	28		
348-	SEQCP	5	42	6	41	7	26	8	24		
349-	SEQCP	9	37	10	36	11	22	12	17		
350-	SEQCP	13	11	14	9	19	7	16	9		

S U B R O U T I N E B U L K D A T A E C H U

CARD COUNT	1	2	3	4	5	6	7	8	9	10
351-	SEUGP	17	31	18	32	14	19	20	15	
352-	SEUGP	21	12	22	8	10C1	47	1002	44	
353-	SEUGP	1003	51	1004	53	1005	55	1006	57	
354-	SEUGP	1007	59	1008	61	1009	63	1010	67	
355-	SEUGP	1011	69	1012	71	1013	73	1014	75	
356-	SEUGP	1015	76	1016	84	1017	87	1018	88	
357-	SEUGP	1019	85	1020	83	1021	81	1022	79	
358-	SEUGP	1023	91	1024	94	1025	95	1026	97	
359-	SEUGP	1027	99	1028	100	1029	103	1030	105	
360-	SEUGP	1031	107	1032	109	1033	112	1034	111	
361-	SEUGP	1035	123	1036	126	1037	122	1038	119	
362-	SEUGP	1039	117	1040	115	1041	127	1042	129	
363-	SEUGP	1043	131	1044	133	1045	135	1046	136	
364-	SEUGP	1047	146	1048	147	1049	145	1050	143	
365-	SEUGP	1051	141	1052	135	1053	161	1054	164	
366-	SEUGP	1055	159	1056	158	1057	155	1058	152	
367-	SEUGP	1059	165	1060	169	1061	174	1062	180	
368-	SEUGP	1063	178	1064	151	1065	167	1066	170	
369-	SEUGP	1067	175	1068	179	1069	184	1070	1	
370-	SEUGP	10001	44	10002	45	10003	29	10004	27	
371-	SEUGP	10005	39	10006	40	10007	25	10008	23	
372-	SEUGP	10009	35	10010	36	10011	21	10012	18	
373-	SEUGP	10013	13	10014	6	10015	5	10016	4	
374-	SEUGP	10017	33	10018	34	10019	20	10020	16	
375-	SEUGP	10021	14	10022	10	10023	48	10024	50	
376-	SEUGP	11003	52	11004	54	11005	56	11006	58	
377-	SEUGP	11007	60	11008	62	11009	65	11010	68	
378-	SEUGP	11011	70	11012	72	11013	74	11014	77	
379-	SEUGP	11015	78	11016	66	11017	85	11018	90	
380-	SEUGP	11019	86	11020	84	11021	82	11022	80	
381-	SEUGP	11023	92	11024	93	11025	96	11026	98	
382-	SEUGP	11027	101	11028	102	11029	104	11030	106	
383-	SEUGP	11031	108	11032	110	11033	113	11034	114	
384-	SEUGP	11035	124	11036	125	11037	121	11038	120	
385-	SEUGP	11039	118	11040	116	11041	128	11042	130	
386-	SEUGP	11043	132	11044	134	11045	137	11046	138	
387-	SEUGP	11047	149	11048	150	11049	146	11050	144	
388-	SEUGP	11051	142	11052	140	11053	162	11054	163	
389-	SEUGP	11055	160	11056	157	11057	156	11058	153	
390-	SEUGP	11059	166	11060	171	11061	173	11062	161	
391-	SEUGP	11063	177	11064	154	11065	168	11066	172	
392-	SEUGP	11067	176	11068	182	11069	183	11070	2	
393-	SPC1	9	2	10017	144	10022				
394-	SPC1	9	3	15	22					
395-	SPC1	9	3	1015	1022	1028	1034	1040	1046	
396-	SPC1	9	3	1052	1056	1064	1070			
397-	SPC1	9	3	10015	10022					
398-	SPC1	9	3	11015	11022	11028	11034	11040	11046	
399-	SPC1	9	3	11052	11058	11064	11070			
400-	SPC1	9	123	4	8	14	16			

S U B R O U T I N E B U L K D A T A E C H U

CARD COUNT	1	2	3	4	5	6	7	8	9	10
401-	SPC1	9	123	1004	1009	1016				
402-	SPC1	9	123	10004	10006	10014	10016			
403-	SPC1	9	123	11004	11009	11016				
	ENDDATA									

TOTAL COUNT= 403

NASTRAN SOURCE PROGRAM COMPILATION
 DMAP-DMAP INSTRUCTION

```

NU.
1 BEGIN NO. 24 LINEAR STATIC ANALYSIS 7 JUN 1976 ;
2 PARAM //DIAGON//47 $
3 FILE GM=SAVE / KNN=SAVE / MNN=SAVE $
4 FILE QC=APPEND/PQG=APPEND/UCV=APPEND $
5 SETVAL //V,N,CARDNO/O $
6 SETVAL //V,N,PIIDS/1/V,N,NUMOD/-1 $
7 SETVAL //V,N,NURKGGX/1 $
8 SETVAL //V,N,NOMCGX/1 $
9 GP1 GEM1,GEM2,/GPL,EQEXIN,CPDI,CSTM,BGPDT,SIL/S,N,LUSET/C/S,N,
  NOCPDI $
10 CEND RFERR,NOCPDT $
11 GP2 GEM2,EQEXIN/ECT $
12 PARAM PCDB//PRES///V,N,JUMPPLOT $
13 CEND P1,JLPPLOT $
14 PARAM //DIAGOFF//47 $
15 PLTHBUY GEM2,ECT,EPT,SIL,EQEXIN,BGPDT/PECT,PSIL,PEQIN,PBGPDT/S,N,
  NHBDY/C,Y,MESH=ND $
16 EQUIV EQEXIN,PEQIN/NHBDY/ECT,PECT/NHBDY/BGPDT,PBGPDT/NHBDY/ SIL,PSIL/
  NHBDY $
17 PLTSET PCDB,PEQIN,PECT/PLTSETX,PLTPAR,GPSETS,ELSETS/S,N,NSIL/ S,N,
  JLPPLOT $
18 CHKPNT PLTPAR,GPSETS,ELSETS $
19 PKTMSG PLTSETX// $
20 SETVAL //V,N,PLTFLG/1 / V,N,PFILE/O $
21 CEND P1,JUMPPLOT $
22 PLUT PLTPAR,GPSETS,ELSETS,CASECC,PBGPDT,PEQIN,PSIL,,ECT,,/PLOTX1/
  NSIL/LUSET/S,N,JUMPPLOT/S,N,PLTFLG/S,N,PFILE $
23 PKTMSG PLOTX1// $
24 LABEL P1 $
25 PARAM //DIAGON//47 $
26 GP3 GEM3,EQEXIN,GEM2/SLT,EIT/O/V,N,NOGRAV/O $
27 CEND LMDS,MDS $
28 TAL, ECT,EPT,BGPDT,SIL,EIT,CSTM/EST,,GEL,GPECT,/V,N,LUSET/O/ S,N,
  NUSIMP//S,N,NOGENL/S,N,GENEL $
29 CEND LSKPENG,NCSIMP $
30 PARAM //DIAGOFF//47 $
31 EMG EST,CSTM,MPT,DIT,GEM2,,/KELM,KDICT,HELM,MUICI,,/S,N,NURKGGX/
  S,N,NOMCGX/O//C,Y,COUPHASS $
32 CHKPNT KELM,KDICT $
33 CHKPNT HELM,MUICI $
34 PARAM //DIAGON//47 $
35 PURGE KGLX/NURKGGX $
36 CEND LEMK,NURKGGX $
37 EMA GPECT,KDICT,KELM,BGPDT,SIL,CSTM/KGGX, $
38 LABEL LEMK $
39 PURGE MCGX/NOMCGG $
40 CEND LMDS,NOMCGG $
41 EMA GPECT,MUICI,HELM,BGPDT,SIL,CSTM/MGX,-1/C,Y,NTMASS=1. $
42 LABEL LMDS $
  
```

5 DISPLACEMENT SET

	-1-	-2-	-3-	-4-	-5-	-6-	-7-	-8-	-9-	-10-	
501*	1049-4	1049-5	1049-6	11049-9	11049-5	11049-6	1068-4	1068-5	1068-6	1068-7	510
511*	1049-5	1049-6	11049-9	11049-5	11049-6	11049-7	11049-8	11049-9	11049-10	11049-11	520
521*	1049-6	1049-7	1049-8	1049-9	1049-10	1049-11	1049-12	1049-13	1049-14	1049-15	530
531*	11049-9	11049-5	11049-6	1049-9	1049-5	1049-6	1049-7	1049-8	1049-9	1049-10	540
541*	11049-5	11049-6	11049-7	1049-6	1049-7	1049-8	1049-9	1049-10	1049-11	1049-12	550
551*	11049-6	11049-7	1049-7	1049-8	1049-9	11049-5	11049-6	11049-7	11049-8	11049-9	560
561*	11049-7	1049-8	1049-9	1049-10	1049-11	1049-12	1049-13	1049-14	11049-5	11049-6	570
571*	1049-8	1049-9	1049-10	11049-5	11049-6	11049-7	1049-8	1049-9	1049-10	1049-11	580
581*	1049-9	1049-10	11049-5	11049-6	11049-7	11049-8	11049-9	11049-10	11049-11	11049-12	590
591*	11049-10	1049-11	1049-12	1049-13	1049-14	1049-15	1049-16	11049-5	11049-6	11049-7	600
601*	11049-11	11049-12	11049-13	1049-14	1049-15	1049-16	1049-17	1049-18	1049-19	1049-20	610
611*	1049-12	1049-13	11049-5	11049-6	11049-7	11049-8	11049-9	11049-10	11049-11	11049-12	620
621*	11049-13	1049-14	1049-15	1049-16							

*** USER INFORMATION MESSAGE JOBS FOR DATA BLOCK KLL

LOCAL SEQ. NO.	EPSILON	STRAIN ENERGY	EPSILONS LARGER THAN .001 ARE FLAGGED WITH ASTERISKS
1	-6.2282216E-13	4.443293E-03	
2	-6.7232667E-13	8.4562669E-04	

DISPLACEMENT VECTOR

POINT NO.	TYPE	T1	T2	T3	K1	K2	R3
1	G	-5.262619E-05	-1.922596E-05	1.375301E-05	0.0	C.0	C.0
2	G	-4.728325E-05	-2.212649E-05	3.446548E-07	0.0	0.0	0.0
3	G	-2.788656E-05	-6.166291E-06	-7.495612E-06	0.0	0.0	0.0
4	G	0.0	0.0	0.0	0.0	0.0	0.0
5	G	-2.866791E-05	2.213701E-05	9.615117E-06	0.0	0.0	0.0
6	G	-2.315911E-05	1.162473E-05	8.852112E-07	0.0	0.0	0.0
7	G	-1.203906E-05	6.729394E-06	-4.120740E-06	0.0	0.0	0.0
8	G	C.C	0.0	0.0	C.C	0.0	0.0
9	G	-1.526834E-05	2.016339E-05	3.064246E-06	0.0	0.0	0.0
10	G	-1.117694E-05	1.220341E-05	-4.039057E-07	C.0	0.0	0.0
11	G	-6.471892E-06	6.296521E-06	-2.158332E-06	0.0	0.0	0.0
12	G	-2.104930E-06	2.408457E-06	-1.752477E-06	C.0	0.0	0.0
13	G	1.342620E-07	1.371654E-08	1.218012E-08	0.0	C.0	0.0
14	G	0.0	0.0	0.0	0.0	0.0	0.0
15	G	1.418585E-08	-1.136030E-07	0.0	0.0	0.0	C.0
16	G	0.0	0.0	0.0	0.0	0.0	0.0
17	G	-1.099438E-05	1.477626E-05	-2.242820E-06	0.0	C.0	0.0
18	G	-7.896861E-06	8.516805E-06	-4.116370E-06	C.0	0.0	0.0
19	G	-4.914150E-06	4.808227E-06	-4.637925E-06	0.0	0.0	C.0
20	G	-2.257953E-06	2.017201E-06	-3.531409E-06	0.0	0.0	0.0
21	G	-5.222137E-07	3.533740E-07	-1.834125E-06	0.0	0.0	C.C
22	G	2.120210E-07	-4.029042E-07	0.0	0.0	0.0	0.0
1001	G	-7.493258E-05	-8.529247E-05	1.617774E-05	0.0	0.0	C.0
1002	G	-6.973025E-05	-8.092189E-05	-2.371153E-07	C.0	0.0	0.0
1003	G	-5.119233E-05	-4.636290E-05	-6.927859E-06	0.0	0.0	C.0
1004	G	0.0	0.0	0.0	C.0	0.0	0.0
1005	G	-9.913128E-05	-1.974152E-04	1.737924E-05	0.0	0.0	0.0
1006	G	-9.620441E-05	-1.873290E-04	7.909002E-07	0.0	0.0	0.0
1007	G	-7.956271E-05	-1.365205E-04	-5.489569E-06	0.0	0.0	C.0
1008	G	-3.852356E-05	-5.881613E-05	-5.643479E-06	C.0	0.0	C.0
1009	G	0.0	0.0	0.0	0.0	0.0	0.0
1010	G	-1.214356E-04	-3.539156E-04	1.605513E-05	C.0	0.0	0.0
1011	G	-1.220961E-04	-3.385078E-04	3.281252E-06	0.0	0.0	0.0
1012	G	-1.120896E-04	-2.893244E-04	-2.945315E-06	0.0	0.0	0.0
1013	G	-8.053301E-05	-2.110353E-04	-2.321522E-06	0.0	0.0	0.0
1014	G	-4.342220E-05	-1.083612E-04	1.521442E-06	0.0	0.0	0.0
1015	G	-2.098735E-05	-4.139509E-05	0.0	0.0	0.0	C.0
1016	G	0.0	0.0	0.0	C.0	0.0	0.0
1017	G	-1.394116E-04	-4.227664E-04	1.343862E-05	0.0	0.0	0.0
1018	G	-1.415844E-04	-4.646147E-04	2.939622E-06	C.0	0.0	0.0
1019	G	-1.350977E-04	-3.617792E-04	-1.515945E-06	0.0	C.0	0.0
1020	G	-1.187044E-04	-3.013732E-04	5.356760E-07	0.0	0.0	0.0
1021	G	-9.068997E-05	-2.364539E-04	1.553598E-06	0.0	0.0	C.0
1022	G	-7.886355E-05	-2.083195E-04	0.0	C.C	0.0	0.0
1023	G	-1.802627E-04	-5.033557E-04	8.567210E-06	0.0	0.0	C.0
1024	G	-1.861268E-04	-4.878377E-04	8.619836E-07	0.0	0.0	0.0
1025	G	-1.856797E-04	-4.576812E-04	-2.074052E-06	0.0	0.0	C.C
1026	G	-1.622252E-04	-4.214407E-04	-5.976770E-07	0.0	0.0	0.0
1027	G	-1.738631E-04	-3.887110E-04	7.217008E-07	0.0	0.0	0.0
1028	G	-1.705180E-04	-3.750655E-04	0.0	0.0	0.0	0.0

FORCES OF SINGLE-POINT CONSTRAINT

POINT NO.	TYPE	T1	T2	T3	R1	R2	R3
4	G	5.742667E+00	4.687903E-01	2.506632E+00	C.C	0.0	0.0
8	G	2.100968E+00	-4.125071E-01	7.308962E-01	0.0	C.C	0.0
14	G	1.017702E-01	-6.981138E-02	1.706380E-01	0.0	0.0	0.0
19	G	0.0	0.0	9.224264E-02	0.0	0.0	0.0
16	G	-1.050246E-01	-4.627373E-03	6.160161E-02	C.C	0.0	0.0
22	G	0.0	0.0	1.567157E-01	C.C	0.0	0.0
1004	G	2.526744E+01	4.894349E+00	6.530153E+00	0.0	0.0	0.0
1005	G	3.644696E+01	1.451339E+01	9.271972E+00	0.0	0.0	0.0
1015	G	0.0	0.0	1.767551E+00	0.0	0.0	C.C
1016	G	1.582889E+01	7.360419E+00	1.670514E+00	C.C	0.0	C.C
1022	G	0.0	0.0	1.158304E+00	0.0	0.0	0.0
1028	G	0.0	0.0	5.1E5370E-01	0.0	0.0	0.0
1034	G	0.0	0.0	2.30850E-01	0.0	0.0	0.0
1040	G	0.0	0.0	1.177553E-01	0.0	0.0	0.0
1046	G	0.0	0.0	8.609080E-02	0.0	0.0	0.0
1052	G	0.0	0.0	2.448168E-01	0.0	0.0	0.0
1058	G	0.0	0.0	5.762325E-01	C.C	0.0	0.0
1064	G	0.0	0.0	1.142333E+00	0.0	0.0	0.0
1070	G	0.0	0.0	8.530007E-01	C.C	0.0	C.C
10004	G	-3.237593E+00	4.919993E-01	-2.543841E+00	0.0	0.0	0.0
10008	G	-5.008877E-01	-3.947772E-01	-2.686415E-01	0.0	0.0	0.0
10014	G	-1.471238E-01	-8.755267E-02	3.649889E-01	0.0	0.0	0.0
10015	G	0.0	0.0	8.067507E-02	0.0	0.0	0.0
10016	G	-1.162912E-01	-5.067468E-03	1.118920E-01	0.0	0.0	0.0
10017	G	0.0	-6.882015E-01	0.0	0.0	0.0	0.0
10018	G	0.0	-9.827962E-01	0.0	C.C	0.0	0.0
10019	G	0.0	-5.783243E-01	0.0	0.0	0.0	0.0
10020	G	0.0	-2.918631E-01	0.0	0.0	0.0	C.C
10021	G	0.0	-1.018713E-01	0.0	0.0	0.0	0.0
10022	G	0.0	-1.731257E-02	1.829902E-01	0.0	0.0	0.0
11004	G	-2.128593E+01	5.062610E+00	-8.548333E+00	0.0	0.0	C.C
11009	G	-3.978900E+01	1.386688E+01	-1.290085E+01	0.0	0.0	0.0
11015	G	0.0	0.0	-3.347250E+00	0.0	0.0	0.0
11016	G	-2.030682E+01	6.996297E+00	-3.171234E+00	C.C	0.0	C.C
11022	G	0.0	0.0	-2.9E1956E+00	0.0	C.C	0.0
11028	G	0.0	0.0	-1.466708E+01	0.0	0.0	0.0
11034	G	0.0	0.0	-9.046102E-01	C.C	0.0	0.0
11040	G	0.0	0.0	-5.147505E-02	C.C	0.0	0.0
11046	G	0.0	0.0	4.753534E-01	0.0	0.0	0.0
11052	G	0.0	0.0	1.396684E+00	0.0	0.0	0.0
11058	G	0.0	0.0	2.027426E+00	0.0	0.0	C.C
11064	G	0.0	0.0	2.294616E+00	C.C	0.0	C.C
11070	G	0.0	0.0	1.5E1585E+00	0.0	0.0	0.0

SUBCOMP J

STRESSES IN FLARE PLATE SOLID ELEMENTS (M.E.A.)

ELEMENT-ID	CORNER GRID-ID	-----CENTER AND CORNER POINT STRESSES-----			LIN. LOADS			MEAN PRESSURE	OCTAHEDRAL SHEAR			
		NORMAL	SHEAR	PRINCIPAL	-A-	-B-	-C-					
1												
SOCKET B GP												
CENTER	X	-3.724564E+00	AY	-1.286974E+02	A	8.875562E+01	LX	C.81	0.57-0.15	3.149220E+01	1.156498E+02	
	Y	-9.755624E+01	YZ	1.148072E+01	B	-1.877152E+02	LY	-0.57	0.82	0.00		
	Z	0.811216E+00	ZX	-9.139277E+00	C	4.482697E+00	LZ	-0.17	-0.02	-0.95		
6	X	-5.267818E+01	AY	-1.337735E+02	A	-4.468872E+01	LX	1.00	0.06-0.04	8.353322E+02	1.059207E+03	
	Y	-2.311857E+03	YZ	1.233842E+02	B	-2.326721E+03	LY	0.08	1.00-0.05			
	Z	-1.414742E+02	ZX	4.307328E+00	C	-1.346010E+02	LZ	-0.03	-0.06-1.00			
5	X	-5.746271E+01	AY	-1.236213E+02	A	-5.058034E+01	LX	1.00	0.05-0.03	8.306345E+02	1.046104E+03	
	Y	-2.295644E+03	YZ	1.233842E+02	B	-2.305494E+03	LY	0.08	1.00-0.06			
	Z	-1.393750E+02	ZX	4.307328E+00	C	-1.326254E+02	LZ	-0.03	-0.08-1.00			
1	X	-1.502338E+01	AY	-1.236213E+02	A	6.817595E+01	LX	-0.36	C.06-0.93	7.099426E+02	1.039101E+03	
	Y	-2.164831E+03	YZ	1.233842E+02	B	-2.178583E+03	LY	0.07	1.00	0.03		
	Z	-5.002544E+01	ZX	-2.258588E+01	C	-1.942884E+01	LZ	-0.93	-0.05-0.37			
2	X	-2.036137E+01	AY	-1.337735E+02	A	8.385638E+01	LX	-0.36	0.06-0.93	7.145662E+02	1.046340E+03	
	Y	-2.183686E+03	YZ	1.233842E+02	B	-2.198515E+03	LY	0.07	1.00	0.04		
	Z	-4.532895E+01	ZX	-2.258588E+01	C	-2.407360E+01	LZ	0.93	-0.05-0.37			
1006	X	1.283058E+01	AY	-1.237735E+02	A	2.143880E+03	LX	-0.06	1.00	0.02	-7.674786E+02	9.135741E+02
	Y	2.130341E+03	YZ	-1.004228E+02	B	2.429536E+01	LY	1.00	0.06-0.05			
	Z	1.407540E+02	ZX	4.307328E+00	C	1.357558E+02	LZ	-0.05	0.02-1.00			
1005	X	2.501788E+01	AY	-1.236213E+02	A	2.067772E+03	LX	-0.06	1.00	0.02	-7.349592E+02	9.433630E+02
	Y	2.059074E+03	YZ	-1.004228E+02	B	1.748833E+01	LY	1.00	0.06-0.05			
	Z	1.247865E+02	ZX	4.307328E+00	C	1.148152E+02	LZ	-0.05	0.02-1.00			
1000	X	1.007826E+01	AY	-1.236213E+02	A	1.971551E+03	LX	-0.06	0.43-0.90	-6.586454E+02	9.304082E+02	
	Y	1.858747E+03	YZ	-1.004228E+02	B	-3.820204E+01	LY	1.00	0.07-0.04			
	Z	-1.946803E+01	ZX	-2.258588E+01	C	3.601610E+01	LZ	-0.05	0.90	0.43		
1002	X	1.776581E+01	AY	-1.337735E+02	A	2.045023E+03	LX	-0.07	0.52-0.85	-6.884350E+02	9.625112E+02	
	Y	2.031380E+03	YZ	-1.004228E+02	B	-2.871458E+01	LY	1.00	0.08-0.03			
	Z	-6.042811E+00	ZX	-2.258588E+01	C	3.674451E+01	LZ	-0.05	0.85	0.52		
2												
SOCKET C: B GP												
CENTER	X	-4.540664E+01	AY	-1.241565E+02	A	1.140388E+02	LX	0.67	C.80-0.44	1.441358E+00	1.144443E+02	
	Y	-4.734119E+01	YZ	5.444130E+01	B	-1.587438E+02	LY	0.83	C.77	0.04		
	Z	-2.149554E+01	ZX	-8.050747E+00	C	1.288073E+01	LZ	-0.39	-0.21	-0.44		
7	X	-3.725171E+01	AY	-1.145275E+02	A	2.932889E+01	LX	-0.01	0.07-1.00	5.441978E+02	8.027846E+02	
	Y	-1.542428E+03	YZ	4.671213E+02	B	-1.707265E+03	LY	0.50	C.45	0.06		
	Z	-1.274135E+02	ZX	3.550512E+01	C	-2.885557E+01	LZ	0.45	-0.30	-0.03		

SUBCUM 3

STRESSES IN HEXAHEDRAL SOLID ELEMENTS (HEX A)

ELEMENT-ID	CORNER GRID-ID	-----CENTER AND CORNER POINT STRESSES-----			DIR. COSINES -A- -B- -C-	MEAN PRESSURE	OCTAHEDRAL SHEAR						
		-----NORMAL	SHEAR	-----PRINCIPAL									
6	A	X	-1.072057E+01	XY	-1.337735E+02	A	-6.273738E+01	L1	1.00	0.00	0.00	9.315757E+02	1.138598E+03
		Y	-2.421493E+03	YZ	4.971213E+02	B	-2.340008E+03	LY	-0.05	0.97	-0.22		
		Z	-3.025142E+02	ZX	3.550912E+01	C	-1.919223E+02	LZ	0.05	-0.22	0.97		
2	A	X	-4.546347E+01	XY	-1.337735E+02	A	1.999321E+01	L1	0.78	0.05	-0.62	8.563292E+02	1.131874E+03
		Y	-2.339236E+03	YZ	4.971213E+02	B	-2.454370E+03	LY	-0.17	0.98	-0.14		
		Z	-1.831855E+02	ZX	-4.761073E+01	C	-1.340109E+02	LZ	-0.80	-0.21	0.77		
3	A	X	-1.926875E+01	XY	-1.145275E+02	A	1.766235E+02	L1	-0.32	0.06	-0.92	4.971715E+02	8.002551E+02
		Y	-1.461544E+03	YZ	4.971213E+02	B	-1.621550E+03	LY	0.29	0.95	-0.06		
		Z	-1.052200E+01	ZX	-4.761073E+01	C	-4.658844E+01	LZ	0.48	-0.29	0.38		
10007	A	X	2.184242E+01	XY	-1.145275E+02	A	1.579429E+03	L1	-0.08	-0.55	-0.93	-5.364358E+02	7.375190E+02
		Y	1.460520E+03	YZ	-3.801863E+02	B	9.790524E+00	LY	0.98	0.17	-0.20		
		Z	1.166040E+02	ZX	3.550912E+01	C	2.008833E+01	LZ	-0.26	0.82	-0.52		
10006	A	X	4.656802E+01	XY	-1.337735E+02	A	2.296701E+03	L1	-0.08	1.00	-0.06	-8.412448E+02	1.031033E+03
		Y	2.213610E+03	YZ	-3.801863E+02	B	3.747794E+01	LY	0.98	0.05	-0.19		
		Z	2.633635E+02	ZX	3.550912E+01	C	1.895813E+02	LZ	-0.19	-0.07	-0.90		
10002	A	X	6.004906E+01	XY	-1.337735E+02	A	2.308815E+03	L1	-0.05	0.93	0.37	-8.565527E+02	1.030502E+03
		Y	2.227525E+03	YZ	-3.801863E+02	B	2.505231E+01	LY	0.98	0.12	-0.15		
		Z	2.820571E+02	ZX	-4.761073E+01	C	2.357412E+02	LZ	-0.19	0.35	-0.92		
10003	A	X	3.289242E+01	XY	-1.145275E+02	A	1.988718E+03	L1	-0.08	0.71	0.70	-9.483149E+02	7.382547E+02
		Y	1.478642E+03	YZ	-3.801863E+02	B	-4.737348E+01	LY	0.98	0.22	-0.16		
		Z	1.335595E+02	ZX	-4.761073E+01	C	1.036028E+02	LZ	-0.26	0.67	-0.70		
SO-MAT C5 B CP													
CENTEN	A	X	-1.492570E+01	XY	-5.991460E+01	A	1.630720E+02	L1	-0.28	-0.45	-0.05	-1.848781E+01	9.844562E+01
		Y	5.523055E+01	YZ	4.930753E+01	B	-9.788890E+01	LY	0.80	-0.60	0.00		
		Z	1.872133E+00	ZX	1.272573E+01	C	1.175837E+01	LZ	0.93	0.66	-0.53		
6	A	X	1.216119E+01	XY	8.988147E+00	A	1.503882E+03	L1	0.02	-0.11	-0.97	-3.684485E+02	8.238406E+02
		Y	1.105318E+03	YZ	7.778662E+02	B	-4.211370E+02	LY	0.89	-0.45	0.09		
		Z	-1.811864E+01	ZX	5.823712E+01	C	1.681412E+01	LZ	0.48	0.89	-0.09		
7	A	X	-5.644868E+01	XY	-1.118807E+02	A	-8.517383E+01	L1	0.97	0.06	0.25	5.049925E+02	1.123589E+03
		Y	-1.488254E+03	YZ	4.848751E+02	B	-2.448208E+03	LY	0.07	0.88	-0.48		
		Z	-6.460652E+02	ZX	7.508574E+01	C	-1.453588E+02	LZ	0.25	-0.48	-0.95		
3	A	X	-1.110566E+02	XY	-1.278015E+02	A	-7.679019E+01	L1	0.96	0.04	0.33	1.014108E+03	1.128432E+03
		Y	-2.113404E+03	YZ	5.285849E+02	B	-2.602055E+03	LY	-0.18	0.89	-0.42		
		Z	-8.178744E+02	ZX	-3.278568E+01	C	-3.034773E+02	LZ	-0.27	-0.48	-0.84		
4	A	X	-7.385252E+00	XY	-7.148560E+00	A	1.337818E+03	L1	-0.02	0.08	-1.00	-2.564288E+02	7.468479E+02
		Y	5.768648E+02	YZ	7.421514E+02	B	-9.547140E+02	LY	0.90	-0.43	-0.09		
		Z	-1.912031E+02	ZX	-4.563849E+01	C	-4.815552E+00	LZ	0.44	0.50	0.06		

SUBCUM 4

STRESSES IN HEXAHEDRAL SOLID ELEMENTS (HEX A)

ELEMENT-ID	CORNER GRID-ID	-----CENTER AND CORNER POINT STRESSES-----			DIR. COSINES -A- -B- -C-	MEAN PRESSURE	OCTAHEDRAL SHEAR						
		-----NORMAL	SHEAR	-----PRINCIPAL									
1007	A	X	3.102688E+01	XY	-1.781555E+01	A	2.157778E+02	L1	-0.02	0.94	0.33	-2.781185E+02	3.120140E+02
		Y	1.881411E+02	YZ	-1.331465E+02	B	2.374318E+01	LY	0.98	0.09	-0.20		
		Z	1.111412E+02	ZX	-1.673008E+01	C	8.882640E+01	LZ	-0.21	0.32	-0.92		
1004	A	X	-5.754495E+01	XY	-5.440282E+00	A	-5.716677E+01	L1	1.00	0.00	0.00	8.502888E+02	1.022817E+03
		Y	-2.223641E+03	YZ	3.906282E+02	B	-2.298888E+03	LY	0.01	0.98	-0.19		
		Z	-2.844458E+02	ZX	9.915256E+00	C	-2.091135E+02	LZ	0.05	-0.19	-0.98		
1008	A	X	-2.411740E+01	XY	-5.421377E+01	A	-5.488432E+00	L1	0.95	-0.02	-0.24	8.380885E+02	1.020444E+03
		Y	-2.214293E+03	YZ	3.506282E+02	B	-2.290000E+03	LY	-0.03	0.98	-0.98		
		Z	-2.758550E+02	ZX	-4.542788E+01	C	-2.178888E+02	LZ	-0.28	-0.19	-0.94		
1009	A	X	-5.754495E+01	XY	5.440282E+00	A	-5.705177E+01	L1	1.00	-0.01	-0.06	8.502888E+02	1.022827E+03
		Y	-2.223641E+03	YZ	3.906282E+02	B	-2.298888E+03	LY	-0.01	0.98	-0.19		
		Z	-2.844458E+02	ZX	-1.067547E+01	C	-2.091758E+02	LZ	-0.06	-0.15	-0.98		
11004	A	X	5.854672E+01	XY	-5.440321E+00	A	2.218010E+03	L1	-0.01	1.00	-0.05	-8.332231E+02	9.815150E+02
		Y	2.130309E+03	YZ	-3.951004E+02	B	9.812137E+01	LY	0.98	-0.05	-0.20		
		Z	3.047141E+02	ZX	6.915256E+00	C	2.234915E+02	LZ	-0.20	-0.05	-0.96		
11006	A	X	5.407777E+01	XY	-5.421377E+01	A	2.227565E+03	L1	-0.02	0.94	0.14	-8.502888E+02	9.768813E+02
		Y	2.145100E+03	YZ	-3.951004E+02	B	6.948834E+01	LY	0.98	0.05	-0.18		
		Z	3.133651E+02	ZX	-4.542788E+01	C	2.534391E+02	LZ	-0.20	0.33	-0.92		
11009	A	X	5.854672E+01	XY	5.440318E+00	A	2.218020E+03	L1	0.01	1.00	0.05	-8.332231E+02	9.815254E+02
		Y	2.130309E+03	YZ	-3.951004E+02	B	5.805527E+01	LY	0.98	0.00	-0.20		
		Z	3.047141E+02	ZX	-1.067547E+01	C	2.235503E+02	LZ	-0.20	0.05	-0.98		

ELEMENT STRAIN ENERGIES

ELEMENT-TYPE • HEXA
SUBCASE 3 • TOTAL ENERGY OF ALL ELEMENTS IN PROBLEM • 2.125516E-02
-1 • 2.125516E-02

ELEMENT-ID	STRAIN-ENERGY	PERCENT OF TOTAL
1	1.247151E-04	0.5868
2	1.151692E-04	0.5418
3	6.240885E-05	0.2955
4	4.807640E-05	0.2262
5	3.056478E-05	0.1439
6	1.153078E-05	0.0542
7	8.188676E-07	0.0039
9	2.040611E-05	0.0960
10	8.905700E-06	0.0419
11	3.463125E-06	0.0163
12	1.176705E-06	0.0055
13	4.212168E-07	0.0020
1001	1.414144E-04	0.6636
1002	1.851362E-04	0.8730
1003	2.436545E-04	1.1463
1004	1.768684E-04	0.8321
1005	2.565645E-04	1.2165
1006	7.883434E-04	3.7090
1008	1.817274E-04	0.8526
1009	3.069104E-04	1.4439
1010	8.440975E-04	3.9713
1011	2.261107E-03	10.6379
1012	2.384876E-03	11.2202
2001	1.059914E-04	0.4987
2002	1.655374E-04	0.7788
2003	4.326985E-04	2.0357
2004	1.362822E-03	6.4117
2005	2.717839E-03	12.7867
2006	4.676283E-05	0.4552
2007	1.552182E-04	0.7303
2008	3.650177E-04	1.7361
2009	9.200056E-04	4.3284
2010	1.561032E-03	7.3442
2011	6.921771E-05	0.3257
2012	1.160833E-04	0.5461
2013	2.513996E-04	1.1828
2014	5.150271E-04	2.4442
2015	7.845804E-04	3.6931
2016	4.404518E-05	0.2072
2017	7.626465E-05	0.3588
2018	1.505644E-04	0.7084
2019	2.646290E-04	1.2450
2020	3.548582E-04	1.6432
2021	2.235327E-05	0.1054
2022	3.947558E-05	0.1857
2023	7.235016E-05	0.3404
2024	1.111822E-04	0.5231
2025	1.376617E-04	0.6477
2026	8.443447E-06	0.0397

SUBJECT 4

GRID POINT FORCE BALANCE									
PLANT-ID	ELEMENT-ID	SOURCE	11	12	13	R1	R2	R3	
11002	3009	MEKA	6.944552E-C2	2.244120E+00	-4.571041E-01	0.0	0.0	0.0	
11002	3013	MEKA	-5.452101E-02	-2.307900E+00	4.245440E-C1	0.0	0.0	0.0	
11002	3014	MEKA	3.710027E-C2	-2.565535E+00	-5.707720E-01	0.0	0.0	0.0	
11002		*TOTAL SO	4.302005E-14	-2.500094E-13	2.021354E-14	0.0	0.0	0.0	
11003	3004	MEKA	-1.972441E-02	2.521440E+00	4.222695E-01	0.0	0.0	0.0	
11003	3010	MEKA	4.421440E-C2	2.447740E+00	-5.611022E-C1	0.0	0.0	0.0	
11003	3014	MEKA	-3.720447E-C2	-2.445510E+00	5.720480E-01	0.0	0.0	0.0	
11003	3015	MEKA	1.274440E-C2	-2.333225E+00	-0.371260E-01	0.0	0.0	0.0	
11003		*TOTAL SO	5.430725E-14	-2.586220E-13	-0.125445E-14	0.0	0.0	0.0	
11004		F-OF-SPC	0.0	0.0	-1.257130E+00	0.0	0.0	0.0	
11004	3010	MEKA	1.244704E-C2	2.448304E+00	4.103050E-01	0.0	0.0	0.0	
11004	3015	MEKA	-1.250704E-C2	-2.448304E+00	4.103050E-01	0.0	0.0	0.0	
11004		*TOTAL SO	5.100570E-14	-3.952714E-15	-1.633410E-14	0.0	0.0	0.0	
11005		APP-LOAD	0.0	-2.495540E+00	0.0	0.0	0.0	0.0	
11005	3011	MEKA	1.422473E-14	2.495540E+00	-4.440842E-15	0.0	0.0	0.0	
11005		*TOTAL SO	1.422473E-14	3.486100E-14	-4.440842E-15	0.0	0.0	0.0	
11006		APP-LOAD	0.0	-4.999995E+00	0.0	0.0	0.0	0.0	
11006	3011	MEKA	-5.421377E-C2	2.576210E+00	1.134192E-C1	0.0	0.0	0.0	
11006	3012	MEKA	5.621577E-C2	-2.420710E+00	-1.134192E-01	0.0	0.0	0.0	
11006		*TOTAL SO	3.620475E-14	-5.189244E-14	-6.439294E-15	0.0	0.0	0.0	
11007		APP-LOAD	0.0	-4.999995E+00	0.0	0.0	0.0	0.0	
11007	3012	MEKA	-5.724370E-C2	2.595545E+00	3.470944E-01	0.0	0.0	0.0	
11007	3013	MEKA	5.724370E-C2	-2.500454E+00	-3.470944E-01	0.0	0.0	0.0	
11007		*TOTAL SO	4.670202E-14	7.422454E-14	2.445430E-14	0.0	0.0	0.0	
11008		APP-LOAD	0.0	-4.999995E+00	0.0	0.0	0.0	0.0	
11008	3013	MEKA	-4.233040E-02	2.580510E+00	5.400935E-01	0.0	0.0	0.0	
11008	3014	MEKA	4.233040E-02	-2.431037E+00	-5.400935E-01	0.0	0.0	0.0	
11008		*TOTAL SO	6.757619E-14	-1.407144E-14	1.101571E-14	0.0	0.0	0.0	
11009		APP-LOAD	0.0	-4.999995E+00	0.0	0.0	0.0	0.0	
11009	3014	MEKA	-2.210055E-C2	2.520602E+00	4.067000E-01	0.0	0.0	0.0	
11009	3015	MEKA	2.210055E-C2	-2.471337E+00	-4.067000E-01	0.0	0.0	0.0	
11009		*TOTAL SO	4.290570E-14	-4.004602E-14	2.430727E-14	0.0	0.0	0.0	
11070		APP-LOAD	0.0	-2.495540E+00	0.0	0.0	0.0	0.0	
11070		F-OF-SPC	0.0	0.0	-7.033040E-01	0.0	0.0	0.0	

APPENDIX I

C-2 MODEL PREPROCESSOR PROGRAM LISTING

```

1. // JOB (C6006,,C4E),C22PREC2,CLASS=B
2. //STEP1 EXEC FORTHCLG,FC=190K
3.     DIMENSION ICARD(20),IGRID(2),IZERO(2),ICHEXA(2),IGRIDS(4000)
4.     INTEGER*2 NGFIDS,11,14
5.     DATA IGRID/'GFID',',',',',IZERO/' (.','0'/',ICORD/'CORD'/',
6.     +ICHEXA/'CHE)',',',',',NGRIDS/4/,11/1/,14/4/
7.     EQUIVALENCE (IGRIDS(1),IG2),(IGRIDS(2),IG1),(IGRIDS(3),IG3),
8.     + (IGRIDS(4),IG4)
9.     READ(5,2)ISTFIP,ISTRPS
10.    2 FORMAT(2I3)
11. C
12. C   THIS PROGRAM IS FOR EXTRACTING BULK DATA FOR A PARTICULAR STFIP
13. C   FROM THE WHOLE FRACKET MULTILAYER BULK DATA, I.E. OBTAINING
14. C   C2 MODEL BULK DATA FROM PREPROCESSOR PRODUCED C1 BULK DECK
15. C
16. C   ECHO STFIP DATA
17.     WRITE(6,6) ISTRIP,ISTRPS
18.     6 FORMAT('1STRIP DATA ECHO',/, '0STFIP NO. = ',T20,I6,/,
19.     + ' TOTAL STFIPS = ',T20,I6)
20.     IF(ISTRIP.LE.1.OR.ISTRIP.GT.ISTRPS)STOP 99
21. 10 READ(1,1)ICAFD
22.    1 FORMAT(20A4)
23.     IF(ICARD(1).NE.IGRID(1).OR.ICARD(2).NE.IGRID(2))GO TO 10
24.     IF(ICARD(1).NE.IZERO(1).OR.ICARD(2).NE.IZERO(2))GO TO 10
25.     CALL CICON(ICARD(3),1,8,1,ITOP)
26.     IF(ITOP.LE.1000.OR.ITOP.GT.1000)GO TO 10
27.     ITCF=ITOP-1
28. 20 READ(1,1)ICAFI
29.     IF(ICAFD(1).NE.ICHEXA(1).OR.ICAFD(2).NE.ICHEXA(2))GO TO 20
30.     CALL CICON(ICARD(7),1,8,1,IG1)
31.     CALL CICON(ICARD(9),1,8,1,IG2)
32.     CALL CICON(ICARD(11),1,8,1,IG3)
33.     CALL CICON(ICARD(13),1,8,1,IG4)
34.     IF(ITCF.NE.IG1.AND.ITOP.NE.IG2.AND.ITOP.NE.IG3.AND.
35.     +ITOP.NE.IG4)GO TO 20
36.     IF(ITCF2.NE.IG1.AND.ITCF2.NE.IG2.AND.ITCF2.NE.IG3.AND.
37.     +ITCF2.NE.IG4)GO TO 20
38.     CALL CICON(ICARD(3),1,8,1,IELE)
39.     IF IAST=0
40.     IMAX=2000
41. 40 WRITE(2,1)ICAFD
42.     READ(1,1)ICAFI
43.     WRITE(2,1)ICAFI
44.     GO 45 J=1,70
45. 45 READ(1,1,END=90)ICARD
46.     IF(ICARD(1).NE.ICHEXA(1).OR.ICARD(2).NE.ICHEXA(2))GO TO 46
47.     CALL CICON(ICARD(3),1,8,1,1)
48.     IF(1.LT.1000)GO TO 30
49.     IF(MOD(1,1000).NE.1)GO TO 30
50.     WRITE(2,1)ICAFI
51.     READ(1,1)ICAFI
52.     WRITE(2,1)ICAFI
53.     GO TO 45
54. 45 CONTINUE
55. STOP 999
56. 20 IELE=IELE+ISTRPS
57.     IF IAST=1
58. 25 READ(1,1,END=40)ICAFD

```

```

60.      IF(ICAFD(1).NE.ICHEXA(1).OR.ICARD(2).NE.ICHEXA(2))GO TC 35
61.      CALL CICON(ICARD(3),1,8,1,1)
62.      IF(1.GT.IPAX.AND.1.LT.ICCCC)GO TO 50
63. 36 IF(1.NE.IELE)GO TO 35
64.      IF(IFIRST.NE.0)GO TO 37
65.      CALL CICON(ICARD(7),1,8,1,1)
66.      NGRIDS=NCFIDS+1
67.      ICFIDS(NGRIDS)=1
68.      CALL CICON(ICARD(13),1,8,1,1)
69.      NGRIDS=NGRIDS+1
70.      IGRIDS(NGRIDS)=1
71.      GO TO 40
72. 37 CALL CICON(ICARD(11),1,8,1,1)
73.      NCFIDS=NGRIDS+1
74.      ICFIDS(NGRIDS)=1
75.      CALL CICON(ICARD(13),1,8,1,1)
76.      NGRIDS=NGRIDS+1
77.      IGRIDS(NGRIDS)=1
78.      GO TO 40
79. 50 IELE=IPAX+1STRIP
80.      IP2=IPAX+1000
81.      IFIRST=1
82.      GO TO 36
83. 50 FEWIND 1
84.      WRITE(6,3)NGRIDS,(IGRIDS(L),L=1,NGRIDS)
85.      3 PCFMT(1,1,2X,(1517,7))
86.      CALL ZSORT2(ICFIDS,NGRIDS,14,11,14)
87.      WRITE(6,3)NGRIDS,(IGRIDS(L),L=1,NGRIDS)
88.      CC 99 1=1,NGRIDS
89.      IF(1.NE.1)GO TO 94
90.      51 FEAL(1,1,END=93)ICARD
91. 94 IF(ICARD(1).EQ.ICDFD)GO TO 60
92.      IF(ICAFD(1).NE.ICFID(1).OR.ICARD(2).NE.IGRID(2))GO TO 91
93.      CALL CICON(ICARD(3),1,8,1,1)
94.      IF(1.NE.IGRIDS(1))GO TO 91
95.      WRITE(2,1)ICARD
96.      CC 92 J=1,70
97.      FEAL(1,1,END=93)ICARD
98.      IF(ICAFD(1).NE.ICRID(1).OR.ICAFD(2).NE.IGRID(2))GO TO 99
99.      CALL CICON(ICARD(3),1,8,1,1)
100.     IF(1.LT.ICCCC)GO TO 99
101.     WRITE(2,1)ICARD
102. 92 CONTINUE
103.     STOP 999
104. 60 WRITE(2,1)ICARD
105.     FEAL(1,1)ICARD
106.     WRITE(2,1)ICARD
107.     GO TO 91
108. 99 CONTINUE
109. 93 ENDFILE 2
110.     STOP
111.     END
112. /*
113. //CD,FTCFCC DD DSN=CNOE0606,CVT,C22ELKMS,DISP=SHR
114. //CD,FTCFCC DD DSN=CNOE0606,CVT,C22BLKSS,UNIT=NYLBR,DISP=1,CATLG)
115. // SFACE=(TRK,(5,5),FLSE),DCE=(RECFM=FB,LKRECL=80,BLKSIZE=3120)
116. //GC.SYSIN ED *
117. 0* 05
118. /*

```

APPENDIX J

C-2 PREPROCESSOR FLOWCHART

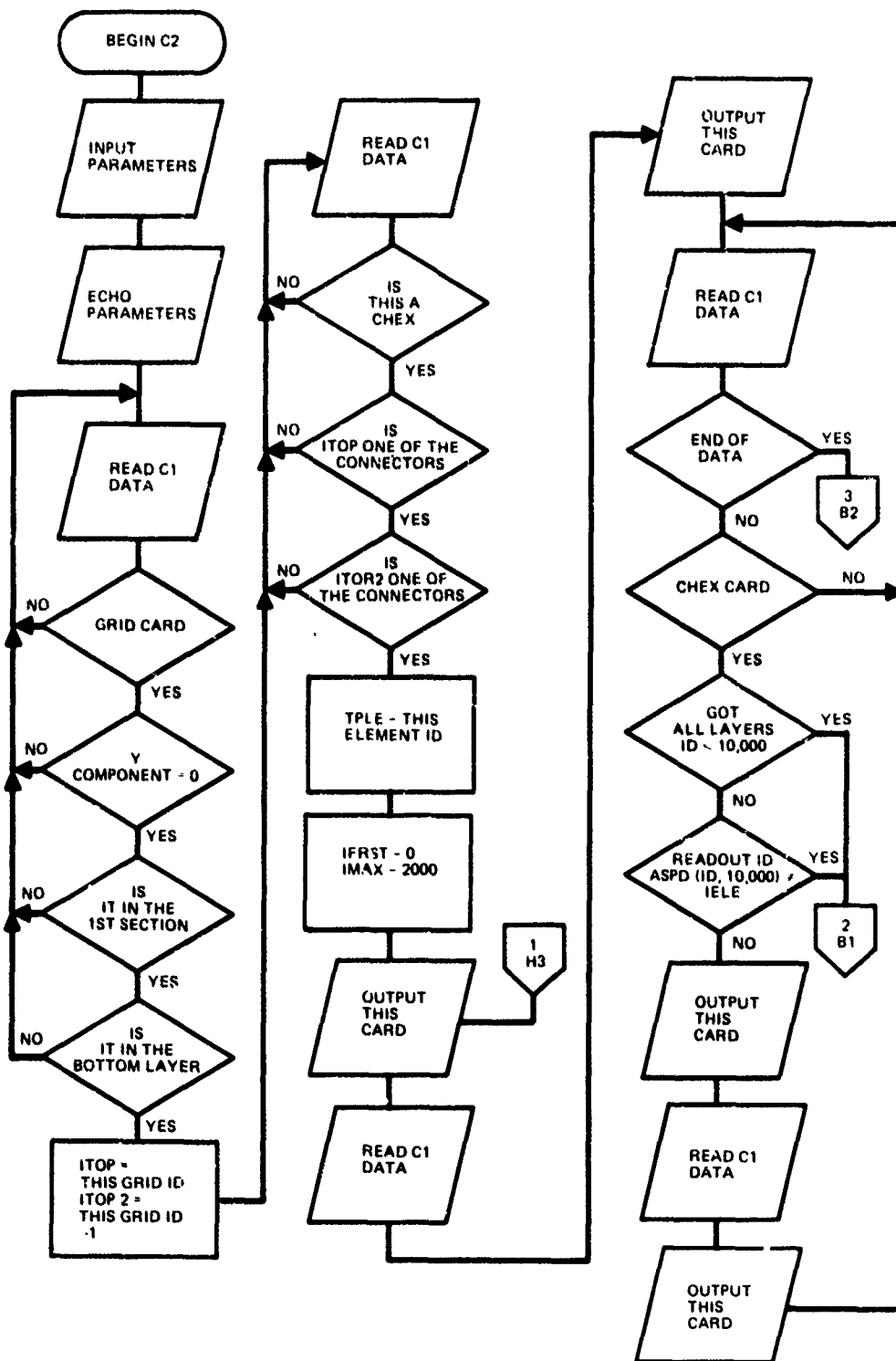

C-2 PREPROCESSOR

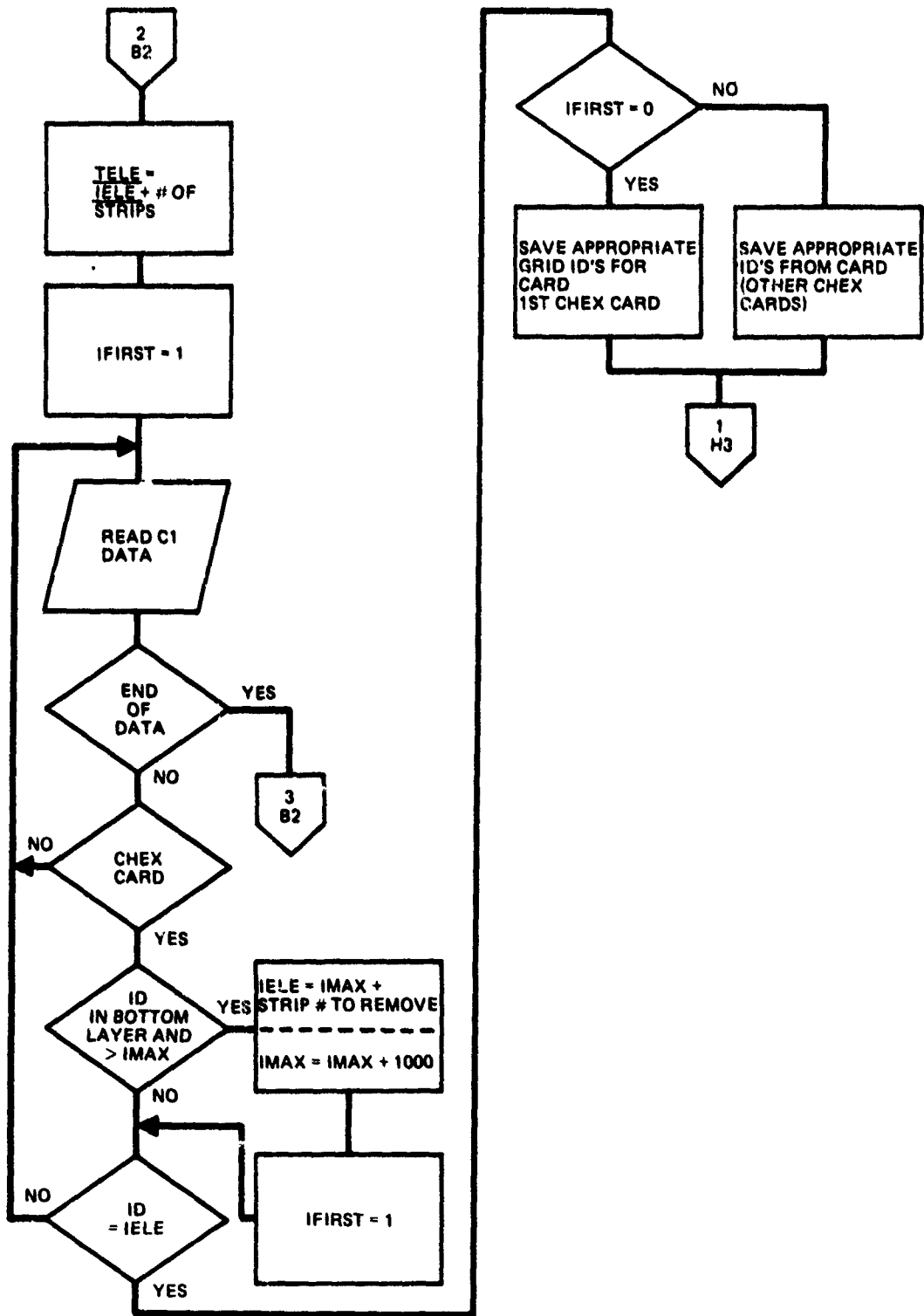

13
F

C-2 PREPROCESSOR

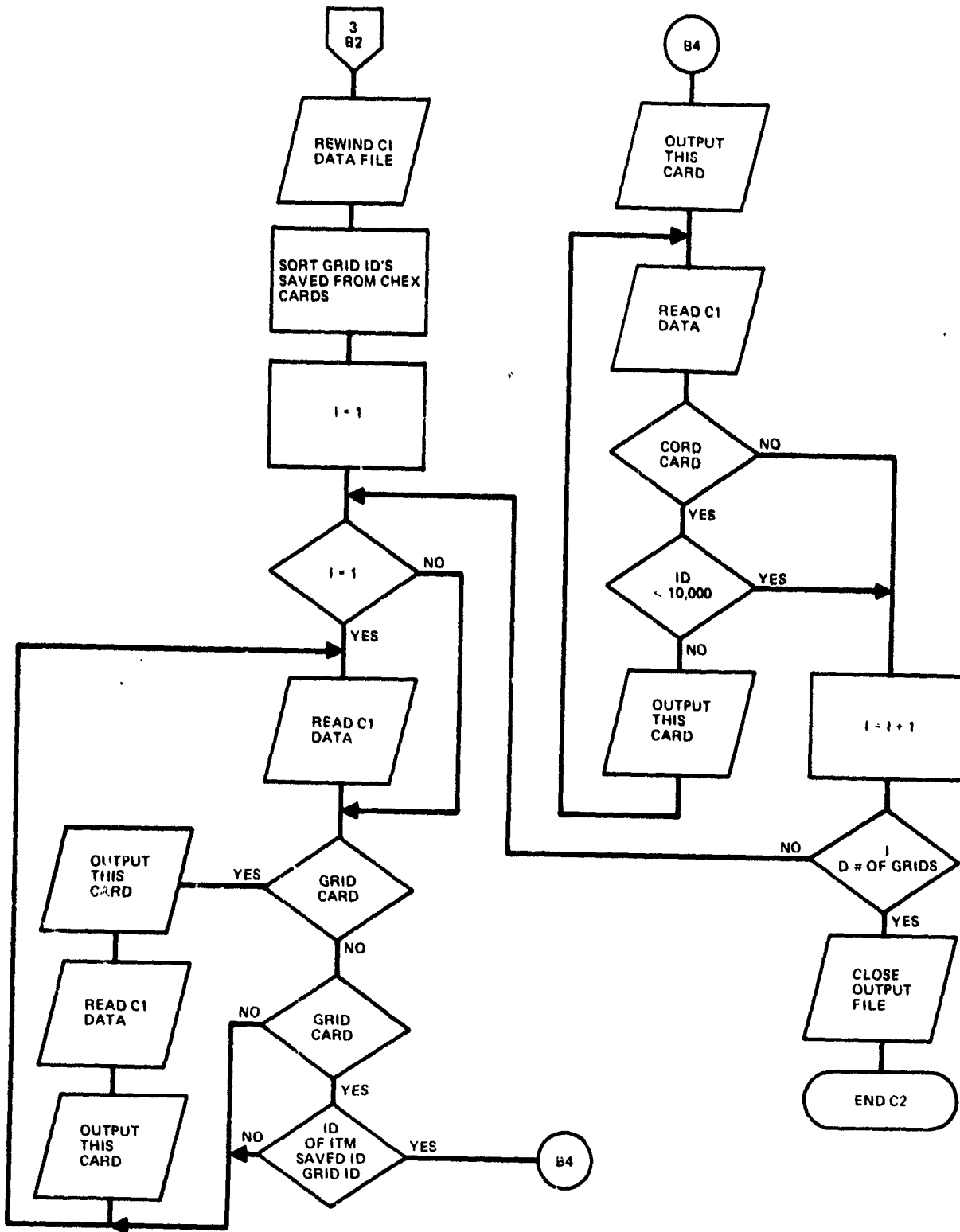

13
B

```

15N C053      STOP 999
15N C054 30 TELE=TELE+1STRPS
15N C055      IFIRST=1
15N C056 35 READ(1,1,END=90)ICARD
15N C057      IF(ICARD(1).NE.ICMAX(1)).OR.ICARD(2).NE.ICMAX(2))GO TO 35
15N C058      CALL CICON(ICARD(3),1,8,1,1)
15N C060      IF(I.GT.IMAX.AND.I.LT.IC000)GO TO 50
15N C062 36 IF(IT.NE.TELE)GO TO 35
15N C064      IF(IFIRST.NE.0)GO TO 37
15N C066      CALL CICON(ICARD(7),1,8,1,1)
15N C067      NGRIDS=NGFIIDS+1
15N C068      IGRIDS(NGRIUS)=1
15N C069      CALL CICON(ICARD(12),1,8,1,1)
15N C070      IGRIDS=NGRIDS+1
15N C071      IGRIDS(NGPIUS)=1
15N C072      GO TO 40
15N C073 37 CALL CICON(ICARD(11),1,8,1,1)
15N C074      NGRIDS=NGRIDS+1
15N C075      IGRIDS(NGRIUS)=1
15N C076      CALL CICON(ICARD(13),1,8,1,1)
15N C077      NGRIDS=NGRIUS+1
15N C078      IGRIDS(NGRIUS)=1
15N C079      GO TO 40
15N C080 50 TELE=IMAX+1STRIP
15N C081      IMAX=IMAX+1CCO
15N C082      IFIRST=1
15N C083      GO TO 36
15N C084 40 REWIND 1
15N C085      WRITE(6,3)NGFIUS,(IGRIUS(L),L=1,NGRIUS)
15N C086      3 FORPAT(11,15,2),(1517,7)
15N C087      CALL ZSOPT2(IGRIUS,NGRIUS,14,11,14)
15N C088      WRITE(6,3)NGRIUS,(IGRIUS(L),L=1,NGRIUS)
15N C089      LC 99 J=1,NGFIUS
15N C090      IF(I.NE.J)GO TO 94
15N C092 91 READ(1,1,END=93)ICARD
15N C093 94 IF(ICARD(1).EQ.ICORU)GO TO 60
15N C095      IF(ICARD(1).NE.IGRID(1)).OR.ICARD(2).NE.IGRID(2))GO TO 91
15N C097      CALL CICON(ICARD(3),1,8,1,1)
15N C098      IF(J.NE.IGRIUS(1))GO TO 91
15N C100      WRITE(2,1)ICARD
15N C101      DC 92 J=1,70
15N C102      READ(1,1,END=93)ICARD
15N C103      IF(ICARD(1).NE.IGRII(1)).OR.ICARD(2).NE.IGRID(2))GO TO 94
15N C105      CALL CICON(ICARD(3),1,8,1,1)
15N C106      IF(K.LT.IC000)GO TO 94
15N C108      WRITE(2,1)ICARD
15N C109 92 CONTINUE
15N C110      STOP 999
15N C111 60 WRITE(2,1)ICARD
15N C112      READ(1,1)ICARD
15N C113      WRITE(2,1)ICARD
15N C114      GO TO 91
15N C115 94 CONTINUE
15N C116 55 ENDFILE 2

```

ISN C117
ISN C118

STOP
END

STRIP DATA FCRL

STRIP NO. # 9
TOTAL STRIPS # 9

20	1039	1040	1041	1042	1043	1044	1045	1046	1047	1048	1049
1039	1040	1041	1042	1043	1044	1045	1046	1047	1048	1049	

APPENDIX L

C-2 PLOT RUN OUTPUT AND UNDEFORMED PLOTS

000001 29, 1978 NASIKAN 3/11/78

NASIKAN CALCULATIVE CONTROL DECK END

10. MODEL 22, CRITICAL STRIP
 SILE 24
 TIME 34
 DIAG 6, 14
 WITH 2, 3, 4
 PLOT 1
 ENDAL 117
 END

000001 29, 1978 NASIKAN 3/11/78

PULL 02% IMPACT 03 IS LAYER CRITICAL STRIP
 C2-PRF-PROCESSOR PRODUCED BULK DATA

EAST CONTROL DECK END

CARD	
COUNT	
1	TITLE 4 MODEL 22% IMPACT 03 IS LAYER CRITICAL STRIP
2	SUBTITLE 4 C2-PRF-PROCESSOR PRODUCED BULK DATA
3	OUTPUT PLOT 1
4	PLOT IN NASIKAN FILE D, 0
5	SET 3 4 1712 2005 1100 2010 3005
6	SET 4 4 ALL
7	
8	1 PLOT SIDE VIEW OF THE STRIP
9	
10	AXIS 2, 2, Y
11	VIEW 0, 0, 0, 0
12	WHEEL-HUSIES 1, 11, AND 111 - DUAL VIEW
13	FIND SCALE SET 4 ORIGIN 0
14	PLOT SET 4 ORIGIN 0
15	
16	1 PLOT HUSIES 1, 11, AND 111
17	
18	AXIS 2, 2, Y
19	VIEW -10, 0, 0, -30
20	WHEEL-HUSIES 1, 11, AND 111 -10, 20, -30 VIEW
21	FIND SCALE SET 4 ORIGIN 0
22	PLOT SET 4 ORIGIN 0
23	
24	1 PLOT ONE LAYER OF THE STRIP
25	
26	AXIS 2, 2, Y
27	VIEW -10, 0, 0, -30
28	PLOT 4 3-D VIEW OF ONE LAYER OF THE STRIP
29	FIND SCALE SET 3 ORIGIN 7
30	PLOT SET 3 ORIGIN 7 LABEL ELEMENTS
31	PLOT SET 3 ORIGIN 7 LABEL ORIGINS
32	
33	BEGIN BULK

TOTAL COUNT= 463

*** USER INFORMATION MESSAGE 201, BULK DATA NOT SORTED, ASUMT WILL RE-ORDER DECK.

CARD COUNT	S U B T I D B U L K D A T A E L E M									
	1	2	3	4	5	6	7	8	9	10
1-	CHL AA 1012	1	1016	1009	1014	1015	11016	11009	*	299
2-	* 49911014	11015								
3-	CHL AA 2005	2	1015	1014	1021	1022	11015	11014	*	365
4-	* 36511021	11022								
5-	CHL AA 2010	2	1022	1021	1027	1026	11022	11021	*	430
6-	* 43011027	11026								
7-	CHL AA 2015	2	1026	1027	1033	1034	11026	11027	*	495
8-	* 49511033	11034								
9-	CHL AA 2020	2	1034	1033	1039	1040	11034	11033	*	560
10-	* 56011039	11040								
11-	CHL AA 2025	2	1040	1039	1045	1046	11040	11039	*	625
12-	* 62511045	11046								
13-	CHL AA 2030	2	1046	1045	1051	1052	11046	11045	*	690
14-	* 69011051	11052								
15-	CHL AA 3005	3	1052	1051	1057	1058	11052	11051	*	755
16-	* 75511057	11058								
17-	CHL AA 11012	11	11016	11009	11014	11015	21016	21009	*	300
18-	* 30021014	21015								
19-	CHL AA 12005	12	11015	11014	11021	11022	21015	21014	*	366
20-	* 36621021	21022								
21-	CHL AA 12010	12	11022	11021	11027	11026	21022	21021	*	431
22-	* 43121027	21026								
23-	CHL AA 12015	12	11026	11027	11033	11034	21026	21027	*	496
24-	* 49621033	21034								
25-	CHL AA 12020	12	11034	11033	11039	11040	21034	21033	*	561
26-	* 56121039	21040								
27-	CHL AA 12025	12	11040	11039	11045	11046	21040	21039	*	626
28-	* 62621045	21046								
29-	CHL AA 12030	12	11046	11045	11051	11052	21046	21045	*	691
30-	* 69121051	21052								
31-	CHL AA 13005	13	11052	11051	11057	11058	21052	21051	*	756
32-	* 75621057	21058								
33-	CHL AA 21012	21	21016	21009	21014	21015	31016	31009	*	301
34-	* 30131014	31015								
35-	CHL AA 22005	22	21015	21014	21021	21022	31015	31014	*	367
36-	* 36731021	31022								
37-	CHL AA 22010	22	21022	21021	21027	21026	31022	31021	*	432
38-	* 43231027	31026								
39-	CHL AA 22015	22	21026	21027	21033	21034	31026	31027	*	497
40-	* 49731033	31034								
41-	CHL AA 22020	22	21034	21033	21039	21040	31034	31033	*	562
42-	* 56231039	31040								
43-	CHL AA 22025	22	21040	21039	21045	21046	31040	31039	*	627
44-	* 62731045	31046								
45-	CHL AA 22030	22	21046	21045	21051	21052	31046	31045	*	692
46-	* 69231051	31052								
47-	CHL AA 23005	23	21052	21051	21057	21058	31052	31051	*	757
48-	* 75731057	31058								
49-	CHL AA 31012	31	31016	31009	31014	31015	41016	41009	*	302
50-	* 30241014	41015								

UNIT LINE DATA FCHU

LINE	1	2	3	4	5	6	7	8	9	10
51-	CHEXA	32065	32	31015	31014	31021	31022	41015	41014	308
52-	"	30841021	41022							
53-	CHEXA	32010	32	31022	31021	31027	31028	41022	41021	433
54-	"	43341027	41028							
55-	CHEXA	32015	32	31028	31027	31033	31034	41028	41027	498
56-	"	49841033	41034							
57-	CHEXA	32020	32	31034	31033	31039	31040	41034	41033	563
58-	"	56341039	41040							
59-	CHEXA	32025	32	31040	31039	31045	31046	41040	41039	628
60-	"	62841045	41046							
61-	CHEXA	32030	32	31046	31045	31051	31052	41046	41045	693
62-	"	69341051	41052							
63-	CHEXA	32035	33	31052	31051	31057	31058	41052	41051	758
64-	"	75841057	41058							
65-	CHEXA	41012	41	41012	41009	41014	41015	51016	51009	303
66-	"	30351014	51015							
67-	CHEXA	42005	42	41015	41014	41021	41022	51015	51014	369
68-	"	36951021	51022							
69-	CHEXA	42010	42	41022	41021	41027	41028	51022	51021	434
70-	"	43451027	51028							
71-	CHEXA	42015	42	41028	41027	41033	41034	51028	51027	499
72-	"	49951033	51034							
73-	CHEXA	42020	42	41034	41033	41039	41040	51034	51033	564
74-	"	56451039	51040							
75-	CHEXA	42025	42	41040	41039	41045	41046	51040	51039	629
76-	"	62951045	51046							
77-	CHEXA	42030	42	41046	41045	41051	41052	51046	51045	694
78-	"	69451051	51052							
79-	CHEXA	43005	43	41052	41051	41057	41058	51052	51051	759
80-	"	75951057	51058							
81-	CHEXA	51012	51	51012	51009	51014	51015	61016	61009	304
82-	"	30461014	61015							
83-	CHEXA	52005	52	51015	51014	51021	51022	61015	61014	370
84-	"	37061021	61022							
85-	CHEXA	52010	52	51022	51021	51027	51028	61022	61021	435
86-	"	43561027	61028							
87-	CHEXA	52015	52	51028	51027	51033	51034	61028	61027	500
88-	"	50061033	61034							
89-	CHEXA	52020	52	51034	51033	51039	51040	61034	61033	565
90-	"	56561039	61040							
91-	CHEXA	52025	52	51040	51039	51045	51046	61040	61039	630
92-	"	63061045	61046							
93-	CHEXA	52030	52	51046	51045	51051	51052	61046	61045	695
94-	"	69561051	61052							
95-	CHEXA	53005	53	51052	51051	51057	51058	61052	61051	760
96-	"	76061057	61058							
97-	CHEXA	61012	61	61012	61009	61014	61015	71016	71009	305
98-	"	30571014	71015							
99-	CHEXA	62005	62	61015	61014	61021	61022	71015	71014	371
100-	"	3711021	71022							

SUMMARY BULK DATA ECHU

CARD COUNT	1	2	3	4	5	6	7	8	9	10
101-	CHEXA	62010	62	61022	61021	61027	61026	71022	71021	436
102-	+	43671027	71028							
103-	CHEXA	62015	62	61026	61027	61033	61034	71028	71027	501
104-	+	50171033	71034							
105-	CHEXA	62020	62	61034	61033	61039	61040	71034	71033	566
106-	+	56671039	71040							
107-	CHEXA	62025	62	61040	61039	61045	61046	71040	71039	631
108-	+	63171045	71046							
109-	CHEXA	62030	62	61046	61045	61051	61052	71046	71045	696
110-	+	69671051	71052							
111-	CHEXA	63005	63	61052	61051	61057	61058	71052	71051	761
112-	+	76171057	71058							
113-	CHEXA	71012	71	71016	71009	71014	71015	81016	81009	306
114-	+	30681014	81015							
115-	CHEXA	72005	72	71015	71014	71021	71022	81015	81014	372
116-	+	37281021	81022							
117-	CHEXA	72010	72	71022	71021	71027	71028	81022	81021	437
118-	+	43781027	81028							
119-	CHEXA	72015	72	71026	71027	71033	71034	81026	81027	502
120-	+	50281033	81034							
121-	CHEXA	72020	72	71034	71033	71039	71040	81034	81033	567
122-	+	56781039	81040							
123-	CHEXA	72025	72	71040	71039	71045	71046	81040	81039	632
124-	+	63281045	81046							
125-	CHEXA	72030	72	71046	71045	71051	71052	81046	81045	697
126-	+	69781051	81052							
127-	CHEXA	73005	73	71052	71051	71057	71058	81052	81051	762
128-	+	76281057	81058							
129-	CHEXA	81012	81	81016	81009	81014	81015	91016	91009	307
130-	+	30791014	91015							
131-	CHEXA	82005	82	81015	81014	81021	81022	91015	91014	373
132-	+	37391021	91022							
133-	CHEXA	82010	82	81022	81021	81027	81028	91022	91021	438
134-	+	43891027	91028							
135-	CHEXA	82015	82	81026	81027	81033	81034	91026	91027	503
136-	+	50391033	91034							
137-	CHEXA	82020	82	81034	81033	81039	81040	91034	91033	568
138-	+	56891039	91040							
139-	CHEXA	82025	82	81040	81039	81045	81046	91040	91039	633
140-	+	63391045	91046							
141-	CHEXA	82030	82	81046	81045	81051	81052	91046	91045	698
142-	+	69891051	91052							
143-	CHEXA	83005	83	81052	81051	81057	81058	91052	91051	763
144-	+	76391057	91058							
145-	CHEXA	91012	91	91016	91009	91014	91015	101016	101009	308
146-	+	308101014	101015							
147-	CHEXA	92005	92	91015	91014	91021	91022	101015	101014	374
148-	+	374101021	101022							
149-	CHEXA	92010	92	91022	91021	91027	91028	101022	101021	439
150-	+	439101027	101028							

		S O R T E D B U L K D A T A E C M U									
CARD COUNT	1	2	3	4	5	6	7	8	9	10	
151-	CHEXA	92015	92	91026	91027	91033	91034	101028	101027		504
152-	*	504101033	101034								
153-	CHEXA	92020	92	91034	91033	91039	91040	101034	101033		569
154-	*	569101039	101040								
155-	CHEXA	92025	92	91040	91039	91045	91046	101040	101039		634
156-	*	634101045	101046								
157-	CHEXA	92030	92	91046	91045	91051	91052	101046	101045		699
158-	*	699101051	101052								
159-	CHEXA	93005	93	91052	91051	91057	91058	101052	101051		764
160-	*	764101057	101058								
161-	CHEXA	101012	101	101016	101009	101017	101015	111016	111009		309
162-	*	309111014	111015								
163-	CHEXA	102005	102	101015	101014	101021	101022	111015	111014		375
164-	*	375111021	111022								
165-	CHEXA	102010	102	101022	101021	101027	101028	111022	111021		440
166-	*	440111027	111028								
167-	CHEXA	102015	102	101026	101027	101033	101034	111026	111027		505
168-	*	505111033	111034								
169-	CHEXA	102020	102	101034	101033	101039	101040	111034	111033		570
170-	*	570111039	111040								
171-	CHEXA	102025	102	101040	101039	101046	101046	111040	111039		635
172-	*	635111046	111046								
173-	CHEXA	102030	102	101046	101045	101051	101052	111046	111045		700
174-	*	700111051	111052								
175-	CHEXA	103005	103	101052	101051	101057	101058	111052	111051		765
176-	*	765111057	111058								
177-	CHEXA	111012	111	111016	111009	111014	111015	121016	121009		310
178-	*	310121014	121015								
179-	CHEXA	112005	112	111015	111014	111021	111022	121015	121014		376
180-	*	376121021	121022								
181-	CHEXA	112010	112	111022	111021	111027	111028	121022	121021		441
182-	*	441121027	121028								
183-	CHEXA	112018	112	111028	111027	111033	111034	121028	121027		506
184-	*	506121033	121034								
185-	CHEXA	112020	112	111034	111033	111039	111040	121034	121033		571
186-	*	571121039	121040								
187-	CHEXA	112025	112	111040	111039	111045	111046	121040	121039		636
188-	*	636121045	121046								
189-	CHEXA	112030	112	111046	111045	111051	111052	121046	121045		701
190-	*	701121051	121052								
191-	CHEXA	113005	113	111052	111051	111057	111058	121052	121051		766
192-	*	766121057	121058								
193-	CHEXA	121012	121	121016	121009	121014	121015	131016	131009		311
194-	*	311131014	131015								
195-	CHEXA	122005	122	121015	121014	121021	121022	131015	131014		377
196-	*	377131021	131022								
197-	CHEXA	122010	122	121022	121021	121027	121028	131022	131021		442
198-	*	442131027	131028								
199-	CHEXA	122115	122	121028	121027	121033	121034	131028	131027		507
200-	*	507131033	131034								

SORTED BULK DATA LUMU

CARD COUNT	1	2	3	4	5	6	7	8	9	10	
201-	CHEXA	122120	122	121034	121035	121039	121040	131034	131035	0	572
202-	*	272131039	131040								
203-	CHEXA	122025	122	121040	121039	121045	121046	131040	131039	0	631
204-	*	637131045	131046								
205-	CHEXA	122030	122	121046	121045	121051	121052	131046	131045	0	702
206-	*	102131051	131052								
207-	CHEXA	123005	123	121052	121051	121057	121056	131052	131051	0	767
208-	*	767131057	131058								
209-	CURDZC	100		.6700	.1700	.0	.6700	.1700	1.0	0	312
210-	*	3121.6700	.1700	.0							
211-	GRID	1009		.6291	.2950	.1000					
212-	GRID	1014		.6700	.2950	.1000					
213-	GRID	1015		.6700	.2950	.0					
214-	GRID	1016		.6500	.2950	.0					
215-	GRID	1021	100	.1250	79.0000	.1000					
216-	GRID	1022	100	.1250	79.0000	.0					
217-	GRID	1027	100	.1250	60.0000	.1000					
218-	GRID	1028	100	.1250	60.0000	.0					
219-	GRID	1033	100	.1250	45.0000	.1000					
220-	GRID	1034	100	.1250	45.0000	.0					
221-	GRID	1039	100	.1250	30.0000	.1000					
222-	GRID	1040	100	.1250	30.0000	.0					
223-	GRID	1045	100	.1250	15.0000	.1000					
224-	GRID	1046	100	.1250	15.0000	.0					
225-	GRID	1051	100	.1250	.0	.1000					
226-	GRID	1052	100	.1250	.0	.0					
227-	GRID	1057		.7950	.0	.1000					
228-	GRID	1058		.7950	.0	.0					
229-	GRID	11009		.6191	.3050	.1000					
230-	GRID	11014		.6700	.3050	.1000					
231-	GRID	11015		.6700	.3050	.0					
232-	GRID	11016		.6500	.3050	.0					
233-	GRID	11021	100	.1350	79.0000	.1000					
234-	GRID	11022	100	.1350	79.0000	.0					
235-	GRID	11027	100	.1350	60.0000	.1000					
236-	GRID	11028	100	.1350	60.0000	.0					
237-	GRID	11033	100	.1350	45.0000	.1000					
238-	GRID	11034	100	.1350	45.0000	.0					
239-	GRID	11039	100	.1350	30.0000	.1000					
240-	GRID	11040	100	.1350	30.0000	.0					
241-	GRID	11045	100	.1350	15.0000	.1000					
242-	GRID	11046	100	.1350	15.0000	.0					
243-	GRID	11051	100	.1350	.0	.1000					
244-	GRID	11052	100	.1350	.0	.0					
245-	GRID	11057		.8050	.0	.2000					
246-	GRID	11058		.8050	.0	.0					
247-	GRID	21009		.6291	.3150	.1000					
248-	GRID	21014		.6700	.3150	.1000					
249-	GRID	21015		.6700	.3150	.0					
250-	GRID	21016		.6500	.3150	.0					

SORTED BULK DATA ECHO										
CARD	1	2	3	4	5	6	7	8	9	10
251-	GRID	21021	100	.1450	75.0000	.1000				
252-	GRID	21022	100	.1450	75.0000	.0				
253-	GRID	21027	100	.1450	60.0000	.1000				
254-	GRID	21028	100	.1450	60.0000	.0				
255-	GRID	21033	100	.1450	45.0000	.1000				
256-	GRID	21034	100	.1450	45.0000	.0				
257-	GRID	21039	100	.1450	30.0000	.1000				
258-	GRID	21040	100	.1450	30.0000	.0				
259-	GRID	21045	100	.1450	15.0000	.1000				
260-	GRID	21046	100	.1450	15.0000	.0				
261-	GRID	21051	100	.1450	.0	.1000				
262-	GRID	21052	100	.1450	.0	.0				
263-	GRID	21057		.8150	.0	.1000				
264-	GRID	21058		.8150	.0	.0				
265-	GRID	31009		.6291	.3250	.1000				
266-	GRID	31014		.6700	.3250	.1000				
267-	GRID	31015		.6700	.3250	.0				
268-	GRID	31016		.6500	.3250	.0				
269-	GRID	31021	100	.1550	75.0000	.1000				
270-	GRID	31022	100	.1550	75.0000	.0				
271-	GRID	31027	100	.1550	60.0000	.1000				
272-	GRID	31028	100	.1550	60.0000	.0				
273-	GRID	31033	100	.1550	45.0000	.1000				
274-	GRID	31034	100	.1550	45.0000	.0				
275-	GRID	31039	100	.1550	30.0000	.1000				
276-	GRID	31040	100	.1550	30.0000	.0				
277-	GRID	31045	100	.1550	15.0000	.1000				
278-	GRID	31046	100	.1550	15.0000	.0				
279-	GRID	31051	100	.1550	.0	.1000				
280-	GRID	31052	100	.1550	.0	.0				
281-	GRID	31057		.8250	.0	.1000				
282-	GRID	31058		.8250	.0	.0				
283-	GRID	41009		.6291	.3350	.1000				
284-	GRID	41014		.6700	.3350	.1000				
285-	GRID	41015		.6700	.3350	.0				
286-	GRID	41016		.6500	.3350	.0				
287-	GRID	41021	100	.1650	75.0000	.1000				
288-	GRID	41022	100	.1650	75.0000	.0				
289-	GRID	41027	100	.1650	60.0000	.1000				
290-	GRID	41028	100	.1650	60.0000	.0				
291-	GRID	41033	100	.1650	45.0000	.1000				
292-	GRID	41034	100	.1650	45.0000	.0				
293-	GRID	41039	100	.1650	30.0000	.1000				
294-	GRID	41040	100	.1650	30.0000	.0				
295-	GRID	41045	100	.1650	15.0000	.1000				
296-	GRID	41046	100	.1650	15.0000	.0				
297-	GRID	41051	100	.1650	.0	.1000				
298-	GRID	41052	100	.1650	.0	.0				
299-	GRID	41057		.8350	.0	.1000				
300-	GRID	41058		.8350	.0	.0				

		SORTED BULK DATA ELMU									
CARD		1	2	3	4	5	6	7	8	9	10
COUNT											
301-	GRID	51069			.6291	.3450	.1000				
302-	GRID	51014			.6700	.3450	.1000				
303-	GRID	51015			.6700	.3450	.0				
304-	GRID	51016			.6500	.3450	.0				
305-	GRID	51021	100		.1750	75.0000	.1000				
306-	GRID	51022	100		.1750	75.0000	.0				
307-	GRID	51027	100		.1750	60.0000	.1000				
308-	GRID	51028	100		.1750	60.0000	.0				
309-	GRID	51033	100		.1750	45.0000	.1000				
310-	GRID	51034	100		.1750	45.0000	.0				
311-	GRID	51039	100		.1750	30.0000	.1000				
312-	GRID	51040	100		.1750	30.0000	.0				
313-	GRID	51045	100		.1750	15.0000	.1000				
314-	GRID	51046	100		.1750	15.0000	.0				
315-	GRID	51051	100		.1750	.0	.1000				
316-	GRID	51052	100		.1750	.0	.0				
317-	GRID	51057			.8450	.0	.1000				
318-	GRID	51058			.8450	.0	.0				
319-	GRID	61009			.6291	.3550	.1000				
320-	GRID	61014			.6700	.3550	.1000				
321-	GRID	61015			.6700	.3550	.0				
322-	GRID	61016			.6500	.3550	.0				
323-	GRID	61021	100		.1850	75.0000	.1000				
324-	GRID	61022	100		.1850	75.0000	.0				
325-	GRID	61027	100		.1850	60.0000	.1000				
326-	GRID	61028	100		.1850	60.0000	.0				
327-	GRID	61033	100		.1850	45.0000	.1000				
328-	GRID	61034	100		.1850	45.0000	.0				
329-	GRID	61039	100		.1850	30.0000	.1000				
330-	GRID	61040	100		.1850	30.0000	.0				
331-	GRID	61045	100		.1850	15.0000	.1000				
332-	GRID	61046	100		.1850	15.0000	.0				
333-	GRID	61051	100		.1850	.0	.1000				
334-	GRID	61052	100		.1850	.0	.0				
335-	GRID	61057			.8550	.0	.1000				
336-	GRID	61058			.8550	.0	.0				
337-	GRID	71009			.6291	.3800	.1000				
338-	GRID	71014			.6700	.3800	.1000				
339-	GRID	71015			.6700	.3800	.0				
340-	GRID	71016			.6500	.3800	.0				
341-	GRID	71021	100		.1900	75.0000	.1000				
342-	GRID	71022	100		.1900	75.0000	.0				
343-	GRID	71027	100		.1900	60.0000	.1000				
344-	GRID	71028	100		.1900	60.0000	.0				
345-	GRID	71033	100		.1900	45.0000	.1000				
346-	GRID	71034	100		.1900	45.0000	.0				
347-	GRID	71039	100		.1900	30.0000	.1000				
348-	GRID	71040	100		.1900	30.0000	.0				
349-	GRID	71045	100		.1900	15.0000	.1000				
350-	GRID	71046	100		.1900	15.0000	.0				

CARD COUNT	S O R T E D B U L K D A T A E C H U									
	1	2	3	4	5	6	7	8	9	10
351-	GRID	71051	100	.1900	.0	.1000				
352-	GRID	71052	100	.1900	.0	.0				
353-	GRID	71057		.8600	.0	.1000				
354-	GRID	71058		.8600	.0	.0				
355-	GRID	81009		.6291	.3700	.1000				
356-	GRID	81014		.6700	.3700	.1000				
357-	GRID	81015		.6700	.3700	.0				
358-	GRID	81016		.6500	.3700	.0				
359-	GRID	81021	100	.2000	.750000	.1000				
360-	GRID	81022	100	.2000	.750000	.0				
361-	GRID	81027	100	.2000	.600000	.1000				
362-	GRID	81028	100	.2000	.600000	.0				
363-	GRID	81033	100	.2000	.450000	.1000				
364-	GRID	81034	100	.2000	.450000	.0				
365-	GRID	81039	100	.2000	.300000	.1000				
366-	GRID	81040	100	.2000	.300000	.0				
367-	GRID	81045	100	.2000	.150000	.1000				
368-	GRID	81046	100	.2000	.150000	.0				
369-	GRID	81051	100	.2000	.0	.1000				
370-	GRID	81052	100	.2000	.0	.0				
371-	GRID	81057		.8700	.0	.1000				
372-	GRID	81058		.8700	.0	.0				
373-	GRID	91009		.6291	.3800	.1000				
374-	GRID	91014		.6700	.3800	.1000				
375-	GRID	91015		.6700	.3800	.0				
376-	GRID	91016		.6500	.3800	.0				
377-	GRID	91021	100	.2100	.750000	.1000				
378-	GRID	91022	100	.2100	.750000	.0				
379-	GRID	91027	100	.2100	.600000	.1000				
380-	GRID	91028	100	.2100	.600000	.0				
381-	GRID	91033	100	.2100	.450000	.1000				
382-	GRID	91034	100	.2100	.450000	.0				
383-	GRID	91039	100	.2100	.300000	.1000				
384-	GRID	91040	100	.2100	.300000	.0				
385-	GRID	91045	100	.2100	.150000	.1000				
386-	GRID	91046	100	.2100	.150000	.0				
387-	GRID	91051	100	.2100	.0	.1000				
388-	GRID	91052	100	.2100	.0	.0				
389-	GRID	91057		.8800	.0	.1000				
390-	GRID	91058		.8800	.0	.0				
391-	GRID	101009		.6291	.3900	.1000				
392-	GRID	101014		.6700	.3900	.1000				
393-	GRID	101015		.6700	.3900	.0				
394-	GRID	101016		.6500	.3900	.0				
395-	GRID	101021	100	.2200	.750000	.1000				
396-	GRID	101022	100	.2200	.750000	.0				
397-	GRID	101027	100	.2200	.600000	.1000				
398-	GRID	101028	100	.2200	.600000	.0				
399-	GRID	101033	100	.2200	.450000	.1000				
400-	GRID	101034	100	.2200	.450000	.0				

CARD COUNT	SORTED BULK DATA ECHO									
	1	2	3	4	5	6	7	8	9	10
401-	GR10	101039	100	.2200	30,0000	.1000				
402-	GR10	101040	100	.2200	30,0000	.0				
403-	GR10	101045	100	.2200	15,0000	.1000				
404-	GR10	101046	100	.2200	15,0000	.0				
405-	GR10	101051	100	.2200	.0	.1000				
406-	GR10	101052	100	.2200	.0	.0				
407-	GR10	101057		.8900	.0	.1000				
408-	GR10	101058		.8900	.0	.0				
409-	GR10	111009		.6291	.4000	.1000				
410-	GR10	111014		.6700	.4000	.1000				
411-	GR10	111015		.6700	.4000	.0				
412-	GR10	111016		.6500	.4000	.0				
413-	GR10	111021	100	.2300	75,0000	.1000				
414-	GR10	111022	100	.2300	75,0000	.0				
415-	GR10	111027	100	.2300	60,0000	.1000				
416-	GR10	111028	100	.2300	60,0000	.0				
417-	GR10	111033	100	.2300	45,0000	.1000				
418-	GR10	111034	100	.2300	45,0000	.0				
419-	GR10	111039	100	.2300	30,0000	.1000				
420-	GR10	111040	100	.2300	30,0000	.0				
421-	GR10	111045	100	.2300	15,0000	.1000				
422-	GR10	111046	100	.2300	15,0000	.0				
423-	GR10	111051	100	.2300	.0	.1000				
424-	GR10	111052	100	.2300	.0	.0				
425-	GR10	111057		.9000	.0	.1000				
426-	GR10	111058		.9000	.0	.0				
427-	GR10	121009		.6291	.4100	.1000				
428-	GR10	121014		.6700	.4100	.1000				
429-	GR10	121015		.6700	.4100	.0				
430-	GR10	121016		.6500	.4100	.0				
431-	GR10	121021	100	.2400	75,0000	.1000				
432-	GR10	121022	100	.2400	75,0000	.0				
433-	GR10	121027	100	.2400	60,0000	.1000				
434-	GR10	121028	100	.2400	60,0000	.0				
435-	GR10	121033	100	.2400	45,0000	.1000				
436-	GR10	121034	100	.2400	45,0000	.0				
437-	GR 0	121039	100	.2400	30,0000	.1000				
438-	GR10	121040	100	.2400	30,0000	.0				
439-	GR10	121045	100	.2400	15,0000	.1000				
440-	GR10	121046	100	.2400	15,0000	.0				
441-	GR10	121051	100	.2400	.0	.1000				
442-	GR10	121052	100	.2400	.0	.0				
443-	GR10	121057		.9100	.0	.1000				
444-	GR10	121058		.9100	.0	.0				
445-	GR10	131009		.6291	.4200	.1000				
446-	GR10	131014		.6700	.4200	.1000				
447-	GR10	131015		.6700	.4200	.0				
448-	GR10	131016		.6500	.4200	.0				
449-	GR10	131021	100	.2500	75,0000	.1000				
450-	GR10	131022	100	.2500	75,0000	.0				

CARD COUNT	SORTED BULK DATA ECHO									
	1	2	3	4	5	6	7	8	9	10
451-	GR10	131027	100	.2500	60,0000	.1000				
452-	GR10	131028	100	.2500	60,0000	.0				
453-	GR10	131033	100	.2500	45,0000	.1000				
454-	GR10	131034	100	.2500	45,0000	.0				
455-	GR10	131039	100	.2500	30,0000	.1000				
456-	GR10	131040	100	.2500	30,0000	.0				
457-	GR10	131045	100	.2500	15,0000	.1000				
458-	GR10	131046	100	.2500	15,0000	.0				
459-	GR10	131051	100	.2500	.0	.1000				
460-	GR10	131052	100	.2500	.0	.0				
461-	GR10	131057		.9200	.0	.1000				
462-	GR10	131058		.9200	.0	.0				

TOTAL COUNT = 462

MAP:ORAP INSTRUCTION

1. PLOTI NIP: 24 - LINEAR STATIC ANALYSIS 7 JUN 1976 1
2. PARAM //DTAGUN//47 1
3. FILE GR*SAVE / *ANN*SAVE / *MR*SAVE 1
4. FILE QU*APPEND/PCC*AT*END/UCV*APPEND 1
5. SEIVAL //V,N,CARDNO/0 1
6. SEIVAL //V,N,MDS//V,N,NDU/1 1
7. SEIVAL //V,N,NDUGA/1 1
8. SEIVAL //V,N,NDUGA/1 1
9. CPT GEOM1,GEOM2,70PL,LOCATN,CPDT,CSIM,NDUPL,STL/S,N,LOUSET/0/S,N,
NDUPT 1
10. CEND KPEM,NDUPT 1
11. CPT GEOM1,GEOM2/1 1
12. PPARAM PLOH/PRES///VSI, JUPPLET 1
13. CEND P1, JUPPLET 1
14. PPARAM //DTAGUN//47 1
15. PLENDY GEOM1,ECT,EP1,STL,LOCATN,NDUPT/PLCT,PSIL,PEQIN,PBOPDT/S,N,
NDUPT/C,Y,NDUPT 1
16. PLOTV EQLT,PLQTH/NDUPT/ECT,ECT/NDUPT/NDUPT,PBOPDT/NDUPT/ STL,PSIL/
NDUPT 1
17. PLTSET PCON,PCQIN,PLCT/PLTSETX,PLTPAR,GPSETS,ELSETS/S,N,NSIL/ S,N,
JUPPLET-1 1
18. CKNPNT PLTPAR,GPSETS,ELSETS 1
19. PFMSC PLTSETX// 1
20. SEIVAL //V,N,PLTFLG/1 //V,N,PELLE/0 1
21. CEND P1, JUPPLET 1
22. PLOT PLTPAR,GPSETS,ELSETS,CASECC,PBOPDT,PLQTH,PSIL,ECT, //PLOTX/
NSIL/LOUSET/S,N,JUPPLET/S,N,PLTFLG/S,N,PELLE 1
23. PFMSC PLTSETX// 1
24. EXIT 1
25. LABEL P1 1
26. PPARAM //DTAGUN//47 1
27. CPT GEOM1,GEOM2/SLT,ET/0/V,N,NDUGAV/0 1
28. CEND CMDS,KLDS 1
29. CPT JLT,EP1,NDUPT,STL,ETT, SIM/ST,GE1,CPCT, //V,N,LOUSET/0/ S,N,
NDUPT/1/S,N,NDUGENL/S,N,CEREL 1
30. CEND CSMPNG,NDUPT 1
31. PPARAM //DTAGUN//47 1
32. CPT EST,CSIM,PE1,ET,GEOM2, //KEM,NDICT,MLL,NDICT, //S,N,NDUGA/
S,N,NDUGA/0//C,Y,CHOPASS 1
33. CKNPNT KEM,NDICT 1
34. CKNPNT NEM,NDICT 1
35. PPARAM //DTAGUN//47 1
36. PPARAM KCG/NDUGA 1
37. CEND LEM,NDUGA 1
38. CPT GPC,NDICT,ELN,NDUPT,STL,CSIM/KCG, 1
39. LABEL LEM 1
40. PFMSC KCG/NDUGA 1
41. CEND KEM,NDUGA 1
42. CPT GPC,NDICT,PE1,NDUPT,STL,CSIM/KCG, //C,Y,INTRASS=1. 1

MESSAGES FROM THE PLOT MODULE

PLOTTER DATA

THE FOLLOWING PLOTS ARE FOR A NASIPLOT PLOTTER.

PAPER SIZE = 20.0 X 20.0, PAPER TYPE = VELLUM

PEN 1 = SIZE 1, BLACK
PEN 2 = SIZE 1, BLACK
PEN 3 = SIZE 1, BLACK
PEN 4 = SIZE 1, BLACK

ENGINEERING DATA

ORTHOGRAPHIC PROJECTION
ROTATIONS (DEGREES) - GAMMA = 0.0, BETA = 0.0, ALPHA = 0.0, AZIS = 0.0, SYMMETRIC
SCALE (OBJECT-TO-PLOT SIZE) = 4.41904E+01

ORIGIN 0 - XO = 2.49477E+01, YO = -9.10004E-01 (INCHES)

LIST OF PLOTS

PLOT 1 UNDEFINED SHAPE

MESSAGES FROM THE PLOT MODULE

PLOTTER DATA

THE FOLLOWING PLOTS ARE FOR A NASIPLOT PLOTTER.

PAPER SIZE = 20.0 X 20.0, PAPER TYPE = VELLUM

PEN 1 = SIZE 1, BLACK
PEN 2 = SIZE 1, BLACK
PEN 3 = SIZE 1, BLACK
PEN 4 = SIZE 1, BLACK

ENGINEERING DATA

ORTHOGRAPHIC PROJECTION
ROTATIONS (DEGREES) - GAMMA = -10.00, BETA = 20.00, ALPHA = -30.00, AZIS = 0.0, SYMMETRIC
SCALE (OBJECT-TO-PLOT SIZE) = 3.84551E+01

ORIGIN 0 - XO = 2.49477E+01, YO = -9.10004E-01 (INCHES)
ORIGIN 5 - XO = 1.78954E+01, YO = -1.99465E+01 (INCHES)

LIST OF PLOTS

PLOT 2 UNDEFINED SHAPE

MESSAGES FROM THE PLOT MODULE

PLOTTER DATA

THE FOLLOWING PLOTS ARE FOR A NASTPLT PLOTTER

PAPER SIZE = 20.0 X 20.0, PAPER TYPE = YELLOW

PLT 1 = SIZE 1, BLACK
PLT 2 = SIZE 1, BLACK
PLT 3 = SIZE 1, BLACK
PLT 4 = SIZE 1, BLACK

ENGINEERING DATA

ORTHOGRAPHIC PROJECTION
ROTATIONS (DEGREES) = GAMMA = +10.00, BETA = 20.00, ALPHA = -30.00, AXES = XZ,XY, SYMMETRIC
SCALE (OBJECT-TO-PLOT SIZE) = 1.251930E-01

ORIGIN 2 = XO = 2.494772E+01, YO = -9.100049E-01 (INCHES)
ORIGIN 5 = XO = 1.789140E+01, YO = -1.594850E+01 (INCHES)
ORIGIN 7 = XO = 2.704458E+01, YO = -2.505588E+01 (INCHES)

LIST OF PLOTS

PLOT 3 UNDEFINED SHAPE

MESSAGES FROM THE PLT1 MODULE

PLT1 DATA

THE FOLLOWING PLOTS ARE FOR 2 MULTIPLOT PLOTS

PAPER SIZE = 20.0 X 20.0, PAPER TYPE = VELLUM

PLT 1 - SIZE 1, BLACK
PLT 2 - SIZE 1, BLACK
PLT 3 - SIZE 1, BLACK
PLT 4 - SIZE 1, BLACK

ENGINEERING DATA

ORTHOGRAPHIC PROJECTION
ROTATIONS (DEGREES) = GAMMA = -30.00, DELTA = 20.00, ALPHA = -30.00, AXES = XZ, YZ, SYMMETRICAL
SCALE ((HUGE(1)-III-PLT1 SIZE) = 5.25793E+01)

ORIGIN 1 - XO = 3.49477E+01, YO = -9.60049E-01 (INCHES)
ORIGIN 5 - XO = 1.70495E+01, YO = -1.54485E+01 (INCHES)
ORIGIN 7 - XO = 2.70495E+01, YO = -2.54485E+01 (INCHES)

LIST OF PLOTS

PLT 4 UNDEFORMED SHAPE

1 10/25/78
MESHES I, II, AND III - O. O. O VIEW

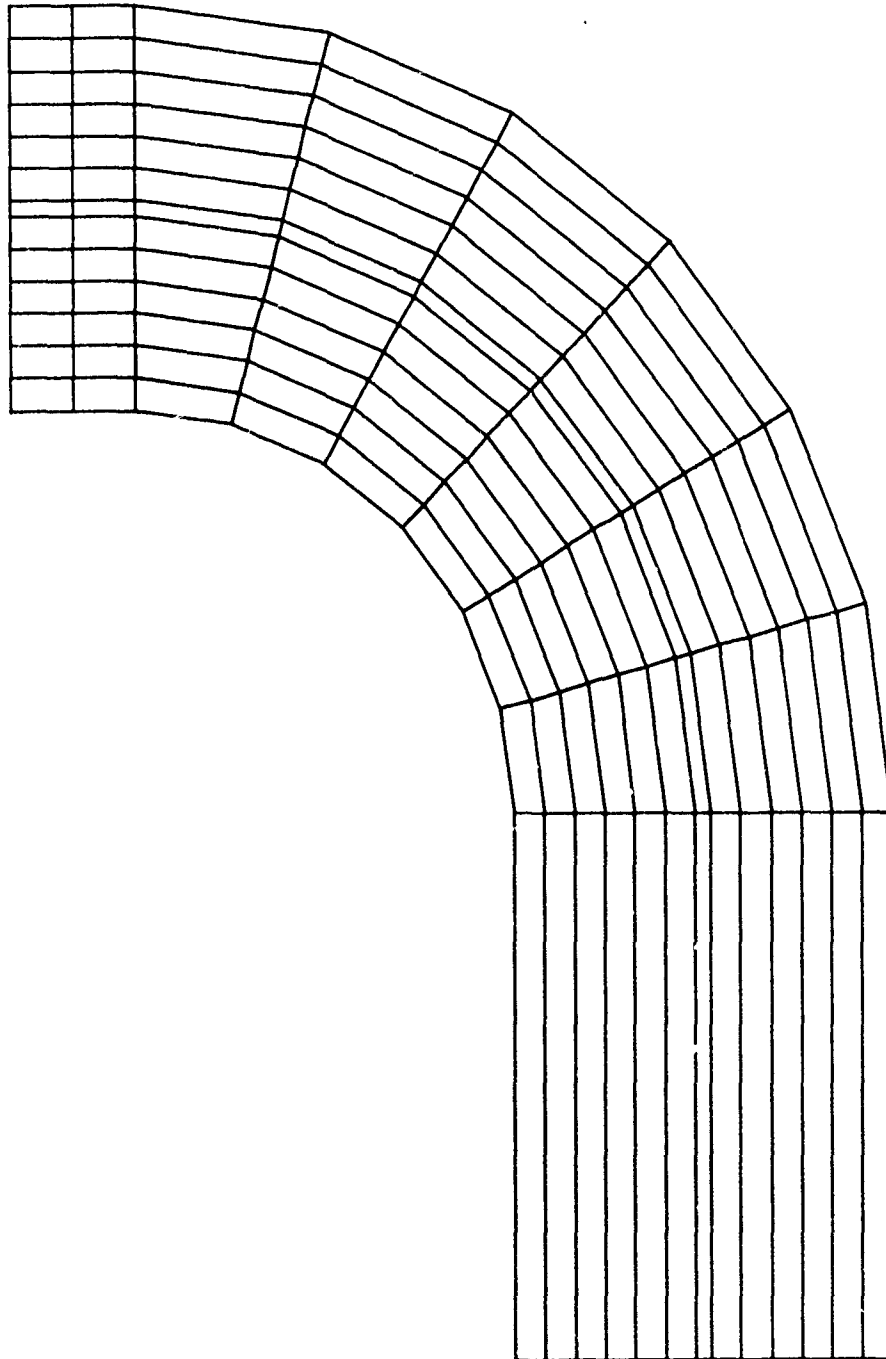

MODEL C2.2 (PHASE 2) 13 LAYER CRITICAL STRIP
C2-PRE-PROCESSOR PRODUCED BULK DATA
UNDEFORMED SHAPE

2 10/25/78
MESHES I, II, AND III -10, 20, -30 VIEW

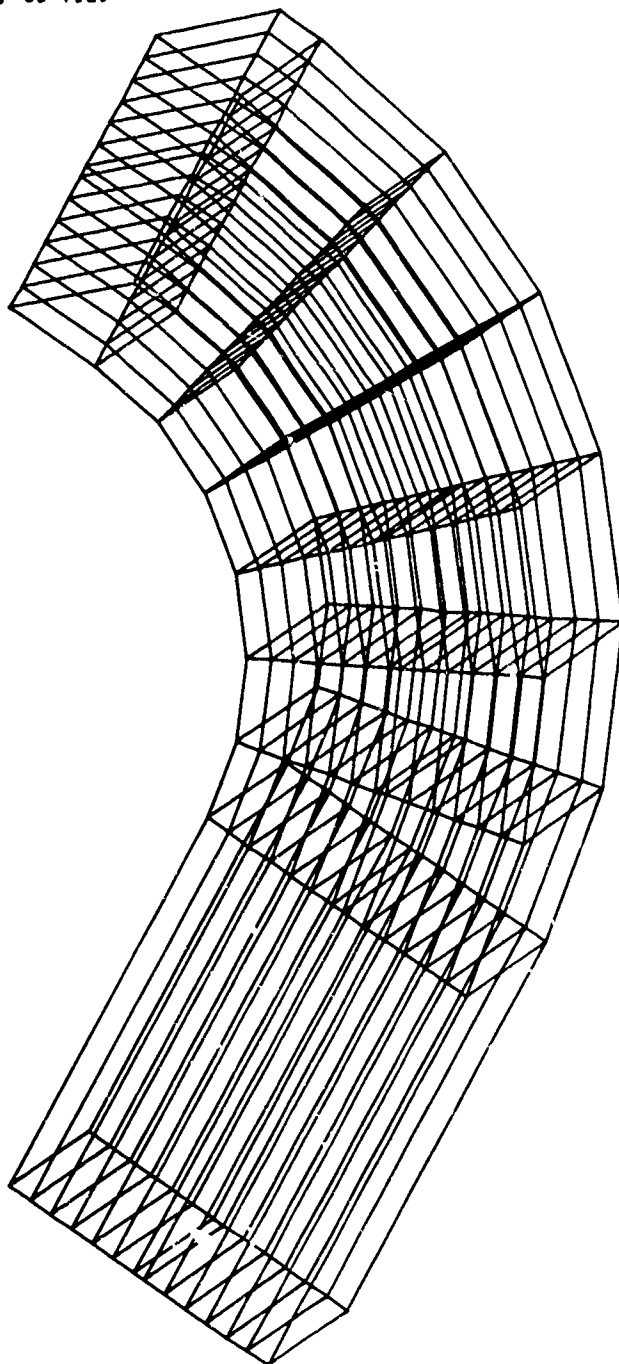

MODEL C2.2 (PHASE 2) 13 LAYER CRITICAL STRIP
C2-PRE-PROCESSOR PRODUCED BULK DATA
UNDEFORMED SHAPE

3 10/25/70
3-D VIEW OF ONE LAYER OF THE STRIP

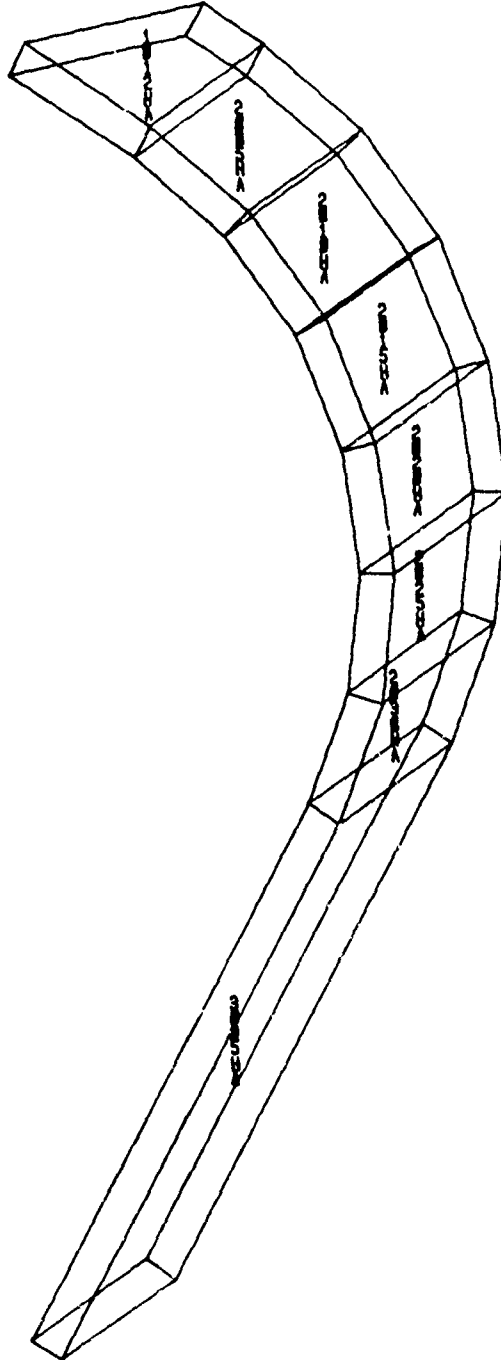

MODEL C2.2 (PHASE 2) 13 LAYER CRITICAL STRIP
C2-PRE-PROCESSOR PRODUCED BULK DATA
UNDEFORMED SHAPE

10/25/78
3-D VIEW OF ONE LAYER OF THE STRIP

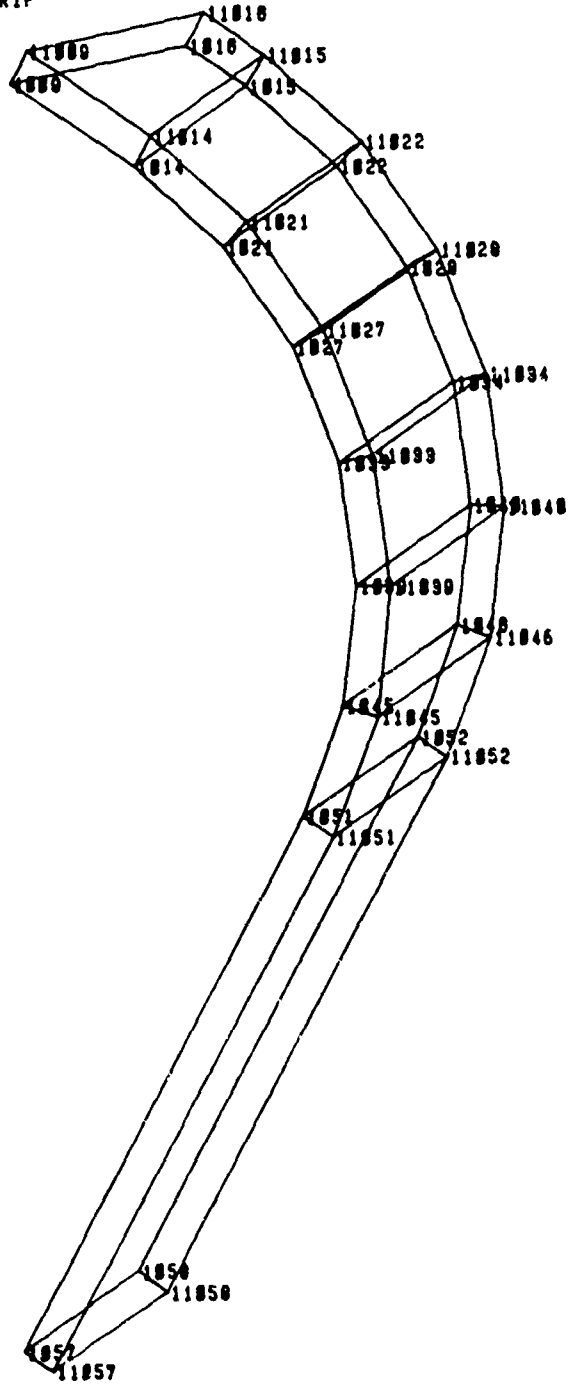

MODEL C2.2 (PHASE 2) 19 LAYER CRITICAL STRIP
C2-PRE-PROCESSOR PRODUCED BULK DATA
UNDEFORMED SHAPE

C A S E C O M P O S I T E M O D E L D E C K C C M U

CARD
COUNT

1 TITLE * COMPOSITE BRACKET MODEL C2.2 (STACK SEQ 2, PHASE 2)
2 SUBTITLE * ONE STRIP ALONG SYM LINE WITH 13 UNEQUAL LAYERS
3
4 * UNLIKE MODEL C1 RUN, LOADS ARE NOW APPLIED AS 2 SUBCASES
5 * WITH CORRESPONDING BOUNDARY CONDITIONS
6
7 SET 1 * 1014, 1015, 1021, 1022, 1027, 1028, 1033, 1034,
8 1039, 1040, 1045, 1046, 1051, 1052, 1057, 1058,
9 131014,131015,131021,131022,131027,131028,131033,131034,
10 131039,131040,131045,131046,131051,131052,131057,131058
11 ULOAD * ALL
12 DISPL * ALL
13 STRESS * ALL
14 SPCFORCE * ALL
15 ESE * ALL
16 CFFORCE * 1
17 *
18 SUBCASE 1
19 LABEL * UNIFORM PULL, NSPLINE ELMS USED FOR PARABOLIC DISIN
20 SPC * 20 *DISPL BCS FROM C1 RUN, SUBNUM 3 * WASHEN * SYM BCS
21 *
22 SUBCASE 2
23 LABEL * CLOCKWISE COUPLE, NSPLINE ELMS USED FOR PARAB DISIN
24 SPC * 21 *DISPL BCS FROM C1 RUN, SUBNUM 4 * WASHEN * SYM BCS
25
26 BEGIN BULK

CARD COUNT	SORTED BLOCK DATA LCHU												
	1	2	3	4	5	6	7	8	9	10	11	12	13
1-	CBAR	1	0	291	1091	1052							
2-	CBAR	2	0	052	1052	1051							
3-	CBAR	3	0	291	252	1051							
4-	CHEXA	1012	1	1012	1005	1014	1015	11016	11009	*	299		
5-		29911014	11015										
6-	CHEXA	2005	2	1015	1014	1021	1022	11015	11014	*	365		
7-		30511021	11022										
8-	CHEXA	2010	2	1022	1021	1027	1028	11022	11021	*	430		
9-		43011027	11028										
10-	CHEXA	2015	2	1028	1027	1033	1034	11028	11027	*	495		
11-		49511033	11034										
12-	CHEXA	2020	2	1034	1033	1039	1040	11034	11033	*	560		
13-		56011039	11040										
14-	CHEXA	2025	2	1040	1039	1045	1046	11040	11039	*	625		
15-		62511045	11046										
16-	CHEXA	2030	2	1046	1045	1051	1052	11046	11045	*	690		
17-		69011051	11052										
18-	CHEXA	3005	3	1052	1051	1057	1058	11052	11051	*	755		
19-		75511057	11058										
20-	CHEXA	11012	11	11016	11009	11014	11015	21016	21009	*	300		
21-		30021014	21015										
22-	CHEXA	12005	12	11015	11014	11021	11022	21015	21014	*	368		
23-		36821021	21022										
24-	CHEXA	12010	12	11022	11021	11027	11028	21022	21021	*	431		
25-		43121027	21028										
26-	CHEXA	12015	12	11028	11027	11033	11034	21028	21027	*	496		
27-		49621033	21034										
28-	CHEXA	12020	12	11034	11033	11039	11040	21034	21033	*	561		
29-		56121039	21040										
30-	CHEXA	12025	12	11040	11039	11045	11046	21040	21039	*	626		
31-		62621045	21046										
32-	CHEXA	12030	12	11046	11045	11051	11052	21046	21045	*	691		
33-		69121051	21052										
34-	CHEXA	13005	13	11052	11051	11057	11058	21052	21051	*	756		
35-		75621057	21058										
36-	CHEXA	21012	21	21016	21009	21014	21015	31016	31009	*	301		
37-		30131014	31015										
38-	CHEXA	22005	22	21015	21014	21021	21022	31015	31014	*	367		
39-		36731021	31022										
40-	CHEXA	22010	22	21022	21021	21027	21028	31022	31021	*	432		
41-		43231027	31028										
42-	CHEXA	22015	22	21028	21027	21033	21034	31028	31027	*	497		
43-		49731033	31034										
44-	CHEXA	22020	22	21034	21033	21039	21040	31034	31033	*	562		
45-		56231039	31040										
46-	CHEXA	22025	22	21040	21039	21045	21046	31040	31039	*	627		
47-		62731045	31046										
48-	CHEXA	22030	22	21046	21045	21051	21052	31046	31045	*	692		
49-		69231051	31052										
50-	CHEXA	23005	23	21052	21051	21057	21058	31052	31051	*	757		

LARD COUNT	SUNTEC BULK DATA ECHO									
	1	2	3	4	5	6	7	8	9	10
51-	* 75731057	31058								
52-	CHEXA 31012	31	31016	31009	31014	31015	41016	41009	*	302
53-	* 30241014	41015								
54-	CHEXA 32005	32	31015	31014	31021	31022	41015	41014	*	368
55-	* 36841021	41022								
56-	CHEXA 32010	32	31022	31021	31027	31028	41022	41021	*	433
57-	* 43341027	41028								
58-	CHEXA 32015	32	31028	31027	31033	31034	41028	41027	*	498
59-	* 49841033	41034								
60-	CHEXA 32020	32	31034	31033	31039	31040	41034	41033	*	563
61-	* 56341039	41040								
62-	CHEXA 32025	32	31040	31039	31045	31046	41040	41039	*	628
63-	* 62841045	41046								
64-	CHEXA 32030	32	31046	31045	31051	31052	41046	41045	*	693
65-	* 69341051	41052								
66-	CHEXA 33005	33	31052	31051	31057	31058	41052	41051	*	758
67-	* 75841057	41058								
68-	CHEXA 41012	41	41016	41009	41014	41015	51016	51009	*	303
69-	* 30351014	51015								
70-	CHEXA 42005	42	41015	41014	41021	41022	51015	51014	*	369
71-	* 36951021	51022								
72-	CHEXA 42010	42	41022	41021	41027	41028	51022	51021	*	434
73-	* 43451027	51028								
74-	CHEXA 42015	42	41028	41027	41033	41034	51028	51027	*	499
75-	* 49951033	51034								
76-	CHEXA 42020	42	41034	41033	41039	41040	51034	51033	*	564
77-	* 56451039	51040								
78-	CHEXA 42025	42	41040	41039	41045	41046	51040	51039	*	629
79-	* 62951045	51046								
80-	CHEXA 42030	42	41046	41045	41051	41052	51046	51045	*	694
81-	* 69451051	51052								
82-	CHEXA 43005	43	41052	41051	41057	41058	51052	51051	*	759
83-	* 75951057	51058								
84-	CHEXA 51012	51	51016	51009	51014	51015	61016	61009	*	304
85-	* 30461014	61015								
86-	CHEXA 52005	52	51015	51014	51021	51022	61015	61014	*	370
87-	* 37061021	61022								
88-	CHEXA 52010	52	51022	51021	51027	51028	61022	61021	*	435
89-	* 43561027	61028								
90-	CHEXA 52015	52	51028	51027	51033	51034	61028	61027	*	500
91-	* 50061033	61034								
92-	CHEXA 52020	52	51034	51033	51039	51040	61034	61033	*	565
93-	* 56561039	61040								
94-	CHEXA 52025	52	51040	51039	51045	51046	61040	61039	*	630
95-	* 63061045	61046								
96-	CHEXA 52030	52	51046	51045	51051	51052	61046	61045	*	695
97-	* 69561051	61052								
98-	CHEXA 53005	53	51052	51051	51057	51058	61052	61051	*	760
99-	* 76061057	61058								
100-	CHEXA 61012	61	61016	61009	61014	61015	71016	71009	*	305

CARD COUNT	S U K T I L B U L K D A T A E L H U										
	1	2	3	4	5	6	7	8	9	10	
101-	+	30971014	71015								
102-	CHEXA	82005	82	81015	81014	81021	81022	71015	71014	+	371
103-	+	37171021	71022								
104-	CHEXA	82010	82	81022	81021	81027	81028	71022	71021	+	438
105-	+	43871027	71028								
106-	CHEXA	82015	82	81028	81027	81033	81034	71028	71027	+	501
107-	+	50171033	71034								
108-	CHEXA	82020	82	81034	81033	81039	81040	71034	71033	+	568
109-	+	56871039	71040								
110-	CHEXA	82025	82	81040	81039	81045	81046	71040	71039	+	631
111-	+	63171045	71046								
112-	CHEXA	82030	82	81046	81045	81051	81052	71046	71045	+	698
113-	+	69871051	71052								
114-	CHEXA	83005	83	81052	81051	81057	81058	71052	71051	+	761
115-	+	76171057	71058								
116-	CHEXA	71012	71	71016	71009	71014	71015	81016	81009	+	308
117-	+	30881014	81015								
118-	CHEXA	72005	72	71015	71014	71021	71022	81015	81014	+	372
119-	+	37281021	81022								
120-	CHEXA	72010	72	71022	71021	71027	71028	81022	81021	+	437
121-	+	43781027	81028								
122-	CHEXA	72015	72	71028	71027	71033	71034	81028	81027	+	502
123-	+	50281033	81034								
124-	CHEXA	72020	72	71034	71033	71039	71040	81034	81033	+	567
125-	+	56781039	81040								
126-	CHEXA	72025	72	71040	71039	71045	71046	81040	81039	+	632
127-	+	63281045	81046								
128-	CHEXA	72030	72	71046	71045	71051	71052	81046	81045	+	697
129-	+	69781051	81052								
130-	CHEXA	73005	73	71052	71051	71057	71058	81052	81051	+	762
131-	+	76281057	81058								
132-	CHEXA	81012	81	81016	81009	81014	81015	91016	91009	+	307
133-	+	30791014	91015								
134-	CHEXA	82005	82	81015	81014	81021	81022	91015	91014	+	373
135-	+	37391021	91022								
136-	CHEXA	82010	82	81022	81021	81027	81028	91022	91021	+	439
137-	+	43991027	91028								
138-	CHEXA	82015	82	81028	81027	81033	81034	91028	91027	+	503
139-	+	50391033	91034								
140-	CHEXA	82020	82	81034	81033	81039	81040	91034	91033	+	569
141-	+	56891039	91040								
142-	CHEXA	82025	82	81040	81039	81045	81046	91040	91039	+	633
143-	+	63391045	91046								
144-	CHEXA	82030	82	81046	81045	81051	81052	91046	91045	+	699
145-	+	69891051	91052								
146-	CHEXA	83005	83	81052	81051	81057	81058	91052	91051	+	763
147-	+	76391057	91058								
148-	CHEXA	91012	91	91016	91009	91014	91015	101016	101009	+	309
149-	+	30891014	101015								
150-	CHEXA	92005	92	91015	91014	91021	91022	101015	101014	+	374

CARD COUNT	1	2	3	4	5	6	7	8	9	10
151-	*	374101021	101022							
152-	CHEXA	92010	92	91022	91021	91027	91028	101022	101021	* 439
153-	*	439101027	101028							
154-	CHEXA	92015	92	91028	91027	91033	91034	101028	101027	* 504
155-	*	504101033	101034							
156-	CHEXA	92020	92	91034	91033	91039	91040	101034	101033	* 569
157-	*	569101039	101040							
158-	CHEXA	92025	92	91040	91039	91045	91046	101040	101039	* 634
159-	*	634101045	101046							
160-	CHEXA	92030	92	91046	91045	91051	91052	101046	101045	* 699
161-	*	699101051	101052							
162-	CHEXA	93005	93	91052	91051	91057	91058	101052	101051	* 764
163-	*	764101057	101058							
164-	CHEXA	101012	101	101016	101004	101014	101015	111016	111004	* 309
165-	*	309111014	111015							
166-	CHEXA	102005	102	101015	101014	101021	101022	111015	111014	* 375
167-	*	375111021	111022							
168-	CHEXA	102010	102	101022	101021	101027	101028	111022	111021	* 440
169-	*	440111027	111028							
170-	CHEXA	102015	102	101028	101027	101033	101034	111028	111027	* 505
171-	*	505111033	111034							
172-	CHEXA	102020	102	101034	101033	101039	101040	111034	111033	* 570
173-	*	570111039	111040							
174-	CHEXA	102025	102	101040	101039	101045	101046	111040	111039	* 635
175-	*	635111045	111046							
176-	CHEXA	102030	102	101046	101045	101051	101052	111046	111045	* 700
177-	*	700111051	111052							
178-	CHEXA	103005	103	101052	101051	101057	101058	111052	111051	* 765
179-	*	765111057	111058							
180-	CHEXA	111012	111	111016	111004	111014	111015	121016	121004	* 310
181-	*	310121014	121015							
182-	CHEXA	112005	112	111015	111014	111021	111022	121015	121014	* 376
183-	*	376121021	121022							
184-	CHEXA	112010	112	111022	111021	111027	111028	121022	121021	* 441
185-	*	441121027	121028							
186-	CHEXA	112015	112	111028	111027	111033	111034	121028	121027	* 506
187-	*	506121033	121034							
188-	CHEXA	112020	112	111034	111033	111039	111040	121034	121033	* 571
189-	*	571121039	121040							
190-	CHEXA	112025	112	111040	111039	111045	111046	121040	121039	* 636
191-	*	636121045	121046							
192-	CHEXA	112030	112	111046	111045	111051	111052	121046	121045	* 701
193-	*	701121051	121052							
194-	CHEXA	113005	113	111052	111051	111057	111058	121052	121051	* 766
195-	*	766121057	121058							
196-	CHEXA	121012	121	121016	121004	121014	121015	131016	131004	* 311
197-	*	311131014	131015							
198-	CHEXA	122005	122	121015	121014	121021	121022	131015	131014	* 377
199-	*	377131021	131022							
200-	CHEXA	122010	122	121022	121021	121027	121028	131022	131021	* 442

SORTED BULK DATA LIST

CARD COUNT	1	2	3	4	5	6	7	8	9	10
201-	442131027	131020								
202-	CHEXA 122015	122	121028	121027	121033	121034	131028	131027		507
203-	507131033	131034								
204-	CHEXA 122020	122	121034	121033	121039	121040	131034	131033		512
205-	512131039	131040								
206-	CHEXA 122025	122	121046	121039	121045	121046	131040	131039		637
207-	637131045	131046								
208-	CHEXA 122030	122	121046	121045	121051	121052	131046	131045		702
209-	702131051	131052								
210-	CHEXA 122005	123	121052	121051	121057	121058	131052	131051		767
211-	767131057	131058								
212-	CURDZC 100		.6700	.1700	.0	.6700	.1700	1.0		312
213-	3121.6700	.1700	.0	.5	.0	.0	.5	.1		466
214-	TURDZK 50		.0	.5	.0	.0	.5	.1		466
215-	466TURDZK	.0	.6	.0						
216-	CRUSE1									
217-	CRID 251	100	.05	.0	.1					
218-	CRID 252	100	.05	.0	.0					
219-	CRID 1009		.6291	.2950	.1000					
220-	CRID 1014		.6700	.2950	.1000					
221-	CRID 1015		.6700	.2950	.0					
222-	CRID 1016		.6500	.2950	.0					
223-	CRID 1021	100	.1250	75.0000	.1000					
224-	CRID 1022	100	.1250	75.0000	.0					
225-	CRID 1027	100	.1250	60.0000	.1000					
226-	CRID 1028	100	.1250	60.0000	.0					
227-	CRID 1033	100	.1250	45.0000	.1000					
228-	CRID 1034	100	.1250	45.0000	.0					
229-	CRID 1039	100	.1250	30.0000	.1000					
230-	CRID 1040	100	.1250	30.0000	.0					
231-	CRID 1045	100	.1250	15.0000	.1000					
232-	CRID 1046	100	.1250	15.0000	.0					
233-	CRID 1051	100	.1250	.0	.1000					
234-	CRID 1052	100	.1250	.0	.0					
235-	CRID 1057		.7450	.0	.1000					
236-	CRID 1058		.7450	.0	.0					
237-	CRID 11004		.6291	.3050	.1000					
238-	CRID 11014		.6700	.3050	.1000					
239-	CRID 11015		.6700	.3050	.0					
240-	CRID 11016		.6500	.3050	.0					
241-	CRID 11021	100	.1250	75.0000	.1000					
242-	CRID 11022	100	.1250	75.0000	.0					
243-	CRID 11027	100	.1250	60.0000	.1000					
244-	CRID 11028	100	.1250	60.0000	.0					
245-	CRID 11033	100	.1250	45.0000	.1000					
246-	CRID 11034	100	.1250	45.0000	.0					
247-	CRID 11039	100	.1250	30.0000	.1000					
248-	CRID 11040	100	.1250	30.0000	.0					
249-	CRID 11045	100	.1250	15.0000	.1000					
250-	CRID 11046	100	.1250	15.0000	.0					

SUBTLE BULK DATA ECHO

LAKU CUUNJ	1	2	3	4	5	6	7	8	9	10
251-	GR1D	11051	100	.1350	.0	.1000				
252-	GR1D	11052	100	.1350	.0	.0				
253-	GR1D	11057		.8050	.0	.1000				
254-	GR1D	11058		.8050	.0	.0				
255-	GR1D	21005		.6291	.3150	.1000				
256-	GR1D	21014		.6700	.3150	.1000				
257-	GR1D	21015		.6700	.3150	.0				
258-	GR1D	21016		.6500	.3150	.0				
259-	GR1D	21021	100	.1450	75.0000	.1000				
260-	GR1D	21022	100	.1450	75.0000	.0				
261-	GR1D	21027	100	.1450	60.0000	.1000				
262-	GR1D	21028	100	.1450	60.0000	.0				
263-	GR1D	21033	100	.1450	45.0000	.1000				
264-	GR1D	21034	100	.1450	45.0000	.0				
265-	GR1D	21039	100	.1450	30.0000	.1000				
266-	GR1D	21040	100	.1450	30.0000	.0				
267-	GR1D	21045	100	.1450	15.0000	.1000				
268-	GR1D	21046	100	.1450	15.0000	.0				
269-	GR1D	21051	100	.1450	.0	.1000				
270-	GR1D	21052	100	.1450	.0	.0				
271-	GR1D	21057		.8150	.0	.1000				
272-	GR1D	21058		.8150	.0	.0				
273-	GR1D	31009		.6291	.3150	.1000				
274-	GR1D	31014		.6700	.3150	.1000				
275-	GR1D	31015		.6700	.3150	.0				
276-	GR1D	31016		.6500	.3150	.0				
277-	GR1D	31021	100	.1550	75.0000	.1000				
278-	GR1D	31022	100	.1550	75.0000	.0				
279-	GR1D	31027	100	.1550	60.0000	.1000				
280-	GR1D	31028	100	.1550	60.0000	.0				
281-	GR1D	31033	100	.1550	45.0000	.1000				
282-	GR1D	31034	100	.1550	45.0000	.0				
283-	GR1D	31039	100	.1550	30.0000	.1000				
284-	GR1D	31040	100	.1550	30.0000	.0				
285-	GR1D	31045	100	.1550	15.0000	.1000				
286-	GR1D	31046	100	.1550	15.0000	.0				
287-	GR1D	31051	100	.1550	.0	.1000				
288-	GR1D	31052	100	.1550	.0	.0				
289-	GR1D	31057		.8250	.0	.1000				
290-	GR1D	31058		.8250	.0	.0				
291-	GR1D	41009		.6291	.3150	.1000				
292-	GR1D	41014		.6700	.3150	.1000				
293-	GR1D	41015		.6700	.3150	.0				
294-	GR1D	41016		.6500	.3150	.0				
295-	GR1D	41021	100	.1650	75.0000	.1000				
296-	GR1D	41022	100	.1650	75.0000	.0				
297-	GR1D	41027	100	.1650	60.0000	.1000				
298-	GR1D	41028	100	.1650	60.0000	.0				
299-	GR1D	41033	100	.1650	45.0000	.1000				
300-	GR1D	41034	100	.1650	45.0000	.0				

COMPOSITE BRACKET MODEL C2.2 (STACK SLO 2, PHASE 2)
ONE STRIP ALONG SYM LINE WITH 13 UNEQUAL LAYERS

OCTOBER 20, 1970 HASIRAN 3/11/70

SORTED BULK DATA ELMU

LARD COUNT	1	2	3	4	5	6	7	8	9	10
301-	GR10	41039	100	.1650	30.0000	.1000				
302-	GR10	41040	100	.1650	30.0000	.0				
303-	GR10	41045	100	.1650	15.0000	.1000				
304-	GR10	41046	100	.1650	15.0000	.0				
305-	GR10	41051	100	.1650	.0	.1000				
306-	GR10	41052	100	.1650	.0	.0				
307-	GR10	41057		.8350	.0	.1000				
308-	GR10	41058		.8350	.0	.0				
309-	GR10	51009		.6291	.3450	.1000				
310-	GR10	51014		.6700	.3450	.1000				
311-	GR10	51015		.6700	.3450	.0				
312-	GR10	51016		.6500	.3450	.0				
313-	GR10	51021	100	.1750	75.0000	.1000				
314-	GR10	51022	100	.1750	75.0000	.0				
315-	GR10	51027	100	.1750	60.0000	.1000				
316-	GR10	51028	100	.1750	60.0000	.0				
317-	GR10	51033	100	.1750	45.0000	.1000				
318-	GR10	51034	100	.1750	45.0000	.0				
319-	GR10	51039	100	.1750	30.0000	.1000				
320-	GR10	51040	100	.1750	30.0000	.0				
321-	GR10	51045	100	.1750	15.0000	.1000				
322-	GR10	51046	100	.1750	15.0000	.0				
323-	GR10	51051	100	.1750	.0	.1000				
324-	GR10	51052	100	.1750	.0	.0				
325-	GR10	51057		.8450	.0	.1000				
326-	GR10	51058		.8450	.0	.0				
327-	GR10	61009		.6291	.3550	.1000				
328-	GR10	61014		.6700	.3550	.1000				
329-	GR10	61015		.6700	.3550	.0				
330-	GR10	61016		.6500	.3550	.0				
331-	GR10	61021	100	.1850	75.0000	.1000				
332-	GR10	61022	100	.1850	75.0000	.0				
333-	GR10	61027	100	.1850	60.0000	.1000				
334-	GR10	61028	100	.1850	60.0000	.0				
335-	GR10	61033	100	.1850	45.0000	.1000				
336-	GR10	61034	100	.1850	45.0000	.0				
337-	GR10	61039	100	.1850	30.0000	.1000				
338-	GR10	61040	100	.1850	30.0000	.0				
339-	GR10	61045	100	.1850	15.0000	.1000				
340-	GR10	61046	100	.1850	15.0000	.0				
341-	GR10	61051	100	.1850	.0	.1000				
342-	GR10	61052	100	.1850	.0	.0				
343-	GR10	61057		.8550	.0	.1000				
344-	GR10	61058		.8550	.0	.0				
345-	GR10	71009		.6291	.3600	.1000				
346-	GR10	71014		.6700	.3600	.1000				
347-	GR10	71015		.6700	.3600	.0				
348-	GR10	71016		.6500	.3600	.0				
349-	GR10	71021	100	.1900	75.0000	.1000				
350-	GR10	71022	100	.1900	75.0000	.0				

COMPOSITE BRACKET MODEL C2.2 (STACK SEQ 2, PHASE 2)
ONE STRIP ALONG SYN LINE WITH 13 UNEQUAL LAYERS

OCTOBER 26, 1970 NASIKAN 3/11/70

SORTED BULK DATA LCHU

CARD COUNT	1	2	3	4	5	6	7	8	9	10
351-	GRID	71027	100	.1900	66.0000	.1000				
352-	GRID	71028	100	.1900	66.0000	.0				
353-	GRID	71033	100	.1900	45.0000	.1000				
354-	GRID	71034	100	.1900	45.0000	.0				
355-	GRID	71034	100	.1900	30.0000	.1000				
356-	GRID	71040	100	.1900	30.0000	.0				
357-	GRID	71045	100	.1900	15.0000	.1000				
358-	GRID	71046	100	.1900	15.0000	.0				
359-	GRID	71051	100	.1900	.0	.1000				
360-	GRID	71052	100	.1900	.0	.0				
361-	GRID	71057		.0600	.0	.1000				
362-	GRID	71058		.0600	.0	.0				
363-	GRID	81009		.6291	.3700	.1000				
364-	GRID	81014		.6700	.3700	.1000				
365-	GRID	81015		.6700	.3700	.0				
366-	GRID	81016		.6500	.3700	.0				
367-	GRID	81021	100	.2000	75.0000	.1000				
368-	GRID	81022	100	.2000	75.0000	.0				
369-	GRID	81027	100	.2000	60.0000	.1000				
370-	GRID	81028	100	.2000	60.0000	.0				
371-	GRID	81033	100	.2000	45.0000	.1000				
372-	GRID	81034	100	.2000	45.0000	.0				
373-	GRID	81034	100	.2000	30.0000	.1000				
374-	GRID	81040	100	.2000	30.0000	.0				
375-	GRID	81045	100	.2000	15.0000	.1000				
376-	GRID	81046	100	.2000	15.0000	.0				
377-	GRID	81051	100	.2000	.0	.1000				
378-	GRID	81052	100	.2000	.0	.0				
379-	GRID	81057		.6700	.0	.1000				
380-	GRID	81058		.6291	.3700	.0				
381-	GRID	91009		.6700	.3700	.1000				
382-	GRID	91014		.6700	.3700	.0				
383-	GRID	91015		.6700	.3700	.0				
384-	GRID	91016		.6500	.3700	.0				
385-	GRID	91021	100	.2100	75.0000	.1000				
386-	GRID	91022	100	.2100	75.0000	.0				
387-	GRID	91027	100	.2100	60.0000	.1000				
388-	GRID	91028	100	.2100	60.0000	.0				
389-	GRID	91033	100	.2100	45.0000	.1000				
390-	GRID	91034	100	.2100	45.0000	.0				
391-	GRID	91034	100	.2100	30.0000	.1000				
392-	GRID	91040	100	.2100	30.0000	.0				
393-	GRID	91045	100	.2100	15.0000	.1000				
394-	GRID	91046	100	.2100	15.0000	.0				
395-	GRID	91051	100	.2100	.0	.1000				
396-	GRID	91052	100	.2100	.0	.0				
397-	GRID	91057		.6600	.0	.1000				
398-	GRID	91058		.6200	.0	.0				
399-	GRID	101009		.6291	.3700	.1000				
400-	GRID	101014		.6700	.3700	.1000				

15
P

SORTED BULK DATA ECHO

CARD		1	2	3	4	5	6	7	8	9	10
401-	GRID	101015			.2700	.3500	.0				
402-	GRID	101016			.6500	.3900	.0				
403-	GRID	101021	100		.2200	75.0000	.1000				
404-	GRID	101022	100		.2200	75.0000	.0				
405-	GRID	101027	100		.2200	60.0000	.1000				
406-	GRID	101028	100		.2200	60.0000	.0				
407-	GRID	101033	100		.2200	45.0000	.1000				
408-	GRID	101034	100		.2200	45.0000	.0				
409-	GRID	101039	100		.2200	30.0000	.1000				
410-	GRID	101040	100		.2200	30.0000	.0				
411-	GRID	101045	100		.2200	15.0000	.1000				
412-	GRID	101046	100		.2200	15.0000	.0				
413-	GRID	101051	100		.2200	.0	.1000				
414-	GRID	101052	100		.2200	.0	.0				
415-	GRID	101057			.0900	.0	.1000				
416-	GRID	101058			.0900	.0	.0				
417-	GRID	111009			.6291	.4000	.1000				
418-	GRID	111014			.6700	.4000	.1000				
419-	GRID	111015			.6700	.4000	.0				
420-	GRID	111016			.6500	.4000	.0				
421-	GRID	111021	100		.2300	75.0000	.1000				
422-	GRID	111022	100		.2300	75.0000	.0				
423-	GRID	111027	100		.2300	60.0000	.1000				
424-	GRID	111028	100		.2300	60.0000	.0				
425-	GRID	111033	100		.2300	45.0000	.1000				
426-	GRID	111034	100		.2300	45.0000	.0				
427-	GRID	111039	100		.2300	30.0000	.1000				
428-	GRID	111040	100		.2300	30.0000	.0				
429-	GRID	111045	100		.2300	15.0000	.1000				
430-	GRID	111046	100		.2300	15.0000	.0				
431-	GRID	111051	100		.2300	.0	.1000				
432-	GRID	111052	100		.2300	.0	.0				
433-	GRID	111057			.0900	.0	.1000				
434-	GRID	111058			.0900	.0	.0				
435-	GRID	121009			.6291	.4100	.1000				
436-	GRID	121014			.6700	.4100	.1000				
437-	GRID	121015			.6700	.4100	.0				
438-	GRID	121016			.6500	.4100	.0				
439-	GRID	121021	100		.2400	75.0000	.1000				
440-	GRID	121022	100		.2400	75.0000	.0				
441-	GRID	121027	100		.2400	60.0000	.1000				
442-	GRID	121028	100		.2400	60.0000	.0				
443-	GRID	121033	100		.2400	45.0000	.1000				
444-	GRID	121034	100		.2400	45.0000	.0				
445-	GRID	121039	100		.2400	30.0000	.1000				
446-	GRID	121040	100		.2400	30.0000	.0				
447-	GRID	121045	100		.2400	15.0000	.1000				
448-	GRID	121046	100		.2400	15.0000	.0				
449-	GRID	121051	100		.2400	.0	.1000				
450-	GRID	121052	100		.2400	.0	.0				

15
B

SORTED BULK DATA LIST

CARD	1	2	3	4	5	6	7	8	9	10
451-	GRID	121057		.9100	.0	.1000				
452-	GRID	121058		.9100	.0	.1000				
453-	GRID	131009		.6291	.4200	.1000				
454-	GRID	131014		.6700	.4200	.1000				
455-	GRID	131015		.6700	.4200	.0				
456-	GRID	131016		.6500	.4200	.0				
457-	GRID	131021	100	.2500	75.0000	.1000				
458-	GRID	131022	100	.2500	75.0000	.0				
459-	GRID	131027	100	.2500	60.0000	.1000				
460-	GRID	131028	100	.2500	60.0000	.0				
461-	GRID	131033	100	.2500	45.0000	.1000				
462-	GRID	131034	100	.2500	45.0000	.0				
463-	GRID	131039	100	.2500	30.0000	.1000				
464-	GRID	131040	100	.2500	30.0000	.0				
465-	GRID	131045	100	.2500	15.0000	.1000				
466-	GRID	131046	100	.2500	15.0000	.0				
467-	GRID	131051	100	.2500	.0	.1000				
468-	GRID	131052	100	.2500	.0	.0				
469-	GRID	131057		.9200	.0	.1000				
470-	GRID	131058		.9200	.0	.0				
471-	MAT	7	3.75	1.75	0.0	1.				
472-	MAT	1	1.7200	4.7200	4.5500	.0	.0	2.1100	ELAS001	
473-	ELAS001	4.7200	.0	.0	.0	1.7200	.0	.0	ELAS002	
474-	ELAS002	6.5000	.0	.0	6.5000	.0	6.0000	.0		
475-	MAT	2	1.7200	4.6400	4.6400	.0	.0	6.6000	ELAS001	
476-	ELAS001	5.3000	.0	.0	.0	6.6000	.0	.0	ELAS002	
477-	ELAS002	6.2500	.0	.0	5.4000	.0	6.2500	.0		
478-	PMAX	6		.01	.01	.01				
479-	PSULID	1	1	50						
480-	PSULID	2	1	100						
481-	PSULID	3	1	0						
482-	PSULID	11	2	50						
483-	PSULID	12	2	100						
484-	PSULID	13	2	0						
485-	PSULID	21	1	50						
486-	PSULID	22	1	100						
487-	PSULID	23	1	0						
488-	PSULID	31	2	50						
489-	PSULID	32	2	100						
490-	PSULID	33	2	0						
491-	PSULID	41	1	50						
492-	PSULID	42	1	100						
493-	PSULID	43	1	0						
494-	PSULID	51	2	50						
495-	PSULID	52	2	100						
496-	PSULID	53	2	0						
497-	PSULID	61	1	50						
498-	PSULID	62	1	100						
499-	PSULID	63	1	0						
500-	PSULID	71	2	50						

CARD COUNT	SORTED BULK DATA LENGTH									
	1	2	3	4	5	6	7	8	9	10
501-	PSULID	72	2	100						
502-	PSULID	73	2	0						
503-	PSULID	81	1	50						
504-	PSULID	82	1	100						
505-	PSULID	83	1	0						
506-	PSULID	91	2	50						
507-	PSULID	92	2	100						
508-	PSULID	93	2	0						
509-	PSULID	101	1	50						
510-	PSULID	102	1	100						
511-	PSULID	103	1	0						
512-	PSULID	111	2	50						
513-	PSULID	112	2	100						
514-	PSULID	113	2	0						
515-	PSULID	121	1	50						
516-	PSULID	122	1	100						
517-	PSULID	123	1	0						
518-	MSPLINE	5001	1.0	1014	11014	123	21014	123	31014	5001
519-	5001	123	41014	123	51014	123	61014	123	71014	5101
520-	5101	123	81014	123	91014	123	101014	123	111014	5201
521-	5201	123	121014	123	131014					
522-	MSPLINE	5002	1.0	1015	11015	12	21015	12	31015	5002
523-	5002	12	41015	12	51015	12	61015	12	71015	5102
524-	5102	12	81015	12	91015	12	101015	12	111015	5202
525-	5202	12	121015	12	131015					
526-	MSPLINE	5003	1.0	1021	11021	123	21021	123	31021	5003
527-	5003	123	41021	123	51021	123	61021	123	71021	5103
528-	5103	123	81021	123	91021	123	101021	123	111021	5203
529-	5203	123	121021	123	131021					
530-	MSPLINE	5004	1.0	1022	11022	12	21022	12	31022	5004
531-	5004	12	41022	12	51022	12	61022	12	71022	5104
532-	5104	12	81022	12	91022	12	101022	12	111022	5204
533-	5204	12	121022	12	131022					
534-	MSPLINE	5005	1.0	1027	11027	123	21027	123	31027	5005
535-	5005	123	41027	123	51027	123	61027	123	71027	5105
536-	5105	123	81027	123	91027	123	101027	123	111027	5205
537-	5205	123	121027	123	131027					
538-	MSPLINE	5006	1.0	1028	11028	12	21028	12	31028	5006
539-	5006	12	41028	12	51028	12	61028	12	71028	5106
540-	5106	12	81028	12	91028	12	101028	12	111028	5206
541-	5206	12	121028	12	131028					
542-	MSPLINE	5007	1.0	1033	11033	123	21033	123	31033	5007
543-	5007	123	41033	123	51033	123	61033	123	71033	5107
544-	5107	123	81033	123	91033	123	101033	123	111033	5207
545-	5207	123	121033	123	131033					
546-	MSPLINE	5008	1.0	1034	11034	12	21034	12	31034	5008
547-	5008	12	41034	12	51034	12	61034	12	71034	5108
548-	5108	12	81034	12	91034	12	101034	12	111034	5208
549-	5208	12	121034	12	131034					
550-	MSPLINE	5009	1.0	1039	11039	123	21039	123	31039	5009

SUNTED BULK DATA ELMU

CARD COUNT	1	2	3	4	5	6	7	8	9	10
551-	5009	123	41039	123	51039	123	61039	123	71039	5109
552-	5010	123	61039	123	51039	123	101039	123	111039	5209
553-	5020	123	121039	123	131039					
554-	MSPLINE	5010	1.0	1040	11040	12	21040	12	31040	5010
555-	5010	12	41040	12	51040	12	61040	12	71040	5110
556-	5010	12	81040	12	91040	12	101040	12	111040	5210
557-	5020	12	121040	12	131040					
558-	MSPLINE	5011	1.0	1045	11045	123	21045	123	31045	5011
559-	5011	123	41045	123	51045	123	61045	123	71045	5111
560-	5011	123	81045	123	91045	123	101045	123	111045	5211
561-	5021	123	121045	123	131045					
562-	MSPLINE	5012	1.0	1046	11046	12	21046	12	31046	5012
563-	5012	12	41046	12	51046	12	61046	12	71046	5112
564-	5012	12	81046	12	91046	12	101046	12	111046	5212
565-	5022	12	121046	12	131046					
566-	MSPLINE	5013	1.0	1051	11051	123	21051	123	31051	5013
567-	5013	123	41051	123	51051	123	61051	123	71051	5113
568-	5013	123	81051	123	91051	123	101051	123	111051	5213
569-	5023	123	121051	123	131051					
570-	MSPLINE	5014	1.0	1052	11052	12	21052	12	31052	5014
571-	5014	12	41052	12	51052	12	61052	12	71052	5114
572-	5014	12	81052	12	91052	12	101052	12	111052	5214
573-	5024	12	121052	12	131052					
574-	MSPLINE	5015	1.0	1057	11057	123	21057	123	31057	5015
575-	5015	123	41057	123	51057	123	61057	123	71057	5115
576-	5015	123	81057	123	91057	123	101057	123	111057	5215
577-	5025	123	121057	123	131057					
578-	MSPLINE	5016	1.0	1058	11058	12	21058	12	31058	5016
579-	5016	12	41058	12	51058	12	61058	12	71058	5116
580-	5016	12	81058	12	91058	12	101058	12	111058	5216
581-	5026	12	121058	12	131058					
582-	SE06P	251	1	252	2	1009	19	1019	20	
583-	SE06P	1015	11	1016	10	1021	15	1022	10	
584-	SE06P	1027	13	1028	14	1032	11	1034	12	
585-	SE06P	1034	9	1040	10	1045	7	1046	8	
586-	SE06P	1051	5	1052	6	1057	3	1058	4	
587-	SE06P	11009	21	11014	24	11019	23	11016	22	
588-	SE06P	11021	25	11022	26	11027	27	11028	28	
589-	SE06P	11033	29	11034	30	11039	31	11040	32	
590-	SE06P	11045	33	11046	34	11051	35	11052	36	
591-	SE06P	11057	37	11058	38	21009	39	21014	42	
592-	SE06P	21015	41	21016	40	21021	43	21022	44	
593-	SE06P	21027	45	21028	46	21033	47	21034	48	
594-	SE06P	21039	49	21040	50	21045	51	21046	52	
595-	SE06P	21051	53	21052	54	21057	55	21058	56	
596-	SE06P	31009	57	31014	60	31019	59	31016	58	
597-	SE06P	31021	61	31022	62	31027	63	31028	64	
598-	SE06P	31033	65	31034	66	31039	67	31040	68	
599-	SE06P	31045	69	31046	70	31051	71	31052	72	
600-	SE06P	31057	73	31058	74	41009	75	41014	78	

SUMMARY BULK DATA ECHU

CARD	1	2	3	4	5	6	7	8	9	10
601-	SEGRP	41015	71	41016	76	41021	79	41022	80	
602-	SEGRP	41027	81	41028	82	41033	83	41034	84	
603-	SEGRP	41039	85	41040	86	41045	87	41046	88	
604-	SEGRP	41051	89	41052	90	41057	91	41058	92	
605-	SEGRP	51009	93	51014	96	51015	95	51016	94	
606-	SEGRP	51021	97	51022	98	51027	99	51028	100	
607-	SEGRP	51033	101	51034	102	51039	103	51040	104	
608-	SEGRP	51045	105	51046	106	51051	107	51052	108	
609-	SEGRP	51057	109	51058	110	61009	111	61014	114	
610-	SEGRP	61015	113	61016	112	61021	115	61022	116	
611-	SEGRP	61027	117	61028	118	61033	119	61034	120	
612-	SEGRP	61039	121	61040	122	61045	123	61046	124	
613-	SEGRP	61051	125	61052	126	61057	127	61058	128	
614-	SEGRP	71009	129	71014	132	71015	131	71016	130	
615-	SEGRP	71021	133	71022	134	71027	135	71028	136	
616-	SEGRP	71033	137	71034	138	71039	139	71040	140	
617-	SEGRP	71045	141	71046	142	71051	143	71052	144	
618-	SEGRP	71057	145	71058	146	81009	147	81014	150	
619-	SEGRP	81015	149	81016	148	81021	151	81022	152	
620-	SEGRP	81027	153	81028	154	81033	155	81034	156	
621-	SEGRP	81039	157	81040	158	81045	159	81046	160	
622-	SEGRP	81051	161	81052	162	81057	163	81058	164	
623-	SEGRP	91009	165	91014	168	91015	167	91016	166	
624-	SEGRP	91021	169	91022	170	91027	171	91028	172	
625-	SEGRP	91033	173	91034	174	91039	175	91040	176	
626-	SEGRP	91045	177	91046	178	91051	179	91052	180	
627-	SEGRP	91057	181	91058	182	101009	183	101014	186	
628-	SEGRP	101015	185	101016	184	101021	187	101022	188	
629-	SEGRP	101027	189	101028	190	101033	191	101034	192	
630-	SEGRP	101039	193	101040	194	101045	195	101046	196	
631-	SEGRP	101051	197	101052	198	101057	199	101058	200	
632-	SEGRP	111009	201	111014	204	111015	203	111016	202	
633-	SEGRP	111021	205	111022	206	111027	207	111028	208	
634-	SEGRP	111033	209	111034	210	111039	211	111040	212	
635-	SEGRP	111045	213	111046	214	111051	215	111052	216	
636-	SEGRP	111057	217	111058	218	121009	219	121014	222	
637-	SEGRP	121015	223	121016	224	121021	227	121022	228	
638-	SEGRP	121027	231	121028	232	121033	235	121034	236	
639-	SEGRP	121039	239	121040	240	121045	243	121046	244	
640-	SEGRP	121051	247	121052	248	121057	249	121058	250	
641-	SEGRP	131009	251	131014	254	131015	253	131016	252	
642-	SEGRP	131021	255	131022	256	131027	259	131028	260	
643-	SEGRP	131033	257	131034	258	131039	261	131040	262	
644-	SEGRP	131045	259	131046	264	131051	263	131052	262	
645-	SEGRP	131057	263	131058	264					
646-	SPL	1	1014	1	-4.34E-51014	1	-1.08E-4			
647-	SPL	1	1015	3	1.52E-6					
648-	SPL	1	1015	1	-2.10E-51015	1	-4.14E-5			
649-	SPL	1	1021	1	-7.07E-51021	1	-2.30E-4			
650-	SPL	1	1021	3	1.55E-6					

SUNIEL BULK DATA ECHO

CAKU CUUNI	1	2	3	4	5	6	7	8	9	10
651-	SPC	1	1022	1	-1.09E-51022	2	-2.60E-4			
652-	SPC	1	1027	1	-1.74E-41027	2	-3.89E-4			
653-	SPC	1	1027	3	1.22E-7					
654-	SPC	1	1028	1	-1.73E-41028	2	-3.75E-4			
655-	SPC	1	1033	1	-2.74E-41033	2	-5.04E-4			
656-	SPC	1	1033	3	-1.03E-6					
657-	SPC	1	1034	1	-2.78E-41034	2	-4.98E-4			
658-	SPC	1	1034	1	-3.75E-41034	2	-5.85E-4			
659-	SPC	1	1034	3	-2.50E-6					
660-	SPC	1	1040	1	-3.92E-41040	2	-5.82E-4			
661-	SPC	1	1045	1	-4.91E-41045	2	-6.30E-4			
662-	SPC	1	1045	3	-3.30E-6					
663-	SPC	1	1046	1	-5.00E-41046	2	-6.28E-4			
664-	SPC	1	1051	1	-5.81E-41051	2	-6.45E-4			
665-	SPC	1	1051	3	-3.26E-6					
666-	SPC	1	1052	1	-5.88E-41052	2	-6.43E-4			
667-	SPC	1	1057	1	-1.00E-51057	2	-6.60E-4			
668-	SPC	1	1057	3	-3.67E-6					
669-	SPC	1	1058	1	-1.01E-51058	2	-6.59E-4			
670-	SPC	1	131014	1	4.48E-5 131014	2	-1.52E-4			
671-	SPC	1	131014	3	8.80E-6					
672-	SPC	1	131015	1	2.42E-5 131015	2	-1.18E-4			
673-	SPC	1	131021	1	5.97E-5 131021	2	-3.58E-4			
674-	SPC	1	131021	3	6.81E-6					
675-	SPC	1	131022	1	4.95E-5 131022	2	-3.33E-4			
676-	SPC	1	131027	1	1.57E-5 131027	2	-5.43E-4			
677-	SPC	1	131027	3	1.73E-6					
678-	SPC	1	131028	1	7.58E-6 131028	2	-5.30E-4			
679-	SPC	1	131033	1	-9.33E-5131033	2	-7.19E-4			
680-	SPC	1	131033	3	-4.84E-6					
681-	SPC	1	131034	1	-1.01E-4131034	2	-7.11E-4			
682-	SPC	1	131034	1	-2.43E-4131034	2	-6.51E-4			
683-	SPC	1	131034	3	-1.08E-5					
684-	SPC	1	131040	1	-2.51E-4131040	2	-6.48E-4			
685-	SPC	1	131045	1	-4.12E-4131045	2	-9.31E-4			
686-	SPC	1	131045	3	-1.43E-5					
687-	SPC	1	131046	1	-4.27E-4131046	2	-9.27E-4			
688-	SPC	1	131051	1	-5.31E-4131051	2	-9.60E-4			
689-	SPC	1	131051	3	-1.51E-5					
690-	SPC	1	131052	1	-5.88E-4131052	2	-9.57E-4			
691-	SPC	1	131057	1	-1.00E-5131057	2	-9.78E-4			
692-	SPC	1	131057	3	-1.30E-5					
693-	SPC	1	131058	1	-1.01E-5131058	2	-9.74E-4			
694-	SPC	2	1014	1	-1.18E-51014	2	-4.11E-6			
695-	SPC	2	1014	3	2.40E-6					
696-	SPC	2	1015	1	-5.59E-61015	2	4.05E-6			
697-	SPC	2	1021	1	-2.32E-51021	2	-1.18E-5			
698-	SPC	2	1021	3	2.41E-6					
699-	SPC	2	1022	1	-1.92E-51022	2	-4.58E-6			
700-	SPC	2	1027	1	-4.17E-51027	2	-3.17E-5			

SURFILL BULK DATA ELMU

CARD COUNT	1	2	3	4	5	6	7	8	9	10
701-	SPC	2	1027	3	1.25E-6					
702-	SPC	2	1028	1	-3.94E-51028	2	-2.99E-5			
703-	SPC	2	1033	1	-6.65E-51033	2	-4.94E-5			
704-	SPC	2	1033	3	1.27E-6					
705-	SPC	2	1034	1	-6.56E-51034	2	-4.86E-5			
706-	SPC	2	1034	1	-1.00E-41034	2	-6.48E-5			
707-	SPC	2	1034	3	8.75E-7					
708-	SPC	2	1040	1	-1.63E-41040	2	-6.45E-5			
709-	SPC	2	1045	1	-1.40E-41045	2	-7.23E-5			
710-	SPC	2	1045	3	1.40E-7					
711-	SPC	2	1046	1	-1.40E-41046	2	-7.23E-5			
712-	SPC	2	1051	1	-1.96E-41051	2	-7.18E-5			
713-	SPC	2	1051	3	8.69E-7					
714-	SPC	2	1052	1	-1.97E-41052	2	-7.15E-5			
715-	SPC	2	1057	1	-4.91E-41057	2	-4.12E-5			
716-	SPC	2	1057	3	2.11E-6					
717-	SPC	2	1058	1	-4.94E-41058	2	-4.10E-5			
718-	SPC	2	131014	1	1.161E-5 131014	2	-1.70E-5			
719-	SPC	2	131014	3	-1.70E-6					
720-	SPC	2	131015	1	5.761E-6 131015	2	-1.64E-5			
721-	SPC	2	131021	1	2.64E-5 131021	2	-5.14E-5			
722-	SPC	2	131021	3	-1.67E-6					
723-	SPC	2	131022	1	1.73E-5 131022	2	-4.88E-5			
724-	SPC	2	131027	1	1.76E-5 131027	2	-4.07E-5			
725-	SPC	2	131027	3	-1.76E-6					
726-	SPC	2	131028	1	1.57E-5 131028	2	-8.88E-5			
727-	SPC	2	131033	1	-5.79E-6 131033	2	-1.40E-4			
728-	SPC	2	131033	3	-2.22E-6					
729-	SPC	2	131034	1	-6.88E-6 131034	2	-1.34E-4			
730-	SPC	2	131034	1	-5.06E-5 131034	2	-1.84E-4			
731-	SPC	2	131034	3	-7.85E-6					
732-	SPC	2	131040	1	-5.16E-5 131040	2	-1.84E-4			
733-	SPC	2	131045	1	-1.21E-4 131045	2	-2.30E-4			
734-	SPC	2	131045	3	-3.37E-6					
735-	SPC	2	131046	1	-1.22E-4 131046	2	-2.30E-4			
736-	SPC	2	131051	1	-2.00E-4 131051	2	-2.51E-4			
737-	SPC	2	131051	3	-3.55E-6					
738-	SPC	2	131052	1	-2.01E-4 131052	2	-2.52E-4			
739-	SPC	2	131057	1	-4.90E-4 131057	2	-2.83E-4			
740-	SPC	2	131057	3	-3.84E-6					
741-	SPC	2	131058	1	-4.92E-4 131058	2	-2.83E-4			
742-	SPC1	14	3	1015	1022	1028	1034	1040	1046	
743-	SPC1	14	3	1052	1058					
744-	SPC1	14	3	11015	11022	11028	11034	11040	11046	
745-	SPC1	14	3	11052	11058					
746-	SPC1	14	3	21015	21022	21028	21034	21040	21046	
747-	SPC1	14	3	21052	21058					
748-	SPC1	14	3	31015	31022	31028	31034	31040	31046	
749-	SPC1	14	3	31052	31058					
750-	SPC1	14	3	41015	41022	41028	41034	41040	41046	

SORTED BULK DATA ECHO

CAKU COUNT	1	2	3	4	5	6	7	8	9	10
751-	SPC1	19	3	41052	41058					
752-	SPC1	19	3	51015	51022	51028	51034	51040	51046	
753-	SPC1	19	3	51052	51058					
754-	SPC1	19	3	61015	61022	61028	61034	61040	61046	
755-	SPC1	19	3	61052	61058					
756-	SPC1	19	3	71015	71022	71028	71034	71040	71046	
757-	SPC1	19	3	71052	71058					
758-	SPC1	19	3	81015	81022	81028	81034	81040	81046	
759-	SPC1	19	3	81052	81058					
760-	SPC1	19	3	91015	91022	91028	91034	91040	91046	
761-	SPC1	19	3	91052	91058					
762-	SPC1	19	3	101015	101022	101028	101034	101040	101046	
763-	SPC1	19	3	101052	101058					
764-	SPC1	19	3	111015	111022	111028	111034	111040	111046	
765-	SPC1	19	3	111052	111058					
766-	SPC1	19	3	121015	121022	121028	121034	121040	121046	
767-	SPC1	19	3	121052	121058					
768-	SPC1	19	3	131015	131022	131028	131034	131040	131046	
769-	SPC1	19	3	131052	131058					
770-	SPC1	19	123	1009	1016					
771-	SPC1	19	123	11009	11016					
772-	SPC1	19	123	21009	21016					
773-	SPC1	19	123	31009	31016					
774-	SPC1	19	123	41009	41016					
775-	SPC1	19	123	51009	51016					
776-	SPC1	19	123	61009	61016					
777-	SPC1	19	123	71009	71016					
778-	SPC1	19	123	81009	81016					
779-	SPC1	19	123	91009	91016					
780-	SPC1	19	123	101009	101016					
781-	SPC1	19	123	111009	111016					
782-	SPC1	19	123	121009	121016					
783-	SPC1	19	123	131009	131016					
784-	SPCAUU	20	1	19						
785-	SPCAUU	21	2	19						
	ENDDATA									

TOTAL COUNT = 785

N A S I R A N S O U R C E P R O G R A M C O M P I L A T I O N
UMAP-UMAP INSTRUCTION

```

NO.
1 BEGIN NO. 24 LINEAR STATIC ANALYSIS 7 JUN 1970 8
2 PARAM //DIAGUN//47 8
3 FILE GM=SAVE / KNN=SAVE / MNN=SAVE 8
4 FILE UC=APPEND/PGC=APPEND/UCV=APPEND 8
5 SETVAL //V,N,CARUND/O 8
6 SETVAL //V,N,MUDS//V,N,NUMUD/-1 8
7 SETVAL //V,N,NURGGA/1 8
8 SETVAL //V,N,NURGGA/1 8
9 GP1 GEUM1,GEUM2,/GPL,EQRXIN,GPDI,CSIM,BUPDI,SIL/S,N,LUSET/O/S,N,
NUGPDI 8
10 LUND NPERK,NUGPDI 8
11 GP2 GEUM2,EQRXIN/ECT 8
12 PARAM PLUB/PRES///V,N,JUMPLUI 8
13 LUND P1,JUMPLUI 8
14 PARAM //DIAGUP//47 8
15 PLTHUDY GEUM2,ECT,EP1,SIL,EQRXIN,BUPDI/PCT,PSIL,PEQIN,PUGPDI/S,N,
NHBUY/C,Y,PESH=NU 8
16 EGVV EQRXIN,PEQIN/NHBUY/ECT,PECT/NHBUY/BUPDI,PUGPDI/NHBUY/ SIL,PSIL/
NHBUY 8
17 PLTSET PLUB,PEQIN,PECT/PLTSETA,PLIPAR,GPSETS,ELSEIS/S,N,NSIL/ S,N,
JUMPLUI 8
18 CHKPN1 PLIPAR,GPSETS,ELSEIS 8
19 PRIMS6 PLTSETA// 8
20 SETVAL //V,N,PLIFLG/1 / V,N,PFILC/O 8
21 LUND P1,JUMPLUI 8
22 PLUT PLIPAR,GPSETS,ELSEIS,CASELL,PUGPDI,PEQIN,PSIL,ECT,, 'PLUTR1/
NSIL/LUSET/S,N,JUMPLUI/S,N,PLIFLG/S,N,PFILC 8
23 PRIMS6 PLUTR1// 8
24 LABEL P1 8
25 PARAM //DIAGUN//47 8
26 GP3 GEUM3,EQRXIN,GEUM2/SLT,ETI/O/V,N,NURGGA/O 8
27 LUND LMUDS,MUDS 8
28 IAI, ,ECT,GP1,BUPDI,SIL,ETI,CSIM/ESI,,GE1,GPCT//V,N,LUSET/O/ S,N,
MUSIMP//S,N,MUGENL/S,N,GENLL 8
29 LUND LSKPLMG,NUSIMP 8
30 PARAM //DIAGUP//47 8
31 EHL EST,CSIP,MP1,DI1,GEUM2,,,/ELM,KUICI,PELM,PUILL,,/S,N,NURGGA/
S,N,NURGGA/O//C,Y,CUUPMSS 8
32 CHKPN1 KEEM,KUICI 8
33 CHKPN1 HELM,MUICI 8
34 PARAM //DIAGUN//47 8
35 PURGE KGGX/NURGGA 8
36 LUND LEMAR,NURGGA 8
37 EHA GPCT,KUICI,KEEM,BUPDI,SIL,CSIM/KGA, 8
38 LABEL LEMAR 8
39 PURGE MGGX/NURGGA 8
40 LUND LMUDS,NURGGA 8
41 LKA GPCT,MUICI,HELM,BUPDI,SIL,CSIM/MGA,-1/C,Y,MIMASS=1. 8
42 LABEL LMUDS 8

```

COMPOSITE BRACKET MODEL (2.2) (STACK SEQ 2, PHASE 2)
 ONE STRIP ALONG SYM LINE WITH 13 UNEQUAL LAYERS

10/10/78 20, 1978 NASIKAN 3/11/78

A DISPLACEMENT SET

	-1-	-2-	-3-	-4-	-5-	-6-	-7-	-8-	-9-	-10-
10	251-1	251-2	251-3	252-1	252-2	252-3				

COMPOSITE BRACKET MODEL (2.2) (STACK SEQ 2, PHASE 2)
 ONE STRIP ALONG SYM LINE WITH 13 UNEQUAL LAYERS

10/10/78 20, 1978 NASIKAN 3/11/78

B DISPLACEMENT SET

	-1-	-2-	-3-	-4-	-5-	-6-	-7-	-8-	-9-	-10-
1001	121051-4	121051-5	121051-6	121052-3	121052-4	121052-5	121052-6	121051-4	121051-5	121051-6 • 1010
1011	131051-4	131051-5	131051-6	131052-3	131052-4	131052-5	131052-6	131051-4	131051-5	131051-6 • 1020
1021	131052-1	131052-2	131052-3	131052-4	131052-5	131052-6	131051-1	131051-2	131051-3	131051-4 • 1030
1031	131051-5	131051-6	131051-1	131051-2	131051-3	131051-4	131051-5	131051-6	131051-1	131051-2

*** USER INFORMATION MESSAGE USED FOR DATA BLOCKS ***

LOAD SEQ. NO.	EPSILON	SINUS ENERGY	EPSILONS LARGER THAN .001 ARE FLAGGED WITH ASTERISKS
2	-1.7670109E-16	4.3949511E-01	

COMPOSITE BRACKET MODEL (2.2 STACK SIG 2, PHASE 2)
ONE STRIP ALONG SYM LINE WITH 13 UNEQUAL LAYERS

CLUSTER 20, 1970 NASIKAN 3/11/70

UNIFORM PULL. SPLINE ELEMS USED FOR PARABOLIC DISTN

SUBCASE 1

DISPLACEMENT VECTOR

POINT NO.	TYPE	11	12	13	K1	K2	K3
251	G	-5.844978E-04	-6.445420E-04	-3.258853E-06	0.0	0.0	0.0
252	G	-5.845015E-04	-6.44573E-04	-3.145288E-04	0.0	0.0	0.0
1009	G	0.0	0.0	0.0	0.0	0.0	0.0
1014	G	-4.340700E-05	-1.080000E-04	1.514444E-06	0.0	0.0	0.0
1015	G	-2.100000E-05	-4.140000E-05	0.0	0.0	0.0	0.0
1016	G	0.0	0.0	0.0	0.0	0.0	0.0
1021	G	-9.064444E-05	-2.320000E-04	1.944444E-06	0.0	0.0	0.0
1022	G	-7.684444E-05	-2.660000E-04	0.0	0.0	0.0	0.0
1027	G	-1.740000E-04	-3.885444E-04	1.220000E-07	0.0	0.0	0.0
1028	G	-1.710000E-04	-3.744444E-04	0.0	0.0	0.0	0.0
1033	G	-2.740000E-04	-5.034444E-04	-1.024444E-06	0.0	0.0	0.0
1034	G	-2.774444E-04	-4.974444E-04	0.0	0.0	0.0	0.0
1039	G	-3.844444E-04	-5.844444E-04	-2.530000E-06	0.0	0.0	0.0
1040	G	-3.920000E-04	-5.814444E-04	0.0	0.0	0.0	0.0
1045	G	-4.494444E-04	-6.294444E-04	-3.300000E-06	0.0	0.0	0.0
1046	G	-4.494444E-04	-6.274444E-04	0.0	0.0	0.0	0.0
1051	G	-5.804444E-04	-6.444444E-04	-3.254444E-06	0.0	0.0	0.0
1052	G	-5.874444E-04	-6.424444E-04	0.0	0.0	0.0	0.0
1057	G	-9.544444E-04	-8.544444E-04	-3.664444E-06	0.0	0.0	0.0
1058	G	-1.010000E-03	-6.584444E-04	0.0	0.0	0.0	0.0
11004	G	0.0	0.0	0.0	0.0	0.0	0.0
11014	G	-4.179687E-05	-1.115200E-04	1.597742E-06	0.0	0.0	0.0
11015	G	-2.017844E-05	-4.736748E-05	0.0	0.0	0.0	0.0
11016	G	0.0	0.0	0.0	0.0	0.0	0.0
11021	G	-8.922444E-05	-2.429271E-04	2.038333E-06	0.0	0.0	0.0
11022	G	-7.756644E-05	-2.154978E-04	0.0	0.0	0.0	0.0
11027	G	-1.717426E-04	-3.438612E-04	1.403216E-07	0.0	0.0	0.0
11028	G	-1.691446E-04	-3.802238E-04	0.0	0.0	0.0	0.0
11033	G	-2.717758E-04	-5.084480E-04	-1.044444E-06	0.0	0.0	0.0
11034	G	-2.758452E-04	-5.024444E-04	0.0	0.0	0.0	0.0
11039	G	-3.824444E-04	-5.401444E-04	-2.647222E-06	0.0	0.0	0.0
11040	G	-3.894666E-04	-5.871044E-04	0.0	0.0	0.0	0.0
11045	G	-4.444444E-04	-6.354444E-04	-3.444444E-06	0.0	0.0	0.0
11046	G	-4.444444E-04	-6.334444E-04	0.0	0.0	0.0	0.0
11051	G	-5.804444E-04	-6.507222E-04	-3.477222E-06	0.0	0.0	0.0
11052	G	-5.874444E-04	-6.487066E-04	0.0	0.0	0.0	0.0
11057	G	-9.544444E-04	-8.657444E-04	-3.850444E-06	0.0	0.0	0.0
11058	G	-1.010000E-03	-6.647222E-04	0.0	0.0	0.0	0.0
21004	G	0.0	0.0	0.0	0.0	0.0	0.0
21014	G	-3.734874E-05	-1.150400E-04	1.813842E-06	0.0	0.0	0.0
21015	G	-1.789844E-05	-5.33601E-05	0.0	0.0	0.0	0.0
21016	G	0.0	0.0	0.0	0.0	0.0	0.0
21021	G	-8.223308E-05	-2.513321E-04	2.283433E-06	0.0	0.0	0.0
21022	G	-7.216063E-05	-2.243010E-04	0.0	0.0	0.0	0.0
21027	G	-1.627451E-04	-3.026140E-04	1.911573E-07	0.0	0.0	0.0
21028	G	-1.608035E-04	-3.891520E-04	0.0	0.0	0.0	0.0
21033	G	-2.631644E-04	-5.203178E-04	-1.241344E-06	0.0	0.0	0.0
21034	G	-2.675012E-04	-5.142584E-04	0.0	0.0	0.0	0.0
21039	G	-3.760508E-04	-5.037075E-04	-3.055722E-06	0.0	0.0	0.0
21040	G	-3.831089E-04	-5.005641E-04	0.0	0.0	0.0	0.0

UNIFORM PULL. MSPLINE ELEMS USED FOR PARABOLIC DISTRN

SUBCASE 1

FORCES OF SINGLE-POINT CONSTRAINT

POINT ID.	TYPE	11	12	13	K1	K2	K3
251	G	0.0	0.0	0.0	-1.952558E+00	-1.066108E-02	1.464418E+00
252	G	0.0	0.0	0.0	-1.952558E+00	-3.331241E-03	-1.464418E+00
1009	G	6.924487E+00	1.019047E+00	2.815610E-01	0.0	0.0	0.0
1014	G	-8.593826E-01	-1.175184E+00	-2.533222E+00	-3.231708E-02	0.0	6.045821E-02
1015	G	8.588856E-01	6.137734E-01	6.203419E-01	0.0	0.0	4.824886E-02
1016	G	6.592603E+00	9.519511E-01	3.280184E-01	0.0	0.0	0.0
1021	G	-3.235127E+00	-8.454262E-01	-1.833750E+00	-1.733587E-02	4.645167E-03	6.325388E-02
1022	G	-3.380303E+00	-1.922837E-01	-4.215069E-01	0.0	0.0	7.755738E-02
1027	G	-3.011029E+00	-1.374071E-01	-9.180728E-01	-4.714608E-03	2.722014E-03	6.984508E-02
1028	G	-3.560829E+00	5.264490E-01	1.963463E-01	0.0	0.0	8.924869E-02
1033	G	-1.349674E+00	3.083801E-01	-3.575627E-01	1.172074E-04	-1.172114E-04	4.662190E-02
1034	G	-1.988568E+00	1.031521E+00	5.858605E-02	0.0	0.0	6.803632E-02
1039	G	-8.670491E-01	6.477575E-01	-1.279674E-01	6.163157E-05	-1.413865E-04	4.281126E-02
1043	G	-1.058969E+00	1.011467E+00	-1.968605E-02	0.0	0.0	5.433124E-02
1045	G	-4.623004E-01	8.597102E-01	8.27881E-04	-2.172637E-05	8.108500E-05	3.976008E-02
1046	G	-7.685056E-01	1.459807E+00	-5.918415E-02	0.0	0.0	5.565664E-02
1051	G	4.264554E-01	-3.800972E+01	-9.068453E-02	0.0	-1.341179E-03	1.544953E+00
1052	G	-1.011030E-01	4.082672E+01	-1.033634E-01	0.0	3.664922E-03	-1.360413E+00
1057	G	2.332221E-02	-2.308348E+00	3.444882E-02	0.0	-5.582164E-04	1.097604E-02
1058	G	-9.753257E-02	-1.843628E+00	-1.936524E-01	0.0	0.0	2.314544E-02
11009	G	6.493392E+00	7.309643E-01	1.483331E-03	0.0	0.0	0.0
11013	G	0.0	0.0	6.903341E-01	0.0	0.0	0.0
11016	G	7.202234E+00	6.170155E-01	8.820634E-01	0.0	0.0	0.0
11022	G	0.0	0.0	6.801376E-01	0.0	0.0	0.0
11028	G	0.0	0.0	4.00128E-01	0.0	0.0	0.0
11034	G	0.0	0.0	2.157419E-01	0.0	0.0	0.0
11040	G	0.0	0.0	9.175564E-02	0.0	0.0	0.0
11046	G	0.0	0.0	1.476735E-02	0.0	0.0	0.0
11052	G	0.0	0.0	-4.483046E-02	0.0	0.0	0.0
11058	G	0.0	0.0	-2.630437E-02	0.0	0.0	0.0
21009	G	6.111633E+00	7.265769E-01	-2.23657E-02	0.0	0.0	0.0
21015	G	0.0	0.0	6.177893E-01	0.0	0.0	0.0
21016	G	6.269170E+00	8.444496E-01	8.104619E-01	0.0	0.0	0.0
21022	G	0.0	0.0	6.260102E-01	0.0	0.0	0.0
21028	G	0.0	0.0	3.735201E-01	0.0	0.0	0.0
21034	G	0.0	0.0	2.05707E-01	0.0	0.0	0.0
21040	G	0.0	0.0	9.25749E-02	0.0	0.0	0.0
21046	G	0.0	0.0	2.204135E-02	0.0	0.0	0.0
21052	G	0.0	0.0	-2.355865E-02	0.0	0.0	0.0
21058	G	0.0	0.0	-1.178678E-02	0.0	0.0	0.0
31009	G	5.283076E+00	7.106318E-01	-1.544493E-01	0.0	0.0	0.0
31015	G	0.0	0.0	4.886815E-01	0.0	0.0	0.0
31016	G	5.391358E+00	6.618674E-01	5.686608E-01	0.0	0.0	0.0
31022	G	0.0	0.0	4.638783E-01	0.0	0.0	0.0
31028	G	0.0	0.0	2.639427E-01	0.0	0.0	0.0
31034	G	0.0	0.0	1.425324E-01	0.0	0.0	0.0
31040	G	0.0	0.0	6.702632E-02	0.0	0.0	0.0
31046	G	0.0	0.0	1.972527E-02	0.0	0.0	0.0
31052	G	0.0	0.0	4.407633E-03	0.0	0.0	0.0
31058	G	0.0	0.0	9.926256E-04	0.0	0.0	0.0

COMPOSITE BRACKET MODEL C222 (STAIR STEP 22 PHASE 2)
ONE STRIP ALONG STR LINE WITH 13 UNEQUAL LAYERS

01/11/76 NASIRAN 2/11/76

82

UNIFORM PULL, ASPHALT FILMS USED FOR PARALLEL DISTN

SUBCASE 1

ELEMENT ID.	S21 S21	S I M I L S S E S			M A X	E L E M E N T S			E L E M E N T S			M.S.-1 M.S.-2
		S22 S22	S23 S23	S24 S24		44141 SIP155	3A-MAX 3B-MAX	44141 SIP155	3A-MAX 3B-MAX			
1	0.0	0.0	0.0	0.0	0.0	1.399233E+01	1.399233E+01	1.399233E+01	1.399233E+01	1.399233E+01		
	0.0	0.0	0.0	0.0	0.0							
2	0.0	0.0	0.0	0.0	0.0	-1.399233E+01	-1.399233E+01	-1.399233E+01	-1.399233E+01	-1.399233E+01		
	0.0	0.0	0.0	0.0	0.0							
3	0.0	0.0	0.0	0.0	0.0	9.773129E+00	9.773129E+00	9.773129E+00	9.773129E+00	9.773129E+00		
	0.0	0.0	0.0	0.0	0.0							

COMPOSITE BRACKET MODEL C222 (STAIR STEP 22 PHASE 2)
ONE STRIP ALONG STR LINE WITH 13 UNEQUAL LAYERS

01/11/76 NASIRAN 2/11/76

SUBCASE 1

ELEMENT-ID	CENTR 6X10+10	CENTR NUMER	CENTR AND SHEAR	S I M I L S S E S	E L E M E N T S	E L E M E N T S	D I R .	C O S I N U S	P R I N C I P A L	M E A N P R E S S U R E	U L T I M A T E S T R E S S	
												44141 SIP155
1012	S O M M A T I O N O F											
1012	1	1.001901E+02	1.001901E+02	1.001901E+02	1.001901E+02	1.001901E+02	1.001901E+02	1.001901E+02	1.001901E+02	1.001901E+02	1.001901E+02	
	2	1.001901E+02	1.001901E+02	1.001901E+02	1.001901E+02	1.001901E+02	1.001901E+02	1.001901E+02	1.001901E+02	1.001901E+02	1.001901E+02	
	3	1.001901E+02	1.001901E+02	1.001901E+02	1.001901E+02	1.001901E+02	1.001901E+02	1.001901E+02	1.001901E+02	1.001901E+02	1.001901E+02	
1013	1	1.001901E+02	1.001901E+02	1.001901E+02	1.001901E+02	1.001901E+02	1.001901E+02	1.001901E+02	1.001901E+02	1.001901E+02	1.001901E+02	
	2	1.001901E+02	1.001901E+02	1.001901E+02	1.001901E+02	1.001901E+02	1.001901E+02	1.001901E+02	1.001901E+02	1.001901E+02	1.001901E+02	
	3	1.001901E+02	1.001901E+02	1.001901E+02	1.001901E+02	1.001901E+02	1.001901E+02	1.001901E+02	1.001901E+02	1.001901E+02	1.001901E+02	
1014	1	1.001901E+02	1.001901E+02	1.001901E+02	1.001901E+02	1.001901E+02	1.001901E+02	1.001901E+02	1.001901E+02	1.001901E+02	1.001901E+02	
	2	1.001901E+02	1.001901E+02	1.001901E+02	1.001901E+02	1.001901E+02	1.001901E+02	1.001901E+02	1.001901E+02	1.001901E+02	1.001901E+02	
	3	1.001901E+02	1.001901E+02	1.001901E+02	1.001901E+02	1.001901E+02	1.001901E+02	1.001901E+02	1.001901E+02	1.001901E+02	1.001901E+02	
1015	1	1.001901E+02	1.001901E+02	1.001901E+02	1.001901E+02	1.001901E+02	1.001901E+02	1.001901E+02	1.001901E+02	1.001901E+02	1.001901E+02	
	2	1.001901E+02	1.001901E+02	1.001901E+02	1.001901E+02	1.001901E+02	1.001901E+02	1.001901E+02	1.001901E+02	1.001901E+02	1.001901E+02	
	3	1.001901E+02	1.001901E+02	1.001901E+02	1.001901E+02	1.001901E+02	1.001901E+02	1.001901E+02	1.001901E+02	1.001901E+02	1.001901E+02	
1016	1	1.001901E+02	1.001901E+02	1.001901E+02	1.001901E+02	1.001901E+02	1.001901E+02	1.001901E+02	1.001901E+02	1.001901E+02	1.001901E+02	
	2	1.001901E+02	1.001901E+02	1.001901E+02	1.001901E+02	1.001901E+02	1.001901E+02	1.001901E+02	1.001901E+02	1.001901E+02	1.001901E+02	
	3	1.001901E+02	1.001901E+02	1.001901E+02	1.001901E+02	1.001901E+02	1.001901E+02	1.001901E+02	1.001901E+02	1.001901E+02	1.001901E+02	
1017	1	1.001901E+02	1.001901E+02	1.001901E+02	1.001901E+02	1.001901E+02	1.001901E+02	1.001901E+02	1.001901E+02	1.001901E+02	1.001901E+02	
	2	1.001901E+02	1.001901E+02	1.001901E+02	1.001901E+02	1.001901E+02	1.001901E+02	1.001901E+02	1.001901E+02	1.001901E+02	1.001901E+02	
	3	1.001901E+02	1.001901E+02	1.001901E+02	1.001901E+02	1.001901E+02	1.001901E+02	1.001901E+02	1.001901E+02	1.001901E+02	1.001901E+02	
1018	1	1.001901E+02	1.001901E+02	1.001901E+02	1.001901E+02	1.001901E+02	1.001901E+02	1.001901E+02	1.001901E+02	1.001901E+02	1.001901E+02	
	2	1.001901E+02	1.001901E+02	1.001901E+02	1.001901E+02	1.001901E+02	1.001901E+02	1.001901E+02	1.001901E+02	1.001901E+02	1.001901E+02	
	3	1.001901E+02	1.001901E+02	1.001901E+02	1.001901E+02	1.001901E+02	1.001901E+02	1.001901E+02	1.001901E+02	1.001901E+02	1.001901E+02	
1019	1	1.001901E+02	1.001901E+02	1.001901E+02	1.001901E+02	1.001901E+02	1.001901E+02	1.001901E+02	1.001901E+02	1.001901E+02	1.001901E+02	
	2	1.001901E+02	1.001901E+02	1.001901E+02	1.001901E+02	1.001901E+02	1.001901E+02	1.001901E+02	1.001901E+02	1.001901E+02	1.001901E+02	
	3	1.001901E+02	1.001901E+02	1.001901E+02	1.001901E+02	1.001901E+02	1.001901E+02	1.001901E+02	1.001901E+02	1.001901E+02	1.001901E+02	
1020	1	1.001901E+02	1.001901E+02	1.001901E+02	1.001901E+02	1.001901E+02	1.001901E+02	1.001901E+02	1.001901E+02	1.001901E+02	1.001901E+02	
	2	1.001901E+02	1.001901E+02	1.001901E+02	1.001901E+02	1.001901E+02	1.001901E+02	1.001901E+02	1.001901E+02	1.001901E+02	1.001901E+02	
	3	1.001901E+02	1.001901E+02	1.001901E+02	1.001901E+02	1.001901E+02	1.001901E+02	1.001901E+02	1.001901E+02	1.001901E+02	1.001901E+02	

COMPOSITE BRACKET MODEL C2.2 (STACK SFO 2, PHASE 2)
 ONE STRIP ALONG SYM LINE WITH 13 UNEQUAL LAYERS

OCTOBER 20, 1978 NASIKAN 3/11/78

UNIFORM PULL. RSPLINE ELEMS USED FOR PARABOLIC DISTRN

SUBCASE 1

ELEMENT STRAIN ENERGIES

ELEMENT-TYPE = HEXA
 SUBCASE 1

* TOTAL ENERGY OF ALL ELEMENTS IN PROBLEM = 1.183829E-02
 * TOTAL ENERGY OF ALL ELEMENTS IN SET -1 = 1.183829E-02

ELEMENT-ID	STRAIN-ENERGY	PERCENT OF TOTAL
1012	4.156528E-04	3.5060
2005	5.630154E-04	4.7559
2010	4.058882E-04	3.4288
2015	2.254115E-04	1.9041
2020	1.468814E-04	1.2389
2025	9.260012E-05	0.7839
2030	5.285947E-05	0.4463
3005	2.148253E-04	1.8147
11012	1.625553E-04	1.3736
12005	2.668607E-04	2.2475
12010	2.171157E-04	1.8340
12015	1.173465E-04	0.9912
12020	6.841434E-05	0.5779
12025	3.352458E-05	0.2866
12030	1.182158E-05	0.0099
13005	4.420405E-05	0.3734
21012	2.921987E-04	2.4683
22005	3.394721E-04	2.8718
22010	1.975630E-04	1.6688
22015	7.668445E-05	0.6478
22020	4.964334E-05	0.4221
22025	9.460284E-06	0.0794
22030	3.832377E-06	0.0324
23005	1.544028E-05	0.1304
31012	1.150184E-04	0.9715
32005	1.561488E-04	1.3188
32010	9.870311E-05	0.8369
32015	3.475702E-05	0.2936
32020	9.627146E-06	0.0830
32025	7.840542E-07	0.0066
32030	3.754735E-08	0.0317
33005	1.914874E-05	0.1618
41012	1.378333E-04	1.1626
42005	1.637058E-04	1.3739
42010	7.224440E-05	0.6103
42015	1.939065E-05	0.1638
42020	3.676816E-06	0.0311
42025	4.236657E-06	0.0358
42030	1.596404E-05	0.1349
43005	7.121517E-05	0.6018
51012	8.963882E-05	0.7521
52005	1.042352E-04	0.8805
52010	4.544453E-05	0.3819
52015	1.275543E-05	0.1077
52020	1.690377E-06	0.0140
52025	4.712664E-06	0.0398
52030	1.756848E-05	0.1484
53005	6.419911E-05	0.5412
61012	4.831034E-05	0.4081

COMPOSITE MARKET VALUE OF STOCK BY PHASE 21
 ONE STRIP ALONG WITH IS UNIQUE LINES

INCLUDED BY YEAR HASIRAN 2/11/70

CELLWISE COMPLE. MSPLINE BELTS USED FOR PARAD DESIG.

SUBCASE 2

POINT-ID	ELEMENT-ID	SOURCE	UNIT PLANT FURCEL BALANCE					
			11	12	13	14	15	
131040	122020	HEAR	2.259400E+03	3.204330E+01	0.322200E+03	0.0	0.0	0.0
131040	122020	HEAR	1.027410E+00	-1.027260E+00	-1.027200E+02	0.0	0.0	0.0
131040		TOTALS0	1.079610E+00	-1.024930E+00	2.325000E+00	0.0	0.0	2.992410E+02
131045	122020	F-UP-SPL	1.254430E+01	7.079200E+01	4.170000E+01	-1.142410E+03	4.203700E+03	2.514550E+02
131045	122020	HEAR	4.273800E+01	1.172990E+02	7.052000E+04	0.0	0.0	0.0
131045	122020	HEAR	4.073000E+01	1.181710E+02	3.151800E+03	0.0	0.0	0.0
131045		TOTALS0	1.074930E+02	2.354900E+02	4.273800E+04	-1.142410E+03	4.203700E+03	2.514550E+02
131046	122020	F-UP-SPL	1.572800E+01	-1.400350E+01	2.773200E+02	0.0	0.0	2.379510E+02
131046	122020	HEAR	4.731470E+01	1.433520E+02	-1.123020E+02	0.0	0.0	0.0
131046	122020	HEAR	4.432740E+01	-1.033100E+00	-1.001050E+02	0.0	0.0	0.0
131046		TOTALS0	1.110700E+02	-1.400350E+01	4.372120E+02	0.0	0.0	2.379510E+02
131051	122020	F-UP-SPL	1.070000E+01	-1.027200E+00	0.045500E+01	0.0	0.0	7.476000E+02
131051	122020	HEAR	1.520920E+01	-1.112950E+01	3.942000E+03	0.0	0.0	0.0
131051	122020	HEAR	0.745710E+01	0.020700E+00	2.922200E+02	0.0	0.0	0.0
131051		TOTALS0	3.341630E+01	-9.906500E+00	6.909700E+03	0.0	0.0	7.476000E+02
131052	122020	F-UP-SPL	1.003000E+01	-1.142410E+01	2.347000E+02	0.0	0.0	7.410000E+02
131052	122020	HEAR	1.247010E+01	0.020700E+00	3.060400E+03	0.0	0.0	0.0
131052	122020	HEAR	2.102120E+01	0.001000E+00	-1.175500E+02	0.0	0.0	0.0
131052		TOTALS0	4.352130E+01	-1.121710E+01	5.131900E+03	0.0	0.0	7.410000E+02
131057	123005	F-UP-SPL	0.222000E+01	-0.027200E+00	0.010000E+01	0.0	0.0	7.201000E+02
131057	123005	HEAR	2.504200E+01	2.200000E+01	3.017000E+03	0.0	0.0	0.0
131057		TOTALS0	2.726200E+01	2.172800E+01	3.027000E+03	0.0	0.0	7.201000E+02
131058	123005	F-UP-SPL	0.252000E+01	-0.027200E+00	2.070000E+01	0.0	0.0	4.020000E+02
131058	123005	HEAR	0.425500E+01	2.711000E+01	2.070000E+03	0.0	0.0	0.0
131058		TOTALS0	0.677500E+01	2.683800E+01	2.090000E+03	0.0	0.0	4.020000E+02

APPENDIX N
ACRONYM DEFINITIONS

1. AFFDL - Air Force Flight Dynamics Laboratory
2. AFML - Air Force Materials Laboratory
3. AGARD - Advisory Group for Aerospace Research and Development (NATO)
4. AHS - American Helicopter Society
5. AIAA - American Institute for Aeronautics and Astronautics
6. ASTM - American Society for Testing and Materials
7. DTIC - Defense Technical Information Center
8. GIDEP - Government Industry Data Exchange Program
9. NASA - National Aeronautics and Space Administration
10. NATO - North Atlantic Treaty Organization
11. SAMPE - Society for the Advancement of Materials and Process Engineering
12. STAR - Scientific and Technical Aerospace Report
13. TAB - Technical Abstract Bulletin
14. USAAMRDL - U.S. Army Air Mobility Research and Development Laboratories
15. USAMMRC - U.S. Army Materials and Mechanics Research Center

16
F

APPENDIX O
STRESS ANALYSIS

REPORT TITLE Advanced Concepts for Composite Joints & Fittings		REPORT NO.
PREPARED BY APC	9/2/80	CHECKED BY
SUBJECT Composite Joint Test, Panel "A"		MODEL NO.

INTRODUCTION

This report summarizes the static and fatigue strengths of the joint and fitting test specimens.

Section 1 covers the wrapped Tension Fitting (Tailboom-to-Fuselage Attachment), Type A.

Section 2 covers the Gearbox Attachment Fitting, Type D.

Section 3 covers the Seat Attachment Fitting, Type K.

Static and fatigue analyses are included for types A and D. No fatigue analysis was included for type K since only static tests were conducted. Loading conditions used for analysis are identical to the baseline metal part loads.

The purpose of the program was to study the feasibility of constructing such joints and fittings and predicting the static and fatigue strength of the fittings for application to future aircraft.

16
B

REPORT TITLE Advanced Concepts for Composite Joints & Fittings		REPORT NO.
PREPARED BY APC	9/2/80	CHECKED BY
SUBJECT		MODEL NO.
<p><u>REFERENCES</u></p> <p>1.0 K.L. Reifsnider and K.N. Louraitis; Fatigue of Filamentary Composite Materials, ASTM Special Technical Publication 636, 1977.</p> <p>2.0 Advanced Composite Design Guide, 3rd Rev., 1977.</p>		

REPORT TITLE Advanced Concepts for Composite Joints and Fittings		REPORT NO.
PREPARED BY APC	9/2/80	CHECKED BY
SUBJECT Composite Joint Test Panel "A"		MODEL NO.
<p><u>DISCUSSION</u></p> <p>The design of a composite tailboom-to-fuselage attachment was investigated. The geometry of the joint and the load levels correspond to those of the YAH-64 helicopter. The test specimen was designed to withstand the maximum static loads experienced by the metal tailboom (crashworthiness condition). Fatigue endurance limits (E.L.) were then determined.</p>		

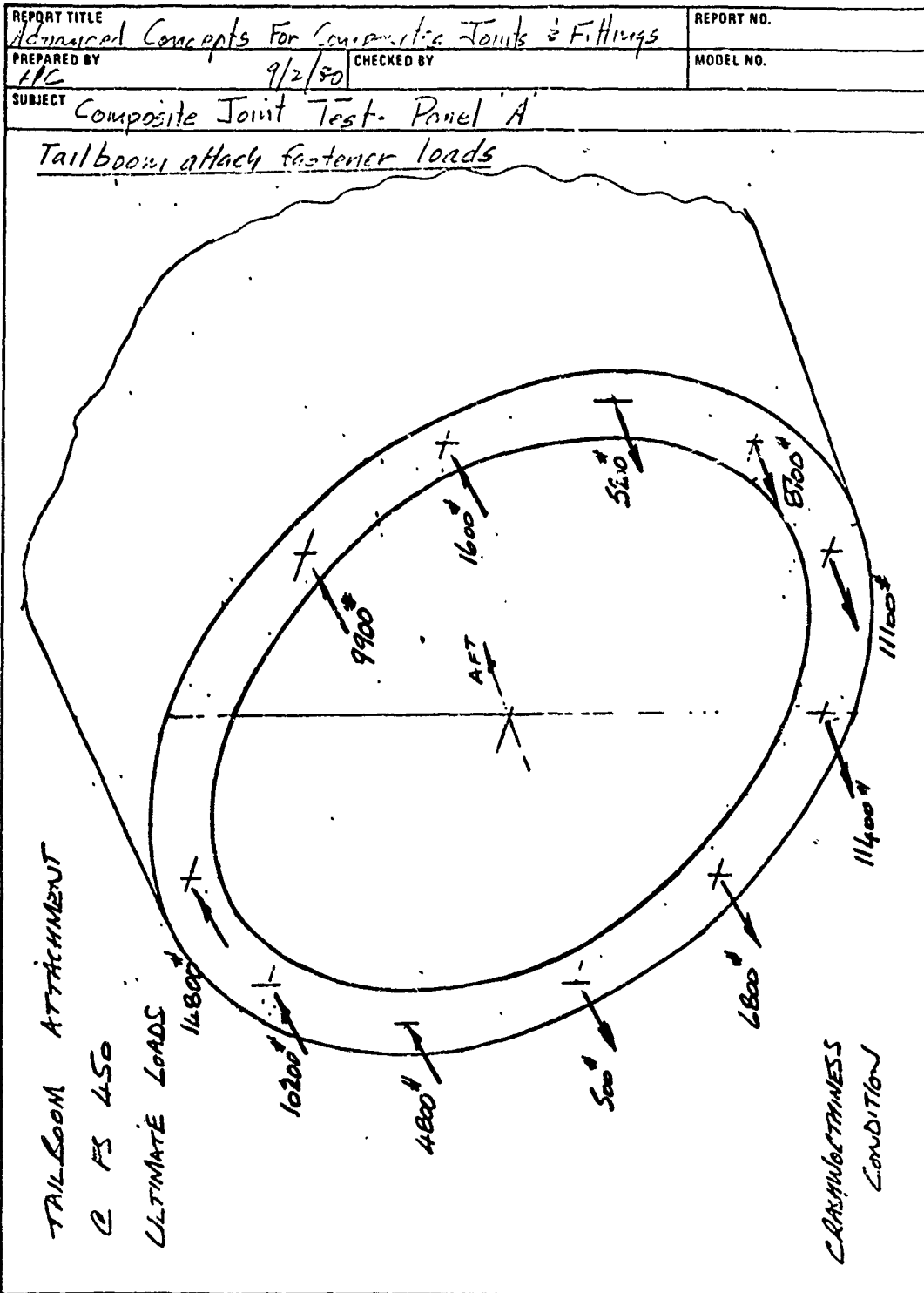

REPORT TITLE ADVANCED CONCEPTS FOR CONCRETE JOINTS & FITTINGS		REPORT NO.
PREPARED BY B. J. SPENCER	CHECKED BY	MODEL NO.
SUBJECT CONCRETE JOINT TEST PANEL A		REV A

DWG No 430-009

TENSION LOADING

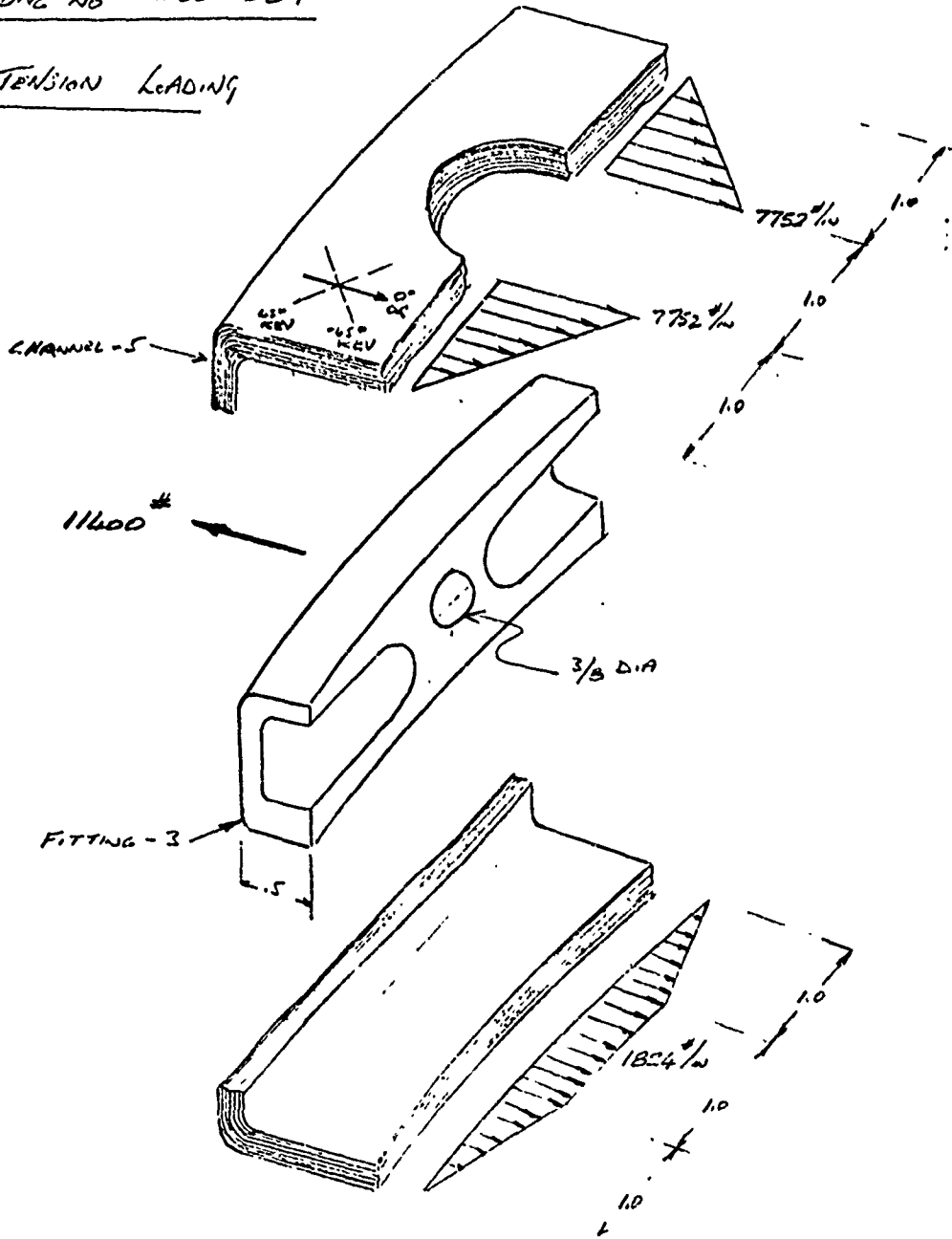

REPORT TITLE ADVANCED CONCEPTS FOR COMPOSITE JOINTS & FITTINGS		REPORT NO.
PREPARED BY B. J. SPENCER	CHECKED BY	MODEL NO.
SUBJECT COMPOSITE JOINT TEST PANEL A		Rev A

DWG No 430-009

COMPRESSION LOADING

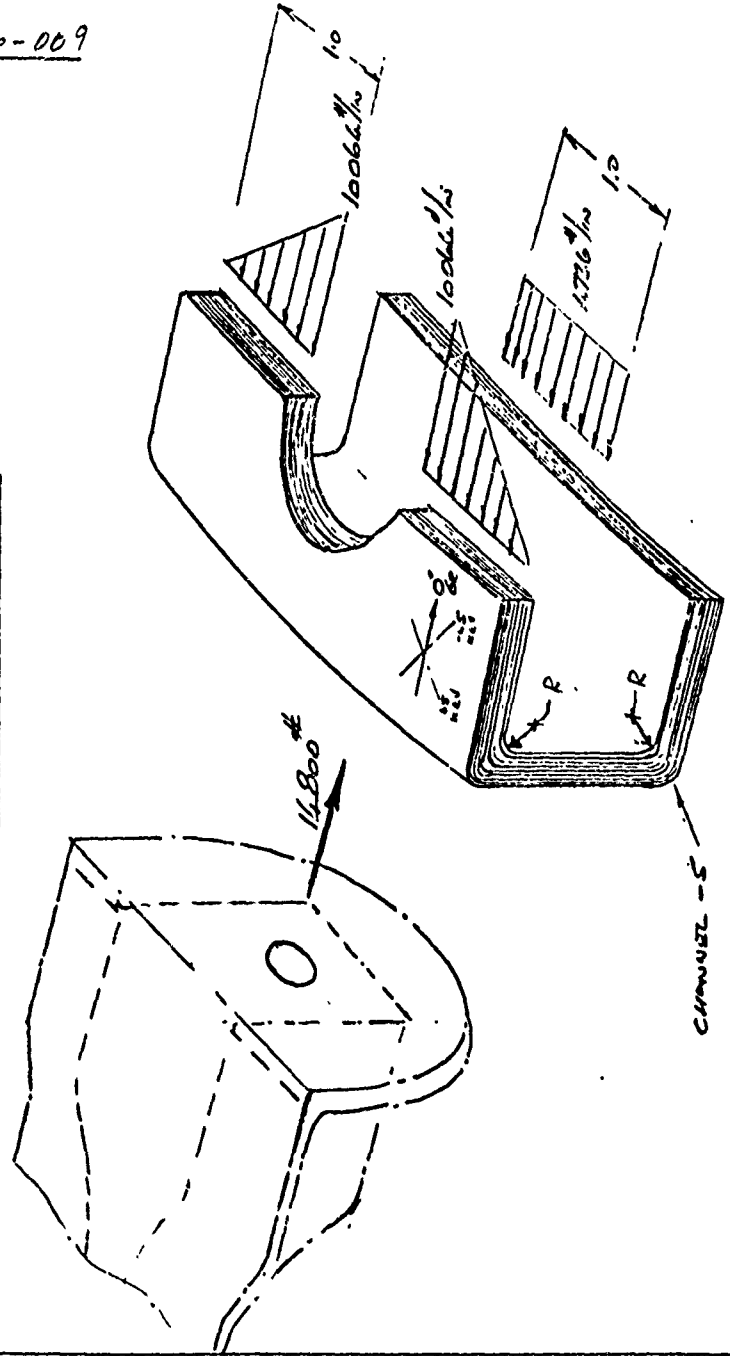

REPORT TITLE ADVANCED CONCEPTS FOR COMPOSITE JOINTS & FITTINGS		REPORT NO.
PREPARED BY B. J. SPENKER	CHECKED BY	MODEL NO.
SUBJECT COMPOSITE JOINT TEST PANEL A		Rev A

DWG No 430-009

CHANNEL -5

LAMINATE $(.5_{92} / .5_{265 \text{ deg}})$ $t = .176$
 TIRE CLOTH
 1600/615 8103/013

MAX COMPRESSION LOAD INTENSITY = 10064 #/in } ADJACENT TO
 MAX TENSION LOAD INTENSITY = 7752 #/in } CUTOUT

STRESSES IN 0° GR

MAX $\sigma_{comp} = \frac{10064}{.088} = 114000 \text{ PSI}$

MAX $\sigma_{ten} = \frac{7752}{.088} = 88100 \text{ PSI}$

Knock down factor
due to small radius

Predicted ten. failure ld } = $\frac{195}{88.1} \times 2 \times 11400 \times .95 = 22,800 \text{ #}$
 Kg 17.03

ALLOWABLES

$\sigma_{cu} = 129000 \text{ PSI}$

$\sigma_{tu} = 195000 \text{ PSI}$

$V_f = .60$

0° T300 GRAPHITE

M.S. = $\frac{129000}{114000} - 1 = 1.12$
 comp

LOAD BETWEEN CHANNEL & OUTER FACE SHEET

MAX $N_x = \frac{14800}{6 \times 2} = 1233 \text{ #/in PER FACE SHEET}$

50% OF THIS LOAD IS SHARED INTO CHANNEL IN .5 IN

$f_{shear} = 1233 \text{ PSI}$

REPORT TITLE ADVANCED CONCEPTS FOR COMPOSITE JOINTS & FITTINGS		REPORT NO.
PREPARED BY B. J. SPENCER	CHECKED BY	MODEL NO.
SUBJECT COMPOSITE JOINT TEST PANEL A		REV A

DWG No 430-009

LAMINA STRAINS

$$N_x = \frac{-14800}{6} = -2467 \text{ #/in}$$

FACE SHEETS ARE ($\pm 45^\circ$ KEV, $\pm 15^\circ$ GR), $E_f = 0.044$

$$\begin{bmatrix} \epsilon_x \\ \epsilon_y \\ \gamma_{xy} \end{bmatrix} = \begin{bmatrix} \frac{1}{8.71} & -\frac{.961}{8.71} & 0 \\ -\frac{.961}{8.71} & \frac{1}{8.71} & 0 \\ 0 & 0 & \frac{1}{2.6} \end{bmatrix} \times \begin{bmatrix} -28000 \\ 0 \\ 0 \end{bmatrix} = \begin{bmatrix} -3214 \\ 3089 \\ 0 \end{bmatrix}$$

$\frac{+15^\circ}{GR}$

$$\begin{bmatrix} \epsilon_1 \\ \epsilon_2 \\ \frac{\gamma_{12}}{2} \end{bmatrix} = \begin{bmatrix} .933 & .067 & -.5 \\ .067 & .933 & .5 \\ .25 & -.25 & .886 \end{bmatrix} \times \begin{bmatrix} -3214 \\ 3089 \\ 0 \end{bmatrix} = \begin{bmatrix} -2792 \\ 2667 \\ -1576 \end{bmatrix}$$

$\frac{+45^\circ}{KEV}$

$$\begin{bmatrix} \epsilon_1 \\ \epsilon_2 \\ \frac{\gamma_{12}}{2} \end{bmatrix} = \begin{bmatrix} .5 & .5 & -1 \\ .5 & .5 & 1 \\ .5 & -.5 & 0 \end{bmatrix} \times \begin{bmatrix} -3214 \\ 3089 \\ 0 \end{bmatrix} = \begin{bmatrix} -63 \\ -63 \\ -3152 \end{bmatrix}$$

REPORT TITLE ADVANCED CONCEPTS FOR COMPOSITE JOINTS & FITTINGS		REPORT NO.
PREPARED BY B.J. SPENCER	CHECKED BY	MODEL NO.
SUBJECT COMPOSITE JOINT TEST PANEL A		Rev A
<p>DWG No 430-009</p> <p><u>FITTING - 3</u></p> <p>MATL - STEEL HT 160 ksi</p> <p><u>SECTION THROUGH 3/8" DIA HOLE</u></p> $B.M. = \frac{7752(.833)}{2} + \frac{1824(.833)}{2} + \frac{1824(.25)}{2} = 4271 \text{ in}^3$ $f_b = \frac{6M}{bt^2} = \frac{6 \cdot 4217}{.6 (1.5)^2} = 169000 \text{ psi}$ $F_b = 240000 \text{ psi}$ $M.S. = \frac{240,000}{169,000} - 1 = \frac{+ .42}{\text{BENDING}}$		

REPORT TITLE <i>Advanced Concepts for Composite Joints & Fittings</i>	REPORT NO.
PREPARED BY <i>APC</i>	CHECKED BY
<i>8/27/80</i>	MODEL NO.

SUBJECT *Composite Joint Test Panel "A"*

*Fatigue allowable.
Shown below is coupon test data for ±45° Kevlar/epoxy*

STATISTICAL ANALYSIS OF THE ±45° CROSS PLY KEVLAR-49 EPOXY IN TENSION-TENSION FATIGUE.

SPEC. NO.	N * CYCLES @ FAILURE	CYCLIC STRESS @ FAILURE	S _n * CYCLIC STRESS @ 5x10 ⁷ N	($\bar{S} - S_n$) ² x 10 ⁻³
- 4	51,810	5625	4175	0.625
- 5	2.5115x10 ⁶	4662	4612	169.744
- 17	2.2365x10 ⁶	4131	4072	16.389
- 18	2.1538x10 ⁶	4001	3940	67.600
		Σ	16,799	254.353

$$\text{MEAN ENDURANCE LIMIT, } \bar{S} = \frac{16,799}{4} \approx 4200 \text{ PSI}$$

$$\begin{aligned} \text{UNBIASED STANDARD DEVIATION, } \sigma_{ub} &= \sqrt{\frac{\sum (S - S_n)^2}{n - 1}} = \\ &= \sqrt{\frac{254.353}{4 - 1}} = 291.177 \end{aligned}$$

$$\bar{S} - 3\sigma_{ub} = 4200 - 3(291.177) = 3326 \text{ PSI}$$

* Specimen E.L.

REPORT TITLE <i>Advanced Concepts for Composite Joints & Fittings</i>	REPORT NO.
PREPARED BY <i>ADC</i>	CHECKED BY
<i>8/27/80</i>	MODEL NO.

SUBJECT *Composite Joint Test Panel "A"* *Rev "A"*
Fatigue Allowables

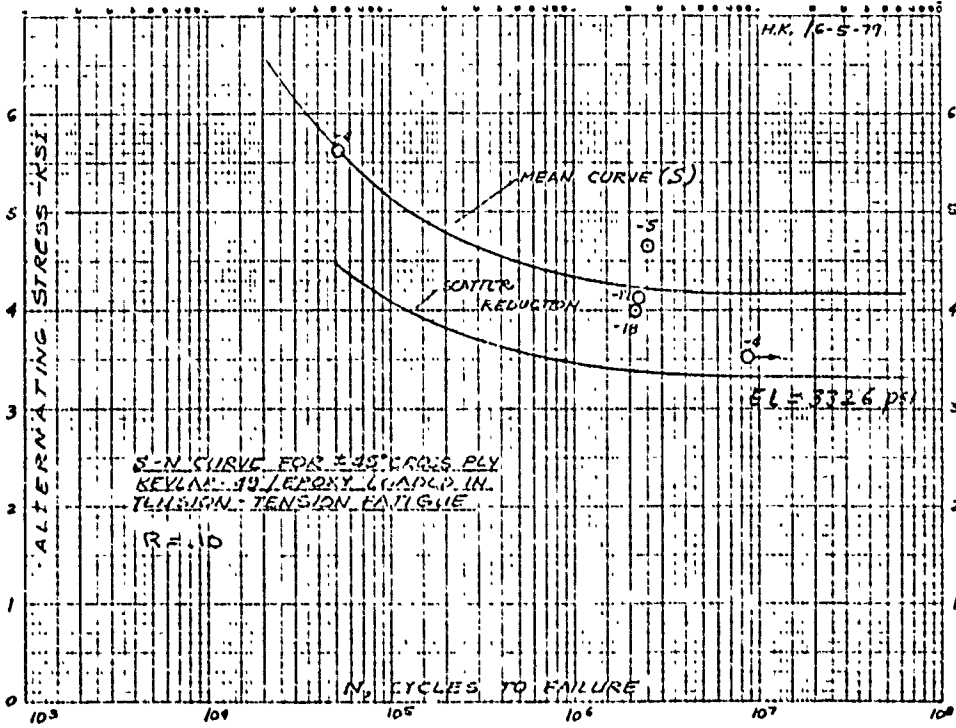

$F_{XTU} = 17,370 \text{ psi}$ } *Kevlar Ref test data*
 $F_{XCU} = 10,500 \text{ psi}$ } $\pm 45^\circ$

COM. F.L. = $\frac{10.5}{17.4} \times 3326 = 2007 \text{ psi}$
for ±45° Kevlar

REPORT TITLE <i>Advanced Concepts for Composite Joints & Fittings</i>	REPORT NO.
PREPARED BY <i>ADG</i>	CHECKED BY
<i>2/28/80</i>	MODEL NO.
SUBJECT <i>Composite Joint Test, Panel A</i>	

Graphite Fatigue Allowables

Ref. Fatigue of Filamentary Composite Materials
ASRI Special Technical Publication 636
By K L Reifsnider and KN Korotits, 1977

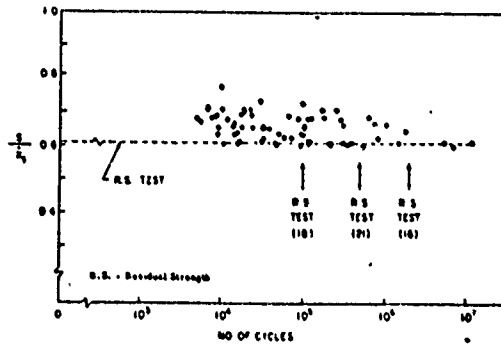

FIG 3-S Relationship.

Notes

- 1., The maximum fatigue stress S is normalized with respect to the static strength \bar{S}_s .
- 2., Test material was unidirectional graphite/epoxy T300/520B with a nominal fiber content of 70 percent by volume.
- 3., Stress Ratio = .10

Review of the curve above indicates that the allowable maximum fatigue stress can be taken as 60 percent of the ultimate static strength (for a stress ratio = .10).

For $\sigma_c = 0$ $F_{tuc} = 195,000 \text{ psi}$

$$195000 \times \underset{\substack{\uparrow \\ \text{scatter} \\ \text{factor}}}{.6}}{.6} \times \underset{\substack{\uparrow \\ \text{factor}}}{.75}}{.75} \times \underset{\substack{\uparrow \\ \text{factor}}}{.90}}{.90} \times \underset{\substack{\uparrow \\ \text{factor}}}{.45}}{.45} = 31,600 \text{ psi } 0^\circ \text{ Ten alt}$$

For $R = .10$

From test data for $\pm 25^\circ$ the ult ten to ult comp ratio is about .30

$$\frac{123}{175} \times .3 \times 31600 = 6000 \text{ psi compression E.L. for } \pm 15^\circ \text{ graphite}$$

\uparrow 0° to 15°
reduction

$$\text{Predicted } \sigma_c = (2007 + 6000) (.044 \times 11.2) = 4100 \text{ \#}$$

REPORT TITLE Advanced Concepts for Composite Joints & Fittings	REPORT NO.
PREPARED BY LPC	CHECKED BY
8/25/80	MODEL NO.

SUBJECT Composite Joint Test Panel "A"

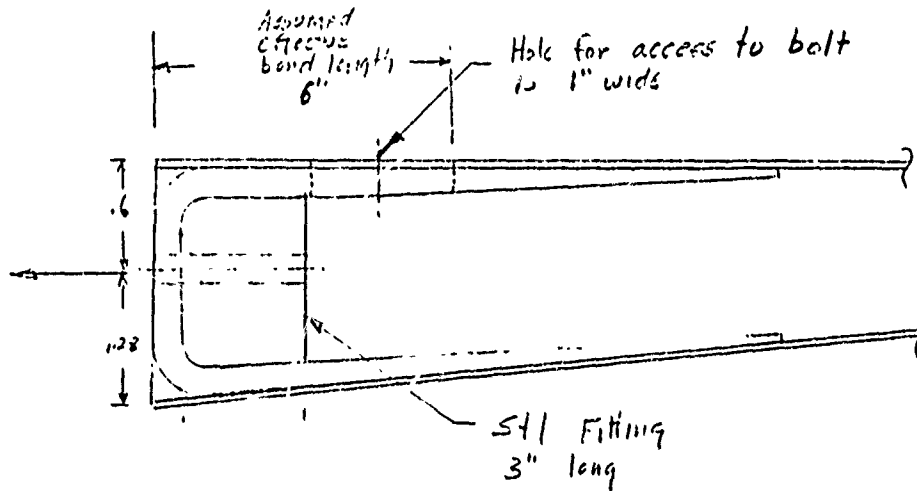

View A

E.L. for face-slit bond = $6(3+3) \times 225 = 8100 \#$ "D" section fitting, fatigue curve for lap joint Pg 20.15

For this $\bar{S} = 2 \times 8100 = 16200 \#$ max fatigue l/d

Predicted $\bar{S} = \frac{16200 - .05 \times 16200}{2} = 7695 \#$ All l/d

REPORT TITLE		REPORT NO.
Advanced Concepts for Composite Joints and Fittings		
PREPARED BY	CHECKED BY	MODEL NO.
APC	9/2/80	
SUBJECT		
Composite Joint Test Section D		
<p><u>DISCUSSION</u></p> <p>The design of a composite vertical stabilizer/tail rotor gearbox attachment for the YAH-64 helicopter was investigated. The test specimen was designed to meet the static load requirements of the metal vertical stabilizer (blade strike condition). Fatigue endurance limits (E.L.) were then determined.</p>		

REPORT TITLE <i>COMPOSITE TAIL SECTION STRESS ANALYSIS</i>		REPORT NO.
PREPARED BY <i>B.J. SPENCER</i>	CHECKED BY	MODEL NO.
SUBJECT <i>VERTICAL STABILIZER</i>		<i>Re: A</i>

*VERTICAL STABILIZER
UPPER 90° GEARBOX ATTACHMENT
ULTIMATE LOADS*

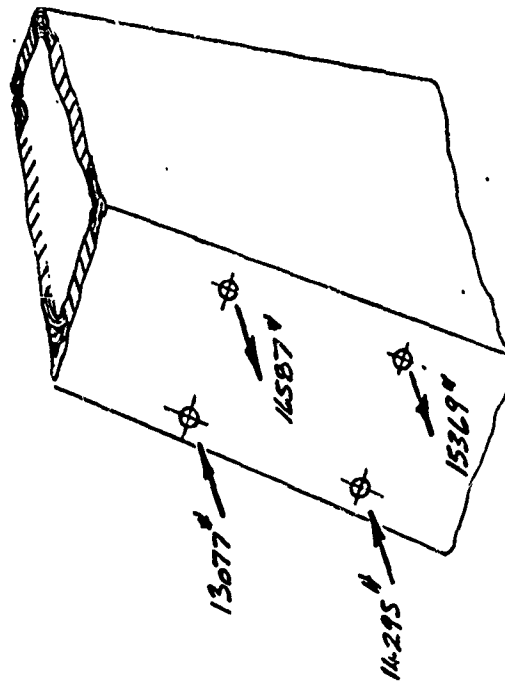

CONDITION 0° STRIKE

REPORT TITLE	COMPOSITE TAIL SECTION STRESS ANALYSIS	REPORT NO.
PREPARED BY	B. J. SPENCER	CHECKED BY
SUBJECT		MODEL NO.
VERTICAL STABILIZER		

VERTICAL STABILIZER
UPPER 90° GEARBOX ATTACHMENT
ULTIMATE LOADS

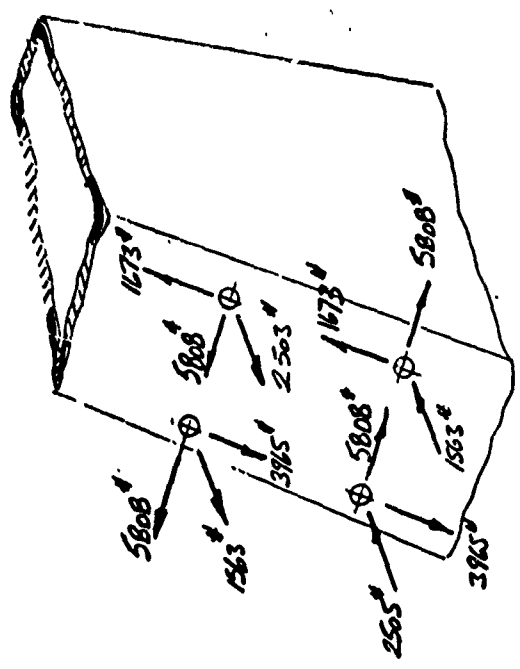

CONDITION 270° STRIKE

REPORT TITLE ADVANCED CONCEPTS FOR COMPOSITE JOINTS & FITTINGS		REPORT NO.
PREPARED BY E.J. SPENCER	CHECKED BY	MODEL NO.
SUBJECT COMPOSITE JOINT TEST SECTION D		REV A

DWG No 430-007

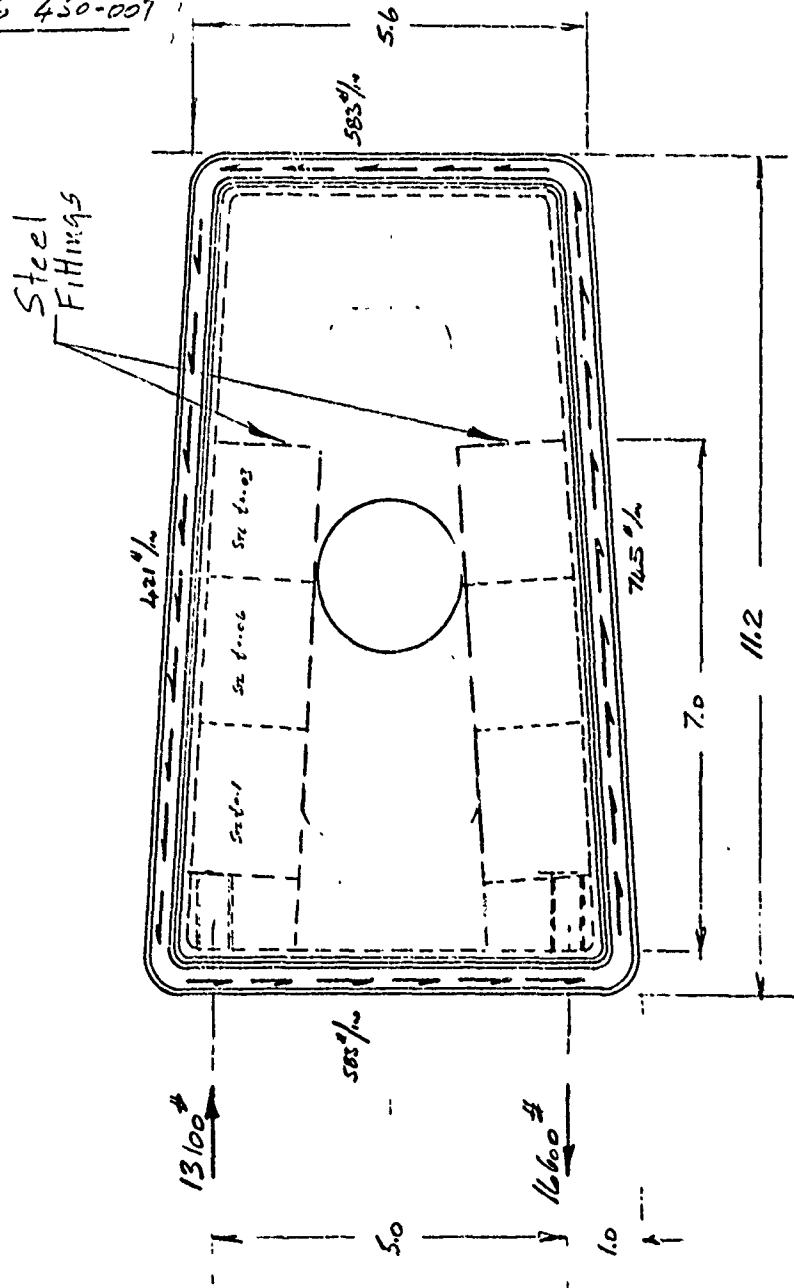

COND - 0" STRIKE
(REF 5MM VERT STRIKE LOGS)

REPORT TITLE <i>ADVANCED CONCEPTS FOR COMPOSITE JOINTS & FITS</i>	REPORT NO.
PREPARED BY <i>S.J. STEVENS</i>	CHECKED BY
MODEL NO.	
SUBJECT <i>COMPOSITE JOINT TEST SECTION D</i>	<i>REV A</i>

DWS No. 480-007 |

SHEAR TEAR OUT

COND 90° STCCE

7/8" DIA
2
3/16"
5608
1.0

$$f_{cr} = \frac{5608}{2(1.0 - \frac{7}{8}) \cdot 3.4} = 15200 \text{ PSI}$$

$$f_{cr} = 15500 \text{ PSI}$$

30% 165

$$Ms. = \frac{15500}{15200} - 1 = \underline{\underline{+1.02}}$$

REPORT TITLE	COMPOSITE JOINTS & FITTINGS	REPORT NO.
PREPARED BY	L. J. SPENCER	CHECKED BY
SUBJECT		MODEL NO.
Dwg No 430-007		Rev A

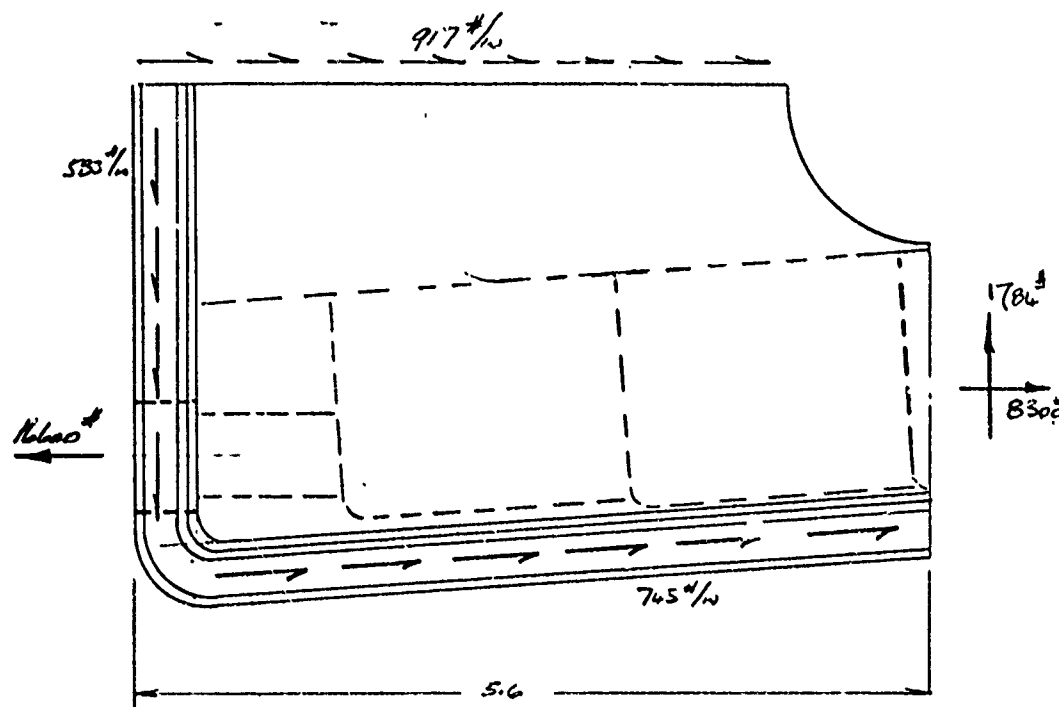

REPORT TITLE ADVANCED CONCEPTS FOR COMPOSITE JOINTS & FITTINGS		REPORT NO.
PREPARED BY E. J. SENEKER	CHECKED BY	MODEL NO.
SUBJECT COMPOSITE JOINT TEST SECTION D		Rev A

DWG No 430-007

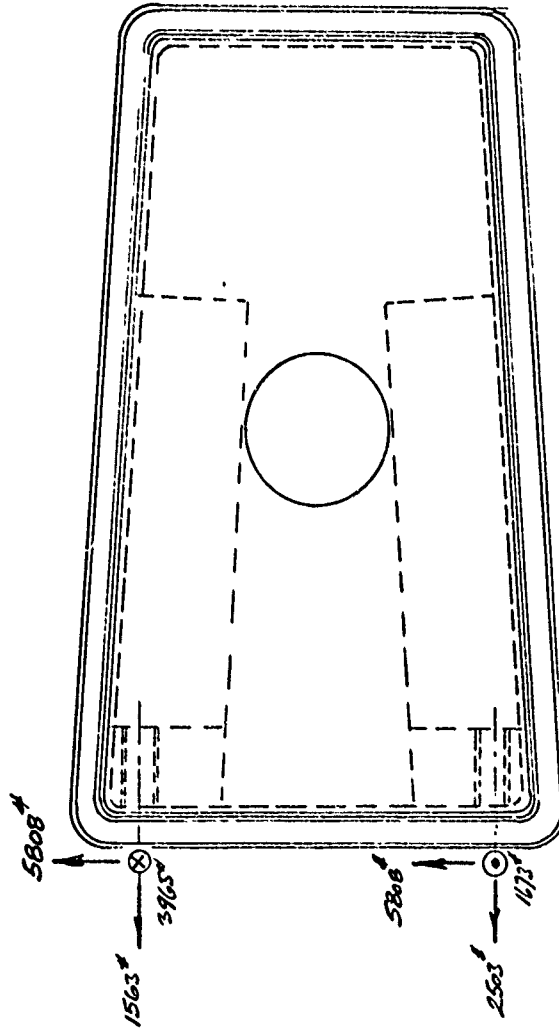

LONG - 90° STRIKE
(REF 15807 SWS LEAS)

REPORT TITLE <i>Advanced Concepts for Composite Joints and Fittings</i>	REPORT NO
PREPARED BY <i>IPC</i>	CHECKED BY
MODEL NO	
SUBJECT <i>Composite Joint Test Section D</i>	

Lap Shr Allowable

GRAPHITE/EPOXY

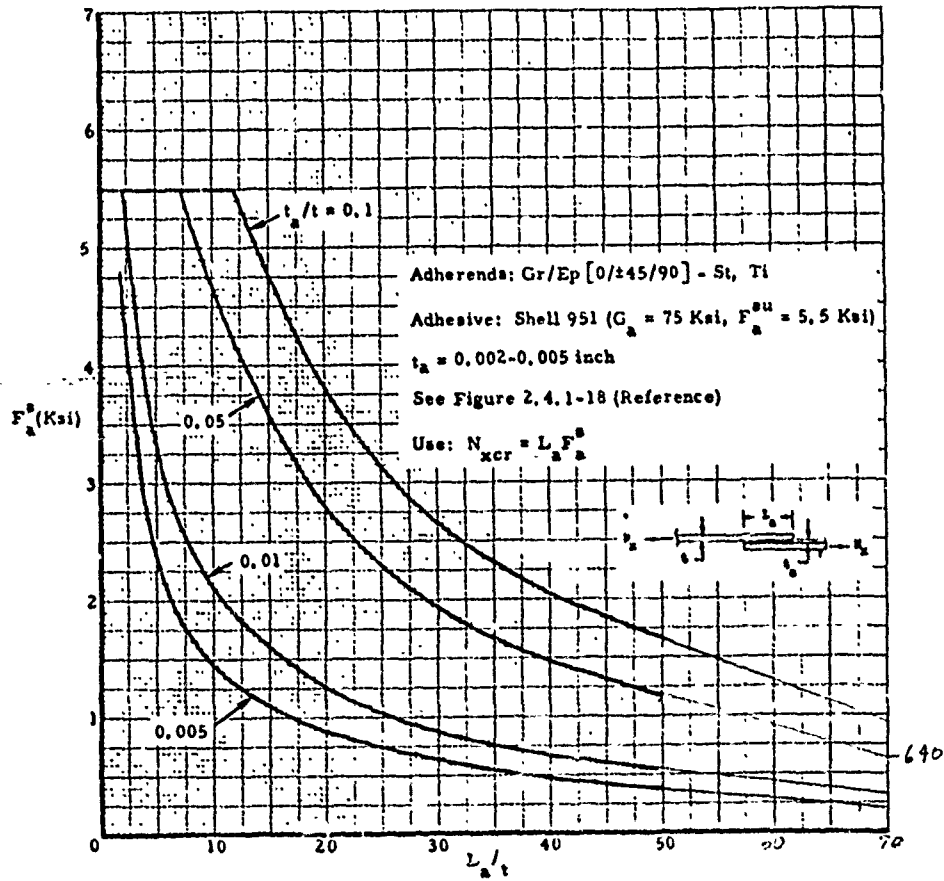

ALLOWABLE STRENGTH CURVES. SINGLE-LAP SHEAR JOINT
Gr/Ep-TO-STEEL OR TITANIUM, SHELL 951

Ref 2

REPORT TITLE <i>Advanced Concepts for Composite Joints & Fittings</i>	REPORT NO.
PREPARED BY <i>APC</i>	CHECKED BY <i>8/25/80</i>
MODEL NO.	
SUBJECT <i>Composite Joint Test Section D</i>	<i>Rev-A</i>

Steel Fitting to Composite ; Bond Fatigue Analysis

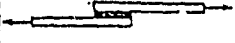
Estimated Room Temperature Allowable Alternating Stress FM-1000 Adhesive		
Stress Ratio: 0.10		
		
Adherend: 2024 T-3 . Clad Aluminum		
Cure: 2 Hours 350° F 25 psi		
Length of Lap	Allowable Alt. Stress *Alt.	Number Of Stress Cycles N
.50 in.	241 psi	10 ⁷
1.00 in.	190 psi	10 ⁷
4.00 in.	109 psi	10 ⁷

The above table shows allowable alternating stress for various lap-joint lengths.

Data given in the Advanced Composite Design Guide for 0.5" lap joint is reduced by the following factor $\frac{109}{241} = .45$. . Its assumed that at 10⁷ cycles the curve is flat.

REPORT TITLE	ADVANCED CONCEPTS FOR COMPOSITE JOINTS & FTG'S	REPORT NO.
PREPARED BY	E J STENCER	CHECKED BY
SUBJECT	COMPOSITE JOINT TEST SECTION D	MODEL NO.
		Rev A

DWG No 430-007

BOND ATTACHMENT OF FTG (-3) TO GR CHANNEL (-5)

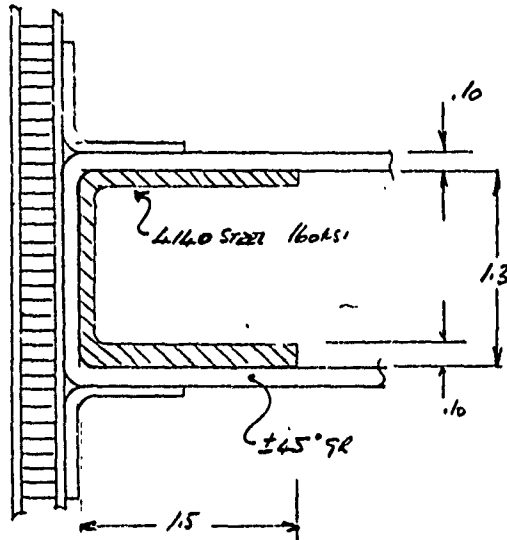

$$\text{Bond AREA} = (2 \times 1.5 + 1.3) 7 = 30 \text{ in}^2$$

$$\text{MAX LOAD} = 16600 \#$$

$$\text{Average Bond Stress} = \frac{16600}{30} = \underline{\underline{550 \text{ psi}}}$$

For a lap shear joint 7" long

$$\frac{L_d}{z} = \frac{.005}{.10} = .05$$

$$\frac{L_d}{z} = \frac{7}{.10} = 70$$

Ref. test set
up

$$115 = \frac{640}{550} - 1 = \underline{\underline{.16}}$$

Predict a failure load of } = 1.16 \times 3300 \text{ Ref pg 20.10}

$$= 3828 \#$$

REPORT TITLE <i>Advanced Concepts for Composite Joints & Fittings</i>	REPORT NO.
PREPARED BY <i>JPC</i>	MODEL NO.
<i>8/25/80</i>	CHECKED BY

SUBJECT *Composite Joint Test Section D* *Raw A*

Steel Fitting to Composite, Bond Fatigue Ana.

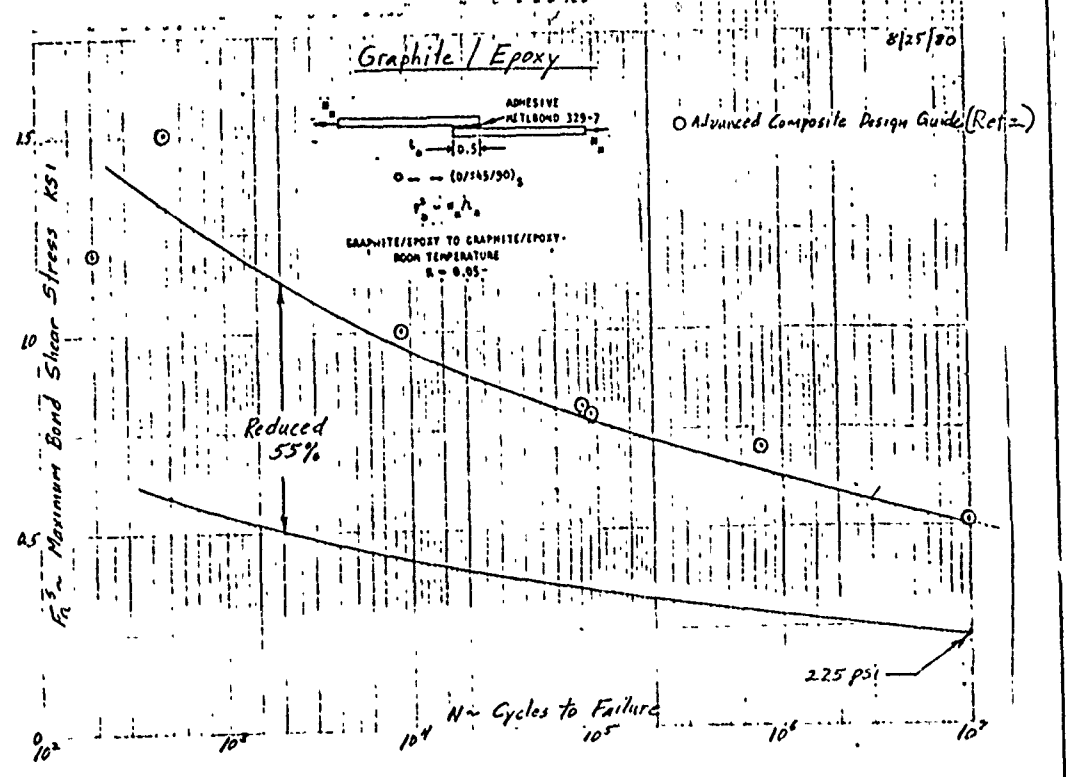

REPORT TITLE Advanced Concepts for Composite Joints and Fittings		REPORT NO.
PREPARED BY APC	9/2/80	CHECKED BY
SUBJECT YAH-64 Upper Co-Pilots Seat Fitting		MODEL NO.
<p><u>DISCUSSION</u></p> <p>A composite seat attachment fitting was designed to investigate the feasibility of fabricating such a part using advanced composite materials. The fitting was designed for the YAH-64 loads (crashworthiness condition).</p>		

REPORT TITLE <i>Advanced Concepts for Composite Joints & Fittings</i>	REPORT NO. 221A
PREPARED BY D. MANCILL	CHECKED BY
MODEL NO.	

SUBJECT
YAH-64 UPPER CO-PILOT'S SEAT FITTING

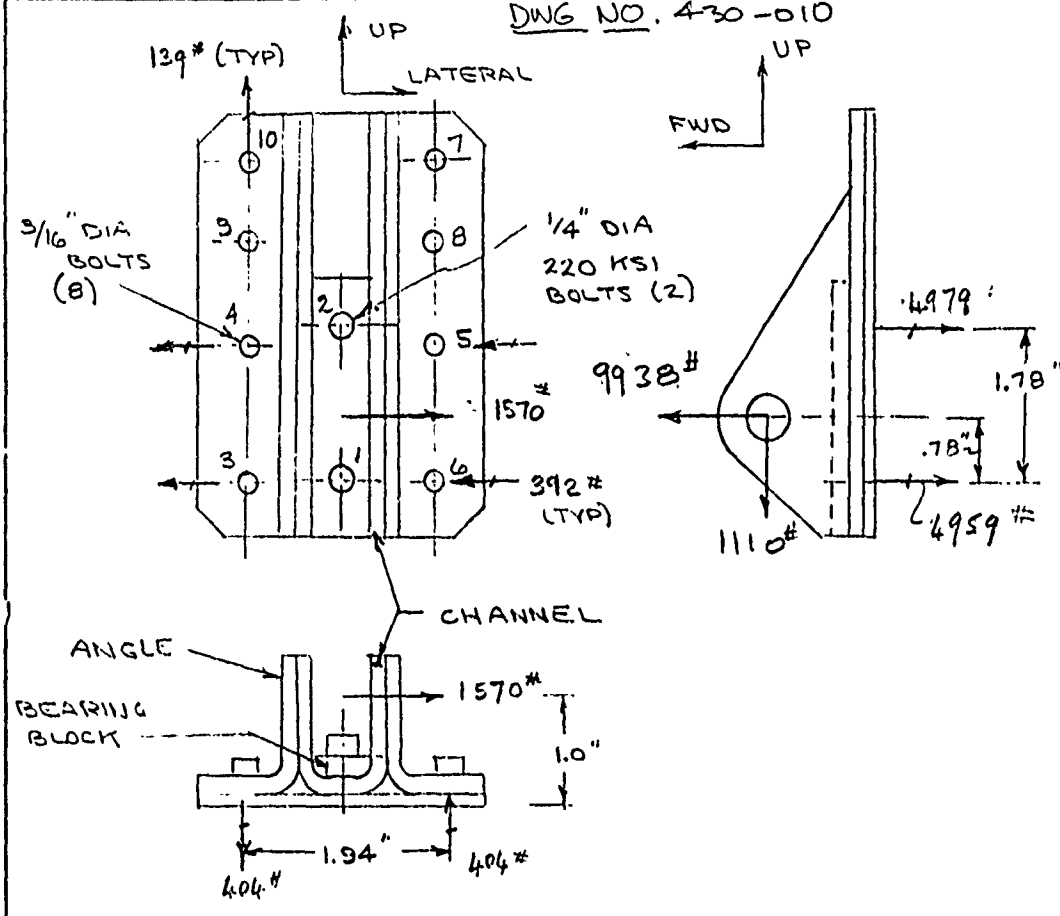

LOAD PATHS

- 1., THE 1/4" DIA (220 KSI) BOLTS IN THE CHANNEL CARRY ALL THE VERTICAL AND FWD LOADS. THE FIBERS OF THE CHANNEL WRAP AROUND THE BEARING BLOCK, THUS ENSURING AN EFFECTIVE MECHANICAL LOCK OF THE FITTING TO THE BACK-UP STRUCTURE.
- 2., THE 3/16" DIA. BOLTS WITH THE ANGLES CARRY THE LATERAL LOAD.

REPORT TITLE <i>Advanced Concepts For Composite Joints & Fittings</i>		REPORT NO.
PREPARED BY <i>APC</i>	<i>2/22/50</i>	CHECKED BY
SUBJECT <i>YAH-64 Upper Co-Pilots Seat Fitting</i>		MODEL NO.

.007/PLY BROADGOODS

ITEM	NO. PLYS	STACKING SEQUENCE	THICKNESS
-3	14	$(0/90)_2 / (\pm 45) / [(0/90) / (\pm 45)]_2 \}_s$.098
-5	12	$[(0/90)_2 / (\pm 45)]_2 \}_s$.084
-7	6	$[(0/90)_2 / \pm 45]_s$.042

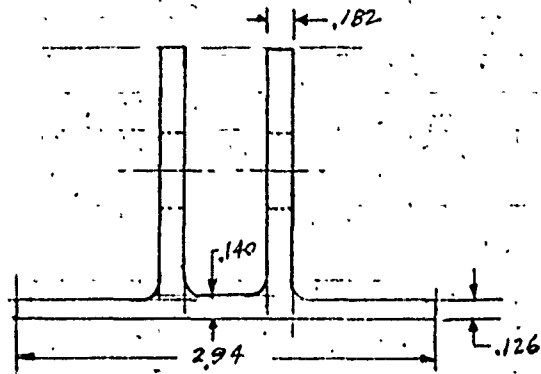

CALCULATED THICKNESSES

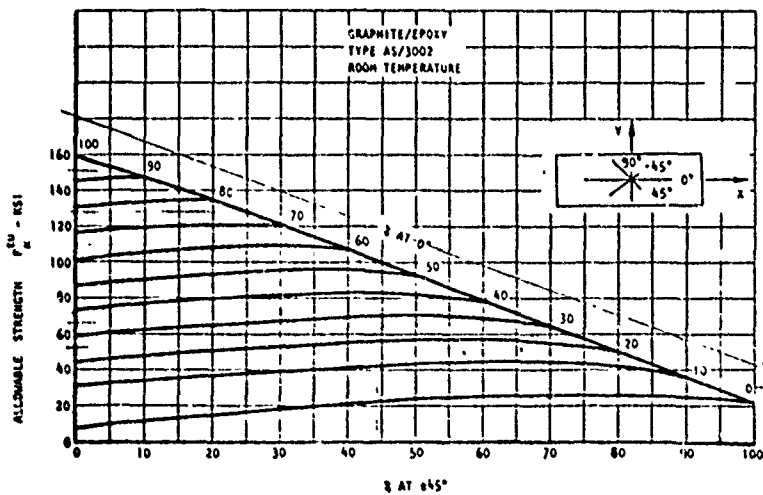

REPORT TITLE <i>Advanced Concepts for Composite Joints & Fittings</i>	REPORT NO. REV A
PREPARED BY D. MANCILL	CHECKED BY
MODEL NO.	

SUBJECT
YAH-64 UPPER CO-PILOT'S SEAT FITTING

DWG NO 430-010

REACTIONS

$$R_{(1)} = \frac{(9938 \cdot 1.0) - 1110}{1.78} = 4959 \#$$

$$R_{(2)} = \frac{(9938 \cdot 1.78) + 1110}{1.78} = 4979 \#$$

CONSERVATIVELY ASSUME ONLY BOLTS 3 THRU 6 CARRY THE LATERAL LOAD.

$$R_{(3) \rightarrow (6)} = \frac{1570 \cdot 1.0}{2 \cdot 1.94} = 404 \#$$

CHANNEL

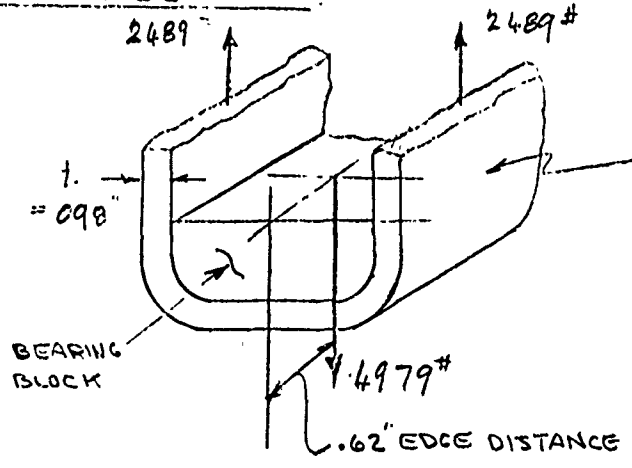

GRAPHITE/EPOXY

- 25% 0°
- 25% 90°
- 50% ± 45°

$$F_x^t = 63000 \text{ PSI}$$

OPEN-HOLE ALLOWABLE

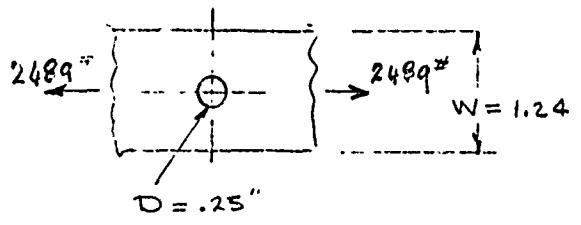

$$\frac{W}{D} = \frac{1.24}{.25} = 4.96$$

ALLOWABLE GROSS STRESS

$$F_x^t = 21500 \text{ PSI}$$

REPORT TITLE <i>Advanced Concepts for Composite Joints & Fittings</i>	REPORT NO. REV A
PREPARED BY D. MANCILL	CHECKED BY
MODEL NO.	
SUBJECT YAH-64 UPPER CO-PILOT SEAT FITTING	

CHANNEL CONT'D.

DWG NO 430-010

$$f_t = \frac{P}{A} = \frac{2489}{1.24 \times .098} = 20500 \text{ PSI}$$

$$M.S. = \frac{21500}{20500} - 1 = \underline{+0.04}$$

TENSION FAILURE AROUND HOLE

1/4" DIA BOLTS

$$P_{APPLIED} = 4974 \#$$

$$P_{ALLOWABLE} = 7530 \# \quad (220 \text{ KSI BOLT})$$

REF MIL-HDBK-5C, PAGE 8-78

$$M.S. = \frac{7530}{4974} - 1 \cong \underline{0.51}$$

ANGLE (GRAPHITE/EPOXY)

COMPOSITE ANGLE TEST RESULTS

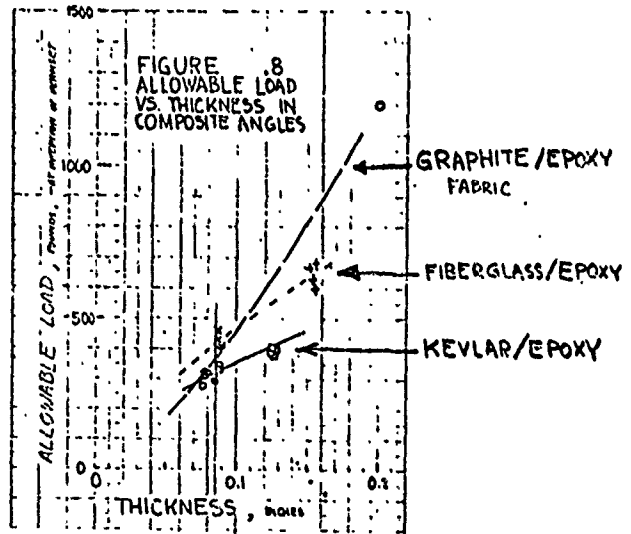

25% 0° } LAY-UP
25% 90° }
50% ±45° }

$$P_{APPLIED} = 404 \#$$

THICKNESS OF ANGLE = .084"

$$P_{ALLOWABLE} = 400 \#$$

$$M.S. = \frac{400}{404} - 1 = \underline{+0.00}$$

REPORT TITLE <i>Advanced Concepts for Composite Joints & Fittings</i>	REPORT NO. REV A
PREPARED BY D. MANCELL	CHECKED BY
MODEL NO.	
SUBJECT YAH-64 UPPER CO-PILOT SEAT FITTING	

LUG ANALYSIS

DWG NO 430-010

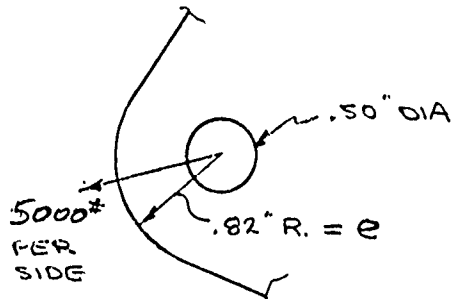

$$t = .098 + .084 = .182$$

(CHANNEL PLUS ANGLE)

$$\frac{D}{t} = \frac{.50}{.182} = 2.78$$

$$\frac{e}{D} = \frac{.82}{.50} = 1.64$$

BEARING STRESS $f_b = \frac{5000}{.50 \times .182} = 55000 \text{ PSI}$

FOR DOUBLE SHEAR JOINT $F_{BR} = 80,000 \text{ PSI}$

$$M.S. = \frac{80,000}{55000} - 1 = \underline{+ .46}$$

BEARING

CHECK LUG SHEAROUT STRENGTH

$$f^{50} = \frac{P}{2t(e - \frac{D}{2})} = \frac{5000}{2 \times .182(.82 - .25)} = 24100 \text{ PSI}$$

FOR 50% $\pm 45^\circ$ $F^{50} = 25,000 \text{ PSI}$

$$M.S. = \frac{25000}{24100} - 1 = \underline{+ .04}$$

SHEAROUT

CHECK NET TENSION STRENGTH

NET TENSION STRESS $f_t = \frac{5000}{.182(1.64 - .50)} = 24100 \text{ PSI}$

$$E = 7.20 \times 10^{+6} \quad \epsilon_t = \frac{2410}{7.2 \times 10^{+6}} = 3350 \times 10^{-6}$$

ALLOWABLE STRAIN = 4000×10^{-6}

$$MS = \frac{4000}{3350} - 1 = \underline{+ .20}$$

NET TENSION