

MICROCOPY RESOLUTION TEST CHART
NATIONAL BUREAU OF STANDARDS-1963-A

AD A 1 1 5 3 3 2

12

9345

JAYCOR

DTIC FILE COPY

DTIC
JUN 8 1982
S D H

DISTRIBUTION STATEMENT A
Approved for public release
Distribution Unlimited

205 South Whiting Street
Alexandria, Virginia 22304

82 05 27 071

JAYCOR

12

INVESTIGATIONS OF CAVITY DESIGNS
FOR A HIGH POWER GYROTRON

J206-81-013/6196

Final Report

Prepared for:

Naval Research Laboratory
Washington, DC 20375

Contract Number N00173-80-C-0282

May 20, 1982

DTIC
ELECTE
JUN 8 1982
D
H

DISTRIBUTION STATEMENT A
Approved for public release
Distribution Unlimited

205 South Whiting Street

Alexandria, Virginia 22304

(703) 823-1300

UNCLASSIFIED

SECURITY CLASSIFICATION OF THIS PAGE (When Data Entered)

REPORT DOCUMENTATION PAGE		READ INSTRUCTIONS BEFORE COMPLETING FORM
1. REPORT NUMBER J206-81-013/6196	2. GOVT ACCESSION NO. AD-A115332	3. RECIPIENT'S CATALOG NUMBER
4. TITLE (and Subtitle) INVESTIGATIONS OF CAVITY DESIGNS FOR A HIGH POWER GYROTRON		5. TYPE OF REPORT & PERIOD COVERED Final Report 05/20/80 - 03/20/81
7. AUTHOR(s) Dr. David Kim, no longer employed by JAYCOR, is currently employed at NRL		6. PERFORMING ORG. REPORT NUMBER J206-81-013/6196
9. PERFORMING ORGANIZATION NAME AND ADDRESS JAYCOR 205 South Whiting Street Alexandria, VA 22304		8. CONTRACT OR GRANT NUMBER(s) N00173-80-C-0282
11. CONTROLLING OFFICE NAME AND ADDRESS Naval Research Laboratory Code 4740, Dr. Michael Read Washington, DC 20375		10. PROGRAM ELEMENT, PROJECT, TASK AREA & WORK UNIT NUMBERS Section F.4.3
14. MONITORING AGENCY NAME & ADDRESS (if different from Controlling Office)		12. REPORT DATE May 20, 1982
		13. NUMBER OF PAGES 58 pages
		15. SECURITY CLASS. (of this report) UNCLASSIFIED
16. DISTRIBUTION STATEMENT (of this Report) 1 - Scientific Officer, Code 4740 1 - Code 4701 1 - Code 4703 2 - Code 2627 12 - DDC		15a. DECLASSIFICATION/DOWNGRADING SCHEDULE
<div style="border: 1px solid black; padding: 5px; display: inline-block;"> <p style="text-align: center;">DISTRIBUTION STATEMENT A</p> <p style="text-align: center;">Approved for public release: Distribution Unlimited</p> </div>		
17. DISTRIBUTION STATEMENT (of the abstract entered in Block 20, if different from Report)		
18. SUPPLEMENTARY NOTES		
19. KEY WORDS (Continue on reverse side if necessary and identify by block number) Gyrotron Gyromonotron Millimeter waves		
20. ABSTRACT (Continue on reverse side if necessary and identify by block number) The scope of the report is the result of investigations for cavity designs of a high power gyrotron. To increase gyrotron output power, consideration was given to increased gun cathode diameters and cavity resonators. The investigations found that ohmic heating and mode competition were two primary problems that must be resolved.		

DD FORM 1473

1 JAN 73

EDITION OF 1 NOV 68 IS OBSOLETE
S/N 0102-LF-014-6601UNCLASSIFIED
SECURITY CLASSIFICATION OF THIS PAGE (When Data Entered)

CONTENTS

- I. Introduction
- II. Preliminary Report, "Comparative Studies of Cavities for a CW, Megawatt, 100 GHz Gyromonotron
- III. Final Report, "Design Considerations for a Megawatt, CW Gyrotron"



Accession For	
NTIS GRA&I	<input checked="" type="checkbox"/>
DTIC TAB	<input type="checkbox"/>
Unannounced	<input type="checkbox"/>
Justification	<i>in a file</i>
By	
Distribution/	
Availability Codes	
Dist	Avail and/or Special
<i>A</i>	

I. INTRODUCTION

The scope of the work covered by this contract involved studies of cavity designs for a high-power gyrotron. One method of increasing the output power of a gyrotron is to simultaneously increase the diameters of the gun cathode and the cavity resonator. As this transverse dimension increases, however, the natural frequency spectrum becomes compressed. Hence, in order to have the device operate only in a single frequency mode, it becomes necessary to use more accurate methods to select the specific modes.

Certain modes, called whispering-galley modes (WGM), are very useful since the fields of the WGM are localized near the resonator outer wall. Thus, they have the smallest volume relative to other modes for that resonator and have little competition with these modes. However, with increasing radius of the resonator, the WGM are even more compressed, thus have an increased danger of competition among themselves.

Experiments in the Soviet Union¹ have shown, however, that mode selection among the WGM is possible by inserting a metal rod in the center of the resonator; i.e., making it a coaxial waveguide structure. They did this by choosing the radii of the inside and outside conducting walls so that the difference between two natural WGM frequencies (the $TE_{g,1,1}$ and $TE_{5,2,1}$ modes in this case) exceeded the negative resorption bandwidth for cyclotron radiation. This permitted the separate excitation of these modes, thereby excluding the possibility of more competition between them.

Because of the above, a specific task for the present study was to evaluate the coaxial waveguide structure and other alternative structures and techniques for improved efficiency and output power of present CW gyrotrons for radar and fusion heating. A related task for improved output and efficiency was to study various beam collector and output window designs at high powers (-1 MW).

During the course of the study it was found² that in order to operate with lower-order WGM in a coaxial resonator, one has to work with very small annulus spacing, thus making electron beam alignment difficult and, more importantly, creating a large ohmic heating on the inner wall. Because of these disadvantages, the study concentrated mainly on other alternatives. Several alternative designs were numerically evaluated and are discussed in two publications presented as Sections II and III.

The study concentrated on only alternative cavity designs and not on the outcoupling problems involving window materials. An extensive study on reliability of ceramics for microwave window applications at high powers is being conducted by Oak Ridge National Laboratory.³

The work done under this contract was performed by Dr. K.J. Kim. Dr. Kim is currently an employee of the Naval Research Laboratory, Washington, D.C. 20375. The publications presented in Sections II and III were coauthored with the individuals as listed.

REFERENCES

1. Bykov, Yu. V., A.I. Goldenberg, L.V. Nikolaev, M.M. Ofitserov, and M.I. Petelin, "Experimental Investigation of a Gyrotron with Whispering-Gallery Modes," *Radio Physics and Quantum Electronics*, Volume 18, No. 10, pp. 1141-1143. (1975)
2. Kim, Kyung J., "Comparative Studies of Cavities for a CW, Megawatt, 100 GHz Gyromontron," *NRL Memorandum Report 4676*, December, 1980.
3. Becher, P.F., Ferber M.K., and Tennery, U.J. "Mechanical Reliability of Ceramics for Microwave Window Applications," *Metals and Ceramics Div., Oak Ridge National Lab Report ORNL/TM-7811*, July, 1981, Oak Ridge, TN.

II. COMPARATIVE STUDIES OF CAVITIES FOR CW, MEGAWATT, 100 GHz
GYROMONOTRON*

ABSTRACT

A preliminary report for designing Megawatt, CW gyromonotron oscillator at 100 GHz is presented. The ohmic heating, mode competition, space charge limit, and electron beam and rf separation are discussed.

*Kim, Kyung J., Read, Michael E.

CONTENTS

I. Introduction. 6

II. Discussion. 6

III. Calculations for various schemes. 10

 A. Coaxial cavity. 10

 B. Whispering gallery modes. 10

 C. TE_{on} modes. 10

IV. Conclusion. 17

 References. 18

I. INTRODUCTION

High power and high efficiency submillimeter wave sources are desired for many practical applications, such as for the electron cyclotron heating in Tokamaks. The Soviets have reported the generation of 1 Megawatt, 110 GHz short pulse signal from a gyrotron⁽¹⁾. There are many obstacles to raising the power level, stretching the pulse width, and increasing the frequency. In this letter we report preliminary work in which these difficulties and possible designs are considered. All the discussions are for the optimum efficiency case with cavity length $L=5\lambda$ (no magnetic tapering) and electron energy of 70 keV.

II. DISCUSSION

For a low Q cavity, the axial dependence of a field is between a traveling wave ($e^{-j\beta z}$) and a standing wave ($\sin kz$). The former dependence is used throughout, and by this choice (the diffraction limited case), the power calculated will be somewhat higher than in the actual case. The fields for the TE_{mn1} modes in a cylindrical wave guide are:

$$E_r = N \left(\frac{j\omega\mu m}{k^2 r} \right) J_m(kr) \sin m\theta e^{j\omega t} e^{-j\beta z}$$

$$E_\theta = N \left(\frac{j\omega\mu}{k} \right) J'_m(kr) \cos m\theta e^{j\omega t} e^{-j\beta z}$$

$$\equiv E_0 J'_m(kr) \cos m\theta e^{j\omega t} e^{-j\beta z}$$

$$H_{\theta} = N \left(\frac{j\beta m}{k^2 r} \right) J_m (kr) \sin m\theta e^{j\omega t} e^{-j\beta z}$$

$$H_r = N \left(\frac{-j\beta}{k} \right) J'_m (kr) \cos m\theta e^{j\omega t} e^{-j\beta z}$$

$$H_z = N J_m (kr) \cos m\theta e^{j\omega t} e^{-j\beta z}$$

$$\text{where } \left(\frac{\omega}{c} \right)^2 = k^2 + \beta^2$$

For the present study, N is chosen for optimum efficiency⁽²⁾.

For example, $E_o J'_m (kr_e) = 2 \times 10^7 \times 0.582$ (Volt/meter) where r_e is the electron beam radius⁽²⁾. This value is known only for the TE_{on} mode, but can be extended to the TE_{mn} mode. The corresponding coaxial waveguide fields are found by replacing J_m with $Z_m (kr)$.

For Example:

$$E_o = N \left(\frac{j\omega\mu}{k} \right) Z'_m (kr) \cos m\theta e^{-j\beta z}$$

where $Z_m (kr) = J_m (kr) Y'_m (ka) - Y_m (kr) J'_m (ka)$, where a=the outer radius and b=the inner radius of the cavity.

The power transmitted through a hollow waveguide of radius a and length L is

$$P = D \frac{\pi c^2 \epsilon}{8fl} (a \cdot E_o \cdot J_m (ka))^2 \left(1 - \left(\frac{m}{ka} \right) \right)^2$$

where $D = 1$ if $m \neq 0$

$D = 2$ if $m = 0$

and ϵ is the permittivity.

The ohmic heating per unit area is,

$$W_L = \frac{D R_s}{4} [N^2 J_m^2 (ka) + N^2 \left(\frac{\beta_m}{K^2 a}\right) J_m^2 (ka)]$$

Where $R_s = \frac{W_L}{2\sigma}$, σ is the conductivity.

The first term is due to the transverse current and the second term is from the axial current. For $m \leq 20$, the axial current contribution of the ohmic heating is less than 9 percent of the transverse current heating.

In a given output coupling scheme,

$$\text{Power} \propto \left(\frac{a \cdot E_o \cdot J_m (ka)}{f \cdot L} \right)^2$$

and the ohmic heating per unit area $\propto \left(\frac{f}{\sigma}\right)^{1/2} \left(\frac{E_o}{f \cdot a}\right) J_m (ka)^2$

To maintain constant (optimum) efficiency,

$$E_o \propto f, L \propto \frac{1}{f}, \text{ and } a \propto \frac{1}{f}, \left(E_o \propto \frac{1}{L}\right) (2),$$

Then the ohmic heating per unit area is found to be proportional to $f^{5/2}$, which can be a major obstacle for high frequency, high power CW devices. In order to maintain reasonable values for the ohmic heating per unit area, while keeping the output power at the required level, large radius (low E_o) cavities are necessary. Because of the large E_o required for efficient operation using the second cyclotron harmonic or with whispering gallery modes large ohmic heating will result, and their use for CW devices may not be desirable.

As shown below, the electron beam radius has to be large in order to avoid space charge effects. This and the above requirements will bring about the necessity for use of cavities where there is expected to be competition between modes. One measure of the mode competition problem is the relative values of starting currents. The starting current of a given mode: ^(1,3)

$$I_{st} \propto \frac{F\{(\omega - \Omega_c) / k_z \cdot v_z\}}{J_m \mp s (kr_e)}$$

Where s is the harmonic number, the magnetic field is along the z direction. So, one can vary the starting current either by varying the electron radius or magnetic field. It may be possible to suppress competing modes by selectively attenuating both the conduction current and the displacement current on the wall with dielectric filters. Prebunching of the electrons is also under consideration (4)(5).

Space charge effects due to the electron self potential relative to the waveguide as well as mutual repulsion is another factor which must be considered. The limiting current for an annular beam due to the first effect, with the approximation that the beam is infinitely thin, is,

$$I_{\max} = \frac{8.5 \times 10^3}{\ln(r_w/r_b)} (\gamma^{2/3} - 1)^{3/2} \quad (6)$$

where r_w is the waveguide radius and r_b is the electron radius, with a finite beam thickness I_{\max} can be lower by as much as factor of 2.

As a typical example, with the electron beam with an energy of 70 keV located at the third peak of the TE_{06} mode, $I_{\max} = 270$ Amperes. The perveance of the beam at 30 Amperes and 70 keV is 1.6μ perts. The critical current where the beam becomes unstable is about five times smaller than I_{\max} (7). Operating at a higher voltage lowers the perveance and raises the critical current, but shortens the optimum cavity length due to faster phase trapping (8), thereby increasing ohmic heating per unit area.

As suggested by the Soviets (9), the RF field structure can be optimized for the efficiency enhancement. Cavity profiling can serve this purpose as well as lowering the diffraction Q (10).

III. CALCULATIONS FOR VARIOUS SCHEMES

A. Coaxial Cavity

For $\Delta \equiv \frac{b}{a} > 0.7$ a power of one megawatt can be produced using TE_{02} or TE_{01} , but for $\Delta < 0.7$ the cross section becomes too small and a higher order mode should be used. For $\Delta \gtrsim 0.8$ the Bessel function root $X'_{on} = X'_{mn+1}$, indicates the potential for serious competition between the modes.

Typical output powers and ohmic heating for low order modes are shown in Table 1. In order to operate with a low order mode, one has to work with a small annulus spacing (making beam alignment critical) and with large ohmic heating on the inner wall. These are perceived as major disadvantages.

B. Whispering Gallery Modes

TE_{mn} waves with $m \gg 1$ and $m \gg n$ are called whispering gallery modes. As shown in Figure 1, where E_{θ} is normalized as before, the large wall heating and radial E-field encountered with these modes are undesirable.

The TE_{m1} type modes appear to be free from mode competition. This has been checked up to $m = 18$ by the linear theory of K. Kreisher and R. Temkin⁽³⁾. Typical starting currents versus the magnetic field for the electron located at the peak of $J'_{18,1}$ are shown in Figure 2.

C. TE_{on} Modes

As shown in Figure 1, TE_{on} modes have the smallest ohmic heating for a given power output. This is because of the slowly decaying property of J'_1 compared to J'_m (where $m > 1$). Unfortunately, operating with a high order mode and locating the electron beam away from the first peak of the Bessel function will bring about several competing modes. Typical examples are shown in Figure 3 and 4. In general, it can be shown that serious mode competitions come only from the mode whose X'_{mn} is close to that of the operating mode ($|X'_{mn} - X'_{m,n}| < 1$). X'_{on} is very close to X'_{2n} for $n > 3$. This competition cannot be avoided by just varying the electron radius because of the similar behavior

Δ	Mode	Radius (Cm)	Power	Ohmic loss
0.7	01	a=0.504 b=0.353	600 kW	
	02	a=1.005 b=0.703	2.2 MW (e at 1st peak of J_1) 2.6 MW (e at 2nd peak of J_1)	
0.8	01	a=0.754 b=0.603	960 kW	
	02	a=1.507 b=1.205	3.6 MW ("1st") 4 MW ("2nd")	$W_L^{IN} = 2.7 \text{ kW/cm}^2$ $W_L^{OUT} = 1.7 \text{ kW/cm}^2$ ($\times \frac{1}{3.6} = 0.75, 0.6 \text{ kW/cm}^2$)
0.9	01	a=1.506 b=1.355	2 MW	$W_L^{IN} = 2.4 \text{ kW/cm}^2$ $W_L^{OUT} = 1.7 \text{ kW/cm}^2$
	02	a=3.011 b=2.71	8 MW ("1st") 8.4 MW ("2nd")	$W_L^{IN} = 3.8 \text{ kW/cm}^2$ $W_L^{OUT} = 3.4 \text{ kW/cm}^2$ ($\times \frac{1}{8} = 0.48, 0.43 \text{ kW/cm}^2$)

TABLE 1

Output power and ohmic heating for various coaxial cavities. The output power is calculated for an RF(E)₀ field which yields the optimum efficiency for a cavity with a length of 1.5 cm operating at a frequency of 100 GHz.

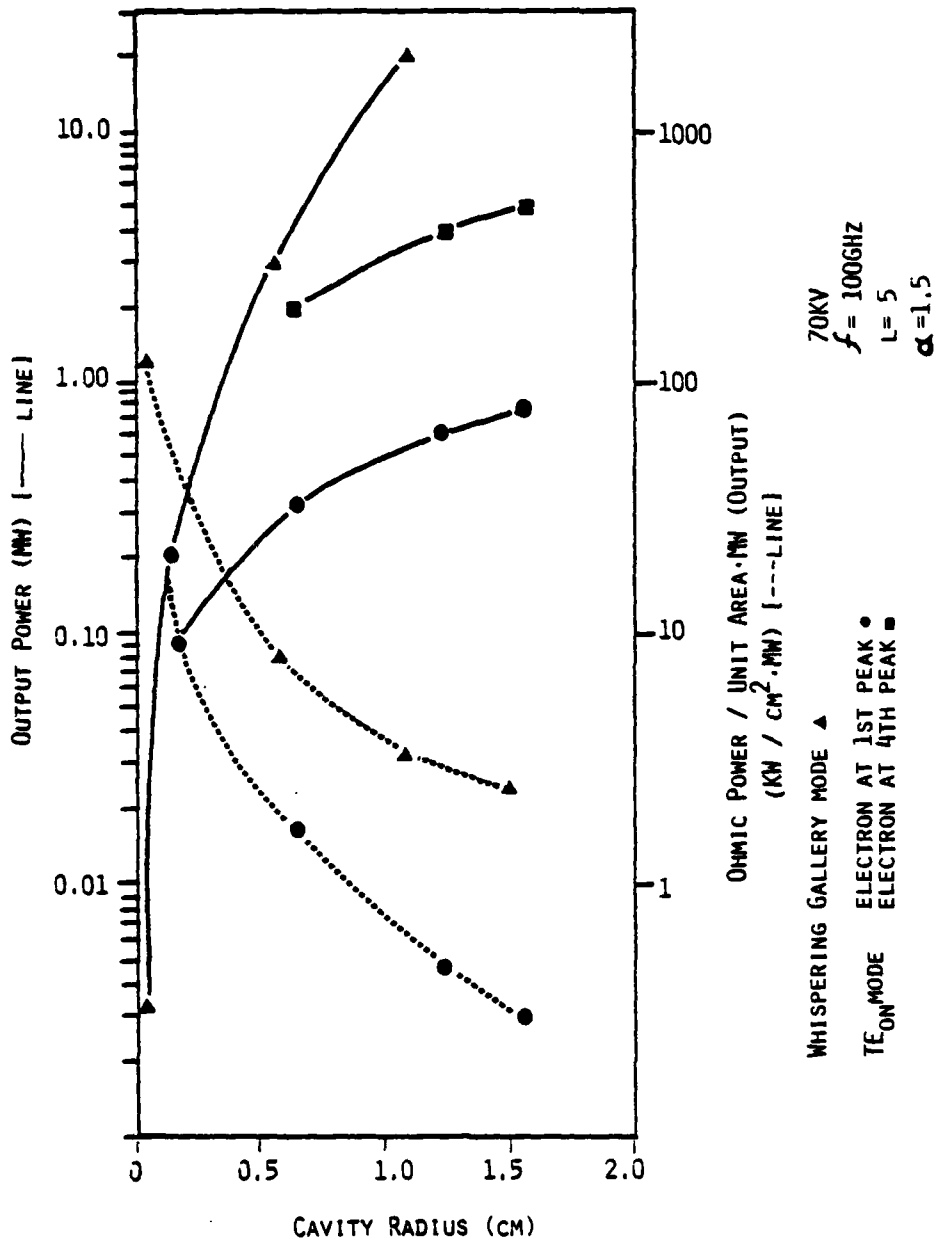

Figure 1: Output power and ohmic loss power for various modes the output power is calculated using an RF field magnitude which yields optimum efficiency.

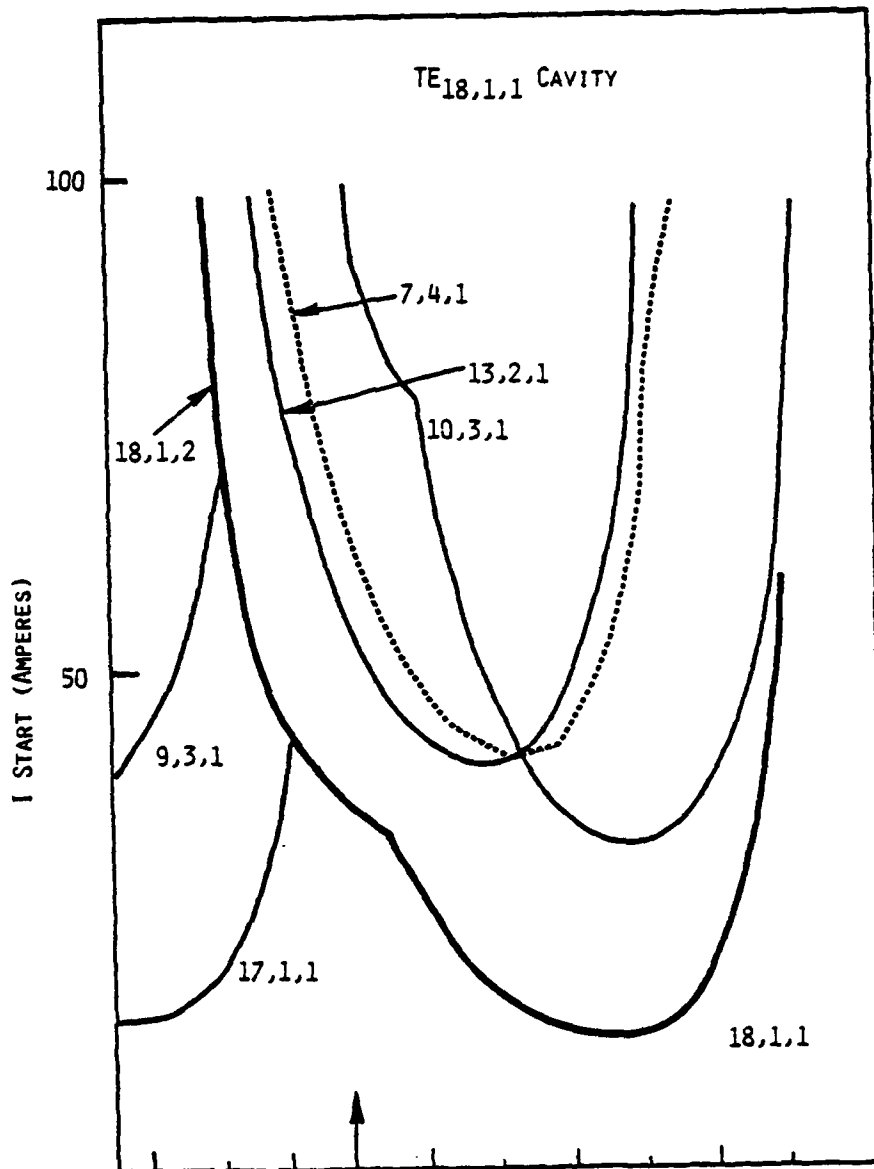

Figure 2: Starting currents of whispering gallery mode and various possible competing modes. (The arrow indicates operating region for optimum efficiency).

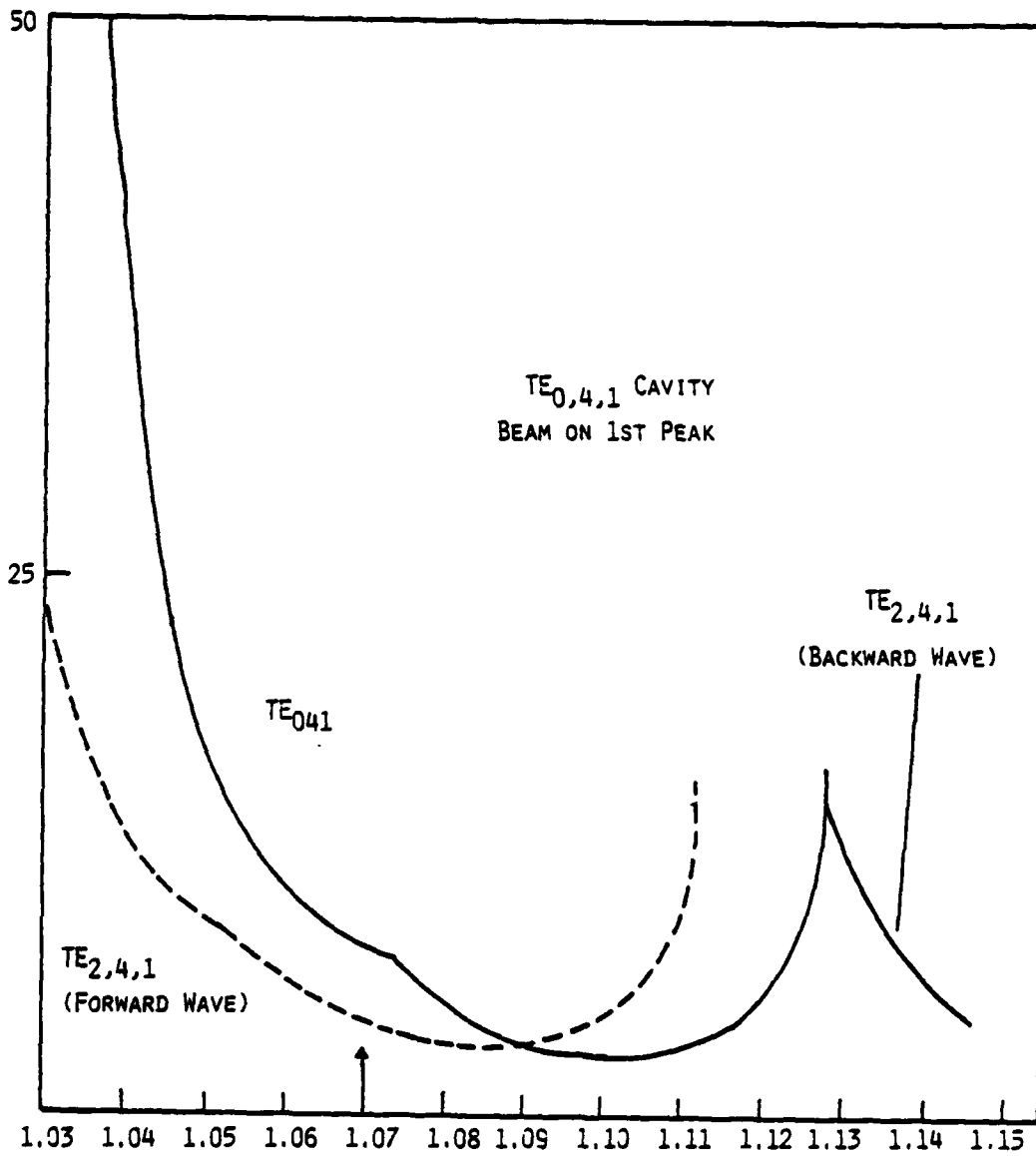

Figure 3: The similar behavior of $TE_{0,4,1}$ mode with $TE_{2,4,1}$ mode.
(The arrow indicates the operating region).

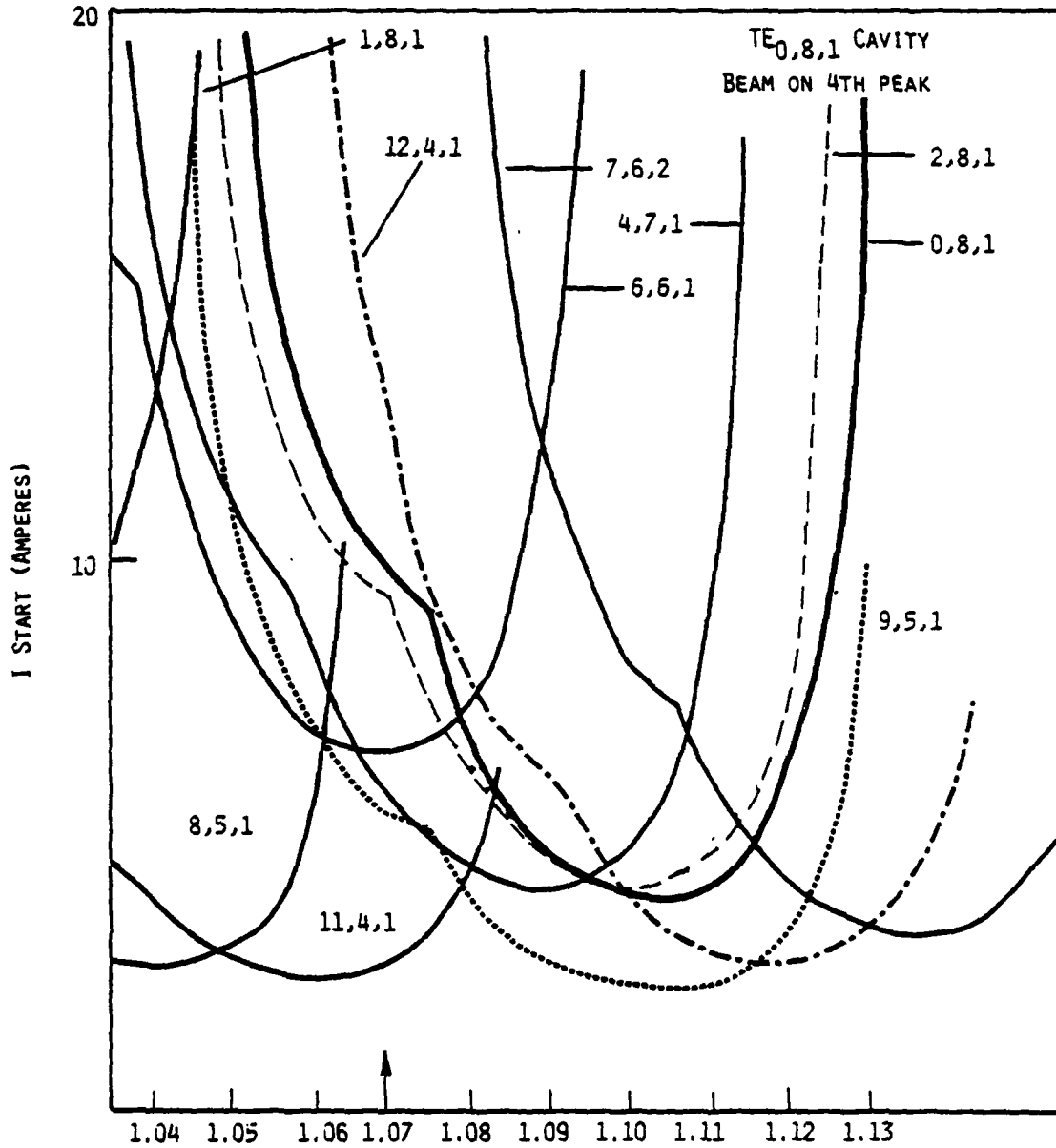

Figure 4: Behavior of various TE modes.

of the respective Bessel functions (cf. $I_{st} \propto \frac{1}{|J_{m\pm 1}(kr_e)|^2}$).

However, selective attenuation of the axial current, thereby attenuating the TE_{mn} mode with $m \neq 0$ could be feasible either by using dielectric rings at both ends of the cavity or by using a helix wound cavity.

TE_{on} modes show the possibility of separating electrons from the rf beam by breaking the waveguide without significantly disturbing the main mode, because it has no axial current (11). However, forcing the electrons to pass through the small gap between waveguides (less than a wavelength) could be a difficult task.

IV. CONCLUSION

Ohmic heating appears to be a major limitation for high power CW gyrotrons. TE_{on} modes show the least ohmic heating for a given output power. However, the mode competition possibility which looks to be associated with these modes, must be resolved before they can be seriously considered for use.

ACKNOWLEDGMENTS

The authors wish to express their appreciation to B. Arfin and K. Chu, for their many contributions to this work.

This work was supported by the Department of Energy, under agreement number DE-AI01-80-ER52065.

REFERENCES

1. A.V. Gaponov, et al., Report for IV International Conference on Infrared and Near Millimeter Waves, December, 1979.
2. M. Read, K. Chu and K. Kim, to be published, International Journal of Infrared and Millimeter Waves, Volume 2 (1981).
3. K.E. Kreisler and R.J. Temkin, International Journal of Infrared and Millimeter Waves 1, 195 (June, 1980).
4. Y.V. Bykov, et al., Scientific Research Institute for Radiophysics 17, No. 8, 1219-1223 (August, 1974).
5. A. Ganguly and K.Chu, Bulletin of the APS, 25, 4514 (1980).
6. M.E. Read and J.A. Nation, J. Plasma Physics, 13, 127-137 (1975).
7. A. Drobot and Kyung J. Kim, (to be published).
8. Robert Lee, K. Chu, and J. Hershfield (Private Communication).
9. Bykov, Yu. V., and A.L. Goldenberg, Radiophysics and Quantum Electronics 18, 791-792 (1975). (IZV VUZ Radio fiz 18, 1544, 1975).
10. M. Caplan, Hughes Technical Report, Number 58, (March, 1980).
11. N. Morita and Y. Nakanishi, IEEE MTT-16 No. 3, 183 (March, 1968).

III. DESIGN CONSIDERATIONS FOR A MEGAWATT CW GYROTRON*

ABSTRACT

Several designs for a 1 MW, 100 GHz gyrotron are presented. Each design is evaluated and shown to be potentially feasible. The problem areas in each design are identified and discussed. There is still considerable research that must be done to determine the optimum design.

*Kim, K. J., Read, M. E.

CONTENTS

I. Introduction. 21

II. Design Considerations 22

III. Examples of Design. 46

IV. Discussion and Conclusion 53

Acknowledgement 53

References. 56

I. INTRODUCTION

Considerable progress has been made in the last decade in research on and development of gyrotron oscillators. These sources have been shown to be capable of producing high power millimeter wave radiation with high efficiency. The highest CW power obtained is 212 KW at 28 GHz ⁽¹⁾ and the highest pulsed power reported is 1.25 MW at 85 GHz. ⁽²⁾ While these achievements are impressive, and represent an improvement in output power of several orders of magnitude over previously existing sources at equivalent frequencies, there is an increasing demand for devices with higher powers and frequencies for both military and fusion related systems. Specifically, some fusion reactor designs call for 50 MW CW at up to 150 GHz for electron cyclotron heating.

For reasons of cost and system complexity it is desirable to reduce to a reasonable minimum the number of individual devices used in a heating system. Therefore, a study has been performed to determine the upper limit on the power of these sources. For simplicity, we focus in this paper on a CW gyrotron oscillator with a frequency of 100 GHz and an output power of 1 MW. Both the conventional (microwave closed cavity) and quasi-optical (Fabry Perot Cavity) types of gyrotrons are considered.

This paper is a summary of the results of several separate studies. Therefore, in many areas, the detailed calculations have been omitted and the discussions are included by reference only.

The paper is divided into four sections, the first of which is the introduction. The second delineates the critical elements of the gyrotron oscillator and includes a brief discussion of the limiting factors on the output power. The third consists of specific designs. The final section is a discussion and conclusion.

II. DESIGN CONSIDERATIONS

The gyrotron is a class of device in which the power is extracted from the perpendicular motion of electrons in a magnetic field via relativistic instability. The frequency of a gyrotron oscillator is determined jointly by a cavity and magnetic resonance. This feature allows the use of a cavity with a much higher mode density than would be possible with only a cavity resonance condition, thereby permitting the cavity dimensions to be large compared to the radiation wavelength. Thus the ohmic dissipation will be much smaller than in most other microwave devices, and much higher output powers are possible for a given frequency.

There are two configurations currently envisioned for gyrotron oscillators. The first, shown in Figure 1, uses a closed cavity which is operated near cutoff, and the electron beam drifts parallel to the direction of propagation of the radiation. All gyrotrons reported operating to date have been of this type. The second, a quasi-optical gyrotron, uses an optical resonator (i.e., made of two reflecting mirrors). This type of gyrotron has never been reported to be realized but has several potential advantages, as are discussed below.⁽³⁾

The elements which may limit the output power and which will be discussed here are the ohmic losses, mode competition in the cavity and the electron beam generation and propagation. The design of the collector and output window are also expected to be critical, but are beyond the scope of this paper.

CAVITY CONSIDERATIONS⁽⁴⁾

Closed Microwave Cavity

Most high power gyrotron oscillators reported to date use a single cavity which supports a TE_{mn1} mode near cutoff. For high power devices this will undoubtedly be a high order mode. Three types of modes have been considered for a circular cavity. In an open cavity, calculations have been made for TE_{0n1} modes and

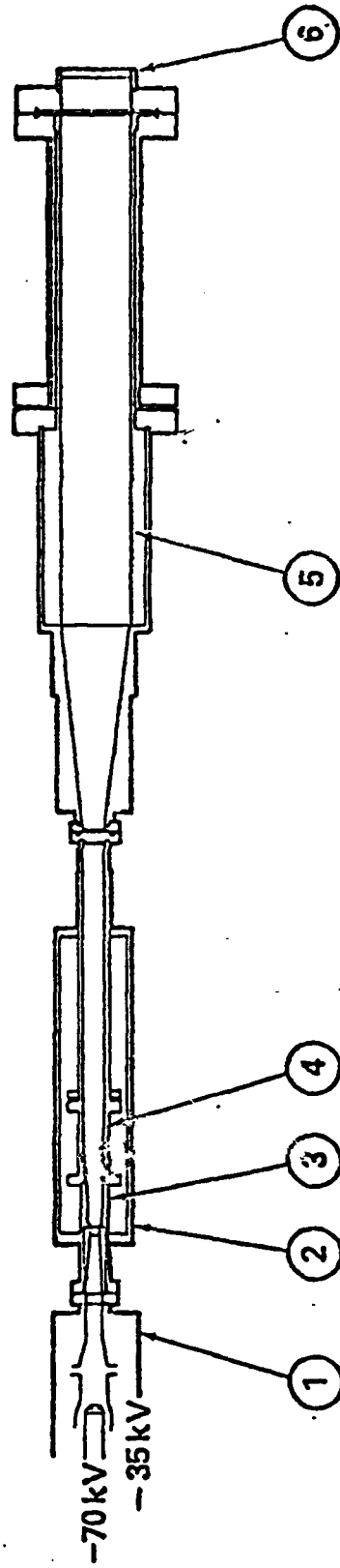
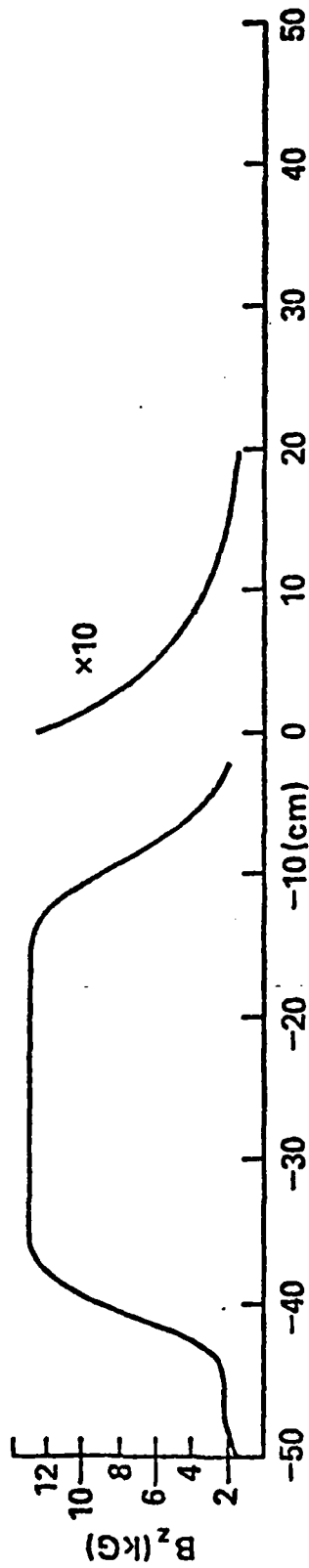

Figure 1. Typical 35 GHz gyrotron oscillator (1) electron gun, (2) vacuum envelope, (3) cavity, (4) output guide, (5) collector, (6) output window.

cavity, TE_{0n1} modes are considered.

Ohmic losses and mode competition are the two principal cavity related parameters which will limit the output power. These are discussed in this section.

The output power achievable with good efficiency depends on several parameters, such as the cavity mode, cavity length, the output Q, the beam voltage, the beam transverse to axial velocity ratio, and the beam temperature. All these parameters have to be optimized simultaneously to find the best design parameters.

The output power of a gyrotron is determined by the mode, the magnitude of the rf fields in the cavity and the Q of the cavity. For high power devices it is generally desirable to use as low an output Q as possible to reduce ohmic heating. An approximation of the lower limit to the output Q of a cavity with length L is the diffraction limit Q, given by $Q_D = 4\pi (L/\lambda)^2$ (λ is the free space wavelength). With this assumption the output power is given by

$$P = \frac{\epsilon_0 \pi c^2 a^2}{8 f L} (E_0 J_m'(ka))^2 \left(1 - \left(\frac{m}{ka}\right)^2\right) \quad (1)$$

where ϵ_0 is the permittivity of free space, c is the speed of light, f the frequency, a the cavity radius, and k the perpendicular wave number. E_0 , the peak electric field amplitude, is given by the expression

$$E_0 = E_\theta [J_m'(kr) \cos(m\theta - 2\pi ft) h(\beta z)]^{-1} \quad (2)$$

where $f^2 = \frac{c^2}{4\pi^2} (k^2 + \beta^2)$, and $h(\beta z)$ is the axial rf electric field profile, which is approximated here by $\sin \beta z$. The value for E_0 which yields the optimum efficiency has been calculated by several authors and has been found to be independent of the operating mode. (5,6,7) The cavity length must be optimized for

high efficiency and for low output Q.

The average ohmic dissipation per unit area in the cavity wall is given by

$$W_L = \frac{R_s k^2 E_o^2}{16\pi^2 f^2 \mu^2} [J_m^2 (ka) + \left(\frac{\beta_m}{k^2 a}\right)^2 J_m^2 (ka)] \quad (3)$$

where the surface resistivity $R_s = (\pi f \mu / \sigma)^{1/2}$ and μ is the permeability. The first and second terms in the bracket are from the transverse and axial wall currents respectively.

From equations (1) and (3) for a given mode, the output power is seen to be proportional to $(a E_o J_m (ka))^2 / (f L)$ and the ohmic loss per unit area proportional to $(f/\sigma)^{1/2} (E_o J_m (ka))^2 / (f a)^2$. From dimensional scaling analysis one can show, for optimum efficiency, $E \propto f$, $L \propto 1/f$, $a \propto 1/f$ and $(E_o \propto 1/L)$. The ohmic loss per unit area is thus found to be proportional to $f^{5/2}$, which is a principal obstacle in the realization of high frequency, high power CW devices. In order to maintain generally accepted values for the ohmic loss ($\leq 1 \text{ kW/cm}^2$), while keeping the output power at the required level, large radius cavities are found to be necessary.

The problem of mode competition is a complex issue. To determine the possibility of competition from unwanted modes we compute starting currents from the linear theory. If there is no other mode with lower starting current than that of the desired mode in the operating region, one can be reasonably assured of no mode competition. However, if for the conditions for which optimum efficiency in the desired mode is achieved the starting current of an other than desired mode is lowest, but for other conditions the starting current of the desired mode is lowest, the situation is less clean, and must be further examined by non-linear theory or experiment. In some cases it may be possible to start the desired mode where its starting current is lowest, then adjust parameters for optimum efficiency, retaining oscillation in the same mode. Such an adjustment would be in the relative

phase of the beam and cavity modes, given by

$$\Delta\phi = \frac{L}{v_{\parallel}} (2\pi f - \beta v_{\parallel} - \Omega_c/\gamma) \quad (4)$$

where Ω_c is the cyclotron frequency (in radians per second), v_{\parallel} the parallel electron velocity, and γ the relativistic mass factor. Variations in the phase can thus be made by adjusting either the beam parameters, v_{\parallel} and γ , or the magnetic field.

There are some indications that once an oscillation is started in a given mode, that mode will keep oscillating as the magnetic field is varied for the higher efficiency operation.⁽¹⁾ But this phenomena needs to be examined more carefully.

The linear theory used here has been derived by K. Kreisher and R. Temkin in the weakly relativistic limit.⁽⁸⁾ The starting currents computed are in agreement to within 5% at 70 kV the results of K. Chu, which are fully relativistic.⁽⁹⁾

Coaxial Cavity

The concept of a coaxial cavity is attractive, because the inherently large beam-radius required implies a relatively straightforward gun design. However, from the standpoint of the cavity design alone, there is no clear advantage over other schemes for the following reasons. With Δ defined as the inner radius over the outer radius, for $\Delta > 0.7$ a power of one megawatt can be produced using either the TE_{01} or TE_{02} mode. But the Bessel function root $X'_{on} = X'_{mn+1}$ ($J'_m(X'_{mn}) = 0$ for TE_{mn} modes), indicating the possibility of competition between these modes. For $\Delta \leq 0.7$ the cavity cross sectional area is too small to generate a megawatt output with an optimum value for E_0 using either of these modes. Thus, a higher order mode must be used, which again means possible mode competition from analogy with the hollow cavity, (see TE_{on} Modes). The coaxial cavity has the additional disadvantage that cooling of the inner wall appears difficult. For these reasons, the coaxial cavity appears less

desirable than the hollow cavity for a CW device.

Whispering Gallery Modes

A plot of P and W_L for the whispering gallery modes (from the equations (1) and (3) above) for a beam of 70 KeV and a frequency of 100 GHz is given in Figure 2.⁽¹⁰⁾ Extrapolation to other voltages can be made by use of Figure 3. The curves can be used for TE_{mn} modes by substitution of $E_0 J_1$, peak for $E_0 J_{m-1}$ (kr_{beam}).

It is clear from Figure 2 that megawatt level powers can be produced with the whispering gallery modes, but with relatively high ohmic heating levels.

To examine the possibility of mode competition the starting current versus magnetic field in the cavity for a $TE_{18,1,1}$ mode is shown in Figure 4. The whispering gallery is seen to be free from mode competition. This has been checked for all modes with m up to 18.

TE_{on} Modes

The output power and ohmic heating for the TE_{on} modes are shown in Figure 5. TE_{on} modes generate the smallest ohmic heating among TE_{mn} modes for a given output power. The ohmic heating for 1 MW output is typically within generally acceptable levels (less than 1 KW/cm²). However, one cannot avoid mode competition with modes with large values of n , especially when the electron beam is located away from the first peak of the Bessel function J_1 . A typical example of such a case, a TE_{08} mode with the beam at the fourth peak, is shown in Figure 6. It can be seen that there is no way to access the desired mode. In general, it can be shown that serious mode competition arises only from the mode whose Bessel function root $X'_{m'n'}$ is close to that of the operating mode (i.e., $|X'_{mn} - X'_{m'n'}| < 0.2$). X'_{2n} is very close to X'_{on} for $n > 5$. The competition between these modes cannot be avoided by varying the beam position because the dependence of starting current on beam position is identified as

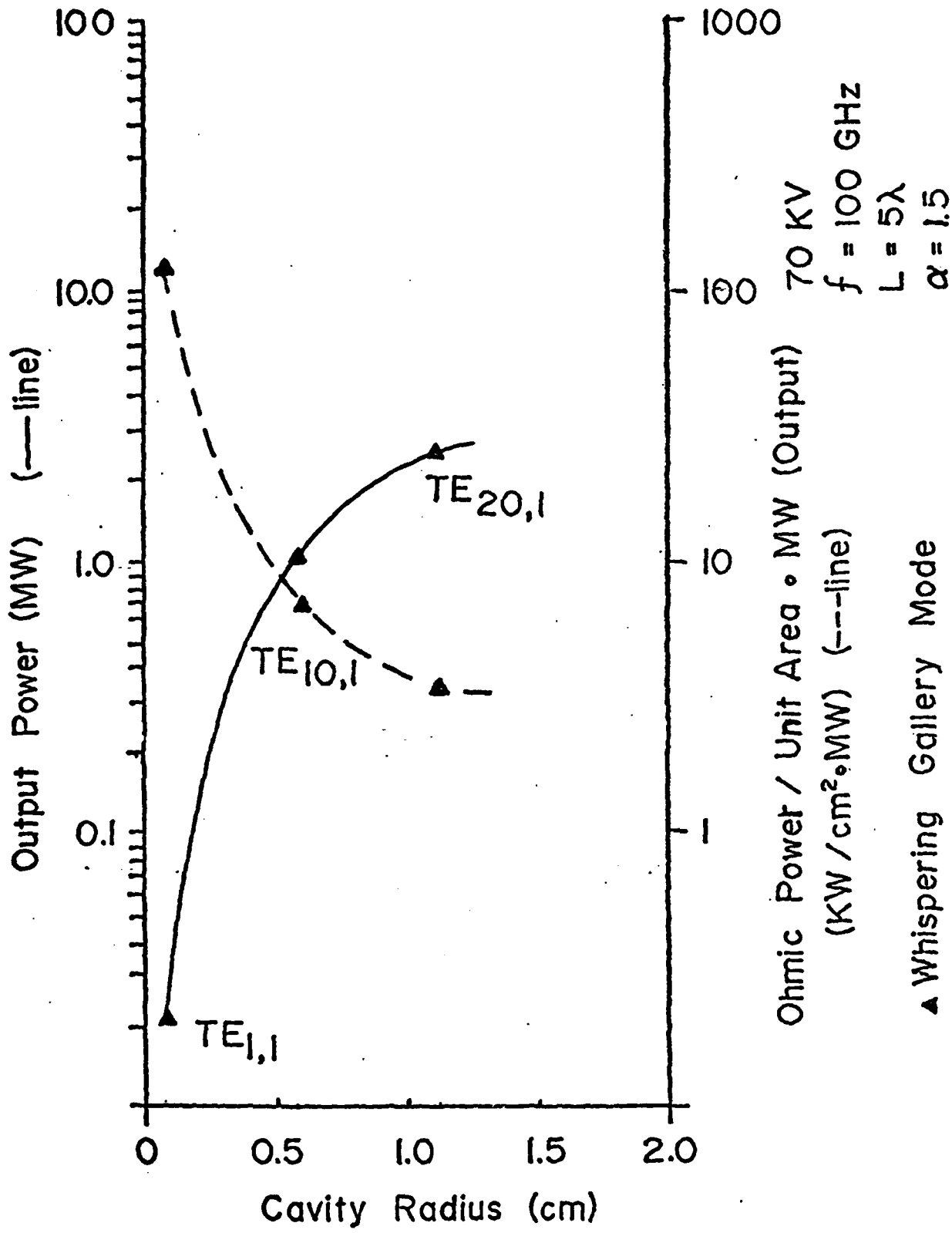

Figure 2. Output power and ohmic loss power for Whispering Gallery Modes. The output is calculated using an rf field magnitude which yields optimum efficiency.

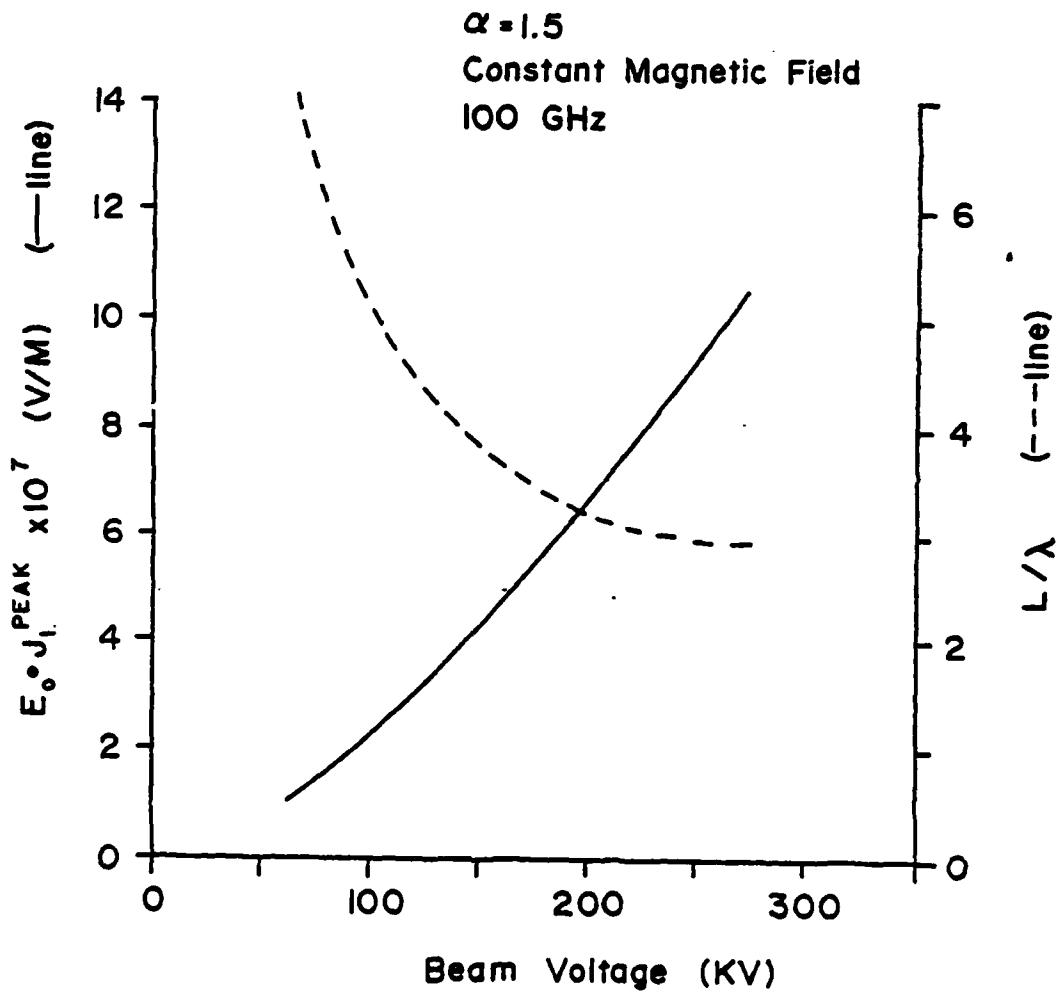

Figure 3. Electric field at the location of electrons and cavity length at optimum efficiency as a function of voltage.

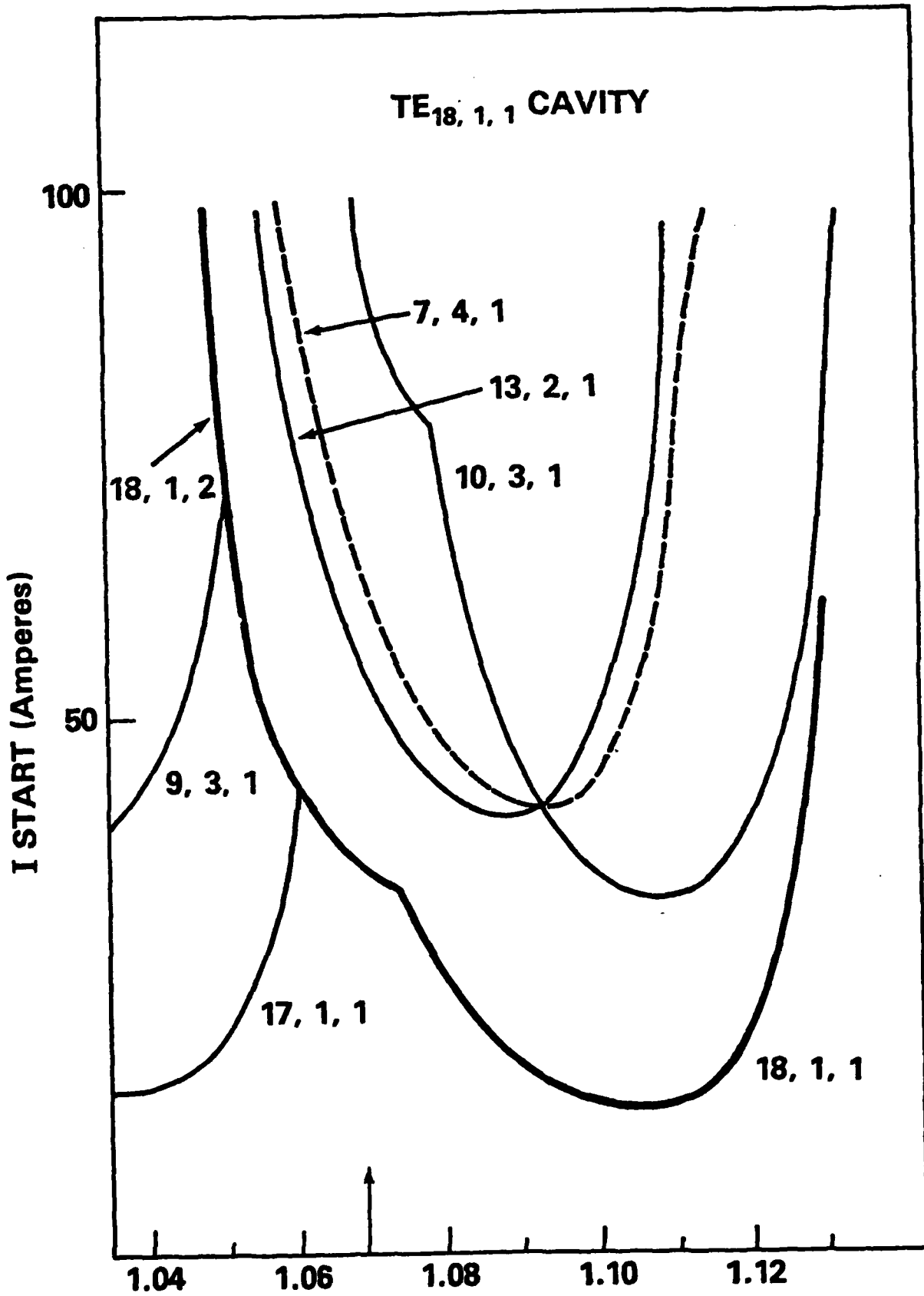

Figure 4. Starting currents of Whispering Gallery Mode and various possible competing modes. (The arrow indicates operating region for optimum efficiency).

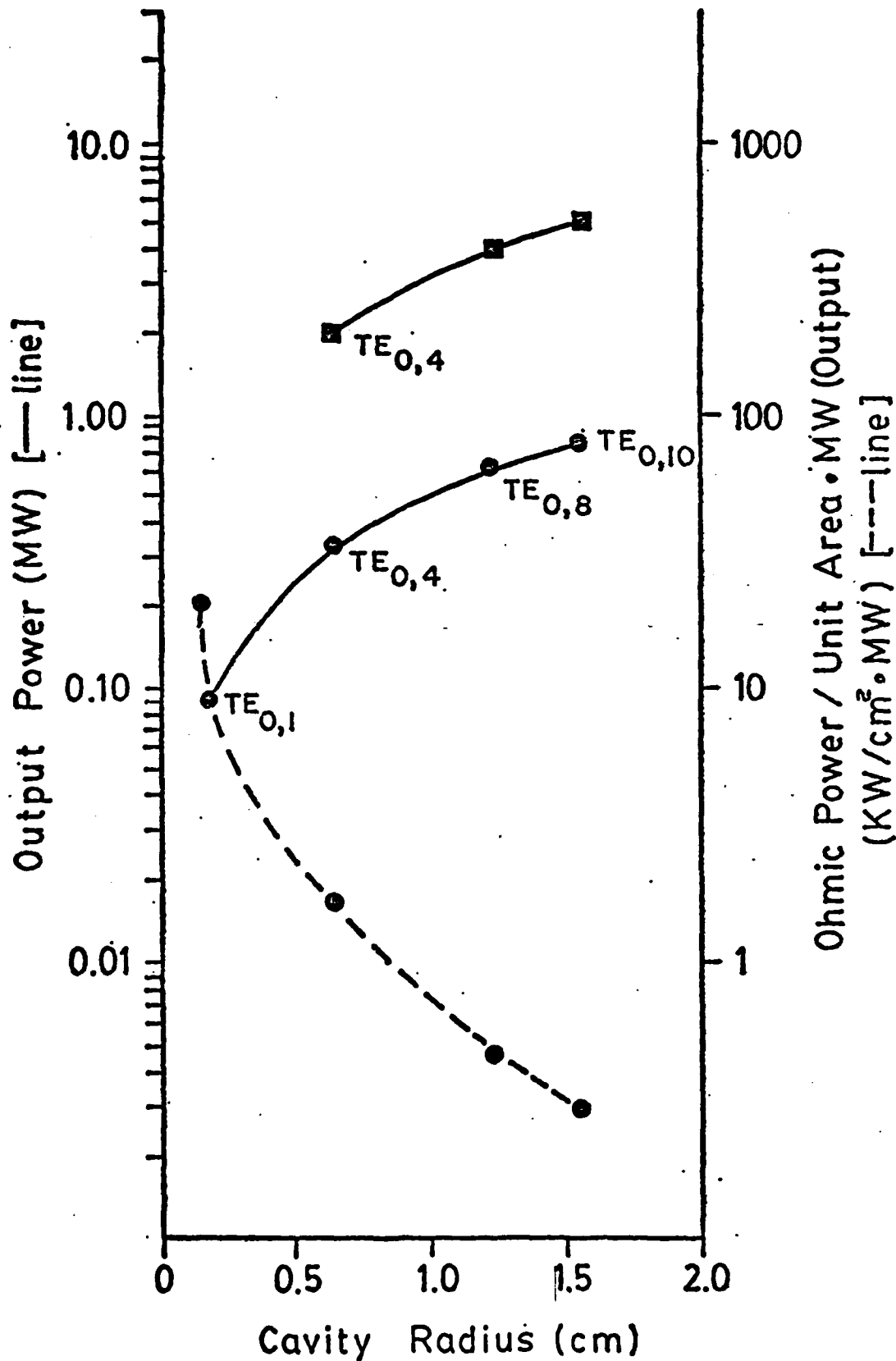

Figure 5. Output power and loss power for TE_{0n} modes. The output power is calculated using an rf field magnitude which yields optimum efficiency.

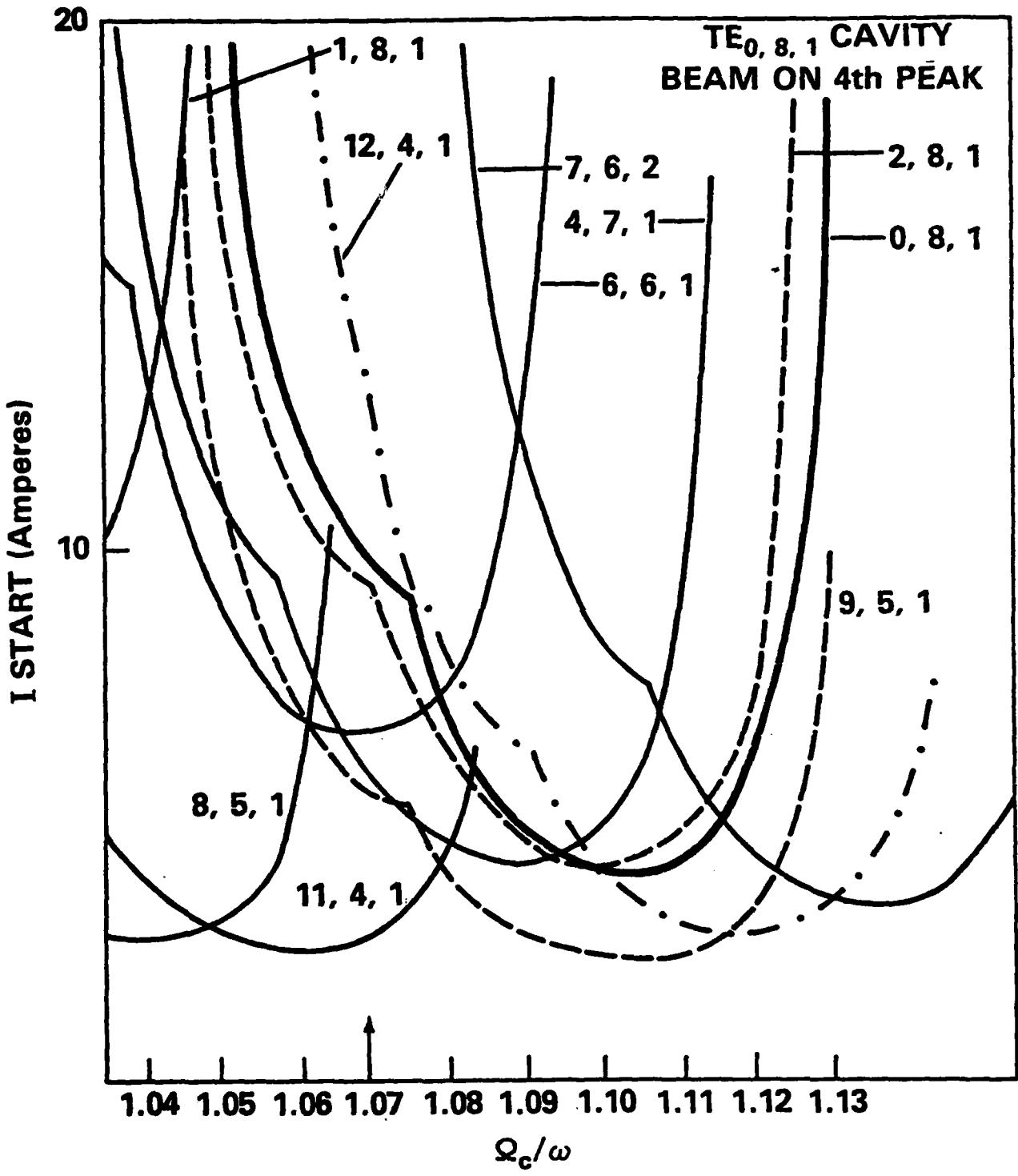

Figure 6. Starting current of TE_{0, 8, 1} mode and various possible competing modes (The arrow indicates operating region).

shown by the relation

$$I_{st} \propto |J_{m+1}(kr_{beam})|^{-2}. \quad (5)$$

A more modest example appears in Figure 7. The TE_{041} mode with beam at the first peak is shown to start oscillation at high magnetic field. Experiments have indicated that oscillation in TE_{041} mode can still be retained, once started, as the relative phase between the cavity and beam modes is increased to a point where good efficiency is obtained.^(11,12) In these experiments the phase shift was caused by changes in v and γ . It is expected that reducing the magnetic field will produce equivalent results. Using this assumption, and the above results, it appears that operation in the TE_{051} mode, with the beam at the second peak of the Bessel function J_0 , should be possible, as shown in Figure 8. However, for the same mode with the beam on the third peak, Figure 9 shows that there is no field for which the starting current for the TE_{051} mode is lowest. Operation in the TE_{051} mode for these conditions is then judged to be unlikely. The desirability of operating with as large as possible beam radius is discussed in "Electron Beam".

Suppression of the non TE_{on} modes by attenuating the axial current (inherent in all but TE_{on} modes) with dielectric rings has been tried. The results were found to be ineffective due to the relatively weak axial current and the weak coupling between the rf fields and wall currents inherent in overmoded cavities. (For modes with $m < 20$, the axial current contribution to the ohmic heating is less than 9% of that of the transverse current).

Open Resonator

The theory for the quasi-optical gyrotron has been developed by several groups.^{(3),(13),(14)} The cavity geometry for this case is that of an optical resonator (see Figure 10). The electron beam can propagate either parallel or perpendicular to

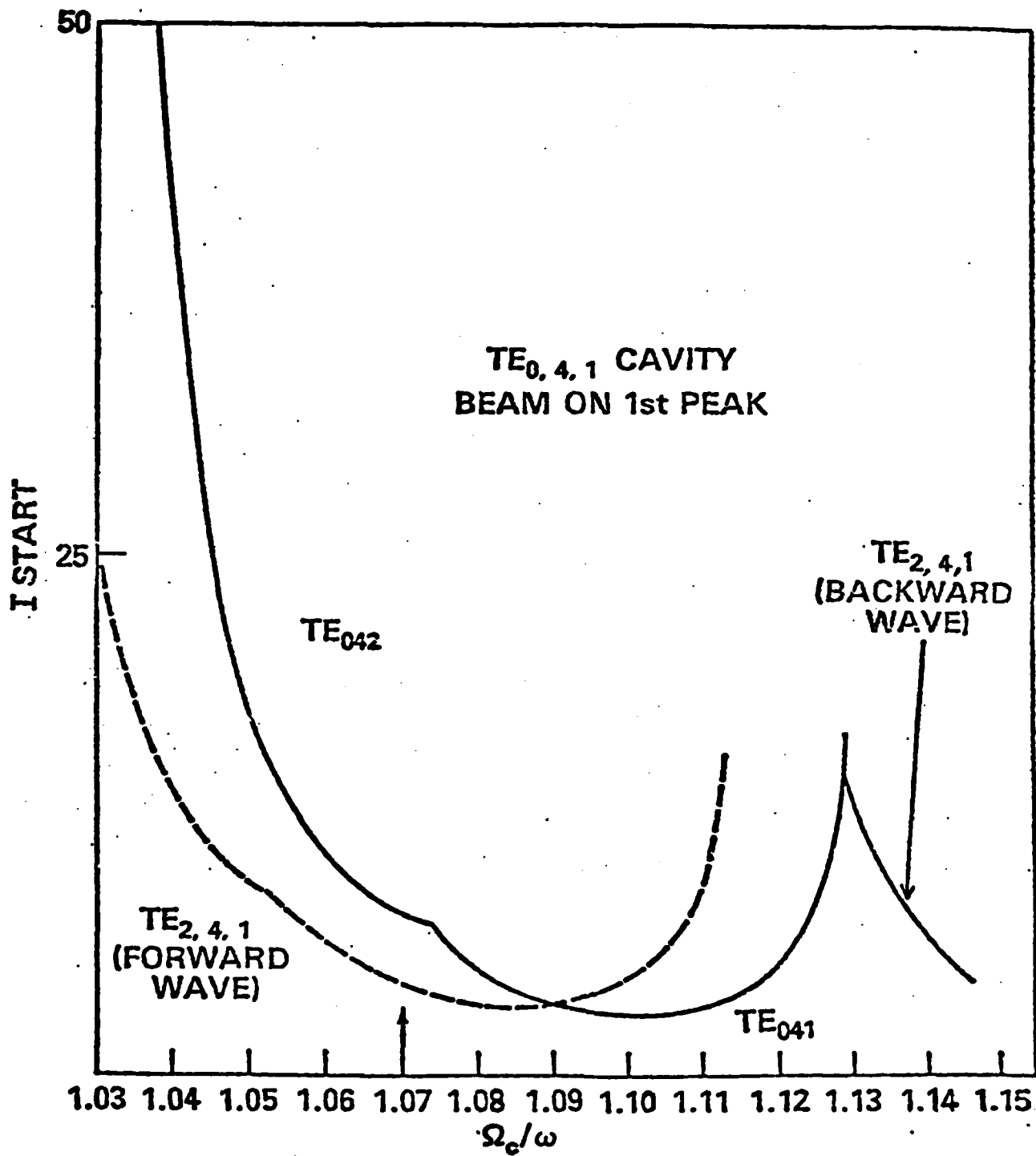

Figure 7. The similar behavior of TE_{0,4,1} mode with TE_{2,4,1} mode. (The arrow indicates the operating region):

STARTING CURRENT
VS
MAGNETIC FIELD

beam at 2nd peak of J_0'
80 kV, $L/\lambda = 5$

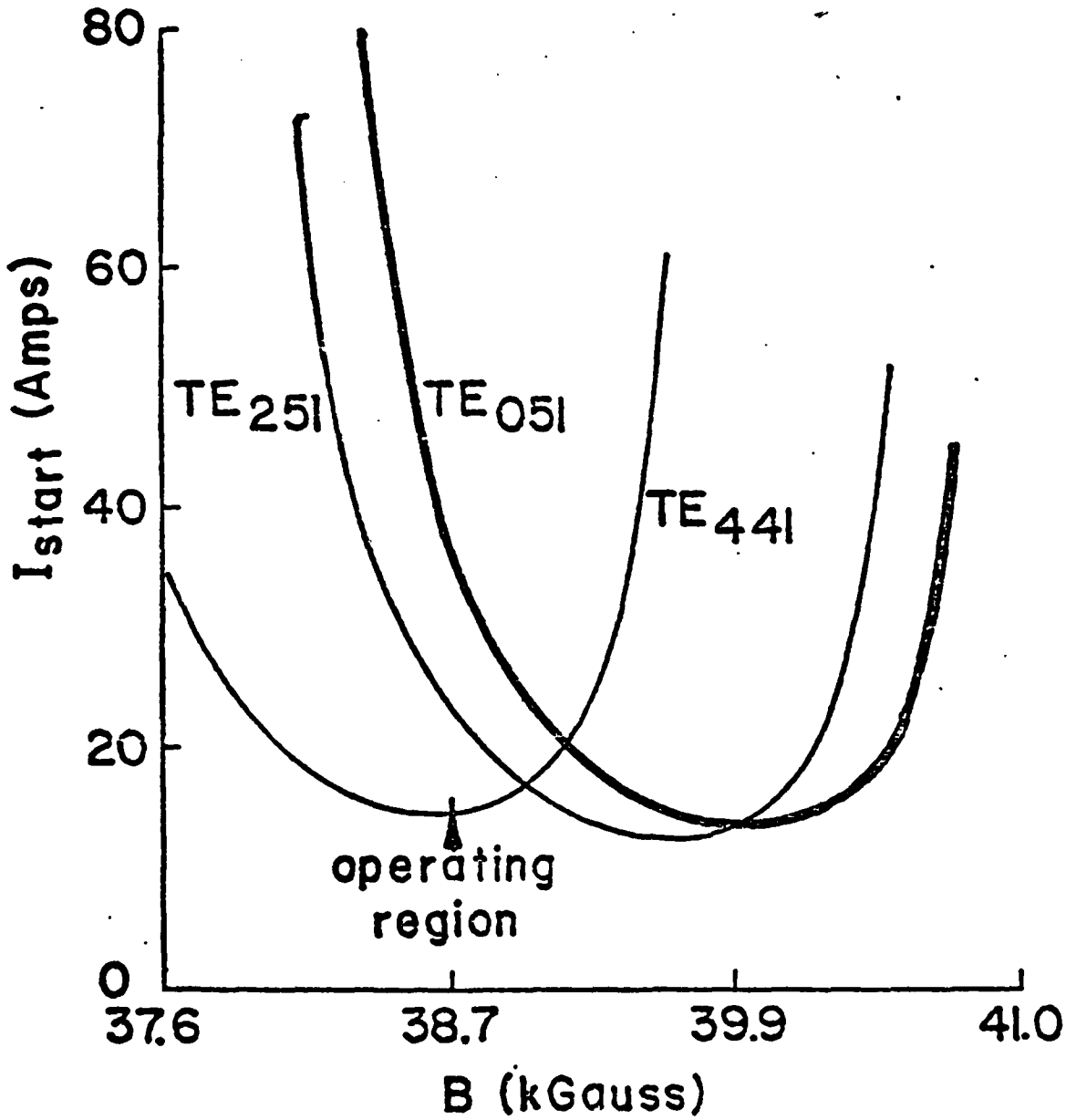

Figure 8. Starting currents of $TE_{0,5,1}$, mode and various possible competing modes.

STARTING CURRENT

vs

MAGNETIC FIELD

beam at 3rd peak of J_0'
80 kV, $L/\lambda = 5$

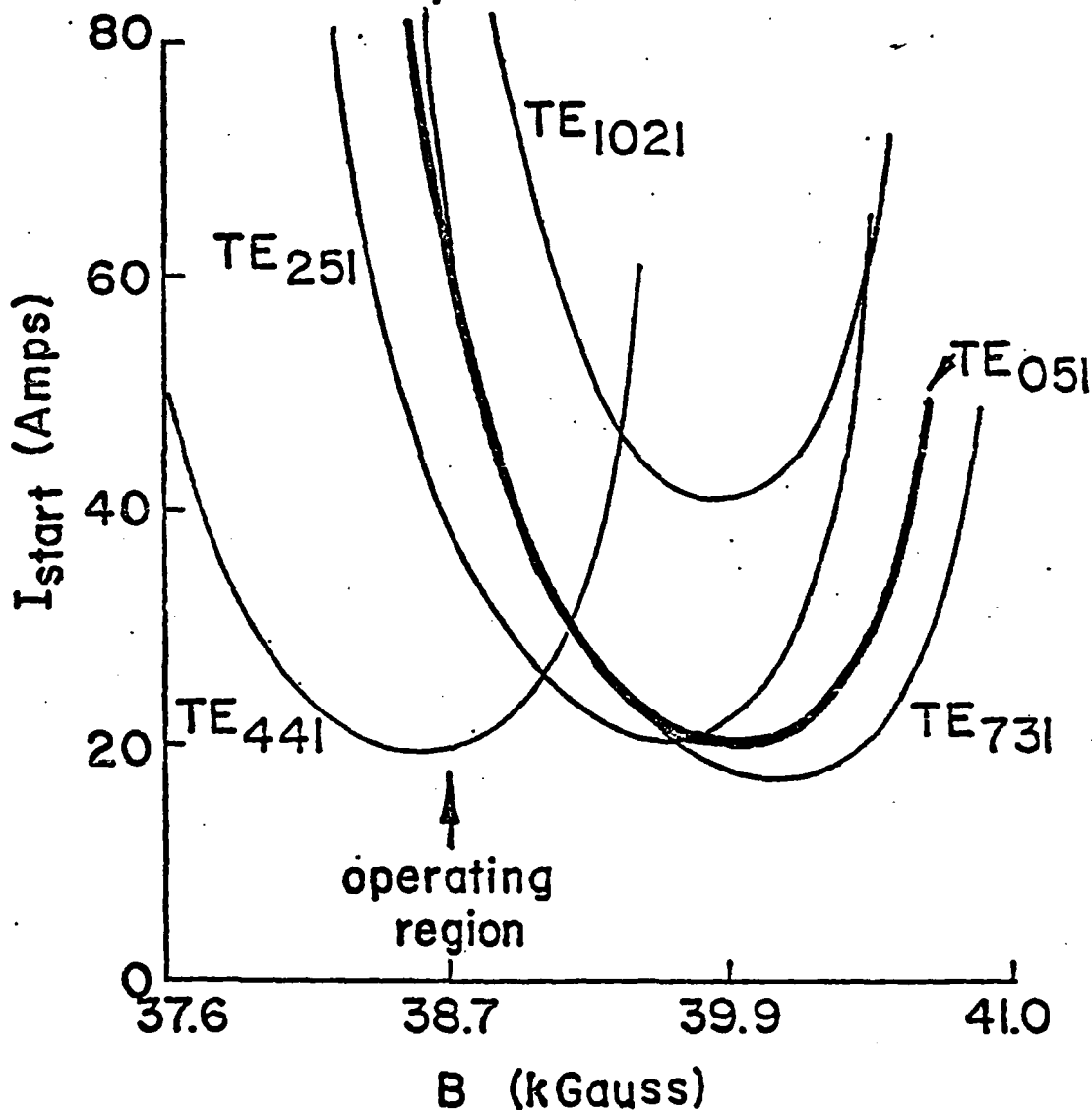

Figure 9. Starting currents of TE_{0,5,1} mode and various possible competing modes.

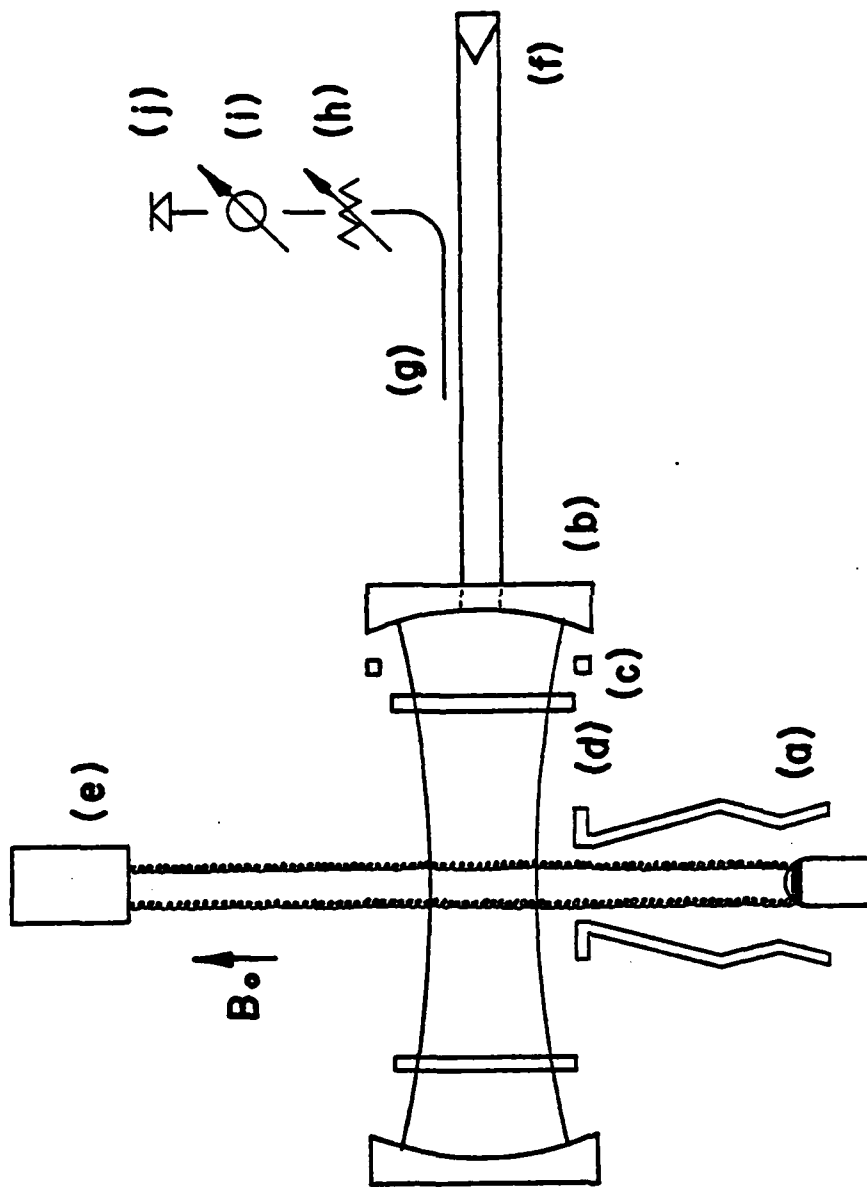

Figure 10. Quasi-optical experiment layout (a) MIC electron gun, (b) holecoupled mirror, (c) iris ring, (d) interaction cavity, (e) collector, (f) calorimeter, (g) directional coupler, (h) variable attenuator, (i) wavemeter, (j) detector.

the resonator axis. In order to obtain reasonable efficiency with the first case the beam velocity spread must be much smaller than what is available from present guns. The second case, which can tolerate beam velocity spreads over 10%, has several distinct advantages over the closed cavity type gyrotrons, specifically: (i) the separation of rf field from electron beam, (ii) high power and high frequency operation due to the large resonator size, (iii) simplicity of the transverse mode control and (iv) natural separation between the cavity and the rf output section. However, the overall geometrically averaged (different beams see different fields) interaction efficiency is somewhat lower than that of closed cavity type gyrotron. Mode competition from different longitudinal modes may be a difficulty due to the relatively long length of the cavity. Interferometric diffractive techniques may be used to suppress these unwanted modes. (15)

The electric field for optimum efficiency can be found from the following empirical relation for $\alpha = 1.5$ beam within a limited range:

$$\frac{2\pi\gamma\omega_0 f}{(\gamma-1)c} \frac{E_0}{B} = 1 \quad (6)$$

ω_0 is half the distance along the beam in which the interaction between beam and radiation takes place, E_0 is the peak electric field, $\gamma = 1/\sqrt{1-(v/c)^2}$ and B is the external magnetic field. Typically ω_0 is the minimum radius of radiation profile in a symmetric resonator. One can vary ω_0 either by adjusting the cavity length or mirror curvature, thereby optimizing E_0 and limiting diffraction losses and ohmic heating.

ELECTRON BEAM

Gun Design

First order gun design trade-offs have been carried out for temperature limited magnetron injection guns (MIGs) for a megawatt CW gyrotron. MIG-type guns have been widely used in

high power gyrotrons in both the U.S. and the Soviet Union. (1), (16)

A first order design theory based on adiabatic beam flow was utilized. The theory is valid for beam current I_0 up to about 20% of the space-charge limited Langmuir current I_L . Above this level, the theory progressively becomes less valid and a much more complicated approach using computer-aided synthesis as described by Manuilov and Tsimring⁽¹⁷⁾ is required for accurate design results. These authors describe experimental high power gyrotron MIGs operating up to $I_0 = 0.5 I_L$. Although in principle it appears that the space-charge limit $I_0 = I_L$ can be reached while still maintaining uniformly oscillating beams, no known work has been done in this current regime for gyrotron applications.

Using the first order design trade-off theory (with I_0 slightly exceeding 20% of I_L in some cases), we have found several alternative gun designs which provide suitable beam geometries and a minimum of 3 MW beam power (approximately 35% electronic efficiency is assumed). The design parameters for three selected MIGs are listed in Table 1 and the design geometry is shown in Figure 11. The first two designs are sized to operate at the second radial peak of the rf field in the TE_{05} cavity and the third design to operate at the fifth peak next to the outside wall of the cavity. In all three designs, the final beams have an annular thickness which keeps the beam within 10% of the peak rf field and the final velocity ratio v_{\perp}/v_z is 1.5 in a magnetic field of 3.98 T. In the beam formation region, the cathode current density is limited to $10A/cm^2$ and the peak cathode field to 80 kV/cm. In all cases, the cathode cone angle is 30° which will produce a laminar flow beam.

The difference between the first and the second designs shown in Table 1 is primarily operating voltage. At 80 kV, the beam current is 30% of the Langmuir limit while at 100 kV, this is reduced to 20%. Velocity spread due to space-charge effects in the beam will be easier to control in the higher voltage gun. Detailed computer simulations of these guns and beam

TABLE 1

Preliminary Parameters for the Three Alternative Guns for the
One Megawatt, TE₀₅ Mode Gyrotron

Radial RF peak no. [beam position in cavity]	2	2	5
Average beam radius, b_0 (mm) [hollow beam]	2.57	2.57	7.15
Cathode voltage, V_c (kV) [beam voltage]	-80	-100	-80
First anode voltage, V_a (kV)	-44.5	-50.6	-31.8
Percent of current limit, I_0/I_L (%)	30	20	20
Cathode radius, r_c (mm)	12.7	12.0	32.7
Cathode slant length, ℓ_s (mm)	4.6	4.0	1.83
Cathode/anode spacing, d (mm)	8.2	8.8	7.56
Cathode magnetic field, B_c (Gauss)	1614	1867	1908
Magnetic field compression ratio, B_0/B_c	24.7	21.3	20.9

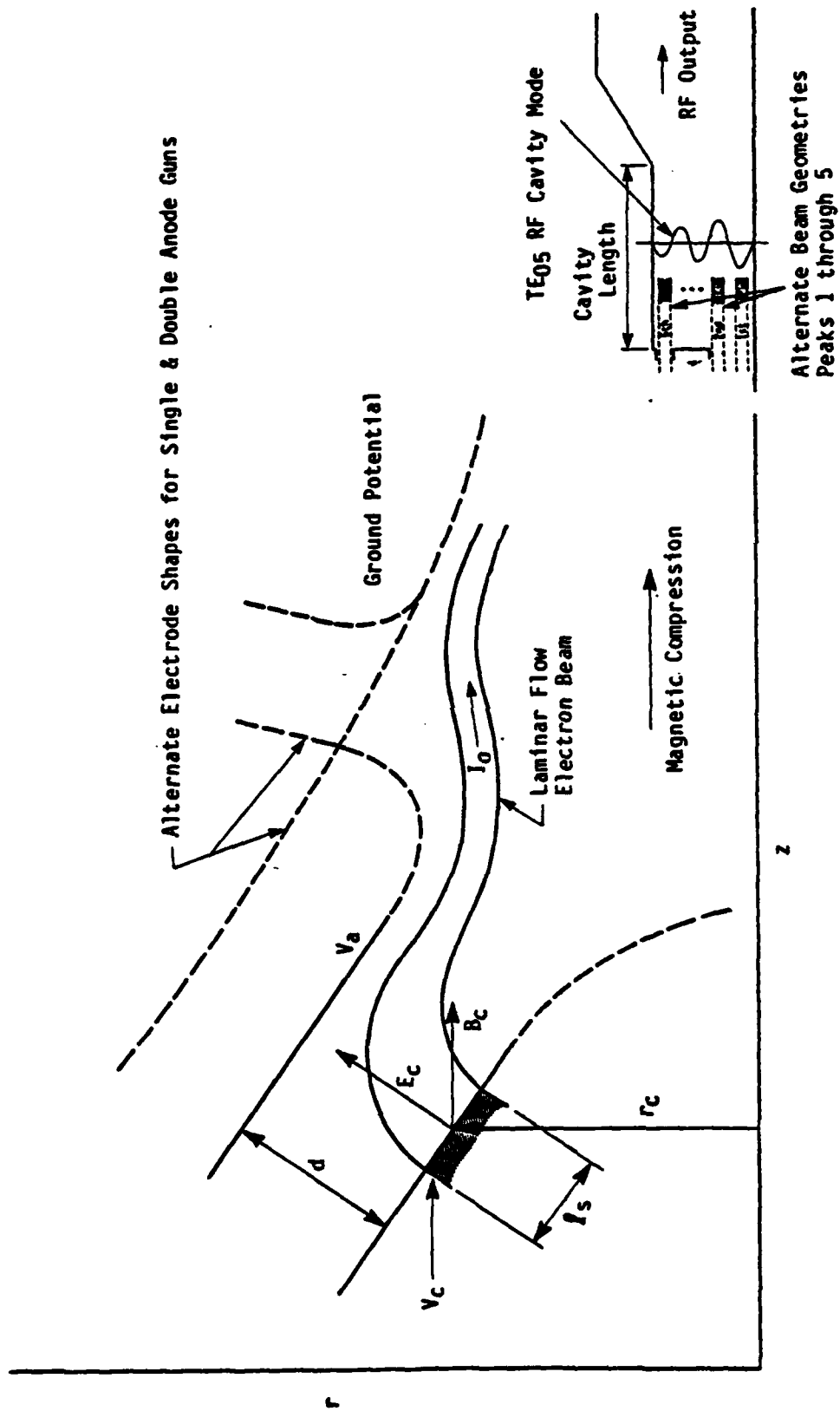

Figure 11. Design geometry and parameters for MIG type gun.

optimization studies are required to determine if the higher voltage design is required to keep longitudinal velocity spread below the 15-20% limit required for high rf efficiency.

The third gun design shown in Table 1 provides a beam geometry which coincides with the fifth radial field peak of the TE₀₅ cavity mode. This beam geometry permits a larger cathode radius to be used (at the same magnetic compression ratio) and therefore helps reduce current density and space-charge problems in the gun. The maximum power from the gun as a function of voltage with the listed parameters is shown in Figure 12.

At the present time, using the first order MIG design theory, it is not possible to predict with any assurance that a 3 MW hollow beam gyrotron gun can be designed to interact with the first radial peak of the rf cavity mode (see Figure 14). This is the most desirable beam size because it allows the electron beam to enter the rf cavity through a cut-off waveguide drift tube which essentially eliminates the problems of rf power getting back into the gun. It is believed that gun designs in which the beam current approaches the Langmuir limit will open up the possibility for attaining such a design because larger cathode radii and higher magnetic compression ratios can be used. Research and development of such designs must await the implementation of computer-aided synthesis design tools.

Electron Beam Transport

The electron beam in the waveguide is decelerated due to the self electric potential depression. Thus, there is a limiting (maximum) current that can be transported for a given configuration and applied voltage.⁽¹⁸⁾ If the beam current exceeds the limiting current, part of the beam will start to oscillate. The limiting current is given by the following formulas for a circular cylindrical waveguide (MKS units):

$$|I|_{\text{limit}} = \left\{ (v_o^* / v_{L*})^{2/3} - 1 \right\}^{3/2} / g^* \quad (7)$$

$$\text{where } v_o^* = 1.954 \times 10^{-6} |v_o| + 1$$

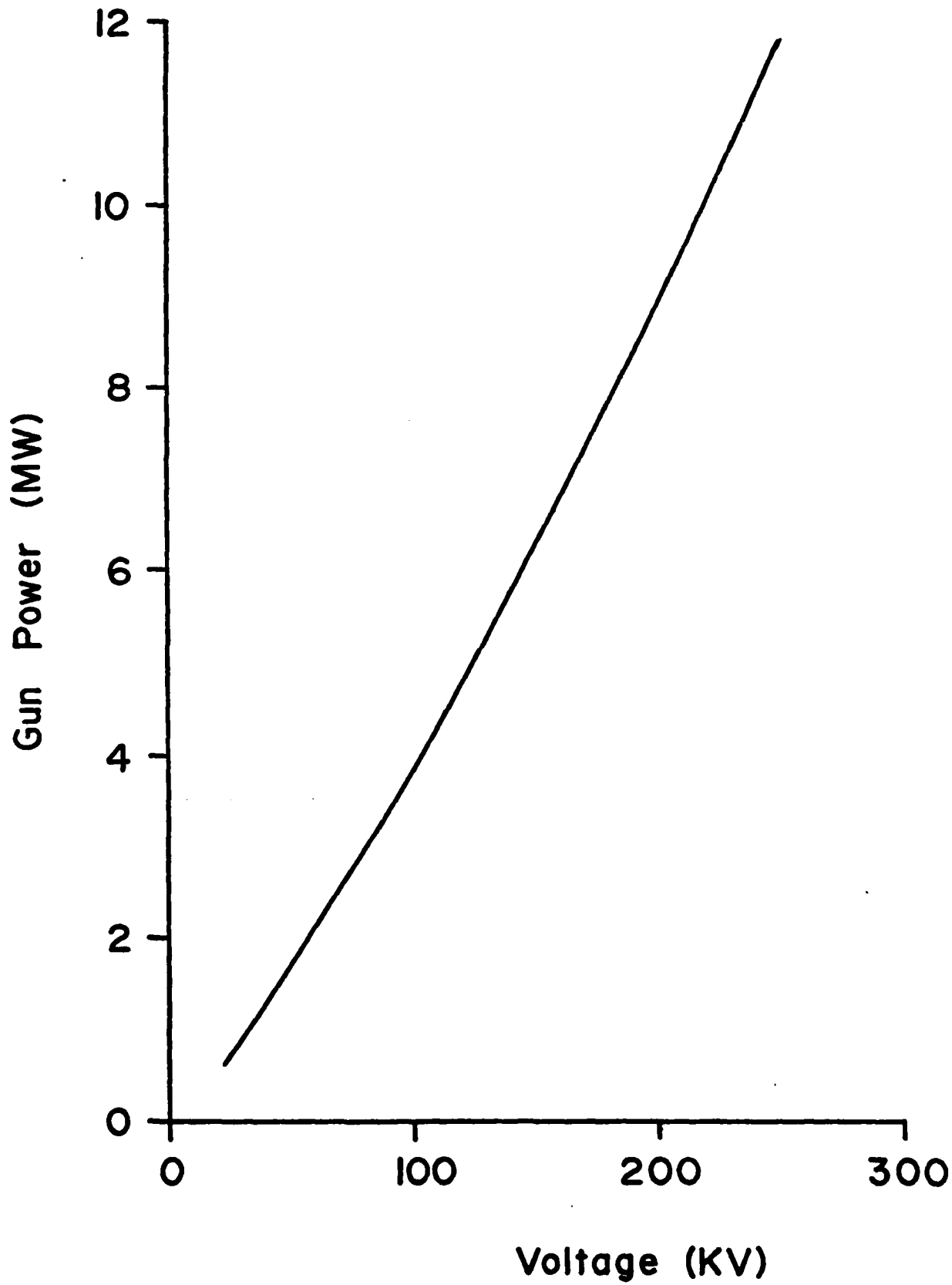

Figure 12. Maximum gun power as a function of voltage, with $I_0/I_L = 30\%$, cathode emission density $10A/Cm^2$, beam radius in cavity 2.6 mm (second peak of $TE_{0,5}$) and $\Delta E_{peak}/E_{peak} = 10\%$ spread.

TE₀₅₁ Cavity with $\alpha=1.5$

- limiting e-beam power
- - rf output power with optimum efficiency

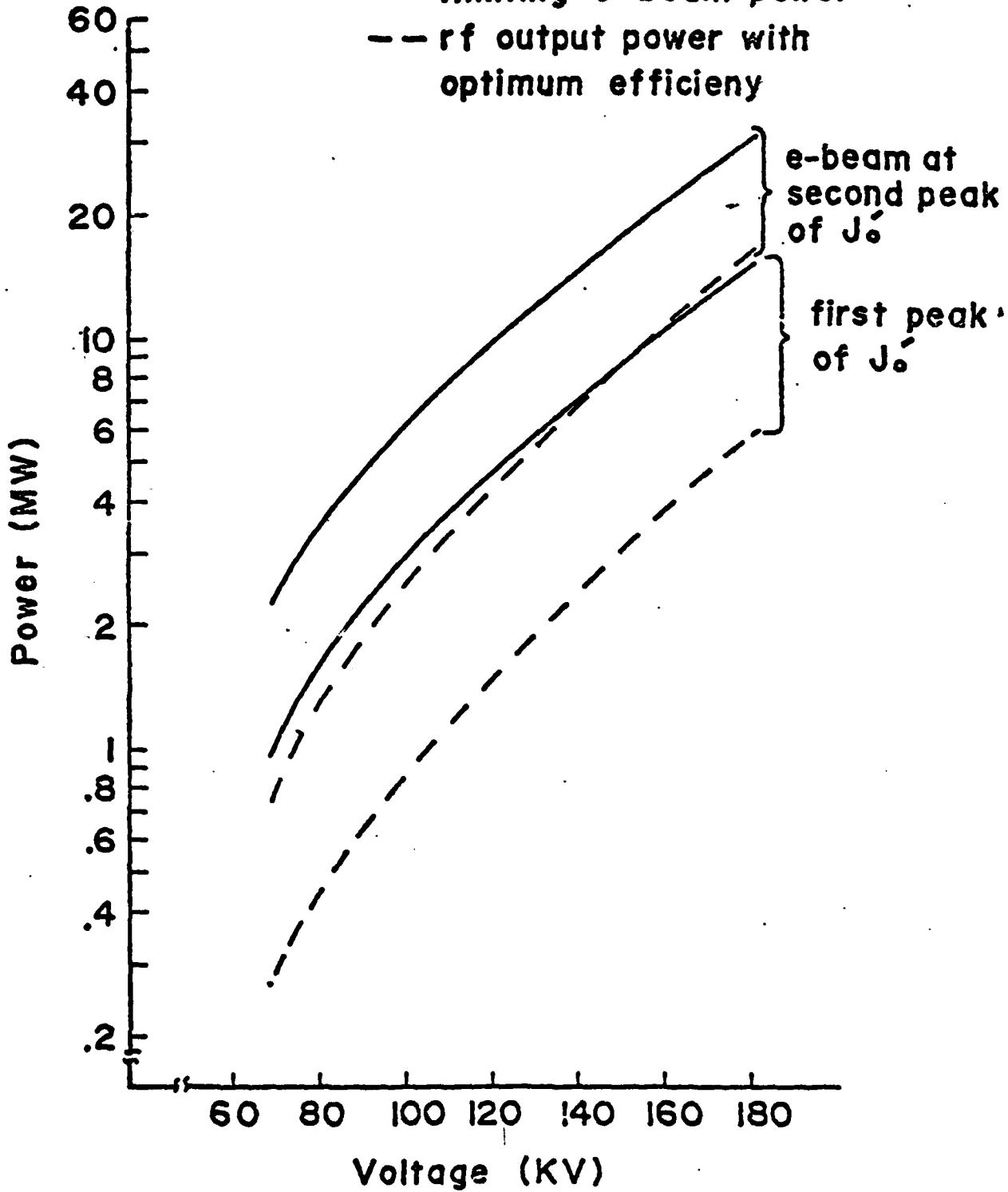

Figure 13. Limiting e-beam power and rf output power as a function of voltage.

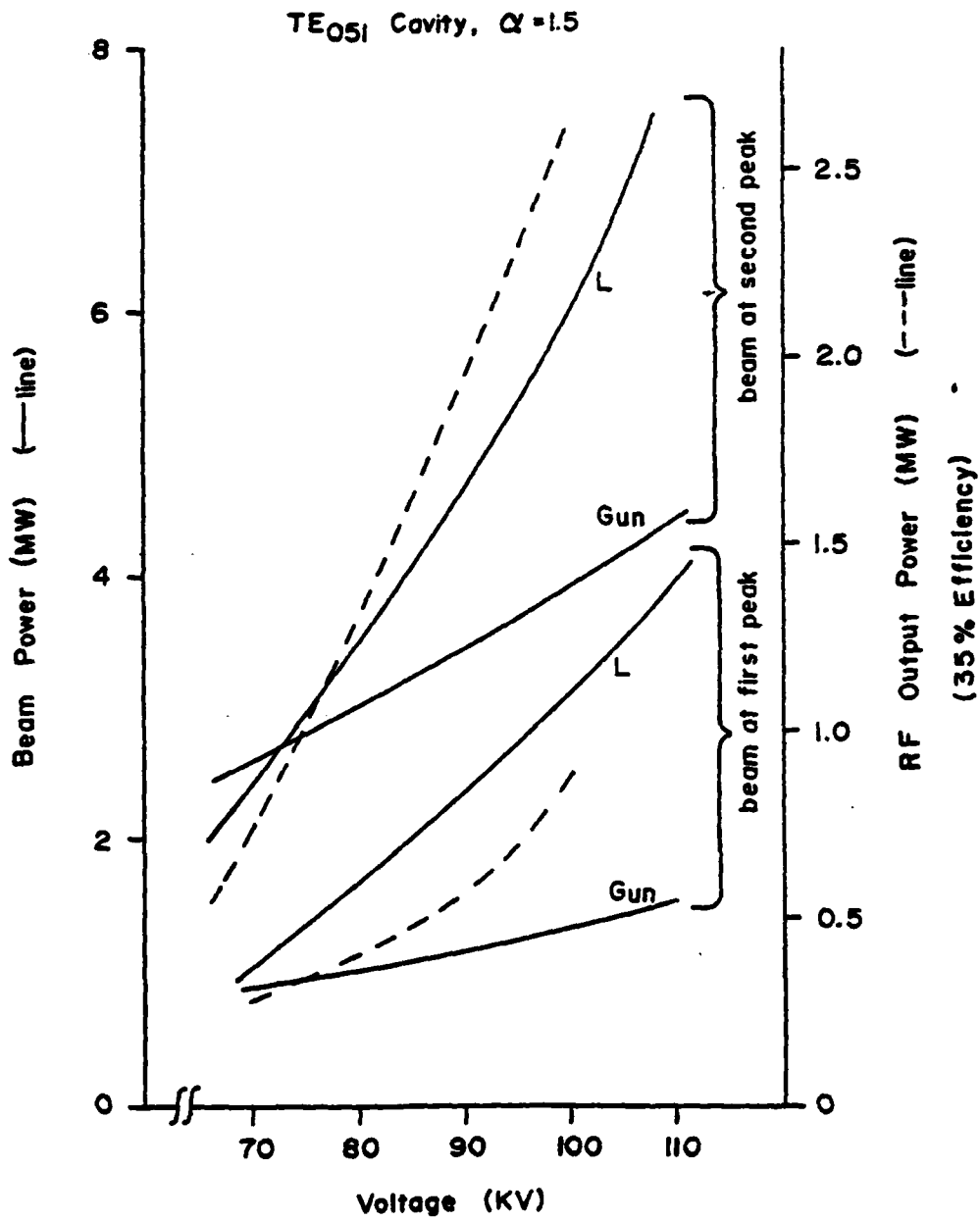

Figure 14. Limiting beam power, gun power (parameters same as in Figure 12) and rf output power as function of voltage.

$$g^* = \frac{60}{R_b} \times 1.954 \times 10^{-6} \times \{g(R_b + \Delta/2) + R_b \ln (a/(R_b + \Delta/2))\}$$

$$g(R_b + \Delta/2) = \int_{R_b - \Delta/2}^{R_b + \Delta/2} dR \left\{ \frac{R_b}{R} - \frac{I (<R)}{I_{total}} \right\}$$

$$\gamma_{\perp} = 1 / \sqrt{1 - (v_{\perp}/c)^2}, \quad a = \text{waveguide radius}$$

R_b = beam mean radius, Δ = beam thickness,

V_0 = applied voltage

From the above equations, it can be seen that the limiting current increases with increasing beam voltage, decreasing α , or increasing ratio of the beam to wall radii.

III. EXAMPLES OF DESIGN

Using the above considerations five designs have been produced. Design parameters for a 1 MW gyrotron which incorporates an electron beam limiting power over 1MW/efficiency, high efficiency (this determines E_0 and L/λ), averaged ohmic heating less than 1 KW/cm² and stable operation from competing modes.

WHISPERING GALLERY MODES

As noted above, the whispering gallery modes look attractive from the standpoint of mode competition and, since the beam position is close to the cavity wall and therefore relatively large in radius, beam generation and propagation. The ohmic heating that is expected (3.5 KW/cm²) is above that desired (1KW/cm²), a factor which considerably lessens the desirability of the concept. However, the trade off of extensive engineering on the cooling problem may have to be made if problems are encountered in other schemes. Gun design parameters are similar to the Case 3 in Table 1.

The design parameters for a gyrotron using a whispering gallery mode are given as Case 1 in Table 4.

TE_{on} MODES

Tables 2 and 3 are provided to search for 1MW gyrotron design parameters. From Tables 2 and 3 it can be seen that, in order to achieve a value for the average ohmic heating of less than $1\text{KW}/\text{cm}^2$, it is necessary to use a mode with n larger than 4. Tables 2 and 3 have design parameters for the TE₀₄, TE₀₅ and TE₀₆ modes for two beam voltages and two beam positions. From Table 3, it becomes clear that for $\alpha = 2$, the ratio of the critical (or maximum) beam power to the output power is less than the value of $1/\text{efficiency}$ required. The lower value of α must then be used. With $\alpha = 1.5$ (see Table 2) the TE₀₅ mode appears acceptable from the viewpoint of critical beam power and ohmic heating.

A graphical display of the wave power (again, for $L/\lambda = 5$) and the maximum beam powers due to space charge limits on the propagation and due to limitations on generation is given in Figures 13 and 14. In these figures the required beam power is assumed to be the output power/0.35, where 0.35 is a fairly conservative value for the efficiency. Ignoring the beam generation problem, it can be seen that 1 MW can be achieved with the beam on the first peak with a beam voltage of approximately 100 kV, and with the beam as the second peak at 80 kV. The problem of beam generation with present design methods precludes a feasible design using the first peak. However, it is presented here since new design methods which may drastically change gun capabilities are being developed. Operation at the second peak looks feasible, considering the above criteria. However, in this case the drift section between the gun and cavity will be so large as to propagate the TE₀₁ mode. The natural mode conversions into this mode will therefore be a source of power that can propagate to the gun, which is undesirable, particularly in CW operation. Therefore, a method of reflecting or absorbing this radiation will be necessary.

TABLE 2

V	E-beam	TE 011		TE 041		TE 061		TE 061		L/λ				
70	first peak	3.6	.06	24	1.1	.21	2	1	.27	1.2	.8	.31	1	6
	second peak	/		2.9	.6	2	2.3	.76	1.2	2	.83	1		
100	first peak			9.5	.2	20	3	.7	1.6	3.1	.9	1	2.2	1.1
	second peak	/		8	2	1.6	6.4	2.6	1	5.5	3	.8		

$\alpha = 1.5$
100 GHz

L/λ at optimum efficiency

E-beam limiting power (first column in MW), output rf power at optimum efficiency (second column in MW) and averaged ohmic heating (third column in kW/cm²/MW output) for various cases.

TABLE 3

V	E-beam	TE 011		TE 041		TE 051		TE 061		L/λ				
70	first peak	2.1	.09	20	.7	.32	1.8	.6	.4	1	.6	.5	.8	5
	of J ₀ '													
KV	second peak				1.7	.9	1.8	1.4	1.1	1	1.2	1.3	.8	
100	first peak	5.5	.36	16	1.7	1.3	1.2	2	1.6	.8	1.3	1.9	.6	4
KV	second peak				4.4	3.7	1.2	4	4.5	.8	3	5.4	.6	

α = 2.0

100 GHz

L/λ at optimum efficiency

TABLE 4

SUMMARY OF EXAMPLES
(1MW @ 100 GHz Output)

Case	1	2	3	4*
Efficiency (%)	45	35	35	30
Mode	TE _{20,1,1}	TE _{0,5,1}	TE _{0,5,1}	TEM ₀₀
Beam Voltage (KV)	70	110	80	90
Beam Current (A)	32	26	36	32
Alpha (α)	2	1.5	1.5	1.5
Beam Position (peak No.)	1	1	2	---
Ohmic Heating (KW/cm ²)	3.2	1.0	1.0	0.4

*Resonator length \approx 58 cm, mirror diameter = 10 cm and mirror radius of curvature = 60 cm, beam radius = 0.33 cm.

With the above caveat two design cases for a TE_{on} cavity are given as Cases 2 and 3 in Table 4. We note that the gun for Case 3 is the first design from Table 1.

MULTI-CAVITY GYROTRON

A third design, a two cavity gyrotron (see Figure 15), is under study to overcome the above difficulties while reducing the possibility of mode competition. In this scheme, the coaxial TE_{01} cavity pre-bunches the beam, as a result the starting current of the TE_{051} mode in the second cavity is reduced substantially and becomes lower than that of any azimuthally non-symmetric mode. Thus the beam could be placed on the third (or higher) radial peak of the field in the output cavity, substantially reducing the beam propagation and generation problems. The power density in the coaxial cavity is expected to be low and no difficulty in cooling the inner wall is expected. This scheme has the additional advantage that, with proper prebunching, the interaction efficiency for a beam with a small velocity spread can be enhanced by more than 10%. However, in order to insure optimum coupling and a correct phase relationship between the two cavity modes an external coupling structure may be necessary.⁽¹⁹⁾ Other embodiments of this concept are currently under investigation.

Design parameters of this type of device are not well defined, but might be expected to be similar to those of Case 3.

QUASI-OPTICAL CAVITY

A fifth design, as shown in Figure 10, is based on the quasi-optical resonator structure. Typically E_0 for optimum efficiency is very large, which demands a total Q of the cavity to be large. The diffraction loss can be an important factor and the resonator must be designed to minimize this below a tolerable limit. The magnet must have a side access bore for the resonator as well as a main bore for the beam to propagate.

By estimating the output power as 30% (typical efficiency) of the power from the gun (figure 12) the output power expected and the output coupling percentage necessary are plotted as a

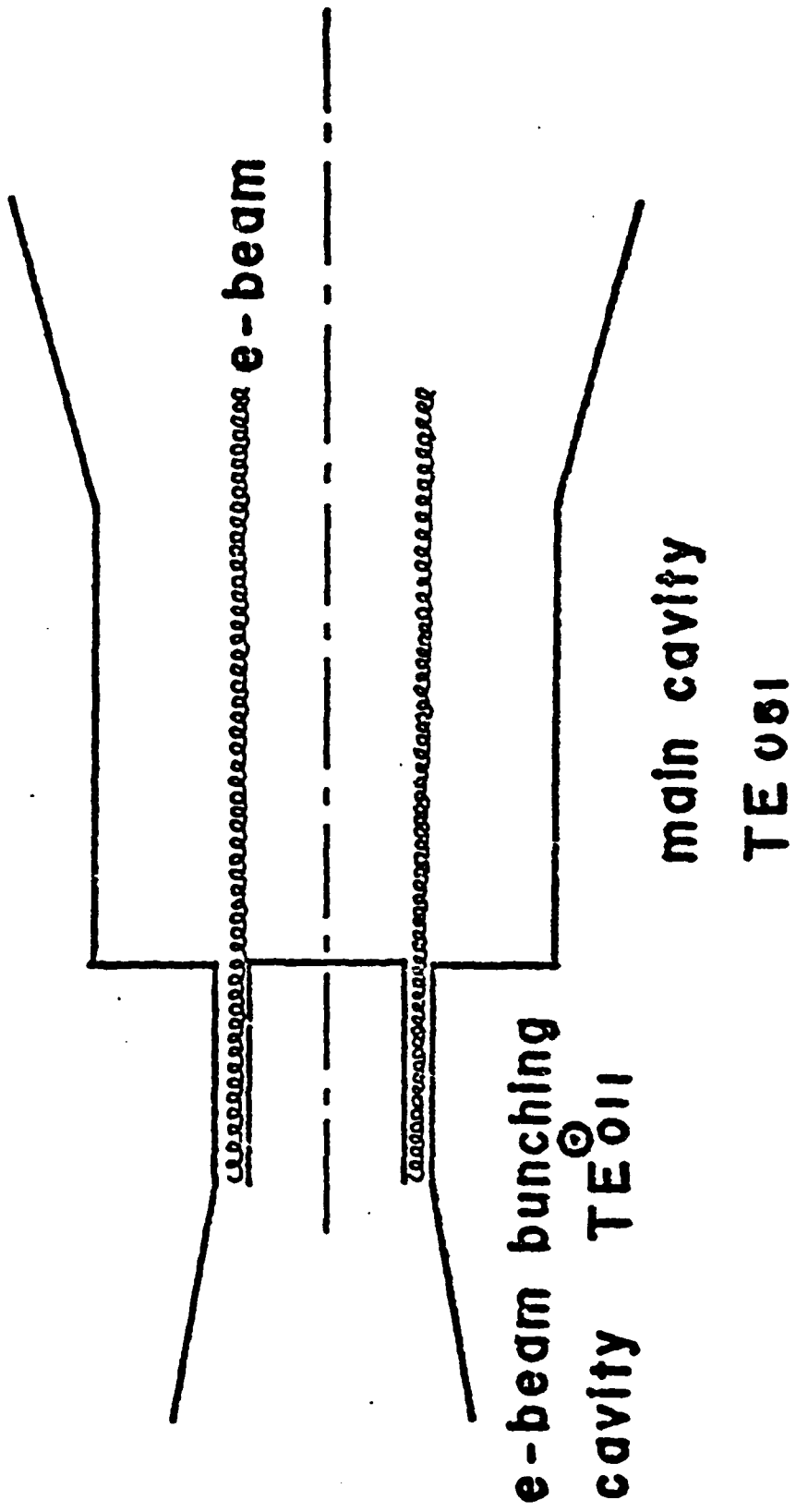

Figure 15. Two cavity gyrotron oscillator. Coaxial cavity is used for the e-beam prebunching.

function of voltage in Figure 16. The design parameters for one megawatt output are given below as Case 4 in Table 4.

It should be noted that P. Sprangle et al.⁽³⁾ reported the increase of the efficiency by more than 10% with linearly tapered magnetic field.

IV. DISCUSSION AND CONCLUSION

We have presented several designs for a 1 Megawatt, 100 GHz oscillator. All of them are potentially feasible, but each requires effort on at least one element in order that it becomes realizable. The difficulties involved in each scheme are summarized in Table 5. At this point, it is certainly risky, if not impossible, to identify any one of those options as being the most promising. We note that those options which have no "severe" problems identified are the least well understood. Improvements in gun design methods or cavity designs or the advent of new concepts could radically change the scenario presented in Table 4. Finally, elements of a complete device not discussed here, such as the output waveguide, windows, and mode transducers could substantially change the weightings given.

It is clear, then, that substantial research is required before an "optimum" design can be determined. Fortunately, present programs at the authors' and other institutions are or will be addressing many of the problems, and a good assessment of the feasibility of a 1MW, 100 GHz gyrotron should be available in the next few years.

ACKNOWLEDGEMENTS

The authors acknowledge the helpful suggestions from B. Arfin and M. Loring.

This work was supported in part by the Department of Energy under agreement #DE-AI01-80ER52065.

Optimum Output Power (MW) (—line)

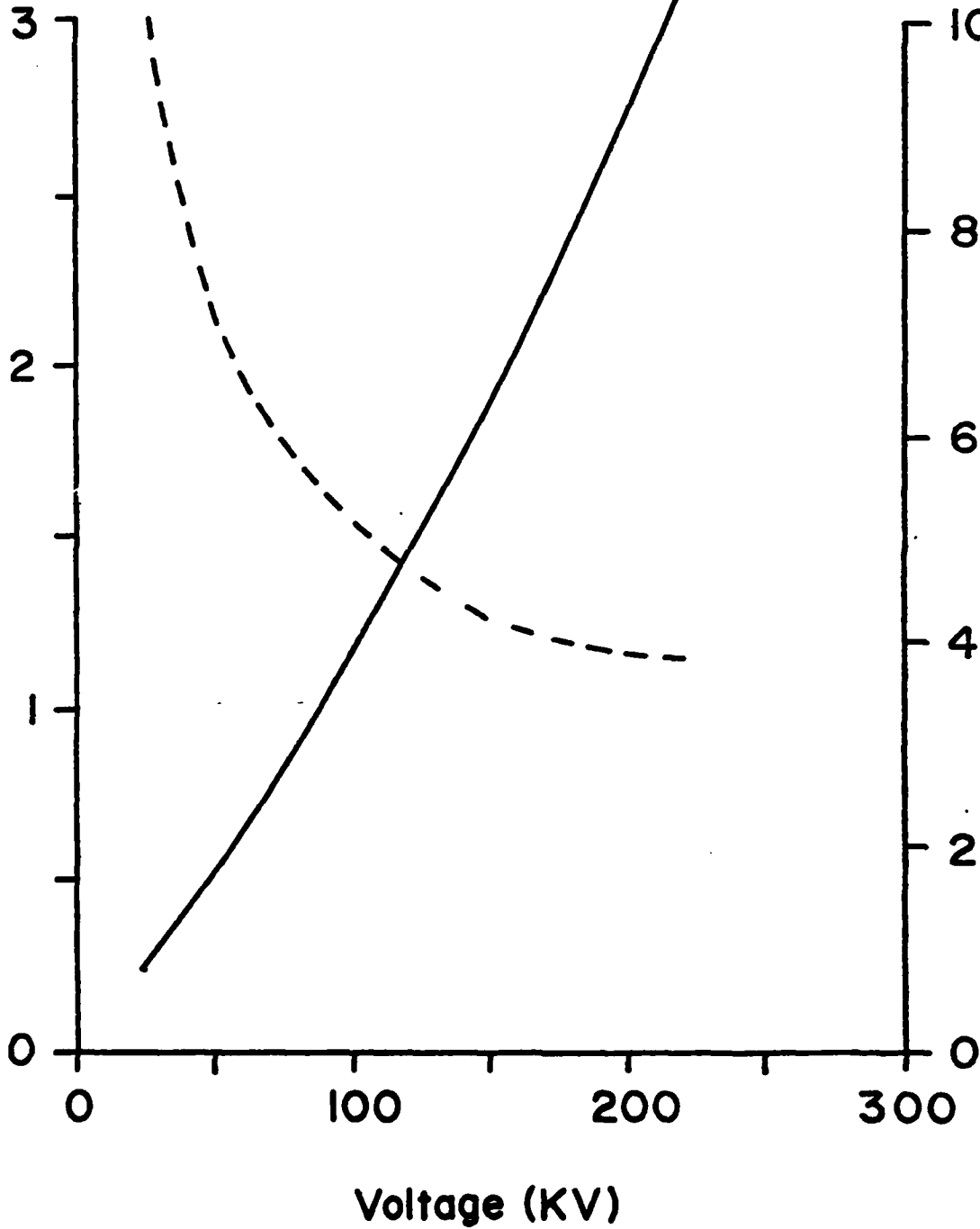

Output Coupling Percentage (%) (---line)

Figure 16. The output power and the necessary output coupling percentage as a function of voltage. The output power is estimated from Figure 11 assuming 30% geometrically averaged interaction efficiency.

TABLE 5

Degree of Difficulty and/or Uncertainty of Elements of
the Cases of Table 4

Case	1	2	3	4
Mode Competition	Slight	Moderate	Moderate/ Difficult	Moderate
Ohmic Heating (Cooling)	Severe	Moderate	Moderate	Slight
Beam Generation	Moderate	Severe	Moderate	Moderate
Other Difficulties	Beam close to wall	-----	RF leakage to gun	Mechanism not demon- strated

REFERENCES

- (1) H. Jory et al, "200 kW Pulsed and CW Gyrotrons at 28 GHz," IEDM Technical Digest #12.1 pp. 304 - 307, (1980), Washington DC.
- (2) A.V. Gaponov et al, "Some Perspectives on Powerful Gyrotrons," International Journal of Infrared and Near Millimeter Waves, 1, No.3, pp. 351-372, (1980)
- (3) P. Sprangle, W. Manheimer, and J.L. Vomvoridis, "Classical Electron Cyclotron Quasi-Optical Maser," Appl. Phys. Lett., 38, part 5, pp. 310 - 313, (1981).
- (4) K. Kim and M. Read, NRL Memorandum Report, to be published (June 1981).
- (5) M. Read et al, "Power Limits in Cylindrical Gyromonotrons," International Journal on Infrared and Near Millimeter Waves, 2, No.2, pp. 159 - 174, (1981).
- K. R. Chu et al, "Methods of Efficiency Enhancement and Scaling for the Gyrotron Oscillator," IEEE MTT-28, No.4, pp. 318-325, (1980).
- (6) H. Doring and Yu Wei, "Optimization of Gyrotrons," Fifth International Conference on Infrared and Millimeter Waves, pp. 092-093, (1980), University of Wurzburg, Germany.
- (7) M. Read et al, "Experimental Enhancement of Gyrotron Efficiencies by Profiled Magnetic Fields," NRL Memorandum Report 4169, (1981).
- (8) K. Kreisher and R. Temkin, "Linear Theory of the Electron Cyclotron Maser," International Journal of Infrared and Millimeter Waves, 1, No.2, pp. 195-223, (1980).

(9) K.R. Chu, "Theory of Electron Cyclotron Maser Interaction at the Harmonic Frequencies," Phys. Fluids, 21, (12), pp. 2354-2364, (1978).

(10) R.C. Lee, J.L. Hirshfield and K.R. Chu, "Scaling and Optimization of Gyromonotron Operational Characteristics," Bull. Am. Phys. Soc., 25, No.8, 4S-12, (1980).

(11) B. Arfin and M. Read, "A Gyrotron Using an Overmoded Cavity," Bull. Am. Phys. Soc., 25, No. 8, 4S-11, (1980).

(12) K. Kreisher and R. Temkin, "Mode Excitation in a Gyrotron," Bull. Am. Phys. Soc., 25, No.8, 3S-12, (1980).

(13) G.N. Rapoport, et al, "Interaction Between Helical Electron Beams and Electromagnetic Cavity Fields," Radio Engineering and Electronic Physics, 12, No.4 pp. 587-595, (1967).

A.F. Kurin et al, "Nonlinear Theory of a Cyclotron Resonance Maser with a Fabry-Perot Resonator," Radio Physics and Quantum Electronics, 19, pp. 742-747, (1976).

(14) A.F. Kurin et al, "Nonlinear Theory of a Cyclotron Resonance Maser with a Fabry-Perot Resonator," Radiophysics and Quantum Electronics, 10, No. 8. pp. 651-654, (1967).

F.A. Korolev and A.F. Kurin, "Cyclotron Resonance Maser with a Fabry-Perot Cavity," Radio Engineering and Electronic Physics, 15, No.10, pp. 1868-1873, (1970).

(15) P.W. Smith, "Mode Selection in Lasers," Proc. IEEE 60, No. 4, pp. 422-440, (1972).

(16) J.L. Seftor et al, "An Investigation of a Magnetron Injection Gun Suitable for Use in a Cyclotron Resonance Maser," IEEE Trans, ED-26, pp. 1609-1616, (1979).

V.A. Flyagin, et al, "The Gyrotron," IEEE Trans. MTT-25, pp. 514-521, (1977).

(17) V.N. Manuilov and Sh.E. Tsimring, "Synthesis of Axially Symmetrical Systems for Shaping Helical Electron Beams," Radio Engineering and Electronic Physics, 24, pp. 111-119, (1979).

(18) A.T. Drobot and K. Kim, "Space Charge Effects on the Equilibrium of Guided Electron Flow with Gyromonotrons," to be published in Int. J. Electronics, (1980).

(19) V.S. Ergakov et al, "Two Resonator CRM Oscillator with External Feedback," Radiofizika 22, No.8, pp. 1011-1019, (1979).

DA
FILM
07-